

Missouri Demonstration  
Project: Design-Build  
Procurement Process for  
Construction on I-29/35  
(kcICON) in Kansas City, MO

Final Report  
June 2013

***HIGHWAYS FOR LIFE***

*Accelerating Innovation for the American Driving Experience.*



U.S. Department of Transportation  
**Federal Highway Administration**

## FOREWORD

The purpose of the Highways for LIFE (HfL) pilot program is to accelerate the use of innovations that improve highway safety and quality while reducing congestion caused by construction. **LIFE** is an acronym for **L**onger-lasting highway infrastructure using **I**nnovations to accomplish the **F**ast construction of **E**fficient and safe highways and bridges.

Specifically, HfL focuses on speeding up the widespread adoption of proven innovations in the highway community. “Innovations” is an inclusive term used by HfL to encompass technologies, materials, tools, equipment, procedures, specifications, methodologies, processes, and practices used to finance, design, or construct highways. HfL is based on the recognition that innovations are available that, if widely and rapidly implemented, would result in significant benefits to road users and highway agencies.

Although innovations themselves are important, HfL is as much about changing the highway community’s culture from one that considers innovation something that only adds to the workload, delays projects, raises costs, or increases risk to one that sees it as an opportunity to provide better highway transportation service. HfL is also an effort to change the way highway community decisionmakers and participants perceive their jobs and the service they provide.

The HfL pilot program, described in Safe, Accountable, Flexible, Efficient Transportation Equity Act: A Legacy for Users (SAFETEA-LU) Section 1502, includes funding for demonstration construction projects. By providing incentives for projects, HfL promotes improvements in safety, construction-related congestion, and quality that can be achieved through the use of performance goals and innovations. This report documents one such HfL demonstration project.

Additional information on the HfL program is at [www.fhwa.dot.gov/hfl](http://www.fhwa.dot.gov/hfl).

## NOTICE

This document is disseminated under the sponsorship of the U.S. Department of Transportation in the interest of information exchange. The U.S. Government assumes no liability for its contents or use thereof. This report does not constitute a standard, specification, or regulation.

The U.S. Government does not endorse products or manufacturers. Trade and manufacturers’ names appear in this report only because they are considered essential to the object of the document.

1. Report No.	2. Government Accession No	3. Recipient's Catalog No	
3. Title and Subtitle Missouri Demonstration Project: Design-Build Procurement Process for Construction on I-29/35 (kcICON) in Kansas City, MO		5. Report Date June 2013	
		6. Performing Organization Code	
7. Authors Shreenath Rao, Ph.D., P.E., Paul Littleton, P.E., Jagannath Mallela		8. Performing Organization Report No.	
9. Performing Organization Name and Address Applied Research Associates, Inc. 100 Trade Centre Drive, Suite 200 Champaign, IL 61820		10. Work Unit No. (TRAIS) C6B	
		11. Contract or Grant No.	
12. Sponsoring Agency Name and Address Office of Infrastructure Federal Highway Administration 1200 New Jersey Avenue, SE Washington, DC 20590		12. Type of Report and Period Covered Final Report	
		14. Sponsoring Agency Code	
15. Supplementary Notes Contracting Officers Technical Representatives: Byron Lord, Mary Huie			
16. Abstract As part of a national initiative sponsored by the Federal Highway Administration under the Highways for LIFE (HfL) program, the Missouri Department of Transportation (MoDOT) was awarded a \$1 million grant to demonstrate the use of innovative technologies for the design-build procurement process. This report documents the contracting method used to encourage contractor innovation and promote fast construction of several bridges, ramps, sound walls, and pavement sections on a 4-mile portion of Interstate 29/35, a six-lane interstate highway in North Kansas City, MO and Kansas City, MO. This project included the construction of the landmark Christopher S. Bond bridge across the Missouri River.  This report includes contracting details of the construction project with specifics on steps MoDOT and the contractor took to make timely decisions, minimize project delays, improve safety, and reduce costs, including details on the quality management program, additional applicable standards, and equal or better change proposals. The report also describes the project construction, including safety improvements and steps MoDOT and the contractor took to engage stakeholders. Details of the experiences of MoDOT and the contractor are also included.  MoDOT's overall conclusion was that the project was successful and the agency would use design-build at fixed-cost contracting on future projects when appropriate. Construction costs for the I-29/35 kcICON project would have likely placed traditional delivery and construction methods (baseline) at \$23.3 million (low estimate) to \$50.5 million (high estimate) more than the as-built case (\$232 million). Moreover, delivering the project in only 2.75 years (compared to 8-plus years for traditional methods) saved highway users an estimated \$11.4 million in delay costs and \$27.5 million in safety costs. Therefore, the estimated total savings from using the innovative HfL project delivery approach range from \$62.1 million to \$89.4 million. In other words, the innovative approach to this \$232 million corridor improvement project had a 27 to 39 percent cost benefit over traditional methods. Highway users also benefited from the increased capacity 5-plus years earlier than if traditional methods were used.			
17. Key Words Design-build, procurement, economic analysis, innovative contracting, Highways for LIFE, kcICON, quality management program		18. Distribution Statement No restriction. This document is available to the public through the Highways for Life website: <a href="http://www.fhwa.dot.gov/hfl/">http://www.fhwa.dot.gov/hfl/</a>	
Security Classif.(of this report) Unclassified	19. Security Classif. (of this page) Unclassified	20. No. of Pages 94	21. Price

**SI\* (MODERN METRIC) CONVERSION FACTORS**

**APPROXIMATE CONVERSIONS TO SI UNITS**

Symbol	When You Know	Multiply By	To Find	Symbol
<b>LENGTH</b>				
(none)	mil	25.4	micrometers	µm
in	inches	25.4	millimeters	mm
ft	feet	0.305	meters	m
yd	yards	0.914	meters	m
mi	miles	1.61	kilometers	km
<b>AREA</b>				
in <sup>2</sup>	square inches	645.2	square millimeters	mm <sup>2</sup>
ft <sup>2</sup>	square feet	0.093	square meters	m <sup>2</sup>
yd <sup>2</sup>	square yards	0.836	square meters	m <sup>2</sup>
ac	acres	0.405	hectares	ha
mi <sup>2</sup>	square miles	2.59	square kilometers	km <sup>2</sup>
<b>VOLUME</b>				
fl oz	fluid ounces	29.57	milliliters	mL
gal	gallons	3.785	liters	L
ft <sup>3</sup>	cubic feet	0.028	cubic meters	m <sup>3</sup>
yd <sup>3</sup>	cubic yards	0.765	cubic meters	m <sup>3</sup>
NOTE: volumes greater than 1000 L shall be shown in m <sup>3</sup>				
<b>MASS</b>				
oz	ounces	28.35	grams	g
lb	pounds	0.454	kilograms	kg
T	short tons (2000 lb)	0.907	megagrams (or "metric ton")	Mg (or "t")
<b>TEMPERATURE (exact degrees)</b>				
°F	Fahrenheit	5 (F-32)/9 or (F-32)/1.8	Celsius	°C
<b>ILLUMINATION</b>				
fc	foot-candles	10.76	lux	lx
fl	foot-Lamberts	3.426	candela per square meter	cd/m <sup>2</sup>
<b>FORCE and PRESSURE or STRESS</b>				
lbf	poundforce	4.45	Newtons	N
lbf/in <sup>2</sup> (psi)	poundforce per square inch	6.89	kiloPascals	kPa
k/in <sup>2</sup> (ksi)	kips per square inch	6.89	megaPascals	MPa
<b>DENSITY</b>				
lb/ft <sup>3</sup> (pcf)	pounds per cubic foot	16.02	kilograms per cubic meter	kg/m <sup>3</sup>

**APPROXIMATE CONVERSIONS FROM SI UNITS**

Symbol	When You Know	Multiply By	To Find	Symbol
<b>LENGTH</b>				
µm	micrometers	0.039	mil	(none)
mm	millimeters	0.039	inches	in
m	meters	3.28	feet	ft
m	meters	1.09	yards	yd
km	kilometers	0.621	miles	mi
<b>AREA</b>				
mm <sup>2</sup>	square millimeters	0.0016	square inches	in <sup>2</sup>
m <sup>2</sup>	square meters	10.764	square feet	ft <sup>2</sup>
m <sup>2</sup>	square meters	1.195	square yards	yd <sup>2</sup>
ha	hectares	2.47	acres	ac
km <sup>2</sup>	square kilometers	0.386	square miles	mi <sup>2</sup>
<b>VOLUME</b>				
mL	milliliters	0.034	fluid ounces	fl oz
L	liters	0.264	gallons	gal
m <sup>3</sup>	cubic meters	35.314	cubic feet	ft <sup>3</sup>
m <sup>3</sup>	cubic meters	1.307	cubic yards	yd <sup>3</sup>
<b>MASS</b>				
g	grams	0.035	ounces	oz
kg	kilograms	2.202	pounds	lb
Mg (or "t")	megagrams (or "metric ton")	1.103	short tons (2000 lb)	T
<b>TEMPERATURE</b>				
°C	Celsius	1.8C+32	Fahrenheit	°F
<b>ILLUMINATION</b>				
lx	lux	0.0929	foot-candles	fc
cd/m <sup>2</sup>	candela per square meter	0.2919	foot-Lamberts	fl
<b>FORCE and PRESSURE or STRESS</b>				
N	Newtons	0.225	poundforce	lbf
kPA	kiloPascals	0.145	poundforce per square inch	lbf/in <sup>2</sup> (psi)
MPa	megaPascals	0.145	kips per square inch	k/in <sup>2</sup> (ksi)

\*SI is the symbol for the International System of Units. Appropriate rounding should be made to comply with Section 4 of ASTM E380. (Revised March 2003)



## **ACKNOWLEDGMENTS**

The project team would like to acknowledge the invaluable insights and guidance of Federal Highway Administration (FHWA) Highways for LIFE Team Leader Byron Lord and Program Coordinators Mary Huie and Kathleen Bergeron, who served as the technical panel on this demonstration project. Their vast knowledge and experience with the various aspects of construction, technology deployment, and technology transfer helped immensely in developing both the approach and the technical matter for this document. The team is also indebted to Missouri Department of Transportation Engineer James Shipley, the Highways for LIFE point of contact for this project, for providing photographs and other project details.

# CONTENTS

<b>INTRODUCTION .....</b>	<b>1</b>
HIGHWAYS FOR LIFE DEMONSTRATION PROJECTS .....	1
<i>Project Solicitation, Evaluation, and Selection</i> .....	1
<i>HfL Project Performance Goals</i> .....	2
REPORT SCOPE AND ORGANIZATION .....	3
<b>PROJECT OVERVIEW AND LESSONS LEARNED .....</b>	<b>4</b>
PROJECT OVERVIEW .....	4
DATA COLLECTION.....	5
ECONOMIC ANALYSIS.....	6
LESSONS LEARNED.....	6
CONCLUSIONS .....	8
<b>PROJECT DETAILS .....</b>	<b>9</b>
BACKGROUND .....	9
PROJECT DESCRIPTION .....	15
<i>Design-Build Procurement Process and Contractor Selection</i> .....	23
<i>Project Incentives and Disincentives</i> .....	24
<i>Review of Additional Applicable Standards</i> .....	25
<i>Review of Equal or Better Change Proposals</i> .....	25
<i>Construction</i> .....	26
<i>Contractor Flexibility and Innovations</i> .....	47
<i>Public Outreach</i> .....	48
<i>Contractor Performance and Awarded Incentives/Disincentives</i> .....	52
<b>DATA ACQUISITION AND ANALYSIS.....</b>	<b>53</b>
SAFETY .....	53
<i>Work Zone and Facilities Safety</i> .....	53
<i>Worker Safety</i> .....	54
CONSTRUCTION CONGESTION.....	54
<i>Faster Construction</i> .....	55
<i>Trip Time or Queue Length During Construction</i> .....	55
QUALITY.....	57
<i>Pavement Test Site</i> .....	57
<i>Sound Intensity Testing</i> .....	57
<i>Smoothness Measurement</i> .....	59
USER SATISFACTION.....	60
<b>ECONOMIC ANALYSIS .....</b>	<b>66</b>
CONSTRUCTION TIME .....	66
DETOUR.....	66
CONSTRUCTION COSTS .....	66
USER COSTS .....	69
<i>Delay Costs</i> .....	69
<i>Safety Costs</i> .....	70
COST SUMMARY .....	71
<b>APPENDIX A.....</b>	<b>72</b>

## FIGURES

Figure 1. Project location.....	9
Figure 2. Existing and proposed typical roadway section on I-29/35.....	10
Figure 3. Existing and proposed typical cross section of I-29/35 south railroad viaduct. ....	11
Figure 4. Typical section of Armour Road under existing bridge on I-29/35. ....	12
Figure 5. New element: proposed cross section of the new Missouri River bridge to replace the existing four-lane (no shoulders) Paseo Bridge. ....	13
Figure 6. New element: proposed cross section of 16th Avenue under the new bridge. ....	13
Figure 7. Existing and proposed typical cross section of I-29/35 north railroad viaduct. ....	14
Figure 8. New element: proposed SPUI at Front Street crossing. ....	15
Figure 9. South end of project—March 2008. ....	16
Figure 10. South end of project—January 2011. ....	16
Figure 11. Front Street interchange—March 2008. ....	17
Figure 12. SPUI at Front Street—January 2011. ....	17
Figure 13. Four-lane Paseo Bridge crossing the Missouri River—March 2008.....	18
Figure 14. Six-lane Bond Bridge crossing the Missouri River—January 2011. ....	18
Figure 15. Levee Road crossing—March 2008. ....	19
Figure 16. Levee Road crossing—January 2011. ....	19
Figure 17. 16th Street exit ramp—March 2008. ....	20
Figure 18. 16th Street exit ramp—January 2011. ....	20
Figure 19. Armour Road interchange—March 2008.....	21
Figure 20. Armour Road interchange—January 2011.....	21
Figure 21. Armour Road and I-29/35—July 2008.....	22
Figure 22. Armour Road and I-29/35—January 2011.....	22
Figure 23. Beginning cofferdam work—August 2008. ....	27
Figure 24. Lowering the permanent casing into the temporary casing—August 2008. ....	27
Figure 25. Twisting the permanent casing into the riverbed—August 2008.....	28
Figure 26. Final alignment of the permanent casing—August 2008.....	28
Figure 27. Augering the drilled shafts—August 2008.....	29
Figure 28. Aerial view of the cofferdam—August 2008.....	29
Figure 29. Aligning the wagon wheel for the rebar lift—August 2008.....	30
Figure 30. Swinging the rebar to the drilled shaft sleeve—August 2008.....	30
Figure 31. Tying the hoop bars to the cage as it is lowered into the drilled shaft—August 2008....	31
Figure 32. Placing 1,450 cubic ft of concrete in one day for the cofferdam seal—October 2008....	31
Figure 33. Delivery of concrete from the deck of the Paseo Bridge—October 2008.....	32
Figure 34. Delivery of concrete from below the deck of the Paseo Bridge—October 2008.....	32
Figure 35. Pouring the concrete into the drilled shaft—October 2008.....	33
Figure 36. A dry cofferdam—October 2008.....	33
Figure 37. Cutting away the casings—October 2008. ....	34
Figure 38. Removed casings—October 2008. ....	34
Figure 39. A total of 235 mi of rebar work—November 2008.....	35
Figure 40. Rebar in place for the first concrete lift—November 2008.....	35
Figure 41. Placing concrete for second lift of downstream pylon leg—November 2008. ....	36

Figure 42. Constructing the roadway strut—March 2009. ....	36
Figure 43. Inside the knuckle of the roadway strut—March 2009. ....	37
Figure 44. Placing reinforcement in the roadway strut—April 2009. ....	37
Figure 45. A third of the way to the top in constructing pylon above the roadway strut—May 2009.....	38
Figure 46. First bridge floor beam, 133 ft long and 66,500 pounds—August 2009.....	38
Figure 47. Two cranes moving floor beam from truck to barge—August 2009. ....	39
Figure 48. Temporary falsework supports the backspan roadway girders—August 2009.....	39
Figure 49. Placing the first floor beam onto the roadway strut—August 2009.....	40
Figure 50. Closeup view of the floor beam installation—August 2009. ....	40
Figure 51. Pier table—August 2009. ....	41
Figure 52. View of pylon construction and pier table placement from the river channel—August 2009.....	41
Figure 53. River bridge deck and north view of the project—March 2010.....	42
Figure 54. Bridge deck placement—April 2010.....	42
Figure 55. Aerial view of the construction of the roadway surface—June 2010. ....	43
Figure 56. Final stay cable installed—August 2010.....	43
Figure 57. Bond bridge dedication ceremony—September 27, 2010.....	44
Figure 58. Bond bridge dedication ceremony—September 27, 2010.....	44
Figure 59. Christopher S. Bond Missouri River bridge—November 2010. ....	45
Figure 60. River bridge lighting event—November 22, 2010.....	45
Figure 61. Removal and recycling of the old Paseo Bridge—March 2011.....	46
Figure 62. Removal of Paseo Bridge nearing completion—June 2011.....	46
Figure 63. kcICON home page developed for public outreach and dissemination of information.....	49
Figure 64. One of the three Web cams with live footage (and recorded footage) at www.kcicon.com, which received 19,615 average monthly visitors. ....	50
Figure 65. Facebook® page for kcICON with 1,197 “Likes.” ....	50
Figure 66. Twitter® page for the kcICON project disseminated information to the general public.....	51
Figure 67. kcICON project YouTube® channel disseminated project videos and other information.....	51
Figure 68. OBSI dual probe system and the SRTT. ....	58
Figure 69. Mean A-weighted sound intensity frequency spectra from before and after construction.....	58
Figure 70. High-speed inertial profiler mounted behind the test vehicle. ....	59
Figure 71. Mean IRI values for the bridges and roadway during pre construction period.....	60
Figure 72. User satisfaction survey results on MoDOT performance. ....	61
Figure 73. User satisfaction survey results on project funding.....	61
Figure 74. User satisfaction survey results on the new bridge. ....	62
Figure 75. User satisfaction survey results on public information. ....	62
Figure 76. User satisfaction survey results on MoDOT performance. ....	63
Figure 77. User satisfaction survey results on MoDOT’s responsiveness on the project.....	63
Figure 78. User satisfaction survey results on MoDOT decisionmaking. ....	64

Figure 79. Project characteristics residents were most satisfied with (by percentage of respondents who were satisfied with the job MoDOT was doing on the kcICON project). ..... 64

Figure 80. Project characteristics residents were most dissatisfied with (by percentage of respondents who were dissatisfied with the job MoDOT was doing on the kcICON project). ..... 65

## TABLES

Table 1. Scoring of the proposals for kcICON project. ....	24
Table 2. Incentive plan for on-the-job training. ....	25
Table 3. Original completion schedule proposed by contractor. ....	26
Table 4. Crash data for I-29/35 before and during the kcICON project. ....	54
Table 5. Post construction crash data.....	54
Table 6. Travel time index for I-29/35 during the kcICON project.....	57
Table 7. Delay times for I-29/35 during the kcICON project.....	57
Table 8. kcICON as-built costs (not including right-of-way acquisition). ....	67
Table 9. kcICON baseline costs (low estimate, not including right-of-way acquisition).....	68
Table 10. kcICON baseline costs (high estimate, not including right-of-way acquisition).....	68
Table 11. Southbound kcICON crash data (before and during construction).....	70
Table 12. Northbound kcICON crash data (before and during construction).....	70
Table 13. Total northbound and southbound kcICON crash data and costs (before and during construction). ....	71



## ABBREVIATIONS AND SYMBOLS

AAS	additional applicable standard
AASHTO	American Association of State Highway and Transportation Officials
ADT	average daily traffic
AADT	annual average daily traffic
CAG	community advisory group
CBD	central business district
dB(A)	A-weighted decibels
DOT	department of transportation
EBCP	equal or better change proposal
FHWA	Federal Highway Administration
HfL	Highways for LIFE
HMA	hot-mix asphalt
HRWA	high-range water-reducing admixture
Hz	hertz
IRI	International Roughness Index
MoDOT	Missouri Department of Transportation
MOT	method of handling traffic
OBSI	onboard sound intensity
OJT	on-the-job training
OSHA	Occupational Safety and Health Administration
PCC	Paseo Corridor Constructors
QA/QC	quality assurance/quality control
RCRS	review, comment, and resolution sheet
RFC	release for construction
RFP	request for proposal
RFQ	request for qualifications
ROW	right-of-way
SAFETEA-LU Users	Safe, Accountable, Flexible, Efficient Transportation Equity Act: A Legacy for Users
SOQ	statement of qualifications
SI	sound intensity
SPUI	single-point urban interchange
SRTT	standard reference test tire
TTI	travel time index
VMT	vehicle miles traveled
VOC	vehicle operating costs
WBS	work breakdown structure

# INTRODUCTION

## HIGHWAYS FOR LIFE DEMONSTRATION PROJECTS

The Highways for LIFE (HfL) pilot program, the Federal Highway Administration (FHWA) initiative to accelerate innovation in the highway community, provides incentive funding for demonstration construction projects. Through these projects, the HfL program promotes and documents improvements in safety, construction-related congestion, and quality that can be achieved by setting performance goals and adopting innovations.

The HfL program—described in the Safe, Accountable, Flexible, Efficient Transportation Equity Act: A Legacy for Users (SAFETEA-LU)—may provide incentives to a maximum of 15 demonstration projects a year. The funding amount may total up to 20 percent of the project cost, but not more than \$5 million. Also, the Federal share for an HfL project may be up to 100 percent, thus waiving the typical State-match portion. At the State's request, a combination of funding and waived match may be applied to a project.

To be considered for HfL funding, a project must involve constructing, reconstructing, or rehabilitating a route or connection on an eligible Federal-aid highway. It must use innovative technologies, manufacturing processes, financing, or contracting methods that improve safety, reduce construction congestion, and enhance quality and user satisfaction. To provide a target for each of these areas, HfL has established demonstration project performance goals.

The performance goals emphasize the needs of highway users and reinforce the importance of addressing safety, congestion, user satisfaction, and quality in every project. The goals define the desired result while encouraging innovative solutions, raising the bar in highway transportation service and safety. User-based performance goals also serve as a new business model for how highway agencies can manage the highway project delivery process.

HfL project promotion involves showing the highway community and the public how demonstration projects are designed and built and how they perform. Broadly promoting successes encourages more widespread application of performance goals and innovations in the future.

### **Project Solicitation, Evaluation, and Selection**

FHWA issued open solicitations for HfL project applications in fiscal years 2006 through 2011. State highway agencies submitted applications through FHWA Divisions. The HfL team reviewed each application for completeness and clarity, and contacted applicants to discuss technical issues and obtain commitments on project issues. Documentation of these questions and comments was sent to applicants, who responded in writing.

The project selection panel consisted of representatives of the FHWA offices of Infrastructure, Safety, and Operations; the Resource Center Construction and Project Management team; the Division offices; and the HfL team. After evaluating and rating the applications and

supplemental information, panel members convened to reach a consensus on the projects to recommend for approval. The panel gave priority to projects that accomplish the following:

- Address the HfL performance goals for safety, construction congestion, quality, and user satisfaction.
- Use innovative technologies, manufacturing processes, financing, contracting practices, and performance measures that demonstrate substantial improvements in safety, congestion, quality, and cost-effectiveness. An innovation must be one the applicant State has never or rarely used, even if it is standard practice in other States.
- Include innovations that will change administration of the State's highway program to more quickly build long-lasting, high-quality, cost-effective projects that improve safety and reduce congestion.
- Will be ready for construction within 1 year of approval of the project application. For the HfL program, FHWA considers a project ready for construction when the FHWA Division authorizes it.
- Demonstrate the willingness of the applicant department of transportation (DOT) to participate in technology transfer and information dissemination activities associated with the project.

MoDOT received \$1.0 million funding for this project through the HfL program in the 2007 solicitation.

### **HfL Project Performance Goals**

The HfL performance goals focus on the expressed needs and wants of highway users. They are set at a level that represents the best of what the highway community can do, not just the average of what has been done. States are encouraged to use all applicable goals on a project:

- **Safety**
  - Work zone safety during construction—Work zone crash rate equal to or less than the preconstruction rate at the project location.
  - Worker safety during construction—Incident rate for worker injuries of less than 4.0, based on incidents reported via Occupational Safety and Health Administration (OSHA) Form 300.
  - Facility safety after construction—Twenty percent reduction in fatalities and injuries in 3-year average crash rates, using preconstruction rates as the baseline.
- **Construction Congestion**
  - Faster construction—Fifty percent reduction in the time highway users are impacted, compared to traditional methods.
  - Trip time during construction—Less than 10 percent increase in trip time compared to the average preconstruction speed, using 100 percent sampling.
  - Queue length during construction—A moving queue length of less than 0.5 mile (mi) (0.8 kilometer (km)) in a rural area or less than 1.5 mi (2.4 km) in an urban area (in both cases at a travel speed 20 percent less than the posted speed).

- **Quality**
  - Smoothness—International Roughness Index (IRI) measurement of less than 48 inches per mile.
  - Noise—Tire-pavement noise measurement of less than 96.0 A-weighted decibels (dB(A)), using the onboard sound intensity (OBSI) test method.
- **User Satisfaction**—An assessment of how satisfied users are with the new facility compared to its previous condition and with the approach used to minimize disruption during construction. The goal is a measurement of 4-plus on a 7-point Likert scale.

## **REPORT SCOPE AND ORGANIZATION**

This report documents the Missouri Department of Transportation's (MoDOT) HfL demonstration project, kcICON, which involved an innovative design-build procurement process for the construction of a 4-mi portion of Interstate 29/35, a six-lane interstate highway in North Kansas City, MO and Kansas City, MO. This project included the construction of the landmark Christopher S. Bond bridge across the Missouri River and full reconstruction or widening of several other bridges, including the construction of a single-point urban interchange (SPUI). The project also included construction of several ramps, sound walls, and pavement sections.

The report presents project details relevant to the HfL program, including the design-bid process, the quality management program, the additional applicable standards (AASs), and the equal or better change proposals (EBCPs), to ensure timely decisionmaking and approvals and finish the construction within 1,390 calendar days, compared to a traditional construction estimate of 10 to 15 years (with a conservative 8-year assumption used for economic analysis). In reality, the project was completed more than 6 months ahead of the accelerated schedule. The report also includes MoDOT performance measures and goals, contractor innovations, HfL performance metrics measurement, and economic analysis.

# PROJECT OVERVIEW AND LESSONS LEARNED

## PROJECT OVERVIEW

This urban project, kcICON, about 4 mi long, is an expansion and reconstruction of I-29/35 from north of Route 210 in North Kansas City southward to the northeast corner of the downtown Kansas City central business district loop. The project is located within the city limits of North Kansas City and Kansas City in Clay and Jackson Counties, MO. The project work included right-of-way acquisition, grading, drainage, paving, grade-separated bridge structures, replacement of the 1,832-foot (ft) Paseo Bridge crossing of the Missouri River with the landmark Christopher S. Bond bridge, an SPUI, retaining walls, interchanges, traffic signals, intelligent transportation system, and aesthetic treatments.

The purpose of the expansion and reconstruction was to increase capacity, improve safety, and provide an improved crossing of the Missouri River. The average daily traffic (ADT) on I-29/35 at the Missouri River bridge crossing was 94,468 in 2005. If highway improvements were not made to I-29/35, traffic volumes were still expected to increase through design year 2030 to an ADT of 110,000 near Front Street (one of the principal arterials crossing the I-29/35 corridor). With improvements to the corridor, the ADT was expected to increase to 130,000 near Front Street. The goals of the design-build project were as follows:

- Deliver the I-29/35 corridor improvements within the total program budget of \$245 million.
- Construct a landmark Missouri River bridge that can be reasonably maintained to provide more than a century of useful service.
- Maximize safety, mobility, aesthetic, and capacity improvements in the corridor.
- Engage stakeholders and the community to successfully develop and deliver the project.
- Meet or beat the project completion date of October 31, 2011.

The use of a design-build contract procurement process with a set contract price was a key innovation used on this project, one of MoDOT's first three design-build projects. Design-build encourages innovations in design, traffic management, and construction phasing. This process provides optimum opportunity and flexibility for contractors to develop and apply innovative engineering and construction techniques. MoDOT also used a new and innovative quality management program for the project. An exclusive project director was assigned to the project who was delegated authority for many project activities that previously were only authorized and approved by MoDOT's chief engineer or the kcICON Commission. This increased authority allowed for more timely decisionmaking and document approval, which resulted in shorter project duration.

Upon receipt of the record of decision, MoDOT began the process of selecting a contractor by releasing a request for qualifications (RFQ) on March 26, 2007. Statements of qualification (SOQ) were received in May from design-build teams interested in competing for the project, and MoDOT short-listed two qualified design-build teams. MoDOT then issued a request for proposals (RFP) and announced the winning contractor on November 14, 2007. The contract was signed on December 20, 2007. Project work began in spring 2008, with concurrent construction

activities in various parts of the corridor. The Missouri River bridge, christened the Christopher S. Bond bridge, was completed in fall 2010 and a dedication ceremony was held September 27, 2010. The opening of the Front Street SPUI in fall 2010 marked the end of major construction on the kcICON project. All lanes and ramps were opened by December 2010, 6 months earlier than scheduled. Minor work continued in 2011, primarily related to the removal of the existing Paseo Bridge, landscaping, striping, and cleanup.

MoDOT's design-build process for the kcICON project involved several general steps: 1) prequalification of design-build teams, 2) issuance of an RFP, 3) selection of a contractor team on a best-value basis, 4) MoDOT's development of conceptual design, and 5) contractor completion of design.

## **DATA COLLECTION**

Safety, construction congestion, quality, and user satisfaction data were collected before, during, and after construction to demonstrate that innovations can be deployed while simultaneously meeting the HfL performance goals in these areas.

- **Safety**
  - Work zone safety during construction—Although the project did not include the performance goal of work zone crash rate equal to or less than the preconstruction rate at the project location, crash data for the 3 years before construction, the 3 years during construction, and 1 year after construction show that the crash rate increased only slightly during the construction years of 2008 to 2010.
  - Worker safety during construction—Although the project did not include the performance goal of an incident rate for worker injuries of less than 4.0 based on the OSHA 300 rate, for the total project, the contractor's amount of lost-time incidents was less than half the industry standard (for an equivalent project). MoDOT personnel had zero lost-time incidents.
  - Facility safety after construction—The post construction crash statistics indicate that the safety performance of the facility after construction exceeded the HfL goal of 20 percent reduction in injuries and fatalities.
  
- **Construction Congestion**
  - Faster construction—Conventional construction methods would have negatively impacted the entire I-29/35 corridor north of the Kansas City central business district with construction-related congestion for an estimated 10 to 15 years. Shortened construction time limited construction impact on traffic flow to less than 3 years, surpassing the goal of reducing construction time by half.
  - Trip time—Because of the scale and complexity of the various project elements, the project did not include the performance goal of less than 10 percent increase in trip time during construction compared to the average preconstruction speed, nor did it include the performance goal of a moving queue length of less than 1.5 mi (travel speed 20 percent less than the posted speed). However, data provided by Kansas City Scout, Kansas City's bistate traffic management system, for a 4.62-mi segment showed that the average peak period delays during construction



were 19.7 seconds and 87.7 seconds (6.7 percent and 29.0 percent) for the northbound and southbound directions, respectively. Average delays during offpeak hours were not significant.

- **Quality**

- Smoothness and noise—Smoothness across the Missouri River bridge was dramatically increased. The International Roughness Index (IRI) dropped from a preconstruction value of 198 in/mi to a postconstruction 130 in/mi. Although the HfL goal for IRI of 48 in/mi—reasonably attainable on long, open stretches of pavement—was not met on this project, the drop in IRI value for this bridge reflects the high quality of construction.
- Noise—The global sound intensity (SI) value for the existing bridge surface was 101.0 dB(A) and 99.6 dB(A) for the new bridge. While not meeting the HfL goal of 96.0 dB(A), the new bridge surface is slightly less noisy than the existing bridge. Overall, the new bridge surface has a reduced low-frequency and an increased high-frequency response. In other words, the new bridge has less of a low rumble sound than the old bridge.
- User satisfaction—The local public gave the project high marks for overall satisfaction. It recognized the importance of this bridge and considered it a good use of taxpayer money.

## **ECONOMIC ANALYSIS**

The costs and benefits of this innovative project approach were compared with a baseline project using a more traditional approach. The economic analysis revealed that MoDOT's approach realized a cost savings of about \$62.1 million to \$89.4 million. In other words, the innovative approach to this \$232 million corridor improvement project had a 27 to 39 percent cost benefit over traditional methods. A significant amount of the cost savings was from reduced construction time.

## **LESSONS LEARNED**

1. Things would have run much more smoothly if more AASs were submitted during the procurement phase.
2. Continue to use the review, comment, and resolution sheet (RCRS) review system to solicit input from all project stakeholders.
3. Design surveys are critical for every project, but when railroads are involved, the design surveys are project threatening. The contract documents should make the railroad approval process and requirements clear in the agreement with any involved railroad companies.
4. Have lots of geotechnical capacity even if you do not think you will need it during procurement and implementation. Sufficient human resources need to be available to perform the calculations, analyze the results, draft the reports, and provide the foundation recommendations.
5. Providing safety training for project team members is a positive so that both MoDOT and the contractor are on the same page on safety (safety equipment required and used on the work site).

6. Quality assessment (QA) forms should be implemented at the first project task force meeting and rules for their completion emphasized. It is important to emphasize completion of the QA forms each and every month.
7. Assign a dollar value to every item listed in the work breakdown structure (WBS).
8. While the river bridge portion of the WBS was very detailed, other sections were not. For clarification and processing purposes, additional attention to detail should be placed on all WBS items.
9. The task force addenda should be very detailed. Also, the use of breakout sessions to discuss significant individual topics was a leveraged tool to involve the cross discipline activities and get input.
10. Regularly scheduled task force meetings were very beneficial, not only to address future conflicts, but also to discuss how things were going on the project.
11. Involving the contractor in the plan reviews and requiring a written RCRS form to be completed forced timely plan review and participation by the contractor and the designer.
12. The regularly scheduled task force meeting with an agenda, schedule, and action items was the proper business tool to drive the design to completion and to hold every individual accountable for participation in and delivery of timely input and comments. The multidisciplinary RCRS meetings also served to provide project coordination in the presence of others to discuss the plans and specifications. Documentation of individual input with the RCRS program served to engage everyone.
13. MoDOT project staff and contractor project staff being colocated in the same building provided a positive image for the project and promoted effective communication. It facilitated the ability to provide answers and make decisions in a timely manner.
14. Release an updated index sheet with each release for construction (RFC) submittal. This will ensure that everyone concerned has the latest RFC sheets and will facilitate the organization of the RFC sets of plans.
15. The design team, the contractor, and the owner should all keep a set of updated RFC notebooks. If the design team keeps a set of plans, it will be able to discover any discrepancies before sending plans to the contractor and owner.
16. Involve third parties early in the project so they are informed about it. By involving them early, the project team can also learn about any third party hot-button issues and address them in the first plan review submittal instead of finding out about them later.
17. Early utility relocations were based on where the projected roadway was being placed. In design-build, early relocations should be discouraged if there is a possibility the utilities could continue to be impacted.
18. Permits requiring completion by MoDOT should be handled in the design-build office (rather than the district office) and numbered accordingly (reference work order number, job number, and consecutive permit number for each utility company).
19. Assigning action items is the only way to truly hold each individual accountable for completing tasks. Action items can be used to accelerate as well as to track work. The successful use of action items typically can be related to the successful completion of a project.

## **CONCLUSIONS**

MoDOT gained considerable experience with the innovations used on this project and, because of its success, is encouraged to include these innovations in future projects. Success was measured in increased safety, quality, cost savings, and the reality of bringing the project to completion in substantially less time than with traditional contracting and construction.

## PROJECT DETAILS

### BACKGROUND

This urban project, kcICON, is located on I-29/35, extending from north of Route 210 in North Kansas City southward to the northeast corner of the downtown Kansas City central business district loop (figure 1). The goal of kcICON is to expand and reconstruct a 4-mi section of I-29/35 to increase capacity, improve safety, and improve the crossing of the Missouri River by replacing the four-lane (no shoulders) Paseo Bridge built between 1952 and 1954 with a six-lane landmark river bridge, later christened the Christopher S. Bond bridge. The bridge design can accommodate two future lanes, shoulders, and bicycle/pedestrian facility. This section of the freeway includes 13 grade-separated bridge structures ranging from 161 ft to over 1,800 ft (including the 1,832-ft-long Paseo Bridge).



Figure 1. Project location.

Figures 2 through 8 show the existing cross sections and proposed cross sections of various key elements of the corridor. In general, the existing cross sections did not have sufficient capacity to carry the projected traffic and the designs proposed consisted of the addition of one or more lanes in each direction to improve capacity.

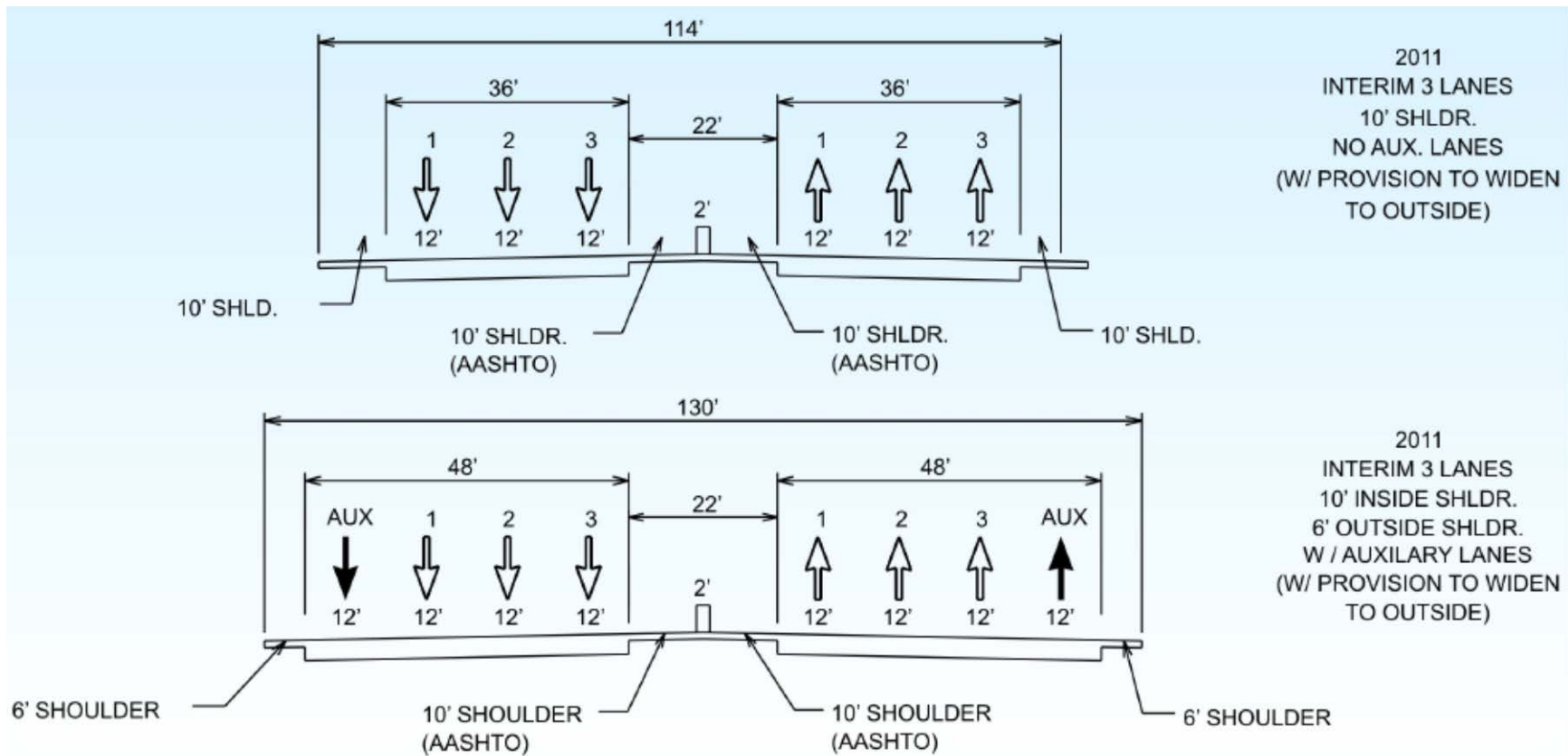

Figure 2. Existing and proposed typical roadway section on I-29/35.

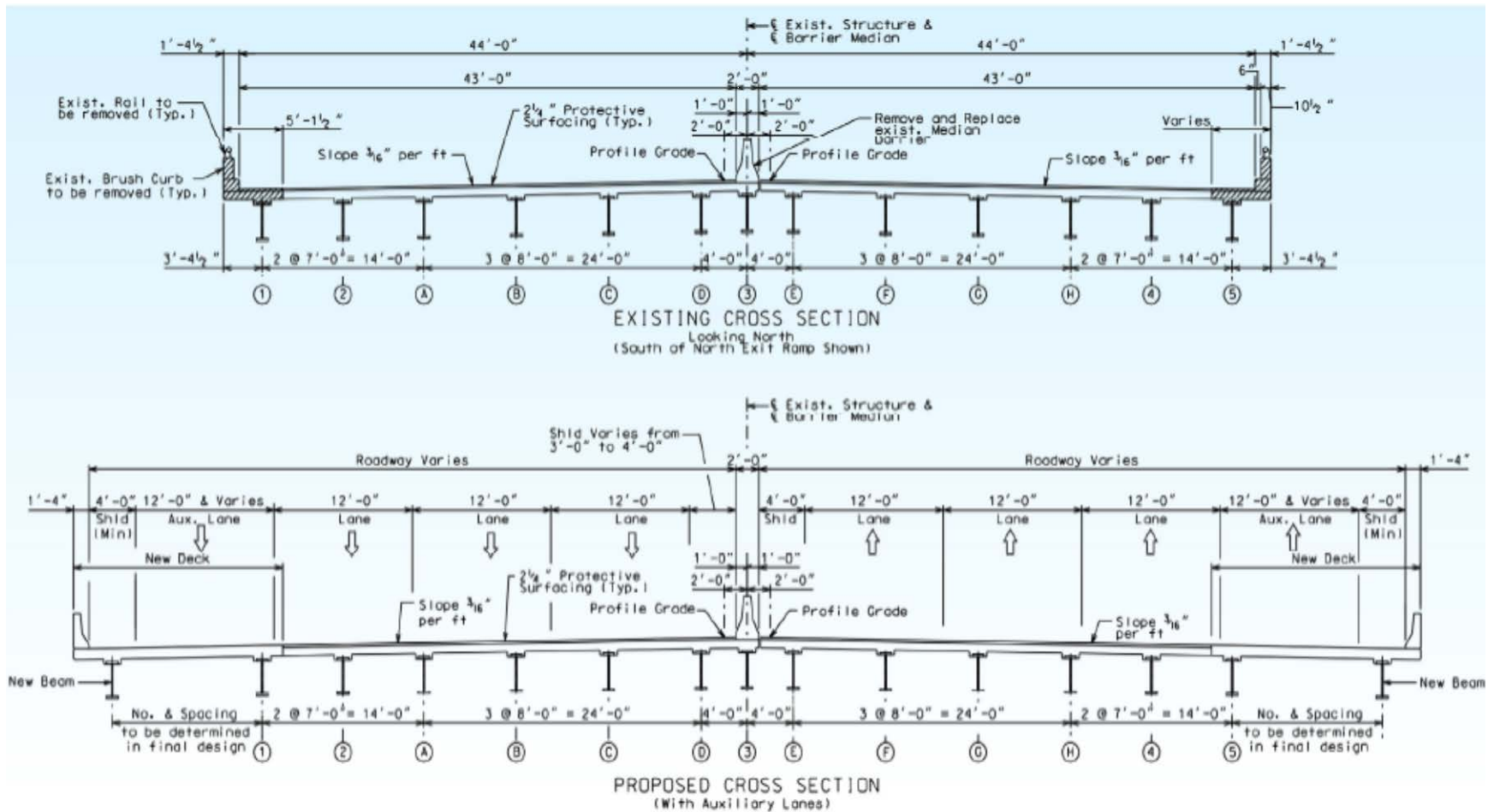

Figure 3. Existing and proposed typical cross section of I-29/35 south railroad viaduct.



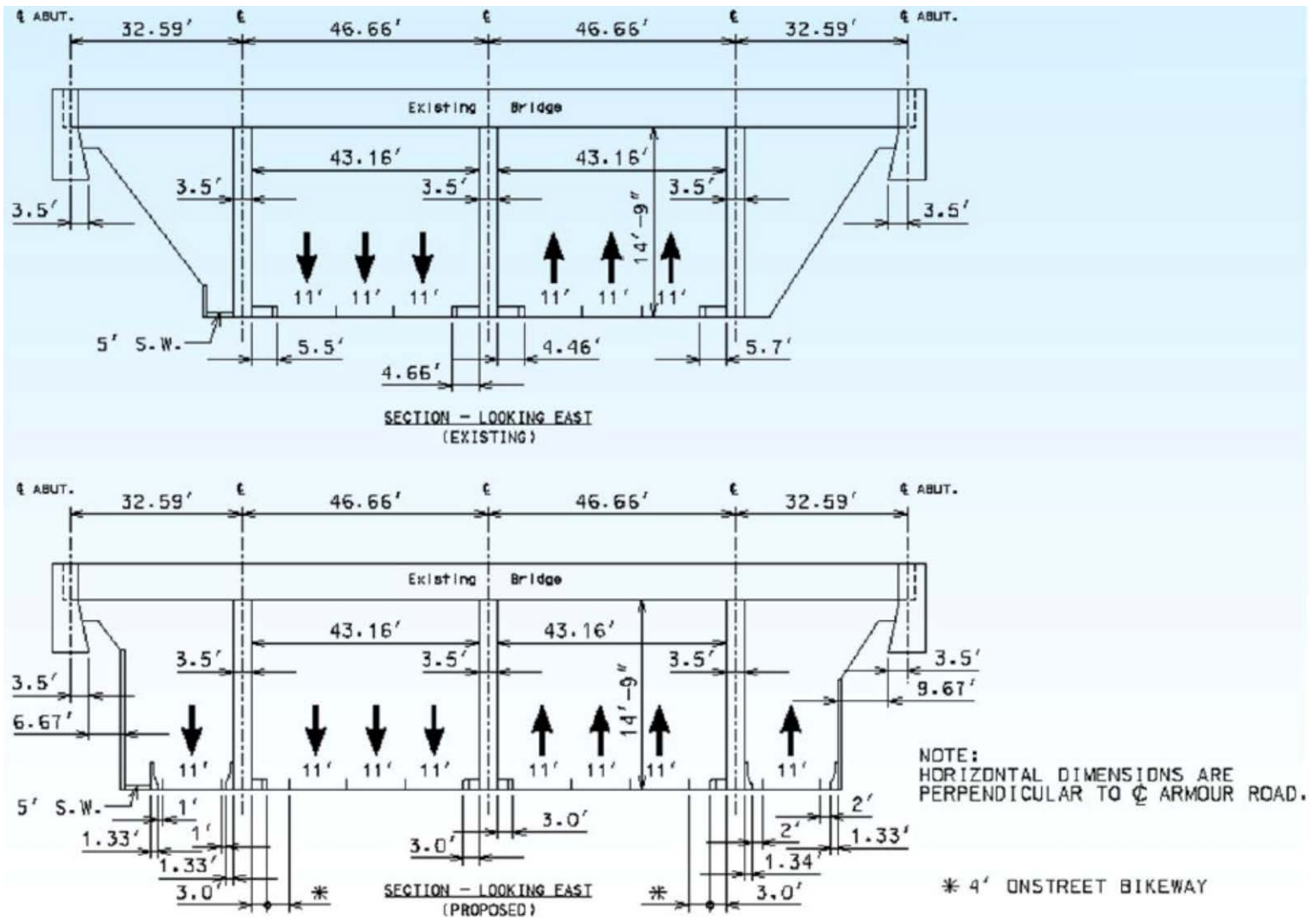

Figure 4. Typical section of Armour Road under existing bridge on I-29/35.

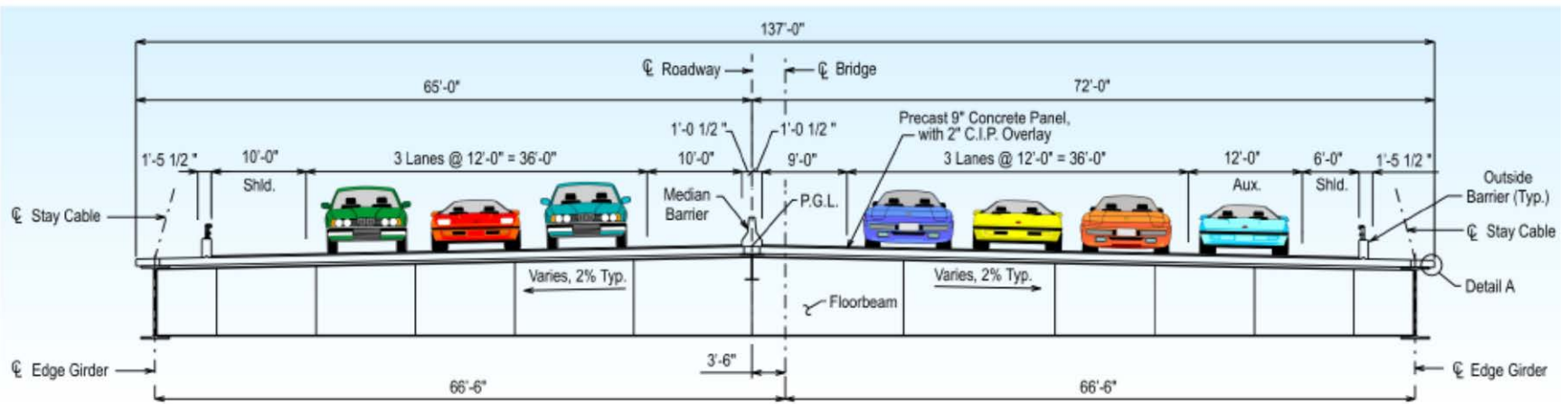

Figure 5. New element: proposed cross section of the new Missouri River bridge to replace the existing four-lane (no shoulders) Paseo Bridge.

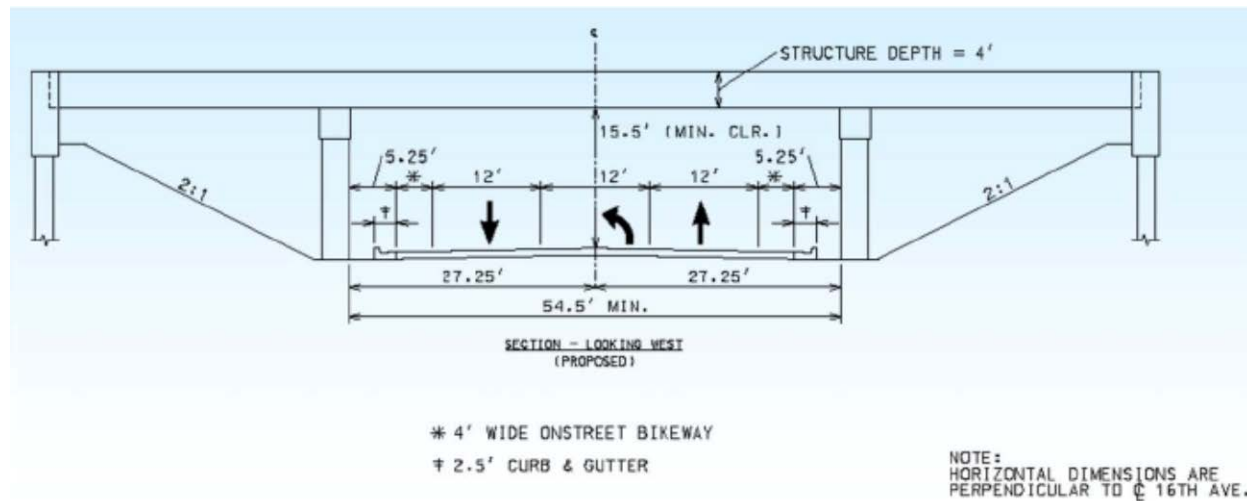

Figure 6. New element: proposed cross section of 16th Avenue under the new bridge.

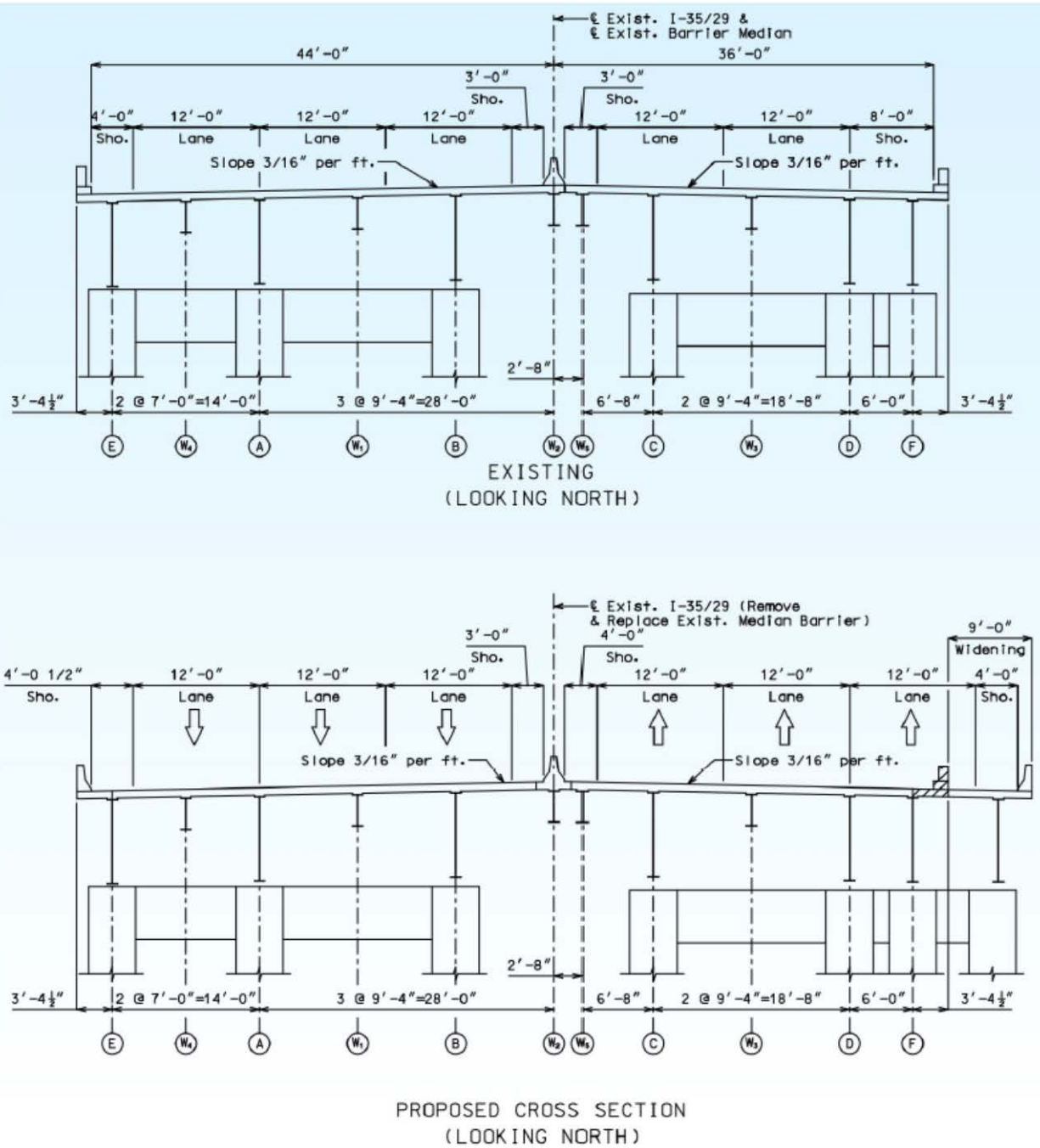

Figure 7. Existing and proposed typical cross section of I-29/35 north railroad viaduct.

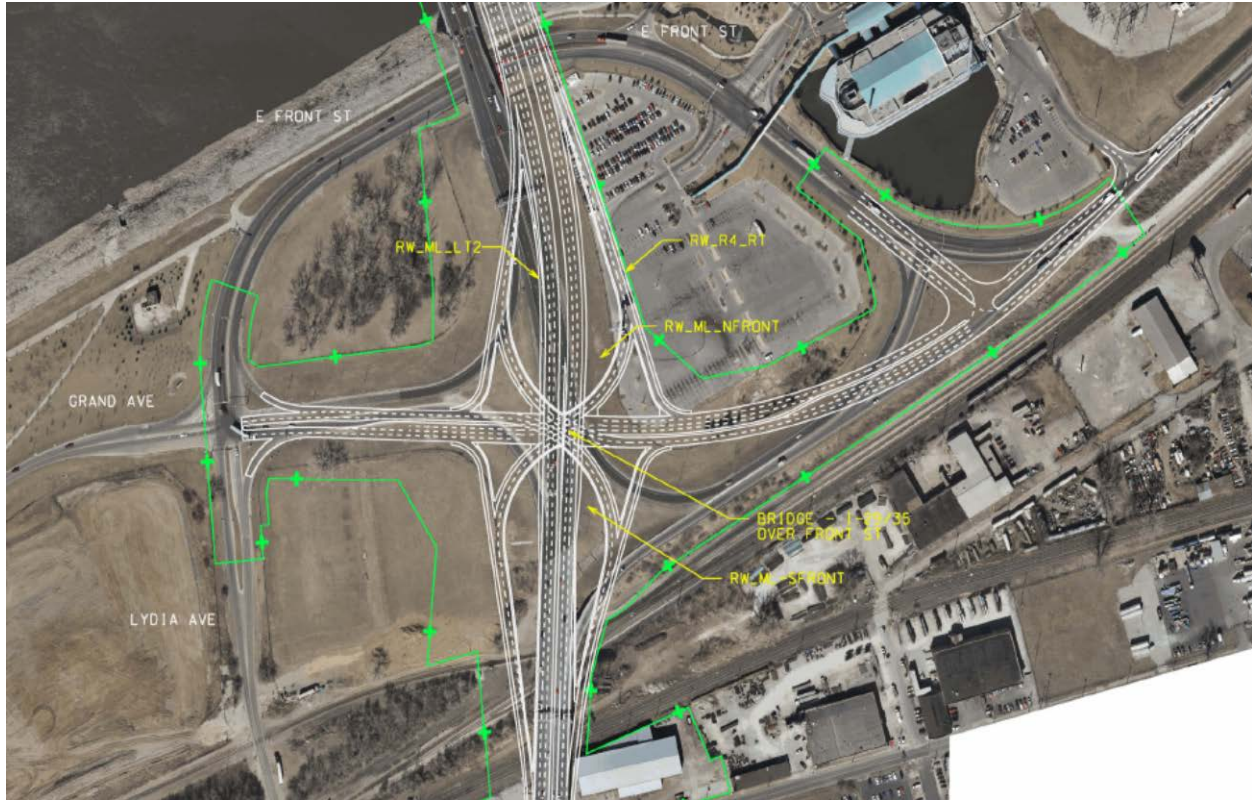

Figure 8. New element: proposed SPUI at Front Street crossing.

The 2005 ADT on I-29/35 at the Missouri River bridge crossing was 94,468. If highway improvements were not made to I-29/35, traffic volumes were expected to increase through 2030 to an ADT of 110,000 near Front Street. With improvements to the corridor, the ADT was forecast to increase to 130,000 near Front Street. The corridor is part of the North American Free Trade Agreement corridor and serves a large industrial area located north of the Missouri River. Before the expansion and reconstruction of this corridor, the movement of truck traffic was constrained by traffic congestion and the operational deficiencies of the interchanges used by truck traffic to access I-29/35. The expansion and reconstruction project provided much-needed improvements to the highway and interchanges to facilitate the movement of trucks and other traffic.

## PROJECT DESCRIPTION

The primary purpose of kcICON was functional (increase capacity, improve safety, enhance aesthetics, and boost mobility) rather than structural (improve condition of pavements and bridges). Figures 9 through 22 show the enhancements made to some of the key elements of the corridor.





Figure 9. South end of project—March 2008.

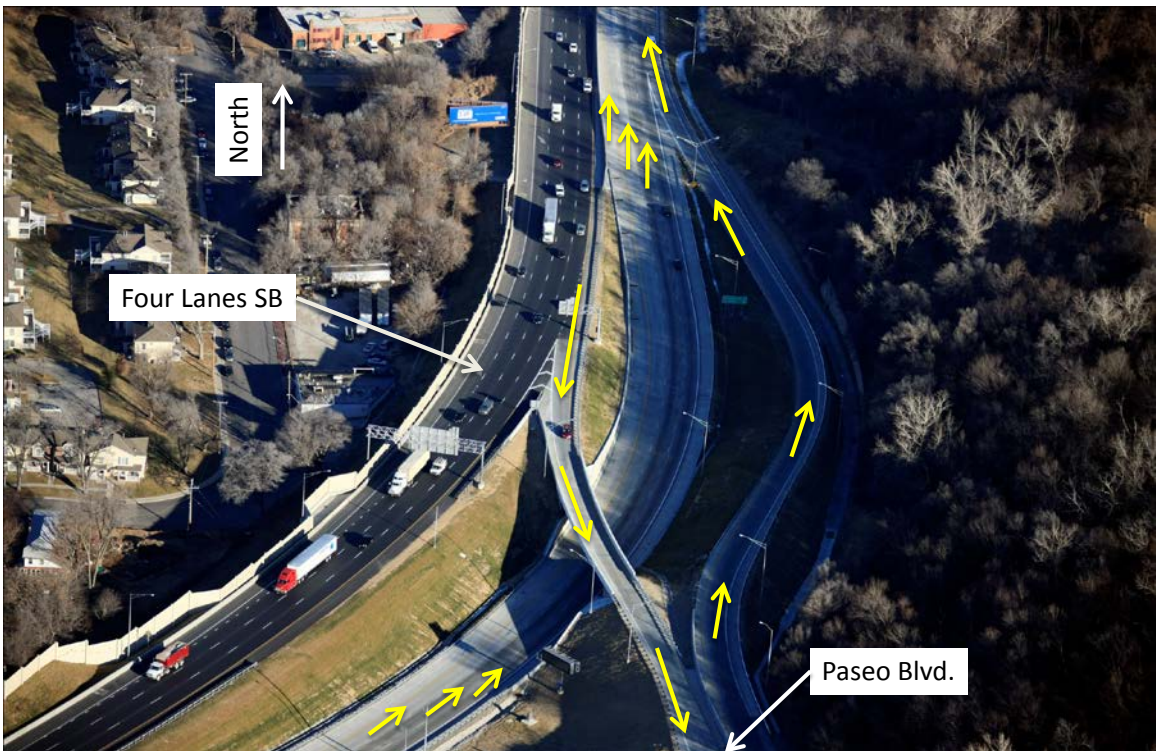

Figure 10. South end of project—January 2011.





Figure 11. Front Street interchange—March 2008.



Figure 12. SPUI at Front Street—January 2011.





Figure 13. Four-lane Paseo Bridge crossing the Missouri River—March 2008.



Figure 14. Six-lane Bond Bridge crossing the Missouri River—January 2011.





Figure 15. Levee Road crossing—March 2008.



Figure 16. Levee Road crossing—January 2011.



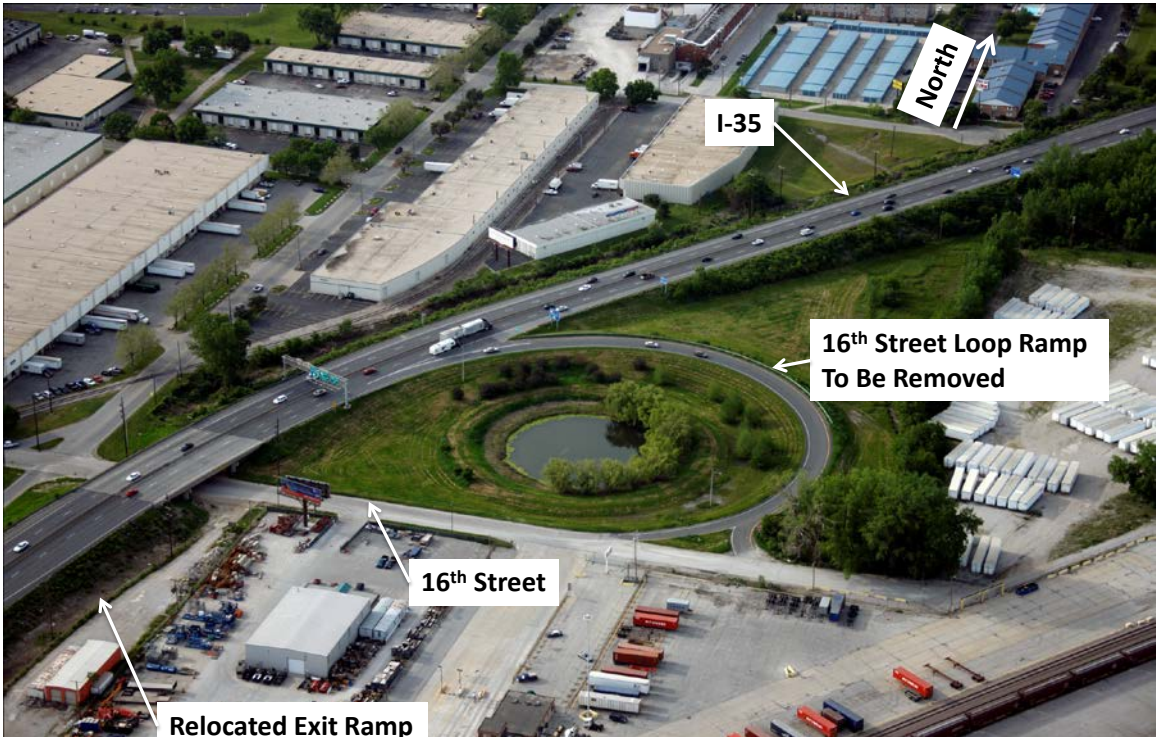

Figure 17. 16th Street exit ramp—March 2008.



Figure 18. 16th Street exit ramp—January 2011.



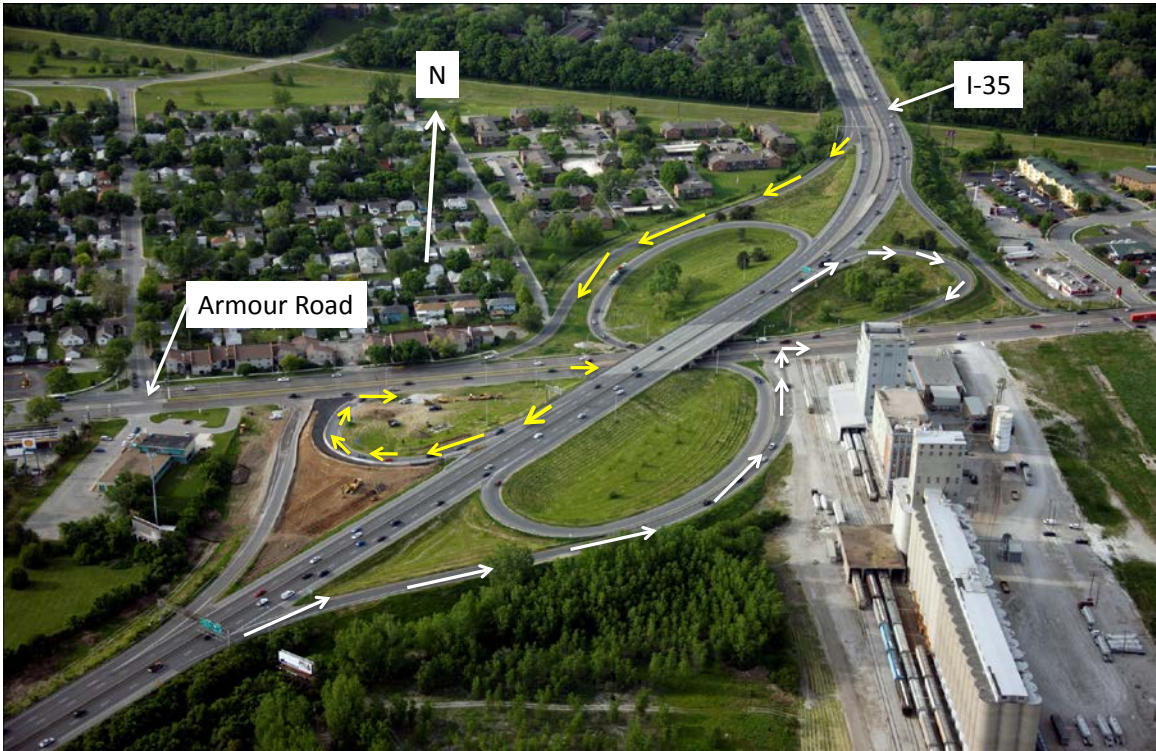

Figure 19. Armour Road interchange—March 2008.



Figure 20. Armour Road interchange—January 2011.





Figure 21. Armour Road and I-29/35—July 2008.

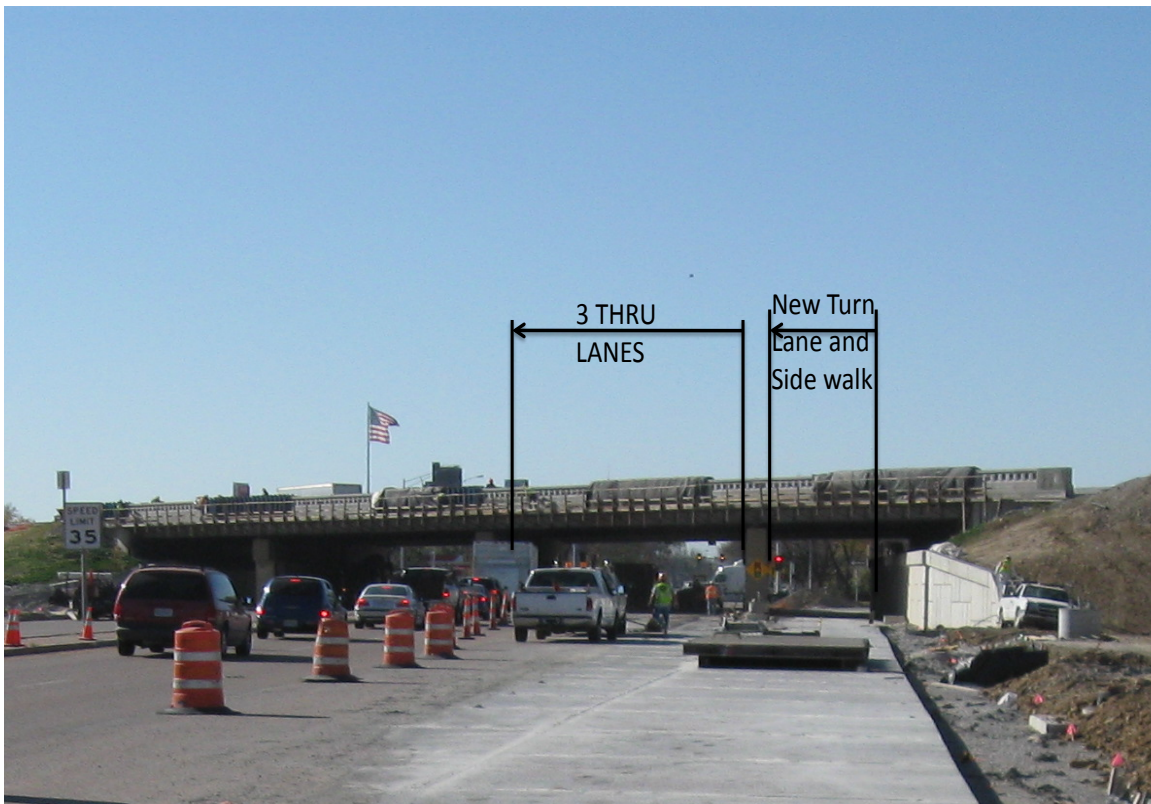

Figure 22. Armour Road and I-29/35—January 2011.

The key innovation on this project was the use of design-build contracting for construction with a set contract price that was specified in the RFP. An interactive but confidential procurement process was set up that allowed maximum flexibility for the proposers to develop and refine proposals. Proposers developed a project scope within the set contract price. The innovative procurement process allowed proposers to develop concepts for a landmark river bridge, as well as other design elements in the corridor, with a minimum of guidelines or requirements. Public input was solicited to determine what would make this bridge a landmark structure. The proposers had an opportunity to attend a public meeting to listen to the concerns and desires of the public and to discuss aesthetics. Representatives of the Community Advisory Group (CAG) were involved in the evaluation and scoring of proposals on the aesthetics of the bridge.

MoDOT used a new and innovative quality management program for the project. The contractor, Paseo Corridor Constructors (PCC), was required to develop, implement, and maintain a quality management system, including a quality manual subject to MoDOT's approval. A quality manager and quality assurance staff, who had no responsibilities in the production of the work and who reported to PCC's top management, were used. MoDOT's quality oversight used an audit approach that entailed checking on a sample basis whether the work complied with the contract document requirements. MoDOT assigned an exclusive project director who was delegated authority for many project activities that previously were authorized and approved only by MoDOT's chief engineer or the kcICON Commission. This increased authority allowed for more timely decisionmaking and document approval, which resulted in shorter project duration.

### **Design-Build Procurement Process and Contractor Selection**

Upon receipt of the record of decision, MoDOT began the process of selecting a contractor by releasing an RFQ on March 26, 2007. SOQs were received in May from design-build teams interested in competing for the project, and MoDOT short-listed two qualified design-build teams. Confidential technical concept meetings were held and MoDOT issued an RFP with a fixed price of \$232 million. The budget for the project was \$245 million, which included right-of-way acquisition and reserves for change orders and incentives. The environmental clearances, right-of-way (ROW) acquisition, and third-party agreements were to be obtained by MoDOT. A CAG consisting of 12 members named by local leaders was established. The CAG held regular meetings and was responsible for outlining local priorities. The CAG was also responsible for scoring the 20 bridge aesthetic points (of the 100 total points) of the proposals.

Proposals were evaluated by MoDOT and the CAG (bridge aesthetics only) based on the criteria shown in table 1. The contract was to be awarded to the contractor whose proposal represented the best value based on the evaluation criteria. The winning contractor (best-value proposer)—Paseo Corridor Constructors (PCC)—was announced on November 14, 2007. Three companies worked together as PCC: Clarkson Construction Co., a majority owner and sponsor of PCC, known for roadway construction; Massman Construction Co., a marine construction and bridge-building expert; and Kiewit Construction Co., a company experienced in design-build and quality assurance. The contract was signed on December 20, 2007.

Table 1. Scoring of the proposals for kcICON project.

<b>Scoring Criterion</b>	<b>Points</b>
Project Definition	30
<b>Landmark Missouri River Bridge(s)—Aesthetics*</b>	<b>20</b>
Landmark Missouri River Bridge(s)—Durability	10
Method of Handling Traffic	15
Completion Schedule	10
Disadvantaged Businesses/Workforce Development	10
Public Information	5
<b>TOTAL</b>	<b>100</b>

\*Scored by CAG

### **Project Incentives and Disincentives**

To reduce the risk of cost overruns, the contract included restrictions affecting the contractor’s ability to make claims for an increase in the contract price or an extension of the completion deadlines. The contractor agreed in the contract to assume such responsibilities and risks and reflected the assumption of such responsibilities and risks in the contract price. Per the contract, if the contractor failed to complete the project within the time limits set in the contract documents, the contractor would have to pay substantial losses and damages resulting from the delays.

The only incentive on this project related to on-the-job training (OJT). The kcICON Commission had set a goal to have 15 percent of the construction and 5 percent of the professional services performed by approved OJT individuals who were minorities, women, or economically disadvantaged individuals.

The contractor would receive an incentive of \$3.50 per hour for each hour worked by an approved OJT individual up to a total of 15 percent of the total workforce in the construction crafts, as shown in table 2. The contractor would receive an incentive of \$3.50 per hour for each hour worked by an approved professional service trainee up to a total of 5 percent of the total workforce in professional services. The contractor would receive an incentive of \$10.00 per hour for each hour worked by an approved OJT individual, once the initial 20 percent goal was achieved. The maximum amount available for the incentives was \$625,000.

Table 2. Incentive plan for on-the-job training.

<b>Type of Incentive</b>	<b>Percent of Hours</b>	<b>Incentive per Hour</b>
<b>OJT</b>	up to 15% of construction labor force	\$ 3.50
<b>Additional OJT</b>	15% to 20% of construction labor force	\$10.00
<b>OJT professional services</b>	up to 5% of nonconstruction labor force	\$ 3.50
<b>Additional OJT professional services</b>	5% to 10% of nonconstruction labor force	\$10.00

### **Review of Additional Applicable Standards**

To encourage innovation and technology adoption, the RFP allowed for proposers to recommend AASs in their proposals for consideration by MoDOT. All AASs that were not Missouri standards or were Missouri standards that were modified by the contractor had to be signed and sealed by a Missouri-licensed professional engineer. All AAS details that included references to other State divisions, requirements, or personnel had to be approved by MoDOT before construction. All AASs that included phrases such as “to the satisfaction of the engineer” or “approved by the engineer” had to be documented as approved by the contractor’s engineer and the justification for such approval had to be documented.

PCC determined it prudent to select MoDOT manuals, standards, and specifications as the basis of its proposal, but recommended revisions to bring it into the design-build work environment. The changes were based on PCC’s experience with other State departments of transportation and design-build projects and proposed to provide MoDOT with a competitively priced, affordable corridor. A list of AASs approved by MoDOT for use in the kcICON project are shown in table A-1 in appendix A.

### **Review of Equal or Better Change Proposals**

To streamline the process of managing a project of this scope and magnitude and to allow for innovations, the contract documents allowed the contractor to propose changes through the use of an equal or better change proposal. An equal or better change proposal is an approved proposal, developed and documented by the contractor, that would modify or require a change in any of the contract document requirements to be implemented that is equal to or better than the underlying requirement. Equal or better change proposals were not allowed that would result in a change in the completion deadline.

The contractor could request MoDOT approval of a change order that was equal to or better than the contract document requirements. MoDOT had the authority to approve, at its sole discretion, in whole or in part, the proposed change order. Once approved, the equal or better changes could be implemented by the contractor without sharing the cost savings.



The EBCPs submitted by the contractor included redline of the changes proposed to the contract requirements involved in the proposed change, a description of why the proposed change was equal to or better than the existing contract requirements, a description of any previous use or tests of the proposal, and the conditions and results, if requested by MoDOT. The contractor would have no claim for any additional costs or delays resulting from the rejection of an EBCP, including development costs, loss of anticipated profit, or increased material or labor costs. Between 2008 and 2011, the contractor submitted 57 EBCPs, 44 of which MoDOT approved. The approved EBCPs are summarized in table A-2 in appendix A.

## Construction

Table 3 shows the completion schedule originally proposed by PCC. However, on March 10, 2010, the completion date for all three segments was changed to July 31, 2011, through EBCP 53. The new completion dates were equal or better because they resulted in a reduction in the total number of lane closure days of 474, improving travel times. The design-build procurement process at a set contractor price allowed the contractor to propose innovations within the scope of the corridor improvement project. The process encouraged and promoted fast construction and opening to traffic of several bridges, ramps, sound walls, and pavement sections.

Various portions of the project were constructed concurrently, but the major activity of this project was the construction of the landmark Missouri River bridge. The construction the Missouri River bridge is documented in figures 23 through 62.

Table 3. Original completion schedule proposed by contractor.

<b>Number</b>	<b>Segment Completed</b>	<b>Completion Deadline</b>
1	I-29/35 South of South Station 125+00	11/1/2009
2	I-29/35 North of 16th Avenue, the 16th Street Interchange, and the Armour/210 Interchange	12/15/2010
3	I-29/35 Corridor (new bridge open to traffic)	6/1/2011
<b>Project</b>	<b>Project Completion (including demolition of existing bridge)</b>	<b>7/31/2011</b>
	<b>Final Acceptance (90 Days after Project Completion)</b>	<b>10/29/2011</b>



Figure 23. Beginning cofferdam work—August 2008.



Figure 24. Lowering the permanent casing into the temporary casing—August 2008.





Figure 25. Twisting the permanent casing into the riverbed—August 2008.



Figure 26. Final alignment of the permanent casing—August 2008.





Figure 27. Augering the drilled shafts—August 2008.



Figure 28. Aerial view of the cofferdam—August 2008.



Figure 29. Aligning the wagon wheel for the rebar lift—August 2008.



Figure 30. Swinging the rebar to the drilled shaft sleeve—August 2008.





Figure 31. Tying the hoop bars to the cage as it is lowered into the drilled shaft—August 2008.



Figure 32. Placing 1,450 cubic ft of concrete in one day for the cofferdam seal—October 2008.





Figure 33. Delivery of concrete from the deck of the Paseo Bridge—October 2008.



Figure 34. Delivery of concrete from below the deck of the Paseo Bridge—October 2008.





Figure 35. Pouring the concrete into the drilled shaft—October 2008.



Figure 36. A dry cofferdam—October 2008.





Figure 37. Cutting away the casings—October 2008.



Figure 38. Removed casings—October 2008.





Figure 39. A total of 235 mi of rebar work—November 2008.



Figure 40. Rebar in place for the first concrete lift—November 2008.





Figure 41. Placing concrete for second lift of downstream pylon leg—November 2008.



Figure 42. Constructing the roadway strut—March 2009.





Figure 43. Inside the knuckle of the roadway strut—March 2009.



Figure 44. Placing reinforcement in the roadway strut—April 2009.





Figure 45. A third of the way to the top in constructing pylon above the roadway strut—May 2009.



Figure 46. First bridge floor beam, 133 ft long and 66,500 pounds—August 2009.



Figure 47. Two cranes moving floor beam from truck to barge—August 2009.



Figure 48. Temporary falsework supports the backspan roadway girders—August 2009.





Figure 49. Placing the first floor beam onto the roadway strut—August 2009.

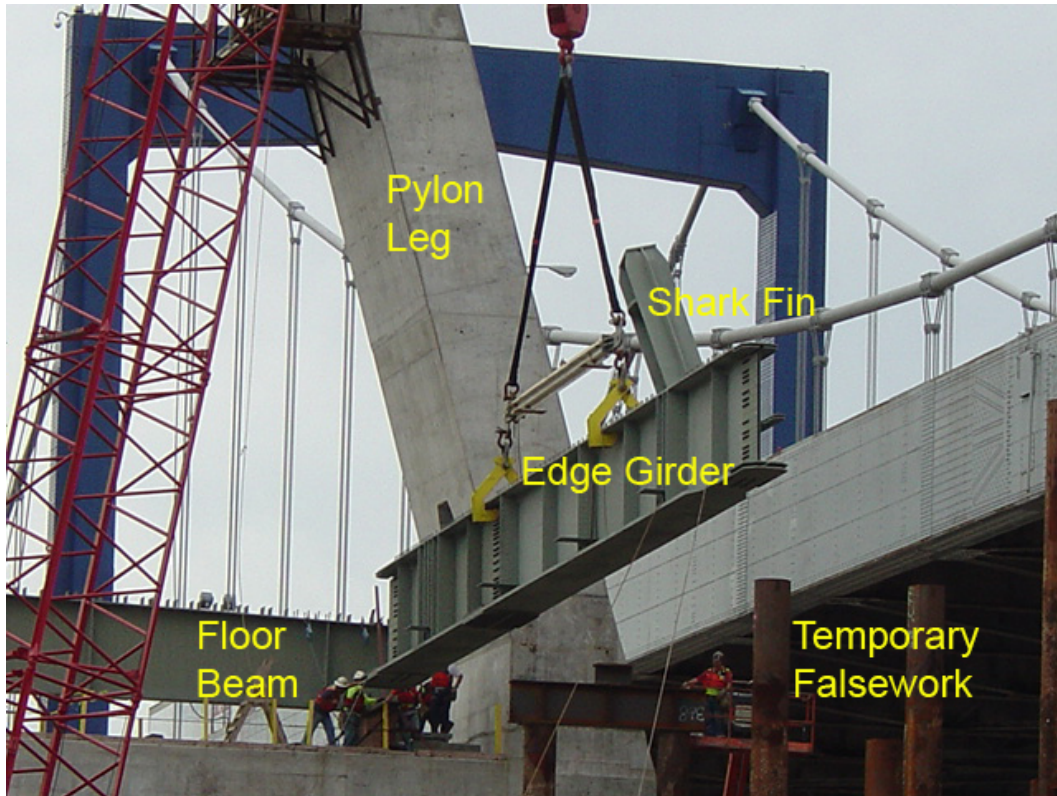

Figure 50. Closeup view of the floor beam installation—August 2009.



Figure 51. Pier table—August 2009.



Figure 52. View of pylon construction and pier table placement from the river channel—August 2009.



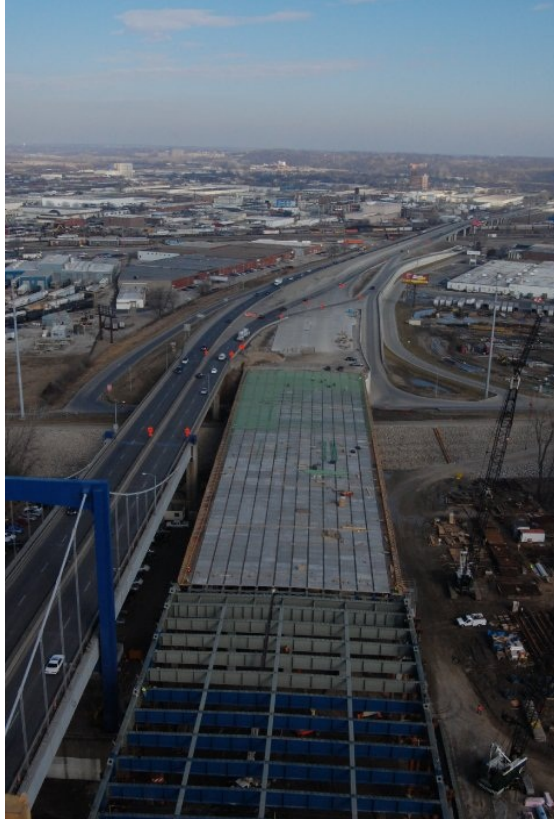

Figure 53. River bridge deck and north view of the project—March 2010.



Figure 54. Bridge deck placement—April 2010.

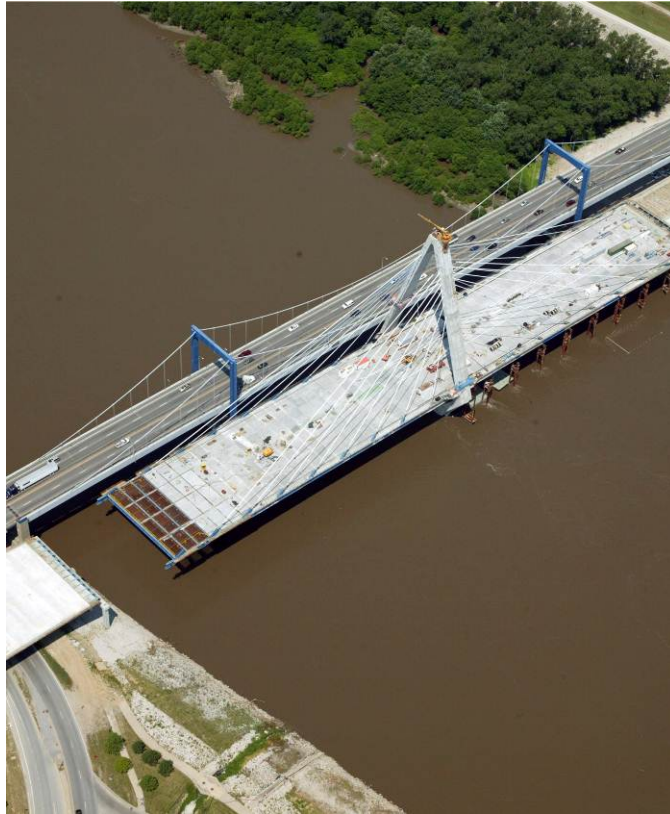

Figure 55. Aerial view of the construction of the roadway surface—June 2010.



Figure 56. Final stay cable installed—August 2010.





Figure 57. Bond bridge dedication ceremony—September 27, 2010.

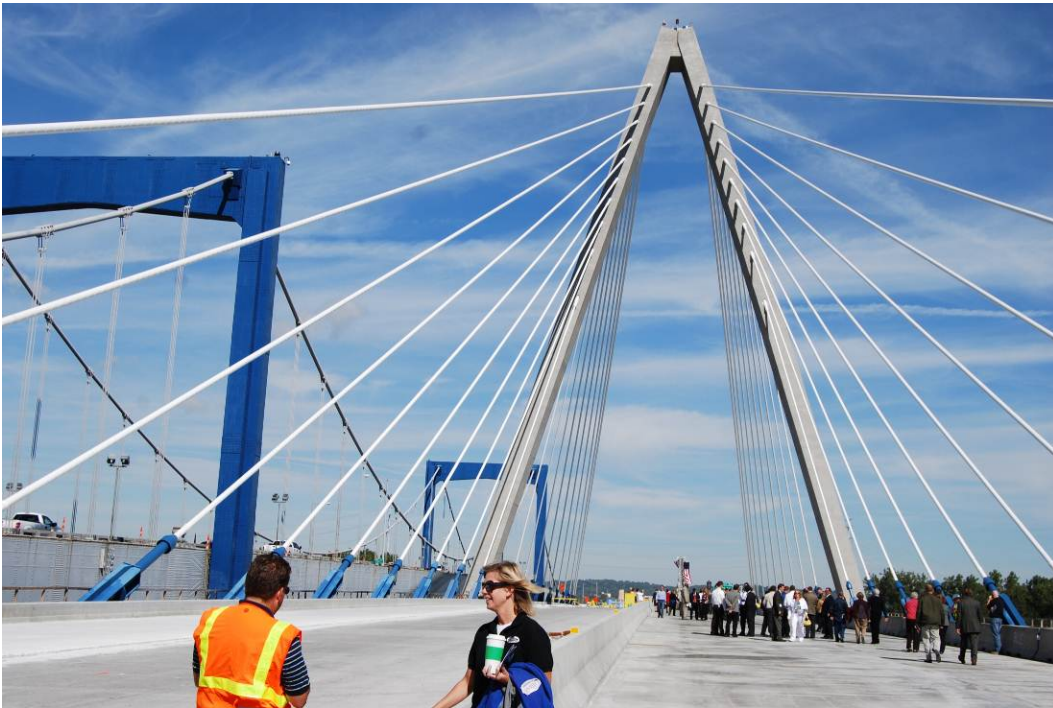

Figure 58. Bond bridge dedication ceremony—September 27, 2010.



Figure 59. Christopher S. Bond Missouri River bridge—November 2010.



Figure 60. River bridge lighting event—November 22, 2010.





Figure 61. Removal and recycling of the old Paseo Bridge—March 2011.



Figure 62. Removal of Paseo Bridge nearing completion—June 2011.

## **Contractor Flexibility and Innovations**

The design-build process with a set fixed price along with the AASs and the EBCPs allowed the contractor substantial flexibility in innovating and seeking and adopting new technologies, methods, and materials that exceeded MoDOT's standards without a corresponding increase in price. As summarized in tables A-1 and A-2 given in the appendix, many large and small innovations were proposed by the contractor and approved by MoDOT. Following are three key innovations that had a substantial impact on the project.

### ***Base-Grouted Slurry-Displaced Drill Shafts***

The innovative technology used for the foundations of the five Bond bridge approach spans was a first for Missouri. Base grouting of the drilled shafts enhances end bearing resistance, which substantially reduces the length of the drilled shaft. Base grouting involves delivering grout under high pressure to the bottom of the drilled shaft after the shaft has been constructed through a distribution system tied into the reinforcing cage. Base grouting provides several benefits: (1) the base grouting under pressure compensates for any imperfections in base cleaning operations, (2) the shaft end bearing resistance is preloaded so that base resistance is mobilized under smaller vertical shaft displacements, (3) the granular soils at or near the base of the drilled shaft are densified, which increases the confining stresses in the soil around the base of the shaft, and (4) during the pressure grouting, measurements of the shaft performance can be related to the axial resistance, providing a form of load verification for each production shaft.

The use of base-grouted drilled shafts for the bridge foundations was a cost-effective technical engineering solution that overcame a difficult geological condition and significantly enhanced the reliability of each shaft.

### ***Precast, Prestressed Concrete Piles for Bridge Foundations***

Early in the project, the price of structural steel nearly doubled in a 9-month period. The historic increase in the price of structural steel along with delayed delivery dates posed a serious threat to the project budget as well as to the ability to complete the project on schedule. PCC evaluated other foundation options to the traditional use of steel pile foundations. PCC elected to use 14-in square precast, prestressed concrete friction piles for the foundations of six bridge structures. MoDOT had not used prestressed concrete piling in bridge foundations for more than 30 years. PCC quickly developed the material and construction specifications for this cost-effective and timesaving design solution. PCC collated the best material specifications and design features from several sources and prepared a material specification and standard plan for the project-specific concrete piles.

The fast fabrication and delivery of the concrete piles (about 3 weeks compared to 16 weeks for steel piles) were crucial to the project and provided flexibility in the construction schedule, thus having a direct impact on road closures and detours and, consequently, construction congestion. The information learned and plans and specifications prepared are expected to greatly benefit MoDOT on future projects.



### ***Inverted-T Bent Cap and a Link Slab for a Joint-Free Bridge Deck***

The project included a new SPUI on I-29/35 over Front Street. Two innovative features employed in the design of the three-span single-point bridge introduced immediate cost savings and reduced future maintenance expenses: an inverted-T bent cap and a link slab for a joint-free bridge deck. The inverted-T bent cap eliminated the negatives of an integral bent cap while maintaining the reduced structural depth for required vertical clearance over Front Street. The prestressed girders were designed simple-span for dead loads and live loads. The ends of the girders supported by the inverted-T bent cap were allowed to rotate with elastomeric expansion bearings. Thus, the prestressed girders are expected to function as designed for the design service life of the bridge. The inverted-T bent cap was a valuable alternative because vertical clearance was critical and the economics demanded the use of prestressed girders.

The standard approach is to provide a mechanical or controlled expansion joint in the bridge deck slab when using simply supported prestressed girders. Although a joint is a functional element of a bridge, it is expensive to install and maintain. As it wears and deteriorates, it commonly contributes to increased road noise from traffic and increased roughness. The functionality of the joint deteriorates over time as a result of debris accumulation. This deterioration leads to the damage of other bridge elements with the infiltration of water and deicing chemicals through the joint. PCC determined that the best solution for the section of the deck slab connecting the two adjacent simple-span girders would be a link slab. A link slab essentially functions as a hinge because it is substantially less stiff than the composite section of the prestressed girders. The link slab eliminates joint leakage associated with the low durability of a joint and minimizes future maintenance costs. With the link slabs at the intermediate inverted-T bents and integral end bents, the SPUI bridge over Front Street has joint-free bridge decks, improving ride quality and smoothness.

### **Public Outreach**

The kcICON project used a variety of tools to inform the public about project issues and gather input and feedback from affected travelers, commuters, and communities. Public outreach was allocated 5 of the 100 points used in evaluating competing contractor proposals.

At the beginning of the project, a CAG consisting of 12 members named by local leaders was established. During the procurement phase, 20 of the 100 total points used to evaluate competing proposals was assigned to the CAG for the architectural style and design aesthetics of the new Missouri River bridge. This level of project involvement had never been attempted by a State DOT. The kcICON project team continued to fully engage the CAG throughout the project. The CAG met monthly with MoDOT's project leadership and provided invaluable direction and insight to the project team. The CAG also served as a sounding board for various project issues. The CAG provided a link between the project team and the broader stakeholder community and offered feedback on a multitude of project issues in a timely manner. The CAG was critical to the success of the project.

A project hotline with an easy-to-remember phone number (816-841-8888) was used on this project. The hotline number was promoted on all communication materials. Callers had the

option of listening to prerecorded schedule information or speaking directly with a project representative at the project office during normal business hours. If the line was busy, calls were forwarded to MoDOT's Traffic Operations Center. Each call on the project hotline was entered into the project's database so it could be easily tracked by when it was received and when a final response was given.

The kcICON project was one of the first of its kind in the country to use multiple online channels (such as a dedicated Web page, dedicated YouTube® site, and dedicated social networking sites such as Facebook® and Twitter®) to disseminate information to the general public (figures 63 through 67).

The kcICON project maintained a comprehensive project Web site ([www.kcicon.com](http://www.kcicon.com)) to inform the public about construction schedules and detour routes as well as other information. Users could also leave comments or request additional project information. Associated with the project Web site were three new project Web cams that MoDOT installed along the Missouri River to show construction of the new Missouri River bridge. Progress photos were captured between 8 a.m. and 3 p.m. daily, and Web page visitors could view the historical progress of the construction.



Figure 63. kcICON home page developed for public outreach and dissemination of information.



Figure 64. One of the three Web cams with live footage (and recorded footage) at [www.kcicon.com](http://www.kcicon.com), which received 19,615 average monthly visitors.

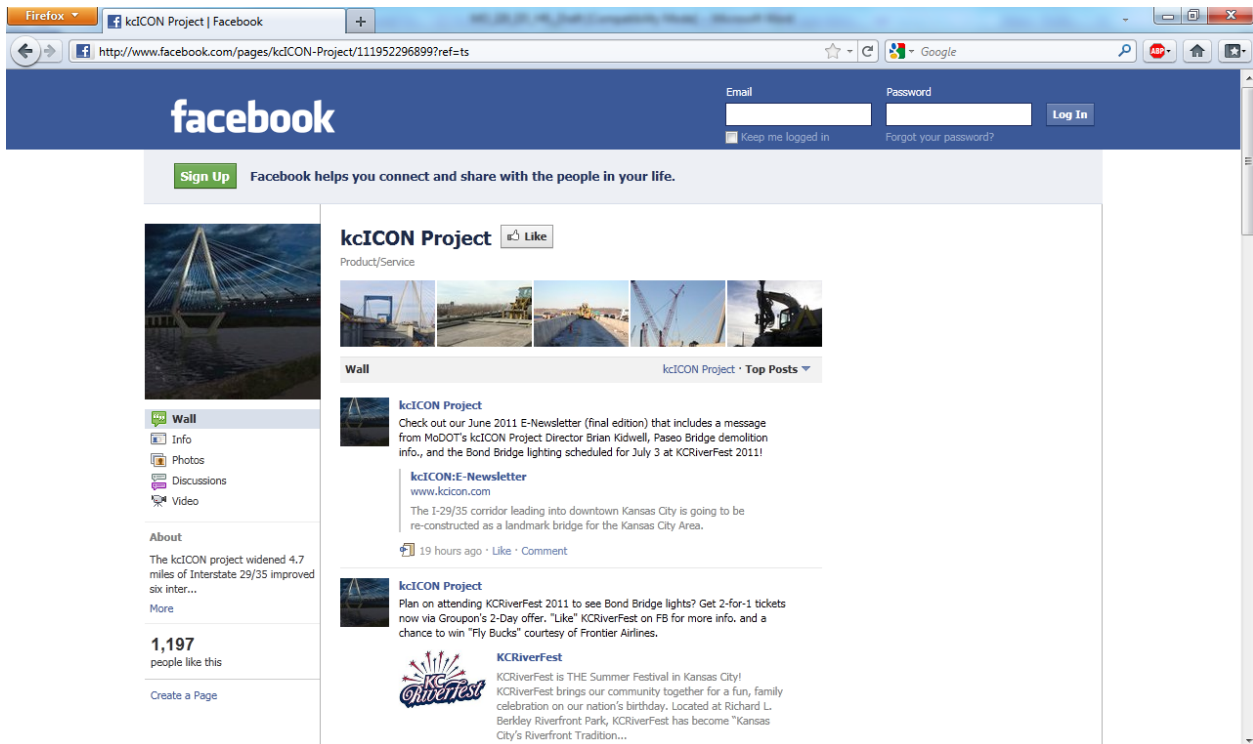

Figure 65. Facebook® page for kcICON with 1,197 “Likes.”

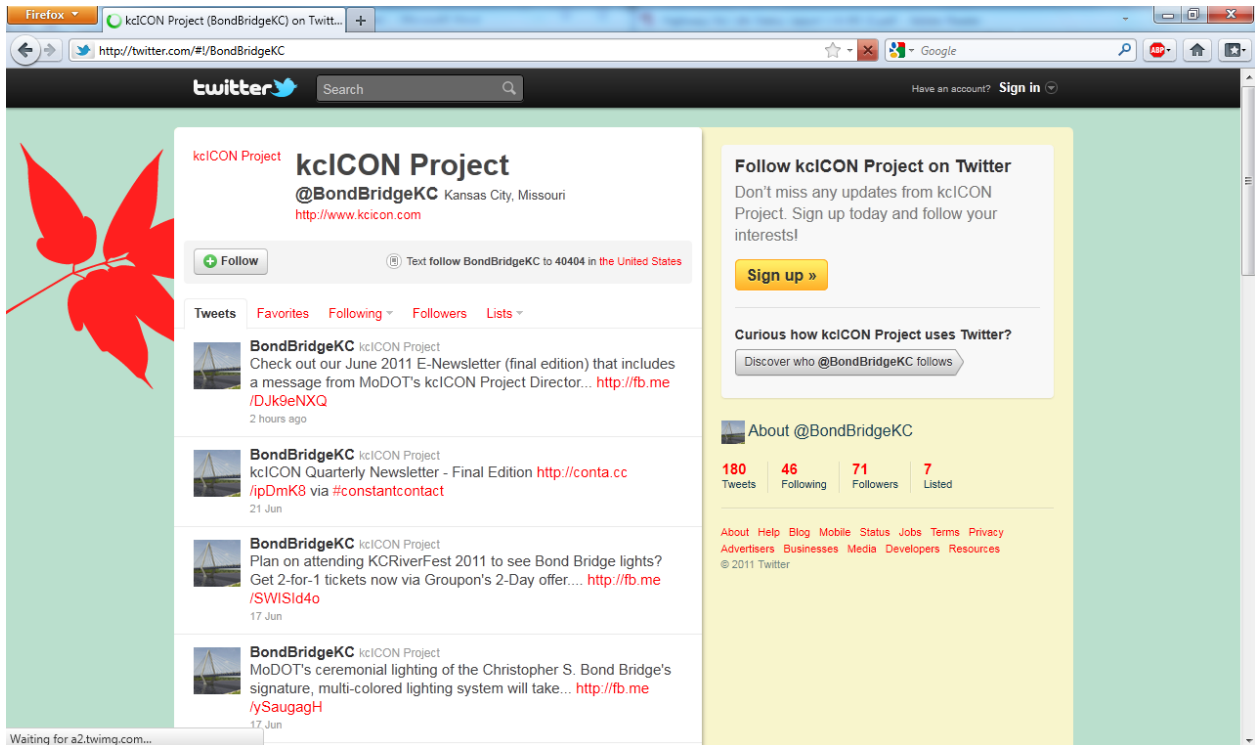

Figure 66. Twitter® page for the kcICON project disseminated information to the general public.

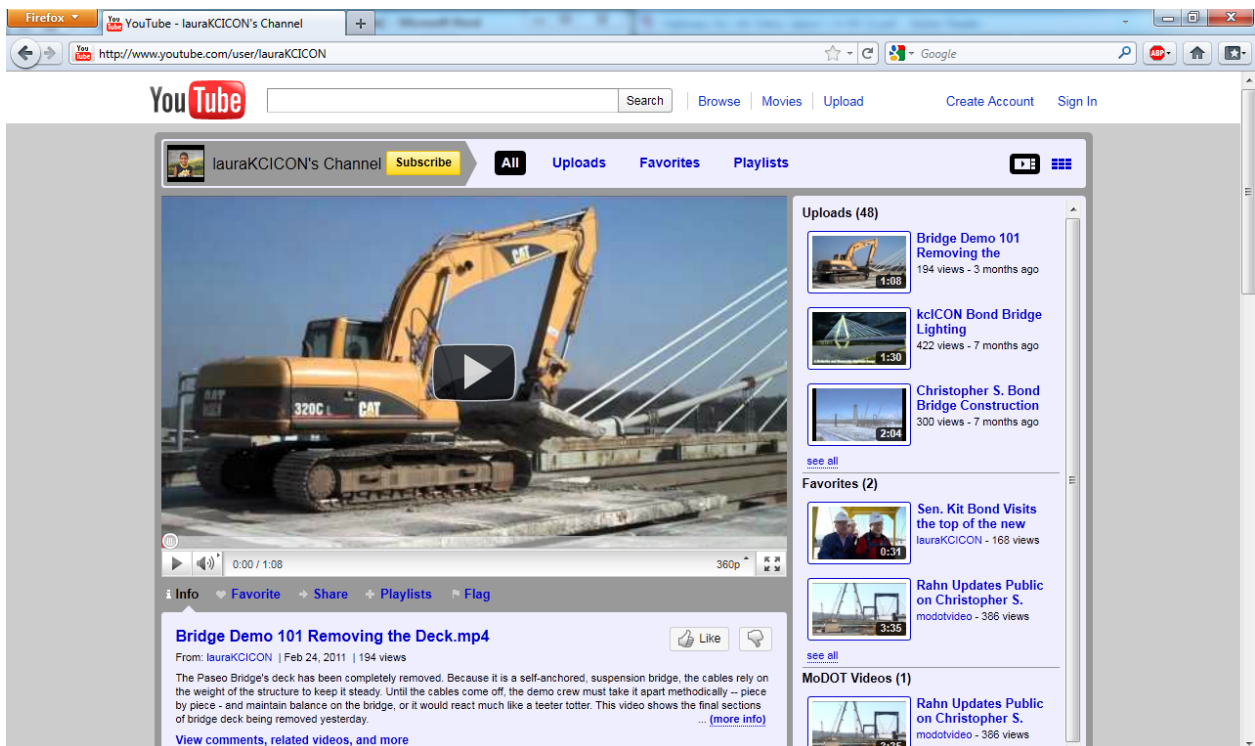

Figure 67. kcICON project YouTube® channel disseminated project videos and other information.



Throughout the project, MoDOT staff were proactive in attending public events in the project area, such as local festivals and fairs. Team members representing the project interacted with the public at these events to discuss project details and receive feedback. Project staff made presentations to or met with more than 10,000 individuals associated with numerous business, neighborhood, civil, professional, government, and student organizations. Public information staff handed out questionnaires at several business meetings requesting input from those most affected by the project. Project staff also surveyed several trucking organizations on the usefulness of the project information being disseminated. All five organizations surveyed reported using the project information and sharing it with members and drivers.

For each quarter of the year, PCC and MoDOT jointly developed and issued a quarterly outreach plan. Each plan provided information on anticipated issues to be encountered during the upcoming quarter, discussed road closures, and provided a separate program plan for each of nine identified stakeholder groups. Each outreach plan described activities and tools to be used or provided during the quarter, evaluated past activities and strategies, and discussed results and lessons learned.

### **Contractor Performance and Awarded Incentives/Disincentives**

The contractor agreed in the proposal and contracting phase to assume all responsibilities and risks and reflected the assumption of such responsibilities and risks in the contract price. Per the contract, if the contractor failed to complete the project within the time limits set in the contract documents, the contractor would have to pay substantial losses and damages resulting from the delays. This was not an issue, however, because the new corridor was open to traffic in November 2010, a full 6 months ahead of the contract schedule open-to-traffic date of June 1, 2011.

As detailed in table 2, the only incentive on this project related to on-the-job training and was not directly related to construction performance or quality. The maximum amount available for the incentives was \$625,000.

## DATA ACQUISITION AND ANALYSIS

This section discusses how well MoDOT project met the specific HfL performance goals in the areas of safety, construction congestion, quality, and user satisfaction.

### SAFETY

#### Work Zone and Facilities Safety

The HfL performance goals for safety include meeting both worker and motorist safety goals during construction. The project did not include performance goals for work zone crash rate or incident rate for worker injuries. However, both were factors in evaluating proposals as part of the “project definition” technical element, which was allocated 30 of the total 100 points. In addition, MOT was allocated 15 of the 100 points.

Before the kcICON project, crash rates in the project corridor were above the 5-year statewide average for all of the mainline sections. Three sections of highway had crash rates over twice as high as the statewide average for similar urban interstate facilities. The existing corridor had traffic operation problems that could lead to crashes because of many closely spaced interchange access points, tight weaving, and short merging and diverging areas. Incident problems also occurred because of high volumes of motorists traveling at interstate speeds while using low-speed interchange designs. In general, the tight, low-speed ramps did not provide enough ramp weave and merge distance or deceleration distance, causing congesting and crashes.

One of the five goals developed for the project was to maximize safety, mobility, aesthetics, and capacity improvements in the corridor. This was achieved by making significant interchange improvements throughout the corridor. Additional right-of-way was acquired so that interchange geometrics could be greatly improved at Armour Road, 16th Street, Bedford Avenue/Levee Road, and Front Street. Improvements were made at the southbound left-hand Paseo Street exit to address the short weave from the Front Street ramp. Tight loop ramps at the Armour Road interchange and at the 16th Street interchange were eliminated. Throughout the corridor, either additional right-of-way or retaining walls were used to improve the length of auxiliary and deceleration lanes and the grades of several ramps.

Table 4 shows the crash data for the 3 years of pre construction period, the 3 years during construction, and 3 year of post construction of the kcICON project. Although the project did not include the performance goal of work zone crash rate equal to or less than the preconstruction rate at the project location, the table shows that the crash rate increased only slightly during the construction years of 2008 to 2010. Even though lane widths were reduced, lanes were closed, shoulders were closed, speed limits were reduced, and traffic became generally more congested with a mix of operating speeds, the crash rate remained virtually unchanged during construction.

Although the project did not include the performance goal of 20 percent reduction in fatalities and injuries as reflected in 3-year average crash rates using preconstruction rates as baseline, the crash rate after construction has decreased significantly, as shown in table 4. A detailed breakdown of post construction crash data, as provided by MoDOT, has been presented in table

5. By comparison, the statewide average for similar urban interstate facilities is 141 crashes per 100 million vehicle miles. Thus, the corridor improvements described above reduced crash rates to below the statewide average for similar facilities. The HfL facility safety goal of 20 percent reduction in fatalities and injuries after construction was achieved.

Table 4. Crash data for I-29/35 before and during the kcICON project.

<b>Years</b>	<b>Total Crashes</b>	<b>AADT</b>	<b>Crash Rate (per 100 million vehicle miles)</b>
2005 through 2007	631 (3 years)	94,507	221.2
2008 through 2010	523 (3 years)	76,907	225.3
2011-February 2013	190 (38 months)	73,872	53.6

Table 5. Post construction crash data.

<b>Crash Type</b>	<b>Number of Crashes</b>	<b>Crash Rate (per 100 million vehicle miles)</b>
Fatalities	1	0.00
Injuries	39	11.0
Property damage	150	42.4
Total crashes	190	53.6

### **Worker Safety**

PCC required orientation safety training for all workers and visitors to the construction site. The safety training was conducted in-house by PCC’s safety director, hired specifically for this project. The safety director’s responsibilities were to promote safe practices in the field by doing site visits and by designating specific work crews as the Safety Crew of the Month.

PCC conducted in-house flagger certification training, rigging training, and railroad safety training for its workers and interested project personnel. PCC also established mandatory safety dress for the construction site. Everyone stepping foot on the project was required to attend a kcICON safety training session. Everyone was also required to wear, at a minimum, protective footwear, a hardhat, eye protection, and a safety vest, on the job site. As part of the kcICON Project Charter between PCC, FHWA, and MoDOT, a term goal of no lost-time incidents was established.

The contractor discussed lost-time incidents at each quarterly partnering meeting with project leadership. Although the project did not include the performance goal of an incident rate for worker injuries of less than 4.0 based on the OSHA 300 rate, for the total project, the contractor's amount of lost-time incidents was less than half the industry standard (for an equivalent project). MoDOT personnel had zero lost-time incidents.

### **CONSTRUCTION CONGESTION**

## **Faster Construction**

Design plan development for this project began in December 2007 and construction began in April 2008. Construction (including demolition of the existing bridge) was completed by July 1, 2011, an extremely short timeframe for the development of design plans and the completion of construction for a \$232 million roadway and bridge contract. While traffic was impacted during construction, the overall length of time was significantly less than with more traditional methods of project delivery. In addition, the construction occurred sooner with the volume of traffic being somewhat less than it would have been in later construction years.

PCC designated two segments of the project for early completion, but as part of the EBCP process the completion date for all segments was changed to July 1, 2011, which reduced the number of lane closure days by 474 and improved travel times.

Through the design-build process, MoDOT reduced the overall construction timeframe by more than 50 percent compared to the traditional design-bid-build process. Per MoDOT's estimate, traditional construction would have taken about 10 to 15 years on a project of this magnitude. This project was constructed using the design-build process in less than 4 years and was opened to traffic 6 months ahead of the accelerated schedule.

## **Trip Time or Queue Length During Construction**

As part of its MOT plan, PCC was innovative in the use of a coordinated towing service in the corridor to remove stranded vehicles in a timely manner and help reduce traffic congestion. PCC contracted with two local towing companies to provide free-of-charge towing services for motorists stranded within the project limits. Once either tow company was notified by local or State law enforcement, MoDOT's Motorist Assist operators, or emergency responders, the tow truck drivers were authorized to quickly tow stranded vehicles to a safe location within a maximum 8-mi radius of the project. Drivers could elect to have their car towed to one of the two participating tow lots, or they could request that their car be towed to another location within the 8-mi limit. Tow companies were under contract to PCC and were required to respond within 15 minutes. During the course of the construction, 122 motorists used this service.

A Regional Mobility Advocacy Team was formed to work with the kcICON project team to proactively identify ways to help ease construction-related traffic impacts. The Regional Mobility Advocacy Team was a working group of 18 community partners brought together to share their ideas on ways to reduce regional traffic impacts caused by kcICON construction. One strategy that resulted from the team's work was to seek and acquire additional funding for the Kansas City Area Transportation Authority so it could provide enhanced transit bus service for the corridor during the project.

Because of the scale and complexity of the various project elements, the project did not include the performance goal of less than 10 percent increase in trip time during construction compared to the average preconstruction speed, nor did it include the performance goal of a moving queue length of less than 1.5 mi (travel speed 20 percent less than posted speed).



Table 6 shows the peak hour travel time index (TTI) for 2010, as reported by the Kansas City Scout Advanced Traffic Management System (KC Scout). The data shown are for the I-29/35 northbound and southbound freeway segments (from I-70 to Parvin Road) and include the results of multiple vehicle detection stations within the segments. The segment length is 4.62 mi in each of the two directions and the entire kcICON project is within the limits of this segment.

The TTI is defined as the ratio of the average travel time over the free flow travel time for a section of the freeway and calculated as follows:

$$TTI = TT_{Avg.}/TT_{Freeflow}$$

KC Scout calculates the TTI for a station using a weighted average with the lane volume as a basis. The TTI for a freeway section is then calculated using a weighted average of all station TTI averages using vehicle miles traveled (VMT) as a basis. VMT is defined as the product of the total station volume and the distance that station represents. If the TTI is 1, then the average travel time is the same as the free flow travel time, meaning there is no delay. If the TTI is 1.5, then the actual travel time is 150 percent of the free flow time, or it takes 1.5 times as long to travel a segment than it would under uncongested conditions.

Table 6. Travel time index for I-29/35 during the kcICON project.

<b>Segment and Freeway Description</b>	<b>Total Peak Period Volume (millions)</b>	<b>Morning Peak TTI</b>	<b>Evening Peak TTI</b>
I-35 NB (I-70 to Parvin Road)	4.48	1.04	1.09
I-35 SB (I-70 to Parvin Road)	6.32	1.50	1.08

Using 55 miles per hour for the free flow speed, 4.62 mi for the segment length, and a TTI of about 1.0 during preconstruction period (based on verbal communication with MoDOT), the average delay times during the morning and evening peak hours were calculated as shown in table 7. Because of the capacity of the roadway, the average delay times during nonpeak hours are assumed to be negligible.

Table 7. Delay times for I-29/35 during the kcICON project.

<b>Segment and Freeway Description</b>	<b>Average Morning Peak Delay Time</b>	<b>Average Evening Peak Delay Time</b>	<b>Average Peak Period Delay Time</b>
I-35 NB (I-70 to Parvin Road)	12.1	27.2	19.7
I-35 SB (I-70 to Parvin Road)	151.2	24.2	87.7

## QUALITY

### Pavement Test Site

Sound intensity and smoothness test data were collected starting and ending 600 ft before and after the bridge in the outermost travel lane. Comparing these data before and after construction provides a measure of the quality of the finished bridge.

### Sound Intensity Testing

SI measurements were made using the currently accepted onboard sound intensity (OBSI) technique AASHTO TP 76-10, which includes dual vertical sound intensity probes and an ASTM-recommended standard reference test tire (SRTT). Data were collected for pre construction period and on the new bridge surface after the bridge was opened to traffic. The SI data were recorded and analyzed using an onboard computer and data collection system. Multiple runs were made in the right wheelpath with two microphone probes simultaneously capturing measurements from the leading and trailing tire-pavement contact areas. Figure 68 shows the dual probe instrumentation and the tread pattern of the SRTT.



Figure 68. OBSI dual probe system and the SRTT.

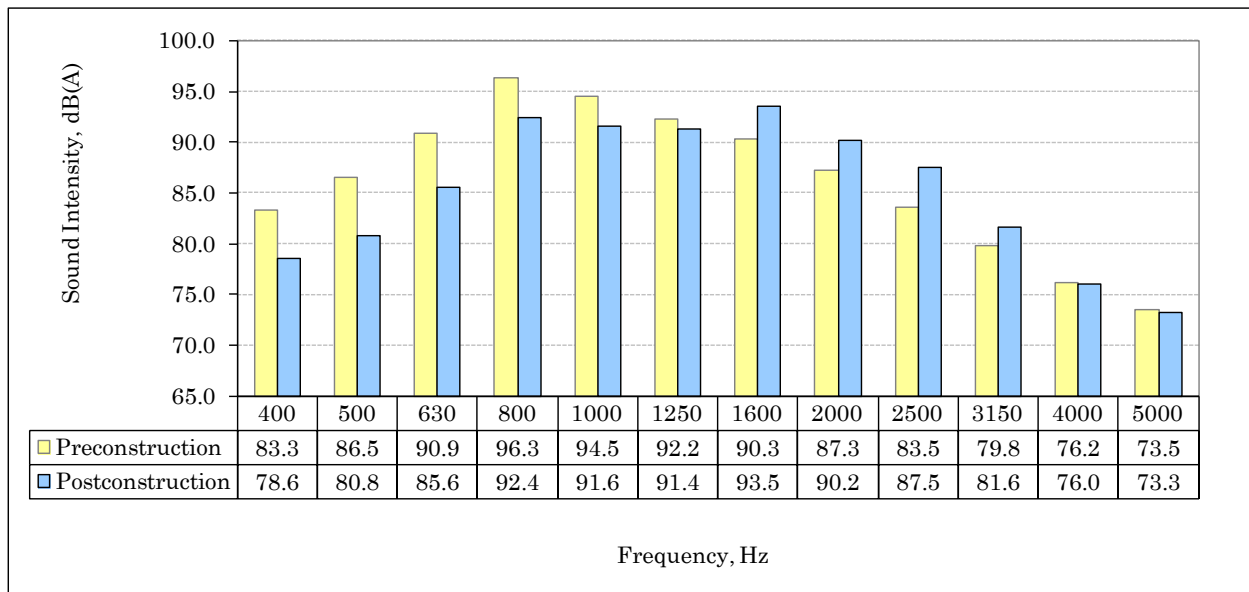

Figure 69. Mean A-weighted sound intensity frequency spectra from before and after construction.

The average of the front and rear SI values was computed to produce a global SI value. Raw noise data were normalized for the ambient air temperature and barometric pressure at the time of testing. The resulting mean SI levels were A-weighted to produce the sound intensity frequency spectra in one-third octave bands, as shown in figure 69.

SI levels were calculated using logarithmic addition of the one-third octave band frequencies across the spectra. The global SI value was 101.0 dB(A) for the existing bridge surface and 99.6 dB(A) for the new bridge. While not meeting the HfL goal of 96.0 dB(A), the new bridge surface is slightly less noisy than the existing bridge. Overall, the new bridge surface has a reduced low frequency and an increased high frequency response. In other words, the new bridge has less of a low rumble sound than the old bridge.



## Smoothness Measurement

Smoothness testing was done in conjunction with SI testing using a high-speed inertial profiler integrated with the test vehicle. The smoothness or profile data were collected from both wheelpaths and averaged to produce an IRI value. Low values are an indication of higher ride quality (i.e., smoother road). Figure 70 shows the test vehicle with the profiler positioned in line with the right rear wheel. Figure 71 graphically presents the IRI values for the preconstruction and newly constructed pavement. The existing bridge had a 198 in/mi value and the new bridge was 130 in/mi. The HfL goal for IRI of 48 in/mi, which reasonably can be met on long, open stretches of pavement, was not met on this project. Nonetheless, the new bridge surface is noticeably smoother than the old bridge.



Figure 70. High-speed inertial profiler mounted behind the test vehicle.

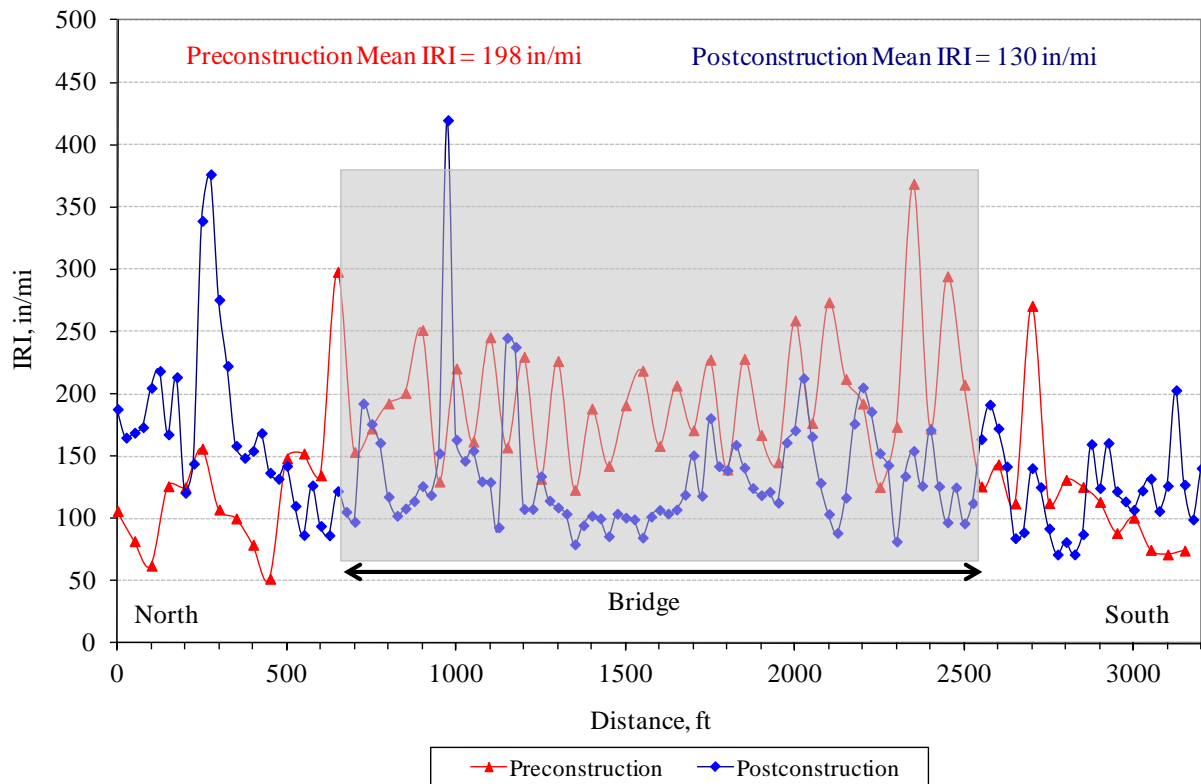

Figure 71. Mean IRI values for the bridges and roadway during pre construction period.

## USER SATISFACTION

The project did not include the performance goal of 4-plus on the 7-point Likert scale for user satisfaction with the new facility compared with its previous condition or user satisfaction with the approach used to construct the new facility to minimize disruption. However, MoDOT conducted a survey of Kansas City area residents living in District 4 as the project neared completion. The two-page survey was administered by phone to a random sample of residents. A total of 1,606 residents participated in the survey. Of those surveyed, 86.4 percent indicated that before the survey they had not heard of the kcICON project. However, of the residents who had not heard of kcICON project, 59.3 percent indicated they were familiar with the construction and improvements being made to that section of I-29/35. The results of the survey are shown in figures 72 through 80.

**1. Satisfaction with the job the MoDOT is doing with the kclCON project, which includes construction of the new Paseo bridge.**

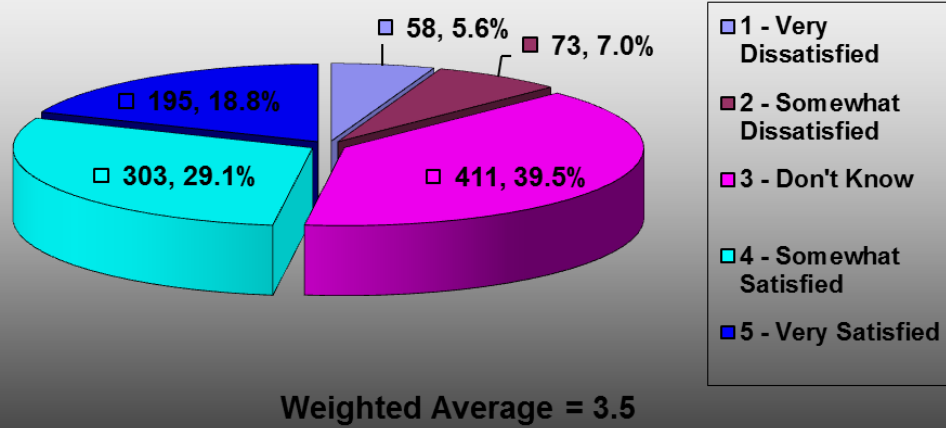

Figure 72. User satisfaction survey results on MoDOT performance.

**2. The kclCON project is a good use of taxpayer dollars.**

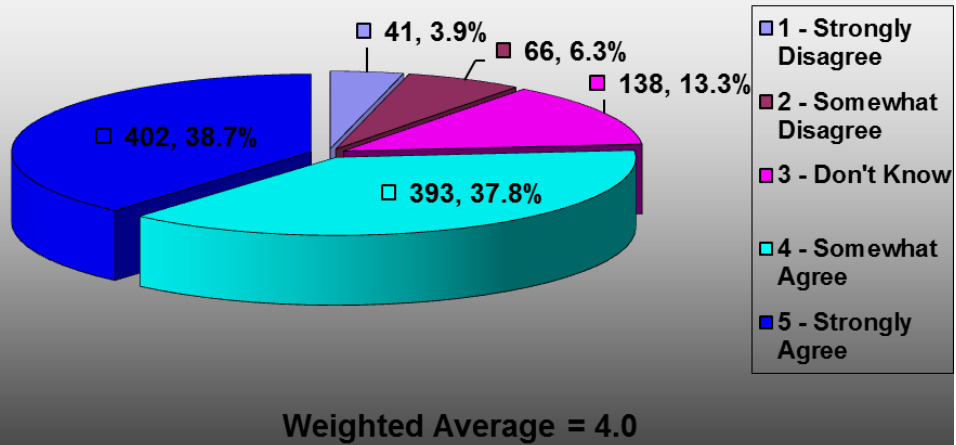

Figure 73. User satisfaction survey results on project funding.



3. The new Paseo bridge (kcICON project) will become a landmark.

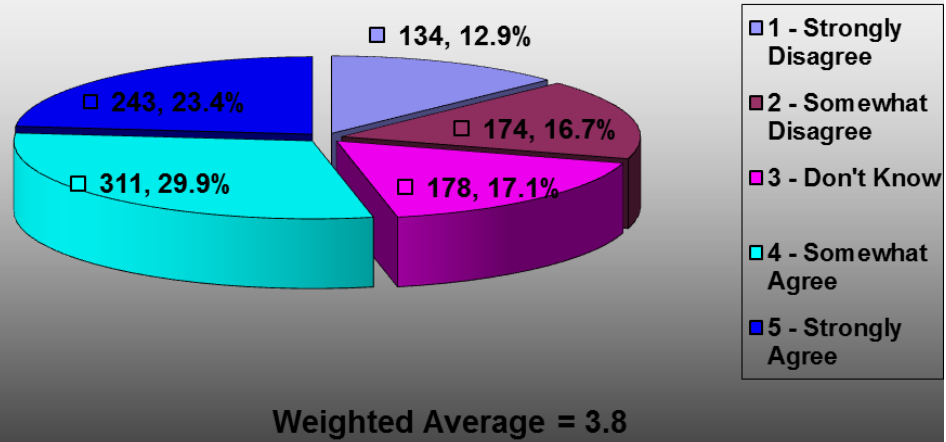

Figure 74. User satisfaction survey results on the new bridge.

4. MoDOT is keeping the public informed about kcICON project.

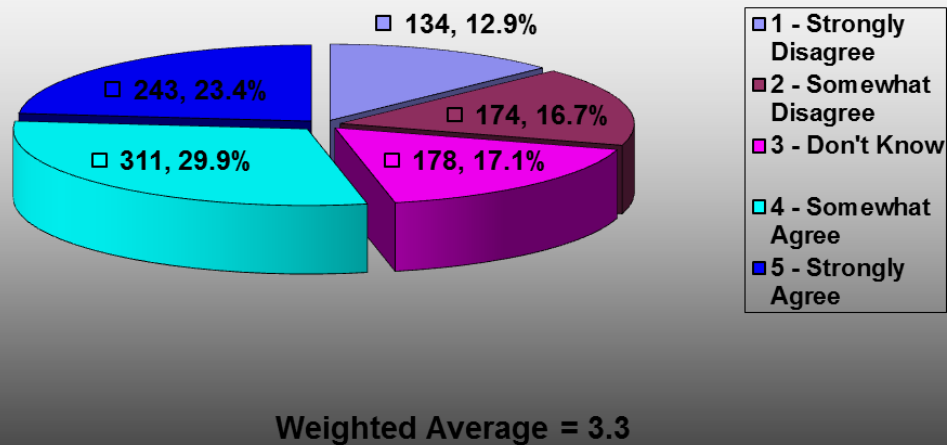

Figure 75. User satisfaction survey results on public information.

**5. kclCON project has improved my opinion of MoDOT.**

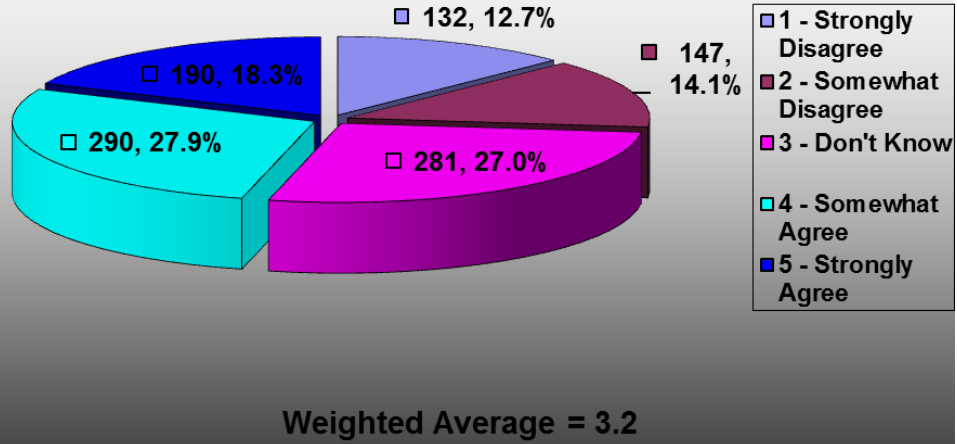

Figure 76. User satisfaction survey results on MoDOT performance.

**6. MoDOT is responsive to questions and issues regarding kclCON project.**

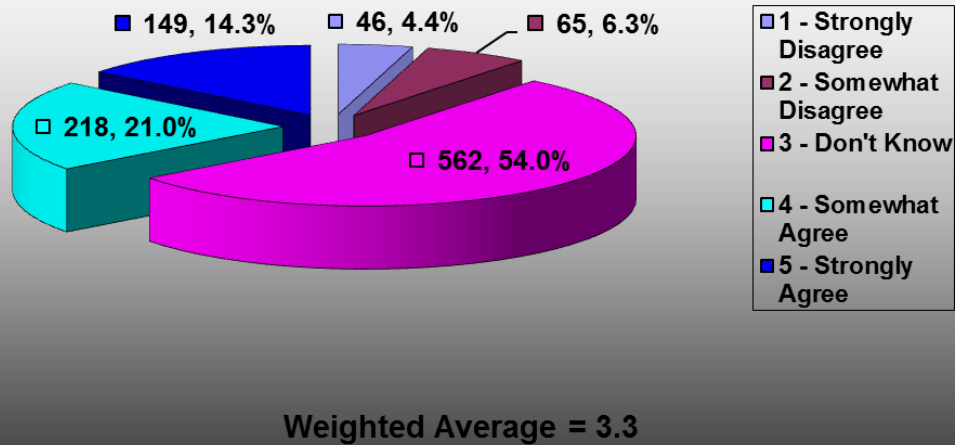

Figure 77. User satisfaction survey results on MoDOT's responsiveness on the project.

**7. MoDOT considers your needs and views in its decision-making.**

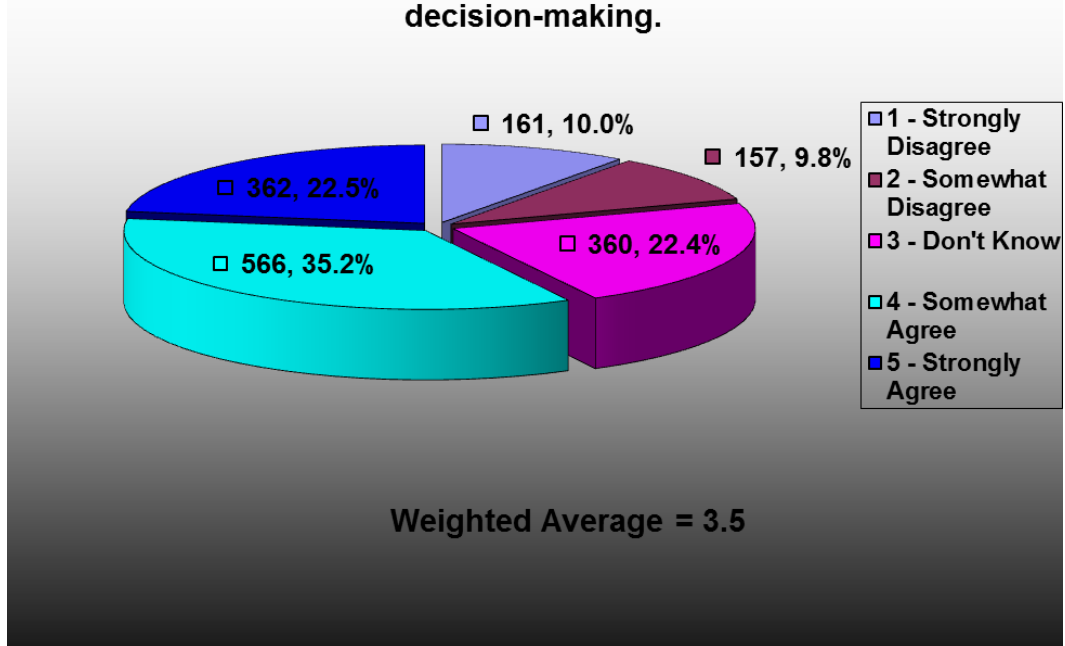

Figure 78. User satisfaction survey results on MoDOT decisionmaking.

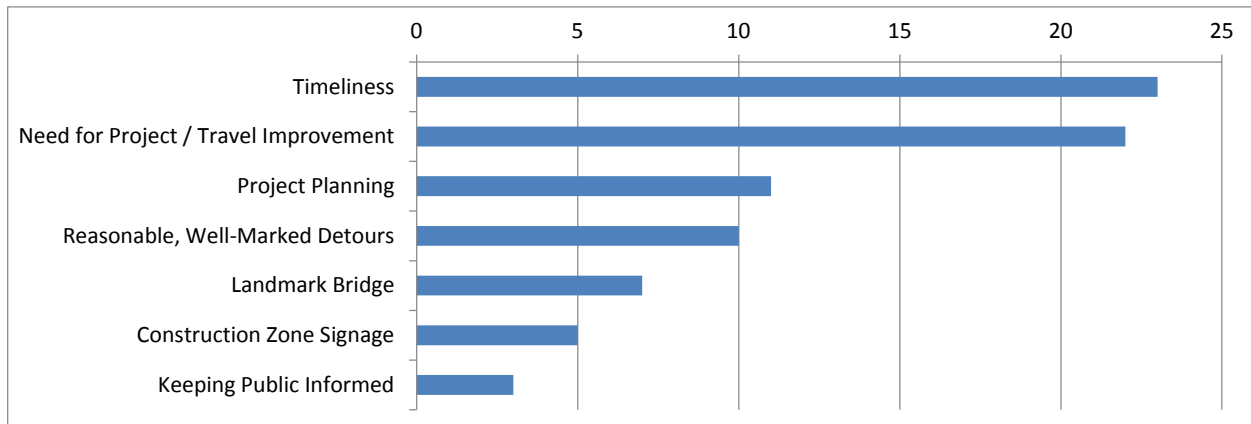

Figure 79. Project characteristics residents were most satisfied with (by percentage of respondents who were satisfied with the job MoDOT was doing on the kcICON project).

Figures 72 through 78 show user satisfaction survey results regarding MoDOT performance, project funding, the new landmark bridge, public information, opinion regarding MoDOT, MoDOT responsiveness, and MoDOT decision-making, respectively. The local public gave the project high marks for overall satisfaction. The public also recognized the importance of this bridge and considered it a good use of taxpayer money.

Of those respondents who were satisfied with MoDOT’s performance on the kciCON project, figure 79 shows the project characteristics with which respondents were most satisfied. The



responses show that the satisfied respondents were most satisfied with the timeliness of the project, travel improvements associated with the project, and the project planning.

Of those respondents who were dissatisfied with MoDOT’s performance on the kciCON project, figure 80 shows the project characteristics with which respondents were most dissatisfied. The responses show that the dissatisfied respondents were most dissatisfied with the timeliness of the project and the detours and traffic delays associated with the project.

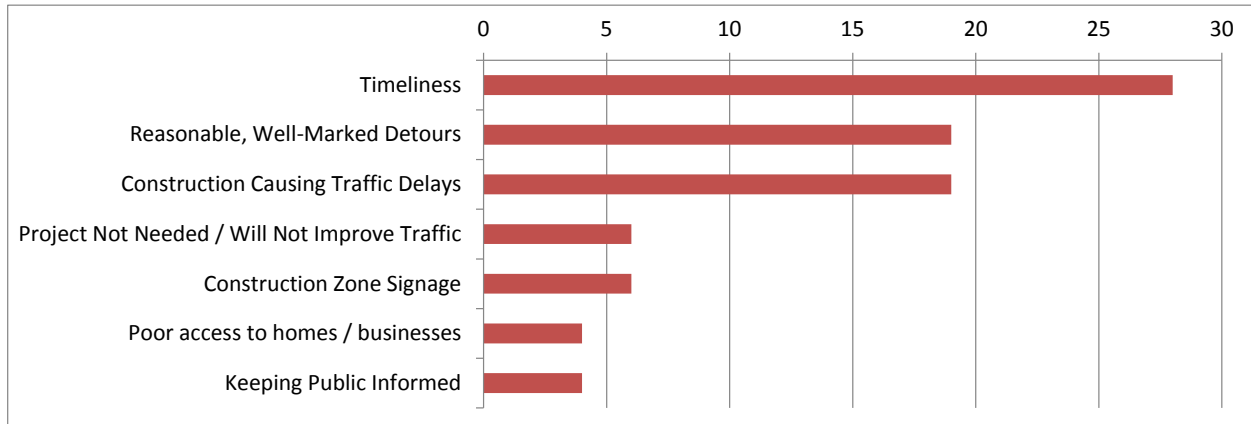

Figure 80. Project characteristics residents were most dissatisfied with (by percentage of respondents who were dissatisfied with the job MoDOT was doing on the kciCON project).

## **ECONOMIC ANALYSIS**

A key aspect of HfL demonstration projects is quantifying, as much as possible, the value of the innovations deployed. This entails comparing the benefits and costs associated with the innovative project delivery approach adopted on an HfL project with those from a more traditional delivery approach on a project of similar size and scope. The latter type of project is referred to as a baseline case and is an important component of the economic analysis. For this economic analysis, MoDOT supplied most of the cost figures for the as-built project. The assumptions for the baseline case costs were determined from discussions with MoDOT.

### **CONSTRUCTION TIME**

MoDOT estimated that it would take 10 to 15 years to complete a project of this magnitude using traditional contracting and construction methods. One of the proposal evaluation criteria was the completion schedule, which was awarded 10 points of the total possible 100 points. Construction for the project began in April 2008 and the new corridor was completed and opened to traffic in 2.75 years (November 2010), more than 6 months ahead of the contract schedule. Since no comparable baseline is available, a start-to-finish construction time of 8 years is used in the economic analysis. The savings in time on this project as compared to traditional contracting and construction methods were due to several factors including concurrent activities of design and construction, project management structure and dedicated staff allowing for timely decision-making, and quick turnaround of contractor submittals due to MoDOT project staff and contractor project staff being colocated in the same building, which promoted effective communication.

### **DETOUR**

Although traffic was detoured through segments of the project on an as-needed basis, no full-scale long-term traffic detours were used for this construction. The new bridge and other elements of the project (SPUI, ramps, sound walls, etc.) were constructed with only minor disruptions to existing traffic. As segments of the project were completed before the overall completion date, those segments were opened to traffic, reducing overall project congestion.

### **CONSTRUCTION COSTS**

Table 8 presents the breakdown of the as-built construction costs. The as-built costs were fixed by the contracting method (design-build at fixed price) and the detailed breakdown was obtained from the contractor's proposal.

Tables 9 and 10 present the breakdown of the baseline (low estimate and high estimate) costs. The baseline costs were obtained from the engineering estimates for the construction project, which were determined using standard unit costs for estimating construction items in 2005 dollars. The low-estimate costs assume that some of the existing structures can be used in the corridor improvement. The high-estimate costs assume that all existing structures would be replaced as part of the corridor improvement. These engineering estimates were obtained from

MoDOT’s preconstruction draft environmental impact statement for the project. While the individual categories are not directly comparable with the contractor’s costs because of differences in cost breakdowns, the total costs are comparable because they include all project costs. Because the baseline cost estimate is inexact, the information presented is a subjective analysis of the likely cost differential rather than a rigorous computation of a cost differential.

Table 8. kcICON as-built costs (not including right-of-way acquisition).

<b>Cost Category As Built (Design-Build at Fixed Price)</b>	<b>Breakdown</b>	<b>Total</b>
Project Management		\$ 33,863,000
Project Administration	\$ 11,945,000	
DBE and Workforce Diversity	\$ 554,000	
Partnering	\$ 28,000	
Mobilization	\$ 10,000,000	
Colocation	\$ 5,816,000	
Bonds and Insurance	\$ 5,520,000	
Quality Management		\$ 5,291,000
Design QA/QC	\$ 11,945,000	
Schedule	\$ 554,000	
Survey	\$ 28,000	
Quality Control	\$ 10,000,000	
Public Information	\$ 900,000	\$ 900,000
Design		\$ 23,000,000
Released for Construction Documents	\$ 18,800,000	
Final Design Documents	\$ 3,750,000	
Design Services During Construction	\$ 225,000	
As-Built Documents	\$ 225,000	
Environmental Management		\$ 702,000
Erosion Control	\$ 647,000	
Construction Noise and Vibration Mitigation	\$ 55,000	
Utilities	\$ 1,648,000	\$ 1,648,000
Geotechnical and Earthwork	\$ 14,965,000	\$ 14,965,000
Signing, Marking, and Lighting	\$ 4,228,000	\$ 4,228,000
Drainage and Sewers	\$ 2,480,000	\$ 2,480,000
Signals and ITS	\$ 4,995,000	\$ 4,995,000
Roadways and Pavements		\$ 22,041,000
North of the Missouri River	\$ 9,280,000	
South of the Missouri River	\$ 12,761,000	
Bridges and Other Structures		\$ 96,906,000
Paseo Connector	\$ 3,125,000	
South Viaduct	\$ 10,580,000	
Front Street Interchange	\$ 3,625,000	
Icon River Bridge	\$ 69,630,000	
North Viaduct	\$ 5,512,000	
16 <sup>th</sup> Avenue	\$ 1,419,000	
Armour/210 Highway	\$ 2,965,000	
Other Structures	\$ 50,000	
Walls		\$ 15,989,000
Retaining Walls	\$ 12,774,000	
Sound Walls	\$ 3,215,000	
Landscaping	\$ 554,000	\$ 554,000
Maintenance of Traffic	\$ 3,988,000	\$ 3,988,000
Maintenance During Construction	\$ 450,000	\$ 450,000
<b>Total Price–Equal to the RFP Fixed Price</b>	<b>\$232,000,000</b>	<b>\$232,000,000</b>



Table 9. kcICON baseline costs (low estimate, not including right-of-way acquisition).

Sub Corridor	Segment	Construction (\$)				Contingency (\$)	Design and Administration (\$)	Total (\$)
		Grade and Drain	Base and Surface	Bridge	Miscellaneous			
North of River	Armour/ Highway 210	185,760	3,107,450	7,230,500	1,183,669	2,341,476	3,090,748	<b>17,139,603</b>
	16 <sup>th</sup> Street	47,120	844,065	1,100,560	593,272	517,003	682,445	<b>3,784,465</b>
	Mainline	6,960,014	5,589,948		7,107,589	3,931,510	5,189,593	<b>28,778,654</b>
River Crossing	Landmark Bridge			54,400,000				<b>54,400,000</b>
	Bedford/ Levee		1,426,048	10,862,800	497,470	2,557,264	3,375,588	<b>18,719,170</b>
	Front Street	270,400	2,478,248	15,651,920	995,368	3,879,187	5,120,527	<b>28,395,650</b>
	Mainline	8,680,731	2,469,792		8,611,614	3,952,427	5,217,204	<b>28,931,768</b>
CBD North Loop (South of River)	Paseo Boulevard	481,479	238,472	972,640	320,510	402,620	531,459	<b>2,947,180</b>
	M-9 (Oak Street)		2,492,382	3,440,960	1,325,707	1,451,810	1,916,389	<b>10,627,248</b>
	Main Street		1,179,838	1,580,960	808,632	713,886	942,329	<b>5,225,645</b>
	Broadway		981,649	7,714,560	491,403	1,837,522	2,425,530	<b>13,450,664</b>
	Mainline	3,962,949	4,911,539	13,084,400	7,330,013	5,857,780	7,732,270	<b>42,878,951</b>
<b>Total</b>		<b>20,588,453</b>	<b>25,719,431</b>	<b>116,039,300</b>	<b>29,265,247</b>	<b>27,442,485</b>	<b>36,224,082</b>	<b>255,278,999</b>

\*MOT costs are included in the miscellaneous construction costs category.

Table 10. kcICON baseline costs (high estimate, not including right-of-way acquisition).

Sub Corridor	Segment	Construction (\$)				Contingency (\$)	Design and Administration (\$)	Total (\$)
		Grade and Drain	Base and Surface	Bridge	Miscellaneous			
North of River	Armour/ Highway 210	185,760	3,107,450	7,230,500	1,183,669	2,341,476	3,090,748	<b>17,139,603</b>
	16 <sup>th</sup> Street	47,120	844,065	2,124,240	593,272	721,739	952,696	<b>5,283,133</b>
	Mainline	6,960,014	5,589,948		7,107,589	3,931,510	5,189,593	<b>28,778,654</b>
River Crossing	Landmark Bridge			54,400,000				<b>54,400,000</b>
	Bedford/ Levee		1,426,048	19,622,640	497,470	4,309,232	5,688,186	<b>31,543,576</b>
	Front Street	270,400	2,478,248	24,430,560	995,368	5,634,915	7,438,088	<b>41,247,579</b>
	Mainline	8,680,731	2,469,792		8,611,614	3,952,427	5,217,204	<b>28,931,769</b>
CBD North Loop (South of River)	Paseo Boulevard	481,479	238,472	972,640	320,510	402,620	531,459	<b>2,947,180</b>
	M-9 (Oak Street)		2,492,382	3,440,960	1,325,707	1,451,810	1,916,389	<b>10,627,248</b>
	Main Street		1,179,838	1,580,960	808,632	713,886	942,329	<b>5,225,645</b>
	Broadway		981,649	7,714,560	491,403	1,837,522	2,425,530	<b>13,450,664</b>
	Mainline	3,962,949	4,911,539	13,084,400	7,330,013	5,857,780	7,732,270	<b>42,878,951</b>
<b>Total</b>		<b>20,588,453</b>	<b>25,719,431</b>	<b>134,601,460</b>	<b>29,265,247</b>	<b>31,154,917</b>	<b>41,124,492</b>	<b>282,454,001</b>

\*MOT costs are included in the miscellaneous construction costs category.

Tables 9 and 10 show that the engineering estimate for the project ranged from \$255.3 million at the low end to \$282.4 million at the high end compared to the as-constructed price of \$232.0 million, corresponding to a savings of 9 to 18 percent in actual construction costs.

## USER COSTS

Generally, three categories of user costs are used in an economic life-cycle cost analysis: vehicle operating cost (VOC), delay costs, and crash- and safety-related costs. The cost differential in delay costs and crash costs was included in this analysis to identify the differences in costs between the baseline and as-built alternatives. Because no detours around the project limits were included in this project, VOC is not applicable for this analysis. The baseline scenario is also assumed to not include any detours around the project limits.

### Delay Costs

The following baseline information was available for the kcICON project:

- Based on the data obtained from KC Scout, the peak period traffic volume on this segment of I-29/35 was 4.48 million in the northbound direction and 6.32 million in the southbound direction in 2010.
- The average delay time on this project was 19.7 seconds in the northbound direction and 87.7 seconds in the southbound direction during peak hours. Delays during offpeak hours were assumed to be negligible.
- About 15 percent of the peak hour traffic was commercial trucks.
- MoDOT also estimated that the daily delay times through the construction zone would be comparable between the two construction approaches (baseline versus as-built) and that the real advantage would be in the faster construction and, therefore, fewer days traffic was actually impacted.
- MoDOT estimates delay costs of \$10.30 per hour for automobiles and \$22.70 per hour for commercial trucks.

Assuming the 2010 traffic volume is representative of the traffic volume throughout the construction project, the delay costs are summarized below:

- **As-constructed delay costs:**  $2.75 \text{ years} \times [(4,480,000 \text{ vehicles/year} \times 19.7 \text{ seconds/vehicle}) + (6,320,000 \text{ vehicles/year} \times 87.7 \text{ seconds/vehicle})] \times (1/3,600 \text{ hours/second}) \times [(0.15 \times \$22.70) + (0.85 \times \$10.30)] \text{ /hour} = \$5,968,000.$
- **Baseline delay costs:**  $8 \text{ years} \times [(4,480,000 \text{ vehicles/year} \times 19.7 \text{ seconds/vehicle}) + (6,320,000 \text{ vehicles/year} \times 87.7 \text{ seconds/vehicle})] \times (1/3,600 \text{ hours/second}) \times [(0.15 \times \$22.70) + (0.85 \times \$10.30)] \text{ /hour} = \$17,362,000.$

The delay cost savings between the as-constructed and baseline alternatives are about \$11.4 million.

## Safety Costs

The preconstruction and during construction crash data for kcICON project limits obtained from District 4 between southbound continuous log 125.506 and 128.594 and northbound continuous log 0.182 to 3.24, from 2006 through November 2011, are shown in tables 11 and 12.

Table 11. Southbound kcICON crash data (before and during construction).

Summary	Preconstruction		During Construction		
	2006	2007	2008	2009	2010
Fatal	1	0	0	0	0
Disabling Injury	4	1	1	0	0
Minor Injury	28	32	26	23	23
Property Damage Only	113	156	90	82	80
Total	146	189	117	105	103
AADT	44,824	45,272	34,334	34,687	34,340

Table 12. Northbound kcICON crash data (before and during construction).

Summary	Preconstruction		During Construction		
	2006	2007	2008	2009	2010
Fatal	0	0	0	2	0
Disabling Injury	2	1	2	4	1
Minor Injury	24	20	29	10	13
Property Damage Only	90	102	99	72	49
Total	116	123	130	88	63
AADT	47,417	47,891	35,826	36,195	35,833

The crash statistics noted above were monetized by assuming Level 5 unit costs from Council et al<sup>1</sup> for the various types of historical crashes shown in tables 11 and 12. The results are summarized in table 13. The following mean comprehensive costs per crash for a rural highway with a posted traffic speed greater than or equal to 50 mi/h (80.4 km/h) were used in the analysis:

- No injury (property damage only) crash—\$7,800
- Minor injury crash—average (\$49,549, \$91,622) = \$70,586
- Disabling injury crash—\$222,311
- Fatal crash—\$4,106,620

<sup>1</sup> These costs were based on F. Council, E. Zaloshnja, T. Miller, and B. Persaud, *Crash Cost Estimates by Maximum Police-Reported Injury Severity Within Selected Crash Geometries* (FHWA-HRT-05-051), Federal Highway Administration, Washington, DC, October 2005.

Table 13. Total northbound and southbound kcICON crash data and costs (before and during construction).

Summary	Preconstruction		During Construction			Postconstruction
	2006	2007	2008	2009	2010	2011-2/2013
Fatal	1	0	0	2	0	1
Disabling Injury	6	2	3	4	1	4
Minor Injury	52	52	55	33	36	35
Property Damage Only	203	258	189	154	129	150
Total	262	312	247	193	166	190
Crash Costs	\$10,694,358	\$6,127,494	\$6,023,363	\$12,633,022	\$3,769,607	\$8,636,374
AADT	92,238	93,163	70,160	70,882	70,173	89,680
<b>Average Crash Costs</b>	<b>\$7,615,071</b>		<b>\$7,475,331</b>			<b>\$2,727,276</b>

Assuming that crash rates, crash costs, and traffic are consistent throughout the construction project for both the as-constructed and the baseline scenarios, the crash costs are summarized below:

- **As-constructed crash costs (for 8 years following start of construction):**  $2.75 \text{ years} \times 7,475,331 \text{ \$/year} + 5.25 \times 2,727,276 \text{ \$/year} = \$34,875,359$
- **Baseline crash costs (for 8 years following start of construction):**  $8.0 \text{ years} \times 7,475,331 \text{ \$/year} = \$59,802,600.$

The crash cost savings between the as-constructed and baseline alternatives are about \$24.927 million.

### COST SUMMARY

Construction costs for the I-29/35 kcICON project would have likely placed traditional delivery and construction methods (baseline) at \$23.3 million (low estimate) to \$50.5 million (high estimate) more than the as-built case (\$232 million). Moreover, delivering the project in only 2.75 years (compared to 8-plus years) saved highway users an estimated \$11.4 million in delay costs and \$25.0 million in safety costs. Therefore, the estimated total savings from using the innovative HfL project delivery approach range from \$59.7 million to \$86.8 million. In other words, the innovative approach to this \$232 million corridor improvement project had a 26 to 37 percent cost benefit over traditional methods. Highway users also benefited from the increased capacity 5-plus years earlier than compared to traditional methods.



**APPENDIX A**  
**Approved Additional Applicable Standards and Equal or Better Change Proposals.**

Table A-1. MoDOT-approved additional applicable standards. Items withdrawn or not approved are not listed.

Item	Type of Standard/Manual	Additional Applicable Standard(s) to be Used, Date or Version	Exceptions, Additions, Clarifications		Approved Date
			Section	Previously Used by	
1	Construction Specifications and General Provisions	Missouri Standard Specifications for Highway Construction, May 2006	Section 701 Drilled Shafts	Alabama DOT, Spec Section 506.3(f)	9/26/2007
3	Standard Drawings	Missouri Standard Plans for Highway Construction, July 2004 (Supplement 8/1/2006)	401.00 Type A2 Shoulders	Design-Build process changes	8/28/2007
			620.20 Snowplowable Raised Pavement Markers	Design-Build process changes	8/28/2007
			604.29C Drop Inlet-PreCast Lid	Incorporated MoDOT Response	10/9/2007
4	Roadway Design	MoDOT PDM Chapter IV Detail Design, Dated 5/1/2006	Section 4-04 Basic Design Criteria	Washington, WSDOT November 2006 Design Manual M22-01	10/9/2007
			Section 4-05 Intersections At Grade	AASHTO, Exhibit 9-55 and 9-58	7/30/2007
			Section 4-06 Interchanges, Revised 3/15/2004	Colorado, CDOT Figure 10-11B and Table 10-5	10/9/2007
			Section 4-07 Urban Projects, Revised 10/1/02	Colorado, CDOT 2005 Design Guide Section 3.3 Subsection 2	10/8/2007
5	Pavement Design	MoDOT PDM Chapter VI Pavement Structure Design, Dated 5/1/2006	Section 6-03 Pavement Structure Design	Incorporated MoDOT Response	10/9/2007
6	Bridge Design	MoDOT LFD Bridge Manual, Revised 4/01/2007	Section 1 General Design Specifications and Practices	Incorporated MoDOT Response	9/7/2007
		MoDOT LFD Bridge Manual, Revised 4/01/2007	Section 2 General Detail Practice	Incorporated MoDOT Response	9/7/2007

Item	Type of Standard/Manual	Additional Applicable Standard(s) to be Used, Date or Version	Exceptions, Additions, Clarifications		Approved Date
			Section	Previously Used by	
		MoDOT LFD Bridge Manual, Revised 04/01/07	Section 3 Design and Detail Practice	Incorporated MoDOT Response	10/5/2007
		MoDOT LFD Bridge Manual Revised 4/01/2007	Section 4 Notes for Design Plans Section 5 Bridge Division Information	Incorporated MoDOT Response	9/7/2007
		MoDOT LFD Bridge Manual, Revised 4/01/2007	Section 6 Seismic Design	Incorporated MoDOT Response	9/7/2007
		MoDOT LFD Bridge Manual, Revised 4/01/2007	Section 8 Preliminary Design	Incorporated MoDOT Response	9/7/2007
		Florida DOT Structures Design Guidelines (LFD), Dated 1/1/2000	Chapter 5.2 Foundations and Geotechnical Data: Load Cases	Florida	9/7/2007
		Michigan DOT Bridge Railing, Aesthetic Parapet Tube	Standard B-25-E and application on precast deck panels per Parkview Avenue over U.S. 131	Michigan	9/7/2007
		Minnesota DOT Bridge Railing	Standard Figure 5 397.157	Minnesota	9/7/2007
		42-in Barrier	U.S. 90 over Biloxi Bay, Sheets BB-04-062, 063, 064, 065, 066	Mississippi	9/18/2007
		6A	Landmark River Bridge(s)	PTI Guide Specification, Recommendation for Stay Cable Design, Testing, and Installation	4th Edition, all sections except Section 5; 3rd Edition, Sections 4 and 5
Design Criteria for Wind Loading on River Bridge Suspended Spans				Design-Build Process Changes	9/7/2007
CEB-FIP Model Code, 1990	Section 2.1.6. Time Effects			Industry Standard	9/21/2007
ASCE Guidelines for the Design of Cable-Stayed Bridges, 1992	Section 1.17 Maximum Deflection and Rotation			Industry Standard	10/1/2007
8	Lighting Design	MoDOT PDM Chapter	Section 8-01	Incorporated	10/10/2007

Item	Type of Standard/Manual	Additional Applicable Standard(s) to be Used, Date or Version	Exceptions, Additions, Clarifications		Approved Date
			Section	Previously Used by	
		VIII Traffic Control Devices, Dated 1/1/2006	Highway Lighting	MoDOT Response	9/26/2007
			Figure 8-01.1 to .21	Design-Build Process Changes	
9	Drainage Design	MoDOT PDM Chapter IX Hydraulics and Drainage, Dated 1/1/2006	Section 9-07 Pavement Drainage	CDOT, T-REX I-25 Project	8/17/2007
10	Signal Design	MoDOT PDM Chapter VIII Traffic Control Devices—Traffic Signals, Dated 1/1/2006; AASHTO Standard Specifications for Structural Supports for Highway Signs, Luminaires, and Traffic Signals, 4th Edition	Section 8-02 Traffic Signals	Design-Build Process Changes	10/5/2007
			Figure 8-02.1-.16	Design-Build Process Changes	8/17/2007
11	Signing and Marking Design	MoDOT PDM Chapter VIII Traffic Control Devices—Highway Signing, Dated 1/12006	Section 8-03 Highway Signing	Design-Build Process Changes	10/8/2007
		MoDOT PDM Chapter VIII Traffic Control Devices—Pavement Marking, Dated 1/1/2006	Section 8-05 Pavement Marking	Design-Build Process Changes	8/17/2007



Table A-2. MoDOT-approved equal or better change proposals. Items withdrawn or not approved are not listed.

<b>EBCP Number</b>	<b>Approved Date</b>	<b>Title</b>	<b>Proposed Change</b>	<b>Existing Requirements</b>
1	3/14/2008	Project office and field laboratory	17 various cubicles, closed-door office, shared use of contractor's QA/QC facilities, better network, additional items and features.	20 office spaces/cubicles at 100 square ft each, QA/QC lab for MoDOT use.
2	3/14/2008	Schedule software	Primavera Systems version P3; provide MoDOT with laptop with P3 software at no additional cost.	Latest version of Primavera Systems Project Planner.
4	3/14/2008	Schedule software	Primavera Systems version P3; provide MoDOT with laptop with P3 software at no additional cost (same as EBCP 2).	Latest version of Primavera Systems Project Planner.
5	7/21/2008	Modified 6-ft pavement inlet	Add project standard plan for 6-ft by 2-ft pavement inlet for use on mainline shoulders with minimum width of 8 ft. This increased width inlet is more efficient and was used in I-64 design-build in St. Louis and by CODOT.	Standards not specified as AAS shall be MoDOT standards effective on proposal due date.
7	6/17/2008	Density testing of bituminous concrete	Colorado procedure CP-81-02 and CP-82-01 at contractors discretion for lifts of 4 in or less. Cores will be used for lifts greater than 4 in. Equal quality and reliability as MoDOT method.	MoDOT TM-41 for testing asphalt using nuclear method.
8	4/30/2008	PAL and qualified lists	AAS of MoDOT's preapproval list and qualified lists. All materials will have same degree of testing as standard MoDOT job. Materials produced by PAL or qualified suppliers will be used.	Preapproval list and qualified lists.
9	4/30/2008	Rock base	Modified version of MoDOT standard specification, Section 303, Rock Base. Modified specification now matches the pavement sections shown in the contractor's proposal documents.	MoDOT standard specification, Section 303, Rock Base.
10	4/30/2008	Shear studs	1-in-diameter shear studs for bridges with composite decks when required by geometric constraints. Provide equal performance in structures as the	Standard MoDOT shear stud sizes.

<b>EBCP Number</b>	<b>Approved Date</b>	<b>Title</b>	<b>Proposed Change</b>	<b>Existing Requirements</b>
			standard MoDOT sizes.	
11	4/30/2008	HRWA addition to drilled shaft concrete	High-range water-reducing admixture (HRWA) at concrete batch plant in lieu of jobsite to provide a better mix consistency. Concern about flash set is mitigated by the retardation of the mix and proximity of the batch plants to the project site.	HRWA addition only at jobsite.
12	5/19/2008	Precast noise wall posts	Steel posts or precast posts (at contractor discretion) to support noise wall panel sections. Same type of post will be used for each entire run of a wall. Provides same structural function.	Steel posts to support noise wall panel sections.
13	12/23/2008	Revisions to MoDOT CADD standards	Enhancements to the standard MoDOT CADD level structure and symbology used to display linear features. Level structure expanded by enhancing existing and creating additional groups. New custom line styles resulting in reduction of text callouts. Line types for retaining walls, guard rails, sound walls, etc., used successfully in I-64 design-build in St. Louis.	MoDOT CADD standards.
14	10/7/2008	Caltrans roadside barriers	Caltrans standard concrete traffic barriers (Type 1 modified, Type 2, and Type 3) in addition to MoDOT standard barriers.	MoDOT standard barriers.
15	9/8/2008	Type 1 and Type 4 barriers for retaining slopes	Type 1 Caltrans and Type 4 (variable height) roadside concrete barriers to be used for retaining slopes in fill circumstances where retained earth is required. Calculations show that the proposed barriers are sufficient for retaining the earth behind them for the designated height. Other states (e.g., CDOT) use variable height barriers for this application. Proposed barrier uses more steel and concrete than the CDOT version. Barrier standard plan reviewed by PCC, Parsons, and MoDOT, jointly through the	MoDOT standard barriers.

<b>EBCP Number</b>	<b>Approved Date</b>	<b>Title</b>	<b>Proposed Change</b>	<b>Existing Requirements</b>
			RCRS process.	
16	9/8/2008	Type 1 roadside barrier moment slab, end anchorage	Addition to MoDOT standard detail drawing consisting of Type 1 concrete barrier with a moment slab end anchorage to be used at all termination ends, whether on retaining mechanically stabilized earth (MSE) wall or on grade. This allows the shoulder to be slip-form paved for a width of 5 to 8 ft from the traveled way to the concrete barrier. Moment slab end anchorage plan reviewed by PCC, Parsons, and MoDOT, jointly through the review comment and resolution process. MoDOT and FHWA approved and used successfully in I-64 design-build in St. Louis.	MoDOT standard detail drawings.
17	6/23/2008	ROW plan, Parcel 16	Modify parcel 16 to allow for the widened south viaduct structure. Existing structure has no water, sewer, or electricity. Contractor proposes to remove 20 ft from this building and add improvements to this property to make the building more marketable for resale. Modified building structure will provide the same functionality as the existing building structure but with improvements.	ROW parcel No. 16 shall not be demolished.
18	8/19/2008	Form G revisions, construction schedules	Revisions to accurately reflect construction schedule. Paseo-North I-35 will not be detoured initially, except for the use of changeable message signs. Total number of lane closure days reduced by 1,305 lane-days.	Completion and duration deadline schedule.
19	7/21/2008	Scale calibration	Revise interval to 6-month calibrations for scales and water metering devices, an industry standard practice used by MoDOT on other jobs.	Scales and water metering devices verified by the contractor every 30 days.
20	7/21/2008	Rigid culvert installation	Standard plans show pipe bedding backfill to the stringline of the pipe. Revise this detail for	Standard MoDOT plans show trench installation details for rigid

<b>EBCP Number</b>	<b>Approved Date</b>	<b>Title</b>	<b>Proposed Change</b>	<b>Existing Requirements</b>
			the use of trench boxes where necessitated by tight access conditions. Instead, backfill with pipe bedding 3 in above the top of the pipe, allowing for compaction with a remote-controlled trench roller after the trench box is moved forward. Industry standard construction method for compacting backfill while safely keeping all laborers inside the trench box. Used on other projects in Missouri.	culverts.
21	8/19/2008	Bridge I-20/35 over Armour Road	Use precast prestressed concrete girders instead of steel girders. Because noise study determined the noise wall could be constructed at a location off the bridge over Armour Road and still provide the required noise reduction, propose that the west barrier be an enhanced aesthetic concrete barrier to match the east barrier.	Southbound widening of bridge at Armour Road to be continuous steel structure. West barrier to be a standard MoDOT barrier capable of supporting a noise wall.
22	7/21/2008	Prestressed concrete piles	Use 14-in KDOT prestressed concrete piles (described in attachments) on Armour Road, 16th Avenue, North Viaduct, and Front Streets. Many States have used these for bridge foundations.	Drilled shafts, driven h-piles, and cast-in-place friction piles for bridge foundations.
23	7/21/2008	Local street curb inlets	Add a project standard plan for a Type G 5-ft by 6-ft curb inlet for use on North Kansas City (NKC) streets where there is inadequate area behind the curb to install other types of curb inlets without interfering with existing utilities. This inlet is a standard APWA Type 2 curb inlet and is a standard type curb inlet used in NKC. Widely used by all municipalities in the KC metro area.	MoDOT street curb inlet standard.
24	9/8/2008	Overhead sign truss	Incorporate MoDOT's recent statewide release of the Overhead Sign Truss Special Sheets allowing for the option to	MoDOT standard plans for signing, pavement marking, and lighting.



<b>EBCP Number</b>	<b>Approved Date</b>	<b>Title</b>	<b>Proposed Change</b>	<b>Existing Requirements</b>
			use a spread footing in lieu of a drilled shaft for butterfly and cantilever sign trusses. The special sheets deemed the spread footing to be equal to or better than the drilled shaft footing. These have been used in other MoDOT projects.	
25	9/25/2008	Prestressed strand in Type C barrier	Allow substitution of a minimum 0.5-in epoxy-coated prestressed strand for reinforcement in Type C barrier. Will not be used on any bridge barrier or curb or terminal ends. MoDOT allows prestressed strands in Type A and Type B barrier drawings. Depth gauges will be used on the concrete saw blades used to cut sawed joints to ensure that prestressed strands are not cut at sawed joints. Calculations provided in memo.	Reinforcement steel in Type C barrier.
26	8/19/2008	MSE wall foundation stabilization	Mechanically stabilized earth (MSE) wall subgrade foundation may require stabilization in some areas of the project. Geotechnical engineer recommends lime or fly ash stabilization. Because there is no MoDOT standard specification for lime stabilization, contractor proposes use of specification developed by District 4 geologist with slight modifications.	
29	8/19/2008	Modified prestressed concrete piles	In EBCP 22, proposed to use 14-in KDOT prestressed concrete piles (described in attachments) on Armour Road, 16th Avenue, North Viaduct, and Front Street. Many States have used these for bridge foundations. Propose to modify KDOT piling to improve driving toughness of the pile by raising prestressing force on the strands and increasing the compressive strength of the concrete.	Drilled shafts, driven h-piles, and cast-in-place friction piles for bridge foundations.
31	10/22/2008	Specification	Use the 10/1/2008 version of	10/1/2007 version of

<b>EBCP Number</b>	<b>Approved Date</b>	<b>Title</b>	<b>Proposed Change</b>	<b>Existing Requirements</b>
		1005 gradation change	MoDOT standard specifications Section 1005.2.4 for D Rock, thus using updated version of the specifications.	MoDOT standard specifications Section 1005.2.4 describes D Rock.
32	12/19/2008	Fly ash content in mass concrete placements	Allow replacement of up to 40 percent of portland cement concrete with approved Class C or Class F fly ash to reduce heat of hydration in placements designated as mass concrete (river bridge pylon footing placement and first pylon leg lift). Increasing the fly ash content reduces the heat of hydration of the mix, reducing the propensity of crack formation from temperature differences between the inside and outside mass of the concrete.	Existing specifications do not address mass concrete.
33	11/10/2008	Overhead sign structures	Use existing overhead sign structure in place. Upgrade the structures as per MoDOT's inspection report. Upgrade project signing to Manual on Uniform Traffic Control Devices 2009 specifications. Relocate existing logo signings to new locations and/or install new logo sign panels provided by MoDOT.	
34	11/10/2008	Section 501 high-early-strength concrete	Use nonchloride accelerating admixtures and increase the slump (to 7 in) to shorten the time taken to obtain required concrete strengths. Provides same concrete quality in less time.	MoDOT standard specifications have no provisions for high-early-strength concrete.
35	2/4/2009	Specification 1083 bearing pads	Use PTFE with fiberglass content between 10 and 35 percent, tensile strength of 1,800 psi or greater, and a slightly higher specific gravity (because of higher fiber content). This type of material has been used as an industry standard for filled PTFE in this application for many years in Missouri.	MoDOT standard specifications section 1038 describes PTFE bearings.
36	2/10/2009	Maximum slump	Increase maximum slump of	MoDOT standard

<b>EBCP Number</b>	<b>Approved Date</b>	<b>Title</b>	<b>Proposed Change</b>	<b>Existing Requirements</b>
		of pylon concrete mixes	pylon concrete to 8 in (EBCP 34 maximum slump was 7 in). Based on contractors' experience in placing and consolidating the first two hollow pylon legs, the increase in slump will provide a more uniform finish to the normal concrete surface and an additional buffer to normal slump variations. The combination of lift height, pylon inclination, and wall geometry makes slump a critical factor in successful placement and consolidation.	specifications for concrete mixes.
37	2/19/2009	Special gore exit sign, sign 171a	Location of exit sign per plans at gore area was not acceptable to Kansas City Southern because of proximity of sign to track KCSRR-3. Relocation not an option because of clearance requirements. Propose using a special 48-in by 36-in sign (as opposed to 72-in by 60-in). Reduce lettering sign for EXIT text, making it a nonstandard sign. Revised sign size acceptable to KCS because it is outside the clear zone, defined as 15 ft from track centerline.	Applicable MoDOT standards for signs.
41	5/18/2009	Concrete slump for noise wall panels	Use 8-in maximum slump for production of noise wall panels, an industry standard that has been previously approved, used, and accepted on other MoDOT projects.	MoDOT standard specifications call for 6-in maximum slump if water reducers are used.
42	6/9/2009	Type T curb inlet	Modify the project standard plan for precast Type T curb inlet; modify the gutter depression for use on Armour Road. Necessary because there is inadequate shoulder width to allow for a 4-ft bicycle lane and a 2-ft gutter depression. Modified gutter pan will be a 2 percent slope from edge of pavement to inlet opening.	MoDOT standards for curb inlets.
43	5/29/2009	Concrete bridge	Remove the 90-minute limit	MoDOT standard

<b>EBCP Number</b>	<b>Approved Date</b>	<b>Title</b>	<b>Proposed Change</b>	<b>Existing Requirements</b>
		deck curing mats	because with the use of the retarder in concrete and favorable weather during a deck pour the 90-minute limit can force the deck to be covered and potentially damaged before curing is adequate.	specification 703.3.6.3.4 calls for curing mats to be placed when the concrete surface will support mats without marring or distorting the finish, but no more than 90 minutes after the concrete is textured.
45	6/10/2009	NU precast girders	Use Nebraska DOR specifications for the fabrication of the NU-2000 girders for the Paseo overpass, allowing the fabricator to use Nebraska-approved source material, material prequalification, and self-consolidating concrete mixes, just as if the girders were being produced for Nebraska.	MoDOT standard specifications.
46	6/17/2009	LRFD for river bridge end bent design	Use LRFD AASHTO Bridge Design Specifications, 4th Edition, 2007, for the design of the river bridge end bents. Load and resistance factor design specifications are standard method for design throughout the industry.	AASHTO ASD Standard Specifications for Highway Bridges, 17th Edition, 2002.
47	7/1/2009	Painting for cable anchorage boxes inside pylon tower legs	Shop prime this fabricated structural steel element to provide protection from weathering.	MoDOT specification does not address coating of the unique, project-specific location of the structural steel anchor boxes inside the pylon upper tower legs.
48	8/10/2009	Section 501 concrete weighing tolerances	Change the plus tolerance to 5 percent. This will produce concrete with equal to or greater strength than designed.	MoDOT standard specification 501.6.1 calls for the weighing of cement to be within a tolerance of plus or minus 0.5 percent.
49	10/6/2009	Specification 1005 gradation change	Use the 10/1/2008 version of MoDOT standard specifications Section 1005.2.4 for E Rock, thus using updated version of the specifications.	10/1/2007 version of MoDOT standard specification Section 1005.2.4 describes E Rock.
53	3/10/2010	Segment completion dates	Revise segment #1 and segment #2 to match the segment #3	Segment #1 and segment #2 were



<b>EBCP Number</b>	<b>Approved Date</b>	<b>Title</b>	<b>Proposed Change</b>	<b>Existing Requirements</b>
			completion date of 7/1/2011, resulting in a reduction in total number of lane closure days by 474 and improved travel times.	scheduled in the contract documents to be completed before the completion of the rest of the project.
55	5/18/2010	Specification section 403 asphalt change	Use the 3/10/2010 version of MoDOT standard specifications Section 403 for asphaltic concrete pavement.	10/1/2008 version of MoDOT standard specification Section 403 describes asphaltic concrete pavement.
56	6/16/2010	MnDOT barrier rail modifications	Use the control joint details from the newer version of MnDOT standard drawing dated 3/30/2010, which provides greater mitigation to midpanel shrinkage cracking of the barrier.	Approved as an AAS (AAS 6.15–Minnesota DOT Bridge Railing) as specified in the contract documents.
57	12/20/2010	Splash pad	Modify the project standard plan for MoDOT splash pad using the KDOT standard outlet flume, which provides the same functionality.	MoDOT standard plan for splash pad, Standard 605.10