

2011

Intelligent Asphalt Compaction Analyzer

Highways for LIFE, Technology Partnerships
Program, Federal Highway Administration

Final Report

Assistance Agreement DTFH61-08-G-00002

Performance Period October 2007 - December 2009



TECHNICAL REPORT DOCUMENTATION PAGE

1. REPORT NO. FHWA-HIF-12-019	2. GOVERNMENT ACCESSION NO.	3. RECIPIENT'S CATALOG NO.	
4. TITLE AND SUBTITLE Intelligent Asphalt Compaction Analyzer		5. REPORT DATE Updated December 2011	
		6. PERFORMING ORGANIZATION CODE DUNS No. 122592439	
7. Report Submitted by Bob Lemon President, Haskell Lemon Construction Company		8. Report Prepared by Sesh Commuri Devon Energy Hall, 110 W. Boyd St., #432 University of Oklahoma, Norman, OK 73019 (405) 325-4302 (tel); (405) 325-7066 (fax); scommuri@ou.edu	
9. PERFORMING ORGANIZATION NAME AND ADDRESS Haskell Lemon Construction Company 3800 SW 10 th Street, Oklahoma City, OK 73108-2047		10. WORK UNIT NO.	
11. CONTRACT OR GRANT NO. DTFH61-08-G-00002		12. SPONSORING AGENCY NAME AND ADDRESS Highways for LIFE Technology Partnerships Program Federal Highway Administration Office of Acquisition Mgmt. (HAAM) 1200 New Jersey Ave., SE, Washington, DC 20590	
		13. TYPE OF REPORT AND PERIOD COVERED Final Report	
		14. SPONSOR CONTACT Ms. Julie Zirlin Program Manager (202) 366-9105 (tel); Julie.Zirlin@dot.gov	
15. SUPPLEMENTARY NOTES			
16. ABSTRACT <p>This report describes the evaluation of the Intelligent Asphalt Compaction Analyzer (IACA) during the compaction of Asphalt Pavements. The IACA consists of sensors to measure the location and vibrations of the roller, an infrared sensor to monitor the mat temperature, and a display to provide the roller operator the estimated pavement density in real-time. The IACA also has built-in features to display vital compaction information like coverage and as-built density for the operator to monitor the progress during compaction.</p> <p>During the report period (2008-2010), independent contractors evaluated the IACA during the construction of both full-depth and overlays of asphalt pavements. A test protocol was developed to determine the short term, as well as the long term performance of the IACA. The evaluation was carried out by seven (7) participating contractors during the construction/remediation of the asphalt pavements across the United States. Roadway cores were extracted at randomly selected locations on the finished pavement and the density of the cores was measured using the AASHTO T-166 method. The validation of the IACA performance was performed by the comparison of the IACA estimated density with the density of the roadway cores at these random locations.</p> <p>The measurements from 180 roadway cores over the duration of the project showed that the IACA was able to estimate the density of the compacted pavement with a mean error of 0.1% (of the Theoretical Maximum Density) and a standard deviation of 0.8. Further, the estimation error had a 95% Confidence Interval of [-1.2 1.2], thereby indicating that the IACA is suitable for use as a contractor Quality/process Control tool during the construction of Asphalt Pavements.</p>			
17. KEY WORDS Intelligent Compaction, Compaction Analyzer, Neural Network, Vibration Analysis		18. DISTRIBUTION STATEMENT Unrestricted.	
19. SECURITY CLASSIF. (OF THIS REPORT)	20. SECURITY CLASSIF. (OF THIS PAGE)	21. NO. OF PAGES	22. PRICE

1.0 Executive Summary

The Intelligent Asphalt Compaction Analyzer (IACA) is a roller mountable system that is capable of estimating the level of compaction of an asphalt pavement during its construction for contractors as part of their quality/process control operations. The IACA uses a neural network to compare the vibrations of the vibratory compactor with known patterns of the vibrations estimate the density/stiffness of the pavement. The IACA technology was developed during the years 2003-2007 and was adapted for field use in 2008 with funding from the Federal Highway Administration (FHWA) under the Highways for LIFE Technology Partnerships Program and Volvo Construction Engineering. Prototype units were assembled in 2008 and their use during the compaction of Hot Mix Asphalt (HMA) pavements was demonstrated in 2009. The results of the field validation of the IACA are discussed in this report.

The chief objective of the project funded under the assistance agreement with the FHWA was the refinement of the IACA technology to enable its early commercialization. The following goals were defined in order to meet this objective.

- G1. Develop a rugged IACA module that could be easily installed on vibratory compactors for use during the construction of asphalt pavements.
- G2. Develop user manuals and calibration procedures for simplified operation.
- G3. Verify the functioning of the IACA during the construction of both full-depth asphalt pavements, as well as overlays of asphalt pavements.
- G4. Verify the ability of the IACA to detect over/under compaction of asphalt pavements.

Goal G1 was accomplished by demonstrating that the IACA unit can be installed on vibratory compactors and used for extended periods of time in harsh construction environment.

Goal G2 was accomplished by demonstrating that the IACA can be used by roller operators and other semi-skilled construction workers after proper training.

Goal G3 was achieved through the selection of construction projects across the United States involving the construction of multiple layers of asphalt pavements, both full-depth asphalt as well as remediation of existing pavements.

Goals G4 was demonstrated through the construction of as-built compaction maps and the verification of the compaction values by in-situ measurements taken on the completed pavement.

Throughout this report, the term 'level of compaction' of an asphalt pavement implies the 'density' of the pavement at the specified location. Moreover, the density is reported as a ratio of the measured density to the maximum theoretical density (MTD) for the mix. Thus, a density of 93.6% implies that the pavement is compacted 93.6% of the maximum theoretical density of the asphalt mix. The IACA has been developed as a contractor's tool but not used by the agencies as part of their acceptance programs.

1.1 Outcomes of the Study

The field evaluations reported in this study was carried out by the asphalt contractor using the equipment that they would normally utilize during the construction. Further, the IACA was used

primarily to evaluate the compaction process. The contractor was not required to adopt new compaction strategies and the IACA output was not used to alter the compaction process. The research team trained the roller operator and the construction crew on the installation and the use of the IACA but did not play a role in the selection of the test locations for validation of the IACA readings or the extraction of cores and the measurement of their density.

- The IACA was implemented using rugged, off-the-shelf components running on Windows XP platform. The components selected were off-the-shelf and readily available through several vendors.
- Installation kits including sensors and wiring harnesses were developed. The total installation time is typically less than 30 minutes. The IACA module was successfully tested on several types of Volvo (Ingersoll Rand) dual drum vibratory compactors (on IR-DD110, IR-DD118, IR-DD132, IR-DD138HF, IR-DD158).
- The calibration of the IACA was performed by the operator using menu options in the IACA's Graphical User Interface (GUI).
- In all the tests conducted as part of the study, the training and calibration of the IACA was realized in less than 2 minutes.
- Over 180 cores extracted from the completed pavement (Full depth as well as overlays) were used to verify the density estimated by the IACA.

At the beginning of the project, contractors were contacted through FHWA and through the Volvo Dealer network to solicit their participation in the study. Information on the construction schedules, type of construction, compaction equipment, and site location were used to determine the schedule for the validation study (Table A1.1 in the Appendix).

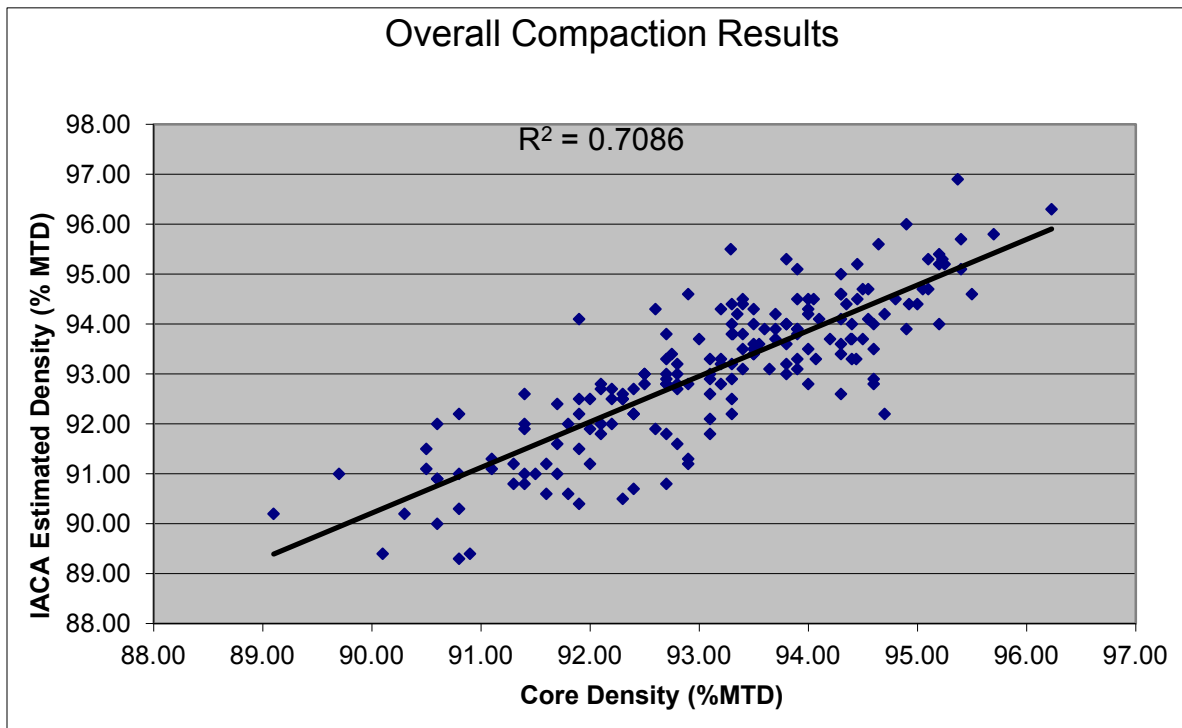

Figure 1.1 Overall compaction results

The evaluations show that the accuracy of the density estimates is within 1.5% of the actual density in 95% of the cases, thereby meeting one of the stated goals of the project. These results demonstrate that the IACA can be used for determining the quality of the asphalt pavement during its compaction. Further, the accuracy of the estimated density makes it suitable for use as a quality control tool for the contractor.

The comparison of the density of the roadway cores from the compacted pavement with the IACA output at the location of the cores is shown in Table 1.3. It is seen from these results that the overall compaction that was achieved during asphalt overlay was significantly higher than that achieved during the construction of full-depth asphalt pavements (mean density of 93.05% versus a mean density of 92.3%). Further, significant variation in the compaction was observed in the Asphalt Concrete (AC) base layers, both for full depth as well as for asphalt overlays (standard deviations of 1.62 and 1.53 respectively). Also, low compaction and high variability was seen during the construction of Full Depth Pavements.

In all, 180 roadway cores were extracted at random from the completed pavements at the test sites selected for this study and were measured using the AASHTO T-166 method¹: "Procedure for the determination of the bulk specific gravity of compacted specimens (Gmb) from pavement cores." The mean density of the cores was 93.13 (standard deviation of 1.36) corresponding to a mean in-place air void level of 6.87%. The IACA estimations at these locations show a mean density of 93.08 (standard deviation of 1.47). Null hypothesis testing showed that there is no significant statistical difference between the density measurements from the cores and the level of compaction estimated by the IACA.

Quality analysis performed using roadways cores extracted after the completion of the construction on Interstate I-86 near Hornell, NY showed that 100 percent of the compacted pavement was compacted to a density level between 92-96% of the theoretical maximum density. Actual compaction data recorded by the IACA showed that 86% of the roadway was compacted to density levels between 93-96% while 12% of the roadway was compacted to density levels between 92-93% of the theoretical maximum density. The IACA also detected that 1% of the completed pavement was under compacted (<92%) while another 1% was over compacted (> 96%).

1.2 Major findings of the study

The primary goal of the project described in this report is the development of a commercial prototype of the IACA technology to enable its early adoption into the market. The prototype developed in this study was shown to be rugged, easily installable on any vibratory compactor, and able to estimate the density in real-time with accuracy is suitable for its use as a quality control device during the construction of asphalt pavements. While the technology is maturing, there has to be a significant education of the workforce before the technology can find widespread use. The following are the major findings of the study.

- The IACA estimates reflect the level of compaction of asphalt pavements during their construction.
- The IACA is suitable for use as a quality control tool during the compaction of asphalt pavements.
- The IACA can reduce quality control personnel making spot checks behind the break down roller during the compaction process. This would have tremendous consequence on the work place safety and will be likely to increase the productivity of the crew.

- While the technology has been successfully demonstrated, the research team found reluctance on the part of the contractor crew to take on the responsibility of data collection and analysis. Significant education of the contractor and DOT personnel is required before Intelligent Compaction technologies can find wide spread use.
- The results reported in this study substantiate the ability of the IACA technology to provide continuous estimates of the density during the compaction of asphalt pavements. This technology is targeted for use by the contractor during the construction process and is not meant to replace any existing specifications or agency acceptance criteria. Further, this technology was not evaluated by any DOT personnel nor was it demonstrated to replace agency acceptance programs.

The contents of this report reflect the views of the author and of Haskell Lemon Construction Company who are responsible for the facts and the accuracy of the data presented herein. The contents do not reflect the views of the Federal Highway Administration or the Oklahoma Department of Transportation (ODOT). This report does not constitute a standard, specification, or regulation. Trade names mentioned in this report are not intended as an endorsement of any machine, contractor, process or product.

SI (METRIC) CONVERSION FACTORS

Approximate Conversions to SI Units

Approximate Conversions from SI Units

Symbol	When you know	Multiply by	To Find	Symbol	Symbol	When you know	Multiply by	To Find	Symbol
LENGTH					LENGTH				
In	inches	25.40	millimeters	mm	mm	millimeters	0.0394	inches	in
Ft	feet	0.3048	meters	m	m	meters	3.281	feet	ft
Yd	yards	0.9144	meters	m	m	meters	1.094	yards	yds
Mi	miles	1.609	kilometers	km	km	kilometers	0.6214	miles	mi
AREA					AREA				
in ²	square inches	645.2	square millimeters	mm ²	mm ²	square millimeters	0.00155	square inches	in ²
ft ²	square feet	0.0929	square meters	m ²	m ²	square meters	10.764	square feet	ft ²
yd ²	square yards	0.8361	square meters	m ²	m ²	square meters	1.196	square yards	yd ²
Ac	acres	0.4047	hectares	ha	ha	hectares	2.471	acres	ac
mi ²	square miles	2.590	square kilometers	km ²	km ²	square kilometers	0.3861	square miles	mi ²
VOLUME					VOLUME				
fl oz	fluid ounces	29.57	milliliters	ml	ml	milliliters	0.0338	fluid ounces	fl oz
gal	gallon	3.785	liters	L	L	liters	0.2642	gallon	gal
ft ³	cubic feet	0.0283	cubic meters	m ³	m ³	cubic meters	35.315	cubic feet	ft ³
yd ³	cubic yards	0.7645	cubic meters	m ³	m ³	cubic meters	1.308	cubic yards	yd ³
MASS					MASS				
Oz	ounces	28.35	grams	g	g	grams	0.0353	ounces	oz
Lb	pounds	0.4536	kilograms	kg	kg	kilograms	2.205	pounds	lb
T	short tons (2000 lb)	0.907	MegaGrams (metric Ton)	Mg (T)	Mg (T)	MegaGrams (metric Ton)	1.1023	short tons (2000 lb)	Mg (T)
TEMPERATURE (exact)					TEMPERATURE (exact)				
°F	degrees Fahrenheit	(°F-32)/1.8	degrees Celsius	°C	°C	degrees Fahrenheit	9/5(°C)+32	degrees Celsius	°F
FORCE and PRESURE or STRESS					FORCE and PRESURE or STRESS				
lbf	Pound-force	4.448	Newtons	N	N	Newtons	0.2248	Pound-force	lbf
lbf/in ²	Pound-force per square inch	6.895	kilopascals	kPa	kPa	kilopascals	0.1450	Pound-force per square inch	lbf/in ²

Table of Contents

1.0	Executive Summary	iii
1.1	Outcomes of the Study	iii
1.2	Major findings of the study.....	v
2.0	Introduction.....	1
2.1	Need Statement	1
2.2	Background	2
2.3	Goals of the Highways for LIFE Technology Partnerships Program	2
2.4	Organization of the Report	3
3.0	Project Description and Work Plan	4
3.1	Phase 0 - Refinement of Research Prototype (September – December 2007)	4
3.2	Phase 1 - Development of Commercial Prototype (February – November 2008).....	5
3.3	Phase 2 - Field Validation of the Commercial Prototype (January - December 2009)	6
	A. Selection of users and test sites for Phase II IACA testing.....	7
	B. Installation and operability testing of the IACA (Short term testing)	7
	C. Long term performance of the IACA during compaction operations	7
4.0	Background and Operational Principle of the IACA	9
4.1	Functional Requirements of the IACA.....	9
	4.1.1 Sensing Requirements	10
	4.1.2 Operational Requirements.....	10
	4.1.3 Calibration Requirements	10
	4.1.4 Display and Recording Requirements	11
4.2	Principle of operation of the IACA	11
	4.2.2 Implementation of the IACA	12
	4.2.3 Training of the Neural Network	13
	4.2.4 Calibration of the Analyzer	14
	4.2.5 Validation of the Analyzer.....	15
	4.2.6 Procedure for calibrating the IACA during the compaction of an asphalt pavement.....	15
5.0	Results of Field Demonstrations	17
5.1	Accuracy of IACA Measurements.....	17
5.2	Quality Analysis of Pavement Construction.....	21
5.3	Ease of IACA installation and calibration	25
6.0	Field Demonstrations of the Intelligent Asphalt Compaction Analyzer.....	30
6.1	Field Demonstration - Reading, Pennsylvania (June 01 - 05, 2009).....	30
	6.1.1 Discussion of Results	32
6.2	Field Demonstration - Tecumseh Road, Norman, OK (March 02, 2009)	33
	6.2.1 Discussion of Results	34

6.3	Field Demonstration - US-65, Carrollton, MO (September 02, 2009).....	36
6.3.1	Discussion of Results	36
6.4	Field Demonstration - I-40, Hinton, OK (June 10- July 10, 2009).....	38
6.4.1	Discussion of Results	41
6.5	Field Demonstration - I-86, Howard, NY (July 22-24, 2009)	43
6.5.1	Discussion of Results	44
6.6	Field Demonstration - HWY 386, Cohocton, NY (August 12-17, 2009).....	45
6.6.1	Discussion of Results	45
6.7	Field Demonstration - I-35, Norman, OK (June 17, 2009 - April 21, 2010)	47
6.7.1	Discussion of Results	48
6.8	Field Demonstration - I-35, Ardmore, OK (July 01 - 31, 2009).....	49
6.8.1	Discussion of Results	50
6.9	Field Demonstration - US-69, Muskogee, OK (April 2009)	50
7.0	Conclusions and Scope of Future Work	51
7.1	Partnership for Success.....	52
7.2	Opportunities for Wide-Scale Implementation and Challenges	52
	References.....	54
	Appendix	57
	Appendix A1	58
	Appendix A2	62
	A2.1 Protocol for short run field tests	63
	A2.2 Protocol for extended run field tests	64
	Appendix A3	66

ACKNOWLEDGEMENTS

The author would like to express their sincere appreciation to the Federal Highway Administration (FHWA) and Oklahoma Department of Transportation (ODOT) and Volvo Construction Equipment Company for providing the funds to support the work presented in this report. Special thanks and appreciation are due to Mr. Eric Weaver, Civil Engineer, FHWA Turner-Fairbank Highway Research Center, Mr. Victor (Lee) Gallivan, Asphalt Pavement Engineer, FHWA, and Mr. William "Bill" King, Jr., LTRC Asphalt Research Engineer, for their assistance throughout this project.

The results presented in this report would not have been possible without the substantial help of the following organizations: A. L. Blades & Sons, Inc; Kinsley Construction; Silver Star Construction; Haskell Lemon Construction Company; APAC Construction; Journagan Construction; and Glover Construction. The author would like to thank these contractors for their willingness to work with the research team and their flexibility in accommodating the needs of the team

The author would also like to Haskell Lemon Construction Company, EST Inc., and Volvo Construction Equipment Company for their assistance at every stage of the project.

LIST OF PARTICIPATING ORGANIZATIONS

S. No	Contractor/ Contact	Address
1	A. L. Blades & Sons, Inc	7610 County Route 65, P. O. Box 590, Hornell, NY 14843 (607) 324-3636
2	Kinsley Construction	2700 Water Street, York, PA 17405 (717) 741-3841
3	Haskell Lemon Construction Co.	3800 South West 10 th , Oklahoma City, OK 73108 (405) 947-6069
4	Silver Star Construction (2 crews)	2401 S Broadway St, Moore, OK 73160 (405) 793-1725
5	APAC Construction (Dale Williams, MoDoT)	Missouri (573) 526-4353; (573) 442-0146
6	Journagan Construction (Dale Williams, MoDoT)	Missouri (573) 526-4353; (417) 839 217
7	Glover Construction	Tulsa, Oklahoma (918 -686-8081)

2.0 Introduction

The Intelligent Asphalt Compaction Analyzer (IACA)¹⁵ is a device that has been demonstrated to assist contractors during the construction of an asphalt pavement continuously in real-time, over the entire length of the pavement during its construction. Quality control techniques currently used in the field involve the measurement of density at several locations on the completed pavement or the extraction of roadway cores. These methods are usually time consuming and do not reveal the overall quality of the construction. Furthermore, any compaction issues that are identified cannot be easily remedied after the asphalt mat has cooled down. The ability of the IACA to estimate the level of compaction of the asphalt pavement during its construction will enable the roller operator to identify and remedy under-compaction of the pavement while avoiding over-compaction.

In recent years, several Intelligent Compaction (IC) technologies have been introduced by manufacturers of vibratory compactors^{4,8,11,19,28,32-34,45}. Uniform compaction of both soil and aggregate bases is achieved through the variation of the machine parameters (amplitude and frequency of vibrations, vectoring of the thrust, etc.). Dynamic control of the machine parameters allows for the application of the vibratory energy only to under-compacted areas and thereby preventing over-compaction and ensuring uniform compaction of the soil/aggregate base³³⁻³⁵. These IC techniques hold promise for the future and their performance is being evaluated by several agencies, including the Federal Highway Administration (FHWA)²¹.

In contrast to the IC technologies being offered in the market place today, the IACA is a measurement device that does not control any aspect of the machine behavior. Further, the IACA is a standalone device that can be retrofitted on any existing vibratory compactor. The main utility of the IACA is in providing real-time estimates of the density of the asphalt mat at each location on the pavement under construction. This information can then be utilized by the roller operator to ensure uniform compaction, address under-compaction, as well as minimize the over-compaction of the pavement.

2.1 Need Statement

Improper compaction of an asphalt mat during construction is a leading cause for the early degradation of asphalt pavements³⁶. Excessive rutting, cracking, potholes etc., that are signs of failure of asphalt pavements can be avoided by using good quality control tools during the compaction process and through the adoption of better construction practices. The most reliable method of measuring pavement density in the quality assurance process is the extraction of field cores at several locations and conducting air voids tests in the laboratory as specified in AASHTO T-166: "Bulk specific gravity of compacted bituminous mixtures using saturated surface-dry specimens." This method of testing, however, is time consuming, costly, and a destructive process. Alternative methods for in-place measurement of density of hot mix asphalt (HMA) layers include both nuclear density gauges and non-nuclear density gauges^{2,37-39}. The nuclear-based devices tend to have problems associated with licensing, equipment handling, and storage. All of these technologies allow only point-wise measurements of density during the construction of an asphalt pavement. This manual process of measurement is time consuming and results in avoidable delays in the

construction while not reflecting the overall quality of the pavement. Thus, there is a need for integrating new technology into vibratory rollers and to develop automated processes that can provide real-time data that can be used to achieve the target levels of compaction. Such a device would not only result in better quality and longer lasting pavements, but will also result in increased productivity of the construction crew, shorter construction times, and reduced construction costs.

2.2 Background

The IACA technology was developed at the University of Oklahoma, Norman during the years 2003-2006 under a research grant from the Oklahoma Center for Advancement of Science and Technology (OCAST)¹². Several tests were first conducted to characterize the compaction process in the laboratory and the data gathered was analyzed to design and develop the prototype IACA. The performance of the prototype was verified through tests in the laboratory using an Asphalt Vibratory Compactor¹³. The results indicate that the compacted specimen reached a mean density of 92.7% with a standard deviation of 0.304. The 95% confidence interval for the first set of tests obtained using the Student's t-distribution is $[92.7 \pm 0.38]$, i.e. [92.32, 93.08]. Similarly when the specified target density is 94%, the compacted specimen was found to have reached a mean density of 93.9% with a standard deviation of 0.313. The 95% confidence interval in this case was [93.48, 94.25]. The results indicate that in both the cases, there is a 95% confidence that the achieved density is within 1.25% of the target density. This compares very favorably with hand held density gauges currently used for quality control in the field¹³.

The performance of the IACA prototype was validated during compaction under a controlled set of conditions. These limited tests demonstrated that the research prototype was capable of estimating the compaction of an asphalt pavement during its construction with accuracy acceptable for use as a quality control tool¹⁷. However, the use of the technology was limited due the need for manual calibration of the IACA. Further, the IACA was implemented on a computational platform that was primarily designed for testing in the laboratory. The use of the IACA technology in the field would require the porting of the IACA application to a rugged embedded hardware that is capable of withstanding extreme vibrations and the harsh environment typically found at construction sites. The development of automated, simple to use calibration techniques, and the validation of the performance during exhaustive field testing were necessary for the IACA technology to gain acceptance.

2.3 Goals of the Highways for LIFE Technology Partnerships Program

The refinement of the IACA technology and the development of a commercial prototype were accomplished between October 2007 - December 2009 under the assistance agreement DTFH61-08-G-00002, Highways for LIFE Technology Partnerships Program, Federal Highway Administration. The prototype of the Intelligent Asphalt Compaction Analyzer (IACA) was developed during the Phase 1 of the project and its testing under real-world conditions was accomplished during the Phase II of this award. The ability of the IACA to continuously estimate the density of the asphalt pavement was demonstrated at several different sites across the country. The IACA provides the roller operator tools to address the targeted level of compaction during the construction process. During this study, the IACA was also shown to be helpful in determining the uniformity of compaction and in detecting over-compaction of pavements during construction. The results of the study carried out under this agreement are presented in this report.

"The purpose of Highways for LIFE (HfL) is to advance Longer-lasting highway infrastructure using Innovations to accomplish the Fast construction of Efficient and safe highways and bridges." †

The IACA aids the asphalt contractor in the construction of well compacted asphalt pavements. Ensuring adequate compaction and the prevention of over compaction of these pavements is critical to their longevity. Further, nondestructive evaluation of the pavements will eliminate the need for the extraction of roadway cores and thereby reduce the occurrence of pot holes and other forms of early degradation of the pavement. The compaction maps that are generated can be used to document the quality of the infrastructure right after the construction and can provide insight into factors affecting the performance of the pavement over time. The ability of the IACA to automatically estimate the density of the pavement will also reduce the need for the test personnel to take spot measurements of the density during the construction of the pavement, thus improving the workplace safety. Therefore, the IACA innovation will directly advance the HfL's goals of improving workplace safety and the improvement in the quality of the highway infrastructure.

2.4 Organization of the Report

This report documents the activities designed to meet the project goals and the results achieved during the three phases of the project. The tasks for Phase 0, Phase I, and Phase II of the project and the milestones in the development process are first discussed in Section 3. The background of the IACA technology and the scope of the development proposed in this study are discussed in Section 4. The results of the field demonstrations are presented in Section 5. The detailed descriptions of the field evaluations are presented in Section 6. The opportunities and challenges for the IACA technology and the conclusions of this study are presented in Section 7. Protocols for the tests conducted during the course of this study, data from the field tests, and the interim reports for each of the project phases are given in the Appendix.

† Highways for LIFE, US Department of Transportation, Federal Highway Administration, <http://www.fhwa.dot.gov/HfL/> (last accessed on October 17, 2010)

3.0 Project Description and Work Plan

The development of a prototype IACA and its systematic testing during the construction of full-depth pavements as well as overlays of asphalt pavements, were carried out under the Phase 0 and Phase 1 activity of this project^{24,25}. Prior to the start of this project, the IACA training and calibration techniques were performed manually, thereby limiting the utility of the IACA. Further, the IACA was implemented on a computational platform that was primarily designed for testing in the laboratory. During the course of this project (Phase I), the IACA application was ported to a rugged embedded hardware that is capable of withstanding extreme vibrations and the environment encountered during the construction of asphalt pavements. Automated, calibration techniques were also developed and the performance of the IACA was verified during field testing conducted by the University of Oklahoma (OU) research team.

In the Phase 2 of the project, tests were conducted by independent users in order to study both the short term, as well as the long term use of IACA during the construction of asphalt pavements. In order to accomplish this objective, five (5) IACA prototypes were developed for installation on vibratory rollers. In addition, the installation kits including wiring harness, mounting brackets, and procedures for installation onto and removal from a roller were also developed. Test protocols were developed to study the factors (subgrade, underlying asphalt layers, calibration, etc) that affect the performance of the IACA, the effect of site (subgrade, compaction of underlying asphalt layers) on the calibration, and the use of the IACA to estimate the mean and variance of the density readings over the entire compacted pavement. The study was limited to the use of vibratory rollers and did not cover the use of oscillatory rollers. The detailed work plan²³ is attached in the Appendix.

3.1 Phase 0 - Refinement of Research Prototype (September – December 2007)

As noted earlier, the IACA has been developed as a research prototype and has been validated to a limited extent in the field. Research was carried out in Phase 0 of this study to automate the training and calibration process. Automation steps were first developed in the laboratory using vibration data collected during field compaction. This vibration data was first used to train the neural network in the IACA. The densities measured from the roadway cores extracted after the construction of the pavement were then used to calibrate the output of the neural network for corresponding densities²⁴. The validation of the calibration process involved the verification of the data at three different construction sites. During this phase of activity, automated calibration procedures using measurements obtained from a nuclear density gauge, as well as a non-nuclear density gauge were also developed. At each of these sites, the IACA was then calibrated using density measurements from roadway cores and the performance was validated by comparing the IACA estimations against core densities.

The following were the goals for this phase of the project.

- a. Develop a procedure to automatically train and calibrate the IACA using measurements of the roller vibrations during compaction.
- b. Validate the training procedure under laboratory setting using real field data.
- c. Demonstrate the training and calibration procedure during preliminary field experiments.

The following are the summary results of this phase of the project:

- a. A low cost WAAS GPS receiver, Trimble ProXT³⁵, capable measuring position with sub-meter accuracy, was integrated with the IACA and automatic calibration procedures were developed. The calibration and training procedures developed were verified using construction data from prior research.
- b. Preliminary studies were conducted during the construction of a full-depth pavement at three sites (base, intermediate layers and shoulder) and the calibration procedure was validated. Test results show that the density estimated by the IACA compares well with the density measured from roadway cores. Results from the 14 core locations indicate that the mean error between the IACA estimations and the actual density as measured from the core is less than 1 pcf (pound-per-cubic-foot) with a 95% confidence interval of less than 3 pcf.

The results of the Phase 0 of the project indicate that the IACA can estimate the density of the asphalt pavement with an accuracy that is suitable for quality control during the construction of the asphalt pavement. The integration of low-cost GPS sensor also improves the commercial feasibility of the technology. Based on the results of Phase 0, the project team commenced the next phase of the project, i.e. the development of a IACA prototype as described in the detailed work plan²³.

3.2 Phase 1 - Development of Commercial Prototype (February – November 2008)

In this phase of the proposed development, the research prototype validated in Phase 0 was used to develop a commercializable prototype of the IACA. The first task in this process was the selection of an electronic module in a rugged enclosure that was suitable for extended operations in the field. The project team coordinated with MathWorks, Inc., and Volvo Construction Equipment to determine a target electronic control module (ECM). The IACA application was then ported onto the target ECM, and the system was validated during the construction of asphalt pavements. Simultaneously, additional sensors to record properties (e.g., temperature) of the asphalt mat were incorporated into the system. Construction sites for validating the prototype were identified and the testing of the IACA to determine the repeatability and the accuracy of the estimations were systematically carried out. This constituted the Milestone M2 of the project.

The accuracy of the density estimates and their repeatability were then investigated over a period of 9 months (March-December 2008). Sites with different mix designs, construction types, lift thicknesses, etc., were identified and the performance of the device was carefully studied. Appropriate refinement in the calibration and operation procedures was made to meet the desired performance. In addition, User Manuals, and Operator Training and Field Reporting procedures were also developed.

The following were the goals for Phase I of the project:

- a. Determine an electronic platform that is tested to SAE J1455²⁷ standard to withstand vibrations and temperature variations encountered in heavy duty off-road applications. Port the IACA application to this platform and test functionality in the laboratory.
- b. Incorporate temperature sensor, odometer, vibration switch, travel direction sensor, GPS sensor and test the commercial prototype during compaction in the field.
- c. Identify five sites for systematic testing of the IACA. The sites selected will be representative of typical construction encountered in the field and will involve full depth construction as well as rehabilitation of existing pavements. The sites will also be selected to cover different

soil types to address varying liquid limit and plasticity indices. A partial list of the test sites that have been identified and their characteristics are given in the Appendix.

- d. The performance of the IACA will be validated during the construction of the base, intermediate, and the surface layers of the asphalt pavement.

The following are the summary results of Phase I of the project:

- a. An Electronic Control Module (ECM) (IDAN²⁶ from RTD Embedded Technologies) was selected and the IACA algorithm was implemented on this platform. The selected hardware was resistant to shock and vibration and was suited for use in off-road applications. The associated software drivers and library functions also allowed the easy porting of the existing IACA application to the selected IDAN platform.
- b. The suitability and performance of the IDAN ECM was verified using vibration data collected during compaction on SH-99 at Seminole (see Phase 0 Progress Report²⁴).
- c. The IDAN prototype was evaluated during the construction of asphalt pavements across Oklahoma. Five different construction sites were selected to verify the ability of the IACA to estimate the density of the asphalt mat during the compaction operation. The selected sites had different geomorphologies and covered a range from the construction of full-depth pavements to overlays and the compaction of multiple lifts of asphalt to simple overlay of a two inch surface course. The analysis of the densities measured from roadway cores and the estimates of the IACA indicate that after calibration, the IACA was able to estimate the densities within 1.5% of the maximum theoretical density of the asphalt mix.
- d. A graphical user interface (GUI) and a display monitor were developed that enabled the operator to easily calibrate the IACA. The GUI also allows for rapid report generation for the project including as-built maps, spatial variation of the compacted density, and core locations and density measured from the cores. Pass by pass variations in density can also plotted to study the rolling pattern and the compaction quality.
- e. Manuals for calibration and evaluation of the IACA were also developed.
- f. Five sets of hardware have been purchased in order to implement five (5) IACA units for rigorous field testing during the Phase 2 of the project (January–December 2009). The team worked with Volvo Construction Equipment to determine production platform, wiring harness, mounting brackets etc. for commercial release of the technology.

The results of the Phase 1 of the project indicated that the IACA was able to estimate the density of the asphalt pavement with an accuracy that was suitable for quality control during the construction of the asphalt pavement. The prototype was rugged and could be produced at a cost that improves the commercial feasibility of the technology. Based on the results of Phase 1, the project team commenced the next phase of the project.

3.3 Phase 2 - Field Validation of the Commercial Prototype (January - December 2009)

The successful deployment of the technology will involve systematic and rigorous testing of the prototype. While the IACA evaluation during the Phase I of the project (2008-2009) was done during the construction of different type of asphalt pavements, the testing was done primarily to ascertain the ease and accuracy of the calibration process. In the Phase 2 of the project, tests are conducted by independent users to study both the short term, as well as the long term use of IACA during the construction of asphalt pavements. To accomplish this objective, a total of five prototype units were

developed for installation on Ingersoll-Rand DD138HF or similar vibratory compactors. Operators were trained on the calibration and use of the technology. The selection of potential users, the protocol for testing, and the performance measures that were studied during these tests are discussed in this section.

A. Selection of users and test sites for Phase II IACA testing

In order to comprehensively study the performance of the IACA, it is necessary to verify the functioning during the construction of Full-depth asphalt pavements, as well as overlays on existing pavements. It is also necessary to study the ability of the IACA to estimate the compaction of different layers of asphalt. At the beginning of the Phase II of the project, the Principal Investigators (PIs) coordinated with the FHWA contracting officer's technical representative (COTR) and distributed a Call for Participation to several regional Departments of Transportations (DOTs). Simultaneously, the PIs also worked through their contacts at Oklahoma Asphalt Pavers Association (OAPA) to identify likely users. The construction schedules and details provided by the end users were used to establish the test schedule for Phase II of the project. The details of the users and the information of the site are provided in Tables A1.1 and A1.2 respectively in the Appendix.

B. Installation and operability testing of the IACA (Short term testing)

The short term tests were structured to obtain feedback from a wide range of users on the installation and usage of the IACA. Specifically, these tests are intended to (a) determine the ease and effectiveness of the installation procedure, (b) the ease and the accuracy of the calibration and validation procedures, and (c) the clarity of the operator training and test procedures. In addition to these, the accuracy and verifiability of the density readings provided by the IACA was also studied. Prior to the evaluation, the research team worked with each contractor to identify the test location, to train the project crew on the test protocol, and the use of the IACA. On the day of the testing, the research team installed the IACA on the roller and helped calibrate the device. The contractor was allowed to use the IACA for a period of time (between two and four weeks) after which the IACA and the test data collected during the evaluation was sent back to the research team. The contractor was also asked to provide feedback on the IACA technology to the research team.

During the compaction, the validation was performed during the construction of each asphalt layer (AC base, intermediate, and surface) and the accuracy of the IACA estimated density was verified through the density of roadway cores.

C. Performance of the IACA during compaction operations

The testing of the IACA was designed to provide information on the consistency of the estimated values during construction. These tests were designed to address the following performance issues:

- a. How often should the IACA be calibrated in the field?
- b. Does the IACA aid or hinder workplace safety?
- c. Can the IACA estimates be used to detect soft spots in the soil subgrades during construction?
- d. Will the use of the IACA help achieve uniform compaction?
- e. Does the use of the IACA affect the productivity?

The data obtained from these tests was used to compare the compaction of different overlays on the same stretch of the pavement. The tests also helped determine if the site characteristics warrant re-calibration of the IACA during the compaction process and if the calibration can be refined over time. The impact of the technology on the productivity of the crew and workplace safety was also analyzed.

The following is a summary of the results of this phase of the project.

- a. Ten prototype units with associated wiring harness and sensors were developed and tested. The functioning of these units was demonstrated on a range of vibratory compactors being used by the contractors.
- b. The tests conducted in Phase II of the project involved the verification of the calibration and accuracy of the IACA as well as its ability to function for extended periods of time. In all the IACA was tested during the construction of full depth asphalt pavements (2 sites), construction of one asphalt layer on existing asphalt pavement (4 sites), and construction of multiple layers of asphalt on AC/PCC base (4 sites). The IACA units were tested at nine different sites across the United States. Extended testing of the IACA was conducted at the remaining three sites. The testing of the IACA was carried out by 7 different contractors.
- c. The installation of the IACA on the compactors was accomplished in less than 15 minutes. The training and calibration of the IACA was also accomplished in less than 2 minutes at each of the sites. The entire installation and calibration process was usually completed in less than an hour.
- d. The IACA estimated level of compaction was validated through comparison with over 180 cores extracted at random from the completed pavements. The IACA estimates reflected the quality of compaction in the field and were shown to be satisfactory for use as a quality control tool in the field.
- e. The IACA can map the coverage of the asphalt mat by the roller in real-time during the compaction process. This is a valuable tool and can help achieve uniformity in compaction. The built in functionality for mapping the surface temperature of the asphalt mat also helps in determining if the 'cessation temperature' has been reached after which further compaction would not be possible.
- f. The 'as-built' maps generated by the IACA are useful documentation of the contractors quality control of the constructed pavement.
- g. In the tests conducted in Phase II of this award, the IACA was calibrated only once for each pavement layer at each site. Further calibration was not required at any of the sites where the IACA was tested.
- h. The IACA was able to detect the existence of soft spots in the base layers as well as over-compaction of the mix. In addition, the IACA estimate of the pavement quality was consistent with the quality estimated using Percent-within-Limits^{9,10,22,29-31} calculations.
- i. The IACA can reduce the frequency of quality control personnel making spot checks behind the break down roller during the compaction process. This would have tremendous consequence on the work place safety and will be likely to increase the productivity of the crew.

4.0 Background and Operational Principle of the IACA

The Intelligent Asphalt Compaction Analyzer (IACA) is based on the hypothesis that a vibratory compactor and the hot mix asphalt (HMA) mat form a coupled system having unique vibration properties that can be identified by an analysis of the power spectrum distribution of the vibrations of the coupled system during the compaction process. Accelerometer measurements are used to extract relevant features from the power spectrum of the vibrations. These features are then classified by frequency and signal power and an artificial neural network-based pattern recognition approach is used to continuously measure the degree of compaction in real time.

The primary purpose of the IACA is to estimate the level of compaction of an asphalt pavement during its construction. The IACA functions on the hypothesis that the vibratory roller and the underlying Hot Mix Asphalt (HMA) pavement form a coupled system. The response of the roller is determined by the frequency of its vibratory motors and the natural vibratory modes of this coupled system. Compaction of an asphalt mat increases its stiffness and as a consequence, the vibrations of the compactor (coupled system) are altered. The knowledge of the properties of the mat and the vibration spectrum of the compactor can therefore be used to estimate the stiffness of the mat. At this time, since the quality specifications are usually specified as a percentage of the Maximum Theoretical Density (MTD) of the asphalt mix, the IACA estimates the level of compaction rather than the stiffness of the mixture. Details of the IACA design, calibration, and field validation can be found in our earlier published work¹²⁻¹⁷. The functional requirements of the IACA are discussed in the following section.

4.1 Functional Requirements of the IACA

The functional requirements of the IACA can be categorized into the following sub-groups: Sensing Requirements, Operational Requirements, Calibration Requirements, Display and Recording Requirements, and Training and User Documentation. The overall functional model is shown in Figure 4.1 and the requirements are discussed in the following sections.

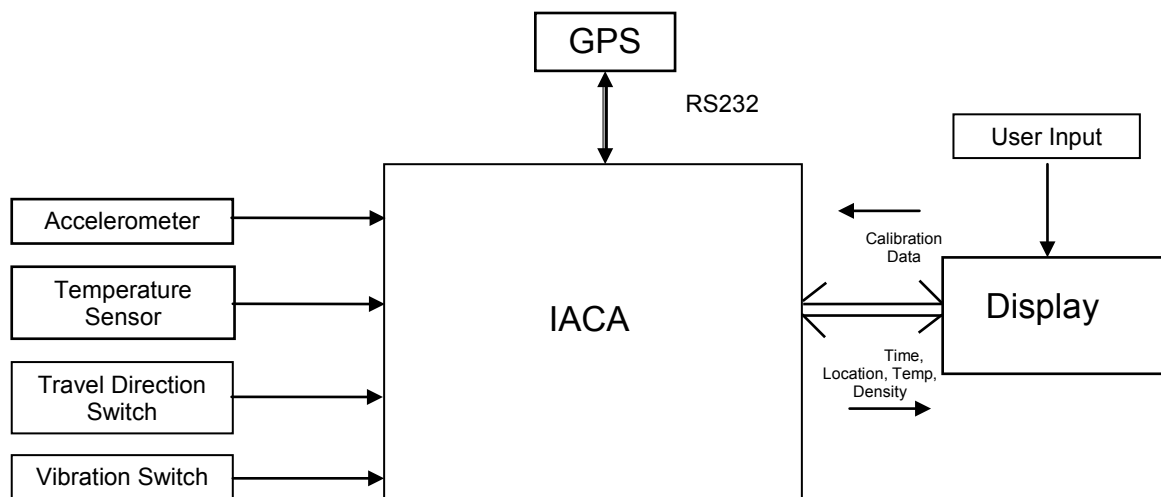

Figure 4. 1 Functional Model of the IACA

4.1.1 Sensing Requirements

The IACA should be able to record the instantaneous spatial position of the compactor on the mat. The IACA should also be able to measure through non-contact means the surface temperature of the mat. In addition, the IACA should be able to detect the state of the vibration motors (ON/OFF) and the direction of travel of the compactor (FORWARD / REVERSE).

- a. GPS Sensor. The GPS sensor should be capable of sub-meter accuracy in measurement and be capable of providing updates every second. The communication interface is through the use of the standard NEMA string and the IACA should be capable of extracting the Latitude and Longitude of the location of the compactor. The interface between IACA and the GPS unit is through RS232 or through a wireless Bluetooth connection.
- b. Temperature Sensor. A non-contact temperature sensor capable of sensing surface temperatures from 0 degrees Fahrenheit ($0^{\circ}F$) to 350 degrees Fahrenheit ($350^{\circ}F$) should be integrated with the IACA. The temperature should be read in at a minimum once every second. The temperature input is typically an analog voltage with a swing between 0 and 5 volts. Calibration routines should account for the DC bias and conversion factor of the sensing device.
- c. Travel Direction Switch Sensor. The IACA should be able to detect the switch status of the roller to determine the direction of travel. This input is typically a digital input to the IACA having discreet logic level (0 or 1) corresponding to Forward / Reverse.
- d. Vibration Switch Sensor. The IACA should be able to detect the switch status of the roller to determine when the vibration motors are turned on. This input is typically a digital input to the IACA having discreet logic level (0 or 1) corresponding to ON/OFF.
- e. Accelerometer Sensor. The IACA should be capable of reading the acceleration of the drum through a tri-axial accelerometer mounted on the frame of the drum. The output of the accelerometer is an analog voltage between 0 and 5 volts. The vertical acceleration of the drum must be sampled at a 1000 Hz (once every milli-second).

4.1.2 Operational Requirements

The IACA reads in the sensed vibrations of the drum and estimates the corresponding density of the mat. The density estimates along with the location of the roller on the mat, the current process time, and the mat temperature are to be displayed to the user at least once every second. The error in the estimated density and the actual density measured from the roadway core should be within limits comparable to point wise density measurement tools in use today (accuracy of PQI 301 is within $\pm 1.5 pcf$ and for nuclear density gauge the accuracy is within $\pm 2.5 pcf$). The density must be displayed to the user as a numeric value (1 decimal precision), as well as a slider bar that indicates the progress in compaction.

The IACA electronics must be housed in a rugged enclosure that is tested for vibration and shock, as well as environmental variables such as temperature and moisture (SAE J 1445 and SAE/TMSC environmental standards).

4.1.3 Calibration Requirements

The use of the IACA requires detailed procedures for calibrating the output of the IACA to minimize the error between the estimates and the density measured off roadway cores. The procedure must provide for calibration in the field using measurements from roadway cores, as well

as measurements taken using a non-nuclear density gauge such as PQI 301 or a nuclear density gauge like the Troxler 3450 gauge. The procedure must also provide a measure of the calibration accuracy. Once the readings from the field are input into the system, the calibration process must be automatic and result in the operational parameters (interconnection weights of the Neural Network and the calibration constants) being set in the IACA for field use during compaction.

The calibration procedures should be able to account for the location of the temperature sensor relative to the ground and provide the user the ability to calibrate the sensor in order to accurately record the surface temperature of the mat.

4.1.4 Display and Recording Requirements

The IACA display should provide the user with real-time information on the location of the compactor, the temperature of the mat, and the estimated density at the location. The density information should be displayed both in a numeric format as well as a visual indication of the level of compaction (e.g. a slider bar). The compaction data (time, latitude, longitude, temperature, density) should also be stored as a text file for retrieval and post processing to generate as-built data maps.

The display is crucial to the field validation of the IACA. Validation in the field would require real-time information of the compaction achieved at any location on the pavement. It is anticipated that the readout from the IACA would be used to correlate the spatial location on the pavement with the estimated densities. This would allow verification with densities measured from roadway cores as well as using point-wise density measuring tools.

The display should also include a mechanism for selecting prior calibration data for use during the construction. The selection of the appropriate calibration data would involve the knowledge of the construction characteristics and the mix information.

4.2 Principle of operation of the IACA

Compaction of an asphalt mat is achieved through the application of energy and pressure by a roller. The asphalt mat and the roller form a coupled system whose response is determined by the frequency of the vibratory motors of the roller and the natural vibratory modes of the coupled system. Compaction of an asphalt mat increases its stiffness and as a consequence, the vibrations of the roller are altered. The knowledge of the properties of the mat and the vibration spectrum of the roller can therefore be used to estimate the stiffness of the mat. Since the density and the modulus of the asphalt mixture are related, the IACA estimates the compacted density of the pavement rather than the stiffness.

A vibratory compactor equipped with IACA is shown in Figure 4.2(a) and the components of the IACA are shown in Figure 4.2(b). The sensor module (SM) in the IACA consists of accelerometers for measuring the vibrations of the compactor during operation, infrared temperature sensors for measuring the surface temperature of the asphalt mat, an user interface for specifying the amplitude and frequency of the vibration motors, and for recording the mix type and lift thickness. The feature extraction (FE) module computes the Fast Fourier Transform (FFT) of the input signal and extracts the features corresponding to vibrations at different salient frequencies. The artificial Neural Network (NN) Classifier is a multi-layer Neural Network that is trained to classify the extracted so that each class represents a vibration pattern specific to a pre-specified level of compaction. The Compaction Analyzer (CA) then post-processes the output of the NN and estimates the degree of compaction in

real time. Details of the IACA and its preferred embodiment are discussed in detail in the IACA patent application¹⁵.

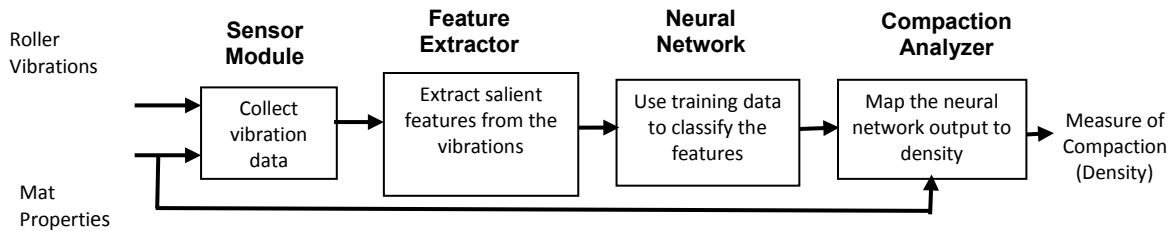
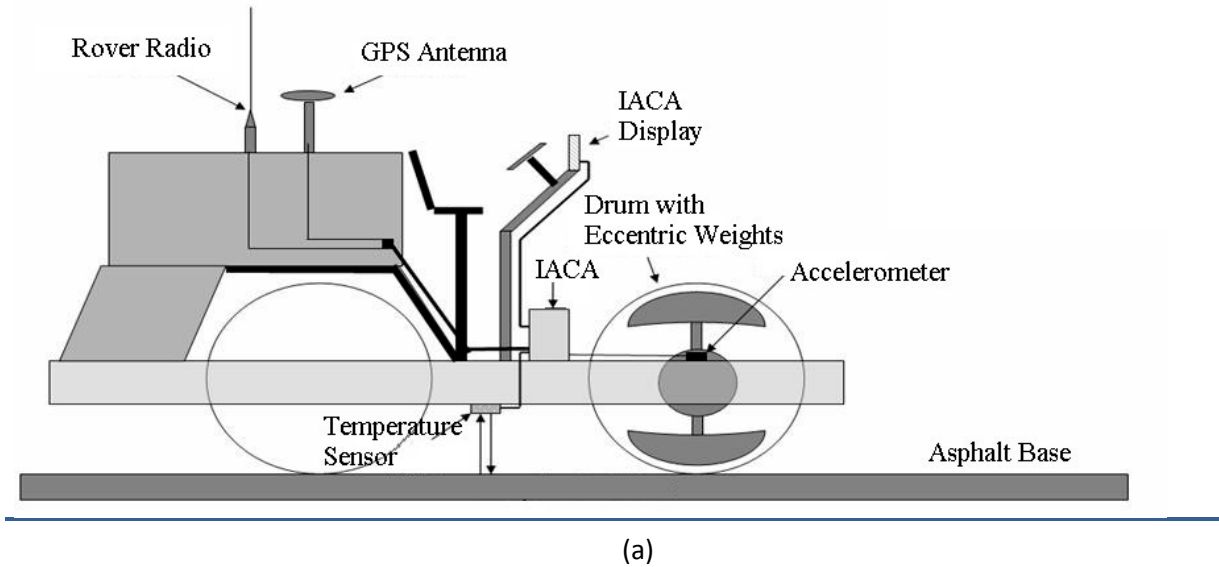

Figure 4. 2 Experimental Setup (a) Instrumentation of the compactor; (b) Functional block diagram of the IACA

4.2.2 Implementation of the IACA

The functional components of the IACA and their operational principles are described in this section.

Sensor Module. In the implementation discussed in this section, the **Sensor Module** of the IACA is comprised of an accelerometer mounted on the frame of a DD-138HFA Ingersoll-Rand vibratory compactor, an Intel Pentium based tablet PC to input the mat properties such as the mix type, binder, pavement layer, layer thickness, target density, etc., and a real-time data acquisition system. The accelerometer used was a CXL10HF3 tri-axial accelerometer manufactured by Crossbow¹⁸, capable of measuring 10g acceleration up to a frequency of 10 kHz. The accelerometer measures the vibrations of the roller frame during the compaction. The surface temperature of the asphalt mat is

measured using an infrared temperature sensor mounted on the frame below the roller. A Trimble Pro XT GPS receiver³⁵ is used to record the instantaneous location of the roller.

Feature Extractor Module. Analysis of the vibratory response of the roller requires the extraction of the frequency components of the vibrations and their amplitudes. These characteristic ‘features’ are related to the roller and the underlying pavement layers. As the pavement layer is compacted, the vibratory response of the roller changes. These changes are visible in the altered spectrum of the roller vibrations as the compaction progresses. The knowledge of these features can then be used to estimate the density of the pavement layer during its compaction.

The feature extractor module of the IACA implements a Fast Fourier Transform to efficiently extract the different frequency components of the roller vibrations. The output of the FFT is a vector with 256 elements, where each element corresponds to the normalized signal power at the corresponding frequency. Since the vibration signal of the roller is sampled at 1 kHz, the frequency spectrum is uniformly distributed from 0 and 500 Hz. In order to classify these vibrations, the 200 elements corresponding to the fundamental frequency of the roller response and its harmonics are used as input to the classifier.

Classifier Module. The artificial Neural Network (NN) classifier implemented in the IACA is a three layer NN with 200 inputs, 10 nodes in the input layer, 4 nodes in the hidden layer, and 1 node in the output layer. The inputs of the NN correspond to the outputs of the feature extraction module, i.e. in this case 200 features in the frequency spectrum. The output corresponds to a signal indicative of the level of compaction reached.

Analyzer Module. The analyzer module uses the mix parameters such as the mix type, binder, pavement layer, layer thickness, and the target density, and the calibration data to convert the output of the classifier to a value representing the density of the asphalt mat at the current location of the roller. The calibration data consists of a slope parameter and an offset parameter that is used to convert the output of the neural network, a number between 0 and 4, to a density value between 0 and 100 (typically between 85 and 96).

4.2.3 Training of the Neural Network

Central to the functioning of the IACA is the neural network that is used to classify the observed vibrations of the compactor into classes representing different levels of compaction. In order to accomplish this, the output of the feature extractor module is analyzed over several roller passes during the calibration process and the total power content in the vibration signal is calculated at each instant in time. Five equally spaced power levels are identified, and the features corresponding to these power levels are used to train the Neural Network. During compaction, the NN observes the features of the roller vibration and classifies these features as those corresponding to one of the levels of compaction. Figure 4.3 shows the features corresponding to five different compaction levels, with the lowest level corresponding to the case where the roller is operating with the vibration motors turned off and the highest level corresponding to the case where the maximum vibrations observed.

4.2.4 Calibration of the Analyzer

The calibration of the Analyzer is a two step process. In the first step, ideal compaction is assumed with the expectation that the analyzer would encounter 'Lay Down' density of the asphalt mat during the first roller pass and a density corresponding to the 'target' density during the final pass of the roller.

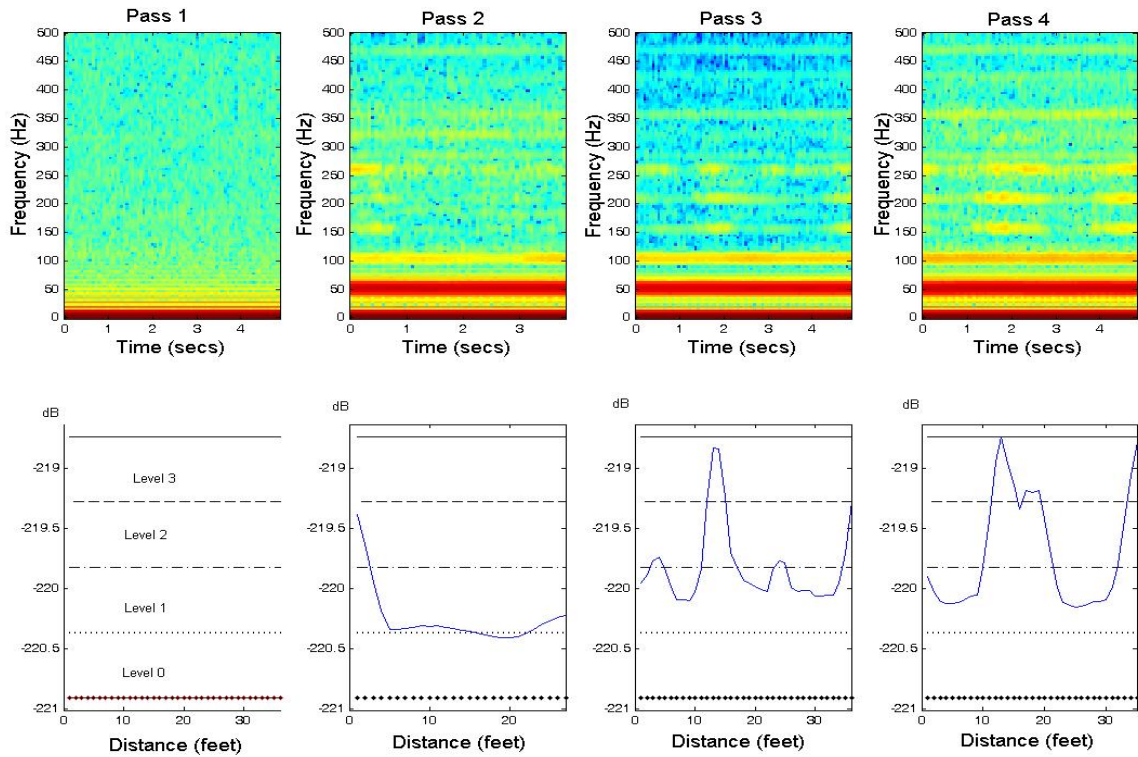

Figure 4.3 Power content of the vibration signal during successive roller passes

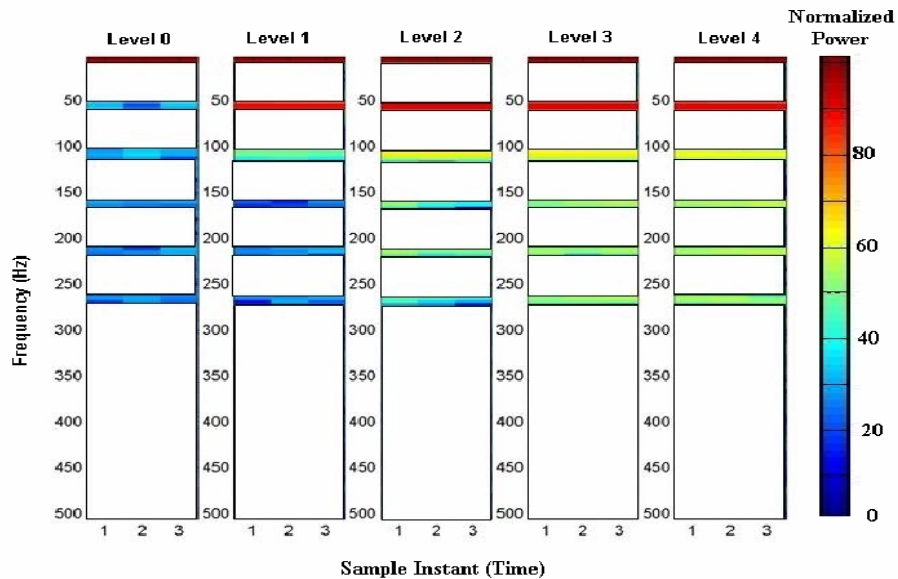

Figure 4.4 Spectral features corresponding to five levels of compaction

During the calibration process, a thirty feet section of the road is first identified and the vibration data is collected during successive roller passes over this stretch. The features extracted from this vibration data (Figure 2.3) are used to train the Neural Network in the Classifier module. After the completion of the training process, the Classifier can recognize five levels of compaction labeled from '0' through '4'. Level 0 corresponds to the situation when the vibratory motors are turned off. The initial calibration assumes that the 'Level 1' of the vibrations corresponds to the "lay down" density of the mat and the 'Level 4' of the vibrations corresponds to the target density specified for the mix. This actual density is an indicator of the maximum compaction that is achievable during field compaction of the asphalt mix and is selected as the target density for IACA calibration.

After the compaction of the 'calibration stretch', three roadway cores are extracted from known locations on the compacted pavement and their density is measured in the laboratory according to AASHTO T-166 method. The offset and slope constants for the compaction analyzer are determined to minimize the mean square error between the estimated density and the density measured from the cores².

4.2.5 Validation of the Analyzer

In order to validate the functioning of the analyzer, core locations are marked at random on the completed pavement and the location of the cores is measured using a GPS sensor. The cores are then extracted and their density is determined in the lab. The GPS readings are used to determine the density estimated by the IACA at these locations during the final compaction pass of the roller. The error between the measured and estimated densities is then studied to determine the statistical measures of performance.

4.2.6 Procedure for calibrating the IACA during the compaction of an asphalt pavement

The evaluation described above has been carried out during the construction of the Hot Mix Asphalt Pavements. The calibration stretch is shown in Figure 4.5 and the procedure for calibration is described below.

- i) The vibration data for calibration of the IACA is first acquired during the construction of a control strip. The control strip is one hundred feet (33 m) long and twelve feet (4 m) wide. A thirty foot (10 m) 'test section' is selected in the middle of the control strip and the GPS sensor is used to trigger the collection of the vibration data as the roller compacts this 'test section.'
- ii) Using the GPS sensor, the coordinates at the beginning and at the end of the test section is obtained by taking measurements at the center of the lane. These coordinates are used to automatically start and stop the collection of the vibration signals as the roller passes over the test strip.
- iii) Three test locations at the center of the lane, five feet (1.6 m), fifteen feet (5 m) and twenty five feet (8.33 m) from the beginning of the test section are marked.
- iv) Using a device similar to a 3450 Troxler Nuclear Density Gauge or a TransTech PQI 301 non-nuclear density gauge, the density of the pavement is measured after each roller pass at each of the test locations marked in step (iii).

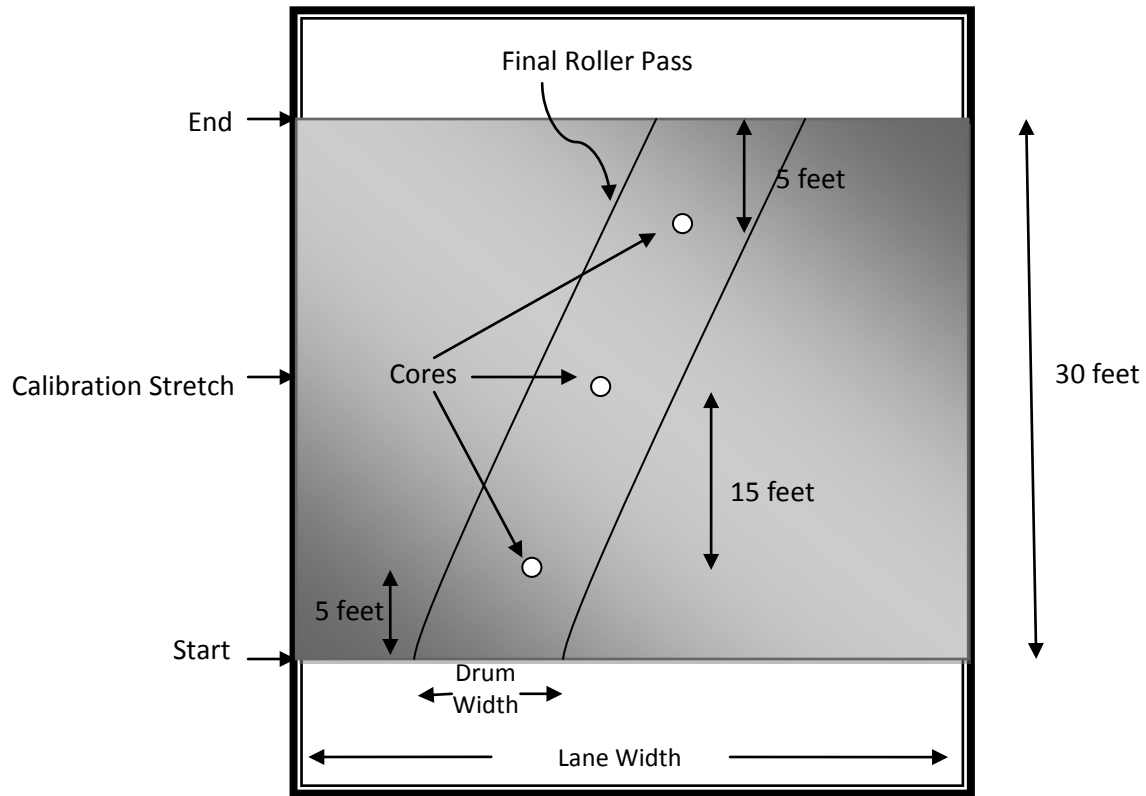

Figure 4.5 Selection of core locations after the final pass of the roller

- v) The compaction process is stopped when no appreciable increase in the density is seen after the roller pass or when roll over, i.e., reduction in measured density is observed. The core locations are marked from the center of the final roller pass at each of the test locations in step (iv). The GPS locations of the cores, as well as the density at the core and in the immediate vicinity of the core are recorded.
- vi) The cores marked in the previous step are extracted and their density is measured in accordance with the AASHTO T-166 method.
- vii) The density measurements taken after each roller pass and the densities of the extracted cores are used to train and calibrate the IACA.

5.0 Results of Field Demonstrations

The field evaluations reported in this section were carried out at 9 different construction sites operated by 7 contractors between January – December 2009. Of these, short term tests of the IACA were conducted at 6 sites and long term tests were conducted at the remaining three sites. The results from these sites are discussed in Sections 6.1-6.6 (and Sections 6.7-6.9). In all 14 contractors had responded to the invitation sent out by the research team and the FHWA, and of these 7 contractors were selected for the field evaluations. Field trials at the construction sites of the remaining contractors could not be carried out due to either scheduling difficulties or lack of follow-up by the contractors. The location of the test sites and the relevant details of the construction are given in Tables A1.1 and A1.2 in the Appendix.

The installation of the IACA was performed by the research team with the assistance of the performing contractors. The cores for calibration and validation of the IACA were marked and extracted by the contractor and their density independently was verified either by EST or the contractor. The density of the cores was determined by the AASHTO T-166 method which specifies the procedure for the determination of the bulk specific gravity of compacted specimens (G_{mb}) from pavement cores. This value is used to estimate the density of the compacted specimen and is used for comparison between roadway compaction tests and the IACA estimated level of compaction values.

5.1 Accuracy of IACA Measurements

The IACA measurements reflected the quality of compaction in the field validations that were conducted during this project. In all, 180 roadway cores were extracted at random from the completed pavements at the test sites selected for this study and their density measured using the AASHTO T-166 method. The comparison of the density of the roadway cores from the compacted pavement with the density estimated by the IACA at the location of the cores is shown in Table 5.1. The mean density of the cores was 93.13 (standard deviation of 1.36) The IACA measurements at these locations show a mean density of 93.08 (standard deviation of 1.47). Null hypothesis testing showed that there is no significant statistical difference between the density measurements from the cores and the density estimated by the IACA.

It is seen from Table 5.1 that the overall compaction that was achieved during asphalt overlay was significantly higher than that achieved during the construction of full-depth asphalt pavements. Further, significant variation in the density was observed during the compaction of the Asphalt Concrete (AC) base layers, both for full depth as well as for asphalt overlays (standard deviations of 1.62 and 1.53 respectively). Also, low compaction and high variability was seen during the construction of Full Depth Pavements.

It is to be noted that the vibratory analysis cannot be applied to static rolling. The impact of the finish rolling using pneumatic and static rollers on the density is minimal. Our studies indicate that under normal conditions the density improves by 0.75-1.0 pcf (pounds per cubic feet) due to finish rolling. This is taken into account in the calibration procedure where the density measurements used are the values measured after the finish rolling.

Table 5.1 Summary of compaction data

# Cores	Type	Mean Density* (Cores)	Std. dev (Cores)	Mean Density* (IACA)	Std. dev (IACA)	Error (IACA-Core)	Std. dev Error†	Max Error (IACA)	R ²
25	AC base (Full Depth)	92.29	1.62	92.21	1.44	-0.08	0.5	1.7	0.83
27	Intermediate (Full Depth)	93.24	0.9	93.12	1.13	-0.08	0.68	-1.3	0.63
15	Surface (Full Depth)	92.1	0.87	92.07	1.03	-0.03	0.62	-1.2	0.63
49	AC base & Intermediate (HMA Overlay)	93.05	1.53	92.91	1.56	-0.14	0.65	-1.5	0.83
64	Surface (HMA Overlay)	93.76	1.04	93.83	1.07	0.15	0.77	-2.2	0.54

* Mean density of the cores extracted after the compaction of the pavement

† Error between the measured density and the density estimated by the IACA

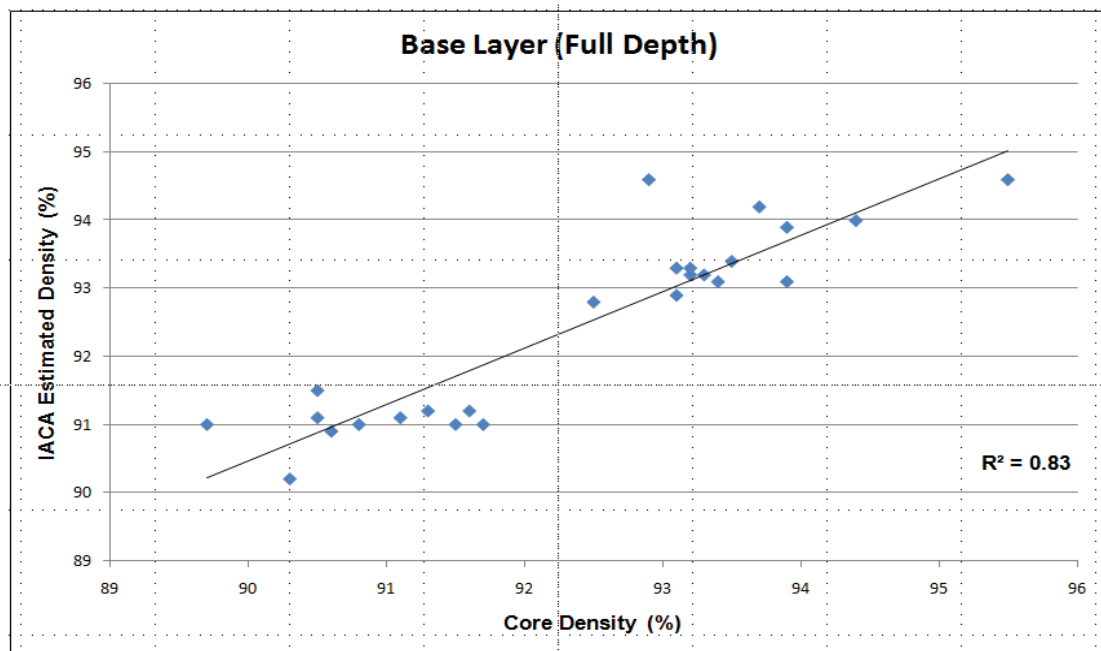

Figure 5.1 Comparison of the IACA estimated density with density determined from cores extracted from AC base layer (Full Depth construction)

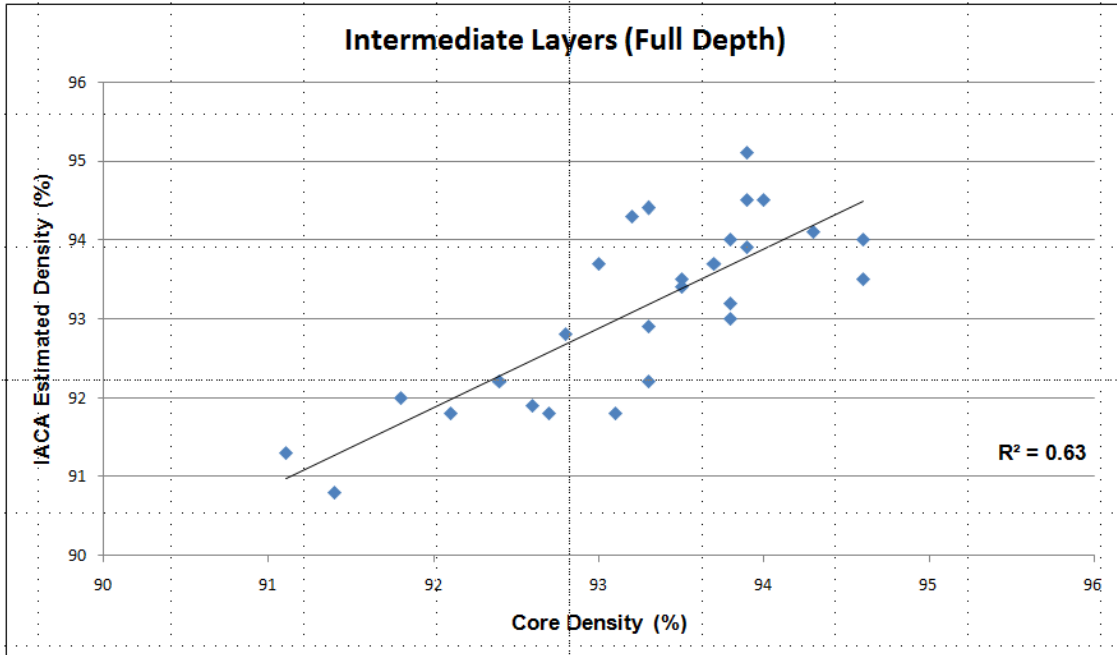

Figure 5.2 Comparison of the IACA estimated density with density determined from cores extracted from AC intermediate layers (Full Depth construction)

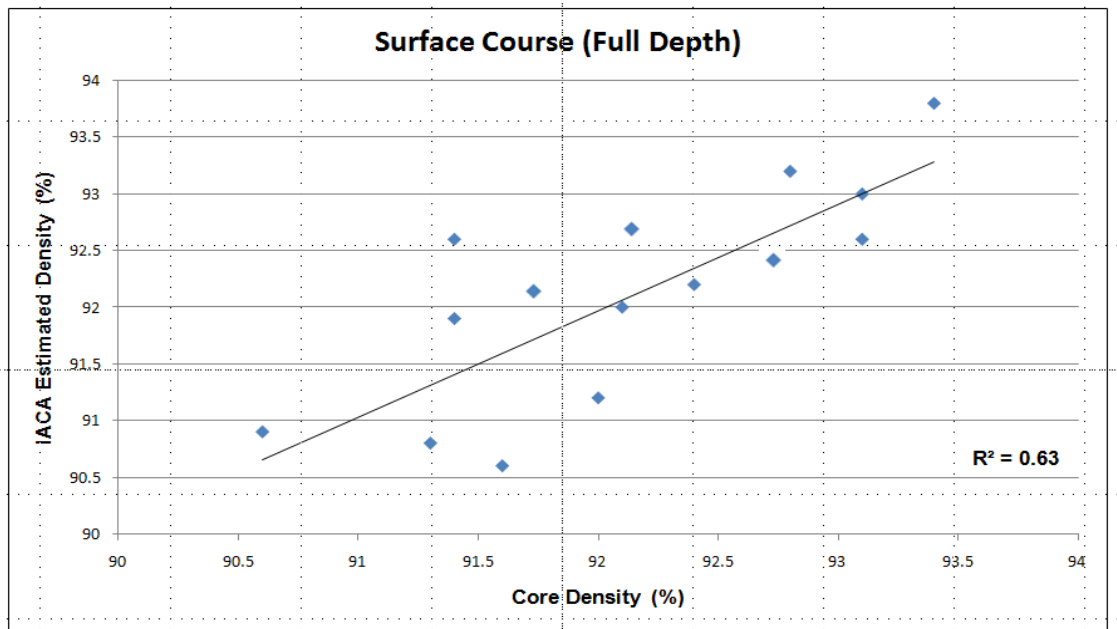

Figure 5.3 Comparison of the IACA estimated density with density determined from cores extracted from surface layers (Full Depth construction)

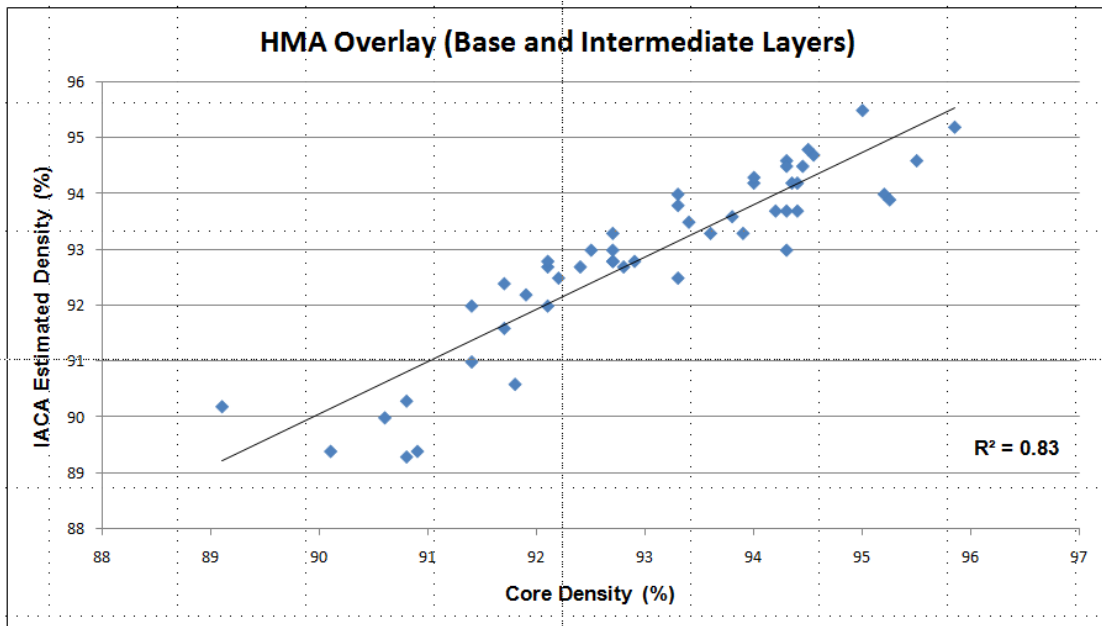

Figure 5.4 Comparison of the IACA estimated density with density determined from cores extracted from AC base and intermediate layers (HMA overlay)

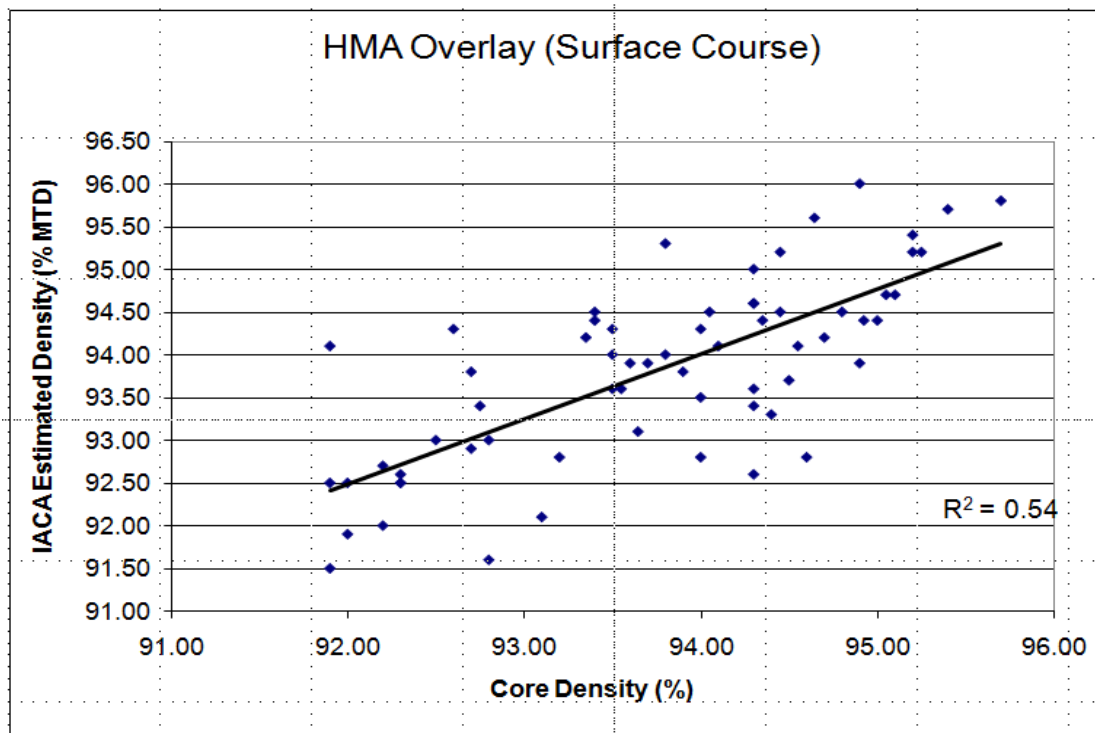

Figure 5.5 Comparison of the IACA estimated density with density determined from cores extracted from surface course (HMA overlay)

During the field tests, the performance of the IACA was observed to depend on the type of construction as well as the thickness of the pavement layer. While the estimates were close to the measured densities for full depth pavements, the IACA estimates had large coefficient of variation for thin surface layers used in overlays.

Further, Figures 5.1 and 5.4 demonstrate that the IACA estimates for the AC base layers and the core measurements are strongly correlated (coefficient of determination = 0.83). Figures 5.2 and 5.3 also indicate that in the case of full depth pavements, the IACA performance is not influenced by the asphalt layer (similar mean and variance as the density measured from the core and identical coefficient of determination). However, in the case on HMA overlay on exiting pavements, thin overlays on existing pavements resulted in larger estimation errors and a lower coefficient of determination (0.54) between estimated densities and the density measured from cores.

5.2 Quality Analysis of Pavement Construction

a. Statistical Quality Analysis.

The construction of asphalt pavements would typically involve the compaction of multiple lanes over several miles of the roadway. Ideally, the compacted density of the entire pavement has to be known in order to determine the quality of compaction. However, such a measurement is infeasible both from a time and cost standpoint when conventional tools and techniques are used. As a consequence, quality determination in the field is usually restricted to taking only a finite number of measurements at randomly selected locations. Percent Within Limit (PWL) is a Statistical Quality Analysis (SQA) method that can be used to ensure the quality of HMA pavements^{10,22}. PWL technique enables the use of a small number of spot tests on the completed pavement to statistically estimate the overall quality of the roadway²¹.

PWL is based on the assumption that the density of the compacted asphalt pavement is normally distributed about a mean density^{9,10}. The variance of the measurements is an indicator of the uniformity of the compaction – larger the variance, greater is the variability of the density about the mean. For example, if four spot tests of density on a mile of compacted asphalt pavement reveal a mean density of 94% (6% air voids) and a standard deviation (σ) of 1%, then it can be construed that 68% of the pavement has density values between 1 standard deviation of the mean density. In other words, about 68% of the pavement is likely to be compacted between 93-95% of the maximum theoretical density. PWL is designed to encourage and reward contractors to achieve uniform, consistent compaction of HMA pavements.

According to the New York DOT Materials Bureau³⁰, PWL is the percentage of the lot between the lower specification limit (LSL) and the upper specification limit (USL). These limits determine the acceptable quality and the corresponding pay factors. During the course of a construction project, the PWL is calculated as follows³⁰.

- i. Four core locations are marked at random for every 1000 tons of asphalt that is laid and compacted.
- ii. The density of each of the cores is measured according to the AASHTO T166 method then the mean (μ) and standard deviation (σ) for the days' production are calculated.

iii. The standard deviation (σ) of the four cores is computed as follows:

$$\sigma = \sqrt{\frac{\sum_{i=1}^n (x_i - \bar{x})^2}{n-1}}$$
 where 'n' is the total number of cores, and x_i is the density of the i^{th} core.

iv. The Lower Quality Index (Q_L) and Upper Quality Index (Q_U) are computed as follows:

and

where **L** is the lower specification limit and **U** is the upper specification limit.

v. **PWL** between **U** and **L** is finally calculated as follows:

where P_U and P_L are determined from Table 1 in Index I³⁰.

The quality of compaction achieved during the long term testing of the IACA was investigated during the construction HMA overlays at two different sites: I-86 near Howard, NY; Hwy 383 near Cohocton, NY. The details of these constructions are presented in Section 4.5 and 4.6. The construction on I-86 involved the overlay of 3.8 miles (6.08 km) of the road using two inches (50.4 mm) of 19mm asphalt mix. After the placement of the asphalt mat, compaction was achieved using a Volvo DD-118HFA vibratory compactor. The construction on I-386 involved the overlay of 3.7 miles (5.92 km) of the road using two inches (50.4 mm) of 19mm asphalt mix. After the placement of the asphalt mat, compaction was achieved using a Volvo DD-118HFA vibratory compactor. The main difference between the two sites was in the preparation of the base layers prior to the construction. In the case of I-86, the rehabilitation of the existing pavement was undertaken by milling a removing a thin lift (0.6 inches / 15.24mm) of Nova Chip from the existing pavement. On the other hand, existing concrete pavement was rubbelized and proof rolled prior to the placement of the asphalt mat.

After calibrating the IACA system, the IACA estimated data was collected during the compaction at both the sites. Four core locations were marked by the New York Department of Transportation (NY-DOT) engineer at the end of each day. The contractor recorded the GPS coordinates of these core locations and then extracted the marked cores as well as companion cores adjacent to the marked locations. The density of the companion cores were measured by the contractor while the remaining cores were processed by NY-DOT. Performing the PWL analysis based on the density measurements from the DOT cores, it was estimated that 100% of the I-86 pavement was compacted between density of 93% and 96% (Table 5.3). Likewise, for the construction on Hwy 386, it was estimated that 100% of the Hwy-386 pavement was compacted between density of 93% and 96% (Table 5.3). On the other hand, using the IACA estimated density, one could conclude that 100% of the constructed pavement on I-86 and 98% of the constructed pavement on Hwy 386 was between 93% and 96% compaction. Table 5.4 shows the actual density estimated during the final roller pass during compaction at both these sites. The data presented in this table reflects the actual density achieved over the entire extent of the construction. The data reiterates the fact that the majority of the construction was of very high quality and less than 1% of the completed pavement was under-compacted.

Table 5.2 Estimates of pavement quality using core densities and IACA estimations

Density Range (DR)	I – 86, Howard, NY		Hwy 386, Cohocton, NY	
	Using Core	Using IACA	Using Core	Using IACA
DR ≤ 88	0	0	0	0
88 < DR ≤ 89	0	0	0	0
89 < DR ≤ 90	0	0	0	0
90 < DR ≤ 91	0	0	0	0
91 < DR ≤ 92	0	0	0	0
92 < DR ≤ 93	0	0	0	2
93 < DR ≤ 96	100	100	100	98
96 < DR ≤ 97	0	0	0	0
97 < DR ≤ 98	0	0	0	0
98 < DR ≤ 99	0	0	0	0
DR > 99	0	0	0	0

Table 5.3 IACA tabulated final compaction density (percent)

Density Range (DR)	I – 86 Howard, NY	Hwy 386 Cohocton, NY
DR ≤ 88	0%	0%
88 < DR ≤ 89	0%	0%
89 < DR ≤ 90	0%	0%
90 < DR ≤ 91	0%	0%
91 < DR ≤ 92	1%	1%
92 < DR ≤ 93	12%	14%
93 < DR ≤ 96	86%	80%
96 < DR ≤ 97	1%	5%
97 < DR ≤ 98	0%	0%
98 < DR ≤ 99	0%	0%
DR > 99	0%	0%

b. Detection of variation in the compaction of pavements

During the preparation of the I-86 site, the contractor had noted the existence of soft spots in the AC base between stations 13500 and 15500 and between stations 10500 and 11500. This stretch corresponded to the section of the highway under a bridge and remediation was not considered feasible. Reconstruction of the as-built maps from IACA estimates show that an average density of 93% was achieved on this stretch in contrast to densities between 94-95% at other locations on the completed pavement.

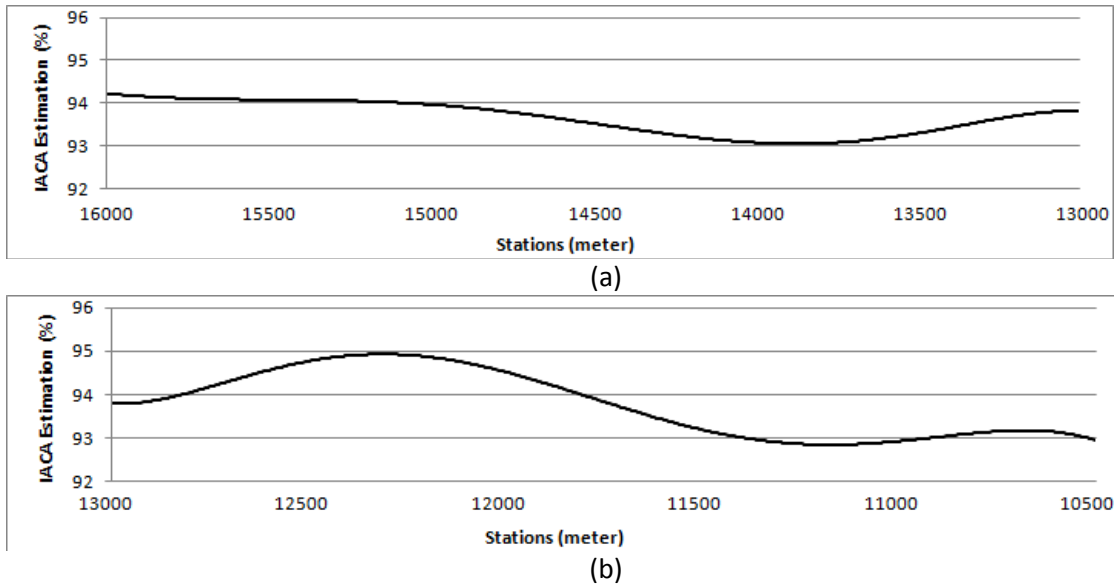

Figure 5.6 As-built density on two sections with low underlying support on I-86

c. Detection of over-compaction during construction

The rolling pattern for a particular compaction job is established by the contractor in cooperation with the agency /DOT representative at the beginning of the job. During the compaction of a test pavement, the density achieved after each roller pass is measured using a handheld gauge. Compaction is stopped when no further increase in density is observed. Cores are extracted at random from the completed pavement and their density was measured in the laboratory to ensure that compaction targets are met. Once the rolling pattern is established, the contractor periodically verifies the final density but does not usually verify the variations in density after each pass or alter the rolling pattern unless necessitated by quality issues. While this process may be adequate to obtain passing quality during the compaction of asphalt pavements, it is not ideal for attaining optimum quality during compaction.

Comparison of IACA density estimates after each roller pass can be a good indicator of the quality and can be used to obtain optimum compaction of the asphalt mat. The density at a test location during successive roller passes is shown in Figure 5.7. In this case, two rollers were operated in tandem with the first roller providing 5 roller passes and then the second roller compacting the pavement with 5 additional roller passes. The variation in density seen during the compaction with the second roller indicates that the target density was achieved by the second roller pass. Additional roller passes not only resulted in lowered density but also resulted in a loss of uniformity in compaction.

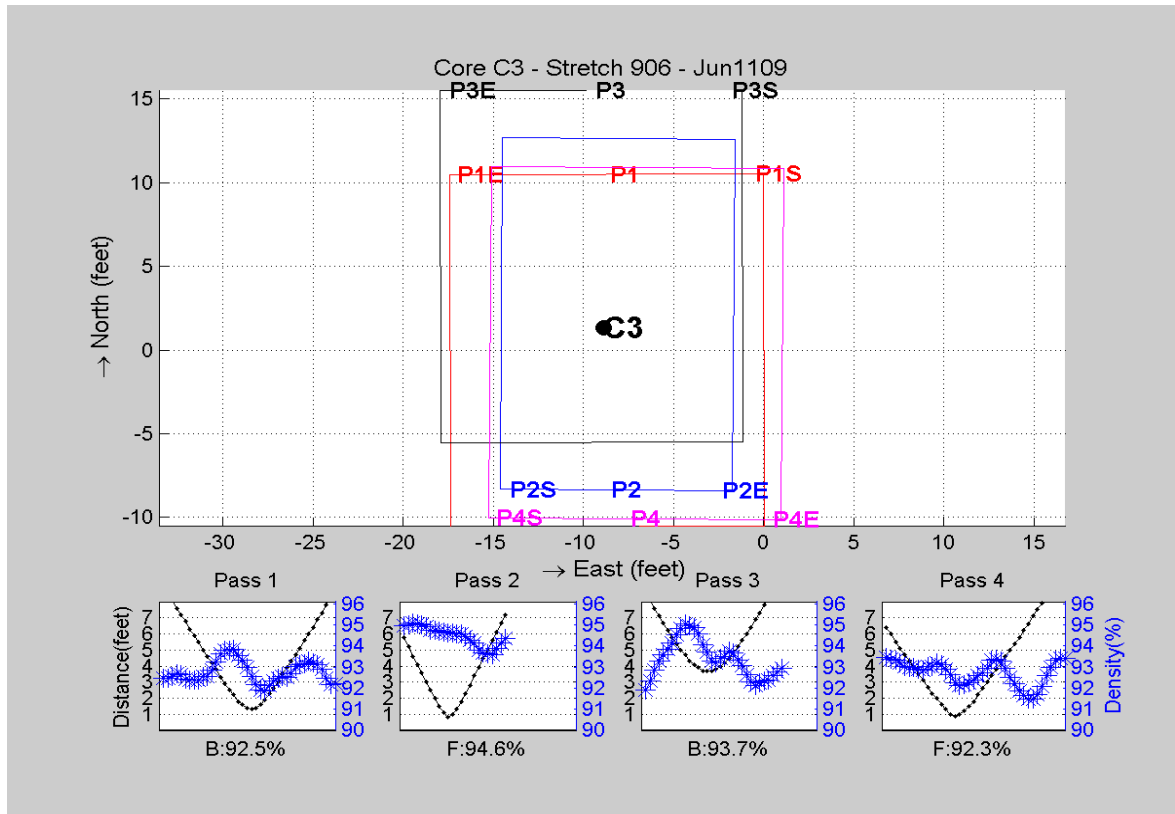

Figure 5.7 Reduction in density as a result of over-compaction of the asphalt pavement

d. Coverage maps and rolling patterns

The IACA has built in functionality to generate complete as-built maps (Figure 5.8). Any measurement data, for example density measured using roadway cores or calibrated gauges, can be superimposed on this map to generate a validated quality measure for the entire project. Further, such maps can be generated in real time as the roller compacts a stretch of the pavement (Figures 5.9 and 5.10). The surface temperature of the mat serves as an indicator of the time remaining before compactive effort would cease to result in increased density.

5.3 Ease of IACA installation and calibration

During each of the field evaluations, the installation of the IACA on the vibratory compactor was completed within 15 minutes by the research team and the training and calibration of the IACA was accomplished within 2 minutes of the completion of the calibration stretch. Figures 5.11 and 5.12 show the IACA installed on a contractor owned Ingersoll Rand DD-90 vibratory compactor and a Volvo owned DD118HFA vibratory compactor. At each site, calibration was performed for each layer of asphalt. The validation results presented in this report were obtained by comparing the density of randomly selected roadway cores with the IACA estimated density at the core locations. Recalibration of the IACA was not found to be necessary during the course of the project.

The operator feedback on the ease of installation and calibration was positive. The displayed information was also well received. However, the research team found that the roller operator primarily paid attention to adhering to the rolling pattern that was established and not to the quality of compaction that was being achieved. The roller operator would seldom look at the display or pay attention to the density estimates and the as-built density maps. Therefore, it was not possible to evaluate the benefits that could result in the uniformity of compaction or the productivity through the use of IACA technology.

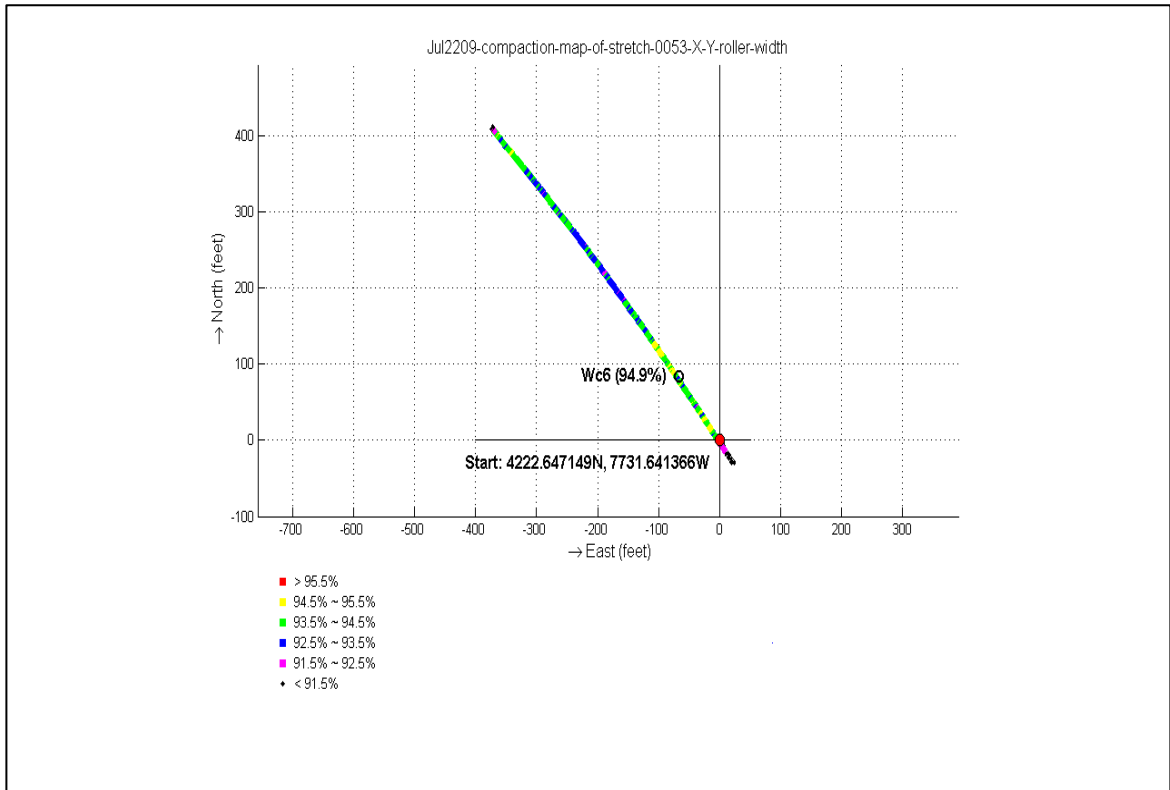

Figure 5.8 As-built compaction map with verifiable density estimates

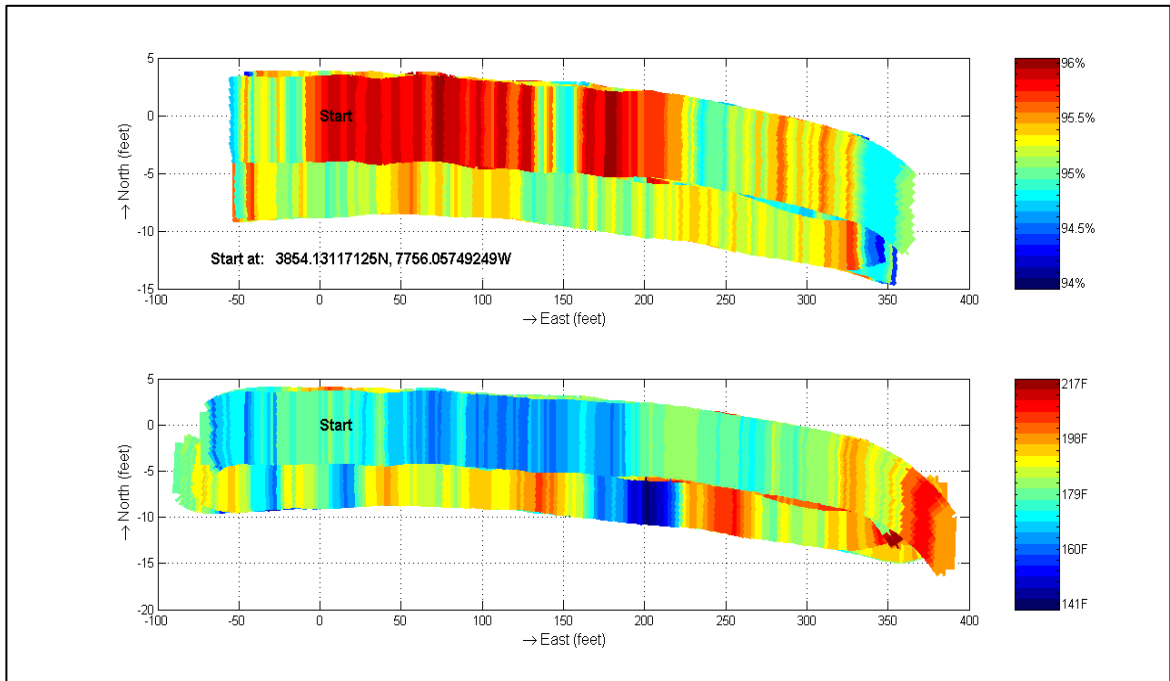

Figure 5.9 Density map and the surface temperature of a stretch of pavement during compaction

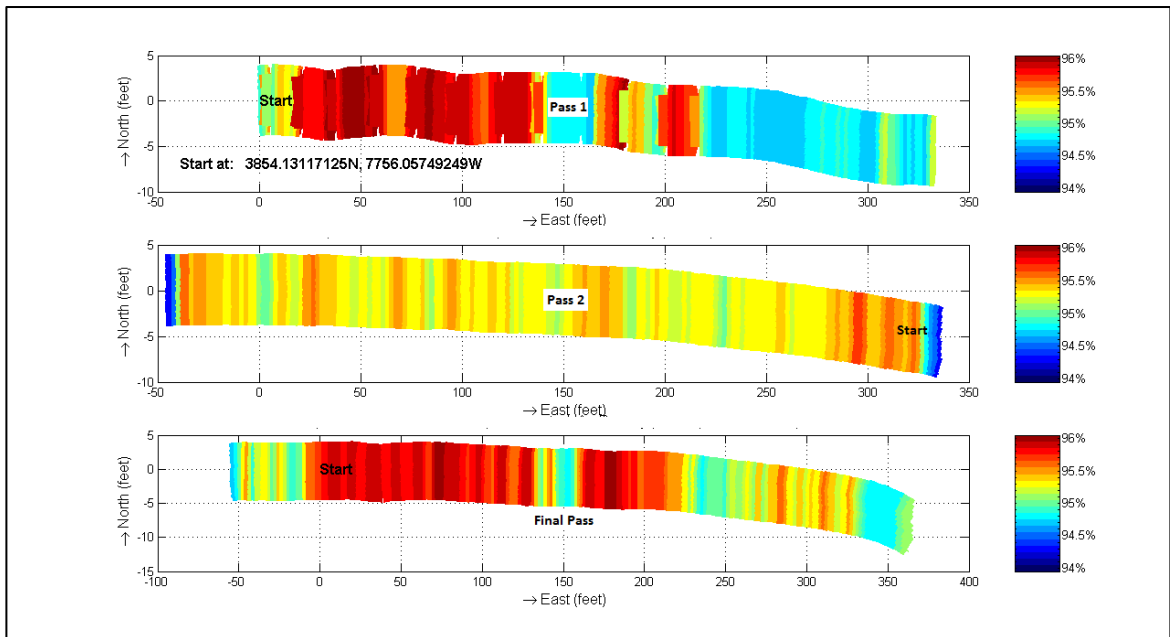

Figure 5.10 Density map for each pass during compaction



(a)



(b)



(c)

Figure 5.11 Installed view of the IACA on a Ingersoll Rand DD-90 vibratory compactor



(a)



(b)

Figure 5.12 (a) Installation of the IACA on a Volvo DD 118HFA roller; (b) IACA in use

6.0 Field Demonstrations of the Intelligent Asphalt Compaction Analyzer

6.1 Field Demonstration - Reading, Pennsylvania (June 01 - 05, 2009)

The performance of the IACA was observed during the overlay of asphalt pavement on highway US-222 near Reading, PA. Remediation of the existing pavement involved milling and removal of 2.54 miles of existing pavement and then compacting a two inch lift of 12.5mm asphalt mix on top of the jointed plain concrete pavement (JPCP) base. Compaction was achieved using Ingersoll Rand DD110 dual drum vibratory compactor. Finish rolling was done using a static steel drum roller Ingersoll Rand DD110 roller. Quality control in the field was performed using a Troxler 3450 nuclear density gauge (NDG). The location of the site is shown in Figure 6.1 and the site details are given in Table 6.1. The accelerometer sensor was located on the axle of the front drum and the GPS receiver was located on the roof of the compactor. The offset in Table 6.1 indicated the lateral separation between the accelerometer and the GPS receiver and was used to relate the GPS measurement to the location of the drum.

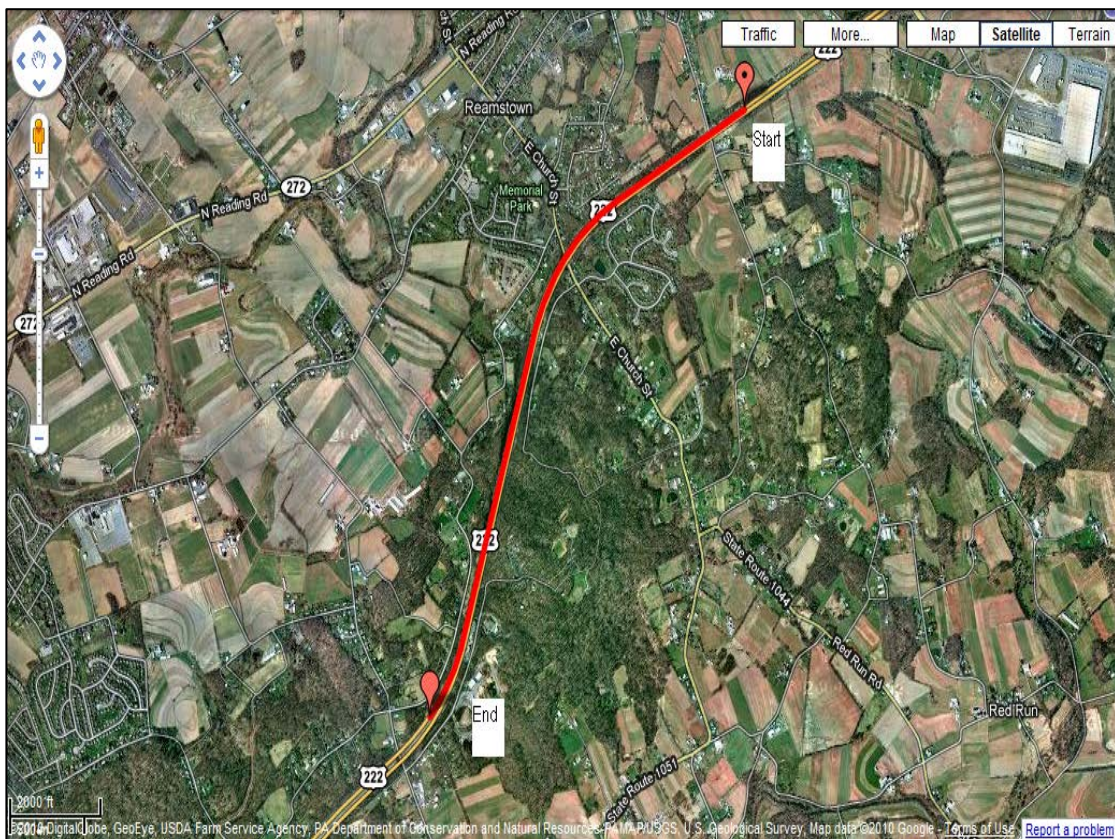

Figure 6. 1 Site location on US-222 near Reading, PA

Table 6. 1 Machine and Site Information (US-222)

Date	June 01, 2009
Location	Reading, PA
Construction type	Mill & Overlay
Lift	1st
Mix	12.5 mm
Thickness	50.8mm
Roller	Ingersoll Rand DD 110
Calibration (using NDG)	3
Validation (using NDG)	12
Settings	
Accelerometer location	front
Offset from GPS receiver (feet)	0
Drum width (feet)	6.5

Table 6. 2 Validation results from US-222, Reading, PA

Core Location	Core Density* (NDG)	Estimated Density* (IACA)	Estimation Error* (IACA-NDG)
C1	93.60	93.50	-0.10
C2	91.80	93.50	1.70
C3	94.90	93.10	-1.80
M4	93.30	91.30	-2.00
M5	94.50	94.30	-0.20
M6	94.50	92.30	-2.20
M7	93.90	94.00	0.10
M8	93.40	94.20	0.80
M9	92.90	94.30	1.40
M10	92.80	93.90	1.10
M11	91.80	94.00	2.20
M12	91.70	93.90	2.20
M13	91.80	92.90	1.10
M14	92.80	93.30	0.50
M15	93.50	93.50	0.00

*% MTD

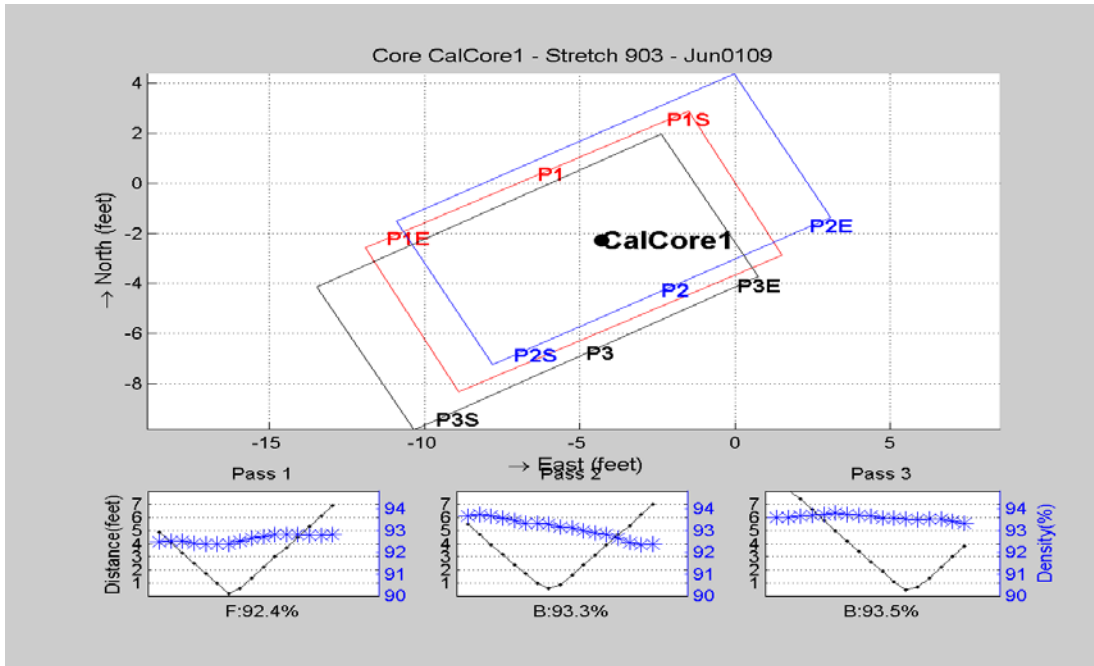

Figure 6. 2 Roller path and estimated densities at core location C1, US-222, Reading, PA

6.1.1 Discussion of Results

On the day of the validation, the project team installed the IACA on the contractor owned and operated IR DD110 compactor. The calibration of the IACA was performed by comparing the IACA estimated density with the density measured using the contractor's calibrated nuclear density gauge. The IACA estimated density at the calibration location 'CalCore 1' during each roller pass is shown in Figure 6.2. In this figure, P1, P2, and P3 represent three consecutive roller passes over the calibration location. P1 and P3 denote the forward movement of the roller while P2 indicates the backward movement of the roller. For each pass, the starting point is designated by 'S' and the termination of the pass is designated by 'E'. For example, P1S represents the starting point for Pass 1 and P1E indicates the terminal point of Pass 1. The graph in the lower panel depicts the variation of the IACA estimated density in the vicinity of the calibration location. From this figure, the operator can verify the increase in density after each roller pass and the uniformity of the compaction at the calibration location.

After the IACA was calibrated, several locations were randomly marked on the compacted pavement and the density at each of these locations was measured using the nuclear gauge. The GPS coordinates of these locations were also measured and the IACA estimated density was recorded. The measured and estimated densities are shown in Table 6.2. The results from these tests indicate that the mean estimation error, i.e. mean of the difference between NDG measured density and IACA estimated Density is 0.32 with a corresponding standard deviation of 1.425. Further, the 95% Confidence Interval for the estimation error is [-0.42, 1.06] which implies that the IACA estimates are statistically similar to the measurements obtained using a nuclear density gauge.

6.2 Field Demonstration - Tecumseh Road, Norman, OK (March 02, 2009)

The project involved the construction of 1.881 miles of an undivided two lane extension of Tecumseh Road between NW 12th Avenue and NE 12th avenue in Norman, Oklahoma (State job # 14391(04), Project #STPY-014B(378)). The IACA was evaluated during the construction of the surface course of a full-depth asphalt pavement. During this evaluation, a three inch (76.2mm) lift comprising of 19mm asphalt mix was compacted using an Ingersoll-Rand DD-118 vibratory compactor. The accelerometer was affixed on the axle of the front drum and the GPS receiver was mounted on the roof of the cab. The longitudinal separation between the GPS receiver and the drum was 4 feet (1.13m) (Table 6.3).

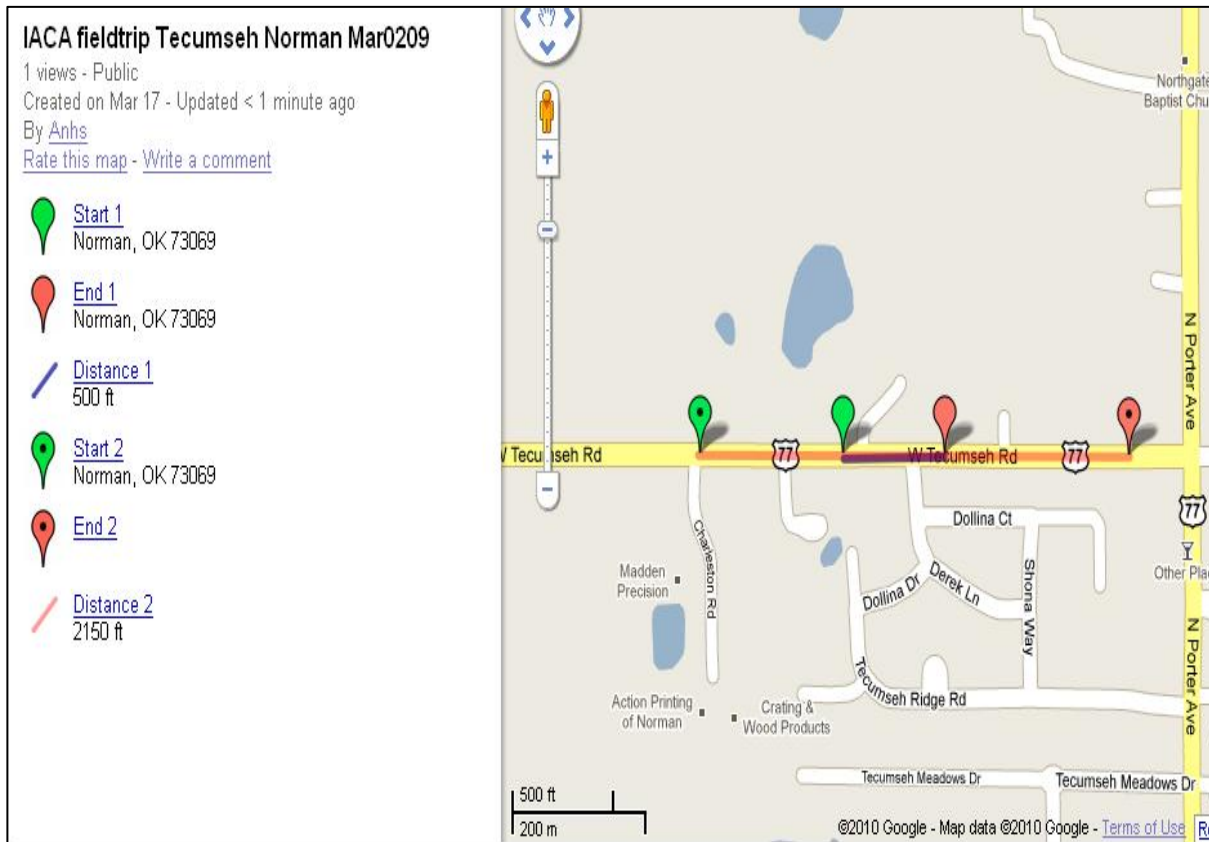

Figure 6. 3 Site location on Tecumseh Road, Norman, OK

Table 6. 3 Machine and Site Information (Tecumseh Road, Norman, OK)

Date	March 02, 2009
Location	Tecumseh Road, Norman
Construction type	Full depth
Lift	Surface
Mix	19 mm (S3)
Thickness	3 inches
Roller	Ingersoll Rand DD118
Calibration Cores #	3
Validation Cores #	4
Settings	
Accelerometer location	Front
Offset from GPS receiver (feet)	4
Drum width (feet)	6.5

6.2.1 Discussion of Results

Prior to using the IACA, the IACA was calibrated by comparing the IACA estimated density with the density measured from three roadway cores as described in Section 2. Raw calibration of the IACA was first performed by comparing the IACA estimated density with the density measured using the target density specified in the mix design sheet. Three cores (Calcore 1, Calcore 2, and Calcore 3 in Table 6.4) were extracted after the pavement has cooled down and their density was measured according to AASHTO T-166 method. The density at these three locations was compared with the IACA estimated density and the calibration parameters were recomputed so as to minimize the mean square error of the estimation process. After the IACA was calibrated, several locations were randomly marked on the compacted pavement and roadway cores were cut and extracted. The measured and estimated densities at these locations are shown in Table 6.4. The results from these tests indicate that the mean estimation error, i.e. mean of the difference between core density and IACA estimated density is -0.46 with a corresponding standard deviation of 0.82. Further, the 95% Confidence Interval for the estimation error is [-1.08 0.16] which implies that the IACA estimates are statistically similar to the measurements obtained using roadway cores.

The IACA estimated density at the validation location 'M6' during each roller pass is shown in Figure 6.2. In this figure, P1, P2, P3, P4 represent four consecutive roller passes over the calibration location. P1 and P3 denote the forward movement of the roller while P2 and P4 indicates the backward movement of the roller. For each pass, the starting point is designated by 'S' and the termination of the pass is designated by 'E'. For example, P1S represents the starting point for Pass 1 and P1E indicates the terminal point of Pass 1. The graph in the lower panel depicts the variation of the IACA estimated density in the vicinity of the calibration location. From this figure, it can be seen that the rolling pattern adopted by the in the operator resulted in 4 roller passes at the core location, but no appreciable increase in the density was observed.

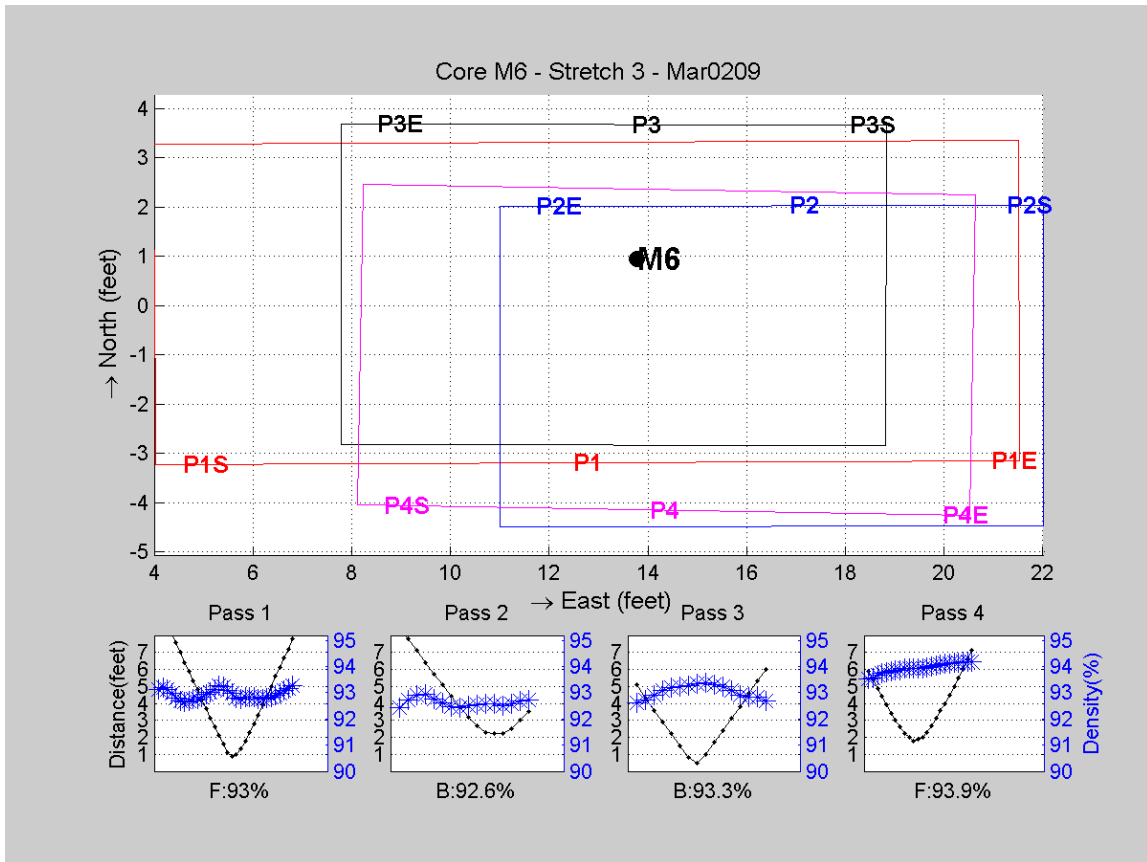

Figure 6. 4 Roller path and IACA estimated density at test location M6, Tecumseh Road, Norman, OK

Table 6. 4 Validation results from Tecumseh Road, Norman, OK

Core Location	Core Density* (Core)	Estimated Density* (IACA)	Estimation Error* (IACA-Core)
Calcore1	94.30	93.10	-1.20
Calcore2	93.80	92.40	-1.40
Calcore3	93.90	92.70	-1.20
M4	93.80	94.20	0.40
M5	93.80	94.10	0.30
M6	93.50	93.90	0.40
M7	94.60	94.10	-0.50

*% MTD

6.3 Field Demonstration - US-65, Carrollton, MO (September 02, 2009)

The performance of the IACA was observed during the overlay of asphalt pavement on highway US-65 near Carrollton, MO. Remediation of the existing pavement involved milling and removal of 1.1 miles of existing pavement and then compacting a 1.75 inch lift of 12.5mm asphalt mix on top of the milled pavement. The mix was trucked to the location by trucks and laid down using a CAT AP10550 paver. Compaction was achieved using Ingersoll Rand DD158HFA dual drum vibratory compactor. Finish rolling was done using an Ingersoll Rand DD130 roller operating in the static mode.

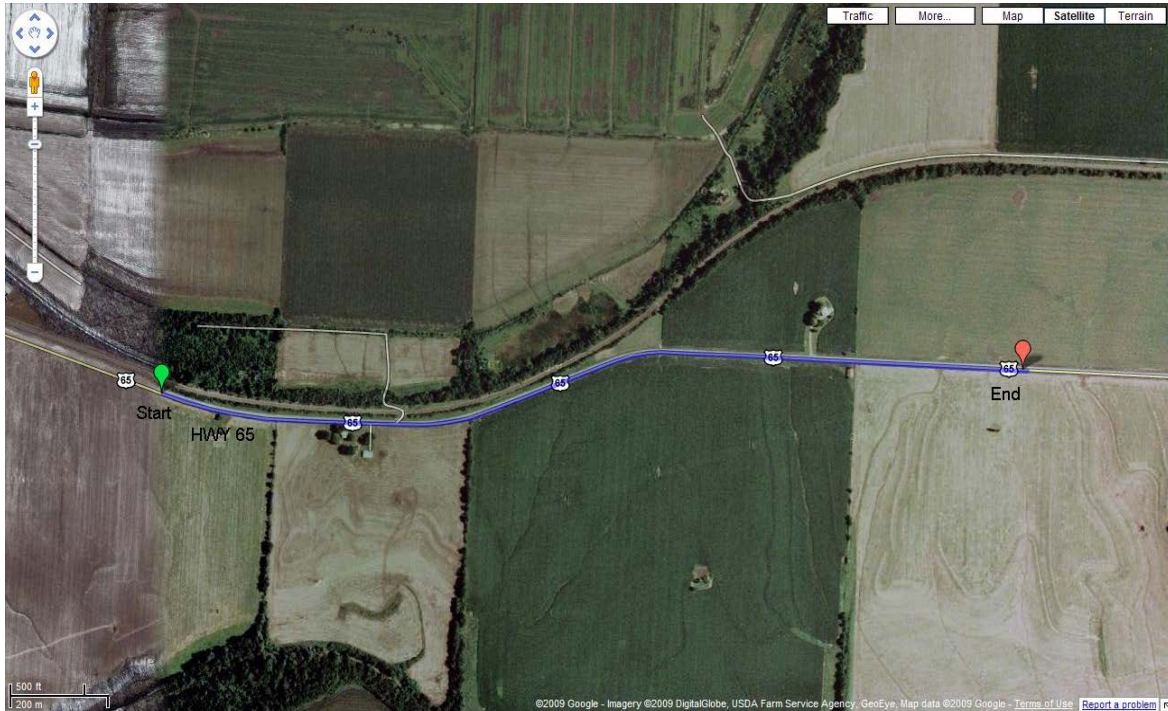

Figure 6. 5 Site location on HWY 65 at Carrollton, MO (near Malta Bend) (1.1 miles from Start to End)

6.3.1 Discussion of Results

Prior to using the IACA, a thirty feet calibration region was first compacted as described in Section 2. The calibration of the IACA was performed by comparing the IACA estimated density with the density measured from three roadway cores extracted from this calibration region. After the IACA was calibrated, several locations were randomly marked on the compacted pavement and roadway cores were cut and extracted. The density of the cores at these locations was then measured using the AASHTO T-166 method. The GPS coordinates of these locations were also measured and the IACA estimated density was recorded. The measured and estimated densities are shown in Table 6.5. The results from these tests indicate that the mean estimation error, i.e. mean of the difference between core density and IACA estimated Density is 0.2% with a corresponding standard deviation of 0.8. Further, the 95% Confidence Interval for the estimation error is [-0.51 0.91] which implies that the IACA estimates are statistically close to the measurements obtained using a roadway cores.

Table 6. 4 Machine and Site Information, HWY 65, Carrollton, MO

Information	
Date	Sep 02, 2009
Location	Marshall MO
Construction type	Mill and Overlay
Lift	Surface
Mix	12.5 mm SP125 09-71 (64-22)
Thickness	1.75"
Roller	Ingersoll Rand DD158
Calibration Cores #	3
Validation Cores #	3
Settings	
Accelerometer location	Rear
Offset from GPS receiver (feet)	8
Drum width (feet)	7

Table 6. 5 Validation results from US-65, Carrollton, MO

Core Location	Core Density* (Core)	Estimated Density* (IACA)	Estimation Error* (IACA-Core)
C1	94.80	94.30	-0.50
C2	95.20	95.40	0.20
C3	95.20	95.40	0.20
W4	93.80	95.30	1.50
W5	93.20	92.80	-0.40
W6	89.70	93.00	†

*% MTD

†damaged core

6.4 Field Demonstration - I-40, Hinton, OK (June 10- July 10, 2009)

The performance of the IACA was observed during the overlay of asphalt pavement on Interstate I-40 near Hinton, OK (Figures 6.6- 6.8). Remediation of the existing pavement involved milling and removal of 6.0 miles of existing pavement and then compacting a 3.0 inch lift of 19mm asphalt mix followed by a second lift of 2.0 inches using the same mix (Table 6.6). Compaction was achieved using a Dynapac and an Ingersoll Rand DD138HF dual drum vibratory compactors operating in tandem. Finish rolling was done using Ingersoll Rand DD118 roller operating in static mode.

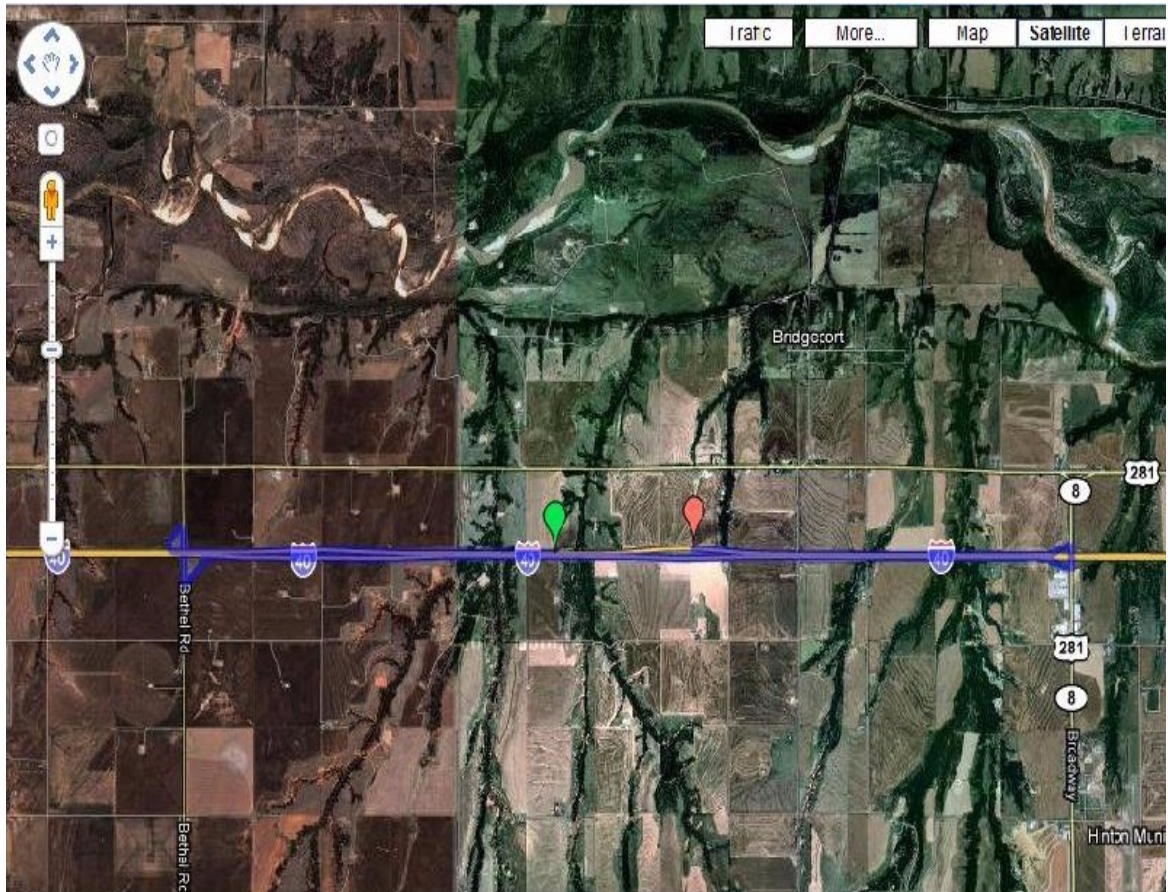

Figure 6. 6 Site location on I-40 (West bound) at Hinton, OK

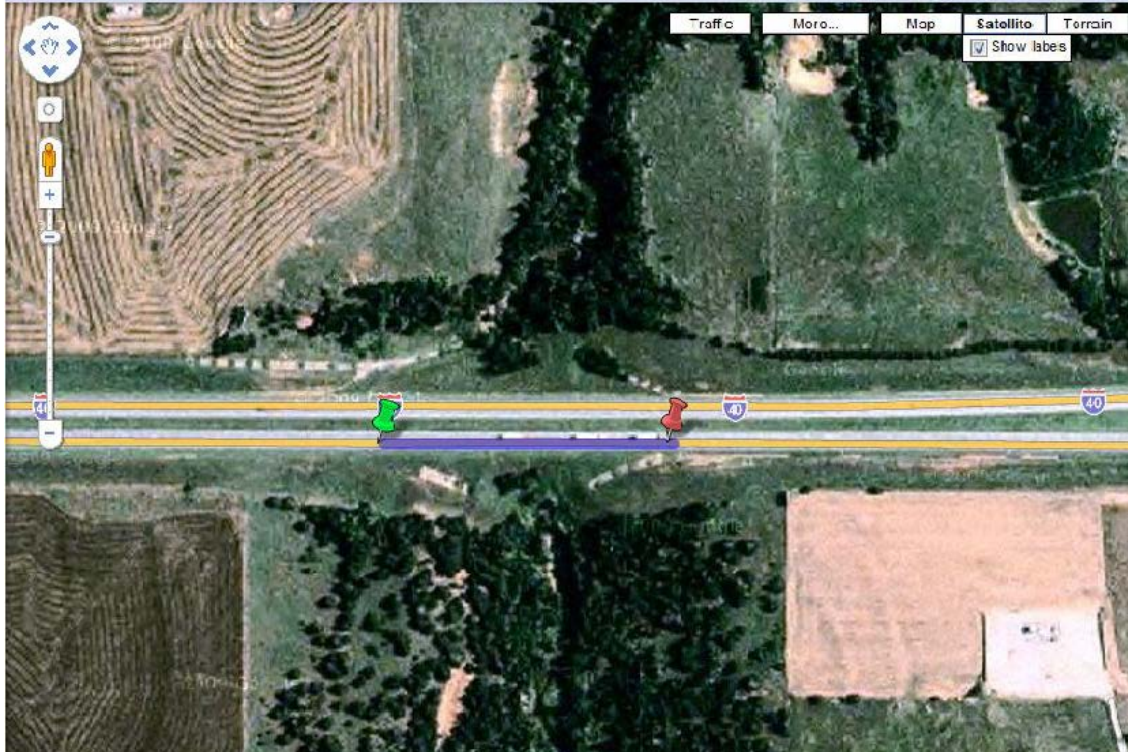

Figure 6. 7 Calibration region on East bound I-40 (Hinton, OK)

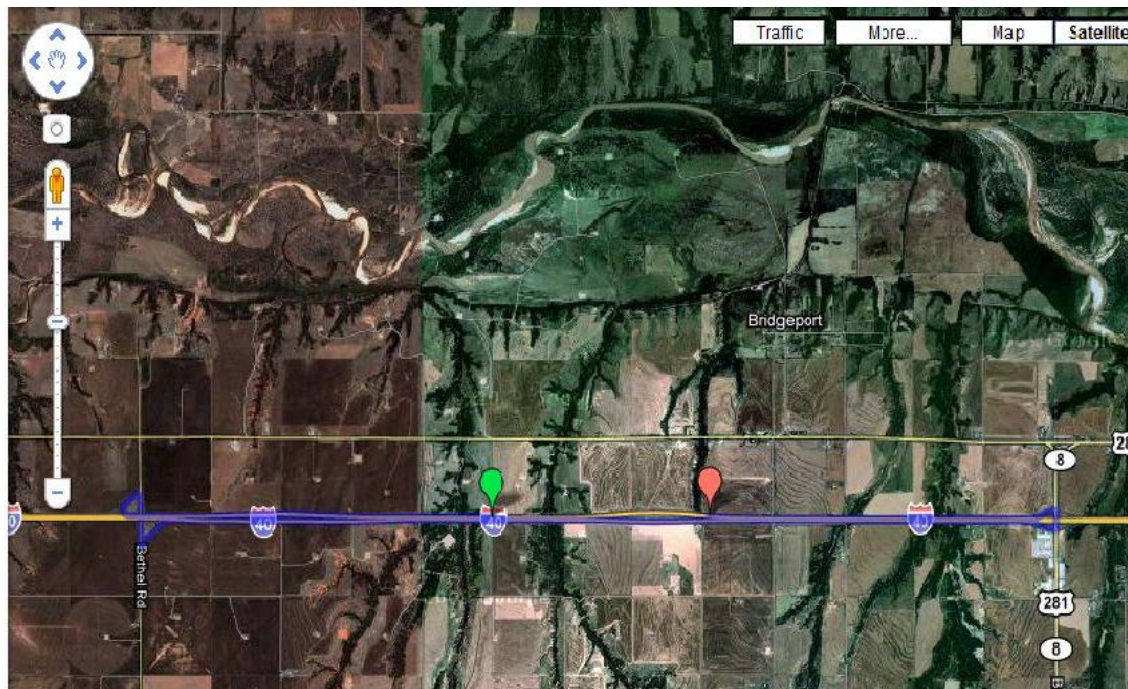

Figure 6. 8 Validation region on East bound I-40 (Hinton, OK)

Table 6. 6 Site and Machine Information, I-40 at Hinton, OK

Date	Jun1009	Jun1109	Jun1209
Location	Hinton OK	Hinton OK	Hinton OK
Construction type	Mill & Overlay	Mill & Overlay	Overlay
Lift	1 st	1 st	2 nd
Mix	19 mm S3 PG-76-28	19mm S3 PG-76-28	12.5mm S4 PG-76-28
Thickness	3 inches	3 inches	2 inches
Roller	Ingersoll Rand DD138HF	Ingersoll Rand DD138HF	Ingersoll Rand DD138HF
Calibration Cores #	0	3	0
Validation Cores #	3	3	6
Settings			
Accelerometer location	front	front	Front
Offset from GPS receiver (feet)	0	0	0
Drum width (feet)	7	7	7

Date	Jun2609	Jul1009
Location	Hinton OK	Hinton OK
Construction type	Mill & Overlay	Mill & Overlay
Lift	2 nd	2 nd
Mix	12.5mm S4 PG-76-28	12.5mm S4 PG-76-28
Thickness	2 inches	2 inches
Roller	Ingersoll Rand DD138HF	Ingersoll Rand DD138HF
Calibration Cores #	3	0
Validation Cores #	0	3
Settings		
Accelerometer location	front	Front
Offset from GPS receiver (feet)	0	0
Drum width (feet)	7	7

6.4.1 Discussion of Results

The calibration and validation of the IACA was performed for both asphalt layers as described in the previous section. Comparison of the density estimated by the IACA and the actual density measured from the roadway cores is shown in Table 6.7 and 6.8. The results from these tests indicate that in the case of the AC base layer, the mean estimation error, i.e. mean of the difference between core density and IACA estimated Density is 0.4% with a corresponding standard deviation of 0.84. Further, the 95% Confidence Interval for the estimation error is [-0.19 0.99]. In the case of the second asphalt layer, the mean of the difference between core density and IACA estimated Density was found to be 0.54% with a corresponding standard deviation of 0.24. Further, the 95% Confidence Interval for the estimation error is [0.34 0.74]. These results also indicate that the IACA estimates are statistically close to the measurements obtained using a roadway cores.

The estimated density at core location C3 is shown in Figure 6.9. It can be seen from the figure that significant compaction was already achieved during the first pass of the roller. Since the two breakdown rollers are operating in tandem, the achieved compaction is higher than in the case where only one roller is used. However, it can be seen from the figure that the additional roller passes actually have a detrimental effect in the sense that the mix is over-compacted and the final compaction that is achieved (92.3%) is far lower than the maximum compaction that was obtained at the completion of the second pass (94.6%). Thus, having access to the IACA estimates can avoid over compaction of the asphalt pavement and result in better quality of compaction.

Table 6. 7 Validation results for first lift I-40, Hinton, OK

Core Location	Core Density* (Core)	Estimated Density* (IACA)	Estimation Error* (IACA-Core)
5210+32	96.23	97.90	1.67
5158+52	94.55	94.00	-0.55
5158+91	93.31	93.40	0.09
Calcore1	95.40	94.70	-0.70
Calcore2	95.10	95.50	0.40
Calcore3	94.50	94.60	0.10
5157+64	95.37	96.50	1.13
5240+86	94.44	95.50	1.06

Table 6. 8 Validation results for second lift I-40, Hinton, OK

Core Location	Core Density* (Core)	Estimated Density* (IACA)	Estimation Error* (IACA-Core)
Calcore1	95.00	94.40	0.60
Calcore2	94.30	94.60	0.30
CalCore3	94.30	94.60	0.30
5273+61	93.65	93.10	0.55
5262+14	94.92	94.40	0.52
5268+98	94.64	95.60	0.96

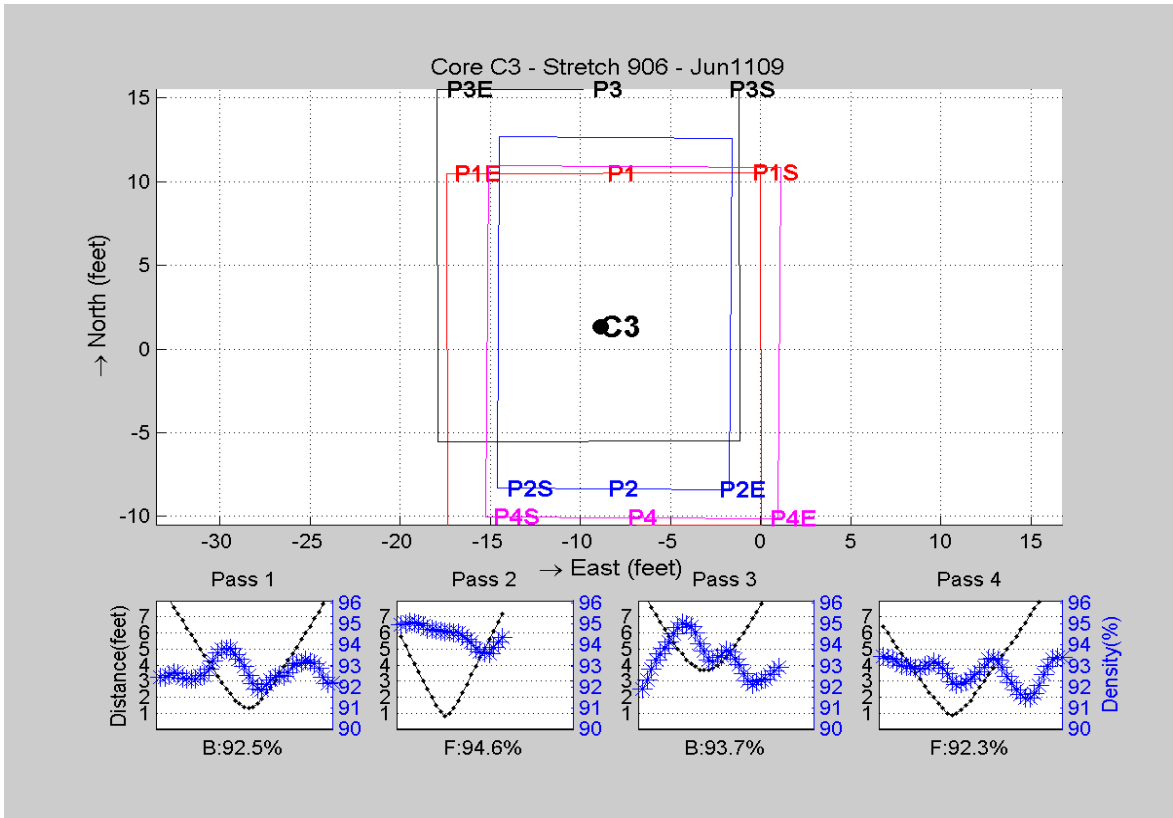

Figure 6. 9 Roller path and IACA estimated density at test location C3, I-40 at Hinton OK

6.5 Field Demonstration - I-86, Howard, NY (July 22-24, 2009)

Field testing of the IACA system was conducted on interstate I-86 near Hornell, New York (Figure 6.10). The rehabilitation of the pavement was undertaken by first milling and removing a thin lift of Nova Chip (0.6 in) from some of the pavement. Then the pavement was paved with a 2.5 in. lift of a 25mm mix, two 2 in. lifts of 19.0mm, and then a 1.6 in. lift of 9.5mm asphalt mix. The IACA data was collected during the construction of the second lift of the 19mm mix. The mix was trucked to the location by trucks and laid down using a VOGELE 2219w paver. Compaction was then achieved using a HAMM HD-130 HV and a VOLVO DD-118 HFA dual drum vibratory compactors operating in tandem. Finish rolling was done using the same VOLVO roller but operating in static mode (see Table 6.9).

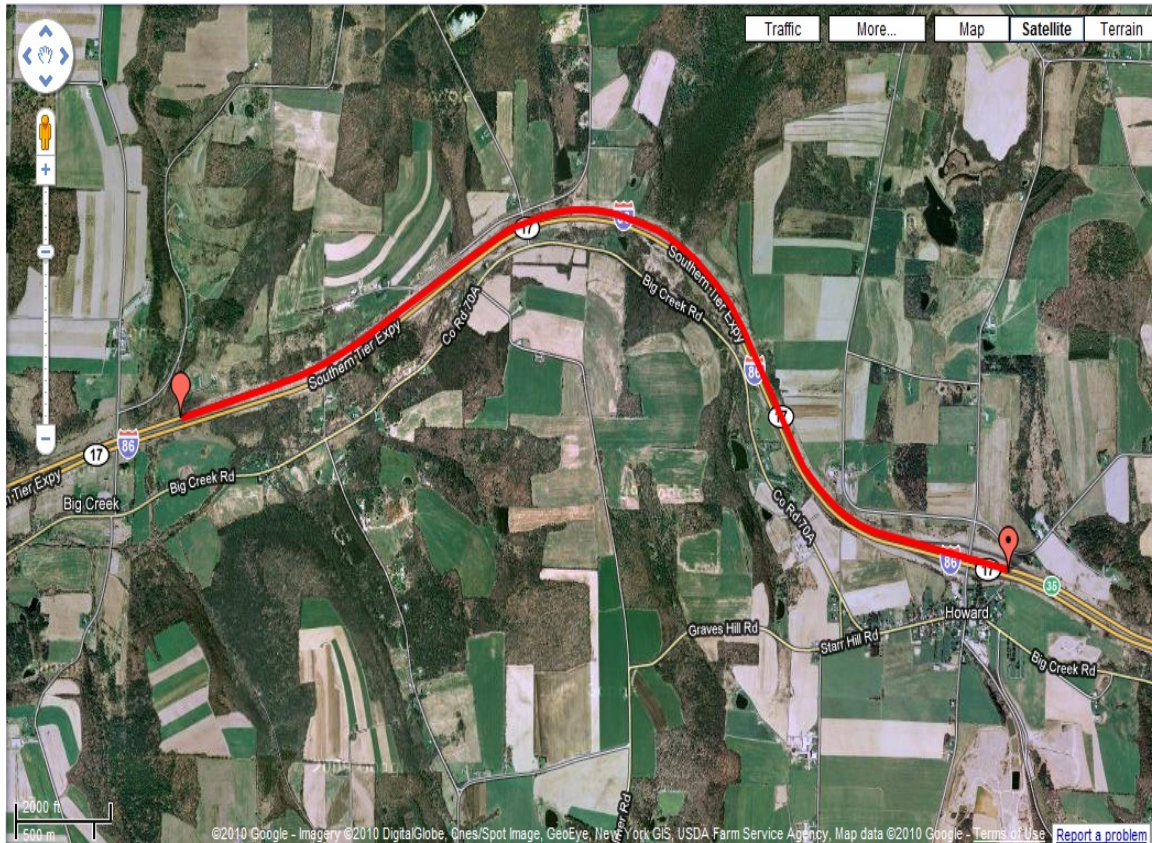

Figure 6. 10 Site location on I86 near Howard, NY (3.8 miles)

Table 6. 9 Site and Machine Information, I-86 near Howard, NY

Date	July 22,2009
Location	Howard, NY
Construction type	Mill & Overlay
Lift	Top
Mix	19mm PG 64-22
Thickness	2 inches
Roller	DD118HFA
Calibration Cores #	3
Validation Cores #	7
Settings	
Accelerometer location	Front
Offset from the GPS receiver (feet)	0
Drum width (feet)	6.5

6.5.1 Discussion of Results

The calibration and validation of the IACA was performed as described in the previous section. Comparison of the density estimated by the IACA and the actual density measured from the roadway cores is shown in Table 6.12. The results from these tests indicate that the mean estimation error, i.e. mean of the difference between core density and IACA estimated Density is 0.13% with a corresponding standard deviation of 0.85. Further, the 95% Confidence Interval for the estimation error is [-0.41 0.66].

Table 6. 10 Validation results from I-86, Howard, NY

Core Location	Core Density* (Core)	Estimated Density* (IACA)	Estimation Error* (IACA-Core)
Calcore1	94.90	93.50	-1.40
Calcore2	94.30	94.80	0.50
Calcore3	94.10	94.50	0.40
WC4	94.45	95.10	0.65
WC5	94.35	93.40	-0.95
WC6	95.25	94.60	-0.65
F1	94.30	94.40	0.10
F2	94.55	95.60	1.05
F3	95.85	96.30	0.45
F4	94.30	95.40	1.10

* % MTD

6.6 Field Demonstration - HWY 386, Cohocton, NY (August 12-17, 2009)

Field testing of the IACA system was conducted on interstate HWY 386 near Cohocton, New York (Figure 6.11). The rehabilitation of the pavement was undertaken by first milling and removing a thin lift of Nova Chip (0.6 in) from some of the pavement. The rest was the existing, very faulted, concrete pavement. The concrete pavement was rubbelized and then proof rolled. Any soft areas were undercut by excavating the pavement and offending sub-base and then replacing it with screened gravel and a lift of 25mm mix. Then the pavement (either rubbelized or undercut) was paved with a 2.5 in. lift of a 25mm mix, two 2 in. lifts of 19.0mm, and then a 1.6 in. lift of 9.5mm asphalt mix. The IACA data was collected during the construction of the second lift of the 19mm mix. The mix was trucked to the location by trucks and laid down using a VOGELE 2219w paver. Compaction was then achieved using a HAMM HD-130 HV and a VOLVO DD-118 HFA dual drum vibratory compactors operating in tandem. Finish rolling was done using the same VOLVO roller but operating in static mode.

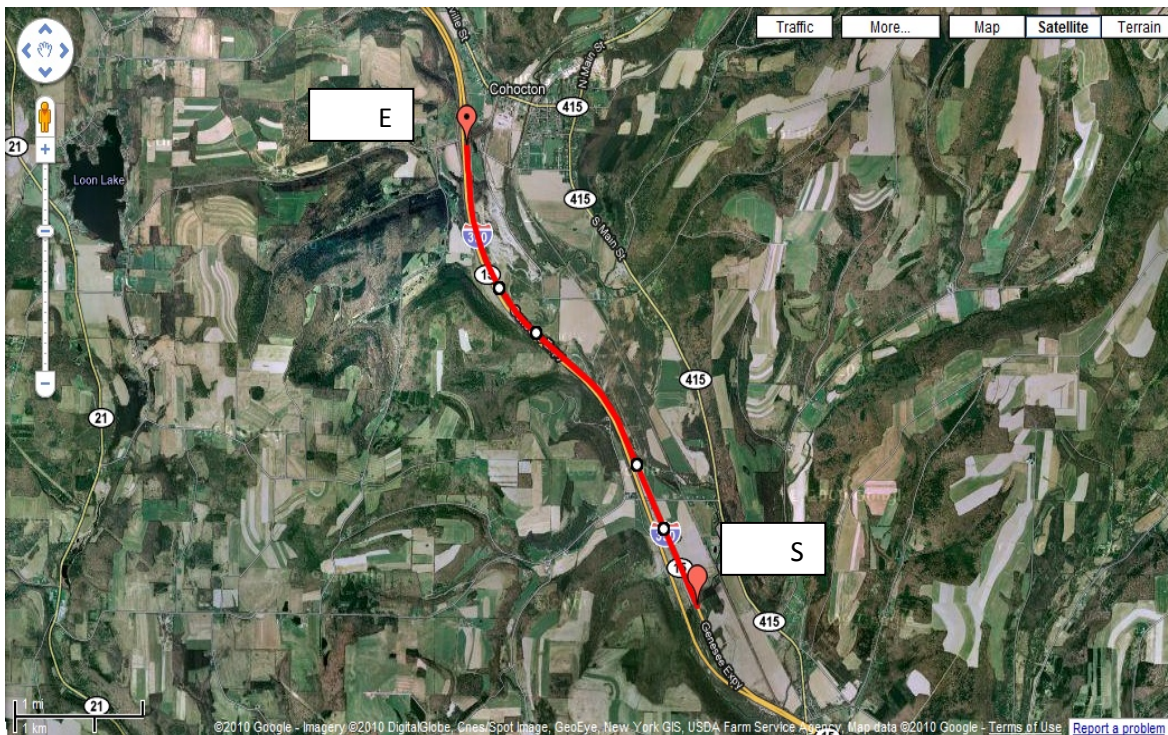

Figure 6. 11 Site location on HWY 386 near Cohocton, NY (3.7 miles)

6.6.1 Discussion of Results

The calibration and validation of the IACA was performed as described in the previous section. Comparison of the density estimated by the IACA and the actual density measured from the roadway cores is shown in Table 6.13. The results from these tests indicate that the mean estimation error, i.e. mean of the difference between core density and IACA estimated Density is 0.01% with a corresponding standard deviation of 0.94. Further, the 95% Confidence Interval for the estimation error is [-0.42 0.44].

Table 6. 11 Validation results from HWY 386, Cohocton, NY

Core Location	Core Density* (Core)	Estimated Density* (IACA)	Estimation Error* (IACA-Core)
Calcore1	94.70	94.00	-0.70
Calcore2	94.00	93.40	-0.60
CalCore3	93.40	94.50	1.10
C1	95.05	93.30	-1.75
C2	94.40	93.40	-1.00
C3	94.55	93.90	-0.65
C4	91.90	93.80	1.90
C5	93.50	94.00	0.50
C6	93.40	94.50	1.10
C7	93.50	92.80	-0.70
Calcore1	94.30	93.70	-0.60
Calcore2	93.70	93.60	-0.10
CalCore3	92.60	93.40	0.80
C4	92.70	93.90	1.20
C5	92.75	93.40	0.65
C7	93.35	92.70	-0.65
C2	94.50	93.80	-0.70
C3	92.80	92.90	0.10
C4	92.20	92.50	0.30

* % MTD

6.7 Field Demonstration - I-35, Norman, OK (June 17, 2009 - April 21, 2010)

The use of the IACA in estimating the stiffness of a multi layer HMA pavement was investigated during the construction of Interstate I-35 in Norman, OK (Figure 6.12). This project involved the expansion of the existing highway, stabilizing the subgrade to a depth of 200 mm using 10% cement kiln dust (CKD), followed by 200 mm thick aggregate base. The asphalt concrete base layer consisted of 100 mm thick asphalt layer of 19 mm Nominal Maximum Aggregate Size (NMAS) S3 (64-22 OK), while the second and third layers were constructed with 19 mm NMAS S3 (76-28 OK) of 100 mm and 75 mm thickness, respectively. A 50 mm surface course of 12.5mm NMAS S4 (76-28 OK) was compacted on top of the three asphalt layers. During the course of the project, the project team had installed the IACA on a contractor owned and operated Ingersoll Rand DD110 roller. The research team helped calibrate the IACA for each pavement layer by verifying the IACA estimated density against 3 calibration cores extracted from the finished pavement. The contractor was allowed to use the IACA instrumented roller and validate the performance of the device.

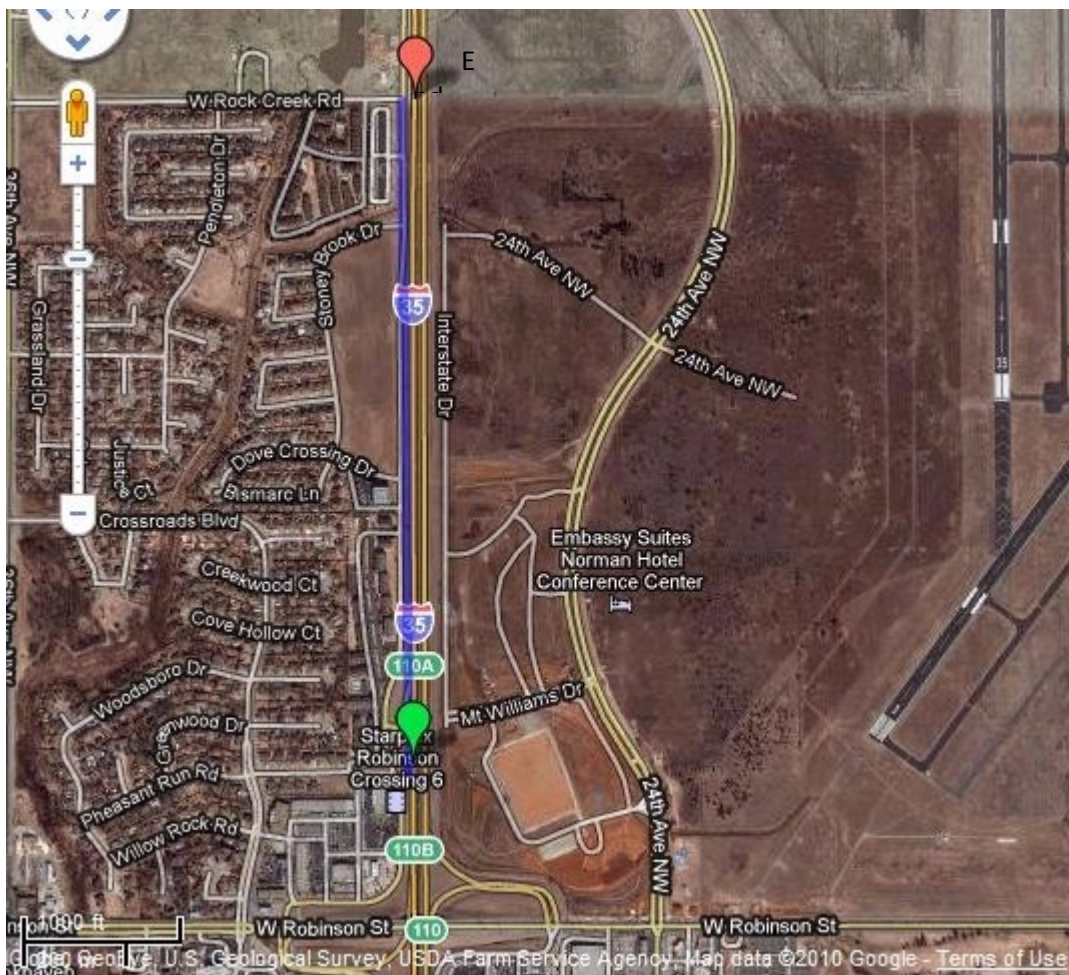

Figure 6. 12 Site location on I-35 in Norman, OK

Table 6. 12 Site and Machine Information, I-35 in Norman, OK

Date	6/17/09	6/18/09	6/22/09	3/15/10
Location	I 35 Norman	I 35 Norman	I 35 Norman	I 35 Norman
Construction type	Full depth	Full depth	Full depth	Full depth
Lift	AC base	2nd	3rd	4th
Mix	S3 64-22 OK	S3 76-28 OK	S3 76-28 OK	S4 76-28 OK
Thickness	4"	3"	3"	2"
Roller	Ingersoll Rand DD110	Ingersoll Rand DD110	Ingersoll Rand DD110	Ingersoll Rand DD110
Calibration Cores #	3	3	3	3
Validation Cores #	2	3	6	15
Settings				
Accelerometer location	front	front	front	front
Offset from GPS receiver (feet)	0	0	0	0
Drum width (feet)	6.5	6.5	6.5	6.5

6.7.1 Discussion of Results

The calibration and validation of the IACA was performed as described in the previous section. For the AC base layer, the tests indicate that the mean estimation error, i.e. mean of the difference between core density and IACA estimated Density is -0.18% with a corresponding standard deviation of 0.36. Further, the 95% Confidence Interval for the estimation error is [-0.5 0.14].

For the second layer of the asphalt pavement, the tests indicate that the mean estimation error is -1.03% with a corresponding standard deviation of 1.22. Further, the 95% Confidence Interval for the estimation error is [-2.03 -0.04].

For the third layer of the asphalt pavement, the tests indicate that the mean estimation error is -0.74% with a corresponding standard deviation of 0.81. Further, the 95% Confidence Interval for the estimation error is [-1.28, -0.21].

For the final layer of the asphalt pavement, the tests indicate that the mean estimation error is 0.11% with a corresponding standard deviation of 0.76. Further, the 95% Confidence Interval for the estimation error is [0.06 0.4].

6.8 Field Demonstration - I-35, Ardmore, OK (July 01 - 31, 2009)

The performance of the IACA was observed during the overlay of asphalt pavement on Interstate I-35 near Ardmore, OK (Figures 6.13- 6.14). Remediation of the existing pavement involved milling and removal of 6.0 miles of existing pavement and then compacting a 2.0 inch lift of 19mm asphalt mix followed by a second lift of 1.75 inches using the same mix. Compaction was achieved using an Ingersoll Rand DD90 dual drum vibratory compactor. Finish rolling was done using Ingersoll Rand DD90 roller operating in static mode.



Figure 6. 13 Site location on I-35 near Ardmore, OK (July 01, 2009)

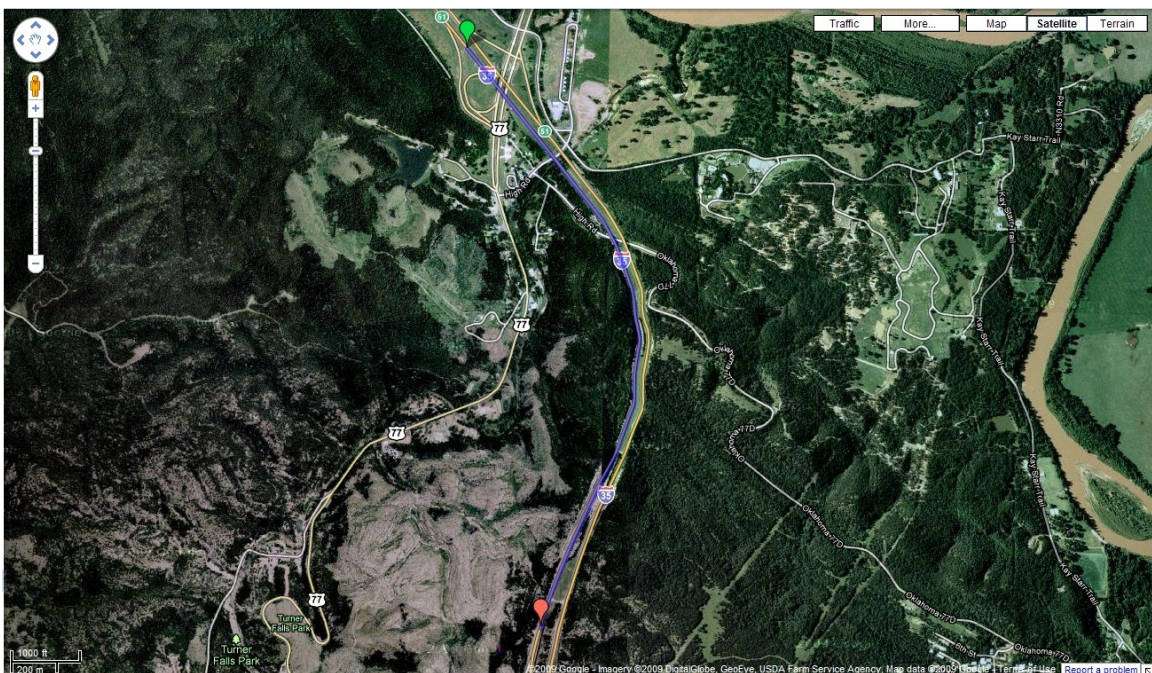

Figure 6. 14 Site location on I-35 near Ardmore, OK (July 07, 2009)

6.8.1 Discussion of Results

Table 6. 13 Validation results from I-35 near Ardmore, OK

Layer Thickness	Core Location	Core Density* (Core)	Estimated Density* (IACA)	Estimation Error* (IACA-Core)
2.5"	Calcore1	92.50	93.00	-0.50
	Calcore2	92.70	92.90	-0.20
	CalCore3	92.80	91.60	1.20
	W4	94.10	90.70	3.40
	W5	94.60	92.80	1.80
1.75"	Calcore1	94.00	93.50	0.50
	Calcore2	93.60	93.90	-0.30
	CalCore3	93.80	94.00	-0.20
	T4	94.30	92.60	1.70
	T5	93.10	90.70	2.40

* % MTD

The project team installed the IACA on the contractor owned Ingersoll Rand DD90 vibratory compactor and trained the operator on the operation of the IACA and its installation/removal each day after its use. The calibration and validation of the IACA for each of the asphalt layers was accomplished by the crew. The IACA device was provided to the contractor for a period of two months (duration of the project). During this time, the operator diligently used the IACA each day during the compaction of the pavement. However, the roller operator did not mark any validation cores on the completed pavement. Therefore, the validation of the IACA was accomplished only at the locations marked by the research team at the beginning of the project (Table 6.13).

6.9 Field Demonstration - US-69, Muskogee, OK (April 2009)

The performance of the IACA could not be conclusively determined during the field trials at US-69 near Muskogee, OK. At this site, a 1.5 inch asphalt overlay was carried out using a 12.5 mm asphalt mix on a concrete subgrade that had cracked in several locations. In this project, the research team was not allowed to extract any roadway cores. The calibration and validation of the IACA was performed using measurements taken by a Nuclear Density Gauge (NDG). NDG readings were taken at three locations for calibrating the IACA and the IACA estimates were investigated at ten random locations by comparing it with the NDG recorded density readings at these locations. At this site, a mean measurement error of 3.0% with a standard deviation of 1.7 was recorded.

7.0 Conclusions and Scope of Future Work

The development of a commercial prototype of the Intelligent Asphalt Compaction Analyzer was addressed in this study. Automation procedures were first developed (Phase 0) to simplify the calibration of the IACA during the construction of asphalt pavements. A rugged electronic computational platform was selected and the IACA application was ported to this computer. A sensor suite and the associated wiring harness were also developed. Installation procedures for retrofitting vibratory compactors with the IACA were demonstrated on a variety of vibratory asphalt compactors. The accuracy and repeatability of the IACA in estimating the density was demonstrated during the construction of asphalt pavements at five different sites in the Phase 1 of the project. Independent testing of the IACA was carried out by independent contractors at nine different sites in Phase II of the project. The main findings of the study carried out under the assistance agreement with FHWA Highways for LIFE Technology Partnerships Program are stated below.

- Low cost rugged sensors and computational platform were selected that resulted in cost savings of over 80% compared to the research prototype that was used prior to this study.
- The commercial prototype that was developed was shown to be rugged, easy to use, and of accuracy necessary for its use as a contractor's quality control tool in the compaction of asphalt pavements.
- The IACA prototype was shown to be a drop in replacement for retrofitting existing vibratory compactors.
- The software utilities that were developed for the analysis can be used on the IACA platform in 'off line' mode or on any desktop computer operating on Windows XP or Windows 7 Operating Systems. The transition between 'on line' density measurement mode and 'off line' analysis mode is intuitive and seamless.
- Several utilities for analyzing the quality of the compaction were implemented in the IACA software. These utilities directly aid the contractor in obtaining uniformity in compaction and increasing the productivity. Specifically, the built in features allow the operator to: check coverage and rolling patterns; investigate pass-by-pass variations in density; monitor the temperature profile of surface of the asphalt mat; and generate as-built maps and statistical estimates of the overall compaction.
- The IACA technology requires the entire project crew has to take on the responsibility for the quality of the pavement. The roller operator has to take care not to over/under compact the pavement. The operator also has to make sure that the pavement receives adequate coverage through vibratory passes of the roller. The project manager has to ensure that the overall quality of the roadway is not compromised and make the necessary adjustments based on the site characteristics and the day to day production from the plant.
- The IACA estimated density reports are a good indicator of the quality of the asphalt pavement.
- A migration path for the evolution of the technology and for integration of additional functionality is in place and has already been demonstrated to the sponsors.

7.1 Partnership for Success

The results achieved in this project demonstrate the importance of teamwork and successful collaborations in the developing innovative solutions to mitigate long standing quality issues during the construction of asphalt pavements. The project team benefited from the close technical cooperation with the Federal Highway Administration and its Field Engineers. Having access to the technical expertise at Volvo Construction Equipment (VCE) Company enabled the team to put together reliable, production ready solutions in a cost effective manner. Further, having access to the dealer network has enabled the team to identify a wider cross section of likely users for testing the IACA. Having ready access to construction sites (Haskell Lemon Construction Company) and material testing facilities (EST Inc) has enabled the rigorous testing of the IACA and contributed to the development of a 'fail safe' and rugged IACA prototype.

The successful partnership between VCE, Haskell Lemon Construction Company, and the University of Oklahoma (OU) has resulted in extending the IACA technology to estimate the stiffness (dynamic modulus) of pavement layers during their construction. This technology is currently being tested during the construction of full depth pavements and asphalt overlays on asphalt/concrete pavements. OU has licensed the IACA technology to VCE and the Stiffness measurements will be available to the users in 2013. Research is currently underway to extend the IACA technology for use during the compaction of soil subgrades.

7.2 Opportunities for Wide-Scale Implementation and Challenges

The results of this study and the ongoing demonstration on Intelligent Compaction(IC) technology²¹ clearly demonstrate that the IC technology is mature and can address several of the quality issues faced by the contractor during the construction of asphalt pavements. Several of these quality issues can be traced back to the lack of adequate tools for quality control during the construction process. The IACA technology can not only rectify this problem, but can also provide complete documentation the quality of the constructed pavement. This will have the immediate effect of increasing the longevity of the pavements and reducing the cost of their maintenance and upkeep. While the competing technologies require the purchase of a new vibratory compactor equipped with IC technology, the IACA can be retrofitted on any vibratory compactor. The IACA is currently in the final stages of production planning and Volvo Construction Equipment is planning on market introduction of the IACA technology in early 2012. The initial IACA offering will be in the form of optional Intelligent Compaction Technology on new Volvo compactors. However, it is anticipated that this technology will be made available to all users in the form of retrofit technology for use on existing compactors. The introduction of the technology has been hampered by weak economic conditions prevailing across the world since 2009.

While the market has been ready for the IC technology for several years, there are several challenges that need to be overcome before the technology can be successfully integrated into the workspace. The primary challenges that the research team encountered during the course of this study are listed below:

- Lack of clear acceptance specifications. Current acceptance specifications require the extraction of roadway cores as a part of the acceptance testing. The pay factors are also calculated based on the density measured from the extracted cores. Thus, the asphalt

contractor is still bound by existing specifications and does not perceive the need for IC based quality testing.

- Lack of incentives for the use of IC technology. While the use of IACA in determining the uniformity of compaction and in the prevention of over/under compaction of asphalt mats has been demonstrated, the cost savings and the increase in productivity that can be obtained have not been adequately recognized by the user community. The primary reason is that the roller operators and the supervisors are entirely focused on the traditional methods of construction and there is a noticeable averseness to risks associated with newer technologies. This can be a significant impediment to the integration of IC technologies into construction practices unless the contractors are incentivized to use of IC technologies. Need for outreach and education. The research team routinely encountered reluctance on part of the user community due to the perception that (a) new technology is risky; (b) new technologies require exceptional literacy and computer skills and in the long term cause job attritions. While the IC demonstrations²¹ address this aspect to some extent, there is still a need for significant outreach and training form the construction crew all the way up to state and federal agencies that oversee the construction of this critical infrastructure.
- Development of incentives for the use of new technology is a process that has been successful in the past. IACA at this time has been demonstrated to be an acceptable contractor's quality control tool which both the contractor and agency can benefit from.

References

1. AASHTO, (2007). *AASHTO T-166 Bulk Specific Gravity Of Compacted Bituminous Mixtures Using Saturated Surface-Dry Specimens*, Washington.
2. Allen, D.L., Schultz, D.B., and Willett, D.A. (2003). *Evaluation of Non-Nuclear Density Gauges*, Kentucky Transportation Center, Lexington.
3. Arambula, E., Masad, E., and Martin, E.A. (2007). *Influence of Air Void Distribution on the Moisture Susceptibility of Asphalt Mixes*, ASCE Journal of Materials In Civil Engineering, vol. 19, no. 8, pp. 655-664.
4. Arasteh, M. M. (2005). "Innovations in Compaction Control and Testing," 2007 Construction Conference, Bismark, ND.
[http://www.dot.nd.gov/conferences/construction/presentations/2007/Intelligent Compaction M Arasteh FHWA.ppt](http://www.dot.nd.gov/conferences/construction/presentations/2007/IntelligentCompactionM%20ArastehFHWA.ppt) (last accessed on October 17, 2010).
5. Asphalt Vibratory Compactor, (2003). Pavement Technology Inc., Covington, GA 30014.
<http://www.pavementtechnology.com/products/vibratorycompactor.asp> (last accessed on October 17, 2010).
6. Beainy, F., Commuri, S., and Zaman, M., (2010). "Achievable quality during the construction of hot mix asphalt pavements," *Journal of the Association of Asphalt Paving Technologists*, submitted July 2010 (*under review*).
7. Beainy, F Commuri, S., and Zaman, M., (2011). "Quality assurance / Quality control during the construction of hot mix asphalt pavements," *ASCE Journal of Construction Engineering and Management*, submitted March 2010 (*under review*).
8. Briaud, J.L., and Seo, J. (2003). *Intelligent Compaction: Overview and Research Needs*, Texas A&M University, College Station.
9. Burati, J.L., Weed, R.M., Hughes, C.S., and Hill, H.S. (2004). *Evaluation of Procedures for Quality Assurance Specifications*, Office of Research Development and Technology, Federal Highway Administration, McLean.
10. Burati, J.L., Weed, R.M., Hughes, C.S., and Hill, H.S. (2003). *Optimal Procedures for Quality Assurance Specifications*, Federal Highway Administration Office of Research Development and Technology, McLean.
11. Camargo, F., Larsen, B., Chadbourn, B., Roberson, R., and Siekmeier, J. (2006). *Intelligent Compaction: A Minnesota Case History*, 54th Annual University of Minnesota Geotechnical Conference.
12. Commuri, S. and Zaman, M., (2007). "Final Report - Intelligent Asphalt Compaction Analyzer," submitted to Oklahoma Center for the Advancement of Science and Technology (OCAST).
13. Commuri,S., and Zaman, M., (2008). "Neural Network Based Compaction Analyzer for Density Measurement during the Construction of an Asphalt Pavement," *International Journal of Pavement Engineering*, vol.9, issue 3, pp. 177 -188.
14. Commuri, S. (2009). "Calibration procedures for the Intelligent Asphalt Compaction Analyzer," USPTO, Patent Application #20100172696, August 26, 2009. Also, filed for patent and PCT, *Method and apparatus for compaction of roadway materials*, application # US/PCT/55619, September 01, 2009.
15. Commuri, S. and M. Zaman, (2010). "Method and apparatus for predicting the density of asphalt," USPTO, 7,669,458, March 02, 2010.
16. Commuri, S., Mai, A.T., and Zaman, M. (2009). *Calibration Procedures for the Intelligent Asphalt Compaction Analyzer*, ASTM Journal of Testing and Evaluation, vol. 37, no. 5, pp. 454-462.

17. Commuri, S., Mai, Anh T., and Zaman, M., (2010). "Neural Network-based Intelligent Compaction Analyzer for Estimating Compaction Quality of Hot Asphalt Mixes," *ASCE Journal of Construction Engineering and Management*, (to appear).
18. Crossbow, (2005). Crossbow Technology Inc., 4145 N. First Street, San Jose, CA 95134.. http://www.xbow.com/Products/Product_pdf_files/Accel_pdf/HF_Series_Datasheet.pdf (last accessed on October 17, 2010).
19. CTC, (2006). *Intelligent Compaction of Soils*, CTC and Associates LLC and WisDOT Research and Communication Services Wisconsin Highway Research Program, Wisconsin.
20. Federal Highway Administration, (2006). *Percent Within Limits: The Quality Measure of Choice*. Focus Newsletter, Federal Highway Administration, March.
21. Federal Highway Administration, (2010). Research project DTFH61-07-C-R0032 "Accelerated Implementation of Intelligent Compaction Technology for Embankment Subgrade Soils, Aggregate Base, and Asphalt Pavement Materials" <http://www.intelligentcompaction.com> (last accessed on October 20, 2010).
22. Gee, K.W. (2004). *Use of Contractor Test Results in the Acceptance Decision, Recommended Quality Measures, and the Identification of Contractor/Department Risks*, Federal Highway Administration and U.S. Department of Transportation, Washington.
23. Haskell Lemon Construction Company, (2008). "Detailed work plan for assistance agreement DTFH61-08-G-0002," submitted to Highways for Life Program Technology Partnerships Program, Federal Highway Administration, Washington, D.C.
24. Haskell Lemon Construction Company, (2008). "Phase 0 progress report for agreement DTFH61-08-G-0002," submitted to Highways for Life Program Technology Partnerships Program, Federal Highway Administration, Washington, D.C.
25. Haskell Lemon Construction Company, (2010). "Phase 1 progress report for agreement DTFH61-08-G-0002," submitted to Highways for Life Program Technology Partnerships Program, Federal Highway Administration, Washington, D.C.
26. IDAN ECM, (2008). RTD Embedded Technologies, Inc., State College, PA. <http://www.rtd.com> (last accessed on October 17, 2010).
27. J1455 (2006). "Recommended Environmental Practices for Electronic Equipment Design in Heavy-Duty Vehicle Applications," SAE International. http://www.sae.org/technical/standards/J1455_200606 (last accessed on October 17, 2010).
28. Landers, K. (2006). The World of Smart Compaction Systems, *Better Roads*, vol. 76, no. 10, pp. 56-59.
29. Ledolter, J., and Hogg, R. (2008). *Applied Statistics for Engineers and Physical Scientists*, 3rd edition, Prentice Hall, pp. 232-316
30. Materials Bureau, (2001). *Hot Mix Asphalt Statistical Pavement Density Determination*, New York City Department of Transportation, Albany.
31. Maupin, G.W., (2007). *Preliminary Field Investigation of Intelligent Compaction of Hot-Mix Asphalt*, Virginia Transportation Research Council, Charlottesville.
32. Moore, W., (2006). "Intelligent Compaction: Outsmarting soil and asphalt," *Construction Equipment*, vol. 4, pp. 39 – 48.
33. Peterson, D. L., (2005). Continuous Compaction Control, MnROAD Demonstration, Report: MN/RC – 2005-07, submitted to Federal Highway Administration, St. Paul, MN 55101.
34. Peterson, L., and Peterson, R. (2006). *Compaction and In-Situ Testing at Mn/DOT TH53*, Minnesota Department of Transportation, St. Paul, MN.
35. ProXT GPS Pathfinder, (2007). Trimble Navigation Limited, Sunnyvale, CA. <http://www.trimble.com/pathfinderproxt.shtml> (last accessed on October 17, 2010).

36. Scherocman, J.A., and Dwight, W. (2008). *Factors Affecting Asphalt Compaction*, Asphalt Institute, from Asphalt Magazine Web site, last accessed April: 10, 2010, http://www.asphaltmagazine.com/singlenews.asp?item_ID=1451&comm=0&list_code_int=mag01-int
37. Schmitt, R., Chetana, R., and Quintus, V (2006). *Non-Nuclear Density Testing Devices and Systems to Evaluate In-Place Asphalt Pavement Density*, Wisconsin Highway Research Program, Madison.
38. Sebesta, S., Estakhri, C., Scullion, T., and Liu, W (2006). *New Technologies for Evaluating Flexible Pavement Construction: Year 1 Report*, Texas Department of Transportation, Austin.
39. S. Sebesta, M. Zeig, and T. Scullion, (2003). *Evaluation of Non-Nuclear Density Gauges for Hmac: Year 1 Report*, Texas Department of Transportation, Austin.
40. Singh, D., Commuri, S., and Zaman, M., (2010). "A procedure to estimate the stiffness of an asphalt pavement during its construction," *Journal of the Association of Asphalt Paving Technologists*, submitted August 2010 (*under review*).
41. Singh, D., Commuri, S., and Zaman, M., (2011). "Evaluation of predictive models for estimating dynamic modulus of HMA mixes used in Oklahoma," *Journal of the Transportation Research Board*, (*accepted for publication*).
42. Singh, D, Mai, A.T., Beainy, F., Commuri, S., and Zaman, M. (2010). "In situ measurement of the stiffness during the construction of a HMA pavement," submitted to the *Journal of Pavement Research and Technology*, January 2010 (*accepted for publication*).
43. Transportation Research Board. (2005). *Transportation Research Circular E-C074: Glossary of Highway Quality Assurance Terms*, Management of Quality Assurance Committee.
44. The Mathworks Inc., 3 Apple Hill Drive, Natick, MA 01760-2098. <http://www.mathworks.com> (last accessed on October 17, 2010).
45. Thompson, M. J., (2006). Intelligent Soil Compaction for Assuring Subgrade Quality, Greater Iowa Asphalt Conference, Des Moines, IA. http://www.ucs.iastate.edu/mnet/_repository/2006/asphalt/pdf/Intelligent_Compaction_for_Assuring_Subgrade_Quality.pdf (last accessed on October 17, 2010).

Appendix

Appendix A1

Table A1.1 Location and site details for the IACA validation

Project ID	Contractor / Performance Period	Description		Type	Lift		Mix
					Type	Thickness	
US-69	Glover Construction Muskogee, OK April 2009	Extent	0.8 mile	Resurfacing	1st	1.5 inches	12.5mm
		# Lanes	2				
		# Lifts	1				
US-222 Reading, PA	Kinsley Construction May 26 -29, 2009	Extent	7.25 miles	Overlay on concrete	1st	2 inches	12.5 mm
		# Lanes	2				
		# Lifts	1				
I-35 Norman, OK	Haskell Lemon Const. Co. June 2009 – April 2010	Extent	1200 feet	Full Depth	AC Base	4 inches	19 mm PG 64-22
		# Lanes	2		2nd	4 inches	19 mm PG 64-22
		# Lifts	3		3rd	3 inches	19 mm PG 78-28
I-40 Hinton, OK	Haskell Lemon Const. Co. June – July 2009	Extent	6 miles	Mill & Overlay	1st	3 inches	19 mm PG-76-28
		# Lanes	1 (driving lane)		2nd	2 inches	12.5 mm PG-76-28
		# Lifts	2				
I-86 Hornell, NY	AC Blades and Sons. June - July 2009	Extent	3.6 miles	Mill & Overlay	1	2 inches	19mm PG-64-22
		# Lanes	1				
		# Lifts	1				
I-35 Ardmore, OK	Silver Star Construction July – August 2009	Extent	6 miles	Mill & Overlay	1st	2 inches	12.5 mm PG 78-28
		# Lanes	2				
		# Lifts	2				
HWY 390 Groveland, NY	AC Blades and Sons. July – August 2009	Extent	3.6 miles	Mill & Overlay	1	3 inches	25mm PG-64-22
		# Lanes	2		2	2 inches	19 mm PG 64-22
		# Lifts	2				
Rte. 65 Carollton, MO	APAC Const. August 24, 2009	Extent		Mill & Overlay	1st	1.75 inches (on top of 1 inch leveling course)	12.5mm
		# Lanes	2				
		# Lifts	1				
Rte. 60 Republic, MO	Journagan Construction September –October, 2009	Extent		Full Depth	AC Base	3.25 inches	25 mm
		# Lanes	2		2	3.25 inches	25 mm
		# Lifts	4		3	3.00 inches	19 mm
					4	2.00 inches	12.5 mm

Table A1. 2 Matrix of field trials with the details of the construction

Project ID	Location	Description		Type	Lift		Mix	# Cores	Density								Misc.		
					Type	Thickness			Mean density	Std. dev	Mean estimate	Std. dev	Min Error	At Core	Max Error	At Core		Mean (error)	Stdev (error)
I-35	Norman, OK	Extent	1200 feet	Full Depth	AC base	4 inches	S3 64-22	5	93.06	0.32	93.08	0.22	0	93.2	0.3	92.5	0.02	0.19	IR DD110
		# Lanes	2		2nd	4 inches	S3 64-22	6	92	0.73	91.4	0.68	0.2	91.8	1.8	92.3	-0.58	0.82	
		# Lifts	3		3rd	3 inches	S3 78-28	9	92.8	0.37	92.1	0.88	0	92.8	1.9	92.7	-0.69	0.8	
I-40	Hinton, OK	Extent	6 miles	Mill & Overlay	1st	3 inches	S3 PG-76-28	6	94.55	0.67	94.35	0.46	0.3	94.5	-0.9	95.5	-0.2	0.52	IR DD130HF
		# Lanes	1 (driving lane)		2nd	2 inches	S4 PG-76-28												
		# Lifts	2																
I-86	Hornell, NY	Extent	3.6 miles	Mill & Overlay	1	2 inches	19mm PG-64-22	8	94.63	0.6	94.28	0.64	0.05	94.45	-1.35	95.25	-0.34	0.67	Volvo DD118HFA
		# Lanes	1																
		# Lifts	1																
I-35	Ardmore, OK	Extent	> 6 miles	Mill & Overlay	1st	2 inches	12.5mm	10	93.55	0.73	92.9	1.19	0.1	92.8	1.7	94.3	-1.05	1.04	IR DD110
		# Lanes	2																
		# Lifts	2																
US-69	Muskogee, OK	Extent	0.8 mile	Resurfacing	1st	1.5 inches	12.5mm	3	93	0.5	93.7	0.7	-0.4	93.5	2	92.5	0.76	1.2	IR DD110
		# Lanes	1																
		# Lines	1																
Lancaster Turnpike US-222	Reading, PA	Extent	2.4 miles	Mill & Overlay	1st	2 inches	12.5 mm	0	93.06*	1.01	96.04	0.77	0	94.5	4.9	91.7	3.0	1.7	IR DD110
		# Lanes	2																
		# Lifts	2																

Appendix A2

A2.1 Protocol for short run field tests

The purpose of the short run tests is to (a) determine the ease and effectiveness of the installation procedure, (b) Clarity of the operator training and test procedures, (c) ease and accuracy of the calibration and validation procedures. In addition these, the following performance issues will also be studied: (d) accuracy and verifiability of the density readings provided by the IACA, and (e) the usefulness of the mat surface temperature in determining the time for cessation of compaction, i.e. the time remaining before the mat cools down to a temperature at which further compaction is not possible. The protocol for the field tests is described below.

- i) The evaluation of the IACA during the construction of short stretches of an asphalt pavement will be undertaken by the participant with limited support from the research team. Prior to the start of the evaluation, the participant will identify the site for conducting the tests and communicate the construction schedule to the research team. A master schedule will be developed and communicated to all the participants by May 08, 2009. The tests can be conducted on a full-depth asphalt pavement or an overlay.
- ii) A week prior to the scheduled test, the research team will conduct an on the site training for the crew during which an overview of the IACA technology and the procedure to calibrate and use the device will be presented. The research team will also assist the participant with the installation of the device on the roller.
- iii) On the day of the test, the IACA is first calibrated. This is done by first selecting a control strip of approximately 100 feet (33m) long. A 30 feet (10m) calibration section is marked off in middle of this control strip. The start and the end of the calibration section is marked by GPS coordinates at the center line of the pavement. The GPS sensor is used to trigger the collection of the vibration data as the roller compacts this calibration section.
- iv) Test locations at the center of the lane, five feet, fifteen feet and twenty five feet from the beginning of the test section.
- v) After each roller pass, a non-nuclear density gauge is used to measure the density at each of the test locations marked in step (iv).
- vi) The compaction process is stopped when no appreciable increase in the density is seen after the roller pass. After the final pass of the roller, five core locations are marked as shown in Figure 2.4. The GPS locations of the cores, as well as the density at the core and in the immediate vicinity of the core are recorded.
- vii) The cores marked in the previous step are extracted and their density is measured in accordance with the AASHTO T-166 method.
- viii) This will allow the research team to investigate the effect of the underlying layers of asphalt pavement of the compaction achieved in the overlaid layers of the pavement.

A2.2 Protocol for extended run field tests

The long term testing of the IACA was designed to provide information on the consistency of the measured values over the entire construction. The following protocol was used for the long term testing of the IACA.

a. Selection of test site

The long term performance of the IACA is studied during the construction of a multiple layers of an asphalt pavement. The construction site that is selected shall have at least 2 layers of asphalt concrete with each layer being at least 3 inches (76.2mm) thick. The pavement shall be at least 2 miles (3.2 kilometers) long and subsequent layers of the pavement must be constructed on the same stretch. A surface course that is at least two inches (50.8mm) thick shall be constructed on top of these two layers. The thickness recommendations are non-binding and are suggested to facilitate the easy extraction of roadway cores and their density measurement using the AASHTO T-166 procedure. Further since 4-5 cores are routinely extracted per lane mile, the extraction of 10-12 random cores for the validation of the IACA does not constitute undue requirement on the contractor.

The performance of the IACA can be verified on thinner lifts of asphalt if necessary. However, if lift thickness prevents the extraction of cores, then the contractor must ensure that a calibrated Nuclear Density Gauge (NDG) is used to obtain 10-12 density readings per mile in lieu of the cores.

b. Installation and calibration

The IACA has to be installed on the compactor and calibrated prior to its use. The installation will be carried out by the research team and the roller operator and the project manager will be trained on the use of the device.

c. Operation, data collection, and analysis

The IACA will be used continuously during the production run. After each layer is compacted, 3 cores shall be extracted at random from each sub-lot of the asphalt mix (typically 10-12 cores are extracted for every 1000 tons of asphalt mix that is laid) and the GPS locations of the cores shall be marked. The vibration data and the density reading of the IACA shall be collected and stored for subsequent analysis. This data is stored on the IACA and shall be downloaded to a laptop/portable memory storage using the download utility that is provided with the IACA.

After the placement of each lot of the asphalt mix (approximately 1 mile long), the as-built map of the pavement shall be generated and region of high and low compaction shall be identified. Three cores shall be extracted where the density estimates are the highest and a further three cores shall be extracted where low density readings are observed. The GPS readings at these core locations and the measured density shall be recorded for analysis.

A second identical stretch of pavement shall be constructed without the IACA information being available to the roller operator. 12 cores shall be extracted at random for measuring the density as per the standard quality control practice. In addition, 3 cores representing the highest density achieved and 3 cores representing the lowest density achieved shall be extracted. The GPS readings at these core locations shall be recorded.

d. Productivity

During the construction of each layer of the pavement, the project manager shall keep track of the total time for the compaction of the layer with and without the use of the IACA. Any delays due to plant/production issues shall be accounted for while determining the productivity of the crew. The productivity of the crew when using the IACA shall be determined and compared to the productivity when the IACA is not in use.

The manpower requirements for the project and the necessity for spot check shall also be monitored and reported.

e. Project Completion

After the project is complete, the research team will uninstall the IACA from the roller. The project manager and the roller operator will have to provide feedback on the usefulness of the IACA measured values and the analyzed information. Any issues that are identified with respect to the site preparation or calibration of the IACA shall also be reported.

Appendix A3
