



U.S. Department
of Transportation
**Federal Highway
Administration**

Office of Engineering
Office of Technology Applications
400 Seventh Street, S.W.
Washington, D.C. 20590

An Overview of Surface Rehabilitation Techniques for Asphalt Pavement

Instructor's Guide

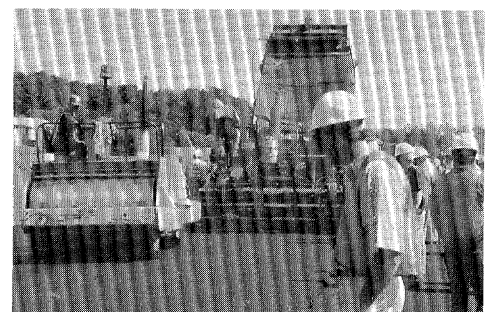
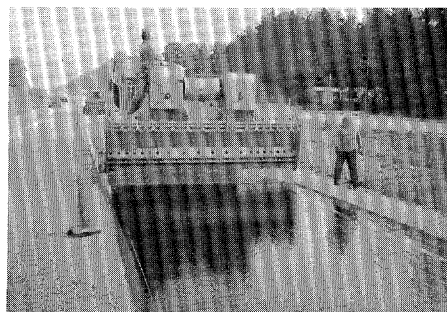
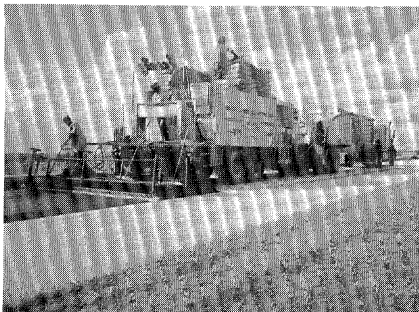

March 1995
Publication No. FHWA-SA-94-074



Notice

This document is disseminated under the sponsorship of the Department of Transportation in the interest of information exchange. The United States Government assumes no liability for its contents or use thereof. The United States Government does not endorse products or manufacturers. Trademarks or **manufacturers' names appear herein only** because they are considered essential to the object of this document.

1. Report No. FHWA-SA-94-074		2. Government Accession No.		3. Recipient's Catalog No.	
4. Title and Subtitle An Overview of Surface Rehabilitation Techniques for Asphalt Pavements Instructor's Guide		5. Report Date December 1994		6. Performing Organization Code	
		8. Performing Organization Report No.		10. Work Unit No. (TRAIS)	
7. Author(s) Hassan Raza, PE		9. Performing Organization Name and Address Federal Highway Administration Office of Engineering, Pavement Division 400 Seventh Street, SW. Washington, D.C. 20590-0001		11. Contract or Grant No.	
12. Sponsoring Agency Name and Address Federal Highway Administration Office of Engineering/Office of Tech. Applications 400 Seventh Street, SW. Washington, D.C. 20590-0001		13. Type of Report and Period Covered Instructor's Guide		14. Sponsoring Agency Code	
		15. Supplementary Notes			
16. Abstract <p>This instructor's guide is developed for a 3- to 6- hour long workshop on surface rehabilitation techniques for asphalt pavements. This workshop will be useful to FHWA, State, and local highway engineers and managers involved with the selection, design, and construction of thin surface rehabilitation techniques.</p> <p>Nearly all highway agencies use some kind of conventional surface rehabilitation technique (such as chip seals, cold mixtures, and thin hot mix overlays) to maintain and extend the service life of their asphalt pavements. The application of these techniques, however, has generally been limited to low-volume roads. In addition, information on design, construction, and performance is often scattered, and evaluations are usually incomplete or not documented.</p> <p>This guide discusses various types of conventional surface rehabilitation techniques, along with many of the emerging techniques. The discussion encompasses design, construction, cost, and performance (where available) of each technique. Recent efforts to gather and transfer information on thin surface technology are also briefly discussed including the Strategic Highway Research Program's efforts and FHWA implementation activities in the preventive maintenance area.</p>					
17. Key Words Emulsion, Polymer, Fog Seal, Sand Seal, Slurry Seal, Micro-surfacing, Hot-Mix Overlay SHRP, Maintenance, Rehabilitation, Technology Transfer			18. Distribution Statement No restrictions. This document is available in a limited supply from the FHWA RD&T Report Center, HRD-11 6300 Georgetown Pike, McLean, VA 22101-2296		
19. Security Classif. (of this report) Unclassified		20. Security Classif. (of this page) Unclassified		21. No. of Pages	22. Price

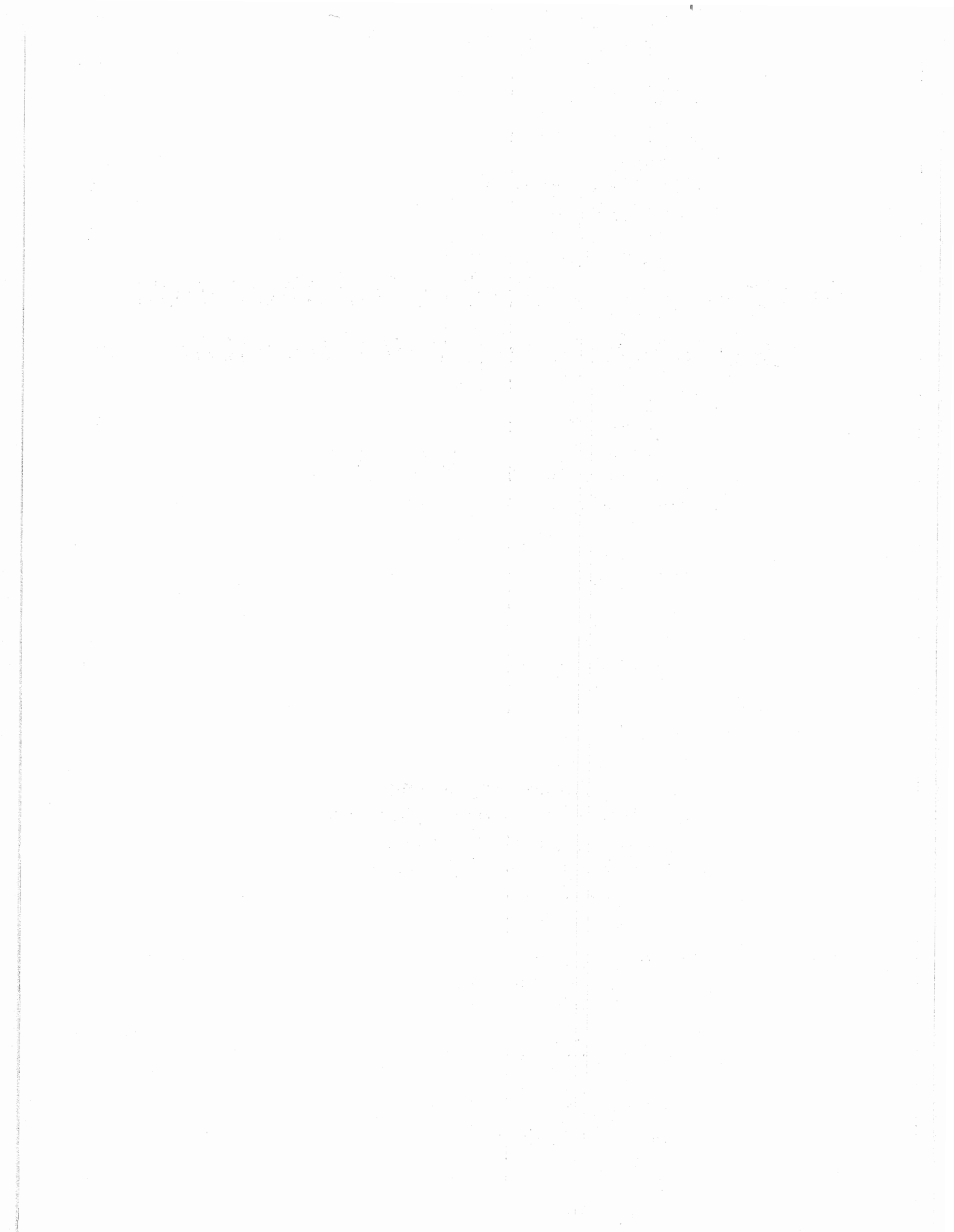

An Overview of Surface Rehabilitation Techniques for Asphalt Pavement

Instructor's Guide

**Office of Engineering
Office of Technology Applications
400 Seventh Street, S.W.
Washington, D.C. 20590**

Preface

This guide is assembled to assist instructors for the presentation of various maintenance treatments and surface rehabilitation techniques for asphalt pavements. This guide is based on information from a variety of sources including: literature, field reviews of existing and ongoing projects, discussion with the user agencies, and review of materials and manufacturing facilities. FHWA publication *An Overview of Surface Rehabilitation Techniques for Asphalt Pavements* (FHWA-PD-92-008) is one of the recommended reference on this subject. Possible audiences for this presentation include engineers and managers of Federal, State, and local highway agencies. The presentation is also useful for members of highway industry.

The Guide is organized into three parts with thirteen sections. The first part provides general information on the types, purpose, and selection of surface rehabilitation techniques. This part also includes a discussion/explanation on various terms associated with thin treatments. The second part (sections 3-11) provides information on design, construction, cost, and performance of various rehabilitation techniques. The final part (sections 12-13) includes conclusion and information on various technology transfer efforts being undertaken in the area of thin surface technology.

This guide is set up in a traditional script format—with visuals given on one side and the correspond-

ing suggested text listed in the other column. The text is specifically designed in such a way as to be a resource to the instructor and attendees. Leaders (...) indicate where the presenter should read directly from the slide.

Along with this guide and the slides, the presenter will need the following equipment and materials to complete the presentation:

- Slide projector
- Screen
- Carousel
- Extension cord (check facilities to see if needed)
- Sign-in sheet
- Handouts

The instructor must handle any preliminary "house-keeping" chores, such as handing out the schedule and instructor's biodata, distributing the necessary handouts including sign off sheet, and determining audience interest. The instructor should also briefly introduce himself or herself, and should have the class participants introduce themselves. Ask each participant to give their name, employer, and job responsibilities. Any background information on the participants will also help instructors structure their presentations so that they will be well received.

Table of Contents

PART I GENERAL

Section 1	
General	1
Section 2	
Introduction	2
Selection of a Technique	3
Definitions	6

PART II INDIVIDUAL TECHNIQUES

Section 3	
Fog Seal	12
Section 4	
Slurry Seal	15
Section 5	
Micro-surfacing	20
Section 6	
Chip Seal	33

Section 7	
Sand Seal	46
Section 8	
Dense Hot Mix	48
Section 9	
OGFC	52
Section 10	
SMA	56
Section 11	
European Thin Hot Mix Overlays	61
Novachip	62

PART III CONCLUSION & TECHNOLOGY TRANSFER

Section 12	
Conclusion	67
Section 13	
Technology Transfer Efforts	68

1. The first part of the document discusses the importance of maintaining accurate records of all transactions and activities. It emphasizes that this is crucial for ensuring transparency and accountability in the organization's operations.

2. The second part of the document outlines the various methods and tools used to collect and analyze data. It highlights the need for consistent data collection procedures and the use of advanced analytical techniques to derive meaningful insights from the data.

3. The third part of the document focuses on the implementation of data-driven decision-making processes. It discusses how data can be used to identify trends, anticipate challenges, and optimize resource allocation across different departments and projects.

4. The fourth part of the document addresses the challenges associated with data management and analysis. It identifies common pitfalls such as data silos, inconsistent data quality, and limited access to data, and provides strategies to overcome these challenges.

5. The fifth part of the document discusses the role of technology in enhancing data management and analysis capabilities. It explores the use of cloud-based solutions, data integration platforms, and artificial intelligence to streamline data processes and improve analytical accuracy.

6. The sixth part of the document emphasizes the importance of data security and privacy. It outlines best practices for protecting sensitive data, including the use of encryption, access controls, and regular security audits to prevent data breaches and ensure compliance with relevant regulations.

7. The seventh part of the document discusses the importance of data literacy and training. It highlights the need for employees at all levels to have a basic understanding of data and its applications, and provides recommendations for developing data literacy programs and training opportunities.

8. The eighth part of the document concludes by summarizing the key findings and recommendations. It reiterates the importance of a data-driven approach and encourages the organization to continue investing in data management and analysis capabilities to drive long-term success and growth.

9. The final part of the document provides a list of references and resources for further reading. It includes links to relevant articles, books, and industry reports that provide additional insights into data management and analysis practices.

10. The document concludes with a call to action, urging the organization to take immediate steps to implement the recommended data management and analysis practices. It emphasizes that a data-driven approach is essential for staying competitive in today's rapidly changing business environment.

SURFACE REHABILITATION TECHNIQUES

Information on Available Techniques

- Design
- Construction
- Cost
- Performance

This workshop/presentation is generally based on the FHWA publication entitled, *An Overview of the Surface Rehabilitation Techniques for Asphalt Pavements*. Information from other sources has also been added as appropriate.

Objective of this presentation is to provide an overview of the various surface rehabilitation techniques currently used in the United States and other countries.

Availability of such information should assist managers and engineers when selecting a strategy to meet both the budget needs and project performance criteria.

PRESENTATION PROTOCOL

- Questions are Encouraged
- Discussion is Encouraged
- We Will Take Breaks

We will like to keep this presentation as informal as possible. Questions are encouraged at all times.

Only through discussion and participation can we fully benefit from this presentation.

PRESENTATION ORGANIZATION

- Introduction
- Individual Techniques
- Technology Transfer Efforts

This presentation is basically divided into three parts: introduction, discussion of various techniques, and technology transfer efforts in surface rehabilitation area.

INTRODUCTION

- Types of Surface Rehabilitation Techniques
- Technique Selection Process
- Definitions

The purpose of this introductory section is to describe surface rehabilitation techniques, discuss selection process, and introduce and define various terms.



As more and more highways age and exhibit signs of functional deterioration, it is becoming increasingly important to find cost-effective surface rehabilitation techniques that can preserve or extend pavement service life until major rehabilitation is performed.

All highway agencies use some type of maintenance/surface rehabilitation technique. However, most of these techniques are of traditional type and are generally used on low to moderate volume roads. Application of these techniques on high-volume roads is rather limited or infrequent, thereby limiting their usefulness.

SURFACE REHABILITATION ALTERNATIVES

- Spray Seals/Cold Mixtures
- Chip Seals
- Thin Hot-Mix Asphalt Overlays
- *Surface Recycling*
- *Milling*
- *Crack Sealing*

Surface rehabilitation techniques can be grouped into the following types...

Thin seals/mixtures (e.g., fog seal, slurry seal, micro-surfacing); chip seals (e.g., single, multiple, cape); thin-hot mix asphalt (HMA) overlays (e.g., open-graded, dense-graded, and gap-graded mixes); surface recycling; milling; and crack sealing.

This presentation covers the first three rehabilitation types.

WHY SURFACE REHABILITATION?

- Improved Ride Quality
- Enhanced Safety
- Extended Service Life

CRITICAL REHABILITATION DECISIONS

- Selection of an Appropriate Technique
- Timing of Application

7 STEP PRELIMINARY ENGINEERING PROCESS

1. Establish Existing Pavement Condition
2. Obtain Project Information
3. Determine Cause of Distress
4. Develop Feasible Alternatives

Surface rehabilitation techniques are used for the following functional improvements.

Improved ride quality by providing a smooth surface that affects not only the riding comfort but also the road user costs. A smooth surface decreases vehicle maintenance costs, fuel costs, and traveling time. Noise is also affected by the surface quality.

Enhanced safety by providing improved skid resistant or rut-free surface.

Extended service life by providing a renewed waterproof surface and protection from aging, oxidation deterioration, and traffic abrasion.

A particular technique may not achieve all of the above functions; however, by achieving even a few, a technique may significantly extend the service life of the pavement and should provide the user with more consistent pavement performance.

Two of the important decisions concerning pavement surface rehabilitation are selection of an appropriate technique, and selection of optimum time to apply the rehabilitation technique.

A treatment should be selected only after carefully reviewing available information and performing engineering and cost analyses. The following steps are usually necessary...

Cont'd

5. Perform Life Cycle Cost Analysis
6. Select Preferred Alternative
7. Construct and Monitor Performance

... While these steps will be briefly discussed in this presentation, it is important to note that selecting an appropriate technique is a two-phase process. First an agency identifies candidate projects and recommend rehabilitation techniques through its Pavement Management System (some States may be using pavement maintenance systems). A PMS priorities, justifies, and support the cost-effectiveness of the candidate projects and techniques. The second step is a more detailed project-level selection phase. At this step the manager or engineer select the most viable technique that meets the needs of the agency.

There are no shortcuts for choosing an appropriate treatment for a given distress.

**STEP 1
ESTABLISH EXISTING
PAVEMENT CONDITION**

- Distress
- Roughness
- Skid Resistance
- Structural Capacity

After a pavement problem is observed, it is usually necessary to perform further investigations to identify the cause and correctly document the needs. The survey should include type and extent of...

**STEP 2
OBTAIN PROJECT INFORMATION**

- Traffic
- Accidents
- Climatic Data
- As-Built Design and Materials

The next step is to gather pertinent project information such as traffic volumes and loading,...

As mentioned before, pavement management system data should be a useful source for such information.

**STEP 3
DETERMINE CAUSE OF DISTRESS**

- Loading
- Materials/Mix
- Climate

The cause of distress should be determined before a technique is chosen. Simply treating the symptoms rather than the cause of the pavement problem can lead to further problems later. There have been instances where the incorrectly selected treatment accelerated pavement deterioration.

Usually distresses are related to...

**STEP 4
DEVELOP FEASIBLE ALTERNATIVES**

- Project Objective
 - Correct/Prevent Distress
 - Provide Skid Resistance
 - Extend Pavement Life
- Engineering Evaluations
 - Traffic, Climate, Performance, Etc.

Having identified the cause of the problem and developed project information, possible solutions need to be identified based on project objectives and engineering evaluation.

Engineering evaluation should consider factors such as traffic, climate, performance, cost, location, traffic control, and availability of materials and contractors.

Most problems will have more than one feasible solution. For example, there can be a short-term lower initial cost solution and a more expensive longer lasting technique.

**STEP 5
PERFORM LIFE CYCLE COST
ANALYSIS**

- Cost
- Performance
- Analysis Period
- Discount Rate

The next step in the selection process is to perform a life cycle cost analysis. The analysis should include costs, expected performance of each alternative, an appropriate analysis period (long term life of the pavement), and economic factors such as "discount rate."

The costs should include initial costs, routine maintenance costs, user costs, and future rehabilitation requirements over the analysis period.

STEPS 6 AND 7

- Select Preferred Alternative
- Construct and Monitor Performance

An alternative should be selected based on lowest life cycle costs. However, the final selection may be affected by budget or other consideration.

The process should not end at selection of an alternative but should also provide for performance evaluation and feedback.

TIMING OF APPLICATION

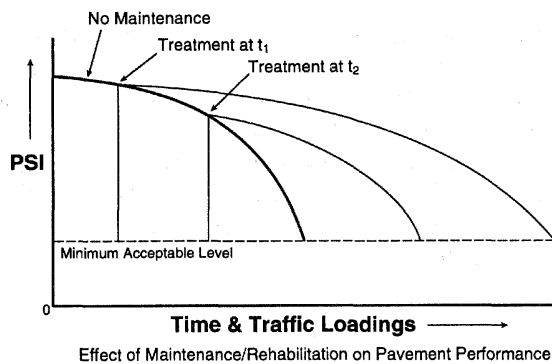

In addition to selection of appropriate technique, the timing of the application can have the significant influence on pavement performance and service life. As shown in this slide, a technique will be more effective if applied early in the pavement life.

While it is known that in order to be effective the rehabilitation techniques must be applied before significant deterioration has set in, it is still not understood when the best timing for the applications is (i.e., should the treatments be applied before any sign of distresses, or should they be applied at some other time during the decay cycle?).

One purpose of the Strategic Highway Research Program (SHRP) H-101 experiment was to answer question on the timing of the application. Several National Cooperative Highway Research Program (NCHRP) reports have also discussed this subject.

DEFINITIONS

- Maintenance and Surface Rehabilitation Techniques
- Pavement Performance
- High Volume Roads
- Polymers
- Asphalt Emulsion
- Breaking and Curing Process

Several terms should be defined since they will be used several times during this presentation. These terms are...

MAINTENANCE AND SURFACE REHABILITATION TECHNIQUES

- Preserve or Extend the Pavement Life
- Preventive or Corrective

Maintenance and surface rehabilitation techniques as discussed in this presentation are broadly defined as work accomplished to the pavement surface to preserve or extend the pavement's serviceability until major rehabilitation or complete reconstruction can be performed.

These techniques may be classified according to their purpose or function as either corrective or preventive.

PAVEMENT PERFORMANCE

- Structural Capacity
- Functional Condition
 - Ride Quality
 - Noise
 - Friction
 - Profile
 - Color

Pavement performance depends on two factors; the pavement's structural capacity and its functional condition such as...

When we consider maintenance or surface rehabilitation techniques, we are simply thinking about improving the functional condition of the pavement. Since little if any structural improvement is developed in the pavement section through the application of surface rehabilitation techniques, they should be considered only for structurally sound pavements.

HIGH VOLUME ROADS

5,000 Vehicles per Day per Lane
or
500,000 80-kN ESALs/Yr

For the purpose of this presentation, high-volume roads are defined as roads that carry more than...

POLYMER TYPE

- Rubber
 - Natural Latex (natural rubber)
 - Synthetic Latex (SBR)
 - Block Co-polymer (SBS)
 - Reclaimed Rubber (old tires)
- Plastic (polyethylene, polypropylene, EVA, PVC)
- Combination of Rubber and Plastic

Polymers are large, predominantly hydrocarbon, molecules built up from a very large number of chemical units linked together in a chain. Many of the emerging techniques use polymer-modified binders. Types of polymers that have been used as modifiers include...

Selection of a particular type of polymer will depend on the performance requirements as well as the existing surface condition.

POLYMER EFFECTS

- Increased Stiffness
- Decreased Temperature Susceptibility
- Improved Adhesion

Polymers are typically credited with increasing the stiffness and decreasing the temperature susceptibility of the binder and improving adhesion between the existing surface and new application.

Since some modifiers and asphalt cements do not mix well with each other, it is important to determine whether polymers will contribute to improving the mixture. The amount and suitability of polymers is generally determined by suppliers through routine tests on the asphalt cements and mixtures.

BREAKING, SETTING, AND CURING

Breaking

- Separation of AC from Water

Breaking Time

- Time When Emulsion Reverts to AC

Breaking, setting, and curing are terms used to describe the behavior of emulsions. Besides the type and amount of emulsifier; the amount of asphalt, temperature and humidity, application of pressure, aggregate absorption, surface chemistry, and surface area play a role in these processes.

Breaking refers to the separation of asphalt cement (AC) from the water on contact with aggregate or pavement. The purpose of the breaking process is to coat the aggregate.

Breaking time refers to the time when emulsion reverts to asphalt cement. Breaking can be detected by a marked color change from brown to black and often by the release of fairly clear to straw-brown water.

Setting

- Early Hardening of the Mixture

Curing

- Complete Removal of Water from Mixture

Setting is usually associated with the hardening (early strength) of the mixture.

Curing is the complete removal of water from the mixture. Although it may take several days before a treatment is completely cured, most of the water is displaced within the first 24 hours.

ASPHALT EMULSION

- Asphalt Cement
- Water
- Emulsifier

An asphalt emulsion is a suspension of asphalt cement in water with an emulsifying agent. In most cases, asphalt cement makes up 55 to 70 percent of the emulsion.

Emulsions are generally used as binders for surface rehabilitation techniques. These are preferred because development of adhesion between binder and aggregate is less affected by damp or dusty aggregates as is the case with asphalt cement. As opposed to cutbacks which have worked well for chip seals, emulsions are used for environmental reasons.

Emulsions are stored and applied at lower temperatures, reducing energy requirements and the risk of fire.

TYPES OF EMULSION

- Anionic (electronegative charge)
- Cationic (electropositive charge)
- Nonionic (neutral)

There are three types of emulsions: anionic, cationic, and nonionic depending on the type of charge on the surface of the asphalt particles. The type of emulsifier (a chemical) determines the type of emulsion.

EMULSION SUBCLASSIFICATION

- Rapid Setting (RS)
- Medium Setting (MS)
- Slow Setting (SS)
- Quick Setting (QS)

Emulsions are further classified according to their breaking characteristics. For example, an RS will break in 1 to 4 minutes, while a medium set may not break for 30 minutes. Mixes using emulsions become unworkable upon breaking. Medium setting emulsions also include four grades of high-float anionic emulsions. High-float emulsions permit a thicker film on the aggregates.

The type or grade of emulsion is determined largely by the type and amount of emulsifier.

EXAMPLE CSS-2H

Emulsions are further classified by the viscosity of the emulsions and hardness of the base asphalt cements. For example CSS-2h refers to a cationic, slow setting, relatively viscous emulsion made of harder base asphalt.

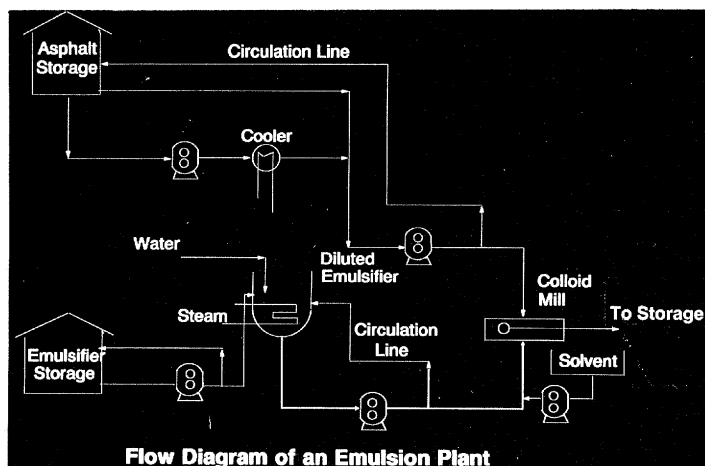

This is a schematic of an emulsion plant. The plant includes separate storage facilities for asphalt cement, emulsifier, water, chemicals, and solvents where used. Emulsion is produced in a high-shear colloid mill, where asphalt cement and emulsifier solution are subjected to intense shear stresses.

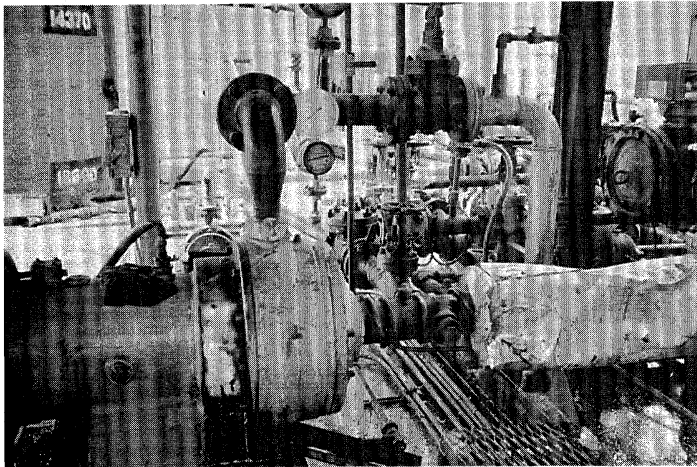

This is a closeup of a shear mill. Shearing results in division of heated asphalt cement into tiny droplets, which are dispersed in diluted emulsifier solution. Asphalt cement and emulsifier solution intake temperatures are normally in the ranges of 135 to 150 °C and 20 to 40 °C, respectively.

The newly formed emulsion comes out of the colloid mill at about 60 to 70 °C.

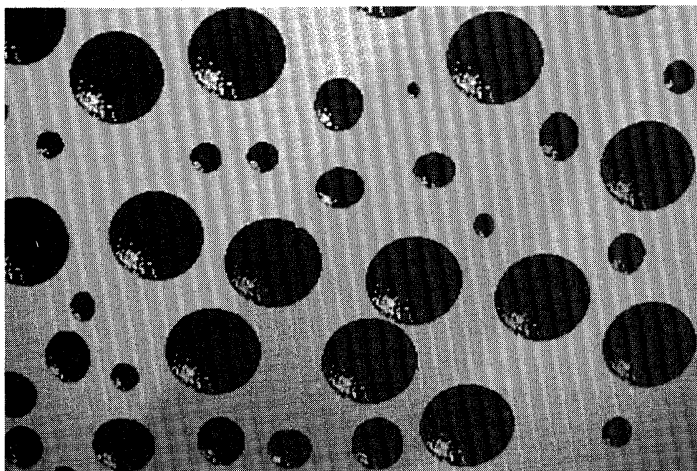

This photo shows dispersion of asphalt particles in emulsion.

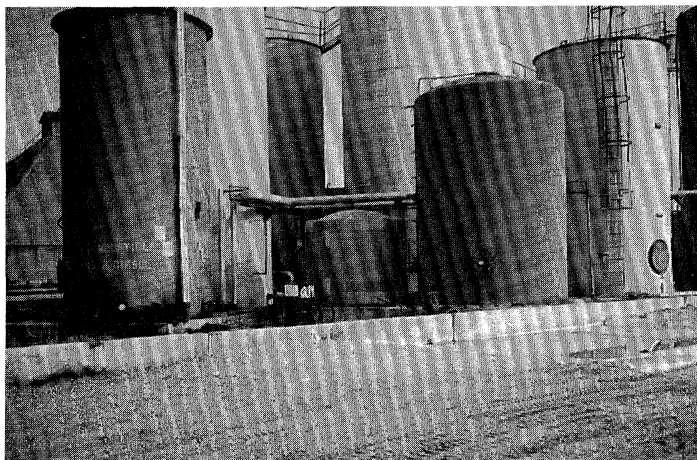

This slide shows storage tanks at an emulsion plant. These tanks store asphalt cement, emulsions, emulsifiers, modifiers, water, and chemicals. AC and emulsions are generally stored in insulated tanks that can be heated if desired.

PART II

Individual Techniques

Section 3

FOG SEAL

Application of Diluted Emulsion

- Seal and Enrich Surface
- Seal Minor Cracks
- Prevent Raveling
- Provide Shoulder Delineation

We will now look at various individual surface rehabilitation techniques.

A fog seal is an application of diluted emulsion without an aggregate cover. It is generally used to...

ENGINEERING FACTORS

- Existing Pavement Condition
- Traffic Volumes
- Traffic Control

Fog seal should only be used where the existing surface is sufficiently porous to absorb a substantial portion of the emulsion.

Fog seals are used on both low and high volume roads. Its primary use on high volume roads has been to prevent raveling of open graded friction courses (OGFCs), (approximately 11 States use fog seal for this purpose), and provide delineation between the mainline and the shoulder. Its wider use on heavily trafficked roads is restricted because the pavement friction may be reduced until traffic wears some of the asphalt from the surface. In addition under adverse weather conditions it may be several hours before a road can be opened to traffic.

EMULSION TYPE

- Slow Setting
- Medium Setting

Generally, slow or medium setting emulsions are used because rapid setting emulsions are prone to break on the aggregate surface, thereby reducing the quantity of asphalt available for filling the voids and resulting in tire pickup. The emulsions are diluted with an equal or greater amount of water to lower the viscosity and therefore allow flow into the voids between the aggregates. Dilution also allows low binder application rates.



An asphalt distributor is used to spray emulsion. The distributor should be calibrated prior to each project. Calibration and other details concerning the distributor are covered later, in the section on chip seals.

APPLICATION

- Application Rate 0.45 to 0.70 ℓ/m^2
- Spray Temperature 20 to 60 °C
- Surface Temperature 15 °C or Above

Emulsion application rates usually range from 0.45 to 0.70 ℓ/m^2 , depending on the pavement texture, local conditions, and traffic. Application rate is kept low to prevent splashing and decreased skid resistance.

A spraying temperature of 21 to 60 °C and surface temperature of 15 °C or above is recommended.

TRAFFIC CONTROL

- Allow Emulsion To Cure
- Use Reduced Speed Limits
- Use Sand if Necessary

The traffic should be rerouted until the emulsion has cured significantly. Under favorable conditions, 2 to 3 hours may be sufficient.

It is desirable to use reduced speeds until traffic wears some of the asphalt off the surface. Sand cover may also be used to improve surface friction.

COST AND PERFORMANCE

- \$0.15 to \$0.20/m²
- 1 to 2 Years

Fog seal cost depends on many factors such as materials, location, size of project, and application rate.

The performance life of this treatment is fairly short, ranging from 1 to 2 years.

SLURRY SEAL

Mixture of Fine Aggregate, Emulsion, Mineral Filler, and Water

- Retard Surface Raveling
- Seal Minor Cracks
- Improve Surface Friction

Slurry seal is a mixture of fine aggregate, emulsion, water, mineral filler, and additive if needed.

Slurry seals are effective where the primary problem is excessive oxidation and hardening of the existing surface. Slurry seals are used to...

A single layer is usually applied in thicknesses of 5 to 10 mm, depending on the aggregate gradation.

ENGINEERING FACTORS

- Traffic Volumes
- Traffic Control
- Existing Pavement

Slurry seals are routinely used on city and county streets. A few States have used slurry seals on moderate and high volume roads. At least one State has used slurry seal to cover open-graded friction course on interstates and other high volume roads. Slurry seals were also applied to moderate to high traffic volume roads under SHRP Experiment SPS-3.

A curing period is necessary before allowing traffic on the slurried surface. Therefore, slurry seals may not be appropriate for situations where early use of facility is required. Under warm conditions slurry seals require 1 to 2 hours or more to cure, depending on the type of emulsion used.

Slurry seal will not perform well if the underlying pavement is cracked.

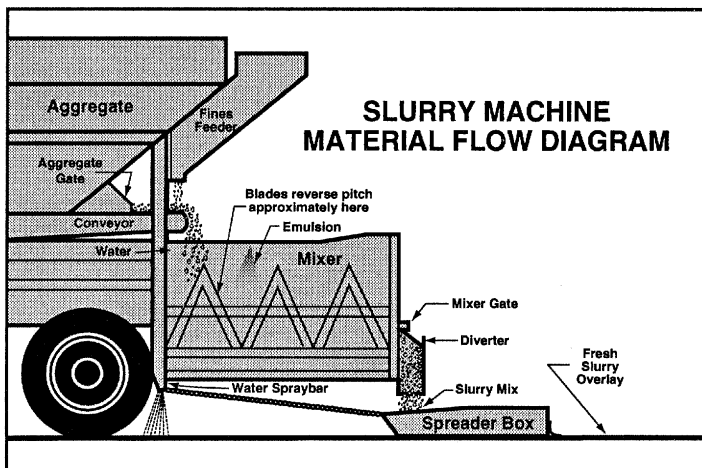

This slide shows a schematic of slurry seal production and application. Slurry seals are generally produced and placed using a truck-mounted slurry machine.

Aggregate, water, filler, and emulsion are proportioned and mixed together in a mixer and applied immediately to the paved surface with a spreader box.

SLURRY SEAL DESIGN

- Selection and Testing of Mixture Components
- Mixture Testing
- Optimum Asphalt Content

A precise design procedure has not yet been developed for slurry mixtures. However, current procedures usually result in acceptable slurry mixtures.

The slurry seal design process consists of (1) selection and testing of mixture components, mainly aggregate and emulsion; (2) mixing tests to determine compatibility of the mixture components; and (3) optimum asphalt cement content.

Detailed information on slurry seal design can be found in industry literature. A useful reference is "Recommended Performance Guidelines for Emulsified Slurry Seal— A105" as published by International Slurry Surfacing Association (ISSA).

SLURRY SEAL MIXTURE CHARACTERISTICS

Type	I	II	III
Top Size Aggregate, mm	2.36	4.75	4.75
Residual Asphalt Content, %	10-16	7-13	6-12
Application Rate, kg/m ²	3-5	5-8	8+
Filler, %	←	0.5 to 2.0	→
Mixing Water, %	←	6 to 11	→

There are three types of slurry seals, with different aggregate composition, binder content, and application rates. The maximum size is 2.36 mm for type I, and 4.75 mm for types II and III. Aggregate gradation is coarser for type III than for type II. Where moderate to heavy traffic is present, only types II and III are used, to obtain maximum skid resistance and an improved wearing surface.

Mineral fillers such as portland cement and hydrated lime are often used as stabilizers. Mineral fillers also affect the break time (usually break time is shortened). If needed, an additive may also be used to control the break time.

Field conditions will affect the quantity of water and additive. It is important that the consistency of the slurry be such that it rolls in a continuous mass.

SURFACE PREPARATION

- Tack Coat
- Crack Sealing
- Surface Moistening

A tack coat is not necessary unless the pavement surface is dry or raveled. A tack coat is needed on all concrete pavements.

All cracks wider than 3 mm should be sealed prior to application of slurry seal.

During hot weather, the pavement is usually prewetted to control premature breaking of the emulsion and to improve bonding with the existing pavement. Fogging should not result in any standing water on the pavement.

WEATHER LIMITATIONS

- Air Temperature (10 °C)
- Pavement Temperature (10 °C)
- No Freezing Within 24 Hours
- No Rain for Several Hours

Slurry seals should be placed when air and pavement temperature is at least 10 °C and there is no chance of freezing within 24 hours after placement. Slurry seals should not be applied during rain, nor should they be applied if rain is expected before the slurry is set.

This is a typical truck-mounted slurry machine for application of slurry seal. These machines have separate tanks for water, emulsion, additive, mineral filler, and aggregate. A water spray bar attached to the rear of truck is used to wet pavement surface ahead of mixture placement.

Calibrated controls are provided to ensure accurate proportioning. These devices should be calibrated at least every 12 months to allow for wear. Calibration prior to a project is usually desirable.

Self-propelled machines are sometimes required for high volume roads. These machines are discussed under "Micro-surfacing."

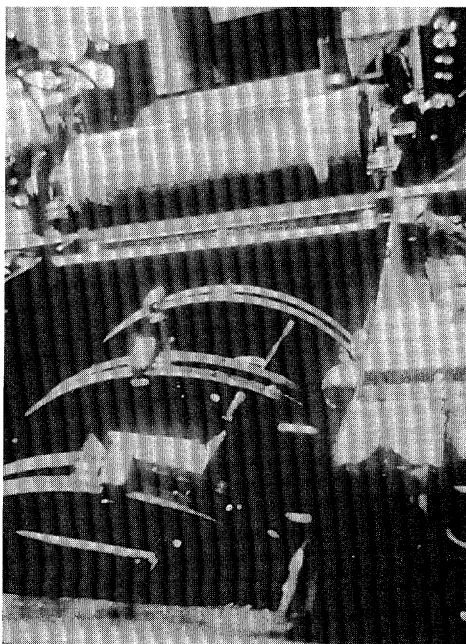

This is the interior of a typical mixer. Mixers are usually fitted with a multibladed single shaft for blending the materials. The slide also shows where the aggregate and mineral filler enter the mixer. Emulsion is introduced at about the one-third point of the mixer.

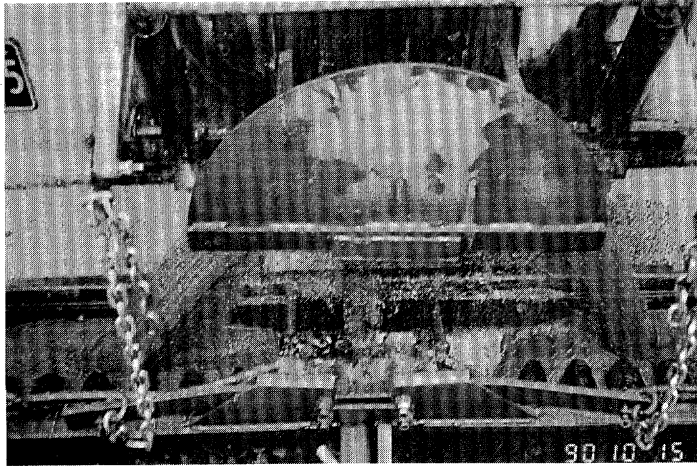

The mixture is discharged into the spreader box through a chute. Some chutes are fitted with a divider. This kind of arrangement helps to distribute the material evenly, particularly when placing slurry in areas of high crown or on superelevated curves. In these cases the slurry should be diverted to the high side of the spreader box, as gravity will keep the lower side filled.

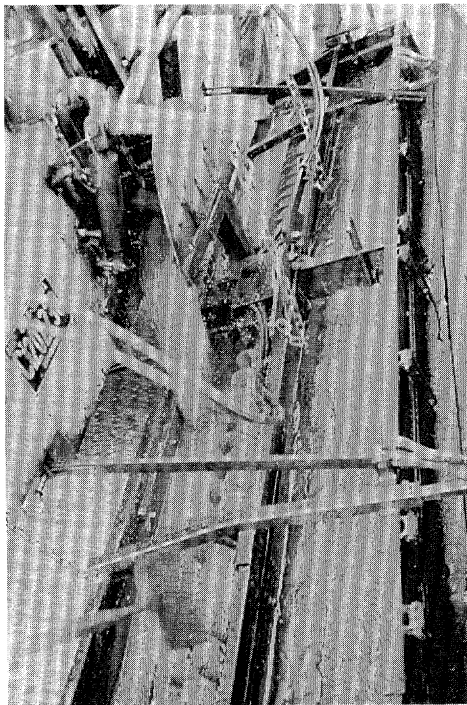

This is a typical spreader box used to place slurry seals. To achieve uniform distribution of material, particularly when quick set (QS) type of slurry is used, newer type spreader boxes that are fitted with augers are recommended. Boxes are fitted with seals on all sides to hold the material within the box while ensuring that a uniform speed and depth are maintained. A drag mop (burlap) is commonly used with the spreader box to provide a uniform texture.

The mixture is applied at speed of 1.5 to 2 km/h.

The slurry should be produced and spread at the optimum consistency and stability. If it is too fluid, the slurry may run into channels, and segregate, resulting in poor skid resistance. If it is too stiff, it may prematurely set in the spreader box or may tend to drag behind the burlap. Because of its fluid nature, many operators prefer to place the slurry while going uphill.



This shows textures of newly placed and few-hour-old slurries. Notice the difference in color.

COST

\$0.80 to \$1.05/m²

- Size of the Project
- Materials Cost and Availability
- Rate of Application
- Location
- Other Project Items

The cost of slurry seal usually ranges from \$0.80 to \$1.05/m² and depends on factors such as...

PERFORMANCE

3 to 5 Years

- Traffic Loadings
- Environmental Condition
- Existing Pavement Condition
- Quality of Materials and Design
- Construction Quality

Slurry seals are considered to have a service life of 3 to 5 years. A 1993 field review of slurry seal sections placed on 81 test sections under SHRP SPS-3 generally confirms this performance expectation.

Factors affecting slurry performance include...

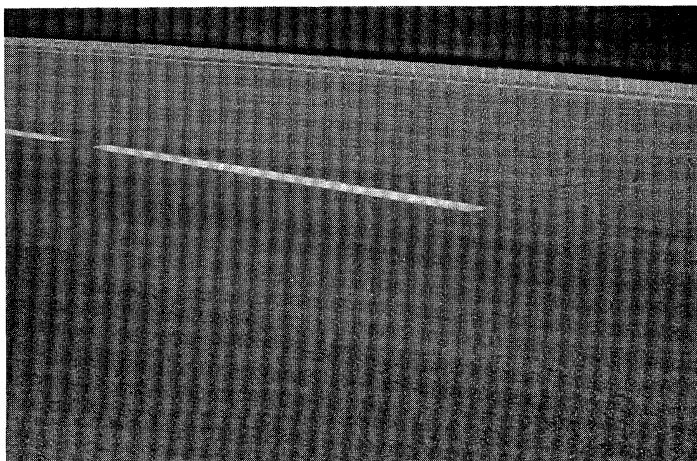

This is a 5-year old slurry seal project in Tennessee. The pavement surface is in good condition with the exception of reflection cracks.

MICRO-SURFACING

- Thin-Surface Paving System (10 to 15 mm)
- Developed in Europe in 1970's
- Introduced in the United States in 1980

Micro-surfacing is a...

Since then many other States have used this treatment on their moderate to heavy volume roads. Most of the micro-surfacing systems are known by their generic name (i.e., micro-surfacing); however, some of the systems are commonly known by trade names such as Ralumac, Macro Seal, and Durapave. Major differences among the various systems are due to the types of emulsifiers and polymers used.

MICRO-SURFACING COMPOSITION

- Aggregate
- Polymer-Modified Emulsion
- Water
- Mineral Filler
- Field Control Additive

Micro-surfacing is basically a slurry seal with a polymer-modified binder and higher quality materials. It consists of...

MAJOR USES

Asphalt Pavements

- Texturing/Sealing
- Rut Filling

Concrete Pavements

- Texturing

Micro-surfacing has been used on both asphalt and portland cement concrete (PCC) pavements. For asphalt pavements it is used to...

For PCC pavements...

Other uses of micro-surfacing include applications on raveled and flushed surfaces, as an interlayer, and minor leveling.

ENGINEERING FACTORS

- Traffic Volumes
- Traffic Control
- Noise
- Experienced Contractor

Micro-surfacing is suitable for both moderate and high volume roads. A road can usually be opened to traffic in about one hour after application in favorable conditions.

Micro-surfacing systems using coarse aggregates may produce relatively higher noise. Quality materials and experienced contractors are usually necessary for acceptable construction, and performance.

- ① Aggregate Bin
- ② Mineral Filler Bin
- ③ Additive Storage
- ④ Aggregate
- ⑤ Emulsion
- ⑥ Water and Additive
- ⑦ Pugmill
- ⑧ Mixture
- ⑨ Spreader Box
- ⑩ Brown to Black Color
- ⑪ Spraybar

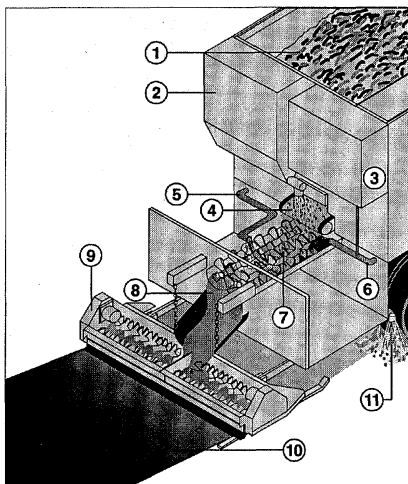

These ingredients are mixed and applied in the field using a mobile mixing unit. Compared to hot-mix asphalt, which is workable when hot and hardens upon cooling, micro-surfacing hardens through an electrochemical process and by the loss of water from the system.

MICRO-SURFACING MIXTURE CHARACTERISTICS

Type	II	III
Top Size Aggregate, mm	4.75	4.75
Application Rate, kg/m ²	5-10	8-16
Asphalt Content, %	5.5-9.5	
Filler, %	0.5-3.0	
Polymer Modifier	As needed	
Water, %	4-12	

Usually two types of micro-surfacing are used, with different aggregate composition, binder content, and application rates. The maximum aggregate size for both types is 4.75 mm. Aggregate gradation for type III is coarser than for type II. Type III is normally used for rut filling and texturing on high volume roads.

Mineral fillers such as portland cement and hydrated lime are often used as stabilizers. Mineral fillers also affect the break time (usually break time is shortened). If needed an additive may also be used to control the break time.

MIXTURE DESIGN STEPS

1. Selection and Testing of Component Materials
2. Mixture Testing
3. Long-Term Performance-Related Testing

DESIGN COMMENTS

- Design Is Evolving
- Sample Preparation Is an Art
- Test Repeatability Not Assured
- Tests Need To Be Standardized
- Design Values Need Validation
- Purpose Is Materials Compatibility
- Industry Continues to Refine Procedures

CONSTRUCTION FACTORS

- Surface Preparation
- Weather Conditions
- Equipment
- Construction Quality
- Specification

The micro-surfacing design process consists of three steps...

The laboratory needs background information, such as existing pavement condition, traffic loading, and climatic conditions. They also need to know the objective of the job (texturing, rut filling, etc.).

Since micro-surfacing is intended for functional improvements only, no structural design is performed.

Detailed information on micro-surfacing design can be found in ISSA publications. FHWA publication FHWA-SA-94-051 is another useful reference on micro-surfacing.

While a large number of projects have performed well, micro-surfacing design is still evolving and needs refinements. Sample preparation and consistency (amount of water and emulsion) have a significant influence on test results. But a reliable sample preparation procedure has not yet been perfected. Therefore, repeatability of tests is not ensured.

Tests are not standardized by ASTM or The American Association of State Highway and Transportation Engineers (AASHTO). In addition, many of the ISSA tests are not used by every design laboratory.

Design standards were developed using limited material combinations, and they need adjustments based on additional testing.

The main purpose of all the design tests at this time is to determine the compatibility of the various materials.

The industry is trying to improve design procedures and adjust standards to reflect the effect of various material combinations.

We will now look at various construction-related items such as...

PREPARATION OF SURFACE

- Treatment of Pavement Cracks/Joints and Other Minor Repair
- Tack Coat
- Water Fogging

Surface preparation for micro-surfacing generally consists of the...

All pavement joints and cracks that are 5 mm or wider should be repaired and sealed before the application. To ensure proper curing of sealant, all cracks should be repaired 1 to 6 months before micro-surfacing application.

Sealant should not be allowed to build up on the surface, otherwise the sealant can be torn by screeds leaving drag or tear marks. In addition, application of too much sealant will bleed through the micro-surfacing.

A tack coat (approximately 0.45 l/m) should be used on all PCC and on dry and raveled asphalt pavements prior to application of micro-surfacing.

The tack coat should be allowed to cure before application of micro-surfacing. A minimum curing period of 0.5 to 2 hours is normally required under favorable conditions. Slow-setting emulsions are normally used.

During hot weather, the pavement is usually prewetted to prevent premature breaking of the emulsion and to improve bonding with the existing surface.

WEATHER CONDITION

- Minimum Temperature 10 °C
- No Rain
- No Freezing Within 24 Hours

Micro-surfacing should not be placed if either the pavement or air temperature is below 10 °C. If placed in cold temperatures, micro-surfacing may ravel and crack. If placed in very hot weather, the surface can break too fast, causing slow interior curing and blistering. Micro-surfacing should not be placed if it will freeze within 24 hours, nor it should be placed during or an hour before rain.

EQUIPMENT

- Self-Propelled Machines
- Truck-Mounted Units

Two types of machines are currently used to place micro-surfacing. These are...

Self-propelled, continuous loading and mixing machines are required for all major highways.

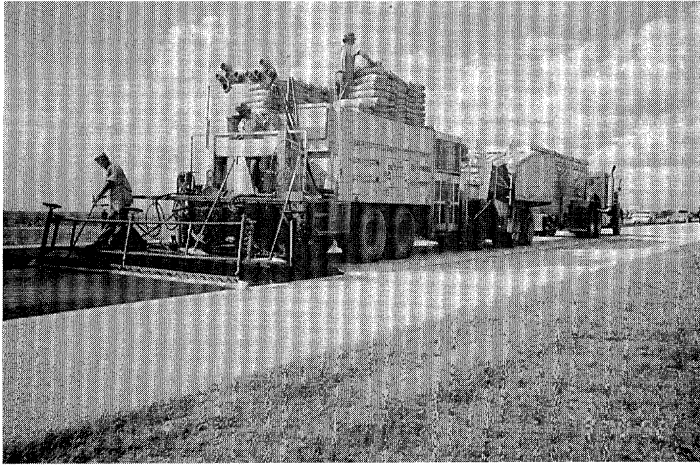

This is a typical self-propelled, front-feed, continuous loading and mixing micro-surfacing machine. The machine comes equipped with aggregate storage space, a bin for mineral filler, and separate tanks for water, emulsion, and additives.

These machines have dual side driver stations on the front to optimize longitudinal alignment. These are also equipped with a nozzle-type spray bar to provide a water spray ahead of the spreader box.

These machines are designed for working speeds of 1.0 to 4.0 km/h and are capable of applying micro-surfacing at the rate of up to 450 Mg per day.

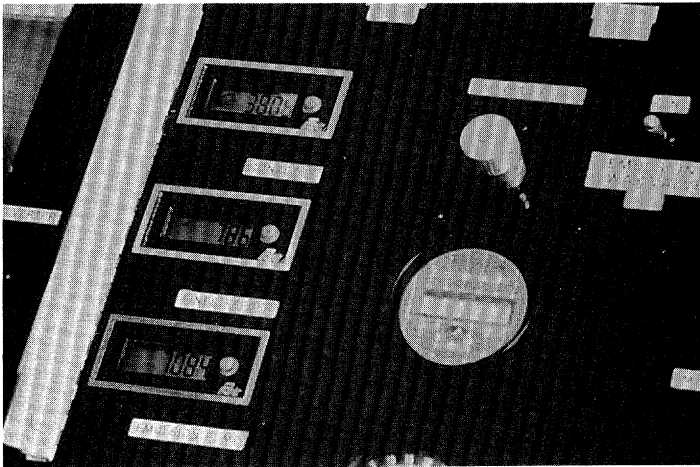

These machines are fitted with controls and meters to properly proportion and monitor the quantity of all components. The controls should be spot-checked prior to start of each project. Amounts of emulsion, aggregate, and mineral filler are fixed prior to placement operation, and only water and additive are slightly modified to obtain proper consistency and break time.

The machine controls should be calibrated at least once every construction season. Calibration prior to each project is desirable.



This is the front of the machine. The aggregate is received by a front hopper, delivered to a storage area, and then fed to the mixer on a conveyor belt.

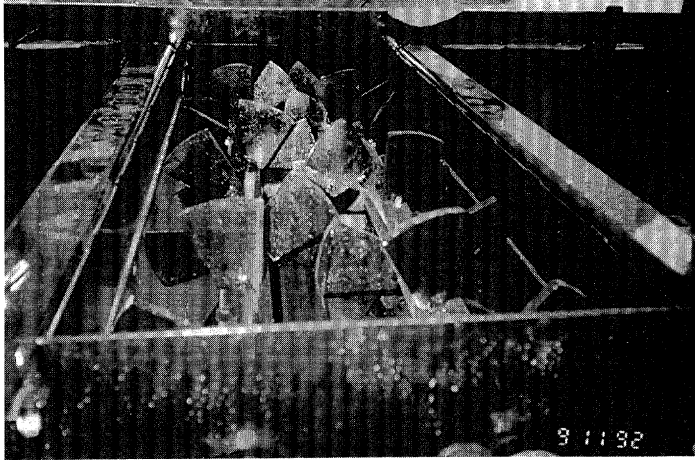

The mixers are about 1 to 1.3 m long and are fitted with multibladed twin shafts to allow thorough mixing of materials.

Mineral filler is added to the aggregate just before it enters the mixer. Water and additives are combined and added to the aggregate as it falls into the mixer. These ingredients are mixed before the emulsion is introduced, usually at about the one-third point of the mixer. The materials are mixed for 5 to 10 seconds prior to discharge into the spreader box, where they are mixed for another 5 to 15 seconds.

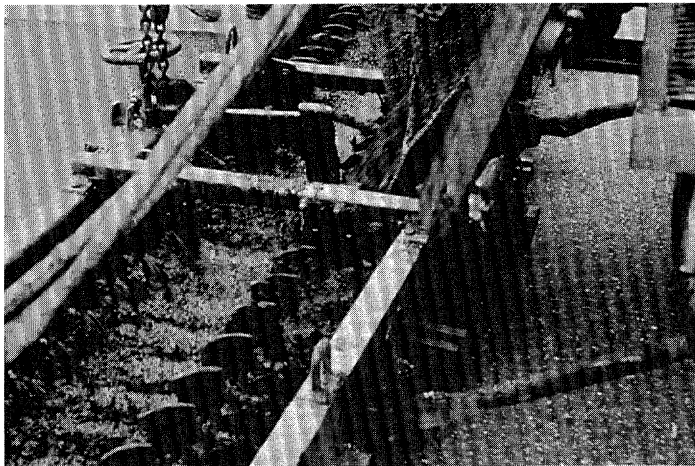

This slide shows a full-width spreader box that is used for texturing. Spreader boxes come in adjustable widths of 2.4 to 4.2 m and are equipped with hydraulically powered twin augers to mix and spread the mixture throughout the box for a uniform application.

Boxes are fitted with seals at the sides, front, and rear to retain the mixture within the box. The rear seal acts as a strike-off and is usually made of a rubber material. Steel strike-offs are preferred by some agencies for leveling work.

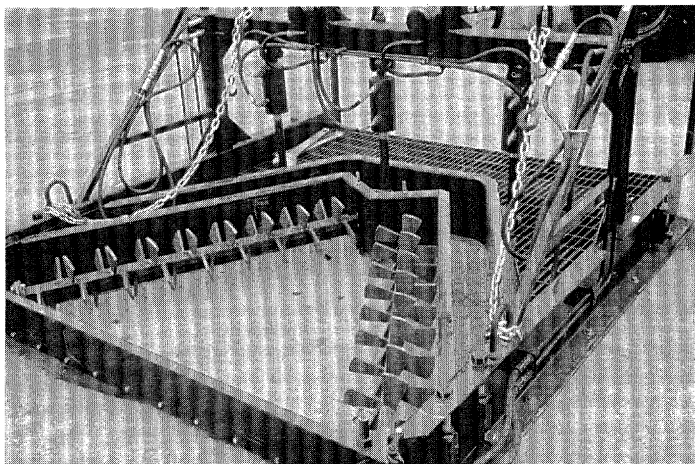

One of the major benefits of micro-surfacing is its capability to fill wheel ruts/consolidation. A special rut box is used for this purpose. Rut boxes come in two sizes, 1.5 and 1.8 m, and have two V-shaped chambers with the point of the V toward the rear of box. The box is fitted with two shafts that have multiple blades to agitate the material continuously. The box is designed to push the larger aggregate to the deeper parts of the rut.

To compensate for the initial compaction by traffic, rut boxes may be adjusted to leave a slight crown in the surface.

Ruts up to 38 mm can be filled with one pass. Multiple passes should, however, be used for greater depths, as thicker layers may not cure properly.

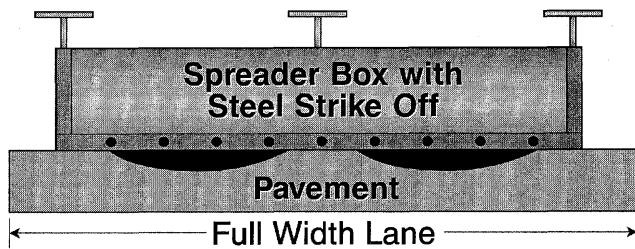

The Scratch Coat is Generally
150 mm Less Than the Width of the Lane

In instances where the surface is uneven or where the depth of wheel ruts is between 5 and 10 mm, two layers of micro-surfacing may be used. The first application should be a scratch course to improve the transverse profile, followed by a surface course.

The scratch course is placed by a full-width spreader box with steel strike-off. During application, the screed is set to make contact with high points on the pavement surface, thereby filling the low points.

CONSTRUCTION QUALITY

Texturing/Sealing

- Rippling
- Drag Marks
- Texture Uniformity
- Joints
- Edge lines

One of the most common uses of micro-surfacing is surface texturing and sealing. Micro-surfacing should result in a smooth, skid-resistant surface. To achieve this, the finished surface should be free from rippling and drag marks. In addition, the surface should have uniform texture and good-quality joints and edge lines.

There are several factors that can affect micro-surfacing applications for texturing and rut filling.

Rippling

- Thin Application
- Application Speed
- Aggregate Gradation and Shape
- Dirty or Worn Screeds
- Drag Mops (where used)

Two types of ripples, transverse and longitudinal, have been observed in the field. Transverse ripples are transverse undulations (i.e., alternate valleys and crests) at regular intervals in the surface of the pavement. Thin applications and speed of spread are considered to cause this type of rippling. Aggregate gradation and size may also be contributing factors.

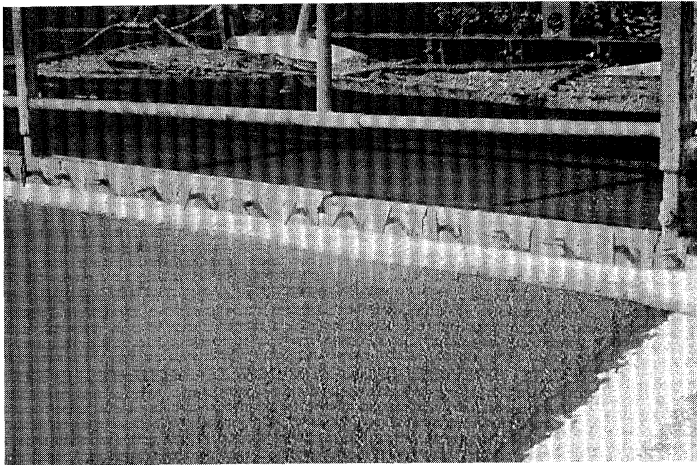

Several contractors now use a secondary strike-off to reduce transverse rippling and improve texture. This slide shows the texture difference between the primary and secondary strike-off.

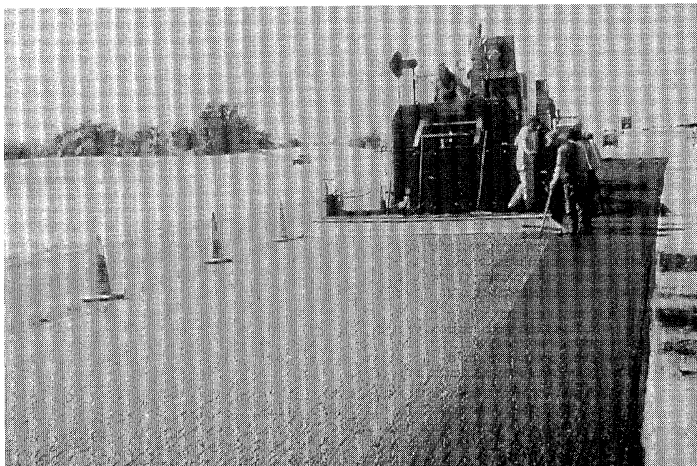

Some contractors use a drag mop for texturing. However, its use on micro-surfacing projects is not recommended because the mix is heavier and drier. Use of a drag mop also results in longitudinal streaking as shown in this slide.

Dirty or worn screeds may also result in longitudinal streaking. Specifications should include construction criteria for both transverse and longitudinal rippling/streaking.

Tear/Drag Marks

- Existing Surface
- Worn Screeds
- Insufficient Material
- Premature Breaking
- Oversized Aggregates

Reasons for tear marks include defects in...

These conditions should be avoided in order to obtain a mark-free surface. Any buildup of sealant or other surface imperfections can cause tear marks.

Worn screeds or buildup of material on the screed during the paving operation can result in drag marks behind the spreader box. Material can also fall off in chunks, leaving an unsightly appearance. The operator should watch for any buildup so that material can be removed before the problems occur.

The lower application rate should be avoided by ensuring that layer thickness is at least 1 1/4 times (preferably 1 1/2 times) the size of the largest aggregate.

To avoid drag marks, it is recommended that the aggregate should be screened just prior to use in micro-surfacing projects. Most State specifications require that the aggregate be passed over a scalping screen prior to use in the mixing machine.

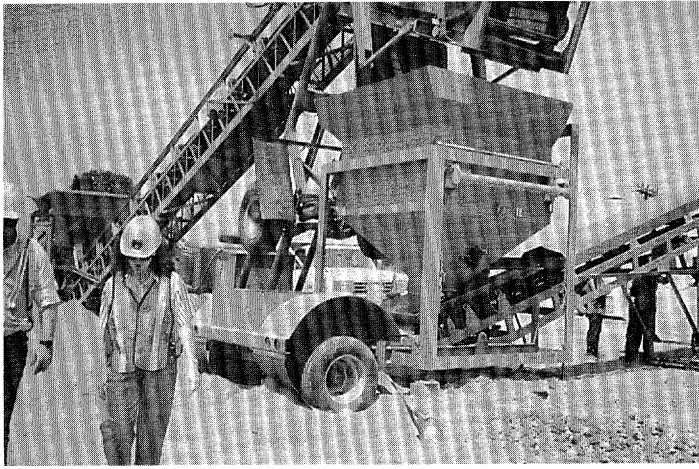

This slide shows a typical scalping screen set up in a stockpile area. The aggregate is stored, weighed, and screened at the stock pile site.

Texture Uniformity

- Avoid Dry Mixture
- Avoid Wet Mixture
- Use a Good-Condition Spreader Box

Several steps can be taken to obtain a uniform texture. These include...

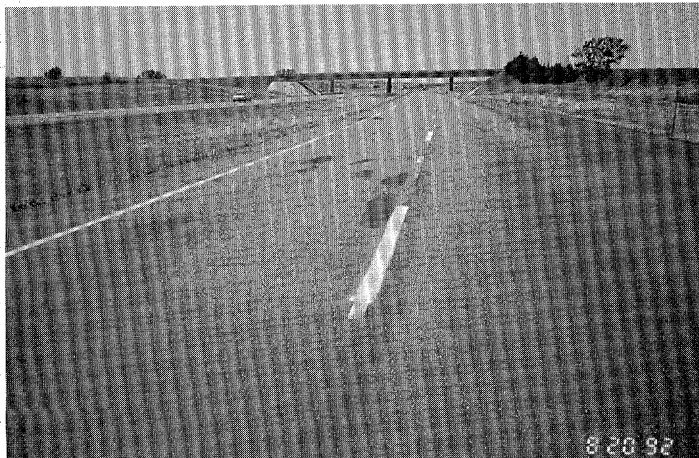

If a very dry mixture is used, it could break/set early and may not bond well with the existing surface. This slide shows a project where debonding started within a few days of placement.

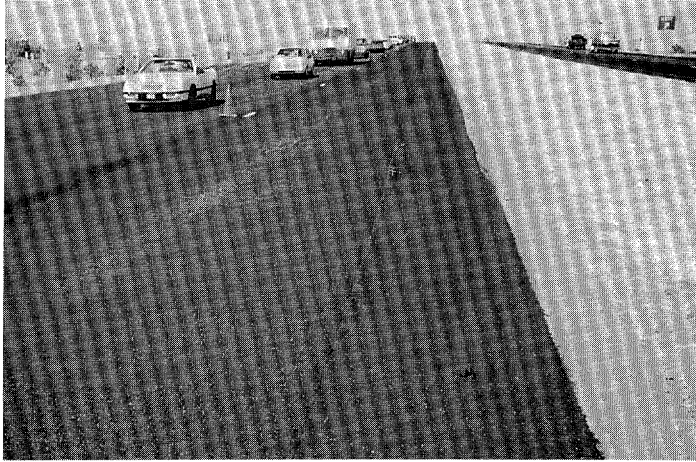

This slide shows a micro-surfacing project 30 to 45 minutes after application. This contrast in texture is usually caused by a wet mixture. The condition of the spreader box also has an affect on texture uniformity. The spreader box should be able to distribute the material evenly across its full width.

Pavement Joints

- Longitudinal
- Transverse

Good transverse and longitudinal joints are important for ride quality and overall project appearance. Current State specifications prohibit excessive overlap, uncovered areas, and unsightly appearance for either transverse or longitudinal joints. However, these parameters are not always well defined or enforced. String line or use of a chain mounted at the front of the machine could facilitate straight uniform longitudinal joints.

RUT FILLING

- Corrected Profile
- Uniform Texture

Rut filling is another major use of micro-surfacing. Rut filling should result in smooth texture and corrected surface profile that should not rerut for several years.

Rut filling by micro-surfacing provides a longer service life if the existing pavement is stable or if the rut is caused by wear or mechanical compaction of the pavement structure. Generally, if the pavement has been in service for 10 years and has developed ruts only 15 to 25 mm deep, the pavement could be considered stable.

Wheel consolidations are generally limited to 5 to 15 mm in depth depending on the surface thickness.



This slide shows a pavement with plastic flow. For this type of pavement, the micro-surfacing will correct the surface profile for only a short period depending on the cause and severity of the rut.

If micro-surfacing has to be used as a temporary measure, any elevated deformations present due to plastic flow should be milled prior to rut filling.

PERFORMANCE

- Texturing/Skid Resistance
- Rut Filling
- Raveled Surfaces
- Flushed Surfaces

Performance of micro-surfacing depends on many factors such as climatic conditions, traffic volume, existing pavement conditions, quality of materials, mixture design, and construction quality.

When properly designed and constructed, micro-surfacing has shown promising results in improving surface friction and filling wheel consolidations, with 4 to 7 years of service life.

Performance results have been mixed but are generally encouraging when micro-surfacing is used to improve...



This is a 5-year-old project on I-70 in Kansas. This pavement is in good condition with the exception of a few cracks and minor consolidation.

Experience of other States, such as Ohio, Virginia, West Virginia, Tennessee, Texas, and Oklahoma, has been very positive in this regard. Nearly all States report 4 to 7 years of acceptable performance.



This bridge deck on the West Virginia Turnpike was micro-surfaced about 8 years ago to improve skid resistance. It is still performing well, with the exception of minor raveling.



This is a 3-year-old rut-filling project on I-94 in Wisconsin. The project did not exhibit re-formation of significant ruts (i.e., ruts of 10 to 20 mm rerutted to only 5 mm). Projects reviewed in Pennsylvania, Texas, Kansas, Oklahoma, Ohio, and North Carolina have revealed 3 to 7 years of acceptable performance.



Micro-surfacing, like other thin treatments, will not prevent cracks reflecting through it. Most of the cracks will reappear within a year. A review of several projects, however, indicates that micro-surfacings have generally kept the reflection cracks fairly closed for a considerable time.



Micro-surfacing has been used to repair OGFCs and raveled surfaces with considerable success. This slide shows a 3-year-old micro-surfacing project placed on top of a raveled OGFC in Oklahoma.

UNIT COST OF MICRO-SURFACING

<i>State</i>	<i>Cost (\$/Mg)</i>
NC	100-110
PA	125-150
VA	100-110
TX	90-95
OK	90-95

Micro-surfacing costs generally vary from...

Costs depend on many factors, including location, availability of materials and contractor, application rates, maintenance of traffic, and other bid items. The number and size of projects in each State also affect the application cost in that State. Micro-surfacing costs approximately two to three times as much as hot-mix asphalt concrete on a weight basis.

Since its unit cost is relatively higher, the cost-effectiveness of micro-surfacing depends on the use of thinner applications.

SLURRY AND MICRO-SURFACING IN EUROPE

- Slurries Since 1920
- Micros Since Late 1970's
- Used for Rut Filling and Texturing
- Latest Design
Fibers and Gap-Graded Mixes

Spain, Germany, and France are the European leaders in the use of slurry and micros. Micros are used for rut filling, profiling, and enhancing surface friction. The rut-filling application is limited to those ruts that are not deeper than 40 mm.

Gap-graded mixtures and incorporation of fibers are the latest innovations. Fibers are considered to increase viscosity, improve skid resistance, and retard cracking.

CHIP SEAL

Asphalt followed by Aggregate Cover

- Single
- Double
- Multiple

A chip seal is an application of asphalt followed immediately with an aggregate cover. Chip seal applications can consist of single or multiple layers ranging in thickness from 10 to 40 mm. Two layers are referred to as a double chip seal.

Rapid setting asphalt emulsion is usually used. When using multiple layers, the first layer should be cured before the application of the second layer.

CHIP SEAL USE

- Seal Surface
- Seal Low-Intensity Fatigue and Block Cracks
- Restore Surface Friction

Chip seals can waterproof the surface, provide low-severity crack sealing, and restore surface friction.

ENGINEERING FACTORS

- Traffic Volume
- Loose Chips and Windshield Damage
- Noise
- Variations in Life Expectancy
- Extended Traffic Control

Chip seals are generally used on low to moderate volume roads. Although chip seals provide effective sealing and friction, the possibility of loose chips and broken windshields along with excessive noise has prompted many States to restrict use of chip seals to low volume roads. Other problems involving chip seals are variable life expectancy and extended traffic control requirements.

DESIGN OF CHIP SEALS

- Estimation of Voids in the Aggregate Structure
- Filling of About 70% of Voids With Asphalt

Various methods (ASTM, Asphalt Institute, McLeod) have been used to design chip seals. All procedures involve some element of judgment and experience and are based on.... The objective is to find proper rates of application for asphalt and aggregate.

Estimation of voids between the aggregate depends on the size, gradation, shape, and orientation of the aggregate. Asphalt quantity is determined for voids that are expected to exist when cover aggregate particles become oriented into their densest positions after rolling and substantial traffic.

Asphalt Institute (AI) and ASTM procedures generally provide estimates while McLeod method provides more specific quantities and is based on determination of average least dimension (ALD) of the cover aggregate (See publication FHWA-IP-79-1 Interim, January 1979). We will go over some of the important chip seal design considerations. Detailed information on chip seal design and placement can be found in industry publications. A useful reference in this regard is the Asphalt Emulsion Manufacturers Association's (AEMA) "A Basic Asphalt Manual."

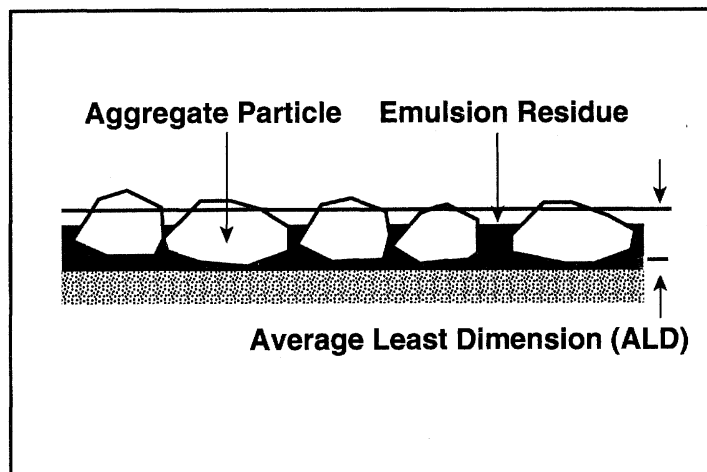

This slide shows the ALD of cover aggregate particles which is the ultimate positions of these particles after considerable traffic.

The ALD of cover aggregate is the average thickness of aggregate particles in their flattest position. ALD depends on the shape and size of the aggregate.

Importance of ALD of the cover aggregate in both the design and service performance of chip seal is illustrated in next two slides.

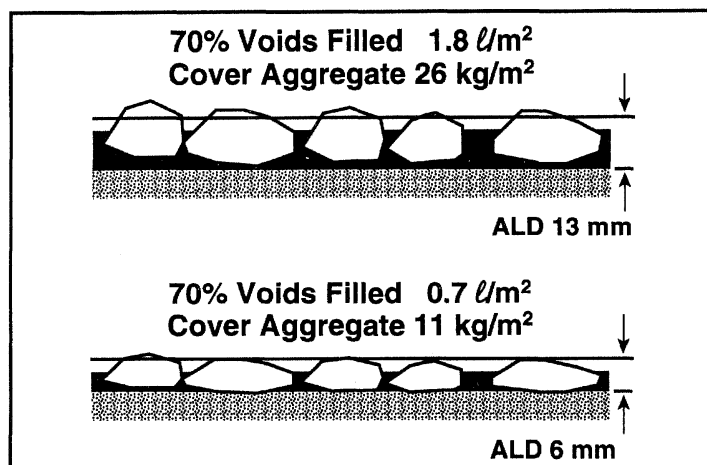

This slide shows the effect of ALD on the quantity of aggregate and asphalt binder. Both aggregates are of same size, but different shapes-one cubical, the other flat. Because of different particle shapes, ALD of one aggregate is 13 mm while ALD of other aggregate is 6 mm.

This difference in ALD will result in different binder and aggregate requirements. This emphasizes the importance of ALD when designing a chip seal.

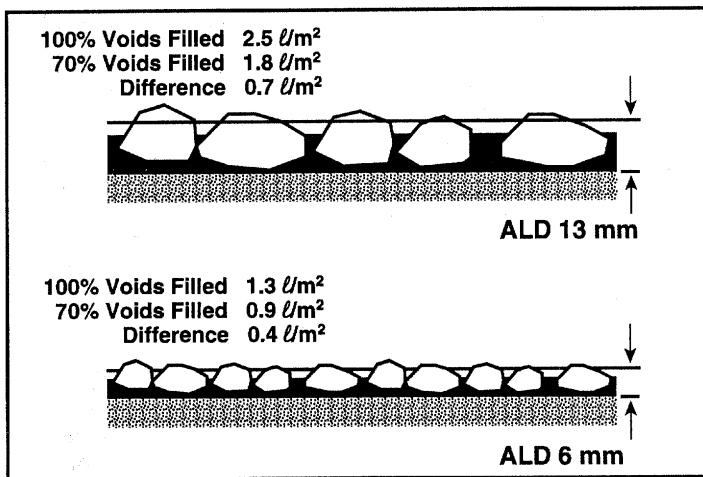

Besides cover aggregate shape, stone size is an important factor in design of chip seals. A larger one-sized aggregate (15 mm or greater) are preferred because they provide longer service life and are less sensitive to small variations in asphalt binder than when smaller aggregates are used. This slide illustrate that the margin of safety against flushing or loss of aggregate is higher for large size than for small size.

Obtaining one-sized aggregate, however, is expensive, and larger particles are more prone to turning and causing excessive noise. The use of small size, on the other hand, is not recommended, as it is more likely to embed in the existing pavement.

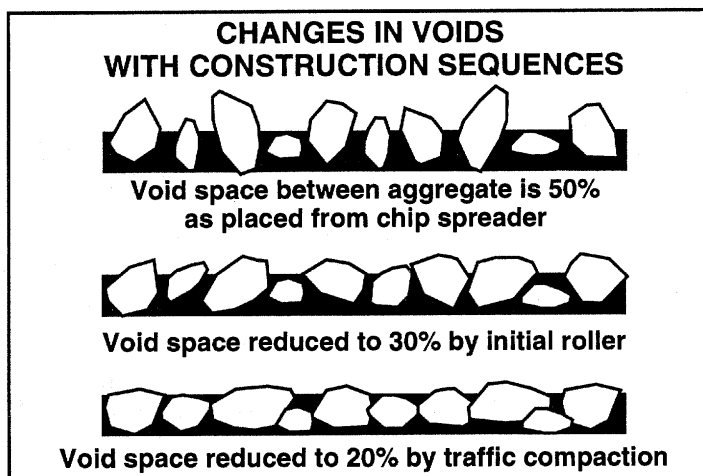

Determination of proper amount of asphalt is a key to successful application. Too much asphalt will result in bleeding, whereas insufficient asphalt will cause raveling. Performance results have shown that particles that are embedded less than 50 percent tend to be torn out by traffic, while those particles that are small may completely submerge in the residual asphalt. This slide shows various levels of embedment during and after construction.

As mentioned earlier, on the average, each cover stone should be embedded in residual asphalt to about 70 percent of its thinnest dimension. The best results are, therefore, obtained when a one-size aggregate is used as most of the particles will embed to same depth. Because of the meniscus effect of the residual asphalt left on the aggregate upon the evaporation of water when emulsion is used, the residual asphalt content can be reduced to 55 to 60 percent of the voids. Embedment after 1 to 2 years should be about 60-80 percent.

AGGREGATE QUANTITY

- Potential for Windshield Damage
- Inadequate Cover

Determination of aggregate quantity is another important design consideration. Too much rock will increase the potential for windshield damage, whereas an insufficient amount will not provide proper cover. Spread rate should be enough to cover the entire surface of binder after rolling.

AI method to determine the application rate for a specific size aggregate is to lay the chips one stone deep, on a 1-m surface and arranging the aggregate so that it fills the surface in the densest condition anticipated to exist in the field after application of traffic, then weigh it. AI's publications include recommendations for asphalt and aggregate quantities based on the size of aggregate.

OTHER FACTORS

- Type of Existing Surface
- Condition of Existing Surface
- Traffic Volume

Asphalt rates and aggregate size must also be adjusted for existing pavement condition and traffic volumes. For example, OGFC surfaces will require more binder to provide an effective seal, whereas flushed pavements will require less asphalt.



We will now look at chip seal construction operations. This slide shows the equipment just prior to the start of the job. Equipment consists of trucks, asphalt distributor, chip spreader, rollers, and brooming devices. Sufficient trucks must be available to prevent stop-and-go operation.



This slide shows a typical chip seal operation.

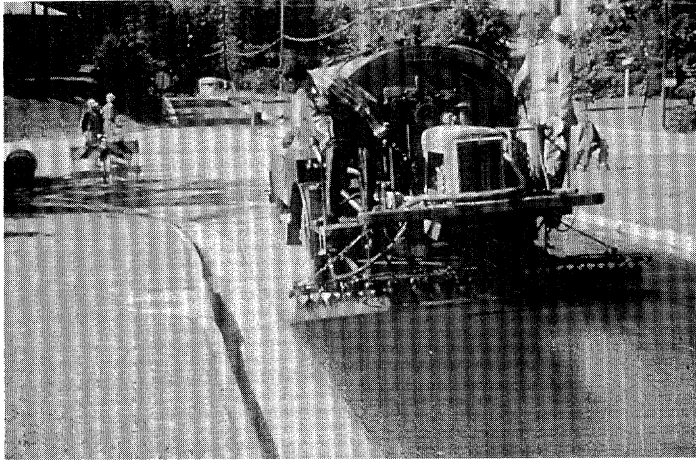

This is a close up of a typical distributor truck. It consists of an insulated tank, asphalt pump, spray bar with nozzles, and controls. The spray bars can cover widths of 3 to 8 m in a single pass, depending on the pump capacity. The truck normally has a capacity of 3,000 to 20,000 l. The tanks are fitted with heaters that can bring the asphalt to an application temperature that will ensure the proper viscosity. During the operation the distributor speed should be kept constant to ensure good longitudinal uniformity of the rate of binder application.

In order to obtain proper embedment, the distributor should not be permitted to advance more than 30 to 40 m ahead of the aggregate spreader.

SPRAY EQUIPMENT

- Nozzle Size, Spacing, and Angle
- Spray Bar Height

Nozzle size, spacing, and angle along with spray bar height are some of the important considerations in spray application. Effect of these variables is illustrated in next few slides.

Recommended nozzle sizes for chip seals are 3 to 5 mm. Different-sized nozzles may be used across the spray bar where significantly different levels of surface texture exist in the wheel path than between the wheel path. However, this practice is not considered practical by many agencies.

ANGLE OF SPRAY NOZZLES

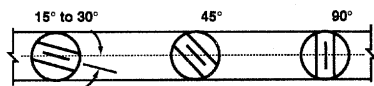

Side View

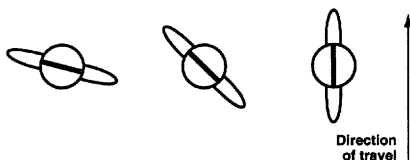

Top View



The nozzle angle in relation to the spray bar must be adjusted so that the spray fans will not interfere with each other. The recommended angle is between 15 and 30 degrees. The nozzle size, spacing, and angle determine the height of the bar.

This slide shows the affect of various angle setting.



Spray bar height must be properly set and maintained to obtain a uniform spread and avoid longitudinal streaking. If the bar is too low, there will be areas of no asphalt. If the bar is too high, dark streaks will appear.

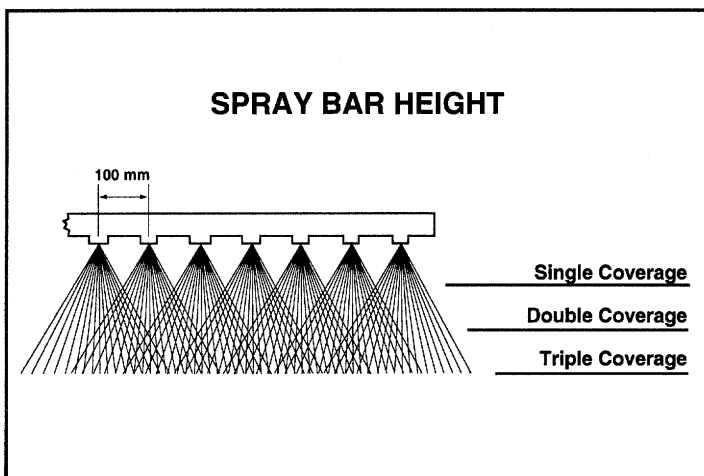

This slide shows affect of spray bar height on spray coverage.

The best result with 100-mm nozzle spacing usually comes from a double coverage, but triple coverage can sometimes be used. A single or double coverage may be more suitable for a 150-mm spacing, because the height of the bar necessary to give a triple coverage may permit wind distortion of the spray fans.

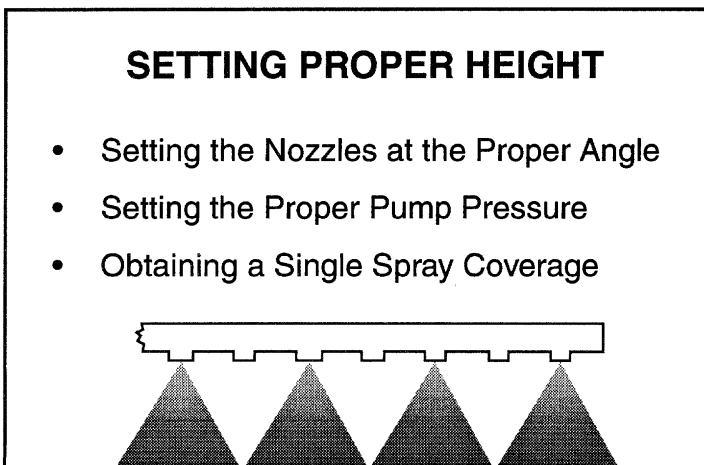

Setting the spray bar height involves...

Determination of the spray bar height is based on the fact that by visual inspection one can determine whether or not single coverage is being applied. For example, to set spray bar height for a double coverage, every other nozzle on spray bar is turned off. The distributor is then operated with the spray bar height varied in 12.5 mm increments. When an even, single coverage is applied to the surface, it will yield a uniform double coverage with all nozzles unplugged. Triple coverage involves the similar procedure, except that two out of every three nozzles are closed. Note that increasing the height for a double coverage by 50 percent will also yield triple coverage.

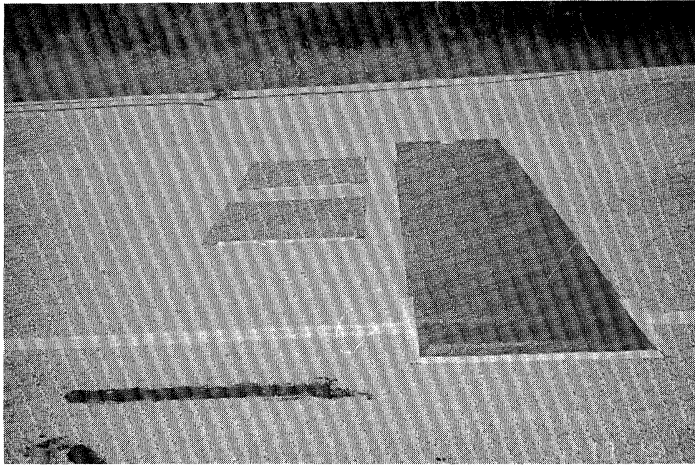

The distributor spray bar should be calibrated prior to each use. Calibration should be done both transversely and longitudinally to compensate for variations in existing pavement texture. Variations in longitudinal application of binder can be checked by measuring the binder deposited on previously weighed metal trays or sheets of heavy paper as shown in this slide.

British "road tray method" as described in Road Note 39 is a useful reference in this regard. ASTM also has a procedure for distributor calibration.



The temperature of the asphalt binder should be checked to avoid using binder that is too hot or cold.

Temperatures of 55 to 80 °C are fairly common for rapid setting emulsions used in chip seal applications. Surface and air temperatures should also be checked. A minimum of 15 °C is recommended for both. Air temperatures of 40 °C or above are not desirable either, as they may reduce the bond.

If asphalt cement is used, it is normally sprayed at temperatures of 130 °C or higher.



This slide shows an application where binder is too hot. Overheating could result in premature breaking of the emulsion or aging of the binder.

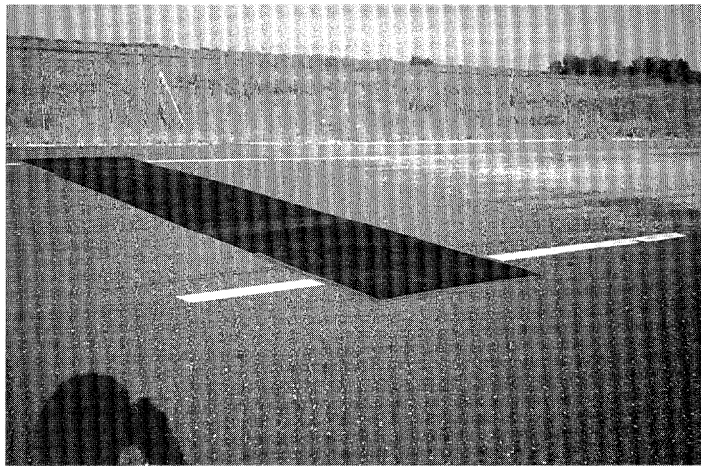

A paper strip should be used at the start and end of the chip seal application in order to obtain a neat joint.

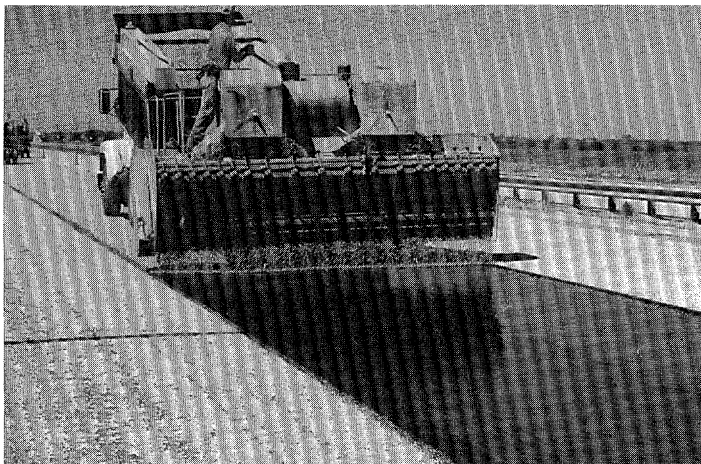

This is a picture of a self-propelled chip spreader. Chips should be spread immediately (before emulsion breaks) after application of asphalt. The desirable time between the application of binder and aggregate is 1 to 2 minutes. This time may be increased (up to a maximum of 3 minutes), depending on the field conditions, such as temperature and humidity.

When there are two passes, the aggregate should be spread on the first half of the roadway so that a 100 to 150 mm strip of asphalt is left exposed along the center line. This will form a lap for the second pass. **Some agencies use fine aggregates (choke) to fill the voids in the coarse aggregate.**



Chip spreaders should be calibrated prior to each application. This can be done by placing mats of known surface area (approximately 1 m) in the path of the spreader. After the spread, chip quantity on each mat is weighed. This procedure provides a measure of consistency of chip spread in both transverse and longitudinal directions. Spreader gates are adjusted to attain the desired quantity of chips.

The calibration should be carried out using aggregates having same size and shape and coming from the same source as the aggregates that are to be used in the chip sealing.

SHRP studies indicate that chip spreaders that kick the aggregate backward or drop the aggregate straight down reduce aggregate rollover and vehicle pickup.



Chips should be rolled immediately after their placement to embed and orient them on their flat side. While either steel or rubber-tired rollers can be used, the rubber-tired are preferred because they force the chips firmly into the binder and into small depressions without crushing them. Tire rollers weighing 6 to 8 metric tons are generally suitable for compaction. Control of tire pressure is important for rubber-tired rollers. Roller speed should not exceed 5 mph so the rock is set, not displaced.

Some agencies require several rollers to provide full coverage in one pass. A minimum of three rollers is recommended. Required number of passes varies from one to five. Usually two to four passes are needed to set the rock. There is no clear evidence on the benefits of additional passes. The last pass should be in the direction of traffic.

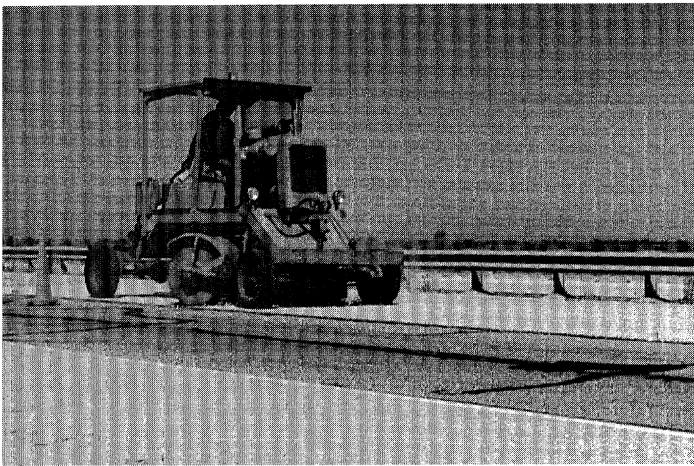

The final step in the chip seal process is brooming of excess chips. Rotary power brooms without excessive broom pressure are recommended. Some agencies require the initial brooming prior to opening the road to traffic. Other agencies wait for 1 day to allow the asphalt binder to set. Brooming should be performed during the cooler morning temperatures. Where embedment is low and there are signs of chip loss after brooming, a fog seal can be used.

TRAFFIC CONTROL

- Pilot Car for 2 Hours
- Speeds 25 to 40 km/h

The road may be opened to traffic after rolling is completed; however, traffic speed on the newly placed surface should be limited to about 25 to 40 km/h until the emulsion is sufficiently set. Usually a period of 2 hours is adequate; this time may be reduced if modifiers are used. A lengthy traffic control is also not required if asphalt cement is used. Studies indicate that the slow-moving traffic helps chip embedment.

COMMON PROBLEMS

- Bleeding
- Raveling
- Streaking

Bleeding and raveling usually result from inappropriate binder application rate. Application during cold weather can result in early loss of cover stone.

Longitudinal streaking results mainly from improper spray bar height, nozzle angle set incorrectly or nozzles set at different angles, different-sized nozzles, some nozzles plugged with cold asphalt, wrong pump speed, or too low pump pressure. Transverse streaking results from spurts in the asphalt spray caused by a worn pump or improper pump speed.

COST

<i>Type</i>	<i>Cost (\$/m²)</i>
Conventional	0.50–0.90
Polymer-Modified	0.55–1.00
Rubberized	1.80–2.20

The average cost of conventional single chip seal is about \$0.75/m². The actual cost depends on the availability of the material, location, traffic, etc.

Polymer-modified chip seals usually cost \$0.05 to 0.15/m² higher than conventional. CRM chip seals cost about twice as much as conventional chip seals.

PERFORMANCE

3 to 6+ years

- Traffic
- Existing Pavement Condition
- Size, Spread Rate, and Type of Aggregate
- Binder and Binder Application Rate
- Environmental Conditions

Chip seal performance life varies from 3 to 6 or more years. The principal factors that affect the performance and the service life of chip seals are...

Chip seal performance has been mixed. On some projects it has performed for many years, whereas on others it failed fairly early.

In Australia and New Zealand, double chip seals are designed for 10 years of service life for moderate to high volume roads.

CHIP SEAL MODIFICATIONS

- Use of Precoated Chips
- Use of Polymer-Modified Chip Seals
- Use of Asphalt Cement

Several techniques have been used to address some of the previously noted problems. These techniques include use of precoated chips, use of polymer-modified binder, use of smaller or light-weight aggregate, and use of asphalt cement.

Precoating of chips serves two purposes: it eliminates surface dust, and it improves the adhesion of the aggregate to the binder. Early adhesion is also advantageous on high volume roads, where it is necessary to open the road to traffic as soon as possible.

If precoated aggregate is used, an asphalt cement content of about 0.75 to 1 percent by weight of the chips and 90 percent or more coating is desired. In addition, the recommended mixing temperature is about 140 °C to prevent excessive hardening. Aggregates that have been correctly coated should separate from each other easily and flow readily through spreaders.

At this time only a few States (Illinois, Oregon, Pennsylvania, Texas, Utah, Virginia) use precoated chips for high volume roads. Difficulty in coating and spreading is the reported reason for lack of use. It is also reported that coated aggregates delay the "break" of cationic emulsions, if used.

Some States use polymer-modified chip seal on their high volume roads. Modified emulsion reduces temperature susceptibility, provides better adhesion to the existing surface, and can be opened to traffic in relatively short period. Both recycled rubber and synthetic polymers have been used as modifiers. While the cost of crumb rubber modified (CRM) chip seals is about twice the cost of conventional seals, the use of synthetic polymers adds only a few cents to the cost of conventional chip seal.

Arizona, California, Texas, and Washington are some of the major users of modified chip seals on high volume roads.

Asphalt cement can be used where road must be opened earlier. Use of asphalt cement, however, is expensive and requires clean aggregate and special equipment for acceptable results.

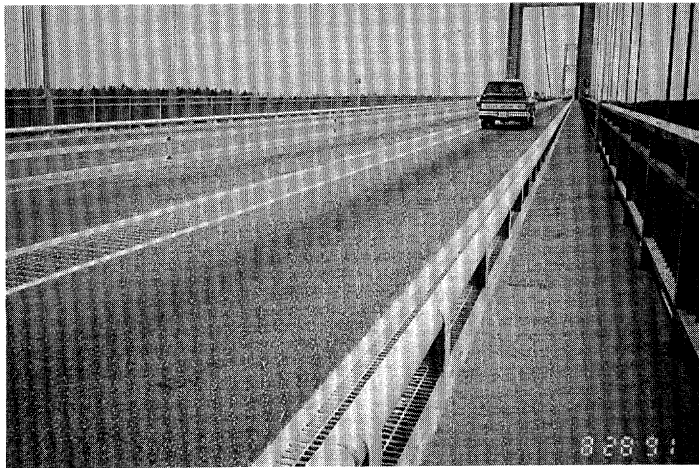

Washington is one of the States that have used polymer-modified chip seals on high-volume roads. This photo shows Tacoma Narrows Bridge, which carries approximately 80,000 vehicles per day. A modified chip seal was used to allow early opening of the bridge.

OTHER CHIP SEAL TYPES

- Sandwich Seal
- Cape Seal

Sandwich seal is a double application of chips with only one application of binder. The system, introduced in France, is used for sealing high volume and flushed pavements. Few experimental sections have been placed in the United States.

A cape seal is a chip seal topped by a slurry seal or micro-surfacing. This system was developed in South Africa. Since this seal system produces no loose chips, it can be used on high volume roads. Several cape seal sections have been placed in the United States, particularly in southern California.

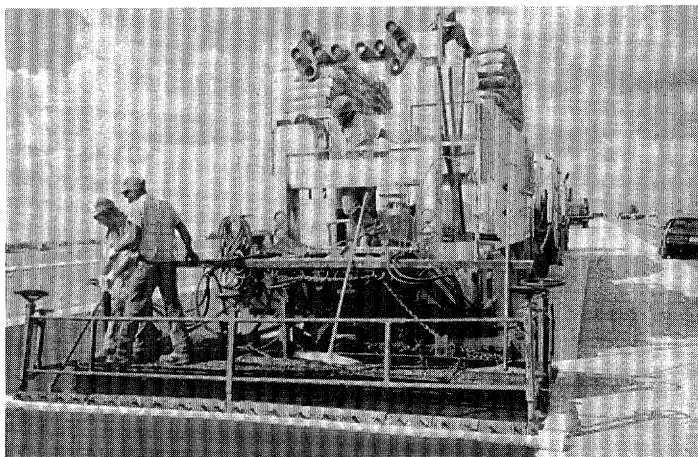

This slide shows application of chip seal followed by micro-surfacing. A cure time of 7 to 10 days should be allowed (unless asphalt cement is used) between the two applications.

CHIP SEALS IN EUROPE AND ELSEWHERE

- Polymer Modified Binders (Europe)
- Larger Aggregate (Australia)

Chip seal systems in Europe, Australia, New Zealand, and South Africa are similar to U.S. systems. Systems in Europe often consist of polymer-modified chip seals. Australia, New Zealand, and South Africa often use relatively larger aggregates to obtain longer service life.

SAND SEAL

Application of Asphalt and Sand

- Enhance Surface Friction
- Enrich Old Surface
- Seal Minor Cracks and Surface

Sand seal is same as chip seal except that finer aggregate is used as cover. Aggregate sizes are typically smaller than 2 mm.

Sand seal is primarily used to improve the frictional characteristics of an existing asphalt pavement. Other uses include...

No specific design methods for sand seals are found. Methods suitable for chip seals are also considered suitable for sand seals.

ENGINEERING FACTORS

- Traffic Volumes and Loadings
- Traffic Control
- Asphalt Binder Quantity

A very few agencies use sand seals on routine basis. When used sand seals have mostly been applied to low volume roads. Some agencies that have applied sand seals on moderate to high volume roads report good performance (ref. NCHRP Topic 24-10).

Its use on high volume roads is limited due to excessive traffic control requirements and difficulty in determining the appropriate binder rate.

APPLICATION

- Emulsion Application Rate 0.7 to 0.9 ℓ/m^2
- Sand Application Rate (5 to 8 kg/m^2)
- Pneumatic Tire Rolling
- Surface Temperature 15 °C or Above

Rapid or medium setting emulsions are normally used for sand seals. Emulsion application rates usually range from 0.70 to 0.90 ℓ/m (0.5 to 0.6 ℓ/m residual asphalt), depending on pavement texture and traffic. Spray is followed by about 5.4 to 8.1 kg/m^2 of sand.

Pneumatic tire rolling is desirable. Two hours of lane closure is generally required under normal conditions.

Sand seal should not be applied unless the surface temperature is at least 15 °C.

COST AND PERFORMANCE

- \$0.40 to \$0.80/m²
- 3 to 6 Years

Sand seal cost depends on many factors relating to materials, location, size of project, application rate, etc. They generally cost less than \$0.80/m².

The performance life of sand seal is limited and generally varies from 3 to 6 years. Variables include traffic, construction quality, materials, and environmental conditions.

THIN HOT-MIX ASPHALT OVERLAYS

Blends of Aggregate and Asphalt Cement

- Dense Mixes
- OGFC
- Gap-Graded Mixes

Thin hot mix asphalt overlays (HMA) are blends of aggregate and asphalt cement. Three types of HMAs (dense, OGFCs, and gap-graded), with thicknesses of 15 to 30 mm, have been used in the United States and other countries to improve functional condition of the pavement.

These mixes are often modified to meet high performance expectations.

ENGINEERING FACTORS

- Traffic Volumes
- Location
- Noise
- Climate
- Traffic Control

Thin HMAs are used on all types of roads for functional improvements. These are particularly suitable for high volume roads in urban areas where longer life and relatively low noise surfaces are desired. These applications are used in all climatic conditions.

Traffic control requirements for thin HMAs are minimal. Specific advantages and limitations of different types of HMAs are discussed under each type.

DENSE MIXES

Blends of AC and Well-graded Aggregate

- Improve Rideability
- Improve Surface Friction
- Enhance Appearance
- Seal Pavement

Thin dense HMAs (weight 30 to 40 kg/m²) are blends of well-graded aggregate and asphalt cement. While the majority of dense overlays are placed in thicker layers (40 mm or thicker), some States have used thinner types.

Dense mixes are used to...

DESIGN METHODS

- Hveem
- Marshall
- Variations of Above

Standard HMA mix design procedures (i.e., Marshall and Hveem design methods along with their variations) are used for thin HMA overlays. These mixes are typically designed for 4 percent air voids. Typical AC content ranges from 5.0 to 6.0 percent. The Asphalt Institute Manual Series 2 is a good reference in this regard.

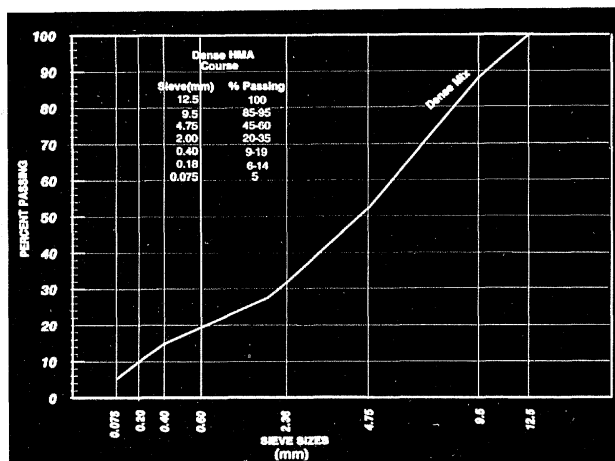

This slide shows typical gradations for thin HMAs.

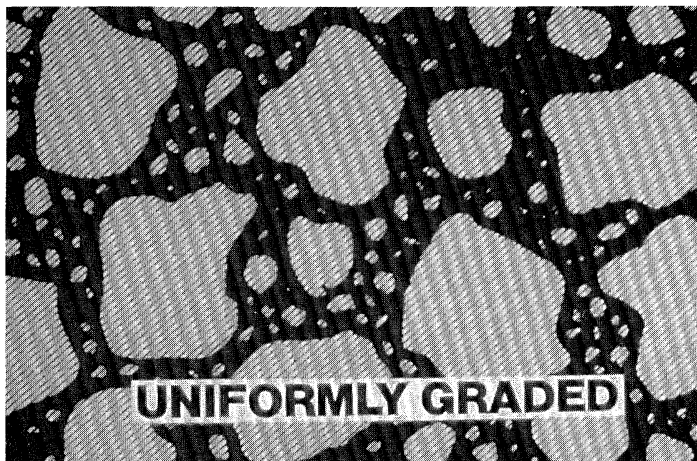

This is a schematic of the structure of dense mix.

SURFACE PREPARATION

- Milling or a Leveling Course
- Crack Sealing
- Tack Coat

Milling or a leveling course should precede thin HMA where pavements need cross-section improvements. In addition, all cracks should be sealed prior to application. Tack coats are usually necessary when using thin HMAs.

CONSTRUCTION PRECAUTIONS

- Warmer Weather (12 °C)
- Quick Rolling (within 3 to 5 minutes)

Mixes should be placed in warmer climates (minimum 12 °C) and should be rolled immediately.

PROBLEMS

- Delamination
- Reflective Cracking
- Maintenance Requirements

The principal problems of thin HMAs are similar to those of other thin techniques.

A recent AASHTO questionnaire indicates that out of nearly 25 States that have tried thin HMAs, 11 report less than satisfactory results. The problems include delamination, reflective cracking, poor friction, low durability, excessive permeability, and maintenance problems when it started to fail.

COST AND PERFORMANCE

- Cost Depends on Layer Thickness
- Performance is Mixed 5–8 Years

The cost of thin HMAs depends largely on layer thickness. Other factors include size of project, traffic control, other bid items, and material and contractor availability. (Note: HMA cost generally ranges between \$28 and \$34 per Mg.)

Their performance on high volume roads has been mixed. A recent NCHRP survey of thin (30 mm or less) HMA applications indicate a mixed performance varying from 5 to 8 years with some States reporting as low as 2 to 4 years and some reporting as high as 9 to 10 years.

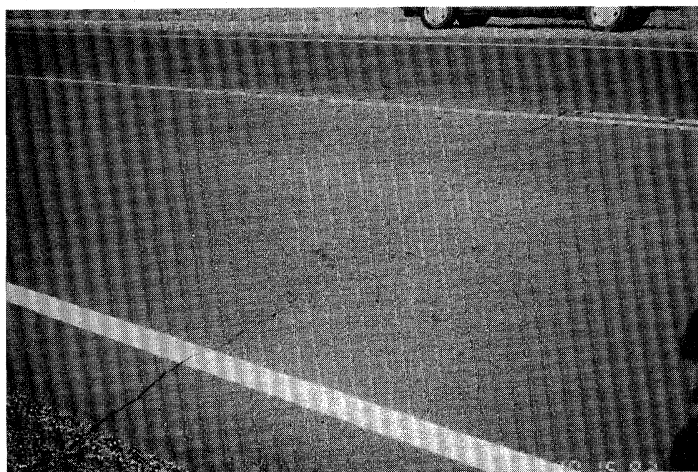

This slide shows a 2-year old dense HMA project in Oklahoma. The pavement had a smooth texture and excellent ride. Note the thermal cracks reflecting through the thin surface.

U.S. OGFCs

Blends of AC and Open-graded Aggregate

- Improved Surface Friction
- Rapid Removal of Water
- Reduced Splash and Spray
- Lower Noise Levels (3 to 5 dB)

These mixes are blends of AC and open-graded aggregate. These are normally 20 mm thick and possess high void contents (15 percent or more). The main benefits of an Open-Graded Friction Course (OGFC) are...

An AASHTO survey indicates that 27 States currently use OGFCs.

OGFC DESIGN

- AC Content 5.5 to 6.5%
- Retained Coating 95% (AASHTO T182)
- Retained Stability 50% (AASHTO 165)
- Mixing Temperature (should result in a viscosity of 700 to 900)

Mix design method for OGFCs is different than for dense mixes. OGFC is designed to have a large number of voids so that water can drain through and over the surface of this mixture. The large air void content is created by using a larger percentage of coarser aggregate.

Optimum AC content of OGFC is a balance between the requirement of thick films to hold the aggregates together and the need to prevent binder runoff. AC content is usually determined by manufacturing trial mixtures and observing the potential for binder runoff. Report FHWA-RD-74-2 and a July 11, 1975 supplement, along with FHWA Technical Advisory T 5040.31 are good references in this respect.

The basic steps in design include a determination of asphalt content, a void analysis, moisture susceptibility testing, and determination of mixing temperature. The mixing temperature normally ranges between 107 and 121 °C to prevent drain-off while still obtaining the coating of the aggregate. Asphalt content generally ranges from 5.5 to 6.5 percent.

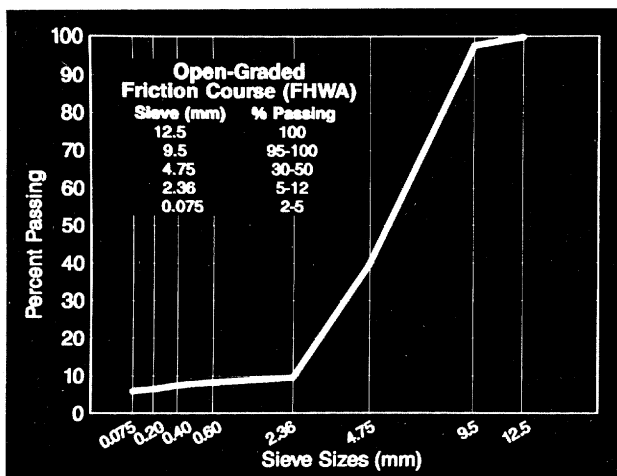

Aggregate gradation recommended by FHWA is shown in this figure. The gradation is characterized by an open-graded mix with a nominal maximum size of 9.5 mm, a high proportion of single-sized aggregate with about 2 to 5% passing 0.075 mm sieve to reduce binder run-off and improve mix stability.

Most of the States use these gradations with slight variations.

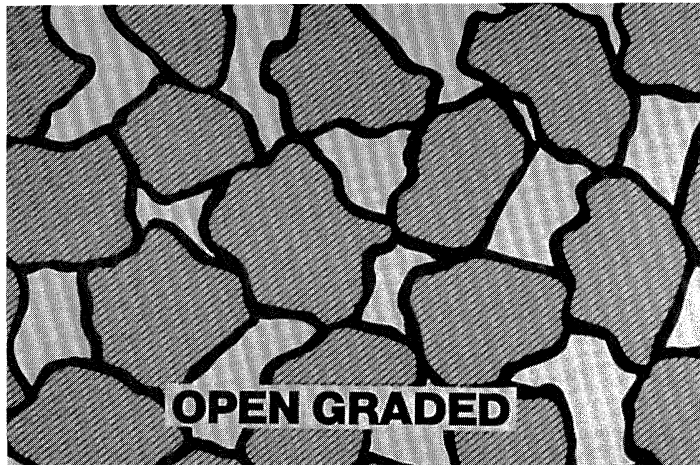

This slide shows a schematic of the OGFC structure. Note the void space between the coarse aggregate.

SURFACE PREPARATION AND ROLLING

- Milling or Leveling Course
- Crack Sealing
- Use a Diluted Fog Seal

The following is a discussion of some of the construction-related items.

An OGFC should not be used over an existing surface that is uneven. An uneven surface should be milled or leveled with a dense HMA. In addition all cracks should be sealed prior to OGFC applications.

Use of a diluted fog seal (0.25 to 0.45 ℓ/m^2) to seal the underlying surface is recommended for the OGFC.

CONSTRUCTION PRECAUTIONS

- Pavement Temperature (16 °C)
- Air Temperature (16 °C)
- Quick Rolling

Since an OGFC is placed as a thin lift, it loses heat quickly. Accordingly, it should be placed when the air and pavement temperatures are at least 16 °C.

Rolling should follow immediately. One or two passes of a 7- to 9-Mg static wheel is usually adequate for compaction of an OGFC. Butt joints are preferred over lap joints.



This slide shows OGFC texture.

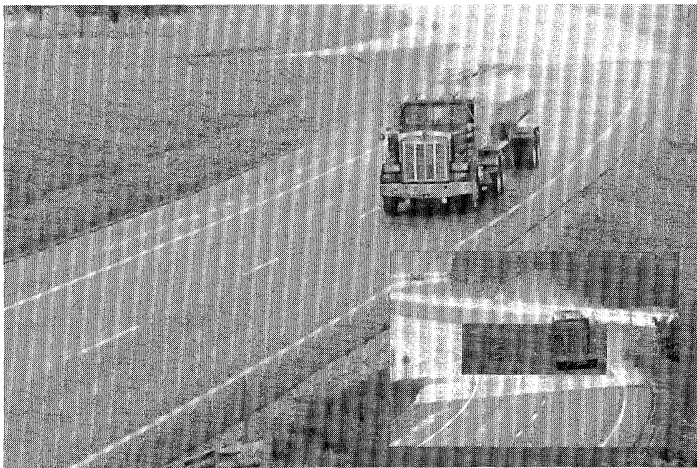

This slide shows differential splash and spray from a truck on dense-graded surface and OGFC during rain storm (from NCHRP Synthesis 180).

LIMITATIONS

- Stripping
- Reflective Cracking
- Raveling
- Increased Salt Requirements
- Special Repair Requirements

Because of the open, porous structure of the mix, the OGFCs are susceptible to several types of distresses, including stripping, rapid formation of reflective cracks, and raveling. Also, during winter, salt spreading is less effective, and more salt is required for ice control. Repairing OGFC is more difficult too. These drawbacks should, however, be considered along with the benefits of wet weather safety, night visibility, and reduced traffic noise.

COST AND PERFORMANCE

- Average cost about \$1.50 to \$1.70/m²
- Average Performance
 - High Volume Roads—8 Years
 - Moderate Volume Roads—10 Years
 - Low Volume Roads—12 years

The average cost of OGFC mixes is about \$39 to \$40/Mg. This compares to about \$32 to \$34/Mg for dense mixes.

OGFC performance depends on the existing pavement condition, traffic loading, environmental conditions, etc. Studies indicate OGFC performance life as...

EUROPEAN OGFCs

- Coarser Aggregate (9.5 to 16 mm)
- More Air Voids (20 to 25%)
- Thicker (35 to 40 mm)
- Use of Modifiers

Coarser aggregate, increased air voids, and thicker layers are used to ensure high draining capacity and reduction in road noise and to preserve these properties over a longer period.

Polymers and fibers are used to prevent binder runoff and to increase durability and aging resistance. The average life is 10 to 12 years.

STONE MATRIX ASPHALT

Blends of AC, Gap-graded Aggregate, and Stabilizer

- Provide Rut-Resistant Surface
- Restore Surface Friction
- Seal the Existing Surface
- Reduce the Noise Level

Stone matrix asphalt (SMA) is a relatively thin 12.5 to 40 mm gap-graded HMA that is used as a surface course on both new construction and surface renewal. These mixes can be viewed as OGFCs with voids filled with mastic of asphalt cement, a stabilizer (fibers or asphalt modifier), and finer aggregate. SMAs are used to...

AGGREGATE QUALITY

- LA Abrasion (30% max., AASHTO 96)
- Soundness Loss (15% max. for sodium sulphate, AASHTO T104)
- Particles Retained on the 4.75 mm Sieve One Fractured Face 100% min. Two Fractured Faces 90% min.
- Absorption (2% max., AASHTO T85)
- Durability Index (40% min., AASHTO 210)

The quality of materials, particularly aggregates, has a strong influence on the SMA performance. Some of the recommended coarse aggregate tests are...

Fine aggregate should consist of a blend of 100 percent crushed, manufactured sands. The liquid limit should not exceed 25 percent as determined by AASHTO T89.

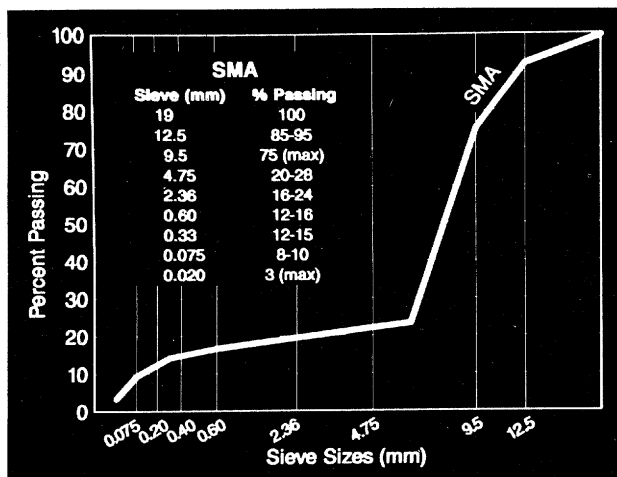

This figure shows a typical aggregate gradation for an SMA mix. As this figure shows, SMA will usually have 70 to 75 percent coarse aggregate (greater than 4.75 mm), and approximately 10 percent filler (passing .075 mm).

The amount of sand is about half as much as used in dense HMA. On the other hand, SMA requires two or three times the mineral dust (0.075 mm or less) of conventional mixes.

Aggregates used in SMA should be as cubical as possible.

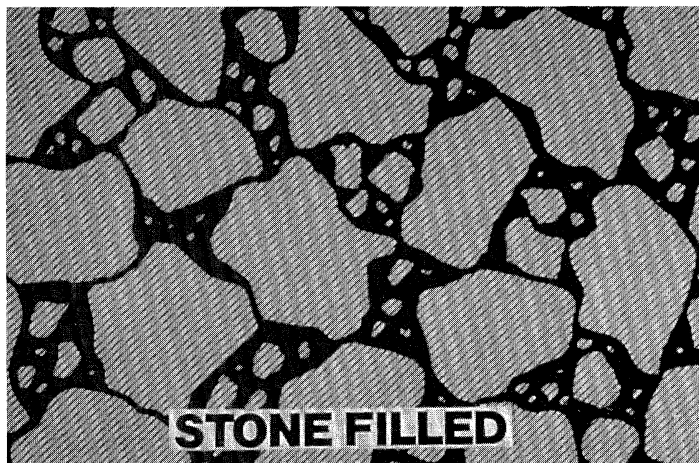

This slide shows a schematic of the SMA gap-graded structure. Note stone-on-stone contact to resist any further densification of the new mat.

MIX DESIGN CHARACTERISTICS

- Number of Blows (50)
- Asphalt Content (6% min.)
- Void in Total Mix (3–4%)
- Stability (1,400 min.)
- Flow (8–16)
- Draindown (0.3% max. after 1 hour)

Marshall procedures are currently used to design SMAs. Specimens are prepared by 50 blows each side.

Typical mix design will have 6 to 7 percent AC and 0.3 to 0.4 percent fibers by weight of mix. Polymers have also been used in SMAs, either alone or with fibers as additives/modifiers. Polymers when used, are applied in the amount of 5 to 7 percent by weight of binder. Voids in total mix are normally kept between 3 and 4 percent.

Other mix criteria include stability, flow, and draindown.

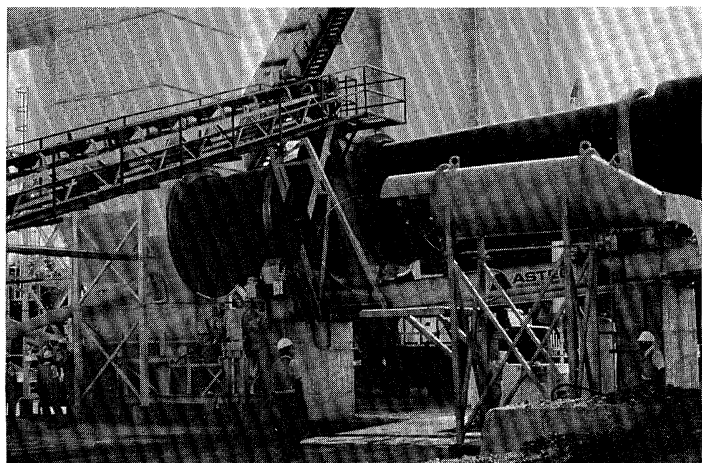

Mixing, transportation, and placement of SMA uses customary equipment and practices. Mixing temperatures of about 155 to 165 °C (175 °C maximum) are usually necessary because of coarser aggregate, additives, and relatively high-viscosity asphalts in SMA mixes. Either a batch or drum mix plant can be used for the production of SMAs.

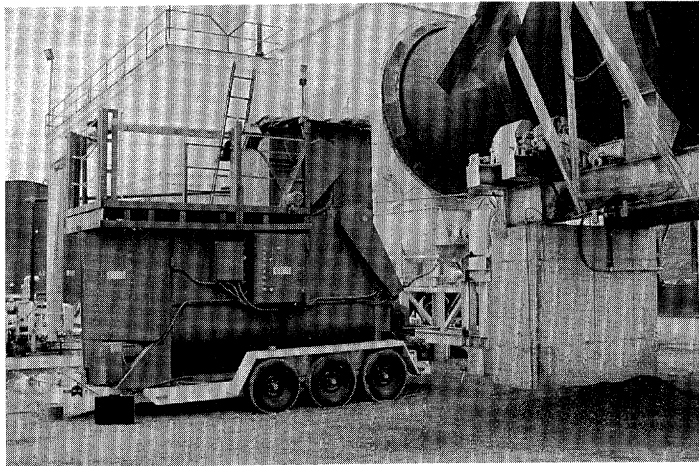

A special blower system is used for fiber introduction and ultimately mixing inside the drum with hot aggregate and asphalt cement.



This shows aggregate, cellulose fibers, and polymer used in a Maryland demonstration project.

SURFACE PREPARATION

- Tack Coat
- Leveling Course, if Needed

A diluted (with equal parts water) slow setting emulsion tack coat is desirable prior to placement of SMA mix on weathered, existing surface. No tack should be used if placed on new or intermediate pavement layer.

Diluted emulsion may be applied at the rate of approximately 0.40 to 0.50 ℓ/m^2 . Where the existing surface is uneven, a leveling course or milling may be required.



For proper compaction the mix temperature, when delivered, should not be less than 145 °C. Rolling should begin immediately after placement to achieve density quickly before the mix temperature decreases significantly. Compaction is done by use of 9 to 10.8 Mg steel-wheeled rollers. Roller speed should not exceed 5 km/h.

Pavement should be compacted to at least 94 percent of maximum theoretical density, with no more than 6 percent air voids.

Traffic should not be placed on the newly compacted surface until the mat has cooled to 60 °C or below.



A material transfer device was used on this project to store and transfer the mix to the paver. This device can store up to 45 Mg of mix and helps in continuous operations.



SMAs have a rich, coarse surface texture.

COST

- United States
20–40% Higher Than Typical Dense Mix
- Europe
10–30% Higher Than Typical Dense Mix

Based on the initial experimental projects, the cost of SMA mixes in the United States is 20 to 40 percent higher than that of conventional dense mixes. Because of higher material quality requirements the costs will probably remain about 20 percent higher than dense mixes.

PERFORMANCE

- 10 to 12 years
- Resistant to
Plastic Flow
Shear
Abrasion

The performance information on SMA is based on European experience. The expected service life of SMAs in Europe ranges from 10 to 12 years. However, European SMA performance experience is based on cooler climates and may not be indicative of performance for extremely warm temperatures experienced in the United States.

Nearly 80 demonstration projects constructed in the United States will provide performance data for different climatic zones and traffic conditions. However, it will be several years before meaningful performance data can be gathered.

FUTURE RESEARCH

- Mix Design (Gyratory Compactor)
- Asphalt Cement Grade
- Stabilizer Type/Introduction
- Performance

The future research on SMAs should be directed at items such as determination of...

European Thin HMAs

- Thin HMA
- Ultra Thin HMA
- Hot Rolled HMA
- GussAsphalt

Several types of thin HMA systems are used in Europe, where they compete with modified slurries, OGFCs, and chip seals for surface rehabilitation and preventive maintenance. These mixes are usually less than 37 mm thick. The combined market share for these mixes is about 10 percent of the overall hot mix production in Europe (approximately 240 million Mg).

Various very thin (20 to 25 mm) and ultra thin (10 to 15 mm) gap-graded mixes are used in Europe, particularly in France. Application rates range from 50 to 65 kg/m² for very thin mixes and from 25 and 35 kg/m² for ultra thin mixes. Special spreading equipment is often used for ultra thin mixes.

Hot rolled mix is a sand asphalt and is mostly used in United Kingdom (UK). Gussasphalt is a mastic asphalt mix that lacks a coarse aggregate structure and is essentially voidless. The stability in this mix is provided by a stiff asphalt cement. The mix requires no rolling. It is primarily used in UK and Switzerland. Its use has been decreasing.

FRENCH MIXES

Very Thin

65–70% of 6/10
5.8–6.0% binder
0.4–0.7 l/m
emulsion tack coat

Ultra Thin

75–80% of 6/10
5.2–5.6% binder
0.8–1.0 l/m
emulsion tack coat

The most common grading for French very thin and ultra thin mixes is 0/10 with a 2/6 mm gap. The difference between these two types lies in the percentage of coarse aggregate and proportion of binder. Very thin mixes have slightly less coarse aggregate and more binder.

Besides having a slightly different formulation, very thin mixes are applied using conventional equipment, whereas ultra thin mixes are applied using special machines.

An emulsion tack coat (polymer modified for high volume roads) is applied prior to mix placement, which plays a dual role of waterproofing the existing surface and tacking the wearing course.

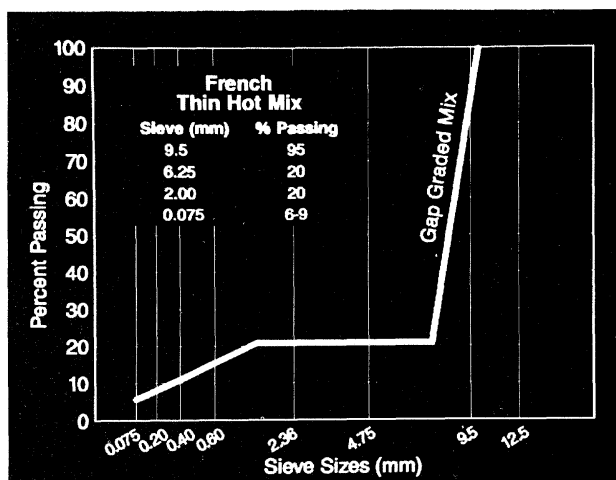

This figure shows a typical aggregate gradation for a 0/10 (10 mm top size aggregate) mix. Note that the mix has a 2/6 mm gap.

NOVACHIP

- Restore Surface Friction
- Seal Existing Surface
- Fill Minor Ruts and Other Surface Irregularities
- Low Noise

Novachip is one of the European ultra thin hot mix overlays. It is used to...

It consists of a layer of hot mix paving material spread over a tack coat. During the summer of 1992, a total of five demonstration projects were placed in three States. During 1993, another three experimental projects were constructed in Pennsylvania. The thickness of this system ranges from 10 to 20 mm depending, on the aggregate size.

MIXTURE COMPOSITION

<i>Sieve, mm</i>	<i>% Passing</i>
9.5	85-100
4.75	25-35
2.00	19-27
0.40	8-13
0.20	6-9
0.075	4-9

- AC 5.1-5.5% (conventional AC)
- Tack Coat 0.7-1.0 ℓ/m^2 (polymer-modified RS emulsion)

Novachip mix AC content ranges from 5 to 5.5 percent. Tack coat application rate is usually kept between 0.70 and 1.00 ℓ/m^2 . Tack coat constitutes about 30 percent of the total binder.



Mixing and transportation of Novachip uses customary equipment and practices. Mixing temperatures of about 160 to 165 °C are used for this system. This slide shows the drum mix plant used for Texas projects.

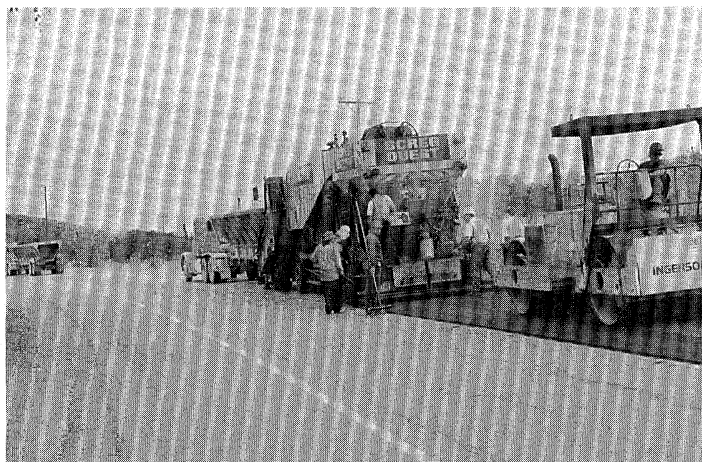

This photo shows the Novachip paving train used on Texas projects. This 12-m long machine spreads both emulsion spray and mix in one pass at a speed of approximately 0.5 to 0.75 km/h.



This photo shows the front of the machine and hopper for receiving the mix and transferring it to the rear.



This photo shows the rear of the machine.

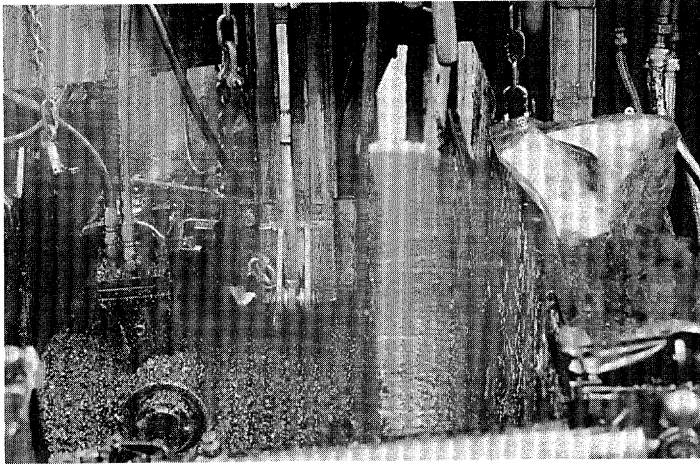

This photo shows the paver augers in operation. Augers on this machine were 2.4-m wide with 0.60-m extensions on each side. The picture also shows the emulsion spray ahead of the augers.

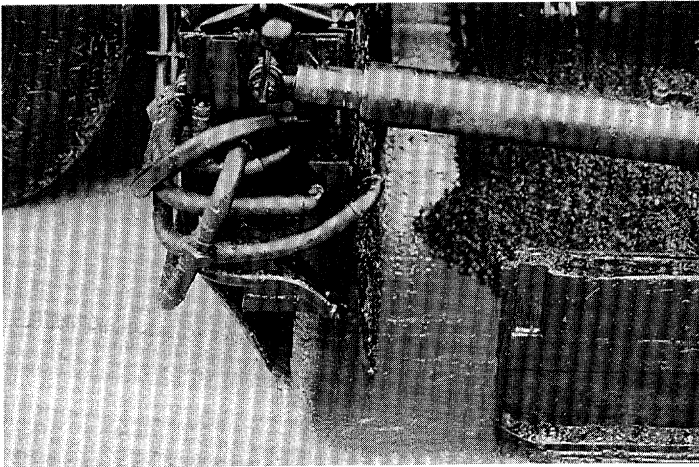

This photo shows a closeup of the spray bar.

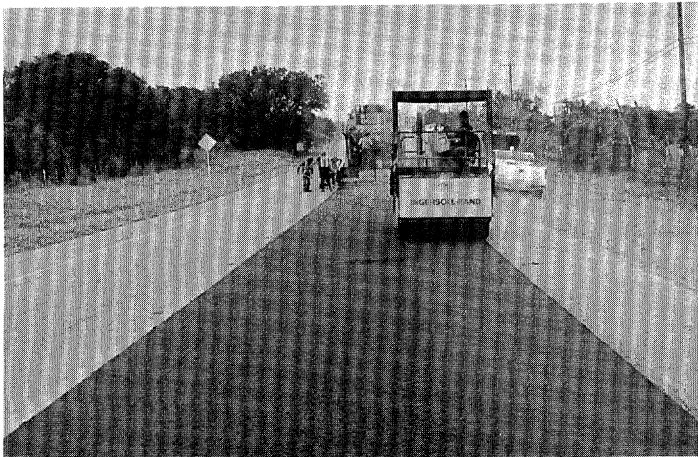

Rolling proceeds immediately behind the paving. On this project, two 9-Mg rollers were used for a total of four passes.



Nurse trucks are used to periodically fill the emulsion tank on the machine. Emulsion tank capacity on these machines is about 8,300 ℓ , adequate for nearly 3 hours of operation. Emulsion is applied at a temperature of 60 °C. The emulsion storage tank is not equipped for reheating the emulsion.



Since Novachip formulation is close to that of OGFC, it has a coarse, rich, open texture, and longitudinal joints are nearly invisible.

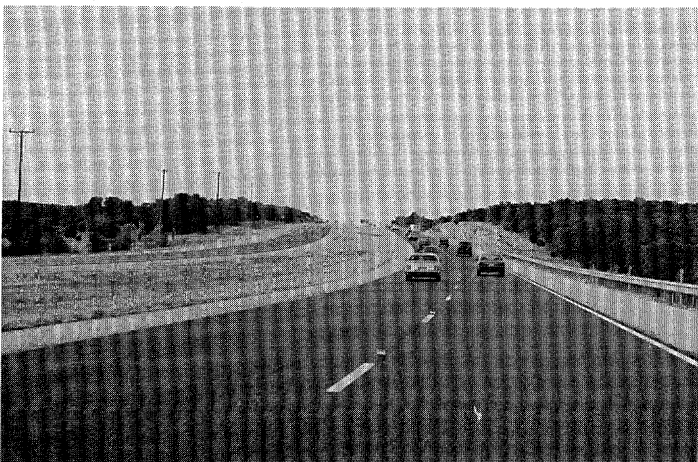

This slide shows a completed Novachip section.

COST

- About \$3.0/m²

PERFORMANCE

- Being Monitored

Novachip construction cost was around \$2.00/m² for the projects in Alabama, Mississippi, and Texas. In addition, \$1.00/m² was charged by the Scrogg Route for technical advice and supplying the paving machine. The in-place cost for Pennsylvania project was \$2.90/m².

The high cost for the 15 mm layer is due to the demonstration nature of the projects. While long-term performance data for projects in the United States will not be available for many years, the projects are being monitored by the responsible agencies. Early results from Texas projects are very promising.

Performance results from 4 to 5 year old French projects are generally positive. Novachip has been observed to absorb extra thicknesses because of depressed areas (up to 10 to 13 mm deep) in the pavement without settlement or rutting. Based on the trends so far observed, it may be reasonable to expect that acceptable levels of surface friction and impermeability can be maintained for 7 to 8 years under heavy traffic.

PART III

Conclusion & Technology Transfer

CONCLUSION

- Improve Functional Condition
- May Offer Cost-effective Solutions
- Should Receive Considerations

We have discussed various surface rehabilitation techniques that can be used to improve the functional condition of pavements. Many of these techniques may offer cost-effective solutions and should receive consideration by managers and engineers to effectively extend the performance of existing pavements and maximizing the use of limited budgets.

CONCERNS

- Anticipated Short Life Expectancy
- Vehicular Damage
- Traffic Disruption During Construction
- Improper Usage
- Lack of Cost and Performance Data
- Tendency to Follow Past Practices

Despite many advantage, acceptance of many of these techniques have been slow. Some of the reasons for lack of use are...

However, such shortcomings may be addressed or minimized by adopting certain measures such as use of engineered binders and improved construction techniques.

Thin surface rehabilitation techniques have assumed considerable significance as construction of new roads or major rehabilitation is becoming less desirable because of scarcity of funding, shortages of quality materials, and other concerns, such as the effect on the environment.

TECHNOLOGY TRANSFER EFFORTS

- FHWA Test and Evaluation Project No. 9
- SHRP SPS-3, SPS-4 Experiments
- NCHRP Syntheses
- FHWA SHRP Implementation Contract

Finally, let us look at some of the efforts being undertaken to gather and disseminate information on surface rehabilitation techniques. These efforts include...

TE-9

- Traditional and Emerging Surface Rehabilitation Techniques
- Focuses on High Volume Roads

The purpose of TE-9 project is to gather and share information on conventional and emerging surface rehabilitation techniques. The project focuses on high-volume roads. Information is being gathered through literature search, field reviews, and discussion with user agencies.

The information from this project will also provide support to FHWA implementation activities related to the maintenance provisions (Section 1009) of 1991 Intermodal Surface Transportation Efficiency Act (ISTEA). ISTEA authorized, for the first time, federal-aid funding for the cost effective preventive maintenance activities on the Interstate system.

TE-9 PRODUCTS

- FHWA-PD-92-008 (Overview Paper)
- FHWA-SA-94-051 (State of the Practice)
- FHWA-SA-94-072 (Instructor's Guide)
- FHWA-SA-94-074 (Instructor's Guide)

Products developed under the TE-9 project include (1) An Overview of Surface Rehabilitation Techniques for Asphalt Pavements (2) State of the Practice - Design, Construction, and Performance of Micro-surfacing, and (3) Instructor's guides for micro-surfacing and rehabilitation techniques.

SHRP H-101 CONTRACT

(SPS-3 and SPS-4 Experiments)

The second major effort in the surface rehabilitation area is SHRP SPS-3 and 4 Experiments. SPS-3 experiment included rehabilitation techniques for flexible pavements, and SPS-4 included techniques for rigid pavements. These experiments were carried out under SHRP contract H-101, entitled "Pavement Maintenance Effectiveness."

The purpose of these experiments was to evaluate the effectiveness of treatments in prolonging the life of pavements and to develop information on the most effective timing of the application.

SPS-3 EXPERIMENT

- Crack Sealing
- Chip Seal
- Slurry Seal
- Thin-Hot Mix Overlays

Under SPS-3 experiment, four traditional treatments were selected and applied to determine their cost-effectiveness and timeliness. These treatments included...

A total of 81 test sections were placed to cover various climatic and pavement conditions as well as moderate to heavy traffic volume roads. These sections will be evaluated for 5 years or until the surface deteriorates.

Uniform design and construction techniques were specified for slurry seals, chip seals, and crack sealing to minimize experimental variables. However, States were allowed to use their own thin HMAs.

Some States constructed supplemental sections using different treatments, procedures, and materials.

SPS-4 EXPERIMENT

- Crack and Joint Sealing
- Undersealing

A total of 35 test sections were programmed to review effect of joint sealing and undersealing on the performance of PCC pavements. There was considerably less interest in the undersealing portion of the experiment.

SPS PERFORMANCE EVALUATION

- Long Term Pavement Performance Data Collection and Analyses Efforts
- Regional Tours by Expert Task Groups

SPS test sites' performance will be determined through Long Term Pavement Performance Division's (LTPP) data collection and analyses efforts. Data collection include periodic surveys and testing of distresses, longitudinal profile, surface friction, and deflection.

Performance data has also been collected by subjective field reviews of SPS-3 and SPS-4 test sites by expert task groups. These reviews have been carried out by the Western SHRP region since 1991. A nationwide review was conducted in fall of 1993.

Early performance data indicate that the majority of sections are performing satisfactorily after nearly 3 years of placement.

COMPARISON OF THIN OVERLAY TO CONTROL

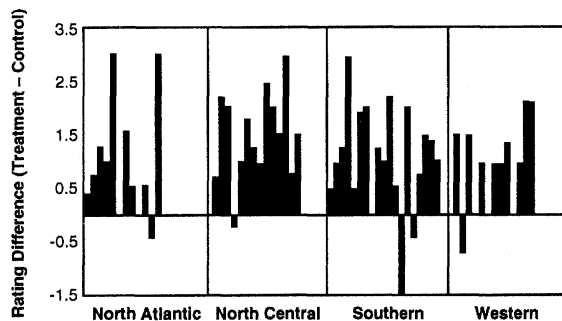

During the reviews, it was noted that pavement sections on which treatments were placed have generally outperformed the sections that received no treatments. This slide shows an example comparison between control section and thin overlay.

The majority of failed sections are chip seal and slurry seal. Western States had more failures than any other regions. North Atlantic region has many chip seal failures. North Central and Southern regions have the fewest failures. In general, treatments placed on good condition pavements are performing better than treatments placed on marginal pavements.

Sealed joints and cracks on PCC pavements are performing well at this time. However, it will be several years before performance of sealed sections versus unsealed sections can be determined. For additional information on 1993 review, see publication FHWA-SA-94-078.

NCHRP STUDIES/SYNTHESIS

- 24-05
- 24-10
- 25-10
- 14-8A

The third effort in this area has been NCHRP past and present studies on thin surface rehabilitation techniques and concept of preventive pavement maintenance. Some of the current studies include: (1) 24-05 pavement management methodologies to select projects and recommend preservation treatments; (2) 24-10 asphalt surface treatments and thin overlays; (3) 25-10 cost effective preventive pavement maintenance; and (4) 14-8A chip seals for high volume roads.

These syntheses are based on literature review, comments and recommendations by the review panel, and responses from user agencies.

FHWA'S SHRP IMPLEMENTATION CONTRACT

- Identify, Evaluate, and Recommend Action on SHRP Treatments and Products and Other Treatments
- Develop and Conduct Workshops
- Develop Test and Evaluation Plans and Provide Technical Assistance

An FHWA contract to implement SHRP products was awarded in June 1994 to Arizona State University. The contractor is required to (1) review SHRP treatments and products and other techniques and make recommendations on the state of readiness and implementation, (2) develop and present workshops, and (3) provide technical assistance to States in field evaluation of selected treatments.