



U.S. Department
of Transportation

**Federal Highway
Administration**

Publication No. FHWA HI-96-027
October 1996

NHI Course No. 13133

Construction of Portland Cement Concrete Pavements

Participant's Manual

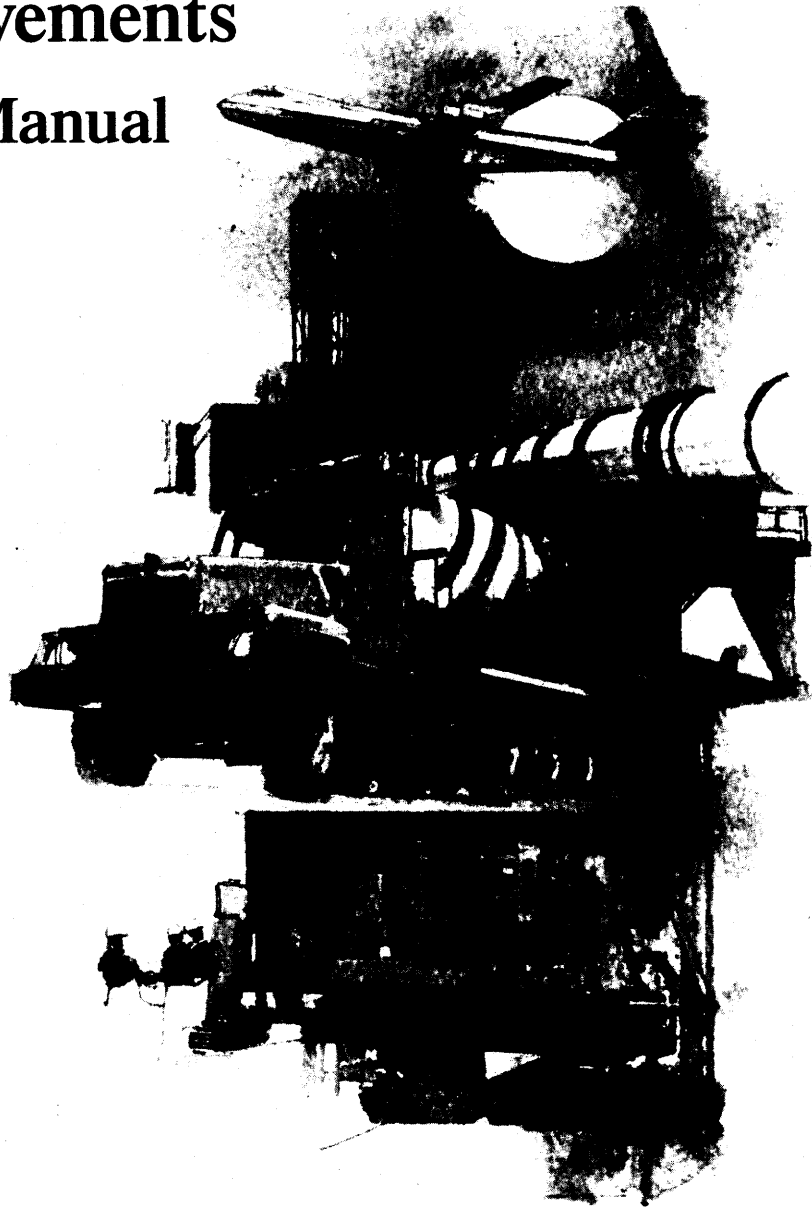

National Highway Institute

**AASHTO/FHWA/INDUSTRY
Joint Training**

NOTICE

This document is disseminated under the sponsorship of the Department of Transportation in the interest of information exchange. The United States Government assumes no liability for its contents or use thereof. The United States Government does not endorse products or manufactures. Trademarks or manufacture's names appear herein only because they are considered essential to the object of this document.

DISCLAIMER

The contents of this report, expressed or implied, reflect the views of the contractor. The contents do not necessarily reflect the official policy of the Department of Transportation. This report does not constitute a standard, specification or regulation.

1. Report No.	2. Government Accession No.	3. Recipient's Catalog No.	
4. Title and Subtitle AASHTO/FHWA Industry Joint Training Construction of Portland Cement Concrete Pavements		5. Report Date January 1995	
		6. Performing Organization Code	
7. Author (s) American Concrete Pavement Association		8. Performing Organization Report No.	
9. Performing Organization Name and Address American Concrete Pavement Association 3800 North Wilke Rd. Suite 490 Arlington Heights, IL 60004		10. Work Unit No. (TRAIS)	
		11. Contract or Grant No. DTFH61-94-C-00024	
12. Sponsoring Agency Name and Address Department of Transportation Federal Highway Administration 400 Seventh Street, S.W., Room 4410 Washington, D.C. 20590		13. Type of Report and Period Covered Participant's Manual	
		14. Sponsoring Agency Code	
15. Supplementary Notes			
<p>16. Abstract</p> <p>This participant's manual accompanies a 2 1/2 day training course "AASHTO/FHWA Industry Joint Training - Construction of Portland Cement concrete Pavements" This training course was developed to provide field personnel, both contractor and agency, with a general working knowledge of field operations. The field operations include: central mix plant operations, ready mix plant operations, slipform paving operations, fixed-form paving operations, joint sawing and sealing operations, and concrete pavement restoration.</p>			
17 Key Words Construction, Quality	18. Distribution Statement		
19. Security Classif. (of this report)	20. Security Classif. (of this page)	21. No of Pages	22. Price

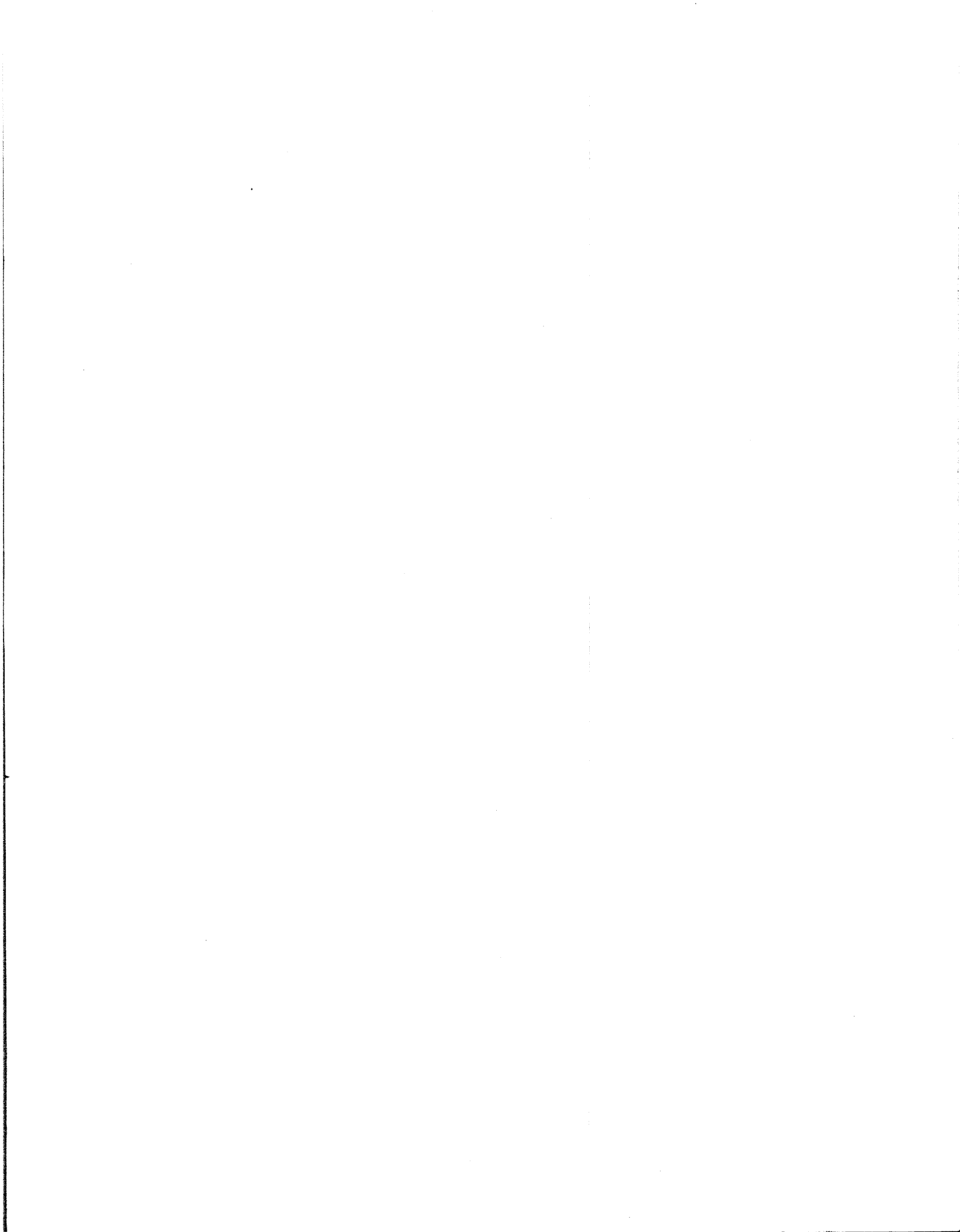

**U.S. Department
of Transportation
Federal Highway
Administration**

March 1996

DTFH61-94-C-00024

AASHTO/FHWA/Industry Joint Training

Construction of Portland Cement Concrete Pavements

Participant's Manual

**Office of Contracts and Procurement
400 Seventh Street, SW
Washington, DC 20590**

**Submitted by:
American Concrete Pavement Association
ERES Consultants, Inc.**

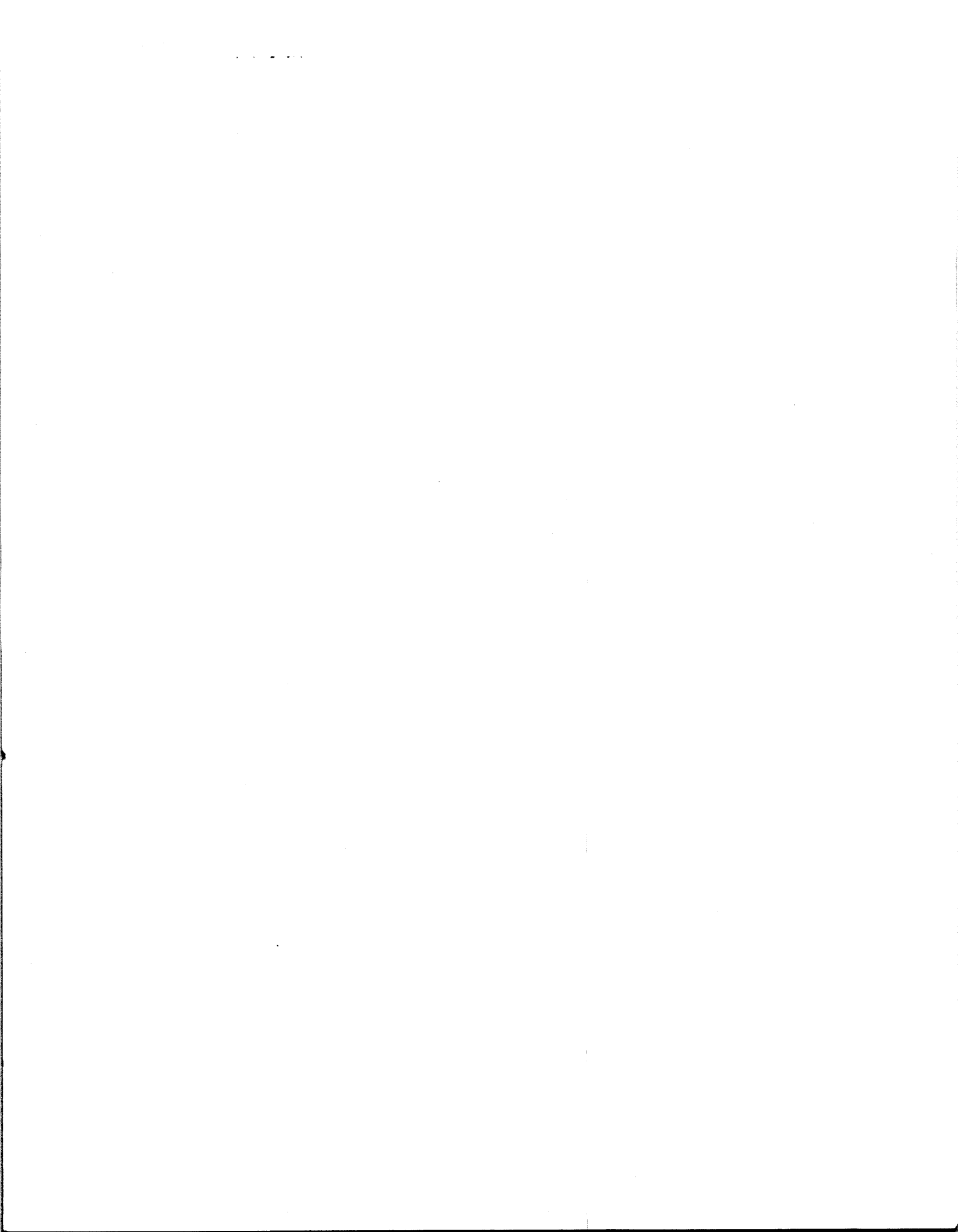

I. Introductions

Introductions

This training course, "AASHTO/FHWA Industry Joint Training - Construction of Portland Cement Concrete Pavements" was prepared specifically for the people doing the work in the field on a daily basis. This course encourages open discussion among the participants.

II Course Overview

CAP - Communication + Preparation

Course Overview

Objectives

The course is divided into subject modules. Each module provides a complete description of the topic presented. Each module will begin with the following objectives:

Understand the need to learn "good practice" in the construction of portland cement concrete pavements.

Gain a working knowledge of portland cement concrete pavement construction.

Recognize the critical factors which affect portland cement concrete pavement performance.

Preconditions

Every module will have a list of preconditions or assumptions. These assumptions limit the scope of the training course to a manageable level.

The training course is not a:

- Pavement design course
- Specification writing course.

The training course is:

- Everyone talking the same language in the field
- Everyone on common ground to begin each project.

Course Schedule

The following is the tentative course schedule. This will vary depending on local requirements and input from the training participants.

Time	Description	Time
Day 1		
8:00 - 9:00 a.m.	I - Introductions	
9:00 - 9:30	II - Course Overview	
9:30 - 10:15	III - Quality in Concrete Pavement Construction	
10:15 - 10:30	BREAK	
10:30 - 11:00	IV - Host Agency Specifications	
XXXXXXXXXX	V - Ready Mix Plant Operations	
11:00 - 12:00	Truck Mixed Concrete	
12:00 - 1:00 p.m.	LUNCH	
1:00 - 2:00	Truck Mixed Concrete (Cont.)	
2:00 - 2:45	Central Mix Concrete	
2:45 - 3:00	BREAK	
3:00 - 4:00	Central Mix Concrete	
4:00 - 4:30	Open Forum Discussion & Questions on Topics Covered	

Course Overview

Course Schedule

Day 2		
8:00 - 8:15 a.m.	Recap of Day 1	
XXXXXXXXXX	VI- Paving Operations	
8:15 - 10:00	Slip Form Paving	
10:00 - 10:15	BREAK	
10:15 - 12:00	Slip Form Paving (cont.)	
12:00 - 1:00	LUNCH	
1:00 - 2:30	Fixed Form Paving	
2:30 - 2:45	BREAK	
XXXXXXXXXX	VII - Saw & Seal Operations	
2:45 - 4:45	Saw & Seal	
4:45 - 5:00	Open Forum Discussion & Questions on Topics Covered	

Course Schedule

Day 3		
8:00 - 8:15 a.m.	Recap of Day 2	
XXXXXXXXXX XXXXXXXXXX	VIII - Concrete Pavement Restoration(CPR) Operations	
815 - 10:30	Concrete Pavement Restoration(CPR)	
10:30 - 10:45	BREAK	
10:45 - 11:00	IX - Course Summary	
11:00 - 11:30	X - Cause & Effects Handbook	
11:30 - 12:00 p.m.	XI - Conclusion Evaluations	

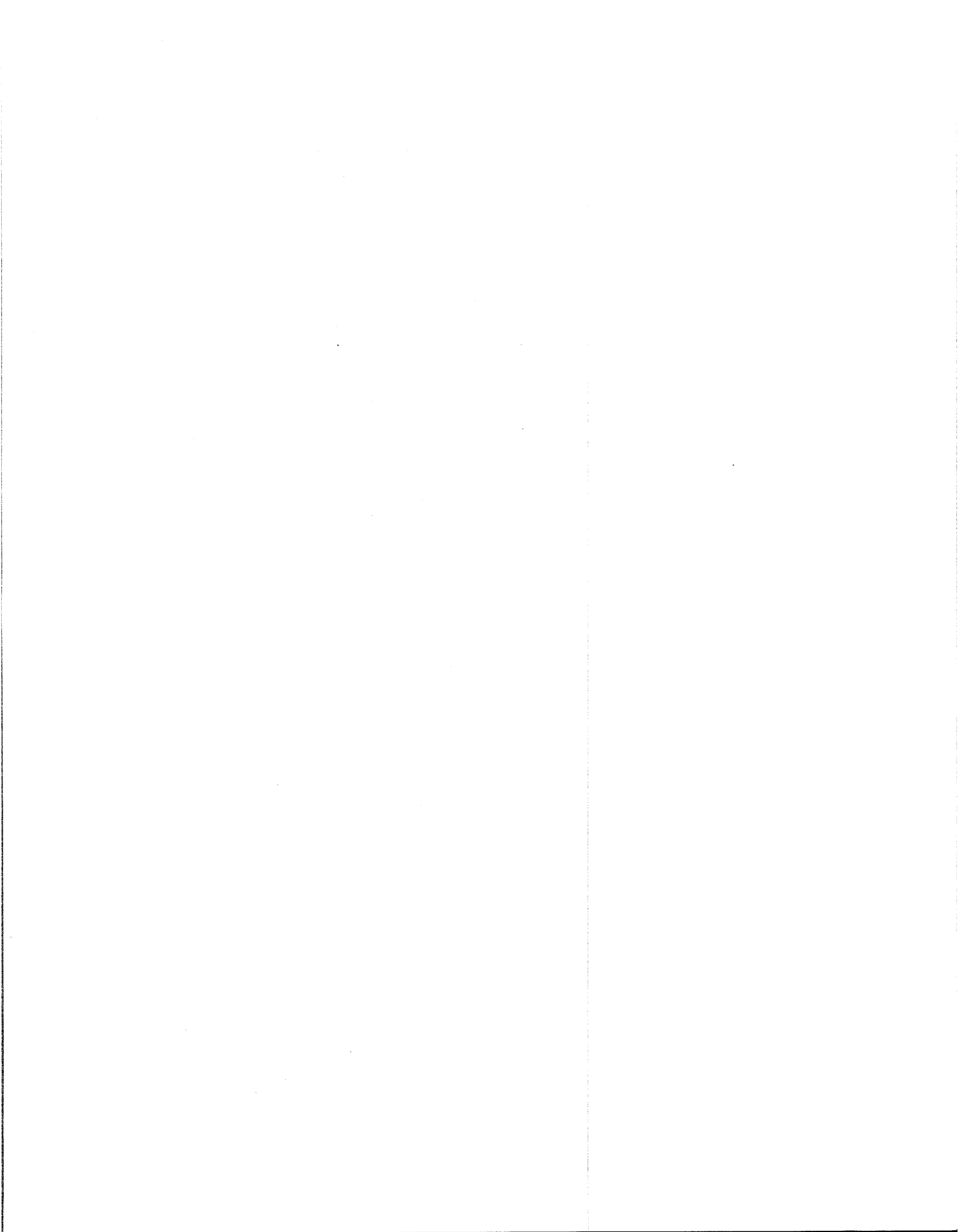

III. Quality In Concrete Pavement Construction

IV. Host Agency Specifications

V. Plant Operations
Truck Mixed Concrete
Central Mixed Concrete

Plant Operations

Plant Operations is contained in 2 separate modules:

- Truck Mixed Concrete
- Central Mixed Concrete

Material Management is contained in Truck Mixed Concrete. A small discussion of the unique aspects of Material Management for Central Mixed Concrete are discussed in that section.

INTRODUCTION

CONCRETE PRODUCTION

Concrete is produced for delivery to the contractor using one of the following methods:

- Central Mixed Concrete
- Shrink Mixed Concrete
- Truck Mixed Concrete

All of these methods of concrete production are considered ready mixed concrete by definition.

CENTRAL MIXED CONCRETE

In a central mixed concrete plant, the batched ingredients are charged into an in-plant stationary mixer. The ingredients are then thoroughly mixed prior to discharge into the delivery unit.

The operator of a central mixed plant or "wet batch" plant is involved in measuring (batching) the ingredients and monitoring the batch into, through, and out of the central mixer. Central mixed concrete is considered a completely mixed product ready for acceptance by the user when discharged from the central mixer.

SHRINK MIXED CONCRETE

Shrink mixed concrete is partially mixed in a central mixer to reduce the bulk volume of the ingredients. For example, the bulk volume of the individual ingredients prior to mixing is about 1.58 cubic meters. Shrink mixing fills in the voids in the coarse aggregate with sand, cementitious materials and water. This reduces the volume to about 1 cubic meter. The material is sufficiently mixed to intermingle the ingredients before discharging.

Plant Operations

- Central Mixed Concrete
- Shrink Mixed Concrete
- Truck Mixed Concrete

TM - 2

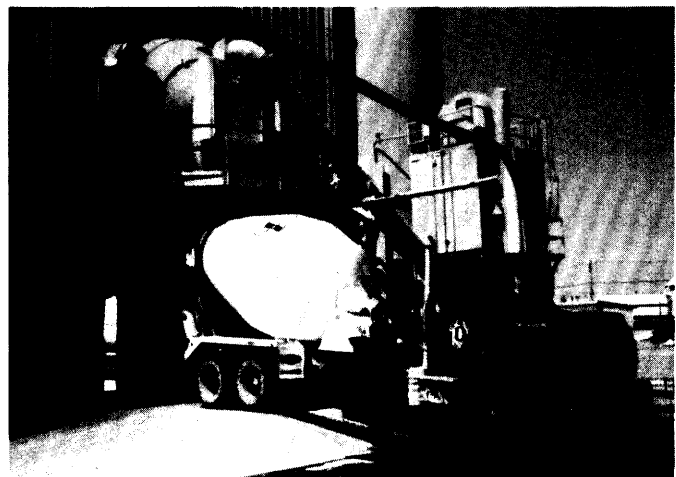
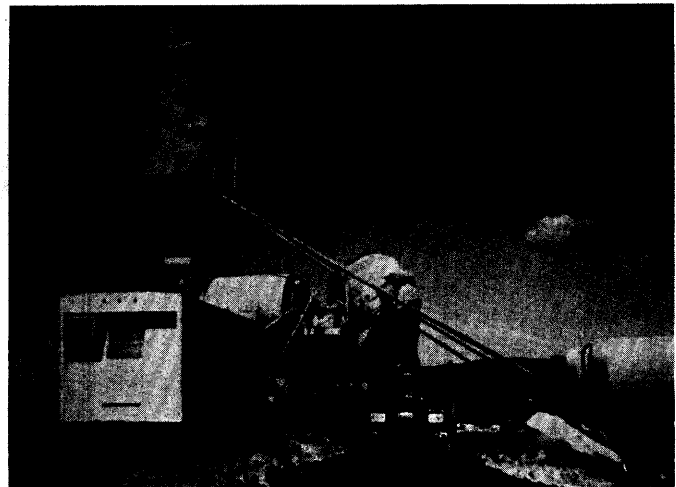

Shrink mixing is used for both central and truck mixed concrete. For central mixed concrete, the shrink mixer discharges into another drum for final mixing. For truck mixed concrete, the shrink mixer discharges into a truck mixer for final mixing.

This is the only reference to shrink mixed concrete during this training course.

TRUCK MIXED CONCRETE

Truck mixed concrete is batched directly into a truck or transit mixer by the plant operator. This process is also known as a "dry batch" operation. The truck mixer driver is responsible for mixing the concrete. The concrete mix is not ready for acceptance until the truck has completed the mixing.

Truck mixed concrete is also referred to as transit mixed concrete.

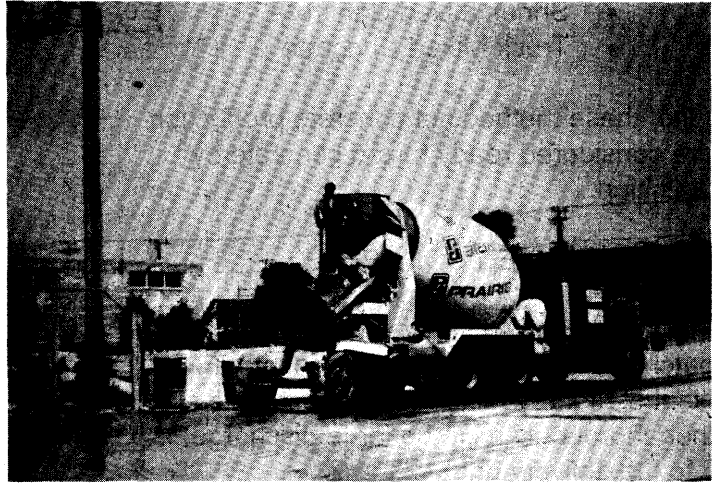

Plant Operations

Truck Mixed Concrete

- A. OBJECTIVES
- B. PRECONDITIONS
- C. TRUCK MIXED CONCRETE
 - 1) Requirements
 - 2) Applications
 - a) Project Type
 - b) Project Location
 - c) Project Specifications
 - d) Project Schedule
 - 3) Communications and Preparation (CAP)
 - 4) Purchase Requirements
 - a) Quality of the Concrete
 - 1. Cementitious Materials
 - 2. Aggregates
 - 3. Water
 - 4. Admixtures
 - 5. Consistency
 - 6. Strength Acceptance
 - b) Quantity of the Concrete
 - 1. Volume
 - 2. Yield
 - 3. Placement Rate
 - 5) Production of Truck Mixed Concrete
 - a) Materials Quality (Certification and Testing)
 - b) Materials Management
 - 1. Aggregates
 - 2. Cementitious Materials
 - 3. Liquid Admixtures
 - 4. Water
 - c) Truck Management
 - d) Water Management
 - e) Trained production Team
 - 1. Loader Operator
 - 2. Dispatcher
 - 3. Plant Operator
 - 4. Truck Driver
 - f) Concrete Production
 - 1. Batching
 - 2. Charging
 - 3. Mixing
 - 4. Delivery
- D. CRITICAL FACTORS

OBJECTIVES

Upon completion of this module the participant will:

- Understand the need to monitor truck mixed concrete production.
- Understand the importance of delivering a consistent product to the paving operation in a timely manner.
- Gain a working knowledge of the truck mixed concrete process.
- Recognize the critical factors in truck mixed concrete that affect placing a quality pavement.

Objectives

- Understand Need to Monitor
- Understand Importance of Consistency
- Gain Working Knowledge
- Recognize Critical Factors

TM - 12

PRECONDITIONS

For the purpose of this module, the following assumptions have been made:

- The concrete mix design has been determined either by the concrete producer or contractor according to the specifications or established by the agency.
- The concrete pavement design has been established.
- The specifications have been established.

Preconditions

- Mix Design Determined
- Pavement Design Established
- Project Specifications Established

TM - 13

Consistency important for smoothness

TRUCK MIXED CONCRETE

This section covers ready mixed concrete manufactured by the truck mixed process. The truck mixed concrete is delivered to the paving contractor in a freshly mixed and unhardened state. This section does not cover the placement, consolidation, curing, or protection of the concrete after delivery to the paving contractor.

In truck mixed concrete, or "dry batch" operation as it is sometimes called, the batches are measured by the plant operator and charged from the weigh hoppers directly into the truck mixers for mixing. The plant operator is responsible for accurately batching the concrete.

The truck mixer driver is responsible for mixing the concrete. Generally, the truck mixer driver completes the mixing in the yard. That allows the driver to examine the mix and determine if it is acceptable prior to leaving the batch plant site. When the mix is right at the plant it will most likely be right when it arrives at the job site. This mixing may also be completed upon arrival at a staging or final check area at the project before the truck is positioned for discharge at the paving site.

The truck mixer is equipped with a revolution counter and slump meter. The driver is capable of estimating the slump to within 12 mm. This meter is used for estimating only. The slump is still measured per the project specifications.

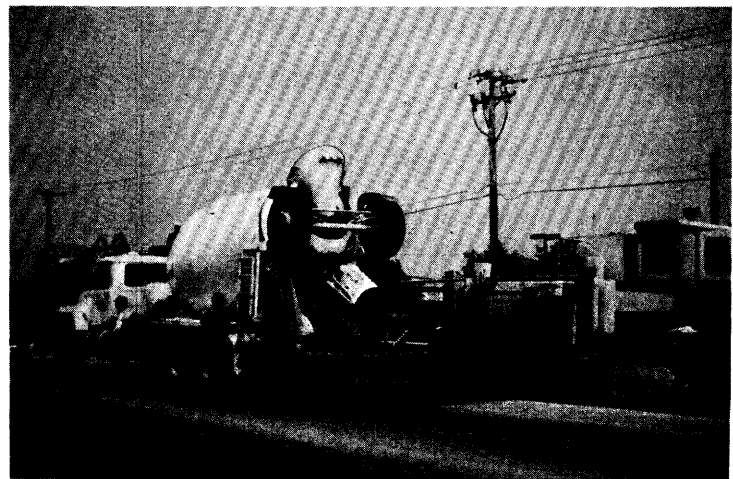
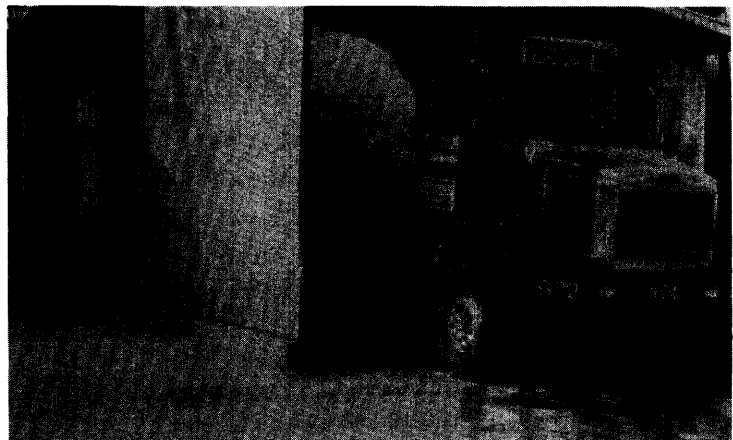
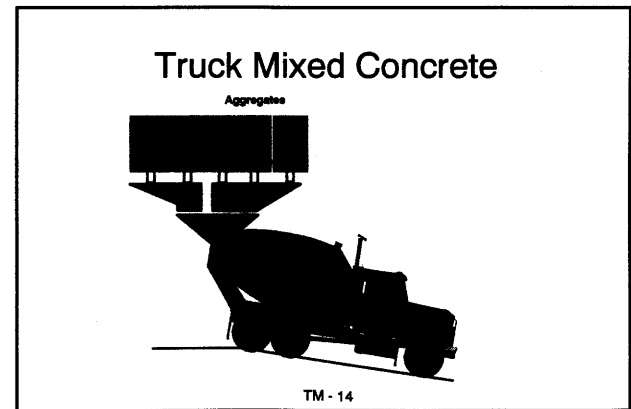

REQUIREMENTS

Requirements for the quality of the truck mixed concrete will be specified for the applicable project. Project specifications for truck mixed concrete normally incorporate American Association of State Highway and Transportation Officials (AASHTO) Specification M-157 for Ready-Mixed Concrete or the American Society for Testing and Materials (ASTM) Specification C-94 for Ready-Mixed Concrete.

Production of truck mixed concrete in conformance with project specifications maximizes the opportunity to achieve a quality product.



Concrete Requirements

- Paving Surface
- Paving Base
- Structural
- Fast Track
- High Strength
- Precast Concrete

TM - 18

APPLICATIONS

All types of concrete paving projects can be constructed with truck mixed concrete. On any particular project, the contractor will make the decision whether to use truck mixed concrete. Contractors identified the following projects where they often use truck mixed concrete for placement of concrete pavement. They are distinguished by type, location, schedule, and specifications.

Project Type

- Paving
 - ⇒ Intersection paving
 - ⇒ Street paving
 - ⇒ Specialty paving (e.g. *FAST TRACK*)
- Pavement repair

Project Location

- Urban environment
- Water management needs
- Traffic

Project Schedule

- Enhanced production
- Additional options
- Staging/Phasing

Truck Mix Application

- Project Type
- Project Location
- Project Specifications
- Project Schedule

TM - 19

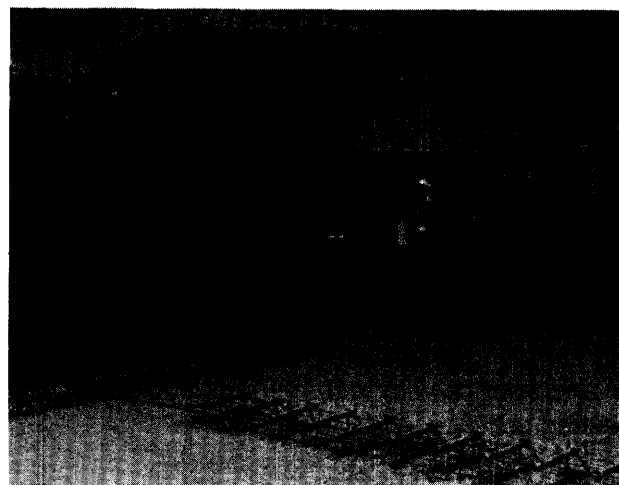

COMMUNICATIONS AND PREPARATION (CAP) ~ PARTNERING

The road to a quality product involves effective communication and preparation (CAP) between the agency (specifier), paving contractor (purchaser), ready mix plant (concrete producer), and testing personnel.

The specifications must clearly state the quality of the concrete required. The quality required is based on the specific element of work for which truck mixed concrete will be used.

The paving contractor must relate the quality needed and provide the concrete producer with a realistic quantity and delivery rate of concrete needed. The quantity estimated must define the total concrete volume needed and the anticipated realistic rate of placement of the concrete at the job site.

The concrete producer must assure the quantity and production requirements of the paving contractor will be accommodated in both volume and delivery rate to the project. In addition, the concrete producer's ready mix manufacturing process must produce a product that meets the paving contractor's and agency's quality requirements.

A CAP meeting will cover who, what, why, where, when and how.

A CAP meeting should be held between the specifier, contractor, testing personnel, and concrete producer to discuss the critical factors that will impact the concrete producer's ability to accommodate the specifier and the contractor. It is also critical to verify that access and procedures for sampling and testing the concrete will be in accordance with test methods and good testing practice.

Communications and Preparation (CAP)

- Agency (Specifier)
- Paving Contractor (Purchaser)
- Concrete Producer/Supplier (Manufacturer)
- Testing Personnel

TM - 25

CAP Meeting

- Quality (Project specifications)
- Placement Rate
- Production
- Testing

TM - 26

CAP Meeting

- Project location
- Project schedule
- Slipform
- Fixed form
- Hand work

TM - 27

The items discussed and decisions made at this CAP meeting will ultimately help ensure the motoring public receives the expected value. This meeting should be held sufficiently in advance of beginning operations to permit time to resolve difficult issues to the mutual satisfaction of all and still allow an on-time, on-budget completion. Distribution of CAP meeting minutes to all impacted by agreements reached and decisions made assures all parties are informed.

The paving contractor would be well advised to visit the ready mix manufacturing plant to review the process that will be used to produce quality, within-specification material. At that time they can review the producer's quality control plan and make necessary modifications to meet project requirements. Likewise, the concrete producer and testing personnel should visit the paving site prior to the start of placing the concrete pavement.

Many localities have ordinances that prohibit certain types of manufacturing during nighttime hours. These may have an impact on the manufacturing of the concrete, the paving, or both. Consider requesting a waiver on these ordinances from local municipalities if they will impact desired operations.

Visit with the neighbors and local businesses. Find out who will be impacted by your project.

"Think Safety" is an essential element on any construction project. All individuals involved with the project must be aware of and trained in sound safety practices.

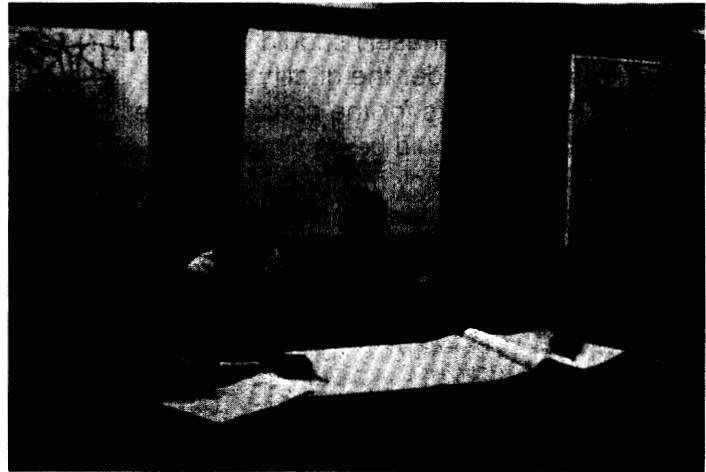

PURCHASE REQUIREMENTS

The contractor (purchaser) should incorporate in the order the quality and quantity requirements for the concrete. The purchase process could be as simple as indicating which agency mix (e.g., Grade A-WR) was needed for the concrete paving and the quantity of material required. The order should also include location, timing, and entrance and exit points.

Quality of the Concrete

Normally, the mix design will be covered in the project specifications; however, in those states that use end result specifications for strength or other properties, the contractor or the concrete producer will establish the mix design. Typically, the agency will specify a minimum cement content and other broad general parameters.

The contractor and the concrete producer need to agree on the specifics for each of the ingredients incorporated into the truck mixed concrete. The contractor must be given timely notification if the concrete producer changes the source for any of the ingredients in the mix.

Purchase Requirements

- Job Mix (Quality)
- Mix Design
- Sampling and Testing
- Placement Rate
- Location
- Entrance & Exit Points
- Time

TM - 29

Quality

- Cementitious Materials
- Aggregates
- Water
- Admixtures (Chemical)
- Consistency
- Strength Acceptance

TM - 30

They also need to agree on the quality measures needed for the specific use. The discussions and agreements include the following:

Cementitious materials

The type and quantity of cementitious materials to be used expressed in kilograms per cubic meter. Cementitious materials can include the following:

- Cement.
- Blended Cement.
- Fly Ash.
- Slag.
- Silica Fume.

The amount and class of fly ash is also a point for discussion. There needs to be a clear understanding how to account for fly ash or other cementitious material being used in the mix. The concrete producer, contractor, and agency need to agree if the cementitious material is added as a partial replacement (substitution) for cement or if the fly ash quantity is in addition to the cement. The replacement/addition question must be carefully discussed because misinterpretations can and do occur.

Cementitious Materials

- Cement
- Blended Cement
- Fly Ash
- Slag
- Silica Fume

TM - 31

Quality

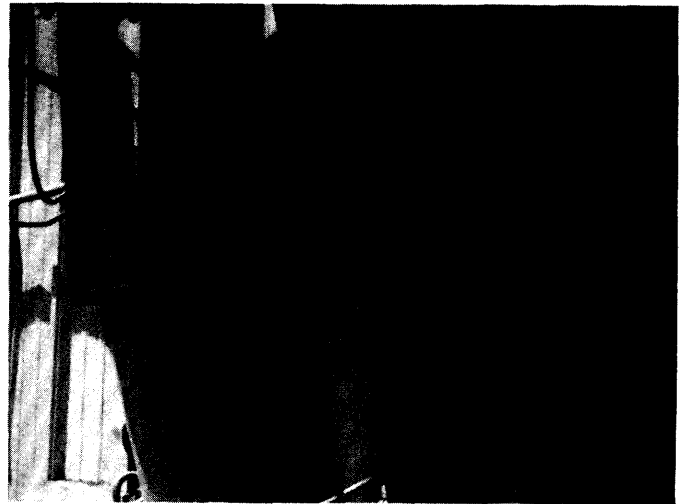

Fly Ash

- Az 90*
- Substitution for a portion of the cement
 - Addition to cement quantity specified

TM - 33

Quality

Aggregates

The size or sizes and amount of coarse and fine aggregates by weight in kilograms per cubic meter. There are many natural and manufactured materials that can be used for the coarse and fine aggregate.

Water

The maximum allowable water content in liters or kilograms per cubic meter. The amount of water relative to the amount of cementitious is called the *water-cementitious ratio*. The ratio is the kilograms of water divided by kilograms of cementitious .

The maximum allowable water includes any surface moisture on the aggregates beyond the absorption, that is, beyond the saturated surface dry (SSD) condition. The method of compensating for aggregate moisture during the batching process should be established by the concrete producer to accurately correct the batch quantities for water and aggregate. The contractor, concrete producer and agency should agree on the process.

Adjusting the amount of water in the mix is required to accommodate for free moisture in the aggregates. Free moisture is any water occurring on the surface of the coarse or fine aggregate particle.







Water

- Water Cementitious Ratio (W/C)
- Saturated Surface Dry (SSD)
- Free Moisture

TM - 37 Quality

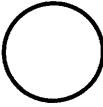
Moisture Conditions

State

Over-Dry	Air-Dry	Saturated Surface Dry	Damp or Wet
			
None	Less Than Potential Absorption	Equal To Potential Absorption	Greater Than Absorption

Total Moisture

TM - 38

Some coarse aggregates are highly absorptive and can demand mix water. When these absorptive coarse aggregates are encountered many concrete producers water the stockpiles.

The understanding of moisture management in the production of truck mixed concrete is an essential element in assuring that consistent material is delivered to the job site. A mix design is very sensitive to increases in moisture, especially from the fine aggregate. The following example shows the effect of free moisture in the sand and the adjustments that are required in the mix.

Concrete mix design using SSD weights	
Materials	Weights
Cementitious	314 kg
Coarse Agg (SSD)	1164 kg
Fine Agg (SSD)	776 kg
Water	124 L
W/C Ratio	0.39

The water cement ratio is the ratio of the weight of total water in the mix to the weight of cementitious material in the mix. In the above example, there is 124 L of water and 314 kg of cementitious material. Since 1 L of water is equal to 1 kg, the computations are straight forward. The w/c for this example is:

$$124 \text{ L} = 124 \text{ kg}$$

$$\frac{124 \text{ L}}{314 \text{ kg}} = 0.39$$

Check local specifications for limits on the water cement ratio.

Batch Water Volume

Water in job mix minus free moisture in aggregates

TM - 39 Quality

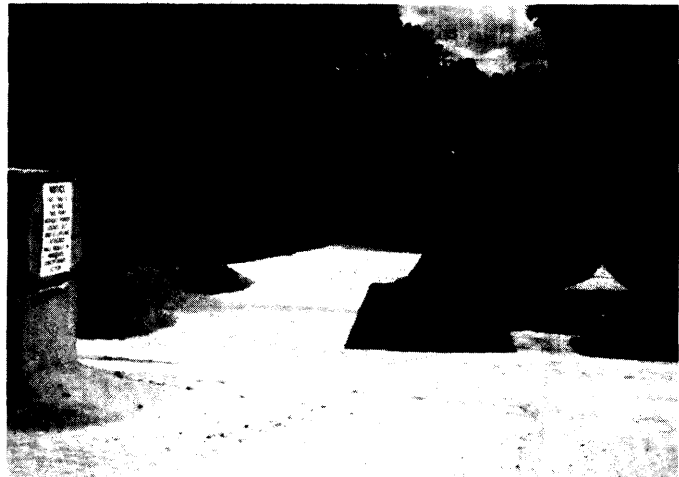

Batch Water Volume

Calculate

Free Moisture Impacts

One m³ of Concrete

TM - 41 Quality

If the fine aggregate contains 4.5% free moisture, an extra 35 liters of water is introduced into the mix. This free moisture in the sand would raise the water/cementitious ratio to 0.51.

If not adjusted, the mix would have too much water, not enough sand, and would significantly change the water/cementitious ratio and slump of the concrete. The probable effects of too much water in the mix are strength reduction, increased permeability and reduced durability.

An adjustment in the mix to account for the free water in the sand is required to maintain the water/cementitious ratio. Both the sand content and water content of the mix must be adjusted. A two iteration manual adjustment produces the following mix proportions.

Concrete mix design adjusted for moisture in sand	
Materials	Weights
Cementitious	314 kg
Coarse Agg (SSD)	1164 kg
Fine Agg	811 kg
Water (Adjusted)	89 L
W/C Ratio	0.39

This adjusted mix has the same water/cementitious ratio, and the sand by weight has been increased to account for the weight of the free moisture. Similarly, the water added to the mix has been reduced because of the free moisture in the sand.

If the moisture is not taken into consideration the slump would be excessive. A simple reduction of the added water would get the consistency but would result in less SSD sand in the mixture and an under yield of concrete.

Design Using SSD Weights

Materials	Weights
Cement	314 kg
Coarse Agg (SSD)	1164 kg
Fine Agg (SSD)	776 kg
Water	124 L
W/C Ratio	0.39
Fine Aggregate (+ 4.5% Moisture)	

TM - 43

Quality

No Adjustment for Moisture

Materials	Weights	
Cement	314 kg	314 kg
Coarse AGG (SSD)	1164 kg	1164 kg
Fine Agg (SSD)	776 kg	741 kg
Water	124 L	159 L
W/C Ratio	0.39	0.51

TM - 44

Quality

Adjusted for Moisture

Materials	Weights		
Cement	314 kg	314 kg	314 kg
Coarse Agg (SSD)	1164 kg	1164 kg	1164 kg
Fine Agg (SSD)	776 kg	741 kg	811 kg
Water	124 L	159 L	89 L
W/C Ratio	0.39	0.50	0.39

TM - 45

Quality

Many concrete producers have an automatic moisture sensing meter tied to the computer controlled batching operations. The moisture sensing system provides information to the computer to automatically adjust the mix on a continuous basis. In the absence of an automated sensing system moisture tests must be performed on the fine and coarse aggregate on a daily basis.

Admixtures

The type and quantity of admixtures expressed in milliliters per kilogram of cement. Normally, the concrete produced will include the following admixtures:

- Air Entraining (AE)
- Water Reducer (WR)

In certain situations the following admixtures may also be used:

- High Range Water Reducer (HRWR)
- Accelerators
- Retarders
- Corrosion Inhibitors

Identify the range of air content and location where samples for determination of air will be taken. Discuss the method of adding liquid admixtures during the batching process. The contractor must be given timely notification if the concrete producer changes the source for the liquid admixtures. Changes in dosage rate must be coordinated with paving operations.

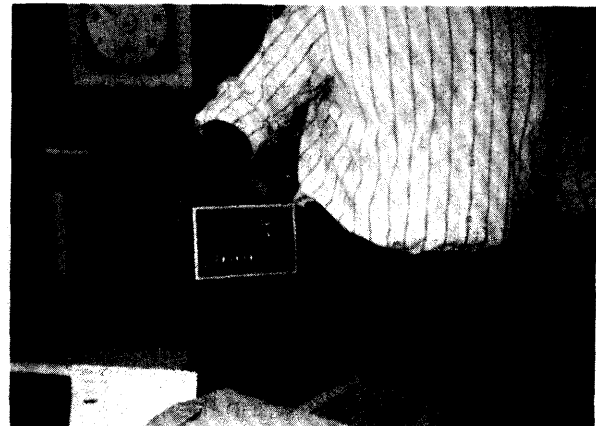

Liquid Admixtures

- Air Entraining (AE)
 - Vinsol resin
 - Synthetic
- Water Reducer (WR)
 - Lignosulfates
- Superplasticizers
 - Lignosulfates

TM - 48

Quality



Consistency

The slump desired. Match workability of the concrete to the type of paving operation, either slip form or fixed form (including hand work). Slip form paving concrete requires material of a consistent low slump for a quality product.

Strength Acceptance

Strength is not normally identified as an acceptance parameter when the project involves an agency-furnished recipe mix design for the concrete.

When statistical acceptance parameters are present, detailed discussions need to take place regarding the mix design. The mix design must be developed to meet the job compressive or flexural design strengths with only a small potential for penalties. This requires that the concrete producer have a thorough understanding of the typical standard deviation at the ready mix plant for the specified mix design. Using this information, the concrete producer is able to produce a mix that minimizes the potential of penalties for low strength. The producer will over design for strength.

Consistency

Match Slump to Placement Application

TM - 51 Quality

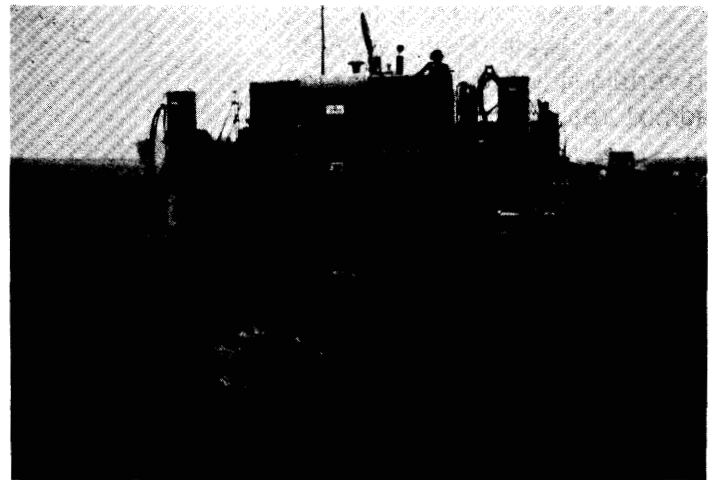

Probably too much load on slip former

Statistical Acceptance Parameters

- Strength: Compressive or Flexural
- Air Content

TM - 54 Quality

The sampling location to collect concrete for making cylinders or beams must be agreed upon. Observe the making, transporting, curing, and testing of the test specimens to ensure that methods used represent good practice. This information should be outlined in the concrete producers quality control plan.

Quantity of the Concrete

Volume

The quantity of material needed for the specific application is computed on a volumetric basis. The calculation to determine the volume involves multiplying length times width times depth and results in cubic meters required.

Yield

The yield is the actual amount of concrete produced to place the calculated volume. Yield is normally expressed as a percentage above or below theoretical volume. Slightly more material is needed to compensate for job variations. Yield is also a function of mix design.

Job Variations: Consideration must be given to the surface tolerances of the base material and the typical variation in pavement thickness. Placing the concrete on an irregular surface compared to a parallel plane will necessitate a slight upward adjustment when calculating the material. Normally, concrete pavement will be placed slightly thicker than required to ensure meeting the thickness requirements without penalty.



Quantity

- Volume
- Material Needed
- Placement Rate

TM - 56

Quantity

Volume = Length x Width x Depth

$$1440 \text{ m}^3 = 1 \text{ km} \times 7.2 \text{ m} \times 200 \text{ mm} \\ (1000 \text{ m} \times 7.2 \text{ m} \times 0.2 \text{ m})$$

TM - 57

Allowance must also be made for loss factors in the concrete operations. A small change may be experienced due to subsidence in the forms, loss of air, or material coating equipment or lost during construction operations.

Moisture loss from concrete is volume loss. Moisture subgrade and protect concrete from moisture loss after placement.

Mix Design: The contractor also needs to work with the concrete producer to determine the yield for the particular mix design. Determination of the yield converts the weights used in the batching process to a volumetric basis. The volume of freshly mixed and unhardened concrete in a given batch is determined from the total weight of the batch divided by the actual weight per 7 liter or 15 liter bucket of concrete. Determination of which size bucket to use is based on the size of the coarse aggregate. The procedures for calculating yield are outlined in ASTM C-138.

Quantity

$$\begin{aligned} \text{Material Needed} &= \text{Volume} + \text{Overrun} \\ &= 1440 \text{ m}^3 + \text{???}\% \end{aligned}$$

TM - 58

Quantity

Determine Job Mix Concrete Yield
Using Method ASTM C-138

TM - 59

Placement Rate

The discussion on slipform paving states that an essential element of a smooth quality ride is maintaining a constant movement of the paving equipment. Thus, it is essential that the contractor and the concrete producer establish a realistic rate of delivery. Delivery rate as it applies to paving will be discussed in Paving Operations.

The rate of production and delivery must be calculated on a realistic cycle time for each truck mixer for loading, mixing, delivery, discharging, and return to the plant.

At a placement rate of $1.512 \text{ m}^3/\text{min}$ it would take 4 minutes to unload a 6 m^3 truck. The time for a concrete truck to arrive at the site, empty the load and begin the return trip is the unloading cycle. This time will vary from project to project. Low slump concrete has different unloading characteristics than high slump concrete. The unloading time of low slump concrete can be reduced by using truck mixers that are specifically designed with wider discharge openings.

An important factor in an urban area is the anticipated congestion that would be encountered by the truck mixers. Estimated delivery and return times are determined based on speed limits, anticipated congestion, and distance to the project. The project itself will likely cause some lane closures and/or detours in the area. Provision must be made to route the truck mixers to the placement operation in an efficient way.

Quantity

Placement Rate (m^3/min) =

Paver Speed (m/min)
x Material Needed (m^3/m)

TM - 60

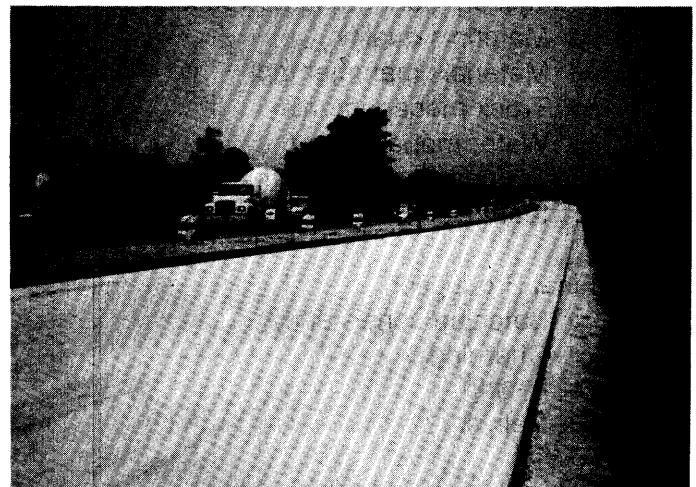
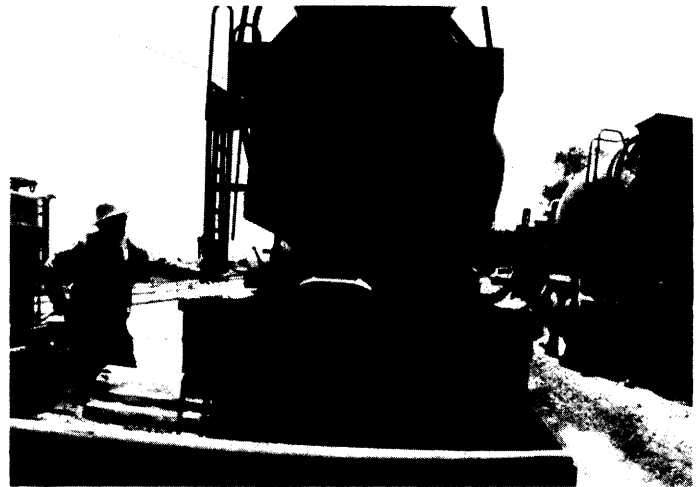

PRODUCTION OF TRUCK MIXED CONCRETE

The concrete batch plant should be designed to ensure a consistent, uniform product from batch to batch.

- Consistency will ensure that the concrete paving operation moves in a uniform fashion.
- Consistency will ensure that the concrete is ready for saw operations in a uniform fashion.

The main components of a truck mixed operation are illustrated.

Many ready mixed concrete plants are inspected or certified to meet agency specifications or the criteria of the National Ready Mixed Concrete Association (NRMCA) plant certification checklist. This should help ensure that the material produced is within specification, although certification does not ensure quality and consistency. Diligent control and quality production practices must be maintained by plant personnel and truck mixer drivers.

There are a number of best management practices that should help maintain consistency. These practices fall in the following areas:

- Production Management Practices
 - ⇒ Materials quality
 - ⇒ Materials management
 - ⇒ Truck management
 - ⇒ Water management
 - ⇒ Trained/qualified production team
- Final Production
 - ⇒ Batching consistency
 - ⇒ Charging
 - ⇒ Mixing
 - ⇒ Delivery

Production of Truck Mixed Concrete

- Consistency
- Consistency
- Consistency

TM - 63

Consistent Production Management Practices

- Materials Quality
- Material Management
- Truck Management
- Water Management
- Trained/Qualified Production team

TM-64

Final Production

- Batching Consistency
- Charging
- Mixing
- Delivery

TM - 65

Materials Quality (Certification and Testing)

The contractor and the concrete producer should discuss the process that is used to determine that all of the materials meet the project specifications. On many projects that will include the development of a quality control (QC) plan. The agency receives any QC plan and is an integral part of this process.

As appropriate, the concrete producer should provide the contractor with certification records. Finally, any material tests that are to be run beyond normal certification requirements should be established by type and frequency. Results of all tests run by the contractor or inspection agency should be made available promptly to the concrete producer's quality control staff.

Material Management

General

The subject of material management is common to both truck mixed and central mixed concrete. Items discussed in this section can be applied to both types of operations. Any features that are unique to one or the other are listed.

Portland cement concrete (PCC) is water, admixtures, aggregates, and cementitious material uniformly mixed together. Material management keeps track of all of the materials used in the production of PCC.

Examine the number of different materials when developing a material management plan. Proper management of all of the materials that influence the quality and consistency of the concrete is essential.

Manage materials for quality while maintaining production.

Materials Quality

- Sampling
- Testing
- Certifications

TM - 67

Material Management

- Aggregates
- Cementitious Materials
- Liquid Admixtures
- Water
- Fibers

TM - 69

Certification

Only deliver certified materials to the project site. Testing or State programs provide proper material certification.

It is essential to handle all materials in such a way as to maintain quality. Mishandling material can effect their quality. Always follow manufactures recommendations.

Aggregate

Aggregate consists of fine aggregate (sand) and coarse aggregate (gravel or crushed stone). Proper stockpile management is vital to consistent quality concrete production. Stockpile management is the coordination of the aggregate delivery, storage, and loading into the central mixed plant.

Maintain uniform gradation throughout the project. Uniform aggregate will contribute to uniform concrete. Prevent aggregate contamination. Consult local specifications for proper stockpiling guidelines. A few basic concepts include the following:

- Pile material in lifts.
- Complete each lift before beginning the next.
- Do not dump material over edges of stockpile.
- Stockpile as much material as practical before using.

Before delivery of the aggregate to the plant site, determine the means of handling the material. Take an inventory of the equipment and personnel responsible for the day-to-day aggregate operations.

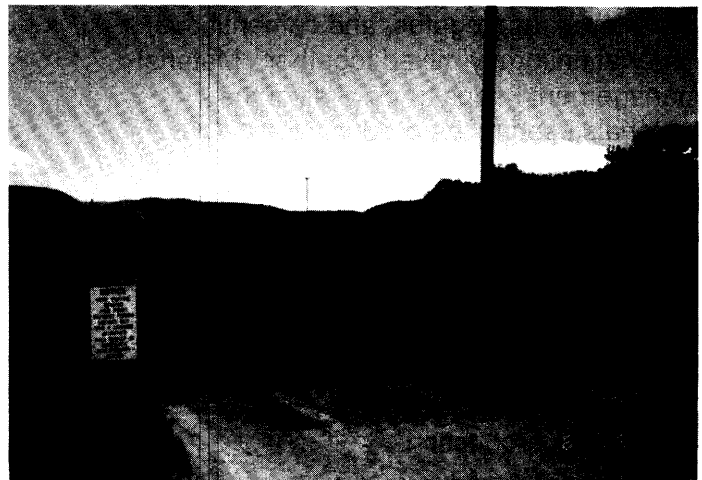

Determine the total amount of aggregate required for the project and daily delivery schedules. Modify these schedules as needed during construction. Be certain that there is enough equipment to handle the incoming material efficiently. Stockpile aggregate in designated areas determined during plant layout.

Coordinate material delivery with expected concrete production. Do not let on site material shortages hold back concrete paving production. If production is large, use more than one stockpile. To enhance the consistence of the concrete, avoid using aggregates that contain free moisture.

It is important to emphasize that there are many critical paths on a paving project. Do not let poor material management be one of them.

As part of daily aggregate monitoring, check gradation and moisture content at regular intervals. These intervals and requirements vary from project to project. Perform testing according to project specifications.



Cementitious Material

Keep different cementitious materials separate. Store cement and fly ash in separate bins. As with the aggregate delivery, determine the total quantity of cement required on the project as well as daily delivery schedules. Delivery tanks are under pressure. Unloading of the cementitious material takes time. Maintain adequate area for cement deliveries.

Storage silos are watertight to prevent contamination. Periodically empty and check silos for caking of the cement and fly ash. Baghouses are normally used to control cement dust emissions during silo loading operations.

Use ground storage or "pigs" to store bulk shipments. Each pig holds approximately 6 to 7 tanker loads of cement. Use extra storage units such as extra parked delivery trucks to supplement storage silos as needed. Correlate the amount of cement in each storage container with concrete production.

Cement yield is important. The amount of cementitious material delivered to the plant site must approximately equal the amount of cement used. The contractor will keep the cement loss to a minimum for economic reasons. The agency uses cement yield as a rough check to ensure the right amount of material is being used.

Cementitious material delivery hoses must be clearly marked. It is imperative that the proper material be loaded into the proper storage silos. Different connections are often used to minimize the risk of this occurring. Material is often delivered at night when no one is around.

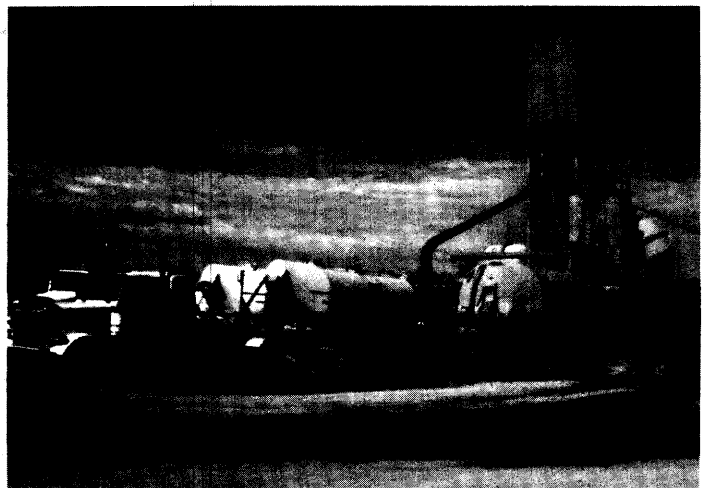

Admixtures

The most common liquid admixtures used for concrete paving are air entraining agents and water reducers. For specialized pours, set retarders, accelerators, or superplasticizers may be required.

Store admixtures to prevent contamination and damage. Protect storage containers from excessive heat and cold. Do not allow admixtures to freeze. If the admixtures are frozen, retest them in accordance with local specifications and the manufactures recommendations.

Admixtures have a tendency to settle. Periodically check the shelf life admixtures. Store admixtures in accordance with local specifications and manufactures recommendations. Keep information placard on storage containers clean and visible.

Water

Water should be clear and clean without objectionable color, smell, or taste. Normally, most specifications require potable water be used in the batching process.

Typically most concrete producers use well water or are connected to the municipal water system. Check that these systems are capable of meeting expected output demands during peak production.

When washout water is used, become familiar with the amount being used and the process of introducing it into the mix. Refer to ASTM C-94 for the specific details when using recycled washout water.

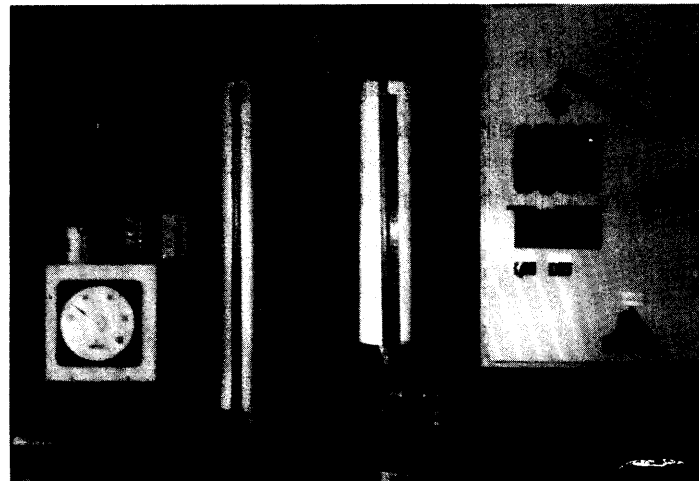
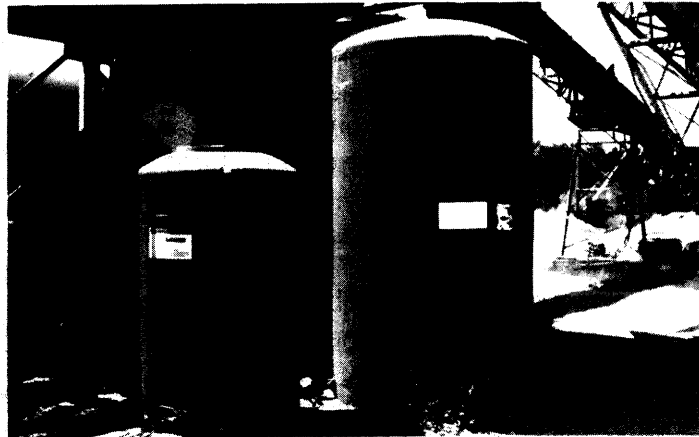

Determine the temperature of the water source. This is critical during hot and cold weather concrete production. Water storage is important when heating or cooling the water. Water temperature can also effect the performance of admixtures.

Fibers

Some concrete mixes use fibers. Most often, they are polypropylene or steel fibers. Each type of fiber has unique handling and batching requirements. Handle the fibers in such a manner to prevent balling. This is especially critical with steel fibers.

Project Characteristics

Each project is unique. Read the project specifications. Understand the history of the materials being used. Good practice must be combined with experience to yield the highest quality concrete.

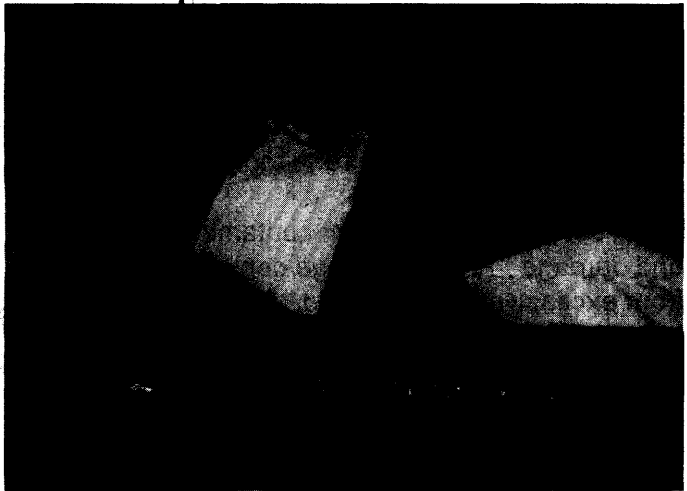

Material Management

- Each project is different
- Each project is unique
- Study local conditions
- Study local specifications

TM - 89

Material Management

It is important to emphasize that there are many critical paths on a paving project. The point to be made here is to not let poor material management be one of them.

TM - 90

Truck Management

Only use truck mixers that are in compliance with AASHTO M 157 OR ASTM C 94. Truck mixers are required to have a rating plate, counter, and water gauge.

The delivery of consistent material to the project site is dependent on truck mixer condition. The blade wear in the truck mixers should be in the acceptable range according to the manufacturer's rating. Check blade wear often. Can have a dramatic effect on mix consistency.

Concrete build-up will reduce mixing efficiency. A quick way to check for build-up is to weigh the trucks periodically. Any inspection in the drum must be in accordance with Occupational Safety and Health Administration (OSHA) requirements for entering a confined space.

Maintain non-agitating and agitating trucks in good condition. Keep trucks clean at all times. Excess concrete that builds up on the inside of these trucks may break off and be incorporated into the pavement. This can lead to premature distress in the new concrete pavement.

DO NOT GO INTO A MIXING DRUM ALONE!

Truck Management

- Rating Plate
- Counter
- Water Gauge
- Blade Wear
- Concrete Build Up
 - Visual
 - Weigh

TM - 92

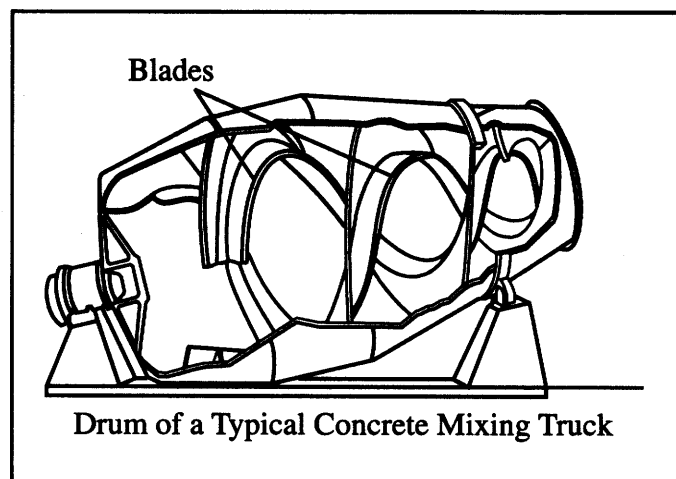
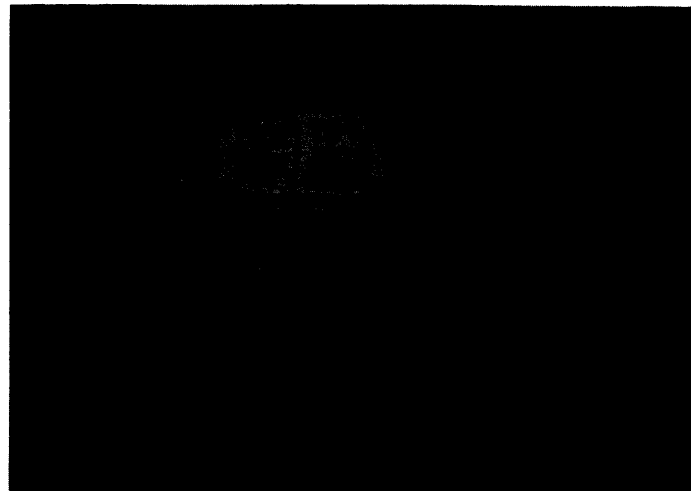

Water Management

Good practices in water management will provide maximum opportunity for delivery of a consistent product to the concrete paving project. Water enters the batch as a part of the ingredients used to make the concrete. Water can also enter the batch during washing operations after batching. The following water must be accounted for in the batching process:

- Batched mixing water at the plant
- Free moisture in the aggregates
- Ice
- Admixtures
- Water used to wash hopper and back fins
- Water added through the truck mixer water system to bring slump up to required level

Washing operations after discharging can impact the next batch of concrete placed in that truck.

It is essential that the concrete producer establish a consistent practice to account for water that may enter the batch during washing operations. The practice established may vary from producer to producer. However, the important element is consistency. The practice at any individual plant must be consistent. The goal is to prevent unaccounted for water from being added to the concrete batch.

Washing operations consist of the following:

- Wash off. At plant after batching
- Wash down. Of chute after discharge
- Washout. Of drum

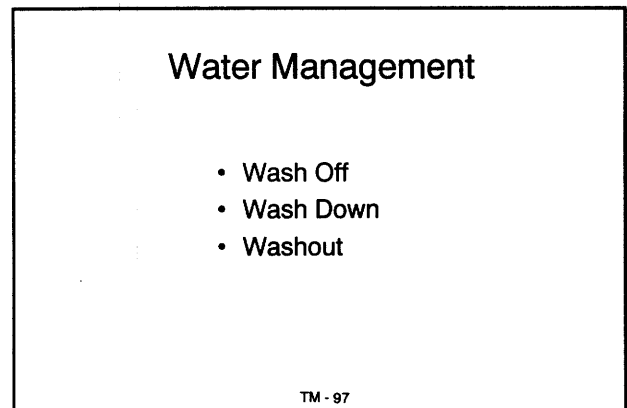
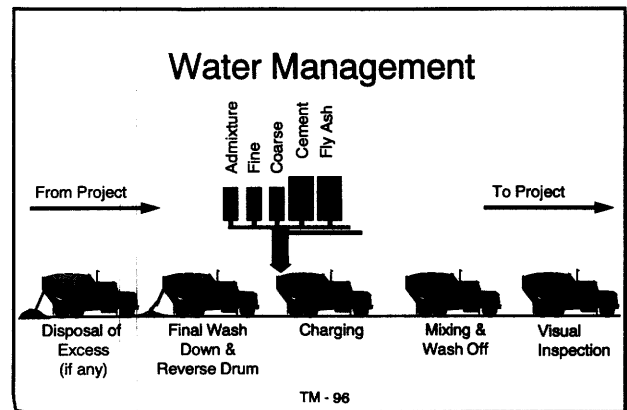

Wash Off

Washing the truck mixer at the plant after loading: The driver washes the back of the mixer to prevent a build-up of materials in this area. Care must be exercised so little wash water enters the mixing drum.

Generally a consistent amount such as 20L is used to wash off the back hopper and fins. This water must be included as a part of the mixing water.

Wash Down

Washing the truck mixer after unloading at the project: The concrete producer should reach an understanding with the contractor about where the wash down residue can be deposited on the project. This usually consists of only chute and discharge hopper wash down.. Truck mixers should never wash into catch basins, shoulders, or road ditches.



WARNING!!

Never Discharge Into Catch Basins,
Shoulders and Roadside Ditches

TM - 99

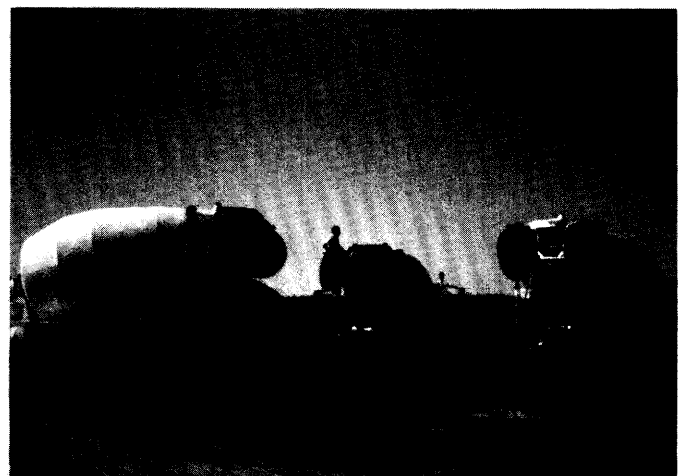

Truck Mixed Concrete

In some cases the truck driver reverses the drum rotation and discharges any remaining water into a washout pit at the plant. This helps ensure that any water that entered the drum during wash down is removed before the next batch is added to the drum.

Concrete left in the truck at the end of a pour is a recyclable resource. Many concrete manufacturers recycle left over concrete into ecology blocks. These have many applications including creating a positive separation between aggregates.

Washout

Washing the truck mixer drum out at the plant: This is usually done at the end of the day's operations. Prior to start up the next day, reverse the drum to discharge any remaining water from washout or rain.

The critical element in water management is consistency and keeping control of all sources of water that goes into the concrete. Implement a process and follow the process.

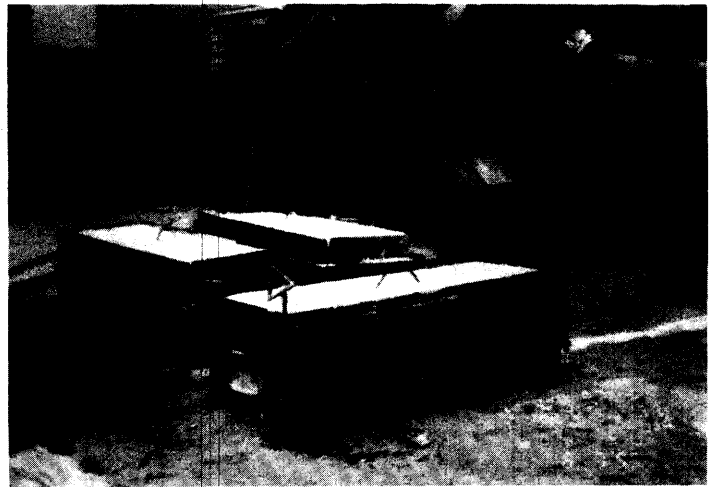
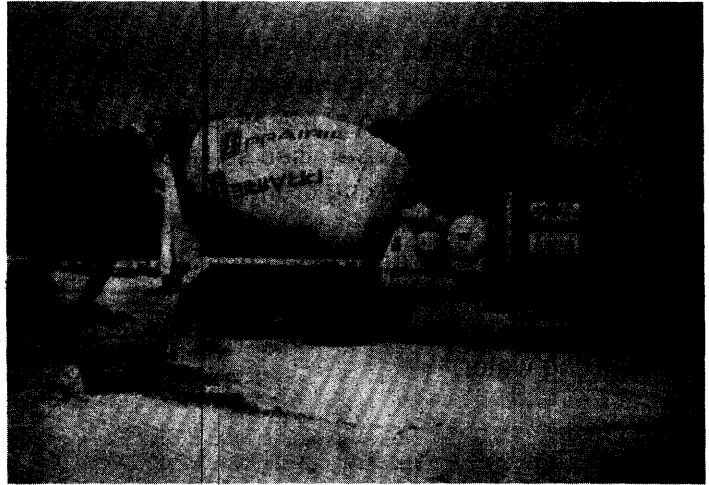

Trained Production Team

The production of a consistent material is ultimately accomplished by people who are knowledgeable and trained in the production of a quality concrete mix. The key individuals for a "dry batch" system are:

- Loader Operator.
- Dispatcher.
- Plant Operator.
- Truck Driver.

Loader Operator

The loader operator is the first line of defense. The charging of the feed hoppers must be done in a manner that eliminates potential for contamination of the aggregates.

In addition, the operator must work the stockpile in a manner that provides as uniform a moisture content as possible. Attention must also be given to work the stockpile to provide uniform gradation. Particular care must be exercised to not segregate the coarse aggregate from its fines.

Finally, the material must be deposited in the proper feed hopper. This individual is also the first line of defense when aggregate shortages could develop.

Loader Operator

- Selection of Proper Material
- Work Stockpile to Provide Uniformity
- Minimize/Eliminate Contamination
- Observe and Report Moisture Variation
- Proper Material in Feed Hopper

TM-105

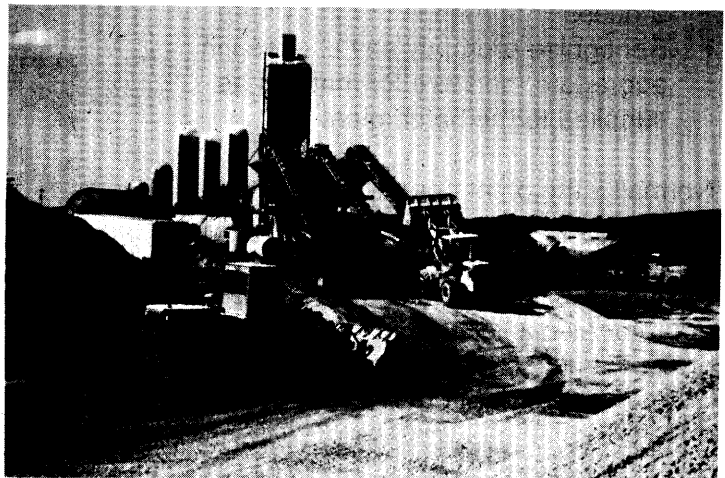

Dispatcher

The dispatcher provides a vital communication link in the production process. The dispatcher should be in constant contact with the paving foreman to balance production with placement. The dispatcher can also ensure that truck mixers designed for paving are routed to the paving projects.

Plant Operator

The plant operator normally performs the following functions:

- The operation of the batching equipment to ensure that the desired batch quantities have been obtained for each load of concrete.
- The remedial operational functions required in the event the batching equipment does not perform as required.
- Manual batching, if necessary.
- The operation of the batch discharge gates in a prescribed manner to obtain the required sequencing or blending of the various ingredients during charging of the truck mixer.
- Assure that correct aggregate moisture contents are used in the batching process
- Recognize promptly any changes in aggregate moisture for material as supplied to the batch plant.

Normally, the plant operator will be given the required concrete proportions and it is his/her duty to properly produce the quantities to be batched. The plant operator also is located in such a manner to provide a critical observation point of good water management practices by the truck drivers.

Dispatcher

- Available Trucks
- Constant Contact with Job Site

TM -108

Plant Operator

- Proper Material Storage
- Batching
- Overview of ALL Plant Operations
- Truck Observation
- Sequencing

TM -109



Truck Driver

The ultimate responsibility for mixing the concrete to the proper slump and on-time delivery is with the truck driver. These individuals also serve as an essential link in the communication chain with the manufacturing plant. Truck drivers have sole responsibility for the last stage of quality control. They ensure that unaccounted for water is not added to the batch during wash off or slump adjustment operations. They must follow consistent practices during all washing operations.

These individuals also have the opportunity to observe if sampling procedures and tests are being conducted in accordance with ASTM and AASHTO procedures. Discrepancies observed must be communicated to the plant for immediate corrective action.

The truck driver is also in the public eye and conveys either a positive or negative image of the truck mixed operation.

Finally, during the entire process the truck driver should operate the truck mixer in a safe, courteous manner.

Truck Driver

- Water Management
- Mixing
- Delivery
- Discharging
- Sampling & Testing Procedures
- Image
- Safety

TM-111



Concrete Production

Batching

Concrete batching is the accurate measurement of the ingredients that will be combined to form truck mix concrete. The solid ingredients, aggregates and cementitious materials are measured by weight. The liquid ingredients, water, and liquid admixtures are normally measured by volume, although they can be weighed. Measuring devices used to batch the ingredients must have been checked for accuracy. Each of the materials must be accurately measured. AASHTO M 157 OR ASTM C 94 specifies the tolerances for the measurement of each of the ingredients.

Concrete Production

- Batching
- Charging Truck Mixer
- Mixing in Truck Mixer
- Delivery

TM -114

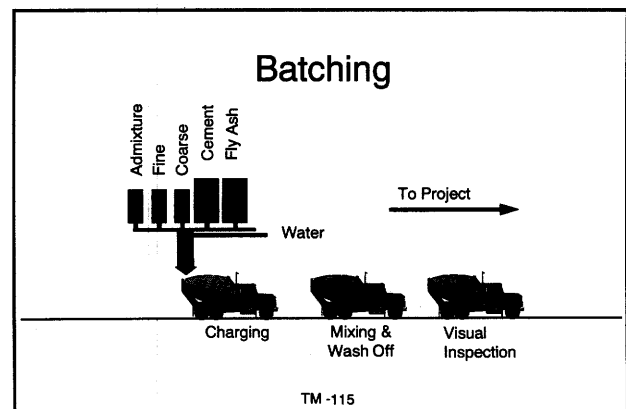

Batching

Accurate Measurement of Ingredients

- Cementitious Material
- Aggregates
- Water
- Liquid Admixtures

TM -116 Concrete Production

During the batching process the aggregates and cementitious materials are discharged from the storage bins directly into the weigh hoppers. Depending on the design of the facility, the weigh hoppers are designed to weigh the coarse and fine aggregates cumulatively or independently. Storage bins must discharge freely with minimum segregation into the weigh hopper. Weigh hoppers should be designed to minimize accumulations of tare materials and to discharge fully. A separate weigh hopper is used for cementitious materials.

Almost all concrete plants utilize automatic batching. These controls start the weighing operation of each material and stop it automatically when the designated weight of each material is reached. The controls are interlocked to ensure introduction of the proper amount of materials in the right sequence. These interlocking controls operate using the applicable tolerances.

Cementitious Materials: When fly ash or other pozzolans are specified in the mix design, they may be weighed cumulatively with the cement. The cement is weighed before weighing the fly ash or pozzolan. This assures that the proper amount of cement is batched prior to introducing any other cementitious materials. Tolerances for batching are in accordance with AASHTO M 157 OR ASTM C 94.

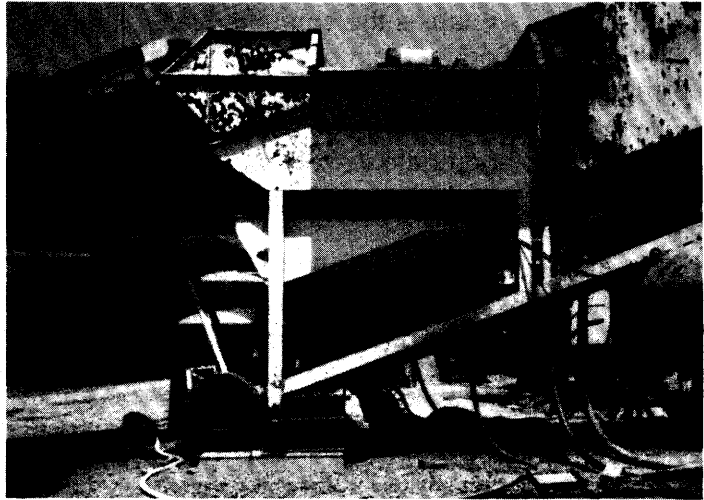

Cementitious Materials into Weigh Hopper

- FIRST:** Cement
- SECOND:** Fly ash and/or pozzolons

TM-119

Concrete Production

Aggregates: The advent of in-hopper moisture meters enables the computerized batching system or the plant operator to automatically account for water that occurs as free moisture in the aggregates. Adjustments to aggregate weights and water volumes are made automatically.

The moisture meter is a tool. Learn how to calibrate it and understand its limitations. The meter must be calibrated or checked frequently.

Water: The water is usually measured by volume and pumped directly to either the truck mixer or a storage tank. An accurate determination of the water added to the batch is absolutely essential to producing consistent truck mix concrete. All water that is entering the batch must be accounted for during the batching process.

Liquid Admixtures: Liquid admixtures are pumped into graduated cylinders for measuring. The admixtures are normally measured by volume, and the measuring devices should be located in view of the plant operator.

These admixtures are added to the batch with the water or on the sand. The dosage rate of most admixtures is determined initially by trial batches, but may require adjustments by observing the results at the project site. Changes in dosage rate can occur depending on temperature, mixing, hauling, and placing.

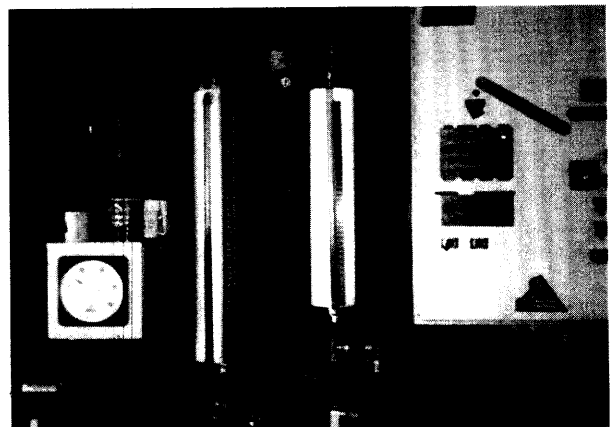
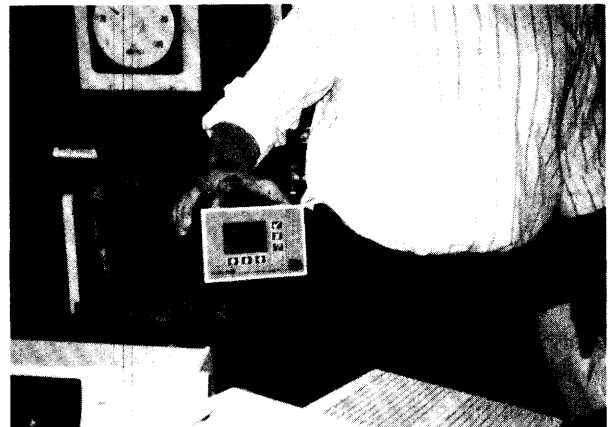
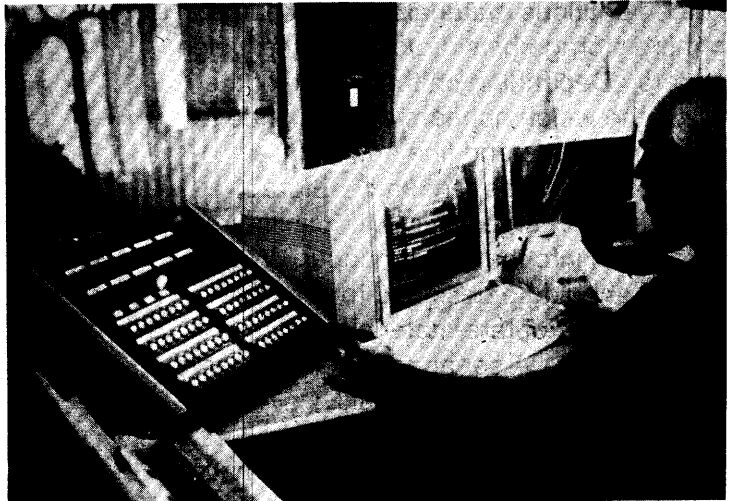

Scales: The scales for the weigh hoppers can be beam, springless dial, or load cell type. Most concrete plants are equipped with a load sensor that encodes the weight electronically. The weight of the material is displayed in the control house on either a computer screen or a digital readout. These must be fully visible to the plant operator. Often, actual material weights for each batch are recorded or kept in a computer file.

Plant scales need to be certified as accurate on a periodic basis. The contractor must ensure that the concrete plant has up to date certification and calibration.

Charging Truck Mixer

Charging is the sequential addition of the ingredients into the truck mixer. This sequencing of ingredients will have an important effect on the uniformity of the truck mix concrete. Elevating the rear portion of the truck mixer during charging operations minimizes the time required to get all the ingredients into the drum.

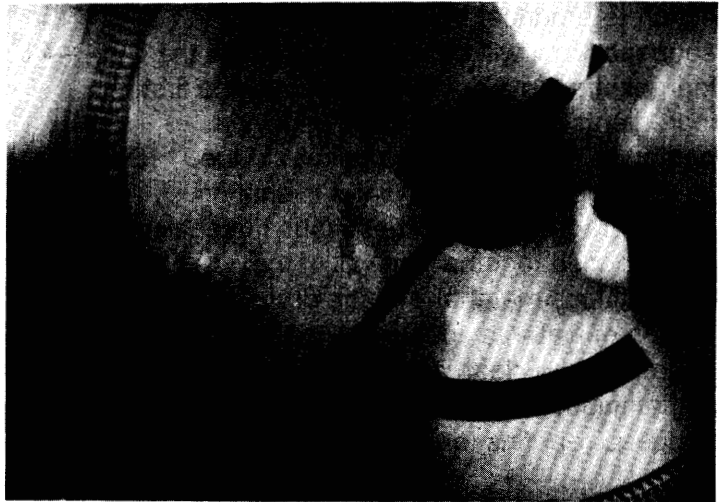

Charging Truck Mixer

The Sequential Addition of Ingredients into the Truck Mixer.

TM -125 Concrete Production



Sequencing: The contractor and the concrete producer should review the sequence that will be used to introduce the ingredients. In a dry batch process, the first ingredients into the drum are usually a portion of the water and a portion of the coarse aggregate. The water is shut off and aggregates and cementitious materials are ribboned together until all of the cementitious material is in the drum. A final portion of water is added with the last of the aggregates to clean and wash any cementitious material clinging to the hoppers, rear fins, and chutes.

There are many opinions on the actual sequencing of the ingredients. In some cases, State specifications establish this operation. In other cases, the experience of the concrete producer results in a particular sequence being used. However, it is essential that the contractor and the concrete producer agree that the sequence process meets the specifications and produces a consistent product. Once agreed upon, the sequencing process should remain the same.

The development of a sequencing diagram is a useful tool in clearly stating the particular charging process used by the concrete plant. This diagram is typical of the practices employed by one truck mixed operation. It is not intended as a specification.

Dust collection is important during charging operations. Take care to minimize the impact on surrounding areas.

Head Packs

A head pack occurs when sand or sand and cementitious material packs in the head of the drum, remains lodged in the head, and is not mixed into the concrete. Typically, head packs will be 300 to 600 mm thick.

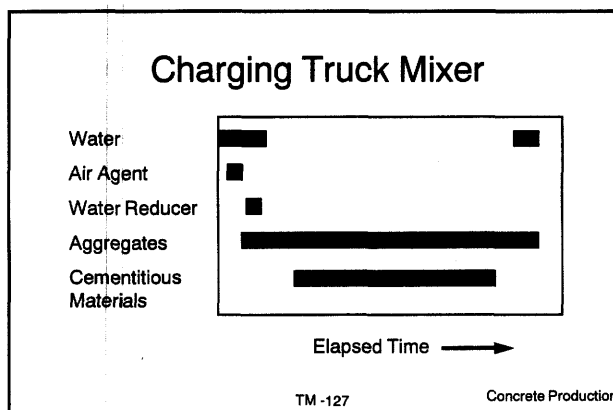

admixture added separately

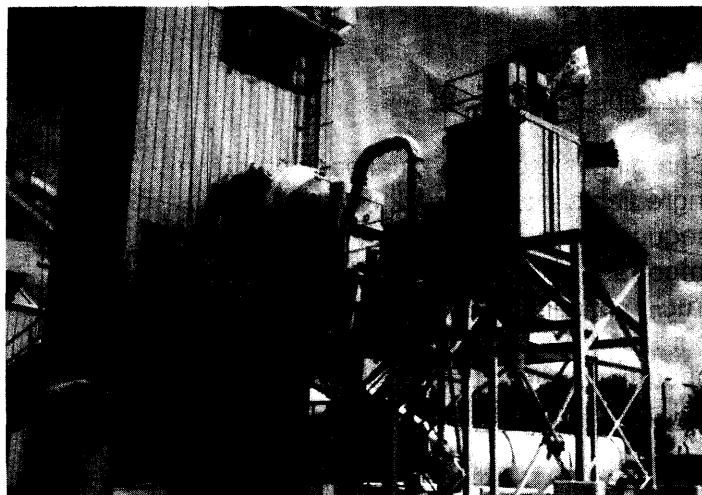

Head packs are difficult to detect because they break up after about half of the concrete has been discharged. Often the material becomes mixed with the remaining concrete during discharge so that the only change noticed in the concrete in the chute will be a change in slump and a slight change in color. Head packs are principally responsible for sand streaks, which occur in the final 3/4th of the discharge.

Because head packs tend to become mixed with the remaining concrete in the drum they can often be seen only as they break loose from the head of the drum. Careful observation through the charging hopper is necessary.

Cementitious Balls

Cementitious balls are accumulations of cementitious material, sand, and sometimes gravel rather than cementitious material per se. The specific causes are a subject of some controversy, but they are more prevalent in batches mixed for a small number of revolutions.

In general, cementitious balls are more often found in ribbon loading than in cementitious -last loading. The majority of cementitious balls are smaller than about 60 to 75 mm in diameter but can range up to 200 mm in diameter.

Avoiding Head Packs and Cementitious Balls

- Proper sequencing of materials is critical.
- Start water before other ingredients.
- Start coarse aggregates before sand or fine aggregates.

On ribbon loading, lead with water and some of the coarse aggregate.

Sequence Troubleshooting

Head Packs & Cementitious Balls

- Proper Sequencing of materials
- Start water before other ingredients
- Start coarse aggregates before sand or fine aggregates

TM -129

Concrete Production

Admixtures: When multiple admixtures are used in the concrete, they must not be allowed to come in contact with each other until both are in the truck mixer drum. Normally, air entraining admixtures are introduced with first water. Introduce a second admixture, if specified, into the water after the first admixture is completely in the drum or add it on the sand.

Liquid admixtures should not come into contact with the dry cementitious material until mixed with the mixing water and the aggregates. When more than one liquid admixture is used always introduce them at different times with the water and aggregates.

Superplasticizers are sometimes added to the truck mixer at the job site and thoroughly mixed into the batch. Admixtures added to truck mixers should be introduced on or over the concrete after the drum has been reversed and pulled concrete over the back fins. Add the admixture on or over the concrete. When the drum is started it will pull the admixture down into the batch.

WARNING

When using more than one admixture

ALWAYS introduce them at different

times!!

TM -130

Concrete Production



Mixing in Truck Mixer

The mixing of the materials is done in accordance with the specific project specifications. A number of agencies limit both the number of mixing revolutions and the total allowable revolutions. Many concrete producers require that the material be thoroughly mixed and inspected by the driver before leaving the plant. After mixing is completed, the truck mixer agitates the concrete according to the concrete producers recommendation.

The project specifications set the maximum amount of time the concrete can remain in the truck mixer prior to discharge.

Delivery

The contractor should receive a batch ticket from the truck mixer driver when the truck mix concrete is delivered to the project site.

When the contractor is satisfied that the batch ticket indicates that the concrete is in accordance with the order, the concrete can be discharged at the project site.

If the contractor is not satisfied with the slump of the concrete one addition of water is permitted to bring the concrete to the desired level. When water is added 30 revolutions of the drum at mixing speed are required to completely mix the water into the batch. Depending on project procedures this might be done at the plant if needed or at a staging area on the project.

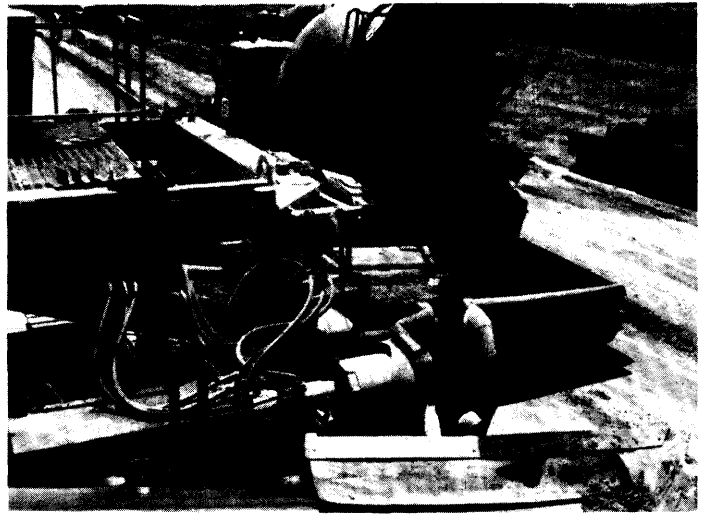

CRITICAL FACTORS

The following critical factors have been identified as essential in the placement of a quality pavement when using truck mixed concrete:

- Water Management.
- Communications.
- Consistent Delivery.
- Material Handling.
- Truck Discharge.
- Truck Driver.
- Observation of Operations.
- Training (Qualified Personnel).
- Proper Certifications.
- Yield of Mix.

Truck Mixed Plant Operations - Group Exercise No. 1

Instructions:

Develop a checklist to be used at the "CAP" meeting for the topic assigned to your group. Remember that the "CAP" meeting is held before the project begins.

The course instructor will assign topics.

Your "CAP" meeting topic is _____.

Central Mixed Concrete

Central Mixed Concrete

Central Mixed Concrete

- I. OBJECTIVES
- II. PRECONDITIONS
- III. CENTRAL MIXED CONCRETE
 - A. Central Mixed Concrete
 - 1. What is Central Mixed concrete
 - B. Communications And Preparations - CAP
 - C. Plant Site Selection
 - 1. General
 - 2. Contractor's input
 - 3. Project location
 - 4. Plant area
 - 5. Traffic flow
 - 6. Material delivery and storage
 - 7. Agency requirements
 - 8. Equipment washout
 - 9. Utilities
 - D. Plant Site Preparation and Layout
 - 1. General
 - 2. Clear the site
 - 3. Positive drainage
 - 4. Plant foundation
 - 5. Cleanout area
 - 6. Aggregate stockpiles
 - 7. Utility connection
 - E. Plant Mobilization/Assembly/Calibration
 - 1. Mobilization and erection
 - 2. Calibration
 - 3. Admixtures
 - 4. Systems check
 - F. Material Management

C) CENTRAL MIXED CONCRETE (CONT)

- G. Batching and Sequence
 - 1. General
 - 2. Proportioning
 - 3. Batching materials
 - 4. Moisture control
 - 5. Charging the mixer

- H. Mixing and Discharging

D) CRITICAL FACTORS

Plant Operations Central Mixed Concrete

OBJECTIVES

Upon completion of this module, the participant will:

- Understand what central mixed concrete is.
- Gain a working knowledge of concrete plant operations.
- Recognize the critical factors that affect pavement performance.

PRECONDITIONS

The following assumptions apply to this module:

- Concrete mix determined and materials selected.
- Concrete pavements designed, that is, thickness, reinforcement, etc.
- Specifications have been established.

Objectives

- Understand central mixed concrete
- Gain a working knowledge
- Recognize critical factors

CM - 3

Preconditions

- Concrete mix determined & materials selected
- Concrete pavement designed
- Specifications established

CM - 4

CENTRAL MIXED CONCRETE

What is Central Mixed Concrete?

Concrete batched and completely mixed in a stationary mixer at the plant site or at a ready mixed concrete plant site is central mixed concrete. A central mixed concrete plant completely mixes concrete before discharging it into haul vehicles. Central mixed concrete is transported in non-agitating trucks, truck mixers, and agitating trucks. Central mixed concrete is ready for testing when discharged from the mixer.

Central mixed concrete differs from truck mixed concrete, which is mixed in a truck mixer, and shrink mixed concrete, which is partially mixed before discharging into a truck mixer for completion of mixing.

Contractors utilize central mixed plants for high production projects. Concrete placed at a rate of 3000 m³ per day is high production. Central mixed operations offer the contractor direct control of concrete production.

Shrink mixing is used to enhance the performance of a central mixed plant. The material are mixed in a preparation drum or shrink drum for a short time to reduce the volume of the bulk materials. The concrete is than transferred to a second drum for final mixing.

Some people also use the terms on-site mixers, stationary mixers, wet-mix, or batch plants to refer to central mixed plants.

Central Mixed Concrete

Concrete batched and completely mixed in a stationary mixer at the plant site is central mixed concrete.

CM - 5



Central Mixed Concrete

- High production
- Contractor has direct control
- Better supply/Only customer
- Shorter hauls
- More control over material supply

CM - 7

COMMUNICATIONS AND PREPARATIONS - "CAP"

Proper planning is an important aspect of central mixed plant operations. This requires a pre-construction meeting between the contractor's crew and agency inspectors. The contractor's crew and agency inspectors will discuss the project expectations (communication) and determine what personnel and equipment are necessary to complete the project (preparations). They will also be better prepared to handle unforeseen circumstances. This action plan or field level partnering agreement, formal or informal, is called Communication And Preparations, or "CAP."

A CAP meeting held before central mixed plant operations begin covers the critical factors that influence central mixed plant operations. The owner and contractor discuss and clarify their expectations. It is important to address all critical items of central mixed concrete production at this time. Items discussed and decisions made at the CAP meeting will impact the contractor, subcontractor, agency and owner, engineer, and motoring public.

As we go through this module, keep in mind what aspects of central mixed production should be discussed at the CAP meeting. There is an opportunity to discuss this at the end of the module.

CAP

- Communications
- And
- Preparations

CM - 8



PLANT SITE SELECTION

General

It is essential that there be uninterrupted flow of concrete from the plant site to the paving operation. This helps provide the uniform supply of concrete necessary to construct a smooth, durable, high quality concrete pavement. Every time a paver has to stop moving, there is a chance for a bump in the pavement.

Contractor's Criteria

The contractor will determine the site location. This gives the contractor the greatest flexibility in phasing the project. Each contractor has different equipment and different philosophies on construction sequencing. Some projects are within convenient distance of a central mixed or ready mixed concrete plant.

Choosing a site that is difficult to stage the project from may result in higher bid prices and a low quality project.

Plant Site Selection

Maintain uninterrupted flow of concrete from the plant site to the paving operation.

SAFETY!

CM - 10

Plant Site Selection

- Contractor's Criteria
- Project Location
- Plant Area
- Traffic Flow

CM - 11

Plant Site Selection

- Material Delivery and Storage
- Agency and Local Requirements
- Equipment Washout/Wash down
- Utilities

CM - 12

Project Location

The project location has a tremendous impact on central mixed plant operations. Some of the considerations include:

- Urban or Rural
- New Construction or Re-Construction
- Traffic Control
- Local Zoning Requirements (noise, dust, etc.)

Project Location

- Urban or Rural
- New Construction or Re-construction
- Traffic Control
- Local Zoning Requirements
- Phasing
- Entry/Exit points
- Environmental

Plant Site Selection

CM - 13

Plant Area

Review the amount of area required to efficiently operate the plant. A plant site large enough to store a sufficient amount of materials to maintain continuous plant operations is required. Consider these critical items:

- Number of different materials
- Expected quantity to stockpile
- Logistics of feeding aggregate to the plant
- Expected total production and production rate
- Traffic flow
- Truck wash out area
- Waste water containment

Plant Area

- Number of different materials
- Expected quantity to stockpile
- Logistics of feeding aggregate to plant
- Expected production
- Traffic flow

Plant Site Selection

CM - 14

For reconstruction projects and those in dense urban areas, area restrictions may place size restrictions on the central mixed plant. It may be possible to use an existing ready mixed concrete plant.



Traffic Flow

Thoroughly examine the entire project site. The transportation of concrete from the plant to the paving operation is an important part of plant site selection. Also consider the delivery and storage of raw materials. Determine if truck load restrictions exist for possible material delivery routes and concrete delivery to the paving operation. Use a separate entrance for material delivery for high production projects.

Establish traffic patterns early and carefully follow them. It is important that everyone is aware of planned traffic flow to ensure the safety of the plant area.

It is important to calculate the number of vehicles that will be in the plant area. include both concrete haul trucks and material delivery trucks. A typical high production day the contractor will produce 3,000 m³ of concrete in 10 hours. We will also assume that each haul truck will average a 15 min round trip to the paver site and back. The concrete mix for a cubic meter is:

Cementitious	315 kg
Course Agg	1200 kg
Fine Agg	800 kg
Water	120 L

Total material for the day is:

Cementitious	945,000 kg
Course Agg	3,600,000 kg
Fine Agg	2,400,000 kg
Water	360,000 L

Assume that the project trucks have the following capacities:

Bulk Cement	18,000 kg
Aggregate	18,000 kg
Haul Vehicle	7 m ³

Traffic Flow

- Delivery of raw materials
- Delivery of concrete to paving operation
- Plant safety
- Inspection personnel safety

Plant Site Selection

CM - 16

Based on these numbers, there will be 53 bulk cement tankers, 330 aggregate trucks and 429 round trips of the haul trucks.

When developing traffic flow patterns it is important to separate material delivery and concrete haul traffic. This will improve safety and efficiency.

THINK SAFETY!

Total Traffic	
Bulk Cement Tankers	53
Aggregate Delivery Trucks	330
Concrete Haul Vehicle	<u>429</u>
Total Vehicle Movements =	812

Over 1 vehicle per minute!!!

CM - 20 Plant Site Selection



Material Delivery and Storage

Allow sufficient area to properly maintain the aggregate stockpiles and provide sufficient area for incoming raw material deliveries. Consider cement or fly ash tanker trucks that may remain on site to maintain material supplies.

Adequate space is needed for bulk delivery of admixtures. Maintain access to the onsite bulk storage containers.

Agency and Local Requirements

Address environmental and zoning issues before finalizing site selection. Obtain required hauling and water permits and address pollution control issues. It is very important to check the local regulations because of variations in specific requirements.

Equipment Washout

Locate equipment washout and washdown areas to minimize deviations from the established traffic flow. Check adherence to local environmental requirements. Washout disposal requirements may differ for each location.

Washout is the removal of excess concrete from the inside of the haul truck. Washdown is the removal of splatter or excess concrete from delivery chutes and vehicle surfaces.

Material Delivery & Storage

- Aggregate
- Cementitious material
- Admixtures

CM - 22

Plant Site Selection

Agency Requirements

- Zoning
- Environmental
- Access permits

CM - 23

Plant Site Selection

Equipment Washout

- Minimize deviations to traffic flow
- Check local environmental requirements

CM - 24

Plant Site Selection

Utilities

It is important to determine the source of water at the location as well as power and communication availability. Carefully evaluate the required water consumption for the project. Examine the capacity of the water source to determine if the water supply is capable of matching needs for concrete production as well as washout and other uses.

Determine the amount of onsite water storage necessary if hourly availability is limited. Different connection requirements may be needed if the water source is from a city municipality, well, or natural body of water such as a pond or stream.

Consider power requirements for the central mixed plant. Hookup to the local power supply can be difficult due to the high power demand. Portable generators are often used to produce the necessary power.

Telephone connections are not critical since wireless communications are normally available.

Utilities

- Water
- Power
- Communication
- Permits

CM - 25 Plant Site Selection

PLANT SITE PREPARATION AND LAYOUT

General

Plant site preparation and layout takes the information accumulated during the plant site selection stage and puts it into action. Proper layout permits all construction and material delivery equipment traffic to flow freely in and out of the central mixed plant site.

Refer to project traffic flow calculations before laying out the plant site. Remember that traffic flow is critical to consistent delivery of materials both into the plant and to the paver.

**Plant Site
Preparation and Layout**

"If I do not have time to do it right the first time, how will I have time to do it right the second time."

CM - 26

**Plant Site Preparation
and Layout**

- Clear the Site
- Positive Drainage
- Plant Foundation

CM - 27

**Plant Site Preparation
and Layout**

- Truck Cleanout Area
- Stockpiles
- Utility Connections

CM - 28

Clear the Site

Before moving any equipment or material onto the site, complete any required grading or topsoil removal. If the site will be restored to its original condition, stockpile salvaged topsoil near the plant.

In addition to topsoil removal, remove all unstable material that may interfere with concrete production. This includes the plant foundation and proposed haul roads.

Clear the Site

- Topsoil removal
- Topsoil Stockpile
- Grading

CM - 29

Plant Site Preparation and Layout

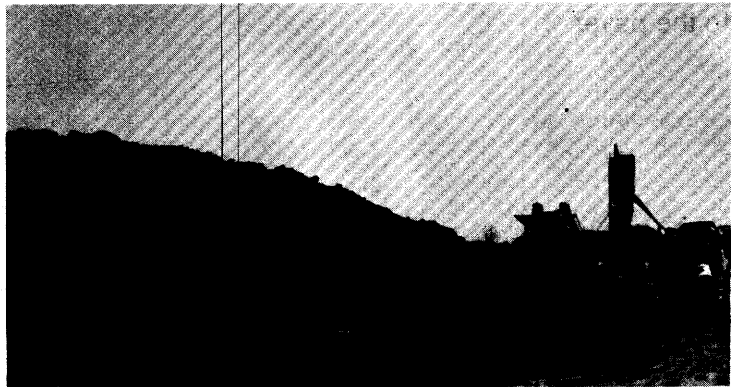

Positive Drainage

Drainage is important during all phases of plant layout. Maintain positive drainage at all times. Central mixed sites need to be capable of producing concrete shortly after a heavy rainfall. Because of this potential, maintain access to the plant. Grade haul roads and delivery access roads to promote positive drainage. Follow required drainage regulations. A retention basin is required for storm water runoff in some areas.

To promote uniform moisture in the aggregate stock piles, mound the base of the stockpile so that free moisture will run away from the base. Material placed in a low area will become saturated and effect the consistency of the concrete.

While maintaining positive drainage, soil erosion must be controlled. The plant site is exposed and is prone to excess erosion. Check local requirements for erosion control before beginning the plant layout.

Plant Foundation

Preparation of the plant foundation varies depending on the existing conditions. Provide uniform support and minimize plant settlement. Excess settlement affects connections and weigh scales. Design the foundation and support to allow for adequate traffic flow.

Have the engineer periodically check the foundation for settlement. Conventional survey techniques are sufficient for settlement evaluations.

Positive Drainage

- IMPORTANT DURING ALL PHASES!
- Grade and stabilize haul roads
- Aggregate stockpiles
- Erosion control

Plant Site Preparation and Layout

CM - 31

Plant Foundation

- Plant settlement
- Traffic flow

Plant Site Preparation and Layout

CM - 32

Cleanout Area

Dedicate adequate room for equipment cleanout. Make the area large enough to handle a sufficient number of concrete trucks so that the delivery of the concrete to the paver is not impeded. Collect and dispose of or recycle wash water and waste concrete in accordance with local requirements.

Stockpiles

Locate the stockpiles in a relatively flat area. This is important for unloading and stockpiling the aggregates. Place a pad or aggregate separation layer in the stockpile area. This will minimize contamination of the aggregate from the soil below and material loss.

The size and location of the aggregate stockpiles are important. Allow enough area for an adequate amount of material. Position the stockpiles to continuously feed the plant with enough aggregate to maintain production rates.

Utility Connections

Connect necessary utilities discussed in the previous section. Do not let the utility connections interfere with traffic flow, material delivery, or concrete production.

THINK SAFETY!

Keep overhead wires out of areas where tall equipment or dump trucks may be used.

Also consider plant security, including flood lights, during plant layout. Provide adequate lighting for night time material delivery.

Cleanout Area

- Sufficient area
- Maintain traffic flow

CM - 33 Plant Site Preparation and Layout

Stockpiles

- Minimize contamination
- Adequate size
- Accessibility
- Efficient location
- Drain water away from stockpiles
- Level operating area for equipment

CM - 34 Plant Site Preparation and Layout

Utility Connections

- Refer to Plant Site Selection information
- Will not interfere with traffic flow
- Plant security
- Night delivery

CM - 35 Plant Site Preparation and Layout

PLANT MOBILIZATION/ASSEMBLY AND CALIBRATION

Mobilization and Assembly

Following plant site preparation, mobilize and erect the central mixed concrete plant. Coordinate to ensure site safety. Provide ample room on the site to properly assemble the concrete plant. Good communication among assembly personnel is especially critical during this phase.

Exhibit extreme care during crane operations involving hoisting and spotting equipment. No the proper hand signals for crane operators during assembly. Wear all required safety clothing including hard hats and safety belts.

Inspection

Before calibrating any component of the central mixed plant, especially the scales, it is important to determine if the component is in proper working order. Calibrating something that does not work is not effective.

Plant Mobilization, Assembly and Calibration

Safety!

CM - 36

Mobilization and Assembly

- Utilize sufficient space
- Prepared foundation
- Coordination is critical
- Maintain safety
- Proper hand signals

CM - 37 Mobilization/Assembly/Calibration

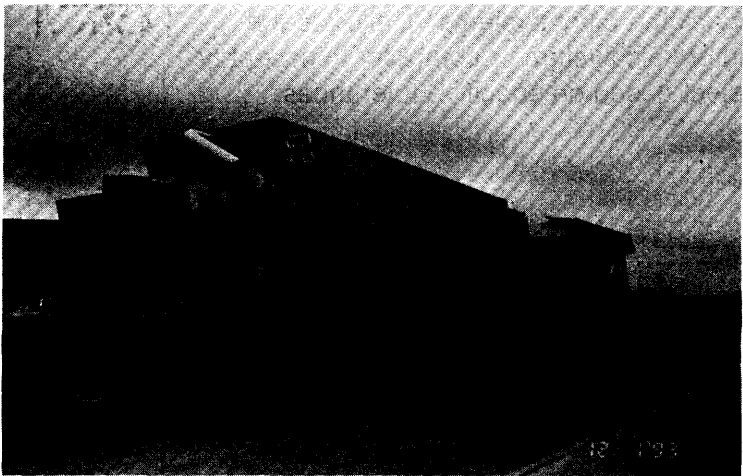

Calibration

Calibrate the plant scales, water meters and admixture delivery systems. Most agencies require calibration of central mixed plants as part of the project. The calibration includes:

- Scales (dial, mechanical or load cells)
- Water meters
- Admixture dispensers
- Delivery tolerances
- Computers
- Automatic Controls

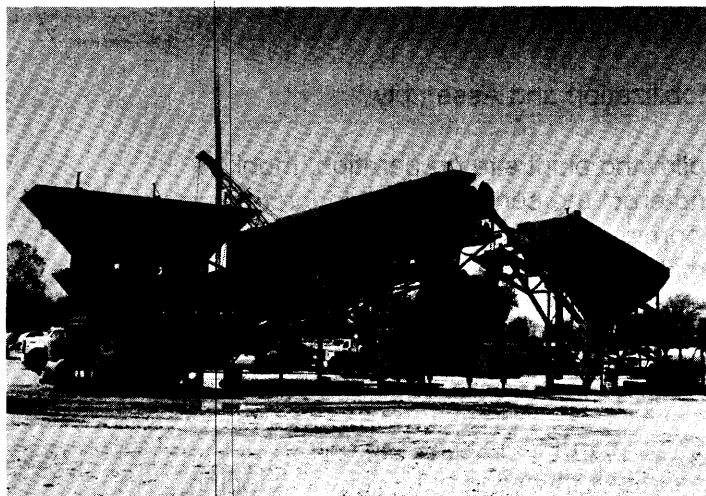

Admixtures

Each admixture is added to the batch of concrete by a separate mechanical metering device. Calibrate the unit by discharging a batch quantity of admixture into a container and measuring.

Systems Check

It is extremely important that the devices used for controlling the flow of materials into the weigh hoppers be able to start and stop at the proper time and in the proper sequence. Accurately controlling batch weights is important in the production of uniform concrete.

Produce several batches of concrete to check the plant systems. Calibrate the automatic system or computer to accept or reject based on specified tolerances.

Calibration

- Scales
- Water
- Admixture delivery
- Computers
- Automatic controls

CM - 40

Mobilization/Assembly/Calibration

Systems Check

- Proper sequence of material gates and flow

CM - 41

Mobilization/Assembly/Calibration

MATERIAL MANAGEMENT

General

Material management is covered in detail in Truck Mixed Concrete. Some specific difference are covered in this section.

In the production of central mixed concrete, the contractor has complete control over all aspects of production. This includes all of the material required to manufacture the concrete. For this reason, it is imperative for the contractor to be certain that the material arriving on site meets the project specifications.

As in truck mixed concrete, do not let poor material management be the limiting factor on concrete production. Keep the project superintendent informed of all potential material shortages.

Material Management

CM - 42

Material Management

Manage material for quality while maintaining production.

CM - 43 Material Management

Material Management

It is important to emphasize that there are many critical paths on a paving project. The point to be made here is to not let poor material management be one of them.

CM - 44

BATCHING AND SEQUENCING

General

A batch of concrete is the amount of material mixed at one time. Sequencing is the order that materials are batched. A typical batch of concrete includes the following:

- Water
- Admixtures
- Course Aggregate
- Fine Aggregate
- Cementitious materials
- Specialty materials

Batching and Sequencing

- Water
- Admixtures
- Coarse Aggregate
- Fine Aggregate
- Cementitious materials
- Specialty Items

CM - 46

Batching Materials

Concrete materials are batched in two groups. One group is the aggregate group, and the other is the cementitious materials group. These materials are either weighed individually or cumulatively.

When materials are weighed individually, each type of aggregate or cementitious material has a separate weigh hopper.

When materials are weighed cumulatively, each group of material is weighed in the same weigh hopper. For the aggregate, first the sand is weighed, then the coarse aggregate. For the cementitious materials, the cement is weighed first, and then fly ash or slag cement, as the case may be.

Batching Materials

- Individual
- Cumulative

CM - 47

Batching and Sequencing

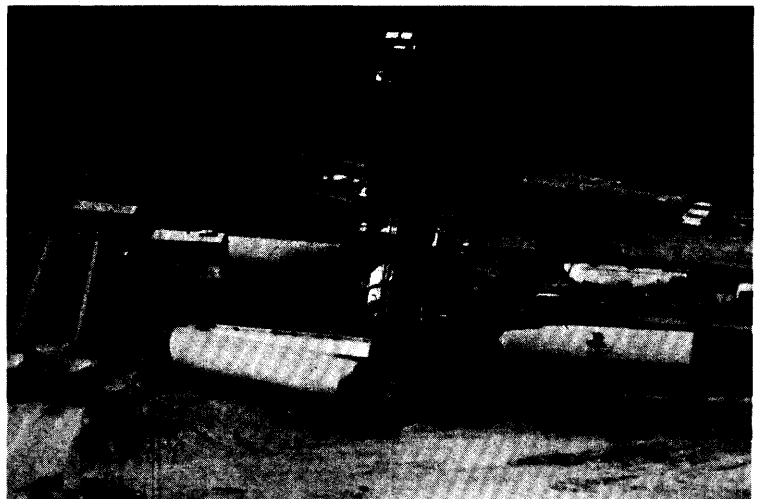
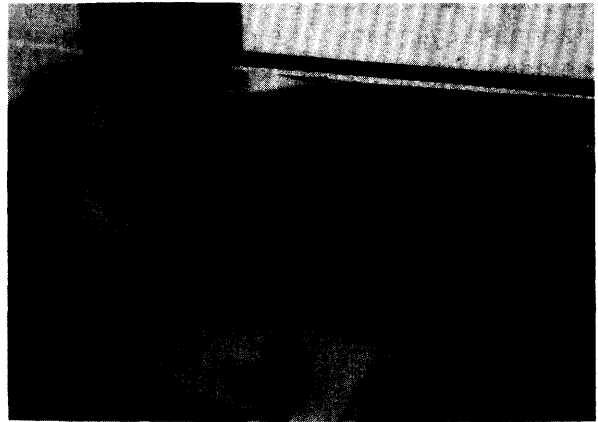

Moisture Control

The moisture condition of the coarse and fine aggregate is critical to the production of consistent concrete. Run moisture contents on all aggregates. The use of moisture probes for monitoring the moisture of the sand is a good idea. Keep moisture probes clean and in good working condition.

Normally, the moisture content of the sand affects the concrete more than the coarse aggregate. The coarse aggregate typically has low absorption values.

Admixtures

Admixtures are batched volumetrically using graduated cylinders. The components of the admixture batching must be maintained. Perform frequent inspection of this system.

Moisture Control

- Critical for uniform concrete
- Moisture probes for sand

CM - 50

Batching and Sequencing



Charging the Mixer

The first step in the sequence of concrete production is charging the mixer. Charging the mixer consists of transferring all of the weighed or measured materials from weigh hoppers and silos into the central mixer. Aggregates are ribbon loaded on conveyor belts. Initial blending takes place on the feed belt. This initial blending enhances mixer performance.

Charging Mixer

- Add all materials
- Sequence is important
- Sequence will vary

CM - 52

Batching and Sequencing

Specific charging sequences vary. Handle fibers and other additives on a case-by-case basis.

Materials are blended in approximate proportions as they enter the mixer. One batch of concrete is being mixed while another is being batched. These operations occur simultaneously.

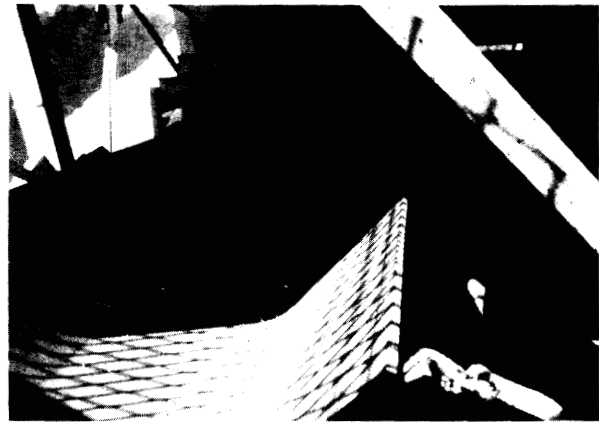
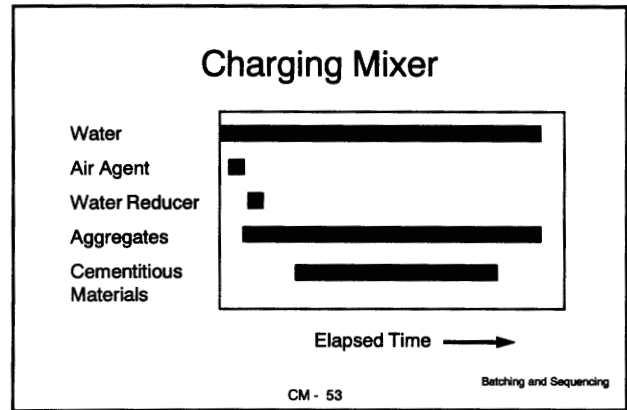

MIX AND DISCHARGE

Mix

Mix the batched concrete to obtain a uniform mixture. Mixing time is a function of drum capacity and size of batch. The concrete mix design can also affect the mixing time. The mixing time begins after all material has been added to the mixer.

Mixing times typically range from 30 to 90 seconds. Check project specifications for local requirements. The drum on a central mix plant is set to a fixed speed.

Record the amount of tempering water used for each batch. Tempering water is water that is added during the mixing after the initial water has finished. Use the total amount of water for determining the mix water/cement ratio.

The mixing action of a central mix drum is different than a truck mixer. The mixing paddles in a central mix drum are set up to discharge the concrete. This is typically accomplished by tilting the drum.

Consistency

The amp meter in a central mixed plant provides an indication of concrete mix consistency. The amp meter is sometimes called the slump meter. Care must be taken when using this meter to control the mix consistency. There is some delay in the reading of this gage. Always let the mix remain in the drum after reaching the desired consistency. It may change after mixing continues and therefore the initial reading is no longer valid.

Mixing

- Uniform concrete
- Check local specifications
- Drum size and capacity
- Completely charge mixer before mixing

CM - 57

Mix and Discharge

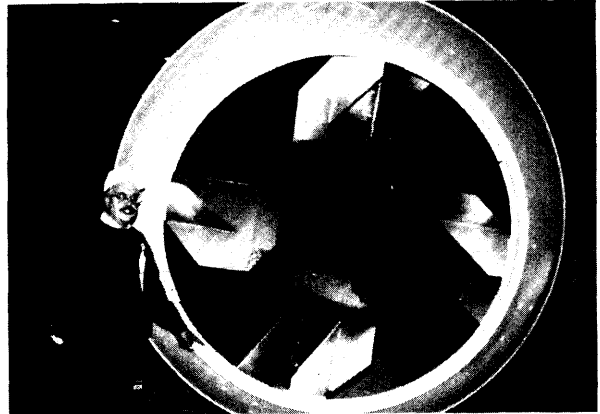

Consistency

- Slump or Amp meter
- Use experience
- Let mix stabilize

CM - 59

Mix and Discharge

Discharge

Discharging the mixed concrete is different for different types of transport equipment. Take discharge time into account when planning for number of trucks to haul the concrete.

It takes longer to discharge into a truck mixer than it does to discharge into an end dump truck or agitator truck with an open top. The type of truck will also affect the unloading times at the paving operation.

Discharge

- Type of haul vehicle
 - Unrestricted opening
 - Agitating
 - End dump
 - Restricted opening
 - Truck mixed truck

CM - 60

Mix and Discharge

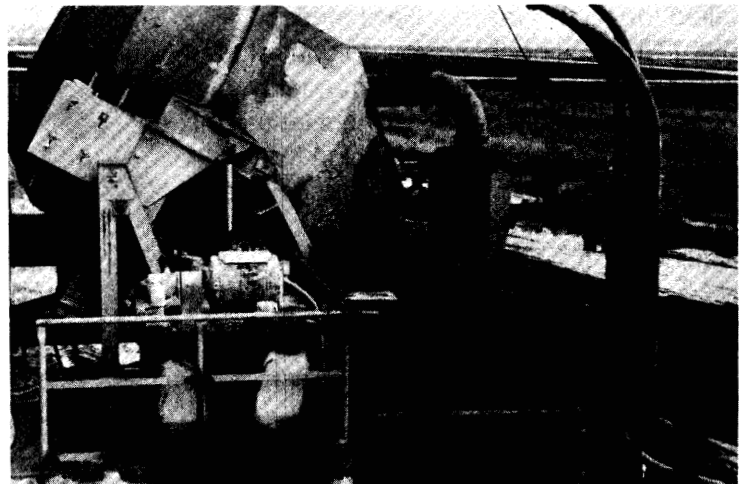
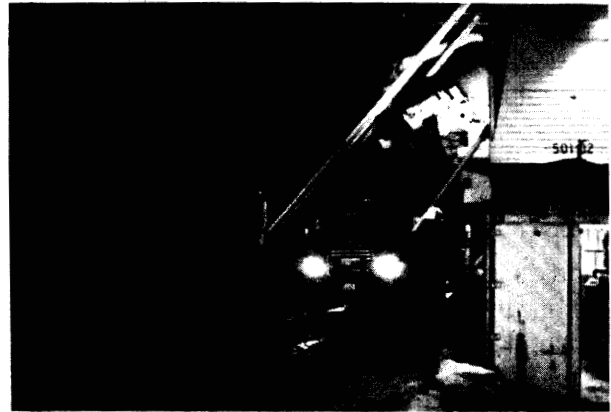

CRITICAL FACTORS

Critical Factors Affecting Central Mixed Plant Operations

- Communications and Preparations ("CAP")
- Plant Site Location
- Uninterrupted flow of material to the paver
- Raw Material Quality and Delivery
- Mixture Consistency
- Material Management
- Quality field personnel

Central Mixed Plant Operations - Group Exercise No. 1

Instructions:

Develop a checklist to be used at the "CAP" meeting for the topic assigned to your group. Remember that the "CAP" meeting is held before the project begins.

The course instructor will assign topics.

Your "CAP" meeting topic is _____.

VI. Paving Operations

Slipform Paving Operations

Fixed Form Paving Operations

Paving Operations

Paving Operations is contained in 2 separate modules:

- Slipform Paving Operations
- Fixed Form Paving Operations.

VI. Slipform Paving Operations

- A. Objectives
- B. Preconditions
- C. Slipform Paving Applications
- D. Slipform Paving Operations
 - 1. Communication and Preparation (CAP)
 - 2. Line and Grade
 - a) Subgrade
 - b) Establishing Grade for Paving
 - (1) Setting Reference Hubs
 - c) Establishing the Stringline
 - 3. Placing Base to Specification and Tolerance
 - a) Pad Line, Track Line and Form Line
 - 4. Equipment Set Up
 - a) Placer/Spreader
 - b) Paver
 - (1) Vibration
 - (a) Purpose:
 - (b) Static Head:
 - (c) Location:
 - (d) Operations:
 - (2) Adjustment of the Sensor System
 - 5. Pavement Steel
 - a) Dowel Bars
 - b) Tie Bars
 - c) Reinforcing Mesh
 - d) Continuous Reinforcing
 - e) Points for Discussion:
- E. The Slipform Paving Process
 - 1. Metering
 - 2. Tamper Bar
 - 3. Beginning Paving Operations
 - a) Delivery
 - 4. Paver Operation
 - a) Paving Speed
 - b) Concrete Head
 - 5. Additional Field Operations
 - a) Headers
 - b) Finishing
 - c) Texturing
 - d) Curing
 - e) Saw & Seal

- F. Summary of Critical Factors
 - 1. Sound Grade To Specification
 - 2. Monitored Supply Of Concrete
 - 3. Consistent Workability
 - 4. Controlled Density
 - 5. Sensor Common Sense
 - 6. Clean & Well Maintained Machine
 - 7. Proper Machine Attitude
 - 8. Weight & Traction
 - 9. Method of Surface Treatment
 - 10. People
- G. Troubleshooting Tips
- H. Situational Exercise

Slipform Paving Operations

Drivers are the ultimate inspectors for the paving industry. They are acutely aware of smoothness or roughness of the road and damage to their vehicles caused by deteriorated roads. These drivers are even more acutely aware and critical when newly constructed highways are rough.

The paving industry has been given a mandate to build better, smoother roads. The application of the principles in this slipform module will contribute to the achievement of higher quality and smoother portland cement concrete pavements.

Objectives

Upon completion of this module the participant will:

- Understand the need to monitor a slipform paving operation.
- Understand the importance of mix consistency to the slipform paving operation.
- Gain a working knowledge of the slipform paving process.
- Recognize the critical factors in slipform paving that affect placing a quality pavement.

Preconditions

For the purpose of this module the following assumptions have been made:

- The concrete mix design has been either determined by the contractor according to the specifications or established by the agency
- The concrete pavement has been designed.
- The specifications have been established.

Slipform Paving

Smooth

Smooth

Smooth

SF - 3

Objectives

- Understand need to monitor
- Understand importance of consistency
- Gain working knowledge
- Recognize critical factors

SF - 4

Preconditions

- Mix Design Determined
- Pavement Design Established
- Project Specifications Established

SF - 5

Slipform Paving Applications

This section of the training course covers the construction of a typical concrete pavement project using the slipform paving method of construction. The methods and techniques discussed and presented represent common practices within the industry at the time this material was compiled. There is continuous improvement in methods and techniques in the concrete pavement construction industry. The practices presented represent "good practice." Practices presented also are not meant to limit innovation of any kind.

Let's define just exactly what is meant by the word *slipform* when applied to concrete pavement construction: To consolidate, form into geometric shape, surface finish a concrete mass (vertical or horizontal) by "slipping" or pulling the forms continuously through and surrounding the plastic concrete mass. In slipform paving of a roadway the forms for shaping the mass, the tools for consolidation, and the tools for surface smoothing are firmly mounted into a self-propelled machine.

Slipform is used in almost every type of paving operation. This technique has broad application for highway and street construction. Contractors have identified the following common construction advantages:

- Uses low slump concrete
- Permits high production paving
- Capable of producing a very smooth riding surface

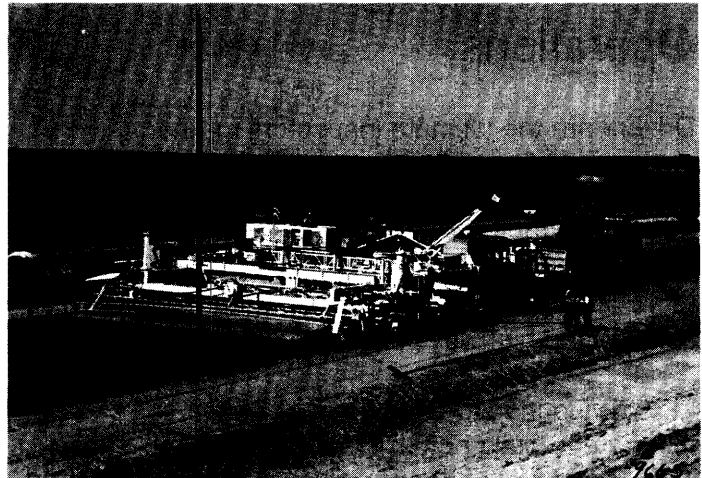

Slipform

- Consolidate
- Form into a Shape
- Finish the Surface

SF - 7



Slipform Paving Operations

Communication and Preparation (CAP)

There are numerous critical factors involved in the construction of a typical concrete pavement project. An important beginning step is the implementation of a communication network between the paving contractor, concrete producer/supplier, agency and testing personnel.

Everyone involved must have the information available in a timely manner to perform their functions, starting with the pre-job conference to final project acceptance. They need to discuss all project elements related to slipform paving with special emphasis on communication, safety, paving access, traffic control and interpretation of project specifications.

The consideration of how the project paving will proceed should start during the design process. Designers should anticipate the potential needs for haul roads, access, and economical lengths of paving.

CAP Meeting Attendees

Contractor's Team

Agency Team

Concrete Producer/Supplier Team

Testing Agency

Miscellaneous

Communication and Preparation (CAP)

- Contractor
- Concrete Producer/Supplier
- Testing Agency
- Surveyor/Staking Crew Chief

SF - 9



Critical Access Factors

- Haul Roads
- Grade Access
- Reasonable Staging
- Working Platform

SF - 11

Line and Grade

Subgrade

The construction of a quality concrete pavement begins with a good subgrade. The subgrade should be well compacted to profile and tolerances within the specified limits.

Subgrade stabilization is performed by a number of agencies. The materials used for this stabilization include pebble quick or slurried hydrated lime, fly ash, portland cement, and granular additives. Moisture and density controlled recompaction of the top lifts of subgrade are often performed prior to trimming for base and subbase installation.

A uniform grade must sustain hauling units to place the base material and provide a platform that will support the compactive effort necessary to densify the base material. As one old timer stated, "You can't crack a walnut on a sponge."

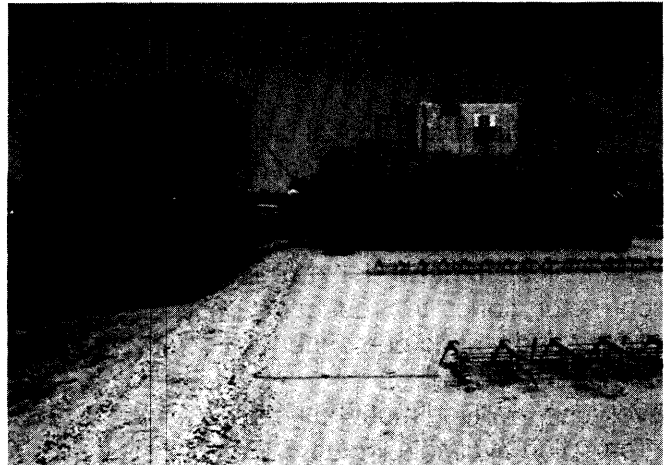

Subgrade

- Proper Compaction
- Built to Specified Tolerances
- Uniform Support
- May be Stabilized

SF - 13

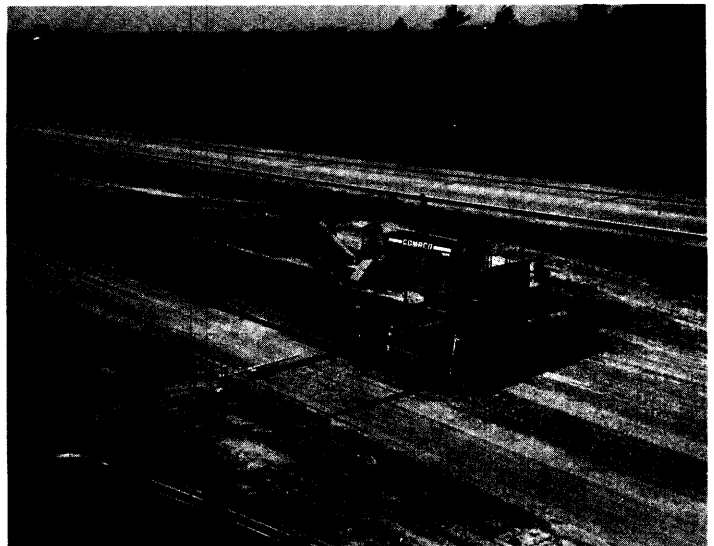

Establishing Grade for Paving

There are instances where the grade has been in place for a lengthy period prior to commencing final subgrade preparations for paving. There are also cases where the grading may not have been finished to the required tolerances. When these conditions are encountered it becomes necessary to make some parallel grade adjustments rather than move large quantities of earth to match the original plan profile. This is accomplished by lowering or raising the existing profile in as lengthy sections as possible to meet the existing grade. Adequate transitions within acceptable geometric tolerances must be provided to meet the adjusted profiles. Any profile adjustments must meet the existing structures.

In most instances of subgrade trimming, windrows of cut material are deposited on the embankment edges. Take care of drainage for the trimmed grade by cutting slots through the berms at adequate intervals to prevent ponding of water. This is especially critical on the low side of superelevated sections. Proper accommodation for drainage will pay dividends during all subsequent construction activities including paving.

The survey party and paving contractor must be in close coordination to ensure complete understanding on the part of both parties about the elevations and offset distances established for grade reference points. These elevations and offsets provide the basis for establishing the stringline. The stringline is used to provide an accurate reference for elevation and alignment control of the trimming, base laying, and paving train.

Establish Grade for Paving

- Verify Subgrade
- Set Line
- Establish Hub Offsets
- Set Hubs

SF - 15

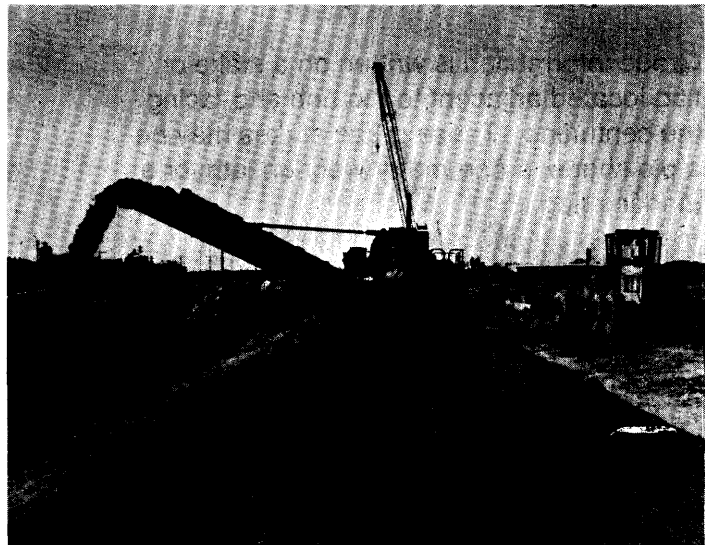

Setting Reference Hubs

Hubs are placed with the use of a total station, Electron Distance Measuring (EDM) equipment or transit and have a tack or punch hole in the top to provide a line exactly referenced to centerline and normal (at a right angle) thereto. The tops of the hubs are shot for elevation that relate to plan profiles.

The contractor will determine the offsets of the hubs for the particular equipment and operations. These offset distances may not be equal on each side of the slab. At times the location normally selected for hubs must be adjusted to accommodate specific project staging and phasing

Grade information is written on a stake or flag located adjacent to the hub and facing the centerline. These grade stakes may be a pie shape, a one meter wooden lath, or a marking flag.

The information generally includes the following:

- Centerline stationing
- Curve information
- Offset distance from edge of slab
- Cut (C) or Fill (F) to 3 millimeters

Generally this grade information is referenced to the top edge of slab. On tangent sections of alignment where both edges of slab are the same elevation, offset and projected grade information would be identical.

IF THE AGENCY USES A WIDENED PAVEMENT, SPECIAL CONSIDERATION IS WARRANTED.



Grade Stake Information

- Stationing
- Offset distance
- Cut or fill from adjacent top edge of slab (offset method)
- Cut or fill from plane projected through both edges of slab (projection method)

SF - 18



Proper communication during the setting of these hubs and the recording of the information on the grade stakes is absolutely essential. All parties must meet to reach agreement for this activity to avoid confusion between the paving crew, the trimming crew, and the survey crew..

The trimming must be performed in a manner that accommodates the slipform paving operation. The trimming crew must be aware if the paving crew intends to pave full width, half width, or any other different dimension. The trimming must be in coordination with the paving.

Projected grades are extensions of an imaginary line connecting the top of the proposed edges of the pavement slab. They are located in line with the offset reference hubs. Rotation of this imaginary line about a point on the slab centerline results in one edge being lowered, accompanied by a corresponding rise on the opposite edge. This is the fundamental concept in establishing grades and utilization of elevated stringlines for grade control of automated trimming of grade, laying bases, and placing concrete pavement.

The survey party will calculate the top of both edges of the slab from the plan profiles and cross sections. The imaginary line, previously discussed, will be connected through the edges of slab and extended to a point over the hubs. The elevation of this imaginary line at the hub location can be determined which enables the calculation of the difference in elevation between the point on line and the top of the hub.

The paving crown (Rooftop or Uniform), superelevated transitions, and superelevated sections will be accommodated by the paving equipment. The various shapes are created by adjustments in the paving equipment.

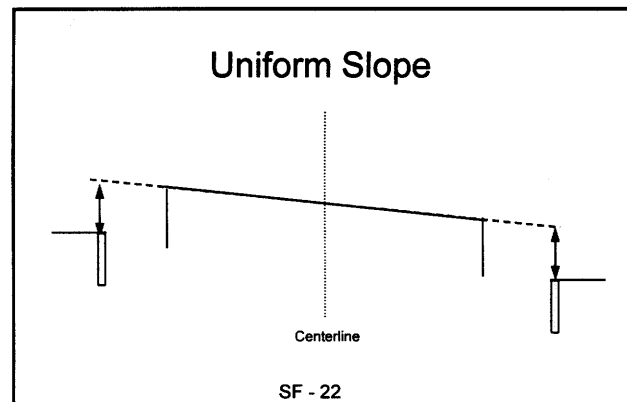
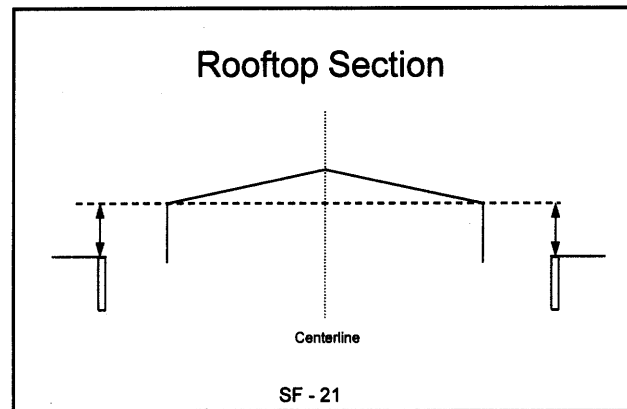
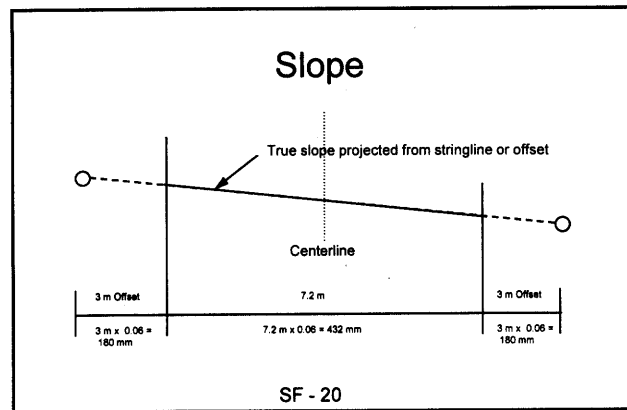

projected + offset method

Circular Curves

In circular curves, spiral curves, and transition sections, the rotation (in a single roadway) is normally around the centerline.

Let's examine how to treat a circular curve to the right with the full rate of superelevation at 6 percent. At a superelevation of 6 per cent there will be a difference in elevation from high to low edges of 432 mm (7.2 m x .06).

The transition from normal crown to full superelevation will be accomplished at a uniform rate through a series of incremental steps. The rotation in this example is about the centerline of the slab.

Step 1

The left side pad line grade has been graded to rise 72 mm in the first phase of the transition distance. Thus, in the first phase of the transition, the left side crown of 72 mm is removed creating a level plane left of centerline. Also, at this time one half of the machine crown of 72 mm has been removed. This places the left edge at an elevation equal to centerline grade. During this phase of the transition there is no change in the right side.

Step 2

In the next phase of the transition the left side pad line raises another 72 mm and the remaining crown is removed from the machine, thereby creating a uniform cross slope. The left edge pad line would now be 144 mm above the right edge. During this phase of the transition the right side pad line would not be altered.

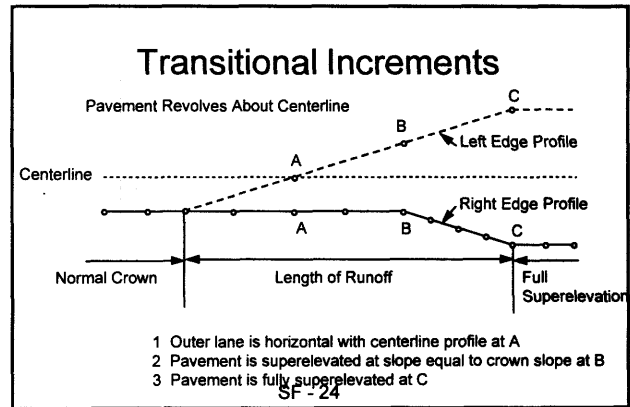
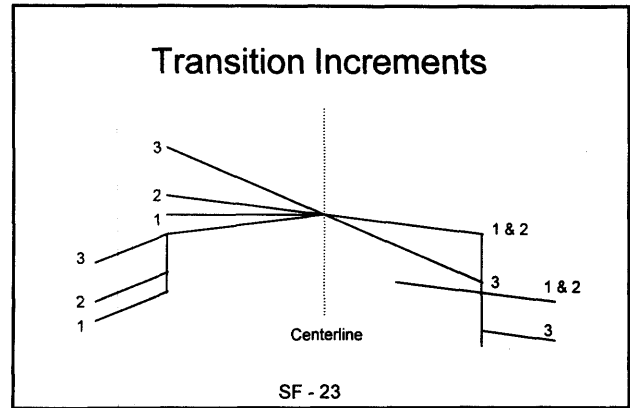

Step 3

During the final phase of the operation the left pad line rises 144 mm, and the right pad line lowers an equal amount. The final superlevation is now achieved. The total cross slope of the pavement slab is at 6 percent, with a total elevation difference between edges of 432 mm.

All of these changes are accomplished at an uniform rate. The rate of transition is established in accordance with the agency requirements for superlevation.

Rotation about the edge of slab can also be used and often is used on dual roadways. Some dual roadways do not use a crown section, which simplifies the transition process.

At this point, communication about proper interpretation of the information shown on the grade stakes is absolutely critical. Miscommunication about how the grades were established could result in the improper superlevation being constructed. The diagram illustrates the result of an incorrect assumption or interpretation. The resulting superlevation would be flatter than required. This could require replacement of the freshly placed concrete.

Calculate the cross slope established if the stringline was set assuming the offset method, when the correct assumption was the projection method. Use the following dimensions:

- 7.2 m = Pavement width
- 1.0 m = Offset Distance
- 6% superlevation required

Calculate actual superlevation of ____%. This is less than the 6% required. According to the AASHTO Publication on Geometric Design the safe operating speed is reduced from 65 mph to ____ mph.

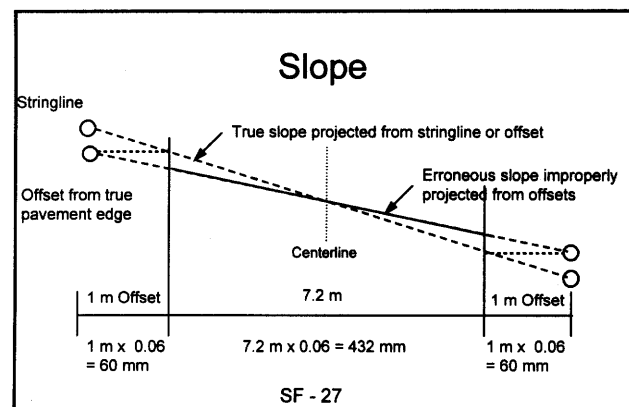
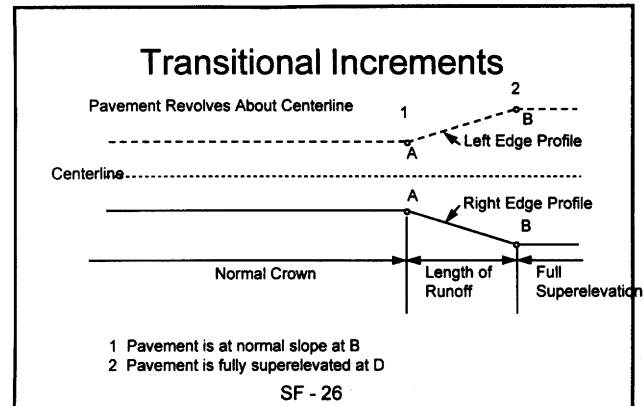
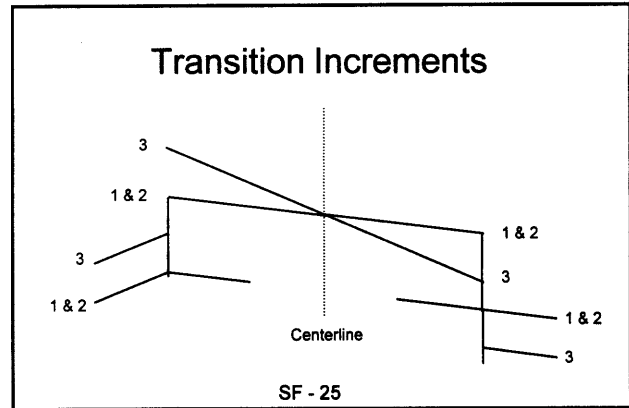

Establishing the Stringline

The stringline sensor line may be wire, cable, woven nylon, polyethylene rope, or another similar material. The stringline stake should be long enough to be rigid when driven into the subgrade. There must be an adequate stake length exposed above grade to allow adjustment of the stringline to the desired height above the subgrade profile.

The stringline stake is placed in a vertical position outside the hub line. When the line is inserted into the holder arm slot it can be adjusted to a point directly over the hub tack point.

The stringline supports are recommended to be located at approximately 8 meter intervals unless horizontal or vertical curves are encountered. In those cases the stringline supports should be placed at closer intervals. Occasionally, in very uniform conditions stringline supports with a 16 meter interval are used.

Many contractors prefer to run a stringline on each side of the paver. They feel that a smoother ride can be obtained with this dual stringline system. The decision to run two stringlines is made based on the contractors proven experience.

The staking system normally includes hand winches placed at appropriate intervals (not more than 300 m) to tighten the line to the extent necessary to avoid any perceptible sagging between stakes. Use caution when tensioning the stringline. A sudden break in the stringline could cause severe injuries. Some agencies increase the visibility of stringlines by placing ribbons on them.

Set Stringline

- Rigid stakes
- Quality line
- No perceptible sagging
- Eyeball for staking errors
- Resurvey staking errors
- Adjust stake spacing to fit conditions

SF - 28



To ensure even tension in the string, pull it out of the rod holders before applying force to tighten the line. Use a small triangular file to remove all nicks or projections in the string slots to prevent tearing of the string.

The machine elevation sensing wand rides beneath the string, and the alignment sensing wand rides against the inside of the string. Neither of these wands should deflect the line a measurable amount.

The completed line installation should be checked by eye following installation. Mistakes in setting the line and any survey staking errors will likely be detected by this check. Communicate with surveyors and ask them to resurvey the area in question before making changes.

Correcting surveying mistakes by eyeballing is a poor substitute for accurate surveying. Meticulous setting of the stringline cannot be overemphasized. This is the time to resolve all questions, prior to any pavement being placed.

Prior to beginning paving Check, Check, and Check the stringline Again and Again!!

Air temperature and relative humidity variations during the day affect the length of line. Check line tension and periodically tighten the winches.

Equipment bumping the line and personnel stumbling into or tripping over the line will require immediate checking and corrective action. Caution must be exercised by all personnel working in the vicinity of the stringline.

In many instances the haul road is located parallel to the stringline. This requires periodic eyeballing of the stringline to determine if any heaving of the grade has occurred that could disturb the hubs and/or line stakes.



Maintain Stringline

- Check
- Recheck
- Check Again

SF - 32

Slipform Paving Operations

Stringlines that have been broken should be replaced rather than tying knots in the line. A break generally is an indication that weather and use have taken their toll.

The stringline stake arms and adjusting bolt sets should be checked at the time of installation to make sure that thread wear or misthreading does not allow arm movement.

To cross the stringline with hauling units or other equipment, remove the string for about 30 meters and place it securely on the ground. Check for any damage before retensioning and using for paving operations.

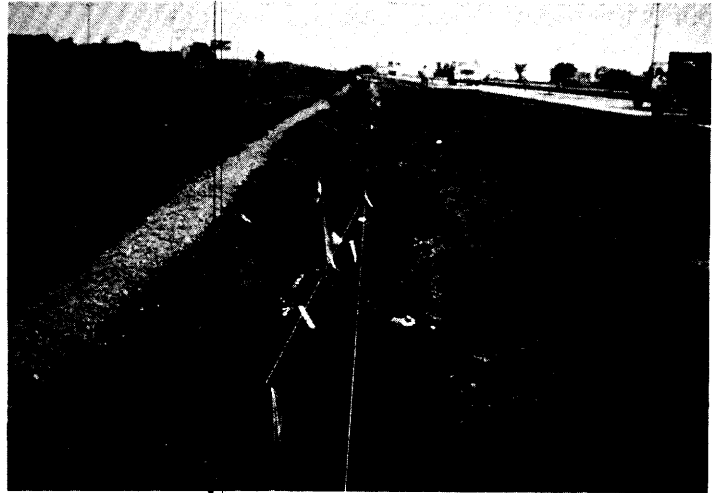

Placing Base to Specification and Tolerance

In the vernacular of pavement design, the word *base* represents the lift of a selected material placed immediately beneath the pavement surfacing. Any selected course of material placed beneath the base is referred to as a *subbase*. The earth grade at the bottom of the pavement structure, whether modified by special treatment or not, is referred to as the *subgrade*.

All of these bases, regardless of placement methods, can be built to acceptable tolerances and provide the working platform necessary to:

- Enhance the quality of performance of the finished product.
- Minimize loss of concrete.
- Eliminate short core penalties.
- Contribute to value added payments such as smoothness.

Most agencies specify trimming of the subgrade with electronically controlled trimmers to a specified tolerance prior to any subbase or base construction. The subbase (if specified) and base are then placed to uniform specified depths.

Place Base to Specified Tolerances

- Enhance pavement performance
- Minimize loss of concrete
- Minimize/eliminate core penalties
- Enhance smoothness

SF - 36

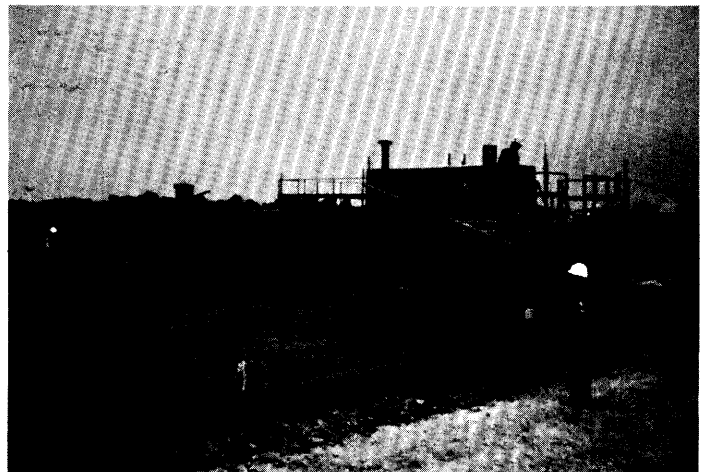
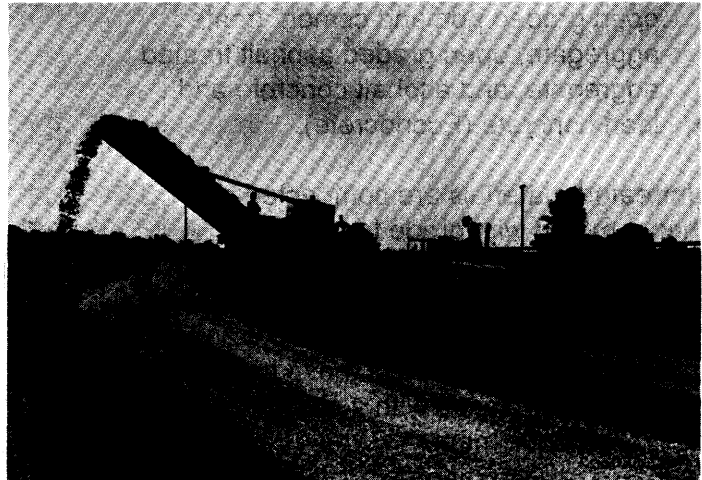

Slipform Paving Operations

Many types of bases are presently being utilized by designers, and the equipment requirements for each can vary considerably.

Some of these base designs include the following:

- Untreated materials such as crushed concrete, dense graded crushed aggregate, cement or fly ash treated dense aggregate, soil cement, and drainable bases.
- Treated or stabilized materials such as open graded portland cement treated aggregate, open graded asphalt treated aggregate, and asphalt concrete and lean concrete (Econcrete).

Untreated materials are compacted and then trimmed with grade trimmers.

Treated materials are normally placed with pavers or modified base equipment and not trimmed. Certain types of these treated bases can be placed with a stringline controlled equipment.

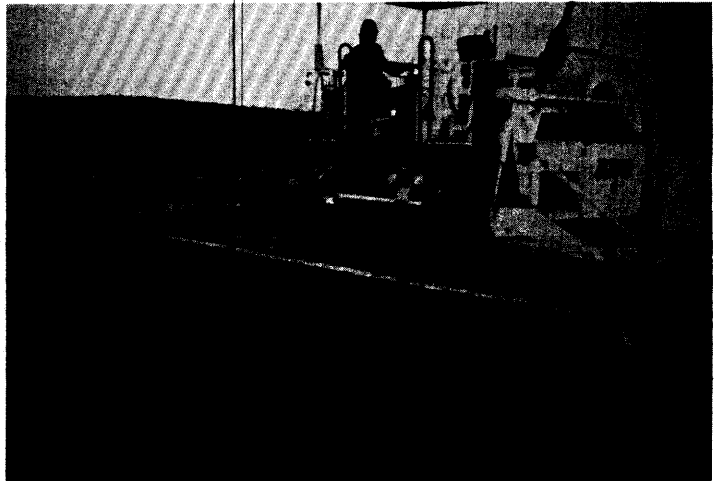
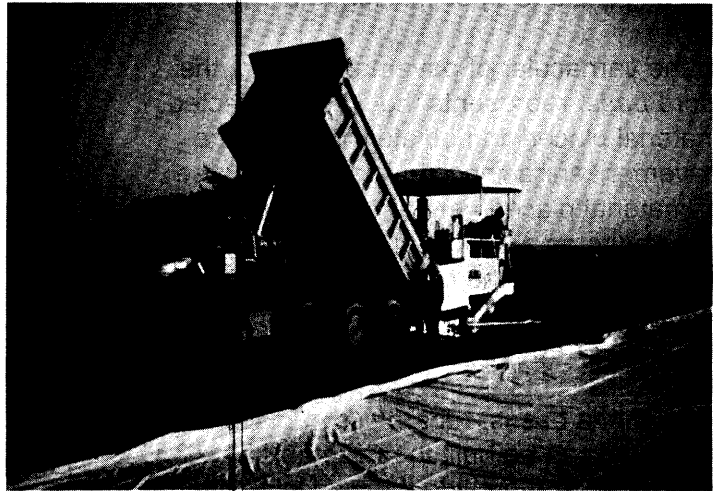

Pad Line, Track Line, and Form Line

Pad line, track line or form line are terms often used to describe the area outside the edge of the proposed pavement which provides the foundation for all the paving equipment operations.

Most contractors believe that this line is one of the major keys to smooth pavement and should encompass the following characteristics.

- The base itself should be extended to a point at least one meter beyond the outside edge of pavement.
- The base should be constructed or trimmed parallel to the projected cross slope of the base. The creation of parallel planes is essential in minimizing the yield loss. In addition, parallel planes ensure both the agency and the contractor that the proper thickness of pavement will be placed over the entire roadbed.
- The base should be durable enough to provide a relatively smooth passage for the entire paving train, including the texturing and curing equipment. The placement of edge drains or underdrains beneath the track lines (longitudinally) prior to paving should be avoided. The weight of the paving equipment can crush the drainage pipes. Most agencies allow the contractor to place these drains after placement of the pavement.
- The pad line should be kept clean of dirt, debris, and surplus concrete during the pavement operations.

Track Line

- Extend base one meter beyond outside edge of pavement
- Construct parallel to base cross slope
- Durable for paving train
- Keep it clean

SF - 41



Slipform Paving Operations

In some cases, the placement of the concrete pavement is directly on an earth grade. Similarly, on some projects the base is not extended through the track line area. When this situation is encountered, the grading personnel need to be alert to soft spots, excess moisture areas, drainage problems, and so on. Early identification of these problem areas means they can be corrected by undercutting and/or stabilizing, thus providing the needed degree of uniformity.

The construction of a quality concrete pavement can be achieved under these circumstances by paying extra attention to paving operation details. Special effort in the area of a strict metering of the concrete to the paver, constant and uniform forward movement, and constant stringline surveillance.

The paving train components can be modified to accommodate access restrictions. During paving operations on relatively narrow local roads the spreader, trimmer and paver are all working in very close proximity to each other. In these situations there is minimal room for a track line and no room for a haul road past the paving operations. Contractors have developed an operation called the "Iowa Special" which trims, spreads and paves in one continuous operation.



Equipment Set Up

Prior to beginning paving there are some critical elements in the process that need extra attention and understanding. These include but are not limited to vibration and paver set up.

Placer/Spreader

The present day placer/spreader generally involves any combinations of the following: an unloading belt, augers, plow system, or strike off. Machines may be sensor controlled for steering, grade, or both. Placer units that do not utilize a strike off are also common. These place a metered supply of concrete in front of the paver by means of a conveying system.

Sensor set up and maintenance, prevention of hydraulic oil leaks, proper strike off control of concrete depth, complete grade coverage, and controlled placement over basket assemblies are the primary concerns.

Paver

Various components of the paver need to be checked prior to commencing paving operations.

- The paving kit needs to be square. This is not a problem with two track pavers, but it can be with four track machines. The paving frame must be set parallel to the line control. If not, the machine will be skewed in forward motion even though the tracks appear to be in line. A straightforward approach to adjust the paving kit to square is use of the "3-4-5" right triangle technique.
- Following paver set up, stringline the pan or forming plate. Both edges and center line should be checked for trueness. The proposed crown should

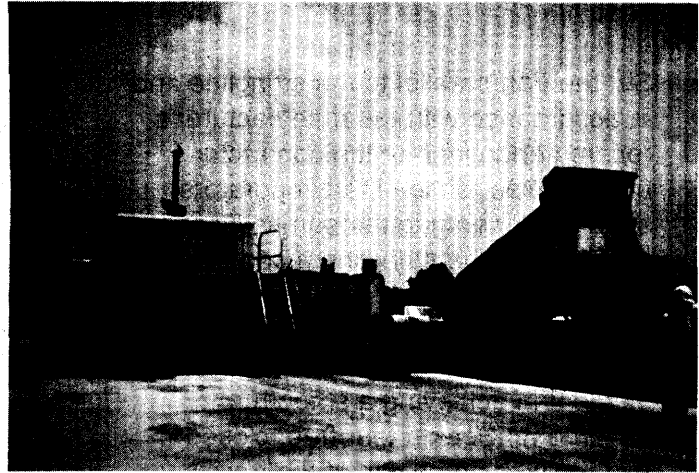

be adjusted in the pan and any following float.

- Set the pan parallel to the stringline and in accordance with the manufacturer's recommendations or the contractor's proven experience. Many operators state that operating the pan as close to parallel with the stringline as possible will provide the best results. This is called adjusting the machine attitude, draft, or angle of attack. This is a critical element in achieving a smooth pavement. Seek a tear free, closed surface with no boil up at the trailing edge of the pan or forming plate.



Equipment Set Up

- Paver
- Vibrators

SF - 49

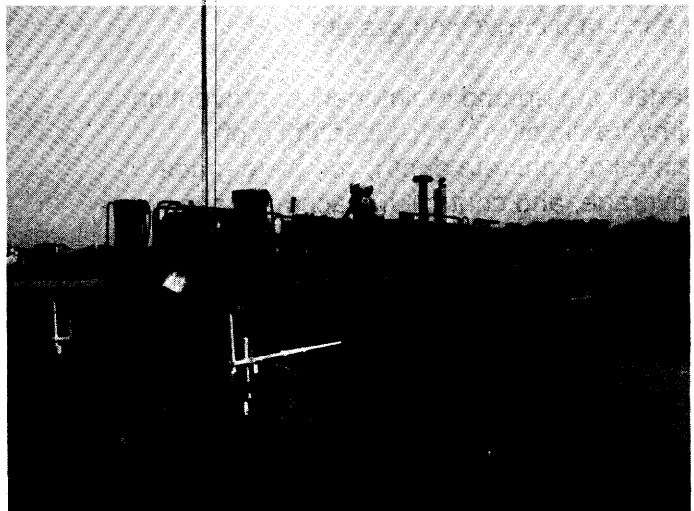

Paver Set Up

- Square up paving kit
- Stringline pan
- Adjust crown
- Adjust machine attitude (draft)

SF - 50

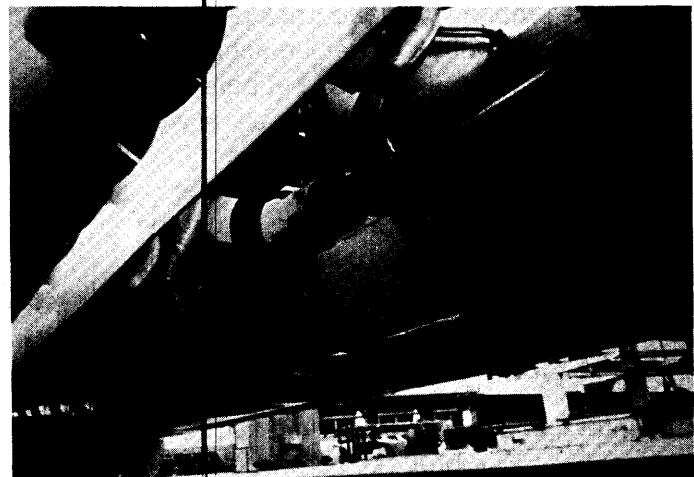

Vibration

This discussion will focus on internal vibration.

Internal vibration is the vibrator-applied energy (centrifugal force) within and internal to the mass of concrete (vertically or horizontally).

Purpose:

The purpose of vibration in the paving process is twofold:

- To consolidate the concrete mass, i.e., remove undesirable voids.
- To fluidize the mass to aid the "flow-through" of the concrete in the slipform process.

Purpose of Vibration

- Consolidate Concrete Mass
- Fluidize the Concrete Mass



Internal Vibration of Concrete

SF - 54

Slipform Paving Operations

The vibrators are mounted on the machines with what is known as an "isolation mounting." Vibrators will work and have equal characteristics in the vertical or horizontal position. They are mounted ahead of the extrusion meter.

The energy transmitted by the vibrator (centrifugal force) is directly proportional to (1) the size of the weight, and (2) the speed of rotation (RPM): The size of the weight is fixed. The back and forth distance that the head of the vibrator moves (amplitude) is also fixed.

The only variable that can be controlled is the speed. This is done by varying or controlling the volume of hydraulic fluid to the hydraulic motor. This controls the speed of rotation, and is measured in vibrations-per-minute (VPM). The amount of the energy and the energy influence change as VPM varies. On electric vibrators VPM are controlled by varying the speed of the generator or alternator.

The energy transmitted by the vibrator is transmitted in a circle. The transmitted energy is equal to 360° surrounding the rotating weight. This is the "zone of influence." The zone of influence will vary:

- with the speed paver
- with the distance of the weight from the driving motor and shaft
- with the care and cleanliness of the isolator mount

Therefore, the "zone of Influence" is cone-shaped.

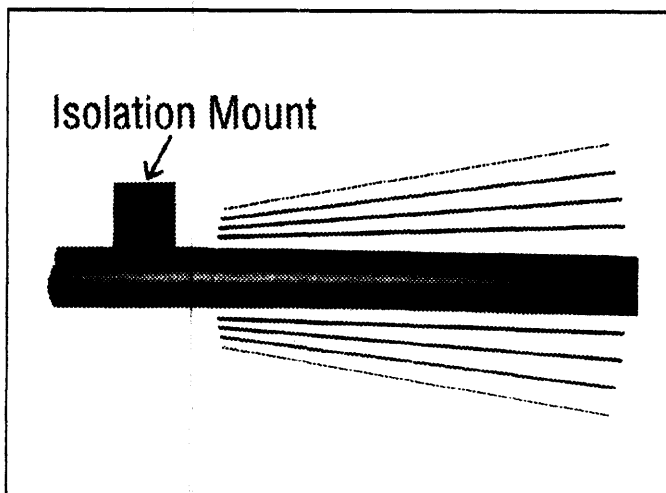

Zone of
Vibration Influence

SF - 59

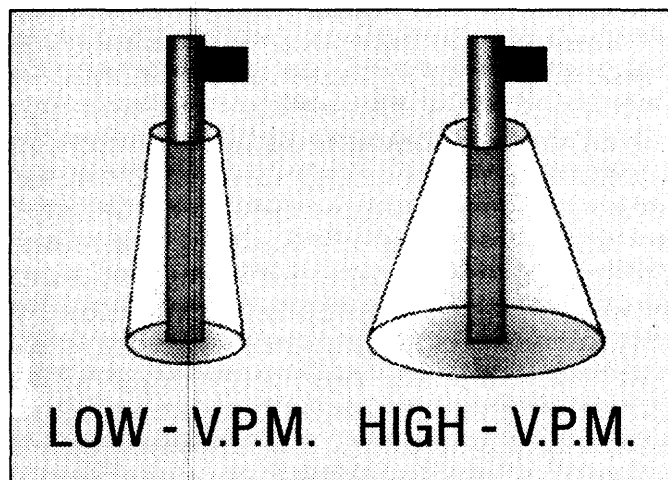

Static Head:

There is another important characteristic of the internal vibrator. An increase of height of the static head developed during the paving process causes an increase in vibrator efficiency.

The energy level (vibration) required to consolidate and fluidize the concrete mass during paving operations varies. This energy required is different for each mix design and depth (mass) of concrete. Generally speaking, the energy requirement varies from 7,000 to 9,000 VPM. Vibrations per minute can be checked using a vibrator tachometer (Vibro-Tach). The check on VPM should be done when the vibrator is under a load.

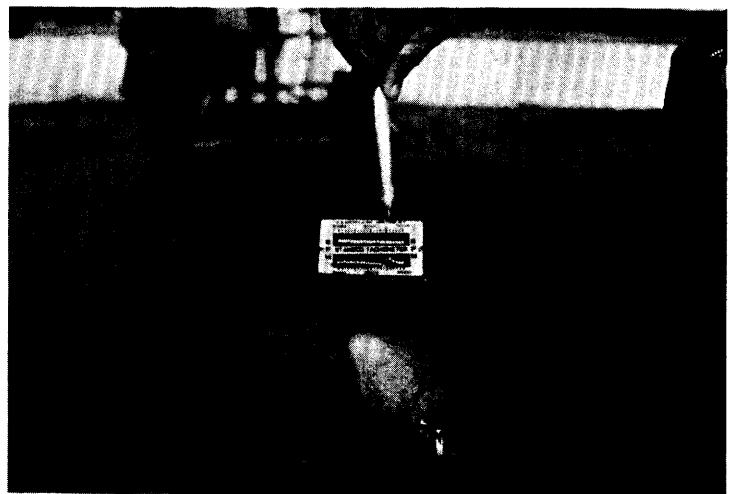
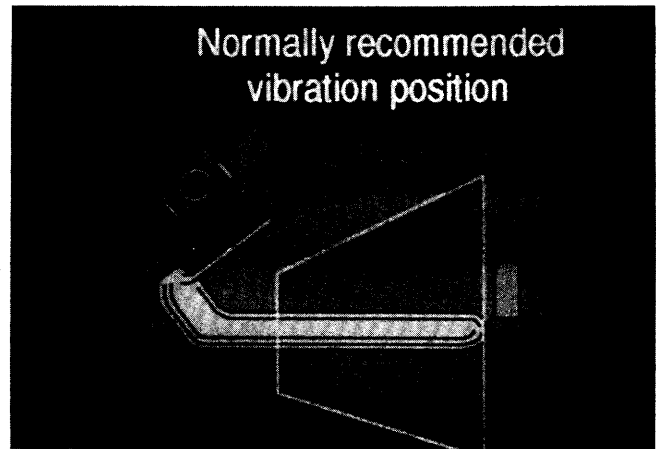

Static Head Affects Vibration

Deeper column greater static head:
greater vibratory effect

SF - 61

Vibration Tip

"Proper static head will help close the coarse aggregate particles behind the vibrator"

SF - 64

Slipform Paving Operations

The effect to achieve is the resonant frequency of the particles within the mixture. Resonant frequency is the energy required to cause the particles to become excited and move closer together, thereby removing the voids. This resonant frequency is different for each particle size (a function of mass and surface area) and varies as the distribution of particles also changes, a function of mix design and gradation.

Location:

The position of the vibrators should be adjusted according to the manufacturer's recommendations or the paving contractor's proven experience with the specific mix. Depending on the appearance of the concrete reaction behind the paver, the energy level is adjusted to a uniform level of VPM to begin paving and readjusted to appropriate levels.

Vibrators in a paver are mounted to take advantage of the zone of influence. Each vibrator is adjustable for position and energy level. Position is a mechanical adjustment performed prior to the paving operation.

The horizontal spacing is set to have a slight overlap of the zone of influence. This overlap normally ranges between 50-75 mm. This is done to permit comingling of the particles and eliminate segregation (as may be the case if the zones were apart).

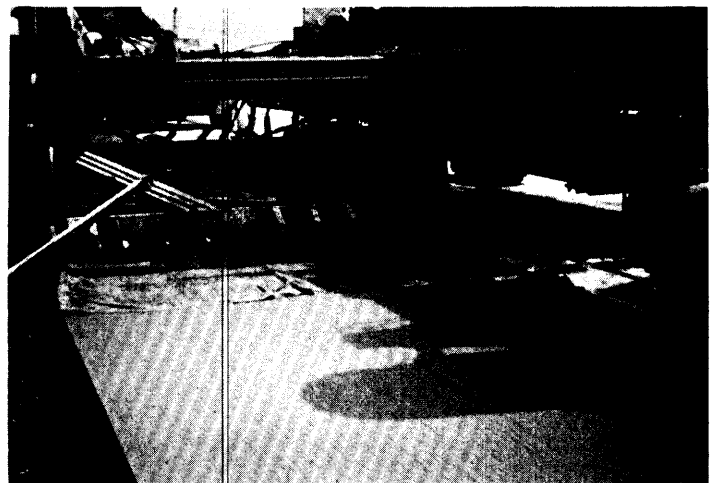
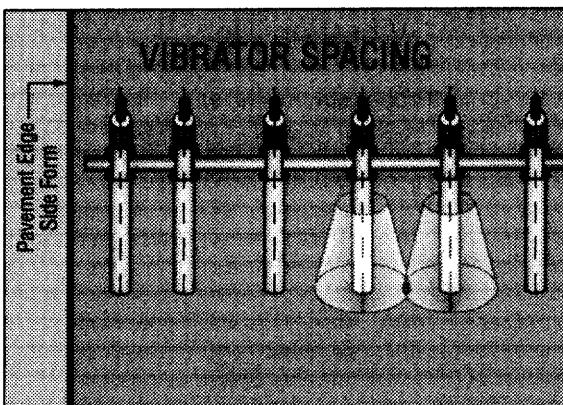

Many contractors prefer a closer spacing because the zone of influence overlap is increased. This closer spacing allows the operator to better control the slab texture.

At a constant forward speed of the paver the zones of influence change as the VPM change. Increased VPM widen the zones; decreased VPM narrow the zones. The energy level required for a particular mix design, at a given paver speed and depth of placement may require more or less vibrators operating at higher or lower energy levels.

Vibrators, while necessary for the paving process, are **NOT** a cure-all for other problems. The vibrator may identify and exacerbate a concrete mix (design) problem, but not cause the problem. The vibrator will not overcome poor paver adjustment or improper paving technique. Vibrators can be misapplied and may cause undesirable results.

Proper vibration will produce a well consolidated concrete mass and leave a uniform appearing surface behind the paver. Vibrator trails should not be visible. Too much vibration can segregate the concrete and drive out entrained air. Too little vibration results in a high volume of entrapped air reducing the strength.

The technology and technique of concrete consolidation by vibration is an approximation, an art.

Supplemental hand vibration is often used along edges and around fixtures.

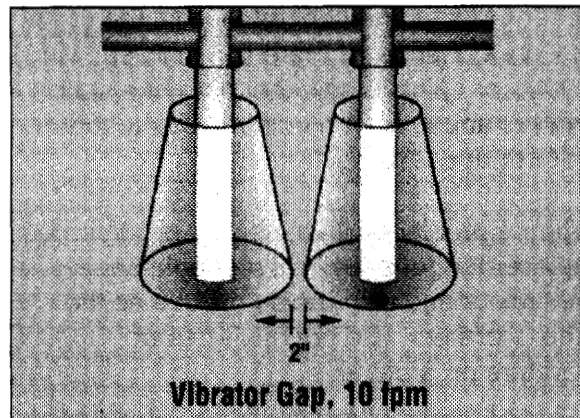
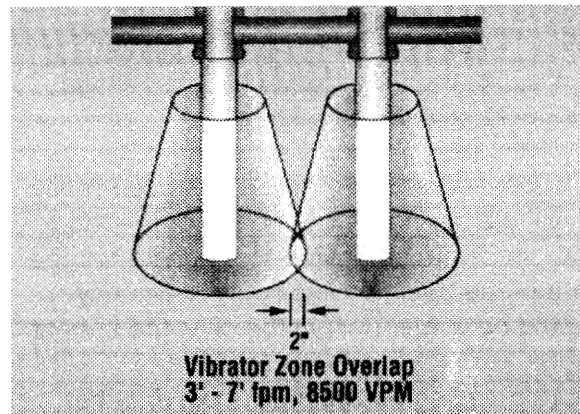

Operations:

Most vibrators used in slipform paving are hydraulic and they should be checked for any evidence of oil leakage.

A supply of replacements should be readily available during paving operations. Check the performance of vibrators again near the end of the day's paving. Any deficiency would be evident when the oil is the hottest.

During paving operations, observing the vibrator gangs is necessary at frequent intervals. Any failure of an individual vibrator is readily apparent. The appearance of the concrete within the grout box area changes if there is a problem with a vibrator. Notice how the top of the static head changes from a uniform look to a non uniform appearance.

When a problem with a vibrator is confirmed replacement of the vibrator should be immediate and with the same size as the other vibrators. Do not mix sizes of vibrators on a paver.

Observance of the concrete behind the paver is a necessary and integral part of good vibration technique. The vibrator trails can be easily observed upon completion of the tining operation. An adjustment in paver speed and or VPM should be immediately made in an effort to eliminate visual signs of the vibrator trails.

The vibrator controls need to be clearly marked to provide an indication to the operator if they are at the proper setting. Be aware of and understand proper operation of vibrator controls.

When embedded steel like continuous is a part of the pavement being placed adjustments may have to be made in vibrator positioning to ensure proper consolidation around the steel.



Grout Box

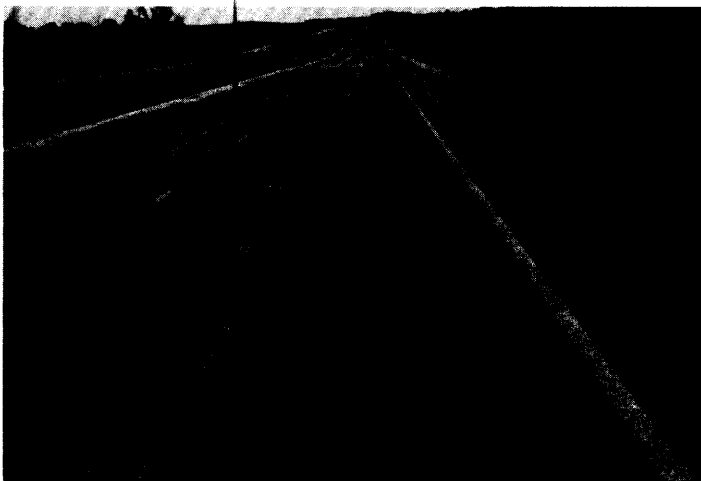

Let's examine the results if the vibration is not in harmony with the mix design. Recent investigations by the State of Iowa revealed that a non-uniform distribution of coarse aggregate can occur which could lead to durability problems. A number of parameters were tested including VPM, paver speed and location of vibrators.

Operation of the vibrators at a rate of 12000 VPM resulted in a non uniform distribution of coarse aggregate particles. Although particle distribution between the vibrators seemed to be uniform, an obvious problem exists at the vibration location. There is little evidence of entrapped air at this higher VPM.

Additional work confirmed the findings of non-uniformity when the vibrators were operated at 12000 VPM. Cores taken revealed a generally homogeneous distribution of particles at a vibration rate of 8000 VPM.

Significant improvement in mix uniformity is noted at a slow paver speed and with the vibrators located at the finished surface of the pavement. There is a small amount of entrapped air.

Examination of the cores taken during normal paver speed operations and vibrators located at the surface indicated a good uniform distribution of aggregate particles. There is some entrapped air evident, but the area closest to the surface has a good uniform distribution of aggregate particles. This is essential for durability.

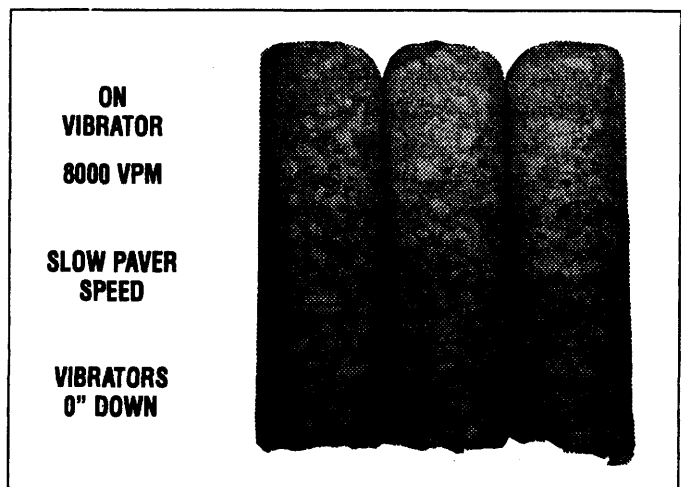
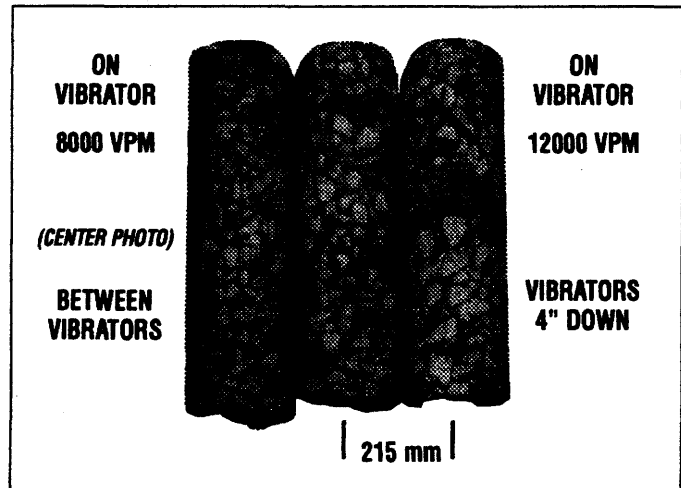
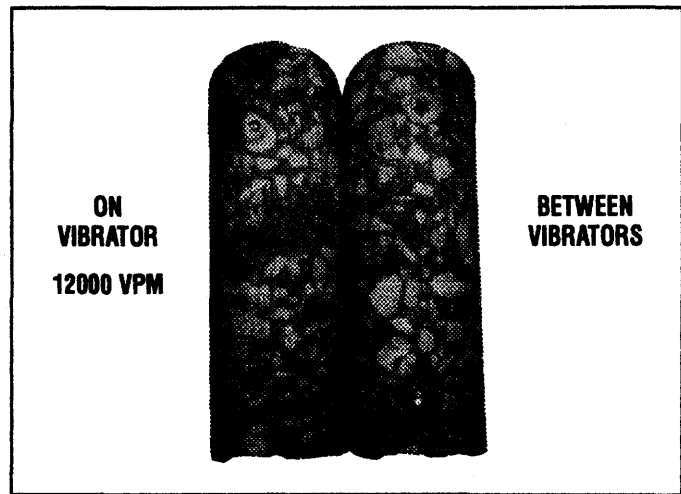

The importance of tuning the vibration to the concrete mix cannot be overstated. Particular attention paid to this phase of the operation should pay off in a sound durable pavement.

Adjustment of the Sensor System

The sensor system should be checked out thoroughly following paver set up. Many types of sensing systems exist, including electric, hydraulic, laser, or sonic. These sensors should be installed and operated according to the manufacturer's recommendations or the contractors proven experience.

The sensor wands should be set as near horizontal as possible and at the same distance from the unit to the stringline. The pressure of the wand against the stringline can be adjusted as needed during paving.

The sensor wands should all be set the same distance, approximately 200 to 250 mm from the unit to the stringline.

Adjustment of the counterbalances will determine the pressure against the lines during operation and will probably require some experimentation. A dampening set screw on each unit can be adjusted to lessen continual seeking movement and rapid changes.

When setting the sensors on the same side of the paver take into account the location of the stringline stakes. Set the sensors a different spacing than the stringline stakes. When the sensor is set at a different distance the wands will not be at the sag point between the stringline stakes at the same time. This minimizes the chance of building a uniformly occurring sag in the pavement.



Paver Sensor System

- Check Thoroughly
- Set Wands Same Distance
- Set Counter Balance
- Set Wands Level

SF - 79

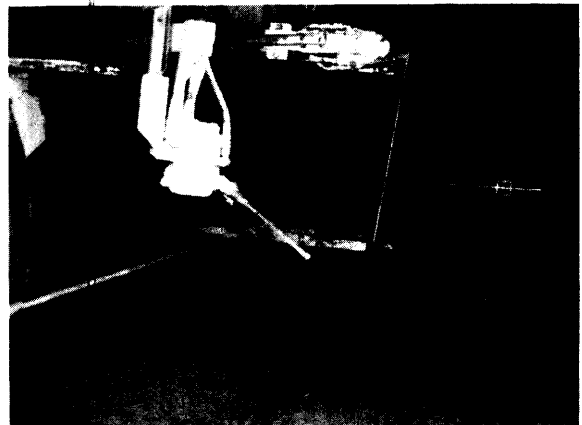

Pavement Steel

Dowel Bars

Dowels are installed at contraction joints to provide load transfer from slab to slab without faulting of the joint. They are generally installed in a heavy wire assembly staked to the subgrade or base. The staking must be adequate to prevent movement at the time of concrete coverage. Staking is placed on the forward edge of both basket assemblies to prevent displacement. Cutting the tie wires of the assembly prior to paving is a recommended practice.

The dowels must be lubricated to allow movement as the slabs expand or contract. Lubricating one half of alternate bars has been commonplace for years, but now total immersion in an agent or spraying of the bars is often used. The key is to provide a thin film of lubricant to assist the movement of the concrete at the dowel. A thick film of grease can react with the concrete and allow voids, which can lead to socketing at the dowel and contribute to premature faulting of the joint.

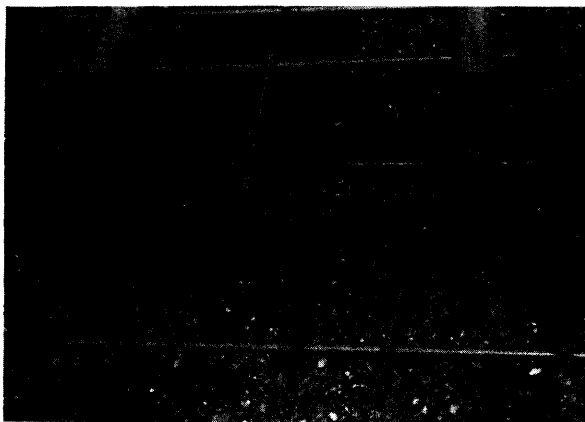

Pavement Steel

- Dowel bars
- Tie bars
- Reinforcing mesh
- Continuous reinforcement

SF - 81

Placing Dowel Bars

- Basket assemblies
- Dowel bar inserters

SF - 82

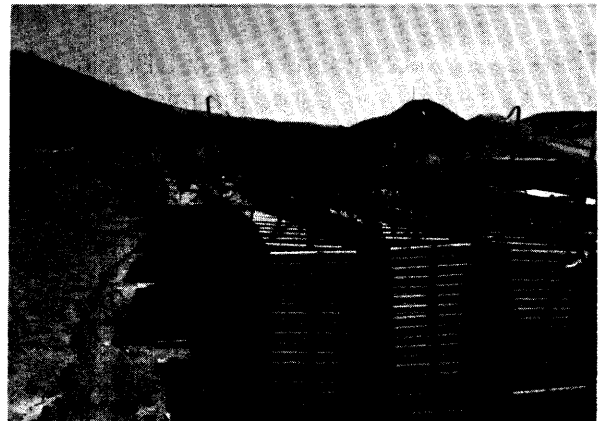

Slipform Paving Operations

When placing doweled transverse expansion joints a dowel cap is needed over the end of the dowel to permit movement into the cap as the expansion material is compressed.

Dowels must be placed parallel to the centerline of the pavement. Placing dowels parallel allows the concrete pavement to expand and contract. This movement is accommodated by the lubricated dowel. When dowels are misaligned the joint can lock and cause cracking near the contraction joint.

Dowel bar inserters (DBI) are now in common usage with several models being utilized. When using the DBI the dowel basket assembly is not needed. The dowel bars are mechanically inserted into the fresh concrete. The elimination of the basket assemblies also provides an open paving lane for hauling and dumping concrete ahead of the paver. The bars are sprayed with a bond breaker lubricant (form oil).

There are two common types of DBI's in use. One system is called the mid mount inserter in which the inserter is an integral part of the paver. Another system utilizes a separate paver for inserting the bars and is followed by another paver for final finishing operations.

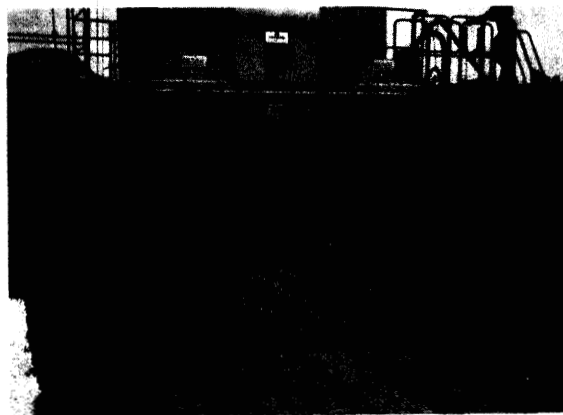
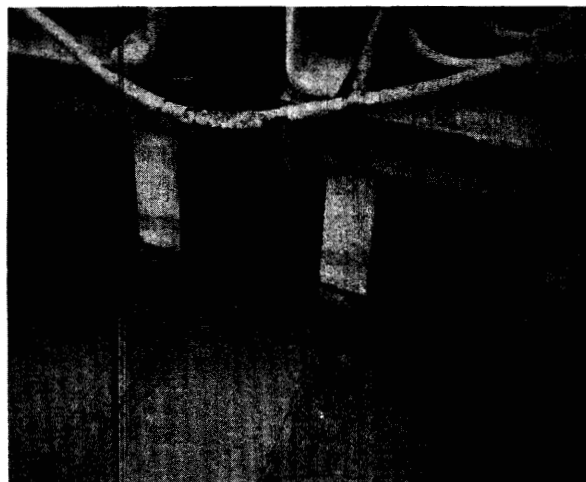

Dowel joints must be carefully marked for joint sawing. When a hinged jointed pavement is specified these must be distinguished from the regular doweled joints.

Periodic probing for proper dowel alignment is performed by contractor personnel with spot checks by the agency.

Smooth dowels or deformed bars are also used at day's work joints in jointed pavements. Installation includes use of a split board notched header. A 2 x 4 member, placed the full length of the header, is attached perpendicular to the bottom half of the header as a dowel or bar support during joint construction.



Tie Bars

Tie bars are installed in practically all longitudinal joints. In the case of centerline joints, the bars are installed at midslab depth in a "hinged joint." In slipform operations, these bars can be pre-placed on bar chairs out in front or placed in the plastic concrete with a wheel or stabbed into the slab with an automatic inserter.

The tie bars involved in longitudinal joints constructed for additional lanes are generally installed with either air, hydraulic, or manual side bar inserters. Bent tie bars are normally installed by placing them on a horizontal plate, attached to the sideform, prior to installation. There is a slit in the traveling side form to accommodate these bars. These bars require straightening prior to placing the added lane or shoulder. If the bars being installed are straight they are normally placed on a guide, attached to the side form, prior to installation. Do not attempt installation of a tie bar that would make contact with the outside dowel of the contraction joint.



Tie Bars

- Set on chairs
- Insert in fresh concrete

SF - 91

Reinforcing Mesh

The normal widths of mesh sheets for a 3.6 meter lane width is 3.3 meters. The length of sheets is, of course, based on joint spacing, specified sheet laps, and gaps at the doweled joints. Proper handling and hoisting of bundles is necessary to avoid crimping and bending of individual sheets.

Placing of mesh can be accomplished by two different methods. Two-lift construction is a common practice. The first lift is placed with a spreader to approximately two-thirds of full slab thickness. A vibrator gang should be a part of this operation. The mesh is then placed, and the second lift of concrete is added. Final consolidation, strike off, and finishing are accomplished by the paver.

In the second method, the initial lift is placed full depth, and the mesh is placed on the surface. A mesh depressor with ridges of proper depth presses the mats into the plastic mix as it moves along the slab ahead of the paver.

Either method can result in forward movement of the mesh to the extent that it encroaches on the limits of the dowel assemblies. Caution must be exercised to prevent this forward movement.

Reinforcing Mesh

- Two lift construction
- Mesh depressor

SF - 95

Continuous Reinforcing

Continuously reinforced concrete pavements (CRCP) use deformed bars that are placed longitudinally throughout the entire length of the pavement. Placement of the steel for this type of pavement can be accomplished by using a couple of different methods. The most certain method of ensuring proper location in the finished product is to place the longitudinal bars on continuous runner chairs with clips attached at planned widths. The bar chairs serve as the horizontal reinforcement.

Another accepted method is to pre-splice the proper number of longitudinal bars out ahead on the base and feed them through a battery of plan-spaced tubes mounted on the spreader unit. If horizontal steel is required, it is placed on the concrete surface and depressed with a series of wheel implanters.

Still another method is using preassembled bar mats utilizing two-lift placement methods and centerline tie bars installed by a wheel planter. These mats could be placed on bar chairs ahead of concrete placement. This method is rarely used.

No 5 or 6

Continuous Reinforcing

- Set on chairs
- Tube feeder

SF - 96

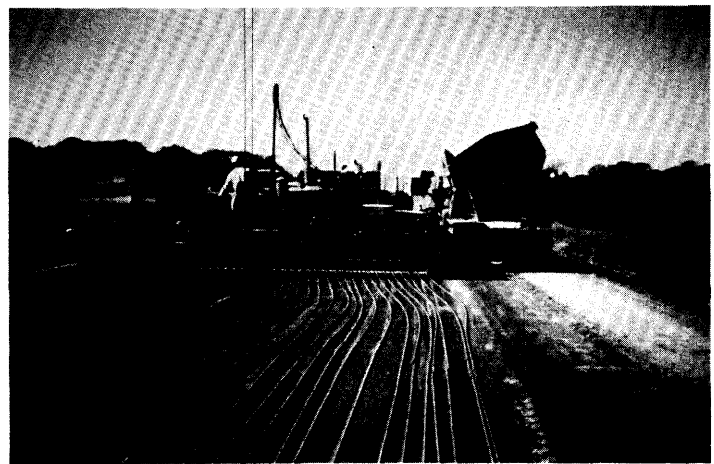
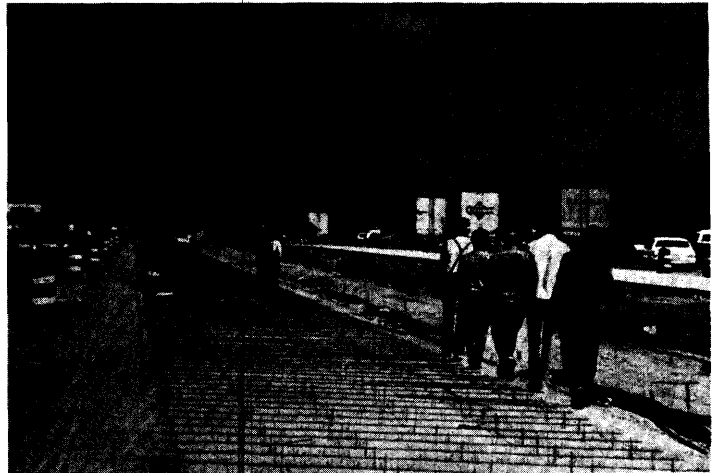

When paving using heavy reinforcement (close spacing or double-course CRCP), it may be desirable to adjust the vibrator to accommodate the steel.

Points for Discussion:

- Reinforcing steel at the time concrete is placed shall be free of mud, oil, or other organic matter that may adversely affect or reduce bond.
- Reinforcing steel with rust, mill scale, or a combination of both is normally considered satisfactory. However, the minimum dimensional weight and tensile properties of hand wire brushed test specimens must meet the applicable ASTM specification requirements.
- Epoxy bars should be handled in a fashion that maintains the integrity of the coating.
- Bar laps, including ties.
- Group staggering.
- Tube cleaning.
- Added steel at headers.

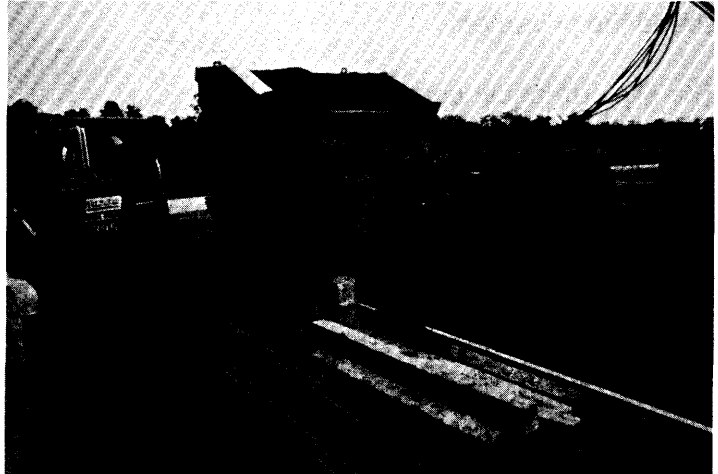
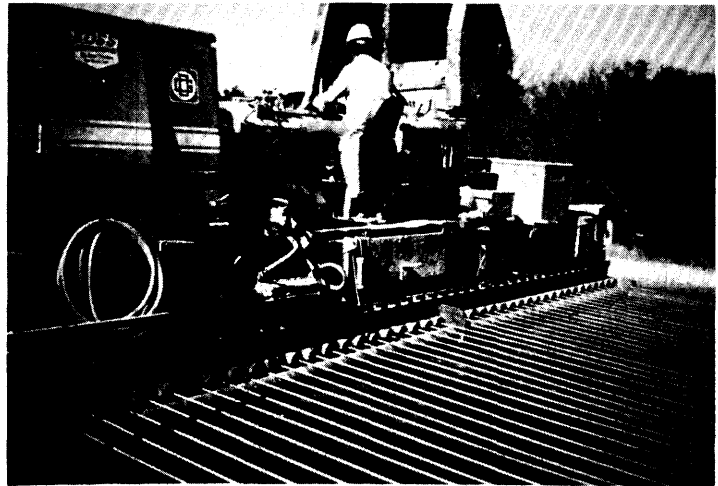

Laps are staggered

Continuous Reinforcing Discussion Points

- Steel condition
- Bar laps
- Group staggering
- Tube cleaning
- Header steel

SF - 101

The Slipform Paving Process

All slipform pavers in the world market are of the "extrusion-type process."

The extrusion process can be simply defined as forcing, pressing or pushing a material through a die or mold to create the desired shape. The simplest example of extrusion is what we do every morning upon rising. We grab our toothbrush and a tube of toothpaste and we proceed to pressure the tube, extruding toothpaste upon the toothbrush. The pressure is extruding; the end of the tube is the die, nozzle or mold; and the toothpaste is in the shape of the mold. In the slipform paver the concrete is squeezed through the mold to form and shape the pavement.

The slipform paver contains the mold components. These components consist of the bottom of the "profile pan" or "forming plate" and the side forms. This system confines the concrete (as the tube in toothpaste) and provides the die or mold for the desired shape. We propel the mold with the tractor. The base or subbase is the bottom of the mold.

The pressure to the concrete comes from the mass weight of the machine upon the forming plate and the taper adjustment, if present, of the side forms confining the concrete. The pressure also comes from the power of the vibrators as they pressurize the area under the paving form and between the side forms.

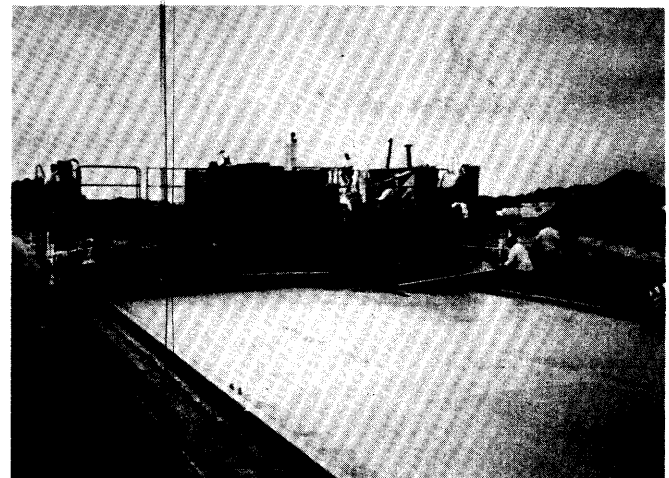
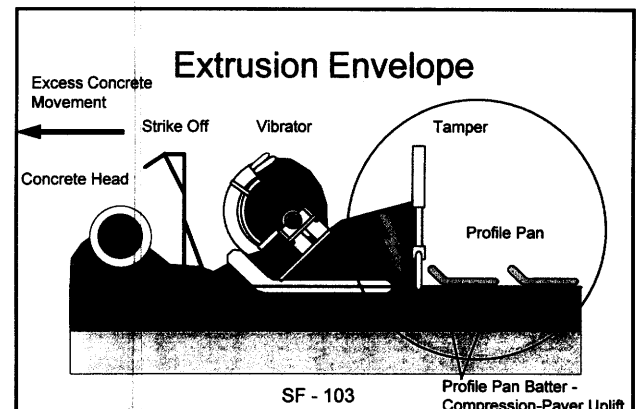
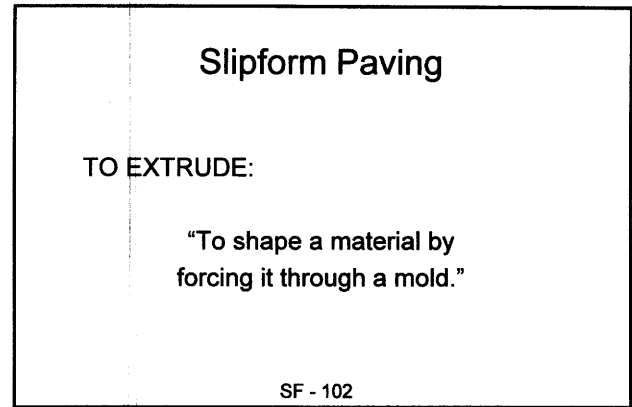

A series of tools is applied during the paving process to perform the functions of filling the forms and creating a uniform shape. These tools are an auger spreader, spreader plow, strike-off, tamper bar, or any combination of these items. There is also a secondary finishing process of some kind to remove slight irregularities from the surface finish.

The energy of the pressure comes from the continuous movement of the slipform mold through the confined mass of concrete. The energy is also applied by continuous vibration that changes particle distribution and lowers face-to-face and particle to steel friction by fluidizing the concrete.

The result desired is a uniform geometric shape and a uniform exact surface in the horizontal and vertical dimension. This is best accomplished by a constant mixture and uniform movement. The following elements should be present during placing operations:

- uniform particle content,
- uniform fluid (water) content,
- constant pressure and vibration, and
- uniform machine movement.

Metering

Some slipform pavers have an area between the auger-strike off and the pan called the "meter box or grout box." This area contains the vibrators and tamper bars, if applicable. Other slipform pavers do not have this box, but have an area where there is a static head above the vibrators. These areas adjacent to the vibrator eccentrics or the zone of influence is the center of the action. The concrete becomes energized (particles in motion), water bubbles exploding, entrapped air rising to escape, and the volume of the mix being reduced. This is the key to the slipform process.

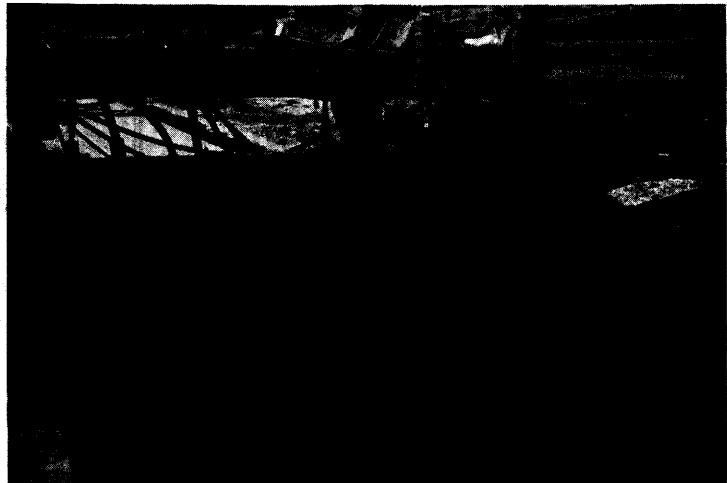
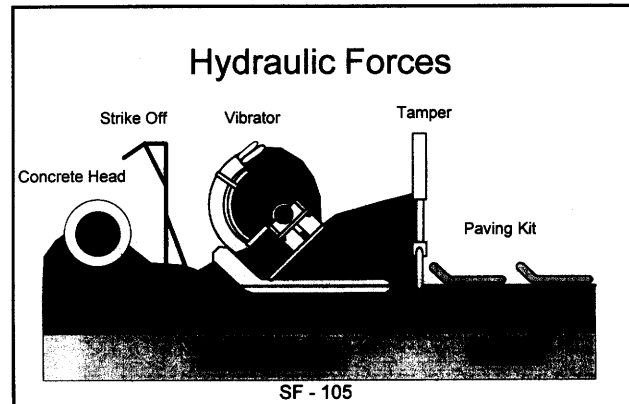

Tamper Bar

The tamper bar is a feature on some slipform pavers. They should be operated in accordance with the manufacturer's instructions. There are a variety of opinions on the function that a tamper bar performs. Some believe that the tamper bar helps tamp the large aggregate below the surface of the slab. Some believe that the tamper bar keeps the large aggregate moving in an area where it may have tendencies to stop or stick. Some believe that the tamper bar keeps the material moving at the meter point so as not to collect and cause flow problems. Still others believe that it's a combination of the three.

The slipform paving process includes several additional elements beyond our tube of toothpaste. In our tube of toothpaste, all of the necessary elements are already in the container. Not so with the paving operations, you must fill the form, seal the ends, and produce the necessary volume of concrete before starting the machine to apply the pressure.

In addition, the volume of material demand is continuous. The delivery of the mixture must be continuous to meet the constant demand. The movement and pressure must be continuous to produce the desired results of shape and finish.

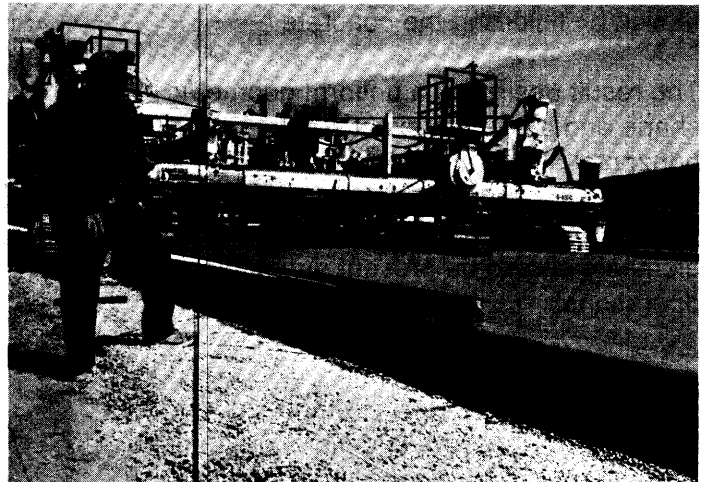

Concrete mixtures have many unique elements. Importantly, its behavior as a fluid is a critical factor during paving operations. A fluid cannot be compressed. Energy applied to a fluid results in equal and opposite transmittal throughout the confined area.

A change in delivery or constituents of the mixture (water, mainly) changes the hydraulic forces imparted by the concrete. These changes require a variation in the applied energy (pressure and vibration).

UNIFORMITY is a critical issue; uniformity in design (mix and geometrics), uniformity in logistics (supply and delivery), uniformity in energy levels (vibration, head pressure, movement) are vital for machine performance and paving results. Any change in these variables can produce a rough-riding pavement.

A Concrete ~~Solution~~ Necessity

- Consistent Delivery
- Consistent Quantity
- Consistent Quality
- Consistent Motion

SF - 110

Beginning Paving Operations

A review of safety measures and cautions for everyone concerned, including agency personnel, is a necessary starting point.

Getting started properly includes the following elements:

- Check all of the equipment in the paving train and approve it as being operational.
- Verify that an acceptable distance of grade is approved for concrete placement.
- Check that approved test reports are available for all materials presently in storage on the job site and the plant site.
- Verify that back up testing equipment is available.
- Verify that all the necessary concrete placement tools are available, such as hand tools, straight edges, hand floats, edgers, and hand vibrators.
- Determine that radio communication with the plant is operational.
- Verify that equipment is available to water the grade.
- Check the stringline again.
- Verify that the day's work header is in place.
- Check weather forecast.

The paving train consists of a number of pieces of equipment. Many paving operations utilize a placer spreader as the first piece of equipment. Second in line is the paver that consolidates and places the materials to final line and grade. This is followed by burlap or astro turf drag. The pavement is then either longitudinally or transversely tined for final friction needs. Many times the tining machine and the curing machine are the same piece of equipment. After tining, the pavement is sprayed with a curing compound. The track line should of adequate stability to support all of the above pieces of equipment.

Getting Started

- Check all equipment and tools
- Verify adequate grade preparation
- Communication with concrete plant
- Check stringline again
- Check weather forecast

SF - 111

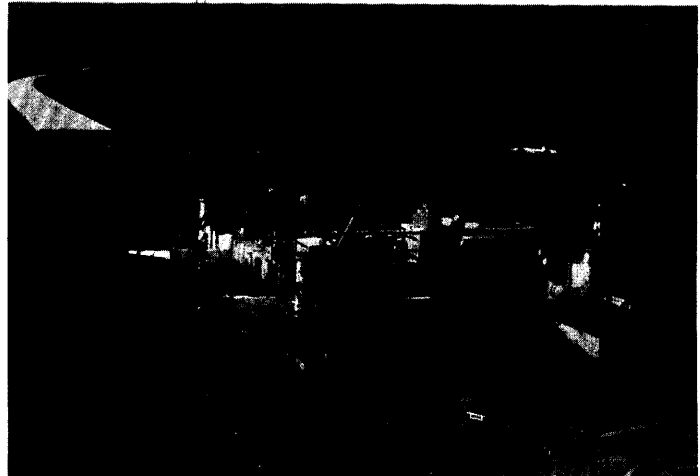

The day's paving operations should begin with the production of two batches. Check the two batches for slump and air at the plant. Acceptance or rejection is at that point. Upon determination that the batches produced are acceptable, delivery and dumping/spreading begins for paving operations. All additional paving operations can now begin.

Delivery of additional batches to load up the machines in the paving train begins at this time. Loading and developing proper spacing normally takes about one half hour. Paving operations are considered fully underway at this point.

Start up operations also include construction of the day's header or matching the in place pavement. Additional material is normally added with an end loader to complete the concrete placement. The finishers are in charge of this operation.

After getting off the header, other general concerns can be addressed as follows:

- Mix workability
- Staying within allowable water/cement ratio
- Adjustments in delivery of concrete
- Probe for depth
- Surface condition behind the paver
- Adjusting paving train forward progress to concrete supply
- Controlling slump between 20 and 50 mm.
- Coordinate slump with plant and correlate with ammeter to provide concrete with a consistent slump to the paver.
- Begin grade yield checks

Initial Paving Operations

Check mix yield

- Control workability
- Probe for depth
- Adjust paver speed to concrete production
- Aim for minimal finishing
- Communicate with plant operator

SF - 114

Grade yield must be checked often to verify proper machine adjustments and grade preparation. Grade yield is the actual amount of concrete placed at the field project site based on the production of a given volume. Slightly more material is needed to compensate for job variations. Calculation of the grade yield allows the contractor and the agency to determine the actual amount of material being placed.

To determine the grade yield calculate the difference between the theoretical volume required and the actual volume placed. For example, the theoretical volume of concrete required for a section of pavement 100m x 7.2m x 250 mm is 180m³. The actual quantity placed may be 188m³. The yield loss in this example is 4.4 percent.

Contractors' personnel will probably be checking grade yield every hour or two. Agency representatives will check yield as needed for an awareness of paving operations.

The most critical factor in controlling yield loss is constructing the pavement to the proper depth. Contractor personnel will continually probe, probe, probe and probe to be assured of correct slab depth and no thin cores. A simple way to measure thickness is to set a plate on an unstabilized base and probe for thickness at that location. Log these results and compare them with yield loss during the days paving. Also compare these results with core results.

The plant operator will be concerned with producing one cubic meter of volume based on one cubic meter of ingredients being added to the batch. Any change should be immediately communicated to the paving foreman.

Thickness

- Probe
- Probe
- Probe

SF - 115



Delivery

Various means of delivery to the spreader or grade are generally tailored to specific situations. Dumps (side, end, ejector, and belly), agitators, truck mixers, live floors, and front end loaders all are in present day use. All need periodic cleaning at an established area for run-off control. Water jets are in common use.

Safety is to be enforced at all times. Back-up alarms, dumping procedures, following dump man's directions, traffic patterns, and the like must be considered.

Remember, controlled uniform delivery rates is one of the first steps to construction of a quality pavement. The paving process must be uniform in quality of concrete, head of material, rate of delivery, placement, creating uniform forces in front of and under the machine. Pavers are finishers, not bulldozers.

Uniformity is the name of the game. If uniformity is not met in all phases, the profilograph will point it out!

The distance from batch plant to the grade operation is a governing factor in obtaining timely delivery of concrete to the paver. The travel time to and from the paving spread is also governed by the haul road conditions. A paved surface and minimal traffic friction would allow usage of a more distant plant site, conversely a dirt surface for the entire round trip would increase the haul time and require an increase in the number of haul units.

Discharging

- Place directly on grade
- Place with spreader
- Place with belt placer
- Safety first

SF - 117

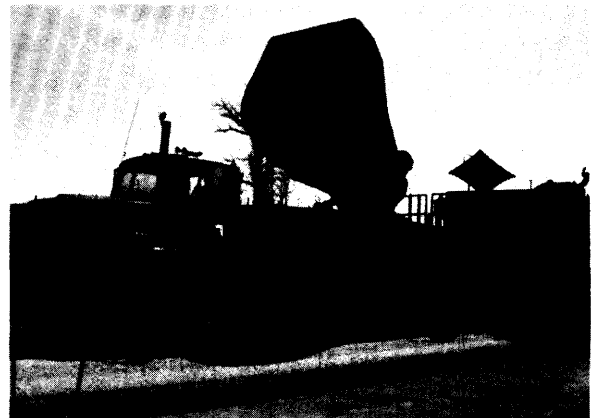

Slipform Paving Operations

Numerous variables enter into supplying concrete to the paver in consistent volumes. Close coordination involving the plant foreman, truck foreman, and concrete foreman is a necessity. The contractor will coordinate the number of trucks needed to keep the paver speed uniform.

When truck mixed concrete is used the contractor and the concrete producer must establish a realistic rate of delivery. The rate of production and delivery must be calculated on a desired cycle time for each truck mixer for loading, mixing, delivery, discharging, and return to the plant.

The placement rate can be defined as the paver speed in meters per minute times the material needed per meter of length. At a paver speed of two meters per minute, a grade yield loss of 5 percent, a section 7.2 meters in width and 200 millimeters thick, the material needed is 3.024 m³/min. At a placement rate of 3.024 m³/min. you would have to establish a unloading time of two minutes for a 6 m³ truck to assure the paver continued to move at a constant speed.

Unloading time: 2 m/min. x 7.2 m x 0.20 m x 1.05 = 3.024 m³/min.

Unloading time is a small part of the overall cycle time. However, anticipate that low slump concrete has different unloading characteristics than high slump concrete. Therefore, to match the required placement rate you need to use a truck mixer specifically designed with wider discharge openings for low slump concrete. Don't let the smallest time increment of the cycle control the placement operation.



hinged joint

Calculate Number of Trucks

- 8 mile round trip (RT)
- 25 mph average speed
- min. per RT = (8/25) x(60)= 19.2 min.
- 5 minute loading (wait inc.)
- 6 minute unloading (wait inc.)
- 19.2 + 11 = 30 minutes per round trip
- USE 2 loads per hour!!

SF - 122

An important factor in an urban area is the anticipated congestion that would be encountered by the concrete delivery vehicles. Estimated delivery and return times should be determined based on speed limits, anticipated congestion, and distance to the project. The project itself will likely cause some lane closures and/or detours in the area. Provision must be made to route the delivery vehicles to the placement operation in an efficient way.

Paver Operation

Paving Speed

Normal paving speeds are in the range of 1 to 2.5 meters per minute. The volume of concrete delivered to the paver should ensure a continuous paving speed. When delivery does not permit a constant speed, vary the speed to match a decrease in delivery and vice-versa. Speeds 3 meters per minute or greater may require a change in the number and spacing of the vibrators.

Concrete Head

Concrete head will be a constant concern of the paver operator, spreader operator and truck dump man. Coordinating their efforts can result in a nominal depth of concrete being pushed ahead by the machine and at the same time avoid having to fill holes at the edges. The goal is to keep the depth of static head about the same thickness as the concrete pavement being placed. Operators use a variety of techniques to keep just enough excess material for dispersal if a shortage develops.

Paver Operation

- Constant uniform motion
- Constant uniform motion
- Constant uniform motion
- Constant uniform motion

SF - 123

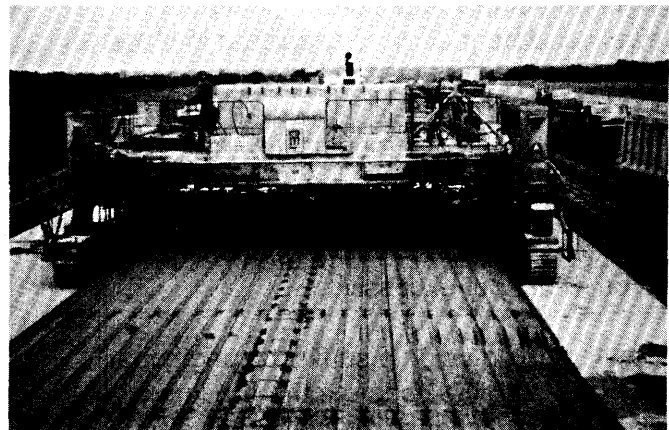

Additional Field Operations

Headers

Headers are considered to be a perpetual problem by concrete foremen, finishers, and a continuing challenge. They should be placed a specified minimal distance away from the last contraction joint. If possible, place the day's header at the contraction joint. Side forms, approximately 3 m in length, should be installed to provide proper edge alignment and confine the area for consolidation. Set the side forms to match the width of the pavement.

The header form should be constructed full length and of proper shape. The smooth dowels or deformed bars should be in place and secured.

The concrete used in the final few meters should be fresh concrete, not the slurry that may have collected in the spreader rolls. Hand consolidation should be patterned and thorough but not excessive.

Straight edging using a sufficient length that laps back onto the concrete that we know has the proper shape. Stringlining is also recommended.

Near the end of large placements, carefully measure the remaining volume so that the amount in the last two or three trucks can be adjusted to provide the required concrete. Aim high, this can prevent waiting for an extra $1/2 \text{ m}^3$ after the plant has closed or the concrete trucks scheduled for other jobs. Do not use concrete spilled or disposed of on the ground to make up any deficiency in material. The material placed at the end of the days' placement should be of a quality consistent with all of the other material used.

**End of Day
Aim High!!**

Days Headers

- Use fresh concrete
- Consolidate thoroughly
- Straight edge
- Stringline
- Edge tool
- Texture and cure timely

SF - 126

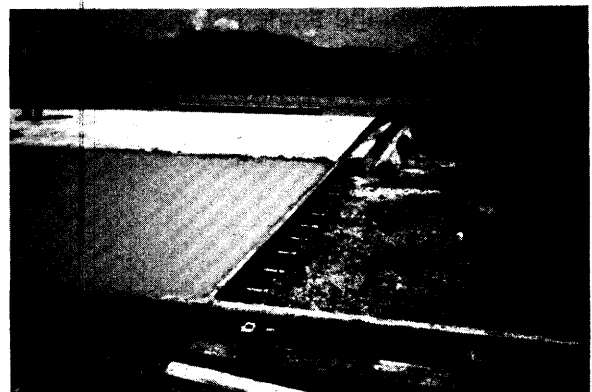

Edge tool the side form edges and the header itself. Use an edging tool with only a minimal radius.

Tine texturing and cure application must be done in a timely manner. Many times this operation at the header is performed by hand.

When starting operations the next day, repeat the process of straight edging and stringlining across the joint.

Day and transverse contraction joints are also constructed by paving beyond the last joint a short distance. This will ensure that you have sound concrete and helps to remove any slurry that may have collected in the spreader rolls. The concrete at the joint location should be well consolidated. Surface tolerances should provide a good level ride on the joint. The joint is marked and the saw crew cuts the pavement full depth. The pavement is removed and holes are drilled for smooth dowels or deformed bars. The dowels or bars are epoxied or grouted into the holes to serve as load transfer.

Cool damp weather conditions that cause slow initial strength gains can create a problem for the drilling process from a possible fracturing standpoint.

Headers on continuous reinforced pavements require special considerations. Additional steel bars are placed at the joint location to increase the cross-sectional area of steel by as much as one-third. Sheets of plywood are placed on top of the steel bars past the joint to avoid spillage of the surplus concrete onto the grade.

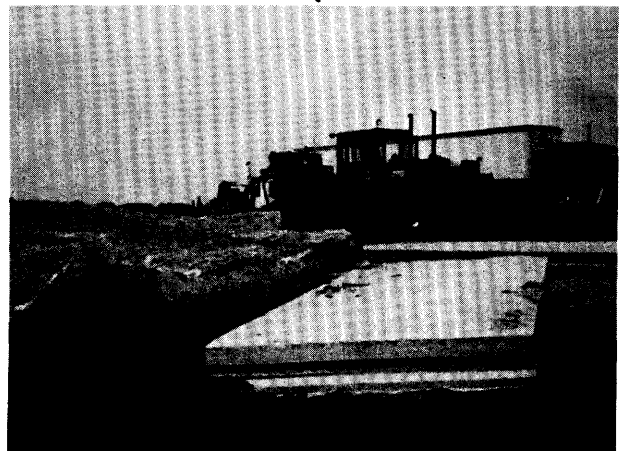
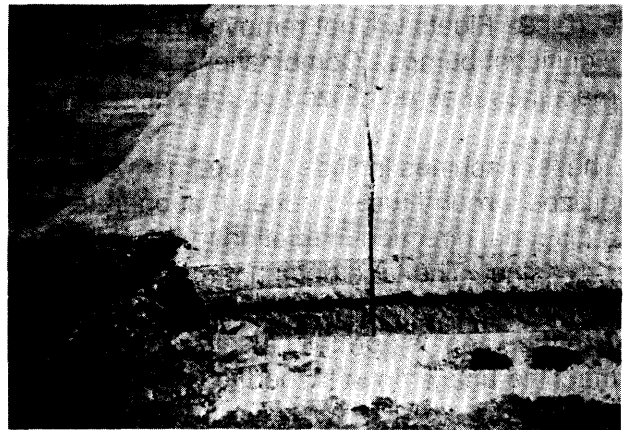

Finishing

When everything (mix, equipment, timing, delivery, etc.) is substantially correct, no finishing other than the burlap drag and tine texturing would be required. However, many things can happen to this outdoor assembly line process requiring correction in the final phase.

Finishing should not be undertaken while any bleed water is present. Under some weather conditions or with some mix peculiarities, bleed water can be significant.

Several pieces of equipment may be utilized to correct minor variations and help seal any small imperfections in the finished slab surface. Floats will not remove any significant bumps. Combinations of these machines may be utilized on the same slab.

These machines include a tube float, which utilizes a round tube or tubes that operate in a diagonal direction in relation to the slab centerline. The tube does not rotate but rests by its own weight on the slab surface. The tube float is normally a self-propelled machine and is not attached to the paver.

Finishing

- Water Management
- Water Management
- Water Management

SF - 133

Closing the Surface

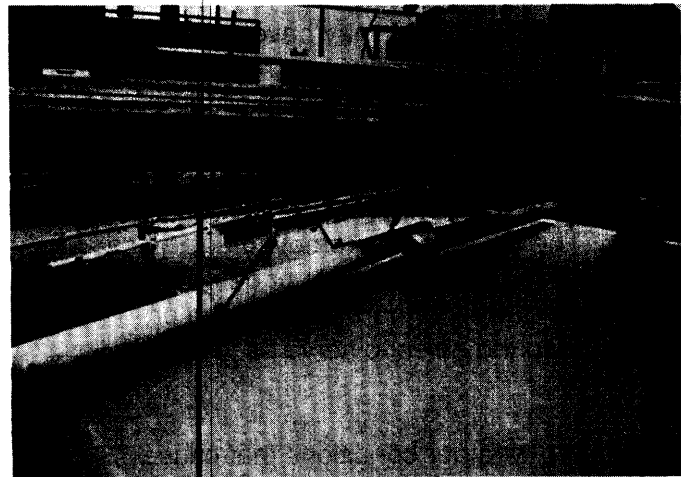

The longitudinal float, which may either be attached to the paver or self-propelled, is a float that may be up to 300 mm wide and 4 to 5 meters long. This float is normally placed parallel or close to parallel with the centerline of the slab. The float is carried from one side of the slab to the other while being oscillated front to rear several millimeters. This is commonly termed the final finisher.

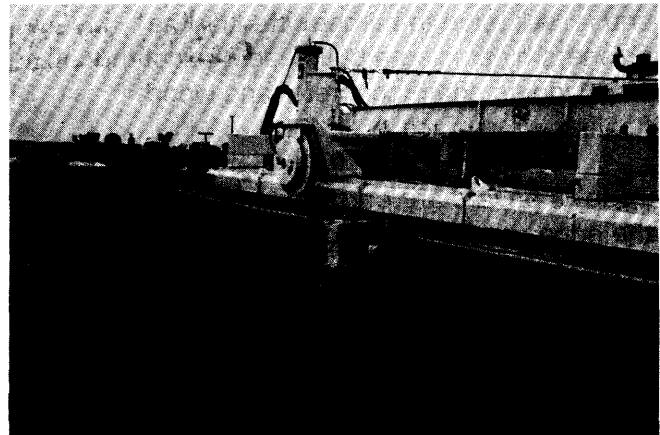

The Lewis float is a truss normally placed on two diagonals from the centerline of the slab away from the rear of the machine. This truss has a narrow float attached to the edges. The float rests on the slab and can be pulled by the paver.

These floats may or may not be equipped with a spray bar and burlap drag. Water should be applied through the spray bar onto burlap drag and used very sparingly and only when required.



Checking the surface behind the paver with a 3 or 4 meter straight edge is a normal procedure. Should any surface imperfections be found, they should be corrected with a hand-operated float. Periodically check the trueness of the straightedge with a stringline.

Lewis float

Slipform Paving Operations

Out-of-tolerance edge slump, for whatever cause, will have to be corrected by the finishers by placing a bulkhead against the slab, adding some concrete, and wood floating the surface.

Today's pavers are equipped to overbuild the edge area and to allow a certain amount of sag to occur as the slab leaves the traveling form. When the mix is within prescribed limits for air and slump, the edge is normally acceptable.

Water, water, more water. That is the cry coming from most concrete finishers. As one contributor to this program stated, "The slab does not need to be baptized." Excess water, if worked into the surface, can cause plastic shrinkage, excessive water cementitious ratio at the surface, and eventual spalling of the surface. An absolute minimum amount of water to close up occasional surface tears is sometimes used, but should be in the form of a mist from a hand pump sprayer.

When water must be used in greater amounts to close the surface, the entire operation must be reviewed, including increasing the mixing water. Equipment breakdowns cause delays that can put a burden on the finishers, but even then, water usage must be strictly limited.

The burlap drag must be kept moist, not sloppy. If a trail of bubbles is observable behind the drag, it has excessive free water.

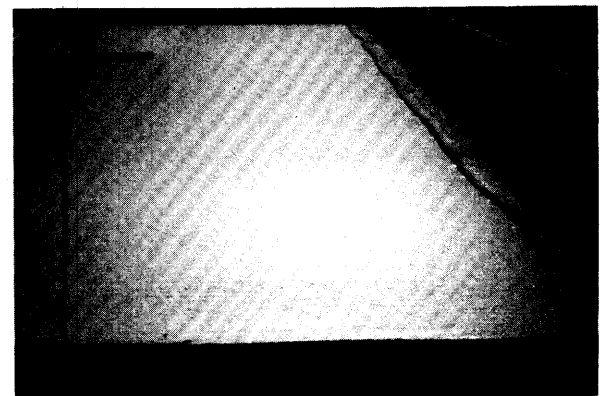
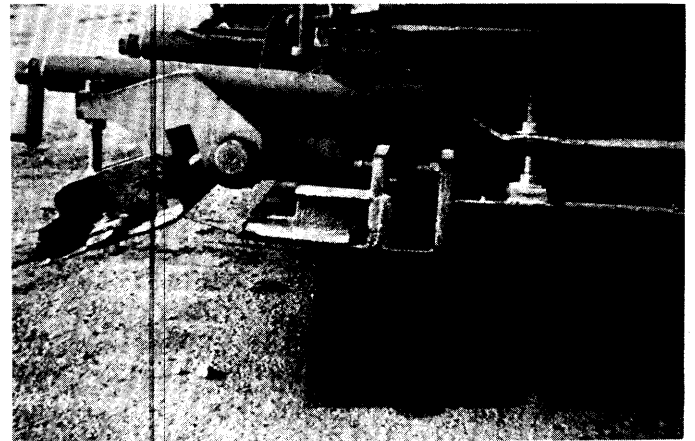
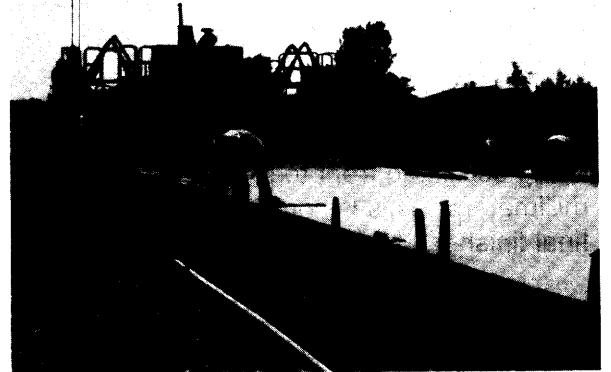

Texturing

Most States are requiring the use of a tine texturing machine to increase the friction of the surface. The macro texture surface features transverse grooves approximately 3 mm to 5 mm in depth, 3 mm wide, and spaced 12 mm to 20 mm apart.

Micro texture is achieved by use of a burlap or Astroturf drag. Both micro texture and macro texture are necessary to ensure the maintenance of acceptable friction numbers throughout the surface life of the pavement.

The tining machine must be parallel to the pavement surface. If the tining bar is not parallel to the pavement surface an uneven pressure will be exerted on the pavement surface, resulting in a nonuniform texture.

Texturing

- Longitudinal
- Transverse
- 20 mm or less spacing
- Random Tine Spacing

SF - 141



Slipform Paving Operations

In some cases the texturing machine is designed to raise from the pavement surface several millimeters away from the edge of slab. This preserves edge integrity and alignment.

In many regions the area (100 to 150 mm) over the proposed joint location is not tined textured. This provides an excellent surface for sawing and sealing operations.

Overlapping of the texturing should be avoided because the resulting thin fins will be extremely fragile.

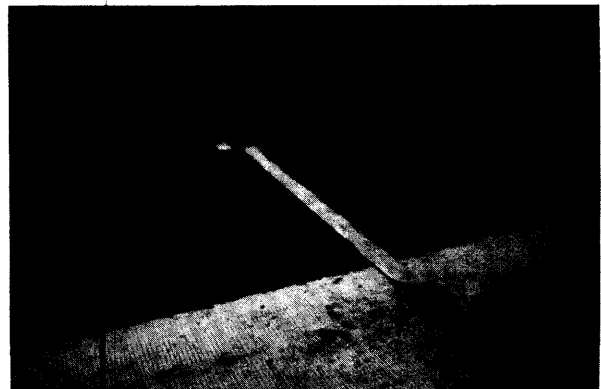
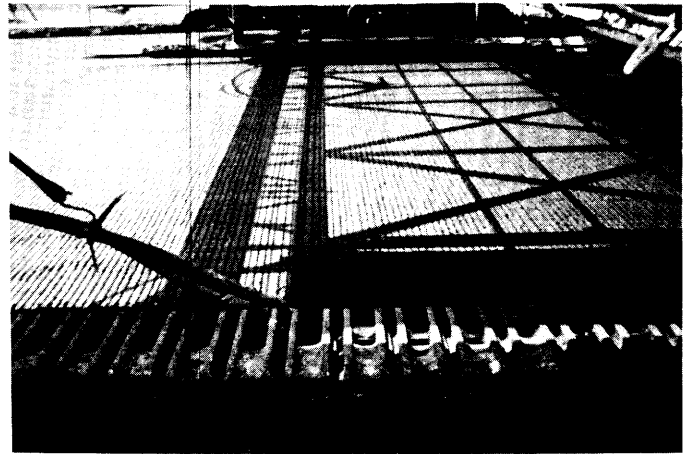
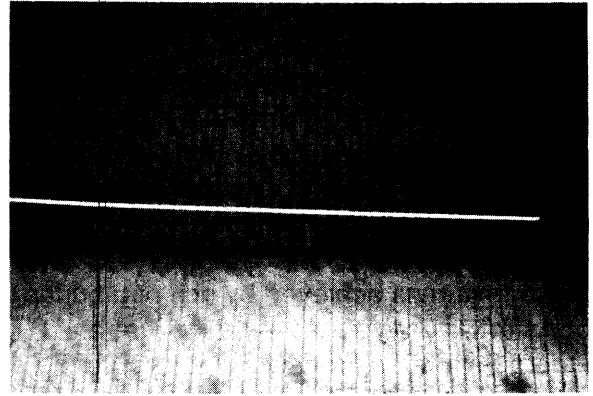

Curing

An important step in concrete paving is the method used to prevent loss of mix water. The surface is sprayed with curing compounds to prevent this loss of mix water. Standard curing materials used include both white pigmented and clear materials and plastic sheets (in case of rain). Curing compounds with fugitive dyes are also available. Curing compounds that are visible when applied provide a visible opportunity to determine uniformity of placement.

The curing compounds should be thoroughly mixed and continually agitated. Most larger projects are utilizing bulk delivery and storage. The bulk storage is normally air agitated, and the spray machine tank is stirred with electrically-driven paddles. Smaller deliveries are usually in barrels. They are common sources of injuries, and care should be emphasized.

Preparing and maintaining the cure spraying machine includes flushing the nozzles before operating. Spare nozzles should be in stock at all times.

The rate of application (square meters/liter) should be checked routinely. Be sure to apply the cure to the vertical slab edges and include them in the rate calculations.

Curing

- Uniform
- Timely
- Check yield

SF - 147

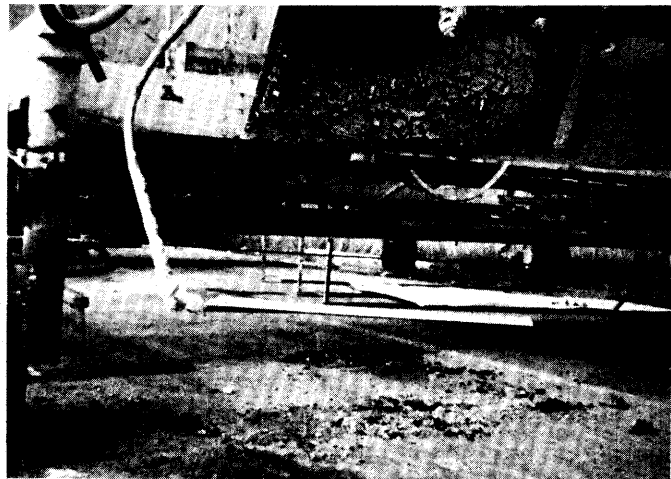

Slipform Paving Operations

When tine texturing is required, the cure application is generally specified to be placed in two coats of one-half rate each. This is done as a forward and back application, with a short time delay at reversal. The back and forth method enhances coverage of the tine texture vertical faces.

Most texturing machines have shields or hoods that shelter the nozzle application operation to prevent spray drift, especially in windy conditions.

The timing of the application is generally considered to be when the finishing of an area is complete. If the tine texturing went well, there is no slurry in the grooves and the faces are standing, it's time to cure. Additionally, when the original sheen has nearly disappeared curing should begin. When weather conditions exist that make the decision when to spray difficult, it is better to spray too early rather than too late.

Saw & Seal

Saw & seal operations are covered in another part of this course. Proper identification of joint location is essential. The type of marking used during paving operations must be communicated to the saw crew.

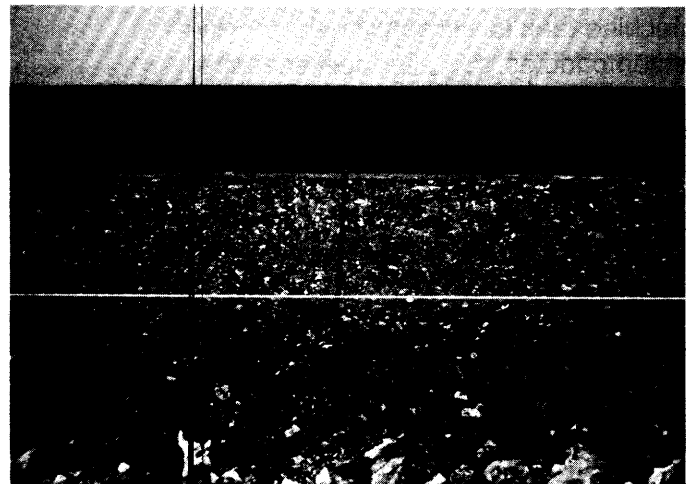
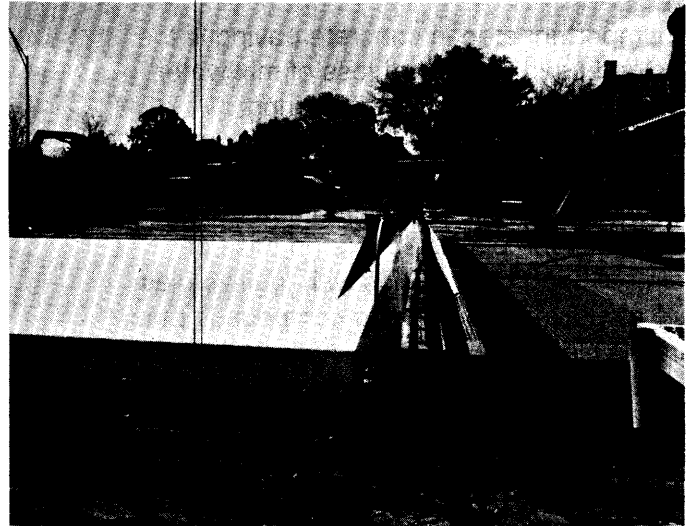

Summary of Critical Factors

An effective slipform paving process will provide the contractor with the maximum opportunity to achieve a smooth pavement. There are 10 critical factors considered essential in contributing to a smooth concrete pavement:

Sound Grade to Specification

Providing a well drained, uniformly well compacted subgrade or base, trimmed to specification tolerance, is the first step towards smooth pavement. The trimmed subgrade or base should provide the ideal index for the final surface.

The accuracy and structural integrity of the base should be continued in the area of the paver track line.

Monitored Supply of Concrete

Monitoring the supply of concrete means continuous quality control. Quality control during the hauling, placing, and finishing of the concrete.

The paving process must be uniform in quality of concrete, head of material, rate of delivery, placement, and forces in front of and under the machine. Pavers are finishers, not bulldozers.

Uniformity is the name of the game. If uniformity is not met in all phases, the profilograph will point it out!

Summary of Critical Factors

- Sound grade
- Monitored supply
- Consistent workability
- Controlled Density

SF - 151

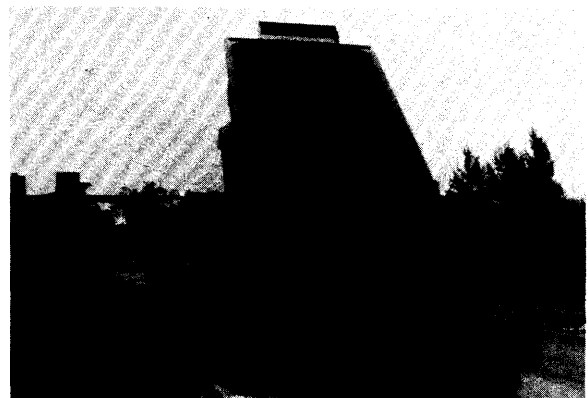

Consistent Workability

Uniformity of workability is important. The adjustments normal to paving machines, batter, taper, overbuild, etc., are designed to permit paver operation for different mix designs. This workability factor, or lack of it, will show in the pavement and on the profilograph.

Controlled Density

Vibration is necessary to fluidize and consolidate the concrete mass and provide a sufficient amount of fines at the surface for a tight micro finish. Over-vibrating will have a tendency to segregate the mix. Under-vibrating will leave undesirable voids.

Vibration is not meant to be a transport medium to move concrete in any quantity. Concrete should be moved by auger, conveyor, or other mechanical means prior to vibration to prevent loss of entrained air and to avoid segregation.

Variance in density caused by careless placement or poor vibration techniques will show in profilograph printouts.

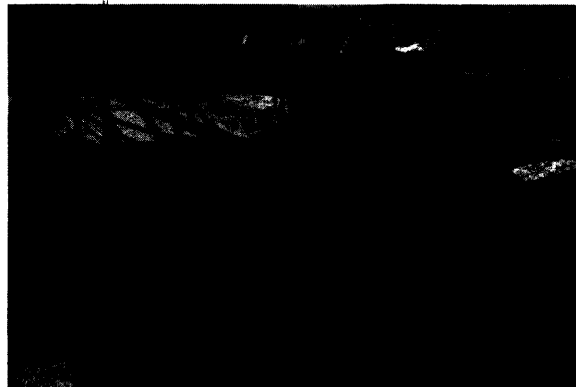

Sensor Common Sense

The stringline must be set accurately, maintained, and checked constantly. Sensor response must be adjusted to avoid too slow a reaction or an excessively fast reaction of the paving machine.

Dual stringline operation of the paving process should be used whenever possible. Profilograph tests have shown that the most accurate and smoothest pavement results are obtained by the use of fixed elevation control on both sides of the paver, a dual stringline.

Stringline discipline needs constant attention and training by supervisors. Traffic crossing the stringline, finishers' long handled tools, lunch boxes, and discarded jackets placed in inappropriate places may account for unexplainable bumps in finished pavements.

Clean & Well Maintained Machine

"Cleanliness is next to godliness." A clean profile or finishing pan will be able to extrude a smooth, well sealed surface. Effective cleaning techniques include high pressure water blasting, steam cleaning, and the use of a form release agent.

Well maintained also means proper adjustments and prompt repair.

Summary of Critical Factors

- Sensor sense
- Clean maintained equipment
- Proper machine attitude

SF - 155

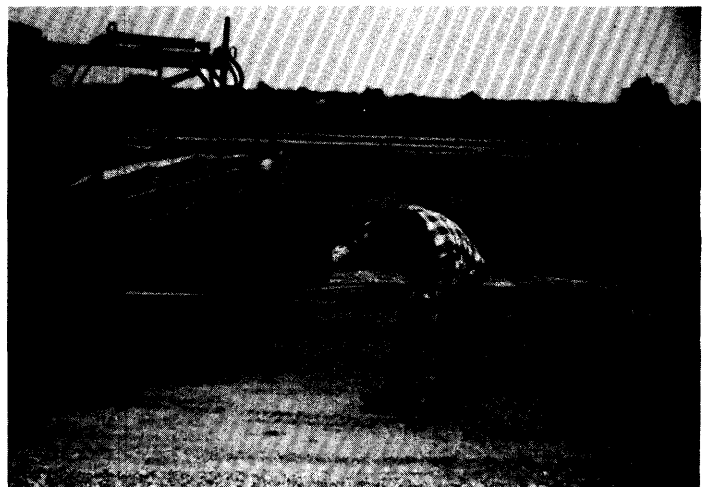

Proper Machine Attitude

The machine attitude is the attack angle in relation to the concrete. The attack angle is not unlike that of an airplane wing. The steeper the attack angle, the greater the lift.

If the angle of attack is forced to change due to "bulldozing" piles, improper sensor adjustment, or varying head of concrete, bumps will result because of uncontrolled lift and release caused by the hydraulic action of the concrete.

Weight & Traction

The principle that makes a slipform paver work is the consolidation of concrete in a confined area. To achieve the controlled consolidation of slipform concrete, the weight must be moved in a smooth, consistent manner.

Traction is related to weight and power. Power must be sufficient to move the loaded machine and provide the necessary energy to the working tools. Traction is dependent upon the grade or platform upon which the paver operates.

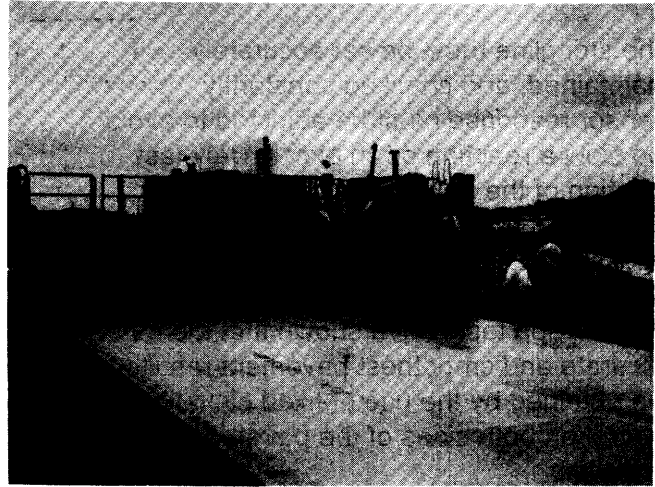

Summary of Critical Factors

- Proper weight & traction
- Proper surface treatment
- People

SF - 159

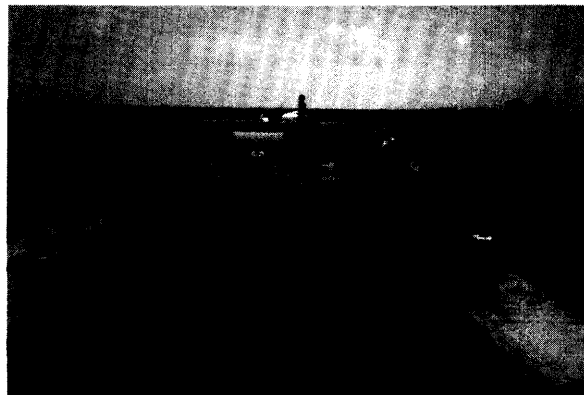

Method of Surface Treatment

Care of operation and timing of the texture process are the two most important factors controlling the appearance and quality. Timing is most important, as the surface condition of the plastic concrete will change due to the drying effect of wind and temperature.

High quality texturing is nearer to art form than a science.

People

Nothing happens until people make it happen. People design pavements, write specifications, inspect materials, do quality control testing, do surveys, set grade stakes and stringline, operate and maintain machines, manage paving operations, and set contractor goals, perhaps more importantly, people train people.

We have the task of not only improving the quality of our product, but also of training the next generation of quality-minded paving professionals.

People are our most important commodity. It takes good people working with a spirit of cooperation to build a good pavement that will make the public happy, the agency happy, and contractor happy.

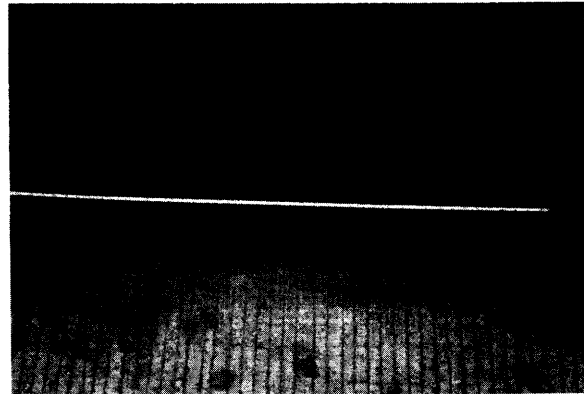

Occasional Irregularities and Steps to Correct

Tearing of the Mix

- Check speed of the paver
- Check square of paving kit to stringline
- Check vibration frequency
- Check draft of the pan
- Check mix proportions
- Check air content
- Check W/C ratio

Bleed Water

- Wait until it evaporates before tining and curing
- Check air content

Troubleshooting Tips

SF - 162

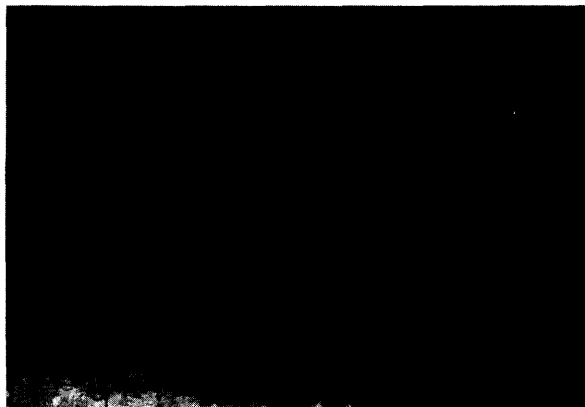

*machine not square
poor vibration*

Tearing of the Mix

- Check speed of paver
- Check square of paving kit to stringline
- Check vibration frequency
- Check draft of the pan
- Check mix proportions
- Check air content
- Check W/C ratio

SF - 164

Too Much Grout on Surface

- Too much water applied to surface
- Over vibration (vibration speed too high)
- Machine moving too slow for vibration

Crawdaddy Holes

- Check air content
- Check W/C ratio & adjust if necessary
- Check vibrators that align with the holes
- Check for proper paver travel speed

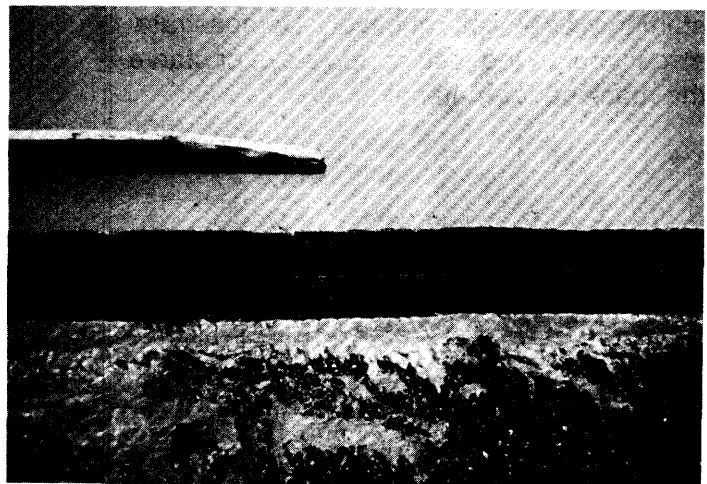
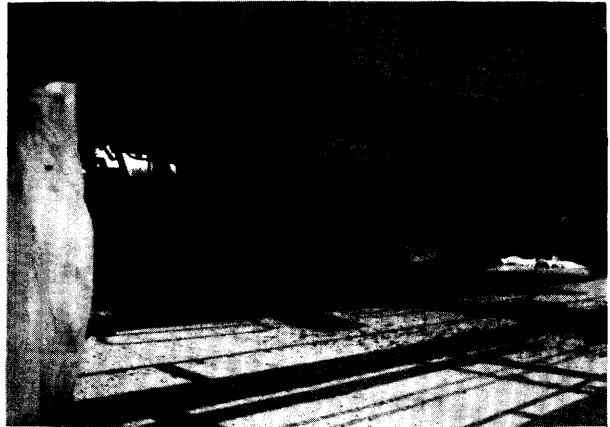

Slipform Paving Operations

Vibrator Streaking (Vibrator Trails Visible behind the Paver)

- Check head above vibrators
- Check materials & mixtures
- Check frequency
- Check paver speed
- Check vibrator positions and spacing
- Check for blown vibrator

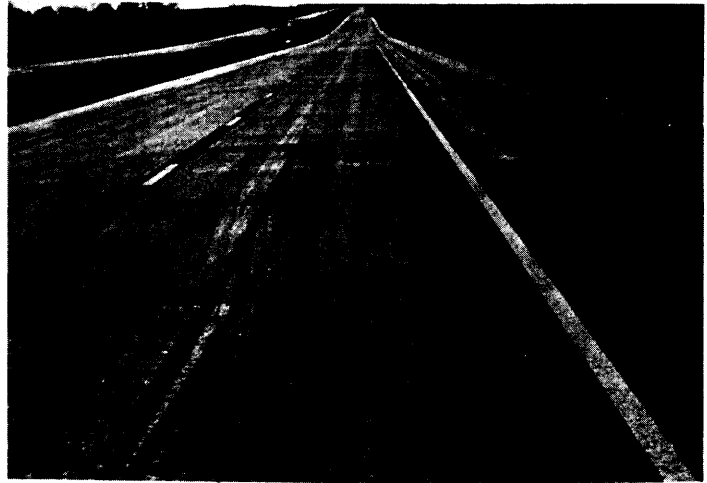

Caving Edges

- Check air content
- Check position of edge vibrators
- Check vibrator frequency
- W/C ratio
- Check mix design (some are more prone to caving edges)

Wide Variances in Texturing

- Inconsistent concrete (review mixing operation, placing, and finishing process)
- Check placing and finishing process
- Check adjustment of the final finisher
- Observe operation of tining equipment
- Vibrator positioning
- Check speed of paver

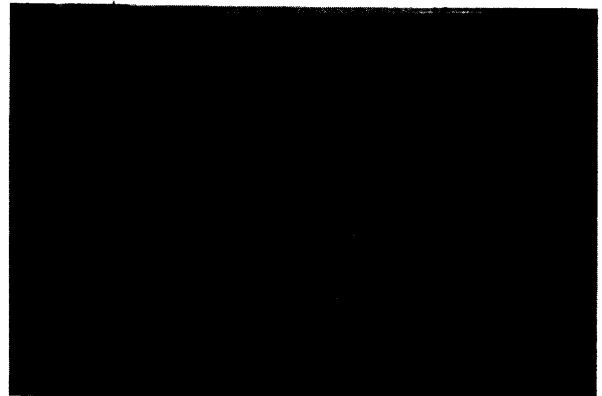

Situational Exercise

Use a caulking gun to demonstrate what happens if you do a lot of stopping and starting with a slipform paver. Demonstrate also if you go too fast, go too slow, or starve the machine for material.

FIXED FORM PAVING

VI. Fixed Form Paving Operations

- A. Objectives
- B. Preconditions
- C. Fixed Form Paving Operations
 - 1. Communication and Preparation
 - a) Points for Discussion
 - 2. Application Advantages
 - 3. Forms
 - a) Materials
 - b) Standards
 - 4. Subgrade
 - 5. Setting the Stringline
 - a) Setting Grade Stringline
 - b) Setting Form Stringline
 - 6. Setting Forms
 - a) Tangent
 - b) Curves
 - c) Curbs
 - d) Preparing Forms for Paving
 - 7. Trim Grade and Compaction
 - 8. Placing Operations
 - a) Reinforcement
 - b) Utilities & Drainage Structures
 - c) Delivery of Concrete
 - d) Paving Operations
 - (1) Form Riding Equipment
 - (2) Small Screeds and Hand Work Equipment
 - (3) Key Elements in Placement
 - (a) Discharge
 - (b) Strike Off
 - (c) Finishing
 - (d) Curb Placement
 - (e) Texturing
 - (4) Curing
 - (5) Saw & Seal
 - 9. Form Removal
 - 10. Form Management
 - 11. Critical Factors

FIXED FORM PAVING

OBJECTIVES

Upon completion of this module the participant will:

- Understand the need to monitor a fixed form paving operation.
- Understand the importance of form line and placement to the fixed form paving operation.
- Gain a working knowledge of the fixed form paving process.
- Recognize the critical factors in fixed form paving that affect placing a quality pavement.

PRECONDITIONS

For the purpose of this module the following assumptions have been made:

- The concrete mix design has been either determined by the contractor or concrete producer according to the specifications or established by the agency
- The concrete pavement has been designed.
- The specifications have been established.

Objectives

- Understand the need to monitor
- Understand the importance of form line and placement
- Gain a working knowledge
- Recognize the critical factors

FF - 3

Preconditions

- Concrete mix has been determined
- Concrete pavement has been designed
- Specifications have been established

FF - 4

FIXED FORM PAVING OPERATIONS

Paving forms are used to hold the concrete in place at the proper grade and alignment and may serve as tracks for the paving equipment.

Fixed Form Paving Operations

- Paving form is the mold
 - Holds concrete in place
 - Establishes grade and alignment
 - Serves as tracks for paving equipment

FF - 5



FIXED FORM PAVING OPERATIONS

Form paving is used for streets, local roads, airports, and complicated, short length and variable-width pavements.

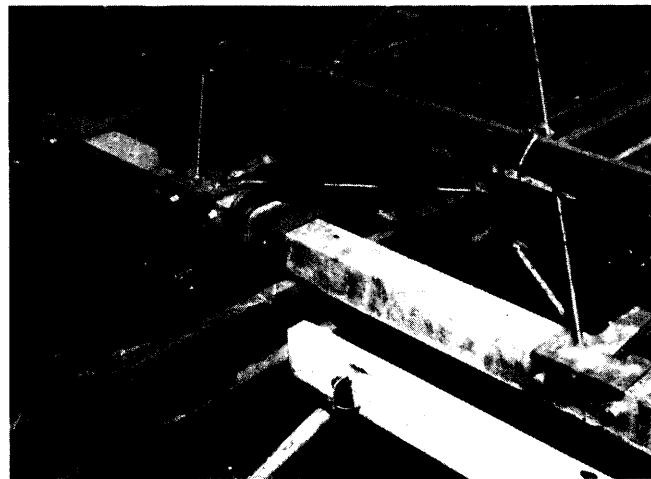
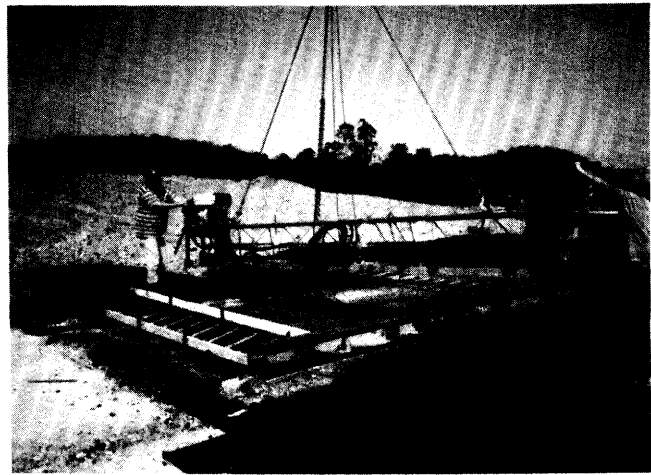
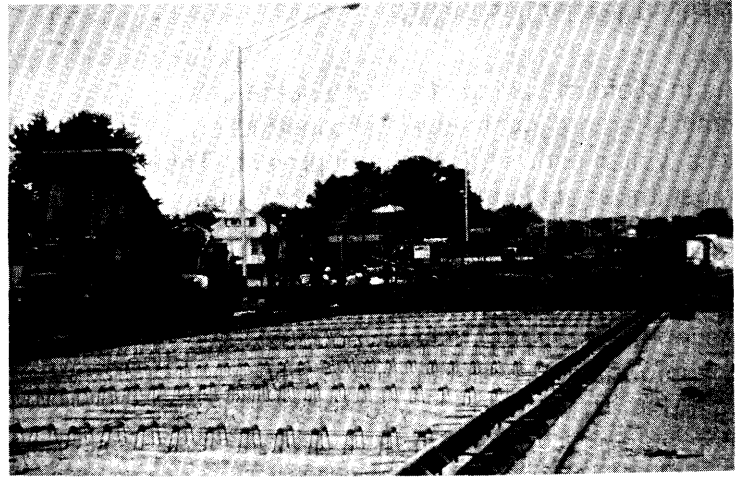

COMMUNICATION AND PREPARATIONS - CAP

As in slipform paving, there are numerous critical factors involved in the construction of a typical concrete pavement project. The most important is the implementation of a communication network.

From the pre-job conference to final project acceptance, everyone involved must have the information available, in a timely manner, that is necessary to perform his or her function.

Communication and Preparation - CAP

- Agency
- Concrete producer
- Contractor
- Testing personnel
- Timely
- Accurate

FF - 11

Points for Discussion

- Survey requirements
- Form line
- Delivery avenue
- Type of placement equipment
- Rate of placement
- Wash out area
- Job safety

FF - 12

APPLICATION ADVANTAGES - FIXED FORM PAVING

- Tight tolerances and side clearance
- Multiple changes of widths
- Blockouts
- Intersections - quadrants open to traffic
- Maintain quality during short concrete supply
- Critical staging for traffic control
- Small inexpensive equipment can place concrete

**Application Advantages
Fixed Form Paving**

- Tight tolerances - side clearance
- Multiple changes of width
- Blockouts
- Intersections - quadrants open to traffic

FF - 13

**Application Advantages
Fixed Form Paving**

- Maintain quality during short concrete supply
- Critical staging for traffic control
- Small inexpensive equipment can place concrete
- An adaptable system

FF - 14

FORMS

The key ingredient in a fixed form paving operation is the form. The form is the mold that determines the pavement depth, width, and surface smoothness for rideability.

A typical paving form is a complex steel section. Its face is the same height as the proposed pavement thickness. It has a wide, flat base to give the form stability. An upper rail carries the paving equipment. Provisions are also made for fastening the form to the subbase and grade with form "pins" (stakes).

Before they are ordered or used for a project, forms should be reviewed to see that they meet all of the requirements listed in the specifications. Choose forms based on the paving equipment and paving process being used. Some projects have specific form requirements, so do not assume the forms in a contractor's stockpile will meet the job requirements-check to be sure for approved use. If forms must be ordered, allow sufficient time for manufacture and delivery when placing order, especially if the forms have a nonstandard depth or tie bar pattern.

Forms

- Mold that determines
 - Pavement depth
 - Pavement width
 - Pavement smoothness

FF - 15

Forms

- Typical form - steel section
 - Wide, flat base for stability
 - Rail to carry paving equipment
 - Pin (stake) holes to anchor to base
 - Connections for adjacent forms
 - Normally, height same as pavement thickness

FF - 16

Forms

- Before ordering or using check
 - Specifications for requirements
 - Approved for use on project
 - Paving equipment needs
 - Paving process needs
 - Adequacy of stockpiled forms
 - Order forms timely

FF - 17

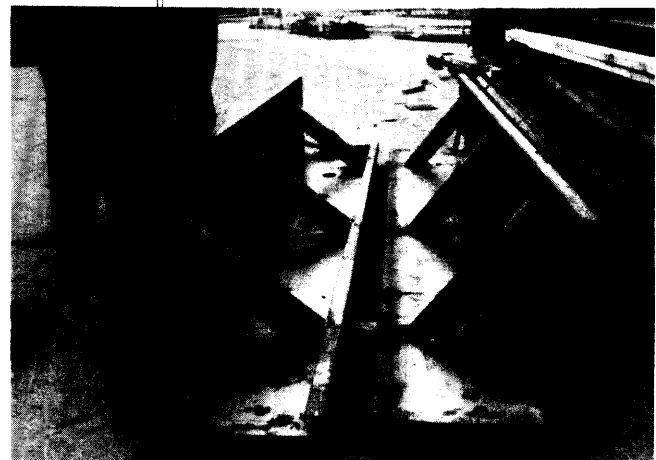

Sometimes the adjacent pavement lanes or curb and gutter section act as the side form. Make sure there are no irregularities at the edge and the top of pavement is kept clean.

Typical specifications may place the following requirements on paving forms:

- Each form section is usually made of metal at least 5.6 mm thick and 3 m long.
- Form depths should equal the edge thickness of the pavement.
- Buildup permitted on form bottom, bolted on to provide proper depth, with 50 mm maximum thickness.
- The base width of the forms should provide stability.
- Flange braces should extend outward on the base not less than 2/3 the depth of the form.

Specifications will differ, but generally the top of the forms must not vary from a true plane (perfectly flat surface) by more than 3 mm in 3 m. Any variance can be detected with a straightedge or stringline. The face of the forms should not vary from a true plane by more than 6 mm in 3 m. A straightedge or stringline should also be used to check the face of the form.

The forms should also meet the following requirements:

All forms should allow for tightly locking the ends of adjacent form sections. The ends of the forms should be flush when they are in position.



Forms

- Typical specifications
 - Metal at least 5.6 mm thick, 3 m long
 - Depth to equal edge thickness pavement
 - Build up permitted
 - Single piece
 - Bolt add on piece to bottom (50 mm maximum)
 - Base width should provide stability
 - Flange braces 2/3 depth of form

FF - 20

Typical Steel Form

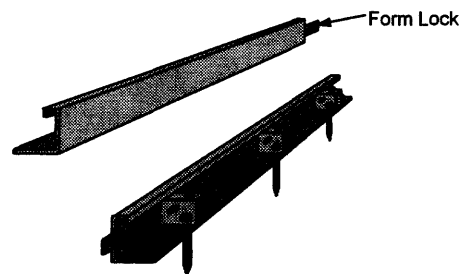

FF - 21

For a secure setting, forms should be staked with a minimum of two iron pins for every 3 m. When in place, the forms should not spring or settle due to the weight and vibration of equipment. Any up-and-down movement of the forms will result in rough pavement.

- All forms must be cleaned and oiled before use.
- Recycle or discard any bent, twisted, or broken forms.

The keylocks illustrated are used for minor alignment changes. One will adjust forms and the other will lock the pin in place.

By driving the inside wedge in further than the outside wedge, the form can be moved in. The cross sectional area of the wedge affects the distance between face of form and pin.

On street returns or tight curves flexible forms of steel or wood are used with similar requirements to steel mainline forms.



Forms

- Specification trueness: not more than
 - Top of form: 3 mm in 3 m
 - Face of form: 6 mm in 3 m
 - Check with a straightedge or stringline

FF - 22

Forms

- Additional requirements
 - Tightly lock to ends of adjacent forms
 - Stake with a minimum of ~~two~~³ pins for each 3 m section
 - Stable under weight or vibration of equipment
 - Clean and oil before use
 - Recycle or discard any bent, twisted or broken forms

FF - 23

Typical Key Locks

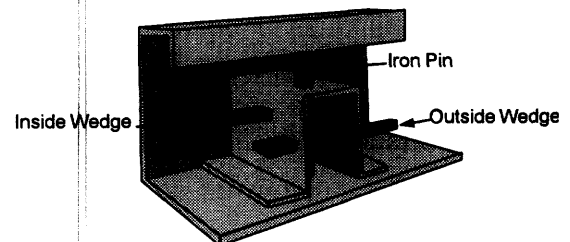

FF - 24

SUBGRADE

Commencing with the raw earth grade, we are assuming a well constructed compacted grade to profile and section tolerances within specified limits the same as slipform paving. All good pavements begin at the bottom.

Compared to slipform, the base may be less critical, however, a good base will produce an improved yield, ride, and pavement performance.

Subgrade

- Stable
- Built to tolerances
- Sound base will produce
 - Improved yield
 - Improved ride
 - Improved pavement performance

FF - 26



SETTING THE STRINGLINE

If form-line grading is done by machine-the usual practice-set the stringline twice. First, set the stringline at an offset height to meet the requirements of the mechanical grader, then set the stringline for form setting.

For form setting, the stringline is set for the face of the form at the top elevation of the form (pavement). The stringline is installed on form pins located with the outside edge of the pins on the proposed edge of slab alignment as measured from the reference hub. Set a stringline pin opposite each reference hub. Using a carpenter's level, the desired finish grade, as shown on the flat, is established by means of a pencil mark on the form pin. The stringline is then put up, fastened securely on each pin, and drawn as taut as is necessary to prevent stringline sags between pins.

Generally, the opposite reference hubs are not tacked for exact alignment control and are used for elevation reference only. Therefore, the alignment for the opposite side of slab stringline is obtained by measuring across the proposed width of slab.

Setting the Stringline

- Form line grading by machine
 - Set grade stringline at offset height for mechanical grader

FF - 28

Setting the Stringline

- Set form stringline
 - Install at face edge, top of form for form setting
 - Install stringline on form pins set at edge of slab opposite reference hubs
 - Set opposite stringline for parallel forms for alignment from first stringline
 - Pull stringlines tight

FF - 29



Setting the Stringline

- Check, Check, Check the stringline
 - Remeasure for elevation and alignment
 - Eyeball for obvious errors
 - Eyeball against adjacent pavement
 - Look for parallel planes

FF - 31

After the stringlines have been set, make one more check with the carpenter's level to make certain the line did not slide up or down during the tightening process.

A reference hub spacing of 10 m is a normal staking procedure.



SETTING FORMS

Form setting is a critical construction step. Forms must be accurately set to line and grade and be supported uniformly by a firm foundation.

The finished smoothness of the pavement depends on the care with which the forms are set and maintained because the finishing equipment rides on the forms. Proper alignment and elevation of the forms will contribute to a smooth pavement.

Because the majority of subgrades and bases are now being trimmed full width with stringline controlled equipment, the form lines have been compacted and are at plan grade. Some contractors still use form line graders that operate with a stringline to trim the form grade lines. A firm and level foundation under all forms is required. The forms must not rest on pedestals of dirt or rock; a uniform base is required for support.

Setting Forms

- Form setting is critical construction step
 - Uniform support
 - Proper maintenance
- Proper alignment and elevations contribute to smooth pavement

FF - 35

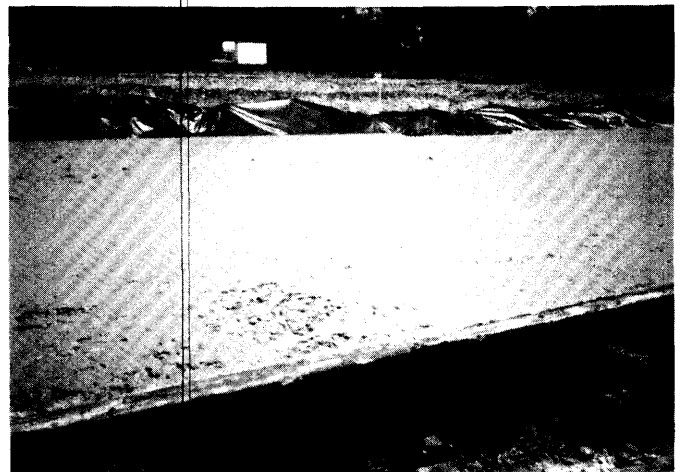

Before the forms are set, they should be individually inspected to determine if they meet the specified requirements. Pin keys should be straight and free moving in the pockets and capable of holding forms tight against the pins. Joint locks should not be bent or worn and should be capable of holding the ends of the form in true alignment. This criteria is an absolute must if the forms are to serve as rails for paving equipment.

Pins of sufficient length to securely hold the forms in place during placing and finishing the concrete should be driven in all pin holes, and keys and form locks should be driven tight. As the key or form locks are driven in, they stabilize the form against the pin, preventing it from moving. These pins should be checked regularly to prevent any form movements caused by equipment moving over the forms.

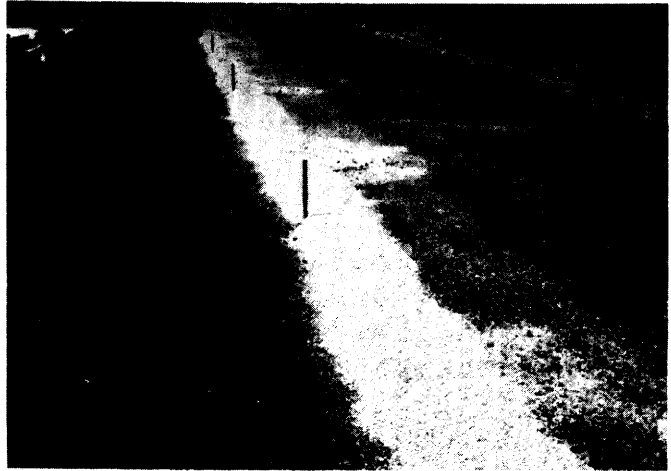

Setting Forms

- Individually inspect before placement
 - Pin keys
 - Joint locks
 - Trueness - top and face

FF - 39



Fixed Form Paving Operations

The top of the inside edge of the form shall match the previously set stringline. Minor alignment corrections can be made utilizing the twin pin keys located on the inside and outside of each pin pocket.

If any form sits above the stringline, it should be tamped or trimmed to the proper grade. If the form sits below the stringline, remove the form and scarify the base. This will prevent separation or peeling of the additional material that must then be added to bring the form to the proper grade line. A firm bed of fine crushed aggregate works well to fill in the low spots. Some projects have used this type of bed for the whole form line.

Setting Forms

- Pins and key locks hold form in place
- Check continually for movement
- Minor alignment corrections - use twin pin keys

FF - 41

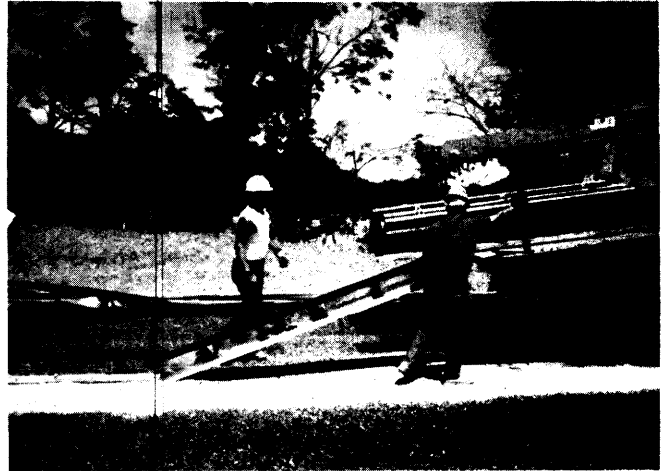

The forms must be set to proper grade and line. Once the forms have been set, they must be checked for overall alignment and tolerance before any paving takes place. The quickest and simplest way of checking is to use the "eyeball" method. Sight along each form line to see that the forms are straight (alignment) and the tops smooth (tolerance). Most of the deviations will be obvious. However, you can use a level to check minor errors, a 3-m straightedge, or stringline. Horizontal alignment can be checked against the offset hubs. Check the width of the roadway between the forms to be sure it conforms to the plans. If any form section is out of line, it should be reset immediately.

Joints between forms must be tight and smooth.



Setting Forms

- Set forms to proper grade - alignment
- Eyeball horizontal and vertical alignment
- Check depth between forms
- Check width between forms
- Check joints between forms

FF - 46

Fixed Form Paving Operations

Keyway strips, when specified, must be attached to the faces of the forms after the forms are in place. Keyways are grooves formed in the vertical edge of one lane of concrete, which later become filled with concrete of the adjacent lane. This provides for load transfer between adjacent lanes.



Setting Forms

- Keyway strips
 - Attach to face of forms
 - Secure tie bars
 - Adjust keyways to match between forms

FF - 48



Keyways between form sections need to be matched to form a smooth horizontal plane parallel to the surface of form. Adjust keyways so they are at proper elevation on the form.

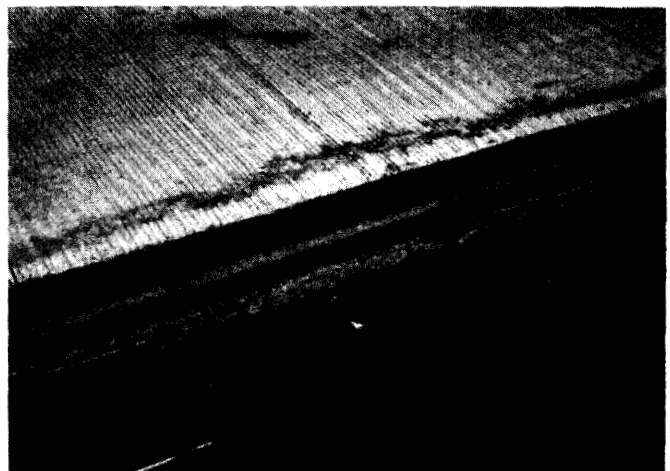
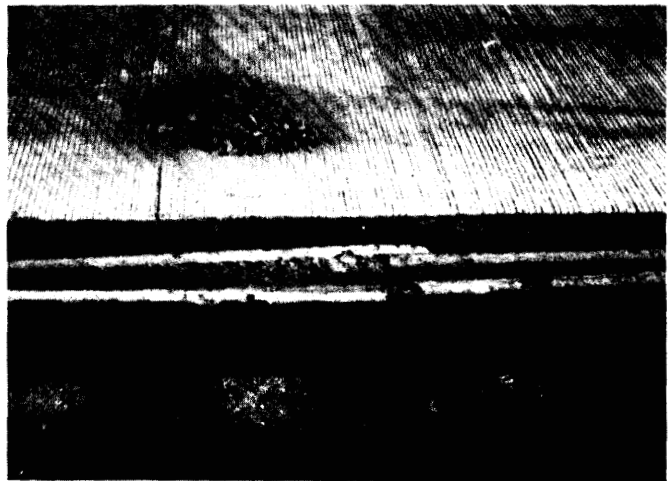

Fixed Form Paving Operations

Tie bolt assemblies or tie bars that connect separately paved adjacent lanes should always be placed so that they are perpendicular to the longitudinal joints. They should be secured by supports to prevent becoming displaced when the concrete is being placed.

Run forms beyond header for proper grades and to allow placing and finishing equipment a platform on grade line to work beyond the pavement's end.

If form riding equipment is used, the proof of a good form setting job will be the absence of form rocking during equipment passage.

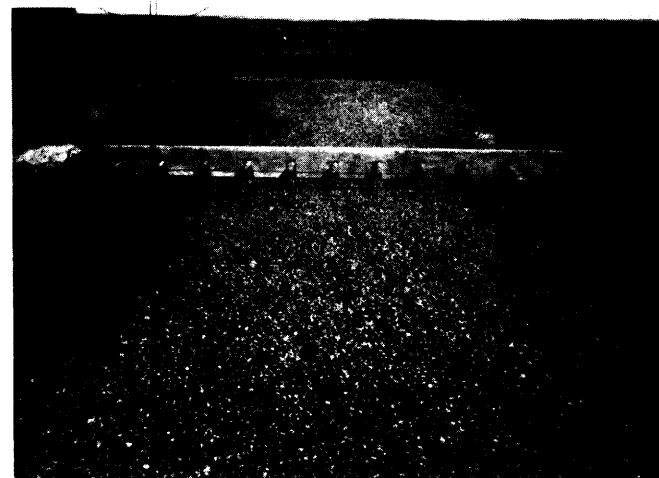
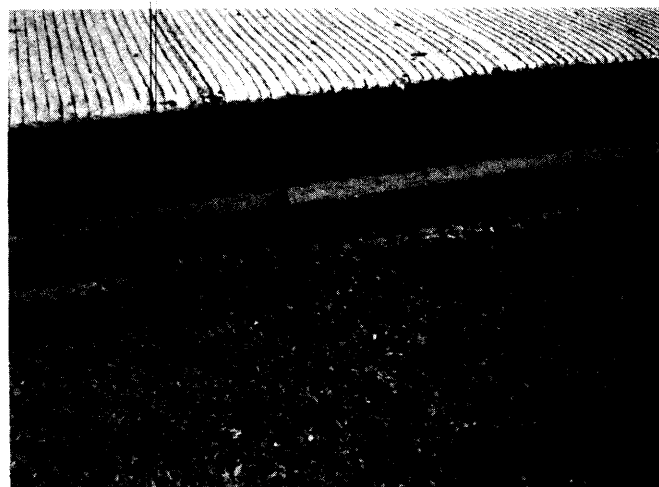
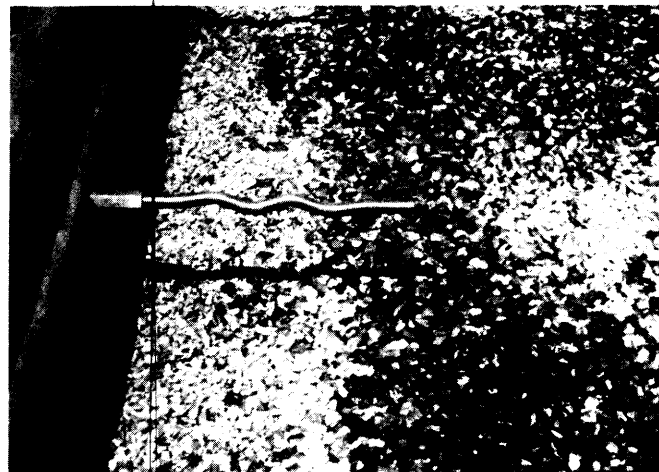

Forming Curves

Flexible forms (steel or wood) used on street returns and other curves of specified radii should be equal in depth to the pavement thickness and be staked or braced to prevent movement during concrete placement.

Obviously, metal forms are most efficient for straight line work. When curves are needed, metal forms can still be used if the radius of the curve is greater than 30 m. On a curve, 3 m straight metal forms must be set in a smooth arc. This permits the paving equipment to maneuver easily around the curve and produce a neat appearance in the finished pavement.

The ends of the form sections must be flush and securely attached to one another. If the adjoining ends are not flush, the paving equipment will be forced up and down, resulting in a bumpy, uneven surface.

If a curve has a radius less than 30 m, flexible form sections must be used to shape the curve. Curved metal forms can be used, although it is not always practical to order these metal forms to fit only one radius. However, if the radius is too small it may not be possible or practical to achieve a smooth curve by using metal forms only. In these situations the contractor could attach wood to metal forms. However, this creates a new problem: form-paving equipment cannot ride on these wood forms. Hence the contractor must use approved equipment for hand placement, consolidation and strike off.

Forming Curves

- Straight section forms set on arc
- Flexible steel forms
- Wood forms

FF - 56

Forming Curves

- Similar requirements to regular steel forms
 - Depth equal pavement thickness
 - Stake in place
 - Ends must attach and be tight

FF - 57

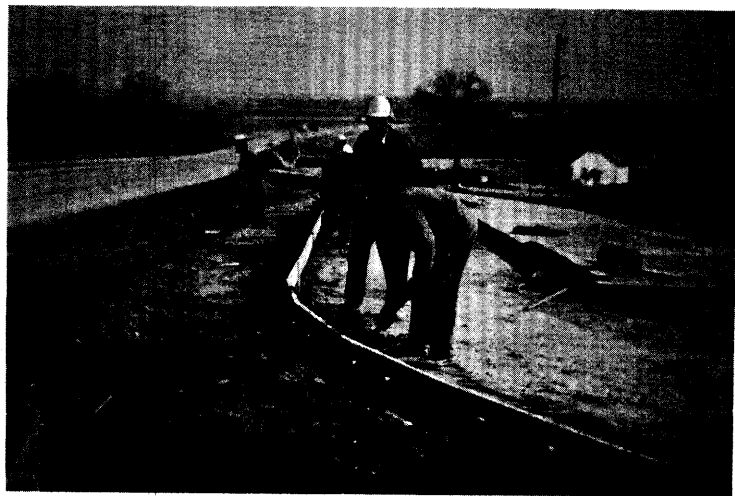

After a curve has been formed, you should call in a survey crew to check it. Compare the crew's findings with the curve data shown in the plans. Extra pins may be needed to hold the wooden forms. These pins may be required both inside and outside the forms in order to make a smooth curve. Any extra pins placed inside the forms will have to be pulled after the concrete is consolidated and before final finishing.

Curbs

Curb type and specifications are as varied as the number of agency specifiers. Make sure the correct curb type is used.

If integral curbs are to be constructed following the placement of the pavement, by either hand forming or use of a curb mule, a curb depth form would be clamped or pinned to the top of the slab form. The curb mules (right and left hand required) are winch propelled. Some machines include integral curb placement as part of one process.

Forming Curves

- Differences
 - May require extra bracing
 - Form paving equipment may not work
 - Hand placement may be required
 - Double check alignment

FF - 59

Curbs

- Check details
- Integral curb
- Straight alignment top and face

FF - 60

Preparing Forms for Paving

Start with clean forms, oil them inside (including keyway) and out prior to concrete placement, and handle them with care. Oiling the outside of the form prior to use makes removal of concrete spilled over the forms during finishing much easier. Oil forms before installation of tie bars or avoid oiling tie bars.

TRIM GRADE AND COMPACTION

Grades that are trimmed following form placement are either trimmed with a fine grade machine that cuts to the proper section or by motor patrols and a tail planer that ride on the forms. A flat steel roller is used following final shaping. The form alignment and profiles should be checked following these operations on subgrade.

Preparing Forms for Paving

- Oil inside and out include keyway
- Do not oil tie bars

FF-61



Trim Grade and Compaction

- Trim after placement of forms
- Final rolling for compaction
- Final check form line
 - Alignment
 - Profile
 - Depth

FF - 63

When granular bases are used, the final trimming may be done after the forms are in place, and the cut material is normally hauled ahead and incorporated into the base being laid. Adding moisture, re-compaction if necessary, and final steel rolling is then accomplished prior to any steel being set.

PLACING OPERATIONS

Reinforcement

Install reinforcement and anchor in place to prevent movement during concrete placement operations.

Mesh reinforcement is normally installed as part of concrete placement operations.

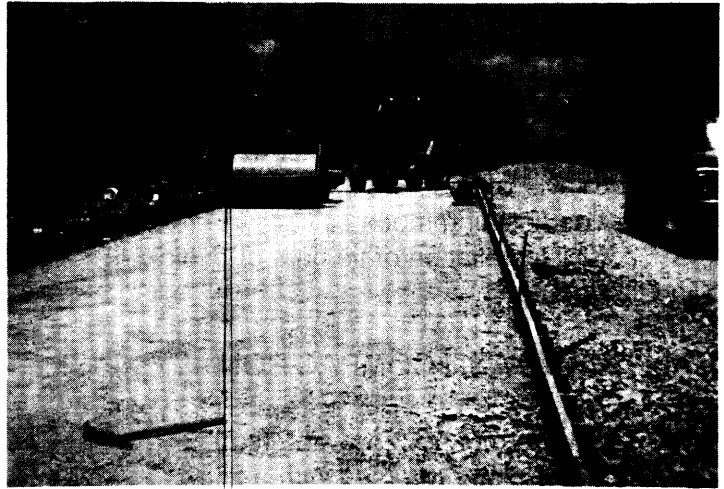

Reinforcement

- Dowel baskets
 - Locate perpendicular to pavement
 - Anchor in place
 - Mark for future reference
- Headers - proper placement
 - Beginning of slab
 - Interrupted operations
 - End of slab

FF - 65



Locate dowel baskets perpendicular to the slab, anchor in place, and mark for future reference.

Headers require care in setting. Place at the beginning and end of the job. Headers may also be required during the day's operations for delivery interruptions or equipment breakdowns.

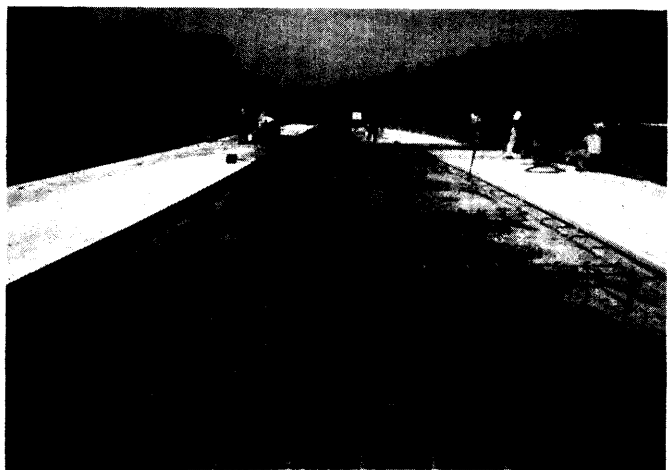
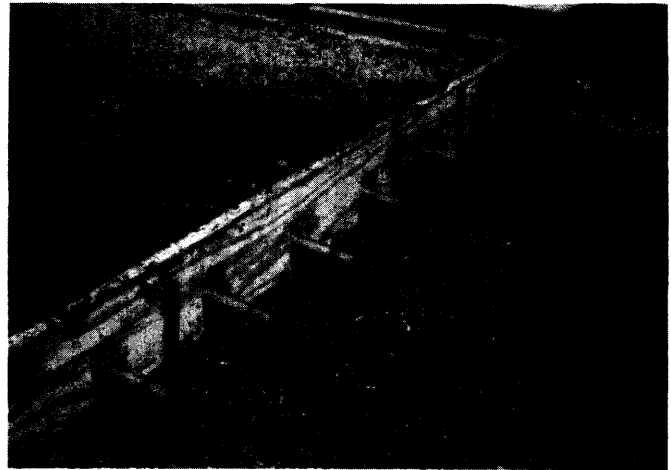
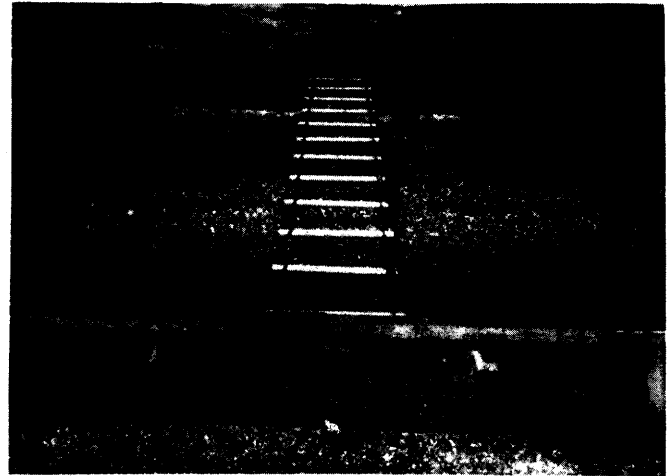

Utilities and Drainage Structures

Urban projects involving storm sewer inlets, junction boxes, water valves, sanitary sewer manholes, natural gas facilities, electrical vaults and cables of all kinds require prior adjustments to proposed grade of various cast iron items or may be boxed out, depending upon local design specification. Fixtures in the form line require boxouts and post paving completion.

Proper compaction over and around these facilities is a necessity to provide uniformity in subgrade support. This includes controlling the moisture content of the material to near optimum.

Utilities - Drainage Structures

- Fixtures on urban projects
- Set to proper elevations and alignment
- Proper compaction around fixtures
- Special jointing may be required

FF - 70

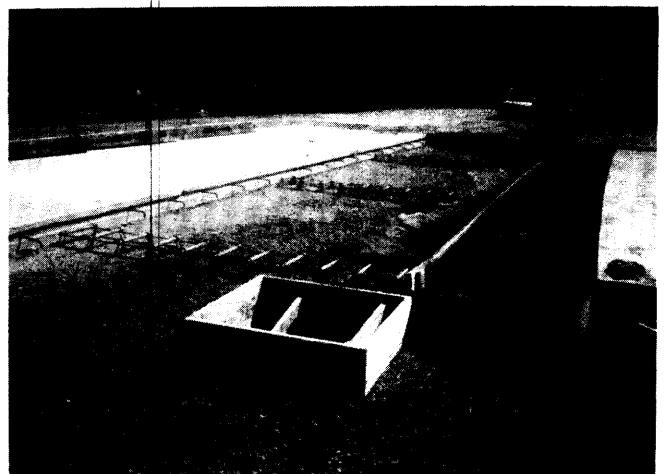

All types of utility and drainage structures, depending on size and location, may require special jointing of the slab to avoid random cracking. This information must be made available to the saw crew.

Jointing layouts of street intersections, alleys, etc. should be available on the plans. Boxouts are normally required wherever adjoining pavement is to be subsequently placed.

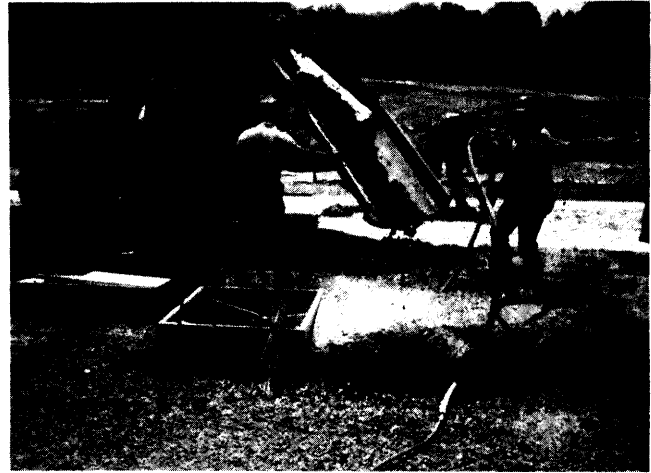

Jointing Special Features

- Jointing layout of street intersections
- Boxout adjoining pavements
- Check plans and details

FF - 74

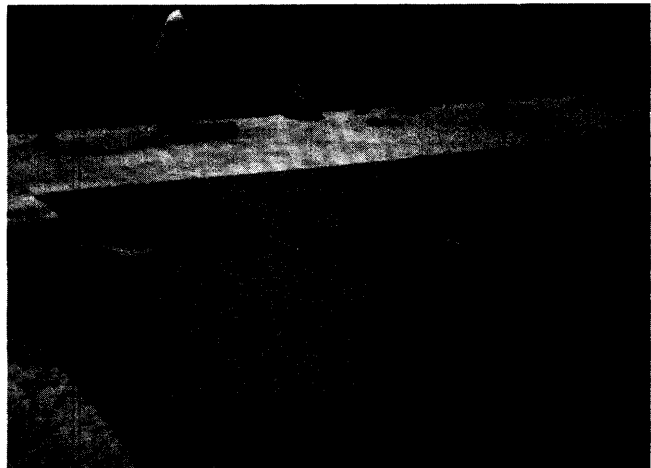

Delivery of Concrete

An avenue for concrete delivery trucks must be designated and communicated to all drivers. Care must be taken so trucks do not disturb the forms or grade near the forms. Delivery of mix should be consistent and of quantity to keep forward progress of paving operations at a rate compatible with placement and finishing operations.

Slump and air content must be consistent and within specification mix design for a quality process.

Delivery of Concrete

- Avenue for delivery trucks
- Care around forms
- Care driving on grade
- Proper strength on new pavements

FF - 76

Delivery of Concrete

- Consistent quality
- Consistent rate
- Rate compatible with
 - Placement
 - Surface finishing operations

FF - 77



Paving Operations

Regardless of the paving method used, it is essential that the concrete be discharged, consolidated, and finished in a uniform manner to eliminate segregation or nonuniform density. Nonuniform placement creates differences in density, allows variance in shrinkage's and results in a rough riding pavement.

UNIFORMITY is the key to placing, consolidating, and finishing concrete pavement with any paving equipment or method.

A consistent and uniform head of concrete in front of the strike off screed needs to be maintained. A head of concrete that does not run over forms or the screed works best. This applies to equipment of all types and sizes.



Delivery of Concrete

- Consistent and within specifications for a quality process
 - Consistent slump
 - Consistent air

FF - 80

Paving Operations

- UNIFORMITY & CONSISTENCY is the key in
 - Placing
 - Consolidating
 - Finishing

FF - 81

Paving Operations

- Consistent - uniform head of concrete
- Consistent vibration pattern

FF - 82

Form Riding Equipment

A conventional form riding train of equipment would include a spreader that has a gang of interval vibrators embedded in the struck off concrete prior to the finishing machines.

If mesh is being installed, two spreaders would be used. The first spreader would strike off the first layer at about 2/3 the final depth of pavement, and the mesh would then be placed.

The finishing machine has twin oscillating screeds, which assist the consolidation process and strike off the concrete to the proper shape. Some trains would include two finishing machines. Some finishing machines have a cantilevered pan float mounted on the rear of the machine which adds a compressive force as the final machine shaping.

On some smaller projects, only the finishing machine is used, and internal vibrators are mounted near the form on each side.

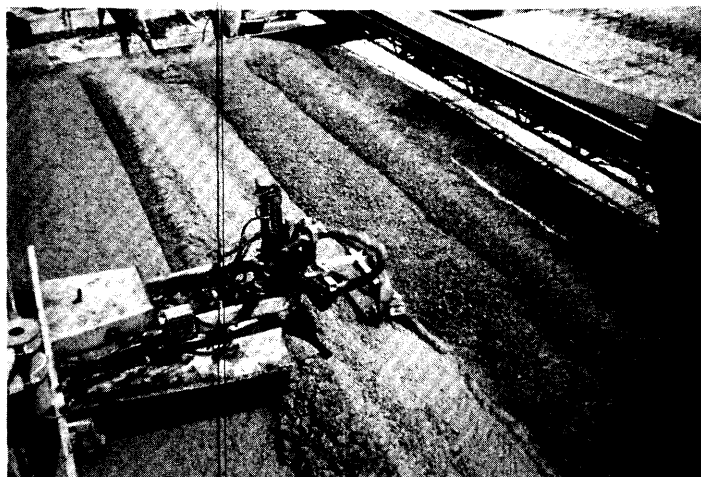

Form Riding Equipment

- Conventional form riding train equipment
 - Spreader with gang internal vibrators
 - Finishing machine
- Automatic machines with paving carriage

FF - 84

Automatic machines, utilizing a heavy duty paving carriage to vibrate, strike off, and longitudinally smooth, seal, and texture the concrete are also being used. These machines ride on the forms or on pipe laid outside the forms, with or without stringline leveling.

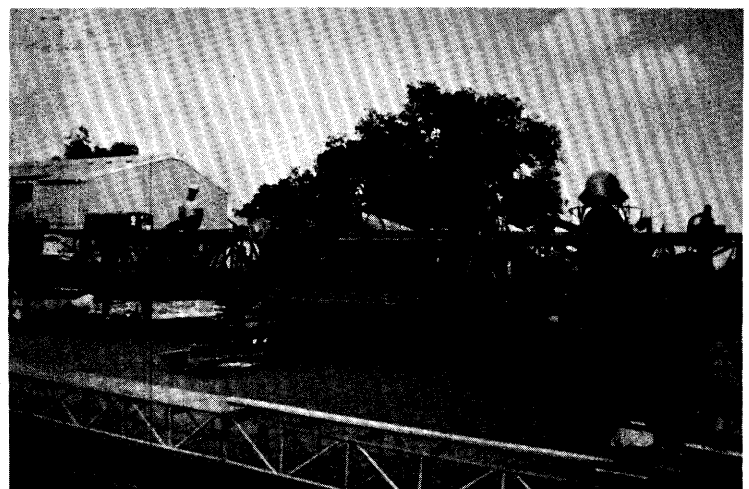
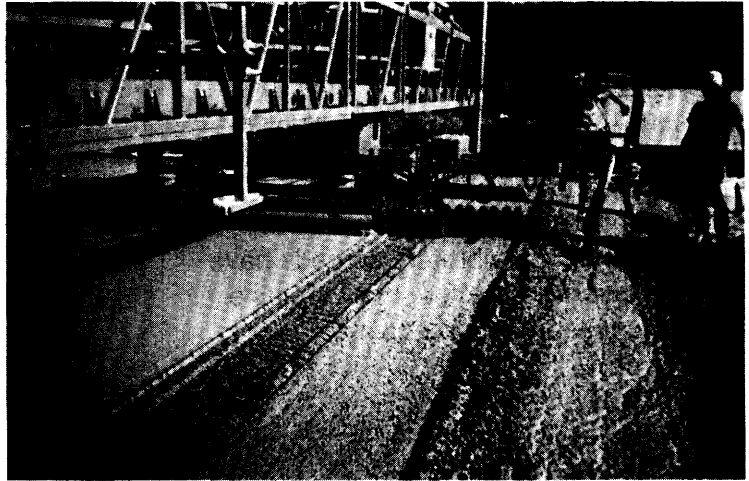

Small Screeds and Hand Placement

For small machine or hand placement, screeding is accomplished in numerous ways, including clary screeds, revolving triple tubes, single tube (drum) finishers, hand operated and self propelled vibratory screeds, and hand operated bull floats. The roller screeds and vibratory screeds have come in common use for small machine and hand placement operations.

Small Screeds/Hand Placement

- Clary screeds - revolving triple tubes
- Single tube finisher - revolving
- Vibratory screeds
 - hand operated
 - self-propelled

FF - 89

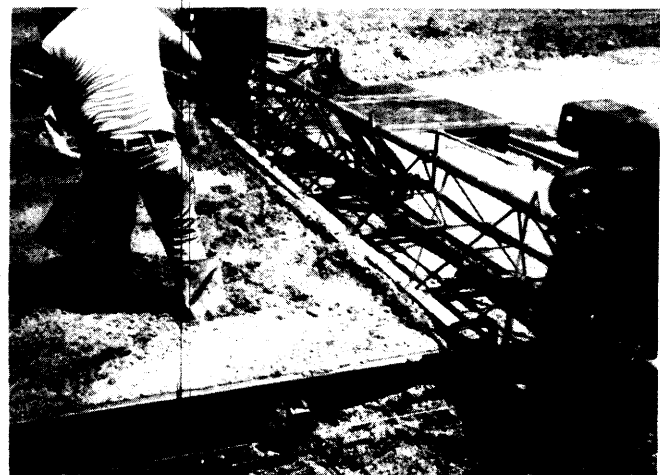

Small machine or hand placing must be done with care. On hand work sections and some short mainline sections, the vibration is generally limited to hand operated spud vibrators working in the concrete ahead of the screed.

The following are the key elements in placement:

- Be sure the concrete is placed and spread uniformly. Move concrete with shovels, not rakes or hand spud vibrators, which can segregate the mix.
- See that vibration is adequate over the total concrete area to obtain proper consolidation.
- Be sure that the workmen keep the vibrating screed moving forward on the forms. If hand screeding is required, it must be done vigorously.



Small Screeds/Hand Placement

- Care required in placement - finishing
- Hand work - hand spud vibration - overlap
- Hand work - floats, highway straight edges
- Be consistent with operations
- Establish consistent procedure - follow it

FF - 93

Key Elements Placement

- Place uniformly
- Vibration adequate for consolidation
- Keep vibrating screed moving forward

FF - 94

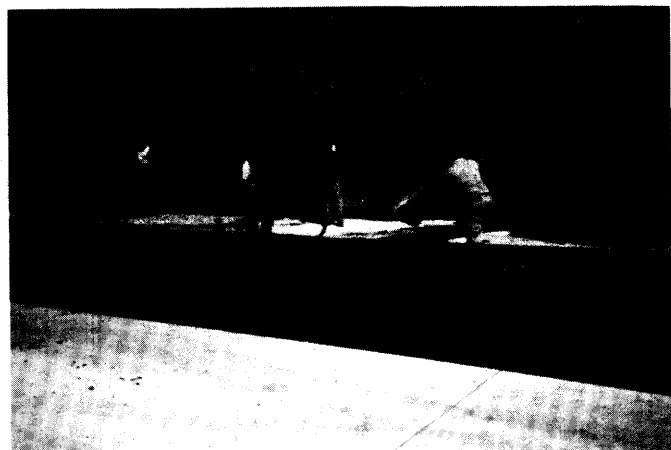

Fixed Form Paving Operations

- The surface must be floated, usually by two men operating hand floats and straightedges. Again, be sure that the work is done thoroughly so the pavement is finished to the proper grade and cross section.
- Successive passes of the screed, if required, should overlap the previous passes. Any excess natural laitance should be wasted over the sides.
- Small irregular areas are often finished with straightedges and cadmium floats only, following hand spud vibration.

Key Elements Placement

- Float the surface
- Finish to proper grade - cross section
- Remember the form is the mold

FF - 96

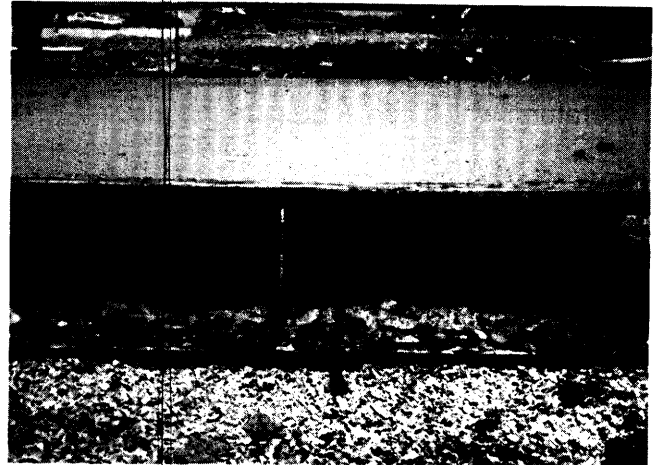

Key Elements Placement

- Overlap passes of screed
- • Waste any excess natural laitance
- Irregular areas
 - spud vibrate
 - finish with hand equipment

material on the top

FF - 98



Curb Placement

The finishing process in the gutter line is critical to maintain water flow, especially on flat grades, high or low points of vertical curves and near storm water intakes. The top edge and face of the curb needs to be established and finished straight, or the whole acceptability of the pavement could be visually in question.

Curb Placement

- Critical gutter grades for drainage
 - high points
 - low points
 - storm water intakes

FF - 100



Fixed Form Paving Operations

Curing

The curing for fixed form paving is similar to slipform paving except that cure needs to be applied to edges after form removal.

Sawing and Sealing

The pavement may need transverse sawing before removal of forms. The transverse joints should be roped for construction traffic before being used as a haul road. Other particulars on sawing and sealing are discussed in that module.

Curing

- Rate according to specifications
- Uniform application
- Timely application
- Cure edges after form removal

FF - 102



FORM REMOVAL

The transverse joints are sometimes sawed prior to removal of forms. This may be a local specification or contractor preference.

In most instances, the forms can be removed in as soon as 6 to 8 hours if extreme care is used during the pin pulling and unlocking of the forms. Pull pins first with a pin extractor (mechanical or hydraulic), then remove forms without prying between the edge of the forms and the concrete. A light tap followed by hand removal is preferred.

After removing the forms, check to see that there was adequate vibration to produce a dense concrete along the form line. Excessive honeycracking indicates insufficient vibration. If necessary, the vibration process should be adjusted when paving resumes.

The edges of the pavement must then be cured as soon after the forms are removed as possible.



Form Removal

- Remove timely
- Pull pins
- Tap lightly before removal
- Check edge for honeycomb
- Cure edges

FF - 106

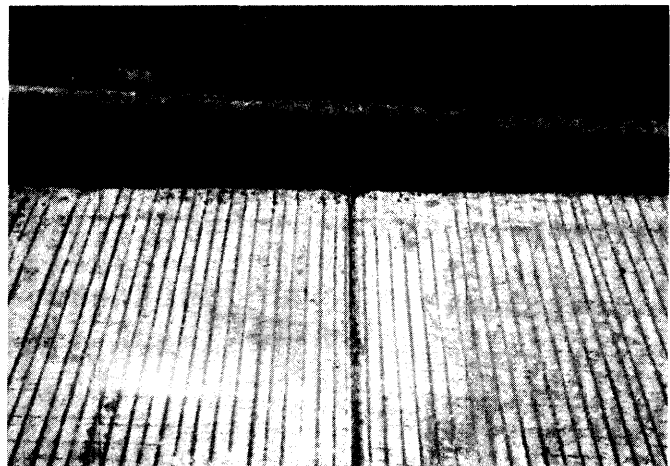

Form Management

Forms should be cleaned immediately after removal if possible; otherwise, they become difficult to clean. Dirty forms are difficult to check with straightedges.

Forms should be treated with care so they are ready to perform for the next day or job. Store them neatly and orderly in trucks, job site or yard. Properly handled, they will last for years.

Form Management

- Clean after removal
- Store neat and orderly - trucks, job site and yard

FF - 108

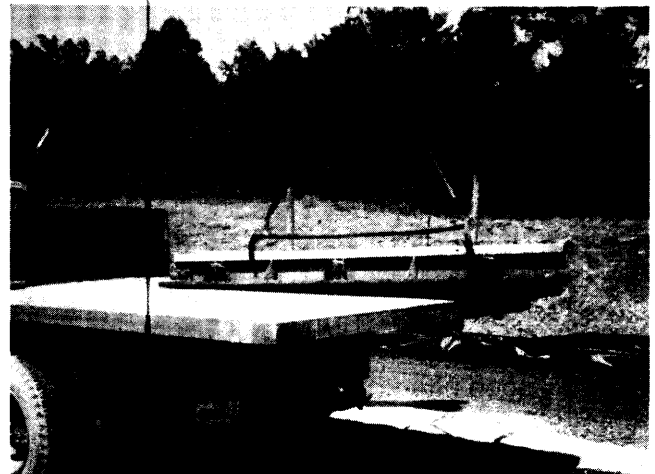

CRITICAL FACTORS OF FIXED FORM CONCRETE PAVING AFFECTING RIDE QUALITY

Producing a good ride with forms is dependent upon numerous factors, including the following, exclusive of design considerations:

- Uniform grade, properly compacted and moistened ahead of concrete placement.
- Good form line compaction, properly graded.
- Forms that meet the specifications.
- Proper stringline erection and form placement, including oiling.
- Proper construction and grading of boxouts and fixture adjustments.
- Proper placement of dowel baskets and preplaced reinforcement, including keyway.
- Consistent mix, slump, and timely delivery.
- Proper placement of the mix on the grade. Cover grade, avoid excessive piles.
- Don't place too far ahead of finishing equipment.
- Adequate vibration and consolidation. If hand puddling, no rakes, move surplus concrete with shovels rather than vibrators, use extra care in placing concrete over the basket assemblies and in vibrating that area.

Critical Factors Fixed Form Paving - Ride Quality

- Uniform grade - properly compacted
- Good form line compaction
- Forms meet specifications
- Proper stringline installation - form placement

FF - 111

Critical Factors Fixed Form Paving - Ride Quality

- Fixture and boxout installation
- Placement reinforcing, dowel baskets, keyways
- Consistent mix, slump

FF - 112

Critical Factors Fixed Form Paving - Ride Quality

- Timely delivery
- Proper placement mix on grade
- Keep within proper distance from spreading operations

FF - 113

- Proper machine adjustments and operation. Steady machine progress enhances smoothness. Avoid excessive finishing. No water buckets or paste brushes. Spray mist if necessary. Straightedge check of slab. Use float to fill any surface voids that show up behind finishing machine.
- Use edger on slab edges, top of curb if placed, and around box-outs and expansion joints if included. Use minimum radius edger compatible with mix being used, especially where future placement of slab will abut.
- Keep burlap drag moist but not sloppy.
- Wait for sheen to disappear before tine texturing, if specified.
- Adequate application of cure, on time.
- Cure sides of slab after form removal.
- Use a good concrete supplier and communicate often.

Most of the above listed items are also applicable to rural projects, with the exception of the utility fixtures and the handling of the concrete ahead of the finishing equipment. Spreaders, vibration equipment, and additional finishers are often necessary for the increased production associated with mainline rural jobs.

Critical Factors Fixed Form Paving - Ride Quality

- Increased production will require additional
 - spreaders
 - vibration equipment
 - finishers

FF - 117

Critical Factors Fixed Form Paving - Ride Quality

- Adequate vibration - consolidation
- Care in placement and vibration
 - dowel baskets
 - keyways
 - fixtures
 - boxouts
 - headers

FF - 114

Critical Factors Fixed Form Paving - Ride Quality

- Proper machine adjustments
- Steady machine progress
- Avoid excessive finishing
- Avoid excessive water on surface
- Straightedge check of slab

FF - 115

Critical Factors Fixed Form Paving - Ride Quality

- Use edger on slab
- Keep burlap drag moist, not sloppy
- Tine after sheen disappears
- Adequate cure
- Communicate often with concrete producer

FF - 116

Group Exercise No. 1

Instructions:

Based on what we have been discussing, list the items that you feel are important about fixed form paving operations. Develop a checklist to be used by the person that you assign to be responsible for.

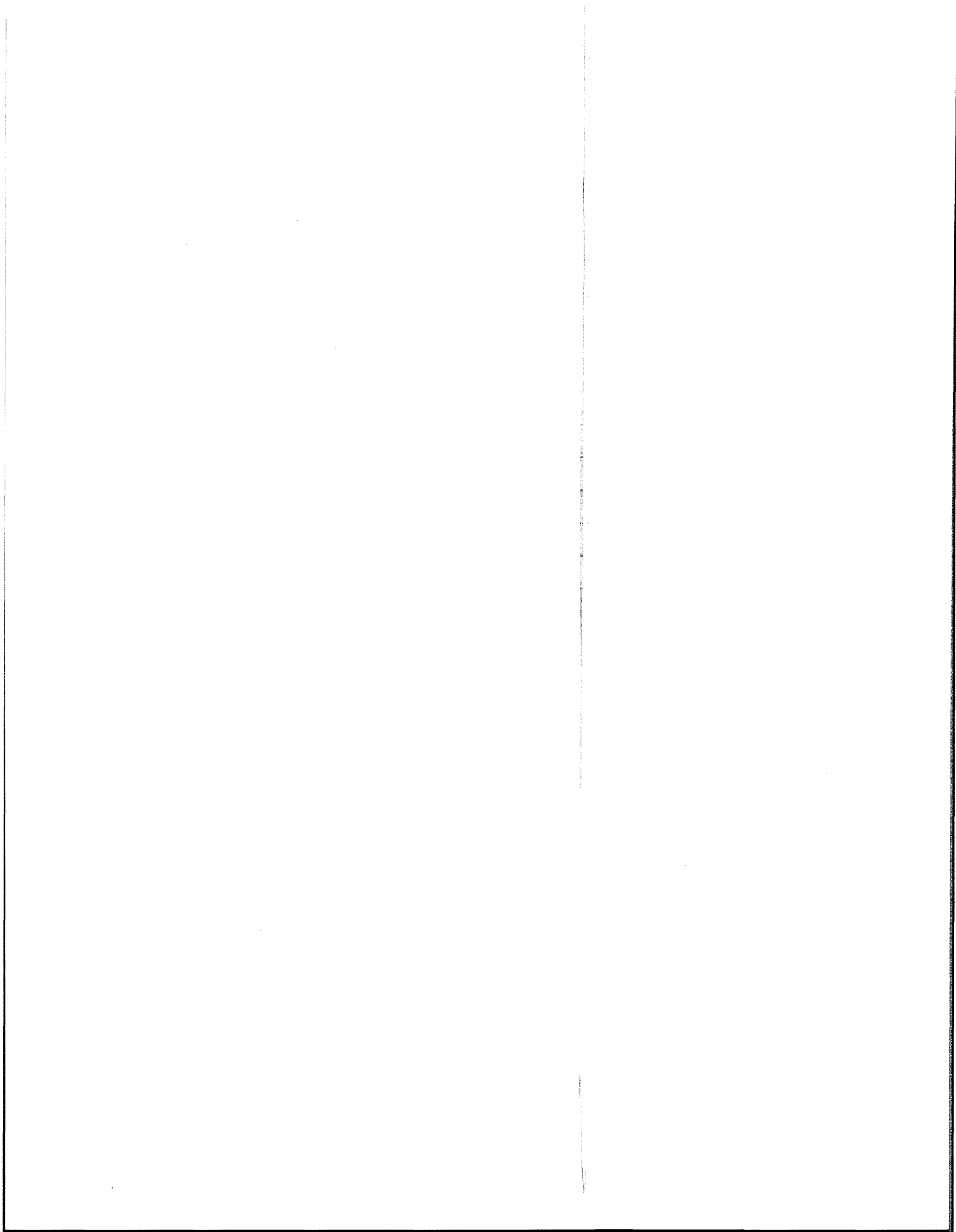

VII. Saw and Seal Operations

Saw and Seal Operations

- A) OBJECTIVES
- B) PRECONDITIONS
- C) SAW AND SEAL OPERATIONS
 - 1) Communications And Preparations - CAP
 - 2) Need for Sawing and Sealing
 - a) Crack Control - Saw
 - b) Joint Performance - Seal
 - c) Slab Movement
 - 3) Sawing
 - a) Types of Pavement Joints
 - 1. Transverse Contraction Joints:
 - 2. Transverse Construction Joints:
 - 3. Transverse Expansion/Isolation Joints:
 - 4. Longitudinal Contraction Joints:
 - 5. Longitudinal Construction Joints:
 - b) Types of Saw Cuts
 - 1. Initial Saw Cut:
 - 2. Widening Cut:
 - 4) Sawing Equipment and Application
 - a) Saw Blade - General
 - b) Types of Sawing
 - 1. Wet Sawing - Diamond Blades
 - 2. Dry Sawing - Abrasive Blades
 - 3. Dry Sawing - Diamond Blades
 - c) Pavement Saws
 - 1. Small Saws
 - 2. Medium Saws
 - 3. Large Saws
 - 4. High Production Saws

- 5) Job Site Operations
 - a) Initial Transverse Saw Cut
 - 1. Locate Joints - Transverse
 - 2. Mark Joint Location - Transverse
 - 3. Sawing Window
 - 4. Saw Timing
 - 5. Joint Raveling
 - 6. Sawing the Transverse Contraction Joint
 - 7. Traffic Considerations
 - b) Initial Longitudinal Saw Cut
 - 1. Locate Joint - Longitudinal
 - 2. Mark Joint Location - Longitudinal
 - 3. Saw Timing
 - 4. Sawing Longitudinal Joint
 - 5. Traffic Considerations
 - c) Widening Cut for Sealant Reservoir
 - 1. Sawing Widening Cut
 - 2. Traffic Considerations

- 6) Joint Sealing
 - a) Materials
 - 1. Formed-in-place Materials
 - 2. Backer Rod Materials
 - 3. Preformed Materials
 - b) Formed-in-place Joint Preparation
 - 1. Water Washing
 - 2. Abrasive Cleaning
 - 3. Air Cleaning
 - 4. Moisture Conditions
 - c) Formed-in-place Install Materials
 - 1. Backer Rod Installation
 - 2. Sealant Installation (Formed-in-place)
 - 3. Hot Applied Sealant - Considerations
 - 4. Cold Applied Sealant - Considerations
 - d) Preformed Joint Preparation
 - 1. Water Washing
 - 2. Air Cleaning
 - e) Preformed Install Materials

D) CRITICAL FACTORS IN SAWING AND SEALING OF NEW CONCRETE PAVEMENTS

Saw and Seal Operations

OBJECTIVES

Upon completion of this module, the participants will:

- Understand the need for properly designed joints in concrete pavements.
- Gain a working knowledge of sawing and sealing operations and applications.
- Recognize the critical factors that affect joint and pavement performance.

PRECONDITIONS

For the purpose of this module, the following assumptions have been made:

- Concrete mix has been determined.
- Joint design has been determined.
- Specifications have been established.

Objectives

- Understand the need for properly designed joints in concrete pavements
- Gain a working knowledge of sawing and sealing terminology operations and applications
- Recognize the critical factors which affect pavement performance

SS - 2

Preconditions

- Specifications are determined
- Concrete mix is determined
- Jointed pavement
- Joint design is determined

SS - 3

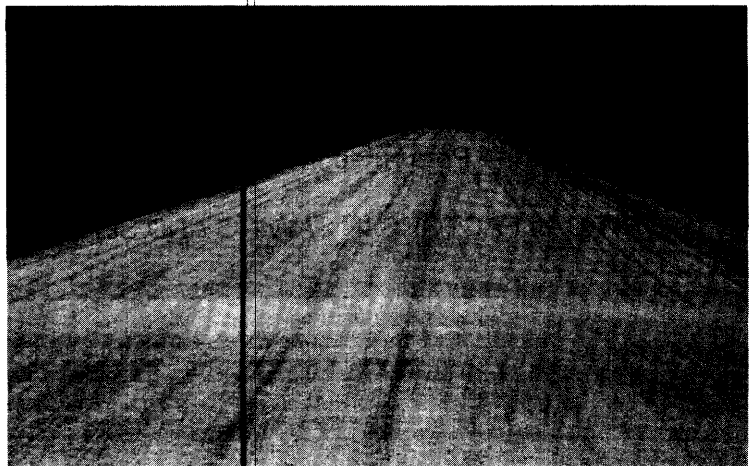

COMMUNICATIONS AND PREPARATIONS - CAP

An important aspect to avoid problems on the sawing and sealing phase of the project is planning and preparations prior to arriving on the job. This can only be accomplished if all parties are adequately informed (communication); have the necessary equipment on the job, understand when and what is to be accomplished, and are ready for any complication (preparations). This could be viewed as an action plan. For purposes of this discussion, it will be called the Communications and Preparations Plan, or CAP.

Primarily, CAP occurs in a meeting held between the paving and sawing crews prior to beginning paving to discuss the factors that influence the sawing and sealing operation. These factors will contribute to success or failure of the project and will have short- and long-term impacts on the performance of the pavement. The items discussed and decisions made at the meeting will also significantly impact the contractor, subcontractor, pavement owner, and motoring public. A number of the elements of the CAP must also be considered during the preparation of the project bid.

The meeting should answer the basic question, What is required with regard to equipment, manpower, and techniques to complete a successful sawing and sealing operation? A checklist will assist in answering the question.

CAP

- Communications
- And
- Preparations

SS - 5

Objectives

- Understand the need for properly designed joints in concrete pavements
- Gain a working knowledge of sawing and sealing terminology operations and applications
- Recognize the critical factors which affect pavement performance

SS - 6

NEED FOR SAWING AND SEALING

Crack Control—Saw

A joint is a designed crack. Cracks in newly constructed concrete pavement occur from concrete shrinkage and temperature differences between the top and bottom of the slab.

A sawed joint provides a plane of weakness to allow the pavement to crack at designated locations. Controlled cracks are much easier to maintain than random cracks. By designing the pavement with joints, the natural cracks can occur without affecting the rideability and performance of the concrete pavement.

Need for Sawing

- Designed crack
- Why crack control
 - Shrinkage cracks
 - Thermal cracks
- Minimize impact of cracks

SS - 8

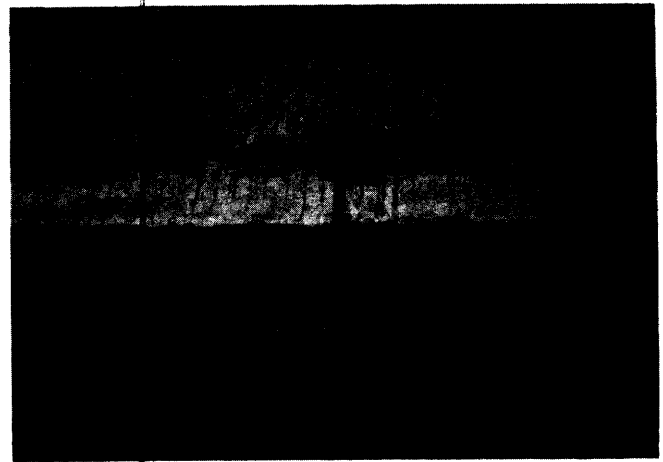

Joint Performance—Seal

Sealing joints minimizes the intrusion of moisture and incompressible material, such as small stones, which can lead to joint faulting, pavement distress, and subgrade failure near joints. Well-sealed joints help maintain the integrity of the joint, pavement slab, and subbase over time.

Joint type, shape, and sealant material are all interrelated and must be compatible for adequate pavement performance.

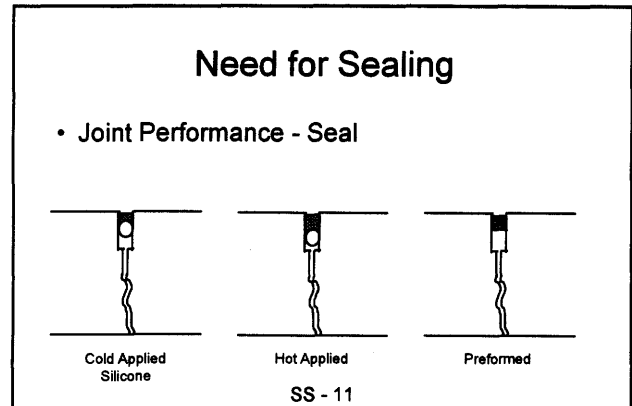

*Backer rod
consume amount of sealant used*

Slab Movement

Although not necessary for sawing and sealant installation procedures, reviewing the relationship between temperature and concrete slab movement is necessary to thoroughly understand joints.

Joint movement (opening or closing) occurs with changes in temperature. The amount of movement depends on the length of the slabs and the temperature change. A long slab will move (expand or contract) more than a short slab for the same change in temperature. A given slab will move more for greater temperature changes.

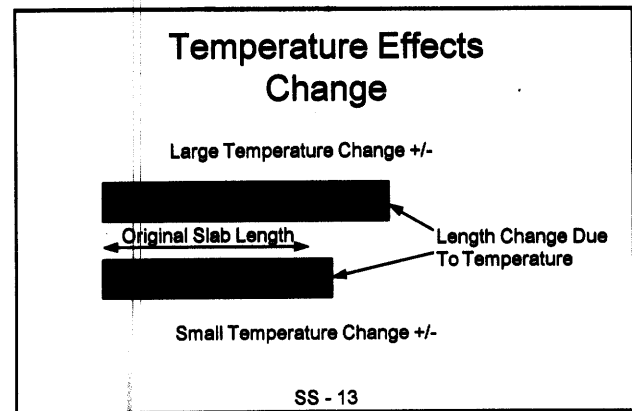
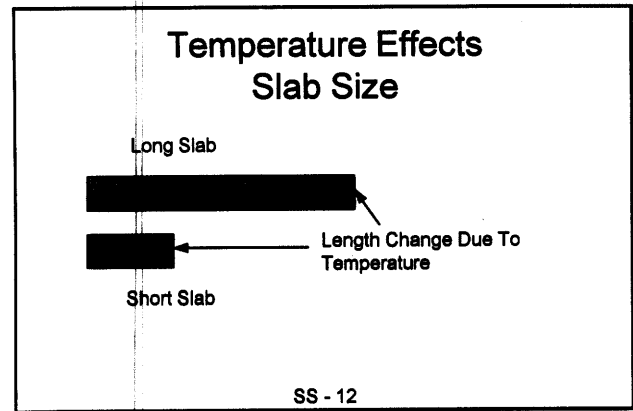

pavements over 14' wide need a Q joint

SAWING

Types of Pavement Joints

The most common types of joints in concrete pavement construction are as follows:

Transverse Contraction Joints

Joints that are constructed transverse (perpendicular) to the centerline and spaced to control cracking from stresses caused by shrinkage, moisture, and thermal changes. Joints may either be oriented at right angles to the centerline or skewed to the centerline.

Transverse Construction Joints

Joints installed at the end of the daily paving operation. These joints are often referred to as headers. Transverse construction joints are also placed when there is a significant delay with concrete delivery to the site or other gaps in continuous paving operations. These should be installed at the location of a planned contraction joint whenever possible.

Transverse Expansion/Isolation Joints

Joints placed at locations that allow movement of the pavement without damaging adjacent structures, such as bridges, drainage structures, or the pavement itself.

Types of Pavement Joints

- Transverse
 - Contraction
 - Construction
 - Expansion/Isolation

SS - 14

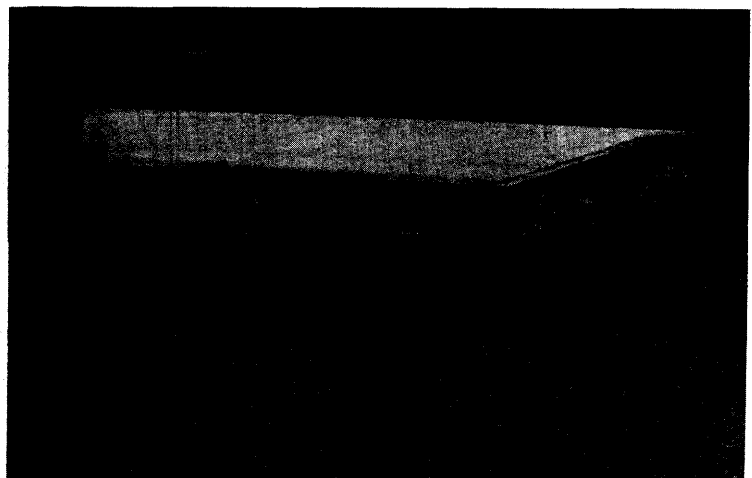
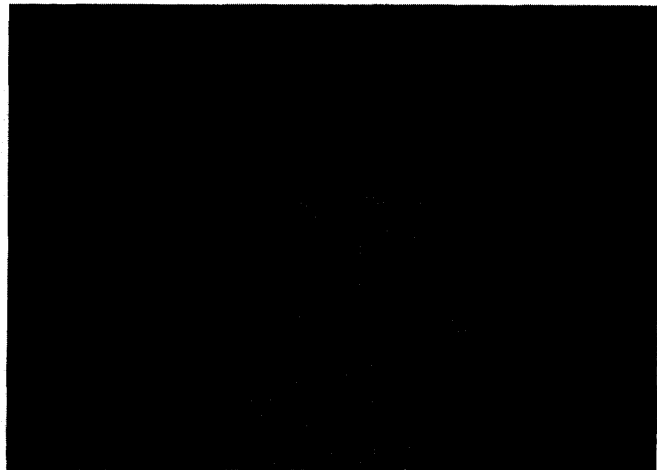

Longitudinal Contraction Joints:

Joints that control cracking where two or more lane widths and shoulders are placed at one time.

Longitudinal Construction Joints:

Joints that join adjacent pavement lanes and shoulders that are paved at different times.

Types of Pavement Joints

- Longitudinal
 - Contraction
 - Construction

SS - 17

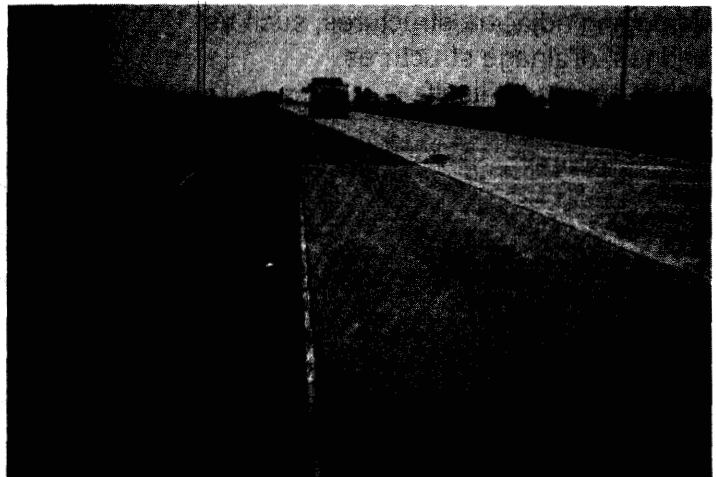

Types of Saw Cuts

Initial Saw Cut:

The initial saw cut creates a plane of weakness to control shrinkage cracking of the slab. Initial saw cuts are made in both transverse and longitudinal directions. Transverse sawing is performed as soon as the concrete slab will support saw equipment and the cut can be made without undue raveling. Longitudinal sawing should be done in conjunction with the transverse sawing.

Notice that the initial saw cut in the photograph is not carried all the way through. Recommended good practice is to carry the initial saw cut through the full width of the slab.

d/3

Widening Cut:

The widening cut is necessary to shape the joint for the sealant material. The widened joint reservoir provides a shape factor that allows the sealant to achieve optimum performance. The shape factor is the ratio of the depth of the joint sealant to the widening cut of the joint. The shape factor is specific to the sealant specified and the joint spacing.

The widening cut can be made at the same time as the initial saw cut when the contractor employs a specially designed saw blade. This special type of blade creates the initial saw cut and the widening cut in a single pass.

Types of Saw Cuts

- Initial Saw Cut (Crack control)
- Widening Cut (Joint sealant reservoir)

SS - 20

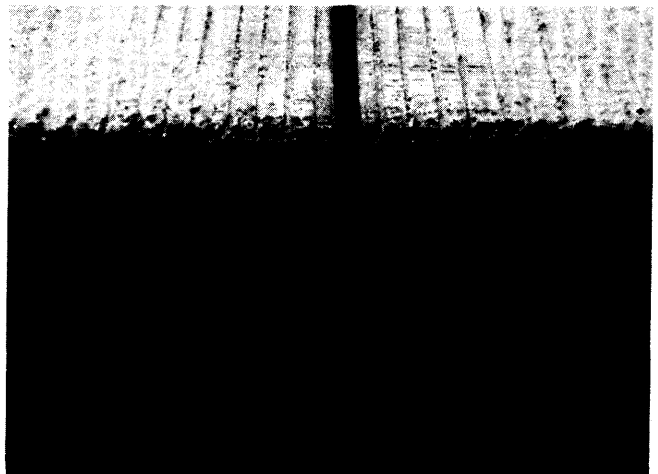
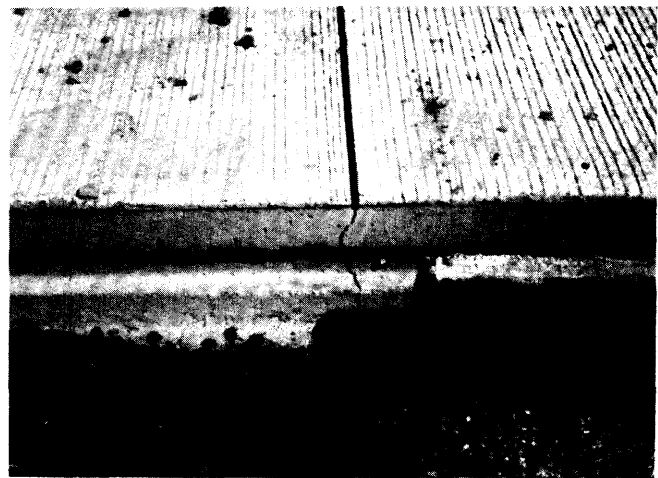

SAWING EQUIPMENT AND APPLICATION

Saw Blade—General

The selection of the proper saw blade is critical to any sawing operation. The saw blade must be compatible with the power output of the saw, the concrete mix design, and the application. Blade selection factors can be described as primary and secondary. Primary factors include hardness and abrasion of coarse aggregate. Secondary factors are power of saw, mix design, age of pavement, admixtures such as fly ash, and fine aggregate abrasion.

Equipment suppliers/manufacturers can provide blades matched to the project needs and should be consulted for assistance with specific project requirements.

Types of Sawing

The types of sawing are wet sawing (diamond blades) and dry sawing (abrasive or diamond blades).

Objectives

- Understand the need for properly designed joints in concrete pavements
- Gain a working knowledge of sawing and sealing terminology operations and applications
- Recognize the critical factors which affect pavement performance

SS - 23

Saw Blade

- Diamond
- Abrasive

SS - 25

Types of Sawing

- Wet sawing
 - Diamond blades
- Dry sawing
 - Abrasive blades
 - Diamond blades

SS - 26

Wet Sawing—Diamond Blades

Wet sawing with diamond saw blades is the most common method of making both the initial saw cut and the widening cut. Diamond saw blades use industrial diamonds as the primary abrasion element. Diamond blades usually require water for lubrication and to cool and protect the host metal. Without water the metal will overheat and melt, which can cause loss of diamonds. Water also eliminates dust associated with dry sawing.

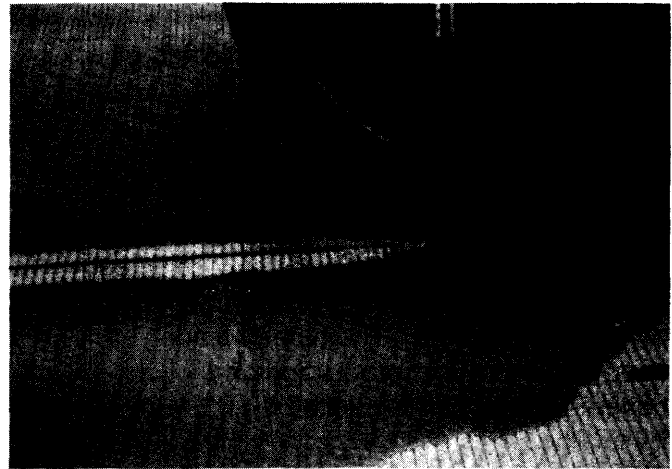

Dry Sawing—Abrasive Blades

Dry sawing is performed with abrasive saw blades. These blades are made of a fiber reinforced silicone carbide or carborundum and do not require water to cool the blade. Dry sawing is most commonly used with softer aggregate such as limestone.

As abrasive saw blades wear, the diameter decreases, therefore, it is important to monitor the saw depth. Checking both the sawed depth and the diameter of the saw blade ensure proper joint sawing.

Dry sawing creates dust. Sometimes water is used to control the dust.

Dry sawing is typically used for low volume applications. This type of sawing operation has limited applications and can become very costly when used under the wrong conditions (i.e., hard aggregates).

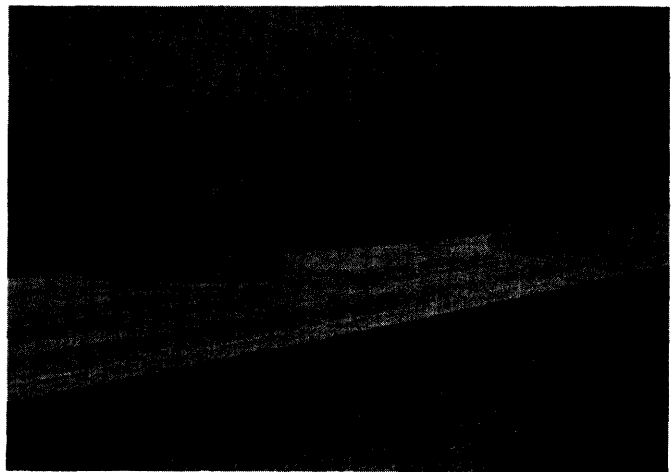

Dry Sawing—Diamond Blades

Dry sawing can also be performed with diamond blades. This type of operation is used mainly for low production paving or to supplement normal sawing on large projects.

Pavement Saws

Pavement saws are generally classified by engine power rating, kilowatts (kW). Pavement saws may also be classified as small, medium, large, and high production. Pavement saws may be self-propelled, self-propelled rideable, or push types. The kilowatt and type of pavement saw selected for a project must match the application and production required. The type of blade used will also affect production and pavement saw performance.

The rotation of the saw blade varies between the different types of pavement saws. On most saws, the blade rotation is clockwise resulting in a down-cut. Down-cut blade rotation tends to minimize raveling on new concrete and helps to propel nonself-propelled saws. On some pavement saws the blade rotation is counterclockwise, resulting in an up-cut.

Small Saws

Small saws range in power between 6 and 13 kW and are most commonly used for dry sawing applications. Saws in this category can either be push type or self-propelled. Lightweight, early cut saws fall into this category.

Pavement Saws

- Small
- Medium
- Large
- High production

SS - 29

Small Saws

- Power 6-13 kW
- Dry applications
- Push type or self propelled
- Lightweight and early cut saws

SS - 30

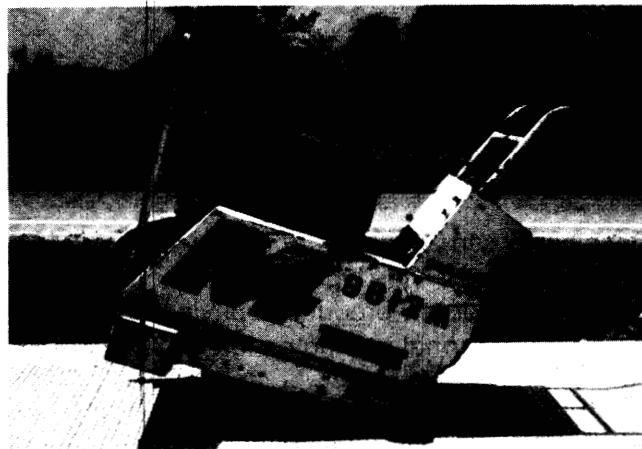

Medium Saws

Medium saws range in power from 15 to 28 kW. These saws are self-propelled and are used for wet sawing operations. An advantage for this size of saw is maneuverability.

Medium Saws

- Power 15-28 kW
- Self propelled
- Wet sawing
- Maneuverability

SS - 32

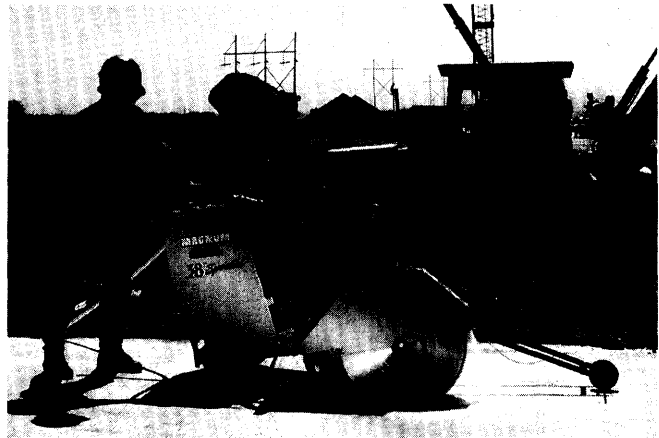

Large Saws

Large saws range in power from 50 to 55 kW. They are self-propelled and used for wet sawing operations. These saws are typically used for longitudinal joints where maneuverability is less critical.

Large Saws

- Power 50-55 kW
- Self propelled
- Wet sawing

SS - 34

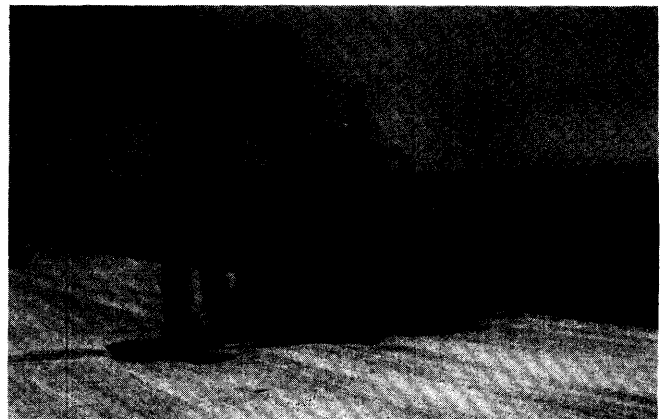

High Production Saws

High production saws include rideable, span, and centerline saws.

The rideable saws range in power from 50 to 55 kW. They are used for wet sawing operations.

Span saws range in power from 50 to 150 kW and are multi-blade saws used for wet sawing operations.

High Production

- Rideable saw
 - Power 50-55 kW
- Span saw
 - Power 50-150 kW
- Centerline saw
 - Power 50-60 kW

SS - 36

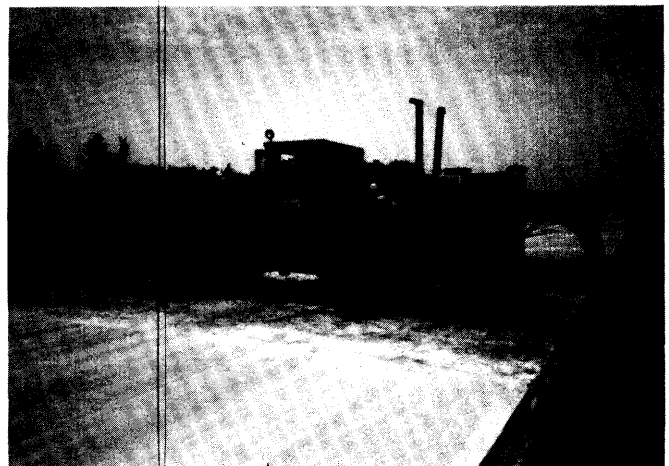
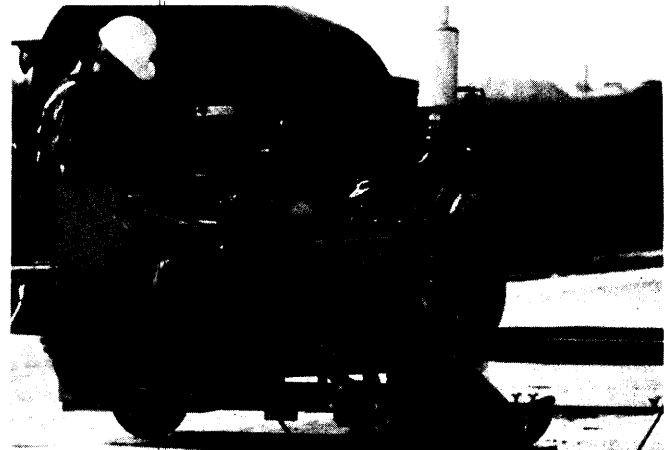

Centerline saws range in power from 50 to 60 kW. Some centerline saws have guides that work off of the edge of the pavement slab. Care must be taken to watch for changes in the geometry of the pavement when using this equipment.

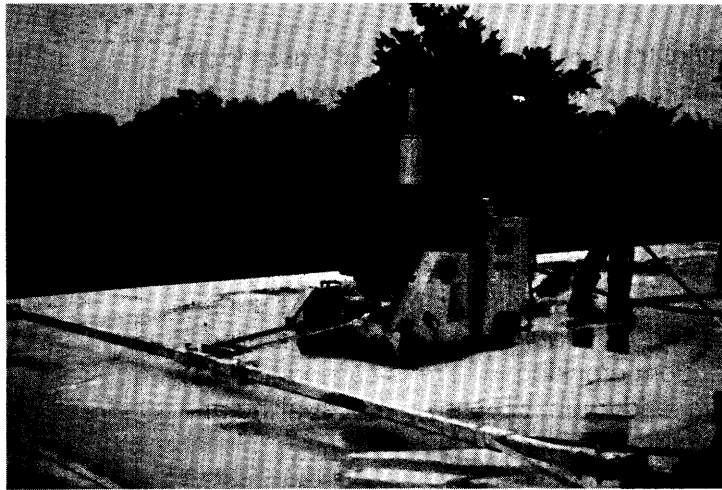

JOB SITE OPERATIONS

The operations on a job site for sawing consist of initial transverse saw cut, initial longitudinal saw cut, and sealant reservoir widening cut.

Job Site Operations

- Initial transverse saw cut
- Initial longitudinal saw cut
- Widening saw cut

SS - 41

Job Site Operations Initial Transverse Saw Cut

- Locate
- Mark/Blank
- Wait (Window)
- Saw
- Traffic considerations

SS - 42

Initial Transverse Saw Cut

Initial transverse sawing to control random cracking requires sawing uniform contraction joints as soon as the concrete has obtained sufficient strength. This cut should not tear or cause the aggregate to dislocate from the concrete. The slab must also be of sufficient strength to support the saw equipment without marring the surface.

Sawing too late can lead to uncontrolled random cracking, whereas sawing too early can lead to unacceptable joint spalling and raveling.

Immediately after initial sawing, the joints should be flushed with water to prevent saw residue from drying in the joint. The residue, if left in place, may prevent opening and closing of the joint during temperature changes or make it difficult to clean the joint prior to sealing.

Locate Joints—Transverse

Locating joints prior to placement of concrete is critical to avoid mistakes before sawing begins. Field locating for each joint is especially critical when load transfer mechanisms, such as dowel bars, are used. The transverse joints are typically located by the paving contractor when installing the dowel baskets. The joint location control points must be marked on both sides of the pavement away from the pavement edge. This prevents the points from being disturbed while the slab is being paved. Do not rely on marks made on fixed forms because the forms may be removed before sawing begins. Some type of pin is recommended for a semipermanent control point.

Pavers equipped with mechanical dowel bar inserters (DBI) have a mechanism that marks the joint location with a paint spot with each insertion of the dowels into the pavement. A pin should be installed on the paint mark to avoid rubbing out the paint with other operations prior to sawing.

Extra care needs to be exercised in locating transverse joints when they are skewed.

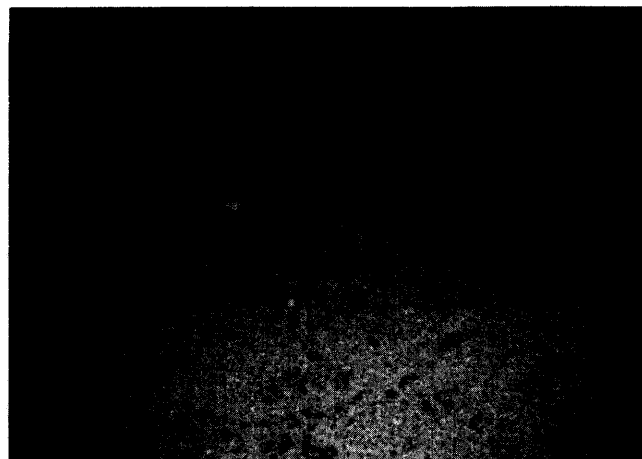

Mark Joint Location—Transverse

The transverse joint is usually marked with a chalk line pulled tight between the marked control points on both sides of pavement. It is essential that the same procedure is followed every time for marking the joint locations. When a span saw is used to make the initial transverse cut it is not necessary to snap a chalk line.

Adjustments to the normal joint pattern may be necessary at intersections and fixtures in the pavement. Understand what changes are required at these locations prior to initiating the job. Normally, the plans will detail changes to the regular joint pattern; however, these changes should be discussed during the CAP process.

When heavy tining is used, the transverse joints should be blanked with additional material. Typically, 100 mm is sufficient. This helps to minimize joint spalling and raveling, which can be caused by heavy tining around the joints.

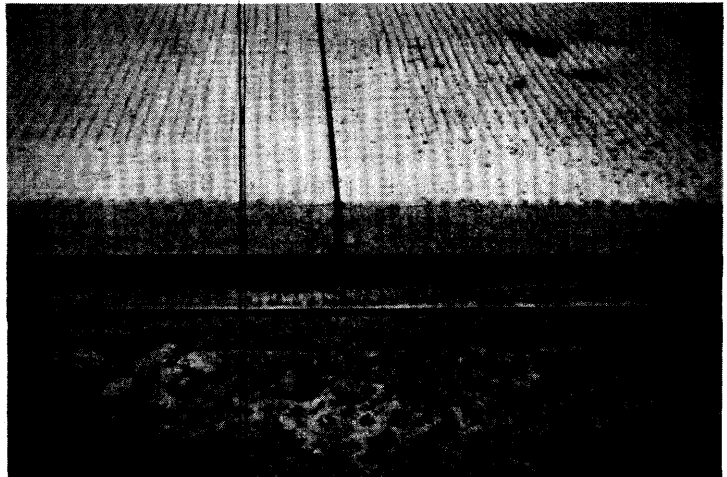
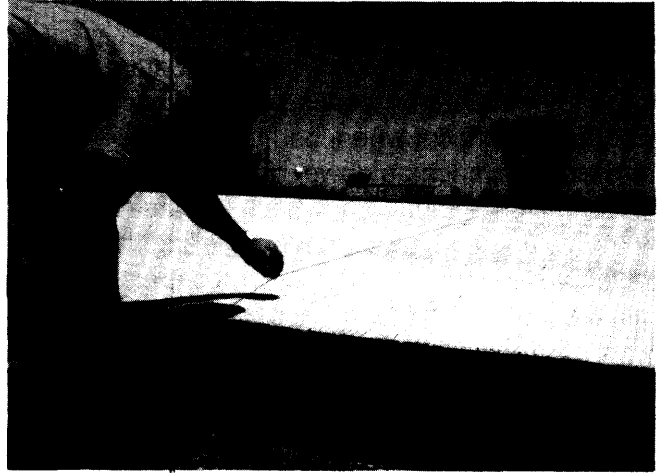

Sawing Window

The sawing window is a short period after placement when the concrete can be cut successfully before it cracks. The window begins when concrete strength is acceptable for joint cutting without excessive raveling along the cut. The window ends when significant concrete shrinkage occurs and induces uncontrolled cracking.

The type of base underneath the concrete pavement will have an effect on the sawing window. A stiffer base or an open graded base will reduce and move the window forward. A granular base may extend the sawing window. Local experience will also play a part in determining the effect of base material on the sawing window

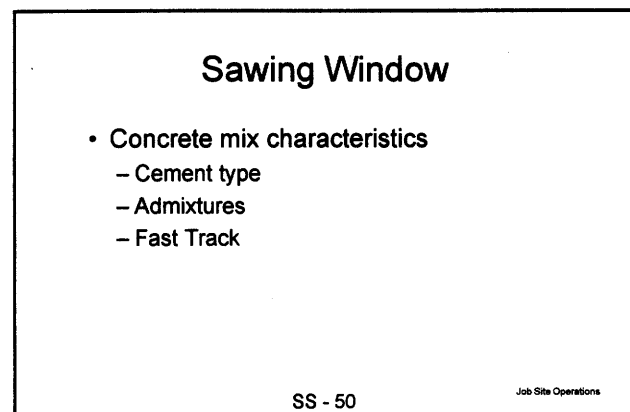
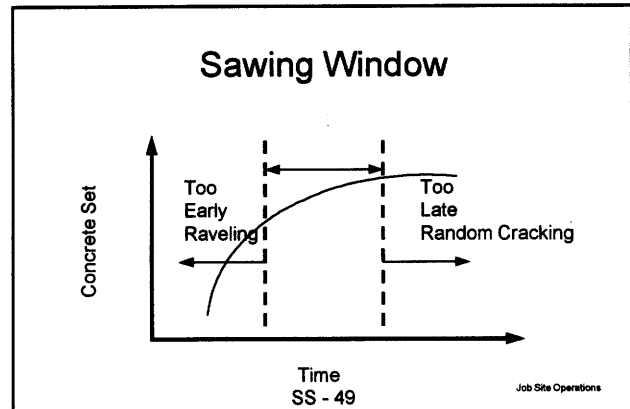

effect window

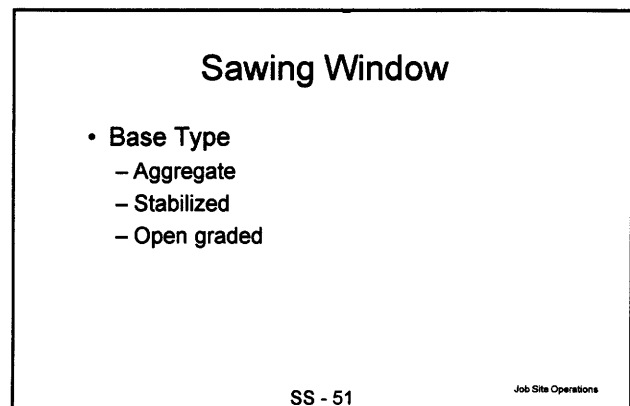

Saw Timing

The timing of sawing after placement of the pavement is critical and requires a fair amount of judgment and experience. The scratch test is one of the simplest tests to help determine when to begin sawing. This test requires scratching the concrete surface with an acceptable tool (e.g., large nail or knife) to observe how deep the surface marks. The harder the surface, the smaller the scratch mark will be. If the scratch removes the surface texture, then it is probably too early to saw without raveling problems.

Another indicator of when to begin sawing is the rate of concrete temperature rise. When the concrete temperature peaks the slab is at maximum expansion. Sawing should begin before the concrete cools significantly and the slabs contract. A thermometer could be placed on the surface of the concrete to measure this temperature change.

The pavement production rate is subject to change. Communication between the sawing crew and the paving crew is a critical component of the sawing operation. It must be continually monitored for changes in production rates and location that may affect saw timing and saw equipment needs.

Sawing Window

- Production schedule - Early cut or conventional

SS - 53

Job Site Operations

Wait

- Scratch test
- Scratch, scratch ahead and scratch again

SS - 54

Job Site Operations

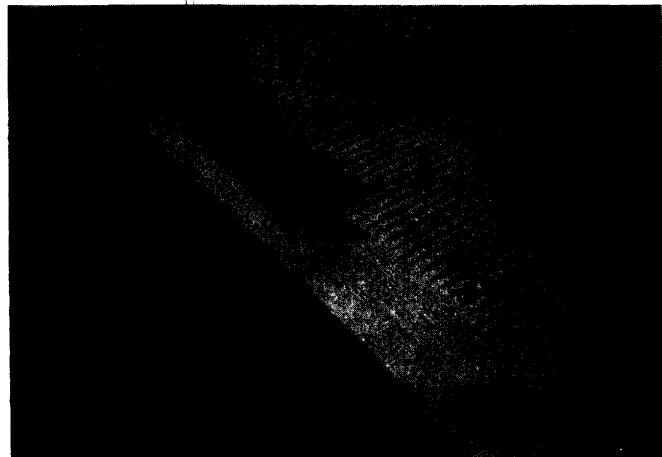

The weather conditions (ambient temperature, wind, humidity, and amount of cloud cover), base temperature, thickness of slab, amount and type of curing compound, type of cement, and admixtures are critical factors that affect the sawing window and saw timing.

When weather conditions change rapidly the potential for transverse random cracking increases. Random cracking can be minimized under these conditions by skip sawing. Skip sawing means sawing every third or fourth planned transverse contraction joint. This is sometimes call sawing control joints.

Sawing Window

- Weather conditions
 - Ambient temperature
 - Wind
 - Humidity
 - Cloud cover
 - Season

SS - 56

Job Site Operations



Joint Raveling

Raveling is a condition that occurs during sawing operations when the concrete has not yet achieved sufficient strength to hold the aggregate in place. Slight raveling is acceptable.

Raveling usually arises due to premature sawing but can also be caused by using the wrong saw equipment and saw blade for a given concrete mix design. Equipment problems also can cause raveling. Common problems include wrong blade specification, water spray tube (plugged or damaged), or improper engine rpm for the size of the saw blade. It is important to match the engine rpm to the size of the blade when making full-depth cuts.

Some agencies require the paving contractors to blank out tining at the location of skewed transverse contraction joints. The blank-out is usually done with a 100 mm wide piece of astroturf, other rugged fabric, belt material or flexible metal band. Workers position the blank-out material at the joint location. The tining machine or hand tine operator pulls the rake over the blank-out material. This minimizes spalling by the sawing operation at the intersection of the tine slots and the sealant reservoir.

When weather conditions are considered to be conducive to the development of random cracking, earlier sawing to prevent cracking should be allowed. Any severe change in weather is considered conducive to random crack development.

Joint Ravelling

- Early sawing
- Surface texturing
- Compatible equipment
- Equipment condition

SS - 58

Job Site Operations

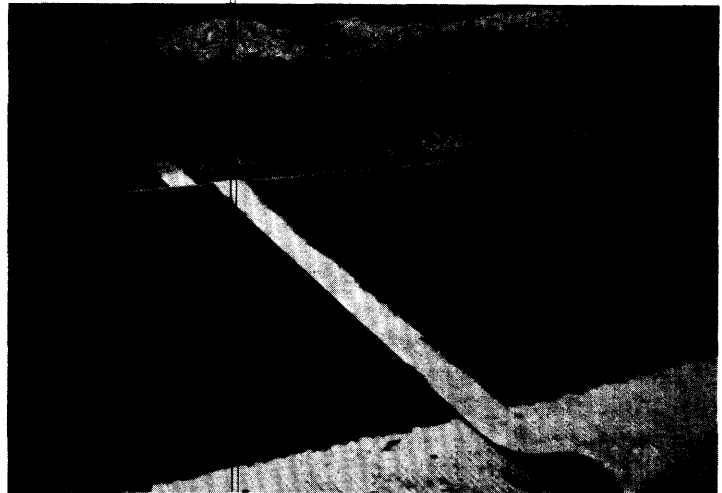

When raveling occurs during initial saw operation, there is usually significant debate about possible negative effects on pavement performance. Raveling can be classified as slight or severe.

Slight raveling most generally will be removed by sawing the widening cut and should not be a concern unless the raveling exceeds the specified width of the sealant reservoir.

Random Cracking

Random cracking occurs when stresses in the pavement exceed the strength of the concrete. Each agency treats random cracks differently when they occur.

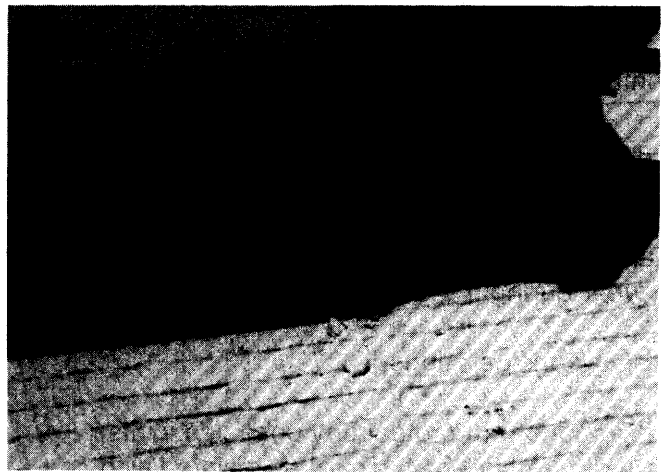
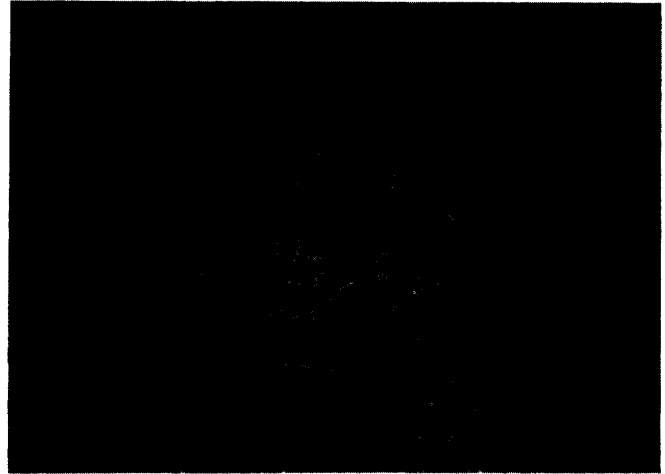

Sawing the Transverse Contraction Joint

It is important for the joint to be marked and sawed in the proper location. Joints should be sawed straight and to the proper depth according to the specifications and the plan details. If the edges of the sawed joint start to ravel excessively, stop sawing. Check the slab in advance of the sawing operation to ensure that it is necessary to wait or postpone the sawing operation. Proceed with the sawing when the scratch test confirms that the slab has gained sufficient strength. Use care to stay within the sawing window.

The speed of sawing is usually controlled by the self-propelling mechanism of the saw and the proper diamond blade specification. Proper speed of sawing is important in controlling proper joint depth.

If abrasive blades are utilized, the diameter must be monitored regularly to ensure that the proper depth is maintained. Blade diameter on abrasive blades decreases due to wear during the sawing operation.

Traffic Considerations

It is important to protect any unsealed joints from dirt and debris typically associated with construction site conditions. If the pavement is to be used for contractor's vehicles (including haul traffic) prior to sealing, then the unsealed joints should be protected with a jute rope or similar material to keep out the dirt and debris.

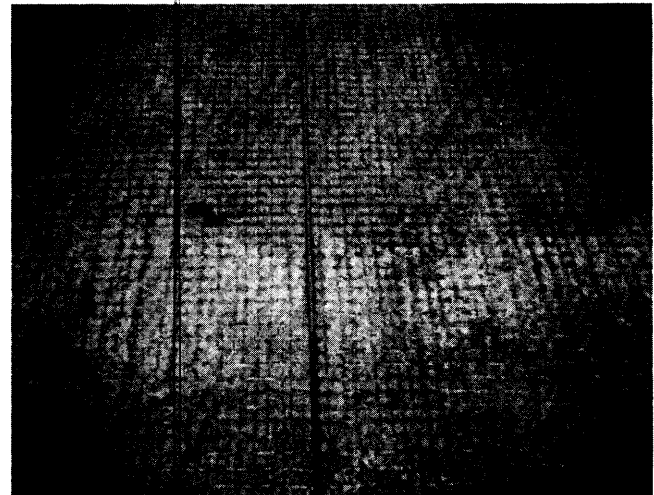
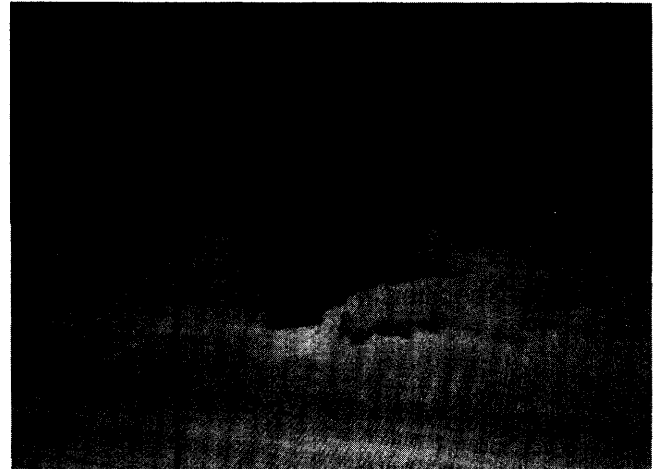

Initial Longitudinal Saw Cut

The initial longitudinal saw cut can be made as soon as the transverse saw cuts are completed. Normally, the longitudinal saw cut is made immediately after completing transverse sawing operations for the previous day's paving. Proper timing of the transverse saw cut is critical to prevent random cracking. Follow the same criteria applied for the initial transverse saw cut when sawing operations proceed immediately behind the paving operation.

Locate Joint—Longitudinal

The longitudinal saw cut should be located by checking the plan locations for the joint and centerline tie steel. Measure off both edges of the slab and at several locations and mark.

Caution must be exercised so the joint is sawed over the tie bars. Check for wider lane widths and variations in lane width, taking care to adjust the edge guide or chalk line location to compensate.

Mark Joint Location—Longitudinal

Mark the location on the slab with a string line between the points previously located or use a centerline guide off the edge of the pavement. When using an edge guide, be aware of any changes in geometry, such as widened lanes, that could lead the saw off course and cut the joint at the wrong location.

Job Site Operations

- Initial transverse saw cut
- Initial longitudinal saw cut
- Widening saw cut

SS - 66

Job Site Operations Initial Longitudinal Saw Cut

- Locate
- Mark/Blank
- Wait (Window)
- Saw
- Traffic considerations

SS - 67

Saw Timing

Complete the initial longitudinal saw cut within a day of the initial transverse saw cut.

Sawing Longitudinal Joint

A centerline saw is normally used for this operation.

Saw straight to a proper depth and at the location indicated according to the specifications and typical sections. Should the saw drift off course, stop, reposition the saw over the proper location, and restart the sawing. Do not slowly realign the saw!

Traffic Considerations

It is important to protect any unsealed joints from dirt and debris typically associated with construction site conditions. If the pavement is to be used for contractor's vehicles (including haul traffic) prior to sealing, then the unsealed joints should be protected with a jute rope or similar material to keep out the dirt and debris. If the joint is a non-working joint, then protection from construction traffic may not be necessary.



Widening Cut for Sealant Reservoir

A widening cut (second cut) is made at the previously sawed joint and is centered over the initial saw cut. This widening cut provides a proper shape factor (depth and width) for the sealant reservoir, which is a critical component for joint sealant performance. The widening cut (depth and width) may be different on transverse and longitudinal joints for a project. Be sure to check the plans and specifications for the details of each type joint.

The widening cut is normally done by wet sawing with diamond blades and can be accomplished in several ways. Special blades can be used which meet the joint reservoir criteria, or several saw blades can be stacked together to obtain the appropriate joint dimensions. Because it is necessary to use wet sawing, flush the joint with water immediately to remove any residue from the wet sawing operation.

The widening cut can be made at the time of the initial saw cut when using a special saw blade commonly referred to as a step cut blade. When the widening cut is made using this process, follow the same procedures discussed in the section on initial transverse saw cut. Sealing the joints cut with the step cut blade needs to be completed before opening the pavement to construction traffic.

Preferred practice is to widen and seal all longitudinal joints first, then widen and seal transverse joints. The transverse joints have more active movement and require a continuous sealant bead for best performance.

Job Site Operations

- Initial transverse saw cut
- Initial longitudinal saw cut
- Widening saw cut

SS - 73

Job Site Operations Widening Saw Cut

- Locate
- Saw
- Traffic considerations

SS - 74

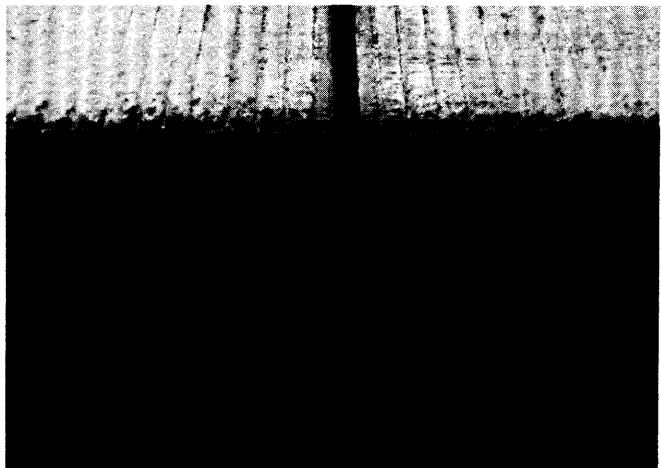

Saw and Seal

An option is to widen all joints (transverse and longitudinal), seal the longitudinal joints, cut the longitudinal sealant at the transverse joints, then seal the transverse joints. Either way, do not overlap the sealant material or backer rod at the intersection of the joints.

Prior to beginning sawing operations check the width and depth of the sealant reservoir to ensure that the shape factor specified is compatible with the type of joint sealant specified. Although this is determined in design and included in project specifications, the shape factor is directly related to and dependent on the specified joint sealant.

Sawing Widening Cut

The widening cut sawing precautions are similar to the other saw cuts, and proper depths should be maintained for the joint to function properly.

Traffic Considerations

It is important to protect any unsealed joints from dirt and debris typically associated with construction site conditions. After widening the joint, do not allow traffic on the pavement until sealing operations are complete. It is recommended to complete the widening cut sawing and sealing operation within a few days.

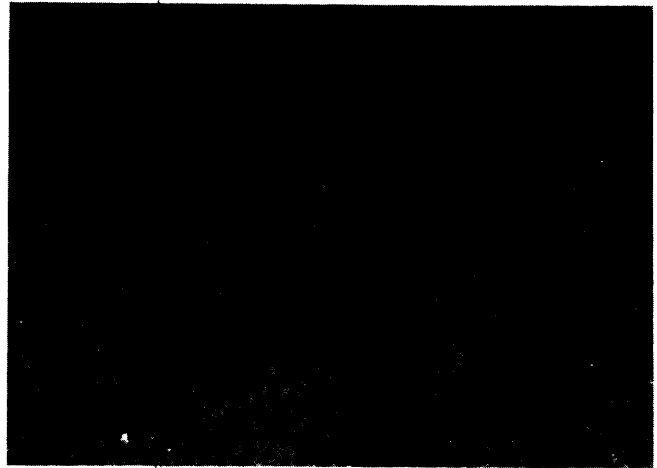

JOINT SEALING

The proper materials and methods of joint sealing are just as important as proper joint sawing for long-term joint performance.

The types of materials and methods for installation are indicated in the specifications for a project. Manufacturer installation guidelines must also be consulted for proper joint performance.

Materials

There are many different joint sealant materials available for use on concrete pavements. These generally fall into two categories, formed-in-place and preformed. The different types of sealant normally specified are shown in Table 1.

Joint Sealing

- Sealant reservoir - Widening cut
- Traffic considerations
- Joint Preparations - Cleaning

SS - 82

Joint Sealing

Sealant Materials

- Formed-in-place
 - Backer rod
- Preformed

SS - 83

Joint Sealing

Table 1

	Common	Joint
	Sealant	Material
Sealant Type	Specification	Properties
Formed-in-place (hot applied)		
Polymeric Asphalt Based	AASHTO M0173	Self-leveling
	ASTM D3405	Self-leveling
	SS-S-1401C	Self-leveling
	ASTM D1190	Self-leveling
Polymeric Sealant	ASTM D3405	Self-leveling
Low Modulus	Modified	Self-leveling
Elastomeric Sealant	SS-S-1614	Self-leveling
Coal Tar, PVC	ASTM D3406	Self-leveling
Formed-in-place (cold applied / single component)		
Silicone Sealant	N.A.	Non sag, toolable. low modulus
Silicone Sealant	N.A.	Self-leveling (no tooling), low modulus
Silicone Sealant	N.A.	Self-leveling (no tooling), ultra-low modulus
Nitrile Rubber Sealant	N.A.	Self-leveling (no tooling), non sag, toolable
Polysulfide Sealant	SS-S-200A	Self-leveling (no tooling), low modulus
Preformed Polychloroprene Elastomeric	Compression	Seals
Preformed Compression Seals	ASTM D2628-81	20-50% allowable strain
Lubricant Adhesive	ASTM D2835	

Formed-in-place Materials

Formed-in-place sealants include hot-applied, cold-applied single-component, and cold-applied two-component.

All formed-in-place sealants depend on long-term adhesion to the joint face for successful sealing. Therefore, proper cleaning on the joint face is important.

A specified reservoir of proper width and depth is required for optimal performance. This shape factor must be compatible with the type of formed in place material specified for the project.

Formed-In-Place

- Hot applied
- Cold applied

SS - 84 Joint Sealing

Backer Rod Materials

The shape factor of a formed-in-place sealant is critical for optimum performance. Use of a backer rod assists in controlling the proper sealant shape. Backer rods also prevent the sealant from flowing out of the bottom of the widening cut and adhering to the bottom of the reservoir. The backer rod diameter should be approximately 25 to 50 percent greater than the reservoir width to ensure a tight fit.

Materials in use for backer rods include the following:

- **Polyethylene Foam:** Polyethylene foam is a closed-cell foam that does not absorb water and is moderately compressible. Because polyethylene foam may melt with hot-applied materials, it is better suited for cold-applied sealants.
- **Cross Linked Polyethylene Foam:** Cross linked polyethylene foam is compatible with hot-applied sealants. It is a closed-cell foam that does not absorb water and is moderately compressible, but will not melt in contact with hot-applied sealant.

Backer Rod Material

- Polyethylene foam (cold)
- Crosslinked polyethylene foam (hot or cold)

SS - 85

Joint Sealing

Preformed Materials

Preformed materials are commonly referred to as compression seals (preformed polychloroprene elastomeric). They are manufactured in a variety of different shapes and sizes. The size of the preformed seal is established in the project specifications. Preformed sealants (compression sealants) depend on long-term compression recovery of the seal for success.

A specified reservoir of proper width and depth is required for optimal joint performance.

Preformed materials do not require a backer rod.

Joint Sealant Material

- Preformed
 - Polychloroprene elastomeric compression sealant

SS - 86

Joint Sealing

Formed-in-place Joint Preparation

Joint preparation is probably the most important element affecting the performance of pavement joint sealants. The reservoir faces must be thoroughly cleaned to ensure good sealant adhesion and long-term performance. Only reservoir faces that will be in contact with the joint sealant need extensive cleaning. Care must be used during this phase of the operation to not damage or spall the edges of the joint face. The steps required in joint preparation for formed-in-place joint sealants are water washing that includes air blowing and air drying, abrasive cleaning, and air cleaning.

Water Washing

Immediately after sawing, a water wash should be used to remove the residue from the joint area. If dry sawing is utilized, the wash aids in removing dust that may accumulate on the joint faces.

Air blowing can be used to aid in the drying process by removing all excess water from the joint. The joint should then be allowed to naturally air dry completely. Air blowing will not remove enough moisture to ensure proper joint sealant adhesion. Perform this operation in one direction to minimize contamination of surrounding areas.

Joint Sealant Installation

SS - 87

Formed-In-Place Joint Preparation

- Flush residue (Widening cut)
- Abrasive Cleaning
- Air Cleaning

SS - 88

Joint Sealant Installation

Abrasive Cleaning

After the joint is sufficiently dry, the joint should be abrasive-blasted to remove any remaining residue and to provide good, uniform surface texture to aid in sealant adhesion. One pass along each joint face should be made while aiming the nozzle at a 45 degree angle so the abrasive braises the joint face and not the bottom of the joint. The nozzle should be kept about 25 mm from the joint and only directed at the vertical joint face where the sealant will adhere. Use of a guide for distance above pavement surface and angle of nozzle is recommended.



Air Cleaning

Just prior to sealing, the joint should be air blown to remove any material that may have been deposited by abrasive-blasting, wind and traffic. Air pressure should be greater than 0.6 MPa. The contractor should be sure that the air compressor is equipped with an operating oil and moisture trap.

The joint surface should be free from water and dust.

Moisture Conditions

Precipitation such as rain, frost and snow requires removal and/or additional drying time prior to cleaning operations. The joints and joint face must be dry and free of moisture for formed-in-place sealants to adhere to the concrete.

Formed-In-Place Moisture Conditions

- Rain
- Frost
- Snow

SS - 90

Joint Sealant Installation

Formed-in-place Install Materials

Backer Rod Installation

Backer rod installation is made after cleaning and before formed-in-place sealant installation. It must be compatible with the formed-in-place sealant material. Backer rod inserts easily with a double-wheeled steel roller or any smooth blunt tool that will force it uniformly to the desired depth. The tool must not puncture or stretch the material. A steel roller allows exchange of the center insertion wheel for different depths and provides the most consistent results. Ensuring that the backer rod is at a consistent and uniform depth in accordance with the specifications cannot be overemphasized. Good practice is to roll the insertion wheel over the backer rod twice.

**Formed-In-Place
Material Installation**

- Backer Rod
- Sealant Material

SS - 91 Joint Sealant Installation

Backer Rod Installation

- Manually or automatic
- Secure fit
- DO NOT STRETCH

SS - 92 Joint Sealant Installation

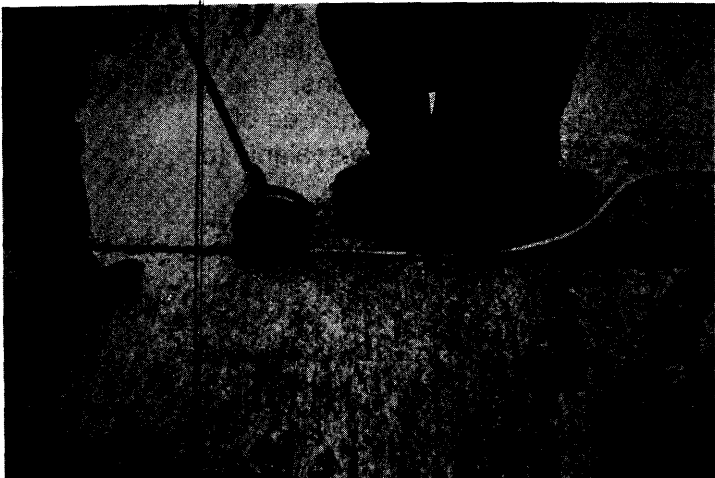

Sealant Installation (Formed-in-place)

Before beginning the installation, check the joint for cleanliness.

Formed-in place sealant installation guidelines include hot- and cold-applied applications. Some of the guidelines are the same for both methods and are discussed first, followed by hot- then cold-applied considerations.

Formed-in-place sealants require uniform installation. The reservoir should be filled from the bottom upward to avoid trapping air bubbles. Do not completely fill or overfill the joint reservoir.

It is important that the contractor pumps the sealant through a nozzle sized for the width of joint reservoir. The nozzle should fit into the reservoir to allow pumping from the top of the backer rod. The injection nozzle forms the sealant bead. Good practice is to draw the nozzle toward the operator. Pushing the nozzle may result in voids and nonuniform sealant cross section.

The joint sealant material should be recessed at least 6 to 8 mm below the pavement surface. This will allow room for upward sealant expansion during summer joint closure. If the joint material extends above the pavement surface, traffic and maintenance equipment may dislodge it from the reservoir.

Sealant Installation Formed-In-Place

SS - 94

Sealant Installation

- Uniform installation
- No moisture
- Recessed below pavement surface
- DO NOT OVERFILL

SS - 95

Sealants should not be spilled on the pavement surface because this creates a waste of material and an undesirable appearance.

A properly installed joint material will adhere to the vertical joint face.

It is important to examine all sealant after installation. An inspector should look at the material and seal characteristics. A simple knife test can indicate how well the sealant adhered to the sidewall. The knife test involves slipping the blade of a knife between the side of joint and sealant material. If there is resistance, then the joint material has adhered to the sidewall. If the knife slips easily between the material and joint face then there is potentially a failure of adhesion and there should be further investigation. This early inspection provides assurance that the installation meets requirements.

Hot Applied Sealant—Considerations

Moisture should not be present in the joint reservoir prior to sealing. If moisture is present in the joint, hot pour sealant may generate steam that will produce holes in the sealant and prevent adherence to the side of the joint face. The joint must be allowed to dry, which includes drying after wetting due to water flushing and rainfall. Consult the manufacturer's guidelines for optimum seal adherence.

Special attention to the heating temperature is vital at the start of the work day. No sealant should be installed before reaching proper installation temperature.

Sealant Material

- Formed-in-place
 - Hot applied
 - Cold applied
 - Cold single component
 - Cold double component

SS - 96

Joint Sealant Installation

Cold Applied Sealant - Considerations

Moisture should not be present in the joint reservoir prior to sealing. Most silicone manufacturers require a drying time of surface dry condition before installation. This includes drying after wetting due to water flushing and even rainfall. Consult the manufacturer's guidelines for optimum seal adherence.

Low-modulus silicone sealants that are not self-leveling require tooling to provide desired results. After applying the sealant, the material is shaped by drawing a tool over the surface in both directions. This forces the sealant into contact with both of the sidewalls just below the top of the joint and produces the proper shape factor. Tooling is necessary within about 10 minutes of installation because the sealant begins curing and forms a "skin."

Aggregates that contain dolomitic limestones can adversely affect the ability of certain silicone sealants to adhere to the joint wall. In these instances consult with the manufacturer of the material for proper application. A primer may be required.

Testing of silicone sealant curing can only be completed after 14 to 21 days. The inspector can remove a small 5 cm sample of sealant. Stretching the segment about 50 percent for about 10 seconds before releasing gives a quick check. A fairly fast and uniform relaxation of the sample indicates adequate curing. Slow rebound and curling of the sample indicates differential curing. The curl results from the upper (cured) seal retracting faster than the lower (less cured) portion. It is important to repair the 5 cm gap in the sealant where the inspector extracted the sample. Use the same brand of material to take advantage of the good adherence the material has to itself.

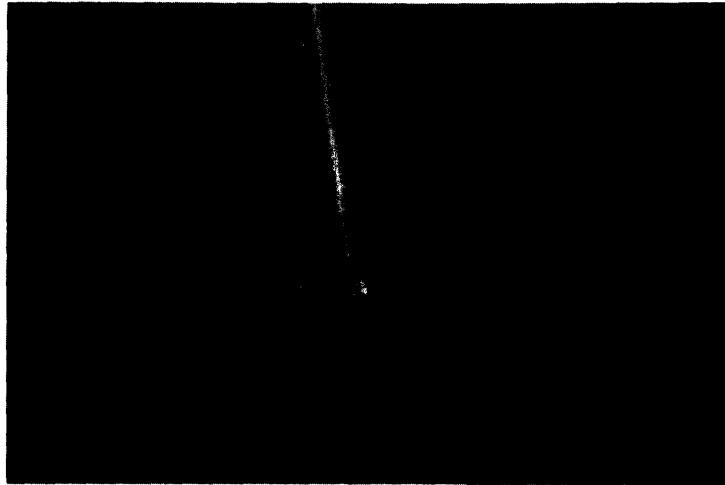

Preformed Joint Preparation

Water Washing

Immediately after sawing, a water wash should be used to remove the residue from the joint area. If dry sawing is utilized, the wash aids in removing dust that may accumulate on the joint faces.

Air blowing can be used to aid in the drying process by removing all excess water from the joint. The joint should then be allowed to air dry completely. Perform this operation in one direction to minimize contamination of surrounding areas.

For preformed joint material, it is only necessary to remove all residue and loose material from the joint before installing the joint material.

Air Cleaning

Just prior to sealing, the joint should be air blown to remove any material that may have been deposited by wind and traffic. Air pressure should be greater than 0.6 MPa. The contractor should be sure that the air compressor is equipped with an operating oil and moisture trap.

Preformed Joint Preparation

- Remove residue
- Air cleaning

SS - 98

Joint Sealant Installation

Preformed Install Material

- Mechanical installation
- No backer rod
- Use of lubricant/adhesive
- DO NOT STRETCH

SS - 99

Preformed Install Materials

The sealing operation for preformed compression seals requires application of a lubricant/adhesive to the reservoir sidewalls. The compression seal is then inserted into the reservoir. It is important to note that no backer rod is used for preformed sealants. The lubricant/adhesive material eases sealant insertion and forms a weak bond that helps hold the seal in place.

If the joint opening is too large or too small for the specified sealant, different sealant may be used. This may occur during colder temperatures.

Joint wall inspection before installation will find any suspect areas. Raveling, spalling, or other irregularity of the joint walls pose potential problems. These areas could reduce the seal's lateral pressure and allow the seal to extrude or pop from the joint. Agreement between the inspector and contractor's personnel on potential problem areas will allow repair before the contract is complete and seal damage occurs.

Sometimes it is necessary to knock off sharp edges along the joint. These edges may make seal installation difficult. Dragging a blunt pointed tool along sawed joints removes them. A mechanized wire brush will also remove burrs and provides consistent results.

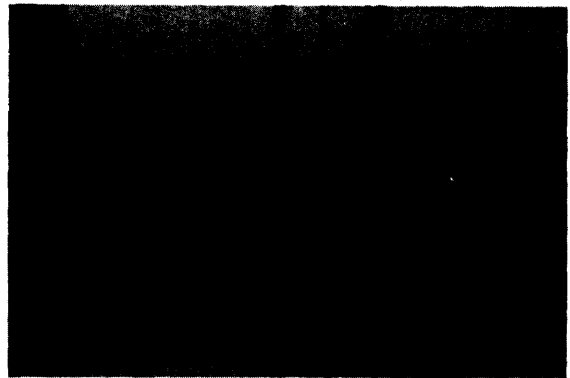

Care is required during installation to avoid twisting or stretching the sealant. More than 5 percent stretch is considered excessive and should be avoided. Mechanical installation machines are available. Even using these machines, stretching of the joint material must be kept to a minimum. The sealant is marked in 1 ft increments from the manufacturer for an aid in checking stretch of material.

At intersections of preformed material, it is recommended to install the longitudinal material first, then cut it at the transverse joint crossings and install the transverse material in a continuous piece. This will allow for continuous installation of both joints, which will help to minimize stretching. Where applicable, a gluing type compound could be applied at the intersections to form a more continuous jointing system. Check with sealant suppliers for a compatible gluing compound if this option is chosen.

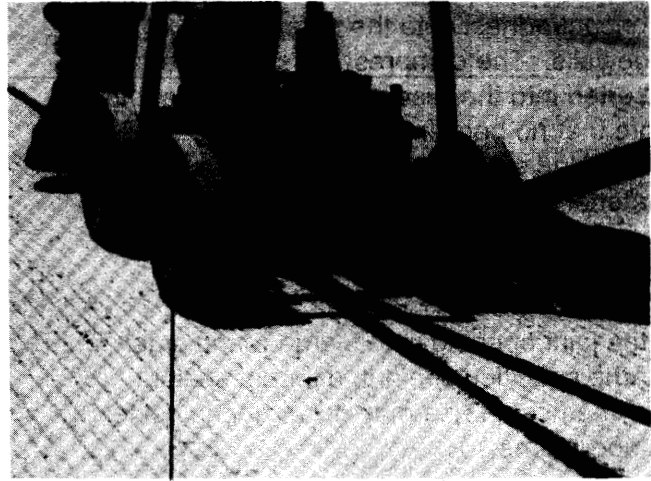

CRITICAL FACTORS IN SAWING AND SEALING OF NEW CONCRETE PAVEMENTS

- Communication and Preparations (CAP)
- Saw equipment selection
- Locating joints
- Saw timing
- Weather is a constant variable
- Saw straight on mark
- Saw to proper width and depth
- Sealant material requirements
- Joint preparation is probably the single most important element affecting performance of joint sealants
- Seal longitudinal joints first before widening reservoir for transverse joints
- Inspection of work. Are the requirements of the project met?

**Critical Factors in
Sawing and Sealing**

- Communication/Arrangements/
Preparations - "CAP"
- Blade/Power unit selection
- Sealant material requirements

SS - 103

**Critical Factors in
Sawing and Sealing**

- Weather is a constant variable
- Layout/Marking of joints
- Timing of initial control sawing
- Saw depth

SS - 104

**Critical Factors in
Sawing and Sealing**

- Carefully following joint layout
- Joint preparation
- Inspection of own work.

SS - 105

Saw and Seal Operations - Group Exercise No. 1

Instructions:

Develop a checklist to be used at the "CAP" meeting for the topic assigned to your group. Remember that the "CAP" meeting is held before the project begins.

The course instructor will assign topics.

Your "CAP" meeting topic is Pavement Joints.

Construction or Contraction

Expansion/Isolation

Transverse

Normal

Skewed

Saw Depth

Dowels

Reservoir

Location

Intersections

Fixtures

Longitudinal

Saw Depth

Saw Timing

Location

Tie Bars

Reservoir

Pavement Geometry

Expansion/Isolation

VIII. Concrete Pavement Restoration (CPR) Operations

VIII. CPR (Concrete Pavement Restoration) Operations — Course Outline

A. Objectives

1. Know the CPR techniques.
2. Understand the purpose of CPR techniques.
3. Be able to suggest field adjustments for patches.
4. Gain knowledge of construction procedures for techniques.
5. Recognize critical factors for good quality techniques.

B. Preconditions

1. Locations of repairs already selected and marked.
2. Designs for repairs established.
3. Specifications established.
4. Field adjustments allowed for patch locations or sizes.

C. Introducing the CPR Techniques

1. Slab Stabilization
2. Full-Depth Patching
3. Partial-Depth Patching
4. Retrofitting Dowel Bars
5. Diamond Grinding
6. Resealing Pavement Joints (& Cracks)

D. Communications, Arrangements, Preparations - CAP

E. Detailing Slab Stabilization Operations

1. Finding Voids
2. Grouts
3. Mixing
4. Drilling Injection Holes
5. Setting the Uplift Beam
6. Pumping Equipment
7. Starting Grout Injection
8. Injection Pattern
9. Stopping Grout Injection
10. Plugging
11. Post testing
12. Construction Limitations

F. Detailing Full-Depth Patching Operations

1. Sizing a Patch
2. Sawing
3. Removal
4. Preparing the Patch Area
5. Drilling Dowel Holes
6. Cleaning Holes
7. Installing Dowels
8. Preparing Longitudinal Joints
9. Placing, Finishing, Curing
10. Sealing the Joints
11. Construction Limitations

G. Detailing Partial-Depth Patching Operations

1. Finding Unsound Concrete
2. Determining the Repair Boundaries
3. Removal by Sawing & Chipping
4. Removal by Carbide-Milling
5. Cleaning
6. Placing the Joint Insert
7. Bonding Agent
8. Placing, Finishing, Curing
9. Construction Limitations

H. Detailing Retrofit Dowel Bar Operations

1. Cutting the Slots
2. Slot Dimensions
3. Preparing the Slots
4. Cleaning the Slots
5. Preparing the Dowels
6. Placing the Dowels
7. Backfill Material
8. Backfilling the Slots

I. Detailing Diamond Grinding Operations

1. What you should know about the pavement condition
2. Setting up the grinding head
3. Selecting saw blades
4. Selecting the blade spacing
5. Operating a grinding machine
6. Slurry removal
7. Monitoring the operation
8. Special conditions

J. Detailing Joint (& Crack) Resealing Operations

1. Removing Old Sealant
2. Shaping the Reservoir
3. Cleaning Reservoir
4. Installing Backer Rod
5. Installing Sealant
6. Expansion or isolation joints
7. Existing lane/shoulder joints
8. Resealing cracks

K. Situational Exercise for Group

Concrete Pavement Restoration (CPR) Operations

Objectives

Upon completion of this module, the participant will:

- Know which techniques constitute CPR (concrete pavement restoration).
- Understand the purpose of each CPR technique.
- Be able to judge whether patching techniques are appropriate where they are marked and make suggestions on adjusting them.
- Gain a working knowledge of the construction procedures for each technique.
- Recognize the critical factors for constructing good quality repairs.

Preconditions

For the purpose of this module, the following assumptions have been made:

- Locations for various repairs have been selected (see note below).
- Designs for patches have been established (i.e., use of load transfer).
- Specifications have been established.
- Adjustments to quantities and types of repair are allowed.

Note: Although the course will assume repair locations have been established, guidance will be given to adjust these locations based on changing and unknown conditions.

Concrete Pavement Restoration (CPR)

Objectives

- Understand purpose of each CPR method
- Gain a working knowledge of construction procedures
- Recognize critical factors for constructing good quality repairs

Preconditions

- Locations for each repair technique have been selected
- Designs for each repair technique have been established
- Specifications for each repair technique have been established
- Field adjustments are allowed

Introducing the Concrete Pavement Restoration (CPR) Techniques

What is CPR?

CPR refers to a series of repair techniques necessary to bring the structural capacity or rideability of a deteriorating concrete pavement to an acceptable condition. While there are actually nine techniques in CPR, this course discusses the six most common. These six techniques not only repair existing deterioration in the pavement, but they also attempt to prevent the same deterioration from occurring in the future.

Comprehensive specifications and construction details are important to establish the quality level expected by the specifier. Each CPR technique has unique construction procedures that will be discussed later.

The purpose of each CPR technique is to repair a particular distress (kind of deterioration) found in concrete pavement. Only one technique may be necessary for pavements with minor deterioration, but all six techniques may be needed where deterioration is more serious.

CPR Techniques

- Slab Stabilization
- Full-Depth Patching
- Partial-Depth Patching
- Retrofitting Dowel Bars
- Diamond Grinding
- Resealing Pavement Joints (& Cracks)

Quality CPR

Specification Details + Construction Details

Purpose of CPR Techniques

- Repair particular distress
- Prevent recurrence of distress
- Improve pavement capacity
 - Structure
 - Traffic
 - Ride

Purpose of Slab Stabilization

Slab stabilization consists of pumping a grout through holes drilled through the slab surface, so as to fill voids that develop beneath the concrete pavement slab or base layers. The voids usually occur near cracks, joints, or along the pavement edge, and are often not more than 3 mm deep. Slab stabilization should not be confused with slab jacking, which is done to raise depressed slabs.

Several common destructive forces cause these types of voids. Heavy traffic loads induce the highest slab deflections near transverse joints and working cracks. These deflections may cause pumping, consolidation, and loss of the subbase or subgrade support. Without support underneath the slab, load stresses in the concrete increase and may cause other problems, such as faulting, corner breaks, and cracking.

Purpose of Full-Depth Patching

Full-depth patching entails removing and replacing at least a portion of a slab to the bottom of the concrete, in order to restore areas of deterioration. Full-depth patches can improve pavement rideability and structural integrity and can extend pavement service life.

The most common problem that requires full-depth patching is joint deterioration. This includes any cracking, breaking, or spalling of slab edges on either side of a transverse or longitudinal joint. Often, this deterioration takes place on the bottom of the concrete slab and may not be visible from the surface.

Slab Stabilization

- Purpose
 - Fill voids
 - Reestablish uniform support.
- Voids From
 - Pumping under traffic
 - Consolidation from overloading
 - Subgrade bearing failure from saturation

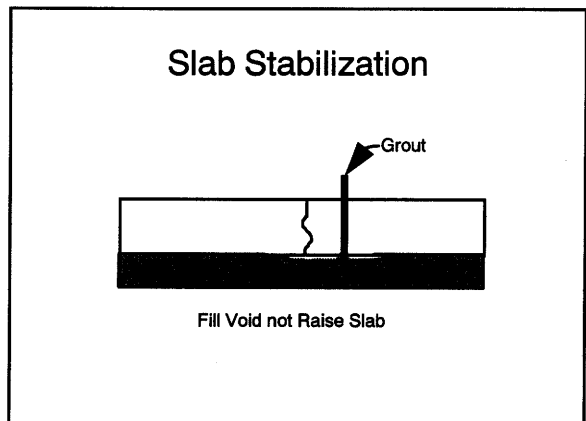

Full-Depth Patching

- Purpose
 - Restore structure
 - Restore ride
- Used for
 - Joint/crack deterioration
 - Broken slabs
 - Corner breaks

Spalls that extend 75–150 mm from the joint are moderately severe and are a sign that more spalling could exist below. Only below-surface problems require full-depth replacement; in other cases, partial-depth repair is usually acceptable. This is an important distinction to know for making field adjustments.

Full-depth repair also is necessary to repair any corner breaks or any slabs with more than one intersecting crack. These are both signs of support problems and lack of structural strength.

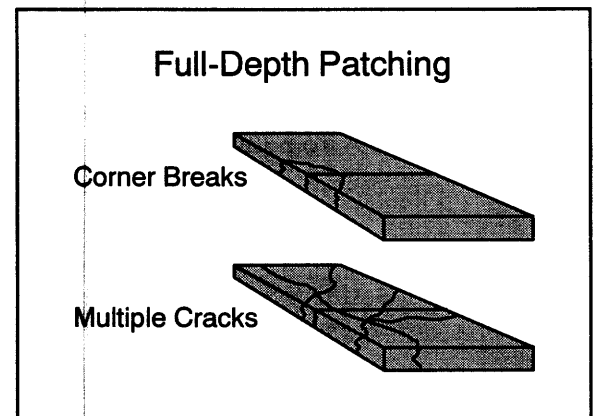
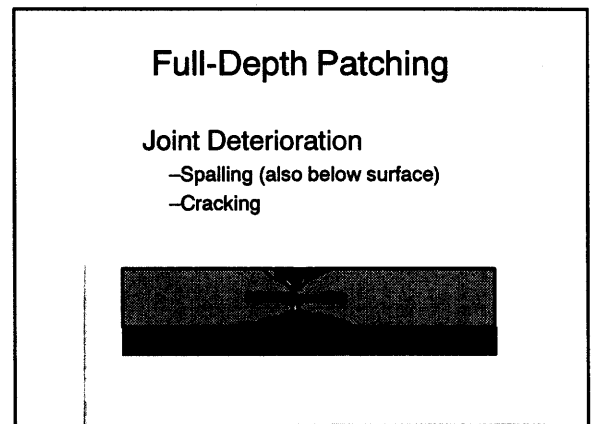
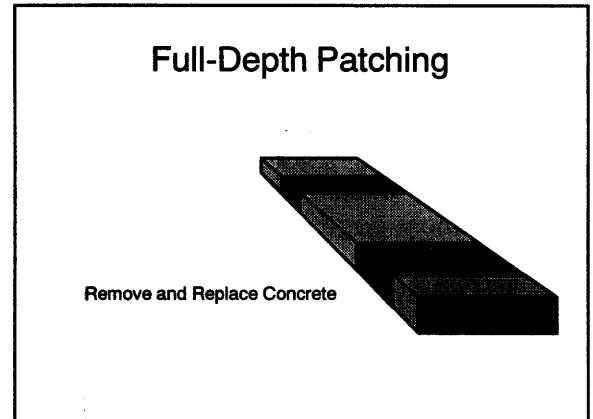

Punchouts in continuously reinforced concrete pavements require full-depth repair. Punchouts can form after many loads. The longitudinal steel in the slab ruptures along the faces of two closely spaced cracks, and a small segment of concrete punches into the subbase. Punchouts are usually about 0.6 m (2 ft) long. Punchouts can also occur where transverse cracks split into a Y about 0.6–1.5 m from a longitudinal edge.

Most full-depth repairs of joint deterioration or punchouts cover at least 6.75 m². For corner breaks or slabs with intersecting cracks, their size may correspond to the area of the entire slab.

Purpose of Partial-Depth Patching

The purpose of partial-depth patching is to restore localized areas of deterioration that do not extend through the slab.

The most common problem is spalling, but partial-depth repair can also be used for small areas with severe scaling. Partial-depth patches are acceptable for most surface problems at joints, cracks, and midslab locations that are within the upper one-third of the slab.

Partial-depth patches are usually very small. Each patch usually covers an area less than about 1 m². They are often only 50–75 mm deep.

Spalling is typically a random localized problem and therefore warrants this targeted repair procedure. Surface spalls create a rough ride and can accelerate development of further problems. Partial-depth patches replace unsound concrete to restore rideability and deter further deterioration. They also provide proper edges for resealing joints and cracks.

Full-Depth Patching

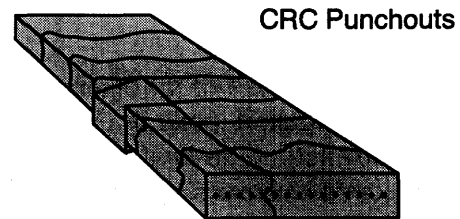

Partial-Depth Patching

- Purpose
 - Repair surface distresses
 - Reestablish joint reservoir
- Used for:
 - Midslab surface spalling
 - Joint spalling
 - Severe scaling

Partial-Depth Repair

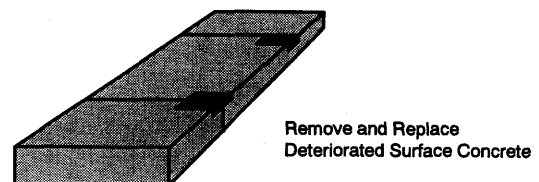

Purpose of Retrofitting Dowel Bars

Retrofitting dowel bars is a method to reestablish load transfer across joints or cracks. It requires cutting slots across each joint to house new dowel bars.

The underlying purpose of retrofitting dowel bars is to repair faulted joints or cracks and prevent recurrence of the faults. However, if the faulted joints or cracks are already badly spalled, retrofitting dowels is not recommended, and full- or partial-depth patching is necessary.

Load transfer refers to the ability of a joint to transfer a portion of a load applied on one slab to an adjacent slab. The higher the load transfer, the more evenly a load near a joint is distributed to the subbase and subgrade. This usually translates into better pavement performance. Poor load transfer leads to faulting, pumping, corner breaks, and spalling.

Retrofitting Dowel Bars

- Purpose
 - Reestablish load transfer
 - Limit future faulting
- Used for:
 - Faulted joints
 - Faulted cracks

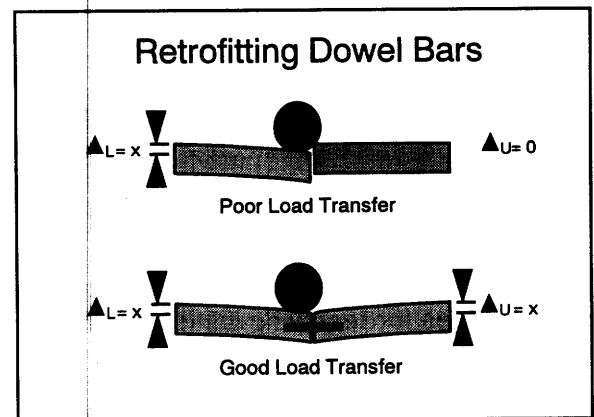
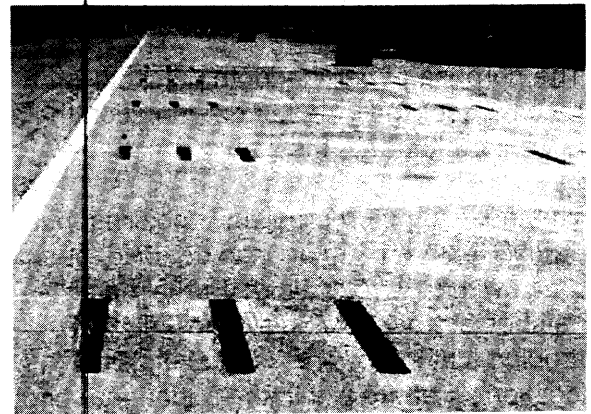

Purpose of Diamond Grinding

The main purpose of diamond grinding is to remove bumps and reprofile the surface of concrete pavements. This decreases the severity of dynamic or impact loads. Impact loads occur as trucks bounce vertically on their suspension system while traveling across bumps or dips. Greater vehicle bounce increases stresses in the slabs and consequently decreases road life.

Diamond grinding also smoothes out roughness from warped or curled slabs and removes ruts from studded tires or excessive tire wear. Grinding also blends the surface of full-depth or partial-depth patches into the surrounding concrete and removes birdbaths to improve the cross slope for drainage.

Diamond grinding is done with specially designed equipment that uses gang-mounted diamond saw blades to cut through bumps in the concrete surface. In essence, the function of diamond grinding equipment is similar to that of a common wood plane. The saw blades shave off the fault or bump and the rear wheels follow behind in the smooth path.

Diamond grinding can also remove bumps from new pavements. The equipment is smaller for new pavement bump grinding, but many of the same principles apply.

Diamond Grinding

- Purpose
 - Smooth the surface
 - Reestablish skid resistance
 - Correct cross-slope
- Used for:
 - Faulted joints
 - Wheel track wear
 - Drainage slope improvements
 - Polished pavement

Need for Diamond Grinding

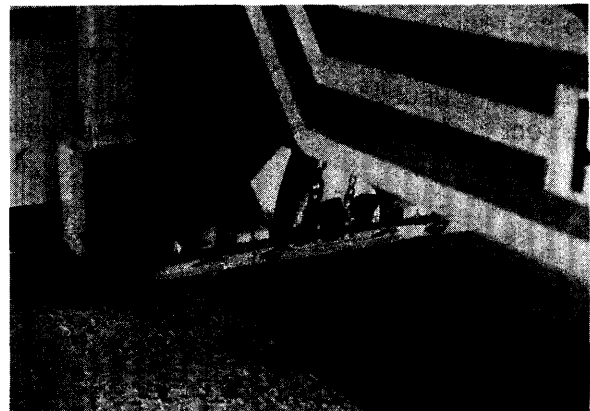
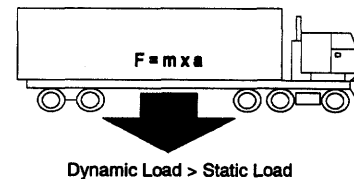

Purpose of Resealing Joints (& Cracks)

Performed alone, joint resealing is a maintenance activity. However, in conjunction with techniques such as patching or surface grinding, joint resealing becomes a necessary part of CPR. It is usually the last step and is done to protect the newly rehabilitated pavement from excessive moisture.

As pointed out in the *Saw & Seal* module, the main purpose of joint sealant is to minimize the passage of water and incompressible material into joints. Resealing is necessary whenever the condition of an existing sealant does not meet these purposes.

A typical hot-pour sealant provides an average of 3 to 5 years of life after proper installation. Some low-modulus or PVC coal-tars can perform well past 8 years. Silicone sealants have performed well for periods exceeding 8 to 10 years on roadways. This type of performance hinges on joint preparation and installation. Of extreme importance is that the joint be clean and dry. Compression seals provide service for periods often exceeding 15 years and sometimes 20 years.

Some cracks will also require sealing to prevent the infiltration of moisture and incompressible materials. The need to seal a particular crack will depend on the orientation and type of crack. Narrow, hairline cracks that remain tight usually do not require sealing, but wide cracks that function like joints do require sealing. These cracks are usually working cracks that are subject to the same movement as transverse joints.

Joint Resealing

- Purpose
 - Protect rehabilitated pavement
- Used for:
 - Replace ineffective sealant
 - Minimize moisture infiltration
 - Minimize incompressible infiltration

Sealing Cracks

Orientation	Width	Repair or Seal?
Transverse or Longitudinal	< 3 mm (Hairline)	No
	3 - 12 mm	Seal
	> 12 mm	Patch

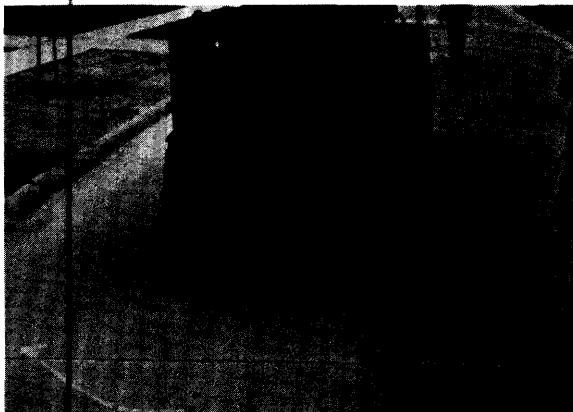

Communications and Preparations - CAP

Both the contractor's crew and inspection personnel should meet on site to discuss the project details before starting work. At this time, conduct a survey to determine those areas that require patches. Clarify what methods the engineers used originally to determine where patches (full- or partial-depth) were necessary.

If partial-depth repairs are part of the plans, ask if the engineers cored the project near typically deteriorated joints. Ordinarily coring is necessary to determine the depth of spalling. Cores may also show the extent of spalling along the slab bottom.

Often the project condition will be different than the plans indicate. This is usually because of the time passage between planning and construction. Long periods between the field survey, plan preparation, and bid opening may lead to an inaccurate description of the actual distress existing when construction begins. In that case, the project plans, engineer's estimate, and contractor's proposed quantities will not reflect the repairs necessary for a successful project. This can become a source of confusion and can lead to neglect in marking distress limits or can lead to poor selection of repair sizes.

If the project plans contain partial-depth repairs, the project specifications should include a special provision that provides freedom to change some partial-depth repairs to full-depth removals if necessary. During construction there may be situations where a distress marked in the plans for partial-depth repair may extend deeper than expected.

It is important at this stage for the contractor's crew and the inspectors to agree on a decision point for changing from a partial-depth patch to a full-depth patch.

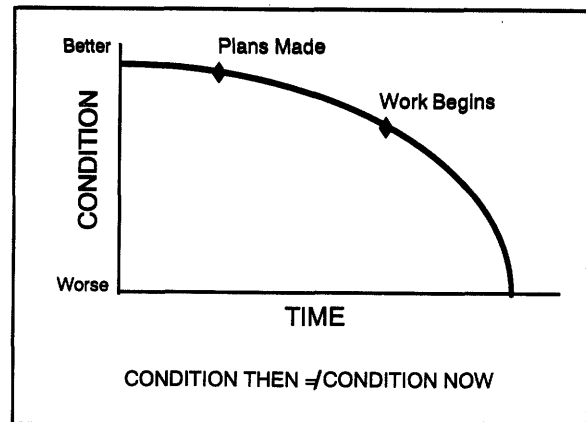
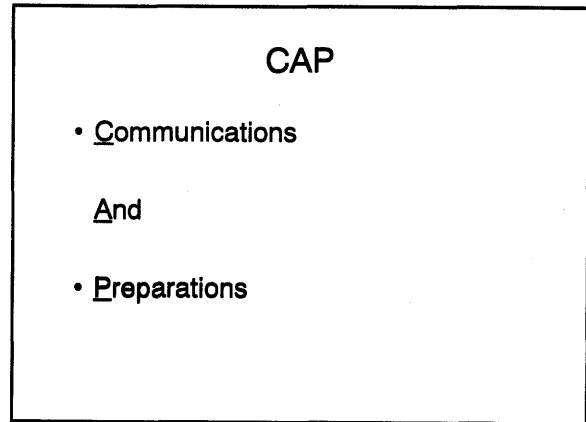

Detailing Slab Stabilization Operations

For construction, the success of stabilization depends on:

- Accurately finding voids.
- Designing & mixing a good grout.
- Using good injection practices.
- Performing post-testing.

Finding Voids — Available techniques for finding voids include: visual inspection, deflection measurement, and ground penetrating radar.

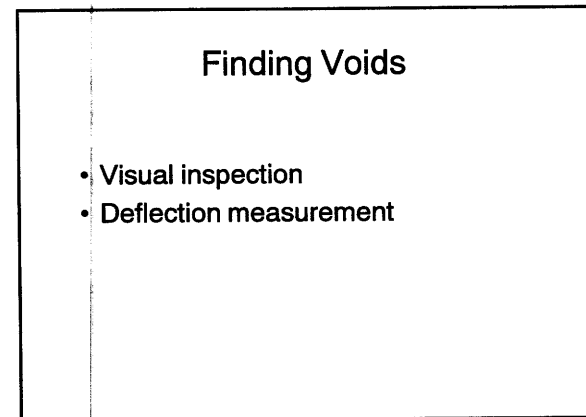
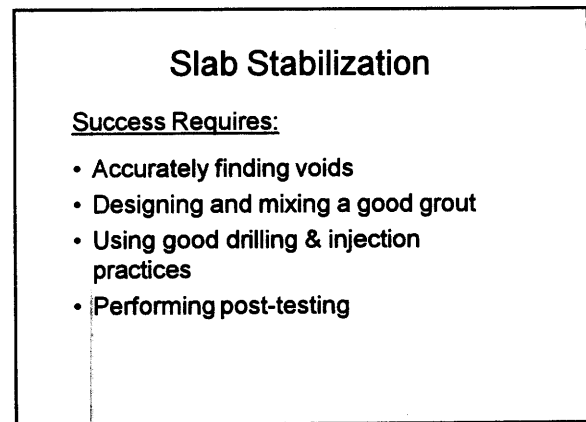
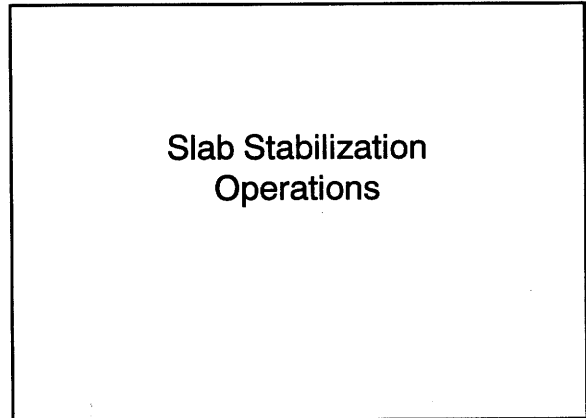

Visual inspection requires looking for transverse joint faulting and any fines near joints or cracks on the traffic lane and shoulder. These are signs of subbase or subgrade pumping, and it is likely that a void exists in that area. Other signs include corner breaks and shoulder drop-offs or depressions.

Visual Inspection

Look For:

- Faulted joints
- Stains from pumping
- Shoulder blow holes
- Corner breaks
- Large shoulder drop-offs
- Depression areas



The most common practice is to measure vertical movement at joints or cracks from a static or dynamic load. A high deflection indicates low support and a probable void. A low deflection indicates good support. Try to test deflections when slab temperatures are cool and relatively constant from day to day (usually nighttime and early morning). Deflections may not indicate a void during hot temperatures, when there is maximum slab expansion and aggregate interlock.

The most common static test uses a loaded truck and deflection gauges like a Benkelman beam. The gauge should measure movement to 0.025 mm.

Take one test at each joint by placing the measuring instrument across the joint. One gauge rests on each slab corner near the shoulder edge. Angle a Benkelman beam at 45° to the pavement edge. After zeroing the gauges, have the truck driver position the loaded truck so that the center of the loaded axle is about 300 mm behind the joint (or crack) and about 300 mm from the pavement edge. The truck axle should weigh 80 kN.

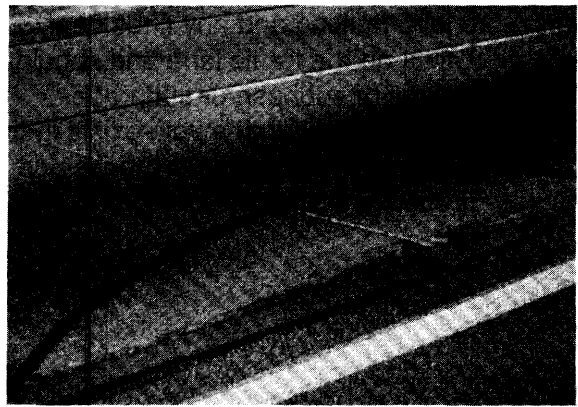

Static Deflection Testing

- Use accurate beam gauge (0.025 mm)
- Use known axle load (80 kN)
- Measure on both sides of joint to compare deflections
- Test when slabs cool



After reading both gauges, move the truck to a similar position about 300 mm past the joint. Then read both gauges again. Most specifications consider a deflection greater than 0.5 mm to 0.6 mm excessive and in need of stabilization.

Grouts — Pozzolan-cement grout is the most common stabilization material. The principal requirements for any stabilization material are strength and the ability to flow into or expand to fill small voids (e.g., 0.125 to 6.350 mm deep). The grout also must displace free water and help to keep water from saturating and weakening support under the joints and slab edges after stabilization is complete.

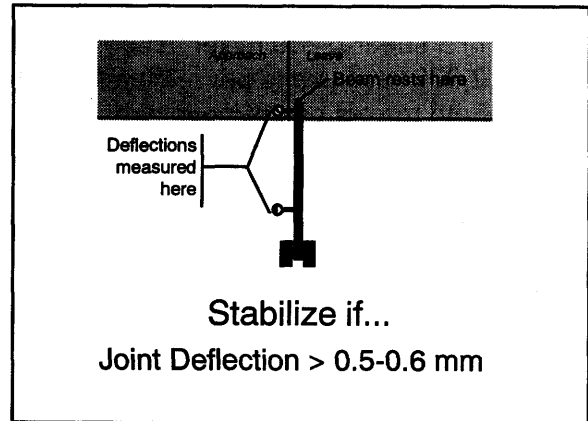
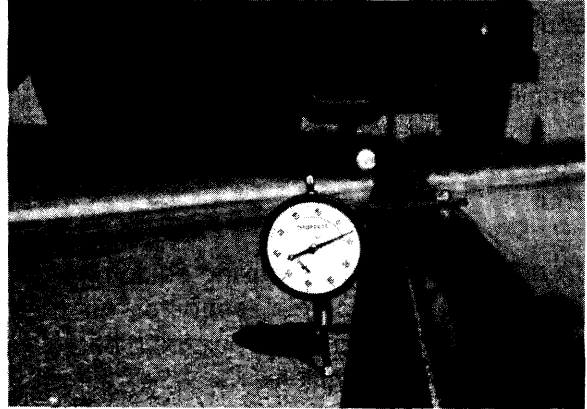

Pozzolan-Cement Grout

- Most common stabilizing material
- Key requirements:
 - fluidity to fill voids
 - strength for durability
- Use flow cone test to qualify fluidity

For each mix, you must determine the quantity of water necessary to meet the flow cone test requirements. The test measures the time necessary for a known quantity of grout to completely flow out of a standard cone. Usually, a flow-cone test time of 10 to 16 seconds is acceptable for a pozzolan-cement grout.

Mixing — Only colloidal mixing equipment provides the agitation necessary for thoroughly mixing fine fly ash or other pozzolan particles. Do not use paddle mixers.

Two common colloidal mixer designs are the centrifugal pump and the shear blade. The centrifugal pump pulls the grout through a mixing chamber at high pressure and high velocity. In a shear-blade mixer, blades rotate at 800 to 2,000 revolutions per minute through the mix. Both mixers can remove air from between the small pozzolanic particles, which enables thorough mixing. After mixing the small particles will remain in suspension and resist dilution by free water.



Mixing Pozzolan-Cement Grout

- Batch in small quantities
- Avoid paddle mixers
- Requires colloidal mixer
 - Centrifugal pump
 - Shear blade
- Mounted on flatbed for mobility

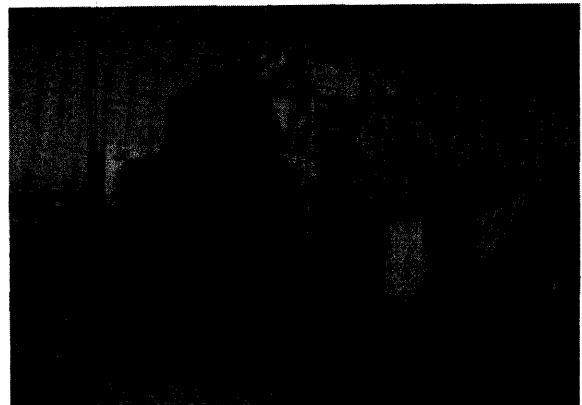

Drilling Injection Holes — Pneumatic and hydraulic rotary percussion drills with carbide or diamond tips are common for drilling grout injection holes. Small, high-speed rock drills (less than 20 kg) and rotary drills with small-diameter coring bits have also been used successfully.

Keep the downward pressure while drilling below 90 kg to avoid conical spalling and break through when nearing the bottom of the slab. Conical spalling can seriously weaken the slab and may result in radial and transverse cracking through the drill hole. The spalled material may also seal off the entrance to the void and become an obstacle to the grout during injection. Maintain a sharp drill bit so that the injection hole is clean and free from surface spalling.

Drilling Injection Holes

- Pneumatic percussion drills
- Hydraulic percussion drills
- Rock drills (<20 kg)
- Small-diameter coring bits on core drill



Drilling Injection Holes

Good Practice with Drills:

- Watch down pressure - keep below about 90 kg
- Reduce drill pressure near base of slab
- Listen for changes in drilling sound

Drill the hole through the depth of the slab and any stabilized subbase layer. The operator should feel or hear the change in drilling pressure from each layer. It is best to add 25 mm to the total drill depth to be sure that the hole extends past the deepest layer.

Use a drill hole diameter of about 30 to 50 mm for pumping pozzolan-cement grouts. Larger diameter drill bits break more easily through the slab bottom, and smaller drills do not make a hole sufficient for grout injection. Select a hole size within this range that is appropriate for your injection equipment.

Drill the injection holes in the pattern indicated on the detail sheet shown in the project plans. Only make the holes at joints or cracks that were found to have voids. There are three basic hole patterns that are appropriate for different voids.

Some contracts require drilling injection holes at all joints despite the presence of voids. This blanket coverage replaces good void finding techniques.

Be cautious to strictly follow injection pressure guidelines on projects with blanket stabilization. Following proper injection techniques should ensure that slabs that do not have voids that will not accept grout. However, inexperienced crews may tend to force grout under slabs because there are injection holes available. Experience shows that forcing grout beneath slabs that do not have voids will likely result in unstable support, high corner load deflections, and eventual slab cracking.

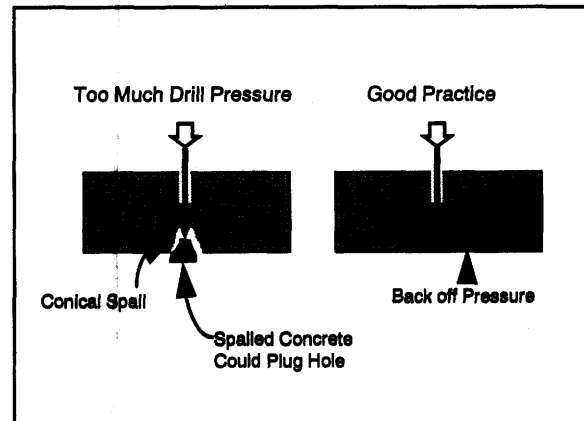

Drilling Injection Holes

Good Practice with Any Equipment:

- Drill through all stabilized layers
- Select bit/core for 30-50 mm diameter hole
- Ensure hole size is appropriate for injection equipment

Injection Hole Pattern

The diagram shows a rectangular slab with a vertical joint or crack. A horizontal line above the slab is labeled '600 mm'. A vertical line below the slab is labeled '600-900 mm'. Below the diagram, the text reads 'For Voids on Leave Side of Joint or Crack'.

Setting the Uplift Beam — Use an uplift beam to monitor slab deflection during grout injection. The uplift beam must have sensitive dial gauges capable of detecting movements of 0.025 mm.

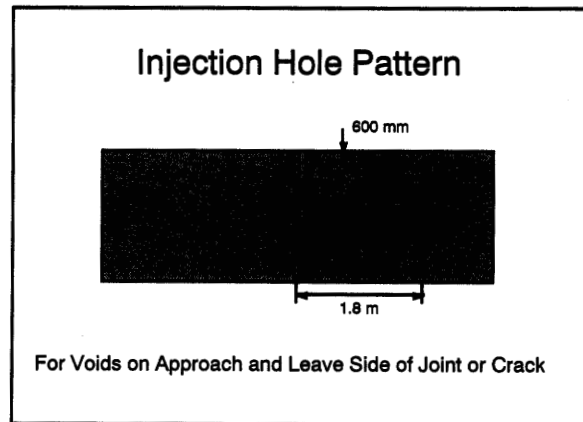
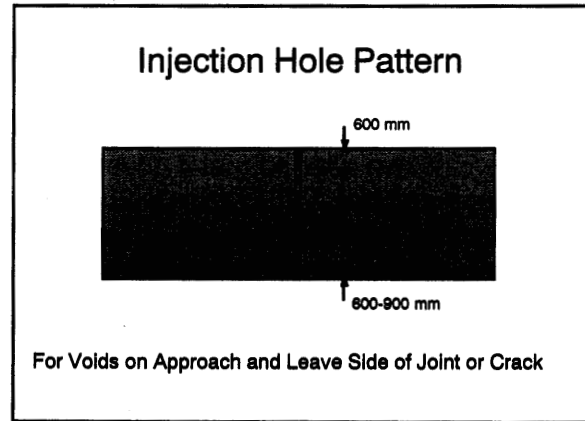

- Setting Uplift Beam**
- Place monitoring gauge near point of injection
 - Place support end of gauge off of the slab

Position the uplift beam carefully to ensure deflection readings are accurate. Place the monitoring gauge near the point of injection and place the support end somewhere off the slab. The support end should be far enough away from the injection area so that it does not rise with slab movement. Any upward movement of the support end would decrease the accuracy and dependability of the deflection monitoring set up.

Pumping Equipment — Pump the grout using either a positive displacement injection pump, or a non-pulsing progressive cavity pump. Piston pumps do not work well. The pulsating piston causes pressure surges that prematurely squeeze water out of the grout.

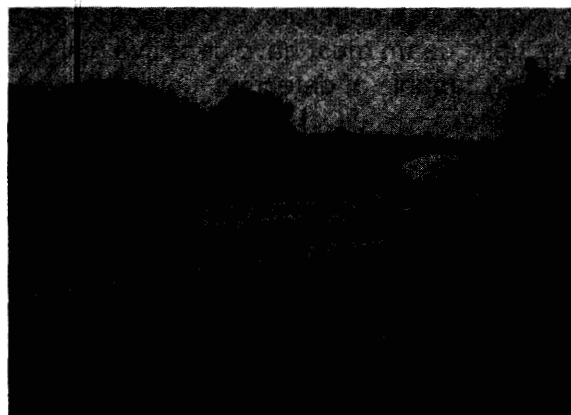

Pumping Grout

- Use non-pulsating pump
- Pump at rate of about 5.5 liters per minute
- Too high pumping rate thickens grout

A desirable pumping rate is about 5.5 liters per minute. The pump should work well maintaining pressures between 0.15 and 1.4 MPa during grout injection. This pressure range ensures placement control and lateral coverage and usually prevents slab raising.

Higher pumping pressures drive off excess water and thicken the grout. This reduces the grout's ability to penetrate and fill voids.

Starting Grout Injection — Try to start and maintain grout injection at a low pumping rate and pressure, usually in the range of 0.3 to 0.5 MPa. The maximum recommended pressure is 0.7 MPa. Sometimes an initial short pressure surge may be necessary to clear debris from the grout hole and to prompt the grout to penetrate the void. The initial surge can be as high as 1.4 to 2.1 MPa but is only acceptable for 2 to 3 seconds. If the pressure does not drop after 3 seconds, there is likely some other problem, such as a hole blockage or poor hole placement.

As a test, you may pour clean water into each grout hole to test how well the water can flow into the void. Sometimes when there is hole blockage the water will fill the hole and then back up onto the slab surface without flowing under the pavement.

To prevent grout extrusion or backup during injection, the injection equipment must include a grout packer that seals the injection hole. Drive packers are metal nozzles that taper and fit snugly into the injection hole. They are appropriate for 25-mm diameter holes. You seat these by tapping with a small hammer or by standing on them during injection. For larger holes, use an expandable packer with a rubber sleeve that expands to fill the hole during injection. In general, expanding-rubber packers are preferable to drive packers because they provide a tighter fit.

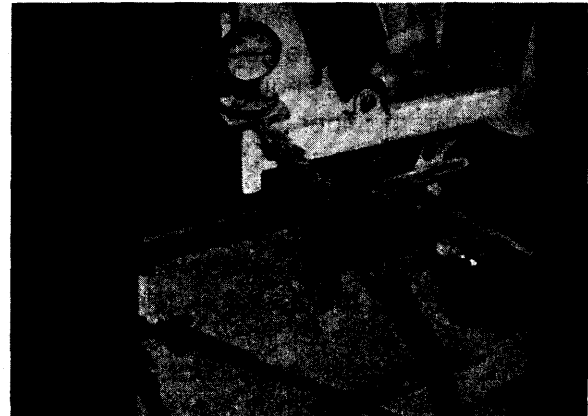

Starting Injection

- Low pumping pressure is ideal (0.3-0.5 MPa)
- Initial 1.4-2.1 MPa surge O.K. to clear hole
- Hole blockage likely if initial surge pressure remains after 3 seconds
- Always seat and check grout packer when starting injection



Injection Pattern — The crew should choose a workable grouting pattern. Many start grout injection in the centerline holes and work toward holes near the shoulders. This pattern drives water from under the slab and moves it toward the outside edges where it can escape through transverse and shoulder joints.

Use caution when pumping through holes near the edges to avoid raising the shoulder. Stabilization material can fill voids beneath the shoulders, but because shoulders are thinner than the mainline slabs they are easier to lift.

Some transverse joints may be open wider than the shoulder joint. In these situations, begin injection through holes near the shoulder joint and drive the excess water out through the transverse joint.

Stopping Grout Injection — Quick response to slab movement is necessary to minimize any slab lift. It is helpful if the injection equipment includes either a return hose from the grout packer to the grout tank or a fast-control reverse switch. These items allow you to stop grout injection quickly when you detect slab movement on the uplift gauge. Most specifications limit slab lift to less than 1 to 2 mm.

When the grout is displacing water from beneath the slab, observe the water as it flows out through joints or cracks. Continue pumping until you see an undiluted mixture of grout flowing from the same area.

Example Grout Injection Pattern

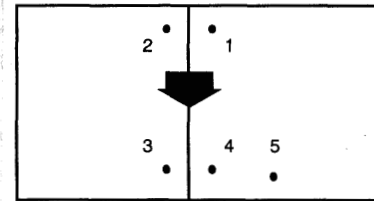

Push any underlying water out toward shoulders

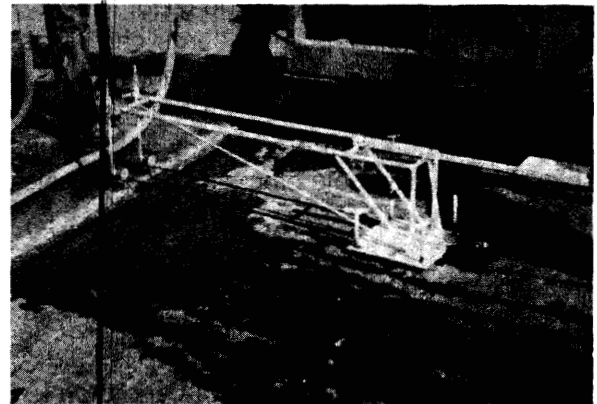

Stop Injection When

- The slab begins to rise
- Grout no longer pumps below the maximum allowable pressure
- You see grout flowing up through adjacent holes

Plugging — Upon completing injection, the specifications might require placing tapered wooden plugs into each hole. The plugs prevent pressure from quickly dissipating and keeps the grout from backing up. The specifications usually prohibit removing the wooden plugs until completing injection at all nearby voids and allowing sufficient time for the grout to set.

Post-Testing — Twenty-four to 48 hours after finishing, test the stabilized slabs using a deflection testing method. This will show the benefit of stabilization. High deflections indicate that the first stabilization attempt did not restore support. The area will require a second attempt. Test again after the second stabilization operation. If high deflections still occur after three attempts, consider replacing or patching the slab.

Construction Limitations — Do not perform slab stabilization operations if:

- The ambient air temperature drops below 4°C.
- The subgrade freezes.

Final Steps

- Insert wooden plugs only if required
- Perform post testing 24-48 hours after stabilizing the slab
 - redo any slabs with high deflections
 - consider replacing slab full-depth after third injection

Limitations

Do not stabilize if:

- Air temperature drops below 4° C
- The subgrade freezes

Detailing Full-Depth Patching Operations

With good design and construction practices full-depth patches should perform for as long as the surrounding concrete slabs.

Sizing a Patch — To size a patch, it is necessary to know the extent of typical deterioration on the pavement. Each patch should replace the concrete and all significant distress. It is advantageous to set repair sizes to go beyond the limits of any subbase voids created from the erosion action of pumping. The figure on the following page shows examples of how to define repair sizes.

Do not attempt to cut costs by limiting patch size despite the expanse of deterioration. This can reduce the repair's ability to extend pavement service life. Remember, in freeze-thaw climates below-slab deterioration may extend 1 m beyond visible distress.

Full-Depth Patching Operations

Sizing a Patch

- Go beyond deterioration
- Remember to check for below-surface spalling
- Minimum length 2 meters
- Adjust as necessary
- Combine closely spaced patches

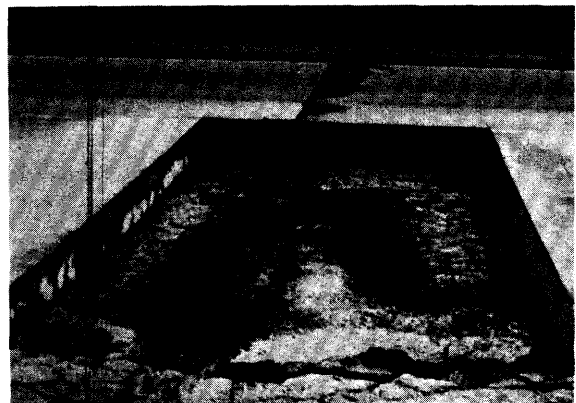

Jointed Plain Pavement

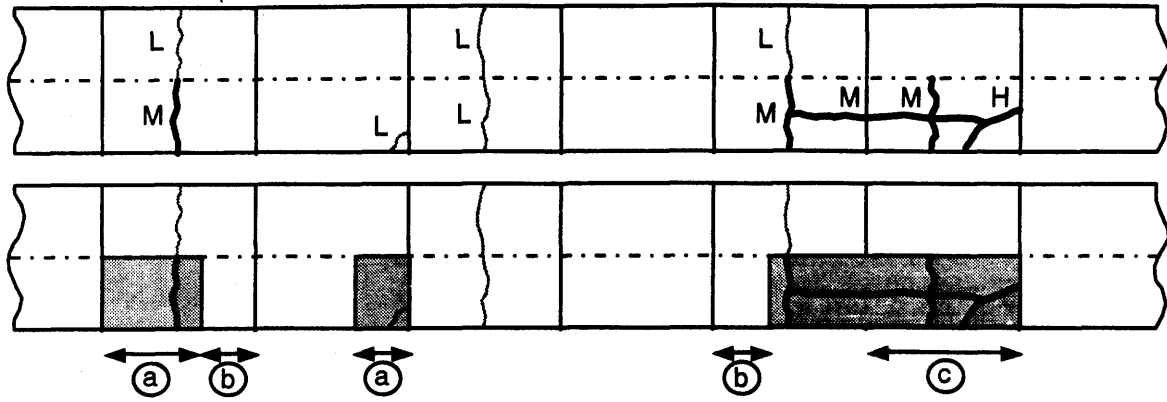

L, M, H = Low-, Medium-, High-Severity

Jointed Reinforced Pavement

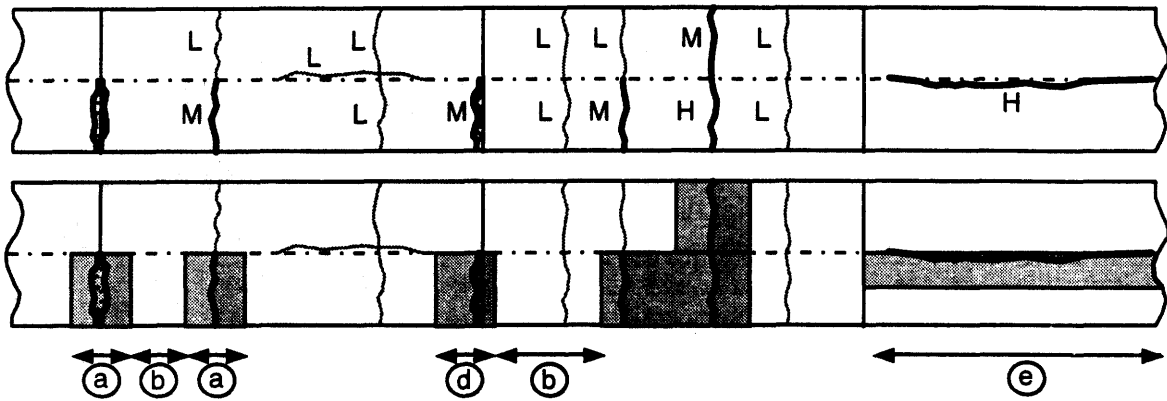

Continuously Reinforced Pavement

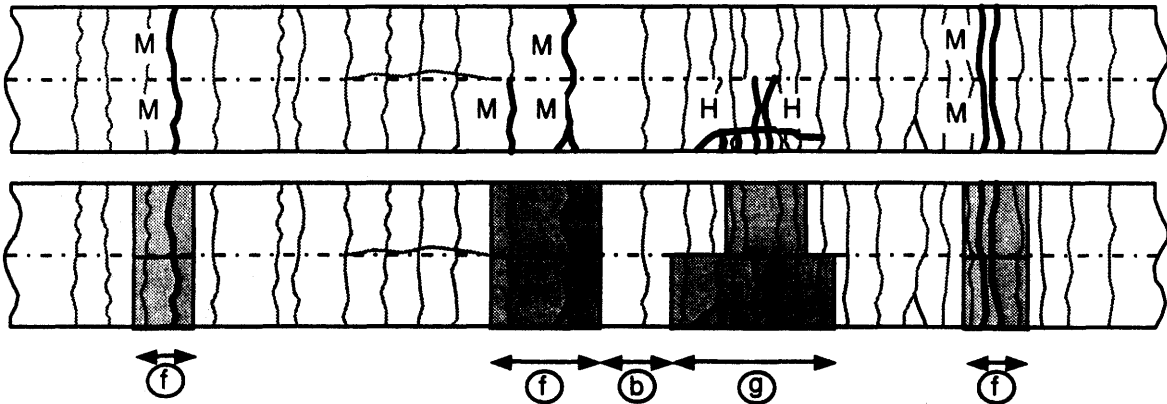

- a. End at existing joint if possible; minimum length is 2 m for doweled joints; 2.5–3.0 m for aggregate interlock joints.
- b. Check distance between patches and nearby joints (see Table 2).
- c. Replace the entire slab if there are multiple intersecting cracks.
- d. Extend the patch beyond joint by 0.3 m to include dowels, even if there is not any deterioration on that side of joint.
- e. For high-severity cracks only; begin and end longitudinal patches on transverse joints; keep joint off wheelpaths.
- f. Extend perimeter beyond nearby cracks to get to solid concrete, even if the nearby cracks do not require repair.
- g. Remove the full length of any deteriorated longitudinal cracks; remove all punchouts.

The minimum patch length for repairing transverse joints and cracks depends on the use of dowels in the transverse patch joints. A minimum patch length of 2 m in the longitudinal direction is acceptable where the patch joints use dowel bars. For CRC pavements a minimum length of 2 m should provide adequate room for steel-splicing and other preparation work.

In the field it may be necessary to adjust the size of patches. The following are recommendations for common situations encountered in the field:

- If the patch boundary at minimum width falls within 2 m of an existing undoweled transverse joint that does not require repair, extend the patch to the transverse joint.
- If the boundary at minimum width falls on an existing doweled transverse joint, and the other side of the joint does not require repair, extend the patch beyond the transverse joint by about 0.3 m to remove the existing dowels.
- If the boundary at minimum width falls on a crack in a continuously reinforced pavement, extend the patch beyond the crack by 0.15 m.

Mark the boundaries on the pavement using a brightly-colored spray paint.

Field Adjustments

If Patch Boundary:

- Falls within 2 m of transverse joint
 - Then extend to include joint
- Falls on or very near a doweled joint
 - Then extend beyond joint 0.3 m to remove the dowels
- Falls on a crack
 - Then extend beyond crack by 0.15 m

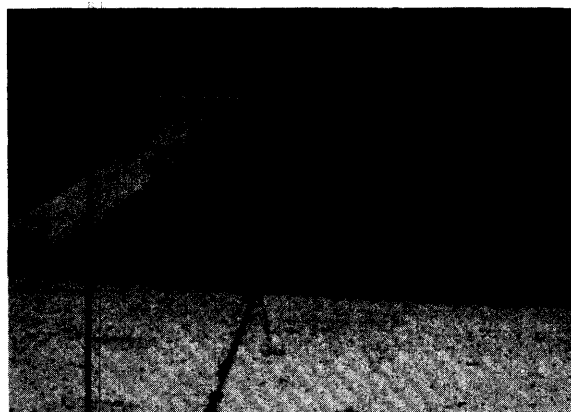

Combining two smaller patches into one large patch often can reduce repair cost. However, the longest patch length should not exceed the pavement's longest slab length.

Sawing — Before removing deteriorated concrete, isolate the area from adjacent concrete and shoulder materials using full-depth saw cuts. The full-depth cuts separate the segment of deteriorated concrete and allow room for its removal with minimal damage to surrounding materials.

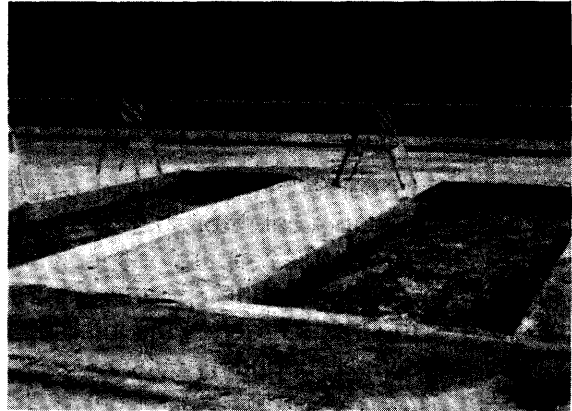

Combine Patches

Slab Thickness, mm	3.6 m Patch Width
175	4.
200	3.4
225	3.0
250	2.7
275	2.4
300	2.4
375	2.0

Sawing Boundaries

- Use diamond bladed saws
- Saw through the joints so base of blade reaches boundary
- Isolate transverse, longitudinal and shoulder
- Provide pressure-relief cut within patch if saws bind

Concrete Pavement Restoration (CPR)

It is preferable to use diamond-bladed saws for the full-depth transverse cuts. Diamond-bladed saws produce straight, smooth, vertical faces that improve the accuracy of dowel bar placement.

Any interior or centerline longitudinal joint also requires a full-depth cut through the existing joint reservoir. The saw operator should continue sawing through the joint to ensure that the base of the blade reaches the intersection with the transverse boundary cuts.

If diamond-bladed saws bind during hot weather, then the concrete slabs are in compression from thermal expansion. To cure this problem you can either saw at night during cooler temperatures or provide pressure-relief cuts with carbide-toothed wheel saws.

Make any pressure-relief cuts at an interval of about 180–360 m before starting any boundary sawing. To avoid damaging adjacent concrete, keep the cuts in the marked patch areas away from the perimeters by about 150–200 mm. Also, do not allow the cut to enter an adjacent slab or penetrate the subbase by more than 12 mm.

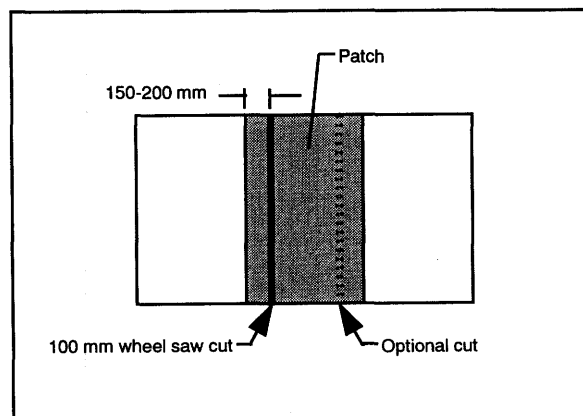

You also may elect to use one or more wheel saw cuts within each patch area to give removal equipment space to grasp the old concrete.

For repairs in continuously reinforced concrete pavements, the transverse perimeter cuts should only extend down about 1/4–1/3 the slab thickness. Then make full-depth cuts for liftout removal closer to the patch interior away from these partial-depth perimeter cuts. The concrete between the cuts provides a buffer to prevent undercut spalling and allows chipping for exposing steel reinforcement.

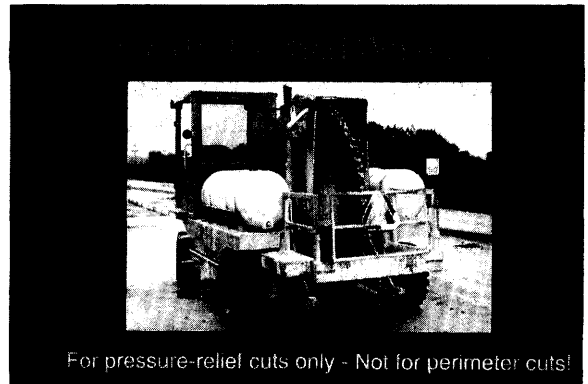
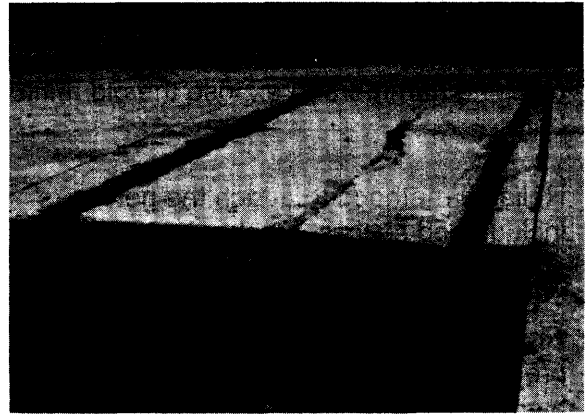

CRC Patches

- Two cuts for each transverse boundary
 - Full-depth inner cut
 - Partial-depth perimeter cut
- Salvage segments of old steel by chipping
- Splice new steel

Concrete Pavement Restoration (CPR)

New steel attaches to salvaged lengths of old reinforcing bars that remain after concrete removal. To avoid damage, use small, 7 kg chipping hammers to expose the old reinforcing bars.

Reliable methods to attach the new bars include tied splices, mechanical fastened splices and welded splices.

Removal — Sawing operations should not precede removal and patch placing operations by more than two days. The full-depth cuts do not provide load transfer and can begin to pump or punch into the subbase, causing unnecessary damage.

It is preferable to lift deteriorated concrete out of place wherever possible. Lifting the old concrete imparts no damage to the subbase and is usually faster and requires less labor than any method that breaks the concrete before removal.

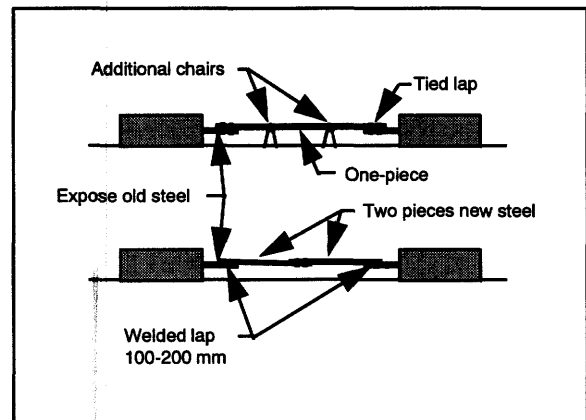
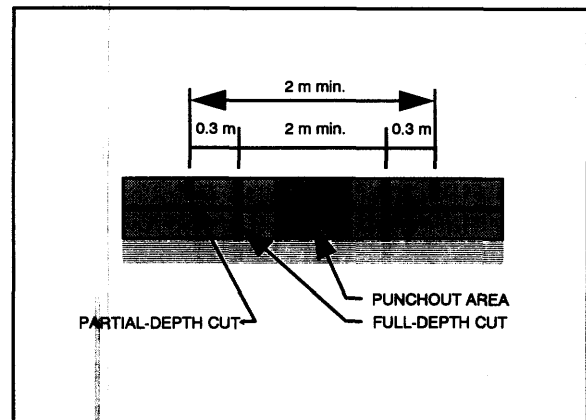

Removal

- **Liftout**
 - Pin and chain
 - Claw
- **Breakup**
 - Handheld pneumatic hammers
 - Drop Hammers or rams

There are many ways to lift the old concrete. The most common liftout method uses a steel chain connected to lift pins. Other methods may require an additional relief cut in the patch area to allow the machinery to grasp the concrete segment.

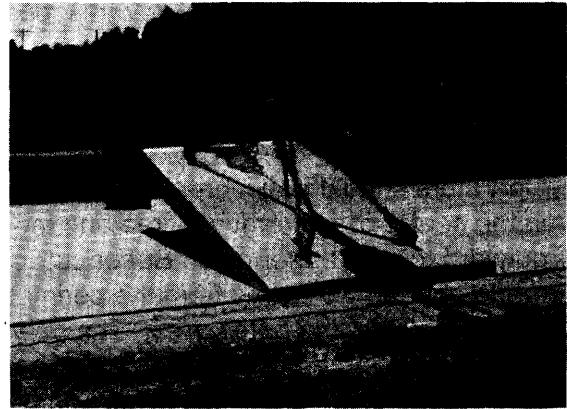

Damage during liftout is not entirely avoidable, and it will probably be necessary to extend the repair if the lifting operation chips the remaining concrete. Damage most often occurs if the old concrete swings during the lift and chips the faces of the remaining concrete. Making a wheel saw cut within the patch area can provide some additional space for lateral movement.

Sometimes concrete joints or cracks are so deteriorated that it is unsafe to remove them by liftout. In these cases it is necessary to break the deteriorated concrete into small fragments for removal by backhoe and hand tools. The drawback to this method is that it often damages the subbase and requires more repair preparation than a liftout procedure. The damage occurs because the breakhammer pushes pieces into the subbase, which requires the backhoe operator to dig into the subbase surface to scoop out broken concrete.



Concrete Pavement Restoration (CPR)

When using mechanized breaking equipment like drop hammers or hydraulic rams, operators must exercise control on the equipment's break energy. Excessive break energy will punch concrete pieces into underlying granular layers.

Operators should begin breaking the concrete in the center of the removal area and move outward toward buffer cuts. Buffer cuts are made about 0.3 m away from the perimeter saw cuts within the patch area. The operator should reduce the break energy (drop height) before starting on the area outside the buffer cuts. Then there will be less chance of damaging concrete beyond the patch perimeter.

Preparing the Patch Area — After removing the old concrete and loose material, the area is ready for subbase preparation.

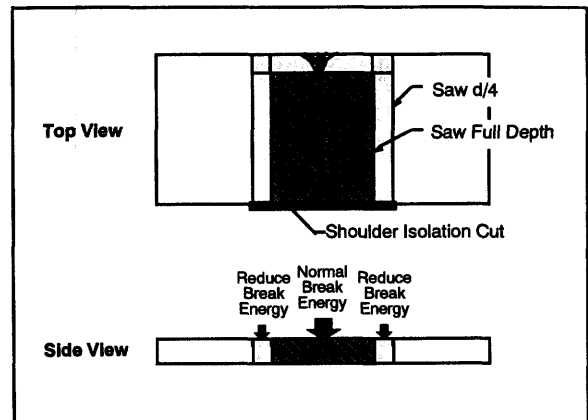

Preparing Patch Area

- Add and compact new subbase material if necessary
- Use 17-27 kN vibratory plate compactors
- Drain rainwater as necessary

If removal operations damage the subbase, it may be necessary to add and compact new subbase material. Ideal backfill materials can reach optimum compaction with small plate compactors that can maneuver in the confined patch area. Use vibratory plate compactors that have a centrifugal force rating from 17 to 27 kN. It also may be necessary to remove and replace soft areas in the subbase.

If the repair area fills with rainwater after concrete removal, the water should be pumped out or drained through a trench cut at the shoulder before repairing the subbase.

Drilling Holes — Automatic dowel drilling rigs are preferable to single, hand-held drills. It is difficult to drill consistent holes using hand-held drills because they are heavy and do not have an alignment guide or jig.

Dowel drill rigs contain one or more drills attached parallel in the rig's frame. The frame acts as the alignment jig to control drill alignment and wandering. However, single, frame-mounted or hand-held drills are necessary where there is not enough room for the multiple-drill rigs.

There are several varieties of drill rigs. The difference depends on their mount and whether they reference the slab or subbase. The three basic types of drill rigs are the following:

Self-propelled, subbase-reference rig



Drilling Holes

- Use gang-mounted drill rig
 - Consistent holes
 - Alignment jig
 - Improved productivity
- Slab reference preferable
- Hydraulic or pneumatic drills O.K.

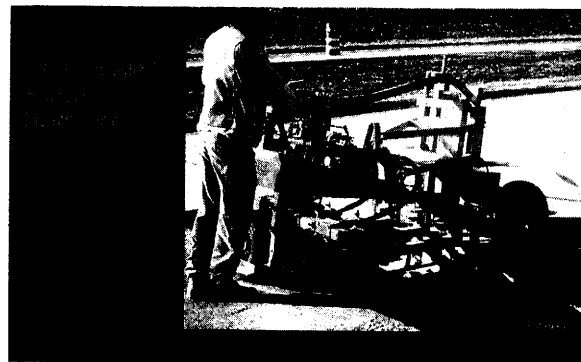

Concrete Pavement Restoration (CPR)

Self-propelled, slab-reference rig

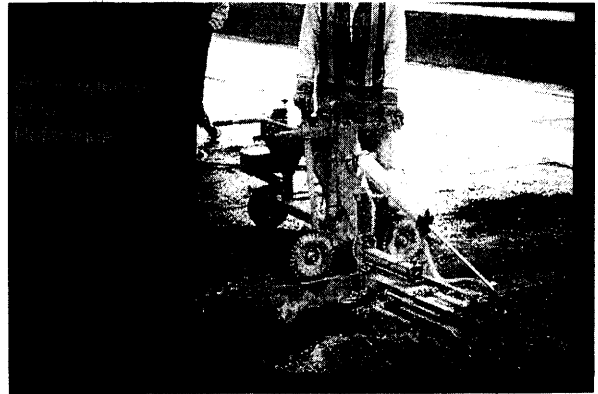

Boom-mounted, slab reference rig

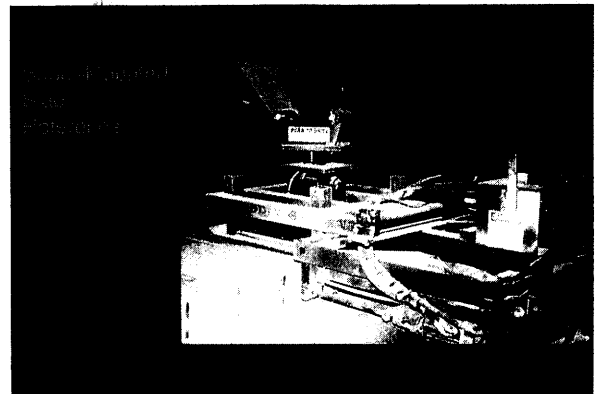

Standard pneumatic or hydraulic percussion drills provide acceptable drilling results for dowel holes. Both drill a typical 225-mm hole in about 30 seconds. Standard pneumatic drills cause slightly more spalling on the slab edge when starting to drill because they impart more impact energy than hydraulic drills. However, this should not effect dowel performance with good installation techniques.

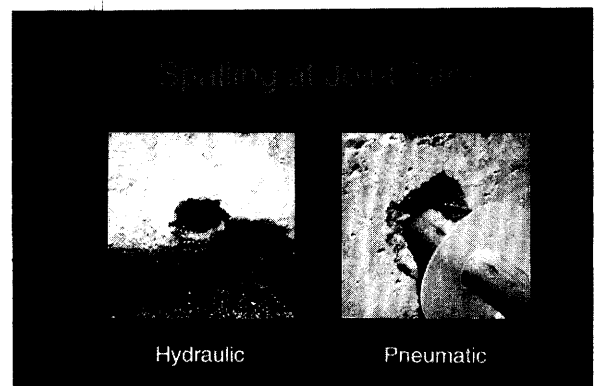

You may need to adjust the location of dowel holes from the plan requirements. Sometimes cracks, heavy mesh reinforcement, or other obstructions exist at the plan location for a dowel hole. It is better to adjust the hole away from an obstacle or eliminate the hole, rather than attempt to drill and place a dowel at a questionable location.

The hole diameter needed will depend on the anchoring material. Cement-based grout requires a hole diameter 5–6 mm larger than the nominal outside dowel diameter. Epoxy anchoring materials only require a hole diameter about 2 mm larger than the nominal dowel diameter.

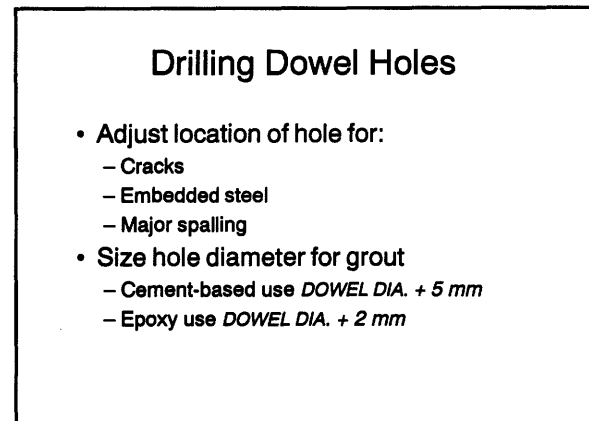
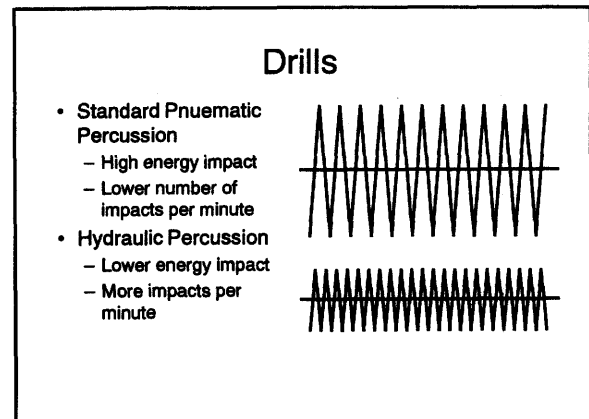

Cleaning Holes — After drilling, clean out the dowel holes with compressed air. Insert the air nozzle to the back of the hole to force out all dust and debris. Dust and dirt prevent the epoxy or non-shrink grout from bonding to the concrete around the hole perimeter. Also, occasionally check the air for oil and moisture contamination from the compressor. The compressor should deliver air at a minimum of 3.4 m³ per minute and develop 0.63 MPa nozzle pressure.

Installing Dowels — To place the anchoring material, use a long nozzle that feeds the material to the back of the hole. This assures that the anchoring material will flow forward along the entire dowel embedment length during insertion. It also decreases the likelihood of leaving voids between the dowel and the concrete. For non-shrink cementitious grouts, a caulk-gun-type tool is preferable. Do not use any method that attempts to pour or push the anchoring material into the hole.

Cleaning Holes

- Compressed air
- Insert air wand to back of hole
- Check compressor for moisture and oil contamination with clean cloth

Installing Dowels

- Feed material to back of hole
- Insert dowel properly
- Use retention disk



For epoxies, the injection wand on the installation unit should contain an auger-type mixing spindle that mixes the two-part epoxy. Prefabricated epoxy cartridges are available that supply enough material for one or two holes; a more cost-effective system for large projects uses a pressurized injection system from bulk epoxy containers.

While pushing in each dowel, twist the dowel about one full revolution to evenly distribute the material around the dowel's circumference. Without the twist, most of the anchoring grout will remain along the bottom of the bar, and voids will be present along the top of the bar.

Sometimes the anchoring material flows out while inserting the dowels. A plastic grout-retention disk provides a barrier that prevents the escape of epoxy or grout. When metered properly, some anchoring material should be visible from the sides of the disk after installation. If no grout can be seen, there may not be enough in the hole.

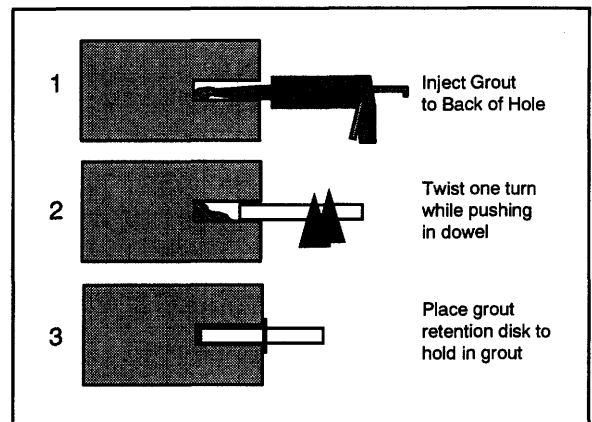

Concrete Pavement Restoration (CPR)

If retention disks are not available, a laborer should trowel some extra grout around the dowel. This is not an ideal installation, but is preferable to leaving a void.

Preparing Longitudinal Joints — Longitudinal patch perimeter joints also require preparation before adding the new concrete. Full slab replacements and repairs longer than 4.5 m require a tie system. Drill and anchor tiebars or wiggle bolts using the same anchoring grout used for dowels. Either #10M to #20M deformed reinforcing bars or two-part threaded couplers are acceptable in most specifications. Typically these are spaced along the longitudinal joint at 750 mm.



Preparing Longitudinal Joints

- For patches > 4.5 meters long
 - Drill and anchor tiebars or wigglebolts
- For patches < 4.5 meters long
 - Place bondbreaking board



For repairs less than 4.5 m long, place a bondbreaking board along any longitudinal face with an existing concrete lane or concrete shoulder. A thin, 5-mm fiberboard or similar material should match the repair area depth and length and sit flush with the longitudinal face of the repair. The bondbreaker allows the patch and the old concrete to move independently.

Placing, Finishing, Curing — Place concrete into the repair area from ready-mix trucks or other mobile batch vehicles. Distribute the concrete evenly to avoid the need for excessive shoveling. Use care to attain good concrete consolidation around dowel bars and along the patch perimeter. Honeycombing reduces concrete strength and durability. Use vertical penetrations of a standard spud vibrator to adequately mobilize the patching concrete. Do not drag the vibrator through the mix—this may cause segregation and loss of entrained air.



Placing Concrete

- Distribute evenly
- Avoid excessive shoveling
- Vibrate uniformly
 - Use vertical penetrations of vibrator
 - Do not drag!!

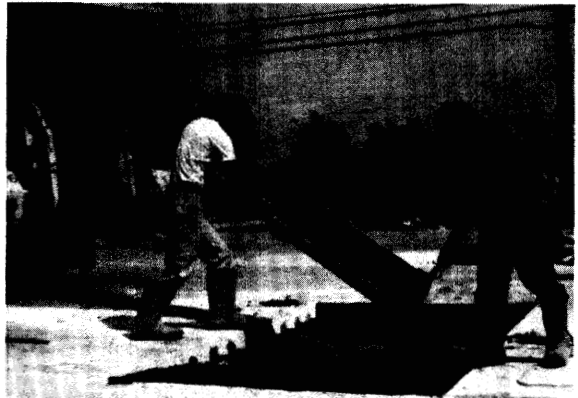

Concrete Pavement Restoration (CPR)

Both vibratory screeds and 3-m straightedges are good tools to strike off and finish a repair surface. It is better to pull the finishing tool across the pavement with the blade parallel to the longitudinal joint for short repairs (<3 m). The tool rests on the old concrete on both sides of the repair and follows the surface of the adjoining slabs. The patch surface will then match the surrounding surface profile. For patches longer than 3 m, finish the surface longitudinally with a vibratory screed.

Texture the patch surface so that it is similar to the surface of the surrounding pavement. Burlap drag and transverse tine surfaces are common. For tine surfaces, the distance between combs for the patch texture should be similar to the distance between combs on the existing surface.

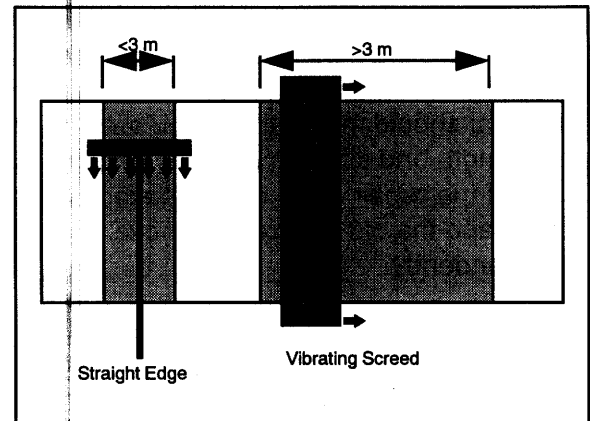

Texturing Patch

- Texture soon after finishing
- Texture similar to surrounding concrete surface
 - burlap drag
 - tine (match spacing)
- Do not delay curing

Curing is important to help the concrete achieve good strength and durability. In general, a liquid-membrane-forming curing compound is adequate as long as you apply it evenly and sufficiently. Use well-maintained pressure spraying equipment that will allow an even application. An application rate of about 5.0 m²/L is sufficient.

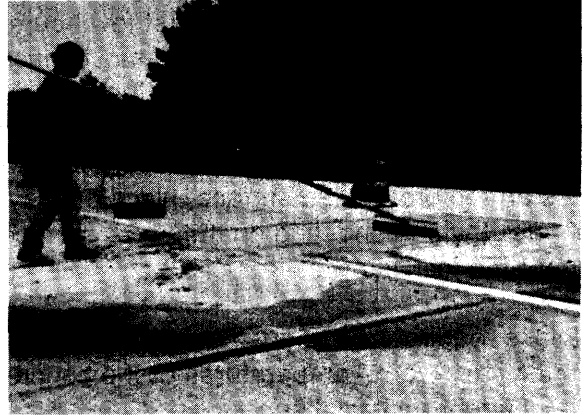

Curing Patch

- Apply curing compound evenly
- Pigment is helpful to see coverage
- Insulation mats useful for:
 - Accelerating strength gain
 - Cold temperatures
- Place polyethylene between patch and insulation

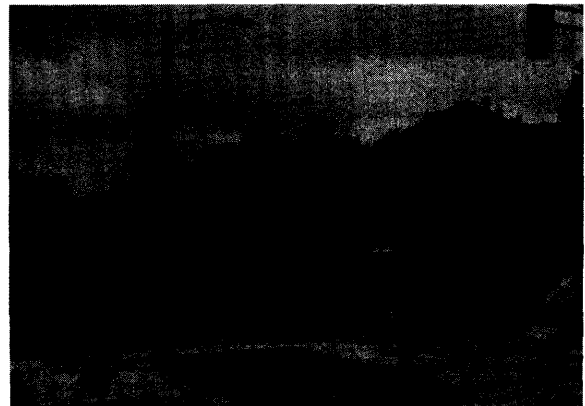

Concrete Pavement Restoration (CPR)

For some cases insulation mats will be required to increase the concrete temperature and accelerate strength gain. The first few hours after pouring the concrete are the most critical for good curing. Therefore, apply the curing compound and insulation as soon as possible after finishing the surface. To prevent moisture loss and to protect the surface, place one layer of polyethylene sheeting on the patch surface under the insulating boards or mats.

Unless required, do not use insulating boards during very warm temperatures or the concrete may undergo thermal shock.

Sealing the Joints — The final step is to form or saw transverse and longitudinal joint sealant reservoirs at the patch boundaries. Sealed perimeter joints will lower the potential for spalling at the patch joints. This step is often done while resealing joints and cracks along the rest of the pavement.

Construction Limitations — The construction limitations for full-depth patching are dictated by the patch mix design. Test the mix for any temperature sensitivities or consult the specifier or supplier for information on the temperature limitations and guidelines for using the mix.

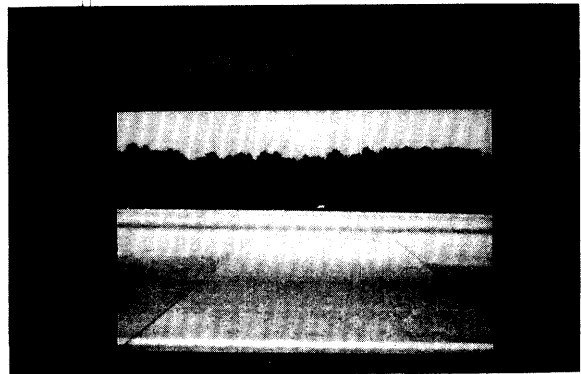
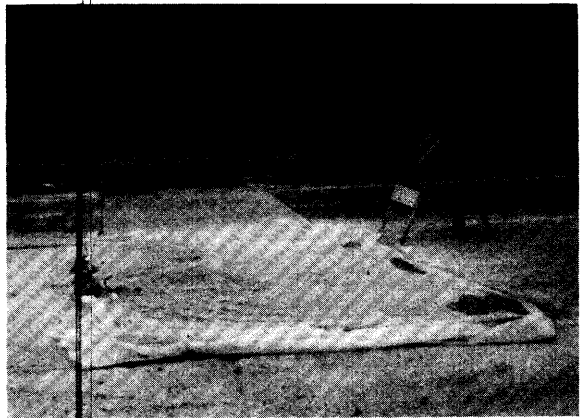

Detailing Partial-Depth Patching Operations

With good design and construction practices partial-depth patches should last as long as the surrounding concrete slabs. The most frequent causes of performance problems are related to misuse of the technique, poor patch material and careless installation. Open discussion during the preliminary meeting and survey can define expectations and eliminate many of these problems.

Finding Unsound Concrete — The first step before placing any patches is to “sound” the concrete surface to find weak areas (delaminations). Often these delaminations result from cracks in the concrete that may not be visible from the surface.

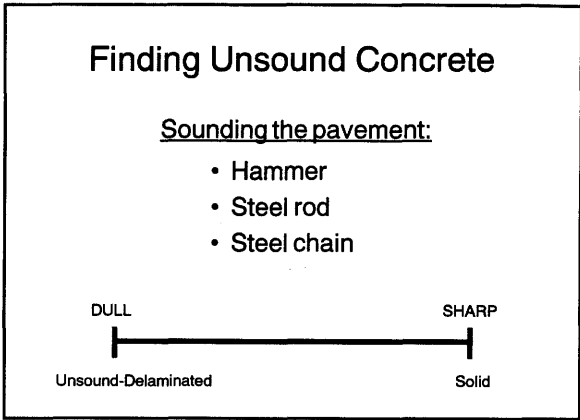
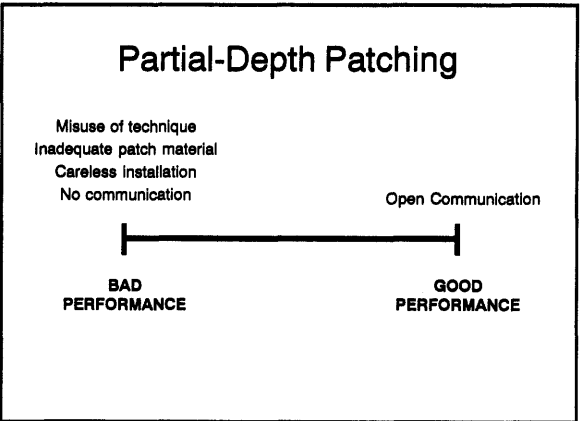
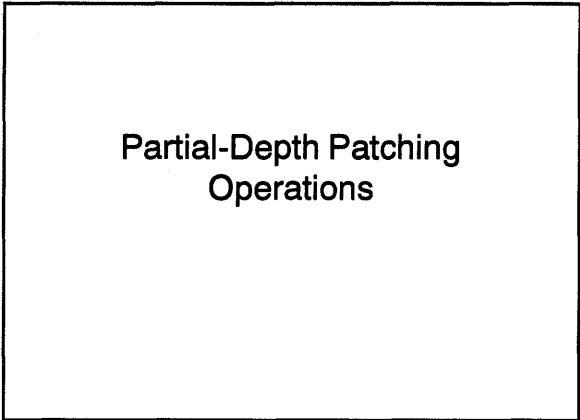

Concrete Pavement Restoration (CPR)

Sounding is done by striking the concrete surface with a steel rod or ball-peen hammer, or by dragging a chain along the surface. A sharp metallic ring indicates sound concrete, whereas a dull or hollow sound indicates unsound concrete.

Start sounding the pavement along transverse joints or cracks and any midslab areas that exhibit visible spalling or severe scaling. If available, refer to the partial-depth patch locations shown in the plans for guidance, but do not rely on them completely. Remember that the condition may be worse now, than it was when the engineers drafted the plans.

Determining the Repair Boundaries — Include all nearby deterioration within the patch boundaries. Clearly mark each boundary with brightly-colored spray paint to outline the removal area.

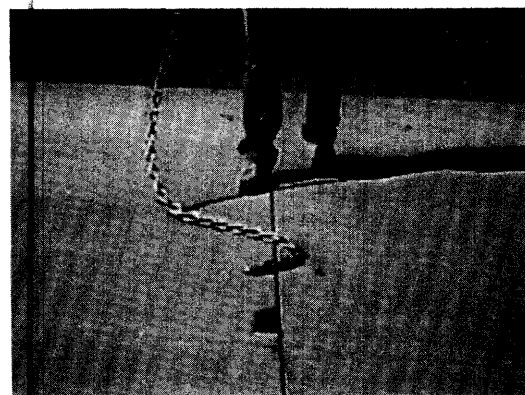

Defining Repair Boundaries

- Minimum length 300 mm
- Minimum width 100 mm
- Go beyond problem by 75-100 mm
- Combine close patches (<0.6 m)
- Repair entire joint if more than 2 patches

Keep the patch boundaries square or rectangular. Irregular shapes are more difficult to saw and usually do not perform well. Use the following guidelines when determining how and where to locate and mark repair boundaries:

- Use a minimum length of 300 mm.
- Use a minimum width of 100 mm.
- Extend the patch limits beyond the delamination marks or visible spalls by 75–100 mm.
- Do not place a patch if the spall is less than 150 mm long and less than 35 mm wide.
- If two patches will be less than 0.6 m apart, combine them into one large patch.
- Repair the entire joint length if there are more than two spalls along a transverse joint.

It is during removal of the concrete that you determine the depth of the patch.

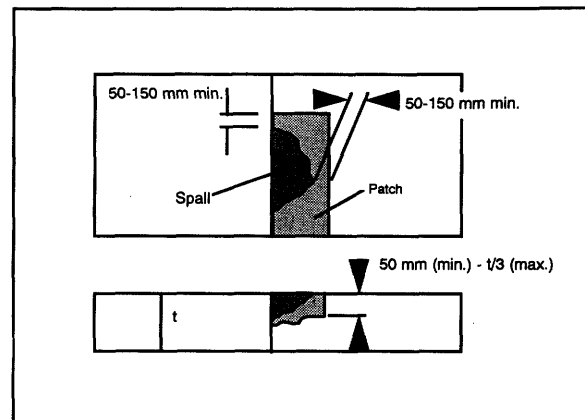

There are two common methods to remove the concrete within the patch area: sawing and chipping, or carbide milling.

Removal by Sawing & Chipping — When using a method that chips the concrete for removal by hand, saw along the perimeter of the removal area. Use diamond-bladed saws set to a depth of about 25–50 mm. The cut should be straight and vertical. Overrun the cut slightly so that the bottom of the cut intersects the patch corner—you can fill the extra length of saw cut later.

Removal

- Sawing and chipping
- Carbide milling
 - Transverse
 - Longitudinal

Sawing & Chipping

- Vertical cut at perimeters
- Diamond blade
- Depth to 50 mm
- Overcut slightly



Break the concrete within the patch area to a minimum depth of 35 mm with light pneumatic hammers. Use a hammer no larger than about 13.5 kg. Lighter, 7-kg hammers are preferable so that it is easier to control the depth of chipping.

Spade bits also are preferable to gouge bits for control of chipping. Even light hammers with gouge bits can damage sound concrete.

Sawing & Chipping

- Break to minimum depth of 35 mm (1/3 slab thickness maximum)
- 13.5 kg maximum hammer
- 7 kg hammer preferable for control
- Spade bits preferable to gouge bits
- Do not expose dowels



Spade Bit



Gouge Bit

Concrete Pavement Restoration (CPR)

Chip the area until you expose sound and clean concrete along the entire bottom of the repair area. The depth of the patch should not exceed about one-third the slab thickness. If more chipping is necessary to find sound concrete, or you expose any dowel bars, switch to a full-depth repair. Experience shows that partial-depth patches perform poorly when in contact with dowel steel.

Do not use chipping alone without sawing the patch perimeters. Experience shows that thin or feathered concrete along the repair perimeter is prone to spalling.

Removal by Carbide Milling — Removal of spalled or delaminated concrete by carbide milling is especially effective where the repair will extend the entire lane width or a majority of the lane width. This method is efficient and economical for large areas. It also leaves a rough surface that promotes bond to the new patch material.

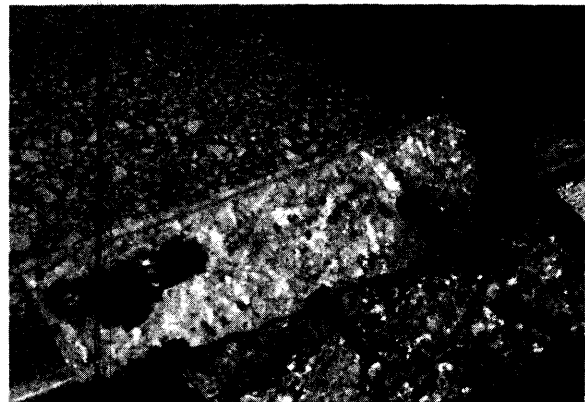
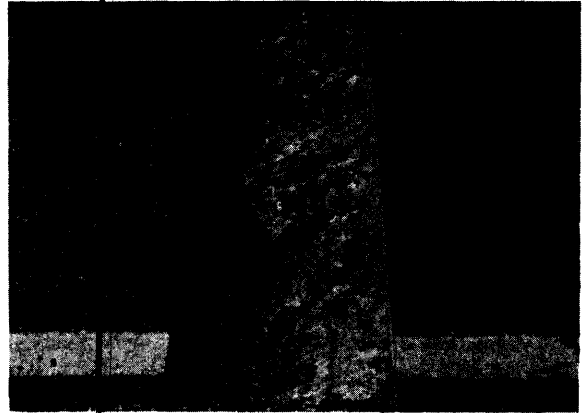

Carbide-Milling

- Efficient for large areas
- Leaves rough surface
- Avoid hand work

Use a milling machine with a kilowatt (horsepower) rating on the high-end for its class. Machines with less power are only suitable for milling asphalt. A milling head width of 300–450 mm is ideal.

The milling machine must have a mechanism that will stop penetration of the milling head at a preset depth. This will prevent excessive removals. Otherwise there is potential danger of damaging dowel bars or reinforcement by milling too deep.

Depending on the equipment and the lane closure scenario, you may mill either across lanes or parallel to the pavement centerline. Milling across lanes is effective for spalling along an entire joint. For smaller, individual spalls, either orientation is effective. The orientation will cause slightly different results, and the milled faces will not be vertical.

Check the milling head occasionally for missing teeth. Replace them as needed.

Milling Machine

- Requirements:
 - High kilowatt (horsepower) rating
 - 300–450 mm milling head width
 - Wheels preferable to tracks
- Transverse orientation
- Longitudinal orientation



After removing the concrete within the removal area, check the bottom by sounding for remaining weak spots. Either chip away the weak areas or consider a full-depth repair if the deterioration goes too deep.

Cleaning — Sandblast the faces and bottom of the patch area. Remove loose particles, oil, dust, and any other contaminants. You should produce a roughened surface.

High-pressure water blasting is an alternative to sandblasting where controlling dust is critical in urban environments. Waterblast equipment for concrete removal should be capable of producing a blast pressure of 100–200 MPa. However, to avoid damage, the equipment must be capable of adjustments that will allow removal of only weakened concrete.

Cleaning

- Check removal by sounding before cleaning
- Sandblast bottom and vertical faces
- Acceptable waterblast:
 - 100-200 MPa pressure
 - Waiting period to dry



Airblow the patch area to remove dust and sandblast residue. Direct the debris away from the patch area so that wind and traffic will not carry it back. Dust and dirt prevent the patching material from bonding to the old concrete.

The air compressor should deliver air at a minimum of 3.4 m³ per minute and develop 0.63 MPa nozzle pressure. Even if the equipment has a filter, occasionally check the air for oil and moisture contamination. Place a clean cloth over the nozzle and blow air through the cloth. Examine the cloth for any discoloration from moisture or oil residue.

Portable backpack blowers also are acceptable for removing dust and dirt from the repair area. However, air compressors with oil and moisture filters are preferred because of the higher pressure.

Placing the Joint Insert — Partial-depth patches that abut working joints or cracks require a compressible insert. The compressible insert reforms the joint or crack and keeps the new patch from bearing on the adjacent concrete. The insert also makes a uniform face that is helpful when resealing the joint or crack.

Cleaning

- Airblow to remove dust & debris
- Direct away from patches
 - Use 0.63 MPa minimum air pressure
 - Oil & moisture free air
 - Check with clean cloth
- Backpack blowers acceptable

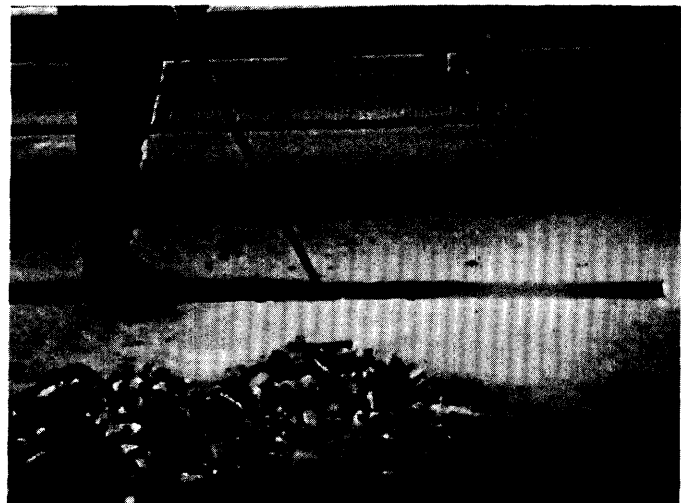

Joint Insert

- Separates patch from adjacent lane
- Reforms joint reservoir
- Provides uniform sealing reservoir
- Acceptable materials:
 - Styrofoam
 - Asphalt-impregnated fiberboard
 - Fiberboard

Concrete Pavement Restoration (CPR)

Common compressible insert materials are Styrofoam or asphalt-impregnated fiberboard. The insert width should match the width of the existing joint or crack. It should also be sized to extend about 25 mm below and 75 mm beyond each end of the patch area. An additional saw cut through the joint or crack may be necessary to allow the insert to fit properly. If large gaps exist around the insert, either cut a new piece or fill the gaps with latex caulk. The insert should prevent patch material from flowing into or across the joint or crack.

Without the compressible insert the patch may fail quickly. Slab expansion in hot weather will force the adjacent slab to bear directly against the small patch. This is termed "point bearing" and will cause failure by pop-out or delamination.

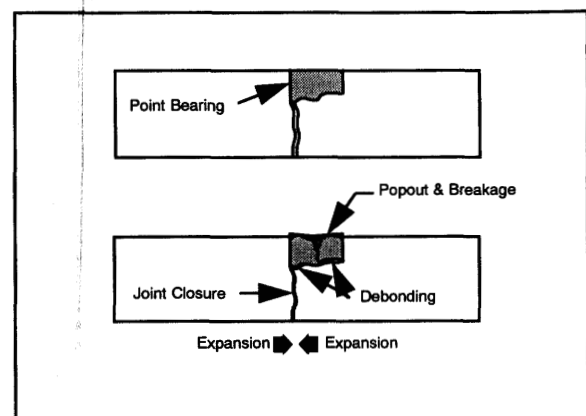
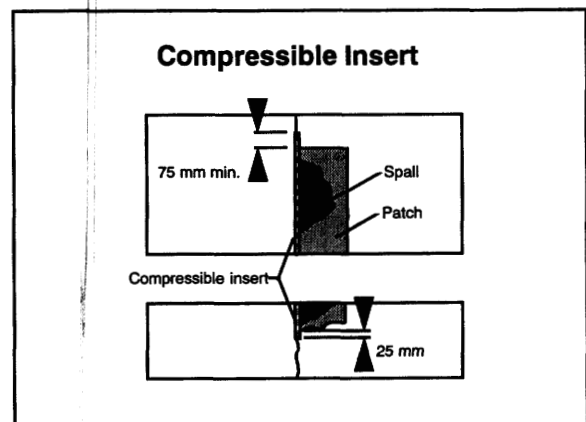

Bonding Agent — Mix cementitious bonding grouts in small batches to avoid waste. The contact time for water and cement grout should not exceed about 90 minutes.

Check the patch area again for any dust or sandblasting residue before placing a bonding agent. The area should be clean and dry. Wiping the area while wearing a dark brown or black cotton glove will easily indicate a dust problem. Airblow again if the dust has settled back in the patch area.

Evenly apply the bonding agent (prime coat or cementitious grout) in a thin coat. Scrubbing a cementitious grout with a stiff-bristled brush works well to get the grout into surface cavities. Epoxy agents may require a less vigorous application. Be sure to cover the entire area with the bonding agent, including the patch walls or edges. Overlapping the pavement surface also will help promote good bonding.

Applying Bonding Agent

- Check patch area cleanliness first
- Clean again if necessary
- Apply agent uniformly
 - Scrub cementitious grout with wire brush
 - Apply epoxy with soft brush
 - Coat all surfaces (horizontal & vertical)

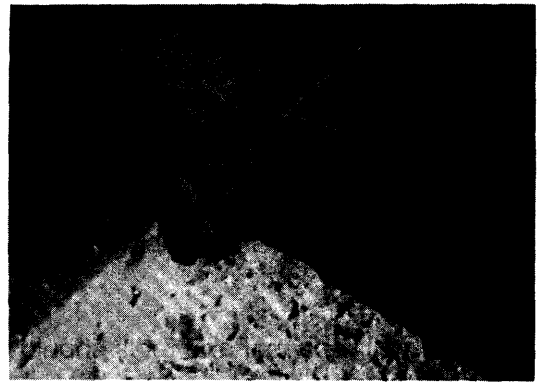

Placing — Unless there are many large patches, mix the patch material on site in small mobile drums or paddle mixers. The typically small spatial volume of partial-depth patches requires small batches to avoid wasting material. If the quantity of patches is large, ready-mix trucks can speed placing operations.

Place concrete into the repair area from wheelbarrows, buggies, or other mobile batch vehicles. For small patches, shovel the patch material. Where the patch material is mixed in ready-mix trucks, direct the concrete into the patch area with the truck's chute. Slightly overfill the patch area to compensate for consolidation.

Vibrate the fresh concrete to eliminate any voids, especially at the interface of the patch and existing concrete. Use small spud vibrators with a diameter of less than 25 mm. Do not drag the vibrator through the mix—this may cause segregation and loss of entrained air. Use small penetrations of the vibrator throughout the patch area. Hold the vibrator about 15°–30° to vertical.

On very small repairs, hand tools should be sufficient to work the repair material and attain adequate consolidation.

Placing Patch Material

- Mix in small quantities
- Place from wheelbarrows, buggies
- Slightly overfill the patch area
- Use small spud vibrators (<25 mm)
 - Hold at 15-30 degrees
 - Do not drag!!



Finishing

- Match surrounding elevation
- Work tool from center toward edges
- Seal saw runouts with grout or liquid epoxy

Finishing — Finish the patch surface to meet the elevation of the surrounding pavement. Trowel the patch outward, from the center toward the edges, to push the patch material against the walls of the patch. This technique provides a smooth transition and increases the potential for high bond strength. Most finishers tend to finish a patch from the edges toward the center, which pulls the material away from the edges.

For small patches, and projects that include diamond grinding, texturing is not important. For projects with many repairs, matching the existing surface texture will produce a more uniform appearance.

For cementitious repair materials, seal the patch perimeter and fill saw cut run outs with a thin one-to-one cement-water grout. Use a paint brush and cover the entire patch perimeter. The grout will form a moisture barrier over the perimeter and will help prevent loss of bond.

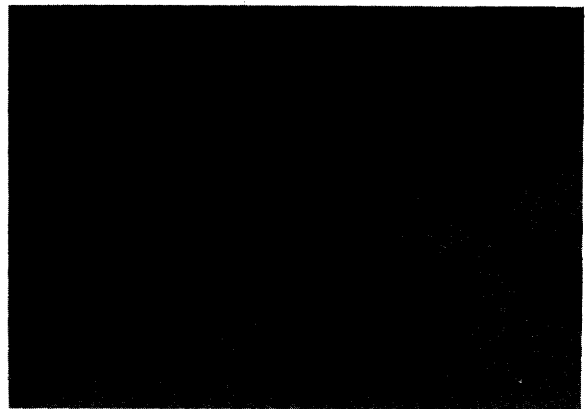
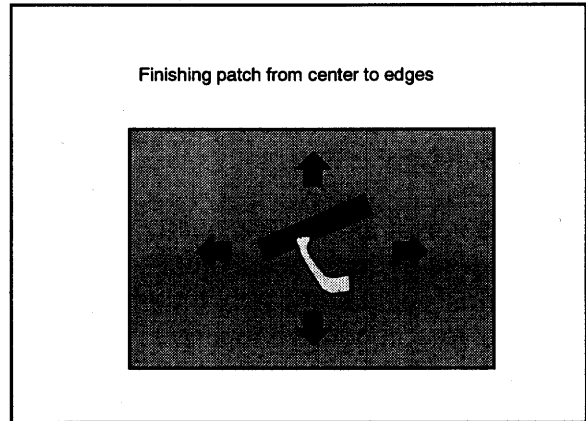

Curing — For curing, apply a liquid-membrane-forming curing compound evenly and sufficiently. Use well-maintained pressure spraying equipment that will allow an even application. An application rate of about 5.0 m²/L is sufficient.

Curing is very important because of the large surface area of these small repairs compared to the small volume of patch material. This relationship is conducive to a rapid moisture loss and is different from most other concrete applications. Neglecting to cure the patches or waiting too long to apply the compound will likely result in excessive material shrinkage and possibly delamination of the patch.

Construction Limitations — The construction limitations for partial-depth repairs are a function of the depth of spalling or deterioration and the requirements of the patch material. Occasionally, what appears to be spalling at the surface extends through the entire depth of the slab. Sometimes, dowel bars or other reinforcement is uncovered while removing unsound concrete. Do not use partial-depth repairs at these locations. Instead, cease constructing a partial-depth patch and switch to a full-depth patch.

Do not place standard portland cement-based patch materials if the air temperature drops below 4°C. Other patch materials may have more stringent weather limitations. Read labels and be familiar with the limitations for the particular patch material you are using.

Curing Patch

- Apply curing compound evenly
- Pigment is helpful to see coverage
- Insulation mats useful for:
 - Accelerating strength gain
 - Cold temperatures
- Place polyethylene between patch and insulation

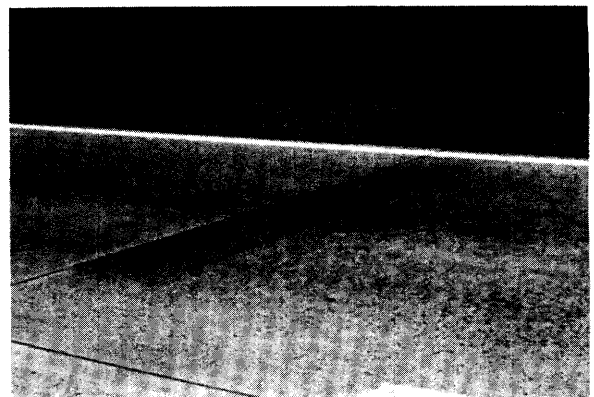
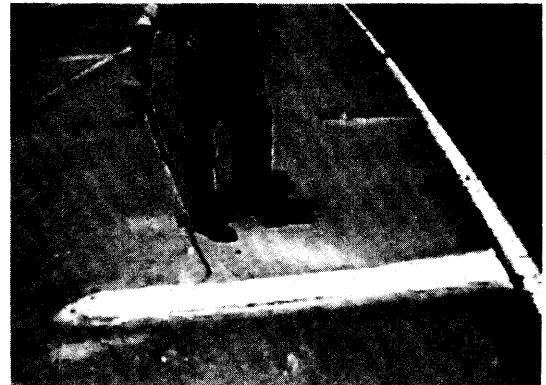

Detailing Retrofit Dowel Bar Operations

Retrofitting dowel bars into an existing concrete pavement joint requires four main operations:

- Cutting the slots
- Cleaning and preparing the slots
- Placing the dowel bars
- Backfilling the slots

Cutting the Slots — Slots for dowels are cut parallel to the pavement centerline and parallel to each other. Careful alignment is necessary so the joint does not lock up when the slabs are expanding and contracting through temperature cycles.

Retrofitting Dowel Bar Operations

Main Operations

- Cutting slots
- Cleaning and preparing slots
- Placing the dowel bars
- Backfilling the slots

Cutting the Slots

- Slot sawing machines
 - Cut parallel to pavement centerline
 - Cut parallel to each other
 - Cut to uniform depth
- Standard saws
 - Multiple cuts
 - More difficult to control
 - Not for high-production

Concrete Pavement Restoration (CPR)

Within the past few years, several contractors and manufacturers have introduced machines made specifically to saw slots for retrofitting dowels. The machines simultaneously cut three to six slots quickly and efficiently. Most employ diamond-bladed saws, but one manufacturer uses a modified carbide-toothed milling machine. The equipment using diamond saw blades have been proven reliable. The modified milling machine has only been used experimentally in the U.S.

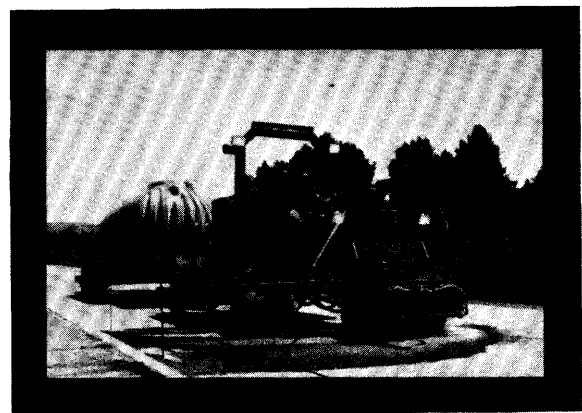
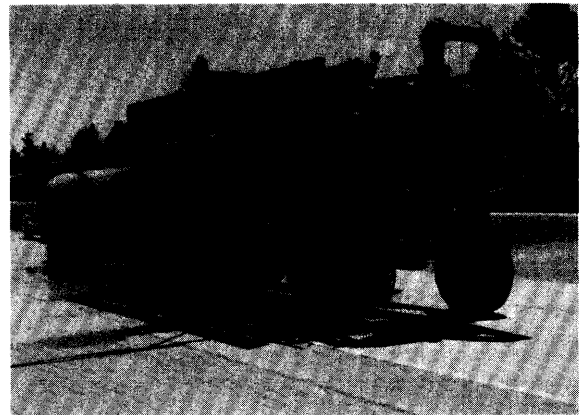
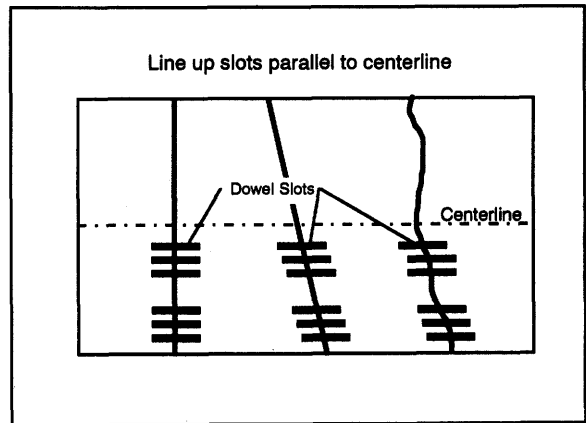

The slot cutters with diamond blades usually require several passes to complete each set of slots. The saw operator positions the cutting head carefully and then plunges the cutting head into the concrete before advancing it across the joint or crack. The first pass forms the slot edges, and subsequent passes cut deeper until the blades reach the required depth. The machine makes two saw cuts for each slot, leaving concrete between the cuts. Workers must remove the concrete later.

For a limited number of slots, you can also use large standard saws equipped with multiple diamond blades to provide the desired slot width. However, care is necessary when you are marking the slot location for good alignment. Usually, the single saw operations do not provide the accuracy and speed now available with the other equipment.

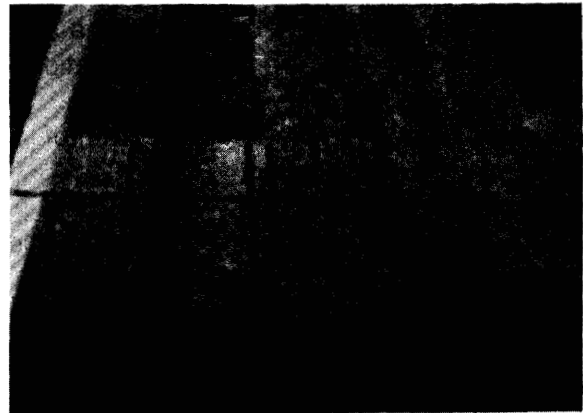
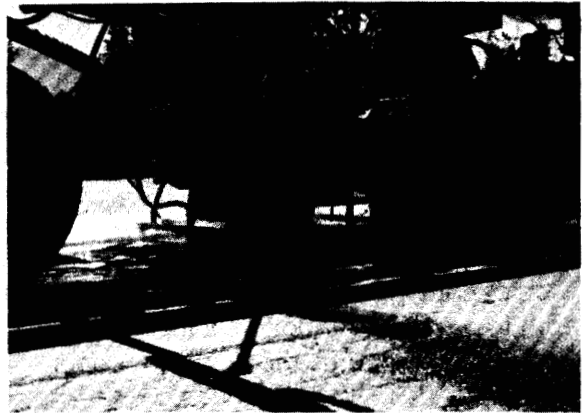

Concrete Pavement Restoration (CPR)

Slot Dimensions — Cut each slot to a width about 20 mm greater than the dowel diameter. For 32 mm diameter dowels, the slot width should be about 50 mm, and for 40 mm diameter dowels the slot width should be about 60 mm.

Cut each slot slightly greater than half the slab depth so the dowels lie about mid-depth. The new slot cutting machines can control saw cut depth to create a flat bottom within the slot. The flat bottom keeps the dowel in proper alignment.

The slot must be long enough so that the dowel can fit into the slot without touching the curved ends of the slot. About 150-mm dowel embedment depth on either side of the joint or crack is adequate, which only requires a 300-mm long dowel. However, most installations use a standard dowel length of 450 mm. Standard dowels require about 900 mm of surface length for each slot.

Specifications usually require that you position the first dowel in the outer wheelpath about 300–450 mm from the pavement edge. The first dowel in the inner wheelpath should start about 450–600 mm from the centerline or longitudinal joint. Dowels are spaced apart about 300–375 mm from one another.

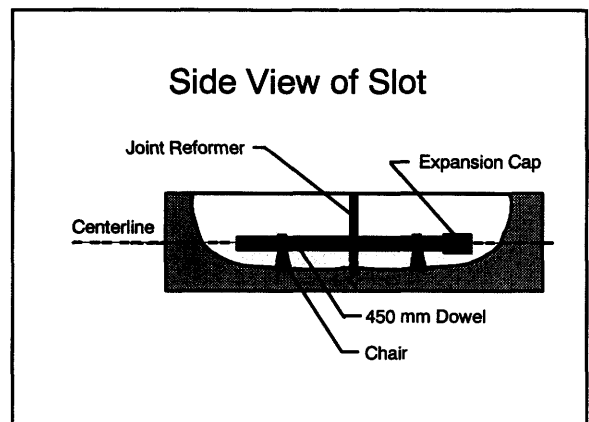
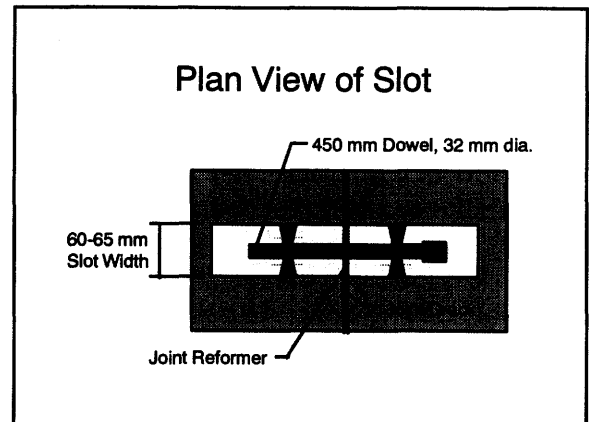

Alternate position of expansion cap

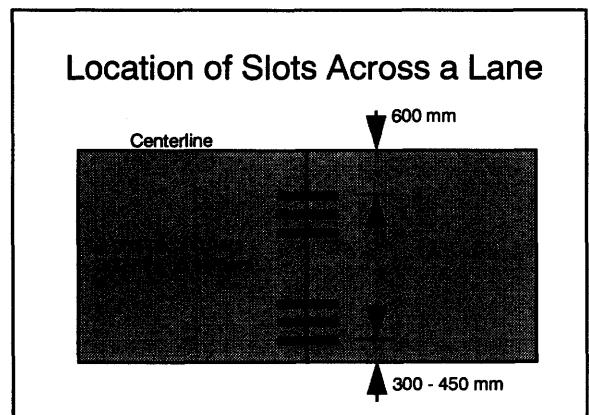

Preparing the Slots — Use light pneumatic hammers (7–13.5 kg) to remove the concrete that remains between the two saw cuts for each slot. With proper technique, the removal can be done in just two or three large pieces. One technique is to place the jackhammer at the end of the fin and work down and along the bottom of the saw cuts. Another method is to place the jackhammer along the side of the slot to break off the fin.

Preparing the Slots

- Use 7-13.5 kg pneumatic hammers
- Chip out in large pieces
 - Pop with hammer at end of fin
 - Pop with hammer along saw cut
- Remove burrs and bumps from base of slot

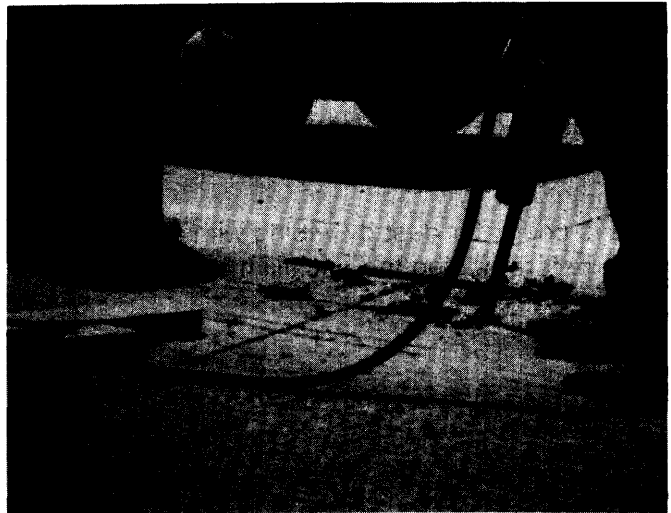

After removing the large concrete pieces, knock off rocks and burrs from the slot bottom with a small hammerhead. This flattens the slot bottom so the dowel can sit level. This also removes any obstacles that might prevent the patching material from completely encasing the dowel bar.

Cleaning the Slots — The slot must be clean before you place the dowel and the patching material. If it is not, the patch material may not bond to the slot sides and the installation may fail.

Use a process similar to preparing the removal area for a partial-depth patch. Use sandblasting followed by airblowing to produce a clean, dry, and roughened surface free of loose particles. In slot cleaning it is equally important to clean the slot walls as it is to clean the base of the slot.

Always check for dust by wiping with a dark glove before adding the backfill material.



Cleaning the Slots

Similar to procedures for partial-depth patches

- Sandblasting first
- Airblow to remove debris
- Check for dust with hand
- Caulk the joint within the slot



The final step before placing the dowels is to caulk the joint (or crack) along the bottom and sides of the slot. The caulk will prevent patch material from working into the crevice of the joint. If the patch material enters the crevice, it may prevent the joint from closing when slabs expand in warm weather. This will likely result in a compression spall in that location.

Preparing the Dowels — The dowels are similar to those for new concrete pavement construction. They should have epoxy-coating over the entire bar to prevent corrosion. This includes the ends of cut dowel bars, which is a modification to regular epoxy coating requirements. You may need to paint some coating onto the end of the dowels to meet this requirement.

Before placing a dowel, you need to attach a non-metallic expansion cap, two non-metallic chairs, and a compressible joint reformer to the dowel. The reformer is made from Styrofoam or filler-board. You also must lubricate the dowels. This is best done in a production line before bringing the dowels onto the job site.

The 6 mm expansion cap and Styrofoam joint reformer provide some freedom of movement for the slab to expand without bearing on the patch material. Chairs support the dowels in the base of the slot, align the dowel, and allow backfill material to surround the bar. The chairs should be large enough to provide 12 mm clearance around the bar.

Lubricate the dowels with a debonding agent like form oil or grease. Be careful not let oil or grease fall onto any of the slot surfaces. The lubricants will prevent the patch material from bonding to the slot. Also avoid using dowel sleeves to replace the expansion cap and lubrication. Sleeves build an inherent “looseness” into the dowel installation that undermines its effectiveness.



Preparing the Dowels

- Add joint former
 - Styrofoam
 - Fiber board
- Attach non-metallic expansion cap to one end
- Use non-metallic chairs (sized for slot)
- Lubricate the dowels



Placing the Dowels — Place each dowel assembly so that the chair legs are in the saw cuts at the bottom of the slot. The joint reformer should be over the joint crack with about one half of the dowel on each side of the joint. The legs of the chairs should also fit tightly against the slot walls to keep the dowel firmly in place. When positioned correctly, the dowel alignment should be true to the surface of the pavement and parallel to the pavement's centerline.

Placing the Dowels

- Ensure that legs of chairs fit tightly against slot walls
- Push assembly to base of slot
- Center reformer on the joint or crack

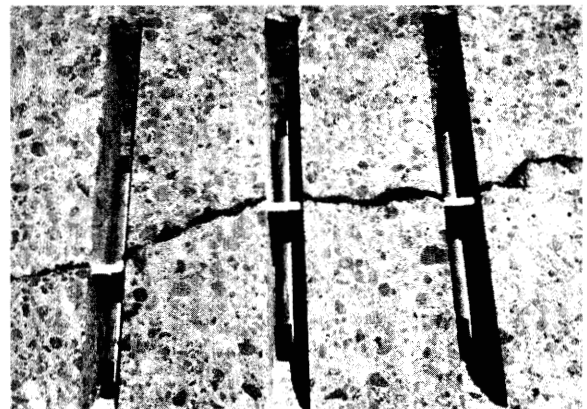
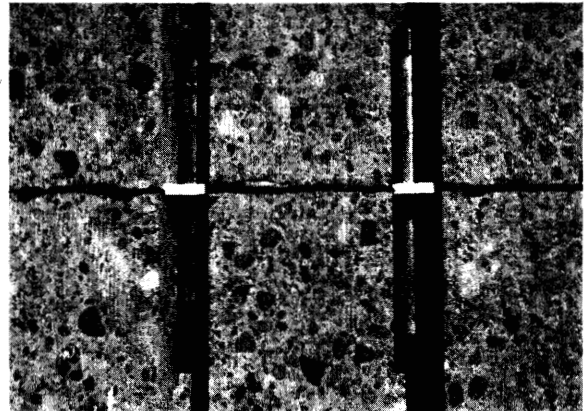

Backfill Material — Any material that works for partial depth patching should work as a backfill material for a dowel slot. Use a maximum aggregate size of about 10 mm so that the mix can completely encase the dowel. Follow the manufacturer's recommendations for all proprietary mixes.

Most mixes will call for accelerating admixtures and aluminum powder to improve the mix set time and reduce shrinkage. Be careful when using chloride accelerators in the patching mix. Too much chloride accelerator may cause the dowel bar to corrode. This is a significant problem with metallic expansion caps and metallic chairs.

Follow the manufacturer's recommendations for all proprietary mixes.

Mix the backfill material on site in small mobile drum or paddle mixers.

Backfilling the Slot — Place concrete into the repair area from wheelbarrows, buggies, or other mobile batch vehicles. Slightly overfill the slot to compensate for consolidation around the dowel.

Vibrate the fresh concrete to eliminate any voids and ensure that you encase the dowel. Use small spud vibrators with a diameter of less than 25 mm. Hold the vibrator about 15°–30° to vertical. Be careful not to hit the dowel bar with the vibrator when placing the patch material or you may knock it out of alignment.

Backfill

- Mix backfill in small quantities
 - Avoid aggregate larger than 10 mm
 - Use care with admixtures
- Vibrate with small spud vibrator
 - 25 mm diameter
 - Avoid touching dowel

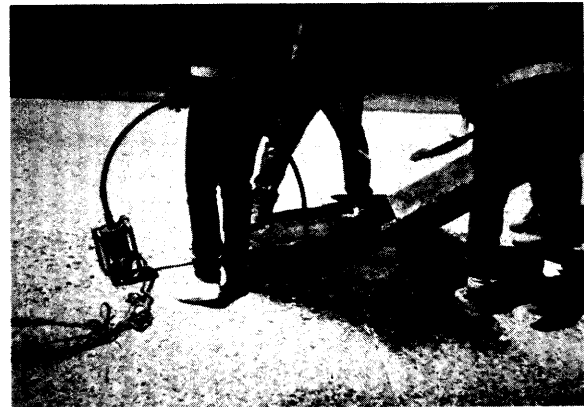

Final Steps

- Finish flush with surrounding surface
- Add curing compound as needed
- Saw over joint reformer

Concrete Pavement Restoration (CPR)

After vibrating the concrete, you may need to put a curing compound on the patch, depending on the weather. Hot and windy conditions will probably require a curing compound, whereas cool, calm conditions will not.

Finishing the slot surface is not usually a critical construction element. The entire pavement surface is usually reprofiled with diamond grinding shortly after the dowel retrofit operations are complete.

The final step is to saw over the compressible joint reformer.



Detailing Diamond Grinding Operations

Diamond grinding is done with specially designed equipment that uses gang-mounted diamond saw blades to cut through bumps in the concrete surface. The resulting profile is a blend of the high and low spots in the existing surface. Diamond grinding cannot alter the profile of the roadway. In most grinding situations the average depth of removal is about 5 mm.

Continuous grinding equipment is much larger than some of the grinding equipment available for bump grinding in new construction. Machines from two manufacturers are currently available in the United States. These machines look very different but work on the same principals.

No D-cracking

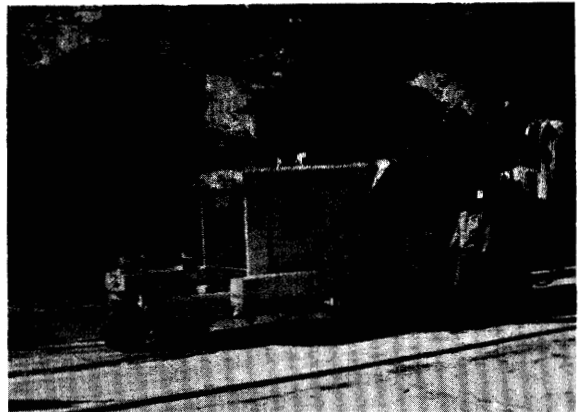
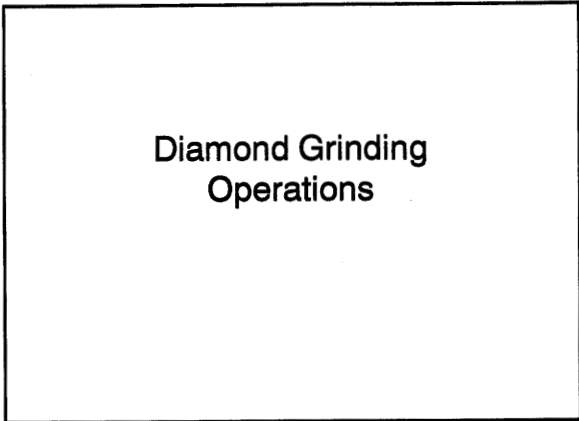

There are four key aspects of successful diamond grinding.

Pavement Condition — Preferably before bidding on a project, collect information on the concrete pavement. This information will help you select the proper blades and the proper blade spacing to set up the grinding head. You can then reasonably estimate grinding head life, grinding machine speed, and productivity.

Information on the coarse and fine aggregate is very important. Aggregate hardness and aggregate abrasiveness impact grinding productivity. For example, 50–75 mm top size aggregate will slow productivity over smaller sizes. If the surface mortar is worn away and the aggregate is exposed along the slab, surface productivity may decrease even more.

Information on the current smoothness profile of the roadway is also helpful, along with patching quantities, faulting depth, and presence of studded tire wear.

Four Keys

- Understand the pavement conditions
- Set up the grinding head properly
- Operate the grinding machine properly
- Monitor the operation

Helpful Information

- Year the pavement was built.
- Pavement type (plain, reinforced)
- Transverse joint spacing.
- The aggregate sources.
- Aggregate hardness.
- Aggregate/sand abrasiveness.
- Aggregate size and exposure.
- Studded tire rut depth.
- Average depth of removal.
- Existing pavement profile (California profilograph)
- Faulting index or average faulting.
- Patching quantities/locations.

Aggregate Hardness

SOFT	MEDIUM	HARD
Limestone	River Gravel	Granite
Dolomite	Trap Rock	Flint
Coral	Granite	Chert
River Gravel		Quartz
		River Gravel

Setting up the Grinding Head — Use the information on concrete age and aggregate hardness when setting up the grinding head. The grinding head cuts the concrete and consists of many diamond saw blades on a shaft or arbor that is about 1 or 1.25 m wide. Most concretes will require around 18 diamond blades per 100 millimeters on the grinding head.

Do not install the blades in a uniform pattern on the grinding head. Lining up the blade segments may produce an uneven grind due to vibration. Randomly installed blades are preferable.

The texture and friction of a newly ground concrete surface depends on the space between blades on the grinding head. You can prolong good skid resistance of soft, easily-polished aggregates by spacing blades further apart. Hard aggregate requires a tight spacing.

Setting up Grinding Head

- Select blade spacing based on aggregate hardness
 - Hard (close spacing)
 - Soft (wide spacing)
- Do not line up blade segments to avoid vibration

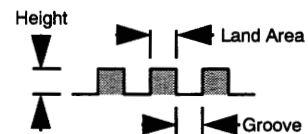

	Range	Hard Aggregate	Soft Aggregate
Grooves	2.25-3.75 mm	2.50-3.75 mm	2.50-3.75 mm
Land Area	1.50-3.25 mm	2.00 mm	2.50 mm
Height	1.50 mm	1.50 mm	1.50 mm
Grooves/m	164-197	174-197	164-177

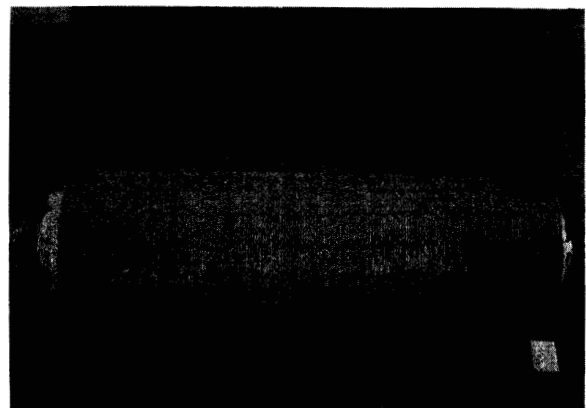

\$60,000

Selecting Saw Blades — The saw blades will influence the grinding head's cutting efficiency and the appearance of the final surface after grinding.

You must select a blade with a metal segment bond hardness that is capable of supporting the individual diamonds as they cut through the concrete. Ideally, the segments (diamonds and metal) must wear at a similar rate. As the metal matrix wears, worn diamonds are released and new ones exposed. If the bond hardness is too low, the diamonds will break free before they wear and become dull. This is inefficient and costly. If the bond hardness is too high for a hard aggregate, the diamonds will dull faster than the metal that holds them in place. The blades will lose their abrasiveness, which will result in poor cutting speed and shortened grinding head life.

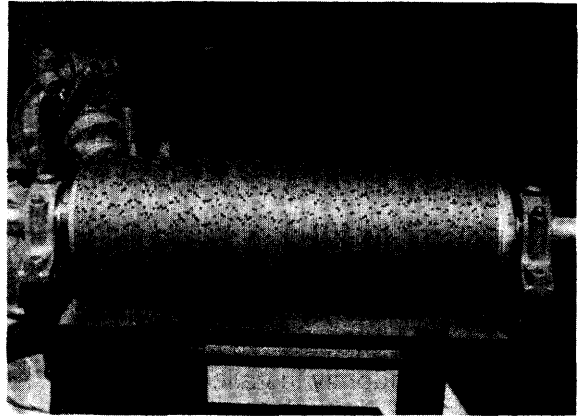

Selecting Saw Blades

- Choose blades with appropriate:
 - Bond hardness
 - Diamond concentration
- Optimize grinding head cutting life
- Even appearance of final surface

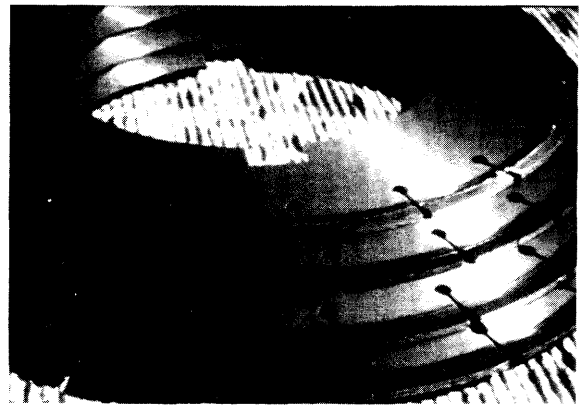

Consult the blade manufacturer's recommendations to choose a blade with a bond hardness appropriate for your aggregates.

Operating a Grinding Machine — The three most important aspects of a grinding machine are its weight, grinding head horsepower, and grinding head blade setup. An operator must know the effects of these factors to properly control the machine to produce an acceptable ground surface. Steering is also an important operator skill.

A diamond grinding machine works like a wood plane. The front sensing wheels detect bumps in the surface, and the grinding head (near the center of the machine) cuts through the bumps. The trailing wheels of the machine follow on the ground surface.

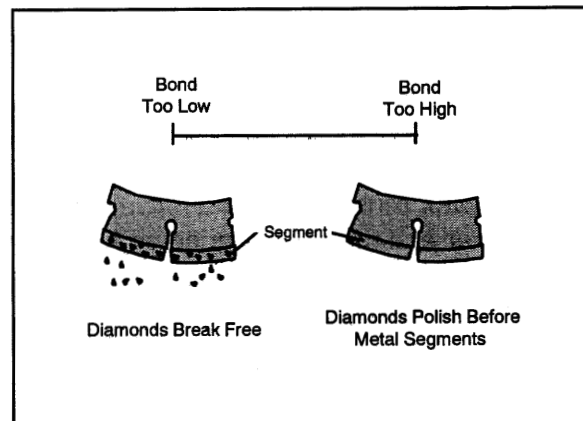

Operating Grinding Machine

Important Aspects of Operation:

- Grinding head blade setup
- Grinding head power
- Machine speed
- Steering

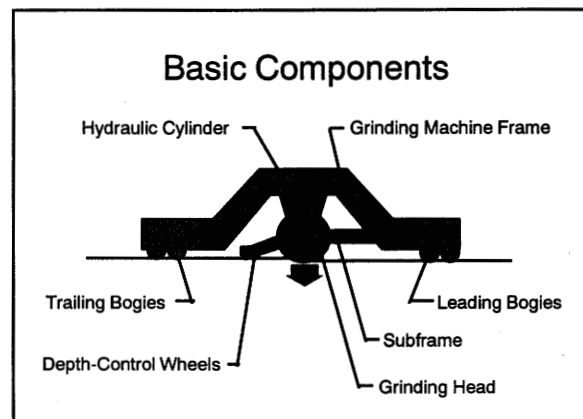

The weight of the grinding machine is the ballast against the force (down pressure) that keeps the grinding head from riding up on bumps in the pavement. If the down-pressure is too low, the machine will merely trace a bump profile and not cut through the bump.

The operator must control the forward speed of the grinder and the set the grinding head depth and down pressure to keep the machine cutting through bumps.

An operator or inspector can check for some variance in the longitudinal cut line to see if the machine is cutting through bumps. If the variance is nearly uniform, most likely the down pressure is not set properly and the operator should lower the grinding head. When the cut depth varies it is a good indication that the operator has the machine cutting through bumps properly.

The grinder operator should try to maintain a constant down-pressure on the grinding head. This will help the machine cut through bumps with similar depth from pass to pass. Unnecessarily altering the down-pressure of the grinding head will likely result in a poor vertical match between passes.

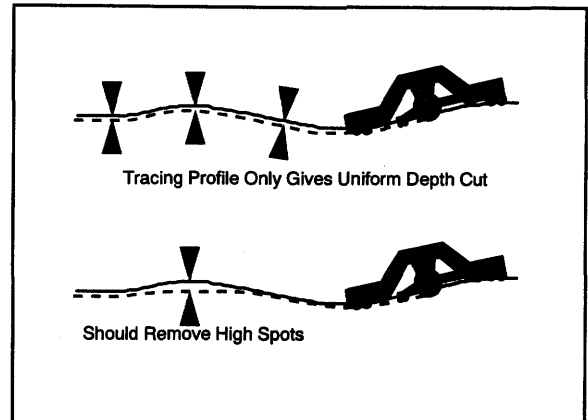

Cutting Through Bumps

- Machine weight is ballast
- To cut bumps must control:
 - Forward speed
 - Grinding head depth
 - Down pressure

Cutting Through Bumps

To Verify Check for:

- Variation in cut depth along longitudinal cut line
- Vertical cut depth match from pass to pass

Check the pass-to-pass vertical match using a 3 m straightedge. You should meet an overlap specification of 3 mm per 3 m.

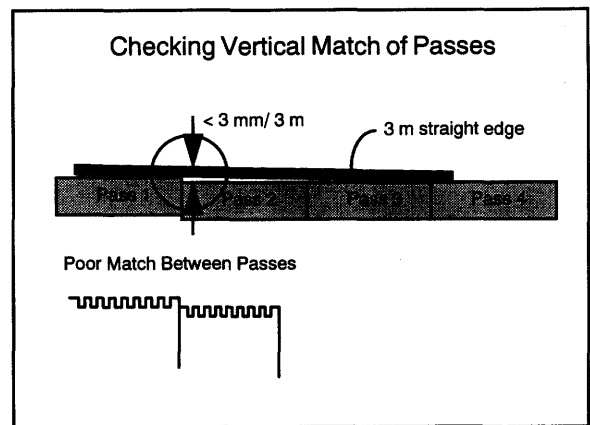
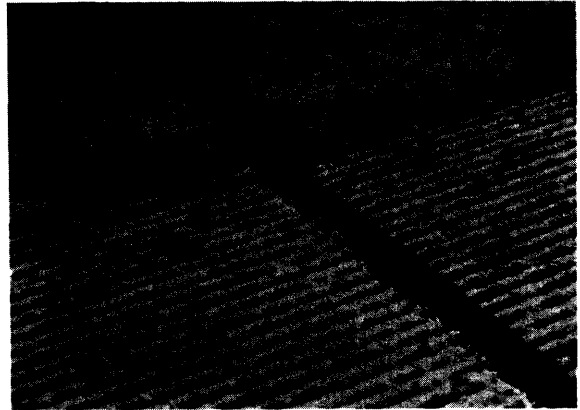

Steady steering is also a necessary operator skill that influences the final ground surface.

Operate a grinding machine parallel to the pavement centerline for continuous grinds. With some practice, an operator should develop the skill to steadily steer the machine without weaving. Weaving can leave "dog tails" in the surface when trying to overlap previous passes. The maximum overlap between passes should be 50 mm.

The best direction for grinding depends on sequencing operations and work zone limitations. The direction of diamond grinding will not influence the smoothness of the resulting profile.

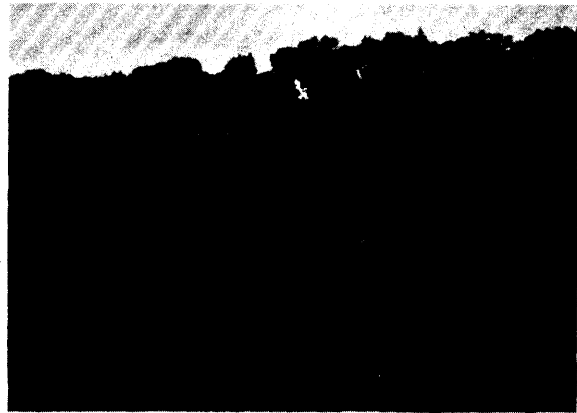

Dogtails

- Result from no horizontal overlap
- Requires steady steering of grinder
- Attempt to maintain 25-50 mm horizontal overlap

Poor Overlap Between Passes

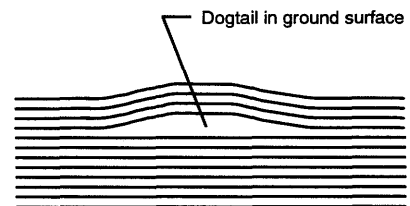

Unground areas are termed "holidays." Carefully read the continuous grinding specifications to determine how much coverage is required. Most specifications allow for some isolated low areas and require only about 95 percent coverage with the grinding texture. Do not lower the grinding head for isolated low spots (holidays) that are less than 0.25 m².

If the grinding operation leaves an unacceptable amount of holidays it will be necessary to lower the grinding head and make another pass.

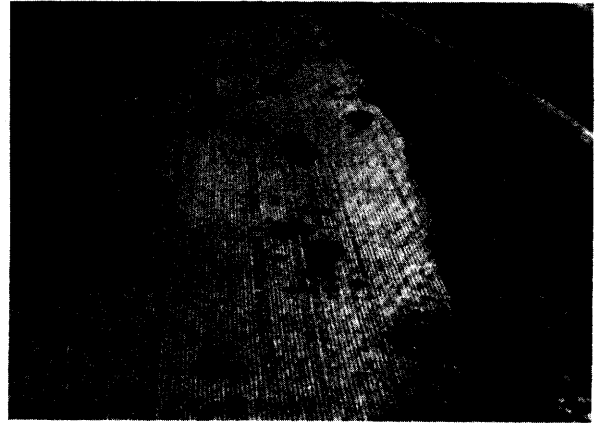

Holidays

- Result from unground areas
- Lower grinding head to avoid
- Specifications allow up to about 5% of area
- Do not adjust head for holidays less than 0.25 m²

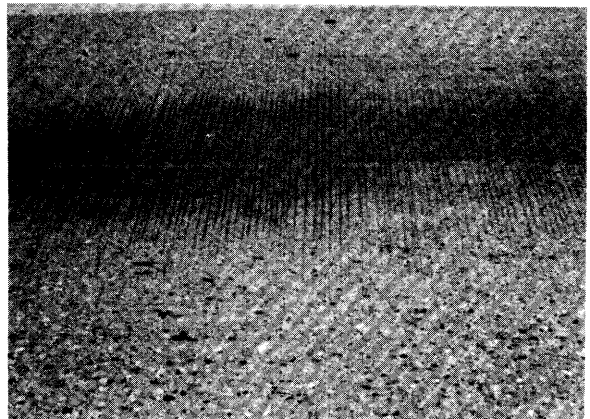

Evaluate your progress by measuring rideability with a California profilograph or similar tool. Be sure to take profile traces before grinding so you can evaluate the profile improvement. Most State specifications will require grinding to meet certain surface profile requirements (like those for new construction). You should be able to improve most pavements to these requirements, or at least a 65 per cent improvement over the pre-grind profile index.

Special Conditions — Watch for expansion joints or other 75- to 125-mm wide gaps in the pavement surface. These may make the cutting head dip into the surface.



Evaluate Rideability

- California profilograph (or similar)
- Take traces before and after grinding
- Should be able to provide 65% improvement over pre-grind profile
- Verify profile index against specification requirement

Special Conditions

- Expansion Joints
- Deflecting slabs

You may encounter problems in grinding slabs that deflect greatly under load. The weight of the grinding machine will deflect the slab and not allow much surface removal by the grinding head. After the machine passes the slab will rebound and faulted joints will return. You can determine if this is a problem by comparing the pre- and post-grind profile index values. If there is not much change, the slab(s) may be deflecting too much. Adjusting the down-pressure of the grinding head may help, but most likely the agency should have stabilized these slabs or required full-depth repair.

Slurry Removal — The grinding equipment uses water to cool the cutting head. Before starting, the operator should check to see that the water supply functions properly. If the water supply is faulty or not turned on, the grinding head will burn up quickly and lead to costly repairs.

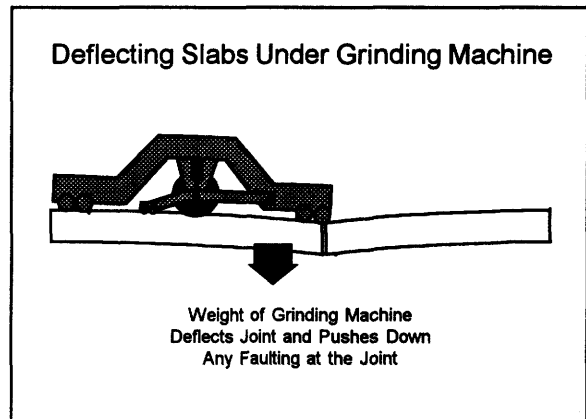
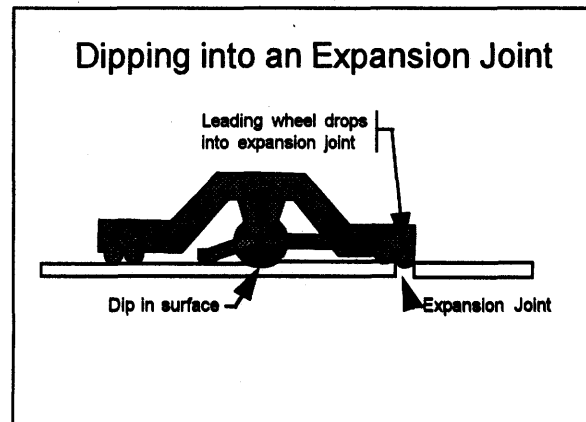

Slurry Removal

- Inert material
- Vacuum systems remove most slurry
- Deposit along shoulder (rural)
- Deposit into trucks for disposal (urban)

Concrete Pavement Restoration (CPR)

All grinding machines also have a vacuum pickup to continually remove slurry or residue from the grinding operation.

In a rural environment it is usually acceptable to deposit the inert slurry onto the side slopes. In an urban environment, it is better to deposit the slurry in a truck equipped to transport the liquid material off the job site.

In an urban environment, it is better to deposit the slurry in a truck equipped to transport the liquid material off the job-site.

The slurry pickup system will leave a damp, but relatively clean, surface. A pavement surface that remains wet with thick, stained water after the grinder passes, is a sign that a slurry pickup system may be clogged or malfunctioning. Check the vacuum hoses first to locate the problem.

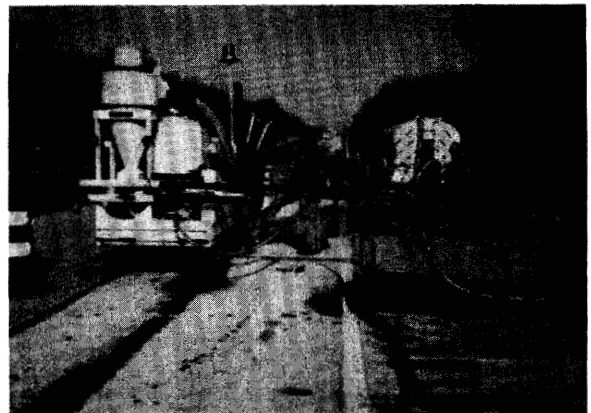
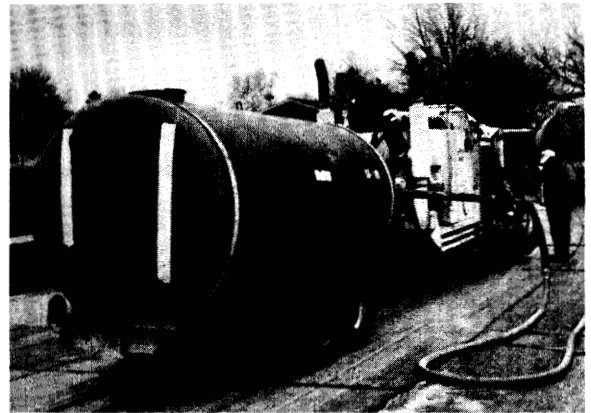
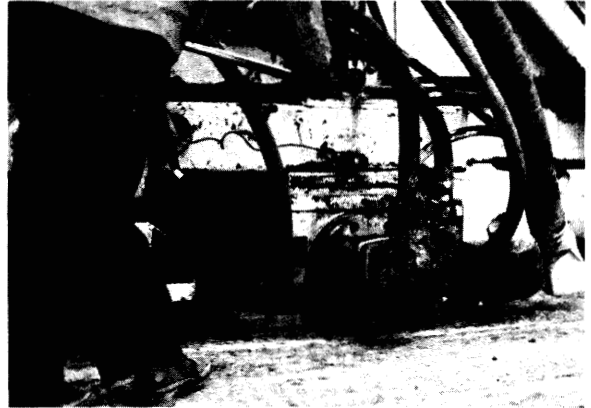

Monitoring the Grinding Machine — Check for blade wear on the grinding head after each day of operation. Look for coning in the blade segments. This is uneven wear, which will alter the desired spacing between fins on the concrete surface. Also check the blades for wear with a pie-tape. Measure the circumference of the grinding head in several locations to judge the evenness of wear and remaining life of the blades (and grinding head).

Finished Surface — The finished surface just after grinding will have thin fins remaining from the area between saw blades. These fins will quickly break free with one or two passes of a roller, or under normal traffic.

If the fins do not break free easily, the grinding head may be excessively worn, or the blade spacing on the grinding head may need to be lowered.

Monitoring Grinding Machine

- Examine surface daily after grinding
 - Unusual patterns
 - Fins that do not break easily
- Check for grinding head wear with pie tape

Check Grinding Head for Wear

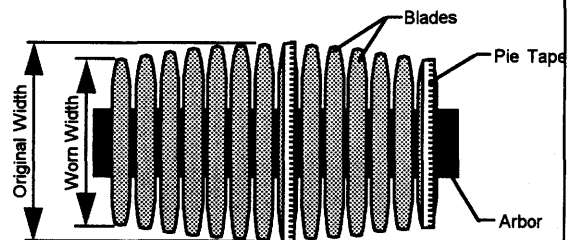

Check with Pie Tape in Several Locations



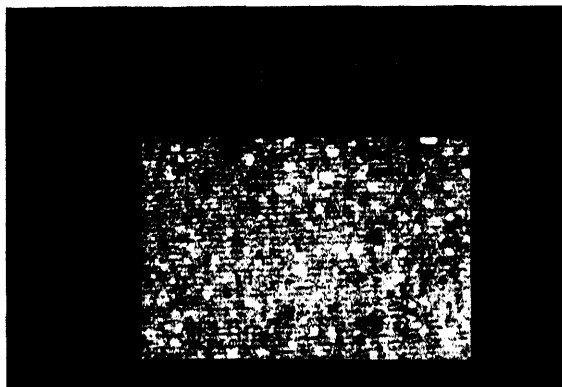

Detailing Joint (& Crack) Resealing Operations

The most favorable times of year to reseal joints are spring and fall because daily temperatures are usually moderate. In moderate temperatures, the joints are not completely open and are not completely closed. Successful resealing consists of five steps.

Old Sealant Removal — Removal of the old sealant and joint face cleaning are necessary to provide a good surface for bonding. Adhesion will not develop by simply filling over an existing sealant. There are several ways to remove an existing sealant. It is important that the methods do not damage the concrete joint reservoir.

*Neoprene needs
Extracting reservoir*

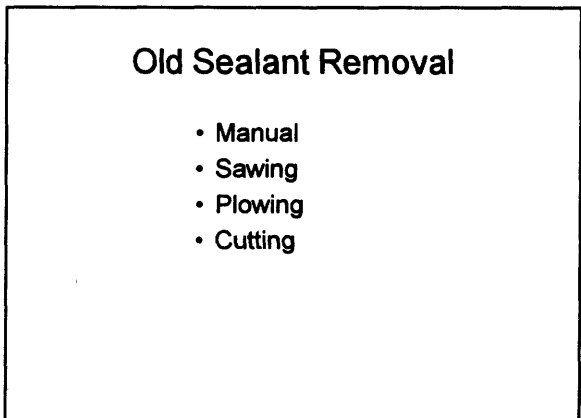
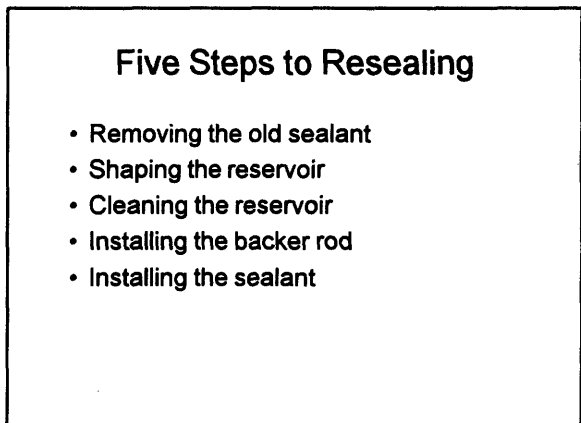
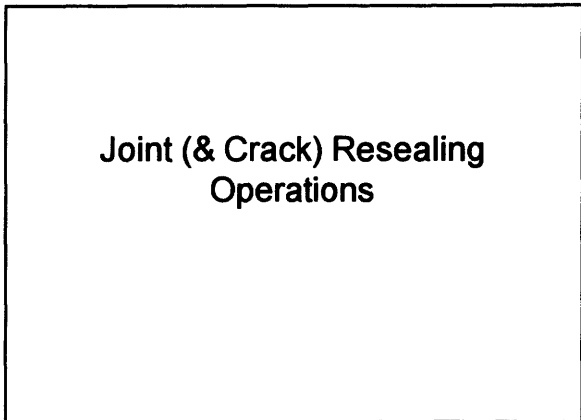

Concrete Pavement Restoration (CPR)

Manual removal is easy for compression seals. This simple method provides a quick result whenever feasible and does not leave much material on the reservoir side walls.

The most common and efficient method for removing old hot-pour or silicone sealants is to saw them with diamond blades. Sawing both removes old sealant and shapes the reservoir for a new sealant.

Plowing can be effective for removing most of the old sealant. A small rectangular plow pulled through the reservoir dislodges most material. Avoid V-shaped plows because they tend to scour the reservoir corners and can easily spall surrounding concrete.

To cut out sealant requires a laborer to run a knife blade along both joint faces. Afterward, the sealant easily pulls free by hand.

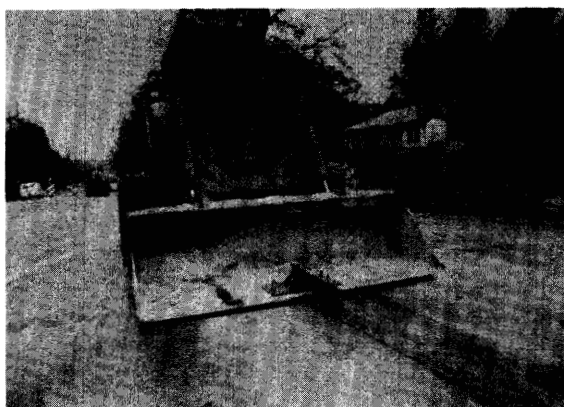
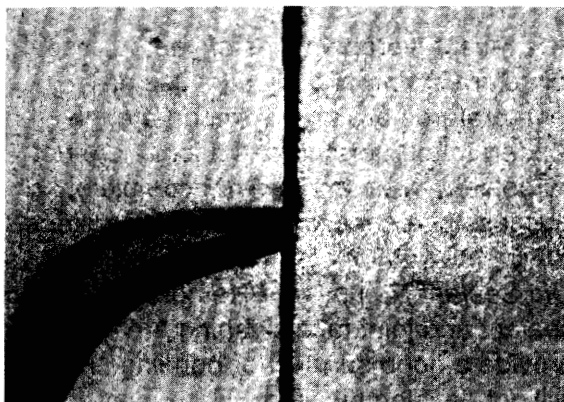

Shaping the Reservoir — You should saw the reservoir after sealant removal to widen it and shape it for the new sealant. Either dry blades or wet diamond blades will work well. The blades remove any remaining old sealant and provide the proper dimensions for the new sealant.

You may eliminate this step if you removed the sealant by hand and the existing reservoir provides adequate dimensions. You may also eliminate this step if the reservoir shape is adequate after sawing out the old sealant.

Shaping Reservoir

- After removing old sealant
- Widen as necessary
- Dislodges all old material

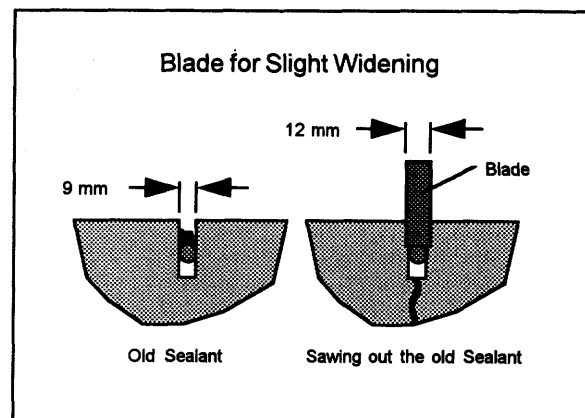

Concrete Pavement Restoration (CPR)

Some minor spalling along the joint face will not inhibit performance of most sealants. However, some partial-depth patching is likely for larger spalls. All patching should be complete before starting reservoir cleaning and sealant installation.

Cleaning the Reservoir — Cleaning is the most important aspect of joint resealing. Reservoir faces require a thorough cleaning to be sure of good sealant adhesion and long-term performance. (Cleaning is not as important for compression seals as it is for liquid sealants.)

No dust, dirt, or visible traces of old sealant should remain on the joint faces after cleaning. It is easier to consistently get joints clean if they are at least 9 mm wide. Ideally, you should not install sealant until the reservoir is clean of visible dust and dirt. An inspector or crew foreman should wipe the reservoir to approve the cleaning.

Do not use chemical solvents to wash the joint reservoir. Solvents can carry contaminants into pores and surface voids on the reservoir faces. Contaminants will inhibit bonding of the new sealant.

For resealing, use the same steps outlined in the *Saw & Seal* module for cleaning the reservoir for newly constructed joints.

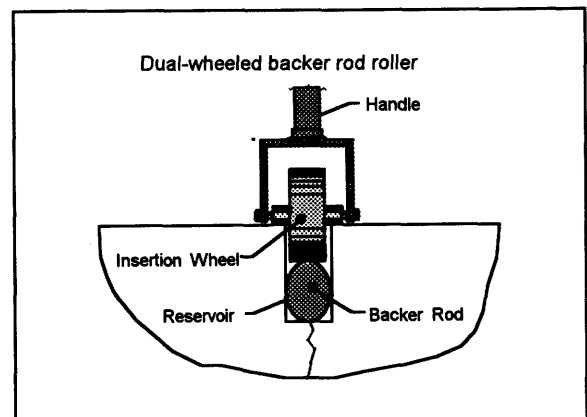
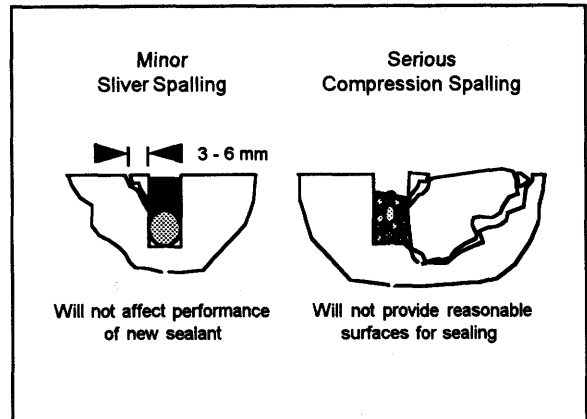

Backer Rod Installation — For most work a dual-wheeled roller is recommended. However, for rehabilitation work with slightly faulted joints a single-wheeled roller may work better. The roller will allow you to reference insertion depth to the low side of a faulted joint. Sealant installation will then be at the appropriate depth. It also recesses the sealant enough to allow sealing the joints before diamond grinding.

Good practice is to roll the insertion wheel over the backer rod twice.

Sealant Installation — Installation requirements are slightly different for each sealant type. Manufacturers recommend some curing time before opening to traffic for most liquid sealants. Some liquid seal manufacturers also specify limits on the ambient and pavement temperatures for installation. Compression seal manufacturers specify desirable limits on sealant stretch and lubrication. Consult the sealant manufacturer's particular product recommendations.

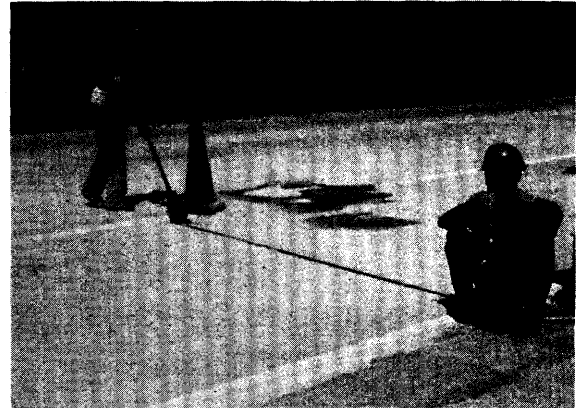
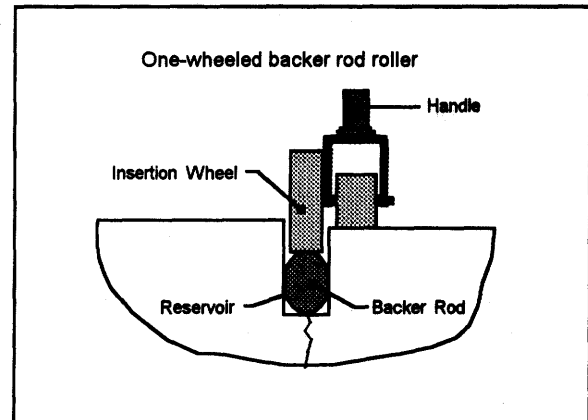

Sealant Installation

- Consult product installation recommendations
- Refer to procedures outlined in *Saw & Seal* module

Concrete Pavement Restoration (CPR)

Follow the same sealant installation recommendations outlined in the *Saw and Seal* module when installing sealant during a resealing operation. Remember to check the boiler temperatures for hot-pours and discard the first few liters of sealant at the beginning of the day.

Expansion/Isolation Joints — Resealing expansion/isolation joints will require removing the sealant only down to the compressible filler. All other steps are similar to those for contraction joints.

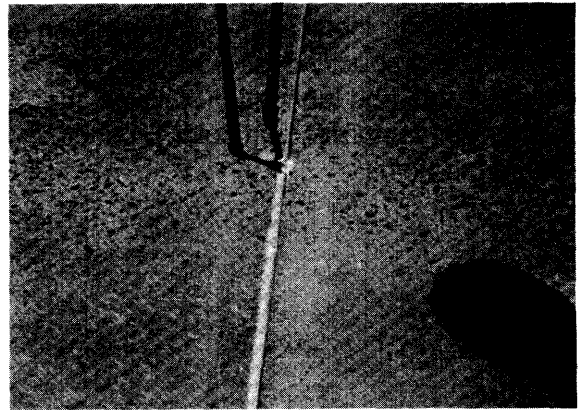
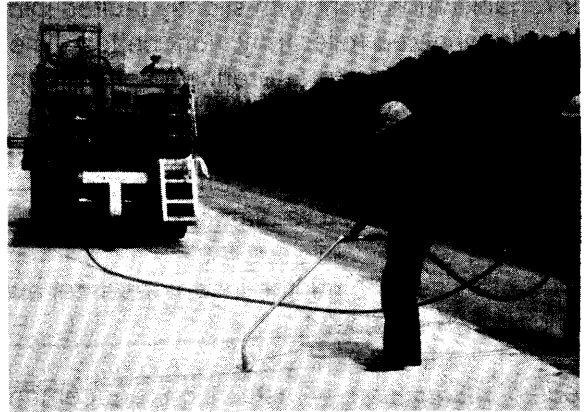

Special Requirements

- Expansion or isolation joints
- Existing lane/shoulder joints
- Cracks

Compressible fillers are typically directly below the sealing material. The fillers are usually nonextruding and act as a backer rod in the wide reservoir.

It may be necessary to place a bond-breaking tape above the filler before installing new sealant. The tape will separate the new sealant from any old sealant that may have been absorbed by the filler. Use a tape width no more than 3 mm narrower than the nominal joint width. This ensures adequate separation and eases installation.

Examine the contraction joints within 30 m of an existing mainline expansion joint. These joints may require special consideration. Often, expansion joint closure allows adjacent contraction joints to open. The width of these contraction joints may be much greater near the expansion joint. To successfully reseal these joints will require larger backer rods and a different shape factor. If you are using compression seals you may also need to increase the seal width.

Existing Lane/Shoulder Joints — It is simpler to seal the reservoir along concrete shoulders than along asphalt shoulders. Sealing and maintaining concrete shoulder joints requires no further effort than is required for centerline, lane separation, or other tied longitudinal joints.

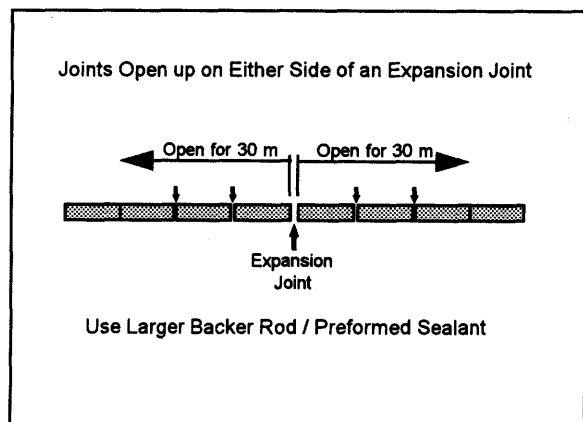
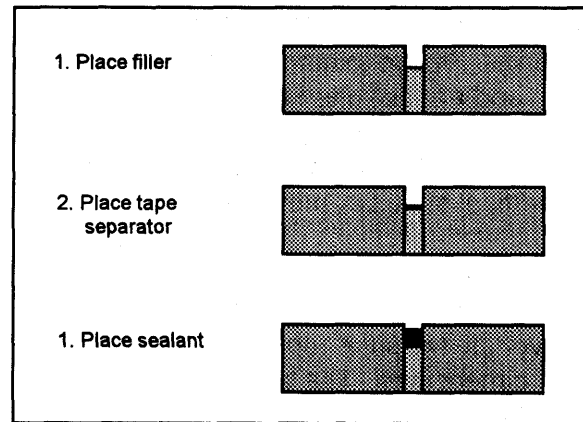

Lane/Shoulder Joints

- 25 mm or greater reservoir against asphalt
- Shaping should remove asphalt and concrete
- Sandblast asphalt too!
- Do not torch

Concrete Pavement Restoration (CPR)

Joints between concrete lanes and bituminous shoulders pose a more difficult sealing challenge. These joints often deteriorate, settle, and are not often in a uniform condition. This requires a 25 mm or greater reservoir width and depth to accommodate the lateral and vertical shoulder movement.

As with all sealing, shoulder reservoir preparation is important. Sawing the joint reservoir delivers the most consistent width and depth dimensions. The saw should cut vertically and remove bituminous material from the edge of the concrete slab. Immediately after sawing a water flush will remove sawing slurry. Both sides of the reservoir require sandblasting. A lighter sandblast pressure along the asphalt face is acceptable. Airblowing just before sealant installation dries the reservoir and removes dust and dirt.

Do not use a propane torch for joint drying and cleaning. Torching has led to concrete spalling and raveling.

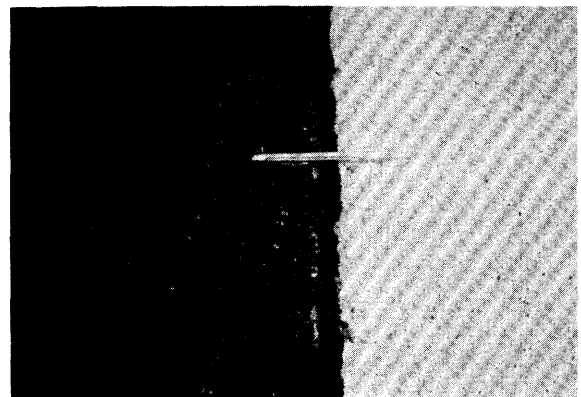
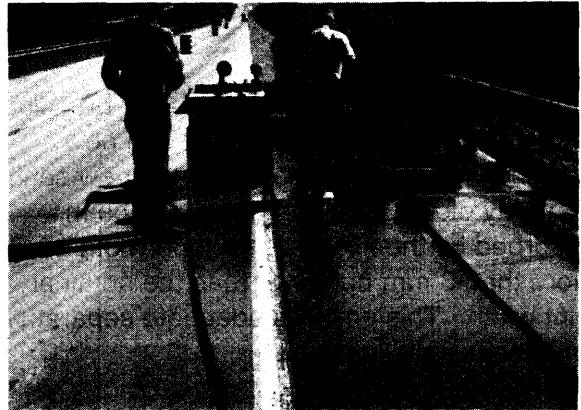

Resealing Cracks — Cracks are not straight and are therefore more difficult to shape and seal. Avoid trying to follow crack wander with a standard blade. Standard blades have a diameter that is too large and are too inflexible for good crack tracing. To follow cracks, saw operators tend to twist the blade in a standard saw. This can endanger the operator and damage the blade. The blade may overheat and may lose segments.

Manufacturers provide special crack-sawing blades to help follow crack "wander." The special blades with diameter from 175 to 200 mm are also more flexible for crack tracing.

Resealing Cracks

- More difficult to:
 - Shape
 - Clean
 - Seal
- Do not expect uniform reservoir
- Same cleaning steps
- May use tape instead of backer rod

Crack Saw Equipment

- Do not use large-diameter blade
 - May overheat
 - May lose segments
 - May endanger operator
- Use pivoting crack saw with small-diameter blade
 - 175-200 mm crack saw blade
 - Flexible to help trace wander

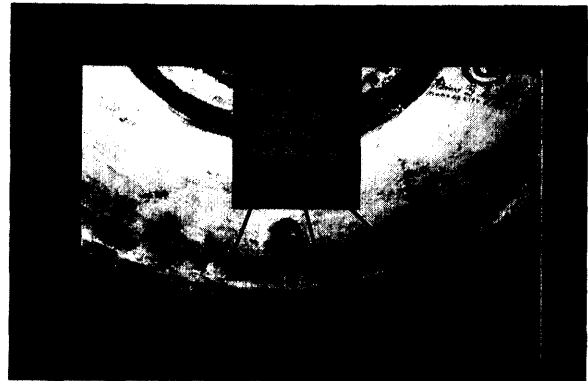

Concrete Pavement Restoration (CPR)

Special crack saws are usually supported by three wheels and are smaller than most joint sawing equipment. Unlike standard saws, a pivot wheel on a crack saw allows easy lateral movement when tracing crack wander.

Avoid using routers for concrete pavement crack tracing. Routers use a vertical spinning bit with a diameter and length sized to produce the desired reservoir dimensions. It is difficult to get good results with routers, so many contractors no longer use them.

Even with the special blades, a sawed crack reservoir will not be as uniform or as clean as a straight joint reservoir. However, try to obtain a reasonably uniform shape factor. It may be necessary to plunge the saw at some tight corners.

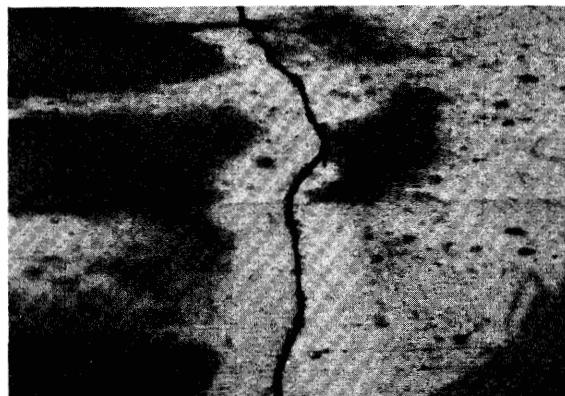
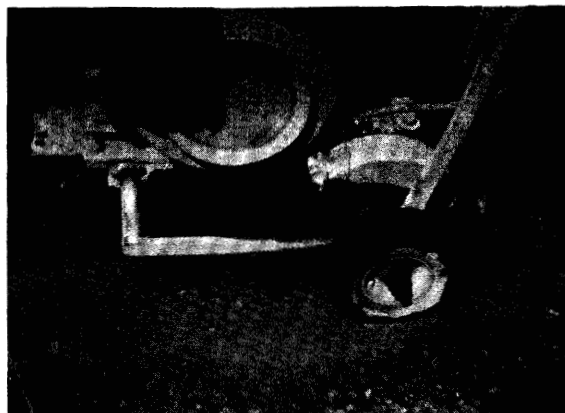

After repair and sawing, crack sealing requires all of the cleaning steps used in joint sealing, including the use of a backer rod and uniform sealant installation.

A completely resealed joint or crack will help minimize moisture infiltration into the newly rehabilitated pavement.

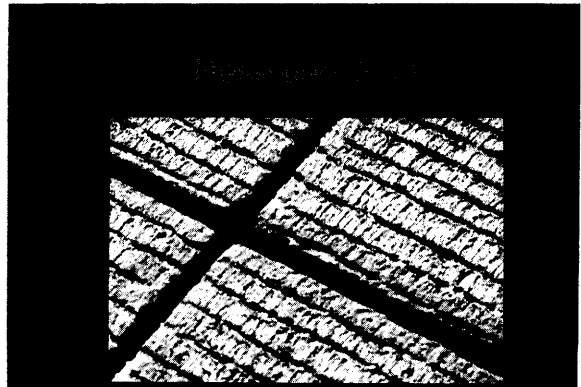

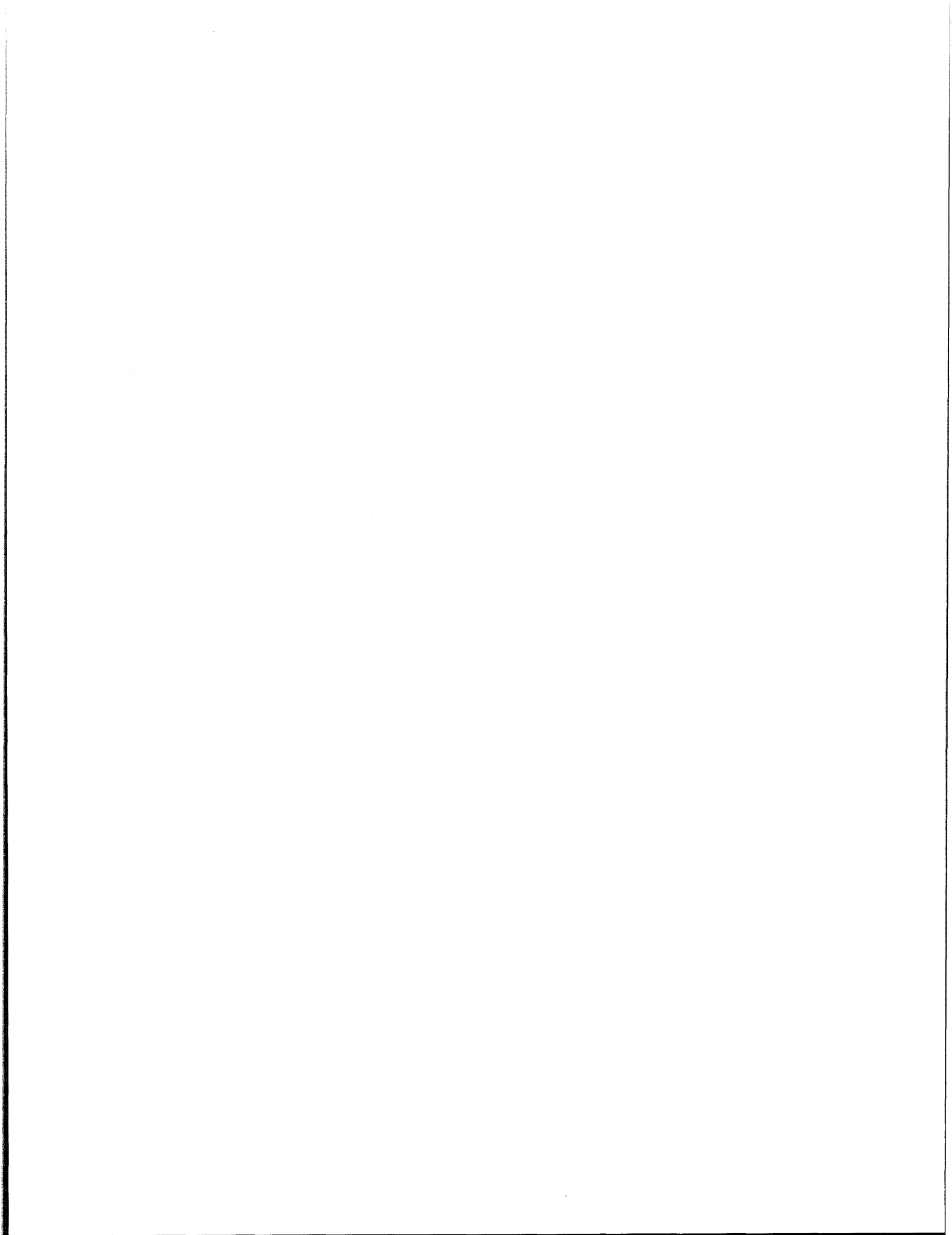

IX. Course Summary

Course Summary

Communication and preparation are critical to any paving operation. By taking the information learned in this training course and using it in the field, you will become the instructors and your coworkers will become the students. This information was designed to be shared. Quality starts with you.

The following discussion provides a brief summary of the training course. These items provide the foundation of "good practice" for the construction of portland cement concrete pavements.

Quality in Concrete Pavement Construction

The American Association of State Highway Transportation Officials, the Federal Highway Administration, and the concrete pavement industry are committed to quality. By working together as a team, agencies and industry are sharing information in order to move into the future.

New people coming into the concrete pavement construction industry, whether through government agencies, consultants or contractor companies, also have had few opportunities to gain an introduction into proper field practices and procedures. And with retirements and attrition, the traditional way of passing on knowledge - from experienced senior staff to their junior counterparts - is being severely challenged. This training course is an extension from this partnership of quality and provides a means of filling an ever widening gap between the experienced and inexperienced field personnel.

This joint effort includes improved acceptance programs, agency testing, quality control and dispute resolution criteria. Incentives will also play an important roll in the pursuit of quality. By using incentives, the public interest is served, the competitive bidding process is maintained, a project partnership is developed, and a positive attitude toward quality is achieved.

Quality is a perspective. By nurturing a true working partnership between owner and builder, we will continue to meet the Nation's ever-expanding transportation needs. This training is the beginning of our quality journey.

"By bringing together America's government and highway industry as partners with a clear, consensus agreement on achieving top quality, we will make our Nation's highways the best they can be."

Tom Larson
Former Federal Highway Administrator

Plant Operations

Consistent concrete begins at the plant. With ready mixed concrete, both truck mixed and central mix, material management plays a big roll in the production of consistent concrete. Computerized batching and monitoring is no substitute for knowledgeable and experienced field personnel.

Critical factors affecting plant operations include:

- Communications and Preparations (CAP)
- Consistent delivery
- Truck driver and discharge rate
- Material management
- Raw material delivery and quality

Paving Operations

A thorough prior knowledge of the project sequence is required for all paving projects. By understanding what operations will be performed next, field personnel are better prepared to handle unforeseen circumstances when they occur.

Traffic around the paving operation can have an impact on pavement quality. Safety around the paving train is the number one priority.

Saw and Seal Operations

Saw timing for crack control can have a tremendous impact on long-term pavement performance. Many items will determine the proper time to saw, such as the type of base, changing weather conditions, and admixtures.

Sealing the sawed joints also impacts long-term pavement performance by minimizing the intrusion of incompressibles and moisture into the joint. Clean joints are important in joint sealant performance.

Concrete Pavement Restoration Operations

Quality concrete pavements last longer. Even with high quality, the pavement will eventually need to be rehabilitated. There are many options for restoring concrete pavements. Each technique has critical aspects that greatly affect performance. These techniques are often used together on a project.

Closing Remarks

Communication is the key to a successful project. When all parties are talking, amazing things can happen. This course provides a common language or starting point for all concrete pavement construction projects. Think safety and quality at all times. The final product is a direct reflection on the people designing and building it.

XI. Glossary of Terms

XI. Glossary of Terms

AASHTO	American Association of State Highway and Transportation Officials
Abrasion Resistance	Ability of a surface to resist being worn away by a rubbing or friction process.
Abrasive Cleaning	A system of cutting or abrading a surface such as concrete by a stream of sand or other abrasive products ejected from a nozzle at high speed by compressed air; often used for cleanup of horizontal construction joints or for exposure of aggregate in architectural concrete.
Absolute Specific Gravity	The ratio of the weight referred to a vacuum of a given volume of material at a stated temperature to the weight referred to a vacuum of an equal volume of gas-free distilled water at the same temperature.
Absolute Volume (of ingredients of concrete or mortar)	The displacement volume of an ingredient of concrete or mortar; in the case of solids, the volume of the particles themselves, including their permeable or impermeable voids but excluding space between particles; in the case of fluids, the volume which they occupy.
Absorbed Moisture	The moisture held in a material and having physical properties not substantially different from those of ordinary water at the same temperature and pressure.
Absorbed Water	Water held on surfaces of a material by physical and chemical forces, and having physical properties substantially different from those of absorbed water or chemically combined water at the same temperature and pressure.
Absorption	The amount of water absorbed under specific conditions, usually expressed as a percentage of the dry weight of the material; the process by which the water is absorbed.
Acceleration	Increase in rate of hardening or strength development of concrete.
Accelerator	An admixture which, when added to concrete, mortar, or grout, increases the rate of hydration of hydraulic cement, shortens the time of set, or increases the rate of hardening or strength development.
ACI	American Concrete Institute
ACPA	American Concrete Pavement Association
Adhesion Loss	The loss of bond between a joint sealant material and the concrete joint face noted by physical separation of the sealant from either or both joint faces.
Adhesives	The group of materials used to join or bond similar or dissimilar materials; for example, in concrete work, the epoxy resins.
Admixture	A material other than water, aggregates, and portland cement (including air-entraining portland cement, and portland blast furnace slag cement) that is used as an ingredient of concrete and is added to the batch before and during the mixing operation.
Adsorption	Development at the surface of a solid of a higher concentration of a substance than exists in the bulk of the medium; especially in concrete and cement technology, formation of a layer of water at the surface of a solid, such as cement, or aggregate, or of air-entraining agents at the air-water boundaries; the process by which a substance is adsorbed.
Aggregate Blending	The process of intermixing two or more aggregates to produce a different set of properties, generally, but not exclusively, to improve grading.
Aggregate Gradation	See <u>Grading</u>

Aggregate Interlock	The projection of aggregate particles or portion of aggregate particles from one side of a joint or crack in concrete into recesses in the other side of the joint or crack so as to effect load transfer in compression and shear and maintain mutual alignment.
Aggregate, Coarse	The largest sized particles in the concrete mix. These particles provide the greatest variable of wear in the sawing system, whether abrasive or diamond.
Aggregate, Dense-graded	Aggregates graded to produce low void content and maximum weight when compacted.
Aggregate, Fine	Aggregate passing the (9.5 mm) sieve and almost entirely passing the No. 4 (4.75 mm) sieve and predominantly retained on the No. 200 (75 mm) sieve.
Aggregate, Gap-graded	Aggregate so graded that certain intermediate sizes are substantially absent.
Aggregate, Heavyweight	Aggregate of high density, such as barite, magnetite, hematite, limonite, ilmenite, iron, or steel, used to produce heavyweight concrete.
Aggregate, Lightweight	Aggregate of low density, such as (a) expanded or sintered clay, shale, slate, diatomaceous shale, perlite, vermiculite, or slag; (b) natural pumice, scoria, volcanic cinders, tuff, and diatomite; (c) sintered fly ash or industrial cinders, used to produce lightweight concrete.
Aggregate, Maximum Size	See <u>Maximum Size of Aggregate</u>
Aggregate, Nominal Maximum Size	In specifications for and descriptions of aggregate, the smallest sieve opening through which the entire amount of the aggregate is permitted to pass; sometimes referred to as "maximum size (of aggregate)."
Aggregate, Open-graded	Concrete aggregate in which the voids are relatively large when the aggregate is compacted.
Aggregate-Cement Ratio	See <u>Cement-Aggregate Ratio</u>
Aggregate	Essentially inert material (material that is chemically nonreactive) which, when bound together into a conglomerated mass by a matrix, forms concrete or mortar.
Agitating Speed	The rate of rotation of the drum or blades of a truck mixer when used for agitation of mixed concrete.
Agitating Truck	A vehicle in which freshly mixed concrete can be conveyed from the point of mixing to that of placing; while being agitated, the truck body can either be stationary and contain an agitator or it can be a drum rotated continuously so as to agitate the contents.
Agitation	The process of providing gentle motion in mixed concrete just sufficient to prevent segregation or loss of plasticity.
Agitator	A device for maintaining plasticity and preventing segregation of mixed concrete by agitation.
Air Content	The amount of air in mortar or concrete, exclusive of pore space in the aggregate particles, usually expressed as a percentage of total volume of mortar or concrete.

Air Void	A space in cement paste, mortar, or concrete filled with air; an entrapped air void is characteristically 1 mm or more in size and irregular in shape; an entrained air void is typically between 10 μ m and 1 mm in diameter and spherical (or nearly so).
Air-Entraining Agent	An addition for hydraulic cement or an admixture for concrete or mortar which causes air, usually in small quantity, to be incorporated in the form of minute bubbles in the concrete or mortar during mixing, usually to increase its workability and frost resistance.
Air-Entraining Cement	A cement that has an air-entraining agent added during the grinding phase of manufacturing.
Air-Entraining	The capability of a material or process to develop a system of minute bubbles of air in cement paste, mortar, or concrete during mixing.
Air-Entrainment	The inclusion of air in the form of minute bubbles during the mixing of concrete or mortar.
Air-Meter	A device for measuring the air content of concrete and mortar.
Air-Water Jet	A high-velocity jet of air and water mixed at the nozzle, used in clean-up of surfaces of rock or concrete, such as horizontal construction joints.
Alkali-Aggregate Reaction	Chemical reaction in mortar or concrete between alkalis (sodium and potassium) released from portland cement or from other sources, and certain compounds present in the aggregates; under certain conditions, harmful expansion of the concrete or mortar may be produced.
Alternate Lane Construction	A method of constructing concrete roads, runways, or other paved areas, in which alternate lanes are placed and allowed to harden before the remaining immediate lanes are placed.
Amount of Mixing	The duration of mixer action used in combining the ingredients of concrete or mortar; in the case of stationary mixers, the number of revolutions of the drum or blades at mixing speed after the cement comes in contact with water or aggregates.
Amplitude	The maximum displacement from the mean position in connection with vibration.
Angle of Repose	The angle between the horizontal and the natural slope of loose material below which the material will not slide.
Angular Aggregate	Aggregate particles that possess well-defined edges formed at the intersection of roughly planar faces.
Architectural Concrete	Concrete that will be permanently exposed to view and which therefore requires special care in selection of the concrete materials, forming, placing, and finishing to obtain the desired architectural appearance.
Area of Steel	The cross-sectional area of the reinforcing bars in or for a given concrete cross section.
ASTM	American Society for Testing and Materials

Automatic Batcher	A batcher equipped with gates or valves which, when actuated by a single starter switch, will open automatically at the start of the weighing operation of each material and close automatically when a designated weight of each material has been reached, interlocked in such a manner that (1) the charging mechanism cannot be opened until the scale has returned to zero, (2) the charging mechanism cannot be opened if the discharge mechanism is opened, (3) the discharge mechanism cannot be opened if the charging mechanism is opened, (4) the discharge mechanism cannot be opened until the designated weight has been reached within the allowable tolerance, and (5) if different kinds of aggregates or different kinds of cements are weighed cumulatively in a single batcher, interlocked sequential controls are provided.
Axle Load	The portion of the gross weight of a vehicle transmitted to a structure or a roadway through wheels supporting a given axle.
Backer Rod	Foam cord that inserts into a joint sealant reservoir and is used to shape a liquid joint sealant and prevent sealant from adhering to or flowing out of the bottom of the reservoir.
Bag (of cement)	A quantity of cement; 42.6 kg in the United States, 39.7 kg in Canada; portland or air-entraining portland cement, or as indicated on the bag for other kinds of cement.
Ball Test	A test to determine the consistency of fresh concrete by measuring the depth of penetration of a steel ball. The apparatus is usually called a Kelly ball.
Bar Chair	An individual supporting device used to support or hold reinforcing bars in proper position to prevent displacement before or during concreting.
Bar Spacing	The distance between parallel reinforcing bars, measured center to center of the bars perpendicular to their longitudinal axes.
Bar Support	A rigid device used to support or hold reinforcing bars in proper position to prevent displacement before or during concreting.
Bar, Deformed	See <u>Deformed Bar</u>
Bar	A member used to reinforce concrete.
Barrel (of cement)	A unit of weight for cement: (170.6 kg) net, equivalent to 4 US bags for portland or air-entraining portland cements, or as indicated by the manufacturer for other kinds of cement. (In Canada, 158.8 kg. net per barrel).
Base Course	A layer of specified select material of planned thickness constructed on the subgrade or subbase of a pavement to serve one or more functions such as distributing loads, providing drainage, or minimizing frost action; also, the lowest course of masonry in a wall or pier.
Base	A subfloor slab or "working mat," either previously placed and hardened or freshly placed, on which floor topping is placed in a later operation; also, the underlying stratum on which a concrete slab, such as a pavement, is placed.
Basket	See <u>Load-Transfer Assembly</u>
Batch Box	Container of known volume used for measuring constituents of a batch of either concrete or mortar in proper proportions.
Batch Mixer	A machine that mixes batches of concrete or mortar.
Batch Plant	Equipment used for batching concrete materials.

Batch Weights	The weights of the various materials (cement, water, the several sizes of aggregate, and admixtures if used) that compose a batch of concrete.
Batch	Quantity of concrete or mortar mixed at one time.
Batched Water	The mixing water added by a batcher to a concrete or mortar mixture before or during the initial stages of mixing.
Batcher	A device for measuring ingredients for a batch of concrete.
Batching	Weighing or volumetrically measuring and introducing into the mixer the ingredients for a batch of concrete or mortar.
Beam Test	A method of measuring the flexural strength (modulus of rupture) of concrete by testing a standard unreinforced beam.
Benkelman Beam	Static deflection measuring tool equipped with dial gauges able to detect slab deflection to 0.025 millimeter.
Bent Bar	A reinforcing bar bent to a prescribed shape such as a truss bar, straight bar with hook, stirrup, or column tie.
Blast Furnace Slag	The non-metallic by-product, consisting essentially of silicates and aluminosilicates of lime and other bases, which is produced in a molten condition simultaneously with iron in a blast furnace.
Bleeding Capacity	The volume of water released from a given volume of paste or mortar by bleeding, usually expressed as a fraction of a cubic centimeter of water per cubic centimeter of paste or mortar. See AASHTO T 158 - expressed as volume of water per unit area of surface or as a percentage of the net mixing water.
Bleeding Rate	The rate at which water is released from a paste or mortar by bleeding, usually expressed as cubic centimeters of water released each second from each square centimeter of surface.
Bleeding	The self-generated flow of mixing water within, or its emergence from, freshly placed concrete or mortar.
Blemish	Any superficial defect that causes visible variation from a consistently smooth and uniformly colored surface of hardened concrete. (See also <u>Bug Holes</u> , <u>Efflorescence</u> , <u>Honeycomb</u> , <u>Laitance</u> , <u>Popout</u> , <u>Rock Pocket</u> , <u>Sandstreak</u> .)
Blended Cement	See <u>Cement, Blended</u>
Blistering	The irregular rising of a thin layer of placed mortar or concrete at the surface during or soon after completion of the finished operation.
Blow Hole	Depressed area in an asphalt shoulder near a transverse joint that is pumping.
Bond Area	The interface area between two elements across which adhesion develops or may develop, as between concrete and reinforcing steel.
Bond Breaker	A material used to prevent adhesion of newly-placed concrete and reinforcing steel.
Bond Hardness	The support (bond strength) that the metal matrix in a diamond saw blade segment provides to each diamond that is embedded within the matrix.
Bond Strength	Resistance to separation of mortar and concrete from reinforcing steel and other materials with which it is in contact; a collective expression for all forces such as adhesion, friction due to shrinkage, and longitudinal shear in the concrete engaged by the bar deformations that resist separation.

Glossary of Terms

Bond Stress	The force of adhesion per unit area of contact between two surfaces such as concrete and reinforcing steel or any other material such as foundation rock.
Bond	The adhesion of concrete or mortar to reinforcement or other surfaces against which it is placed; the adhesion of cement paste to aggregate.
Bonding Agent	A substance applied to an existing surface to create a bond between it and a succeeding layer, as between a subsurface and a terrazzo topping.
Bonding Layer	A layer of mortar, usually 3 to 13 mm thick, spread on a moist and prepared hardened concrete surface prior to placing fresh concrete.
Box Out	To form an opening or pocket in concrete by a box-like form.
Broom Finish	The surface texture obtained by stroking a broom over freshly placed concrete. See also <u>Brushed Surface</u> .
Brushed Surface	A sandy texture obtained by brushing the surface of freshly placed or slightly hardened concrete with a stiff brush for architectural effect or, in pavements, to increase skid resistance.
Bug Holes	Small regular or irregular cavities, usually not exceeding 15 mm in diameter, resulting from entrapment of air bubbles in the surface of formed concrete during placement and compaction.
Bulk Cement	Cement that is transported and delivered in bulk (usually in specially constructed vehicles) instead of in bags.
Bulk Density	The mass of a material (including solid particles and any contained water) per unit volume, including voids.
Bulk Specific Gravity	The ratio of the weight in air of a given volume of a permeable material (including both permeable and impermeable voids normal to the material) at a stated temperature to the weight in air of an equal volume of distilled water at the same temperature.
Bulking Factor	Ratio of the volume of moist sand to the volume of the sand when dry.
Bulking	Increase in the bulk volume of a quantity of sand in a moist condition over the volume of the same quantity dry or completely inundated.
Bull Float	A tool comprising a large, flat, rectangular piece of wood, aluminum, or magnesium usually 20 cm wide and 100 to 150 cm long, and a handle 1 to 5 m in length used to smooth unformed surfaces of freshly placed concrete.
Burlap	A coarse fabric of jute, hemp, or less commonly flax, for use as a water-retaining covering in curing concrete surfaces; also called Hessian.
Butt Joint	A plain square joint between two members.
Calcareous	Containing calcium carbonate, or less generally, containing the element calcium.
Calcium Chloride	A crystalline solid, CaCl_2 ; in various technical grades, used as a drying agent, as an accelerator of concrete, a deicing chemical, and for other purposes.
Calcium Lignosulfonate	An admixture, refined from paper-making wastes, employed in concrete to retard the set of cement, reduce water requirement and increase strength.
Caliche	Gravel, sand, or desert debris cement by porous calcium carbonate or other salts.

California Bearing Ratio	The ratio of the force per unit area required to penetrate a soil mass with a 19.4 sq cm circular piston at the rate of 1.27 mm per min to the force required for corresponding penetration of a standard crushed-rock base material; the ratio is usually determined at 2.5 mm penetration.
CAP	Communications and Preparation
Cap	1) A suitable material bonded to the surfaces of test specimens to produce plane areas so as to ensure uniform distribution of bearing during compression strength testing; 2) The cap on a expansion joint.
Capacity	The volume of concrete permitted to be mixed or carried in a particular mixer or agitator, usually limited by manufacturer's standards or by specifications to a maximum percentage of total gross volume; also the output of concrete, aggregate, or other product per unit of time (as plant capacity or screen capacity); also load-carrying ability or limit of structure.
Capillarity	Uptake of water or other liquids as a result of surface tension phenomenon.
Capillary Absorption	The action of surface tension forces which draws water into capillaries (i.e., in concrete) without appreciable external pressures.
Capillary Flow	Flow of moisture through a capillary pore system, such as concrete.
Capillary Space	In cement paste, any space not occupied by anhydrous cement or cement gel. (Air bubbles, whether entrained or entrapped, are not considered to be part of the cement paste.)
Capillary Transmission	Passage of water or other fluid through capillaries, either by capillarity or under hydraulic pressure; capillary flow.
Capillary	In cement paste, any space not occupied by unhydrated cement or cement gel (air bubbles, whether entrained or entrapped, are not considered to be part of the cement paste).
Carbide-Milling	Surface removal or sawing done with carbide milling machine; Machine uses blade or arbor equipped with carbide-tipped teeth that impact and chip concrete or asphalt.
Carbonation	Reaction between carbon dioxide and the products of portland cement hydration to produce calcium carbonate.
Cast-In-Place	Concrete placed and finished in its final location.
Cement Content	Quantity of cement contained in a unit volume of concrete or mortar, ordinarily expressed as pounds, barrels, or bags per cubic yard.
Cement Factor	See <u>Cement Content</u>
Cement Gel	The colloidal material that makes up the major portion of the porous mass of which mature hydrated cement paste is composed.
Cement Paste	Constituent of concrete consisting of cement and water.
Cement, Blended	A hydraulic cement consisting essentially of an intimate and uniform blend of granulated blast-furnace slag and hydrated lime; or an intimate and uniform blend of portland cement and granulated blast-furnace slag cement and pozzolan, produced by intergrinding Portland cement clinker with the other materials or by blending Portland cement with the other materials, or a combination of intergrinding and blending.
Cement, Expansive	A special cement which, when mixed with water, forms a paste that tends to increase in volume at an early age; used to compensate for volume decrease due to drying shrinkage.

Glossary of Terms

Cement, High-Early-Strength	Cement characterized by producing earlier strength in mortar or concrete than regular cement, referred to in the United States as "Type III."
Cement, Hydraulic	A cement that is capable of setting and hardening under water, such as normal portland cement.
Cement, Normal	General purpose portland cement, referred to in the United States as "Type I."
Cement, Portland-pozzolan	A hydraulic cement consisting essentially of an intimate and uniform blend of portland cement or portland blast-furnace slag cement and fine pozzolan produced by intergrinding portland-cement clinker and pozzolan, by blending portland cement or portland blast-furnace slag cement and finely divided pozzolan, or a combination of intergrinding and blending, in which the pozzolan constituent is within specified limits.
Cement-Aggregate Ratio	The ratio, by weight or volume, of cement to aggregate.
Cement	See <u>Portland Cement</u>
Cementitious	Having cementing properties.
Central Mixer	A stationary concrete mixer from which the fresh concrete is transported to the work.
Central-Mixed Concrete	Concrete that is completely mixed in a stationary mixer from which it is transported to the delivery point.
Chair	See <u>Bar Support</u>
Chalking	A phenomenon of coatings, such as cement paint, manifested by the formation of a loose powder by deterioration of the paint at or just beneath the surface.
Charging	Introducing, feeding, or loading materials into a concrete or mortar mixer, furnace, or other container or receptacle.
Checking	Development of shallow cracks at closely spaced but irregular intervals on the surface of mortar or concrete.
Chipping	Treatment of a hardened concrete surface by chiseling away a portion of material.
Chute	A sloping trough or tube for conducting concrete, cement, aggregate, or other free-flowing materials from a higher to a lower point.
Coefficient of Thermal Expansion	Change in linear dimension per unit length or change in volume per unit volume per degree of temperature change.
Cohesion Loss	The loss of internal bond within a joint sealant material; noted by a noticeable tear along the surface and through the depth of the sealant.
Cohesiveness	The property of a concrete mix which enables the aggregate particles and cement paste matrix therein to remain in contact with each other during mixing, handling, and placing operations; the "stick-togetherness" of the concrete at a given slump.
Cold Joint	A discontinuity produced when the concrete surface hardens before the next batch is placed against it.
Colloidal Mixer	Grout mixing device that uses a high velocity blade to shear or separate cementitious particles in order to break surface tension and enable complete contact between the particles and mixing water.
Combined Aggregate Grading	Particle size distribution of a mixture of fine and coarse aggregate.

Compacting Factor	The ratio obtained by dividing the observed weight of concrete which fills a container of standard size and shape when allowed to fall into it under standard conditions of test, by the weight of fully compacted concrete which fills the same container.
Compaction	The process whereby the volume of freshly placed mortar or concrete is reduced to the minimum practical space, usually by vibration, centrifugation, tamping, or some combination of these; to mold it within forms or molds and around embedded parts and reinforcement, and to eliminate voids other than entrained air. See also <u>Consolidation</u> .
Compound, Curing	See <u>Curing Compound</u> , <u>Membrane Curing</u>
Compound, Joint Sealing	An impervious material applied as a coating or to fill joints in pavements or structures.
Compound, Sealing	An impervious material applied as a coating or to fill joints or cracks in concrete or mortar. See also <u>Joint Sealant</u> .
Compressible Insert	Board used to separate a partial-depth patch from an adjacent slab, usually consisting of a 12-mm thick Syrofoam or compressed fiber material that is impregnated with asphalt.
Compression Seal	See <u>Preformed Compression Seal</u>
Compression Test	Test made on a specimen of mortar or concrete to determine the compressive strength; in the United States, unless otherwise specified, compression tests of mortars are made on 50-mm cubes, and compression tests of concrete are made on cylinders 152 mm in diameter and 305 mm high.
Compressive Strength Average	The term used to describe the average compressive strength of a given class or strength level of concrete; in ACI 214, defined as average compressive strength required to statistically meet a designated specific strength.
Compressive Strength	The measured resistance of a concrete or mortar specimen to axial loading; expressed as pounds per square inch (psi) of cross-sectional area.
Concrete Finishing Machine	A machine mounted on flanged wheels which rides on the forms or on specially set tracks, used to finish surfaces such as those of pavements; or a portable power driven machine for floating and finishing of floors and other slabs.
Concrete Spreader	A machine designed to spread concrete from heaps already dumped in front of it, or to receive and spread concrete in a uniform layer.
Concrete Vibrating Machine	A machine that compacts a layer of freshly mixed concrete by vibration.
Concrete, Fibrous	Concrete containing dispersed, randomly oriented fibers.
Concrete, Gap-graded	See <u>Gap-Graded Concrete</u>
Concrete, Green	Concrete that has set but not appreciably hardened.
Concrete, Normal-weight	Concrete having a unit weight of approximately 2400 kg/m ³ made with aggregates of normal weight.
Concrete, Ready-mixed	See <u>Ready-mixed Concrete</u>
Concrete, Reinforced	Concrete construction that contains mesh or steel bars embedded in it.

Concrete, Structural	Concrete used to carry structural load or to form an integral part of a structure; concrete of a quality specified for structural use; concrete used solely for protective cover, fill, or insulation is not considered structural concrete.
Concrete, Transit-mixed	See <u>Transit-mixed Concrete</u>
Concrete, Truck mixed	Concrete, the mixing of which is accomplished in a truck mixer.
Concrete, Vibrated	See <u>Vibrated Concrete</u>
Concrete	A composite material that consists essentially of a binding medium in which are embedded particles or fragments of a relatively inert material filler. In portland cement concrete, the binder is a mixture of portland cement and water; the filler may be any of a wide variety of natural or artificial aggregates.
Cone, Slump	See <u>Slump Cone</u> and <u>Slump</u>
Consistency	The relative mobility or ability of fresh concrete or mortar to flow. The usual measures of consistency are slump or ball penetration for concrete and flow for mortar.
Consolidate	Compaction usually accomplished by vibration of newly placed concrete to minimum practical volume, to mold it within form shapes or around embedded parts and reinforcement, and to reduce void content to a practical minimum.
Consolidation	The process of inducing a closer arrangement of the solid particles in freshly mixed concrete or mortar during placement by the reduction of voids, usually by vibration, centrifugation, tamping, or some combination of these actions; also applicable to similar manipulation of other cementitious mixtures, soils, aggregates, or the like. See also <u>Compaction</u> .
Construction Joint	The surface where two successive placements of concrete meet, occasionally with a keyway or reinforcement across the joint.
Construction Loads	The loads to which a permanent or temporary structure is subjected during construction.
Continuously Reinforced Pavement	A pavement with continuous longitudinal steel reinforcement and no intermediate transverse expansion or contraction joints.
Contraction Joint	A plane, usually vertical, separating concrete in a structure or pavement, at a designated location such as to prevent formation of objectionable shrinkage cracks elsewhere in the concrete. Reinforcing steel is discontinuous.
Contraction	Decrease in length or volume. (See also <u>Expansion</u> , <u>Shrinkage</u> , <u>Swelling</u> , and <u>Volume Change</u> .)
Control Joint	See <u>Contraction Joint</u>
Conveyor	A device for moving materials in concrete construction, usually a continuous belt, an articulated system of buckets, a confined screw, or a pipe through which material is forced by air or water.
Core Test	Compression test on a concrete sample cut from hardened concrete by means of a core drill.
Core	A cylindrical specimen of standard diameter drilled from a structure or rock foundation to be tested in compression or examined petrographically.
Coring	The act of obtaining cores by drilling of structure or rock foundations.

Corner Break	A portion of the slab separated by a crack that intersects the adjacent transverse or longitudinal joints, describing about a 45° angle with the direction of traffic. The length of the sides is usually from 0.3 meters to one-half of the slab width on each side of the crack.
Course	In concrete construction, a horizontal layer of concrete, usually one of several making up a lift; in masonry construction, a horizontal layer of block or brick. See also <u>Lift</u> .
Cover	In reinforced concrete, the least distance between the surface of the reinforcement and the outer surface of the concrete.
CPR	Concrete pavement restoration; the combination of available concrete repair techniques in one project.
Crack Saw	Small three-wheeled specialty saw useful for tracing the wandering nature of a transverse or longitudinal crack; usually contains a pivot wheel and requires a small diameter crack sawing blade.
Cracking	The process of contraction or the reflection of stress in the pavement.
Crazing	Minute surface pattern cracks in mortar or concrete due to unequal shrinkage or contraction on drying or cooling.
CRC Pavement	Continuously reinforced concrete pavement; see <u>Continuously Reinforced Pavement</u> .
Cross Section	The section of a body perpendicular to a given axis of the body; a drawing showing such a section.
Crushed Gravel	The product resulting from the artificial crushing of gravel with a specified minimum percentage of fragments having one or more faces resulting from fracture. See also <u>Coarse Aggregate</u> .
Crushed Stone	The product resulting from the artificial crushing of rocks, boulders, or large cobblestones, substantially all faces of which possess well-defined edges and have resulted from the crushing operation.
Crusher-run Aggregate	Aggregate that has been broken in a mechanical crusher and has not been subjected to any subsequent screening process.
Cubic Yard	Normal commercial units of measure of concrete volume, equal to 27 cubic feet.
Cumulative Batching	Measuring more than one ingredient of a batch in the same container by bringing the batcher scale into balance at successive total weights as each ingredient is accumulated in the container.
Curb Form	A retainer or mold used in conjunction with a curb tool to give the necessary shape and finish to a concrete curb.
Cure	Maintenance of temperature and humidity for freshly placed concrete during some definite period following placing and finishing to ensure proper hydration of the cement and proper hardening of the concrete.
Curing Blanket	A built-up covering of sacks, matting, hessian, straw, waterproof paper, or other suitable material placed over freshly finished concrete. See also <u>Burlap</u> .
Curing Compound	A liquid that can be applied as a coating to the surface of newly placed concrete to retard the loss of water or, in the case of pigmented compounds, also to reflect heat so as to provide an opportunity for the concrete to develop its properties in a favorable temperature and moisture environment. See also <u>Curing</u> .

Curing	The maintenance of a satisfactory moisture content and temperature in concrete during its early stages so that desired properties may develop.
Damp	Either moderate absorption or moderate covering of moisture; implies less wetness than that connoted by "wet," and slightly wetter than that connoted by "moist." See also <u>Moist</u> and <u>Wet</u> .
Darby	A hand-manipulated straightedge about one meter long used during the early stage leveling operations of concrete finishing as a supplement to floating (not a float).
DBI	A dowel bar inserter that places the load transfer bar into plastic concrete as part of the paving operation.
Dead Load	A constant load that in structures is due to the mass of the members, the supported structure, and permanent attachments or accessories.
Defoaming Agent	An admixture used for reducing or limiting the air content of fresh concrete.
Deformed Bar	A reinforcing bar with a manufactured pattern of surface ridges that provide a locking anchorage with surrounding concrete.
Deformed Reinforcement	Metal bars, wire, or fabric with a manufactured pattern of surface ridges that provide a locking anchorage with surrounding concrete.
Dehydration	Removal of water from a material, frequently but not always by heat; the water may have been held by either chemical or physical forces.
Density (dry)	The mass per unit volume of a dry substance at a stated temperature. See also <u>Specific Gravity</u> .
Density Control	Control of density of concrete in field construction to ensure that specified values as determined by standard tests are obtained.
Density	Mass per unit volume; by common usage in relation to concrete, weight per unit volume, also referred to as unit weight.
Design Strength	Load capacity of a member computed on the basis of allowable stresses assumed in design.
Deterioration	1) Physical manifestation of failure (e.g., cracking delamination, flaking, pitting, scaling, spalling, staining) caused by environmental or internal autogenous influences on rock and hardened concrete as well as other materials; 2) decomposition of material during either testing or exposure to service. See also <u>Disintegration</u> and <u>Weathering</u> .
Diamond Grinding	The process used to remove the upper surface of a concrete pavement to remove bumps and restore pavement rideability; also, equipment using many diamond saw blades on a shaft or arbor to shave the surface of concrete slabs.
Disintegration	Reduction into small fragments and subsequently into particles. See also <u>Deterioration</u> , <u>Mechanical Weathering</u> , and <u>Weathering</u> .
Dispersing Agent	An admixture capable of increasing the fluidity of pastes, mortar or concretes by reduction of inter-particle attraction.
Distress	Physical manifestation of deterioration and distortion in a concrete structure as the result of stress, chemical action, and/or physical action.
Dog Tail	Area of unground concrete resulting when a diamond grinding operator does not adequately steer the machine and does not overlap a previous pass.

Dolomite	A mineral having a specific crystal structure and consisting of calcium carbonate and magnesium carbonate in equivalent chemical amounts (54.27 and 45.73 percent by weight, respectively); a rock containing dolomite as the principal constituent.
Dowel Lubricant	A material applied to part of the surface of a dowel to reduce bond with the concrete and permit axial movement.
Dowel	1) A steel pin, commonly a plain round steel bar, which extends into two adjoining portions of a concrete construction, as at a joint in a pavement slab, so as to transfer shear loads; 2) a deformed reinforcing bar intended to transmit tension, compression, or shear through a construction joint.
Down Pressure	The force that keeps the grinding head on a diamond grinding machine cutting through bumps in the concrete surface and prevents the grinding head from riding up and merely tracing the bump profile.
Drainage	The interception and removal of water from, on, or under an area or roadway; the process of removing surplus ground or surface water artificially; a general term for gravity flow of liquids in conduits.
Drive Packer	For slab stabilization or slab jacking, tapering metal nozzle that seats into an injection hole by tapping or standing on foot plate. Usually most appropriate for small-diameter holes.
Drop Hammer	Impact-type pavement breaking equipment.
Dropchute (articulated)	A vertical succession of tapered metal cylinders, the lower end of each fitting into the upper end of the one below, used to confine a falling stream of concrete where necessary to avoid its striking embedded parts or scattering excessively, or to prevent separation when concrete leaves a chute or a conveyor belt.
Dropchute (flexible)	A rubberized, heavy canvas tube extending down between curtains of steel in forms, from the bottom of a hopper or crane bucket, to confine a falling stream of concrete where this is necessary. Will enter spaces and will withdraw without catching on steel much better than the articulated metal dropchute.
Dropchute	A device used to confine or to direct the flow of a falling stream of fresh concrete.
Drum Speed (RPM)	The various rates of rotation of the drum of a mixer when used for charging, mixing, agitating, or discharging. These various drum speeds are usually outlined on the mixer rating plate.
Dry Mix	A concrete, mortar, or plaster mixture, commonly sold in bags, containing all components except water; also a concrete of near zero slump.
Dry Mixing	Blending of the solid materials for mortar or concrete prior to adding the mixing water.
Dry Process	In the manufacture of cement, the process in which the raw materials are ground, conveyed, blended, and stored in a dry condition. See also <u>Wet Process</u> .
Dry Rodded Weight (DRW)	Weight per unit volume of an aggregate compacted dry by rodding under standardized conditions.
Dry-Batch Weights	Weights of materials, excluding water, to make a batch of concrete.
Dry-Rodded Volume	The volume that would be occupied by an aggregate if it were compacted dry under the standardized conditions used in measuring unit weight of aggregate.

Glossary of Terms

Dry-Rodding	Tamping of dry coarse aggregate in a calibrated container to measure its unit weight.
Drying Shrinkage	Contraction caused by drying.
Durability	The ability of concrete to remain unchanged while in service; resistance to weathering action, chemical attack, and abrasion.
Dynamic Load	A variable load; i.e., not static, such as a moving live load, earthquake, or wind.
Dynamic Loading	Loading from units (particularly machinery) which, by virtue of their movement or vibration, impose stresses in excess of those imposed by their dead load.
Early Strength	Strength of concrete developed soon after placement, usually during the first 72 hours.
Edge Form	Formwork used to limit the horizontal spread of fresh concrete on flat surfaces, such as pavements or floors.
Edger	A finishing tool used on the edges of fresh concrete to provide a rounded edge.
Efflorescence	Deposit of salts, usually white in color, appearing upon the surface or found within the near-surface pores of concrete or masonry.
Engineer-Architect	The architect, engineer, architectural firm, engineering firm, or architectural and engineering firm, issuing project drawings and specifications, or administering the work under contract specifications and drawings, or both.
Entrained Air	Round, uniformly distributed, microscopic, non-coalescing air bubbles entrained by the use of air-entraining agents; usually less than 1 mm in size.
Entrapped Air	Air in concrete which is not purposely entrained. Entrapped air is generally considered to be large voids (larger than 1 mm).
Evaporable Water	Water set in cement paste present in capillaries or held by surface forces; measured as that removable by drying under specified conditions. See also <u>Nonevaporable Water</u> .
Expanding Rubber Packer	For slab stabilization or slab jacking, nozzle containing an expandable rubber sleeve that expands from injection pressure to fill the injection hole during injection of stabilizing material.
Expansion Joint	Pavement joint that allows large closure movement to prevent development of lateral compression between adjacent concrete slabs; usually used to isolate an on-line structure, such as a bridge.
Expansion Sleeve	A tubular metal covering for a dowel bar to allow its free longitudinal movement at a joint.
Expansion	Increase in length or volume. See also <u>Autogenous Volume Change</u> , <u>Contraction</u> , <u>Moisture Movement</u> , <u>Shrinkage</u> , and <u>Volume Change</u> .
Exposed Concrete	Concrete surfaces formed so as to yield an acceptable texture and finish for permanent exposure to view. See also <u>Architectural Concrete</u> .
External Vibrator	See <u>Vibration</u>
False Set	The rapid development of rigidity in a freshly mixed Portland cement paste, mortar, or concrete without the evolution of much heat, which rigidity can be dispelled and plasticity regained by further mixing without addition of water; premature stiffening, hesitation set, early stiffening, and rubber set are terms referring to the same phenomenon, but false set is the preferred designation.

Faulting	Differential vertical displacement of a slab or other member adjacent to a joint or crack.
FHWA	Federal Highway Administration
Field-cured Cylinders	Test cylinders cured as nearly as practicable in the same manner as the concrete in the structure to indicate when supporting forms may be removed, additional construction loads may be imposed, or the structure may be placed in service.
Final Set	A degree of stiffening of a mixture of cement and water greater than initial set, generally stated as an empirical value indicating the time in hours and minutes required for a cement paste to stiffen sufficiently to resist to an established degree, the penetration of a weighted test needle; also applicable to concrete and mortar mixtures with use of suitable test procedures. See also <u>Initial Set</u> .
Final Setting Time	The time required for a freshly mixed cement paste, mortar, or concrete to achieve final set. See also <u>Initial Setting Time</u> .
Finish	The texture of a surface after compacting and finishing operations have been performed.
Finishing Machine	A power-operated machine used to give the desired surface texture to a concrete slab.
Finishing	Leveling, smoothing, compacting, and otherwise treating surfaces of fresh or recently placed concrete or mortar to produce desired appearance and service. See also <u>Float</u> and <u>Trowel</u> .
Fixed Form Paving	A type of concrete paving process that involves the use of fixed forms to uniformly control the edge and alignment of the pavement.
Flash Set	The rapid development of rigidity in a freshly mixed Portland cement paste, mortar, or concrete, usually with the evolution of considerable heat, which rigidity cannot be dispelled nor can the plasticity be regained by further mixing without addition of water; also referred to as quick set or grab set.
Flexible Pavement	A pavement structure that maintains intimate contact with and distributes loads to the subgrade and depends on aggregate interlock, particle friction, and cohesion for stability; cementing agents, where used, are generally bituminous materials as contrasted to portland cement in the case of rigid pavement. See also <u>Rigid Pavement</u> .
Flexural Strength	A property of a material or structural member that indicates its ability to resist failure in bending. See also <u>Modulus of Rupture</u> .
Float Finish	A rather rough concrete surface texture obtained by finishing with a float.
Float	A tool (not a darby) usually of wood, aluminum, or magnesium, used in finishing operations to impart a relatively even but still open texture to an unformed fresh concrete surface.
Floating	The operation of finishing a fresh concrete or mortar surface by use of a float, preceding troweling when that is to be the final finish.
Flow Cone Test	Test that measures the time necessary for a known quantity of grout to completely flow out of and empty a standard sized cone; usually used in slab stabilization to determine the water quantity necessary for stabilization grout.

Glossary of Terms

Flow	1) Time dependent irrecoverable deformation. See <u>Rheology</u> . 2) A measure of the consistency of freshly mixed concrete, mortar, or cement paste in terms of the increase in diameter of a molded truncated cone specimen after jiggling a specified number of times.
Fly Ash	A concrete mix additive that is used as a replacement for cement in the concrete mix. Fly ash addition is important information in determining when to saw.
Form Oil	Oil applied to interior surface of formwork to promote easy release from the concrete when forms are removed.
Form	A temporary structure or mold for the support of concrete while it is setting and gaining sufficient strength to be self-supporting.
Free Moisture	Moisture having essentially the properties of pure water in bulk; moisture not absorbed by aggregate. See also <u>Surface Moisture</u> .
Free Water	See <u>Free Moisture</u> and <u>Surface Moisture</u>
Full-depth Patching	Removing and replacing at least a portion of a concrete slab to the bottom of the concrete, in order to restore areas of deterioration.
Gap-graded Concrete	Concrete containing a gap-graded aggregate.
Gradation	See <u>Grading</u>
Grading	The distribution of particles of granular material among various sizes, usually expressed in terms of cumulative percentages larger or smaller than each of a series of sizes (sieve openings) or the percentages between certain ranges of sizes (sieve openings).
Gravel	Granular material predominantly retained on the 4.75 mm (No. 4) sieve and resulting from natural disintegration and abrasion of rock or processing of weakly bound conglomerate.
Green Concrete	See <u>Concrete, Green</u>
Green Sawing	The process of controlling random cracking by sawing uniform joint spacing in early age concrete without tearing or dislocating the aggregate in the mix.
Grinding Head	Arbor or shaft containing many diamond blades on diamond grinding equipment.
Gross Vehicle Load	The weight of a vehicle plus the weight of any load thereon.
Gross Volume (of concrete mixers)	In the case of a revolving-drum mixer, the total interior volume of the revolving portion of the mixer drum; in the case of an open-top mixer, the total volume of the trough or pan calculated on the basis that no vertical dimension of the container exceeds twice the radius of the circular section below the axis of the central shaft.
Grout-Retention Disk	Small plastic disk that provides a barrier to prevent grout or epoxy from escaping from a dowel hole.
Grout	A mixture of cementitious material and water, with or without aggregate, proportioned to produce a pourable consistency without segregation of the constituents; also, a mixture of other composition but of similar consistency. See also <u>Neat Cement Grout</u> and <u>Sand Grout</u> .
Hairline Cracking	Barely visible cracks in random pattern in an exposed concrete surface which do not extend to the full depth or thickness of the concrete, and which are due primarily to drying shrinkage.
Hardener	A chemical applied to concrete floors to reduce wearing and dusting.

Hardening	When portland cement is mixed with enough water to form a paste, the compounds of the cement react with water to form cementitious products that adhere to each other and to the intermixed sand and stone particles and become very hard. As long as moisture is present, the reaction may continue for years, adding continually to the strength of the mixture.
Harsh Mixture	A concrete mixture which lacks desired workability and consistency due to a deficiency of mortar.
Harshness	Deficient workability and cohesiveness caused by insufficient sand or cement, or by improperly graded aggregate.
Header	A transverse construction joint installed at the end of a days paving operation or other placement interruptions. To a contractor, a header is the location at which paving will resume on the next day.
Heat of Hydration	Heat evolved by chemical reactions of a substance with water, such as that evolved during the setting and hardening of portland cement.
Heavy-Weight Aggregate	An aggregate of very high unit weight, such as barium, boron, or iron ore, steel shot or punchings, which forms a high density mortar of concrete when bound together with hardened cement paste.
Heavy-Weight Concrete	Concrete in which heavy aggregates are used to increase the density of the concrete; unit weights in the range of 165 to 330 pounds per cubic foot are attained.
High Range Water-Reducing Admixture	See <u>Water-Reducing Admixture (high range)</u>
High-Early-Strength Cement	See <u>Cement, High-Early-Strength</u>
High-Early-Strength Concrete	Concrete which, through the use of high-early-strength cement or admixtures, is capable of attaining specified strength at an earlier age than normal concrete.
Holiday	An unground area in a diamond ground surface resulting when the head on the diamond grinding equipment does not cut deep enough to touch a low spot in the surface.
Honeycomb	Concrete which, due to lack of the proper amount of fines or vibration, contains abundant interconnected large voids or cavities; concrete which has honeycomb is improperly consolidated.
Hooked Bar	A reinforcing bar with the end bent into a hook to provide anchorage.
Horizontal-Axis Mixer	A concrete mixer of the revolving drum type in which the drum rotates about a horizontal axis.
Hot-pour Sealant	Joint sealing materials that require heating for installation, usually consisting of a base of asphalt or coal tar.
Hydrated Lime	A dry powder obtained by treating quicklime with sufficient water to convert it to calcium hydroxide.
Hydration	The chemical reaction between cement and water which causes concrete to harden.
Hydraulic Cement	A cement that is capable of setting and hardening under water due to the chemical interaction of the water and the constituents of the cement.
Hydraulic Ram	Impact-type pavement breaking equipment.
Inclined-Axis Mixer	A truck with a revolving drum that rotates about an axis inclined to the bed of the truck chassis.

Incompressibles	Small concrete fragments, stones, sand or other hard materials that enter a joint sealant, joint reservoir, or other concrete pavement discontinuity.
Initial Set	A degree of stiffening of a mixture of cement and water less than final set, generally stated as an empirical value indicating the time in hours and minutes required for cement paste to stiffen sufficiently to resist to an established degree the penetration of a weighted test needle; also applicable to concrete or mortar with use of suitable test procedures. See also <u>Final Set</u> .
Initial Setting Time	The time required for a freshly mixed cement paste to acquire an arbitrary degree of stiffness as determined by specific test.
Injection Hole	Hole drilled vertically through a concrete slab that is used to inject stabilizing grout underneath the slab or subbase layers.
Isolation Joint	A separation between adjoining parts of a concrete structure, usually a vertical plane, at a designed location such as to interfere least with performance of the structure, yet such as to allow relative movement in three directions and avoid formation of cracks elsewhere in the concrete and through which all or part of the bonded reinforcement is interrupted. See also <u>Contraction Joint</u> and <u>Expansion Joint</u> .
Jitterbug	A grate tamper for pushing coarse aggregate slightly below the surface of a slab to facilitate finishing. See also <u>Tamper</u> .
Joint Depth	The measurement of a saw cut from the top of the slab to the bottom of the cut.
Joint Deterioration	See <u>Spalling, Compression</u>
Joint Filler	Compressible material used to fill a joint to prevent the infiltration of debris and to provide support for sealant.
Joint Sealant	Compressible material used to exclude water and solid foreign materials from joints.
Joint Shape	The vertical dimension of a saw cut. Many times this refers to the final cut prior to sealing. Many times this is widening of the original saw cut.
Joint, Construction	See <u>Construction Joint</u>
Joint, Contraction	See <u>Contraction Joint</u>
Joint, Expansion	See <u>Expansion Joint</u>
Joint	A plane of weakness to control contraction cracking in concrete pavements. A joint can be initiated in plastic concrete or green concrete and shaped with later process.
Keyway	A recess or groove in one lift or placement of concrete which is filled with concrete of the next lift, giving shear strength to the joint. See also <u>Tongue and Groove</u> .
Laitance	A layer of weak and nondurable material containing cement and fines from aggregates, brought to the top of overwet concrete, the amount of which is generally increased by overworking and overmanipulating concrete at the surface by improper finishing.
Layer	See <u>Course</u>
Lean Concrete	Concrete of low cement content.
Lift	The concrete placed between two consecutive horizontal construction joints, usually consisting of several layers or courses.
Liquid Sealant	Sealant materials that install in liquid form and cool or cure to their final properties; rely on long-term adhesion to the joint reservoir faces.

Load Transfer	The ability of a joint or crack to transfer a portion of a load applied on side of the joint or crack to the other side of the joint or crack.
Load-Transfer Assembly	Most commonly, the unit (basket or plate) designed to support or link dowel bars during concreting operations so as to hold them in place, in the desired alignment.
Longitudinal Cut Line	The vertical edge remaining in the surface of a concrete slab after a pass by diamond grinding equipment.
Longitudinal Joint	A joint parallel to the long dimension of a structure or pavement.
Longitudinal Reinforcement	Reinforcement essentially parallel to the long axis of a concrete member or pavement.
Lot	A defined quantity.
Low Modulus	Does not readily tear.
Manual Batcher	A batcher equipped with gates or valves that are operated manually, with or without supplementary power (pneumatic, hydraulic, or electrical), the accuracy of the weighing operation being dependent on the operator's observation of the scale.
Map Cracking	1) Intersecting cracks that extend below the surface of hardened concrete; caused by shrinkage of the drying surface concrete which is restrained by concrete at greater depths where either little or no shrinkage occurs; vary in width from fine and barely visible to open and well-defined. 2) The chief symptom of chemical reaction between alkalis in cement and mineral constituents in aggregate within hardened concrete; due to differential rate of volume change in different portions of the concrete; cracking is usually random and on a fairly large scale, and in severe instances the cracks may reach a width of 0.50 in. See also <u>Checking</u> , <u>Crazing</u> , and <u>Pattern Cracking</u> .
Mass Concrete	Concrete placed in large volumes and containing large maximum size aggregate.
Mass	The physical property of matter that causes it to have weight in a gravitational field.
Maximum Size Aggregate (or top size)	The largest size aggregate particles present in sufficient quantity to affect properties of a concrete mixture.
Mechanical Analysis	The process of determining particle-size distribution or grading.
Membrane Curing	A process that involves either liquid sealing compound (e.g., bituminous and paraffinic emulsions, coal tar cut-backs, pigmented and nonpigmented resin suspensions, or suspensions of wax and drying oil) or nonliquid protective coating (e.g., sheet plastics or "waterproof" paper), both of which types function as films to restrict evaporation of mixing water from the fresh concrete surface.
Mesh Reinforcement	See <u>Welded-Wire Fabric Reinforcement</u>
Mesh	The number of openings (including fractions thereof) per unit of length in either a screen or sieve in which the openings are 6 mm or less.
Mix Design	See <u>Proportioning</u>
Mix	The act or process of mixing; also mixture of materials, such as mortar or concrete.
Mixer Capacity	The volume of concrete permitted to be mixed or carried in a particular mixer or agitator.

Mixer Efficiency	The adequacy of a mixer in rendering a homogeneous product within a stated period; homogeneity is determinable by testing for relative differences in physical properties of samples extracted from different portions of a freshly mixed batch.
Mixer, Batch	See <u>Batch Mixer</u>
Mixer, Horizontal Shaft	A mixer having a stationary cylindrical mixing compartment, with the axis of the cylinder horizontal, and one or more rotating shafts to which mixing blades or paddles are attached; also called <i>Pugmill</i> .
Mixer, Nontilting	A horizontally rotating drum mixer that charges, mixes, and discharges without tilting.
Mixer, Open-top	A truck-mounted mixer consisting of a trough or a segment of a cylindrical mixing compartment within which paddles or blades rotate about the horizontal axis of the trough. See also <u>Mixer, Horizontal Shaft</u> .
Mixer, Tilting	A rotating drum mixer that discharges by tilting the drum about a fixed or movable horizontal axis at right angles to the drum axis. The drum axis may be horizontal or inclined while charging and mixing.
Mixer, Transit	See <u>Truck Mixer</u>
Mixer	A machine used for blending the constituents of concrete, grout, mortar, cement paste, or other mixture.
Mixing Cycle	The time taken for a complete cycle in a batch mixer; i.e., the time elapsing between successive repetitions of the same operation (e.g., successive discharges of the mixer).
Mixing Plant	See <u>Batch Plant</u>
Mixing Speed	Rotation rate of a mixer drum or of the paddles in an open-top, pan, or trough mixer, when mixing a batch; expressed in revolutions per minute (rpm), or in peripheral feet per minute of a point on the circumference at maximum diameter.
Mixing Time	The period during which the ingredients for a batch of concrete are being combined by the mixer. For stationary mixers, the time is measured from the completion of batching cement and aggregate until the beginning of discharge. For truck mixers, mixing is given in term of the number of revolutions of the drum at mixing speed.
Mixing Water	The water in freshly mixed sand-cement grout, mortar, or concrete, exclusive of any previously absorbed by the aggregate (e.g., water considered in the computation of the net water-cement ratio). See also <u>Batched Water</u> and <u>Surface Moisture</u> .
Mixture	The assembled, blended, commingled ingredients of mortar, concrete, or the like, or the proportions for their assembly.
Modified Portland Cement	A portland cement having moderate heat of hydration. This term was replaced by <i>Type II cement</i> beginning in 1960.
Modulus of Rupture	A measure of the ultimate load-carrying capacity of a beam, sometimes referred to as "rupture modulus" or "rupture strength." It is calculated for apparent tensile stress in the extreme fiber of a transverse test specimen under the load which produces rupture. See also <u>Flexural Strength</u> .
Moist	Slightly damp but not quite dry to the touch; the term "wet" implies visible free water, "damp" implies less wetness than "wet," and "moist" implies not quite dry. See also <u>Damp</u> and <u>Wet</u> .
Moisture Barrier	A vapor barrier.

Moisture Content of Aggregate	The ratio, expressed as a percentage, of the weight of water in a given granular mass to the dry weight of the mass.
Moisture-free	The condition of a material that has been dried in air until there is no further significant change in its mass. See also <u>Mass</u> and <u>Overdry</u> .
Mortar	Concrete with essentially no aggregate larger than about 3/16 inch.
Mud Balls	Balls of clay or silt ("mud").
Natural Sand	Sand resulting from natural disintegration and abrasion of rock. See also <u>Sand</u> and <u>Aggregate, Fine</u> .
NCHRP	National Cooperative Highway Research Program
Neat Cement Grout	Grout consisting of portland cement and water.
NHI	National Highway Institute
No-Slump Concrete	Concrete with a slump of 6 mm or less. See also <u>Zero-slump Concrete</u> .
Nominal Maximum Size (of aggregate)	In specifications for and descriptions of aggregate, the smallest sieve opening through which the entire amount of the aggregate is permitted to pass; sometimes referred to as "maximum size (of aggregate)."
Nominal Mix	The proportions of the constituents of a proposed concrete mixture.
Nominal Size	See <u>Maximum Size of Coarse Aggregate</u>
Non-air-entrained Concrete	Concrete in which neither an air-entraining admixture nor air-entraining cement has been used.
Nonagitating Unit	A truck-mounted container for transporting central-mixed concrete that is not equipped to provide agitation (slow mixing) during delivery. (Dump truck)
Nonevaporable Water	The water that is chemically combined during cement hydration; not removable by specified drying. See also <u>Evaporable Water</u> .
Nontilting Mixer	See <u>Mixer, Nontilting</u>
NRMCA	National Ready Mixed Concrete Association
Ovendry	The condition resulting from having been dried to essentially constant weight, in an oven, at a temperature that has been fixed, usually between 221 and 239° F (105 and 115° C).
OverSanded	Containing more sand than would be required for adequate workability and satisfactory finishing characteristics.
OverVibration	Vibration of concrete more than is necessary for good consolidation and elimination of entrapped air.
OverWet	The consistency of concrete when it contains more mixing water and hence is of greater slump than is necessary for ready consolidation.
Partial-Depth Patching	Patches for restoring localized areas of surface deterioration; Usually for compression spalling problems, severe scaling, or other surface problems that are within the upper one-third of the slab depth.
Particle-Size Distribution	The division of particles of a graded material among various sizes; for concrete materials, usually expressed in terms of cumulative percentages larger or smaller than each of a series of diameters or the percentages within certain ranges of diameter, as determined by sieving.
Pattern Cracking	Fine openings on concrete surfaces in the form of a pattern; resulting from a decrease in volume of the material near the surface, an increase in volume of the material below the surface, or both.
Pavement (concrete)	A layer of concrete over such areas as roads, sidewalks, canals, airfields, and those used for storage or parking. See also <u>Rigid Pavement</u> .

Paving Train	An assemblage of equipment designed to place and finish a concrete pavement.
PCA	Portland Cement Association
PCC	Portland Cement Concrete
Pea Gravel	Screened gravel the particle sizes of which range between 3/16 and 3/8 inch in diameter.
Peeling	A deterioration process in which thin flakes of mortar break away from a concrete surface.
Percent Fines	Amount, expressed as a percentage, of material in aggregate finer than a given sieve, usually the No. 200 (75 μ m) sieve; also, the amount of fine aggregate in a concrete mixture expressed as a percent by absolute volume of the total amount of aggregate.
Pie Tape	Tape used to measure the circumference of the grinding head blades on diamond grinding equipment.
Pitting	A localized disintegration taking the form of cavities at the surface of concrete.
Placement	The process of placing and consolidating concrete; a quantity of concrete placed and finished during a continuous operation; also inappropriately referred to as <i>Pouring</i> .
Placing	The deposition, distribution, and consolidation of freshly mixed concrete in the place where it is to harden; also inappropriately referred to as <i>Pouring</i> .
Plain Bar	A reinforcing bar without surface deformations, or one having deformations that do not conform to the applicable requirements.
Plain Concrete	Concrete without reinforcement.
Plane of Weakness	The plane along which a body under stress will tend to fracture; may exist by design, by accident, or because of the nature of the structure and its loading.
Plastic Consistency	Condition of freshly mixed cement paste, mortar, or concrete such that deformation will be sustained continuously in any direction without rupture; in common usage, concrete with slump of 80 to 100 mm.
Plastic Cracking	Cracking that occurs in the surface of fresh concrete soon after it is placed and while it is still plastic.
Plastic Deformation	Deformation that does not disappear when the force causing the deformation is removed.
Plastic Shrinkage Cracking	The result of rapid moisture loss in the surface or mass of the concrete pavement.
Plastic	A condition of freshly mixed concrete such that it is readily remoldable and workable, cohesive, and has an ample content of cement and fines, but is not over-wet.
Plasticity	That property of fresh concrete or mortar which determines its resistance to deformation or its ease of molding.
Plasticizer	A material that increases the plasticity of a fresh cement paste, mortar, or concrete.
Pneumatic	Moved or worked by air pressure.
Point Bearing	Occurs when a partial-depth patch is made without the compressible insert; also, slab expansion in hot weather forces an adjacent slab to bear directly against a small partial-depth patch and causes the patch to fail by popout or delamination.

Popouts	Pits or craters in the surface of concrete resulting from localized expansive forces associated with particles of unsound aggregate or contaminating materials, such as wood or glass.
Porosity	The ratio, usually expressed as a percentage, of the volume of voids in a material to the total volume of the material, including voids.
Portland Cement	A commercial product which when mixed with water alone or in combination with sand, stone, or similar materials, has the property of combining with water, slowly, to form a hard solid mass. Physically, portland cement is a finely pulverized clinker produced by burning at high temperatures mixtures containing lime, iron, alumina, and silica in definite proportions and then interground with gypsum to give the properties desired.
Portland-pozzolan Cement	See <u>Cement, portland-pozzolan</u>
Pozzolan-Cement Grout	Common slab stabilization grout consisting of water, portland cement and pozzolan; usually fly ash.
Pozzolan	A siliceous or siliceous and aluminous material, which in itself possesses little or no cementitious value but will, in finely divided form and in the presence of moisture, chemically react with calcium hydroxide at ordinary temperatures to form compounds possessing cementitious properties.
Preformed Compression Seal	Joint sealant that is manufactured ready for installation and is held in a joint by lateral pressure exerted against the reservoir by the seal after being compressed during installation.
Preservation	The process of maintaining a structure in its present condition and arresting further deterioration. See also <u>Rehabilitation, Repair, and Restoration</u> .
Pressure-Relief	Cut made in a concrete pavement to relieve compressive forces of thermal expansion during hot weather.
Proportioning	Selection of proportions of ingredients for mortar or concrete to make the most economical use of available materials to produce mortar or concrete of the required properties.
PSI	1) Pounds per square inch; a measure of the compressive, tensile or flexural strength of concrete as determined by appropriate test. 2) In pavements, the Performance Serviceability Index.
Pugmill	A stationary mechanical mixer for blending cement and aggregate.
Punchout	In continuously reinforced concrete pavement, the area enclosed by two closely spaced transverse cracks, a short longitudinal crack, and the edge of the pavement or longitudinal joint, when exhibiting spalling, shattering, or faulting. Also, area between Y cracks exhibiting this same deterioration.
QC/QA	Quality Control/Quality Assurance
Quality Assurance	Actions taken by an owner or his representative to provide assurance that what is being done and what is being provided are in accordance with the applicable standards of good practice for the work.
Quality Control	Actions taken by a producer or contractor to provide control over what is being done and what is being provided so that the applicable standards of good practice for the work are followed.
Random Cracking	A non-controlled crack outside of the uniform sawed joints.

Raveling	The displacement of aggregate or surface concrete from sawing; normally indicates that concrete strength is too low for sawing.
Reactive-Aggregate	Aggregate containing certain silicic or carbonate compounds that are capable of reacting with alkalis in portland cement, in some cases producing damaging expansion of concrete.
Ready-Mixed Concrete	Concrete manufactured for delivery to a purchaser in a plastic and unhardened state. See <u>Central-mixed Concrete</u> , <u>Shrink-mixed Concrete</u> , and <u>Transit-mixed Concrete</u> .
Rebar	Abbreviation for "reinforcing bar." See <u>Reinforcement</u> .
Rebound Hammer	An apparatus that provides a rapid indication of the mechanical properties of concrete based on the distance of rebound of a spring-driven missile.
Recycled Concrete	Concrete that has been processed for use, usually as aggregate.
Rehabilitation	The process of repairing or modifying a structure to a desired useful condition. See also <u>Preservation</u> , <u>Repair</u> , and <u>Restoration</u> .
Reinforced Concrete	Concrete containing adequate reinforcement (prestressed or not prestressed) and designed on the assumption that the two materials act together in resisting forces. See also <u>Plain Concrete</u> .
Reinforcement, Dowel-bar	See <u>Dowel</u>
Reinforcement, Transverse	Reinforcement at right angles to the longitudinal reinforcement; may be main or secondary reinforcement.
Reinforcement	Bars, wires, strands, and other slender members embedded in concrete in such a manner that the reinforcement and the concrete act together in resisting forces.
Relative Humidity	The ratio of the quantity of water vapor actually present to the amount present in a saturated atmosphere at a given temperature; expressed as a percentage.
Release Agent	Material used to prevent bonding of concrete to a surface. See also <u>Bond Breaker</u> .
Remoldability	The readiness with which freshly mixed concrete responds to a remolding effort, such as jiggling or vibration, causing it to reshape its mass around reinforcement and to conform to the shape of the form. See also <u>Flow</u> .
Repair	To replace or correct deteriorated, damaged, or faulty materials, components, or elements of a structure. See also <u>Preservation</u> , <u>Rehabilitation</u> , and <u>Restoration</u> .
Reservoir	The part of a concrete joint that normally holds a sealant material. Usually a widening saw cut above the initial saw cut.
Restoration	The process of reestablishing the materials, form, and appearance of a structure to those of a particular era of the structure. See also <u>Preservation</u> , <u>Rehabilitation</u> , and <u>Repair</u> .
Retardation	Reduction in the rate of hardening or strength development of fresh concrete, mortar, or grout; i.e., an increase in the time required to reach initial and final set.
Retarder	An admixture that delays the setting of cement and hence of mixtures such as mortar or concrete containing cement.
Retempering	Addition of water and remixing of concrete or mortar which has lost enough workability to become unplaceable or unusable. See also <u>Tempering</u> .

Retrofit Dowel Bars	Dowels that install into slots cut into the surface of an existing concrete pavement.
Revibration	A second vibration applied to fresh concrete, preferably as long after the first vibration as the concrete will still respond properly.
Rheology	The science of dealing with flow of materials, including studies of deformation of hardened concrete, the handling and placing of freshly mixed concrete, and the behavior of slurries, pastes, and the like.
Ribbon Loading	Method of batching concrete in which the solid ingredients, and sometimes the water, enter the mixer simultaneously.
Rich Mixture	A concrete mixture containing a large amount of cement.
Rigid Pavement	Pavement that will provide high bending resistance and distribute loads to the foundation over a comparatively large area.
Rock Pocket	A portion of hardened concrete consisting of a concentration of coarse aggregate that is deficient in mortar; caused by separation during placement or insufficient consolidation, or both; see <u>honeycomb</u> .
Rod, Tamping	A straight steel rod of circular cross section having one or both ends rounded to a hemispherical tip.
Rod	A specified length of metal, circular in cross section with one end rounded, for compacting concrete or mortar test specimens.
Rodability	The susceptibility of fresh concrete or mortar to compaction by means of a tamping rod.
Rodding	Compaction of concrete by means of a tamping rod. See also <u>Rod</u> , <u>Tamping</u> , and <u>Rodability</u> .
Sack	See <u>Bag</u> .
Sample	A group of units, or portion of material, taken from a larger collection of units or quantity of material, which serves to provide information that can be used as a basis for action on the larger quantity or on the production process; the term is also used in the sense of a sample of observations.
Sampling, Continuous	Sampling without interruptions throughout an operation or for a predetermined time.
Sampling, Intermittent	Sampling successively for limited periods of time throughout an operation or for a predetermined period of time. The duration of sample periods and of the intervals between are not necessarily regular and are not specified.
Sand Grout	Grout mixture containing water, portland cement, and sand.
Sand Streak	A streak of exposed fine aggregate in the surface of formed concrete caused by bleeding.
Sand-Aggregate Ratio	The ratio of sand to coarse aggregate by weight or volume.
Sand-coarse Aggregate Ratio	Ratio of fine to coarse aggregate in a batch of concrete, by weight or volume.
Sand	The fine granular material (usually less than 3/16 inch in diameter) resulting from the natural disintegration of rock, or from the crushing of friable sandstone.
Saturated Surface-dry (SSD) Particle Density	The mass of the saturated-surface-dry aggregate divided by its displaced volume in water or in concrete. (Also called <i>Bulk Specific Gravity</i>).

Saturated Surface-Dry	Condition of an aggregate particle or other porous solid when the permeable voids are filled with water but there is no water on the exposed surface.
Saturation	1) In general, the condition of the coexistence in stable equilibrium of either a vapor and a liquid or a vapor and solid phase of the same substance at the same temperature. 2) As applied to aggregate or concrete, the condition such that no more liquid can be held or placed within it.
Saw Blade, Abrasive	A concrete sawing medium that uses non-diamond abrasion elements. These blades do not need water to cool, but water is sometimes used.
Saw Blade, Diamond	A concrete sawing medium that uses industrial diamonds as the primary abrasion element. These blades are normally water cooled to protect the host metal from melting and prematurely dislodging the diamonds.
Saw Cut	A cut in hardened concrete utilizing diamond or silicone-carbide blades or discs.
Sawed Joint	A joint cut in hardened concrete, generally not to the full depth of the member, by means of special equipment.
Sawing	Cutting of joints in hardened concrete by means of special equipment utilizing diamond or silicon carbide blades or discs; cut goes only part way through the slab.
Scaling	Flaking or peeling away of the near-surface portion of hydraulic cement concrete or mortar.
Schmidt Hammer (trade name), Swiss Hammer, or Rebound Hammer	A device used to estimate the compressive strength of hardened concrete by measuring surface hardness.
Screed Guide	Firmly established grade strips or side forms for unformed concrete that will guide the strikeoff in producing the desired plane or shape.
Screed	1) To strike off concrete lying above the desired plane or shape. 2) A tool for striking off the concrete surface, sometimes referred to as a <u>Strikeoff</u> .
Screeding	The operation of forming a surface by the use of screed guides and a strikeoff. See also <u>Strikeoff</u> .
Screen (or sieve)	A plate or sheet of woven cloth or other device, with regularly spaced apertures of uniform size, mounted in a suitable frame or holder for use in separating material according to size.
Sealant	See <u>Joint Sealant</u> and <u>Membrane Curing</u>
Sealing Compound	See <u>Joint Sealant</u> and <u>Membrane Curing</u>
Sealing	The process of filling the sawed joint with material to prohibit intrusion into the joint of water and incompressible materials.
Secondary Sawing	The sawing that takes place to establish shape in the joint. Many times this shape is the reservoir of the joint.
Segregation	The tendency, as concrete is caused to flow laterally, for coarse aggregate and drier material to remain behind and for mortar and wetter material to flow ahead. This also occurs in a vertical direction when wet concrete is over-vibrated, the mortar and wetter material rising to the top. In the vertical direction, segregation may also be called <u>Stratification</u> .

Semiautomatic Batcher	A batcher equipped with gates or valves that are separately opened manually to allow the material to be weighed but which are closed automatically when the designated weight of each material has been reached.
Separation	The tendency, as concrete is caused to pass from the unconfined ends of chutes or conveyor belts, for coarse aggregate to separate from the concrete and accumulate at one side; the tendency, as processed aggregate leaves the ends of conveyor belts, chutes, or similar devices with confining sides, for the larger aggregate to separate from the mass and accumulate at one side; the tendency for solids to separate from the water by gravitational settlement. See also <u>Bleeding</u> and <u>Segregation</u> .
Set-accelerating Admixture	See <u>Accelerator</u>
Set-retarding Admixture	See <u>Retarder</u>
Set	The condition reached by a cement paste, mortar, or concrete when it has lost plasticity to an arbitrary degree, usually measured in terms of resistance to penetration or deformation. <u>Initial set</u> refers to first stiffening. <u>Final set</u> refers to attainment of significant rigidity.
Setting of Cement	Development of rigidity of cement paste, mortar, or concrete as a result of hydration of the cement. The paste formed when cement is mixed with water remains plastic for a short time. During this stage it is still possible to disturb the material and remix without injury, but as the reaction between the cement and water continues, the mass loses its plasticity. This early period in the hardening is called the "setting period," although there is not a well-defined break in the hardening process.
Setting Time	The time required for a specimen of concrete, mortar or cement paste, prepared and tested under standardized conditions, to attain a specified degree of rigidity.
Settlement Shrinkage	A reduction in volume of concrete prior to the final set of cementitious mixtures, caused by settling of the solids and by the decrease in volume due to the chemical combination of water with cement. See <u>Plastic Shrinkage</u> .
Settlement	Sinking of solid particles in grout, mortar, or fresh concrete, after placement and before initial set. See also <u>Bleeding</u> .
Shrink-mixed Concrete	Ready-mixed concrete mixed partially in a stationary mixer and then mixed in a truck mixer.
Shrinkage Crack, Plastic	Crack resulting from rapid evaporation of moisture and resulting volume change near the surface of a concrete pavement slab; usually appear as short, parallel cracks that only extend down partially through the slab thickness.
Shrinkage Crack	Crack from restraint of shrinkage due to volume or temperature reduction.
Shrinkage Cracking	Cracking of a structure or member due to failure in tension caused by external or internal restraints as reduction in moisture content develops, or as carbonation occurs, or both.
Shrinkage	Decrease in length or volume.
Sieve Analysis	The classification of particles, particularly of aggregates, according to sizes as determined with a series of sieves of different openings.

Silicone Sealant	Liquid joint sealant consisting of silicone-based material.
Silicone	A resin, characterized by water-repellent properties, in which the main polymer chain consists of alternating silicon and oxygen atoms, with carbon-containing side groups; silicones may be used in joint sealing compounds, caulking or coating compounds, or admixtures for concrete.
Skid Resistance	A measure of the frictional characteristics of a surface.
Slab Jacking	Process of injecting grout materials beneath concrete slabs in order to lift or elevate the slabs.
Slab Stabilization	Process of injecting grout materials beneath concrete slabs in order to fill voids without raising the concrete slabs.
Slip Form Paving	A type of concrete paving process that involves extruding the concrete through a machine to provide a uniform dimension of concrete paving.
Slipform	A form that is pulled or raised as concrete is placed; may move in a generally horizontal direction to lay concrete evenly for highway paving or on slopes and inverts of canals, tunnels, and siphons; or vertically to form walls, bins, or silos.
Slump Cone	A mold in the form of the lateral surface of the frustum of a cone with a base diameter of 8 in (203 mm), top diameter 4 in (102 mm), and height 12 in (305 mm), used to fabricate a specimen of freshly mixed concrete for the slump test.
Slump Loss	The amount by which the slump of freshly mixed concrete changes during a period of time after an initial slump test was made on a sample or samples thereof.
Slump Test	The procedure for measuring slump.
Slump	A measure of consistency of freshly mixed concrete, mortar, or stucco equal to the subsidence measured to the nearest 6 mm of the molded specimen immediately after removal of the slump cone.
Slurry	Mixture of water and concrete particles resulting from concrete sawing or grinding.
Solid Volume	See <u>Absolute Volume</u>
Sounding	Process of tapping concrete slab surface with metal object, listening for tone from the impact, to determine areas of delamination.
Soundness	In the case of a cement, freedom from large expansion after setting. In the case of aggregate, the ability to withstand aggressive conditions to which concrete containing it might be exposed, particularly those due to weather.
Spalling, Compression	Cracking, breaking, chipping, or fraying of slab edges within 0.6 meter of a transverse joint.
Spalling, Sliver	Chipping of concrete edge along a joint sealant; usually within 12 millimeters of the joint edge.
Spalling, Surface	Cracking, breaking, chipping, or fraying of slab surface; usually within a confined area less than 0.5 square meters.
Specific Gravity Factor	The ratio of the weight of aggregates (including all moisture), as introduced into the mixer, to the effective volume displaced by the aggregates.
Specific Gravity	The ratio of the weight in air of a given volume of material at a stated temperature to the weight in air of an equal volume of distilled water at the same temperature.

Split Batch Charging	Method of charging a mixer in which the solid ingredients do not all enter the mixer together; cement, and sometimes different sizes of aggregate, may be added separately.
Spud Vibrator	A vibrator used for consolidating concrete, having a vibrating casing or head, that is used by insertion into freshly placed concrete.
Standard Deviation	The root mean square deviation of individual values from their average.
Static Load	The weight of a single stationary body or the combined weights of all stationary bodies in a structure (such as the load of a stationary vehicle on a roadway); during construction, the combined weight of forms, stringers, joists, reinforcing bars, and the actual concrete to be placed. See also <u>Dead Load</u> .
Stationary Hopper	A container used to receive and temporarily store freshly mixed concrete.
Storage Hopper	See <u>Stationary Hopper</u>
Stratification	The separation of over-wet or over-vibrated concrete into horizontal layers with increasingly lighter material toward the top; water, laitance, mortar, and coarse aggregate will tend to occupy successively lower positions (in that order).
Strength	A generic term for the ability of a material to resist strain or rupture induced by external forces. See also <u>Compressive Strength, Fatigue Strength, Flexural Strength, Shear Strength, Splitting Tensile Strength, Tensile Strength, Ultimate Strength, and Yield Strength</u> .
Stress	Intensity of internal force (i.e., force per unit area) exerted by either of two adjacent parts of a body on the other across an imagined plane of separation; when the forces are parallel to the plane, the stress is called <i>shear stress</i> ; when the forces are normal to the plane the stress is called <i>normal stress</i> ; when the normal stress is directed toward the part on which it acts it is called <i>compressive stress</i> ; when it is directed away from the part on which it acts it is called <i>tensile stress</i> .
Strikeoff	To remove concrete in excess of that required to fill the form evenly or bring the surface to grade; performed with a straightedged piece of wood or metal by means of a forward sawing movement or by a power operated tool appropriate for this purpose; also the name applied to the tool. See also <u>Screed</u> and <u>Screeding</u> .
Subbase	A layer in a pavement system between the subgrade and base course or between the subgrade and a portland cement concrete pavement.
Subgrade	The soil prepared and compacted to support a structure or a pavement system.
Sulfate Attack	Chemical or physical reaction between certain constituents in cement and sulfates in the soil or ground water; sufficient attack may disrupt concrete that is susceptible to it.
Sulfate Resistance	The ability of aggregate, cement paste, or mixtures thereof to withstand chemical attack by sulfate ion in solution.
Superplasticizer	See <u>Water-Reducing Admixture (high range)</u>
Surface Moisture	Water retained on surfaces of aggregates capable of mixing with portland cement in concrete; distinguished from absorbed moisture, which is contained inside the aggregate particles.

Surface Retarder	A retarder used by application to a form or to the surface of newly placed concrete to delay setting of the cement to facilitate construction joint cleanup or to facilitate production of exposed, aggregate finish.
Surface Tension	That property, due to molecular forces, that exists in the surface film of all liquids and tends to prevent the liquid from spreading.
Surface Texture	Degree of roughness or irregularity of the exterior surfaces of aggregate particles or hardened concrete.
Surface Vibrator	A vibrator used for consolidating concrete by application to the top surface of a mass of freshly mixed concrete; four principal types exist: vibrating screeds, pan vibrators, plate or grid vibratory tampers, and vibratory roller screeds.
Surface Voids	Cavities visible on the surface of a solid. See also <u>Bug Holes</u> .
Surface Water	See <u>Surface Moisture</u>
Swelling	Increase in length or volume. See also <u>Autogenous Volume Change</u> , <u>Contraction</u> , <u>Expansion</u> , and <u>Volume Change</u> .
Tamper	1) An implement used to consolidate concrete or mortar in molds or forms. 2) A hand-operated device for compacting floor topping or other unformed concrete by impact from the dropped device in preparation for strikeoff and finishing; contact surface often consists of a screen or a grid of bars to force coarse aggregates below the surface to prevent interference with floating or trowelling. See also <u>Jitterbug</u> .
Tamping	The operation of compacting freshly placed concrete by repeated blows or penetrations with a tamping device.
Temperature Rise	The increase of temperature caused by absorption of heat or internal generation of heat, as by hydration of cement in concrete.
Tempering	The addition of water and mixing of concrete or mortar as necessary to bring it initially to the desired consistency. See also <u>Retempering</u> .
Tensile Strength	Maximum stress that a material is capable of resisting under axial tensile loading based on the cross-sectional area of the specimen before loading.
Texture	The texture or configuration apparent in an exposed surface, as in concrete and mortar, including roughness, streaking, striation, or departure from flatness.
Texturing	The process of producing a special texture on either unhardened or hardened concrete.
Thermal Expansion	Expansion caused by increase in temperature.
Thermal Movement	Change of dimension of concrete or masonry resulting from change of temperatures. See also <u>Contraction</u> and <u>Expansion</u> .
Thermal Shock	The subjection of newly hardened concrete to a rapid change in temperature which may be expected to have a potentially deleterious effect.
Tie Bar	Bar at right angles to and tied to reinforcement to keep it in place; bar extending across a construction joint.
Tilting Concrete Mixer	See <u>Mixer, Tilting</u>
Time of Haul	In production of ready-mixed concrete, the period from first contact between mixing water and cement until completion of discharge of the freshly mixed concrete.

Time of Set	Time required after addition of water to cement for cement paste, mortar, or concrete to attain a certain arbitrary degree of hardness or strength.
Time of Setting	See <u>Initial Setting Time</u> and <u>Final Setting Time</u> .
TMMB	Truck Mixer Manufacturers' Bureau; most truck mixers carry TMMB rating plates.
Tongue and Groove	A joint in which a protruding rib on the edge of one side fits into a groove in the edge of the other side, abbreviated "T & G." See also <u>Keyway</u> .
Topping	1) A layer of high quality concrete placed to form a floor surface on a concrete base, or 2) a dry-shake application of a special material to produce particular surface characteristics.
Transit-mixed Concrete	Concrete, the mixing of which is wholly or principally accomplished in a truck mixer. (Same as truck mixed concrete.)
Transverse Cracks	Cracks that develop at right angles to the long direction of the member.
Transverse Joint	A joint normal to the longitudinal dimension of a structure.
Transverse Reinforcement	See <u>Reinforcement, Transverse</u>
TRB	Transportation Research Board
Trial Batch	A batch of concrete used for establishing or checking proportions.
Trowel	A flat, broad-bladed steel hand tool used in the final stages of finishing operations to impart a relatively smooth surface to concrete floors and other unformed concrete surfaces; also, a flat triangular-bladed tool used for applying mortar to masonry.
Truck Mixer	A concrete mixer suitable for mounting on a truck chassis and capable of mixing concrete in transit. See also <u>Horizontal-Axis Mixer</u> , <u>Inclined-Axis Mixer</u> , and <u>Agitator</u> .
Under-Sanded	A concrete mixture that is deficient in sand content; a condition associated with poor workability or finishing characteristics.
Unit Water Content	The quantity of water per unit volume of freshly mixed concrete, often expressed as pounds or gallons per cubic yard. It is the quantity of water on which the water-cement ratio is based and does not include water absorbed by the aggregate.
Unit Weight	See <u>Bulk Density</u> and <u>Specific Gravity</u>
Unreinforced Concrete	See <u>Plain Concrete</u>
Unsound Aggregate	An aggregate or individual particles of an aggregate capable of causing or contributing to deterioration or disintegration of concrete under anticipated conditions of service.
Uplift Beam	Beam-like movement detection device used to monitor slab lift during slab stabilization.
Vibrated Concrete	Concrete compacted by vibration during and after placing.
Vibration Limit	That time at which fresh concrete has hardened sufficiently to prevent its becoming mobile when subject to vibration.
Vibration, External	External vibration employs vibrating devices attached at strategic positions on the forms and is particularly applicable to manufacture of precast items and for vibration of tunnel-lining forms; in manufacture of concrete products, external vibration or impact may be applied to a casting table.

Vibration, Internal	Internal vibration employs one or more vibrating elements that can be inserted into the concrete at selected locations, and is more generally applicable to in-place construction.
Vibration, Surface	Surface vibration employs a portable horizontal platform on which a vibrating element is mounted.
Vibration	Energetic agitation of concrete produced by a mechanical oscillating device at moderately high frequency to assist consolidation and compaction.
Vibrator	An oscillating machine used to agitate fresh concrete so as to eliminate gross voids, including entrapped air but no entrained air, and produce intimate contact with form surfaces and embedded materials.
Vibratory Plate Compactor	Motorized, one-man tool consisting of a vibrating square plate that transmits energy to compact granular materials.
Volume Batching	The measuring of the constituent materials for mortar or concrete by volume.
Volume Change	An increase or decrease in volume.
Wash (or Flush) Water	Water carried on a truck mixer in a special tank for flushing the interior of the mixer after discharge of the concrete.
Water-Cement Ratio	The ratio of the amount of water, exclusive only of that absorbed by the aggregates, to the amount of cement (or cementitious materials) in a concrete or mortar mixture; preferably stated as a decimal by weight.
Water-Gain	See <u>Bleeding</u>
Water-Reducing Admixture (high range)	A water-reducing admixture capable of producing large water reduction or great flowability without causing undue set retardation or entrainment of air in mortar or concrete.
Water-Reducing Admixture	A material that either increases slump of freshly mixed mortar or concrete without increasing water content or maintains a workability with a reduced amount of water, the effect being due to factors other than air entrainment; also known as water reducer.
Water-Reducing Agent	A material that either increases workability of freshly mixed concrete without increasing water content or maintains slump with a reduced amount of water.
Weathering	Changes in color, texture, strength, chemical composition or other properties of a natural or artificial material due to the action of the weather.
Weight Batching	Measuring the constituent materials for mortar or concrete by weight.
Welded-Wire Fabric Reinforcement	Welded-wire fabric in either sheets or rolls, used to reinforce concrete.
Well-Graded Aggregate	Aggregate having a particle size distribution which will produce maximum density; i.e., minimum void space.
Wet Process	In the manufacture of cement, the process in which the raw materials are ground, blended, mixed, and pumped while mixed with water; the wet process is chosen where raw materials are extremely wet and sticky, which would make drying before crushing and grinding difficult.
Wet	Covered with visible free moisture; not dry. See also <u>Damp</u> and <u>Moist</u> .

Wiggle Bolt	Two-piece threaded bolt system used for tying lanes of concrete pavement; usually consists of a female section that is cast into a vertical slab face, and an angled male end which screws into the female coupler.
Wire Mesh	See <u>Welded Wire Fabric</u>
Workability	That property of freshly mixed concrete or mortar which determines the ease and homogeneity with which it can be mixed, placed, compacted, and finished.
Working Crack	A crack in a concrete pavement slab that undergoes significant deflection and thermal opening and closing movements; Typically oriented transverse to the pavement centerline and near a non-functioning transverse contraction joint.
Yield	The volume of fresh concrete produced from a known quantity of ingredients; the total weight of ingredients divided by the unit weight of the freshly mixed concrete.
Zero-Slump Concrete	Concrete of stiff or extremely dry consistency showing no measurable slump after removal of the slump cone. See also <u>Slump</u> and <u>No-Slump Concrete</u> .

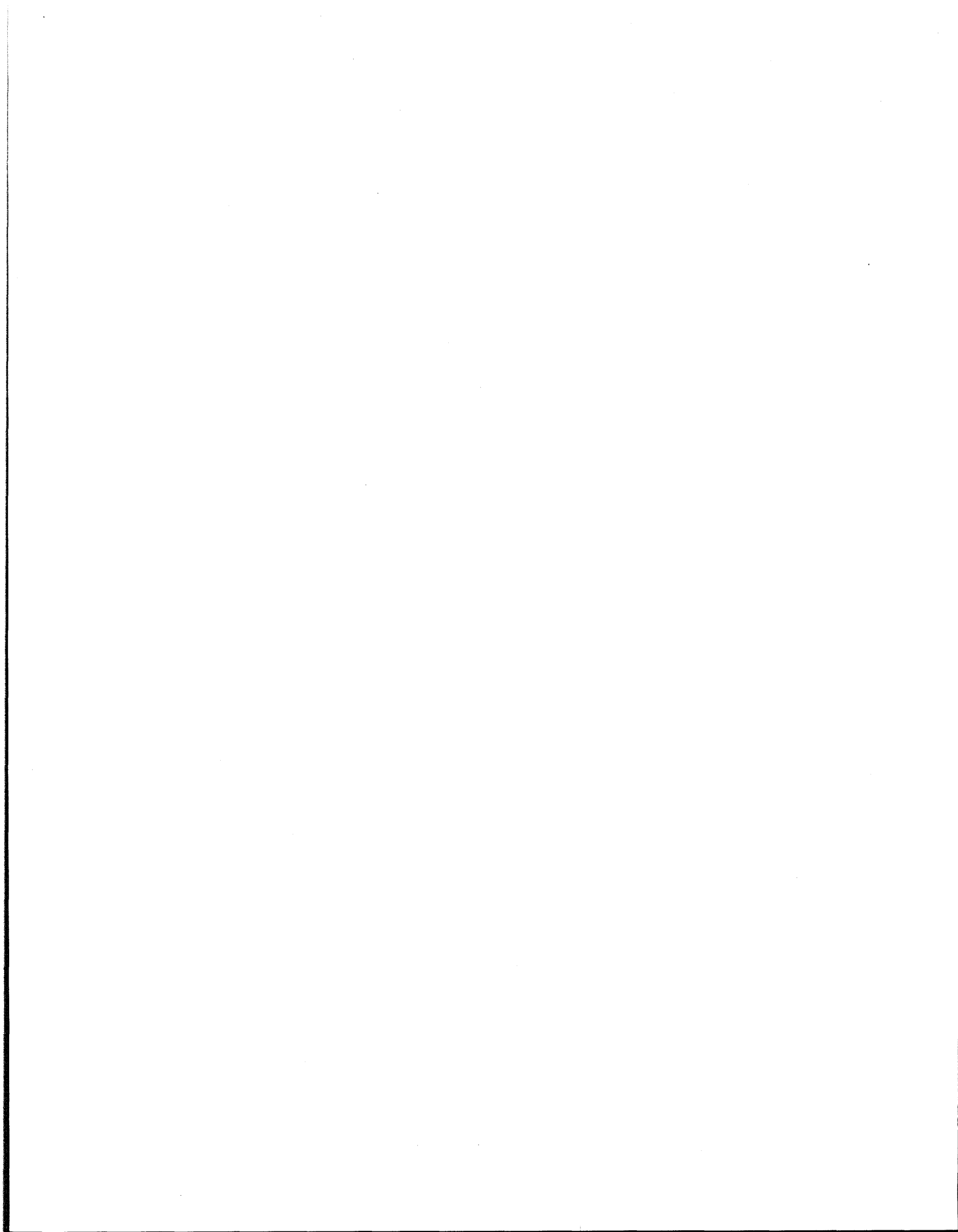

A. Appendix

Appendix

GENERAL

This appendix contains material that will be inserted into the Participants Manual as the course progresses. The following pages contain summaries for the class exercises. There is no grading for the course. I encourage all course participants to only reference the appendix when asked to do so by the instructor. Remember, we are all here to learn.

Plant Operations

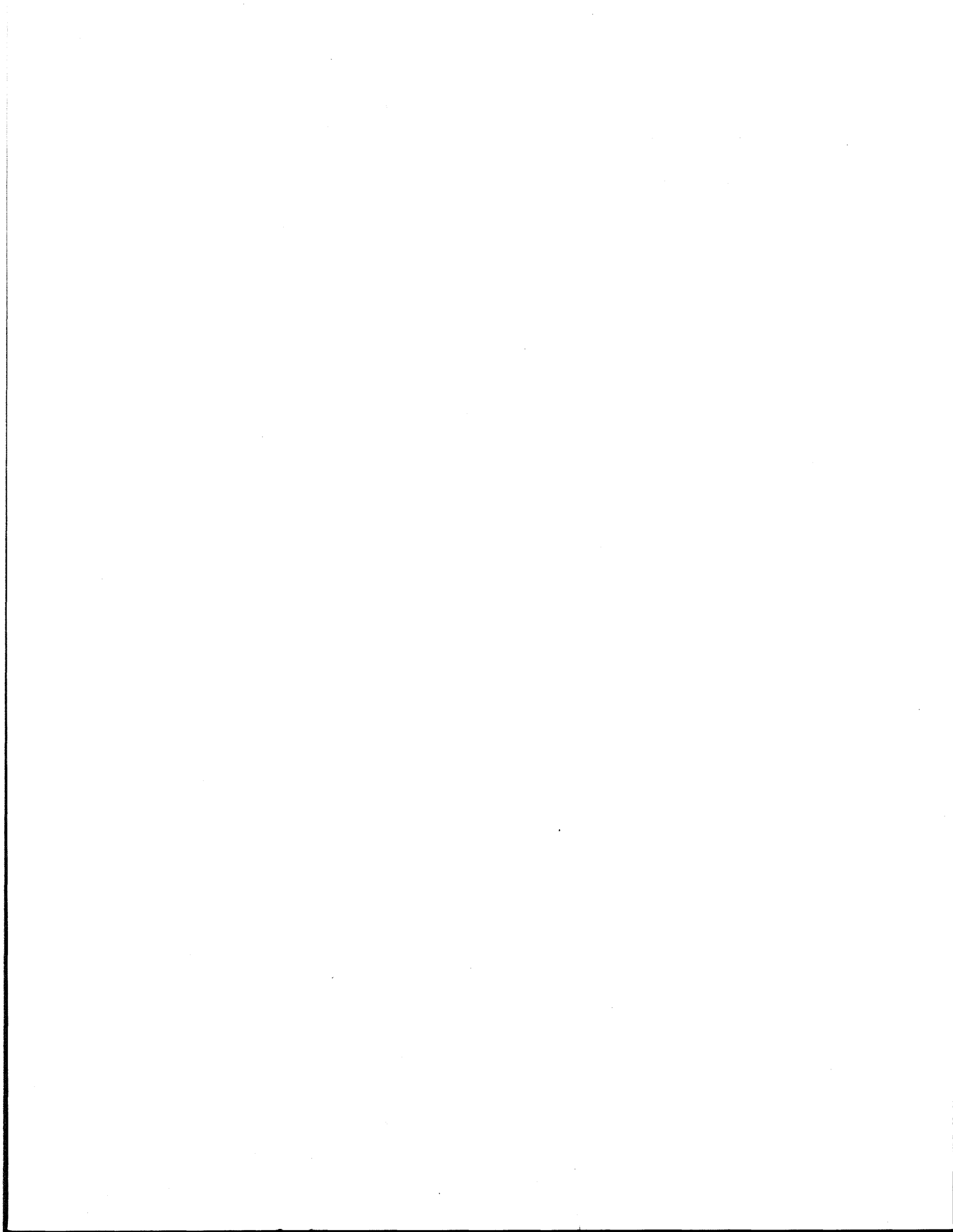

Truck Mixed Field OOPS!

Field OOPS! - "Wishy Washy"

The Situation:

When discharging the concrete from the truck mixer, the beginning of the load has a slump that is too high and towards the end of the load, the slump is too low.

The First Reaction:

Mix longer
Add water to get out of mixer

The Action:

Examine mechanics of truck mixer such as blade wear and rotation counter.
Examine sequencing diagram.

The Prevention:

Monitor materials and moisture contents of aggregates. Follow the sequencing diagram.

Truck Mixed Field OOPS!

Field OOPS! - "Confused Concrete"

The Situation:

It seems that every truck arrives at the paving site with a different slump. The first truck is too wet and the next load is too dry.

The First Reaction:

Check to see if the driver added water in transit or at the yard.

The Action:

Call plant to check on free moisture in aggregate.

Check calibration on moisture probes.

Check stockpiles. Is the material loader working the aggregate piles in a consistent manner?

Check drivers process of wash off and wash down.

Check plant scales.

The Prevention:

At the CAP meeting, discuss the key contact people at the plant and the paving site. These people must be able to contact each other quickly to resolve problems of inconsistency.

Truck Mixed Field OOPS!

Field OOPS! - "Goodness Gracious"

The Situation:

As the concrete is being unloaded from the truck mixer, the dump person notices lumps of dry material. These lumps turn out to be either cementitious balls and/or clay balls.

The First Reaction:

Throw out of mix. If excessive, do not use the load of concrete.

The Action:

Cementitious Balls

Check sequencing.

Check paddle and blade wear...

If fibers are being used, check how fibers are being added and dispersed in the concrete.

Clay Balls:

Check the stock piles.

Check loader operator procedures.

Look for contamination.

The Prevention:

Determine what the proper material handling procedures will be upfront and follow them.
Monitor and adjust the sequencing as necessary to minimize the occurrence of cementitious balls.

Truck Mixed Field OOPS!

Field OOPS! - "Stick In The Mud"

The Situation:

The truck mixer truck arrives on the job site and the mix is so stiff that you can not get the concrete out of the mixer.

The First Reaction:

Make sure that the discharge fins are clean.

The Action:

Check the batch weights versus the job mix formula.
Take truck out of rotation for further inspection.
Add water to get concrete out of drum.

The Prevention:

Pay close attention to materials.
Monitor charging sequence.

Central Mixed Concrete - CAP

Instructions:

Develop a checklist to be used at the "CAP" meeting for the topic assigned to your group. Remember that the "CAP" meeting is held before the project begins.

Your "CAP" meeting topic is Plant Site Selection

Land Owner

Utility Locations

Permits and Zoning

Plant Access

Type of Ground

Haul Road

Water Access Central to Project Location

Size of Site

Proximity to Residential

Traffic Flow

Storm Water Runoff

Central Mixed Plant Operations - CAP

Instructions:

Develop a checklist to be used at the "CAP" meeting for the topic assigned to your group. Remember that the "CAP" meeting is held before the project begins.

Your "CAP" meeting topic is **Plant Site Preparation and Layout**

Safety

Traffic Flow

Access to Highway

Stockpile Location and Design

Material Handling Process

Drainage

Stockpile Platform

Permits

Open Communications

Zoning

Utilities

Safety

Portable communication, Radios

Testing Lab Numbers

Emergency Numbers

Bulletin Board Information

Haul Road Location

Production Plan

Qualified Personnel

Community Concerns

Safety

Central Mixed Concrete - CAP

Instructions:

Develop a checklist to be used at the "CAP" meeting for the topic assigned to your group. Remember that the "CAP" meeting is held before the project begins.

Your "CAP" meeting topic is **Plant Mobilization/Assembly/Calibration**.

Safety issues.

Plant delivery and assembly schedule

Coordination with Material Delivery

Zoning Requirements

Equipment inspection.

Calibration: Who will calibrate?

Scales

Water meters

Admixture dispensers

Local tolerances

Computers

Automatic controls

When will material be run through the plant to test the systems?

Utility Locations (Above & Below Ground)

Abutting residences

Preparation of the Site

Plant Operations and Inspection

Central Mixed Concrete - CAP

Instructions:

Develop a checklist to be used at the "CAP" meeting for the topic assigned to your group. Remember that the "CAP" meeting is held before the project begins.

Your "CAP" meeting topic is Material Management - Aggregates.

Stockpiling

Good Base

Stockpile Construction

Adequate space

Construction of Stockpile

Charging Storage Bins

What type of separation layer will be used under the aggregate stockpiles?

Has material delivery been correlated to expected concrete production?

What is the total amount of aggregate to be used on the project?

Has the proper amount of equipment assigned to handle the incoming material & feed the central mixed concrete plant?

What precautions are being taken to keep the materials separate?

Source

Moisture Content at Delivery

Person Certified for Testing

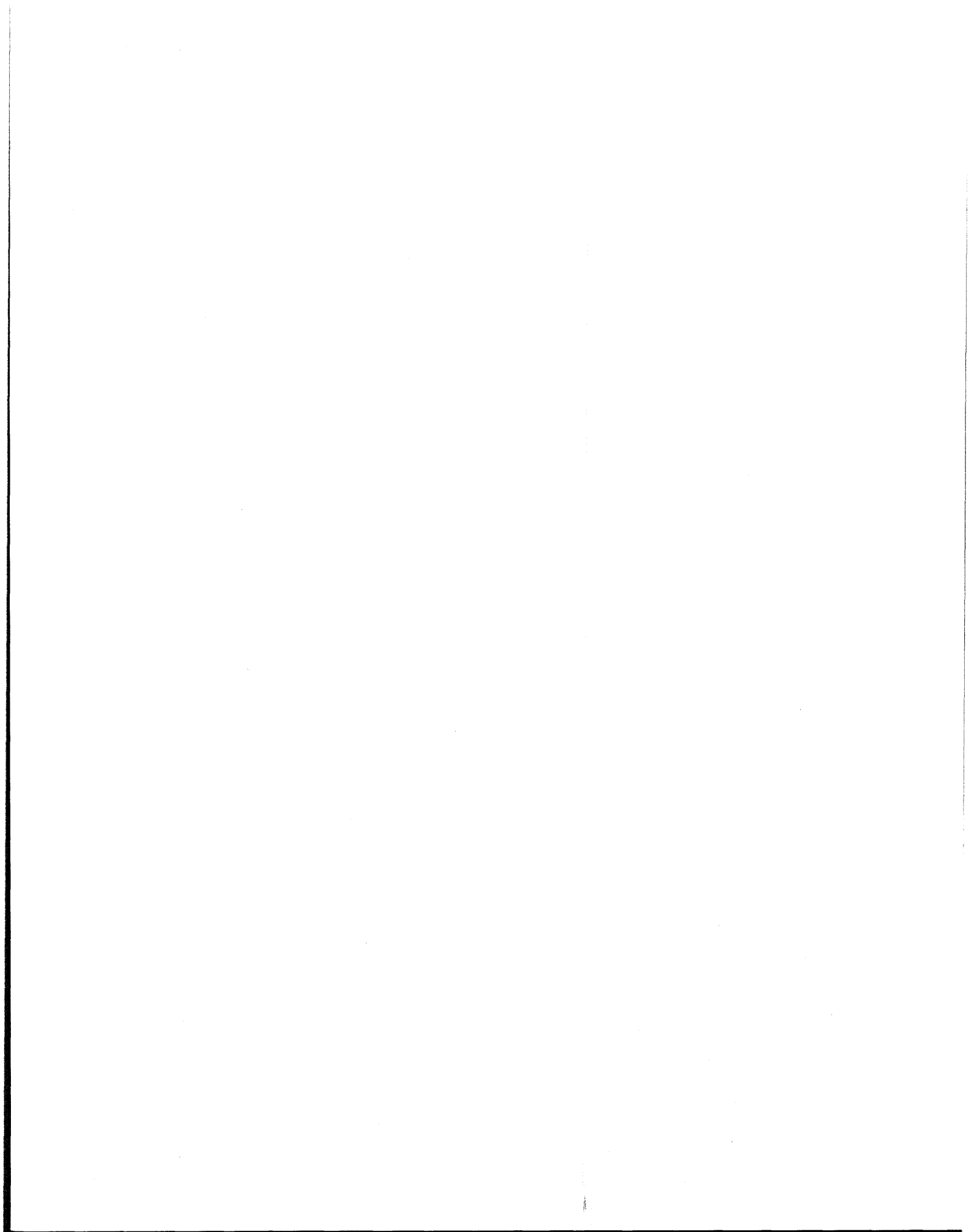

Paving Operations

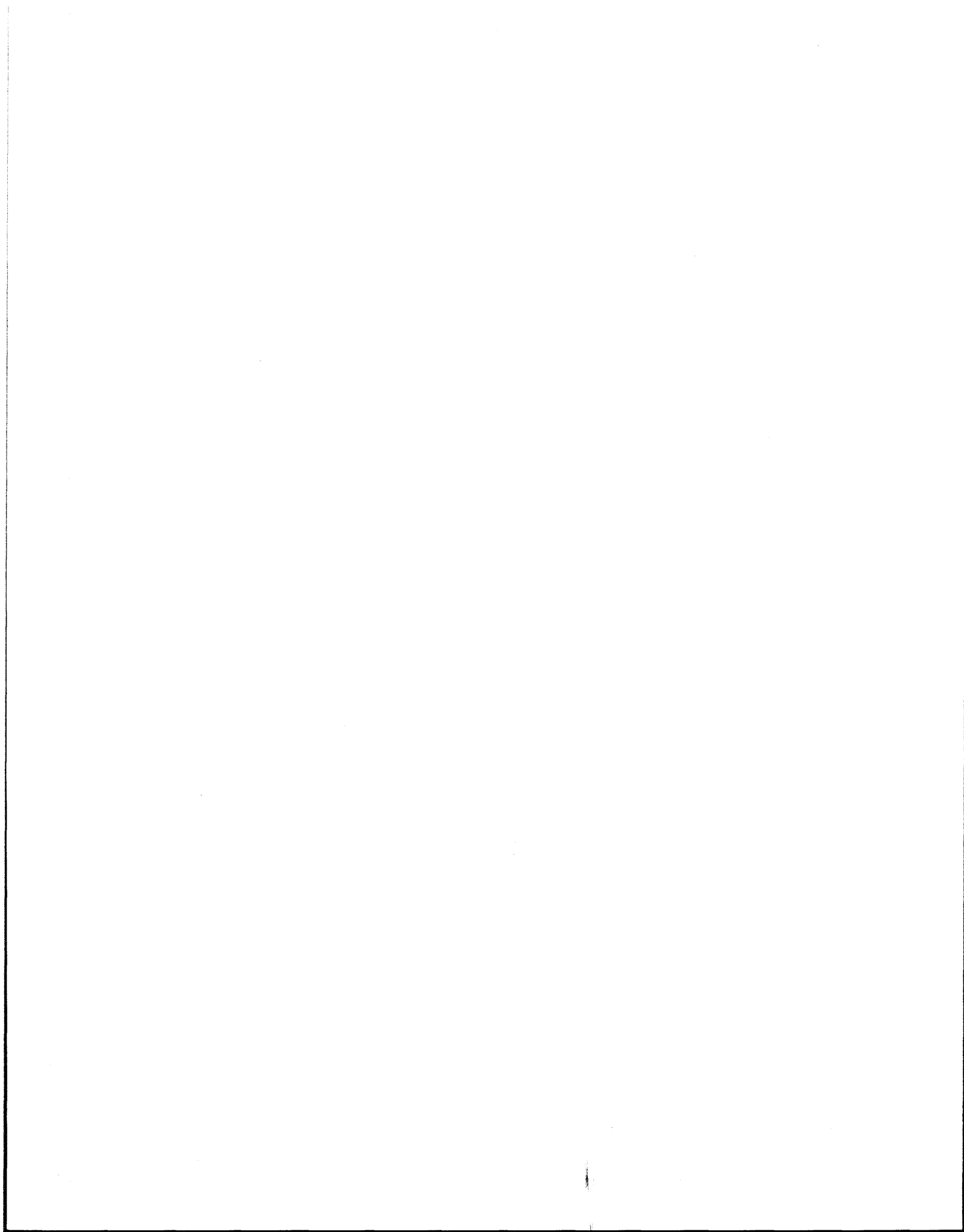

Saw & Seal Operations

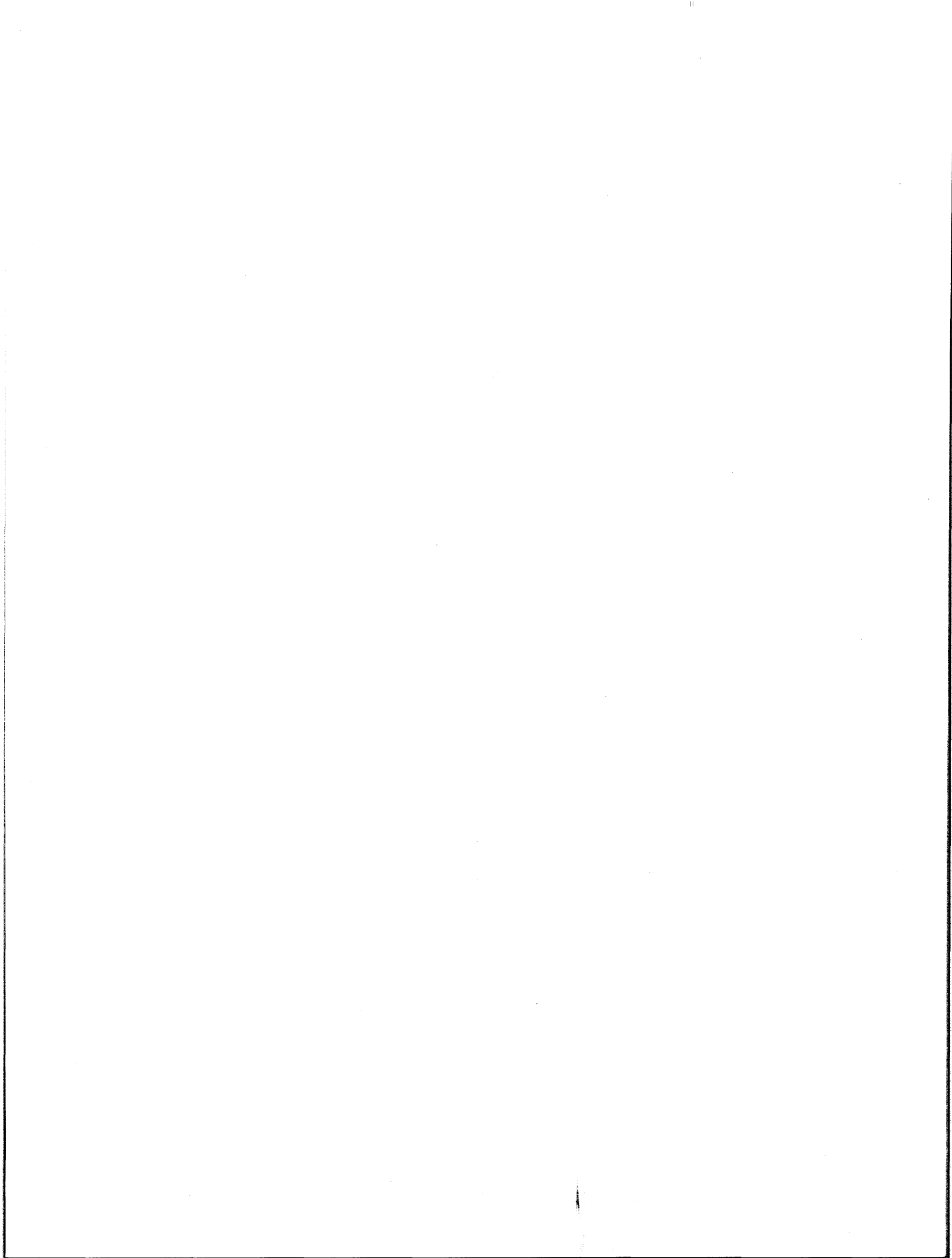

Saw and Seal Field OOPS!

Field OOPS! - "ZIG ZAG"

The Situation:

Sawing of centerline joint is in process. Notice that saw is off line.

The First Reaction:

Stop sawing and evaluate situation.

The Action:

Check all reasons why the saw could be off centerline.

- inattention of operator?
- check edge ahead and behind saw - is the edge straight on slab?
- check condition of edge guide - has it changed or malfunctioned?
- saw blade core has lost tension?
- other equipment or operation problems?
- has centerline been properly marked if hand marked?

Back-up to where saw was on centerline

Reset saw straight and start sawing again.

Check to make sure that saw is on intended line.

Epoxy the saw cut made at the wrong location.

The Prevention:

Review operations frequently.

Check ahead on edge of slab for inconsistency.

Check and double check header areas. If using an edge guide, then the header areas may need hand marked and sawed without an edge guide.

Operators must be attentive to duties and equipment.

If operations feel wrong then something is probably wrong. Check and recheck operations.

Check saw equipment and edge guides at beginning and end of days run and periodically during operations. Make it a habit.

Saw and Seal Field OOPS!

Field OOPS! - "QUICKSAND (aka - THAT SINKING FEELING)"

The Situation:

Sawing is in process and everything is going normal. Suddenly saw and operator start sinking into the slab.

The First Reaction:

Stop sawing and remove saw from area. Clean wet concrete from saw.

The Action:

Scratch ahead to define limits of non-hardened concrete.

If it is not an isolated area (one or two loads), does the whole slab ahead of you need more time to cure before proceeding?

If it is an isolated area, move ahead of the area and resume sawing. Notify job site superintendent of problem.

If it is the whole slab ahead of you, wait, scratch test, then resume sawing when scratch test indicates slab has hardened sufficiently to proceed.

The Prevention:

Use scratch test ahead of sawing operations to continuously monitor slab hardness condition.

Keep in contact with paving superintendent to monitor progress of paving operations and conditions which may affect saw timing.

Scratch, scratch ahead and scratch often.

Saw and Seal Field OOPS!

Field OOPS! - "RICE KRISPIES (aka - Snap, Crackle & Pop)"

The Situation:

Sawing is in process and everything is going normal. Suddenly on the transverse joint you begin to saw or on the slab ahead of you a random transverse crack snaps and pops (can be very loud).

The First Reaction:

Move transverse sawing operation ahead three to four joints and saw. This skip sawing may need to proceed ahead until saw timing gets back in the window.

The Action:

The sawing operation has fallen out of saw cut window and is hardening at a rate which is exceeding sawing operations.

Scratch test ahead to define limits of problem area.

May need additional equipment on job to keep within saw cut window.

The Prevention:

Consider increasing equipment on job to match paving production and concrete hardening rate.

Keep informed of paving production schedules and variables which can affect hardening rate of pavement.

Scratch test to determine appropriate time to start sawing operations.

The fix of the transverse crack can be accomplished with crack saw and sealant and with a dowel bar retrofit if a dowel bar is required in transverse joints. Coordinate fix with specifying agency.

Saw and Seal Field OOPS!

Field OOPS! - "THE PITS"

The Situation:

Sawing operations are proceeding at a normal rate and the rate of sawing slows down or the saw will not cut.

The First Reaction:

Stop sawing operations and investigate.

Check saw blade to see if it is worn or damaged.

Check water on blade for proper amount.

Check for proper rpm of saw blade.

The Action:

If none of the first reaction items improve the situation, then check if there has been a change in aggregate on the job. The coarse aggregate will have the biggest impact to sawing operations.

A different saw blade and/or blade control techniques may be required for the change in aggregate.

The Prevention:

Ask questions in the CAP meeting about different aggregate sources. Will there be aggregates from different sources as the job progresses?

Communicate with the job superintendent as the project progresses for any changes in the mix delivered to the site.

Saw and Seal Field OOPS!

Field OOPS! - "MAYBERRY (aka - Off to Jail We Go)"

The Situation:

You are night time sawing in a residential area (2:00 a.m.). The saw operator is the only person on the job site. Suddenly the local police show up on the job with lights flashing. Demands you stop sawing immediately since you are violating both the local noise ordinance and working beyond time requirements of local ordinance. The local residents have called the mayor to complain. The officer does not care about your explanation of why you are sawing at this hour, and what will happen to the pavement if you stop. The officer becomes very agitated and threatens to haul you off to the police station. He may even do it if provoked.

The First Reaction:

Remain calm. Explain very courteously that it is important to continue to saw the pavement or it will random crack and the whole slab may need replacing.

Indicate you were not aware of the local ordinances and apologize for the inconvenience.

Ask for his name along with badge number.

Give him your job superintendents 24 hour telephone number and ask that the officers dispatcher give the superintendent a call or offer to call your superintendent with the officer in attendance.

Ask him if the municipality is willing to stand the expense of replacing the pavement if it is not sawed timely.

Try to convince him that you need to stay on the job until the incident can get resolved.

The Action:

Get the job superintendent involved with the public relations as quickly as possible.

Show that you are concerned about the residents.

Indicate that this will not happen again until ordinance issues are clarified or waived for the project.

The Prevention:

Find out the local ordinance requirements before a job begins. Communicate in the CAP meeting.

Saw and Seal Field OOPS!

Field OOPS! - "MAYBERRY (aka - Off to Jail We Go)" (cont.)

Do not assume that someone else has verified local ordinances.

Inform the police department yourself that night time sawing will be done on the project weeks ahead of time.

If there are ordinances on the books which restrict noise or working hours, have the requirements waived or modified for the project in writing. Keep a copy of the waiver on the job site in your vehicle.

Know the 24 hour telephone number of the job superintendent and name of the agency representative in charge of the project and how to contact them.

CPR

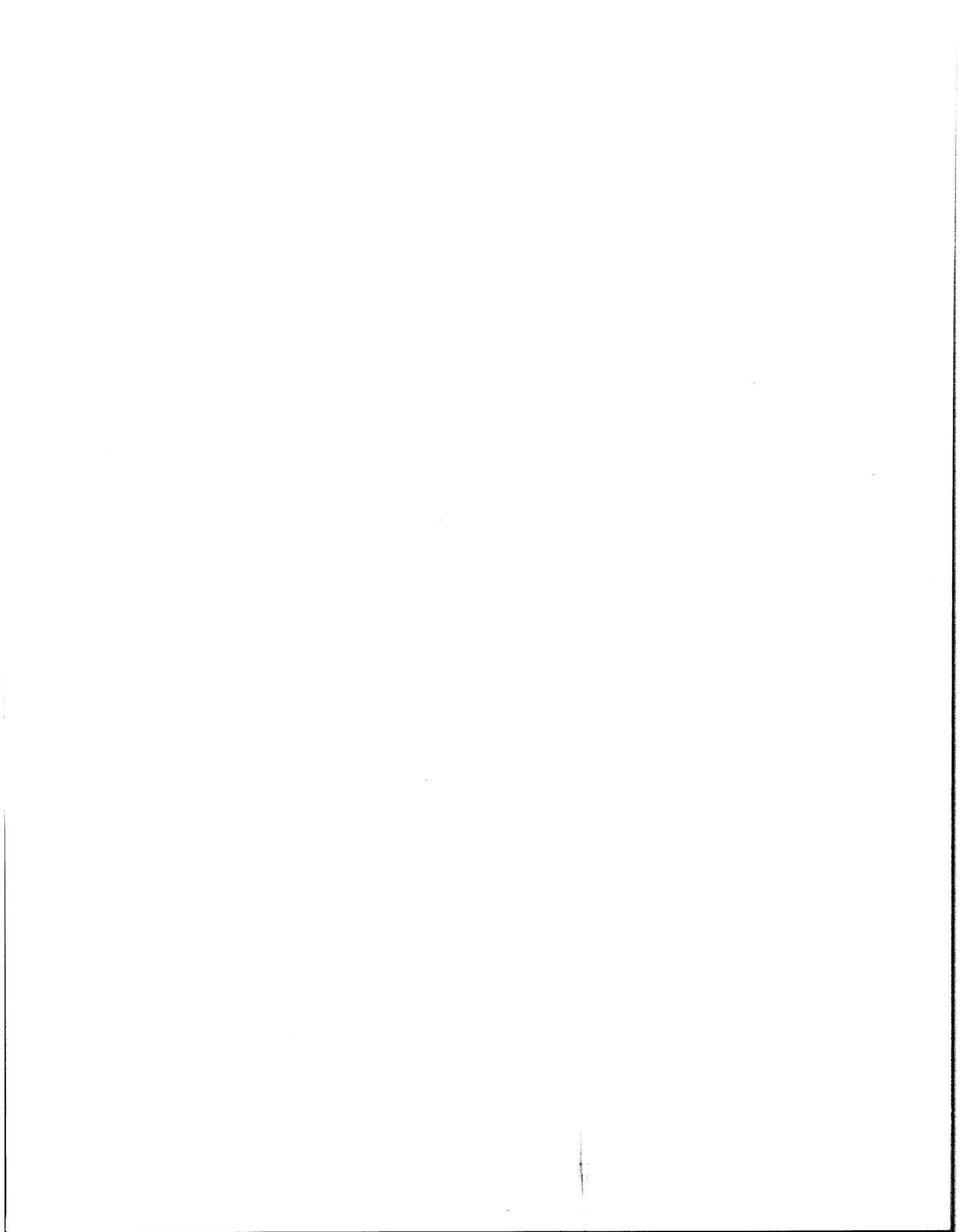

UP, UP & AWAY

The Situation:

You are pumping grout, watching the gages with no indication of movement, suddenly you feel the slab you are on and the shoulder rising.

The First Reaction:

Stop pumping.

The Action:

Check gages to be sure they are working properly.

Check for proper position of modified benkleman beam on shoulder and slab, be sure adjacent grout hole/s are not plugged, apply load on slab and shoulder to reseal position if possible.

The Prevention:

Water flush before pumping to insure access to void and adjacent hole/s. Reduce pumping rate and pressure. Double check gages and beam for proper operation and position.

THERE SHE BLOWS

The Situation:

You are pumping grout, suddenly without warning the grout ejects from the hole, spewing grout over everything and everyone.

The First Reaction:

Stop pumping and help clean grout from the inspector.

The Action:

Check packer for proper "fit" in the hole.

Reduce pumping rate and pressure.

Be sure you that grout has access to the void and adjacent hole/holes.

The Prevention:

Double check grout packer for proper fit in the hole.

Water flush to insure access to void and adjacent hole/s.

Always keep pumping rate and pressure to a manageable level for job conditions.

BOTTOMLESS PIT

The Situation:

An exceptionally high amount of grout is pumped in a hole with no indication of lift or pressure increase.

The First Reaction:

Stop pumping and check adjacent for culvert, edge drain etc.

The Action:

If a probable large cavity like a pipe, culvert or edge drain is located, don't attempt to stabilize this area.

Be sure the shoulder and both slabs are not all being lifted together so detection with benkleman beam is not possible.

The Prevention:

Pre-check areas to be stabilized for culverts, pipes, or edge drains.

Always check volume put in each hole so when one takes much more than usual you can investigate the cause before causing extreme damage.

POTATO CHIPS

The Situation:

When you are lifting out a slab for full depth repair, you damage the adjacent slab.

The First Reaction:

Stop lifting immediately to avoid more extensive damage.

The Action:

Adjust lift cables and position lifting device to assure a vertical pull.

You will have to re-saw and remove the broken section of the adjacent slab.

The Prevention:

Be sure the slab is isolated with full depth saw cuts on all four sides and that lift cables are positioned and lift device is properly oriented for a vertical pull.

A fork-lift or crane can provide a more vertical lift than a front end loader.

GOTCHA

The Situation:

You are sawing a full depth cut when suddenly you feel a snap and hear your saw belts squeal.

The First Reaction:

Shut down saw and remove saw from the blade.

The Action:

Wait for slab to cool and release blade if possible or make another full depth "angled" cut inside the area to be removed to provide a small pie shape slab adjacent to the stuck saw blade so blade is released when the pie is drilled and pulled up and toward the shoulder with the lift out device.

The Prevention:

Make the transverse cuts when pavement is cool, before the longitudinal cuts are made and use small wedges in the saw cut before completing the cut to prevent binding the blade.

LOOK OUT BELOW

The Situation:

You are lifting a slab when it disintegrates in mid air.

The First Reaction:

Holler "FORE," stop lifting and lower lifting device.

The Action:

Complete this removal with back-hoe or shovels.

The Prevention:

Angle lift pins and position cables so the fragmented pieces are bound together during lift out.

Keep lift height to absolute minimum on fragmented slabs.

HELLO DOWELLY

The Situation:

You expose a dowel bar when chipping a spalled area for a partial depth repair.

The First Reaction:

Stop chipping, this will become a full depth repair as you are either over 1/3 the slab depth or the dowels are not placed properly.

The Action:

Sound adjacent pavement and mark out for a minimum length, lane width full depth repair.

The Prevention:

Use light chipping hammer and chip no deeper than necessary to remove all un-sound concrete.

MUSCLEMAN

The Situation:

When chipping a spall you break concrete below 1/3 of the slab depth.

The First Reaction:

Stop chipping, this will become a full depth repair.

The Action:

Mark out for a full depth repair.

The Prevention:

Use a weaker worker or a smaller hammer.

Multiple saw cuts (2" apart) can expedite removal and keep chipping depth to a minimum.

SHALLOW MINE

The Situation:

You are placing the dowel in the slot and realize the slots are cut too shallow.

The First Reaction:

Do not place bar in slot, and report situation to foreman.

The Action:

Using same machine that cut the slots, align it carefully and saw slots to proper depth and remove remainder of chunk to the proper depth.

The Prevention:

Be sure slot-saw is adjusted to proper depth by checking the slot depth right behind the saw as necessary.

Make an extra pass with saw to correct for any saw "ride-out."

SPLIT THE DIFFERENCE

The Situation:

Dowel cannot be centered over joint/crack and still maintain clearance at both slot ends.

The First Reaction:

Do not place dowel in slot if a minimum of 7" can't be on both sides.

The Action:

Core drill ends of slot or remove enough radius with a chipping hammer to provide the proper clearance.

The Prevention:

Center slot saw properly and make cuts long enough to provide proper clearance (allowing for radius) or core drill ends of slot at proper dimension to allow clearance.

BOW-WOW

The Situation:

You are grinding around a curve and realize you are leaving a narrow strip of un-cut pavement ..a dog tail!

The First Reaction:

Gradually raise cutting head from the cut, back up get on line, and resume cutting.

The First Reaction:

If a narrow un-cut strip remains at cuts or set-ins, idle engine, remove down pressure and cut this strip being careful not to gouge too deep on either side or go so fast you overheat the few blades that are doing the work.

The Prevention:

Lead the machine, over steering to compensate for the curve.

Align machine frame and the pointer before setting the head in.

THE GREAT ESCAPE

The Situation:

You are grinding along when suddenly you notice that slurry is escaping all over the road.

The First Reaction:

Gradually raise head, but keep vacuum bar in contact with the road.

The Action:

Check for air leaks in hoses, separator tank or metal elbows, on suction side of vacuum system or obstruction to the proper amount of air such as plugged hoses, bent vacuum bar, adjustment of vacuum bar.

Check exhaust for proper air flow.

The Prevention:

Keep vacuum system clean and in top condition fixing everything as it happens.

When more than one problem exists it makes trouble shooting very difficult.

Check performance periodically to monitor blower wear with a vacuum gage.

OLD FAITHFUL

The Situation:

Grinding along all is well, suddenly machine begins to shake and slurry spews out the blower exhaust like old faithful.

The First Reaction:

Gradually raise head out of the cut and shut water off.

Allow slurry pump to catch up and allow vacuum to clear itself if it will.

The Action:

Check slurry discharge pipe or hose for blockage.

Check slurry pump for a stalled engine, drive pump or slipping belt.

If system will not clear itself, shut pump down, drain separator tank and clear out solids.

When system is clear..flush separator and fill with clean water until it blows through exhaust to clear out abrasive particles.

The Prevention:

Keep slurry discharge system in top conditions, repair all pin holes when pumping into slurry tank and avoid kinks or ruptures in discharge hose.

Keep discharge pump fueled or if hydraulic, keep belt tight enough to drive but loose enough to slip when pump hits a solid blockage.

The operator may detect problems by sound and shake before blow-over occurs.

PRINGLES

The Situation:

You are plowing out old joint sealant when you notice the plow is spalling the edge of the joint.

The First Reaction:

Stop plowing and determine the cause of spalling.

The Action:

Use a square "not vee shaped plow"; reduce down pressure on plow.

Adjust alignment if spalling one side only.

Try plowing the opposite direction if possible.

The Prevention:

Use square plow bit and proper size for joint width.

Use diamond saw or water blasting to remove old sealant.

ROD-GONE

The Situation:

You are sealing joint and notice backer rod has dropped out of sight.

The First Reaction:

Stop sealing and determine cause.

The Action:

Use larger backer rod on joints that are "open".

The Prevention:

Keep two or three sizes of backer rod on the job and use them as needed to have a snug fit. Don't saw sealant reservoir too deep.

Do not stretch backer rod during installation.

UNTRAINED SEAL

The Situation:

You are installing backer rod and notice there is residual sealant left on the joint walls.

The First Reaction:

Remove backer rod and clean joint again, being sure all residual sealant is removed, especially if old sealant is not compatible with new sealant.

The Action:

Clean sidewall with waterblast, sandblast, wire brush or diamond saw.

The Prevention:

Modify removal and cleaning procedure to be sure all sealant is removed with a minimal increase in joint width.



