

PAVEMENT MAINTENANCE EFFECTIVENESS PREVENTIVE MAINTENANCE TREATMENTS

Instructor's

Guide



U.S. Department
of Transportation
**Federal Highway
Administration**



Innovation Through
Partnership

NOTICE

This document is disseminated under the sponsorship of the Department of Transportation in the interest of information exchange. The United States Government assumes no liability for its contents or use thereof.

The contents of this report reflect the views of the contractor who is responsible for the accuracy of the data presented herein. The contents do not necessarily reflect the official policy of the Department of Transportation.

This report does not constitute a standard, specification, or regulation.

The United States Government does not endorse products or manufacturers. Trade or manufacturer's names appear herein only because they are considered essential to the object of this document.

PAVEMENT MAINTENANCE EFFECTIVENESS PREVENTIVE MAINTENANCE TREATMENTS

Instructor's

Guide

PREPARED FOR
U.S. DEPARTMENT OF TRANSPORTATION
FEDERAL HIGHWAY ADMINISTRATION

PREPARED BY
CENTER FOR ADVANCED
TRANSPORTATION SYSTEMS RESEARCH
ARIZONA STATE UNIVERSITY

FEBRUARY 1996

PUBLICATION No. FHWA-SA-96-028



U.S. Department
of Transportation
Federal Highway
Administration



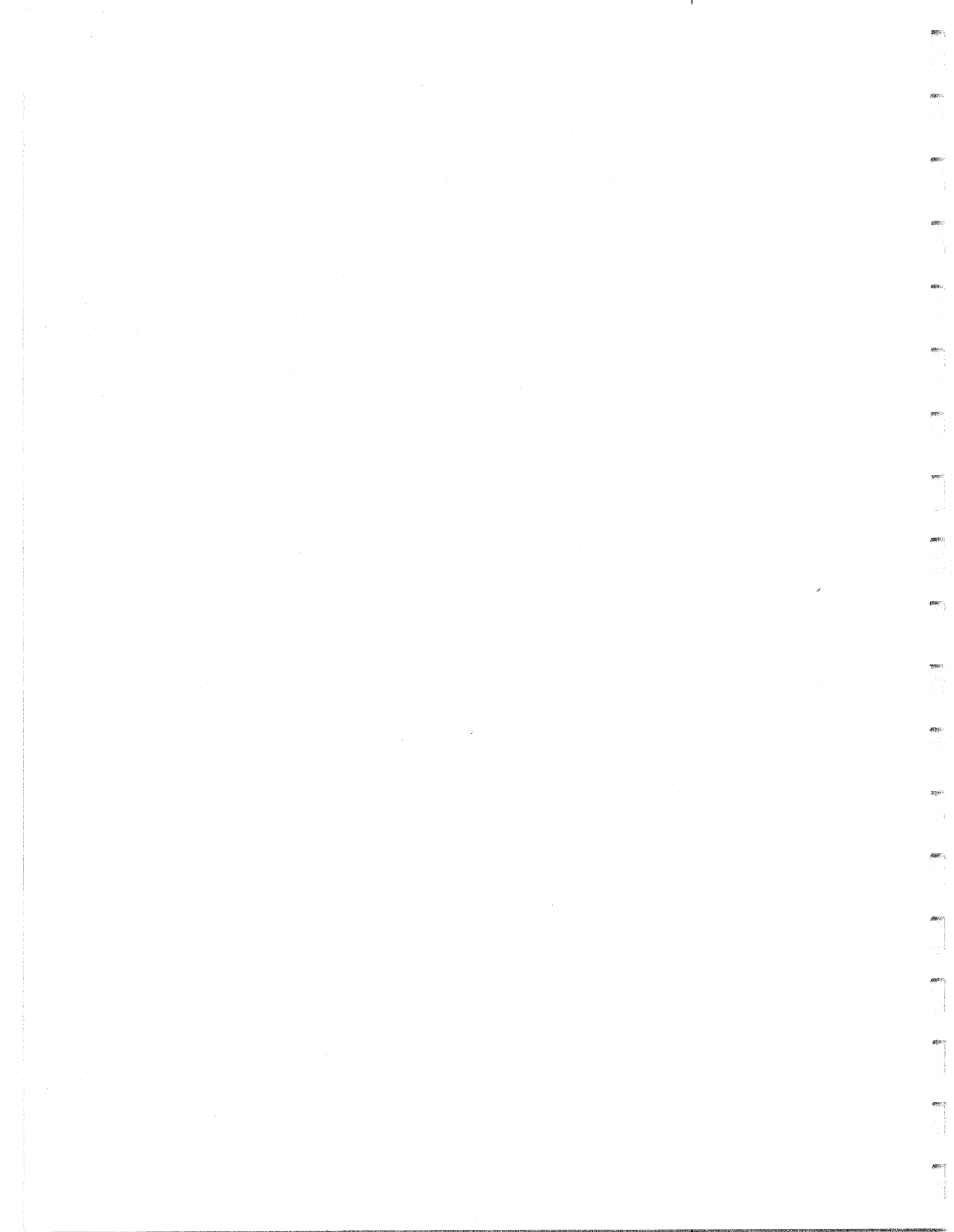

Workshop Schedule

<u>Session and Title</u>	<u>Time</u>
1. The Case for Preventive Maintenance	8:00 - 8:45
2. Engineering a Preventive Maintenance Program	8:45 - 9:30
3. Materials for Preventive Maintenance	9:30 - 10:15
Break	10:15 - 10:30
4. Fog Seals and Rejuvenators	10:30 - 10:45
5. Chip Seals	10:45 - 12:00
Lunch	12:00 - 1:00
6. Cold Thin Seals - Slurry Seals	1:00 - 1:45
7. Cold Thin Seals - Micro-Surfacing	1:45 - 2:15
Break	2:15 - 2:30
8. Thin Hot-Mix Asphalt Overlays	2:30 - 3:30
9. Crack Treatments for Flexible Pavements	3:30 - 4:00
10. Preventive Maintenance of Concrete Pavements	4:00 - 4:45
Closure and Evaluation	4:45 - 5:00

PREFACE

This Instructor Guide was developed to facilitate a slide presentation on the state of the practice for pavement preventive maintenance treatments. The Guide is based on information collected during the preventive maintenance research of the Strategic Highway Research Program. The target audience for this presentation includes state highway maintenance engineers, pavement management engineers, and district or area supervisors with responsibility for selecting and constructing pavement preventive maintenance treatments.

The Guide is organized into nine sections to track the Participant Handbook that accompanies this workshop. The first session is an introduction to the needs and benefits of preventive maintenance. The second section presents the need for engineering the selection and design of pavement preventive maintenance treatments. One key point of this session is that pavement preventive maintenance treatments are an important tool for providing pavements in a cost-effective manner; the selection, design, and construction of these treatments must therefore be done with care in order to obtain the maximum benefit. The third section is a review of the materials used for preventive maintenance on flexible pavements. This section establishes a common vocabulary in the materials used for the balance of the workshop. The remainder of the sections provide specific information about each of the treatment types.

This guide is set up in a traditional script format, with visual aids presented on one side and corresponding comments listed in the accompanying column. The text is designed to assist the instructor with key points that should be presented for each visual aide. Materials needed for this workshop include:

- Slide projector
- Screen
- Carousel
- Extension cord
- Sign-in sheet
- Evaluation forms

The instructor must handle any preliminary "housekeeping" chores, such as handing out the schedule and instructor's biodata, and distributing the necessary handouts, including the sign-in sheet, evaluation forms, and Participant Handbook. The instructors should briefly introduce themselves and ask the participants to introduce themselves. Each participant should state their name, employer, and job responsibilities. The instructors should try to incorporate participants experience into the workshop at appropriate times.

Contents

Section 1 - The Case for Pavement Preventive Maintenance	1
Section 2 - Engineering a Pavement Preventive Maintenance Program	19
Section 3 - Materials for Preventive Maintenance	29
Section 4 - Pavement Preventive Maintenance Treatment - Fog Seals and Rejuvenators	43
Section 5 - Pavement Preventive Maintenance Treatment - Chip Seals	53
Section 6 - Pavement Preventive Maintenance Treatment - Cold Thin Seals, Slurry Seals	79
Section 7 - Pavement Preventive Maintenance Treatment - Cold Thin Seals, Micro-Surfacing	93
Section 8 - Pavement Preventive Maintenance Treatment - Thin Hot-mix Asphalt Overlays	111
Section 9 - Pavement Preventive Maintenance Treatment - Crack Treatment for Flexible Pavements	135
Section 10 - Pavement Preventive Maintenance Treatment - Rigid Pavements	151

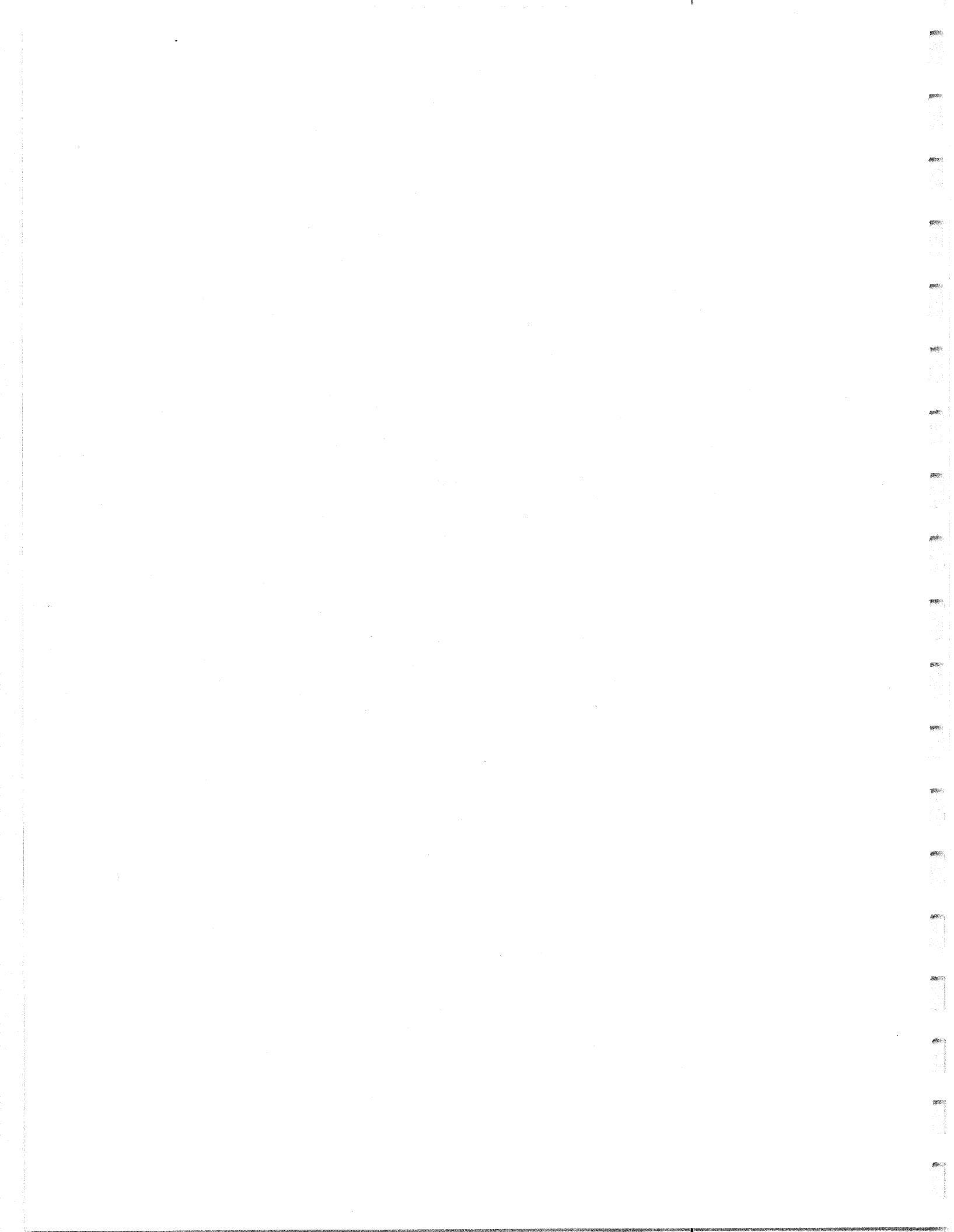

1. Report No. FHWA-SA-96-028		2. Government Accession No.		3. Recipient's Catalog No.	
4. Title and Subtitle Preventive Maintenance Effectiveness - Preventive Maintenance Treatments Instructor's Guide			5. Report Date February, 1996		
			6. Performing Organization Code		
7. Author(s) John P. Zaniewski and Michael S. Mamlouk			8. Performing Organization Report No.		
9. Performing Organization Name and Address Center for Advanced Transportation Systems Research Mail Code 6306 Arizona State University Tempe, AZ 85287			10. Work Unit No. (TRAVIS)		
			11. Contract or Grant No. DTFH-61-94-C-00032		
12. Sponsoring Agency Name and Address Federal Highway Administration Office of Engineering/Office of Technology Applications 400 Seventh Street S.W. Washington, DC 20590			13. Type of Report and Period Covered June 1994 - February 1996		
			14. Sponsoring Agency Code		
15. Supplementary Notes Contracting Officer's Technical Representative - Michael R. Smith, Pavement Division, HNG-40, Phone: 202-366-4057					
16. Abstract <p>Pavement preventive maintenance is an important tool for extending the service life of pavements in a cost effective manner. Many of the available treatments are currently used by state highway agencies for pavement preservation. However, to be effective as a preventive maintenance practice, these treatments must be placed on the pavement much earlier in the pavement service life than is currently the practice. The purpose of this document is to describe the need for and benefits of preventive maintenance, discuss the engineering applications of these treatments, review the materials used for preventive maintenance, and describe the application process for these treatments. The treatments described in this document include: fog seals, slurry seals, micro-surfacing, chip seals, thin hot-mix overlays, and crack sealing of flexible pavements; crack and joint sealing, subsealing, and retrofit of dowel bars of rigid pavements.</p> <p>This Instructor's Guide was developed to support a one day workshop on Pavement Maintenance Effectiveness - Preventive Maintenance Treatments.</p>					
17. Key Words Pavement preventive maintenance, flexible pavements, rigid pavements, preventive maintenance treatments			18. Distribution Statement No restrictions. This document is available to the public from the National Technical Information Service, Springfield, Virginia 22161		
19. Security Classif. (of this report) Unclassified		20. Security Classif. (of this page) Unclassified		21. No. of Pages 174	

METRIC (SI)* CONVERSION FACTORS

APPROXIMATE CONVERSIONS TO SI UNITS			
Symbol	When You Know	Multiply By	To Find
LENGTH			
in	Inches	2.54	centimeters
ft	feet	0.3048	meters
yd	yards	0.914	meters
mi	miles	1.61	kilometers
AREA			
in ²	square inches	6.452	centimeters squared
ft ²	square feet	0.0929	meters squared
yd ²	square yards	0.836	meters squared
mi ²	square miles	2.59	kilometers squared
ac	acres	0.395	hectares
MASS (weight)			
oz	ounces	28.35	grams
lb	pounds	0.454	kilograms
T	short tons (2000 lb)	0.907	megagrams
VOLUME			
fl oz	fluid ounces	29.57	milliliters
gal	gallons	3.785	liters
ft ³	cubic feet	0.0328	meters cubed
yd ³	cubic yards	0.765	meters cubed

Note: Volumes greater than 1000 L shall be shown in m³.

APPROXIMATE CONVERSIONS TO SI UNITS			
Symbol	When You Know	Multiply By	To Find
LENGTH			
mm	millimeters	0.039	Inches
m	meters	3.28	feet
yd	yards	1.09	yards
km	kilometers	0.621	miles
AREA			
mm ²	millimeters squared	0.0016	square inches
m ²	meters squared	10.764	square feet
yd ²	kilometers squared	0.39	square miles
ha	hectares (10,000 m ²)	2.53	acres
MASS (weight)			
g	grams	0.0353	ounces
kg	kilograms	2.205	pounds
Mg	megagrams (1000 kg)	1.103	short tons
VOLUME			
mL	milliliters	0.034	fluid ounces
L	liters	0.264	gallons
m ³	meters cubed	35.315	cubic feet
m ³	meters cubed	1.308	cubic yards
TEMPERATURE (exact)			
°C	Celsius temperature	9/5 (then add 32)	Fahrenheit temperature
°F	Fahrenheit temperature	5/9 (after subtracting 32)	Celsius temperature

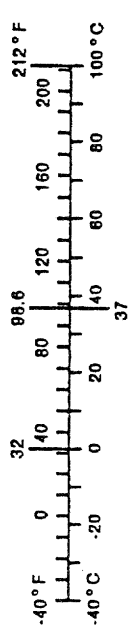

These factors conform to the requirement of FHWA Order 5190.1A

*SI is the symbol for the International System of Measurements

*The Case for Pavement
Preventive Maintenance*

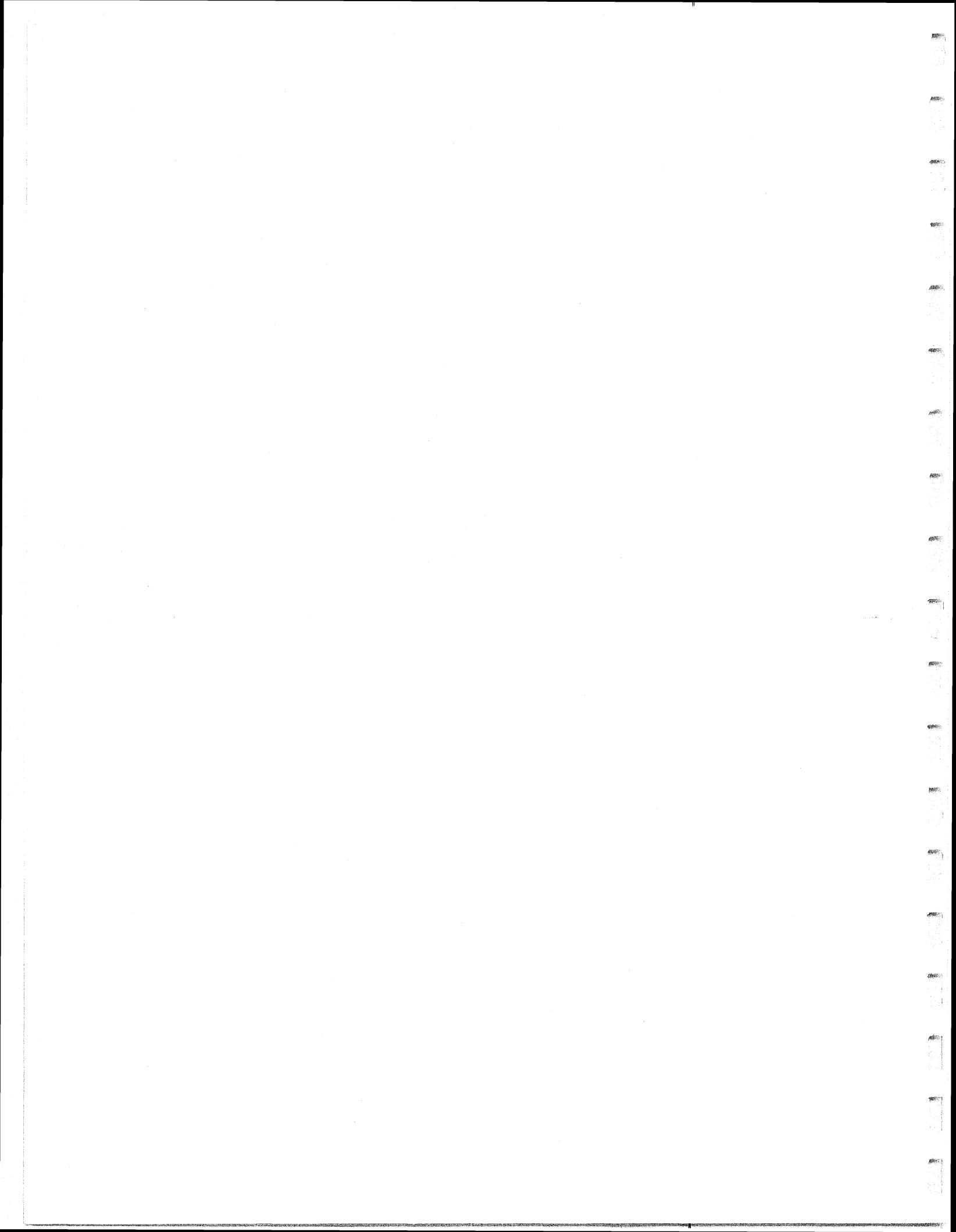

**PAVEMENT
MAINTENANCE EFFECTIVENESS,
PREVENTIVE MAINTENANCE
TREATMENTS**

**Federal Highway Administration
Arizona State University**

Welcome to the FHWA Workshop on Pavement Maintenance Effectiveness - Maintenance Treatments. I'm _____, the Principal Instructor, and I'll be accompanied by my Co-Instructor, _____. This workshop was developed by Arizona State University under contract to the Federal Highway Administration.

This is a presentation about the effectiveness and use of pavement preventive maintenance. The workshop is designed to acquaint highway engineers with the state of the art in preventive maintenance technologies. It is hoped that this workshop will generate an increased awareness of the need for, and the benefits of, effective pavement preventive maintenance.

OVERVIEW OF WORKSHOP

- ▶ **Pavement Preventive Maintenance**
- ▶ **Treatments**

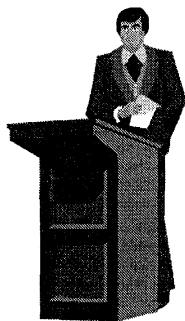

This workshop consists of two types of sessions:

1. A review of the need for preventive maintenance and the engineering and materials that are required for a successful program.

2. Types of preventive maintenance treatments.

The objective of the workshop is to:

1. Recognize the potential for cost-effective pavement preventive maintenance programs to improve the quality of service to the traveling public.

2. Review the different types of preventive maintenance treatments that can be applied to pavements.

**THE CASE FOR
PREVENTIVE
MAINTENANCE**

The first session of the workshop reviews the need for preventive maintenance. An effective preventive maintenance program requires a change in existing attitudes toward pavement design and maintenance. Pavement preventive maintenance is applied to pavements in good structural condition to extend the life of the pavement in a cost-effective manner.

SESSION OBJECTIVES

- Overview
- Define a Preventive Maintenance Program
- Lessons from SHRP

The objectives of this session are to:

1. Present an overview of a pavement preventive maintenance program.
2. Define a preventive maintenance program and the types of treatments available.
3. Review some findings of the Strategic Highway Research Program.

NEED FOR PREVENTIVE MAINTENANCE

Current Status of Highways

- Funding
- Condition

Pavement preventive maintenance promotes the efficient use of highway funds and improves pavement condition.

DISTRIBUTION OF FEDERAL OBLIGATION

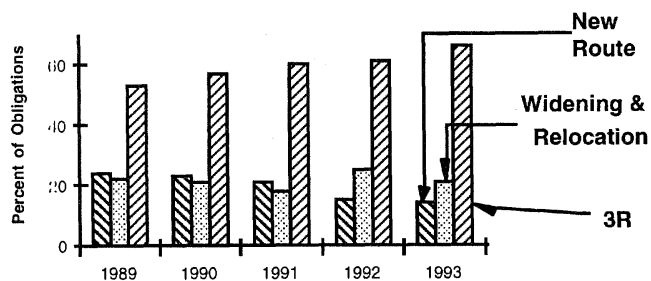

Federal funding has traditionally focused on constructing new facilities, while upgrading and preserving existing highways. Since much of the required infrastructure is already in place, the emphasis must shift to getting the greatest value from existing highways. The percentage of funding applied to new construction is decreasing while funds for rehabilitation of the system are increasing.

PAVEMENT CONDITION

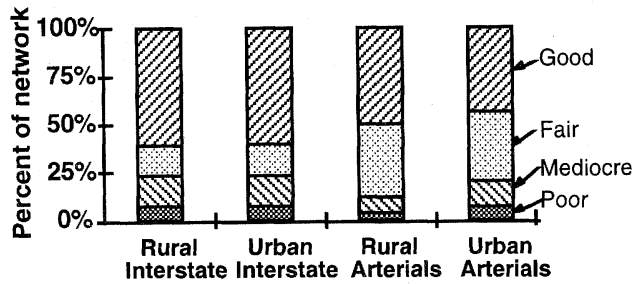

60% of the Interstate system is in good condition. Less than 50% of the urban and rural arterials are in good condition. With the reduction in construction of new highways, further deterioration of the system is anticipated if current policies are continued. However, through a preventive maintenance program, the pavements that are in good condition can be maintained in a cost-effective manner. This will slow the rate that pavements degenerate into conditions requiring rehabilitation or reconstruction.

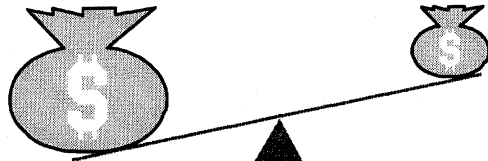

Needs:

Maintain \$ 50 billion
Eliminate backlog \$ 210 billion

Budget:
\$ 27 billion

A study by the FHWA estimated the current funding need to be \$50 billion per year to maintain pavements in their existing condition. Improving the condition of the network by eliminating the backlog of pavement projects currently in need of rehabilitation would require \$210 billion annually. The current budget is approximately \$ 27 billion. Under existing policies, inadequate funding will clearly lead to a deterioration in pavement conditions.

PAVEMENT PREVENTIVE MAINTENANCE DEFINITION

A program strategy to:

- arrest light deterioration
- retard progressive failures
- reduce the need for routine maintenance and service activities

There are several different definitions of pavement preventive maintenance. This definition recognizes that preventive maintenance is a program strategy that can arrest light deterioration, retard progressive failures, and reduce the need for routine maintenance activities.

Page 4 of the Participants Handbook has the definitions of preventive maintenance.

OBJECTIVE

Keep the pavement condition above a level that would require corrective maintenance or other strategies.

The objective of such a program strategy is to extend the functional life of the pavement by applying treatments before the pavement deteriorates to a condition that requires a corrective treatment, such as a structural overlay. Thus, relatively inexpensive treatments are used to increase the life of the pavement.

PROGRAM STRATEGY

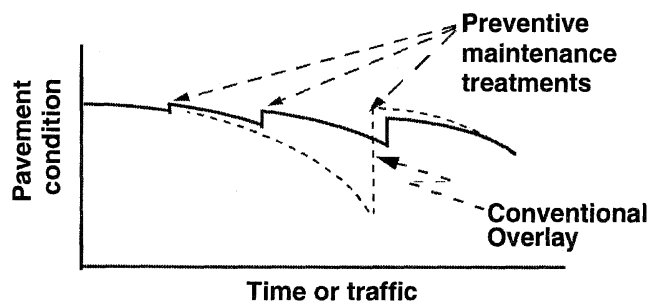

A pavement preventive maintenance program strategy consists of a series of treatments applied to the pavement over time. An effective strategy would feature a combination of different treatments, such as periodic crack treatment followed by chip sealing. The objective of this program is to provide a better quality of service to the highway user, both in terms of the quality of pavement conditions and the cost-effectiveness of pavement preservation.

FLEXIBLE PAVEMENT TREATMENTS

- **Crack treatment**
- **Fog seal**
- **Chip seal**
- **Thin hot-mix overlay**
- **Thin cold seal**

Flexible pavement preventive maintenance treatments:

Crack treatment - sealing and filling

Fog sealing - asphalt emulsion sprayed on the surface

Chip sealing - asphalt binder followed by layer of uniform aggregates

Thin hot-mix overlay - using conventional or modified hot mix asphalt concrete.

Thin cold seal - emulsion and aggregates mixed at the job site.

Though these treatments are not new, their application in a timely manner can greatly improve their effectiveness.

RIGID PAVEMENT TREATMENTS

- **Crack and joint sealing**
- **Under sealing**
- **Retrofit of dowels**

Types of preventive maintenance treatments for rigid pavements:

Crack and joint sealing

Under sealing - filling of voids under the slab

Retrofit of dowels - for example, mid-slab cracks in jointed reinforced pavements.

When should a pavement preventive maintenance treatment be applied?



One of the most important questions is when should a preventive maintenance treatment be applied?

Let's think about this relative to our experience with maintenance of the department's fleet of vehicles and equipment.

HOW MUCH OIL SHOULD A CAR BURN BEFORE CHANGING THE OIL?

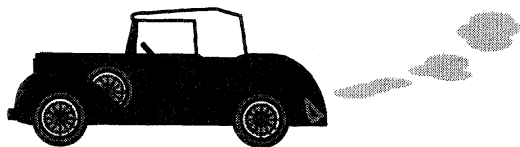

Maintenance personnel recognize the need to change oil regularly on their vehicle fleet. This activity defers engine wear and the need for costly repairs. **Not** performing this activity, both **early** in the engine's life and on a **routine basis**, results in premature damage, ending in costly engine replacement. What happens if you change the oil and filters **after** the engine has started to smoke? Will this repair the damage? Of course not. The engine damage has already occurred.

The situation is similar for pavement preventive maintenance. Preventive maintenance treatments must be applied **early** in the pavement's life, **before** the pavement shows significant distress, and the treatments must be applied on a **routine basis**. The application of a treatment after significant pavement distress has occurred is a stop gap approach to keep the pavement open to traffic and ending in costly pavement rehabilitation. Continued application of this **stop-gap** approach is costly to the taxpayers and not acceptable as we move into the next century.

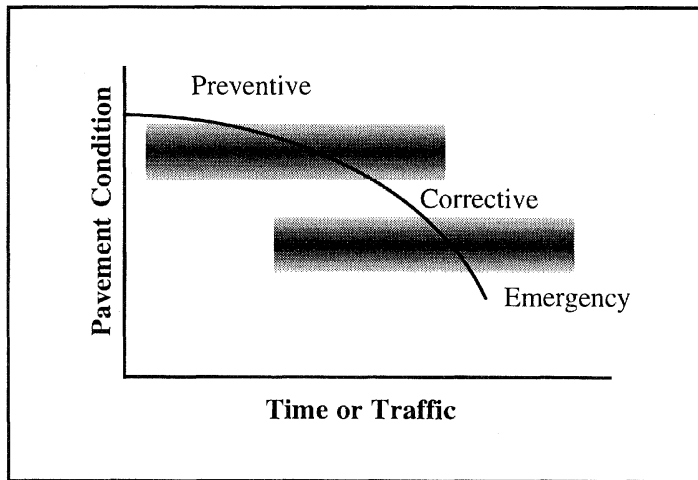

Since many preventive maintenance treatments will also correct limited pavement distress, there is some confusion about when a maintenance treatment is preventive as opposed to being corrective. Most of the preventive maintenance treatments discussed in this workshop can be applied as either corrective or preventive treatments. The distinction is the timing of the treatment and the condition of the pavement. In general, preventive maintenance treatments are applied to pavements in good structural condition. This treatment usually takes place much earlier in the pavement's life in comparison to common practice in the pavement industry.



Depending on the type of distress, some pavements in fair condition can be treated with preventive maintenance treatments. Examples include:

- Environmental distresses - weathering and raveling
- Rutted pavements - if the rutting is due to densification and has stabilized.

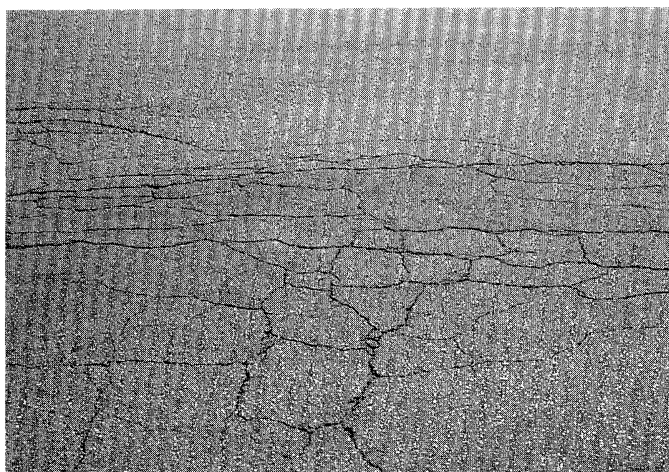

Severely distressed pavements are not candidates for preventive maintenance. Sometimes a maintenance treatment is applied to these pavements as a stop-gap measure. However, this is not a preventive maintenance application of the treatment. The service life of the treatment will be much shorter than if the treatment were applied to a pavement in good structural condition.

WHEN?

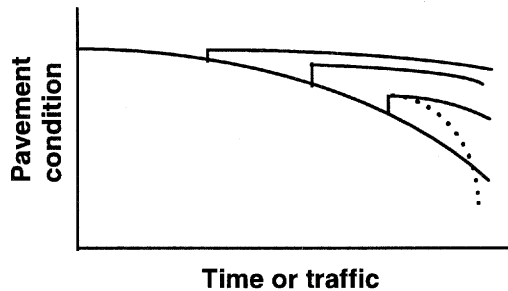

The timing of preventive maintenance treatments was addressed in the SHRP research. Preventive maintenance treatments were placed on pavements in good, fair, and poor conditions. In general, the better the condition of the pavement, the better the preventive maintenance treatment performed. Sealing a moist pavement that is in poor condition can actually accelerate the rate of distress development.

ALTERNATIVES

- | | | |
|----------------------------|---|----------------------------|
| ① Structural overlay | } | ❖ longer life |
| ② Partial mill and replace | | ❖ more traffic disruptions |
| ③ Reconstruction | | ❖ higher cost |

The alternative to preventive maintenance is to allow the pavement to deteriorate until either a structural overlay or reconstruction is required. These treatments allow traffic to use the pavement longer without traffic disruptions; however, the capital cost is much greater.

DEVELOPING A PROGRAM

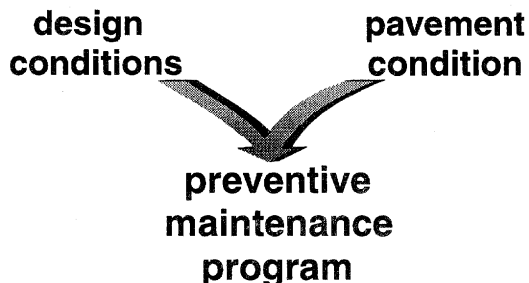

Developing a preventive maintenance program requires rules for selecting the type and timing of preventive maintenance treatments. This requires evaluation of design conditions and pavement conditions to formulate the program.

DESIGN CONDITIONS

- Existing pavement
- Traffic
 - past
 - future
- Environment

Design conditions include:

Existing pavement structure - is it adequate for the anticipated traffic?

Past and present traffic - average daily traffic and equivalent axle loads.

Environment - moisture, solar radiation.

PAVEMENT CONDITIONS

- Structural
- Roughness
- Skid resistance
- Distress

Pavement condition can be evaluated in terms of:

Structure - Is the pavement capable of carrying the anticipated traffic?

Roughness - What quality of service is the pavement providing to the traveling public?

Skid resistance - Is the pavement surface safe under wet weather conditions?

Distress - Are there maintenance problems that need to be addressed?

PAVEMENT DISTRESS

- Traffic load
- Environmental
- Interactions

Pavement distresses are generally a function of traffic loads, environmental conditions, and their interaction. It is important to understand the nature and causes of distress in selecting an appropriate treatment.

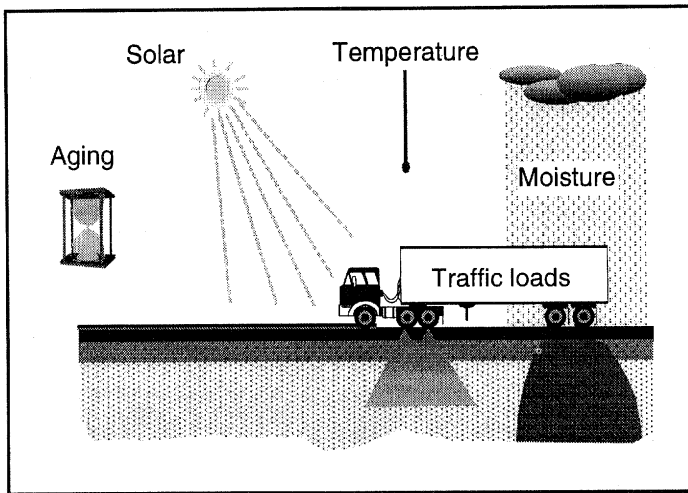

Interaction effects occur when environmental conditions magnify or accelerate the impact of traffic loading. For example, traffic stresses under a cracked pavement, that allows moisture into the subgrade, are greater than an under an uncracked pavement. The same level of traffic loads therefore cause greater damage to the cracked pavement.

PREVENTIVE MAINTENANCE FUNDING

NHS & ISTEA

- **Preventive maintenance can be federally funded**
- **If demonstrated to be cost-effective**

ISTEA permits the use of Federal funds for preventive maintenance projects if the cost-effectiveness is demonstrated with a pavement management system. This represents a change in the policy that was formerly used to determine the availability of federal aid. The objective of the current policy is to improve the cost-effectiveness of providing high quality pavements for the traveling public. The current National Highway System bill allows funding of preventive maintenance treatments on the entire NHS and removes the requirement of using a pavement management system to demonstrate the cost-effectiveness.

INFORMATION NEEDS

- **Types of treatments**
- **Performance**
- **Cost**

The information needed to determine the cost-effectiveness of a pavement preventive maintenance treatment includes the type of treatment being considered, its performance or life, and the cost of the treatment itself. The cost should include all expenditures over the life of the treatment. Data from the agency's pavement management systems can assist in determining cost-effectiveness.

Types of preventive maintenance treatments have already been defined: crack treatments, fog seals, chip seals, thin hot-mix overlays, and thin cold seals for flexible pavements; and joint and crack sealing, undersealing, and retrofit of dowel bars for rigid pavements.

Treatment	Age	Frequency	Life
Crack filling	5-6	2-4	2-4
Single Chip	7-8	5-6	5-6
Multiple Chip	7-8	5-6	5-6
Slurry Seal	5-10	5-6	5-6
Micro-surfacing	9-10	5-6	5-6
Thin HMA OL	9-10	9-10	7-8

A recent NCHRP study by Geoffrey found that preventive maintenance treatment practices vary by state. Treatments are initiated after a minimum of five years of service. With the exception of crack filling and thin hot-mix overlays, all treatments are applied at a frequency of five to six years, and extend pavement life by a similar amount.

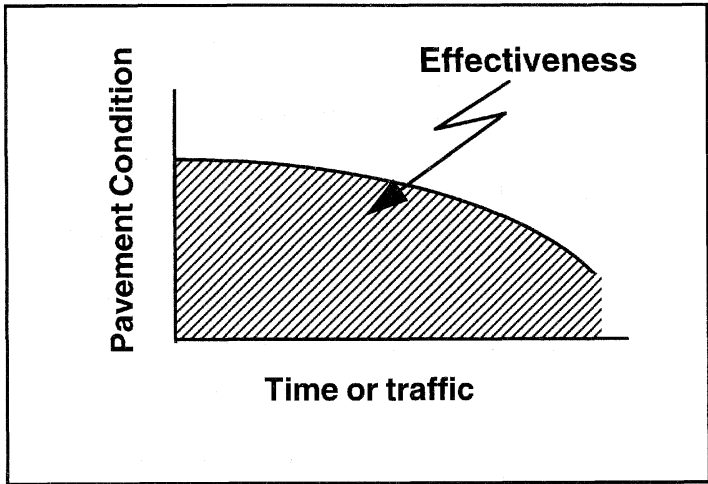

Effectiveness is defined as the area under the pavement condition versus time (or traffic) curve. Treatments or strategies with a low rate of deterioration are more effective than pavements that deteriorate rapidly.

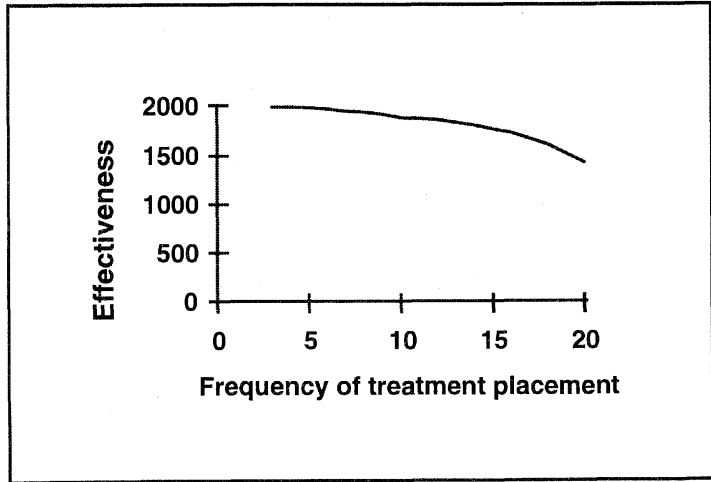

Based on an analysis of the performance of preventive maintenance treatments, a treatment frequency of five to six years is more effective than extending the time between treatments. The effectiveness of the treatment decreases by increasing the time between treatments.

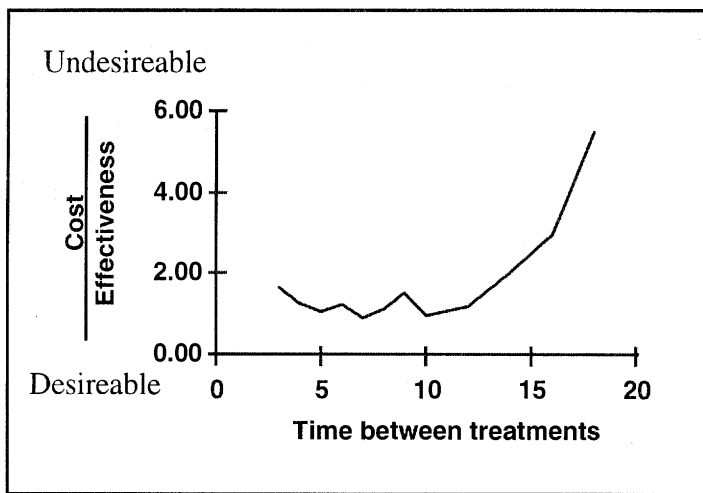

Treatments placed with a frequency of 5 to 10 years are four to five times more cost-effective than reconstruction of the pavement. A low value of cost-effectiveness is desirable. The blip in the curve at year nine is caused by the assumptions made relative to the initial condition of the pavements at the time the preventive maintenance program was initiated.

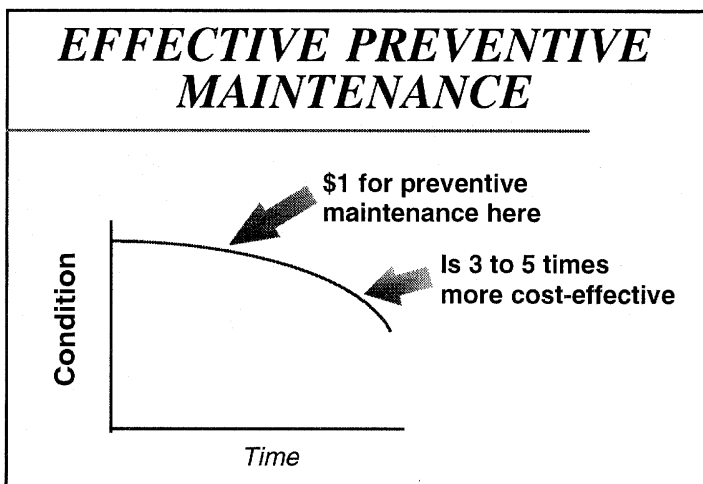

The New York DOT found preventive maintenance to be 3.65 times more cost-effective than a "do nothing" strategy. A Corps of Engineers study found chip seals to be four times more cost-effective than allowing a pavement to deteriorate.

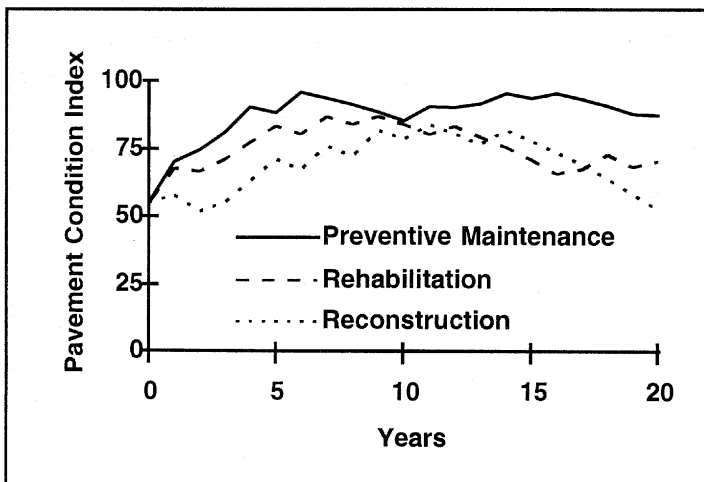

An analysis of the results of applying a preventive maintenance program to an existing network demonstrates that the preventive maintenance program will improve the condition of the network over time in comparison to either a rehabilitation only or a reconstruction program. This analysis assumed the initial condition of some of the pavements to be below standard for preventive maintenance. This accounts for the dip in the condition of the network at about year 10. After that time the condition of the network remains fairly constant.

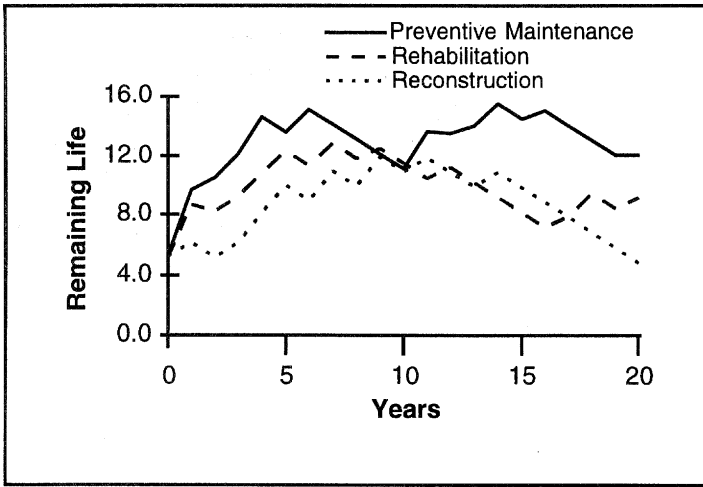

The remaining life of the pavement network is also improved by the preventive maintenance program.

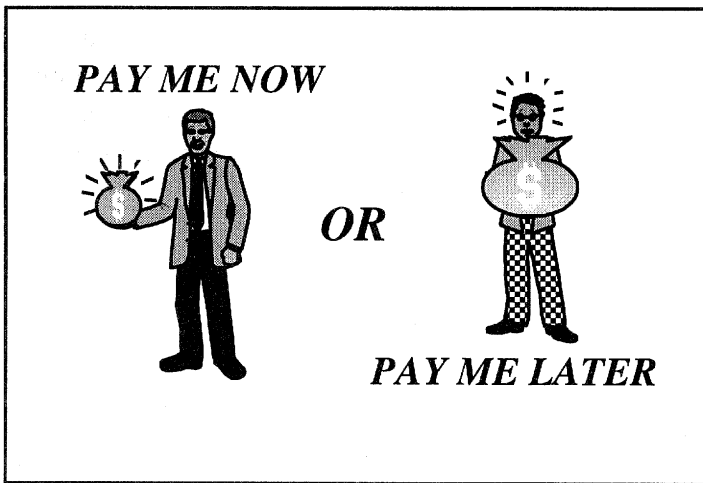

The use of preventive maintenance reflects the old adage, "You can pay me now or pay me later." In automotive terms, regularly paying a few dollars for changing oil and filters is much less expensive than replacing the motor. Not only is replacing the motor more expensive, but generally, the driver suffers while operating the vehicle with a marginal motor that needs repairs. Paying later is both more expensive and provides a lower quality of service.

SHRP PREVENTIVE MAINTENANCE RESEARCH

- **Nationwide test sections**
- **High-volume, high-speed highways**
- **Good, fair, and poor pavements**

Interest in pavement preventive maintenance was expressed in the Strategic Highway Research Program. Preventive maintenance treatments were applied across the nation to a variety of pavement design situations and conditions.

Layout of flexible pavement test sections

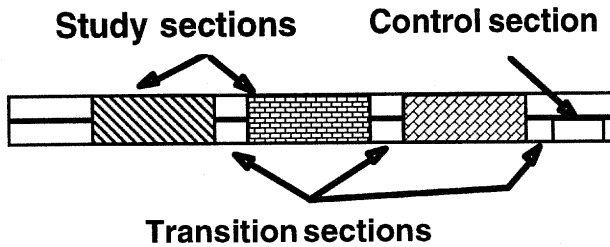

The SHRP experimental site contained each of the SHRP experimental treatments, plus any state designed treatments, and a control section. The control section did not receive any treatment. All of the sections were separated by transition sections.

FLEXIBLE PAVEMENT TREATMENTS

- **Chip seals**
- **Crack sealing**
- **Slurry seals**
- **Thin hot mix overlays**
- **State supplemental sections**

Treatments included in the SHRP research include:

Crack sealing

Chip seals

Slurry seals

Thin hot-mix overlays

State-designed supplemental sections in which other treatments, such as micro-surfacing, and different specifications were used.

RIGID PAVEMENT TREATMENTS

- **Joint and crack sealing**
- **Undersealing**
- **State supplemental sections**

Rigid pavement treatments were more limited than flexible pavements. Treatments included:

Joint and crack sealing

Undersealing

State-designed supplemental sections; e.g., retrofit of dowel bars on cracked jointed reinforced concrete pavements.

EXPERT TASK GROUP OBSERVATIONS

- ▶ **Treated sections outperforming control sections**
- ▶ **Performance related to *existing* pavement condition**
- ▶ **Most sections are performing well**

Data from the SHRP research is incomplete at this time. Key findings from an expert task group demonstrated:

Treated sections are outperforming control sections. Performance of the treatment is related to existing pavement condition at the time the treatment was placed.

Most sections are performing well, although some chip seal sections failed at the time of construction.

CONCLUSION

Existing pavement condition is important to treatment's performance

SHRP research has demonstrated that pavement condition is an important factor in the life of the treatment. Treatments should be applied to pavements in good condition.

CONCLUSION

When properly designed and constructed, preventive maintenance treatments can be applied to high-speed, high-traffic volume roads.

Preventive maintenance treatments can be used on high-speed, high-traffic volume roads if the treatments are properly designed and constructed. As will be noted throughout this course, there are correct and incorrect procedures for the design and construction of preventive maintenance treatments. Failure to follow well-established procedures will lead to premature failure of the treatment and possible damage to the pavement structure.

CONCLUSION

**Pavement preventive maintenance
should be viewed as a
program over time**

Preventive maintenance treatments have a limited life, on the order of five to six years. To be effective, a preventive maintenance plan should call for repeated application of treatments over time. The plan can also include a variety of maintenance applications, such as crack sealing and surface treatments.

CONCLUSION

**Preventive maintenance
is cost-effective**

Pavement preventive maintenance is known to be cost-effective. This has been demonstrated by studies of the life and cost of preventive maintenance, experience of state highway agencies, and theory. Continued application of **stop-gap** maintenance is costly to the taxpayers and not acceptable as we move into the next century.

Under the ISTEA and NHS legislation, Federal participation in preventive maintenance treatments is now possible and encouraged.

TEST AND EVALUATION WORK PLANS

- ❖ **Guides for state agencies interested in conducting field experiments**
- ❖ **FHWA assistance in designing, conducting and monitoring experiments**
- ❖ **Technical assistance application**

In conjunction with this and other maintenance workshops, the FHWA is sponsoring a technical assistance program for states interested in doing their own field studies of pavement preventive maintenance methods. Test and Evaluation Work Plans have been developed serve as guides for designing, installing, and monitoring experimental preventive maintenance sections.

The work plans are accompanied by a Technical Assistance Application that can be completed by interested agencies and submitted to the local FHWA division offices for consideration.

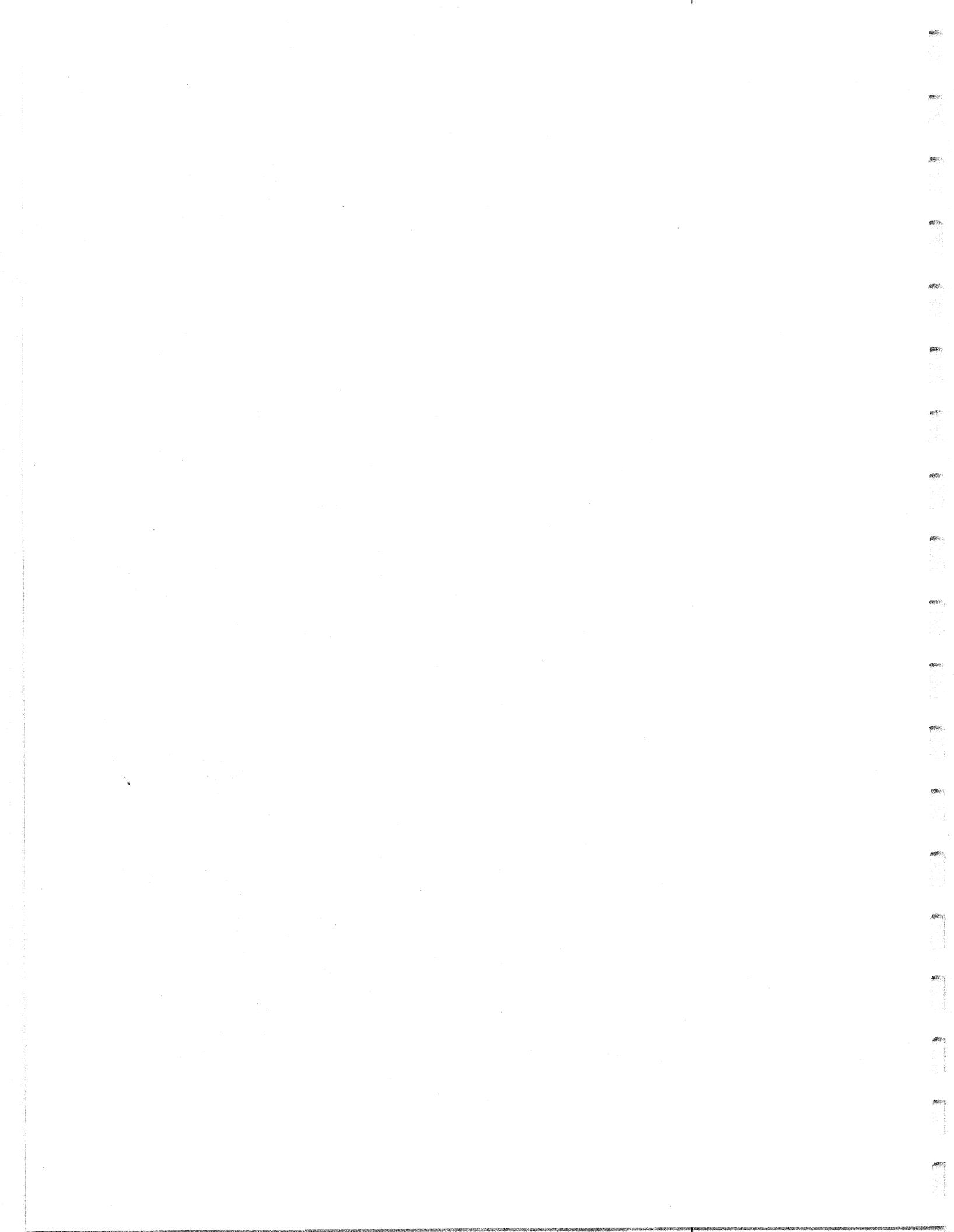

*Engineering a Pavement
Preventive Maintenance
Program*

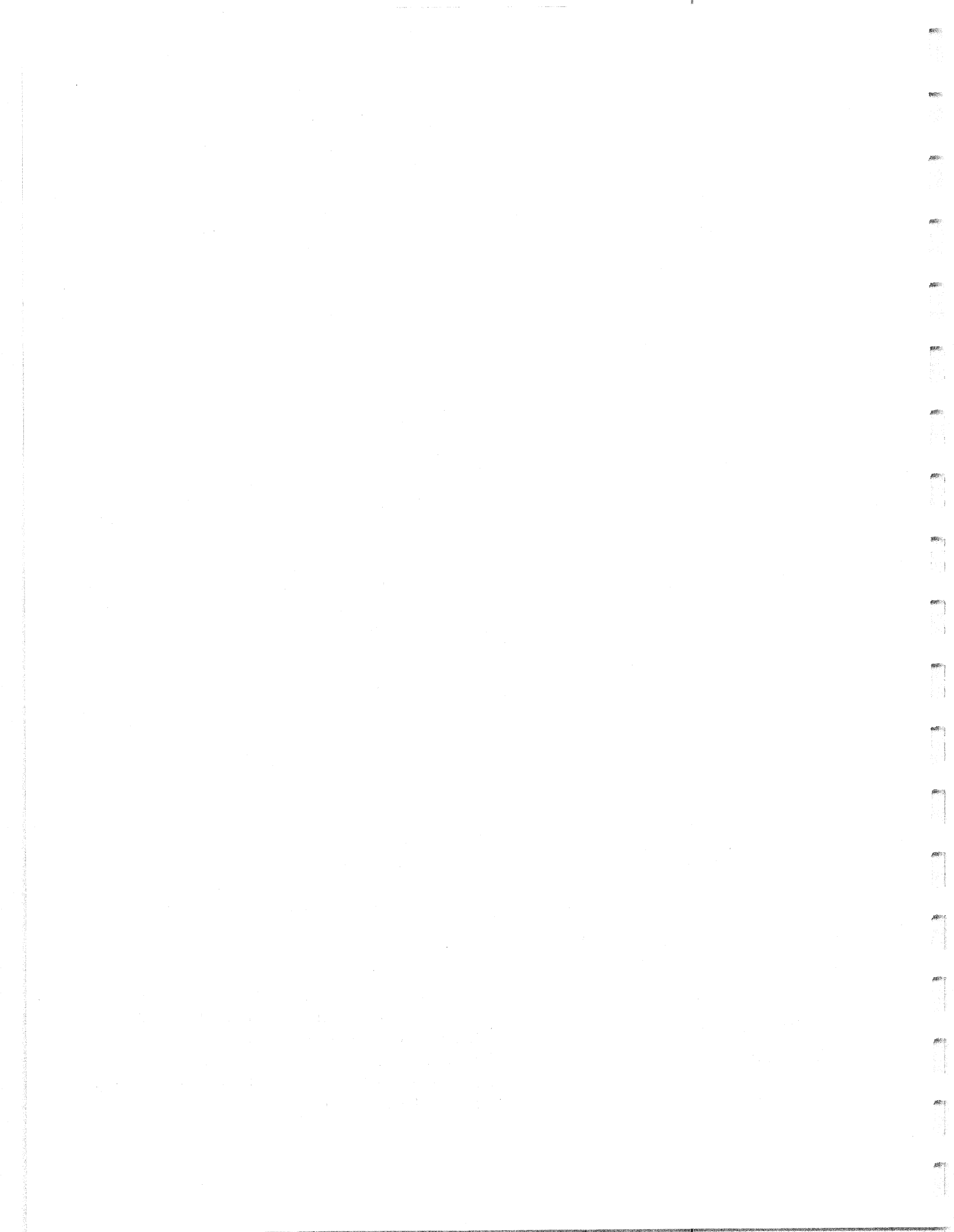

ENGINEERING A PREVENTIVE MAINTENANCE PROGRAM

This session presents information on engineering a pavement preventive maintenance program.

OBJECTIVE

Overview process of engineering a pavement preventive maintenance program.

The objective of this session is to present the concept that a preventive maintenance program should represent a considerable expenditure of highway resources. Treatment selection and design should be considered on a case-by-case basis. Rules of thumb can be helpful in planning a general preventive maintenance program, but the particulars for a specific application should be determined based on existing conditions at the site.

ELEMENTS

- ◆ **Selection of pavement sections**
- ◆ **Design treatment**
- ◆ **Preventive maintenance program**
- ◆ **Quality control**
- ◆ **Monitoring**

Rules must be developed for the selection, design, timing, quality control, and monitoring of the preventive maintenance treatment. Selection of sections is based on pavement condition, ADT, and environmental considerations. Once a section is selected, treatment design is largely a matter of mix design of the treatment. A preventive maintenance program identifies the type of treatments that should be applied over the life of the pavement structure. Quality control measures are required to ensure the performance of the project. A monitoring program should be established to evaluate the cost-effectiveness of the different treatments.

SELECTION OF TREATMENTS

Pavement condition

- environmental distress
- roughness
- skid resistance

Selection of a treatment for a section depends on the condition of the pavement. Pavements with adequate structural capacity are good candidates for preventive maintenance. Sections with a limited amount of environmentally related distress can be viable candidates for preventive maintenance treatments. Most preventive maintenance treatments are too thin to correct significant roughness. Some improvement can be achieved with thin hot-mix overlays. Treatments that renew the pavement surface, such as chip seals, thin cold-seals and hot-mix overlays, can correct skid resistance problems.

Distress

Fatigue Cracking
Block Cracking

Edge Cracking
Longitudinal Cracking
Reflection Cracking
Transverse Cracking

Preventive Maint.

Not a candidate
Thin cold seal, chip,
thin HMAC

Crack treatment
Crack treatment
Crack treatment
Crack treatment

The selection of a pavement maintenance treatment should be based on the condition of the pavement. In general, structural distress (fatigue cracking) cannot be corrected with preventive maintenance treatments. Other distresses of low to moderate severity, can be corrected with preventive maintenance treatments. These distress types are defined in the SHRP LTPP pavement distress identification manual. State highway agencies can develop their own manuals and selection rules appropriate local conditions.

Block cracking should be discussed with the class.

Distress

Rutting

Densification of
pavement

Unstable surface

Preventive Maint.

Fill ruts with micro-surfacing,
then surface treatment

Not a candidate if extensive

Preventive maintenance treatments can be applied to rutted pavements if the ruts are stable. Stable ruts are usually the result of densification of the pavement layers for a period following construction. Placing a treatment on an unstable pavement will only temporarily repair the pavement. The level of rutting can be monitored over a period of time, particularly during the summer, to determine if the ruts are stable.

<u>Distress</u>	<u>Preventive Maint.</u>
Shoving	Not a candidate if extensive
Bleeding	Sand seal, chip seal, micro-surfacing
Polished aggregate	Thin cold seal, thin HMAC, chip seal
Raveling	Fog, thin cold seal, thin HMAC, chip seal

Similarly, pavements with shoving are not good candidates for preventive maintenance treatments. Pavements with bleeding are problematic since the excess asphalt on the pavement surface can continue to bleed through the treatment. Pavements with polished aggregate and raveling are good candidates for preventive maintenance.

<u>Distress</u>	<u>Preventive Maint.</u>
Patch/patch deterioration	Not a candidate if extensive
Potholes	Not a candidate if extensive

Pavements with “excessive” patching and potholes are not good candidates for preventive maintenance, unless the cause of the distress is identified and corrected. For example, if a local drainage deficiency is contributing to the development of distresses, the problem can be corrected. Full depth patches can be placed, then the entire pavement surface treated with a preventive maintenance treatment.

COMBINATION OF DISTRESSES

- ◆ **Combine treatments to repair all distresses**
- ◆ **Curing time between treatments**

Many pavements display more than one type of distress. A preventive maintenance project can be designed to treat each of the distresses. For example, moderate severity cracking should be sealed prior to the application of a surface seal. In this case, adequate time should be allowed between the crack sealing and the surface sealing to allow the crack sealant to completely cure. Also, over-filling the crack should be avoided in order to reduce bleeding of the sealant through the seal.

TRAFFIC

- ◆ Preventive maintenance not structural
- ◆ Durability is key
- ◆ Durability related to mix-design

Since preventive maintenance is not intended to improve the structural capacity of the pavement, thickness design is not required. The ability of the pavement to resist the abrasive action of traffic is important. This is related to the mix design.

ENVIRONMENT

Preventive maintenance is effective for correcting environmental distress

- prevents water intrusion
- renews the surface

Periodic renewal of the pavement surface provides several benefits. It seals the pavement surface, preventing water from penetrating into the pavement structure. Surface seals provide a new pavement surface, controlling the effects of oxidation and volatilization. Since environmental conditions remain fairly constant over time, preventive maintenance treatments can be programmed based on time rather than the amount of traffic the pavement carries.

CONSTRUCTION CONSIDERATIONS

- ◆ Speed of construction
traffic control
MUTCD
- ◆ Life of the treatment

Minimizing traffic restrictions is important in the selection of a preventive maintenance treatment. Traffic control must be in effect for the entire construction period, including the time required for the treatment to cure. Correct traffic control procedures, such as those contained in the Manual for Uniform Traffic Control Devices, are required whenever traffic is restricted. The performance life of the treatment is particularly important for high-volume roads. Preventive maintenance treatments generally do not last as long as rehabilitation.

TREATMENT DESIGN

- ◆ **No structural design**
- ◆ **Mix design**
 - **aggregate characteristics**
 - **binder**
 - **quantities**
- ◆ **Specifications**

Preventive maintenance treatments are not based on structural considerations. Instead criteria such as the desired surface texture, capabilities of equipment, etc. determine the thickness of the treatment. This will dictate the selection of materials used in the design. The design process consists of determining the appropriate binder, aggregate characteristics, and quantities of each. The design process includes preparation of specifications for controlling the construction process.

PROGRAM

Periodic application of preventive maintenance treatments

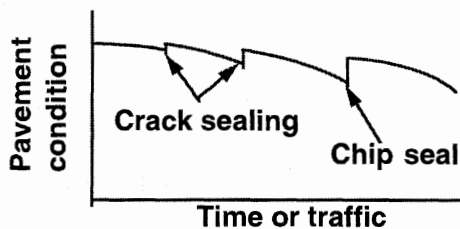

A preventive maintenance program consists of a series of preventive maintenance treatments over time. The program can consist of a mix of different treatment types, which can be programmed based on policy. For example, for one class of roads, a program may consist of sealing cracks biannually, with renewal of the pavement surface every five to six years.

QUALITY CONTROL

- ◆ **Means and Methods**
- ◆ **End-Result**
- ◆ **Performance**

Regardless of the effort used in the design process, the quality of a preventive maintenance treatment is limited by the ability of the constructor to place the treatment in the required manner. Specifications define the construction objectives of the agency. These may be expressed as:

- Means and methods
- End-result
- Performance

MEANS AND METHODS

- ◆ **Agency defines means and methods for performing work**
- ◆ **Split responsibility**
 - Contractor
 - Agency

Highway construction is traditionally controlled by the use of means and method specifications. These define the materials, equipment, and procedures for construction. In addition, the specifications define certain characteristics that the constructor must achieve during the project. This results in a split responsibility for the quality of the project. For example, the constructor can use the specified materials and construction procedures but fail to achieve the desired characteristics. This often leads to conflict in defining each party's liability in the event of a substandard product.

END-RESULT SPECIFICATIONS

- ◆ **Agency defines required properties**
- ◆ **Contractor controls process to achieve properties**
- ◆ **Responsibility is contractor's**

End-result specifications define requirements with respect to the quality and characteristics of the product without identifying the means and methods required to achieve the specified results. The contractor has complete control over the construction process and the agency evaluates whether the final product has the desired characteristics. The contractor has responsibility for quality, and the agency has responsibility for acceptance. The success of end-result specifications is determined by an agency's ability to define the properties of the pavement that should be controlled during construction.

PERFORMANCE SPECIFICATIONS

- ◆ **Contractor warrants performance for a specified time period**
- ◆ **Contractor controls design, materials, and construction**
- ◆ **FHWA - TE-14 spec. for micro-surfacing**

Performance specifications require the constructor to take responsibility for the performance of the pavement. The constructor warrants the quality of the pavement for a specified time period and assumes responsibility for repairing a pavement that fails to perform in accordance with the specifications. The agency objective is to obtain a specified level of service for the users, rather than pavements based on physical characteristics.

The FHWA has developed a guide to performance specification for the construction of micro-surfacing. This spec. can serve as an example of the elements that should be included in a performance specification.

MONITORING PERFORMANCE

- ◆ **New applications of existing methods**
- ◆ **Application of emerging technology**
- ◆ **Need to evaluate cost-effectiveness**

Monitoring the performance of preventive maintenance treatments is required for determining the cost-effectiveness of the treatments. Even conventional treatments that are used in a new way (such as chip seals on high-volume roads) need to be evaluated. Much of the evaluation can be carried out through the agency's pavement management system.

REQUIRED DATA

- ◆ **Structure**
- ◆ **Traffic**
- ◆ **Pavement Condition**
- ◆ **Treatment Features**
- ◆ **As-built data**

Data needed for monitoring the cost-effectiveness of a treatment include:

Pavement structure

Traffic, ADT and ESAL

Pavement condition, both before construction of the treatment and throughout its life

Design data for the treatment

As-built data and any construction problems.

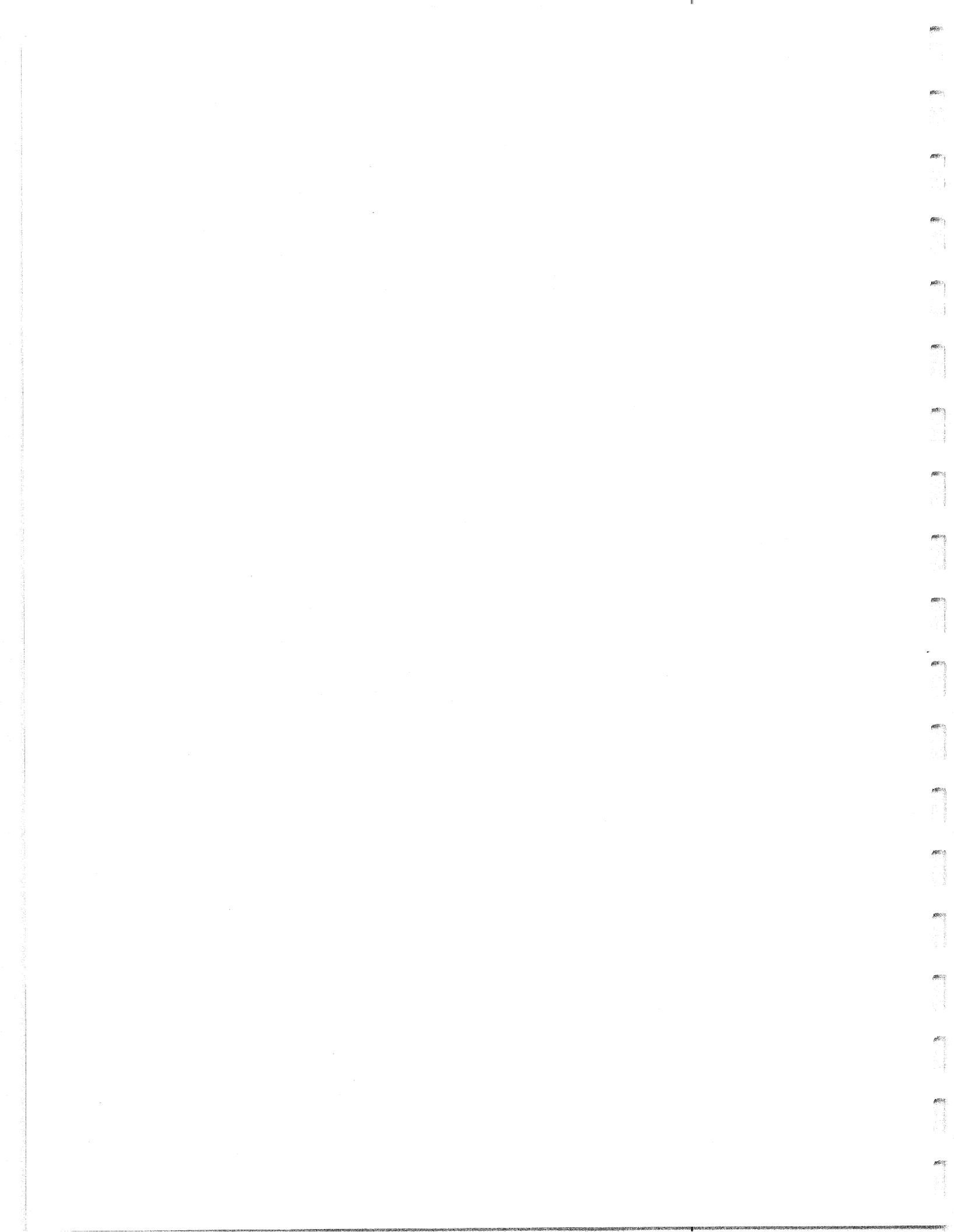

*Materials for
Preventive Maintenance*

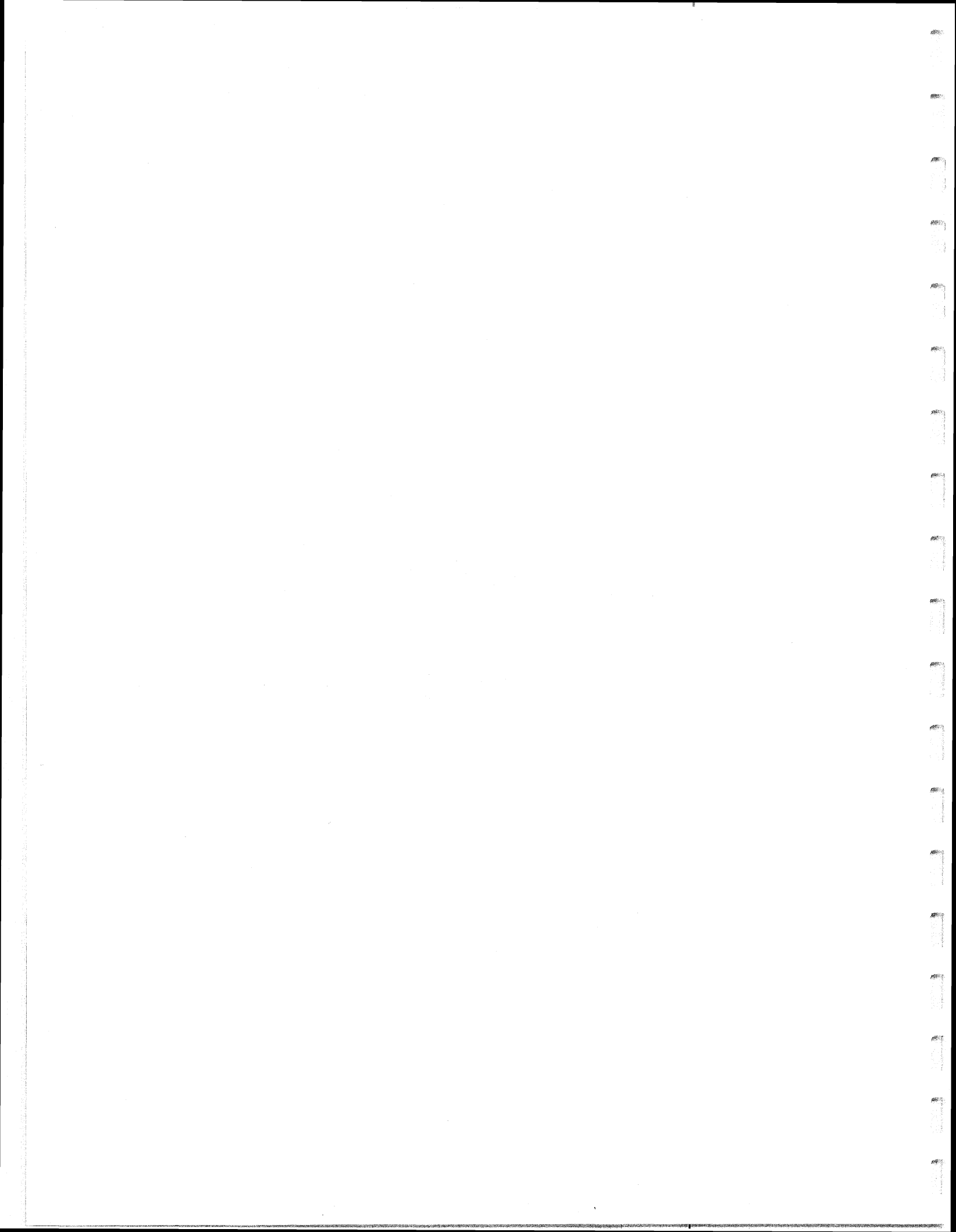

Preventive maintenance of flexible pavements uses asphalt-based binders and aggregates.

MATERIALS FOR PREVENTIVE MAINTENANCE

OBJECTIVE

Overview of materials used for preventive maintenance on flexible pavements

This session addresses the common materials used in the construction of preventive maintenance treatments for flexible pavements. This review establishes a common terminology for describing the individual treatments in subsequent sessions.

BINDERS

- ◆ **Asphalt Cements**
- ◆ **Emulsions**
- ◆ **Cutbacks**

Flexible pavement preventive maintenance treatments use asphalt-based binders. These can be neat asphalt cement, an emulsion of asphalt cement and water, or a dilution of asphalt cement with a fuel to produce a cutback. Historically, cutbacks have been important materials for preventive maintenance. However, because current environmental restrictions inhibit their use, cutbacks will not be considered in this workshop.

ASPHALT CEMENT

- ◆ **Definition**
- ◆ **Grades**
 - ❖ **Pen grades**
 - ❖ **AC**
 - ❖ **AR**
 - ❖ **SUPERPAVE**

Asphalt cement is a high molecular weight hydrocarbon derived from the distillation of crude oil. Asphalt's characteristics are sensitive to temperature and duration of the applied load. Asphalt cements are graded based on their penetration, viscosity without conditioning, or viscosity after conditioning. Three grading methods are commonly used: Pen, AC, and AR. In addition, SHRP has defined performance grades for asphalt cement.

PENETRATION GRADING

Simple test to measure the consistency of asphalt

Penetration grading of asphalt cement is based on the distance a needle with fixed characteristics will penetrate into an asphalt sample at 25°C. It is specified by the allowable penetration range. In addition, the asphalt cement must meet criteria for flash point, ductility, loss on heating, and penetration of residue from rolling thin film oven conditioning.

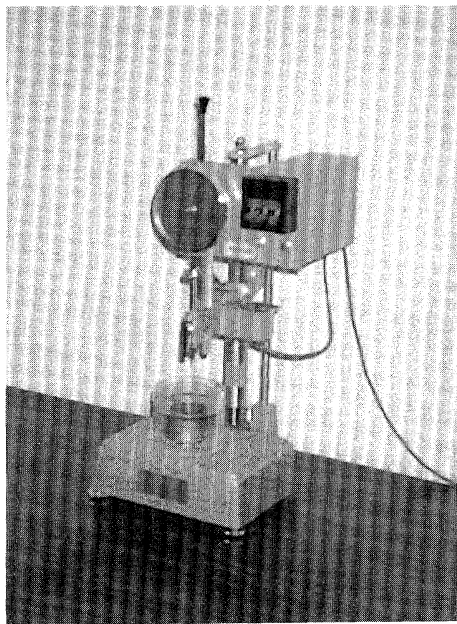

The penetration test is used to grade asphalt cement. In this test, the penetration of a needle into the surface of an asphalt cement sample is measured after five seconds. The shape and weight of the needle are defined in the standards for the test.

PENETRATION GRADES

**40-50, 60-70, 85-100,
120-150, 200-300**

-
↙ ↘
Maximum penetration
Minimum penetration

The lower the penetration numbers, the harder the asphalt cement.

AC GRADING

**Based on the viscosity of the
asphalt cement without
aging.**

AC grading of asphalt cement is based on the absolute viscosity of unconditioned asphalt cement. The absolute viscosity is measured at 60°C. In addition, the asphalt cement must meet requirements for kinematic viscosity, penetration, and flash point. After aging with the rolling thin film oven procedure, the sample must also meet requirements for kinematic viscosity and ductility.

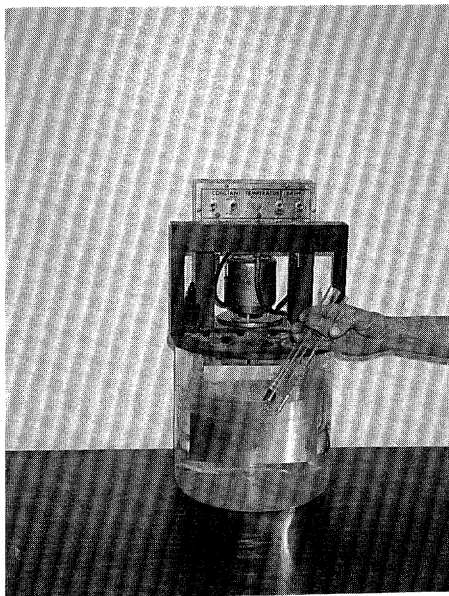

Absolute viscosity is determined by measuring the amount of time it takes for the asphalt cement to flow through a calibrated viscometer.

AC GRADES

**AC-2.5, AC-5, AC-10,
AC-20, AC-40**

AC- # 1/100 of midpoint of the
allowable viscosity range
AC-20, viscosity range
1,600 to 2,400 poises
Asphalt cement

AC grades are specified by the midpoint of the allowable viscosity range. The allowable tolerance is plus or minus 20 percent of the midpoint.

AR GRADING

- ◆ **Asphalt conditioned prior to grading**
- ◆ **Simulates hardening during mixing**

AR grades are specified based on the characteristics of asphalt conditioned using the rolling thin film oven procedure. This simulates asphalt hardening during mixing in an asphalt concrete plant. In addition, the asphalt must meet specifications for kinematic viscosity, penetration, flash point, percent of original penetration, and ductility.

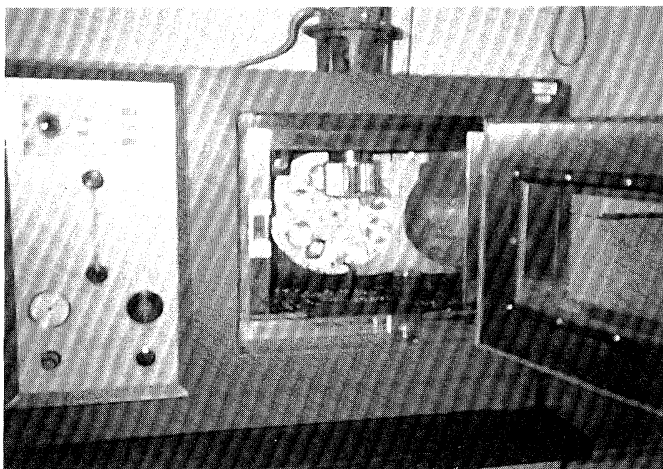

The rolling thin film oven equipment is used to simulate hardening of asphalt cement during mixing of HMA.

AR GRADING

**AR-10, AR-20, AR-40,
AR-80, AR-160**

AR- #
1/100 midpoint of
viscosity after aging,
AR-40, viscosity range
3,000 to 5,000 poises
Aged residue

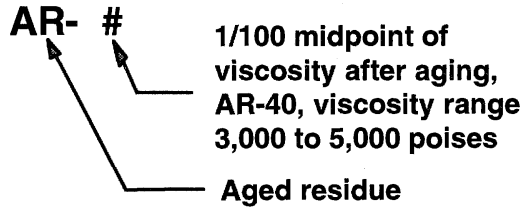

AR grades are specified by the midpoint of the allowable viscosity range. The allowable tolerance is plus or minus 25 percent of the midpoint.

SUPERPAVE

**Performance Grading based on
“highest” and “lowest” expected
pavement temperatures.**

A new asphalt cement grading procedure was developed during the SHRP. However, this procedure will take time to gain wide acceptance, and so it is not covered in this workshop.

EMULSIONS

**Asphalt globules dispersed in
water and emulsifying agents.**

Asphalt emulsions consist of asphalt cement globules dispersed in water and emulsifying agents. The globules are formed by physically breaking down the asphalt cement in a colloidal mill. Emulsion asphalt typically has 60 to 70 percent asphalt residue, 30 to 40 percent water, and a fraction of a percent of emulsifying agent. Mixing the emulsion with aggregates or spraying it onto a pavement causes the asphalt globs to come together thus forming the binder.

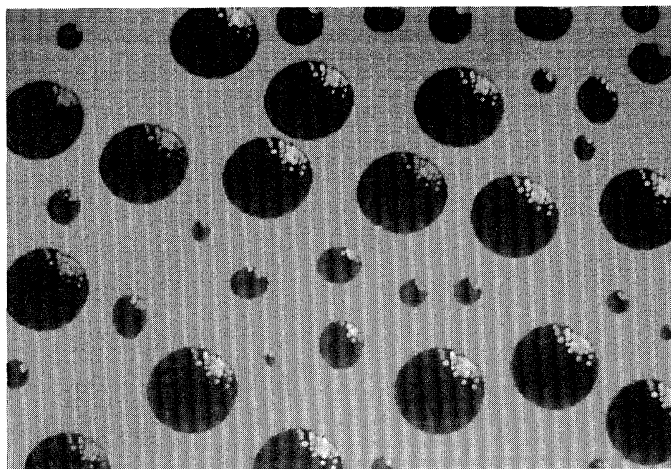

The asphalt cement is dispersed throughout the water carrying medium.

EMULSION TYPES

Depends on electrical charge of emulsifier and set rates

- ❖ **Anionic - negative**
- ❖ **Cationic - positive**
- ❖ **Nonionic - neutral**

Emulsion types reflect the charge of the emulsifying agent, the rate of setting, and the consistency of asphalt cement. Asphalt emulsions are manufactured with anionic, cationic, and nonionic charges. Anionic emulsions have a negative charge and are used with aggregates that have a positive charge.

EMULSION TYPES & GRADES

- | | |
|---------------------|-------------------|
| ◆ Anionic | ◆ Cationic |
| ❖ RS-1, RS-2 | ❖ CRS-1, CRS-2 |
| ❖ MS-1, MS-2, MS-2h | ❖ CMS-2, CMS-2h |
| ❖ HFMS-1, HFMS-2 | ❖ CSS-1, CSS-1h |
| ❖ HFMS-2h, HFMS-2s | |
| ❖ SS-1, SS-1h | |

ASTM has specifications for rapid, medium, and slow set emulsions with either positive or negative charges.

In addition, there are high-float emulsions that have a quality, imparted by the addition of certain chemicals, that permits a thicker asphalt film on the aggregate particles with minimum probability of drainage.

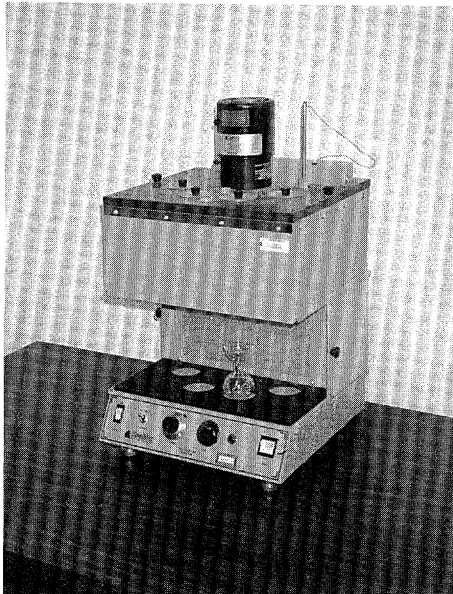

The Saybolt-Furol device is used to measure the viscosity of emulsions. In this test, the amount of time required for a fixed amount of material to flow through a calibrated orifice is measured.

EMULSION NOMENCLATURE

CMS -1h

h = hard asphalt residue, s = soft

1,2 = indicates emulsion viscosity

M = medium set, R = rapid, S = slow

C = cationic, HF = high float

Emulsion names are coded to provide information about the characteristics of the emulsion. In the example shown on the slide, the first letter, "C", stands for a cationic emulsion. The next letter defines the set rate for the emulsion, in this case, the "M" is for a medium set emulsion. The "1" indicates a low viscosity emulsion as measured with the Saybolt-Furol test. The "h" at the end of the name indicates the penetration of the asphalt cement is in the range of 40 to 90.

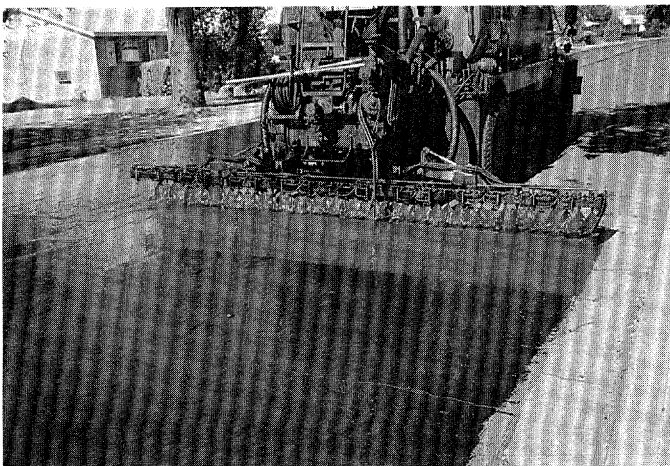

The emulsion mixture is brown. As the asphalt droplets coalesce, the mixture turns black.

QUICK SET EMULSIONS

- ◆ **Not an ASTM standard**
- ◆ **Widely used for slurry seals and micro-surfacing**

QS-1, QS-1h

CQS-1, CQS-1h

In addition to ASTM standards, there are several other emulsions available on the market. One of the most popular is the Quick Set Emulsion used for slurry seals. QS emulsions are available with anionic and cationic charges and normal and hard grade asphalt cement. The allowable Saybolt-Furol viscosity range of the QS is lower than that of other emulsions, but there is an overlap; e.g., QS-1 is allowed to be in the range of 15 to 90 sec., whereas SS-1 is in the range of 20 to 100.

RAPID-SET APPLICATIONS

- ◆ **Chip seal**
- ◆ **Sand seal**

Rapid-set emulsions are used to minimize construction time. They are used for chip seals, sand seals, and seal coats.

MEDIUM-SET APPLICATIONS

- ◆ **Crack sealing**
- ◆ **Sand seal coat**

Medium-set emulsions are used for crack sealing and sand seal coats.

SLOW-SET APPLICATIONS

- ◆ Slurry seal
- ◆ Fog seal

Prior to the development of quick-set emulsions, slow sets were used for slurry seals. In addition, slow-set emulsions are used for fog seals. The slow-set emulsions remain in the emulsion form longer, thereby, allowing more time for the emulsion to penetrate into small cracks.

BINDER MODIFIERS

Special binder characteristics

- ❖ temperature-susceptibility
- ❖ aggregate bonding
- ❖ elasticity

A variety of products are available to modify the characteristics of asphalt cement. Generally, these modifiers attempt to alter the temperature-viscosity, aggregate bonding, and elasticity of asphalt cement. Rubber is one of the most widely used modifiers. It can be from either ground tires or a natural latex product. Several types of plastics are used to increase mix stiffness and reduce rutting potential.

AGGREGATES

Characteristics

- ❖ Gradation
- ❖ Shape
- ❖ Surface Texture
- ❖ Toughness & Hardness
- ❖ Porosity

The quality of aggregates is evaluated based on gradation, shape, surface texture, toughness, and porosity.

GRADATION

- ❖ Dense grade
- ❖ Open
- ❖ Gap
- ❖ One-sized

Gradation is the distribution of aggregate sizes.

EXAMPLE GRADATIONS

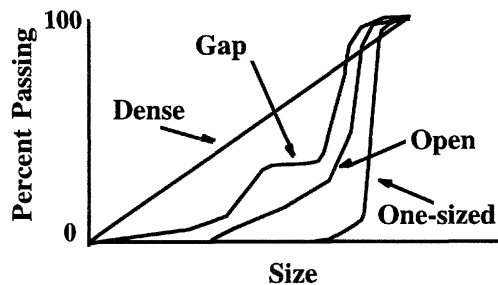

Four types of gradations are defined based on their shape on a sieve analysis chart. Well- or dense-graded aggregates have a distribution of aggregate sizes that give the maximum possible density. When the size axis has a power 0.45 scale, a maximum-density gradation aggregate plots as a straight line. One-sized aggregates are composed predominantly of one size of aggregate. Open-graded aggregates are missing fine materials and have high porosity. Gap-graded aggregates are missing one size of aggregate as shown by the horizontal portion of the distribution curve.

GRADATIONS USED FOR TREATMENTS

Dense	HMAC, Slurry Seals & Micro-surfacing
Gap	Stone Matrix Asphalt
Open	Open-Graded Friction Courses
One-size	Chip seals

Different treatment types use different aggregate distributions. Hot-mix asphalt concrete, HMAC, uses dense-graded aggregates. Actually, the gradation for HMAC varies off the maximum density line to create voids in the mineral aggregate that allow space for the binder. Slurry seals and micro-surfacing use well-graded fine aggregate. The binder modifier used with stone matrix asphalt requires gap grading of the aggregate. Open-graded aggregates are used for friction courses to increase the permeability of the asphalt concrete. One-size aggregates are used for chip seals.

SHAPE & TEXTURE

All preventive maintenance treatments require angular aggregates with rough texture.

Shape and texture control the stability of the mix. All preventive maintenance treatments require angular aggregates with high surface texture.

FLAKENESS

- ◆ **Ratio narrowest to widest dimension of the aggregate**
- ◆ **Long-narrow aggregates inhibit compaction**

Flakiness is the ratio of the longest to narrowest portion of the aggregate. Long-narrow aggregates inhibit compaction of asphalt concrete to a high density.

HARDNESS & TOUGHNESS

- ◆ **Resistance to mechanical degradation**
- ◆ **Los Angeles Abrasion test**

The ability of the aggregate to resist degradation due to traffic loads determines its hardness or toughness.



*Pavement Preventive
Maintenance Treatment*

Fog Seals

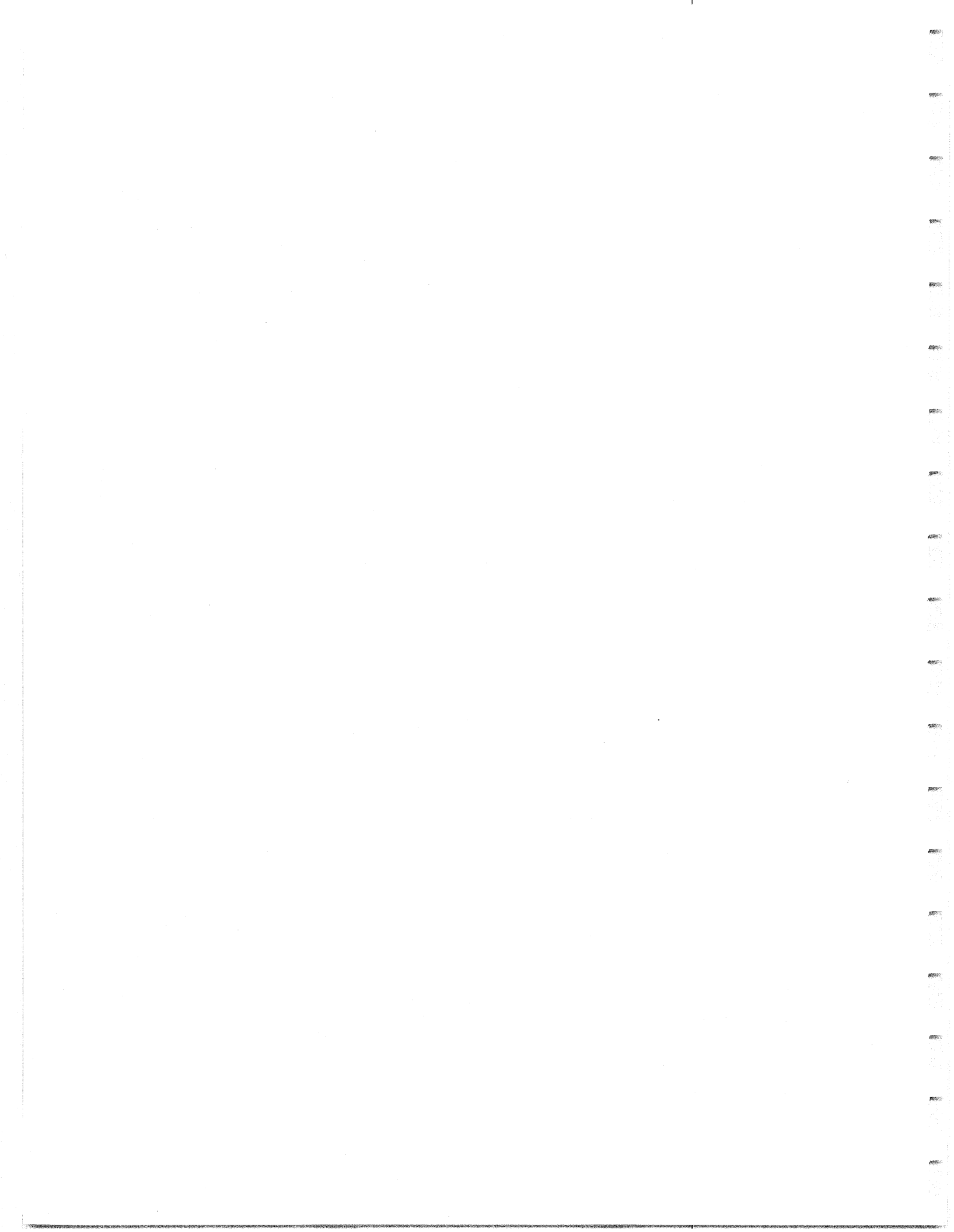

PREVENTIVE MAINTENANCE TREATMENT

FOG SEALS and REJUVENATORS

This session of the workshop covers fog seals and rejuvenators.

OBJECTIVES

- ◆ Discuss fog seal techniques
- ◆ Design / material selection
- ◆ Construction
- ◆ Performance
- ◆ Variations

The objective of this section is to discuss the proper techniques for fog sealing with respect to design and material selection, construction, and performance. The use of rejuvenators is also covered.

FOG SEAL

- ◆ Light application of diluted emulsion
- ◆ Renews surface
- ◆ Seals small cracks & voids
- ◆ Retards raveling
- ◆ Shoulder delineation

A fog seal is a light application of diluted asphalt emulsion. Fog seals are used on both low- and high-volume roads. Fog seals are used to:

1. Renew old asphalt surfaces;
2. Seal small cracks and surface voids;
3. Prevent raveling of chip seals, pavement laid in cold weather, and open-graded surfaces in high-volume roads; and
4. Maintain and delineate shoulders in high-volume roads.

PAVEMENT CONDITIONS

- ◆ **Porous surface**
- ◆ **Low / moderate raveling**
- ◆ **Low / high traffic volume**
- ◆ **High skid resistance**
- ◆ **Stable surface**

Fog seals are used only where the existing surface is sufficiently porous to absorb substantial amounts of the emulsion. Fog seals are generally applied to pavements displaying low- to moderate-severity weathering or raveling. Fog seals are used on both low- and high-volume roads. Fog seals should never be applied to a pavement that has low skid resistance or unstable asphalt concrete as indicated by rutting or shoving.

FOG SEAL MATERIALS

- ◆ **Diluted emulsion**
 - **Anionic / cationic**
 - **Slow / medium setting**
- ◆ **Proper consistency for application and filling cracks**
- ◆ **Possible sand cover**

The material used for fog seal is an anionic or cationic slow- or medium-setting emulsion diluted with an equal amount of water. The consistency of the material should be controlled to allow proper application, and promote flow into fine cracks and small voids. A sand cover may also be used to improve surface friction.

FOG SEAL APPLICATION

- ◆ **Application rate 0.45-0.70 l/m² depending on weathering**
- ◆ **Not too much**
- ◆ **Spray temperature = 20 - 60°C**

The application of the binder is usually kept at a low rate of 0.45 to 0.7 liters/m², depending on the degree of weathering of existing pavement. Heavier applications may cause splashing and decrease in skid resistance. A spray temperature of the emulsion between 20 to 60°C is recommended.

CONSTRUCTION CONSIDERATIONS

- ◆ **Pavement Preparation**
 - **Clean / no loose fragments**
 - **Dry surface**
- ◆ **Pavement temperature >15°C**
- ◆ **No rain threat**

Before applying the fog seal, the pavement surface needs to be cleaned using a power broom. The surface also has to be dry.

The fog seal should be applied when the temperature of the pavement surface is above 15°C and there is no threat of rain.



The pavement surface should be cleaned with a power broom prior to placing the fog seal.

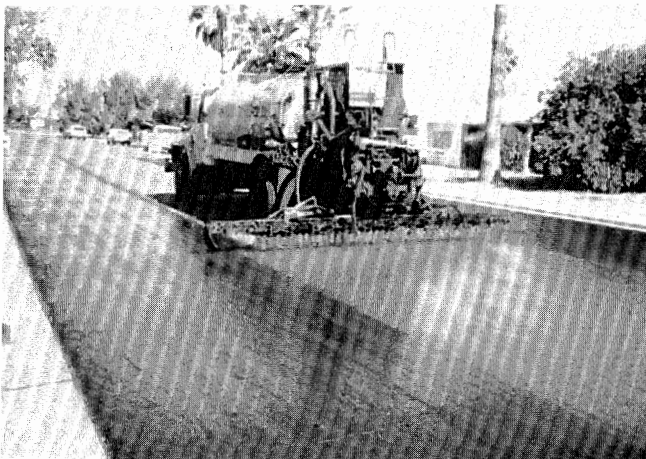

The emulsion is then sprayed onto the pavement surface with a calibrated distributor truck.

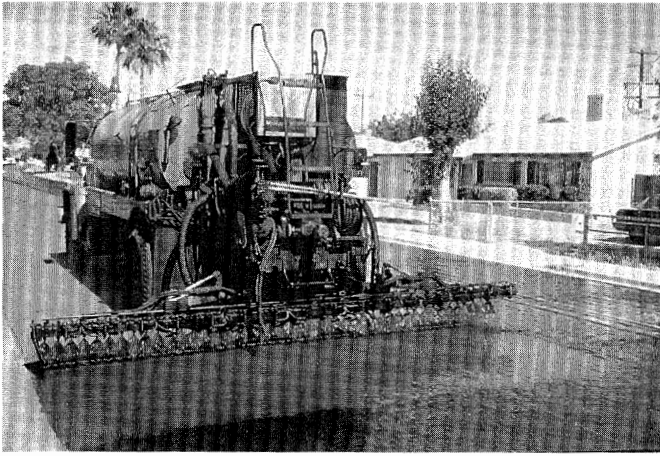

Notice the brown color of the emulsion before breaking and the black color after breaking.

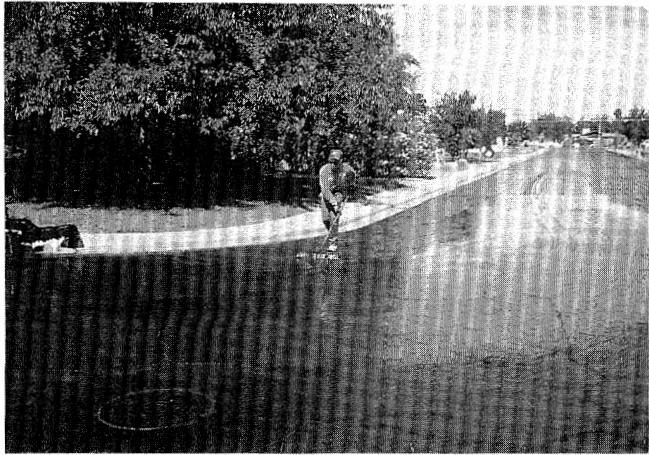

Handwork is sometimes required at the beginning or end of an application, and in corners or at intersections.

TRACKING

Use sand to prevent tracking at intersections and dirveways

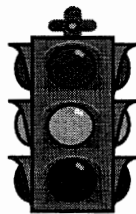

Sand can be applied at intersections and other cutouts to prevent tracking of the fresh emulsion.

TRAFFIC CONTROL

- ◆ Cures in 2 to 3 hours or more
- ◆ May initially reduce friction
- ◆ Better to initially reduce speed

Traffic should be rerouted until the emulsion has cured significantly. Under favorable conditions, 2 to 3 hours may be sufficient.

The use of fog seal on high-volume roads is restricted because friction may be initially reduced until traffic wears some of the asphalt from the surface. During this time, it is desirable to reduce traffic speed. In addition, under adverse weather conditions, it may be several hours before the road can be opened to traffic.

INSPECTION & ACCEPTANCE

- ◆ Materials
- ◆ Construction procedure
- ◆ Equipment
- ◆ Application rate
- ◆ Distributor speed

Before work begins equipment should be checked to ensure that it is in good working condition. Nozzles should be clean, clear, and at the correct angle; the spray bar should be at the correct height; and the pump set at the proper pressure. The spray bar should be calibrated prior to each use. Calibration is checked by spraying the emulsion on metal trays or sheets of heavy paper and weighing the amount of emulsion applied. To ensure uniform application, this process is repeated in both longitudinal and transverse directions. The asphalt distributor should be driven at the appropriate speed.

STATE SPECIFICATIONS

- ◆ Materials
- ◆ Application rate
- ◆ Construction requirements
- ◆ Weather conditions
- ◆ Method of measurement
- ◆ Basis of payment

Typical state specifications describe materials, application rates, construction requirements, weather conditions, method of measurement, and basis of payment. For example, the Arizona Department of Transportation requires the material to be diluted with one part water to two parts emulsified recycling agent.

PERFORMANCE & LIMITATIONS

- ◆ Fairly short life (1 - 2 years)
- ◆ Not effective for:
 - Large cracks
 - Low skid resistance
 - Rutting or shoving
 - Structural deficiency

Fog seals are not effective for long-term crack sealing. The average service life of fog seals is 1 to 2 years.

Fog seals must not be applied to pavements with large cracks, low skid resistance, rutting, shoving, or structural deficiency.

REJUVENATORS

Materials applied to aged, oxidized asphalt surfaces to:

- ◆ Rejuvenate surface
- ◆ Prevent raveling
- ◆ Coat stripped surface
- ◆ Potentially reduce crack development

Generally, rejuvenators are materials applied to the surface of aged, oxidized asphalt pavements. They rejuvenate the surface, prevent raveling, coat stripped surfaces, and may reduce crack development.

REJUVENATOR MATERIALS

- ◆ Proprietary
- ◆ Not proprietary such as
 - Recycling agents
 - Cationic oil in water emulsion of selected blend

Rejuvenating materials can be classified into two groups. The first group consists of proprietary materials that are sold by their trade names. The second group fits within general specification limits, such as those proposed for recycling agents by the Pacific Coast Conference on Asphalt Specifications, or materials that have been defined as "a fine-particle-size, cationic, oil-in-water emulsion of a selected blend of four principle fractions of maltenes."

REJUVENATOR LIMITATIONS

- ◆ **Same as fog seals**
- ◆ **Potential of damaging surface**
- ◆ **Always construct a test strip**

Rejuvenating agents may cause a skid hazard if applied in excess. They should not be used if the pavement: 1) contains excess asphalt; 2) is distorted, corrugated or shows signs of instability; or 3) is structurally deficient as may be indicated by alligator cracking.

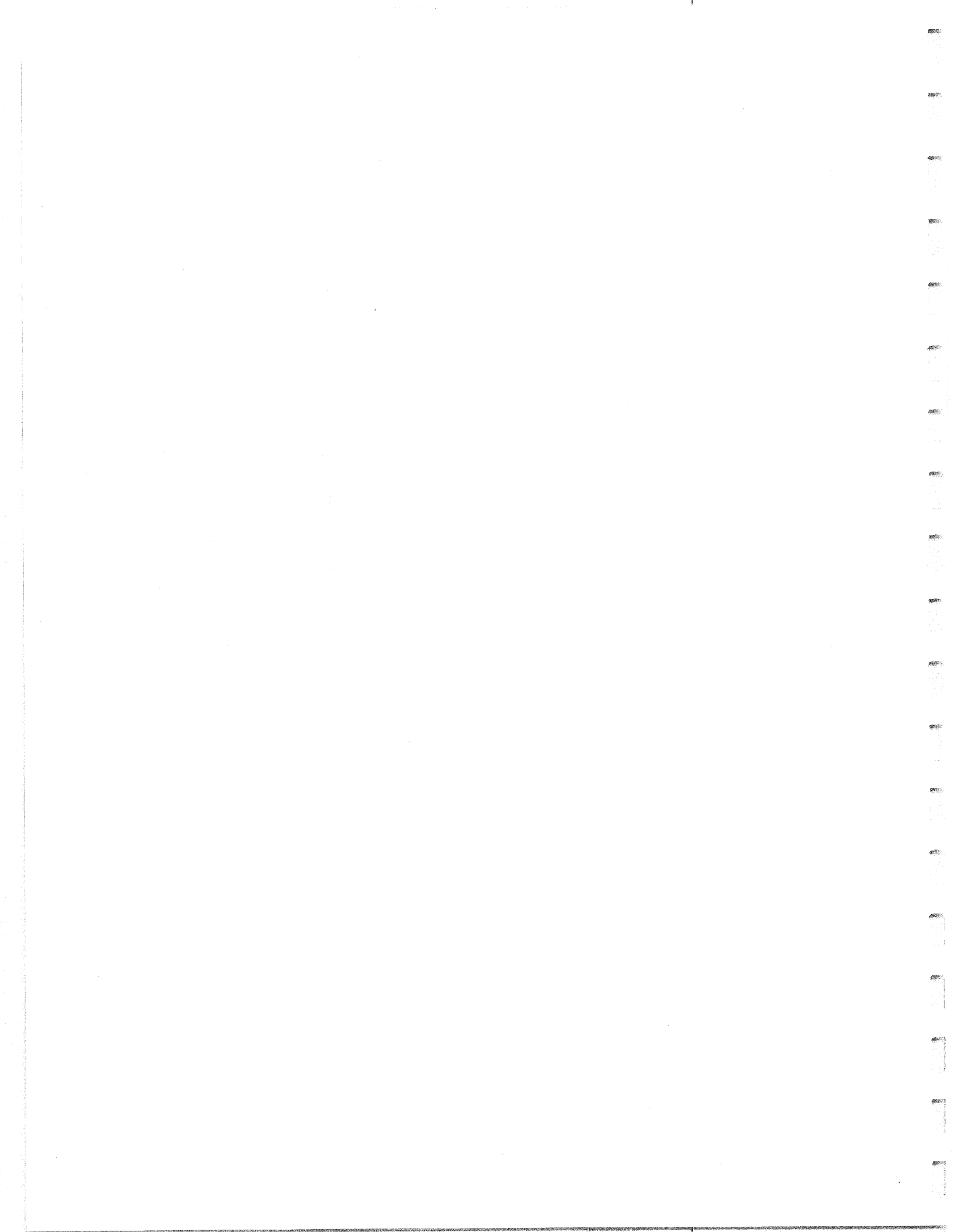

*Pavement Preventive
Maintenance Treatment*

Chip Seals

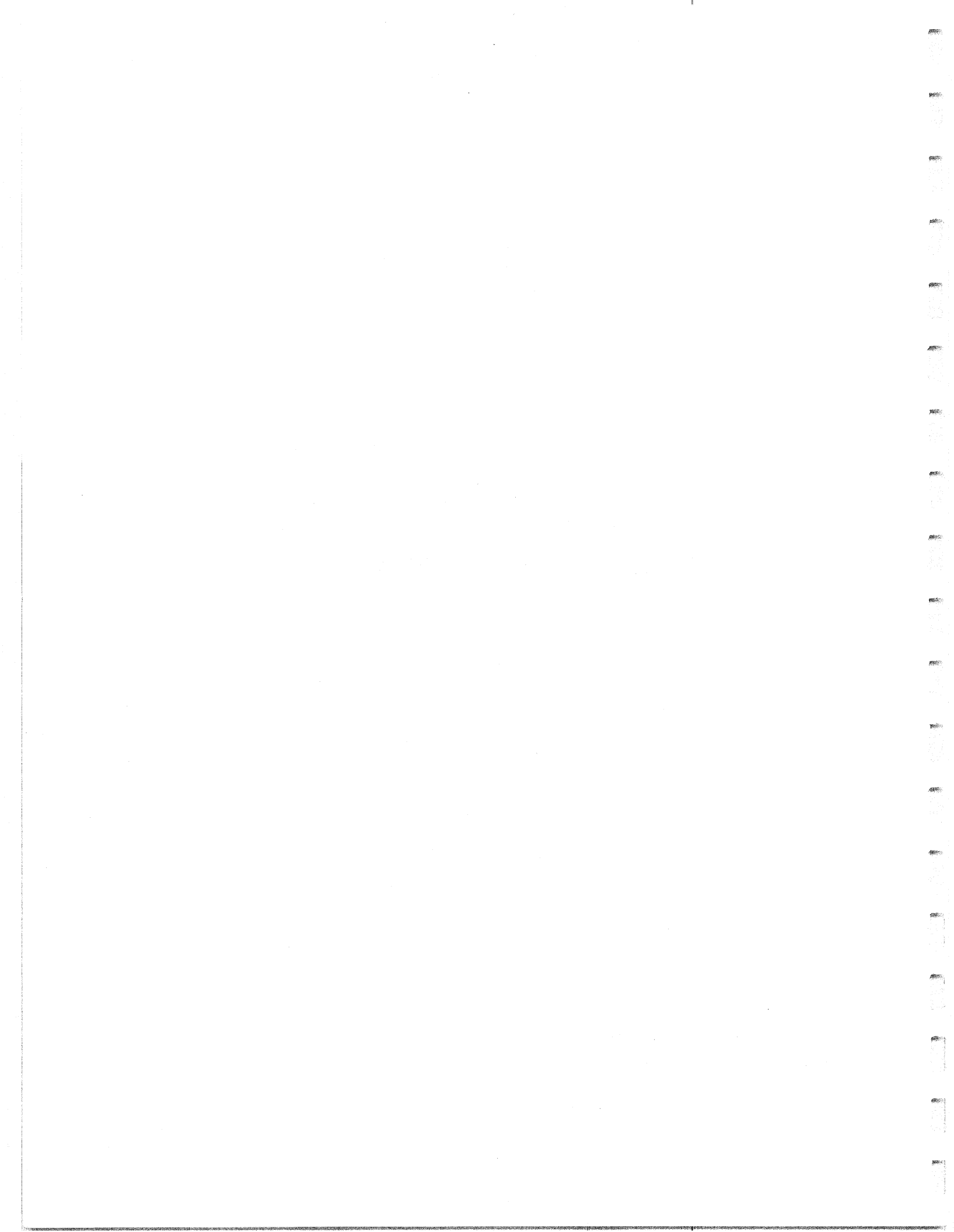

PREVENTIVE MAINTENANCE TREATMENT

CHIP SEALS

This session presents information on chip seals and related treatments.

OBJECTIVES

- ◆ **Chip seal techniques**
- ◆ **Design / material selection**
- ◆ **Construction**
- ◆ **Variations**
- ◆ **U.S. and other experience**

The objective of this section is to present proper techniques for chip sealing with respect to material selection, design, and construction. Variations of chip seal applications will be shown, including single, double and triple chip seals; modified binders; precoated aggregates; sand seal; and sandwich seal. The experience in the U.S. and other countries will also be discussed.

CHIP SEAL

- ◆ **An application of asphalt binder covered by a layer of one-size aggregate**
- ◆ **Also known as surface treatment, seal coat, or armor coating**

A single chip seal is a sprayed application of asphalt binder immediately covered by a single layer of aggregate of uniform size.

USES OF CHIP SEALS

- ◆ **Wearing course**
- ◆ **Waterproofing the surface**
- ◆ **Sealing small cracks**
- ◆ **Improving surface friction**

The chip seal course is used as a wearing course. It also waterproofs the surface, seals small cracks, and improves the surface friction.

USE ON HIGH-VOLUME ROADS

- ◆ **Limited use due to:**
 - **Possible vehicle damage**
 - **Lack of Federal aid**
 - **Lack of effectiveness data**
 - **Short & variable life**
- ◆ **Getting more common**

Chip sealing is widely used for low-volume roads. In spite of its benefits, chip sealing has not been widely used in high volume highways due to the possibility of loose chips damaging vehicles, lack of Federal aid, lack of effectiveness data, relatively short performance life, and variable life expectancy. The use of chip sealing on high-volume roads has become more common in recent years. A recent study showed that 10 states use chip seal on high-traffic volume facilities.

CONSIDERATIONS FOR USE

- ◆ **Low to moderate traffic volume**
- ◆ **Loose chips**
- ◆ **Snow plow damage**
- ◆ **Increased noise level**
- ◆ **Variable life expectancy**
- ◆ **Extended traffic control**

When selecting the chip seal as a preventive maintenance treatment, the following factors have to be considered. Chip seal is best suited for low- to moderate-traffic volume. Loose chips may cause windshield damage, and snow plowing can scrape chips off of the pavement surface, thereby reducing the effectiveness of the chip seal. Chip seals increase tire-pavement noise levels due to its course texture. The expected performance life of chip sealed pavements varies from one case to another. Finally, chip seal construction requires traffic control for an extended period of time. The speed of vehicles on the fresh chip seal must be controlled in order to prevent traffic from tearing the stones off the surface.

SHRP EXPERIENCE

- ◆ **No uniform design method**
- ◆ **Design method should consider aggregate embedment**
- ◆ **Upper and lower temperature limits**
- ◆ **Calibrate equipment**

Chip seals were constructed during SHRP research with mixed success: 1/4 of sections failed, surviving sections have shown good performance. There is a need for uniform design procedures that include aggregate embedment as a design factor. Upper and lower temperature limits should be included in the specifications. Equipment is not being routinely calibrated.

PAVEMENT CONDITION FOR SUCCESSFUL CHIP SEAL

- ◆ **Structurally sound**
- ◆ **Patched and cured**
- ◆ **Clean surface with no loose fragments**
- ◆ **Dry surface**
- ◆ **Pavement temperature > 20°C**

Since chip seal does not significantly increase the structural capability of pavement, the existing pavement must be structurally sound in order to obtain a long performance life. The existing pavement has to be repaired, patched, and allowed to cure before applying the chip seal. The existing surface has to be clean with no loose fragments. The pavement surface also has to be dry, with a temperature of more than 20°C.

BINDER SELECTION

- ◆ **Rapid-setting emulsion, asphalt cement, or cutback**
- ◆ **Emulsion is preferred:**
 - **Used with damp aggregates**
 - **Environmental reasons**
 - **Cost**

The binder used for chip seals is usually rapid-setting emulsion, although medium-setting emulsion could be used with fine aggregates. Asphalt cutback or asphalt cement can also be used. Asphalt emulsion is preferred over asphalt cement, since it can be used with damp aggregates. Emulsion is also preferred over cutback based on environmental concerns and a slight savings in cost.

AGGREGATE FOR CHIP SEALS

- ◆ **One-sized aggregates (9.5 mm)**
- ◆ **Cubic particle shape**
- ◆ **Resistant to abrasion and degradation**
- ◆ **Several states use precoated aggregates**

The aggregates used for chip seals have to be one-sized (about 9.5 mm) in order to provide good stability and maximum contact with tires. Cubic particles are preferred for the same reasons. Aggregates also have to have good resistance to abrasion and degradation to resist traffic traction and impact.

About six states routinely use precoated aggregate on high-volume roads in order to provide better bond between asphalt and aggregate and eliminate the dust during construction.

ASTM D1139 REQUIREMENTS

- | | |
|--|--------------|
| ◆ LA abrasion | 40% - |
| ◆ Two crushed faces | 60%+ |
| ◆ Sodium sulfate soundness | 12% - |
| ◆ Magnes. sulfate soundness | 18% - |
| ◆ Clay lumps, friable particles | 3% - |
| ◆ Flat or elongated pieces | 10% - |

ASTM D1139 stipulates the following requirements for aggregates.

LA abrasion	40% max.
Two crushed faces	60% min.
Sodium sulfate soundness	12% max.
Magnesium sulfate soundness	18% max.
Clay lumps, friable particles	3% max.
Flat or elongated pieces (for sizes No. 5, 6, and 7)	10% max.

APPLICATION RATE

- ◆ **Find proper application rates**
- ◆ **Enough asphalt to hold aggregate, but not so much that it will bleed**
- ◆ **Either mathematical or lab procedure**

Before construction, the chip seal has to be designed in order to find the proper application rates for both asphalt binder and aggregates. The asphalt quantity must be sufficient to hold the aggregate particles without raveling, but not so much that it would bleed. Both mathematical and laboratory procedures are available for designing chip seals.

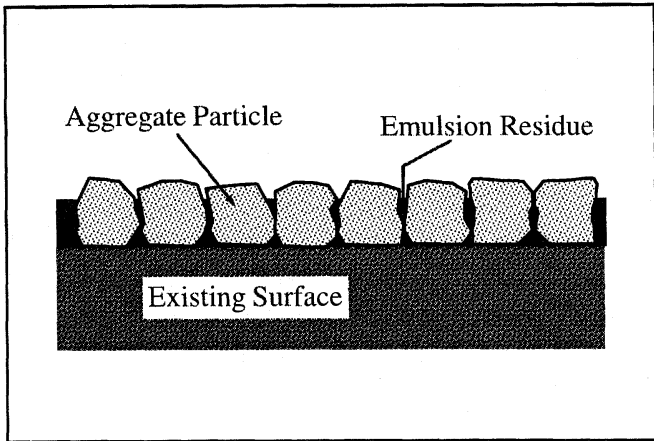

Aggregate and asphalt application rates are controlled in such a way as to produce a surface one stone thick with enough asphalt to hold the aggregate in place, but not so much that it will bleed. The binder should fill the voids between aggregate particles about 2/3 to 3/4 of the depth. An embedment depth of aggregate into the asphalt film of 50 to 70 percent is typical.

APPLICATION RATES

Agg. Nom. Size (mm)	AASHTO Size No.	Agg. (kg/m ²)	Emulsion (l/m ²)
19 -9.5	6	22-27	1.8-2.3
12.5-4.75	7	14-16	1.4-2.0
9.5 - 2.36	8	11-14	0.9-1.6
4.75-1.18	9	8-11	0.7-1.9
Sand	M-6	5-8	

This slide shows typical application rates for aggregate and asphalt emulsions as a binder according to the recommendations of the Asphalt Emulsion Manufacturers Association. Similar rates are recommended by ASTM D1369. Note that when the nominal aggregate size decreases, both aggregate and binder quantities decrease.

APPLICATION RATES (Cont.)

Agg. Nom. Size (mm)	AASHTO Size No.	Agg. (kg/m ²)	AC (l/m ²)
19.0-9.5	6	22-27	1.6-2.0
12.5-4.75	7	14-16	0.9-1.4
9.5-2.36	8	11-14	0.7-1.1

This slide shows typical application rates for aggregate and asphalt cement as a binder.

ADJUST RATES FOR:

- ◆ **Local experience**
- ◆ **Surface condition**
- ◆ **Traffic volume**
- ◆ **Specific gravity of aggregate**
- ◆ **Aggregate size**
- ◆ **Aggregate precoating**

The material quantities shown in the last two tables should be adjusted for specific job conditions. Local experience is often the best guide to determining the amount of binder needed. Asphalt should be increased for absorbent or badly cracked surfaces, or decreased if the surface is with flushed asphalt. If the aggregate specific gravity is outside of the range of 2.55 and 2.75, the amounts of aggregate shown in the table should adjusted. If the aggregate has a gradation on the fine side of the specified range, a binder rate closer to the lower limit of the quantity range should be used. Precoating aggregate reduces the amount of binder required to coat the aggregate during the chip seal construction.

LABORATORY DESIGN

- ◆ **1 m x 1 m x 25 mm pan**
- ◆ **Place one layer of aggregate**
- ◆ **Fill with water to top of aggregate**
- ◆ **Volume of binder is 2/3 of water**
- ◆ **Adjust binder rate to road condition and traffic volume**

The application rates for aggregates and emulsions can be determined in the laboratory. Aggregate spread rate is determined by weighing the amount of aggregate required to cover an 1 m² pan. The pan is then filled with water until the surface of the water comes just to the top of the aggregate. The quantity of binder is approximately two-thirds of the water volume. This binder quantity is adjusted for surface condition and traffic volume. The quantity of asphalt should be increased if the road is absorbent or badly cracked, and decreased if the road is flushed. The binder content is reduced for high traffic volumes.

PREPARATION & WEATHER

- ◆ **Survey pavement condition**
- ◆ **Patch, seal, and cure**
- ◆ **Air temperature > 10°C**
- ◆ **Pavement temperature > 20°C**
- ◆ **Dry surface**
- ◆ **No threat of rain**

Before applying the chip seal the condition of the existing pavement must be surveyed. Damaged areas must be patched and wide cracks sealed. After curing, the surface is to be cleaned with a power broom. Many specifications require the air temperature be at least 10°C before chip sealing begins. Some require a road surface temperature above 20°C before work starts. Chip sealing should never be started when the surface is wet or when it is threatening to rain.



Existing pavement must be repaired and cured before applying the chip seal.

CONSTRUCTION PROCEDURE

- ◆ **Clean with power broom**
- ◆ **Spray binder**
- ◆ **Spread aggregate immediately**
- ◆ **Roll immediately**
- ◆ **Allow binder to cure**
- ◆ **Sweep excess aggregate**

It is important to follow correct construction procedures in order to obtain long-lasting chip seal application.

Asphalt binder is sprayed, after which aggregate is immediately spread. The pavement is then rolled immediately to embed aggregate and orient particles on their flat side. After the binder is cured, sweep excess aggregate. Excess aggregate can cause dislodgment of the other aggregate.

EQUIPMENT

- ◆ **Trucks**
- ◆ **Asphalt distributor**
- ◆ **Chip spreader**
- ◆ **Rollers**
- ◆ **Power brooms**

The main pieces of equipment are trucks, asphalt distributor, chip spreader, rollers, and power brooms.



Existing pavement needs to be cleaned before chip sealing.

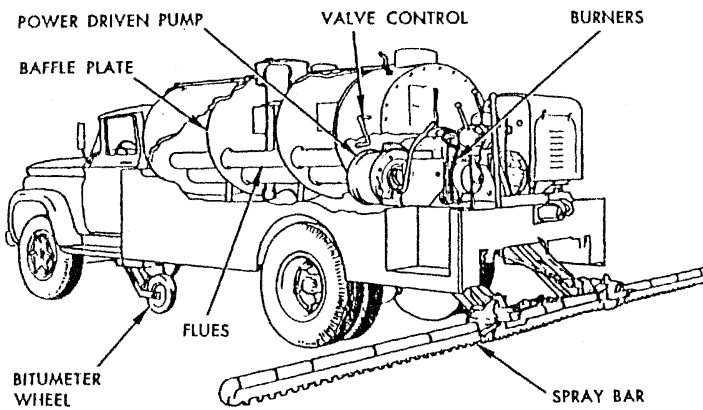

The asphalt distributor consists of an insulated tank, asphalt pump, spray bar and nozzles, bitumeter wheel, and controls. Most distributors are equipped with a heating system that will maintain the binder at the proper temperature. The asphalt distributor is equipped with a control system that governs the flow of material, a pump tachometer or a pressure gauge that registers the pump output, and a bitumeter. The bitumeter displays the rate and cumulative traveled distance. The bitumeter should be kept clean and checked for accuracy at regular intervals.



This slide shows the equipment just prior to the start of the job. Equipment consists of trucks, asphalt distributor, chip spreader, rollers, and brooming devices. Sufficient trucks must be available in order to ensure continuous operation without stopping.

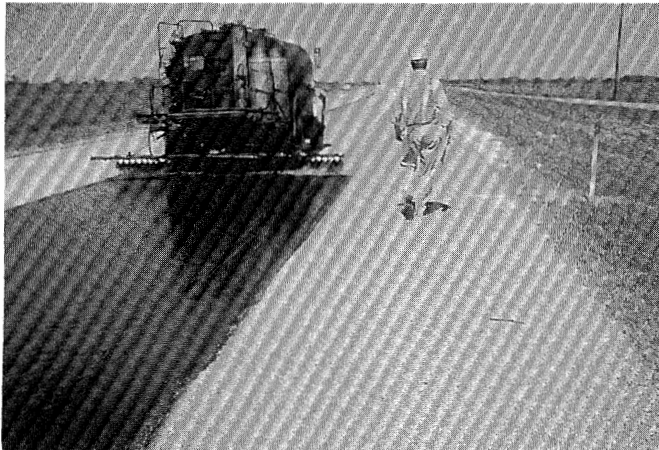

This slide shows an asphalt distributor in operation. The typical capacity of the truck varies from 3,000 to 20,000 liters. The spray bar can cover a width of 3 to 9 m in a single pass, depending on pump capacity. In order to obtain proper embedment and a good bond between asphalt and aggregate, the distributor should not be permitted to advance more than 30 to 40 m ahead of the aggregate spreader.

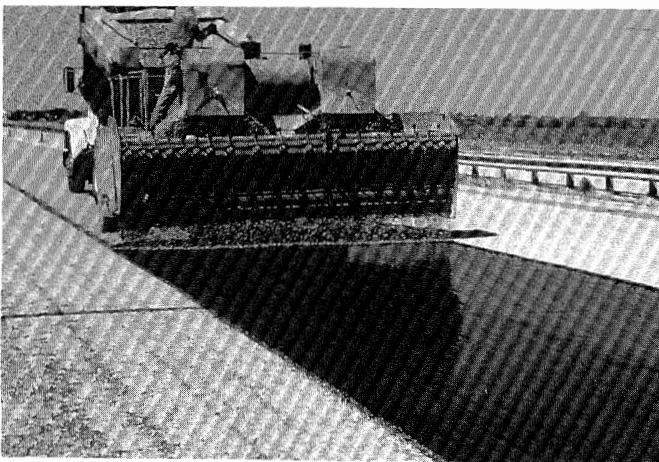

The chip spreader should follow the asphalt distributor immediately before emulsion breaks. The time between the application of binder and aggregate should not exceed 1 to 2 minutes. This time may be increased to 3 minutes, depending on temperature and humidity.

When two passes are required, it is good practice to spread the aggregate on the first half of the roadway so that a 100 to 150 mm strip of asphalt is left exposed along the center line. This will form a lap for the second pass.



This slide shows another typical chip seal operation.



The chip sealed pavement should have a uniform-single layer of chips that are embedded to 50% of their depth immediately following rolling.



Rolling should be performed immediately after spreading the chips to embed and orient them on their flat side. The rubber-tired rollers force the chips firmly into the binder and small depressions without crushing. Rollers weighing 6 to 8 metric tons are suitable. Adjust the tire pressure of rubber-tired rollers to manufacturer's recommendation. The roller speed should not exceed 10 km/h to avoid displacing the chips. The use of several rollers is preferred, so that full coverage can be accomplished in one pass. The required number of passes varies from one to five. Usually 2 to 4 passes are needed to produce good embedment of the chips. The last pass should be in the direction of traffic.

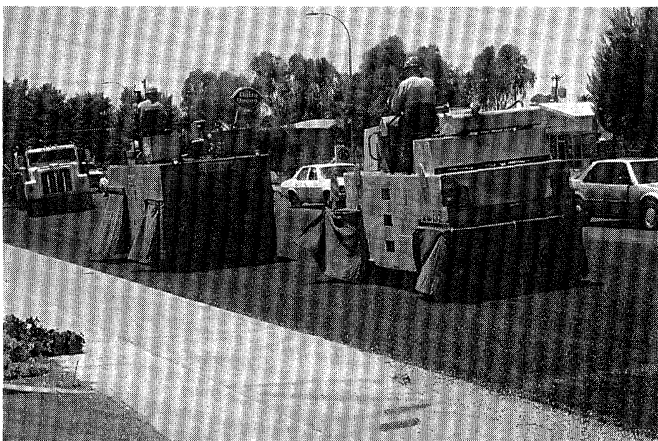

Sometimes rollers are covered to reduce the scatter of chips and to maintain the heat.

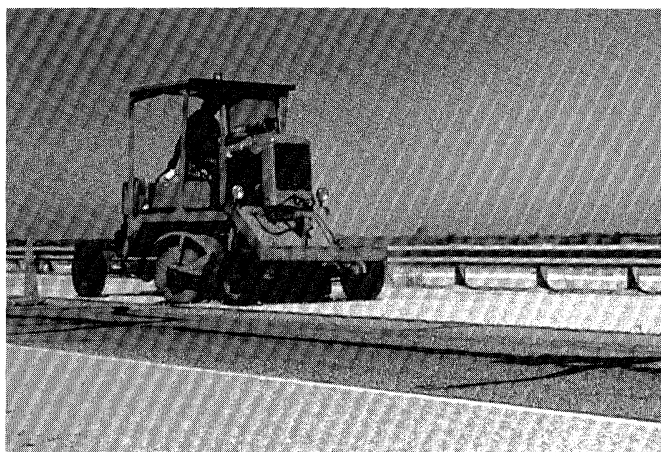

After the binder is set, excess chips are swept by light brooming. Rotary power brooms are recommended. The time required before brooming varies from one agency to another and generally ranging from one day to a few weeks. In any case, a good bond between binder and chips is a prerequisite. Brooming should be performed during the cooler morning hours. If embedment is low and there are signs of chip loss after brooming, a fog seal can be applied.

TRAFFIC CONTROL

- ◆ **Open road to traffic after rolling and removing excess aggregate**
- ◆ **Limit speed to 25 - 40 km/h for 2 hours**
- ◆ **Use pilot car**

The road may be opened to traffic after rolling is completed and excess aggregate is removed. Traffic speed should be limited to about 25 to 40 km/h for about 2 hours on newly placed chip seals. This time may be increased in humid weather or reduced if modifiers or asphalt cements are used. A pilot car can be used to control traffic speed.

INSPECTION & ACCEPTANCE

- ◆ **Nozzles are clear and at the correct angle**
- ◆ **Spray bar at correct height**
- ◆ **Pump at proper pressure**
- ◆ **Verify spray bar calibration**

Before work begins, equipment should be checked to make sure it is in good working condition. Nozzles should be clear and at the correct angle, the spray bar at the correct height, and the pump set at the proper pressure. Calibration of the spray bar should be verified.

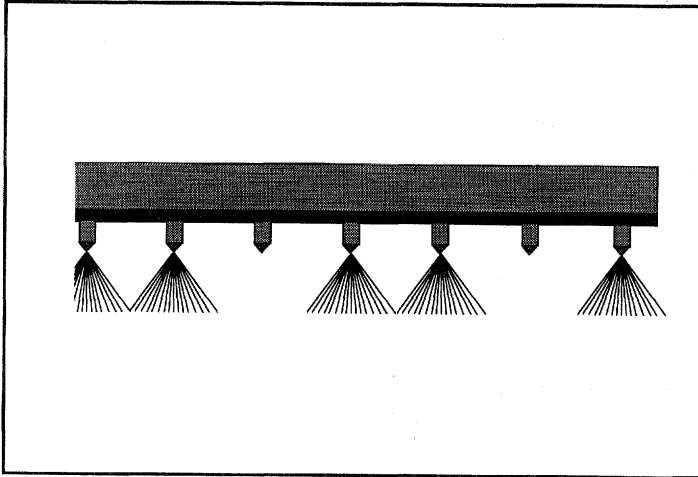

This slide shows a spray bar with plugged nozzles due to cold asphalt or imperfections. The use of plugged nozzles results in a non-uniform application of binder or uncovered longitudinal streaks.

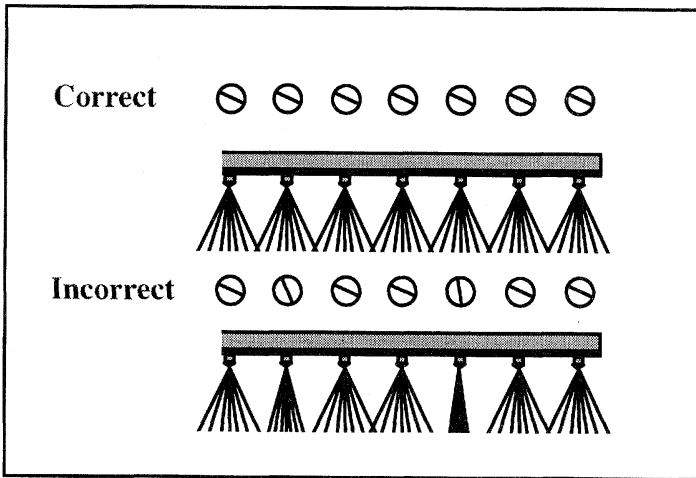

Nozzles have to be set at an angle so that the spray fans do not interfere with one another. The nozzle angle varies according to the make of the distributor, but is typically between 15 and 30 degrees. It is important that all nozzles be set at the proper angle within close tolerances in order to obtain a uniform application rate.

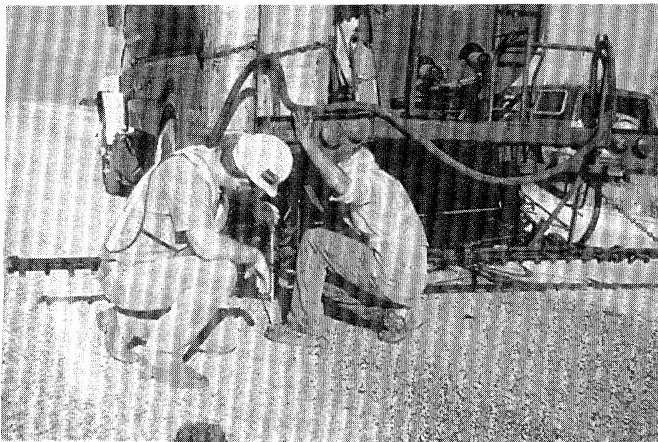

The height of the spray bar must be properly set and maintained to obtain a uniform spray and avoid longitudinal streaking. If the bar is not adjusted at the proper height, there will be areas that are either without asphalt or that receive excess asphalt.

The spray bar height should be adjusted to produce exactly single, double, or triple coverage. Double coverage is more suitable for a 100-mm nozzle spacing, but triple coverage can also be used. The spray bar height for triple coverage may permit wind distortion of the spray fans.

The height required to produce single coverage is determined by visual observation. To obtain double coverage, every other nozzle is turned off and the spray bar is raised in increments of 15 mm until single coverage is obtained. This height will produce double coverage when all nozzles are unplugged. Triple coverage can be obtained using a similar procedure, except that two out of every three nozzles are closed. Note that the height needed for double coverage is twice of that of single coverage, and that of triple coverage is 1.5 times that of double coverage.

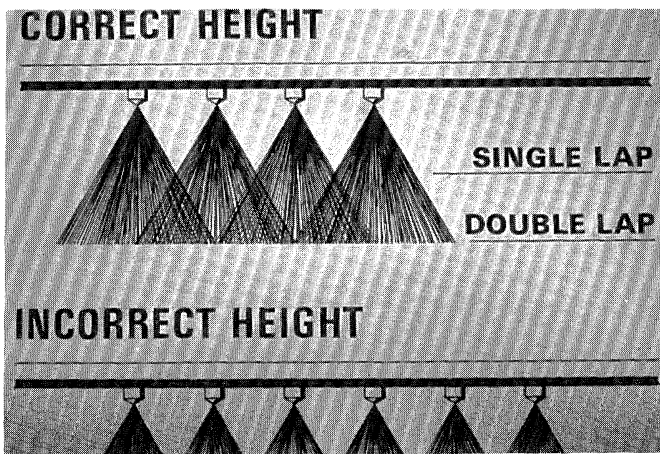

This slide shows the correct height of the spray bar. Nozzles with different application rates can be used in the wheel paths to avoid flushing.



The application rate of the spray bar should be calibrated prior to each use. Calibration is performed using pre-weighted metal trays or sheets of heavy paper to determine the amount of binder per unit area. To ensure uniform binder application, this process is repeated in both longitudinal and transverse directions.

INSPECTION & ACCEPTANCE

- ◆ **Proper temperature of asphalt**
- ◆ **Proper speed of asphalt distributor**
- ◆ **Aggregate spreader working properly**
- ◆ **Calibrate aggregate spreader**

Asphalt should be at the proper temperature before spraying. The asphalt distributor should be driven at the appropriate speed. The aggregate spreader should be checked to ensure proper working condition. The application rate of aggregate should be calibrated as shown in a later slide.

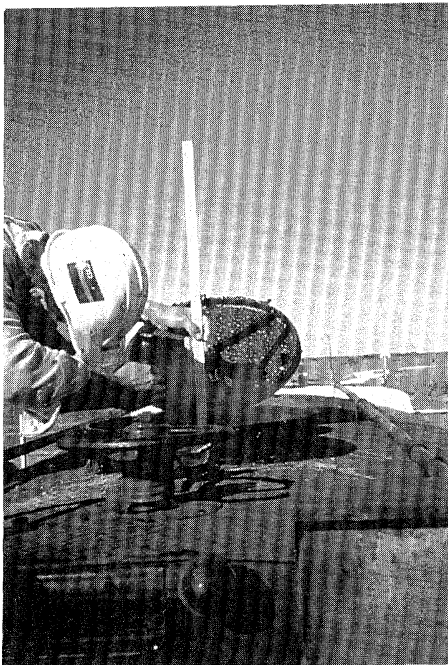

The asphalt binder should not be too hot or too cold. A typical range of binder temperature between 55 and 80°C is common when rapid setting emulsions are used. If asphalt cement is used, it is normally sprayed at temperatures of 130°C or higher. Both surface and air temperatures should not be below 15°C. Air temperatures of 40°C or higher may reduce the bond.

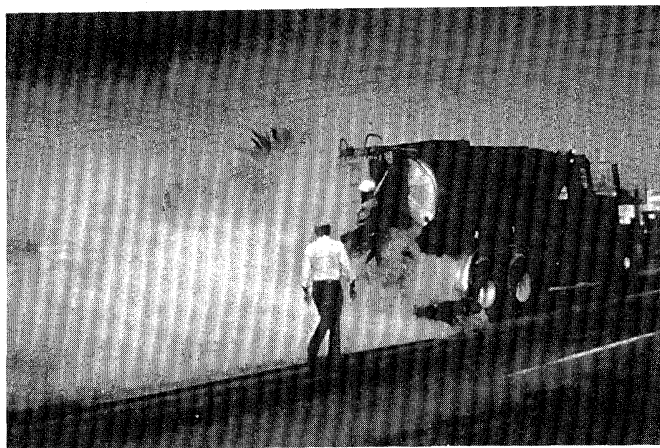

Overheating could prematurely break the emulsion, thereby reducing the bond with the aggregates. This slide shows an application where the binder is too hot as detected by the fumes.

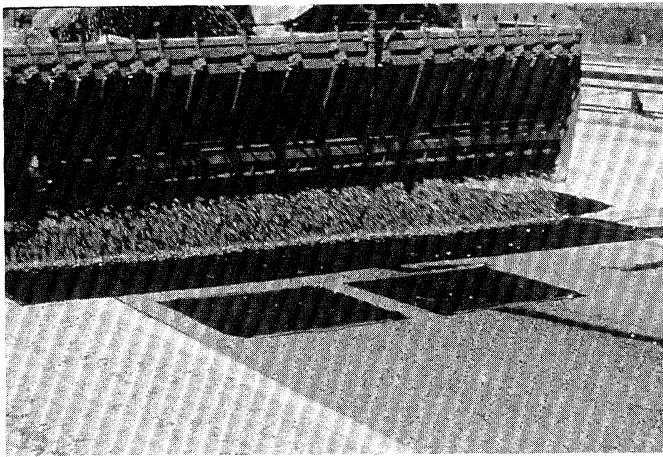

The aggregate spread rate should be adjusted to form a single layer. The rate of chip spreading and the consistency of spreading in both transverse and longitudinal directions should be checked prior to each application. Calibration of the chip spreaders can be accomplished by placing mats of known surface area (approximately 1 m²) in the path of the spreader. Chip quantities on each mat are weighed. Spreader gates are adjusted to disburse the desired quantity of chips. Calibration should be performed using the same aggregate used in the chip sealing.



A neat transverse joint can be obtained by using a paper strip at the start and end of the chip seal application.

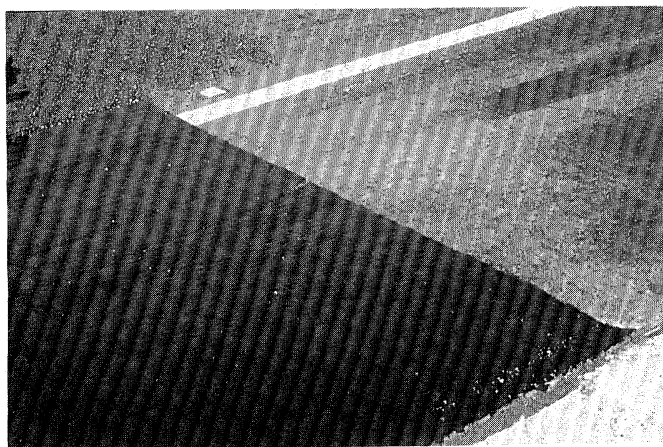

This is what the transverse joint should look like. Longitudinal joints can be eliminated by using full-width applications.

STATE SPECIFICATIONS

- ◆ **Materials**
- ◆ **Application rate**
- ◆ **Construction details**
- ◆ **Weather conditions**
- ◆ **Method of measurement**
- ◆ **Basis of payment**

Typical state specifications include descriptions of work, application rate, construction details, weather conditions, methods of measurement, and basis of payment.

CHIP SEAL PERFORMANCE

- ◆ **4 to 7 years on highways with 5,000 vpd/lane**
- ◆ **SHRP SPS-3 project**
- ◆ **Timing of application is critical**

Chip seals typically provide good performance on highways with 5,000 vpd for about 4 to 7 years. Several chip seal projects were constructed under the SHRP SPS-3 project. Preliminary indications show that timing of chip seal application is critical to its performance and cost-effectiveness.

PERFORMANCE (Cont.)

Performance depends on:

- ◆ **Traffic**
- ◆ **Pavement condition**
- ◆ **Aggregate size, rate, and type**
- ◆ **Binder type and rate**
- ◆ **Environmental conditions**

Chip seal performance has been mixed. It has performed for many years in some projects, whereas others failed relatively early. Performance varies depending on factors such as traffic volume and load; existing pavement condition; size, rate, and type of aggregate; type and rate of binder; and environmental conditions.

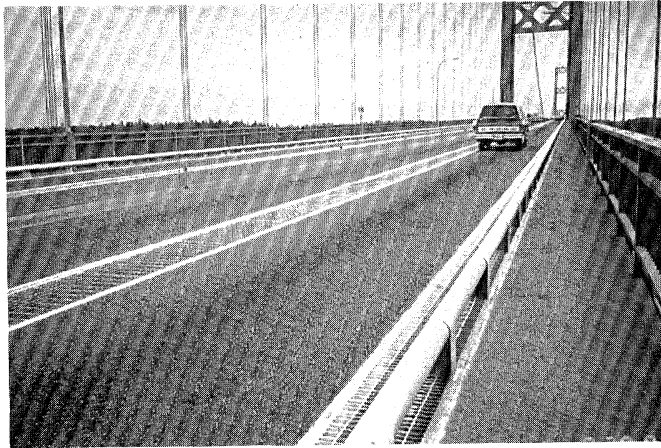

Chip sealing has been applied on many high traffic volume roads and bridges. This slide shows Tacoma Narrows bridge, which carries approximately 80,000 vehicles per day. A polymer-modified binder was used to allow early opening of the bridge.

CHIP SEALS ELSEWHERE

- ◆ **Polymer modified binders (Europe)**
- ◆ **Large aggregate (Australia, New Zealand, and South Africa)**

By and large, chip seals in Europe and other countries are similar to those in the U.S. However, polymer-modified binders are commonly used in Europe. In countries such as Australia, New Zealand, and South Africa, large stone aggregate is used to obtain long service life.

CHIP SEAL LIMITATIONS

- ◆ **Windshield damage**
- ◆ **Tire noise**
- ◆ **Prolonged traffic control**
- ◆ **Flushing or streaking**
- ◆ **Premature failure**
- ◆ **Aggregate cost**

If a chip seal is not properly designed or constructed, several problems can result. Windshield damage may occur if the chips are not adequately embedded in the asphalt, excessive stones are not swept, and traffic control is not maintained. Other problems include increased tire noise, prolonged traffic control during construction, flushing, streaking due to non-uniform binder application, and potential for premature failure, such as loss of chips by traffic wear or snow plow damage. Another limitation of chip seal applications is the cost of obtaining the one-sized aggregates needed for long-lasting chip seals.

VARIATIONS ON CHIP SEAL

- ◆ **Alternate binders**
- ◆ **Double and triple chip seals**
- ◆ **Precoated chips**
- ◆ **Sand seal**
- ◆ **Sandwich seal**
- ◆ **Cape seal**

Several variations can be used with the chip seal to address some of the previously noted problems. These variations include using single, double, or triple chip seals; modified binders; asphalt cement; precoated chips; sand seal; and sandwich seal. The use of multiple chip seals fills the voids between aggregate particles and increases service life.

Sand seal, sandwich seal, and cape seal are other alternatives to chip seals.

ALTERNATE BINDERS

- ◆ **Polymer modified emulsion**
- ◆ **Crumb-rubber modified asphalt**
- ◆ **Asphalt cement**

Some states, such as Arizona, California, Texas, and Washington, use polymer-modified chip seal on high-volume roads. Modified emulsion reduces temperature susceptibility, provides better adhesion to the existing surface, and allows the road to be opened to traffic earlier. Both recycled rubber and synthetic polymers have been used as modifiers. The use of asphalt cement as a binder also allows opening the road to traffic earlier. However, it increases the cost and requires clean aggregate and special equipment to achieve acceptable results.

MULTIPLE CHIP SEAL

- ◆ **2 or 3 alternate applications of asphalt and aggregate**
- ◆ **Each successive layer = 1/2 of preceding layer**

A double or triple chip seal consists of two or three alternate applications of asphalt and aggregate, respectively. The nominal top size of the cover aggregate for each successive course should not be more than one-half that of the preceding one. When using multiple chip seal applications, the first layer should be cured before application of the second layer.

Chip seal is also known as seal coat, surface treatment, or armor coating.

MULTIPLE CHIP SEAL (Cont.)

- ◆ **Layer thickness = Aggregate size of first course**
- ◆ **Double chip seal costs are 1 1/2 times that of single chip seal**
- ◆ **Double chip seals last > twice single chip seals**

The aggregate size of the first course determines surface layer thickness, while the aggregate in the following layers fills the voids in the preceding layers.

Double chip seals cost about 1 1/2 times more than single chip seals. However, double chip seals usually give more than twice the service life of single chip seals.

PRECOATED CHIPS

- ◆ **Eliminates dust**
- ◆ **Improves bond**
- ◆ **Coated chips should separate and flow readily thru spreader**

Precoated aggregate is used by some states such as Illinois, Oregon, Pennsylvania, Texas, Utah, Virginia and Arizona. Precoating eliminates surface dust and improves adhesion between aggregate and binder. Early adhesion is advantageous on high-volume roads to allow early opening of the road to traffic. In this case an asphalt cement content of about 0.75 to 1% by weight of chips and 90% or more coating are desired. A mixing temperature of about 140°C is recommended. Correctly coated aggregate particles should separate from each other easily and flow readily through spreaders.

SAND SEAL

- ◆ **Asphalt binder followed by sand cover $\leq 6.35\text{mm}$**
- ◆ **Binder is rapid or medium setting emulsion**
- ◆ **Mostly for low-volume roads**

Sand seal is an application of asphalt followed by a sand cover aggregate. The sand or stone screenings should be 6.35 mm sieve size or smaller. The binder used for sand seals is usually a rapid setting (anionic or cationic) or a medium setting (anionic or high-float) emulsion. Therefore, sand seal is essentially the same as chip seal, except that finer aggregate is used as cover. It has mostly been applied to low-volume roads. Some agencies have applied sand seals on moderate- to high-volume roads and have reported good performance.

USES OF SAND SEALS

- ◆ **Improve microtexture**
- ◆ **Renew old surfaces**
- ◆ **Seal small cracks and voids**
- ◆ **Retard raveling**
- ◆ **Maintain & delineate shoulders**

Sand seals are used to:

1. Improve surface friction;
2. Renew old asphalt surfaces;
3. Seal small cracks and surface voids;
4. Prevent raveling of chip seals, pavements laid in cold weather, and open-graded surfaces in high-volume roads; and
5. Maintain and delineate shoulders in high-volume roads.

SAND SEAL APPLICATION

- ◆ **Emulsion rate = 0.7 - 0.9 liters/m² depending on:**
 - **Texture of existing surface**
 - **Local conditions**
 - **Traffic**
- ◆ **Sand rate = 5 - 8 kg/ m²**

The rate of emulsion application varies from 0.7 to 0.9 liters/ m², depending on the texture of the existing surface, local conditions, and traffic. Sand is applied at a rate of about 5 to 8 kg/m².

CONSTRUCTION & PERFORMANCE

- ◆ **Surface Temperature 15°C+**
- ◆ **Pneumatic rollers**
- ◆ **Normally 2 - 3 hr lane closure**
- ◆ **Performance life = 3 - 6 years**

Sand seal should not be applied unless the surface temperature is at least 15°C. Pneumatic tire rollers are recommended. Two hours of lane closure is generally required under normal conditions. The performance life varies between 3 and 6 years. Variables include traffic, construction quality, materials, and environmental conditions.

SAND SEAL LIMITATIONS

- ◆ **No long-term crack sealing**
- ◆ **Excessive traffic control**
- ◆ **Difficulty in determining appropriate binder rate**
- ◆ **May not provide distinct delineation**

Among the limitations of sand seals is that the treatment is not effective for long-term crack sealing. The use of sand seals on high-volume roads is limited, due in some cases to excessive traffic control requirements and difficulty in determining the appropriate binder rate. In addition, sand seal may not provide the distinct delineation, depending on the aggregate color.

SANDWICH SEAL

**One application of binder
between two layers of aggregate**

Small Aggregate (2.36-4.75 mm)

Emulsion

Large Aggregate (4.75-9.5 mm)

Sandwich seal is an application of binder sandwiched between two layers of aggregate. In this process, one-sized aggregates 4.75 to 9.5 mm are spread on a clean and dry pavement at a rate of about 80% of the amount needed to provide coverage at one stone thickness and then compacted. Asphalt emulsion is then applied at a rate of 1.2 to 1.5 times the amount required for a conventional single-course treatment. A second course of one-sized 2.36 to 4.75 mm aggregate is applied and rolled.

SANDWICH SEAL CONSTRUCTION

- ◆ **Clean and dry pavement**
- ◆ **Clean aggregate**
- ◆ **Light-weight steel roller on bottom aggregate layer**
- ◆ **Slow-moving pneumatic roller on top aggregate layer**

Before applying the sandwich seal, the existing pavement must be clean and dry. All aggregates used in the sandwich seal application have to be clean. A light-weight steel roller may be used to seat the first layer of aggregate. A slow-moving pneumatic roller is used to compact the top aggregate layer.

SANDWICH SEAL USES

- ◆ **Seals pavements**
- ◆ **Improves skid resistance**
- ◆ **Same life as double chip seal**
- ◆ **More economical than double chip seal**

Sandwich seal is used for sealing high-traffic pavements and flushed pavements. It also improves skid resistance. Sandwich seal has approximately the same service life as the double chip seal. It is more economical than the double chip seal, however since only one application of binder is used.

CAPE SEAL

- ◆ **Chip seal topped with slurry seal or micro-surfacing**
- ◆ **Named after Cape Province of South Africa**

A cape seal is chip seal topped with a slurry seal or micro-surfacing. The name is derived from the Cape Province of South Africa where it was originally developed.

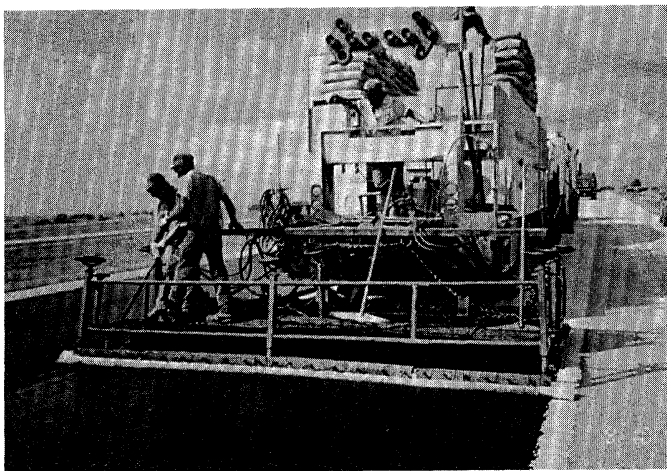

This slide shows a cape seal project where a chip seal is followed by micro-surfacing. A cure time of 4 to 10 days should be allowed between the two applications, unless asphalt cement is used with the chip seal.

PROPERTIES OF CAPE SEAL

- ◆ **Dense surface with improved skid resistance and a relatively long service life**
- ◆ **No loose cover stones**
- ◆ **More suited for high traffic volume roads**

The cape seal provides a dense surface with improved skid resistance and a relatively long service life. No loose cover stones are typically produced. These properties of cape seal make it very suitable for high traffic volume roads.

CAPE SEAL CONSTRUCTION

- ◆ **Apply single chip seal**
- ◆ **Cure for 4 - 10 days**
- ◆ **Broom regularly**
- ◆ **Apply slurry seal**
- ◆ **Cure for 2 -12 hr. depending on temperature**

A single course of chip seal is applied in the conventional manner. A cure time of 4 to 10 days is required for the chip seal before applying the slurry seal. During that time, the surface has to be regularly broomed in order to provide better adherence of the slurry. After the chip seal has been cured, the slurry seal is applied to fill the voids between the cover stones. After applying the slurry seal, traffic should be detoured for about 2 hours in warm weather, and 6-12 hours or more in cool weather.

CAPE SEAL APPLICATION

Rates for a 15 mm layer

- **Emulsion 1.4-2.0 liters/m²**
- **Chips 14-16 kg/m²**
- **Slurry mix 3-5.5 kg/m²**
(usually Type I)

For a 13 mm thick layer, the emulsion is applied at a rate of about 1.4 to 2.0 l/m², the chip at a rate of 14 to 16 kg/m², and the slurry mixture (usually type I) at a rate of 3 to 5.5 kg/m².

PERFORMANCE & LIMITATIONS

- ◆ **Better resistance to studded tires than chip seals**
- ◆ **Long construction time**

Test track data indicate better studded tire damage resistance than a chip seal.

One of the limitations of the cape seal is the need to restrict traffic flow twice for construction of the seal.

*Pavement Preventive
Maintenance Treatment*

Cold Thin Seals

Slurry Seals

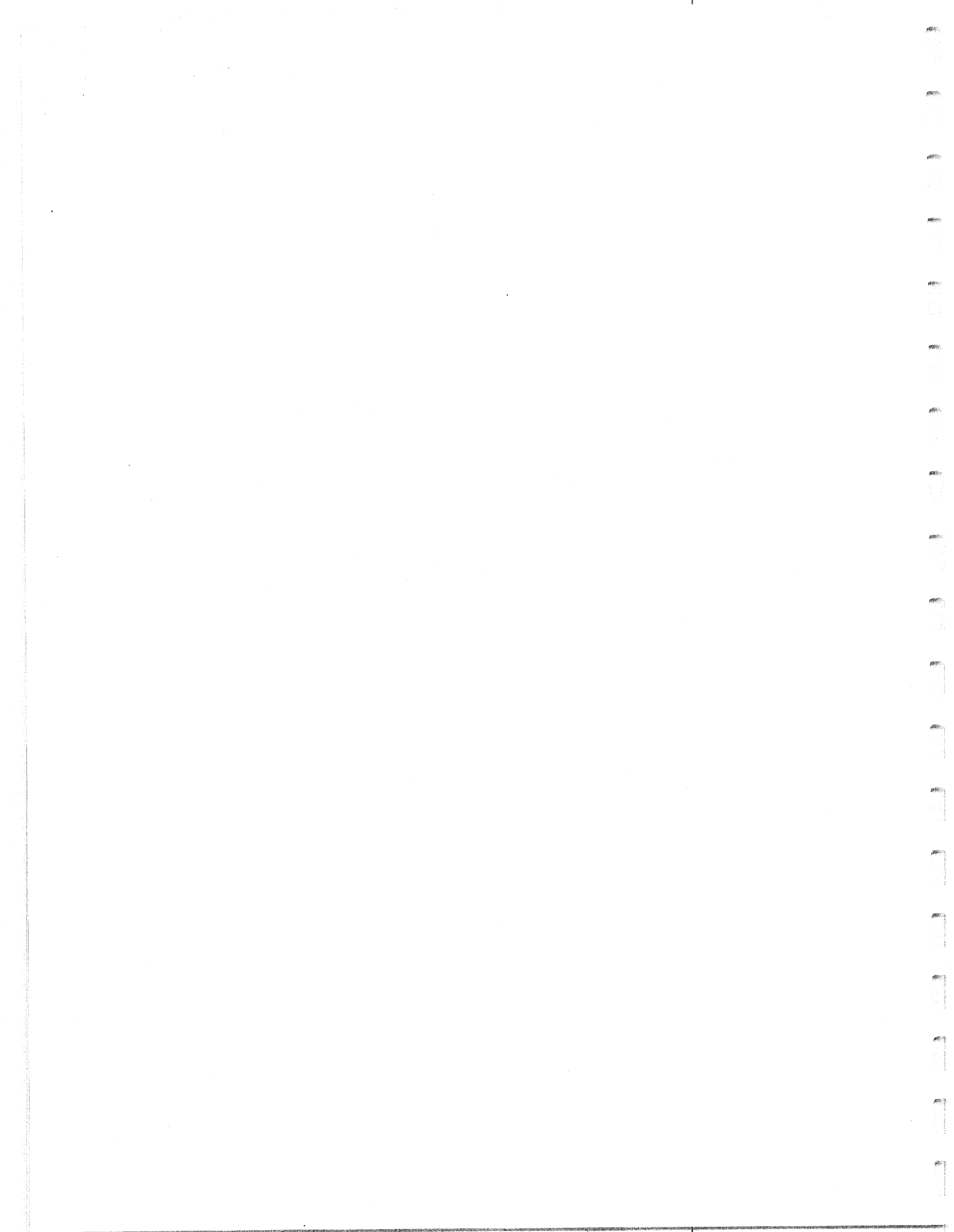

**PREVENTIVE MAINTENANCE
TREATMENT**

**COLD THIN
SEALS**

This section covers cold thin seals. Cold seals require combining asphalt emulsions with aggregate at the job site. There are many factors that control the quality of these treatments and operator skill is required in order to achieve sound results and good project performance.

OBJECTIVES

- ◆ Cold seal techniques
- ◆ Design / Material selection
- ◆ Construction
- ◆ Variations
- ◆ U.S. and other experience

The main objective of this section is to discuss the proper techniques for slurry seal with respect to material selection, design, and construction.

The experience in the U.S. and other countries will also be discussed.

COLD THIN SEALS

- ◆ Slurry seals
- ◆ Micro-surfacing

Cold thin seals consist of slurry seals and micro-surfacing.

COLD THIN SEALS

SLURRY SEALS



We will first talk about slurry seals and other related treatments.

SLURRY SEAL

A slurry mixture of:

- ◆ Quick or slow setting emulsion
- ◆ Well-graded fine aggregate
- ◆ Mineral filler (in most cases)
- ◆ Water
- ◆ Single Coat = 5 mm thick

Slurry seal is a mixture of slow or quick setting asphalt emulsion, well-graded fine aggregate, and mineral filler (in most cases) mixed with water to produce a slurry consistency. The thickness of a single coat of slurry seal is approximately 5 mm.

USES OF SLURRY SEALS

- ◆ Seals minor cracks and voids
- ◆ Retards surface raveling
- ◆ Improves surface friction
- ◆ Delineates pavement areas

Slurry seals are used for:

1. Sealing minor surface cracks and voids;
2. Retarding surface raveling;
3. Improving surface friction characteristics; and
4. Delineation of different pavement surface areas.

CONSIDERATIONS FOR USE

- ◆ **Mostly for city and county streets**
- ◆ **Few moderate- & high-volume roads**
- ◆ **1 to 2 hr. or more curing period**

Slurry seals are routinely applied on city and county streets. Only a few states have used slurry seals on moderate- and high-volume roads. At least one state has used slurry seal to cover open-graded friction course on Interstates and other high-volume roads. Slurry seals were also applied on moderate- to high-volume roads under SHRP Experiment SPS-3.

A curing period is necessary before allowing traffic on the slurred surface. Under warm conditions, slurry seals require 1 to 2 hours or more to cure.

SHRP EXPERIENCE

- ◆ **81 SHRP slurry seal test sections in U.S. and Canada (SPS-3 experiment)**
- ◆ **Generally improve pavement performance**

Single application slurry seals were applied to 81 SHRP test sections throughout the U.S. and Canada (SHRP SPS-3 experiment). These sections are now being evaluated under the FHWA's Long-Term Pavement Performance (LTPP) program. The slurry seals generally improve pavement performance relative to the control section..

CONDITIONS FOR SUCCESS

- ◆ **No cracks or movements under traffic**
- ◆ **No rutting or shoving**

To achieve a successful slurry seal application, the existing pavement should have no large cracks or movements under traffic. The pavement must also be stable, with no excessive rutting or shoving.

SLURRY SEAL TYPES

TYPE	GENERAL USAGE
I	Crack sealing (low traffic)
II	Corrects raveling (moderate to heavy traffic)
III	Fills minor irregularities & restores friction (heavy traffic)

The International Slurry Surfacing Association identifies three types of slurry seal with different aggregate gradations and percentages of asphalt residue. Type I is generally used for crack sealing in low traffic areas. Type II is used to correct raveling oxidation in moderate to heavy traffic areas. Type III is used to fill minor irregularities and restore friction. It is also used as the first course in multi-course applications for heavy traffic areas.

SLURRY CHARACTERISTICS

TYPE	I	II	III
Max. Size, mm	2.36	4.75	9.5
% Residue	10-16	7-13	6-12
Rate, kg/m²	3-5	5-8	8+
Filler =	0.5-2.0%		
Mixing Water =	6-11%		

Since increasing traffic volume requires the use of a higher order slurry type, moving from Types I, II, and III requires an increase in the maximum aggregate size, an increase in asphalt residue content, and an increase in the application rate as shown in this slide. Type I slurry has the finest aggregate gradation, while Type III has the coarsest gradation. Also, Type III produces maximum skid resistance and a superior wearing surface in comparison to slurry types.

Mineral fillers such as portland cement and hydrated lime are often used as stabilizers and to reduce the break time of the emulsion. Other additives may also be used to control break time. Quantities of water and additives depend on field conditions.

SLURRY SEAL MATERIALS

- ◆ **Quick setting emulsion**
- ◆ **Well-graded fine aggregate**
- ◆ **Mineral filler (in most cases)**
- ◆ **Water**
- ◆ **Additives to help setting**

The materials used to prepare the slurry seal mix are slow- or quick-setting asphalt emulsion, well-graded fine aggregate, mineral filler (in most cases), and water. Additives such as portland cement, hydrated lime, or aluminum sulfate liquids are often used in small quantities to help in setting the slurry.

SLURRY SEAL MIX DESIGN

- ◆ **Trial-and-error procedure**
- ◆ **Selection and testing of components**
- ◆ **Mixtures testing**
- ◆ **Optimum asphalt content**

The design of slurry seal mixture is currently performed using a trial-and-error procedure. This process usually results in an acceptable slurry mixture. The process consists of the following three steps: 1) selection and testing of the mixture components, mainly aggregate and emulsion; 2) testing of the slurry mixture to determine compatibility of the mixture components; and 3) determination of the optimum asphalt content. Detailed information on slurry seal design can be found in industry literature.

CONSTRUCTION CONSIDERATIONS

- ◆ **Seal cracks, patch, & cure**
- ◆ **Broom**
- ◆ **Tack coat if dry or raveled**
- ◆ **Continuous operation**
- ◆ **Pre--wet if hot weather**

Crack sealing and patching of the existing surface must be completed and allowed to cure prior to the application of a slurry seal. Since the slurry seal is very thin, crack sealing should be flush with, or just below, the pavement surface. Immediately prior to construction of the slurry seal, the pavement surface should be cleaned with a power broom. If the existing pavement is dry or raveled, a tack coat is used before the slurry seal application. During hot weather, if a tack coat is not used, the surface of the pavement should be dampened before the slurry seal is applied.

WEATHER CONDITIONS

- ◆ **Air temperature = 10°C+**
- ◆ **Pavement temperature = 10°C+**
- ◆ **No freezing within 24 hours**
- ◆ **No rain for several hours**

To obtain best performance, both air and pavement temperatures should be at least 10°C and there should be no chance of freezing within 24 hours after placement. Slurry seal should not also be applied during rain or if rain is expected before the slurry is set.

CONSTRUCTION EQUIPMENT

- ◆ Power broom
- ◆ Slurry machine to mix the materials and apply the slurry
- ◆ Possible rubber tired roller

A slurry machine is used to mix the materials in a form of slurry. The slurry is immediately applied to the paved surface. The power broom is required to clean the pavement immediately prior to placing the slurry. In some cases, a pneumatic roller is used to seat the material and promote rapid stiffening of the mix.

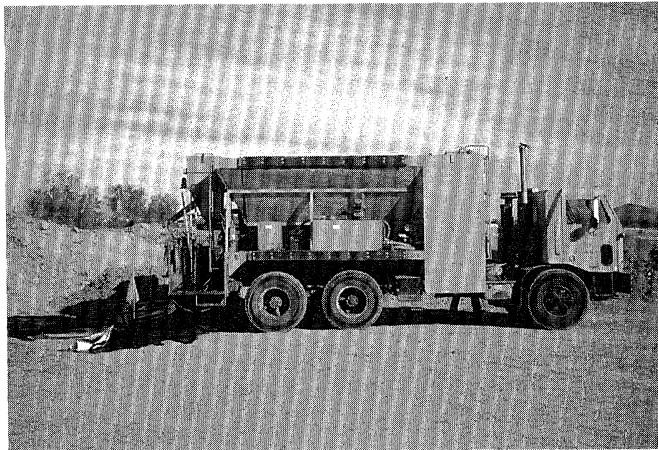

This slide shows a typical truck-mounted slurry machine being used to apply the slurry seal mixture. The machine has separate tanks for water, emulsion, additives, mineral filler, and aggregate. A water spray bar attached to the rear of the truck is used to wet the pavement surface ahead of the mixture placement.

It is desirable to calibrate the machine before use to insure accurate proportioning. Self-propelled machines are sometimes required for high-volume roads.

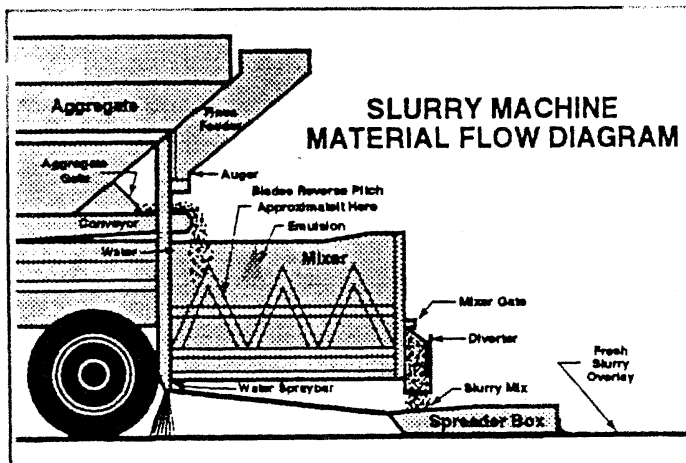

Slurry seals are generally produced and placed using a truck-mounted slurry machine. This slide shows a flow diagram of materials in the slurry machine.

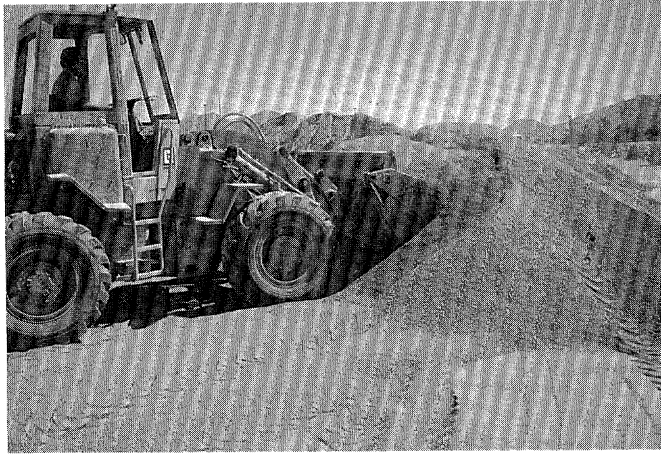

Sand being loaded into the slurry machine.

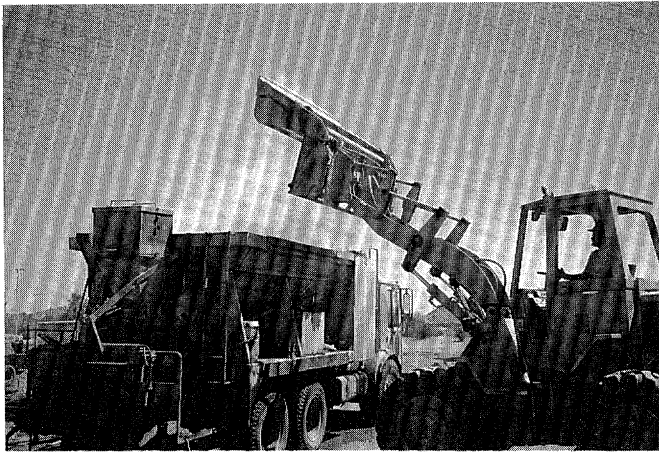

Loading the aggregate bin with sand.

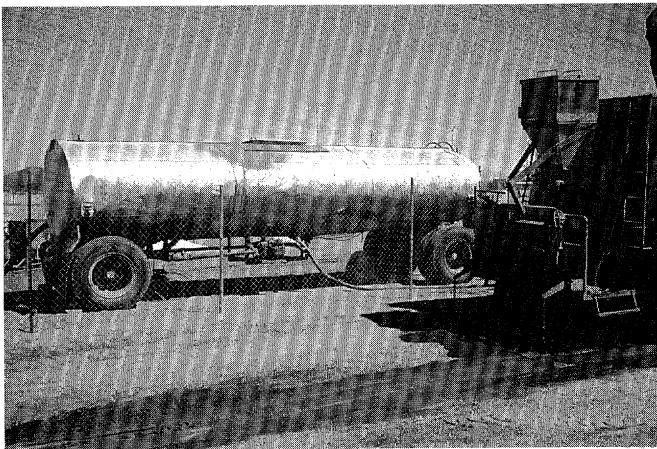

Emulsion being added to the slurry machine.

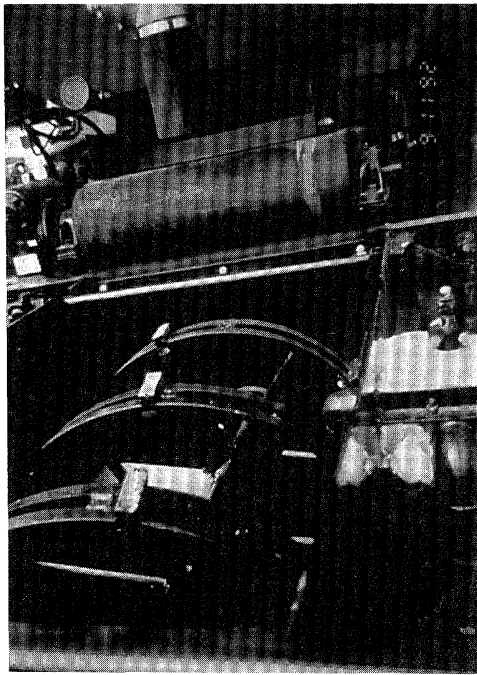

This slide shows the interior of a typical mixer. A multi-bladed single shaft is usually used for blending the materials. Aggregate and mineral filler are introduced into the mixer. Emulsion is introduced at about the one-third point of the mixer.

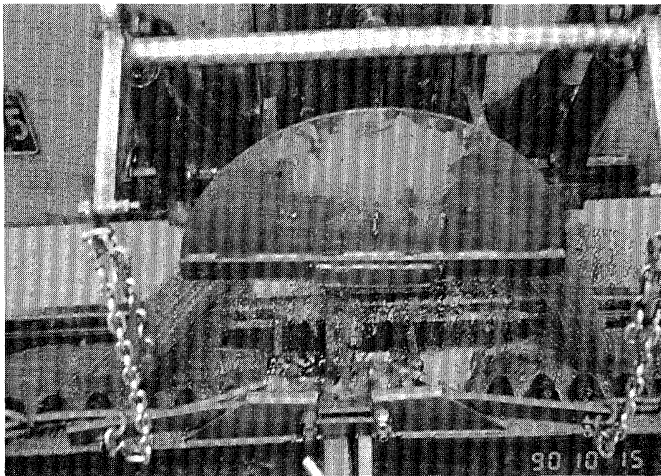

A chute is used to discharge the mixture into the spreader box. Some chutes are fitted with a divider to evenly distribute the material. This is particularly important when placing slurry in areas of high crown or on superelevated curves. In such cases, the slurry should be diverted to the high side of the spreader box, since gravity will keep the lower side filled.

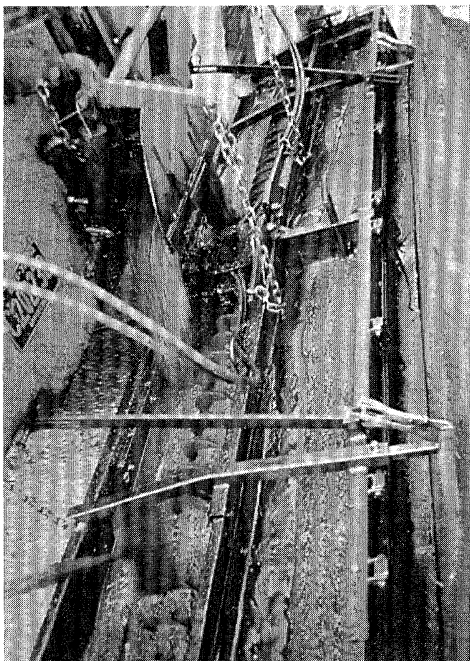

Newer-type spreader boxes fitted with augers are recommended to achieve uniform distribution of material, particularly when quick-set-type slurry is used. Boxes are fitted with seals on all sides to hold the material within the box while ensuring that a uniform coverage and depth are maintained. A drag mop (burlap) is commonly used with the spreader box to achieve a uniform texture.



This slide shows a typical slurry seal operation. Notice the brown color of the emulsion. Emulsion has to be used before breaking. The mixture is applied at a speed of 1.5 to 2 km/h. The slurry should be produced and spread at its optimum consistency and stability. If it is too fluid, the slurry may run into channels and segregates, resulting in poor skid resistance. If it is too stiff, it may prematurely set in the spreader box or may tend to drag behind the burlap. Because of its fluid nature, many operators prefer to place the slurry while going uphill.

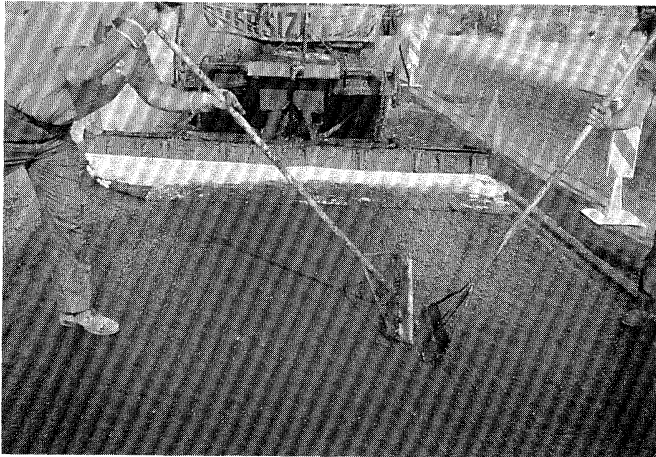

In some areas, manual spreading may be required in order to obtain a uniform layer.

CONSTRUCTION CONSIDERATIONS

- ◆ **Roll only at locations subject to abrasion**
- ◆ **Use 4.5 Mg pneumatic tire roller**
- ◆ **Start rolling when clear water can be pressed out with a piece of paper**

Some construction precautions have to be considered when applying the slurry seal. It is not necessary to roll a normal thickness of slurry seal, except at locations subject to abrasion caused by severe steering, braking, or acceleration. In such cases, the slurry can be rolled by a 4.5 Mg pneumatic tire roller. Rolling can start as soon as clear water can be pressed out of the slurry mixture with a piece of paper without the appearance of discoloration. Rolling is normally suggested in airport construction.

TRAFFIC CONTROL

Detour traffic to allow curing:

- ◆ **2 hours in warm weather**
- ◆ **6-12 hours or more in cool weather**

Traffic should be detoured for about 2 hours in warm weather, and 6-12 hours or more in cool weather. This time is needed to allow for curing of the slurry.

INSPECTION & ACCEPTANCE

- ◆ **Materials**
- ◆ **Mix design**
- ◆ **Equipment**
- ◆ **Construction procedures**

In order to obtain good slurry seal performance, proper materials, mix design, equipment, and construction procedures should be used.

STATE SPECIFICATIONS

- ◆ **Materials**
- ◆ **Mix design and proportioning**
- ◆ **Construction requirements**
- ◆ **Weather conditions**
- ◆ **Method of measurement**
- ◆ **Basis of payment**

State specifications for slurry seal include description of work, materials, mix design, proportioning, construction requirements, method of measurement, and basis of payment.

SLURRY SEAL PERFORMANCE

3 - 5 years depending on:

- ◆ **Traffic**
- ◆ **Environment**
- ◆ **Existing pavement**
- ◆ **Quality of materials & design**
- ◆ **Construction quality**

The nominal life of slurry seals is 3 to 5 years on roads with moderate to heavy traffic (ADT of 5000 vehicles/lane). The slurry seal performance is affected by several factors, including traffic loading, environmental conditions, existing pavement condition, quality of materials and design, and construction quality.

SLURRY SEAL LIMITATIONS

- ◆ **Not suitable if surface is:**
 - **cracked**
 - **moves under traffic**
- ◆ **Long curing time**

Slurry seals do not perform well if the underlying pavement surface is cracked and moves under traffic. Also, slurry seals typically require longer curing times than chip seals.



*Pavement Preventive
Maintenance Treatment*

Cold Thin Seals

Micro-Surfacing

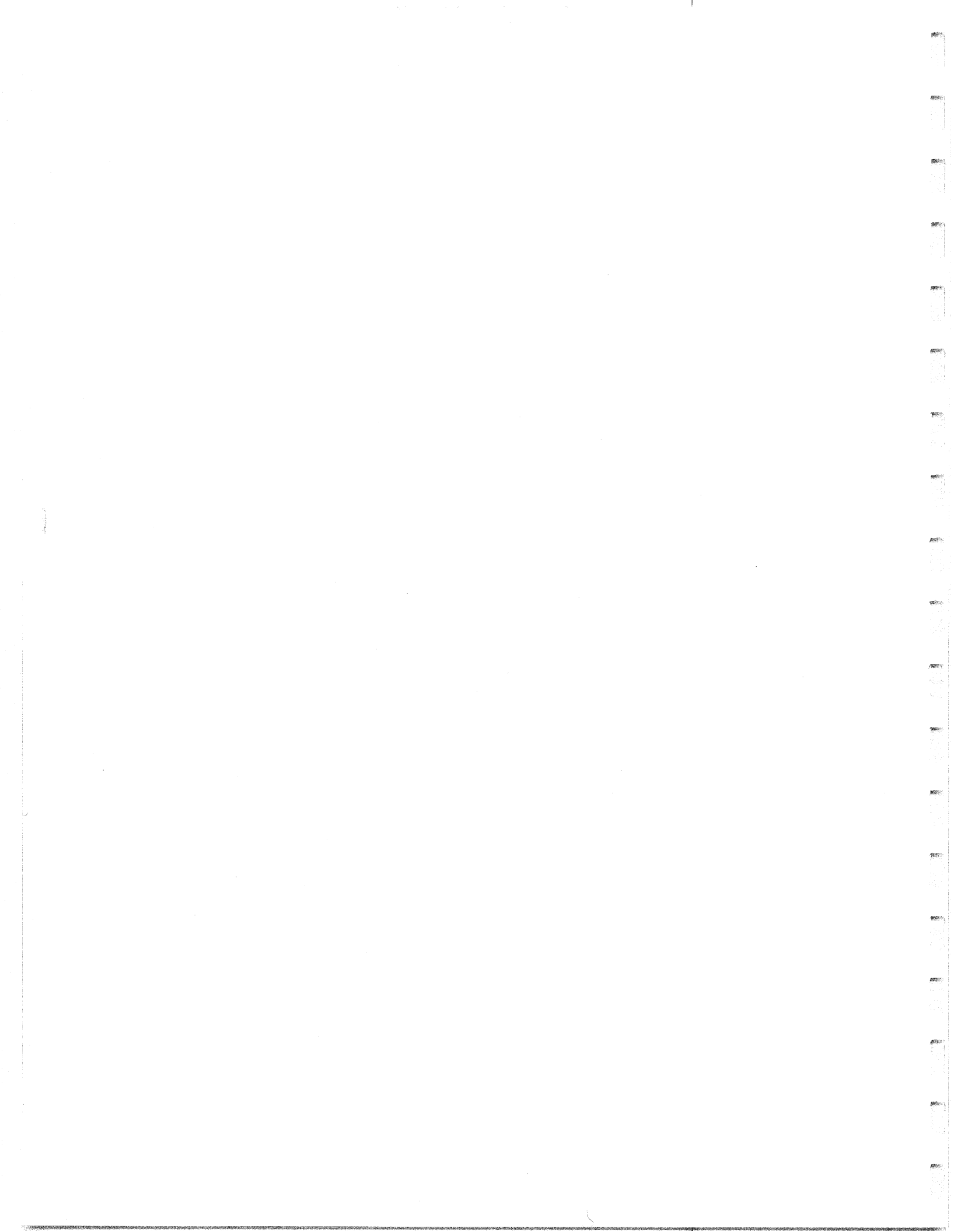

COLD THIN SEALS

MICRO-SURFACING

Now we will discuss micro-surfacing.

MICRO-SURFACING

- ◆ **Thin paving system (10-15mm)**
- ◆ **Polymer-modified emulsion**
- ◆ **Crushed aggregate**
- ◆ **Mineral filler**
- ◆ **Water**
- ◆ **Additives (as needed)**

Micro-surfacing is a thin surface paving system composed of polymer-modified asphalt emulsion, 100 percent crushed aggregate, mineral filler, water, and field control additives as needed. It is applied as a thin 10-15 mm surface treatment.

MICRO-SURFACING

- ◆ **Can be viewed as polymer-modified slurry seal**
- ◆ **Except:**
 - **Cures faster**
 - **Placed in a thicker layer**

Micro-surfacing can be also viewed as a polymer-modified cold paving slurry seal system. Micro-surfacing differs from conventional slurry seals in that it cures and develops strength faster and can be placed in a thicker layer than slurry seals.

MICRO-SURFACING HISTORY

- ◆ **Developed in Europe in 1970s**
- ◆ **Introduced in U.S. in 1980**
- ◆ **Major users are KS, OH, OK, PA, TN, TX, and VA**
- ◆ **Used for rut filling and texturing**

Micro-surfacing was developed in Europe in the 1970s. It was first introduced in the U.S. in 1980 in Kansas. Since then, many other state and local agencies have used this treatment to address certain pavement conditions on their moderate- to heavy-volume roads. Major user states are Kansas, Ohio, Oklahoma, Pennsylvania, Tennessee, Texas, and Virginia.

Micro-surfacing cures through an electrochemical process and by the loss of water from the system.

USES OF MICRO-SURFACING

- ◆ **Asphalt Pavements**
 - **Texturing / sealing**
 - **Rut filling**
- ◆ **Concrete pavements**
 - **Texturing**

Micro-surfacing has been used on both asphalt and portland concrete pavements. For asphalt pavements, it has mostly been used for texturing, sealing, and rut filling. Micro-surfacing can provide a long-term solution for rut if the pavement is stable. If the rut is unstable and is progressing due to plastic flow, micro-surfacing provides a short-term solution. For concrete pavements, it has been used mostly for texturing.

OTHER USES

- ◆ **Raveled & flushed surfaces**
- ◆ **Oxidized surfaces**
- ◆ **Crack/void filling**
- ◆ **Minor leveling**
- ◆ **Interlayer**

Other uses of micro-surfacing include 1) applications on oxidized, raveled, and flushed surfaces 2) crack and void filling 3) minor leveling and 4) as an interlayer.

CONDITIONS FOR MICRO-SURFACING

- ◆ **No large cracks or movements under traffic**
- ◆ **No excessive irregularities or shoving**
- ◆ **Moderate- & high-volume roads**

To achieve a successful micro-surfacing application, the existing pavement should have no large cracks or movements under traffic. The pavement must also be stable, with no excessive irregularities or shoving. Micro-surfacing is suitable for both moderate- and high-volume roads.

MICRO-SURFACING MATERIALS

- ◆ **Quick-set polymer modified CSS-1h**
- ◆ **Manufactured crushed stone such as granite, slag, limestone, etc.**

Micro-surfacing guidelines are available from the International Slurry Surfacing Association. The emulsion shall be quick-set polymer modified CSS-1h and shall conform to the requirements of AASHTO M208 and ASTM D2397, in addition to other requirements. The aggregate shall be manufactured crushed stone such as granite, slag, limestone, chat, or other high-quality aggregate or a combination thereof.

MATERIALS (Cont.)

Type	II	III
Top size, mm	9.5	9.5
Application, kg/m ²	5 to 10	8 to 16
% Asphalt content	5.5 to 9.5	
% Filler	0.5 to 3.0	
Polymer modifier	As needed	
% Water	4 to 12	

Two types of micro-surfacing (Types II and III) with different aggregate gradations, binder contents, and application rates are defined by the International Slurry Surfacing Association. The maximum aggregate size of both types is 9.5 mm.

Mineral fillers such as portland cement and hydrated lime are often used as stabilizers and as a means of reducing the break time. An additive may also be used as needed to control the break time.

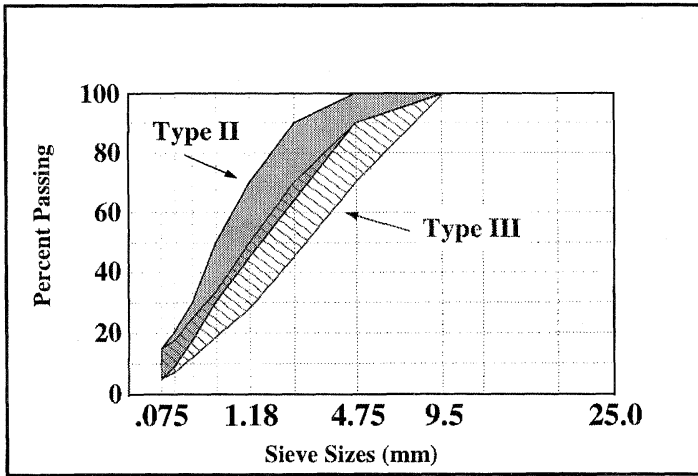

These are the aggregate gradations of Types II and III plotted on a 0.45 power graph. Type III has coarser gradation than Type II and is usually used for rut filling and texturing on high-volume roads.

EUROPEAN EXPERIENCE

- ◆ Close to ISSA gradation
- ◆ PC or hydrated lime, if required
- ◆ Polymer solids = 3%+
- ◆ Latest innovations
 - Fibers
 - Gap-graded mixes

European countries use aggregate gradations close to that recommended by ISSA. The mineral filler, if required, is a non-air-entrained portland cement or hydrated lime. A minimum of 3% polymer solids, based on asphalt weight, is generally used. The latest European innovation includes the incorporation of fibers and the use of gap-graded mixtures. The incorporation of fibers increases viscosity, improves skid resistance, and retards cracking.

MICRO-SURFACING DESIGN

- ◆ Component selection & testing
- ◆ Mixture testing to determine
 - Properties
 - Water content
 - Filler & additives
 - Optimum asphalt content
- ◆ Performance-related testing

The micro-surfacing mixture design process consists of:

1. Component selection and testing;
2. Mixture testing to determine;
 - a) mixing and application characteristics of emulsion and aggregate
 - b) effect of water content
 - c) effect of filler and additives
 - d) optimum asphalt content, and
3. Performance-related tests on mixture samples.

DESIGN COMMENTS

- ◆ **Purpose is material compatibility**
- ◆ **Test repeatability not assured**
- ◆ **Design is evolving**
- ◆ **Tests need to be standardized**
- ◆ **Design values need validation**

The design tests determine the compatibility of various materials. However, since a reliable sample preparation procedure has not been perfected, the repeatability of tests is not assured. The design process of micro-surfacing is still evolving, and the industry is currently trying to improve the design procedures and adjust standards to reflect the effect of various material combinations. There is a need to standardize the test procedure used to design micro-surfacing, and design values must be validated as well.

APPLICATION RATE

- ◆ **Single application needs 8 to 16 kg/m²**
- ◆ **For retexturing, use 8 to 19 kg/m² depending on thickness**
- ◆ **For rut filling, rate varies according to rut depth**

The application rate for retexturing seals on high-volume roads ranges from 8 to 19 kg/m², depending on the desired surfacing thickness. In general, 8 to 16 kg/m² is used for layer thicknesses of 5 to 15 mm for a single application. For wheel ruts, the application rate varies according to the rut depth.

PAVEMENT PREPARATION

- ◆ **Repair/seal joints & cracks**
- ◆ **Clean road**
- ◆ **Tack coat if:**
 - **extremely dry or raveled surface**
 - **concrete**
- ◆ **Pre--wet during hot weather**

Potholes, as well as joints and cracks that are 5 mm or wider, should be repaired and sealed before the application of micro-surfacing. Repairs should have sufficient time to cure and should not be allowed to build on the surface. Otherwise, the sealant could be torn by screeds during the application of micro-surfacing, leaving drags or tear marks. Clean the surface. On asphalt pavements, a tack coat is not required unless the surface is extremely dry or raveled. A tack coat should be used on concrete pavements. During hot weather, the pavement is usually prewetted to control a premature breaking of the emulsion and to improve bonding with the existing surface.

WEATHER CONDITIONS

- ◆ **Air temperature $\geq 10^{\circ}\text{C}$**
- ◆ **Pavement temperature $\geq 10^{\circ}\text{C}$**
- ◆ **No rain**
- ◆ **No freezing within 24 hours**

Micro-surfacing should not be placed if either pavement or air temperature is below 10°C , if it is raining, or if there is a forecast of ambient temperature below 0°C within 24 hours of placement. If placed in very hot, dry weather, the surface can break too fast, causing water retention and slowing interior curing. Hot weather requires a formulation change to extend the mixing time to enable the micro-surfacing to be properly applied.

CONSTRUCTION EQUIPMENT

- ◆ **Self-propelled machine**
- ◆ **Truck-mounted unit**

Two types of machines are currently used to place micro-surfacing. These include a self-propelled machine and a truck-mounted unit. The self-propelled machine is more efficient than the truck-mounted unit.

SELF-PROPELLED MACHINE

Self-propelled, front-feed, continuous mixing machine

- ◆ **Proportioning device**
- ◆ **Mixer**
- ◆ **Spreader box**
- ◆ **Rut box for rut filling**

The first type of micro-surfacing equipment we will discuss is the self-propelled, front-feed, continuous loading and mixing machine. This machine includes: 1) proportioning devices equipped with individual volume or weight controls for proportioning materials; 2) mixer fit with multibladed twin shaft to allow thorough blending of materials; 3) spreader box for texturing/sealing and scratch (leveling) applications; and 4) rut box for rut filling.



This is a typical self-propelled, front-feed, continuous-loading machine for mixing and placing the micro-surfacing mixture. The working speed of the machine ranges from 2 to 4 km/h. The machine is capable of applying micro-surfacing at a rate of up to 500 metric tons per day. It has dual side driver stations on the front to optimize longitudinal alignment and includes aggregate storage space, a bin for mineral filler, and separate tanks for water, emulsion, and additives. A nozzle-type spray bar is also available to provide a water spray ahead of the spray box.

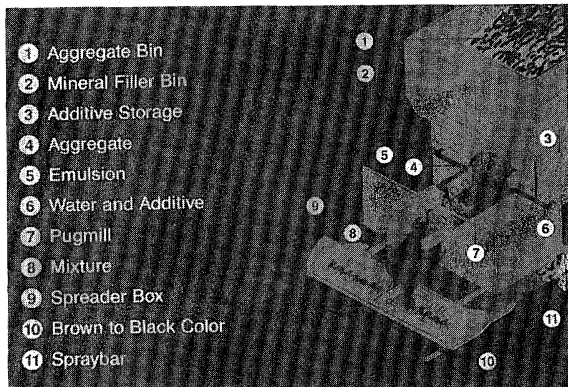

This is a sketch of the self-propelled machine showing its various components. The aggregate is received by the front hopper, delivered to the storage area, and then fed to the mixer on a conveyor belt.

Controls and meters are used for proportioning and monitoring the quantity of all components. The machine controls should be calibrated at least once every construction season (preferably prior to each project).

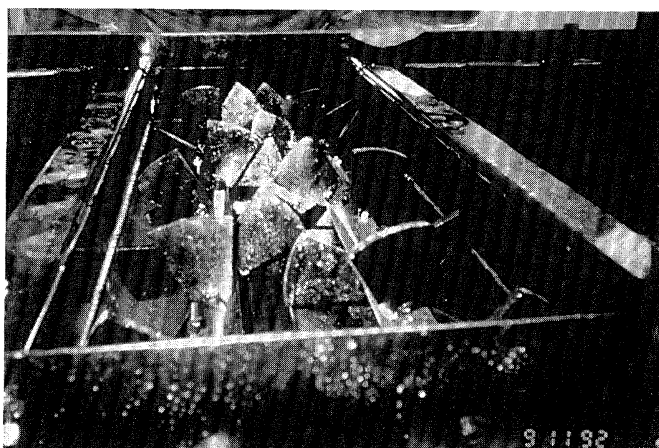

The mixers are fitted with multibladed twin shafts to allow thorough mixing of materials. The mixers are about 1 to 1.3 m long.

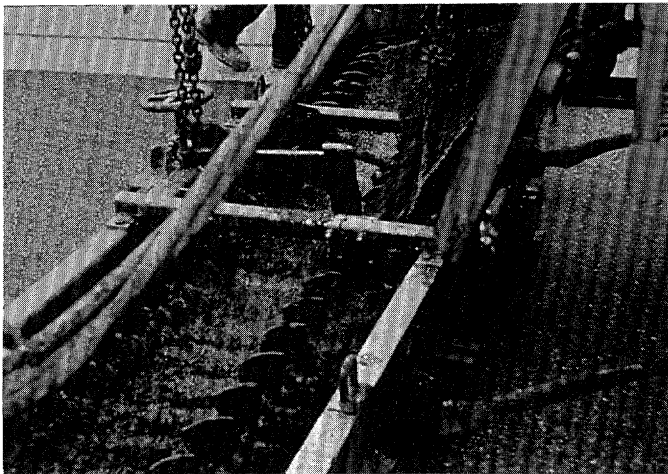

The spreader box is used for texturing purposes. The width of the box is adjustable between 2.4 and 4.2 m and is equipped with hydraulically powered twin augers to uniformly mix and spread the mixture.

The spreader box is fitted with seals at all sides to retain the mixture within the box. The rear seal acts as a strike-off and is usually made of a rubber material. Steel strike-offs are preferred by some agencies for leveling work.

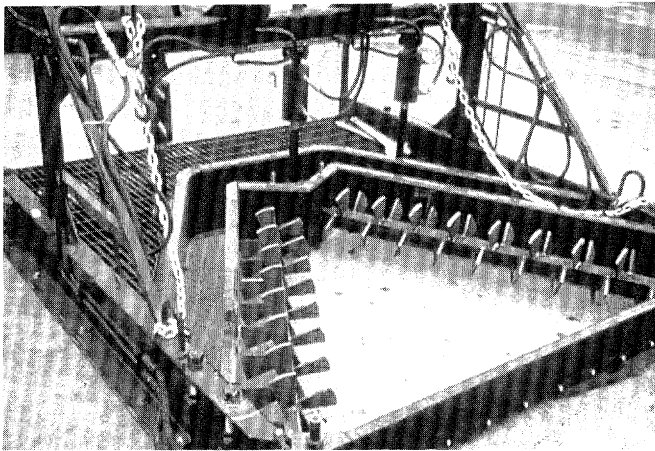

A special rut box is used to fill wheel ruts and depressions. The rut box is either 1.5 m or 1.8 m wide and has two V-shaped chambers with the point of the V toward the rear of box. Continuous agitation of the material is achieved by means of two shafts with multiple blades. The box is designed to push the larger-size aggregate to the deeper parts of the rut. The box is capable of filling up to 40 mm ruts in one pass. To fill deeper ruts, multiple passes should be used, as thicker layers may not cure properly.



This slide shows a spreader box with a steel strike-off. During application, the screed is set to make contact with high points on the pavement surface in order to fill the low points. In cases where the surface is uneven or where the depth of wheel ruts is between 5 to 15 mm, two layers of micro-surfacing may be used. A scratch course is applied first to improve the transverse profile, followed by a surface course. Each wheel rut is filled separately. A slight crown in the surface can be added to compensate for compaction. It is recommended to add 3 mm of crown for every 25 mm of rut. No more than 5 mm of crown should be provided to avoid possible drainage problems.



This slide shows the truck-mounted micro-surfacing machine. This type of machine is typically used for smaller projects. A fully loaded truck can place between 1400 m² (or 0.4 and 0.5 lane-km) of finished product, depending on the truck capacity.

INSPECTION & ACCEPTANCE

Finished surface should be smooth and skid resistant:

- ◆ **No rippling**
- ◆ **No drag marks**
- ◆ **Uniform texture**
- ◆ **Good quality joints & edge lines**

Micro-surfacing should produce a smooth, skid resistant surface. To achieve this result, the finished surface should be free of rippling and drag marks. In addition, the surface should have uniform texture, good quality joints, and neat edge lines.

CAUSES OF RIPPLING

- ◆ **Too thin application**
- ◆ **Too fast application**
- ◆ **Aggregate gradation and size**
- ◆ **Dirty and worn screeds**
- ◆ **Drag mops (if used)**

Two types of ripples, transverse and longitudinal, have been observed in the field. Transverse ripples are alternate valleys and crests at regular intervals in the surface of the pavement in the transverse direction. Thin and fast applications could cause this type of rippling. Other contributing factors are aggregate gradation and size, dirty and worn screeds, and drag mops (if used).

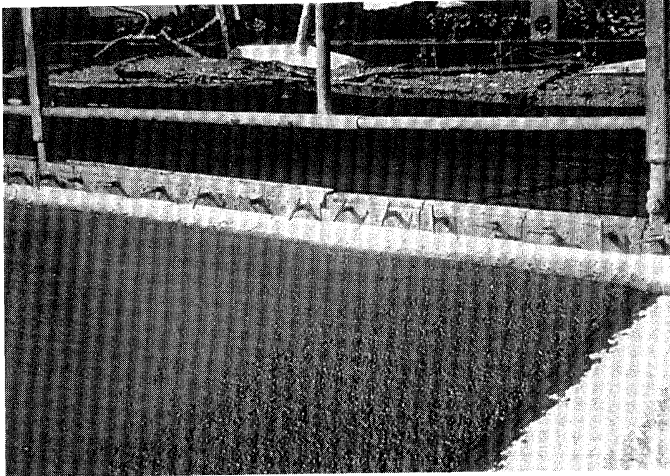

A secondary strike-off can be used to reduce transverse rippling and improve texture. This slide shows the texture difference between the primary and secondary strike-off.

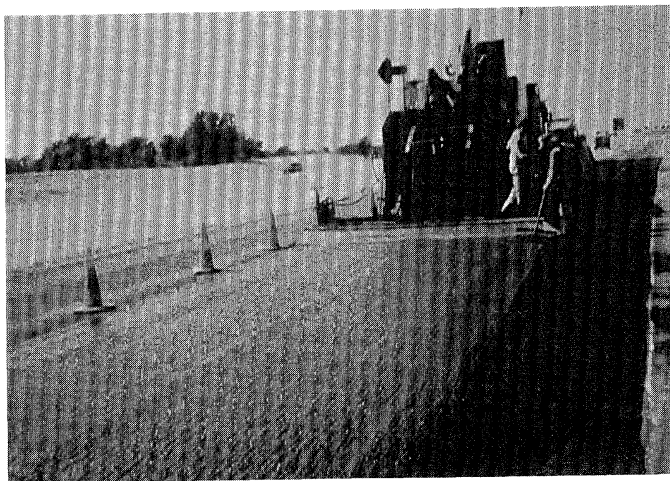

A drag mop has been used by some contractors for texturing. However, use of the drag mop is not recommended, since the micro-surfacing mix is heavy and dry. The use of a drag mop can also result in longitudinal streaking. Specifications should include construction criteria for both transverse and longitudinal rippling and streaking.

TEAR / DRAG MARKS

- ◆ Imperfections of existing surface
- ◆ Dirty or worn screeds
- ◆ Insufficient materials
- ◆ Premature breaking
- ◆ Oversized aggregate

Tear and drag marks could occur due to several factors:

1. Any buildup of sealant or other surface imperfection;
2. Worn screeds or buildup of materials on the screed,
3. Insufficient materials;
4. Premature breaking of the emulsion; and
5. Oversized aggregate.

Aggregate should be screened just prior to use in micro-surfacing projects to avoid drag marks.

TEXTURE UNIFORMITY

- ◆ **Avoid too-dry mixture**
- ◆ **Avoid too-wet mixture**
- ◆ **Use good spreader box**

To obtain uniform texture, avoid using a too-dry or too-wet mixture. Also, consistency in moisture must be maintained. The spreader box should also be in good condition.

MIXTURE CONSISTENCY

- ◆ **If too stiff, it may set prematurely**
- ◆ **If too fluid, it may segregate**
- ◆ **Slightly drier mixes perform better than wetter mixes**

When the micro-surfacing mixture is deposited in the spreader box, it should be of desirable stability and consistency. If the mix is too stiff, it may prematurely set in the spreader box or will drag under the strike-off. If it is too fluid, the mixture may segregate or run into channels, and binder-rich fines may migrate to the surface, resulting in uneven surface friction. Slightly drier mixtures generally perform better than wetter mixtures.



This slide shows a project where debonding started within a few days of placement. This may have been caused by the use of a very dry mixture. In such cases, the mixture could break/set early and may not bond well with the existing surface. Another reason for the debonding could be the drain-down of the emulsion which could not provide the necessary tack.

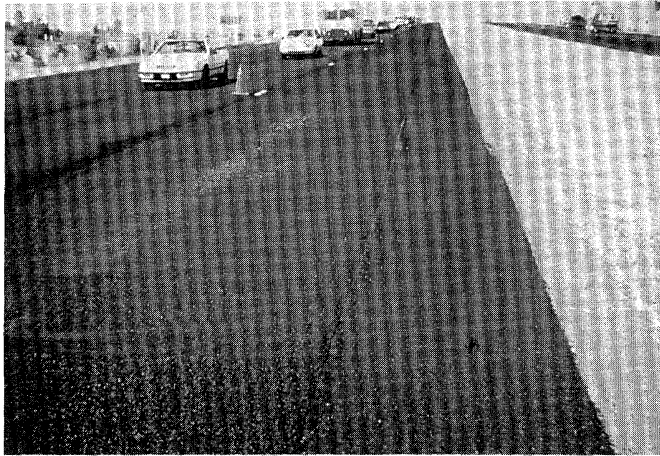

This slide shows a micro-surfacing project 30 to 45 minutes after application. Note the contrast in texture, which is usually caused by the use of a wet mixture. The condition of the spreader box may also have an affect on the uniformity of the texture. The spreader box should be able to distribute the material evenly across its full width.

JOINTS AND EDGE LINES

- ◆ **Should be of good quality for ride and appearance**
- ◆ **Avoid excessive overlap and uncovered areas**
- ◆ **Use string line or chain**

During application of micro-surfacing, it is important to produce good quality joints and edge lines in order to provide good ride quality and promote overall project appearance. Current state specifications prohibit excessive overlap, uncovered areas, and unsightly appearance for either transverse or longitudinal joints. However, these parameters are not always well defined or enforced. To facilitate straight and uniform longitudinal joints, a string line or a chain mounted at the front of the machine can be used.

CONSTRUCTION PRECAUTIONS

- ◆ **Do not place if:**
 - **Pavement or air temp. < 10° C**
 - **Raining**
 - **Forecast of temperature < 0° C**
- ◆ **High temperature can require a change in formulation**

Micro-surfacing should not be placed if either the pavement or air temperature is below 10°C, if it is raining, or if there is a forecast of ambient temperature below 0°C within 24 hours of placement. If placed in very hot, dry weather, the surface can break too fast, causing water retention and slowing interior curing. Very hot weather requires a change in formulation that allows longer mixing times to enable the micro-surfacing to be properly applied.

CONSTRUCTION PRECAUTIONS (Cont.)

- ◆ **Construct a test strip prior to actual placement**
- ◆ **Inadequate design or quality control might cause raveling, debonding, or rutting**

Since micro-surfacing is a quick-set system, laboratory designs may not work well under field conditions. Therefore, it is highly desirable to construct a test strip prior to actual placement.

During field reviews, a few projects had experienced raveling, debonding, and/or rutting immediately after construction. Inadequate design and/or construction quality control appeared to be the main reasons for these irregularities.

TRAFFIC CONTROL

Open road to traffic one hour after placing

Micro-surfacing is designed so that the system can sustain rolling traffic one hour after application.

STATE REQUIREMENTS

82 - 90%	Aggregate
2 - 4%	Latex polymer by weight of asphalt
1.5 - 3%	Non-air entrained PC (mineral filler)
6 - 11%	Asphalt residue

Most states require the following:

- 1) 82 - 90% aggregate,
- 2) 2 - 4% latex polymer by weight of asphalt,
- 3) 1.5 - 3% non-air entrained portland cement as a mineral filler,
- 4) 6 - 11% asphalt residue.

PERFORMANCE

Varies depending on:

- ◆ **Climate**
- ◆ **Traffic**
- ◆ **Existing pavement**
- ◆ **Materials / mixture design**
- ◆ **Construction quality**

The performance of micro-surfacing is affected by several factor. These include climatic conditions, traffic loading, existing pavement conditions, quality of materials, mixture design, and construction quality.

PERFORMANCE (Cont.)

- | | |
|--|---------------------|
| ◆ Wheel rut resistance | 4 to 7 years |
| ◆ Skid resistance | Efficient |
| ◆ Raveling resistance | Good |
| ◆ Resistance to reflection cracks | None |
| ◆ Flushing treatment | Good |
| ◆ Interlayer | Good |

When properly designed, constructed, and used on structurally sound pavements, micro-surfacing has generally performed well in resisting wheel ruts for 4 to 7 years. Micro-surfacing improves skid resistance and has been used by a number of states to address raveling with good results. Micro-surfacing, like other thin treatments and overlays, offers no long-term resistance to reflective cracks. Some states use micro-surfacing to address flushing on asphalt pavements. Pennsylvania and Oklahoma have used micro-surfacing as an interlayer, and both report good performance. However, this is not a standard use of this treatment.



This slide shows a 5-year-old micro-surfacing on I-70 in Kansas. With the exception of a few cracks and minor consolidation, good performance was reported. Experience of other states has been very positive in this regard. Nearly all states report 4-7 years of acceptable performance.

MICRO-SURFACING COST

- ◆ **Unit cost = three times as much as hot-mix or more**
- ◆ **Cost is offset by:**
 - **Thin layers**
 - **No appurtenance adjustment**
 - **Easier traffic control**

The unit cost of micro-surfacing is about three times or more in comparison to the unit cost of hot-mix plant mixtures. However, the cost is offset by the fact that thin layers of micro-surfacing are used. In addition, micro-surfacing does not require adjustments to appurtenances such as curbs, shoulders, drainage inlets, and guardrails. In fact, the total construction cost of micro-surfacing might be less than that of hot mix overlay because of ease in traffic control and the thin applications.

MICRO-SURFACING LIMITATIONS

- ◆ **Special equipment**
- ◆ **Experienced contractor**
- ◆ **Mixes are aggregate-specific**

Micro-surfacing requires special application equipment with a more powerful and faster mixer than that used for slurry seals. The contractor has to have solid experience in similar applications. Also, because of the fast-setting characteristics of micro-surfacing, mixes are more aggregate-specific than normal slurry seals.



*Pavement Preventive
Maintenance Treatment*

*Thin Hot-Mix Asphalt
Overlays*

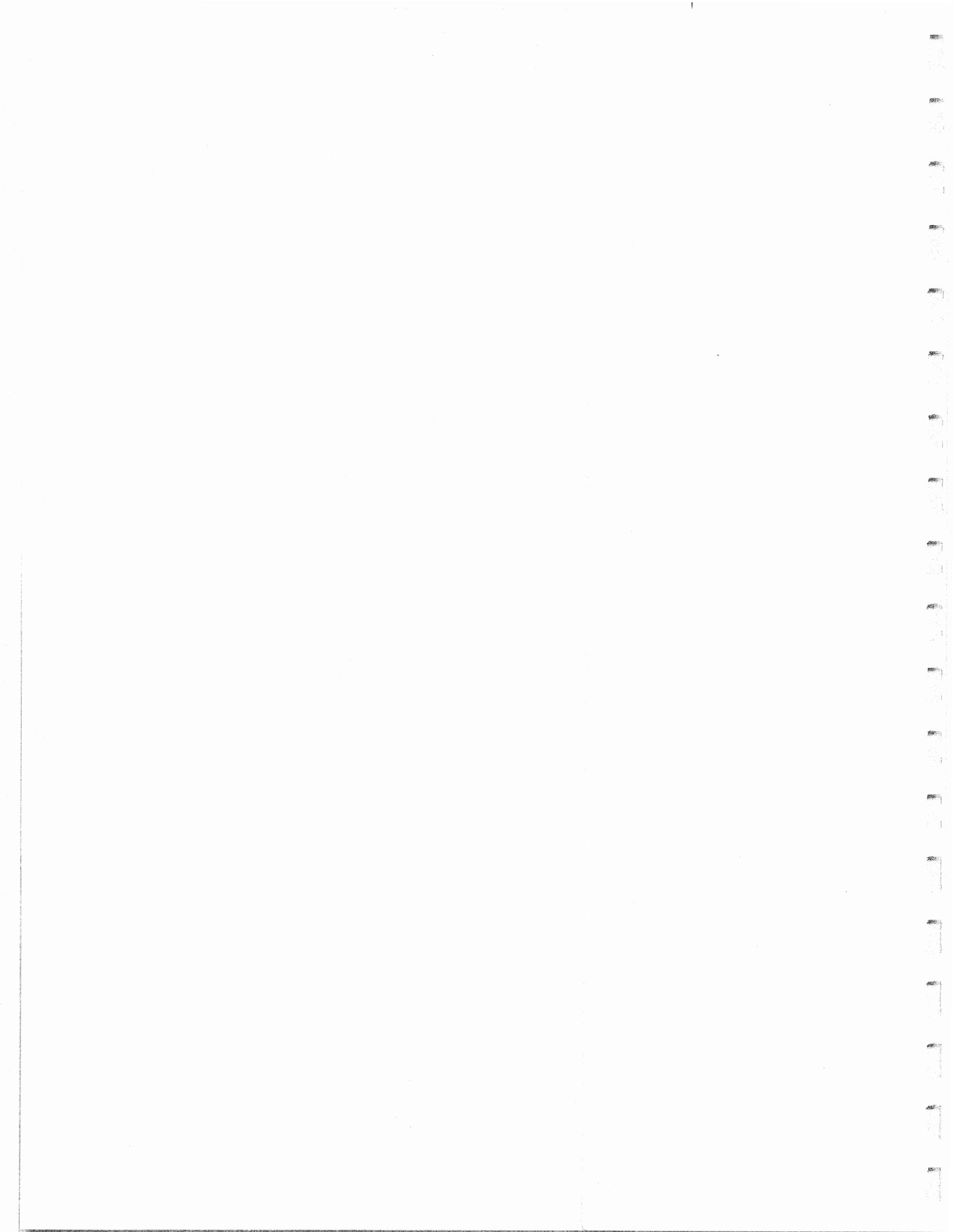

PREVENTIVE MAINTENANCE TREATMENT

THIN HOT-MIX ASPHALT OVERLAYS

This session presents the design, construction, and use of thin hot-mix overlays. Hot-mix overlays can be classified by their aggregate gradation as dense, open, and gap. This session presents a general review of HMAC as a group with notes on the special characteristics of open- and gap-graded mixes. After the general discussion of HMAC, the last portion of the session provides further information on gap-graded mixes, as this is an emerging technology.

OBJECTIVES

- ◆ **Thin hot-mix asphalt overlay**
 - **Material selection / design**
 - **Construction**
 - **Variations**
- ◆ **European / U.S. experience**

The main objective of this session is to discuss the proper techniques for thin hot-mix asphalt overlay with respect to material selection, design, construction, and variations of dense-graded thin overlays will also be shown. In addition, the experience in the U.S. and other countries will be discussed.

THIN HOT-MIX ASPHALT OVERLAY

- ◆ **Dense-graded**
- ◆ **Open-graded friction course**
- ◆ **Gap-graded**

Hot mix asphalt (HMA) is a mixture of asphalt cement and aggregate blended together and laid at a high temperature. Thin HMA overlays with thicknesses ranging from 15 to 40 mm have been used in the U.S. and other countries to improve the functional condition of pavements. Thin HMA overlays can be classified according to aggregate gradation: dense-graded, open-graded friction course (OGFC), and gap-graded (stone matrix asphalt, SMA) overlays.

SHRP EXPERIENCE

- ◆ 81 dense-graded sections
- ◆ Thickness 20 to 40 mm
- ◆ HMA overlays correct roughness better than other treatments.
- ◆ SMA constructed as state sections.

Eighty-one dense-graded sections were constructed during the SHRP experiments. Thicknesses ranged from 20 to 40 mm. ETG evaluation indicated the HMA overlays perform better than other treatments on rough pavements.

BINDER CONSIDERATIONS

- ◆ Dense - conventional
- ◆ Gap- and open-graded
 - Modify binders to increase viscosity
 - Drain down test

Conventional asphalt concrete is used for dense-graded mixtures. Asphalt cement grade selection is based on temperature range and traffic levels. Gap- and open-graded mixtures require more stability from the binder. Modifiers are frequently used to increase the viscosity at higher working temperatures. Fibers may be used with gap-graded mixtures to increase stability and provide thicker asphalt films.

AGGREGATE SELECTION

- ◆ Conventional quality requirements
- ◆ Good surface texture required for stability

All thin hot-mix overlays require high quality aggregates, particularly with respect to the surface texture of the aggregate. For example, dense-graded mixes may require 30% crushed faces, whereas stone matrix asphalt requires that 100% of the particles greater than 4.75 mm have one crushed face and 90% must have two crushed faces.

Gradation requirements vary depending on the type of mixture.

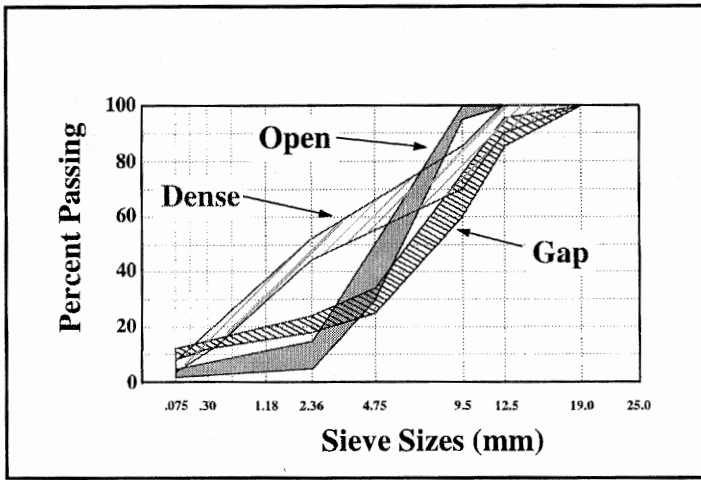

This graph shows typical gradations of dense-graded, open-graded, and gap-graded aggregates. Dense-graded aggregate contains appropriate amounts of various sizes to form a high density mixture with a very small amount of air voids between aggregate particles. Open-graded aggregate contains very small amounts of fine aggregate, leaving a high void content between particles. Gap-graded aggregate is missing one or more sizes.

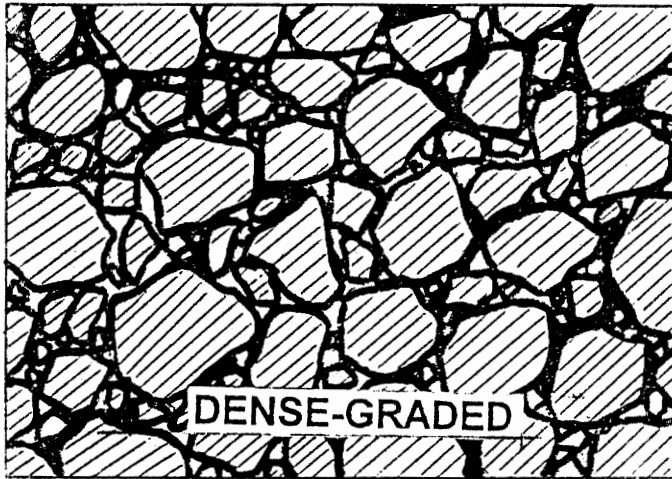

This is a schematic of the structure of dense mix. The distribution of aggregate sizes fills voids between larger aggregates with smaller aggregates, leaving only enough room for the binder and air voids needed for a quality mix. Dense-graded aggregates provide stability in the mix and minimize the need for binder.

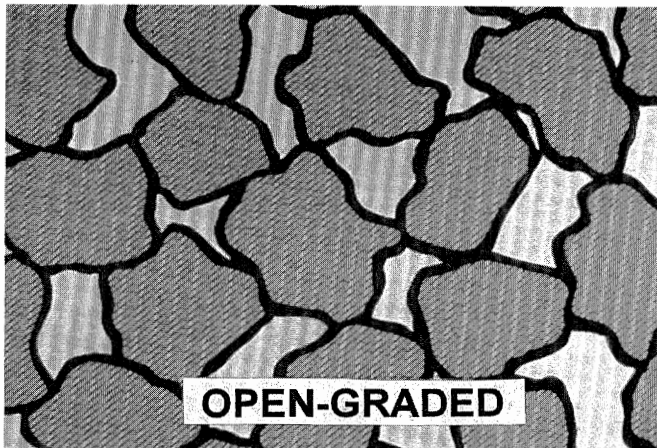

Open-graded mixes have a high void content, allowing water to drain through the structure. However, an open gradation is inherently unstable, limiting the use of open-graded mixes to thin applications.

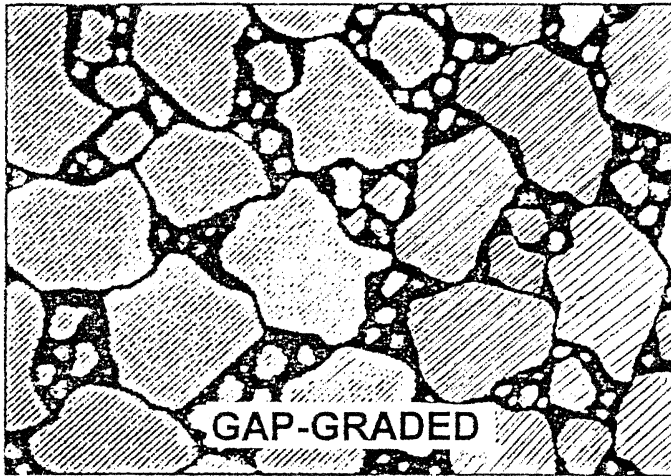

In gap-graded mixes, the large size aggregates bear directly on each other and the voids are filled with a mastic of fine aggregates and binder. With proper binder selection, this can be a very stable mix that resists plastic deformation and studded tire abrasion.

MIX DESIGN

- ◆ **Dense & Gap**
 - **Conventional Marshall or Hveem**
 - **SHRP - possible in the future**
- ◆ **Open-grade**
 - **based on the surface capacity of the aggregate**

Conventional procedures, such as Marshall and Hveem, are used for dense- and gap-graded mix designs. SUPERPAVE is under evaluation for design of these mixtures.

OGFC mix design seeks to achieve a balance between film thickness for stability and the need to prevent runoff. The asphalt content is based on the surface capacity of the aggregate to retain asphalt, as determined by the kerosene equivalency test. Typical asphalt content is 5.5 to 6.5% with 15% air voids or more.

THIN OVERLAY USES

- ◆ **Extends pavement life**
- ◆ **Improves ride quality**
- ◆ **Corrects surface defects**
- ◆ **Restores skid resistance**

Thin overlays extend the life of structurally sound pavements by improving functional condition. It provides a flexible and smooth riding surface. Minor surface defects are covered up, giving the appearance of a "new" pavement. However, reflection cracking will appear in a short time. All three types of thin hot-mix overlays improve the skid resistance of the surface.

CONSIDERATIONS FOR USE

- ◆ **Withstands heavy traffic**
- ◆ **No stone loss or binder run-off**
- ◆ **Minimal dust during construction**
- ◆ **Short traffic disruption**
- ◆ **High salvage value**
- ◆ **Does not correct weaknesses**

Thin dense-graded hot-mix overlays have many benefits. There is minimal generation of dust during construction. Thin dense-graded hot-mix overlays can be designed for heavy traffic. There is no stone loss that might cause windshield damage and no binder run-off that may result in discoloration of concrete gutters. HMA does not require curing time, allowing minimal traffic disruption. It can be reclaimed and reused in recycled asphalt pavement giving high salvage value. The thin layer does not appreciably correct structural weaknesses in the existing pavement surface.

CONDITIONS FOR SUCCESS

- ◆ **New or old pavement surface**
- ◆ **Structurally sound**
- ◆ **Milling or leveling course if rough**
- ◆ **Repair cracks and distresses**

Thin dense-graded hot-mix overlays can be placed over either new or old pavement surface. Since it does not add much to the structural capability of the existing pavement, the pavement has to be structurally sound. If the existing pavement is too rough, milling or leveling course is needed. In addition, cracks and other distresses should be repaired before placing thin dense-graded hot-mix overlay.

OPEN-GRADED ADVANTAGES

- ◆ **Improves skid resistance**
- ◆ **Reduces/eliminates spray**
- ◆ **Noise reduction**

The primary advantage of OGFC in comparison to other treatments is its ability to drain water through the surface. Eliminating water from the surface improves skid resistance and reduces spray under wet conditions. Removing the water from the surface also reduces headlight glare from the pavement surface.

The open-graded surface also absorbs vehicle sound.

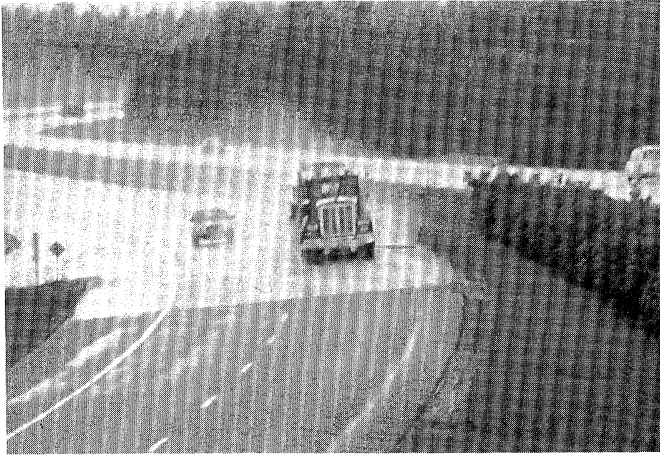

The ability of OGFC to reduce tire spray is shown in this side-by-side comparison.

GAP-GRADED ADVANTAGES

- ◆ **Resists rutting**
- ◆ **Low temperature performance**
- ◆ **Slow aging**
- ◆ **Resistant to abrasion from studded tires**

Properly designed gap-graded mixes are very stable and durable. The stability resists rutting better than conventional HMAC. Low- temperature performance is improved due to greater asphalt film thickness around the aggregates. This also reduces the rate of aging. In addition, the high durability of the mix helps reduce abrasion by studded tires.

CONSTRUCTION

- ◆ **Conventional HMAC process**
- ◆ **Cools quickly**
- ◆ **Gap-graded mixes are 'harsh'**
 - **higher temperature**
 - **compaction**

By and large, conventional construction procedures are used for hot-mix overlays. Thin layers cool rapidly - compaction should be completed within 3-5 minutes after placement.

Gap-graded mixtures can be harsh and may require special care for proper placement and compaction.

WEATHER CONDITION

Since the mixture cools fast, better compaction can be achieved in warm weather (10°C+)

Because of the thin layer thickness, the mixes cool rapidly after spreading; thus, work should be carried out in warm weather when air temperature is 10°C or above.

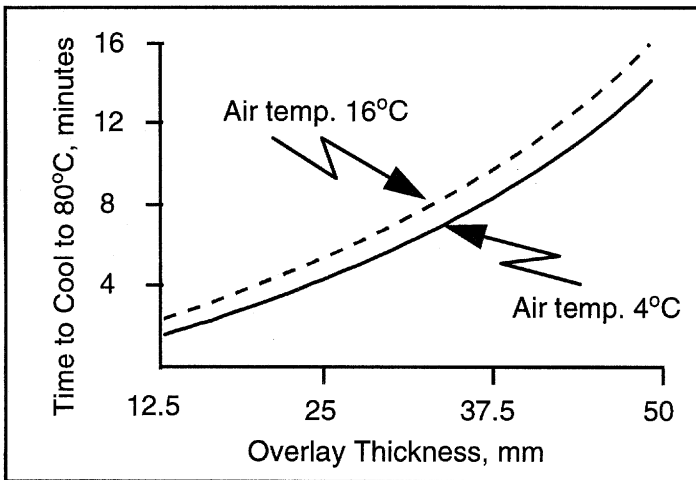

The rate of cooling of the overlay depends on the overlay thickness, wind speed, and the temperatures of the mix, existing pavement, and air. Since preventive maintenance overlays are less than 35 mm, compaction must be completed in 3 to 5 minutes under typical construction conditions.

CONSTRUCTION PRECAUTIONS

- ◆ Warm weather
- ◆ Mill or repair if needed
- ◆ Apply tack coat
- ◆ Appropriate top aggregate size
- ◆ Good quality control

If the old pavement is rough, it should be milled or a leveling course placed before applying the thin overlay. Cracks in the existing pavement should be repaired before the thin overlay is placed. A tack coat should be applied to ensure bonding. The maximum aggregate size should be appropriate for the overlay thickness used. Finally, it is important to maintain good construction quality control.

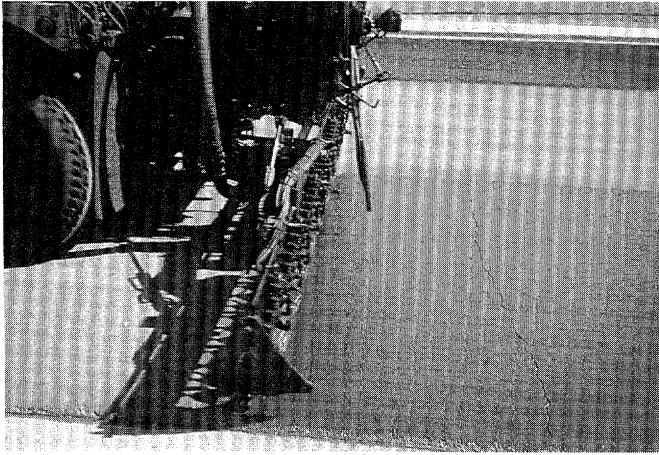

This slide shows tack coat application; a means of providing a good bond between the existing surface and the thin overlay.

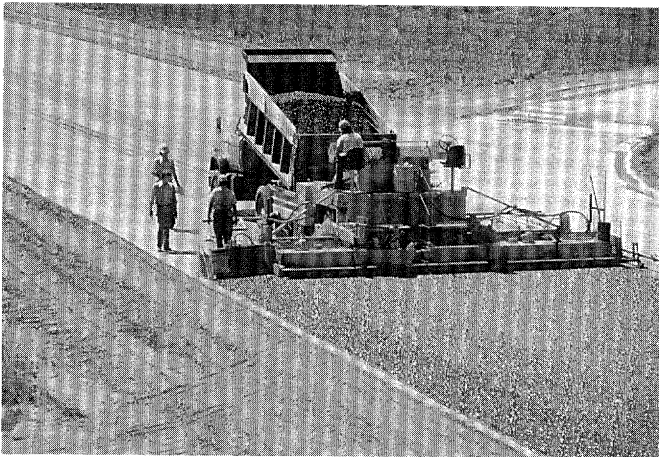

This slide shows paving a thin dense-graded hot-mix overlay.



This slide show compaction of thin dense-graded hot-mix overlay.

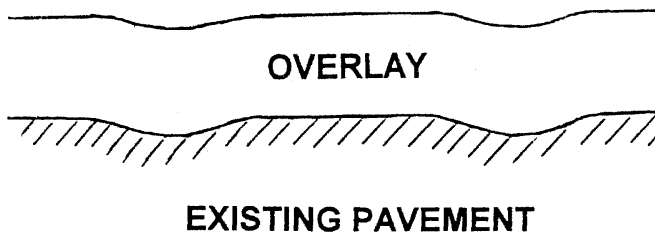

This sketch shows that, if the existing surface is rutted, and no milling or leveling course is used, the thin overlay may develop new rutting. This occurs because the overlay in the rutted areas is not compacted to the same density as the rest of the pavement. Hence, traffic can cause additional compaction in the wheel paths, resulting in ruts.



This slide shows debonding that may occur if no tack coat is used to bond the thin overlay to the existing surface.

STATE SPECIFICATIONS

- ◆ **Description**
- ◆ **Materials**
- ◆ **Construction details**
- ◆ **Weather conditions**
- ◆ **Method of measurement**
- ◆ **Basis of payment**

Conventional specifications are used for thin hot-mix overlays. Particular attention should be paid to the ambient temperature due to the overlay's rapid rate of cooling.

TRAFFIC CONTROL

**Open road to traffic when
mix is cool**

Since no curing time is required for HMA, the road can be opened to traffic soon after the mix is compacted and cooled.

LIMITATIONS

- ◆ **Not effective for strengthening**
- ◆ **Possible debonding**
- ◆ **Does not remove large roughness**
- ◆ **Reflection cracking**
- ◆ **Maintenance of OGFC**

If an overlay is needed for strengthening the existing pavement, thin overlays are seldom cost-effective. Thin overlays are generally prone to debonding from the existing surface. In addition, thin dense-graded hot-mix overlays do not remove significant roughness in existing pavements. They are also more susceptible to reflection cracks than thick overlays.

Patching of OGFC should be done with an open-graded material. Otherwise, the drainage path in the surface may be blocked, leading to a variety of drainage-related problems.

PERFORMANCE ***(years)***

	Typical	Range
Dense	5 to 9	2 to 10
OGFC	8 to 12	12+
Gap	10 to 12	?

Due to the variety of overlay types and applications, the performance of thin hot-mix overlays is difficult to define. A NCHRP study found states reporting typical service lives of 5-8 years for dense graded overlays of less than 30 mm. The overall range is from 2 to 10 years. This variance could be due to the condition of the pavement when the overlay was placed. OGFC has a reported range of 8 to 12 years, with some applications lasting longer. European experience with stone matrix asphalt is reported to be 10 to 12 years.

VARIATIONS ON GAP GRADED THIN HOT-MIX OVERLAY

Several types of gap-graded mixes are available for use in preventive maintenance. These treatments represent an emerging technology. The most widely-used gap-graded technology is Stone Matrix Asphalt (SMA).

GAP-GRADED OVERLAY TYPES

- ◆ Stone matrix asphalt (SMA)
- ◆ Very thin HMA
- ◆ Ultra-thin HMA
- ◆ Hot-rolled mix (sand asphalt)
- ◆ GussAsphalt
- ◆ Novachip

Several types of gap-graded thin overlay are available; these provide alternatives to the other preventive maintenance treatments. Gap-graded thin overlay mixes are usually less than 40 mm thick, and include such types as stone matrix asphalt, very thin HMA, ultra-thin HMA, hot-rolled mix (sand asphalt), GussAsphalt, and Novachip.

DEFINITION OF SMA

- ◆ Relatively thin (15-40 mm) gap-graded hot mixture
- ◆ High proportions of CA, binder, and mineral filler
- ◆ Low amount of middle-size aggr.
- ◆ Stabilizing additives

SMA is a relatively thin layer (15 to 40 mm) of gap-graded, densely compacted, hot-mix asphalt. The SMA mix is different from normal dense-graded hot mix in that there are high proportions of coarse aggregate, binder, and mineral filler in the SMA mix. The mix also has a low amount of middle-size aggregate. Stabilizing additives, such as fibers or asphalt modifiers, are also used. The SMA mix can be viewed as an OGFC that has had its voids filled with a mastic of asphalt cement, a stabilizer, and fine aggregate.

USES OF SMA

- ◆ **Developed in Europe in 1970s**
- ◆ **Used as surface course for:**
 - **New construction**
 - **Surface renewal**
- ◆ **Provides rut-resistant surface**
- ◆ **Restores surface friction**

This mix was developed by European contractors in the 1970s. It is used as a surface course on both new construction and surface renewal to provide a rut-resistant wearing course and restore surface friction.

USES OF SMA (Cont.)

- ◆ **Seals existing surface**
- ◆ **Resistance to studded tires**
- ◆ **Slow aging**
- ◆ **Good low-temperature performance**

The SMA seals existing surface. It also offers resistance to the abrasive action of studded tires, provides slow aging, and good low-temperature performance.

SMA MATERIALS

- ◆ **Coarse aggregate**
- ◆ **Crushed / natural sand**
- ◆ **Asphalt cement**
- ◆ **Additives**

SMA consists of coarse aggregate, crushed and natural sand, asphalt cement, and additives. Although the components are essentially the same as those of dense-graded HMA, the proportions and the material requirements differ.

AGGREGATE QUALITY

- ◆ Aggregates have strong influence
- ◆ Mostly crushed CA and FA
- ◆ Natural sand $\leq 10\%$
- ◆ Open gradation on the coarse side of the maximum density line
- ◆ More contact points between CA

The aggregate plays an important role in the SMA mix. Both the coarse and fine aggregates in SMA mixtures are generally 100 percent crushed materials. Rounded natural sand is not recommended and can only be used in limited amounts; generally less than or equal to 10 percent by total aggregate weight. The aggregate gradation is open on the coarse side of the maximum density line on the 0.45 power chart. This increases the coarse aggregate's stone-on-stone contact.

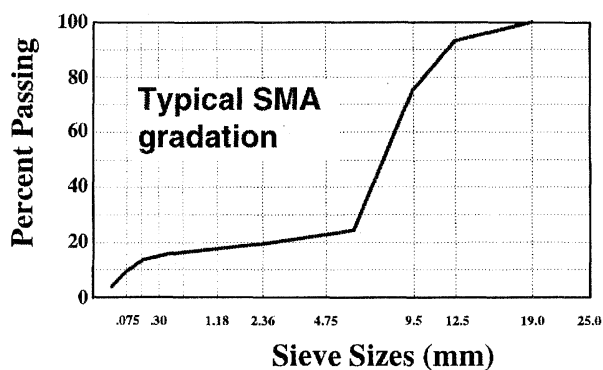

This is the typical aggregate gradation for an SMA mix. SMA usually has 70 to 75% coarse aggregate (greater than 4.75 mm), and approximately 10% filler (passing 0.075 mm).

The amount of sand is about half as much as that used in dense HMA. SMA also requires two or three times the mineral dust (passing 0.075 mm) of the dense mixes.

This gradation increases contact between the large aggregates, thus providing stability.

AGGREGATE QUALITY (Cont.)

- ◆ Cubic shape and rough texture
- ◆ Minimal flat & elongated particles
- ◆ Hard
- ◆ Resists polishing
- ◆ Resists abrasion

The aggregates must have: (1) a highly cubic shape and rough texture to resist rutting and movement, (2) a hardness that can resist fracturing under heavy traffic loads, (3) a high resistance to polishing, and (4) a high resistance to abrasion. Like many other types of mixtures, aggregates used in SMA mixtures, cannot have an excessive amount of flat and/or elongated particles.

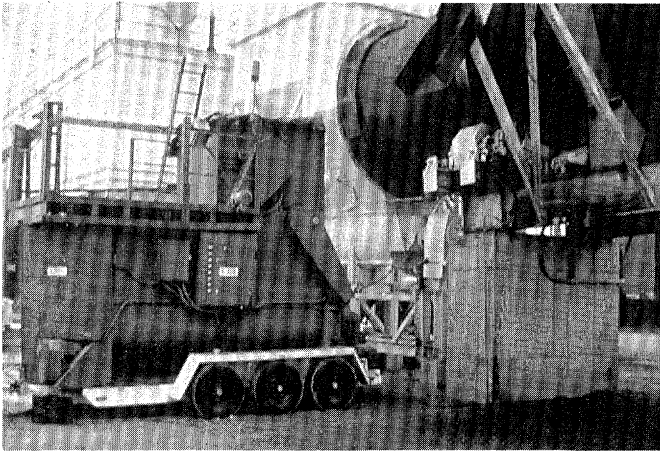

The fiber is introduced and mixed inside the drum with hot aggregate and asphalt cement using a special blower system.

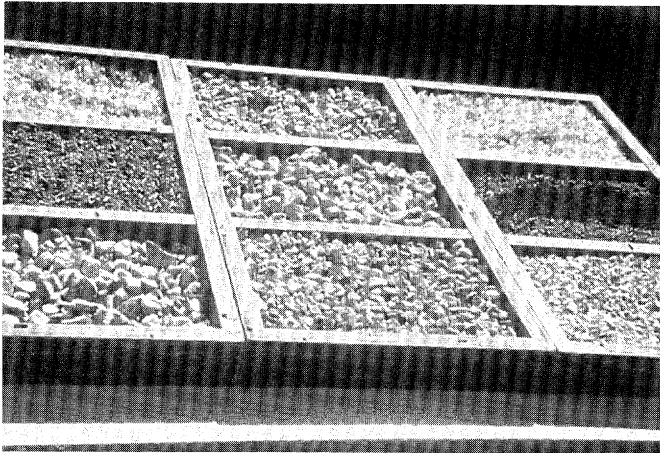

This slide shows aggregate, cellulose fibers, and polymer used in a Maryland demonstration project.

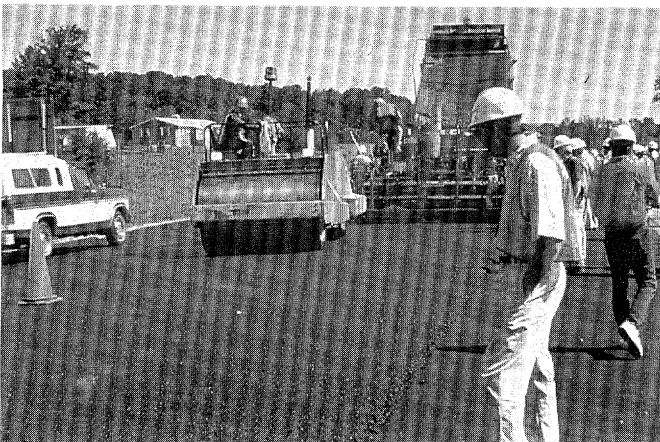

To obtain proper compaction, the mix is delivered at a temperature not less than 145°C. Rolling should begin immediately after placement with a 9 to 10.8 Mg steel-wheeled roller. Roller speed should not exceed 5 km/h.

Pavement should be compacted to at least 94 percent of maximum theoretical density, with no more than 6% air voids. The newly-compacted mat must cool to 60°C or below before opening the road to traffic.



This slide shows the rich and coarse surface texture of SMA.

SMA CONSTRUCTION

- ◆ Use HMA customary equipment
- ◆ Cover and insulate truck beds
- ◆ Roll mixture immediately
- ◆ Use steel wheel rollers
- ◆ Do not use pneumatic rollers

Customary equipment is used for mixing, transportation, and placement of SMA. Truck beds should be covered and insulated if necessary, so that the mixture can be delivered on the road at the specified temperature. Due to the nature of the SMA mixture, the surface should be rolled immediately. Compaction is usually accomplished by use of 9 to 11 Mg steel-wheeled rollers, although vibratory rollers may also be used. Pneumatic tire rollers should not be used on SMA.

SMA PERFORMANCE

- ◆ 10 to 12 years in Europe
- ◆ 20 to 40% higher than HMA
- ◆ 80 demonstration projects in the U.S. in different climatic zones

The expected service life of SMA in Europe has been reported to be approximately 10 to 12 years, which is about 20 to 40 percent higher than dense asphalt concrete. In the U.S., 80 SMA demonstration projects have been constructed in different climatic zones. Some of these projects were built within the SHRP SPS-3 experiment. Future evaluation of these experimental projects will provide information on the effectiveness of these mixes in the United States.

SMA PERFORMANCE (Cont.)

- ◆ **Resistant to**
 - **Plastic flow**
 - **Shear**
 - **Abrasion**
 - **Cracking**
 - **Skid**
- ◆ **Noise level equals to HMA**

Germans pavement engineers report that SMA is very resistant to plastic deformation. They also rank SMA as superior to normal dense mix in terms of its resistance to shear, abrasion, cracking, and skid resistance, while noise levels remain equal to those of HMA.

SMA LIMITATIONS

- ◆ **Draindown of binder & mineral filler**
- ◆ **Bleeding**
- ◆ **Poor initial skid resistance**
- ◆ **High initial cost**

Potential problems with SMA mixtures include: (1) drainage or separation of the binder and mineral filler during storage, hauling and placement; (2) bleeding; and (3) poor initial skid resistance due to high asphalt content. Therefore, stabilizing agents such as fibers, rubbers, polymers, Lake Trinidad asphalt, carbon black, artificial silica, or a combination of these materials are added to stiffen the mastic. The initial cost of SMA mixes is also higher than that of dense mixes.

OTHER GAP-GRADED OVERLAYS

- ◆ **Very thin HMA**
- ◆ **Ultra-thin HMA**
- ◆ **Hot-rolled mix (sand asphalt)**
- ◆ **GussAsphalt**
- ◆ **Novachip**

Other types of thin gap-graded HMA overlays are available and have been used in Europe. These systems compete with other preventive maintenance treatments. These mixes are usually less than 40 mm thick. The combined market share for these mixes accounts for roughly 10% of overall hot mix production in Europe (approximately 240 million Mg). Among these systems are very thin HMA, ultra-thin HMA, hot-rolled mix (sand asphalt), GussAsphalt, and Novachip.

VERY THIN HMA

- ◆ **20 - 25 mm thick**
- ◆ **Gap-graded aggregate**
- ◆ **5.8 - 6.0% binder**
- ◆ **Emulsion tack coat**
- ◆ **Conventional equipment**

Very thin HMA is used in Europe, particularly in France. It is spread in layers of 20 to 25 mm. It contains gap-graded aggregate and 5.8-6.0% binder. An emulsion tack coat is typically used with a rate of 0.4 to 0.7 liters/m². The tack coat plays a dual role of waterproofing the existing surface and tacking the wearing course. Conventional equipment is used to spread the mix. An application rate of 50 to 65 kg/m² is used.

ULTRA-THIN HMA

- ◆ **10 - 15 mm thick**
- ◆ **Gap-graded aggregate**
- ◆ **5.2 - 5.6% binder**
- ◆ **Emulsion tack coat**
- ◆ **Special spreading equipment**

Ultra-thin HMA is also used in Europe, particularly in France. It is spread in layers of 10 to 15 mm, and contains gap-graded aggregate and 5.2-5.6% binder. An emulsion tack coat is typically used at a rate of 0.8 to 1.0 liters/m². Similar to very thin mixes, the tack coat plays a dual role of waterproofing the existing surface and tacking the wearing course. Special equipment is used to spread the mix. An application rate of 25 to 35 kg/m² is used.

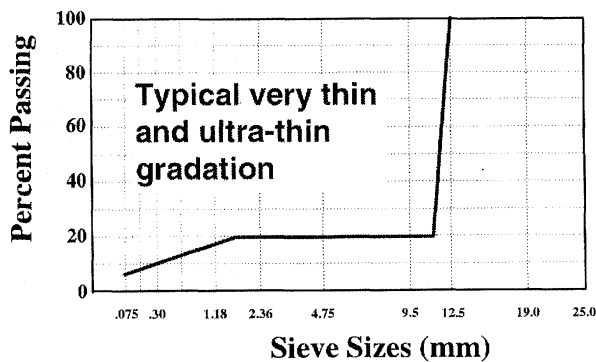

This graph shows the gap-graded aggregate used in very thin and ultra-thin hot mixes. The gradation is referred to as 0/10, indicating that the sizes range from 0 to 10 mm. The gradation has a gap between 2 and 6 mm sieves (2/6 mm gap). Very thin mixes have slightly less coarse aggregates than ultra-thin mixes.

HOT ROLLED MIX

- ◆ Also called sand asphalt
- ◆ Aggregate is:
 - Manufactured sand,
 - Natural sand, or
 - Slag screening
- ◆ May include mineral filler

The hot rolled mix is mostly used in the United Kingdom. It is also called sand asphalt. The aggregate used in this mix is either manufactured sand, natural sand, or slag screening. The mix may also include mineral filler.

GUSSASPHALT

- ◆ Mastic asphalt mix (voidless)
- ◆ No coarse aggregate
- ◆ Stiff asphalt cement
- ◆ No rolling required

GussAsphalt is a mastic asphalt mix that is essentially voidless and lacks a coarse aggregate structure. The stability of this mix is provided by a stiff asphalt cement. The mix requires no rolling. It is primarily used in the U.K. and Switzerland.

NOVACHIP

- ◆ 10 to 20 mm thick
- ◆ Open-graded mix
- ◆ 5.1 to 5.5% conventional AC
- ◆ Tack coat (polymer modified)

The Novachip thickness ranges from 10 to 20 mm, depending on the aggregate size. The material is a hot mix asphalt with an open graded aggregate and a maximum size of 9.5 mm. The Novachip mix contains 5.1 to 5.5% conventional AC. The Novachip layer is spread over a polymer-modified RS or CRS emulsion tack coat. The tack coat application rate is usually kept between 0.70 to 1.00 liters/m². Several demonstration projects were placed in the U.S. in 1992 and 1993.

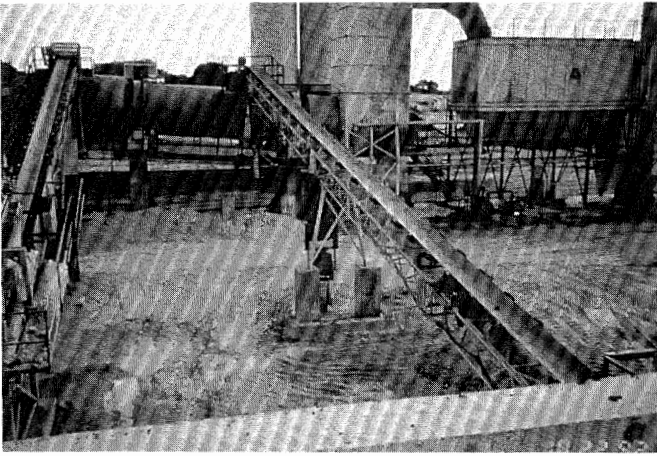

Again, customary equipment and practices are used in the mixing and transportation of Novachip. The mixing temperature varies from 160 to 165°C. This slide shows the drum mix plant used for Texas projects.



This slide shows the Novachip paving operation used in Texas. A 12m-long machine is used to spread both emulsion spray and mix in one pass at a speed of approximately 0.5 to 0.75 km/h.



This slide shows the rear of a Novachip machine.

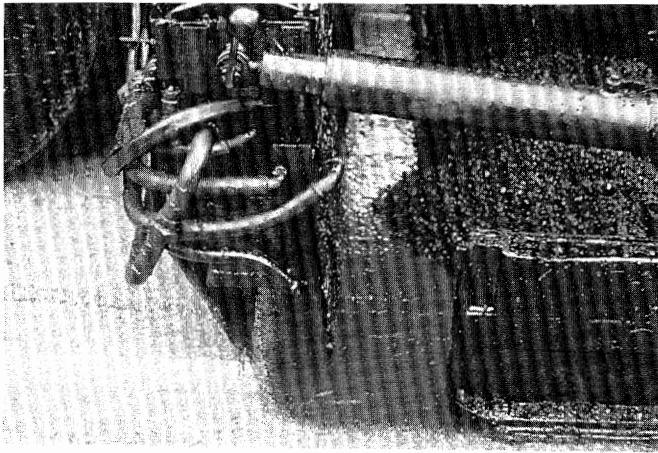

This is a close-up of the spray bar.



The Novachip mix is rolled immediately after placement. Two 9Mg rollers were used for a total of four passes.



This photo shows nurse trucks used to periodically fill the emulsion tank on the machine. Emulsion tank capacity on these machines is about 8,300 liters; adequate for nearly 3 hours of operation. Emulsion is applied at a temperature of 60°C. The emulsion storage tank was not equipped for reheating the emulsion.



Novachip has a coarse, rich, open texture, and longitudinal joints are nearly invisible.

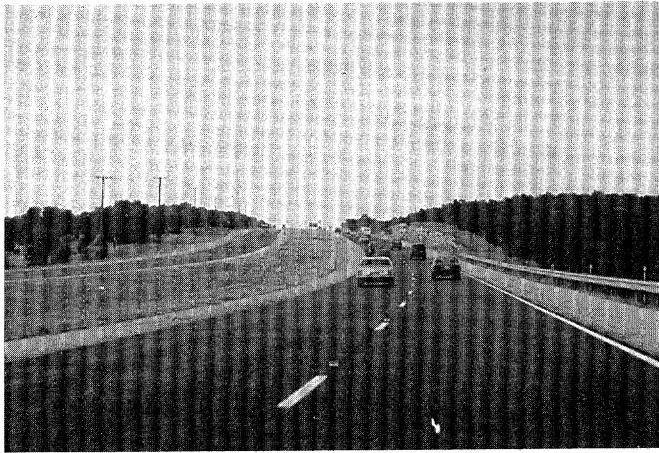

This is a completed Novachip project.

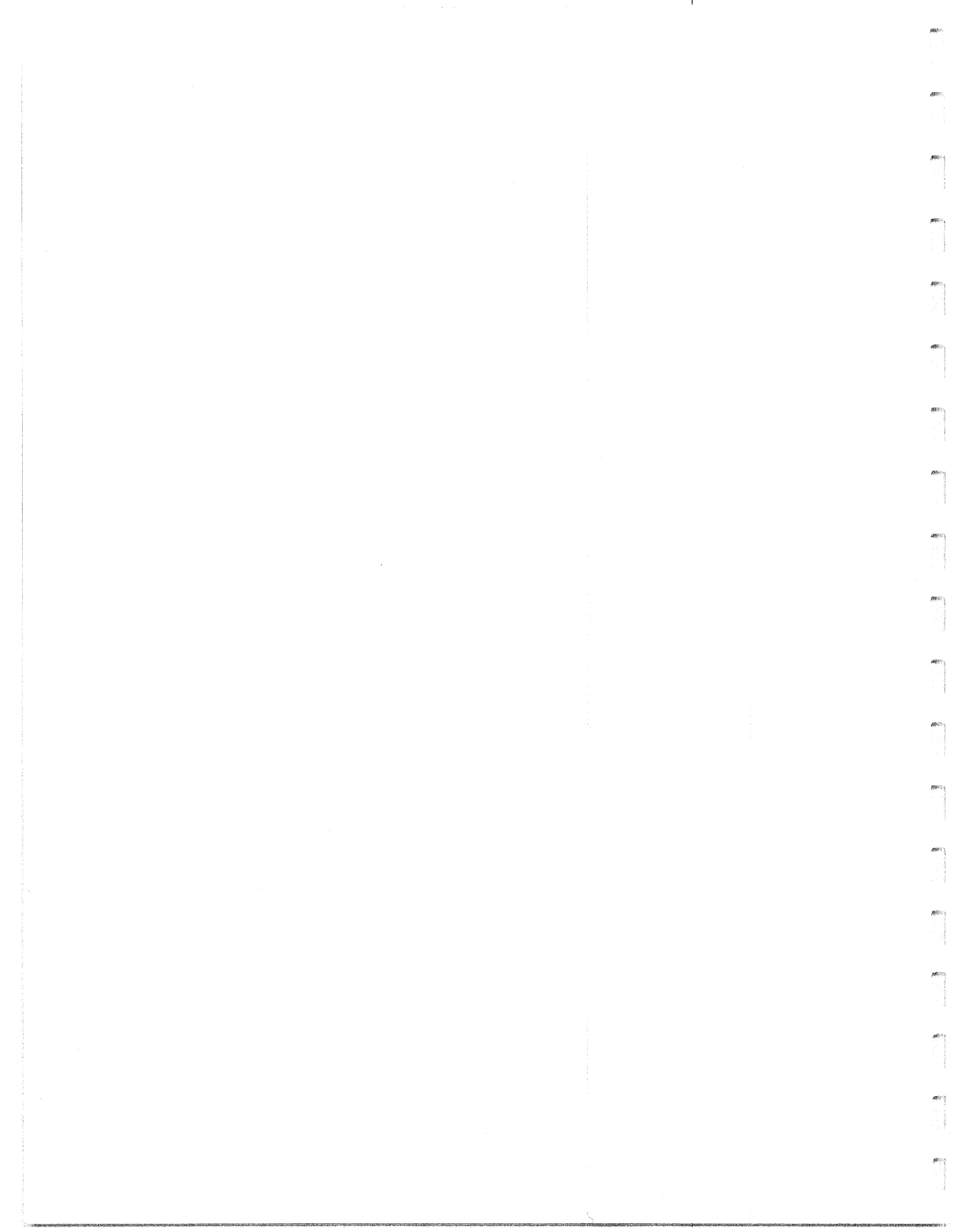

*Pavement Preventive
Maintenance Treatment*

*Crack Treatment for
Flexible Pavements*



PREVENTIVE MAINTENANCE TREATMENT

CRACK TREATMENT OF FLEXIBLE PAVEMENTS

Crack sealing is one of the oldest forms of pavement maintenance. Crack treatments are both a corrective and preventive maintenance, as sealing the pavement limits the intrusion of water and subsequent related damage.

OBJECTIVE

Crack sealing techniques

- ◆ **Design / material selection**
- ◆ **Construction**
- ◆ **Performance**
- ◆ **Limitations**

The main objective of this section is to discuss the proper techniques for crack treatment of flexible pavements in terms of design and material selection, construction, performance, and limitations.

CRACK TREATMENT OF FLEXIBLE PAVEMENTS

- ◆ **Routine maintenance**
- ◆ **Involves cleaning & sealing**
- ◆ **Prevents/reduces intrusion of:**
 - **Water**
 - **Incompressible materials**

Crack treatment of flexible pavements is a routine maintenance activity that basically involves cleaning out the cracks that are wide enough to clean, and then sealing the clean cracks with a sealant material. Crack treatment prevents or reduces intrusion of water and incompressible materials. SHRP project H-101 included crack sealing as a preventive maintenance treatment. However, SHRP projects H-105 and H-106 provide more detailed information relative to crack treatment.

SHRP H-101 EXPERIENCE

- ◆ **81 Sections**
- ◆ **Route & clean**
- ◆ **Dry with hot-air lance**
- ◆ **Follow up?**

Crack sealing was performed on 81 sections during the H-101 research. Cracks were routed and cleaned with a hot air lance. The ETG that has reviewed the performance of these sections reports that the seals are not being maintained on a regular basis.

INNOVATIVE MATERIALS AND TESTING

- ❖ **22 Sections**
- ❖ **Throughout North America**
- ❖ **Covered**
 - **Crack sealing**
 - **Pothole repair**

In addition to the H-101 research, crack treatments were studied in detail in the H-106 research project, Innovative Materials Development and Testing. On this project, maintenance treatments were constructed on 22 test sites throughout the U.S. and Canada. The sections were constructed between March 1991 and February 1992, and performance was monitored through March 1993. Much of the information in this session is based on the findings of this project.

CONDITIONS FOR SUCCESS

Type of maintenance depends on crack -

- ◆ **Density**
- ◆ **Severity**
- ◆ **Pattern**

Crack treatments are appropriate for low- to moderate-density cracks of moderate severity. Longitudinal, transverse, and edge cracks can be treated. Fatigue and block cracking are not good candidates.

CRACK TREATMENT DESIGN

- ◆ **Crack Sealing**
Seal out water & incompressibles
- ◆ **Crack Filling**
Seal out water & preserve adjacent pavement

Crack sealing is the placement of specialized materials either above or into *working* cracks using a unique configuration to prevent the intrusion of water and incompressibles into the crack.

Crack filling is the placement of materials into *nonworking* cracks to substantially reduce infiltration of water and to reinforce the adjacent pavement.

WORKING VS. NONWORKING CRACKS

- ◆ **Working crack moves 3 mm or more**
- ◆ **Nonworking crack moves less than 3 mm**

Working refers to horizontal and/or vertical crack movements greater than or equal to 3 mm, while *nonworking* refers to movements of less than 3 mm.

SEALING VS. FILLING

- ◆ **Sealing**
For working cracks with limited edge deterioration
- ◆ **Filling**
For nonworking cracks with moderate/no edge deterioration

Crack sealing is generally more difficult to accomplish than crack filling. Sealing requires considerably more forethought, greater costs, and the use of specially-formulated materials and more sophisticated equipment.

Normally, working cracks with limited edge deterioration should be sealed, while nonworking cracks with moderate to no edge deterioration should be filled.

SHRP GUIDELINES

Crack Density	Edge Deterioration		
	Low	Moderate	High
Low	None	CT ??	CR
Moderate	CT	CT	CR
High	ST	ST	Rehab.

CT = Crack Treatment

CR = Crack Repair

ST = Surface Treatment



Preventive
Maintenance

The SHRP H-106 guidelines for selecting crack treatments are based on the density of cracking and the condition of the crack edge. Crack treatment for the low density / moderate severity condition needs to be studied on a case-by-case basis. Surface treatment of high density cracking is corrective maintenance. When placed on a deteriorated condition, surface treatments will have a limited life. *This is different from the timing recommendation for a preventive maintenance treatment as presented in this workshop.* For preventive maintenance, the pavement should be in good condition as indicated in the red box on the slide. Crack repair is performed on high severity deteriorated cracks. The failed material is removed and the area is patched.

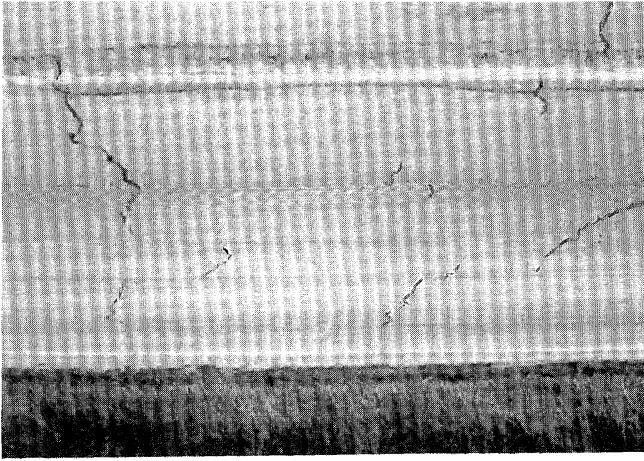

This slide shows a pavement with high density cracking which makes it a candidate for surface treatment such as chip seal or slurry seal. In this application, these treatments will be a corrective action rather than preventive maintenance.

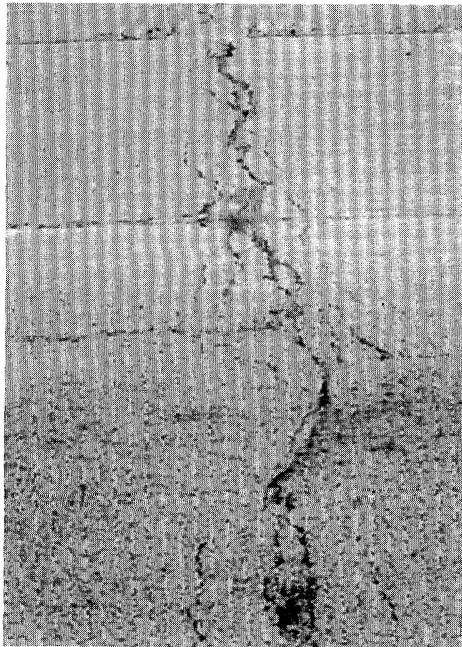

This pavement is a candidate for crack repair, such as partial-depth or spot patch.



This pavement is a candidate for transverse crack sealing.

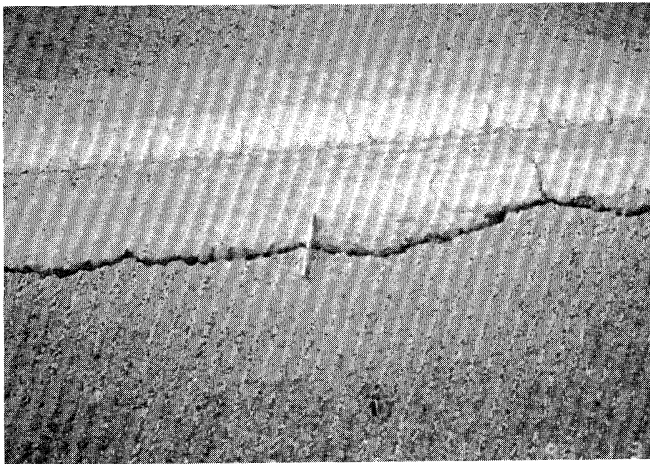

This pavement is a candidate for crack filling.

SEALING/FILLING MATERIALS

- ◆ **Cold-applied thermoplastic**
- ◆ **Hot-applied thermoplastic**
- ◆ **Chemically cured thermosetting**

Materials for sealing/filling asphalt pavement cracks may be divided into three categories:

1. Cold-applied thermoplastic materials such as emulsion and polymer-modified emulsion.
2. Hot-applied thermoplastic materials such as:
a) asphalt cement, b) mineral-filled asphalt cement, c) fiberized asphalt, d) asphalt rubber, e) rubberized asphalt, and e) low-modulus rubberized asphalt.
3. Chemically-cured thermosetting materials.

THERMOPLASTICS

- ◆ **Asphalt lacks flexibility & is very temperature-susceptible**
- ◆ **Rubber & other additives improve flexibility**

Asphalt cement, liquid asphalt, mineral-filled asphalt cement, and fiberized asphalt possess little flexibility and are very temperature-susceptible. Therefore, they are limited to use as fillers for nonworking cracks.

The addition of rubber polymer improves the flexibility of the asphalt. The degree of flexibility basically depends on the type and nature of the asphalt, percentage of vulcanized rubber used, and how the rubber is incorporated into the asphalt (i.e., mixed or melted in). Other additives are often incorporated into the asphalt, either exclusively or along with rubber, to increase resilience.

CHEMICALLY-CURED THERMOSETTING

- ◆ **Cured by chemical reaction from liquid to solid**
- ◆ **Self-leveling silicon is an example**

Chemically-cured thermosetting materials are cured by chemical reaction from a liquid state to a solid state.

Self-leveling silicone is one of the sealant materials that is cold-applied and does not require tooling, since it is self-leveling.

SEALING CONFIGURATIONS

- ◆ **Flush-fill**
- ◆ **Reservoir**
- ◆ **Overband**
- ◆ **Combination:
Reservoir and overband**

Sealant and filler materials can be placed in cracks in numerous configurations. These configurations are grouped into four categories: a) flush-fill, b) reservoir, c) overband, and d) combinations of reservoir and overband.

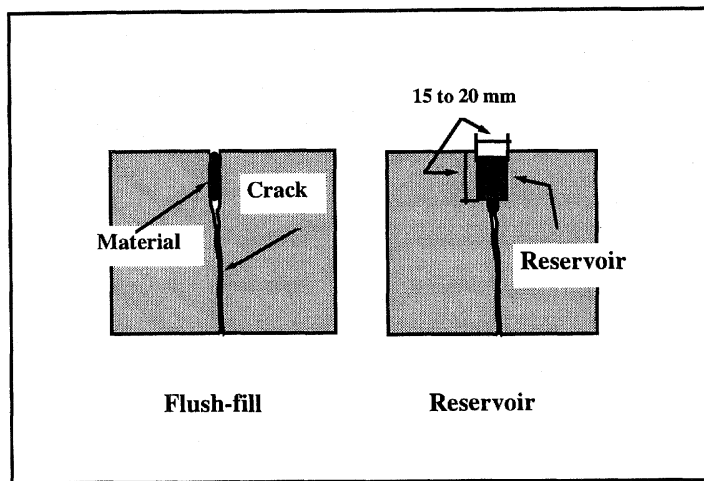

This slide shows flush-fill and reservoir configurations.

In the flush-fill configuration, material is simply dispensed into the existing, uncut crack, and the excess material is struck off. In the reservoir configuration, material is placed only within the confines of a cut crack (i.e., crack reservoir). Bonding is improved with routing (reservoir configuration).

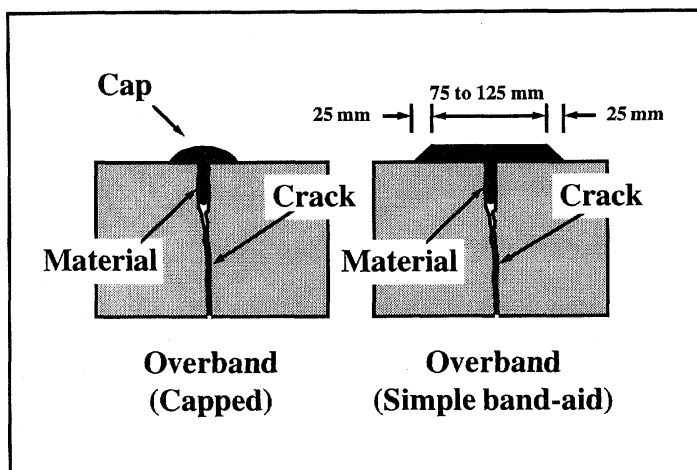

This slide shows two types of overband configurations; capped and simple band-aid.

In the overband configuration, the material is placed into and over an uncut crack. In this case, the material over the crack can be left unshaped (creating a capped shape) or shaped using a squeegee (creating a simple band-aid shape). Overband and excessive joint seal material are not recommended since they create surface bumps and may cause the sealant to be picked up by snow plows.

CRACK TREATMENT PROCEDURE

- ◆ **Crack routing (optional)**
- ◆ **Crack cleaning & drying**
- ◆ **Material preparation & application**
- ◆ **Material finishing/shaping (optional)**
- ◆ **Blotting (optional)**

Crack treatment consists of at least two and up to five steps, depending on the type of treatment (sealing or filling), treatment policy, and available equipment. These steps are: 1) crack cutting (routing or sawing), 2) crack cleaning and drying, 3) material preparation and application, 4) material finishing/shaping, and 5) blotting.

PAVEMENT PREPARATION

Crack routing

- ◆ **Rotary-impact router**
- ◆ **Diamond blade**

Open cracks should be routed to a width of 10 mm and a depth of 20 mm using either a rotary-impact router or diamond-blade crack saw. Routing is used to allow the sealant to enter the crack.



This slide shows a rotary-impact router.

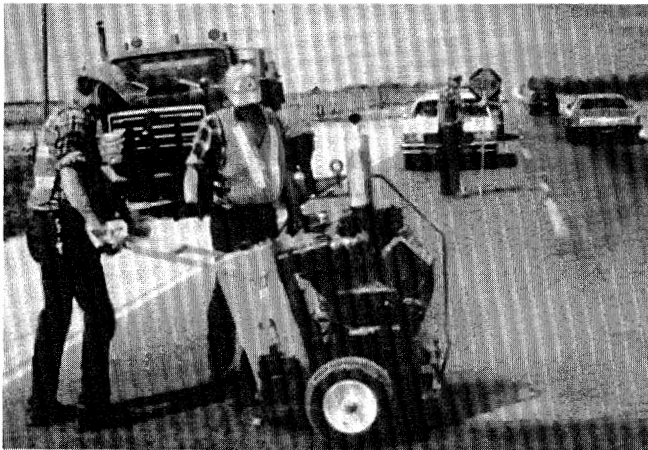

This slide shows a diamond-blade crack saw.

PAVEMENT PREPARATION (Cont.)

Cleaning & drying

- ◆ **Broom**
- ◆ **Compressed air**
- ◆ **Sandblasting**
- ◆ **Hot air blasting (heat lance)**

The next step is to clean and dry the crack. For best results, the crack should be cleaned with a stiff-bristled broom, compressed air, or sand blasting. Hot air blasting uses a heat lance to dry the crack. Moisture will inhibit bonding of the crack sealer to the walls of the crack.



This slide shows cleaning a crack with compressed air.

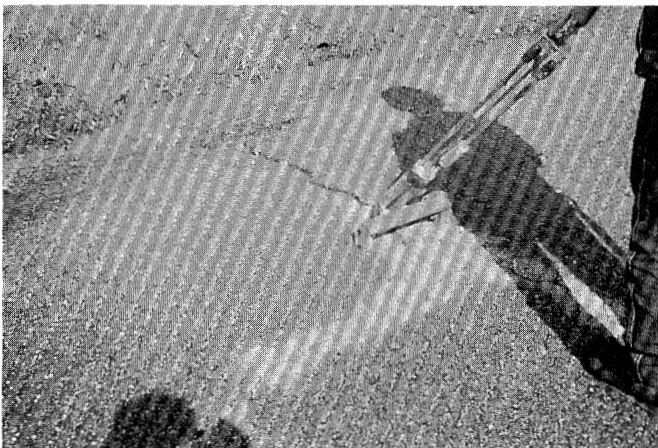

Hot air blasting (using a heat lance) dries the crack before sealing. The maintenance technician should take care not to burn the asphalt around the crack by moving the heat lance too slowly.

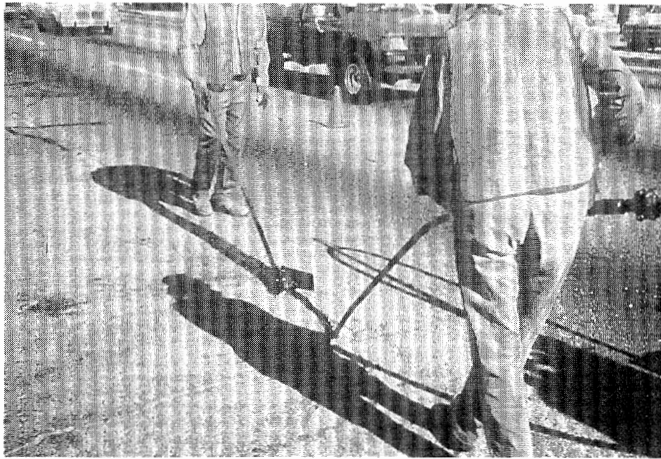

This slide shows sealant being applied with a pressure applicator. A hand squeegee is used to remove excess sealant.

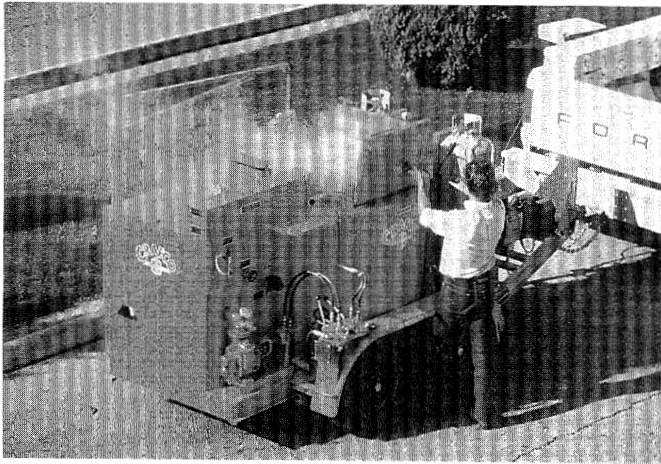

This is an example of a machine used to heat the sealant. The sealant may be delivered in plastic bags and placed in the kettle with the bag. The machine is equipped with a compressor that pumps the sealant.



A shoe is sometimes attached to the applicator to ensure proper application without excess sealant.



This is an example of a well-sealed crack.



The sealant material can also be applied using a pouring pot, as shown in this slide.

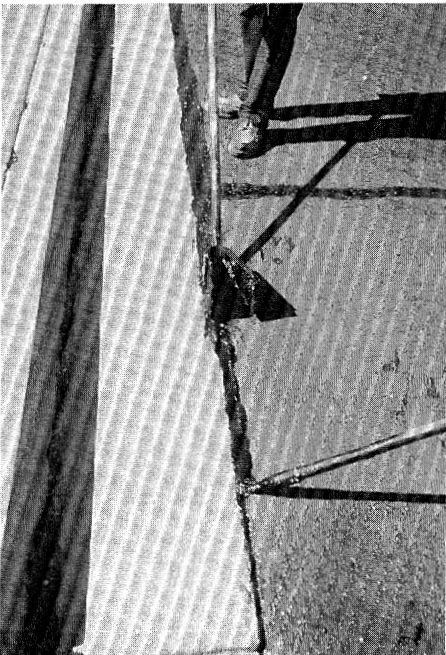

The longitudinal joint between the pavement and the gutter has to be cleaned and sealed in the same manner as other cracks. These joints are often overlooked, resulting in poor pavement performance.

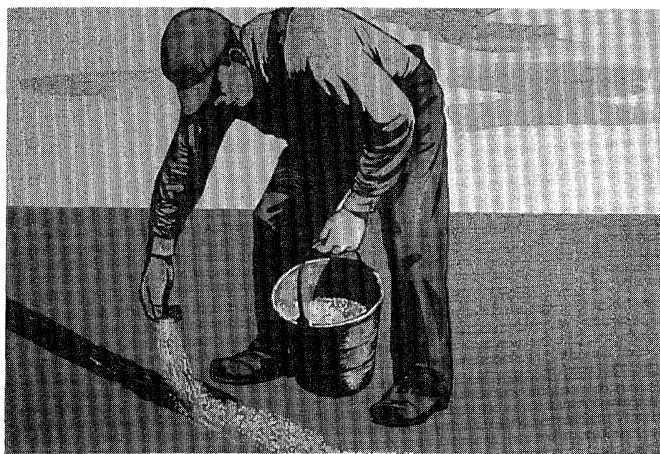

This slide shows sprinkling the surface of the sealed crack with dry sand to prevent sealant pick-up by traffic.

WEATHER CONDITIONS

- ◆ **When crack is open in cool weather (7 to 18°C)**
- ◆ **Spring or fall**

Ideally, crack sealing should be conducted shortly after working cracks have developed to an adequate extent and at a time of year when temperatures are moderately cool (7 to 18°C), such as in the spring or fall.

TRAFFIC CONTROL

- ◆ **Detour traffic until seal cures**
- ◆ **Cover sealant with sand for quick opening**
- ◆ **Begin filling at pavement centerline**

Traffic should be rerouted until the sealant material cures. If the pavement is to be opened to traffic immediately after sealing, the sealant must be protected against pick-up by tires, which can be accomplished by dusting the cracks with fine sand, mineral dust, or a similar material.

It is a good practice to work from the centerline to the edge of the pavement to avoid backing into the stream of traffic.

INSPECTION & ACCEPTANCE

- ◆ **Check equipment**
- ◆ **Appropriate materials**
- ◆ **Proper construction procedures**

In order to obtain long-lasting seals, equipment must be checked to ensure that it is in good working condition, that appropriate materials are used, and that proper construction procedures are followed.

STATE SPECIFICATIONS

- ◆ **Materials**
- ◆ **Construction details**
- ◆ **Weather limitations**
- ◆ **Method of measurement**
- ◆ **Basis of payment**

State specifications usually include descriptions of work, materials, construction details, weather limitations, method of payment, and basis of payment.

CRACK TREATMENT PERFORMANCE

- ◆ **Retards deterioration**
- ◆ **Retards cupping deformation**
- ◆ **May extend life by 4 years**

Crack sealing effectively retards internal and external deterioration and slows down the progress of cupping deformation (depression of pavement profile at the transverse crack). It was found that rout-and-seal treatment of transverse cracks can extend the service life of pavements by at least four years.

CRACK TREATMENT LIMITATIONS

- ◆ **Limited to low-severity cracks**
- ◆ **Limited service life**
- ◆ **Must be repeatedly applied**

Crack sealing is limited to low-severity cracks. High-severity cracks (such as fatigue cracks) are seldom routed and sealed individually, because the intensity of the crack patterns usually warrants an area treatment rather than an individual crack treatment. Such treatment may involve removal and replacement, overlay, or seal coat for low-severity fatigue cracking.

*Pavement Preventive
Maintenance Treatment*

Rigid Pavements

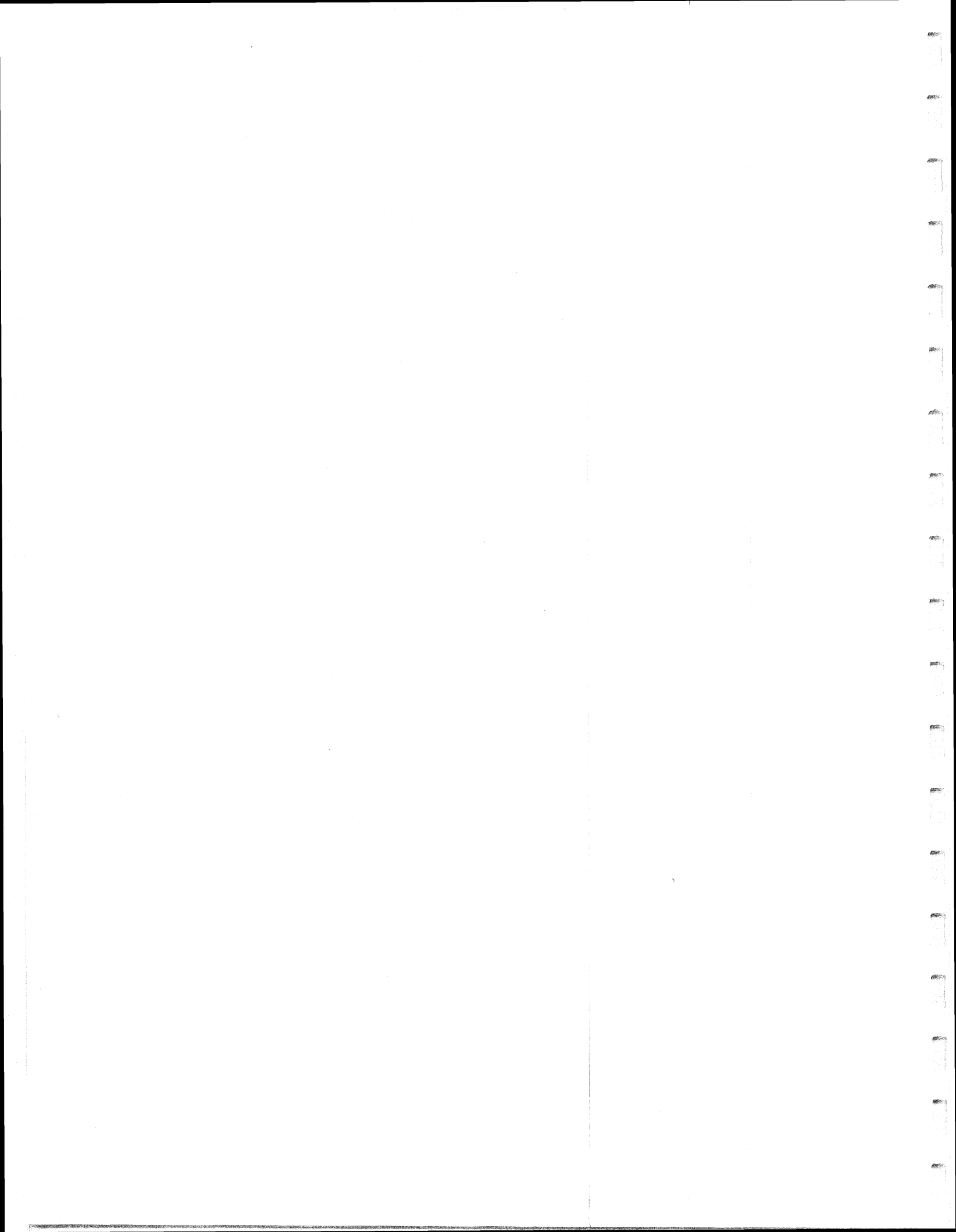

PREVENTIVE MAINTENANCE TREATMENT

PREVENTIVE MAINTENANCE OF CONCRETE PAVEMENTS

This section of the presentation deals with preventive maintenance of concrete pavements, which includes crack and joint sealing, undersealing, and retrofit of dowel bars.

OBJECTIVES

- ◆ **Crack and joint sealing**
- ◆ **Subsealing (undersealing)**
- ◆ **Techniques related to:**
 - **Design / material selection**
 - **Construction**

The main objective of this module is to discuss proper techniques for crack and joint sealing as well (as undersealing of concrete pavements) with respect to material selection, design, and construction.

SHRP EXPERIENCE

- ◆ **Projects:**
 - H-101 Preventive maintenance
 - H-105 Innovative Materials, Pavement Surface Repair
 - H-106 Innovative Materials, Development and Testing
- ◆ **22 Preventive maintenance sections**
 - Crack and joint seal
 - Undersealing

Research on concrete pavement maintenance was conducted over the course of three projects. Preventive maintenance was evaluated in the H-101 research, where sections were constructed with crack and joint sealing and undersealing of slabs. In addition, some states constructed retrofit of dowel bars sections.

The sections are performing well and it will be several years before performance models can be developed.

CRACK & JOINT SEALING

- ◆ **A routine maintenance activity**
- ◆ **To prevent intrusion of:**
 - **Water**
 - **Incompressible materials**

Sealing cracks and joints is a routine maintenance activity performed to inhibit the intrusion of surface water and incompressible materials into the opening. Water entering the pavement structure has several detrimental effects, including: pumping, freeze thaw damage, increased traffic stresses, and saturation of the subbase and subgrade.

WARRANTS FOR SEALING

- ◆ **Percent failed sealants**
- ◆ **Pavement type, pavement & sealant condition, & available fund**
- ◆ **Rating numbers based on sealant & pavement condition, traffic level, & climate**

Excessive delay in replacing a failing sealant system in concrete pavement joints can result in more rapid deterioration of the pavement. However, replacing the sealant too early waste precious maintenance funds. Therefore, an optimum time for resealing should be determined. Some states specify resealing joints when a specified amount of sealant material (25 to 50%) has failed, allowing moisture and/or incompressible materials to progress past the sealant to the underlying layers. Other agencies base the decision on pavement type, pavement and sealant condition, and available funding. A more complete method is to calculate rating numbers based on the sealant and pavement condition, traffic levels, and climatic conditions.

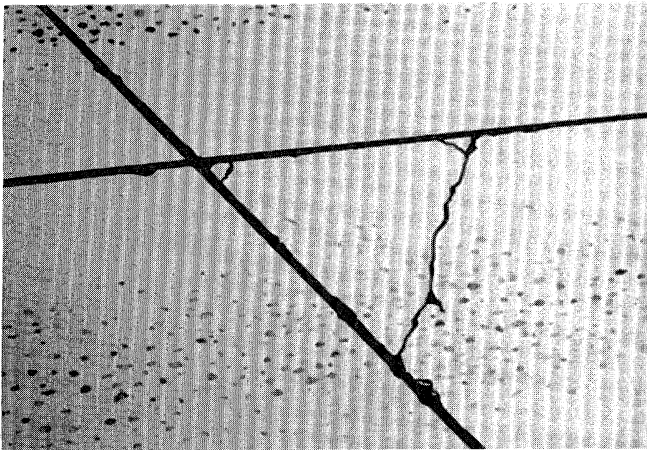

This slide shows a cracked concrete pavement. Cracks in concrete pavement may be longitudinal, transverse, or diagonal.

EFFECT OF NOT SEALING

Water infiltration may cause:

- ◆ **Pumping**
- ◆ **Void spaces under slab**
- ◆ **Corrosion of dowel and tie bars**
- ◆ **Freeze-thaw slab deterioration**

If cracks and joints are not routinely sealed, water infiltration may cause pumping. Pumping is the ejection of water and fine materials from underneath the slab through open joints and cracks when wheel loads are applied. Pumping results in the formation of void spaces under the slab, which eventually lead to loss of support of the concrete slab. Water infiltration may also cause corrosion of dowel and tie bars. Infiltration of water may also lead to slab deterioration due to the freeze-thaw effect.

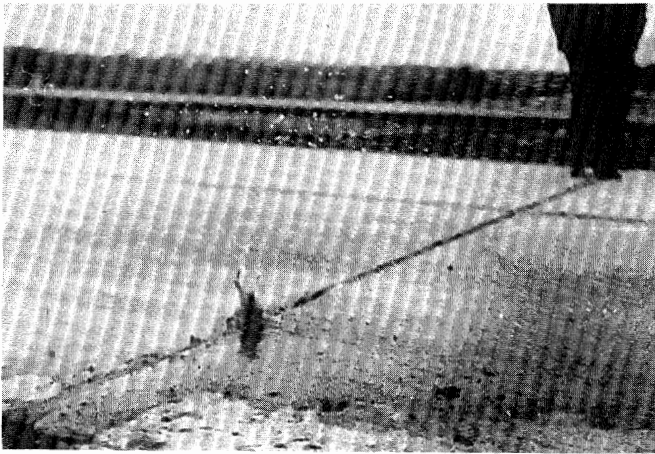

This slide shows pumping of water and fines through a joint in a concrete pavement.

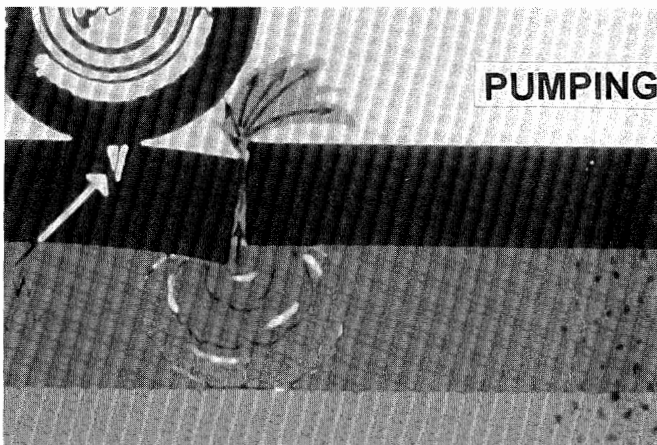

This sketch shows how pumping develops. When the materials under the slab get wet and the wheel load is applied, the water and fine materials are ejected through the crack or joint.

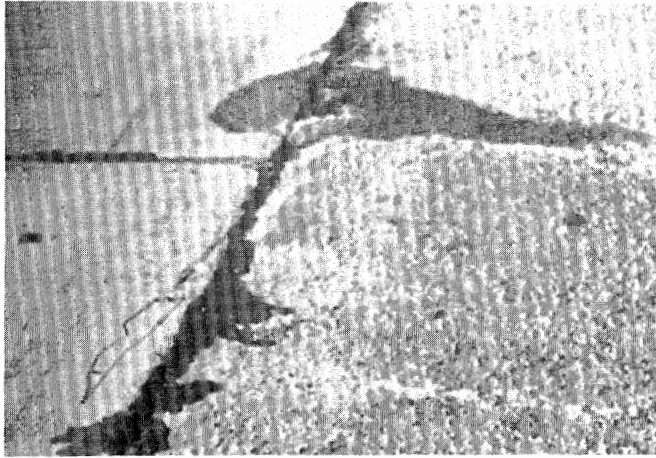

This slide also shows pumping, as indicated by water at the joints.

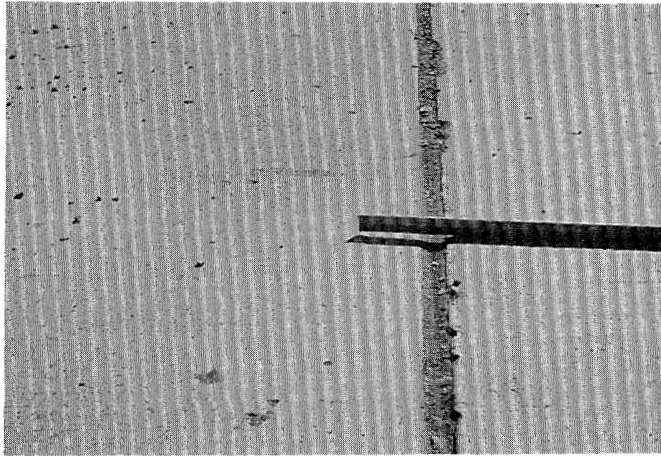

When void space is formed under the slab, faulting may occur.

EFFECT OF NOT SEALING (Cont.)

Incompressible materials may cause:

- ◆ **Blowup**
- ◆ **Joint deterioration**
- ◆ **Spalling**

The intrusion of incompressible materials in joints may cause blowup, joint deterioration, or spalling. Failures such as these may be caused by the compressive stresses that occur when concrete slabs are prevented from expanding when the temperature increases.

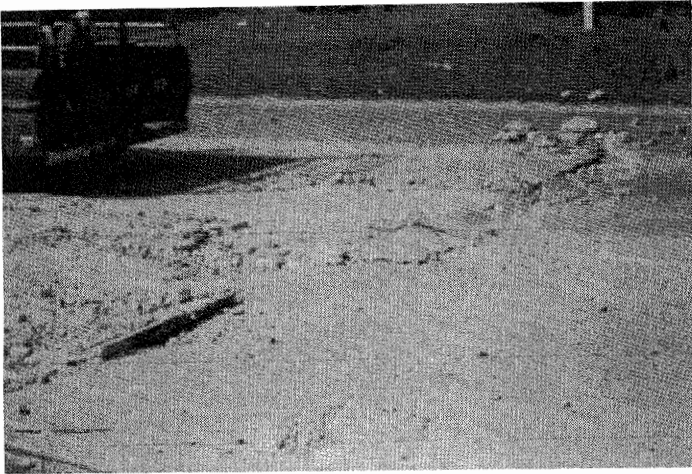

This slide portrays blowup in concrete pavement.

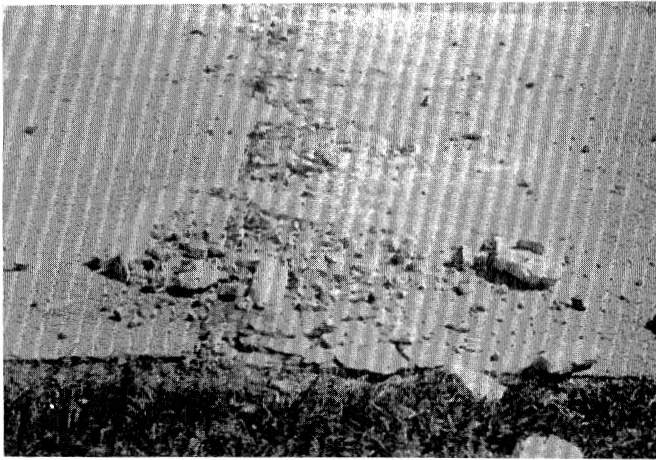

This photo shows joint spalling.

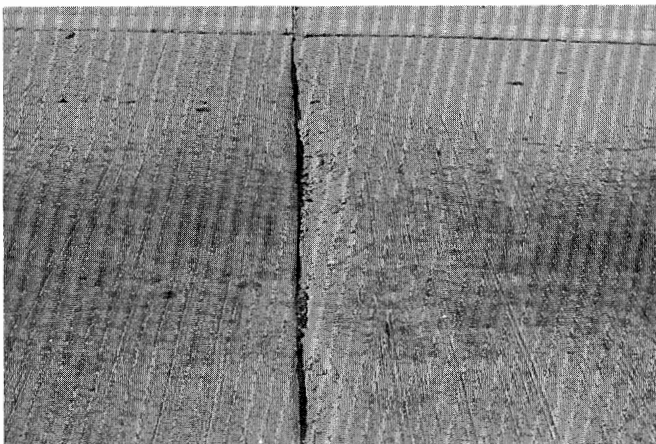

This slide depicts a badly spalled crack edge.

SEALING MATERIALS

- ◆ **Thermoplastic materials**
- ◆ **Thermosetting materials**
- ◆ **Preformed compression seals**

Sealant materials have to be durable, ductile, resilient, adhesive, and cohesive. There is a wide variety of sealants on the market today, each with its own inherent characteristics. The general categories used by the American Concrete Institute (ACI) to differentiate among sealing materials are:

1. Thermoplastic materials;
2. Thermosetting materials; and
3. Preformed compression seals.

THERMOPLASTIC SEALANTS

- ◆ **Bitumen-based**
- ◆ **Affected by heating & cooling**
- ◆ **Vary in elastic & thermal properties**
- ◆ **Affected by weathering**

The thermoplastic sealants are bitumen-based materials that typically soften upon heating and harden upon cooling, usually without change in chemical composition. These sealants vary in their elastic and thermal properties and are affected by weathering to some degree. They include asphalt cement, asphalt emulsion, polymer-modified asphalt emulsion, asphalt rubber, fiberized-asphalt, PVC coal tar, rubberized asphalt, and low-modulus rubberized asphalt.

THERMOSETTING SEALANTS

- ◆ **Set by adding solvent**
- ◆ **Cure chemically**
- ◆ **4 - 10 times more expensive**
- ◆ **Cost is offset by less material & lower labor & equipment costs**

Thermosetting sealants are typically one- or two-component materials that set by the release of solvents or cure through a chemical reaction. Some of these sealants have demonstrated the potential for good performance, but they are also four to ten times more expensive (in terms of material cost) than standard rubberized asphalt. However, thermosetting sealants are often placed thinner and may have lower labor and equipment costs. Such sealants include polysulfide, polyurethane, and silicon.

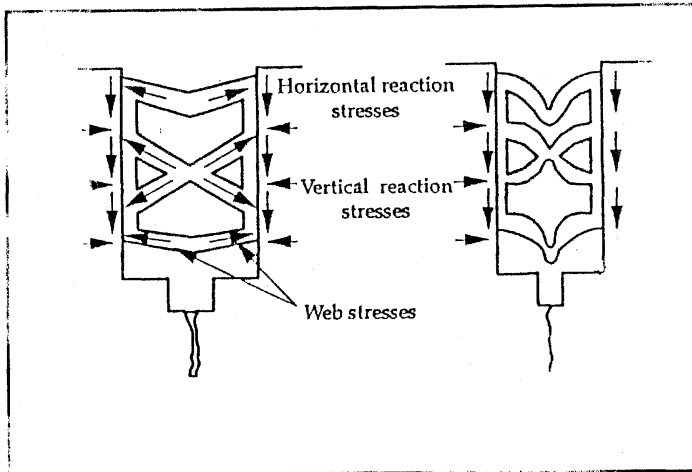

Preformed compression seals are premolded strips of styrene, urethane, neoprene, or other synthetic materials that are designed to be placed in PCC pavement joints under compression. Preformed compression seals are designed to be compressed 20 to 50% of their uncompressed width.

CONSTRUCTION PROCESS

- ◆ **Remove old sealant**
- ◆ **Rout joint sidewalls**
- ◆ **Clean and dry**
- ◆ **Install backer rod**
- ◆ **Install new sealant**

Before placing new sealant, the old sealant has to be removed. At the time of sealing, the crack must be completely free of dirt, dust, and other materials that might prevent proper bonding of the sealant.

In cases where cracks are open, a groove about 10 mm wide and 20 mm deep should be made along the crack. Machines such as diamond-blade random-cut saws, random crack grinders, and vertical-bit routers are used. The sawing or grooving tool must be capable of closely following the path of the crack required and widening the top to the required section without causing excessive spalling or other damage to the concrete.

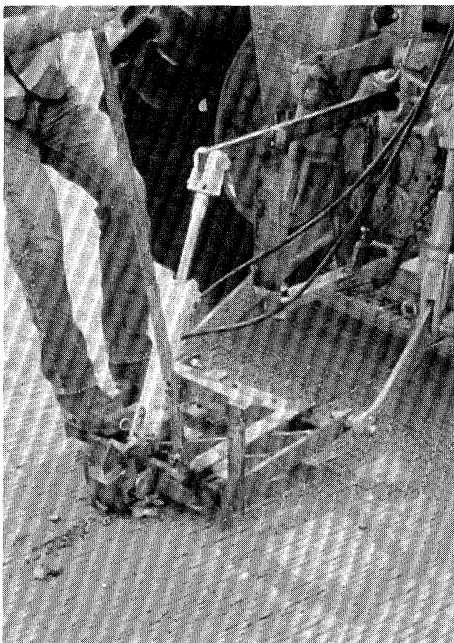

This slide shows removal of the old seal.

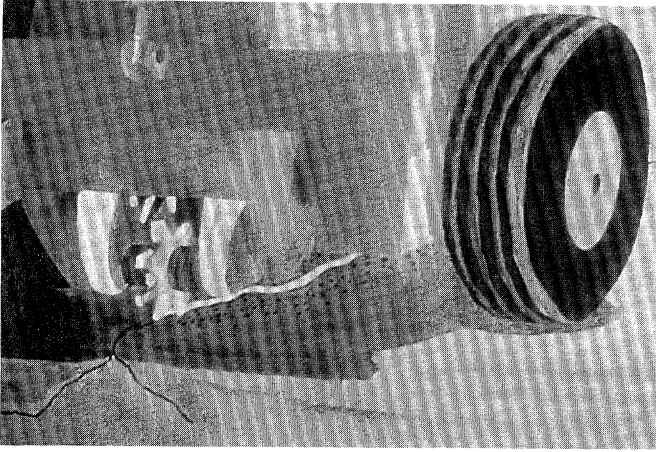

This slide presents a sketch of a router.

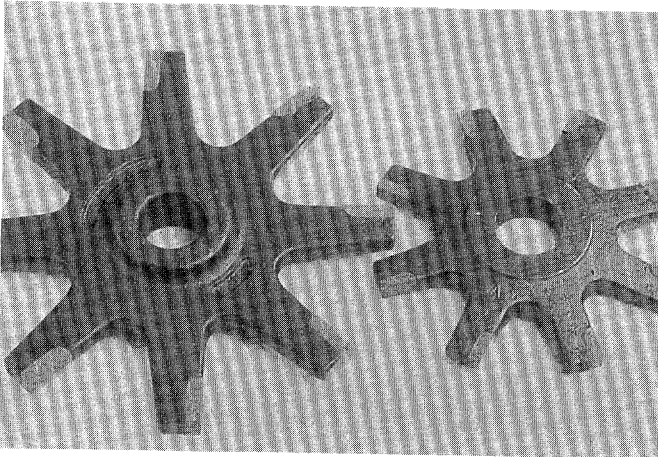

This slide depicts the blades of a router.

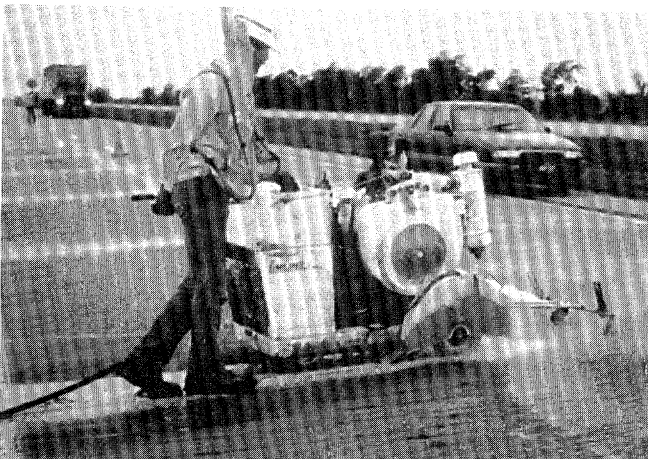

A diamond-bladed saw can be used to shape the crack before sealing.

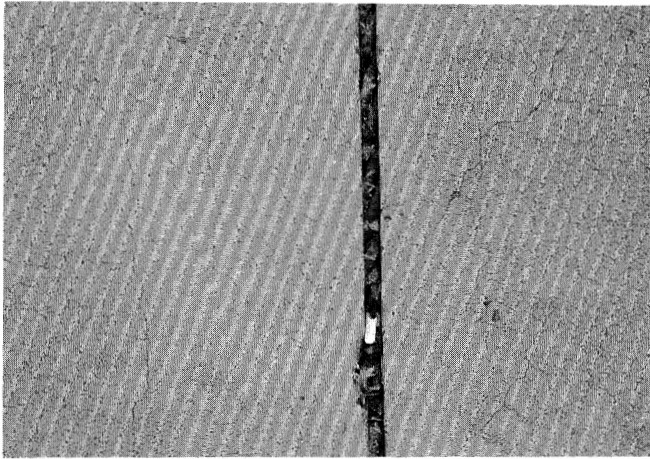

This slide shows a joint filled with debris. At the time of sealing, the crack must be completely free of dirt, dust, and other materials that might prevent effective bonding of the sealant.



A heat lance can be used to dry the joint before sealing.

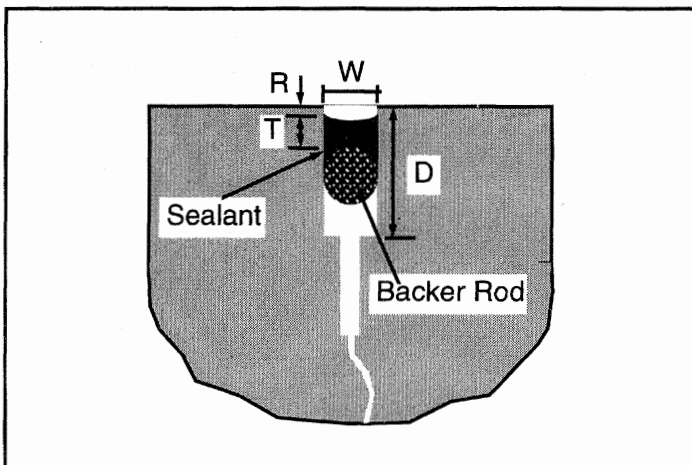

Backer rod is inserted into PCC joints and cracks to control the thickness of the sealant and keep the sealant from bonding to the bottom of the reservoir. The backer rod must be flexible, compressible, non-shrinking, non-reactive, and non-absorptive. Materials for backer rod include extruded closed-cell polyethylene foam, cross-linked extruded closed-cell polyethylene foam, and extruded polyolefine foam.



The backer rod is pressed into the joint to the required depth for optimum shape factor. The shape factor is the ratio of the depth of sealant to the in-service width of the joint. Sealant manufacturers generally recommend a shape factor for their materials. A practical shape factor is 3:2.



This slide shows sealant being applied with a sealant applicator.

STATE SPECIFICATIONS

- ◆ **Materials**
- ◆ **Construction details**
- ◆ **Construction requirements**
- ◆ **Method of measurement**
- ◆ **Basis of payment**

State specifications usually include description of work, materials, construction requirements, method of measurement, and basis of payment.

TRAFFIC CONTROL

- ◆ **Detour traffic until sealant cures**
- ◆ **Cover sealant with sand for quick opening**
- ◆ **Begin filling at centerline**

Traffic should be detoured until the sealant material cures. If the pavement is to be opened to traffic immediately after sealing, the material must be protected against pick-up by tires which can be accomplished by dusting the cracks or joints with fine sand, mineral dust, or a similar material.

It is a good practice for workmen to begin filling operations at the centerline, with movement back toward the edge of the pavement in order to avoid backing into the traffic stream.

SEALING PERFORMANCE

- ◆ **Reduces pumping and creation of voids**
- ◆ **Preserves pavement condition**
- ◆ **Extends pavement life**

Sealing joints and cracks generally reduces the potential for pumping and the creation of voids under the slab. Thus, crack and joint sealing typically preserves pavement condition and extends the service life of the pavement. However, the literature lacks conclusive evidence on performance and cost-effectiveness. Studies are ongoing in Kentucky, Iowa, Michigan, North Dakota, and Wisconsin.

SEALING LIMITATIONS

- ◆ **Limited to low severity cracks**
- ◆ **Not recommended for cracks extending across full lane**
- ◆ **Routing may cause spalling**

If the existing pavement is badly deteriorated, sealing cracks and joints may not be effective. In such cases, the slab may continue to crack and spall. Crack sealing is not recommended for repair of wide cracks that extend across the full-lane width of CRCP. It is also possible that routing actually contributes to further spalling by stressing the already weakened surface or cracked areas that have "micro-cracks" which were not visible during original routing.

SUBSEALING (UNDERSEALING)

- ❖ **Filling voids under the slab**
- ❖ **Stabilize slabs**
- ❖ **Grind to restore ride quality**

Subsealing of concrete pavements involves filling the voids under the concrete pavement slab with a material such as cement grout or bituminous materials. These are applied under pressure through holes drilled in the slab. If the pavement is faulted, ride quality can be restored by grinding.

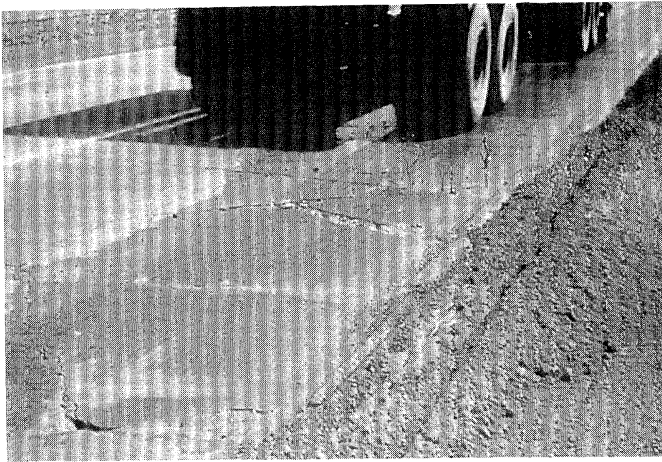

With the continuous application of heavy traffic loads, concrete pavement slabs tend to lose the uniform support of the underlying subbase or subgrade. The presence of water and fine materials may result in pumping and migration of fine-grained materials from beneath the slab through joints and cracks, which in turn leads to erosion of granular and stabilized subbases. This can occur in varying degrees and at scattered locations.

Void formation under slab at joint

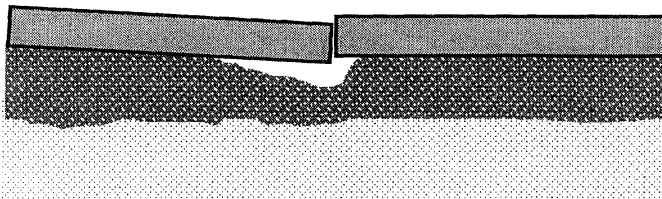

This slide illustrates the formation of a void space under a slab. The void space gradually increases, and eventually, the slab loses its support. Faulting and breaking of the slab may follow.

Void repair with subsealing and grinding

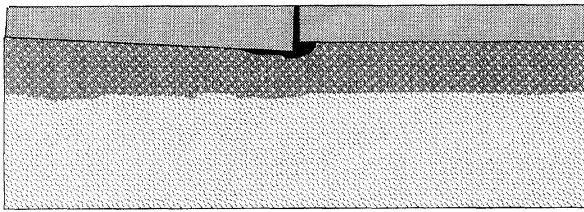

Faulting can be removed by diamond grinding of the pavement surface after the slabs are stabilized.

VOID DETECTION

- ❖ Visual inspection
- ❖ Truck deflections (Benkleman Beam)
- ❖ Deflection (nondestructive) testing
- ❖ Radar or infrared testing
- ❖ Epoxy and drilling method

Voids must be detected quickly, otherwise damage will be accelerated. Available methods include:

1. Visual inspection to locate distress areas, such as the presence of holes or depressions in the adjacent asphalt shoulder edge, excessive vertical movement of the slab at joints or cracks, or faulting of joints.
2. Proof rolling with heavy-loaded, rubber-tired equipment at 3 km/h to reveal areas of excessive deflection or pumping.
3. Deflection testing with nondestructive devices to detect the presence and extent of voids.
4. Ground-penetrating radar equipment or infrared thermology to detect the location and extent of voids.
5. Use of epoxy and drilling to detect the extent of voids.

LOAD TRANSFER

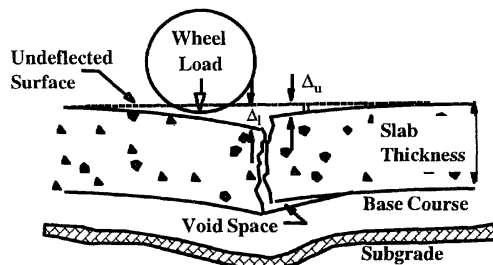

Load transfer efficiency is one method determining the presence of voids. Load transfer efficiency is defined as the ratio of the unloaded slab deflection to the loaded slab deflection, usually multiplied by a factor of 100. The closer this ratio is to 100, the better the load transfer, reducing the likelihood that a void is present.

MATERIAL REQUIREMENTS

- ❖ **During pumping**
- ❖ **Very flowable to fill voids**
- ❖ **Sufficient body to displace water**

Grouting materials must be very flowable during pumping and exhibit low internal friction, so that they can move through very small openings and follow water channels to fill existing voids. The grouting material must also have sufficient body to displace free water from beneath the slab.

MATERIAL REQUIREMENTS (Cont.)

After hardening:

- ◆ **Strong**
- ◆ **Durable**
- ◆ **Insoluble**
- ◆ **Incompressible**
- ◆ **Nonerodable**

After pumping and hardening, the material must yield a grout mix that is adequately strong, durable, insoluble, incompressible, and nonerodable.

TYPICAL MATERIALS

- ❖ **Portland cement and water with or without sand, lime dust, pozzolan, and other admixtures**
- ❖ **Hot asphalt cement**

Several grouting materials can be used including portland cement and water with or without sand, lime dust, pozzolan, and other admixtures. Hot asphalt cement can also be used.

EQUIPMENT

- ❖ **Portland cement-type grout**
- ❖ **Drilling device**
- ❖ **Grout mixer**
- ❖ **Pump**
- ❖ **Consistency tester**
- ❖ **Miscellaneous**

Required equipment varies with the type of grout used. Equipment for portland cement-type grouts include a hole drilling device, grout mixer, pump, and consistency tester. Other miscellaneous items are also needed, such as hoses, valves, pressure gages, dial gages to measure slab movements, plugs for plugging holes, proper safety cloths, and traffic control devices.

EQUIPMENT (Cont.)

- ❖ **Asphalt grout**
- ❖ **Drilling device**
- ❖ **Insulated pressure distributor**
- ❖ **Booster heater**
- ❖ **Asphalt applicator (nozzles)**
- ❖ **Miscellaneous**

Equipment for asphalt cement grout includes a drilling device, an insulated pressure distributor or tank truck, a booster heater, and asphalt applicators (nozzles). Other miscellaneous items are also needed, such as hoses, valves, pressure gages, dial gages to measure slab movements, plugs for plugging holes, proper safety cloths, and traffic control devices.

SUBSEALING PROCESS

- ❖ **Void detection**
- ❖ **Material selection**
- ❖ **Efficient grout distribution pattern**
- ❖ **Pumping**
- ❖ **Plug holes after pumping**
- ❖ **Back-fill with cement or concrete**

The undersealing process involves void detection, material selection, and the use of efficient grout distribution patterns. The pattern will depend on the location and size of voids under the slab.

The amount of grout used depends on the size of voids to be filled. The grout material is pumped until it appears along the shoulder line or joints, denoting that sufficient material has been pumped. Upon completion of subsealing the holes should be immediately plugged with temporary wood plugs. The holes are later back-filled with a stiff cement grout or concrete mixture and finished to match the pavement texture.



This photo depicts the process of raising a slab to its original grade with a high-softening-point asphalt cement.

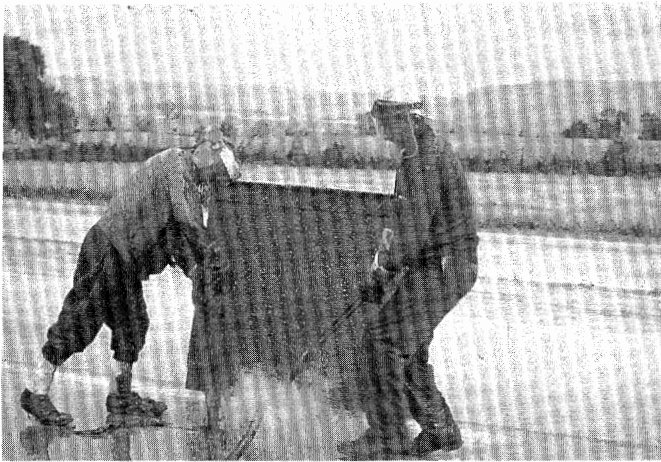

This slide shows the equipment used for undersealing. Note the proper clothing of the working crew. Helmets and clothing should not leave any skin exposed to avoid injury in the event of materials blowing back from the hole or any equipment malfunction.



This slide illustrates the process of subsealing.

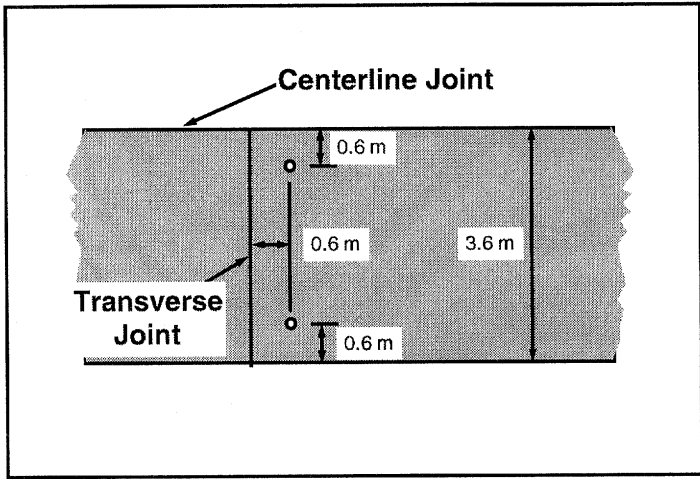

This is a typical hole pattern for jointed concrete pavements.

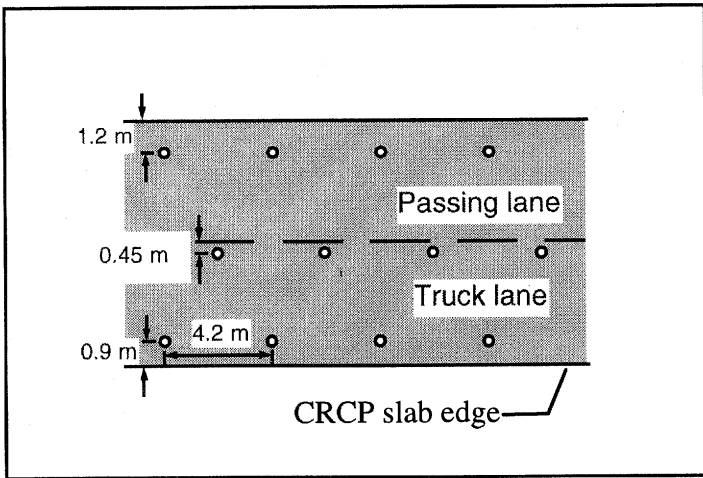

This is a typical hole pattern for continuously reinforced concrete pavements.

CONSTRUCTION PRECAUTIONS

- ❖ **Considerable experience**
- ❖ **Trained personnel**
- ❖ **Special equipment**
- ❖ **Follow-up effectiveness testing**
- ❖ **Safety precautions**

Subsealing require considerable expertise, trained personnel, and special equipment. Follow-up effectiveness testing is recommended and safety precautions are required - especially when the nozzle is withdrawn from the hole. The work is particularly well-suited to specialty contractors capable of correcting unsatisfactory conditions without damaging the pavement.

TRAFFIC CONTROL

**Traffic can be allowed
back on newly-grouted
slabs after 1 to 3 hours**

Traffic can be allowed back on newly-grouted slabs after 1 to 3 hours.

INSPECTION & ACCEPTANCE

- ❖ **Equipment**
- ❖ **Materials**
- ❖ **Construction procedures**
- ❖ **Safety precautions**

Before work begins, equipment should be checked to ensure that it is in good working condition. Appropriate materials should be used and proper construction procedures should be followed. All safety requirements must be satisfied.

STATE SPECIFICATIONS

- ❖ **Materials**
- ❖ **Construction procedures**
- ❖ **Construction conditions**
- ❖ **Method of measurement**
- ❖ **Basis of payment**

Typical state specifications include materials, construction procedures, construction conditions, method of measurement, and basis of payment.

SUBSEALING COSTS

Several ways to estimate costs:

- ❖ \$25 per m³ of cement grout
- ❖ \$3 per hole
- ❖ \$16 per bag of cement

The 1980's data show an average of \$25 per m³ of cement grout, or about \$3 per hole and \$16 per bag of cement.

PERFORMANCE

- ❖ Increases structural integrity
- ❖ Extends pavement life
- ❖ Provides smooth ride
- ❖ Reduces faulting progression
- ❖ Reduces slab deflection
- ❖ Reduces reflection cracking

Subsealing provides continuous support under the slab, which in turn increases the structural integrity of the pavement section and extends its performance life. Slabjacking provides a smooth ride and reduces further progression of faulting. Undersealing with cement grout or asphalt cement also reduces deflections before the overlay and reduces reflective cracking in the overlay.

SUBSEALING LIMITATIONS

Subsealing requires:

- ◆ Considerable experience
- ◆ Trained personnel
- ◆ Special equipment
- ◆ Safety precautions

Subsealing require considerable experience, trained personnel, special equipment, and adherence to safety precautions.

RETROFIT OF DOWEL BARS

- ❖ **Reestablish load transfer**
- ❖ **Benefits - reduce:**
 - ◆ **Faulting**
 - ◆ **Pumping**
 - ◆ **Corner Breaks**
 - ◆ **Spalling**

Rigid pavements without dowel bars at the joints, or pavement slabs with mid-slab cracks can lack adequate load transfer across the joint or crack. Inadequate load transfer predisposes the pavement to several failure mechanisms including: faulting, pumping, corner breaks, and spalling. Retrofit of dowel bars across either a joint or mid-slab crack can restore load transfer and increase the life of the pavement.

Retrofit of dowel bars was included as SHRP state supplemental studies by Kansas and South Dakota. Other states have experimented with this form of preventive maintenance.

CONSTRUCTION PROCESS

- ❖ **Traffic control**
- ❖ **Cut slots**
- ❖ **Clean and prepare slots**
- ❖ **Place dowels**
- ❖ **Backfill slots**

The construction process for retrofitting dowel bars is fairly straight forward. Traffic control is established for the work zone. Slots for the dowel bars are cut with diamond bladed saws. The slots are cleaned out using a pneumatic hammer and sand blasting. The dowels are placed on non-metallic chairs. A cement based grout is used to backfill the slots. Traffic control is maintained until the grout has adequate strength to resist traffic stresses.

DOWEL BAR LAYOUT

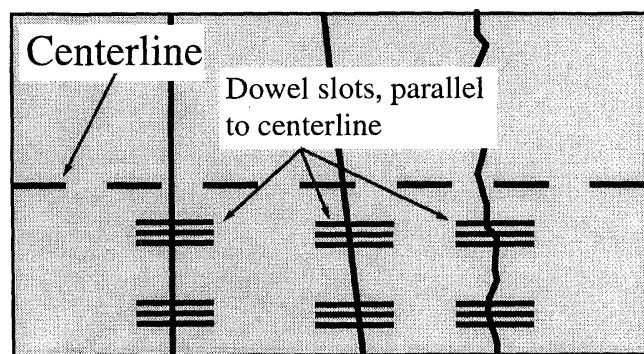

The retrofit dowel bars are generally placed in groups of three in each of the wheel paths. Depending on the traffic distribution, dowel bars may be placed only in the travel lane or in both the travel and passing lanes. The dowels must be placed parallel to the centerline of the pavement, even if the joint or crack is at an angle.

PLAN VIEW OF SLOT DIMENSIONS

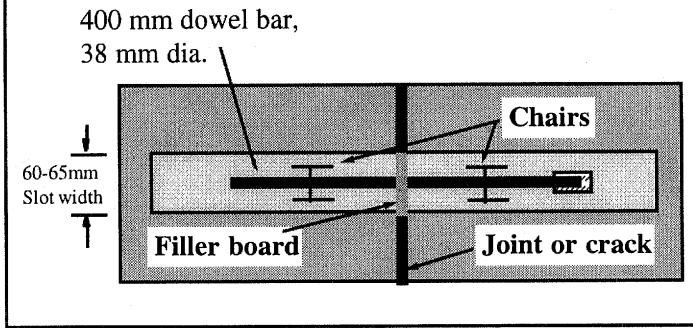

Slots are cut to a width of 60 to 65 mm. Some contractors use ganged saw-blades to cut the sides of all slots in a single pass. The material between the saw cuts is cleaned with a jack-hammer. Small burs and rocks are smoothed-out with a small hammer-head attachment. This flattens the slot bottom so the dowel can sit level. The slots are cleaned with sand blasting to produce a clean, dry, and roughened surface for the grout bonding. Caulk is placed along the sides and bottom of the joint or crack to prevent the grout from penetrating into the joint or crack. Hardened grout in the crevice could hinder the joint from closing during warm weather. A filler board is used to maintain joint continuity.

SIDE VIEW OF SLOT

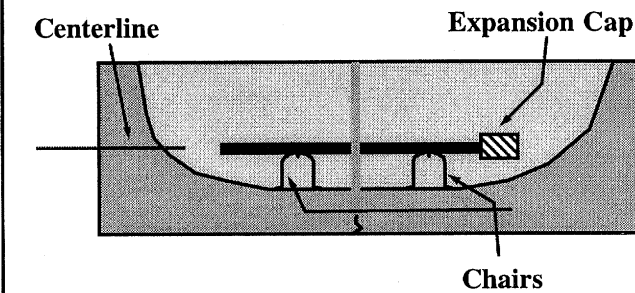

The dowels are similar to those used for new construction. They should be epoxy coated to prevent corrosion. A non-metallic expansion cap is placed on one end of the bar.

The slot is typically twice the length of the dowel bar. Most installations use standard dowel bars that are 450 mm long, requiring a 900 mm slot.

Non-metallic chairs are used to support the bar. Care must be taken to place the bar at the mid-depth of the slab, parallel to the pavement centerline, and true to the pavement surface.

GROUT MATERIAL

- ❖ **Max. aggregate size of 10 mm**
- ❖ **Accelerator - reduce construction time**
- ❖ **Aluminum powder - control shrinkage**
- ❖ **Mix on site**

The grout is typically a portland cement concrete mix with a maximum aggregate size of 10 mm to permit the grout to flow around the dowel bar. An accelerator may be used to reduce the time traffic must be diverted. Aluminum powder can be used to reduce the shrinkage of the grout during hardening. The grout is generally mixed on site in a small mobile drum or paddle mixer.

FINISHING THE PATCH

- ❖ **Overfill the slots**
- ❖ **Vibrate**
- ❖ **Cure**
- ❖ **Reprofile surface**
- ❖ **Seal joints and cracks**

The slots are overfilled with grout to allow for settlement during consolidation. A small spud vibrator is used to consolidate the grout around the dowel bar; taking care not to displace the dowel with the vibrator. A curing compound is placed over the patched slot to prevent the evaporation of water from the grout. Usually, the entire surface of the pavement is reprofiled with a diamond grinder to provide a smooth riding surface. Finally, joints and cracks are sealed to prevent the intrusion of water.

The End



This concludes our presentation on Pavement Maintenance Effectiveness - Pavement Maintenance Treatments. We appreciate your attendance and participation. At this time, please fill-out the course evaluation forms. We carefully consider your comments on the quality of the information and presentation given at this short course. Thanks again.



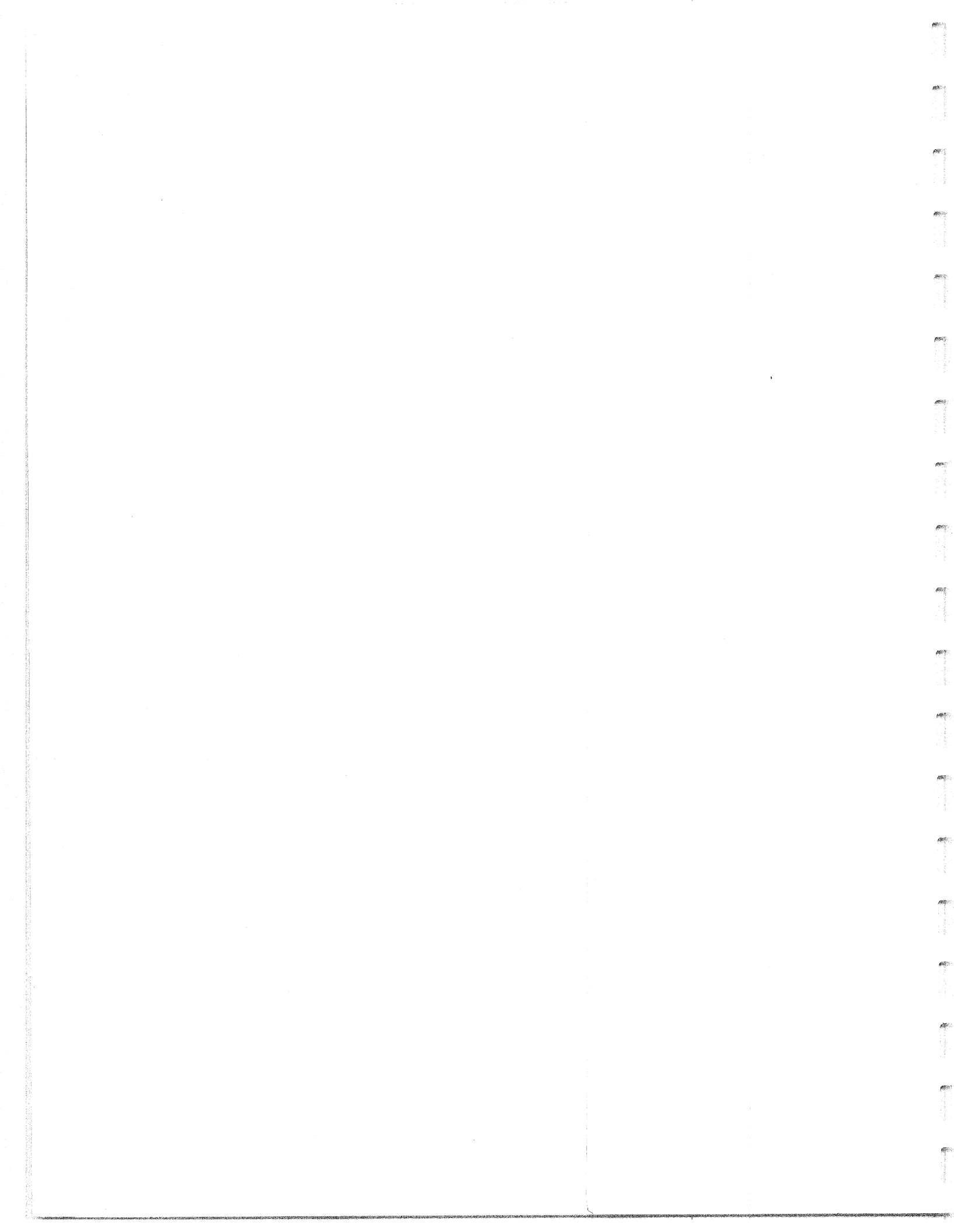



Faint, illegible text at the bottom left of the page.

Faint, illegible text at the bottom right of the page.

Federal Highway Administration
U.S. Department of Transportation
400 Seventh Street, SW
Washington, D.C. 20590

Publication No. FHWA-SA-96-028
HNG-40/2-96(4C)P