

---

# Crumb

# Rubber

---

# Modifier

---

## Workshop Notes

*Design Procedures*  
◆ and ◆  
*Construction Practices*



Innovation Through Partnerships



U.S. Department  
of Transportation  
**Federal Highway  
Administration**

---

# Crumb

# Rubber

---

# Modifier

---

## Workshop Notes

*Design Procedures*  
♦ and ♦  
*Construction Practices*



Innovation Through Partnerships



U.S. Department  
of Transportation  
**Federal Highway  
Administration**

THE UNIVERSITY OF CHICAGO LIBRARY

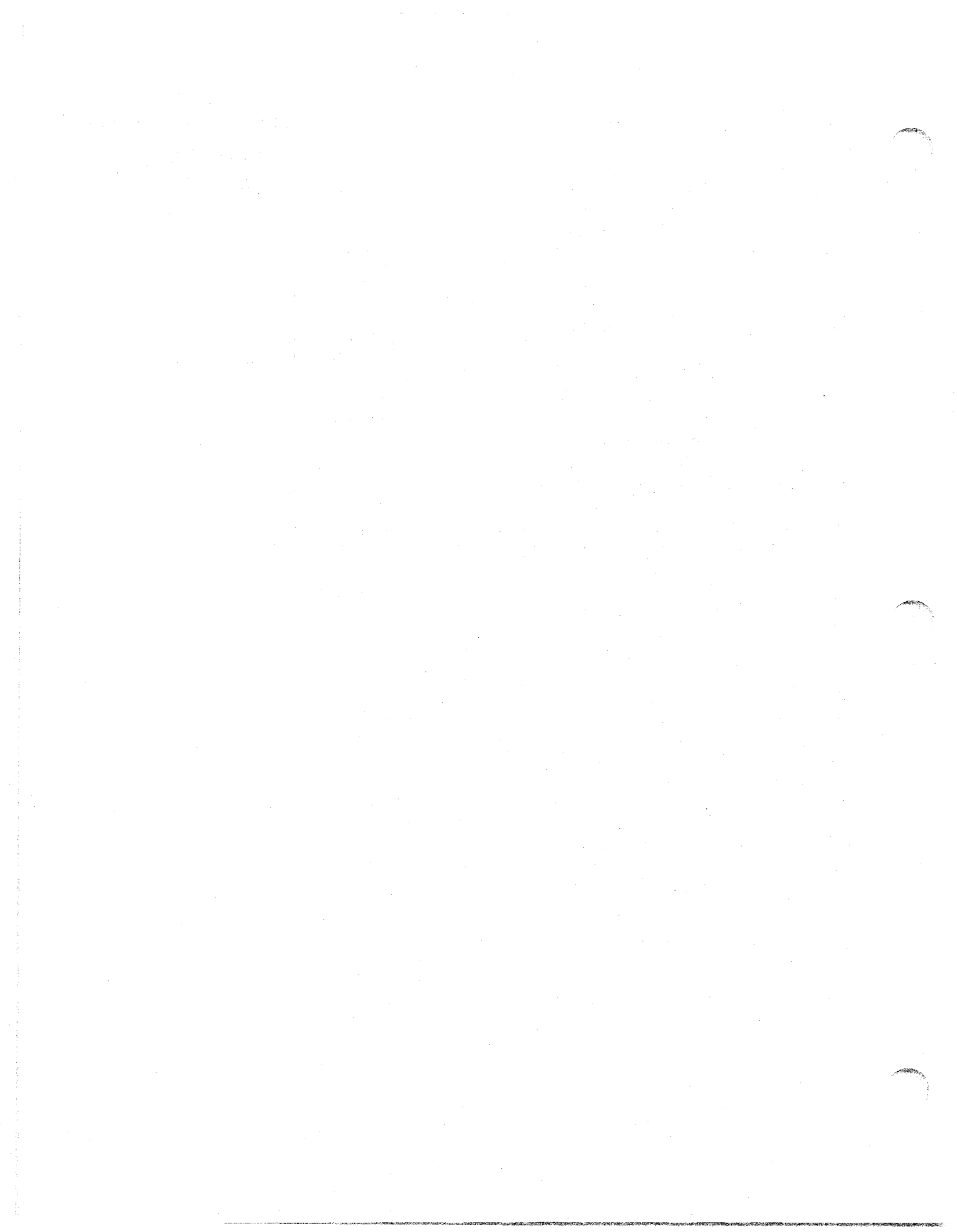
1964  
MAY 15 1964  
LIBRARY

UNIVERSITY OF CHICAGO LIBRARY

---

## **Opening Remarks**

---



---

The Intermodal Surface Transportation Efficiency Act of 1991, commonly referred to as ISTEA, initiated major changes in the Federal-aid highway program. Section 1038 of ISTEA contains provisions for each State to begin incorporating scrap tire rubber into their asphalt paving materials. A number of activities are underway as a result of Section 1038, and I would like to briefly highlight them for you. Then I will share some comments on the implications of the section.

This workshop is one of our activities to address Section 1038. It is intended to "jump start" our understanding of HOW TO . . . . HOW TO properly design and HOW TO properly construct asphalt pavements which incorporate scrap tire rubber. The workshop was developed through the cooperation of highway agencies and the asphalt industry and will discuss present procedures and practices for this technology. The workshop is not intended to be a forum for debating the research or implementation provisions of ISTEA Section 1038.

There are three principle unresolved issues regarding the use of these materials and the legislation clearly identifies them. They are (1) the affect on the environment and human health, (2) the ability to recycle paving materials which contain scrap tire rubber, and (3) the actual field performance of the material. As required by Section 1038, the FHWA and EPA have jointly initiated studies to examine these unresolved issues. The study of these issues on a national scale is complicated and costly. The present projected cost for the research studies exceeds \$5,000,000. Results from these studies will be developing over a number of years and, even though some of the questions may never be completely satisfied, the research is expected to qualify the principle issues.

It is well understood that both highway agencies and the asphalt paving industry are affected by this legislation. The products are initially more expensive. Although they have been shown to be "cost-effective" in some research studies, most areas of the country have not evaluated these materials and their "cost-effectiveness" remains unknown.

## **FHWA Opening Remarks**

In closing, we hope that these next two days will expand our understanding of the technologies which incorporate scrap tire rubber into asphalt paving materials. And allow you to take this technical information back to your respective States and develop an implementation program which satisfies the ISTEA requirements and provides the best highway infrastructure that is possible.

## Moderator's Notes

The objective of this workshop is to provide the highway community (both agencies and industry) with the best understanding of the design procedures and construction practices presently used to incorporate scrap tire rubber [Crumb Rubber Modifier (CRM)] into asphalt paving materials. You will hear presentations from some of the most knowledgeable professionals in the country. Over the next two days, each session has been designed to build your understanding of the technologies and practices presently available.

The agenda for the workshop is broken into three main categories: background, detail, and experience. The first day (Sessions 1-7) provides both technical and practical background information on the materials and technologies encompassing scrap tire rubber in asphalt paving. The morning of Day-2 (Sessions 8-11) provides detailed information on design procedures and construction practices. These sessions draw upon Day-1's understanding to develop better decisions regarding pavement applications, mix design, and construction. The last group of presentations will share both the national and regional experience of agencies and industry who have applied these paving materials.

Although the concept of incorporating scrap tire rubber into asphalt paving materials has been around for over 25 years, the technology has not developed in many parts of the country. Like many aspects of asphalt pavement engineering, there are differing positions on materials, mix design, application, and construction. It is probable that there is more than one valid "correct" answer. Even the experts do not always agree. This workshop will provide sound technical positions for a number of variables and you, the workshop participants, can draw your own conclusions regarding the appropriate application of the technologies for your needs.

This workshop is a technical program. It is intended to increase the highway community's level of knowledge on the design and construction aspects of incorporating scrap tire rubber into asphalt paving materials. As mentioned in the opening remarks, it is not a forum for

---

discussing the legislation. Your assistance in maintaining a technical focus during this workshop is greatly appreciated.

Strict compliance with the time for each session must be followed in order to complete the two day program. A question and answer period will follow the formal presentation(s) in each session. We ask that you keep the questions related to the topic of the present session. Please review the agenda and note the progression of subjects. The interest generated by one session may be addressed in a later session and specific questions should be held until that particular session. Do not view these guidelines as a restriction to asking questions, that is not the intent. They are intended to guide the program and allow all of the participants to acquire the greatest benefit from each session topic.

We will hold the break and lunch periods to the times specified. The program will reconvene promptly as scheduled. All participants are asked to be seated before the session begins. Thank you for your cooperation.



The first part of the document discusses the importance of maintaining accurate records of all transactions. It emphasizes that every entry should be supported by a valid receipt or invoice. This ensures transparency and allows for easy verification of the data.

In the second section, the author outlines the various methods used to collect and analyze the data. This includes both primary and secondary data collection techniques. The primary data was gathered through direct observation and interviews with key personnel. Secondary data was obtained from internal company reports and industry publications.

The analysis of the data revealed several key trends and insights. One major finding was the significant impact of market fluctuations on the company's performance. Another important observation was the need for more robust risk management strategies to mitigate potential losses.

Based on these findings, the author proposes several recommendations for future actions. These include implementing more stringent controls over financial reporting, enhancing the accuracy of data collection processes, and exploring new market opportunities to diversify the company's revenue streams.

In conclusion, this study highlights the critical role of data in decision-making and the importance of maintaining high standards of accuracy and integrity. The findings provide a clear path forward for the organization to improve its operational efficiency and financial stability.



# Contents

---

- Agenda
- Opening Remarks
- Session 1 — National and State Legislation
  - authors: Office of Engineering  
Federal Highway Administration
  - Mary Sikora  
Recycling Research, Inc.
- Session 2 — Defining the Terminology
  - author: Office of Engineering  
Federal Highway Administration
- Session 3 — Production of Crumb Rubber Modifier (CRM) Material
  - author: Tim Baker  
Baker Rubber, Inc.
- Session 4 — Historical Development
  - author: Ray Brown  
National Center for Asphalt Technology
- Session 5 — Description of Technologies
  - authors: Prithvi Kandhal & Doug Hanson  
National Center for Asphalt Technology
- Session 6 — Cost Factors
  - author: Mary Strooup-Gardiner  
University of Minnesota
- Session 7 — Specification Guidelines
  - author: Michael Heitzman  
Office of Engineering  
Federal Highway Administration

## Contents (cont.)

---

- **Session 8 — Pavement Applications**  
author: Freddy Roberts  
Louisiana Tech. University
- **Session 9 — Binder Design Procedures**  
author: Jim Chehovits  
Crafco, Inc.
- **Session 10 — Mix Design Procedures**  
authors: Jim Chehovits  
Crafco, Inc.  
  
R.G. Hicks  
Oregon State University
- **Session 11 — Construction Practices**  
authors: EnvirOtire  
  
Asphalt Rubber Producers Group
- **Session 12 — National Project Evaluations**  
author: Byron Ruth  
University of Florida
- **Session 13 — Regional Project Evaluations**

## **Session 1.0**

---

# **National and State Legislation**

---

by

**Office of Engineering  
Federal Highway Administration**

**Mary Sikora  
Recycling Research, Inc.**

# 1.0 Contents

---

1.1	National Legislation . . . . .	1-3
1.2	State Legislation . . . . .	1-7
1.2.1	The States . . . . .	1-8
1.2.2	Market Development . . . . .	1-11
1.2.3	Conclusion . . . . .	1-13
1.2.4	1991 State Legislative and Regulatory Review . . . . .	1-13

PUBLIC LAW 102-240—DEC. 18, 1991

**1.1 National  
Legislation**

**INTERMODAL SURFACE TRANSPORTATION  
EFFICIENCY ACT OF 1991**

**SEC. 1038. USE OF RECYCLED PAVING MATERIAL.**

(a) **ASPHALT PAVEMENT CONTAINING RECYCLED RUBBER DEMONSTRATION PROGRAM.**—Notwithstanding any other provision of title 23, United States Code, or regulation or policy of the Department of Transportation, the Secretary (or a State acting as the Department's agent) may not disapprove a highway project under chapter 1 of title 23, United States Code, on the ground that the project includes the use of asphalt pavement containing recycled rubber. Under this subsection, a patented application process for recycled rubber shall be eligible for approval under the same conditions that an unpatented process is eligible for approval.

(b) **STUDIES.**—

(1) **IN GENERAL.**—The Secretary and the Administrator of the Environmental Protection Agency shall coordinate and conduct in cooperation with the States, a study to determine—

(A) the threat to human health and the environment associated with the production and use of asphalt pavement containing recycled rubber;

(B) the degree to which asphalt pavement containing recycled rubber can be recycled, and;

(C) the performance of the asphalt pavement containing recycled rubber under various climate and use conditions.

(2) **DIVISION OF RESPONSIBILITIES.**—The Administrator shall conduct the part of the study relating to paragraph (1)(A) and the Secretary shall conduct the part of the study relating to paragraph (1)(C). The Administrator and the Secretary shall jointly conduct the study relating to paragraph (1)(B).

(3) **ADDITIONAL STUDY.**—The Secretary and the Administrator, in cooperation with the States, shall jointly conduct a study to determine the economic savings, technical performance qualities, threats to human health and the environment, and environmental benefits of using recycled materials in highway devices and appur-

tenances and highway projects, including asphalt containing over 80 percent reclaimed asphalt, asphalt containing recycled glass, and asphalt containing recycled plastic.

(4) **ADDITIONAL ELEMENTS.**—In conducting the study under paragraph (3), the Secretary and the Administrator shall examine utilization of various technologies by States and shall examine the current practices of all States relating to the reuse and disposal of materials used in federally assisted highway projects.

(5) **REPORT.**—Not later than 18 months after the date of the enactment of this Act, the Secretary and the Administrator shall transmit to Congress a report on the results of the studies conducted under this subsection, including a detailed analysis of the economic savings and technical performance qualities of using such recycled materials in federally assisted highway projects and the environmental benefits of using such recycled materials in such highway projects in terms of reducing air emissions, conserving natural resources, and reducing disposal of the materials in landfills.

**(c) DOT GUIDANCE.**—

(1) **INFORMATION GATHERING AND DISTRIBUTION.**—The Secretary shall gather information and recommendations concerning the use of asphalt containing recycled rubber in highway projects from those States that have extensively evaluated and experimented with the use of such asphalt and implemented such projects and shall make available such information and recommendations on the use of such asphalt to those States which indicate an interest in the use of such asphalt.

(2) **ENCOURAGEMENT OF USE.**—The Secretary should encourage the use of recycled materials determined to be appropriate by the studies pursuant to subsection (b) in federally assisted highway projects. Procuring agencies shall comply with all applicable guidelines or regulations issued by the Administrator of the Environmental Protection Agency.

**(d) USE OF ASPHALT PAVEMENT CONTAINING RECYCLED RUBBER.**—

(1) **STATE CERTIFICATION.**—Beginning on January 1, 1995, and annually thereafter, each State shall certify to the Secretary that such State has satisfied the minimum utilization requirement for asphalt pavement containing recycled rubber established by this section. The minimum utilization requirement for asphalt pave-

ment containing recycled rubber as a percentage of the total tons of asphalt laid in such State and financed in whole or part by any assistance pursuant to title 23, United States Code, shall be—

- (A) 5 percent for the year 1994;
- (B) 10 percent for the year 1995;
- (C) 15 percent for the year 1996; and
- (D) 20 percent for the year 1997 and each year thereafter.

(2) **OTHER MATERIALS.**—Any recycled material or materials determined to be appropriate by the studies under subsection (b) may be substituted for recycled rubber under the minimum utilization requirement of paragraph (1) up to 5 percent.

(3) **INCREASE.**—The Secretary may increase the minimum utilization requirement of paragraph (1) for asphalt pavement containing recycled rubber to be used in federally assisted highway projects to the extent it is technologically and economically feasible to do so and if an increase is appropriate to assure markets for the reuse and recycling of scrap tires. The minimum utilization requirement for asphalt pavement containing recycled rubber may not be met by any use or technique found to be unsuitable for use in highway projects by the studies under subsection (b).

(4) **PENALTY.**—The Secretary shall withhold from any State that fails to make a certification under paragraph (1) for any fiscal year, a percentage of the apportionments under section 104 (other than subsection (b)(5)(A)) of title 23, United States Code, that would otherwise be apportioned to such State for such fiscal year under such section equal to the percentage utilization requirement established by paragraph (1) for such fiscal Year.

(5) **SECRETARIAL WAIVER.**—The Secretary may set aside the provisions of this subsection for any 3-year period on a determination, made in concurrence with the Administrator of the Environmental Protection Agency with respect to subparagraphs (A) and (B) of this paragraph, that there is reliable evidence indicating—

- (A) that manufacture, application, or use of asphalt pavement containing recycled rubber substantially increases the threat to human health or the environment as compared to the threats associated with conventional pavement;



(B) that asphalt pavement containing recycled rubber cannot be recycled to substantially the same degree as conventional pavement; or

(C) that asphalt pavement containing recycled rubber does not perform adequately as a material for the construction or surfacing of highways and roads.

The Secretary shall consider the results of the study under subsection (b)(1) in determining whether a 3-year set-aside is appropriate.

(6) **RENEWAL OF WAIVER.**—Any determination made to set aside the requirements of this section may be renewed for an additional 3-year period by the Secretary, with the concurrence of the Administrator with respect to the determinations made under paragraphs (5)(A) and (5)(B). Any determination made with respect to paragraph (5)(C) may be made for specific States or regions considering climate, geography, and other factors that may be unique to the State or region and that would prevent the adequate performance of asphalt pavement containing recycled rubber.

(7) **INDIVIDUAL STATE REDUCTION.**—The Secretary shall establish a minimum utilization requirement for asphalt pavement containing recycled rubber less than the minimum utilization requirement otherwise required by paragraph (1) in a particular State, upon the request of such State and if the Secretary, with the concurrence of the Administrator of the Environmental Protection Agency, determines that there is not a sufficient quantity of scrap tires available in the State prior to disposal to meet the minimum utilization requirement established under paragraph (1) as the result of recycling and processing uses (in that State or another State), including retreading or energy recovery.

(e) **DEFINITIONS.**—For purpose of this section—

(1) the term “asphalt pavement containing recycled rubber” means any hot mix or spray applied binder in asphalt paving mixture that contains rubber from whole scrap tires which is used for asphalt pavement base, surface course or interlayer, or other road and highway related uses and—

(A) is a mixture of not less than 20 pounds of recycled rubber per ton of hot mix or 300 pounds of recycled rubber per ton of spray applied binder; or

(B) is any mixture of asphalt pavement and recycled rubber that is certified by a State and is approved by the Secretary, provided that the total amount of recycled rubber from whole scrap tires utilized in any year in such State shall be not less than the amount that would be utilized if all asphalt pavement containing recycled rubber laid in such State met the specifications of subparagraph (A) and subsection (d)(1); and

(2) the term "recycled rubber" is any crumb rubber derived from processing whole scrap tires or shredded tire material taken from automobiles, trucks, or other equipment owned and operated in the United States.

Waste or scrap tires pose a substantial waste management challenge due both to the large number of scrap tires generated annually (approximately 230–240 million) and to their engineered properties which insure their safety, durability in use and long product life. In total, the U.S. Environmental Protection Agency (EPA) estimates scrap tire inventories (in U.S.) number between 2 and 3 billion tires. Ultimately, reduction of these scrap tire inventories depends upon developing and enhancing markets and applications for scrap tire rubber.

On the State level this ongoing concern prompted over 40 States (as of July, 1992) to enact legislation or regulations to control scrap tires. While the State approaches to scrap tire recycling are as varied as the States themselves, certain common elements appear in the legislative requirements of the laws. In general, the laws may:

- establish a funding mechanism
- require a set of rules for collecting, transporting, processing and storing tires
- impose disposal bans and/or landfill restrictions
- set up a fund to provide for grant and loan programs, research and development activities and scrap tire pile abatement
- contain provision encouraging States to provide scrap tire recycling and reuse education and training opportunities.

On the national side, several legislative proposals were introduced in the 102nd Congress. In addition to the Intermodal Surface Transportation Efficiency Act of 1991 (ISTEA) which is the catalyst for this workshop, tire recycling credit bills were introduced by Congressman Torres and Senator Wirth (H.R. 871 and S. 396). A tire recycling research bill (H.R. 1511) was introduced by Rep. Hochbrueckner. Senator

## 1.2 State Legislation

Chafee introduced two bills (S. 1038 and S. 1039) to encourage tire recycling through the use of crumb rubber in asphalt, abate existing tire piles, and impose a tax on tires. Concurrently, Rep. Slattery introduced H.R. 3058 to encourage States to come up with their own scrap tire management plan. A companion bill H.R. 3059 would have provided financial assistance to the States to eliminate existing scrap tire piles and manage future tire disposal. Section 1038 of ISTEA which governs the use of recycled materials in pavement, is a combination of the Senate (Chafee) and House (Slattery) versions.

Briefly then, that is the historical picture of scrap tire legislation. I would like to focus the remainder of this presentation on two main issues:

1. the requirements of State legislation/regulations including mandates, bans, incentives, etc., for the individual States in each region;
2. potential funding sources (State and Federal programs) which may assist agencies and industries dealing with scrap tires, particularly as it relates to implementing the ISTEA.

### 1.2.1 The States

One of the key elements critical to the success of ISTEA is an adequate number of processors of quality raw materials. In many States, scrap tire laws and regulations are influencing the development of a scrap tire management infrastructure that is expected to encourage competitiveness among processors thus raising quality standards for materials and reducing the cost of raw materials (such as crumb rubber) to end-users.

Forty-seven States have addressed scrap tire management since Minnesota passed the first law in 1985 (see charts, Transparency I).

Three States, Alaska, Delaware and New Mexico have not passed laws or regulations specifically targeting scrap tires.

Of the 47, fourteen States regulate either the collection, transporting, processing or storage of scrap tires and impose landfill restrictions—either bans or a requirement for tires to be size-reduced in some way.

Thirty-two States have a funding mechanism (i.e., disposal fee, tire tax) and some combination of regulatory requirements (e.g., storage, collection, processing rules).

In many States, scrap tire laws are a provision or section of comprehensive recycling or solid waste management laws which require local communities develop recycling management plans for tires. North Carolina, Missouri, Oregon, Wisconsin, California, Kansas and Kentucky are among those States.

State Scrap Tire Laws/Regs		July 1992		
State	Funding Source	Regulations	Landfill Restrictions	Market Incentives
AL		S P		
AR	\$1.50/tire retail sales	S P H	tires must be cut and monofilled	grants/tax credits
AZ	2% sales tax on retail sale	S P H	bans whole tires—1/92	
CA	\$.25/tire disposal fee	S	bans whole tires—1/93	grant/loans 5% PP
CO		S P		
CT		S		10% PP
FL	\$1/tire retail sales	S P H	tires must be cut	DOT required use R&D grants, 10% PP
GA	\$1/tire mgt. fee	to be written	bans whole tires—1/95	
HI			(Honolulu only) bans whole tires—7/92	
ID	\$1/tire retail sales	S	bans whole tires	\$20/ton—\$1/retread—grants
IL	\$1/tire retail sale and \$.50/vehicle tire	S P H	bans whole tires—7/94	grants/loans, proc. required
IN	permit fee tire storage sites	S		10% PP/grants
IA		H	bans whole tires	recycled content required
KS	\$.50/tire retail sales	S P H	tires must be cut	municipal grants
KY	\$1/tire retail sales	S	tires must be cut	loans/RC preference
LA	\$2/tire retail sales—2/92	S P H	tires must be cut	state should buy recycled
ME	\$1/tire disposal fee	S P H		state should buy recycled loans/grants
MD	\$1/tire first sale 2/92	S P H	bans tires—1/94	5% PP
MA		S	bans whole tires	10% PP
MI	\$.50/vehicle title fee	S P H		grants
MN	\$4/vehicle title transfer	S P H	bans whole and cut tires	grants
MS	\$1/tire retail sales	S P H draft draft	to be written	grants
MO	\$.50/tire retail sales	S H	bans whole tires	10% PP
MT		S		state req. to buy recycled
NE	business assessment fee \$1/tire retail sale			grants
NV	\$1/tire fee on new tires	to be written		10% PP, grants educ. & hwy. projects

LEGEND: S: Storage P: Processor H: Hauler Proc: Procurement RC: Recycled Content

State	Funding Source	Regulations	Landfill Restrictions	Market Incentives
NH	town graduated vehicle registration fee	S	tires must be cut unless facility exempt	state should buy recycled
NJ		S P		state should buy recycled
NY		S H		grants/DOT use
NC	1% sales tax on new tires	S P H	tires must be cut	funds county tire collection
ND		S		
OH		S	tires must be cut—1/93	
OK	\$1/tire on new tire sales	S P	tire must be cut	grants/processor credits
OR	\$1/tire disposal tax new tire sales—ends 10/1/92	S P H	tires must be cut	state should buy recycled
PA		S		EPA proc. guidelines
RI	\$.50/tire tax on new tire sales	S P		promotes use of recycled products
SC	\$2/tire new sales	S P H	bans whole tires	state req. to buy recycled grants to counties
SD	\$.25/tire vehicle registration			grant fund to be developed
TN	\$1/tire retail sales		bans whole tire—1/95	grants/equipment credits
TX	\$2/tire retail sales—1/92	S	bans whole tires	processor credit 15% pref. A/R
UT	graduated tax per tire size	S P H		\$20/ton
VT			bans whole tire	state req. to buy recycled 5% PP
VA	\$.50/tire disposal fee on new tire sales	S P	bans whole tires	processor credit or subsidy
WA	\$1 fee on new tire sales	S P H		grants
WV		S P H		state req. to buy recycled
WI	\$2/tire per vehicle title fee	S P H	tires must be cut—12/31/94	\$20/ton/grants
WY		S		state shall buy recycled

LEGEND: S: Storage P: Processor H: Hauler Proc: Procurement RC: Recycled Content

The waste tire program in Oregon has been phased out as required by the Oregon tire law which had a five year sunset date for the program. Minnesota and Wisconsin will soon complete cleanup of existing tire piles in their States. Overall, the remaining States are currently involved in implementing the rules established by their respective legislatures.

More and more State waste tire programs and economic development agencies are implementing aggressive marketing strategies to develop scrap tire recycling industries within their borders. These States are reaching into their bag of "economic" tools to offer tax incentives, procurement policies, minimum content legislation and grants and loans to industries that use recyclable materials. In addition, both State and federal government agencies are adopting favorable purchase and procurement policies to buy more recycled products.

Another trend developing among States to aid market development for recycled materials is an increase in cooperative marketing programs. Cooperative marketing in recycling generally refers to a group of government entities and/or businesses that agree to collaborate on providing a specified set of services at no cost to enhance their individual marketing efforts. The goal of this cooperation is to move recyclables more efficiently and cost effectively from sellers to buyers than individual members can achieve on their own. The benefits include: improved prices, reliability of services, ability to provide buyers with a larger and more consistent volume of materials, improved transportation efficiency, alleviates storage constraints, and increased purchasing and negotiating clout.

### ***Economic Tools***

- tax incentives/credits
- procurement policies
- minimum content legislation
- price preferences
- grants
- low interest loans
- direct reimbursement
- recycling markets directories

### ***Federal Sources of Research Funds***

Environment-related research and development (R & D) responsibilities are disbursed among different agencies at the federal level. In addition, many programs overlap. The following is a brief listing.

## **1.2.2 Market Development**

**Environmental Protection Agency**  
Office of Research & Development  
401 M Street, SW  
Washington, D.C. 20460  
PHONE: (202) 260-7676

DESCRIPTION: EPA has about \$300 million in research funds and operates research programs within the Office of Research and Development which has 8 offices in Washington, D.C. and 12 laboratories throughout the U.S. EPA augments its research program with contracts, interagency agreements and a small competitive grants program.

**National Science Foundation**  
1800 G Street, NW  
Washington, DC 20550  
PHONE: (202) 357-5000

DESCRIPTION: This is the principal federal grant making agency for basic environment-related research. Overall the foundation dispenses about \$500 million for broad-defined environmental research ranging from ecology to atmospheric sciences.

**Environmental Health Sciences**  
Division of Toxicology  
P.O. Box 12233  
Research Park, NC 27709  
PHONE: (919) 541-3267

DESCRIPTION: Leading federal environmental health research organization. Its \$220 million research budget is devoted to investigating the toxicological properties of chemicals and their potential for causing cancer and adverse side effects.

**Center for Disease Control**  
200 Independence Ave. SW  
Washington, D.C. 20201  
PHONE: (202) 472-7136

DESCRIPTION: Within this organization, the National Institute for Occupational Safety and Health, the Center for Environmental Health and Injury Control, and the Agency for Toxic Substances and Disease Registry sponsor a variety of environment related R & D activities.

**Department of Energy**  
Office of Energy Research  
1000 Independence Ave., SW  
Washington, D.C. 20580  
PHONE: (202) 586-5430

**DESCRIPTION:** This department devotes approximately \$100 million each year to environmental research, primarily through its Office of Energy Research. This research emphasizes the health and ecological effects of toxic substances associated with energy and weapons production. In addition, in 1991, more than \$5 billion have been appropriated to the department to cleanup wastes at nuclear energy weapons research and testing facilities throughout the country. For tires, the Office of Industrial Programs has grant money available for projects involving the use of tires which can show an energy savings or benefit.

**Department of the Interior**  
1849 C Street, NW  
Washington, D.C. 20240  
PHONE: (202) 208-5717

**DESCRIPTION:** Environmental R & D within this department is conducted primarily by the Fish and Wildlife Service, the U.S. Geological Survey, the Bureau of Mines and the Bureau of Reclamation.

State laws have helped create an infrastructure of companies and services to support the collection, transport and processing of recyclables. In addition, State laws have provided a number of incentives to increase recycling capacity, mitigate health hazards associated with scrap tire piles, develop awareness of the disposal problem scrap tires create, and encouraged the development of some markets.

Overall, the positive gains in scrap tire management realized by States in the last few years will help set the stage for the successful implementation of ISTEA. However, the long-term success of both State scrap tire management programs and the continued use of recycled rubber under the provisions of ISTEA is going to depend on several factors including the development of technical specifications and definitions, increased government purchasing and use of recycled rubber, expansion of existing markets for recycled rubber and development of new applications.

Source: (Reprinted) *Scrap Tire News*, Vol. 6, No. 1, January, 1992

### **Alabama**

#### **Current Laws/Regulations:**

- Solid waste regulations require the following permits for scrap tire operations:
  - Solid waste permit required for facilities which dispose.

### **1.2.3 Conclusion**

### **1.2.4 1991 State Legislative and Regulatory Review**



- Facilities which store and/or process tires must have health permit. Requirements include a manifest record showing origin of tires delivered to site and destination of tires leaving the site, stacking dimensions, separation distances and site descriptions.

- One monofill for shredded tires permitted and operating.

In 1991:

- Tire Recycling Center established at Gadsden State Community College to conduct study mandated by legislature. Study was completed in 1991.

In 1992:

- State solid waste management plan expected to be completed in 1992.
- The Department of Environmental Management is preparing draft language for a tire bill to be introduced in 1992 which includes provision for a \$1/tire surcharge on tires to fund scrap tire collection and disposal.

### *Alaska*

Current Laws/Regulations:

- State is developing a solid waste management plan. Tires are generally landfilled.
- Recycling bill gives bidders' preference to recycled products.

### *Arizona*

Current Laws/Regulations:

- **House Bill 2687** which established a 2% sales tax on the retail sale of new tires was amended under Senate Bill 1252 passed July 28, 1991, to allow car dealers to charge a maximum amount of \$1/tire at the sale of the vehicle from the original maximum of \$2, when manufacturer does not specify the charge of the tire as a separate component.
- New motor vehicle tire dealers are still required to collect a fee of 2% of the purchase price for each tire sold but not more than \$2/new tire sold.
- **Senate Bill 1252** also requires a manifest disposal system for waste tires and establishes registration procedures for collection sites. A county or a private enterprise cannot charge a tipping fee unless one of the following conditions exist:
  - They are not receiving monies from the grant fund.
  - Waste tires are manifested as originating outside of the county.
  - A seller of motor vehicle tires is not preregistered at the collection site where registration is required.

- When a county's pro rata share is 2% or less than that of the grant fund and after a year of receiving monies from the waste tire grant fund, can demonstrate that the cost of the waste tire disposal exceeds the amount received.
- The county or private enterprise receiving a contract or grant shall provide at least one waste tire collection site in the county, and shall not refuse to accept waste tires from designated dealers.
- A resident of the county may dispose of five waste tires per year at a collection site center within their county at no cost.
- Bans whole tires from landfills as of January 1, 1992.

### *Arkansas*

#### Current Laws/Regulations:

- **Act 749**, a comprehensive recycling law:
  - Establishes a \$1.50/tire disposal fee on retail sales of tires effective July 1, 1991 to fund a waste tire recycling and grant program.
  - Requires tires be shredded/split prior to landfilling.
  - Requires the Arkansas Pollution Control and Ecology Commission (APCEC) to establish permits and permit fees for waste tire processing facilities, waste tire collectors and collection centers.
  - Places a \$1/tire fee on all tires imported into Arkansas, effective July 1, 1991.
  - Authorizes APCEC to license statewide disposal facilities for tires.
  - Creates a five-member State marketing board for recyclables.
  - Gives a 10% price preference for retread purchases for State vehicles. Retread tires generated within Arkansas receive an additional 1% price preference.
- **Act 748** establishes a 30% income tax credit for equipment used to reduce, reuse or recycle solid waste.
- **Act 752** establishes regional solid waste management authorities and requires authorities to provide collection centers for tires.

### *California*

#### Current Laws/Regulations:

- Scrap tire law (**AB 1843**) passed in 1989:
  - Established a \$.25/tire disposal fee on all used tires left with a dealer or other seller, effective July 1990. Fee expected to generate \$3 million annually for the CA Tire Recycling Management Fund administered by the Integrated Waste Management Board

(CIWMB). The fund provides grants to qualified companies engaged in tire recycling, reuse, recovery or reduction operations.

- Requires statewide plan for designating landfills and solid waste transfer stations for the storage of waste tires.
- Provides a 5% purchase price preference for products made from materials derived from used tires.
- **SB 1322**, also passed in 1989, allows the Dept. of General Services and CIWMB to promulgate regulations for the purchase of retread tires by the State of CA and requires the use of retreads on State vehicles (other than high speed vehicles) after July 1, 1991.

In 1992:

- Effective July 1, 1992, major (over 5,000 tires) waste tire facilities must obtain a major waste facility permit from the CIWMB. Permit requirements include fire prevention, security and vector control measures, tire pile size and height limits, closure and pile reduction plans, financial assurance and operator liability.
- In February 1992, the CIWMB will issue requirements for obtaining a minor (under 3,000 tires) waste tire facility permit.
- Due January 1992, CIWMB report on the feasibility of using tires as a fuel supplement for cement kilns, lumber operations and other industrial processes.

### *Colorado*

Current Laws/Regulations:

- Scrap tire regulations for storage, disposal and processing facilities effective May 1988 (S.W. regs SEC. #9)
  - Limits the number of tires a facility can accept to the number it can process, store, recycle or dispose of in a year.
  - Identifies storage requirements including fire control, security, access roads and permits.
  - Defines safe storage as placing tires or tire shreds in trenches and covering with plastic and dirt.
- Enforcement program in place.

In 1992:

- HB 1231 has been introduced and if passed would affect tires as follows:
  - Place a \$1/tire surcharge on retail sale of tires and on new vehicle tires.
  - Require tire pile site owners to register with CO Department of Health and Hazardous Materials (DOH). CO DOH would assess and permit piles.
  - Establish a grant fund for tire pile abatement and tire recycling projects.

## **Connecticut**

### **Current Laws/Regulations:**

- Tire storage facilities must be licensed by the State Department of Environmental Protection. Requirements include groundwater protection, environmental health and safety provisions and financial assurance (Guidelines for Rubber Tire Storage Areas [1978-80]).
- State mandatory recycling act designates tires as future recyclables. Tires can be accepted at landfills until there are facilities with tire recycling capabilities in the State.

### **In 1991:**

- Tires begin to be diverted from landfills to a waste tire energy facility in the State.

## **Delaware**

### **Current Status:**

- No legislation.
- Two county landfills contract mobile shredding services.
- Shredded tires may be landfilled.
- Limited quantities of whole tires are currently landfilled.
- Currently working on diverting whole tires to incineration facility for electrical generation.

## **Florida**

### **Current Laws/Regulations:**

- **SB 1192**, a scrap tire law enacted in 1988:
  - Requires a \$1/tire tax on the retail sale of tires.
  - Requires tires to be cut prior to landfilling.
  - Waste tire sites must be closed or located at a permitted facility.
  - Processing or disposal facilities must be under permit.
  - Small processing facilities, collection centers and mobile operators must have a general permit.
  - Waste tire collectors must be registered.

### **As of January 1, 1992:**

- 750 waste tire hauling/collection companies have registered 1,825 trucks.
- 28 mobile shredders permitted or have made application for operating permits.
- 11 fixed waste tire processing permits issued.
- DOT using crumb rubber in asphalt for road resurfacing.
- Tire chips can be used as landfill daily cover material.

- Several RDF facilities are burning tire chips. Percentages vary by facility.
- DER has three firms under contract to perform cleanup services.
- One contract to demonstrate innovative technologies has been signed. One company withdrew from the program. Negotiations continue with two companies.
- Two cleanups in progress. Over 1 million tires each.

### *Georgia*

#### Current Laws/Regulations:

- Solid Waste Management Act, passed in 1990, required the State to develop solid waste management plan by January 1, 1991.
  - Requires counties to develop solid waste management plans by 1992. Counties must identify the plan for any wastes generated in their jurisdiction.
  - Allows landfill operators to refuse tires or require that they be shredded or chipped before disposal.
  - Tires may be considered as a recyclable material at a facility that processes tires if 60% of the tires processed go to an end use market.

#### In 1992:

- The Environmental Protection Division (EPD) has developed draft language for a tire recycling bill. EPD expects to introduce the bill to the 1992 legislature. Provisions in the draft language include:
  - A \$2/tire retail tire sales fee to fund tire pile cleanups and provide reimbursement for recycling.
  - A \$0.90/tire reimbursement to tire haulers who collect and transport tires to recycler.

### *Hawaii*

#### Current Laws/Regulations:

- Honolulu County is developing a scrap tire management program.

#### In 1992:

- The Department of Accounting and General Services is reviewing (under legislative direction) its procurement rules and specifications. Preliminary reports indicate a 10% preference for retread tires will be included.
- A \$1/tire advanced disposal fee is expected to be proposed to the legislature.

## **Idaho**

### **Current Laws/Regulations:**

- **H.B. 352** passed by the 1991 Idaho legislature affects tires as follows:
  - Sets a \$1/tire fee per tire sold at retail or wholesale in the State.
  - Establishes a Waste Tire Grant account.
  - Provides a \$0.10/tire credit to dealers for accounting/reporting expenses.
  - Provides end users of tires and tire derived materials a \$20/ton reimbursement for eligible uses, such as energy recovery, shredding, soil erosion control, collision barriers, crumb rubber for asphalt use or as a raw material for other products and hauling to out-of-state processing facilities.
  - Provides a \$1/tire for passenger and light truck tires to be used for retreading operations in Idaho.
  - Requires tire sellers accept waste tires equal to the number of tires sold at the point of transfer.
  - Requires waste tire collection sites register with the Department of Environmental Quality within six months of passage of the bill.
  - Bans disposal of tires at landfills and incineration sites (except as allowed under permissible fuel uses), effective July 1, 1991.
  - Requires tires to be disposed at waste tire collection site beginning January 1, 1993.

## **Illinois**

### **Current Laws/Regulations:**

- **H.B. 1085 (PA 86-452)**, enacted August 31, 1989:
  - Created the Used Tire Management Program.
  - Established a financial assistance program for local governments to cleanup tire piles, develop markets for tire-based products, and control mosquito infestations in tire piles.
- **S.B. 989 (PA 87-727)**, enacted September 23, 1991:
  - Establishes a new fee on tires sold, prioritizes how monies generated shall be earmarked, requires tire retailers to accept used tires for recycling, and requires the development and implementation of a plan to eliminate large tire piles. The act also creates the following waste management hierarchy for used tires generated in this State:
    1. Reuse of tire casings for remanufacture or retreading.
    2. Processing of tires into marketable products, such as stamped parts from portions of tire casings.

3. Total destruction of tires into a uniform product that is marketable as a fuel or recycled material feedstock.
  4. Total destruction of tires through primary shredding to produce a nonuniform product for use in road beds or other construction applications, or at a landfill or similar site for soil erosion control or cover.
  5. Total destruction of tires to a nonuniform product consistency for direct landfill disposal.
- Funding sources:
    - Effective January 1, 1990, \$0.50 of each vehicle title fee is deposited into a Used Tire Management Fund. Generating approximately \$1.7 million annually, this source expires on December 31, 1994.
    - Effective July 1, 1992, \$1/tire fee on retail sales. Approximately \$8-\$10 million is expected to be generated annually (PA 87-727).
  - Collector, Seller and Hauler Regulations:
    - Licensing waste tire transporters were finalized in 1990.
    - Effective July 1, 1992, retailers are required to accept for recycling used tires from customers, at the point of transfer, in a quantity equal to the number of new tires purchased (PA 727).
  - Storage and Processor Regulations:
    - Financial assurance required for sites with more than 5,000 tires.
    - Effective April 1, 1991, used tire storage facilities must
      - » limit tire pile height and size
      - » assure that tires are stored or processed in a manner that prevents water from accumulating in the tire
      - » main daily records of tires received and processed.
    - Effective January 1, 1991, sites with more than 50 used tires must be registered with the IL EPA and report the number of tires accumulated, vector control status, and handling and processing procedures.
    - Any retailer that accepts used tires for recycling under PA 87-727 shall not allow the tires to accumulate for periods of more than 90 days.
  - Disposal Restrictions:
    - Whole tires are banned from landfill disposal unless tires are shredded and landfill actively seeks alternative uses for the tire scraps, effective July 1, 1994.
  - Marketing Incentives:
    - IL Department of Energy and Natural Resources' Used Tire Recovery Program:
      - » awards low interest loans to expand existing used tire processing facilities in the State;

- » funded five tire-derived fuel test burns in 1991.
- » is making low interest loans available to fuel users to retrofit existing equipment or make improvements to facilitate the use of TDF.
- » conducted a test of passenger retread tires with the IL State Police.
- » conducted a test with rubber modified asphalt concrete in conjunction with the IL Department of Transportation.
- » administers a program to:
  - assist local government and private industry in establishing facilities and programs to collect, process and utilize waste tires and tire derived material;
  - demonstrate innovative technologies to collect, store, process or utilize used and waste tires and tire derived materials;
  - apply demonstrated technologies.
- **H.B. 1159 (PA 87-476)**, enacted September 13, 1991, requires the IL Department of Central Management Services to develop and implement a program to use retreads as replacement tires on State-owned vehicles whenever possible.

## *Indiana*

### Current Laws/Regulations:

- **PL. 19-1990** established regulations on the disposal of lead acid batteries and waste tires. The law:
  - Created a waste tire management fund, effective July 1991, to pay for cleaning up tire dumps when the responsible party is unknown or cannot afford the cleanup. The waste tire management fund is supported by permit fees from waste tire storage sites, appropriations and other fees as established by the General Assembly. [Waste tire storage/processing site permit requirements have not been finalized, thus no permits have been issued or funds generated for tire cleanup.]
  - Created permit requirements for waste tire storage facilities to include at minimum:
    - » Proof of financial responsibility.
    - » Records to show quantity of tires handled, their source, the quantity of material (whole, cut or shredded) shipped from the site, and documentation showing its final destination.
    - » Site closure plan.
    - » Contingency plan for protecting public health and the environment.
  - Established a Waste Tire Task Force to develop market options.



- Established a 10% price preference for State purchase of supplies that meet recycled content requirement specified in the law.
- **PL. 236-1991** affects tires as follows:
  - Requires retailers to post a notice advising customers that a retailer is required to retain the customer's take-off tires for recycling.
  - Limits the amount of time retailers and wholesalers can retain whole tires.
  - Sets forth ways in which wholesalers and retailers can dispose of tires.
  - Defines requirements for registering/licensing scrap tire haulers and processing facilities.
  - Defines waste tire cutting facilities.
  - Establishes operating requirements.
  - Sets a \$100/year permit fee.

**In 1991:**

- The Indiana Department of Waste Management (IDEM) issued interim guidelines for waste tire cutting facility and storage facility permits. The guidelines establish the number of tires that may be stored at either cutting or storage facilities, sets forth fire protection/safety requirements, on-site waste water requirements, mosquito control requirements, identifies tire pile size requirements for whole and processed tires.
- The Waste Tire Task Force focused on markets for scrap tires and tire remediation plans.

**In 1992:**

- A bill being debated in the current legislature is intended to streamline the process for waste tire storage and tire cutting facilities.
- The bill would also extend the life of the Waste Tire Task Force.

***Iowa***

**Current Laws/Regulations:**

- **House File 753**, passed in 1989, bans whole tires from landfill disposal effective July 1, 1991. According to IA Administration Code landfilled tire pieces must be no longer than 18" on any side.
- IA DNR submitted a waste tire abatement report to the General Assembly as mandated in House File 753. The report recommends:
  - That waste tire haulers be registered and bonded.
  - The use of TDF at the State's three public universities.
  - Local governments use tire chips as a leachate collection medium in landfills.
  - A financial mechanism to fund the program. Preferred method is a vehicle registration surcharge.

- Modified bounty system for local governments only to receive rebates on pile cleanups.
- IA DNR intends to draft administrative rules for tire processing and storage facilities.
- **House File 706**, passed in June 1991, regulates waste tire haulers in the following ways:
  - Waste tire haulers are defined as hired transporters of more than 40 waste tires in a single load for commercial purposes
  - Waste tire haulers must obtain a certificate of registration from the Secretary of State
  - Under the registration requirements, haulers are liable for any costs associated with improper disposal of tires. Other hauler registration requirements include a registration fee and posting of a surety bond. Registration certificates are valid for one year
  - Generators and disposers of tires must contract with a registered hauler for removal of waste tires
  - Transporters of waste tires for final disposal are required to dispose of tires at permitted sanitary disposal facilities.

### ***Kansas***

#### Current Laws/Regulations:

- **SB 310**, a recycling bill was signed into law in June, 1990. The bill:
  - Bans landfilling of whole tires (effective July 1, 1990).
  - Provides for the disposal of cut tires (sufficiently small) in a landfill.
  - Allows whole tires to be used as part of a proven and approved leachate collection system.
  - Allows cut tire chips to be used as daily cover material in landfills.
  - Sets a \$.50/tire excise tax on retail sale of new tires.
  - Establishes a waste tire management fund to provide grants to cities and counties for scrap tire recycling, management, collection and disposal operations (Spring, 1992).
  - Establishes a system of permits for waste tire processing facilities, collectors and collection centers (Spring, 1992).

### ***Kentucky***

#### Current Laws/Regulations:

- **HB 32** signed into law April 1990:
  - Places a \$1/tire tax on retail sales of tires.

- Establishes a waste tire trust fund for cleanup of tire piles and to fund loan programs to develop uses for waste tire material and for collection and storage programs.
- Requires registration of piles with more than 100 waste tires.
- Requires that only tires "rendered suitable for disposal" be land-filled.

### *Louisiana*

#### Current Laws/Regulations:

- **Act 185**, a solid waste recycling, and reduction law passed in 1989, affects scrap tires in the following ways:
  - Tires must go to permitted recycling or solid waste disposal or waste tire collection sites, effective January 1, 1990.
  - Effective January 1, 1991, whole tires will not be accepted at landfills for disposal. Tires must be cut or shred prior to disposal.
  - Establishes the following waste tire regulations:
    - » Manifest, reporting, site notification requirements.
    - » Permit requirements for transporters, waste tire collection, and processing facilities.
    - » Establishes outdoor/indoor storage requirements.
    - » Establishes tire dealer responsibilities.
  - Sets a \$2/tire fee on retail sales, effective February, 1992.

### *Maine*

#### Current Laws/Regulations:

- **P.L. 1989** passed in 1989 affects as follows:
  - Requires \$1/tire advance disposal fee (paid on retail sale) to fund pile cleanup and scrap tire recycling grants and loan programs, effective January 1990.
  - Required ME DOT to prepare a report on the use of ground tire rubber as an additive to asphalt concrete. Completed March 1990.
  - Established a DOT recycling project to review feasible alternatives for using recyclable materials in construction, including ground rubber from tires. Report completed in 1991.
  - Chapter 406 of the State Solid Waste Management plan contains regulations for scrap tire storage and disposal including:
    - » Surface and groundwater protection.
    - » Fire control and security measures, access roads, and buffer areas.
    - » Operating licenses.

- Effective April 1, 1991, scrap tire haulers are required to be licensed, meet manifest requirements and show financial responsibility.

## *Maryland*

### Current Laws/Regulations:

- **HB 1202** passed in 1991 affects tires as follows:
  - Beginning February 1, 1992, a \$1/tire will be charged on the first sale of all new tires in Maryland by a tire dealer, including new tires sold as part of a vehicle.
  - The Maryland Department of Environment (MDE) is required to write licensing regulations for scrap tires. Proposed regulations were completed in January 1992. All scrap tire collectors, haulers and handlers are required to be licensed by July 1, 1992 under the proposed regulations.
  - Directed Maryland Environmental Services (MES) to establish the Maryland Tire Recycling System to include scrap tire collection facilities, scrap tire haulers, scrap tire recyclers and an approved resource recovery facility that uses tires as a fuel substitute or an approved facility that uses tires as a tire derived fuel. Request for proposals for inclusion in the system to be issued in January 1992.
  - Requires that facilities that use tires for fuel may only be approved/licensed if no other options for returning tires to the marketplace for reuse exist.
  - Bans tires from all Maryland landfills after January 1, 1994.
- **MES Scrap Tire Management Program to date:**
  - Retreaded Tire Utilization Pilot Project underway.
  - Remanufactured Tire Demonstration Project underway.
  - Promote the use of tire chips as a supplemental fuel in cement kilns. Testing underway.
  - Research asphalt in composting. Experiment began October 1, 1991.
  - Promote use and manufacture of scrap tire material products. Catalog of products issued.
  - Tire reef project.
- State completed a market study for recyclables, including tires, in 1990.

### *Massachusetts*

#### Current Laws/Regulations:

- State Solid Waste Management Facility Regulations ban whole tire from landfills effective December 31, 1991.
- Interim policy on tire site design for tire storage, collection, processing and disposal sites includes the following permit criteria:
  - Site location, topography, wetlands impact.
  - Proof of site ownership.
  - Site dimensions, tire pile dimensions, number of tires received and processed.
  - On-site fire prevention/control plan.
  - Security measures.

#### In 1992:

- An act to Protect the Environment and Public Health by Proper Disposal of Certain Automotive Wastes, sponsored by Rep. Joan Menard (D-Somerset) is expected to be refiled. The Act would include provisions for a \$5/vehicle registration title transfer fee to fund waste tire abatement; establish permit requirements for tire haulers, processors, collection/storage sites; encourage establishment of waste tire collection centers; and allow tire dealers to charge disposal fees up to 5% of tire retail sales price.

### *Michigan*

#### Current Laws/Regulations:

- P.A. 148 of 1990 places a \$.50 tire disposal surcharge on each certificate of vehicle title. Monies from the surcharge are deposited in the scrap tire regulatory fund.
- P.A. 133 of 1990 establishes the scrap tire regulatory fund to provide monies for scrap tire pile cleanups on public land and administrative costs of implementing and enforcing scrap tire regulations. The act also:
  - Regulates tire storage for uncovered tire collection sites with more than 500 tires.
  - Requires all scrap tire collection sites to register with the Department of Natural Resources (DNR) annually. Registration fee—\$200/yr.
  - Requires all scrap tire haulers to register with DNR.
  - Requires tire retailers to use registered scrap tire haulers.
  - Requires sites with more than 100,000 tires to be processors.

#### 1991 Statistics:

- 306 haulers registered.

- 207 registered collection sites holding approximately 15 million tires.
- Over 100 tire site cleanups completed.
- Identified additional 200 (approx.) sites for compliance status.

Expected in 1992:

- Decrease in the number of sites in compliance because of bonding companies' reluctance to write required surety bonds. (Surety bonds of \$100,000/acre of tire collection required by law, effective January 1992.)

### **Minnesota**

Current Laws/Regulations:

- Scrap tire law passed in 1985:
  - Requires a \$4 tax on vehicle title transfers. Approximately \$2.6 million generated annually for the Waste Tire Program to fund cleanup and grant/loan programs.
  - Bans tires from landfills.
  - Requires retailers to accept as many waste tires from a customer as are sold to that customer.
  - Allows tire retailers to charge a disposal fee.
  - Requires transporter identification.
- MN reports the following progress in managing the State's scrap tires:
  - Since 1990, the MN Pollution Control Agency (MPCA) has awarded almost \$340,000 in grants and loans to MN businesses and government organizations to develop markets for recycled waste tires.
  - 89 transporters have valid identification numbers.
  - 6 permitted waste tire processors process approximately 9.4 million waste tires per year.
  - MPCA estimates 80% of the waste tires from the State's 280 tire dumps will be cleaned up or under cleanup control after July 1, 1992. Cleanup should be completed by December 31, 1994.
  - Cleanup Statistics:
    - » 5.4 million tires at 107 tire dumps have been cleaned up.
    - » 2 million tires at 60 tire dumps currently under contract.
    - » In 1992, MPCA will award cleanup contracts for 3 million tires at 47 tire dumps.
    - » After July 1, 1992, about 800,000 tires at 80 tire dumps will remain to be cleaned up.
  - 80% of the tires processed in MN are used to produce tire-derived fuel, none of which is burned in the State.

- The remaining 20% of the tires are processed for crumb rubber applications for use as roadbed material, light-weight fill and other applications.

### *Mississippi*

#### Current Laws/Regulations:

- **SB 2985**, a disposal bill for batteries, tires and household hazardous waste, was passed in 1991. The new law:
  - Establishes a \$1/tire fee on retail sales of tires beginning January 1, 1992. Fifty cents of each dollar collected will be placed in a grant fund for counties and cities to help fund scrap tire management programs.
  - Requires owners and operators of waste tire collection sites to complete site notifications to the Department of Environmental Quality (DEQ) by October, 1991.
  - Requires waste tire collection sites be approved by DEQ.
  - Requires registration for waste tire haulers.
  - Requires DEQ to promulgate rules and regulations pertaining to collection, transportation, storage, processing and disposal of waste tires. It is expected that a landfill ban on whole tires will be included in the rules. Most likely the rules will allow shredded tires to be landfilled. Rules due by July 1, 1992.
  - Grant regulations due by March 31, 1992.
  - Effective January 1, 1992, waste tire haulers and transporters must be registered.
  - Effective January 1, 1992, waste tire haulers/collectors, generators and processors must maintain manifest records of the number of tires generated from a facility, transported and processed, reused or disposed.

### *Missouri*

#### Current Laws/Regulations:

- **SB 530**, an omnibus solid waste bill passed in 1990, includes provisions for regulating tires as follows:
  - Places a \$.50/tire tax on retail sales of new tires.
  - Bans whole tires from landfills, effective January 1, 1991.

#### Storage/Processor Regulations:

- Sites that store more than 500 tires for more than 30 days to obtain a permit from the Dept. of Natural Resources (DNR). Sites that store fewer than 500 tires do not need a permit but must conform to storage requirements.

- Sites that obtained a first-stage waste tire permit in 1991 must apply for second-stage permit.
- Sites with no first-stage permit in 1991 must apply for a second-stage permit to store over 500 tires.
- Second-stage permit application requirements include:
  - Application form.
  - Detailed site and operation plans.
  - Topographic and boundary surveys.
  - Land use and zoning within 500 feet.
  - Closure plans.
  - Financial assurance.
  - Contingency plans.
  - Evidence of property ownership.
  - \$200 application fee.

#### Collector/Seller/Hauler Regulations:

- Waste tire haulers who carry more than 25 tires per load must obtain a DNR permit.
- Haulers with first-stage permits were required to apply for second-stage permits by December 1, 1991. Second-stage haulers permit carries a \$100 annual fee.
- Businesses that haul their own tires do not require a permit.
- Requires tire dealers to use only permitted haulers and keep records of where their tires go.

#### Other Activities:

- An advisory council was established to help develop waste tire rules.
- An advisory council is being formed to develop grant criteria.
- Requires the State DOT to undertake demonstration projects using recovered rubber from waste tires as surfacing material, structural material, sub-base material and fill consistent with standard engineering practices.

#### Market Incentives:

- Establishes purchase preferences for products that use recovered materials including retread tires.
- Allows for tire tax funds to be spent for cleanup of tire dump sites and to provide grants to businesses that use scrap tires as a fuel or in a product.

### **Montana**

#### Current Laws/Regulations:

- Tires are currently accepted at landfills, MSW landfills and inert material fills.



- Scrap tire collection/storage facilities must be permitted and licensed as a solid waste management facility.

### *Nebraska*

#### Current Laws/Regulations:

- **LB 163**, a waste reduction and recycling bill passed in April 1990:
  - Levies a \$1/tire fee on retail sale of new tires. Fee applies to new car sales.
  - Proceeds from the \$1/tire fee are deposited in the Waste Reduction and Recycling Incentive Fund. The fund is administered by the Dept. of Environmental Control to help establish waste reduction and recycling programs. There is no dedicated fund for tire recycling.

### *Nevada*

#### Current Laws/Regulations:

- Comprehensive solid waste management plan being written by the Department of Conservation and Natural Resources (DCNR) to identify legislative and regulatory needs. Expected to be presented mid-1992.
- **AB 320**, an omnibus recycling bill, passed by the Nevada legislature in 1991 sets a \$1/tire fee on the sale of new tires, effective January 1992. Revenues for the first 20 months will be diverted to the DCNR, the Governor's Office of Community Service and local counties for recycling education, planning and assistance. After this 20 month period, the funds will roll over to the State highway fund to develop projects which incorporate tires in highway use.
- Permitting regulations for haulers, processors and tire storage will be written by the State regulatory agencies in accordance with provisions of AB 320.

### *New Hampshire*

#### Current Laws/Regulations

- **HB 332-FN-A (Chapter 89-263)** an Automotive Waste Disposal law passed in 1989 provides for waste tires in the following ways:
  - Authorizes towns to collect fees for collection and disposal of town motor vehicle wastes including tires, batteries and used oil.
  - Requires the Office of State Planning (OSP) to submit a legislative proposal to increase the town's fees (at the town's request) if fees prove insufficient under existing legislation.

- Requires OSP maintain and distribute to the State's towns a current list of approved contractors for collection and disposal of motor vehicle waste.
- The Solid Waste District Law (RSA 149-M:13I) requires towns/districts to provide a site or access to a site for disposal of residents' tires.

In 1991:

- The legislature approved language to modify the definition of motor vehicle wastes.
- Storage requirements for outdoor and indoor waste tire collection sites were adopted. Requirements include security measures, pile size limits, berms and other fire control provisions.
- Tires must be cut prior to landfilling (some exceptions apply).
- A committee to study the development of a State waste tire management program was established. The committee is required to identify and study the reuse of waste tires for asphalt aggregate, water mains and other uses. Final report due February 1992.

### *New Jersey*

#### Current Laws/Regulations:

- Statewide mandatory Recycling Act passed in 1987 affects tires as follows:
  - Tires qualify for municipal tonnage grant credits specified in the act.
  - Contains a provision for industries purchasing new recycling equipment to receive a 50% tax credit against their State corporate business tax.
- Regulations regarding scrap tire processors and storage of scrap tires passed November 18, 1991.

#### Scrap Tire Program Progress to date:

- Dept. of Environmental Protection (DEP) has a *Recycling Handbook for Selected Material* (batteries, waste paper, plastics, ferrous auto, and scrap tires) available.
- NJ DOT completed demonstration project for using tire derived materials in road construction applications.
- NJ DOT is testing the use of retread passenger tires on fleet vehicles.
- NJ DEP has drafted a tire recycling Demonstration Project Proposal in response to federal legislation which appropriated \$1 million in funding to the State to develop a model program to recycle tires. The proposed model program will focus on:
  - Development of on-site management practices to minimize and control the potential hazards associated with scrap tire stock-

piles. The program will also focus on preventing new pile accumulations.

- Evaluation of end-use technologies in terms of economic efficiencies and overall effectiveness to manage scrap tire piles.

### *New Mexico*

#### Current Laws/Regulations:

- Solid waste in New Mexico is regulated by the Solid Waste Act of 1990 and newly revised Solid Waste Regulations. Tires are not addressed in these regulations.
- Annual waste tire generation estimated at 1.25 million tires/year.
- Tires are currently stockpiled and/or landfilled.
- Split tires are used to contain landfill cell liners at the City of Albuquerque landfill.

### *New York*

#### Current Laws/Regulations:

- An amendment to Chapter 226 (Section 27-0303) of the Environmental Conservation Law, passed by the NY General Assembly in 1990, designates commercial waste tires as a regulated waste and requires transporters to register with the DEC. Commercial waste tires are defined as waste tires that are transported for a fee for the purpose of reuse, recycling or disposal. The ruling is designed to insure that tires are transported to environmentally permitted tire recycling, processing or storage sites.
- Scrap tire storage and processing facilities are regulated under terms of Part 360, Regulations for Solid Waste.
- Governor's Executive Order 142 directs the Department of Transportation (DOT) to develop specifications for use of recycled rubber in paving materials. It also directs the Department of Economic Development (DED) to work with DOT to develop supply sources of recycled materials within the State. DED is further required to work with the Department of Environmental Conservation (DEC) in developing an audited cost analysis of recycled materials as components of paving materials. Report was issued September 1991.

#### In 1992:

- The Governor's 1992-93 Executive Budget includes a \$5/tire fee for funding various environmental programs.

## *North Carolina*

### Current Laws/Regulations:

- **SB 111** passed in 1989:
  - Levies a 1% sales tax (effective January 1990) on new tire sales.
  - Requires counties to provide a site for tire collection by March 1990.
  - Requires scrap tire haulers to be registered.
  - Requires permits for collection and processing sites.
  - Allows counties to impose tipping fees for tires if sales tax fails to generate adequate funding.
  - Requires certification forms to accompany each load of scrap tires.

## *North Dakota*

### Current Laws/Regulations:

- No legislation proposed.
- Landfills accept tires; many co-mingle with MSW.
- Some cities transport tires to recyclers.
- Rules proposed in 1992 would regulate stockpiling of tires.

## *Ohio*

### Current Laws/Regulations:

- **HB 592** the State solid waste management plan approved June 1989 requires:
  - Effective January 1, 1993, tires must be shredded or processed (cut, sliced, etc.) prior to disposal.
  - Effective January 1, 1995, neither whole or shredded tires will be accepted for disposal at sanitary landfills. Tires will only be accepted at tire monofills (shredded) or at legitimate recycling facilities.
  - Effective August 1, 1991, Ohio EPA finalized draft rules for storage of waste tires. The rules limit storage to 2,500 sq. ft., tire piles must be covered, and 50 ft. fire lanes maintained between the piles.
  - Ohio EPA expects to draft monofill regulations in 1992.

## *Oklahoma*

### Current Laws/Regulations:

- **OK Waste Tire Recycling Act** implemented July 1, 1989:
  - Places a \$1/tire surcharge on new tire sales.

- Created a Waste Tire Indemnity Fund to help eliminate existing stockpiles of tires and promote recycling of waste tires.
- Establishes a reimbursement up to \$0.50/tire for each tire processed if the facility meets the following criteria:
  - » Is permitted by the OK State Department of Health (OSDH) and operating in compliance.
  - » Document that at least 25% of the tires processed came from illegal tire dumps identified by OSDH.
  - » Document that the tires for which reimbursement is requested have been processed to a particle size not more than four square inches.
- Waste tires are eligible for additional compensation at a rate of \$0.35/tire for the collection and transportation of waste tires for each tire processed based on the following criteria:
  - » Demonstrate quarterly that the facility actively collects tires from each county in the State regularly.
  - » Submit proposed tire collection schedules and routes to OSDH.
  - » Demonstrate it is operating in compliance with OSDH permit.
- Tire storage and processing facilities are regulated as Type VI Solid Waste Processing Facilities and must meet tire pile size limitations for whole and processed tires, have proper fire protection and berms.
- Tire haulers and transporters are not regulated.

Waste Tire Program progress to date:

- As of August 1991, \$2,685,662 has been remitted to the Waste Tire Indemnity Fund.
- As of August 1992, 4,080,171 waste tires have been processed.
- 2 waste tire processing facilities are permitted in OK.

**Oregon**

Current Laws/Regulations:

- Waste tire law passed in 1987 set up a self-funded comprehensive program for waste tires including:
  - Regulation of storage and landfill disposal of waste tires.
  - Chipping requirement for landfilling tires effective July 1, 1989.
  - Regulation of transportation of waste tires.
  - \$1/tire disposal tax on the sale of new tires, used to clean up tire piles and to promote the use of waste tires by subsidizing markets for waste tires or chips.
- **SB 66** passed in 1991 requires General Services to conduct a study to compare quality and performance of retread and new tires. The

Department is required to report results of the study to the 1993 Legislature.

In 1992:

- \$1/tire fee sunsets on October 1, 1992.
- Reimbursement ends June 30, 1992.

Waste tire program progress to date:

- 1.3 million tires have been cleaned up from 21 waste tire piles. DEQ funded \$1,346,000 of the cleanup costs.
- 5 additional waste tire pile cleanups are underway using public funds.
- 101 waste tire pile owners have voluntarily removed a total of 437,000 tires.
- 16 regular storage sites have been permitted.
- 18 landfills have modified their solid waste permits to add temporary storage of waste tires.
- More than 100 waste tire carrier permits have been issued.
- 2 paper mills are burning TDF.
- 4 cement companies are burning TDF.
- TDF produced in OR is being used at a CA cement kiln.

Reimbursement program to date:

- \$780,000 reimbursement funds approved as of March 3, 1991. Represent 4.5 million passenger tire reuse.
- Major use reimbursed: TDF (75%).
- Other uses reimbursed:
  - Buoys made of whole tires.
  - Bias ply chips for playground cover.
  - Molded rubber products from granulated tires.
  - Marine products from stamped bias ply truck sidewalls.
  - Light fill roadbed base to repair section of highway (used 575,000 waste tires).

[The above uses were reimburses at a rate of \$0.01 per lb.]

Reimbursement: Demonstration Projects

- Benton County Paving Projects: One mile of Alpine Cut-Off Road and 1.5 miles on Evergreen Road were paved with PlusRide. DEQ reimbursed the construction company \$39,000 for use of the equivalent of about 24,000 passenger tires in the two projects.
- Portland Area Projects: The DEQ cooperated with Portland's Metropolitan Service District to have generic specifications developed for rubber-modified asphalt concrete (RUMAC). Two demonstration projects utilizing generic RUMAC in the Portland area are planned for 1991 by the City of Portland and Multnomah County.

- Other proposals: Other proposed demonstration projects are for laminated tires and molded highway guard rail blocks or cushions. The demonstration projects must be completed before June 30, 1992.

[The above demo projects can be reimbursed at a rate higher than the \$0.01/lb. as these recycling uses of waste tires do not yet have an established market.]

### *Pennsylvania*

#### Current Laws/Regulations:

- Interim storage policy for tires, effective 1988:
  - Limits duration of tire storage.
  - Requires isolation distances between piles, access control, hazard prevention, nuisance control, record keeping, reporting and site closure.
  - Sets pile size height and width limits.
  - Allows solid waste permit exemptions for storage or beneficial use of waste tires and tire-derived materials to facilities in compliance with provisions of the interim storage policy.
  - Policy applies to storage at processing sites.

#### In 1992:

- **HB 297** (originally introduced in 1991) is being carried over to the 1992 legislature and includes:
  - A ban landfilling of whole tires.
  - Establishment of a \$1/tire fee on new tire sales.
  - Creation of a waste tire management fund.
  - Site registration requirements for storage and processing of tires.
  - Encouragement of research and education.

### *Rhode Island*

#### Current Laws/Regulations:

- **RIGL 37-5.1:**
  - Imposes a \$.50/passenger tire tax on new tire sales effective January 1, 1990. Revenues from the tire tax are deposited in a State recycling fund along with monies generated from surcharges on other "hard-to-dispose-of" wastes. State expects to generate \$3 million/year from the fees to fund education and technical assistance programs for "hard-to-dispose-of materials," and for grant and research programs; to survey, track and monitor hard-to-dispose-of-material; and to establish regional collection centers for hard-to-dispose-of-materials.

- Tire recyclers are assessed an initial license fee of \$50 and an annual renewal fee of \$25.
- **RIGL 23-63**, "Vehicle Tire Storage and Recycling" addresses tires in the following ways:
  - Restricts disposal of waste tires to one of 3 methods:
    - (a) delivery to facilities operated by the State Solid Waste Management Corporation;
    - (b) delivery to a licensed privately-operated tire storage, recycling or recovery facility; or
    - (c) delivery for transport to an out-of-state recycling facility.
  - Bans the burning of scrap tires within the State as a source of fuel.
  - Bans the export of tires for burning outside the State as a fuel source and within 30 miles of any reservoir watershed.
  - Exporting tires for burning outside the limits is contingent on a satisfactory environmental impact statement and public hearing.
  - Requires facilities storing more than 400 tires to obtain a license.
  - Tire recycling or recovery businesses must be licensed by Dept. of Environmental Management.

Proposed 1992 legislation would institute a deposit system for tires.

### ***South Carolina***

#### **Current Laws/Regulations:**

- **SB 388 (HB 3096)**, SC's Solid Waste Policy and Management Act of 1991 affects scrap tires as follows:
  - Imposes a \$2/tire fee on the sale of each new tire effective November 1, 1991.
  - Requires owners and operators of waste tire sites to notify the SC Department of Health and Environmental Control (DHEC) of the site's location, size and number of tires accumulated.
  - DHEC must submit a waste tire management and disposal report to the General Assembly within six month of the bill's effective date.
  - Requires State and county solid waste plans to include a section on waste tires.
  - Requires counties to establish waste tire collection sites within twelve months of promulgation of the regulations.
  - Counties may not charge additional disposal fees except for oversize and out-of-state tires.
  - Bans whole waste tires from disposal at landfills (effective 6 months after DHEC regulations).



- Requires DHEC to establish regulations for permitting/registering collectors, processors, haulers and disposers of waste tires.
- Requires the State Treasurer to remit a \$1.50/tire sold in each county based on population for collection and disposal of waste tires generated in the county.
- Retailers and wholesalers may be refunded \$1/tire delivered to a permitted waste tire disposal facility.
- Provides for deposit of the remaining \$0.50/tire of the tire fee in a Waste Tire Grant Trust Fund. Grants may be provided to local governments from the Trust Fund to develop the use of TDF burning, to establish and/or expand waste treatment facilities, to remediate tire piles, and for research and development.
- Establishes a ten-member Waste Tire Committee.

### *South Dakota*

#### Current Laws/Regulations:

- Tires are managed under provisions of the State's revised solid waste regulations effective July 1990, including:
  - General permits for tire processing and storage facilities.
  - Allowance for tire handlers to accumulate up to 100,000 tires annually before removal.
  - Gives counties responsibility for writing solid waste ordinances. Several counties require tire to be cut into at least 4 pieces prior to landfilling.
  - Prohibits open burning of tires except in areas with populations under 5,000.

#### In 1991:

- Ottertail Power burning tires for fuel.
- Office of Waste Management and SD DOT working to develop specifications for asphalt rubber.

#### In 1992:

- Legislation has been introduced. Provisions include:
  - \$0.25/tire per vehicle registration fee (not to exceed \$1/vehicle).
  - Fees would be remitted to State to develop a grant fund for tire recycling end uses.

### *Tennessee*

#### Current Laws/Regulations:

- Public Chapter 451 of the State's comprehensive solid waste plan passed in 1991 affects scrap tires as follows:
  - Bans disposal of whole waste tires at landfill sites effective January 1, 1995.

- Requires counties to establish at least one waste tire collection site within the county by January 1, 1995.
- Requires the Department of Environment and Conservation (DEC) to purchase 6 mobile shredders and/or contract with a shredding service, using funds available from the Solid Waste Management Fund, to meet the State's waste tire disposal needs.
- Allows the State planning office to disperse one-time-only grants to assist counties in locating, collecting, and appropriately disposing of waste tires.
- Sets a \$1/tire fee on the retail sale of new tires, effective October 1, 1991.
- Establishes credits for the purchase of tire shredding equipment.
- Prohibits counties from imposing additional disposal fees or surcharges on tires.

### *Texas*

#### Current Laws/Regulations:

- **SB 1516**, passed in 1989, requires scrap tires to be shredded, split or quartered within 60 days of receipt at a disposal site.
- **SB 1340**, an omnibus recycling bill passed in 1991, affects tires as follows:
  - Imposes a \$2/tire fee on the sale of new passenger and truck tires effective January 1, 1992.
  - Requires the fee be deposited in a special waste tire recycling fund and used to pay qualifying processors \$0.85 for every 18.7 lbs. of shredded tires, effective April 1, 1992.
  - Limits disposal fees transporters can charge on tires delivered to processors receiving reimbursements from the waste tire recycling fund.
  - Gives preference to the use of rubber in State road paving projects as long as the cost of the rubber is within 15% of the alternatives based on comparative life-cycle costing figures.
  - Requires Department of Health (DOH) to develop a list of unauthorized tire dumps and prioritize the list.
  - Requires processors to remove 25% of the tires they shred for reimbursement to be taken from the DOH Priority Enforcement List.
  - Requires tire transporters and process/storage sites to register with the DOH.
  - Requires permits for tire transporters mobile processing sites and stationary storage sites.

## *Utah*

### Current Laws/Regulations

- **SB 5** passed in May, 1990 effects tires as follows:
  - Establishes per tire graduated tax on tire sales including new car sales (effective July 1, 1990) as follows:
    - » \$1/tire up to 14 inches.
    - » \$1.50/tire 15 to 19 inches.
    - » \$2/tire 19 to 26 inches.
  - Monies generated from the tax will be deposited in a recycling fund.
  - Provides a \$20/ton per use reimbursement to recyclers for products containing tire derived materials including TDF. Sunsets in 5 years.
  - Gives local health departments authority for waste tires.
  - Local health departments have adopted regulations for collection, storage and hauling of waste tires. The rules include:
    - » Licensing requirements for waste tire collectors and haulers and waste tire storage and processing facilities.
    - » Enforcement of a manifest tracking system to regulate tire collection.

## *Vermont*

### Current Laws/Regulations:

- **Act 286** passed June, 1990, affects tires as follows:
  - Prohibits the landfilling of tires after January 1, 1992.
  - Authorizes a 5% price preference for products containing recycled materials.
  - Allows for an even higher price preference if the State entities who will use the product agree on that amount.
- The State Solid Waste Management Program published in 1989 includes specific language addressing waste tires including a requirement for the State to develop a funding mechanism for tire recycling and for the investigation of tire processing and recycling options for use in the State.

## *Virginia*

### Current Laws/Regulations:

- Waste tire bill passed in 1989 imposes a \$.50/tire disposal fee on the sale of new tires effective January 1, 1990. The money collected from the tax will be deposited in a Waste Tire Fund. Approximately \$3 million in funds as of December 1991.

- Legislation established a Used Tire Management Advisory Committee to make recommendations on scrap tires in the State.
- Advisory Committee and Dept. of Waste Management are currently developing a management program which issued a request for proposals from any recycling/disposal technology.
- Demonstration of the State's overall scrap tire management plan will commence in 1992. Components of the plan are collection centers; hauling contractors; processing centers; reporting and documentation systems; evaluation; and implementation.

### *Washington*

#### Current Laws/Regulations:

- **HB 1671**, the Waste Not Washington Act passed a \$1/tire fee on the retail sale of new tires for 5 years. Authorized uses of the money are grants to local governments for removal of tire piles and enforcement, information and education, marketing studies, and contracts by the State.
  - Requires licensing rules for tire haulers including \$250/year carrier license.
  - Haulers must document delivery of scrap tires.
- Waste tire program progress to date:
  - A Waste Tire Advisory Committee (WTAC) was formed to implement HB 1671 and to help formulate current policy.
  - DOE ranked the tire piles across the State based on environmental, health and safety factors.
  - DOE developed a list of qualified contractors.
  - 16 of the 25 largest tire piles were cleaned up in 1991. Approximately 817,878 tires.
  - Two additional tire pile cleanups are underway at piles estimated to contain 300,000 and 500,000 tires respectively.
  - About \$2 million from the \$1/tire fee was available for cleanup in 1991.

### *West Virginia*

#### Current Laws/Regulations:

- **SB 18, Chapter 20-11-8**, (passed October, 1991) bans disposal of all tires in landfills effective June 1, 1993. Waste tire regulations include:
  - Waste tire haulers under jurisdiction of WVA Public Service Commission must have a waste hauler license.
  - Waste tire processors (stationary facilities) must have a solid waste permit.

- Shredded tires may be used as landfill daily cover or in the landfill liner as a leachate drainage.
- No more than 1,000 tires can be stored unless permitted for storing a large number.
- Tires must be split/cut or shredded prior to landfilling; shreds must then be dispersed in the workface of the fill with other wastes.
- Alternate burial plans for non-cut or whole tires will be approved if the plan gives adequate assurance that tires will stay buried.
- Mobile shredders are not required to have a permit.
- Storage at processing facilities is limited to 2 piles of whole tires and no more than 18 piles of shredded tires (pile size: 200 ft. x 50 ft. x 15 ft.).

### *Wisconsin*

#### Current Laws/Regulations:

- **AB 481** passed in 1987 affects tires as follows:
  - Establishes a \$2/tire fee on vehicle titles effective May 1, 1988. The fee generates approximately \$3 million annually.
  - Requires waste collectors, transporters, storage and processing facilities to be licensed.
  - Provides eligible companies a \$20/ton reimbursement for use of waste tires or tire-derived materials.
- **Act 355** enacted into law in 1990 requires all communities to have mandatory recycling programs and bans scrap tires from landfills starting in 1995.
- **Waste tire abatement progress as of January, 1992 [Department of Natural Resources (DNR) Abatement Projects]:**
  - 12 waste tire stockpile cleanups completed in 1991.
  - 5 waste tire pile cleanups in progress.
  - Approximately 5 million tires will have been cleaned up when all 17 stockpiles completed. Total cost: \$5.25 million.
  - Voluntary site cleanups have removed another 600,000 waste tires.
  - To date all the material processed and removed at cleanup sites has been used for energy recovery.
  - By July 1993, DNR expects to have cleaned up the 40 largest stockpiles in the State.
- **Waste Tire Management/Recovery Grant Progress as of January 1992:** 17 projects funded since 1989 at a cost of approximately \$650,000. The projects explored a variety of issues with regard to the reuse and management of waste tires. Funded projects include:

- Air emission testing to evaluate air emission resulting from the combustion of waste tires with coal and wood waste. [Recipient: Packaging Corp., Tomahawk. Cost: \$51,000.]
- Environmental assessment of air emissions for the proposed waste tire/medical waste incinerator. [Recipient: Bureau of Air Management. Cost: \$35,000.]
- Testing combustion technology. [Recipient: WI Power and Light. Cost: \$50,000.]
- Investigating fuel feed system designs to accommodate combustion of waste tire material in fluidized bed boilers. [Recipient: Fort Howard Paper. Cost: \$50,000.]
- Testing the development of various rubber products, e.g. bed liner for pickup trucks. [Recipient: K.W. Math. Cost: \$50,000.]
- Testing leachate characteristics of shredded waste tires. [Recipient: State Lab of Hygiene. Cost: \$3,000.]
- Testing medium to assess use of waste tires as absorbing medium for volatile compounds in landfills. [Recipient: Univ. of WI. Cost: \$3,000.]
- Research use of waste tires for highway improvement projects. [Recipient: WI DOT and the University of WI. Cost: \$50,000.]
- Test development of rubber products using waste tire material. [Recipient: Humane Mfg. Cost: \$50,000.]
- Establish model enforcement/education program for waste tire generators/haulers. [Recipient: City of Milwaukee. Cost: \$50,000.]
- Develop pilot waste storage facility. [Recipient: Brown County. Cost: \$18,599.22.]
- Test combustion of shredded waste tires in a travelling grate stoker boiler. [Recipient: Northern States Power Co. Cost: \$45,500.]
- Pave a 1-to 2-mile section of County Highway G with a rubberized asphalt. [Recipient: Vilas County Highway Dept. Cost: \$50,000.]
- Determine feasibility of using shredded waste tires alone or in mixtures to supplement landfill liners and covers. [Recipient: Univ. of WI-Madison. Cost: \$49,930.]
- Eliminate the disposal of waste tire at the City of Janesville Sanitary Landfill by constructing a storage area and diverting this material for use as an energy source. [Recipient: City of Janesville. Cost: \$32,725.]
- Develop and implement a 2-phase management plan to establish a county-wide program to collect stored waste tires and waste tire generated in the county annually and to divert them to a beneficial use such as energy recovery. [Recipient: Chippewa County. Cost: \$30,411.85.]

- 
- Conduct air emission and ash testing of combusting shredded waste tires with petroleum coke and coal to determine compliance with environmental regulations at a fluidized bed boiler. [Recipient: Manitowoc Public Power. Cost: \$35,000.]

### ***Wyoming***

#### **Current Laws/Regulations:**

- The Environmental Quality Act affects tires as follows:
  - Sets reasonable amounts for storage of tires at retail stores, collection centers, landfills, etc.
  - Establishes bonding and location requirements and a permitting system for solid waste facilities. [Tires defined as solid waste.]
  - Limits the accumulation of waste (including tires) prior to disposal.

## **Session 2.0**

---

# **Defining the Terminology**

---

by

**Office of Engineering  
Federal Highway Administration**



## 2.0 Contents

---

2.1	Paving Materials . . . . .	2-3
2.2	Paving Equipment . . . . .	2-8
2.3	Pavement Structure . . . . .	2-14
2.4	Pavement Distress . . . . .	2-16
2.5	Asphalt Additives . . . . .	2-24
2.6	Scrap Tire Rubber . . . . .	2-27

Sources: (Reprinted with permission) Asphalt Handbook, 1989 Edition, The Asphalt Institute  
*Hot-Mix Asphalt Paving Handbook*, 1991, AASHTO, et al.

**Asphalt**—A dark brown to black cementitious material in which the predominating constituents are bitumens which occur in nature or are obtained in petroleum processing. (ASTM\* Designation D8.)

**Asphalt Cement**—Asphalt that is refined to meet specifications for paving, industrial, and special purposes. (See Specifications for Asphalt Cement, ASTM Designation D 946 AASHTO\*\* Designations M 20 and M 226). Its penetration is usually between 40 and 300. The term is often abbreviated A.C.

**Asphalt Joint Sealer**—An asphalt product used for sealing cracks and joints in pavement and other structures.

**Asphalt, Natural (Native)**—Asphalt occurring in nature which has been derived from petroleum by natural processes of evaporation of volatile fractions leaving the asphalt fractions. The native asphalts of most importance are found in the Trinidad and Bermudez Lake deposits. Asphalt from these sources often is called *Lake Asphalt*.

**Asphalt Primer**—A cutback asphalt product of low viscosity that penetrates into an aggregate base/subbase upon application.

**Bitumen**—A mixture of hydrocarbons of natural or pyrogenous origin, or a combination of both; frequently accompanied by nonmetallic derivatives which may be gaseous, liquid, semisolid, or solid; and which are completely soluble in carbon disulfide.

**Cutback Asphalt**—Asphalt cement which has been liquefied by blending with petroleum solvents (also called diluents). Upon exposure to atmospheric conditions the diluents evaporate, leaving the asphalt cement to perform its function of cementing and waterproofing.

a. **Rapid-Curing (RC) Asphalt**—Cutback asphalt composed of asphalt cement and a naphtha or gasoline-type diluent of high volatility. (See Specifications for Rapid-Curing Asphalt, ASTM Designation D 2028 or AASHTO Designation M 81).

\*American Society for Testing and Materials.

\*\*American Association of State Highway and Transportation Officials.

## 2.1 Paving Materials

b. **Medium-Curing (MC) Asphalt**—Cutback asphalt composed of asphalt cement and kerosene-type diluent of medium volatility. (See Specifications for Medium-Curing Asphalt, ASTM Designation D 2027 or AASHTO Designation M 82).

c. **Slow-Curing (SC) Asphalt**—Cutback asphalt composed of asphalt cement and oils of low volatility. (See Specifications for Slow-Curing Asphalt, ASTM Designation D 2026 or AASHTO Designation M 141).

**Emulsified Asphalt**—An emulsion of asphalt cement and water that contains a small amount of an emulsifying agent, a heterogeneous system containing two normally immiscible phases (asphalt and water) in which the water forms the continuous phase of the emulsion, and minute globules of asphalt form the discontinuous phase. Emulsified asphalts may be of either the anionic, electronegatively charged asphalt globules, or cationic, electropositively charged asphalt globule types, depending upon the emulsifying agent. (See Specifications for Emulsified Asphalts, ASTM Designation D 977 or AASHTO Designation M 140 and Specifications for Cationic Emulsified Asphalts, ASTM Designation D 2397 or AASHTO Designation M 208).

**Aggregate**—Any hard, inert, mineral material used for mixing in graduated fragments. It includes sand, gravel, crushed stone, and slag.

**Aggregate, Coarse**—That retained on the 2.36 mm (No. 8) sieve.

**Aggregate, Fine**—That passing the 2.36 mm (No. 8) sieve.

**Asphalt Base Course**—A foundation course or pavement layer consisting of mineral aggregate, bound together with asphalt material on which successive course(s) are placed.

**Asphalt Emulsion Slurry Seal**—A mixture of slow-setting emulsified asphalt, fine aggregate and mineral filler, with water added to produce slurry consistency.

**Asphalt Fog Seal**—A light application of a slow-setting asphalt emulsion diluted with water and without mineral aggregate cover.

**Asphalt Leveling Course**—A course (asphalt aggregate mixture) of variable thickness used to eliminate irregularities in the contour of an existing surface prior to superimposed treatment or construction.

**Asphalt Overlay**—One or more courses of asphalt construction on an existing pavement. The overlay may include a leveling course, to correct the contour of the old pavement, followed by uniform course or courses to provide needed thickness.

**Asphalt Prime Coat**—An application of a low viscosity cutback asphalt product to an absorbent surface. It is used to prepare an untreated base for an asphalt surface. The prime penetrates into the base and plugs the voids, hardens the top and helps bind it to the overlying asphalt course.

**Asphalt Seal Coat**—A thin asphalt surface treatment used to waterproof and improve the texture of an asphalt wearing surface. Depending on the purpose, seal coats may or may not be covered with aggregate. The main types of seal coats are aggregate seals, fog seals, emulsion slurry seals and sand seals.

**Asphalt Surface Course**—The top course of an asphalt pavement, sometimes called asphalt wearing course.

**Asphalt Surface Treatments**—Asphalt surface treatment is a broad term embracing several types of asphalt or asphalt-aggregate applications, usually less than 25 mm (1 inch) thick, to a road surface. The types range from a light application of emulsified or cutback asphalt to single or multiple surface layers made up of alternating applications of asphalt and aggregate.

**Asphalt Tack Coat**—A very light application of asphalt, usually asphalt emulsion diluted with water. It is used to ensure a bond between the surface being paved and the overlying course.

**Base Course**—The layer of material immediately beneath the surface or intermediate course. It may be composed of crushed stone, crushed slag, crushed or uncrushed gravel and sand, or combinations of these materials. It also may be bound with asphalt (see *Asphalt Base Course*).

**Mineral Filler**—A finely divided mineral product at least 70 percent of which will pass a 75  $\mu\text{m}$  (No. 200) sieve. Pulverized limestone is the most commonly manufactured filler, although other stone dust, hydrated lime, portland cement, fly ash and certain natural deposits of finely divided mineral matter are also used.

**Single Surface Treatments**—A single application of asphalt to any kind of road surface followed immediately by a single layer of aggregate of as uniform size as practicable. The thickness of the

treatment is about the same as the nominal maximum size aggregate particles. A single surface treatment is used as a wearing and waterproofing course.

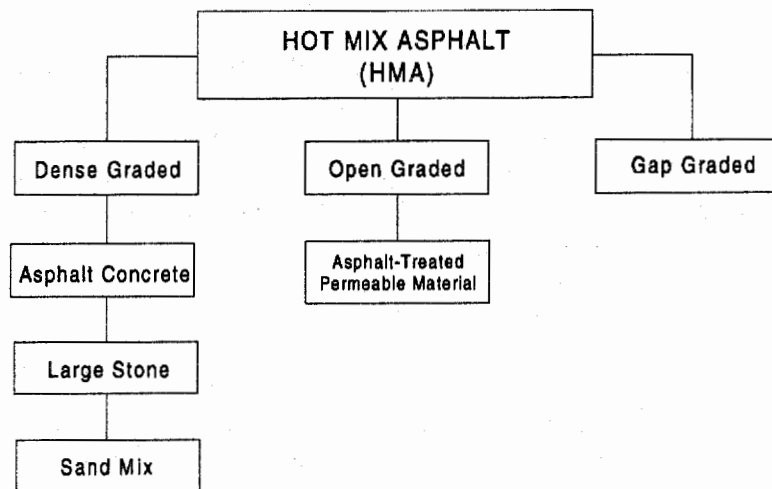
**Subbase**—The course in the asphalt pavement structure immediately below the base course is called the subbase course. If the subgrade soil is of adequate quality it may serve as the subbase.

**Subgrade**—The soil prepared to support a structure or a pavement system. It is the foundation for the pavement structure. The subgrade soil sometimes is called “basement soil” or “foundation soil.”

### Hot-Mix Asphalt

The term hot-mix asphalt (HMA) is used generically to include many different types of mix that are produced at an elevated temperature in an asphalt plant. The category of HMA is divided into three different types of mixes, depending primarily on the gradation of the aggregate used in the mix (Figure 2-1). The three mix types are (a) dense graded, (b) open graded, and (c) gap graded.

Figure 2-1. Types of HMA mixes



---

## **Dense-Graded Asphalt Concrete**

Dense-graded asphalt concrete consists of a uniform or continuous aggregate grading with an asphalt cement binder. It is also called asphaltic concrete or bituminous concrete.

## **Large-Stone Mixes**

By definition, a large-stone HMA mix is one that contains some coarse aggregate that has a nominal size greater than 1 in. In essence, this mix is still a dense-graded material but has a greater percentage of larger size coarse aggregate in the mix.

## **Sand Mix**

Sand mix is an asphalt mix that is made without coarse aggregate. Typically, 100 percent of the aggregate passes the 3/8-in. (9.5-mm) sieve and the majority of the particles also pass the No. 4 (4.75-mm) sieve.

## **Open-Graded Friction Course (OGFC)**

An open-graded friction course is one that consists primarily of coarse aggregate, a minimal amount of fine aggregate, and asphalt cement binder. The main purpose of this mixture is to provide a very open surface texture; one that will allow water to drain into the mix and that provides a significant amount of large aggregate (macrotexture) for contact with a vehicle traveling over the pavement surface.

## **Open-Graded Asphalt-Treated Permeable Material**

An open-graded asphalt-treated permeable material is designed primarily to allow for the passage of a large quantity of water through the mix as quickly as possible. The purpose of this layer is to provide a drainage course within the pavement structure.

## **Gap-Graded Asphalt Mixes**

A gap-graded asphalt mix is essentially the same as an open-graded mix; however, the amount of fine aggregate incorporated into the mix is usually greater than the amount of fine aggregate used in the open-graded mix. The aggregate gradation in the middle-size aggregate [that between the No. 4 (4.75-mm) and the No. 30 (600  $\mu\text{m}$ ) or No. 40 (425  $\mu\text{m}$ ) sieves] is missing or present only in small amounts.

## 2.2 Paving Equipment

Source: (Reprinted with permission) *Hot-Mix Asphalt Paving Handbook*, 1991, AASHTO, et al.

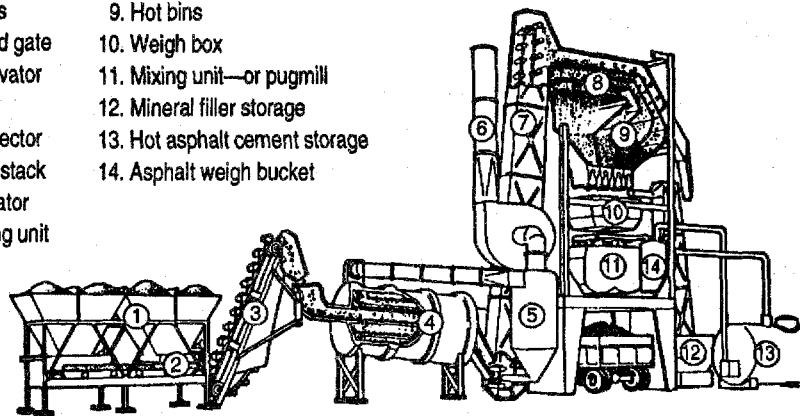
### Batch Plants

The major components of a batch plant are the cold-feed system, asphalt cement supply system, aggregate dryer, mixing tower, and emission-control system. The plant tower consists of several elements: hot elevator, screen deck, hot bins, weigh hopper, asphalt cement weigh bucket, and pugmill. These components are shown in Figure 2-2.

**Figure 2-2. Batch plant components (Asphalt Institute)**

Fourteen Major Parts:

- |                   |                                |
|-------------------|--------------------------------|
| 1. Cold bins      | 9. Hot bins                    |
| 2. Cold feed gate | 10. Weigh box                  |
| 3. Cold Elevator  | 11. Mixing unit—or pugmill     |
| 4. Dryer          | 12. Mineral filler storage     |
| 5. Dust collector | 13. Hot asphalt cement storage |
| 6. Exhaust stack  | 14. Asphalt weigh bucket       |
| 7. Hot elevator   |                                |
| 8. Screening unit |                                |



The aggregate used in the mix is removed from stockpiles and placed in individual cold-feed bins. The gathering conveyor transports the combined aggregate to the charging conveyor, which carries it up to the aggregate dryer.

The dryer operates on a counter flow basis. The aggregate is introduced into the dryer at the upper end and moves down the drum both by the drum rotation (gravity flow) and by the flight configuration inside the rotating dryer. As the aggregate is tumbled through the exhaust gases, the material is heated and dried. The hot, dry aggregate is discharged from the dryer at the lower end.

The hot aggregate is transported to the top of the plant mixing tower by a bucket elevator. The aggregate is held in the hot bins until it is discharged from a gate at the bottom of each bin into a weigh hopper. The correct proportion of each aggregate is determined by weight.

At the same time that the aggregate is being proportioned and weighed, the asphalt cement is pumped from its storage tank to a separate weigh bucket located on the tower just above the pugmill.

The aggregate in the weigh hopper is emptied into a twin shaft pugmill, and the different aggregate fractions are mixed together. After this brief dry-mix time, the asphalt cement from the weigh bucket is discharged into the pugmill and the wet-mix time begins.

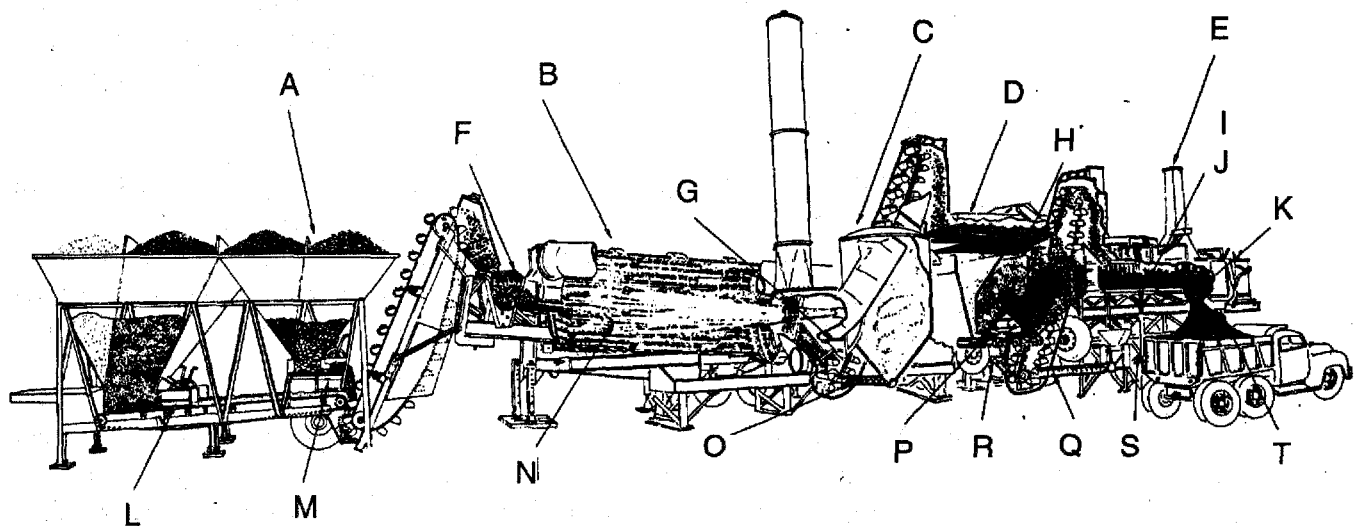
When mixing is complete, the gates on the bottom of the pugmill are opened and the mix is discharged into the haul vehicle or into a conveying device that carries the mix to a silo and eventually into the truck.

### Continuous Mix Plants

The components of this type of plant include the cold-feed system, asphalt cement supply system, aggregate dryer, hot-bucket elevator, screen unit, hot bins, mixing unit and holding hopper, and emission control system. (Figure 2-3)

The cold-feed bins are similar to those used on a batch plant. Material is proportioned from each bin by the size of the discharge gate opening

**Figure 2-3. Continuous-mix plant components (Asphalt Institute)**



A Cold aggregate storage and feed; B Dryer; C Dust collector; D Gradation control unit; E Mixer; F Grizzly; G Fan; H Vibrating screen; I Transfer pump; J Pugmill K Pugmill jacket; L Belt feeder; M Reciprocating feeder; N Flights; O Collected fines; P Gates; Q Mineral filler feed; R Aggregate sample point; S Metering pump; T Discharge Hopper.



and deposited on the gathering conveyor. The aggregate is transferred to a charging conveyor for delivery to the dryer. Inside the dryer the moisture in the combined aggregate is removed as the material is heated from ambient temperature to the desired mixing temperature. The dried and heated aggregate is then carried up an inclined bucket elevator to the screen deck.

The aggregate is continuously removed from the bins, proportioned according to the desired gradation in the mix, and transported to the pugmill. The asphalt cement is kept in a storage tank and then pumped to the mixing tower, where it is sprayed on the aggregate. The asphalt cement, measured by volume instead of weight, is mixed continuously with the aggregate as the two materials are moved toward the discharge end of the pugmill by the mixing paddles.

Because the mixing is a continuous process, a small capacity, temporary holding hopper is provided at the discharge end of the mixer to store the material until it can be delivered into a haul truck.

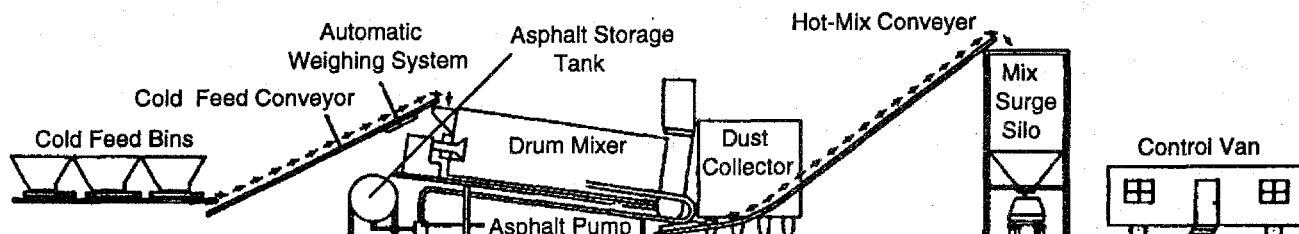
### Drum Mix Plants

#### *Parallel-Flow Drum Mixer*

The parallel-flow drum mix plant, shown in Figures 2-4 and 2-5 is a form of the old-style continuous mix plant. It consists of five major components: the coldfeed system, asphalt cement supply system, drum mixer, surge silo, and emission-control equipment.

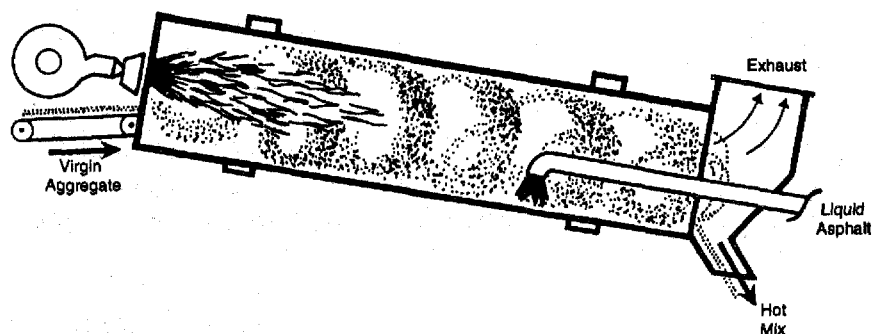
The cold-feed bins are used to proportion the material to the plant. The aggregate on each feeder belt is deposited onto a gathering conveyor that runs beneath all of the cold-feed bins. The combined material is

**Figure 2-4. Drum mix plant components (Asphalt Institute)**



normally passed through a scalping screen and transferred to a charging conveyor for transport to the drum mixer.

**Figure 2-5. Parallel-flow drum mix plant (Astec)**



The conventional drum mixer is a parallel-flow system; the exhaust gases and the aggregate move in the same direction. The burner is located at the upper end (aggregate inlet end) of the drum. The aggregate enters the drum either from a charging chute above the burner or on a slinger conveyor under the burner. The aggregate is moved down the drum by a combination of gravity and by the flight configuration inside the drum. As it travels, the aggregate is heated and the moisture removed.

The new aggregate and reclaimed material, if used, move into the rear half of the drum. The asphalt cement is injected onto the aggregate. Mineral filler and/or baghouse fines are also added into the back of the drum, either just before, or in conjunction with, the addition of the asphalt cement.

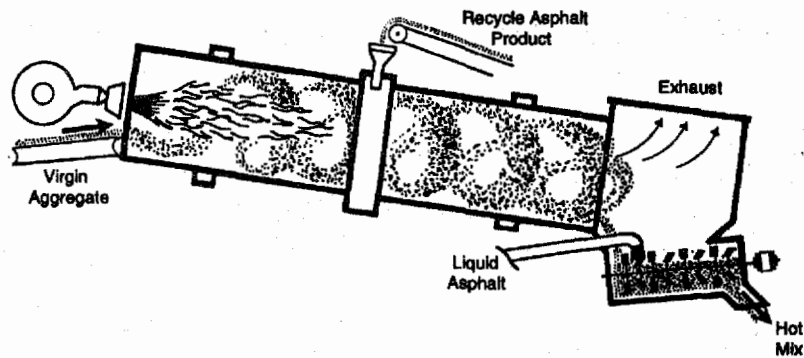
The asphalt mix is deposited into a conveying device for transport to a surge silo. The silo converts the continuous flow of mix into a batch flow for discharge into the haul vehicle.

### ***Drum Mix Coater Plant***

In the late 1980s, a number of variations to the conventional drum mix plant were introduced to the hot-mix asphalt-paving industry. One of these plant types is the "coater" plant. For this type of drum mixer the asphalt cement injection pipe has been removed from the drum. The uncoated aggregate, which is heated and dried inside the parallel-flow drum, is discharged into a single- or dual-shaft mixing chamber, where it is sprayed with asphalt cement. The blending of the asphalt cement

and the aggregate takes place as the materials move from one end of the mixing unit to the other. When mixing is complete, the material is delivered to the device used to transport it to the silo. Figure 2-6 is an illustration of the "coater" type of drum mix plant.

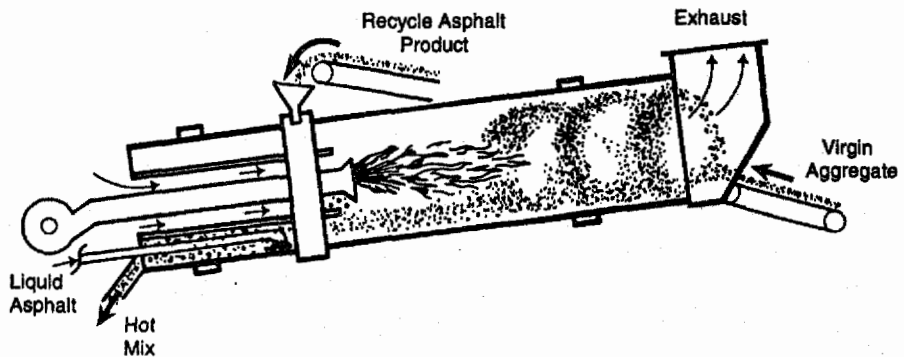
**Figure 2-6. Drum mix coater cutaway (Astec)**



**Counter Flow Drum Mixer**

A recent development in continuous mix plant design is the counter flow drum mix plant. As shown in Figure 2-7, the aggregate enters the drum from the upper end, whereas the burner is located near the lower end of the drum, similar to its position on a batch plant dryer. The aggregate moves down the drum against the flow of the exhaust gases—in a counter flow direction.

**Figure 2-7. Counter flow drum mixer components (Astec)**

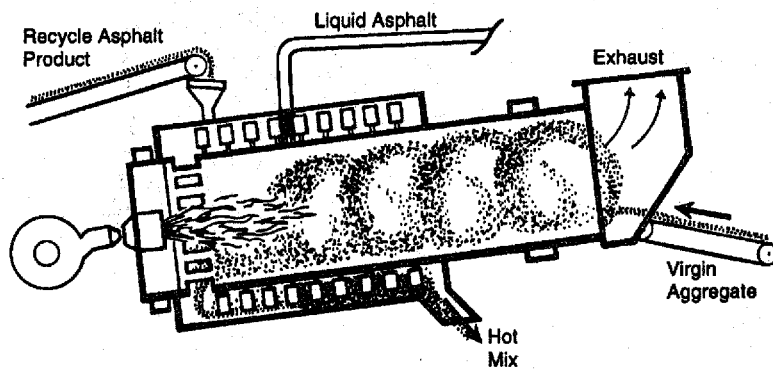


An extension to the drum is used to provide for the mixing of the heated and dried aggregate with the asphalt cement.

### ***Double Barrel Drum Mixer***

The asphalt cement in this double barrel plant is introduced into the aggregate after the aggregate is discharged from the inner drum into the outer drum. As shown in Figure 2-8, blending of the two materials occurs as the aggregate and asphalt cement are conveyed back uphill in the outer drum by a set of mixing paddles attached to the inner drum.

**Figure 2-8. Double barrel drum mixer (Astec)**



## **Compaction Equipment**

### ***Static Steel Wheel Rollers***

Static steel wheel rollers normally range in weight from 3 to 14 tons and have compression drums or rolls that vary in diameter from approximately 40 in. to more than 60 in.

### ***Pneumatic Tire Rollers***

For this type of roller the compactive effort applied to the mix is a function of the wheel load of the machine, the tire pressure, and the tire design (tire size and ply rating). Rollers that are equipped with tires that are 7.50 x 15 or less are not normally effective as a breakdown roller; pneumatic tire rollers with larger-size tires should be employed. The minimum weight of the pneumatic tire roller should be 15 tons.

The tires on the pneumatic roller will often pick up the mix when an oversanded surface course mix or a mix with some particular additives is being compacted.

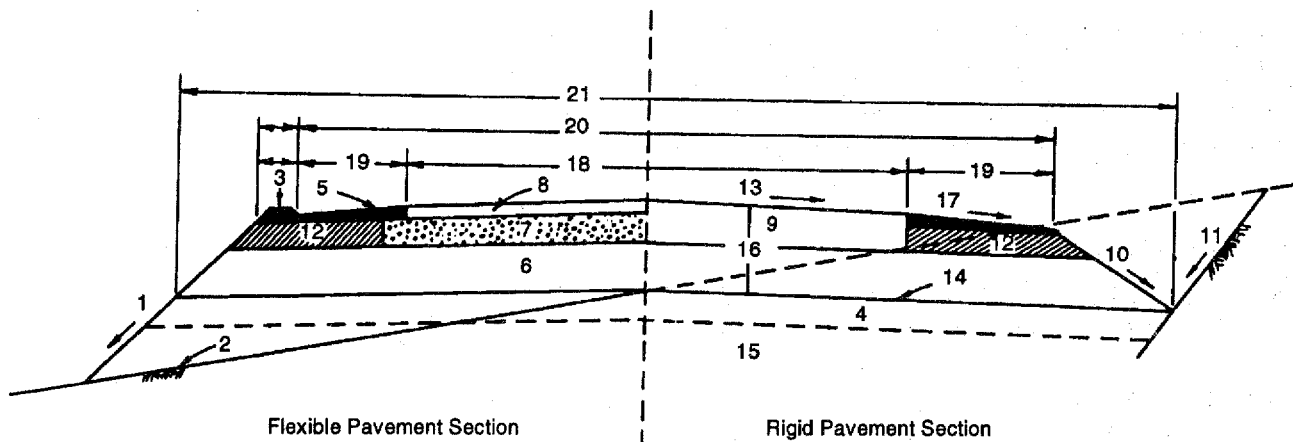
### Vibratory Rollers

Vibratory rollers come in a variety of configurations. These rollers have two types of compactive force that is applied to the hot-mix asphalt: static weight and dynamic (impact) force. The compactive effort derived from the static weight of the roller is caused by the weight of the rolls and frame. The compactive effort derived from the impact force is produced by a rotating eccentric weight located inside the drum (or drums). The elements of comparison for the dynamic component of a vibratory roller are the magnitude of the magnitude of the centrifugal force, its vibrating frequency, the nominal amplitude, and the ratio of the vibrating and nonvibrating masses acting on the drum.

## 2.3 Pavement Structure

Source: (Reprinted with permission) *AASHTO Guide for Design of Pavement Structures*, 1986, AASHTO

Figure 2-9. Typical section for rigid or flexible pavement structure



- |   |                         |
|---|-------------------------|
| 1 - FILL SLOPE                            | 11 - CUT SLOPE          |
| 2 - ORIGINAL GROUND                       | 12 - SHOULDER BASE      |
| 3 - DIKE                                  | 13 - CROWN SLOPE        |
| 4 - SELECTED MATERIAL OR PREPARED ROADBED | 14 - SUBGRADE           |
| 5 - SHOULDER SURFACING                    | 15 - ROADBED SOIL       |
| 6 - SUBBASE                               | 16 - PAVEMENT STRUCTURE |
| 7 - BASE COURSE                           | 17 - SHOULDER SLOPE     |
| 8 - SURFACE COURSE                        | 18 - TRAVEL LANES       |
| 9 - PAVEMENT SLAB                         | 19 - SHOULDER           |
| 10 - DITCH SLOPE                          | 20 - ROADWAY            |
|   | 21 - ROADBED            |

**Composite Pavement**—a pavement structure composed of an asphalt concrete wearing surface and portland cement concrete slab; an asphalt concrete overlay on a PCC slab is also referred to as a composite pavement.

**Contraction Joint**—a joint normally placed at recurrent intervals in a rigid slab to control transverse cracking.

**Equivalent Single Axle Loads (ESAL's)**—summation of equivalent 18,000-pound single axle loads used to combine mixed traffic to design traffic for the design period.

**Expansion Joint**—a joint located to provide for expansion of a rigid slab, without damage to itself, adjacent slabs, or structures.

**Layer Coefficient ( $a_1, a_2, a_3$ )**—the empirical relationship between structural number (SN) and layer thickness which expresses the relative ability of a material to function as a structural component of the pavement.

**Longitudinal Joint**—a joint normally placed between traffic lanes in rigid pavements to control longitudinal cracking.

**Low-Volume Road**—a roadway generally subjected to low levels of traffic; in this Guide, structural design is based on a range of 18-kip ESAL's from 50,000 to 1,000,000 for flexible and rigid pavements, and from 10,000 to 100,000 for aggregate-surfaced roads.

**Maintenance**—the preservation of the entire roadway, including surface, shoulders, roadsides, structures, and such traffic control devices as are necessary for its safe and efficient utilization.

**Pavement Rehabilitation**—work undertaken to extend the service life of an existing facility. This includes placement of additional surfacing material and/or other work necessary to return an existing roadway, including shoulders, to a condition of structural or functional adequacy.

**Pavement Structure**—a combination of subbase, base course, and surface course placed on a subgrade to support the traffic load and distribute it to the roadbed.

**Resilient Modulus**—a measure of the modulus of elasticity of roadbed soil or other pavement material.

## 2.4 Pavement Distress

**Structural Number (SN)**—an index number derived from an analysis of traffic, roadbed soil conditions, and environment which may be converted to thickness of flexible pavement layers through the use of suitable layer coefficients related to the type of material being used in each layer of the pavement structure.

Source: (Reprinted with permission), *Distress Identification Manual for the Long-Term Pavement Performance Studies*, 1990, SHRP

### Asphalt concrete surfaced pavement distress types

#### *Distress Type*

#### Cracking (Figure 2-10)

1. Alligator (Fatigue) Cracking
2. Block Cracking
3. Edge Cracking
4. Longitudinal Cracking
5. Reflection Cracking at Joints
6. Transverse Cracking

#### Patching and Potholes

7. Patch/Patch Deterioration
8. Potholes

#### Surface Deformation (Figure 2-11)

9. Rutting
10. Shoving

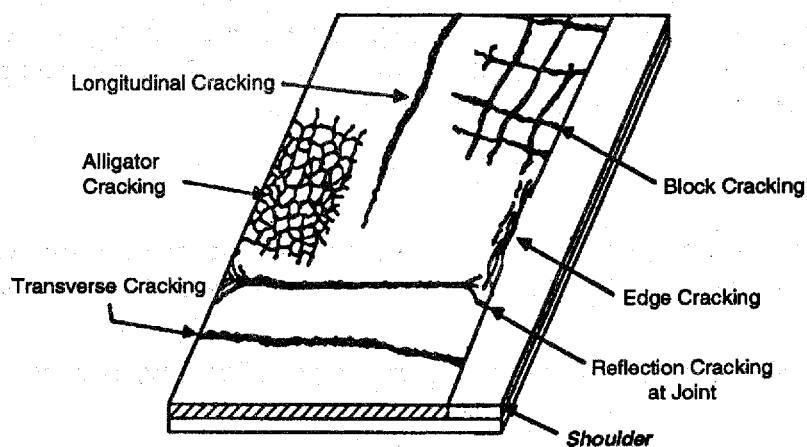
#### Surface Defects (Figure 2-12)

11. Bleeding
12. Polished Aggregate
13. Raveling and Weathering

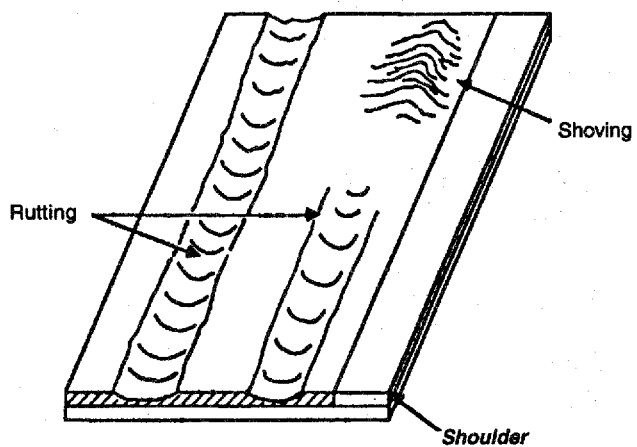
#### Miscellaneous Distress

14. Lane-to-Shoulder Dropoff
15. Lane-to-Shoulder Separation
16. Water Bleeding and Pumping

**Figure 2-10. Cracking of asphalt concrete pavement**

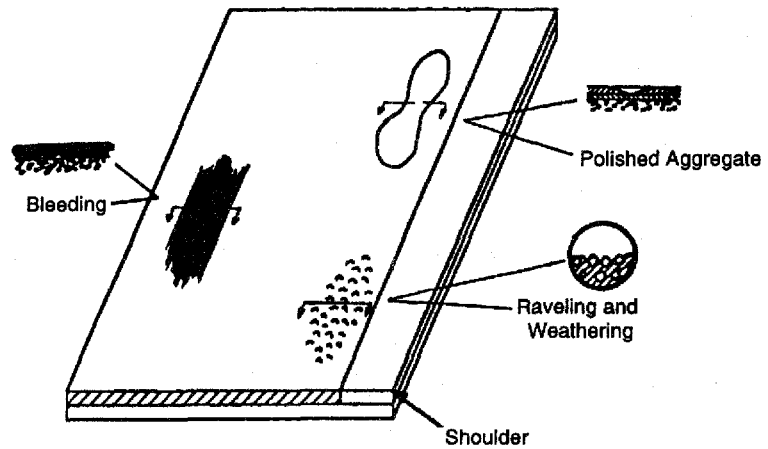


**Figure 2-11. Surface deformation of asphalt concrete pavement**





**Figure 2-12. Surface defects of asphalt concrete pavement**



**Jointed concrete surfaced pavement distress types**

***Distress Type***

**Cracking (Figure 2-13)**

1. Corner Breaks
2. Durability "D" Cracking
3. Longitudinal Cracking
4. Transverse Cracking

**Joint Deficiencies (Figure 2-14)**

5. Joint Seal Damage of Transverse Joints
6. Spalling of Longitudinal Joints
7. Spalling of Transverse Joints

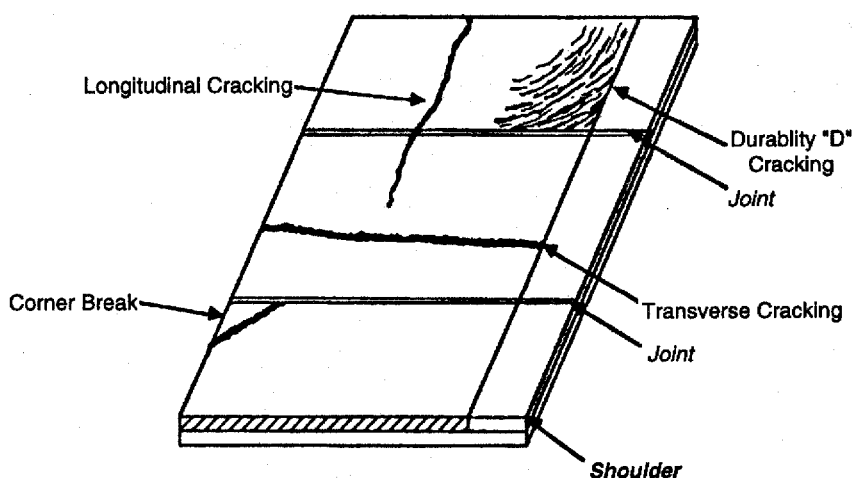
**Surface Defects (Figure 2-15)**

8. Map Cracking and Scaling
9. Polished Aggregate
10. Popouts

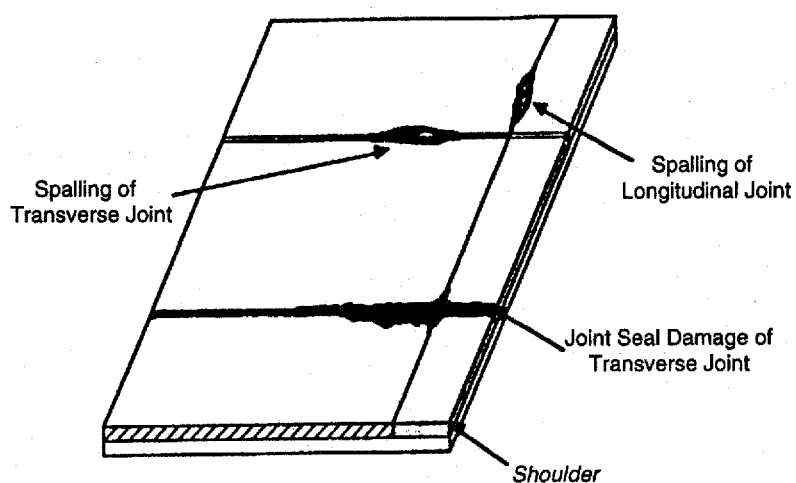
Miscellaneous Distress (Figure 2-16)

11. Blowup
12. Faulting of Transverse Joints & Cracks
13. Lane-to-Shoulder Dropoff
14. Lane-to-Shoulder Separation
15. Patch/Patch Deterioration
16. Water Bleeding and Pumping

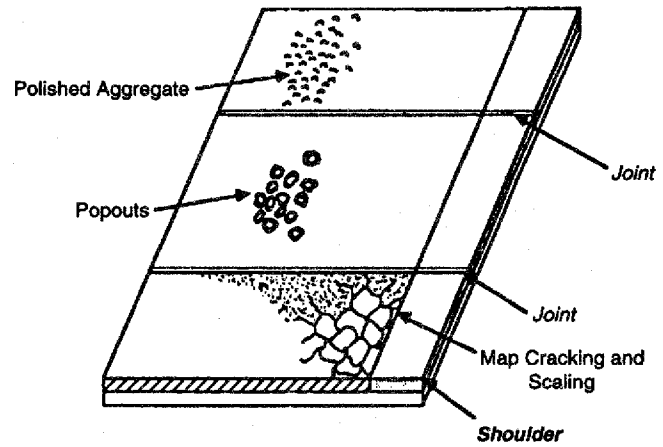
**Figure 2-13. Cracking of jointed concrete pavement**



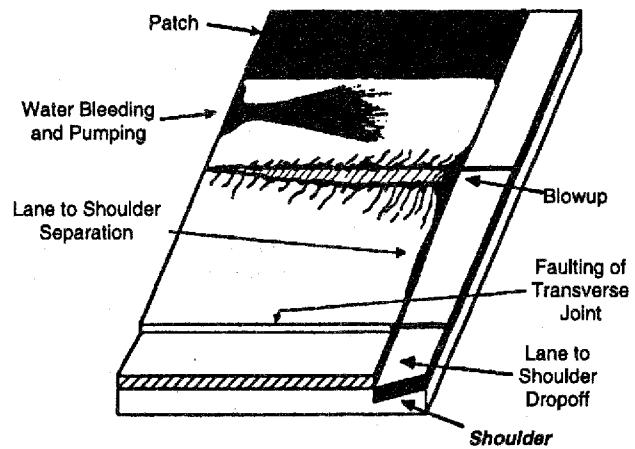
**Figure 2-14. Joint deficiencies of jointed concrete pavement**



**Figure 2-15. Surface defects of jointed concrete pavement.**



**Figure 2-16. Miscellaneous distresses of jointed concrete pavement**



## Continuously reinforced concrete surfaced pavement distress types

### *Distress Type*

#### Cracking (Figure 2-17)

1. Durability "D" Cracking
2. Longitudinal Cracking
3. Transverse Cracking

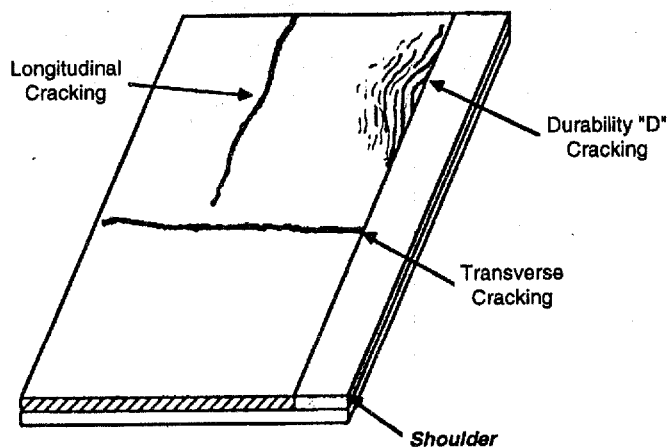
#### Surface Defects (Figure 2-18)

4. Map Cracking and Scaling
5. Polished Aggregate
6. Popouts

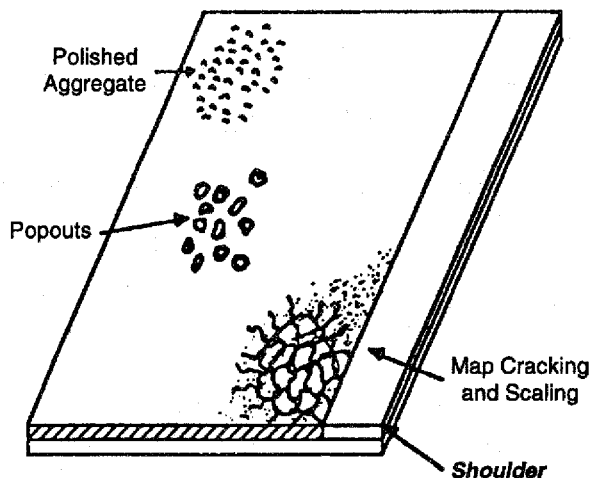
#### Miscellaneous Distress (Figure 2-19)

7. Blowups
8. Construction Joint Deterioration
9. Lane-to-Shoulder Dropoff
10. Lane-to-Shoulder Separation
11. Patch/Patch Deterioration
12. Punchouts
13. Spalling of Longitudinal Joint
14. Water Bleeding and Pumping

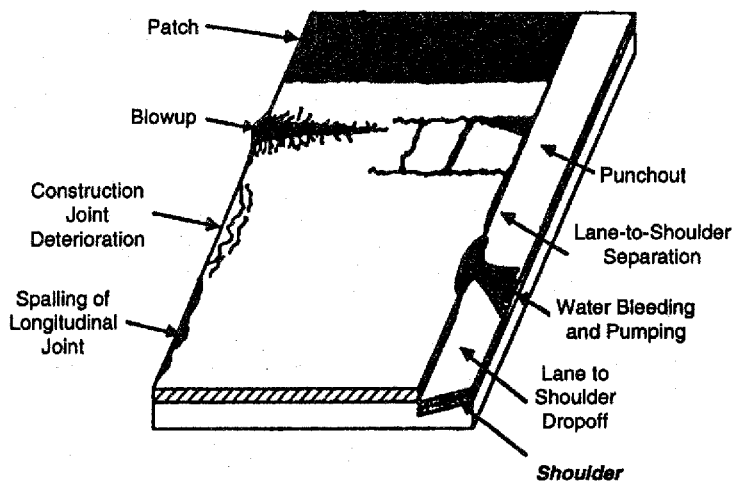
**Figure 2-17. Cracking of continuously reinforced concrete pavement**



**Figure 2-18. Surface defects of continuously reinforced concrete pavement**



**Figure 2-19. Miscellaneous defects of continuously reinforced concrete pavement**



**Alligator Cracking**—a series of small, jagged, interconnecting cracks caused by failure of the asphalt concrete surface under repeated traffic loading.

**Bleeding**—identified by a film of bituminous material on the pavement surface that creates a shiny, glass-like, reflective surface that may be tacky to the touch.

**Block Cracking**—the occurrence of cracks that divide the asphalt surface into approximately rectangular pieces, typically one square foot or more in size.

**Corner Break**—a diagonal crack forming between the transverse and longitudinal joint, which extends down through the slab, allowing the corner to move independently from the rest of the slab.

**Durability Cracking**—the breakup of concrete due to freeze-thaw expansive pressures within certain aggregates.

**Edge Cracking**—fracture along the pavement perimeter from soil movement beneath the pavement.

**Map Cracking**—a series of interconnected hairline cracks that extend only into the upper surface of a concrete slab.

**Polished Aggregate**—surface mortar and texturing worn away to expose coarse aggregate in the concrete, which is now glossy in appearance and smooth to the touch.

**Popouts**—small pieces of pavement broken loose from the surface.

**Pothole**—a bowl-shaped depression in the pavement surface.

**Pumping**—the ejection of water and fine materials under pressure through cracks under moving loads.

**Punchout**—a localized area of the slab that is broken into pieces. Aggregate interlock is lost, leading to steel rupture, and allowing the pieces to be punched down into the subbase and subgrade.

**Raveling**—the wearing away of the pavement surface caused by the dislodging of aggregate particles.

**Reflection Cracking**—the fracture of asphalt concrete above cracks or joint, in the underlying pavement layer(s).

**Rutting**—the occurrence of longitudinal surface depressions in the wheel paths.

**Shoving**—permanent, longitudinal displacement of a localized area of the pavement surface caused by traffic pushing against the pavement.

**Spalling**—chipping of the slab surface within 2 ft. of a joint or crack.

## 2.5 Asphalt Additives

Source: (Reprinted with permission), *Using Additives and Modifiers in Hot Mix Asphalt (Part A)*, 1988, NAPA

There are numerous ways that one could sort out the various additives and modifiers into an orderly presentation. The NAPA Quality Improvement Committee has adopted an overall classification that was first suggested by Terrel and Walter. A version of this classification is shown in the following table.

**Generic classification of asphalt modifiers**

Type	Examples
1. Filler	Mineral filler: crusher fines lime portland cement fly ash  Carbon black Sulfur
2. Extender	Sulfur Lignin
3. Rubber a. Natural latex b. Synthetic latex c. Block copolymer d. Reclaimed rubber	<b>POYMERS</b> Natural rubber Styrene-butadiene or SBR Styrene-butadiene-styrene or SBS Recycled tires
4. Plastic	
5. Combination	Blends of polymers in 3 & 4
6. Fiber	Natural: Asbestos Rock Wool  Man-made: Polypropylene Polyester Fiberglass
7. Oxidant	Manganese salts
8. Antioxidant	Lead compounds Carbon Calcium salts
9. Hydrocarbon	Recycling and rejuvenating oils Hardening and natural asphalts
10. Antistrip	Amines Lime

---

### ***Filler***

Mineral fillers include mineral dust from the screening and crushing of aggregates, and from fly ash, portland cement and lime. Other materials such as sulfur and carbon black have been used more recently to improve mixtures, and may not be strictly mineral fillers, but perhaps have special binding qualities in addition to the role of filler. These materials have traditionally been used in HMA for the purpose of providing stiffening or reinforcement to the binder as well as "filling in" the voids in the aggregate matrix.

### ***Extender***

Some materials such as sulfur and lignin have been used to "extend" the asphalt cement by substitution or partial replacement within the mixture. The intent is often to replace some of the asphalt cement with a material that is less costly, but also has binding qualities in itself or in combination with asphalt cement. Further, some extender materials may provide other benefits such as reduced oxidation rates.

### ***Polymer***

Substances made of giant molecules formed by the union of simple molecules (monomers); for example polymerization of ethylene forms a polyethylene chain.

### ***Rubber***

The group of rubbers (also called elastomers) includes both natural and synthetic rubber in various forms such as latex and reclaimed rubber from tires. These materials, when stretched at room temperature, will snap back to their original shape and size upon release.

### ***Latex***

Milky colloid in which natural or synthetic rubber or plastic is suspended in water.

### ***Plastic***

This term is usually applied to those polymeric materials that can be made to flow under stress. Plastics are usually thermoset materials, meaning that they can be heated and will flow under stress, but once cooled, cannot be re-softened by heat.



### ***Fibers***

Natural, synthetic and steel fibers have all been used in HMA. The usual approach is to incorporate very fine, short fibers into the binder (usually conventional asphalt cement) or mixture, depending upon its form, chemistry, and intended function. The fibers provide some reinforcement, but also provide a finely divided material with a high surface area that permits the application of thicker than normal films of asphalt cement on the aggregate.

### ***Oxidants***

The term "catalyst" could also be applied to this group because the intent is to accelerate stiffening or hardening of the binder. Thus, the effect is similar to oxidative hardening, but the chemical mechanism may be different. These materials provide a structuring that is intended to overcome such phenomena as tenderness, rutting, and shoving.

### ***Antioxidants***

These materials retard the effect of oxidative hardening of asphalt cement. Throughout the construction process and during the service life of a pavement there is continuing aging in progress. The oxidation process tends ultimately to stiffen the asphalt cement to the point of brittleness. Small amounts of antioxidants are used to slow down this phenomenon.

### ***Hydrocarbons***

This broad term as used here is intended to include materials that are added to asphalt binders or mixtures to soften or rejuvenate the asphalt cement.

### ***Antistrips***

Some aggregate-asphalt cement combinations perform very well while others have stripping problems. Some chemical materials improve the adhesion between asphalt cement and aggregate when moisture is present. Small amounts of chemicals such as amines or lime, added to the asphalt binder or aggregate or mixture, often tend to reduce stripping.

Source: *State of the Practice—Crumb Rubber Modifier*,  
1992, FHWA

**Asphalt Rubber (AR)**—asphalt cement modified with crumb rubber modifier

**Buffing Waste**—high quality scrap tire rubber which is a by-product from the conditioning of tire carcasses in preparation for retreading.

**Crackermill**—process that tears apart scrap tire rubber by passing the material between rotating corrugated steel drums, reducing the size of the rubber to a crumb particle (generally 4.75-millimeter to 425-micron (No.4 to No.40) sieve).

**Crumb Rubber Modifier (CRM)**—a general term for scrap tire rubber that is reduced in size and is used as a modifier in asphalt paving materials.

**Cryogenic**—process that freezes the scrap tire rubber and crushes the rubber to the desired particle size.

**Diluent**—a lighter petroleum product (typically kerosene) added to asphalt rubber binder just before the binder is spray applied to the pavement surface.

**Dry Process**—any method that mixes the crumb rubber modifier with the aggregate before the mixture is charged with asphalt binder. This process only applies to hot mix asphalt production.

**Extender oil**—an aromatic oil used to supplement the asphalt/crumb rubber modifier reaction.

**Granulated CRM**—cubical, uniformly shaped, cut crumb rubber particle with a low surface area which are generally produced by a granulator.

**Granulator**—process that shears apart the scrap tire rubber, cutting the rubber with revolving steel plates that pass at close tolerance, reducing the size of the rubber to a crumb particle (generally 9.5-millimeter to 2.00-millimeter (3/8-inch to No.10) sieve).

**Ground CRM**—irregularly shaped torn crumb rubber particles with a large surface area which are generally produced by a crackermill.

## 2.6 Scrap Tire Rubber

**Micro-mill**—process that further reduces a crumb rubber to a very fine ground particle, reducing the size of the crumb rubber below a 425-micron (No. 40) sieve.

**Reaction**—The interaction between asphalt cement and crumb rubber modifier when blended together. The reaction, more appropriately defined as polymer swell, is not a “chemical reaction.” It is the absorption of aromatic oils from the asphalt cement into the polymer chains of the crumb rubber.

**Rubber Aggregate**—Crumb rubber modifier added to hot mix asphalt mixture using the dry process which retains its physical shape and rigidity.

**Rubber Modified Hot Mix Asphalt (RUMAC)**—hot mix asphalt mixtures which incorporate crumb rubber modifier primarily as rubber aggregate.

**Shredding**—process that reduces scrap tires to pieces 0.15 meter (6 inches) square and smaller.

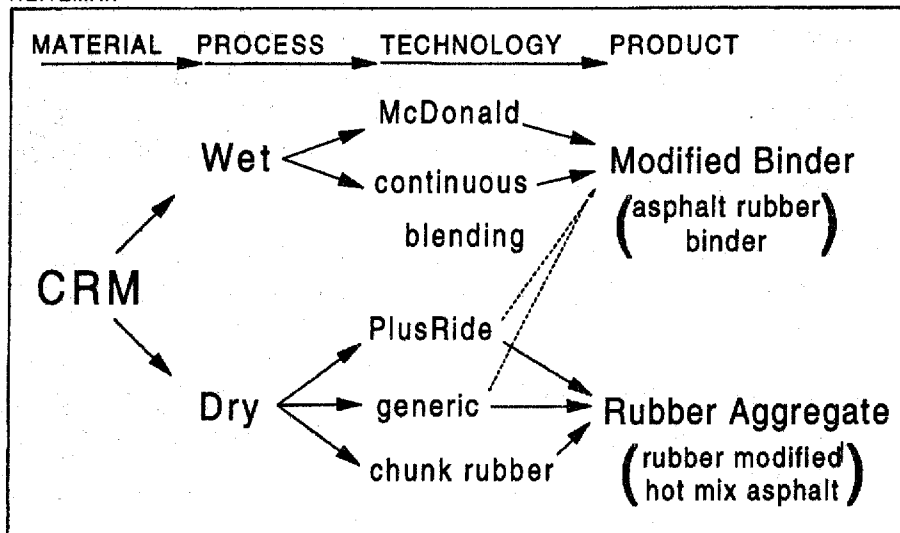
**Stress Absorbing Membrane (SAM)**—A surface treatment using an asphalt rubber spray application and cover aggregate.

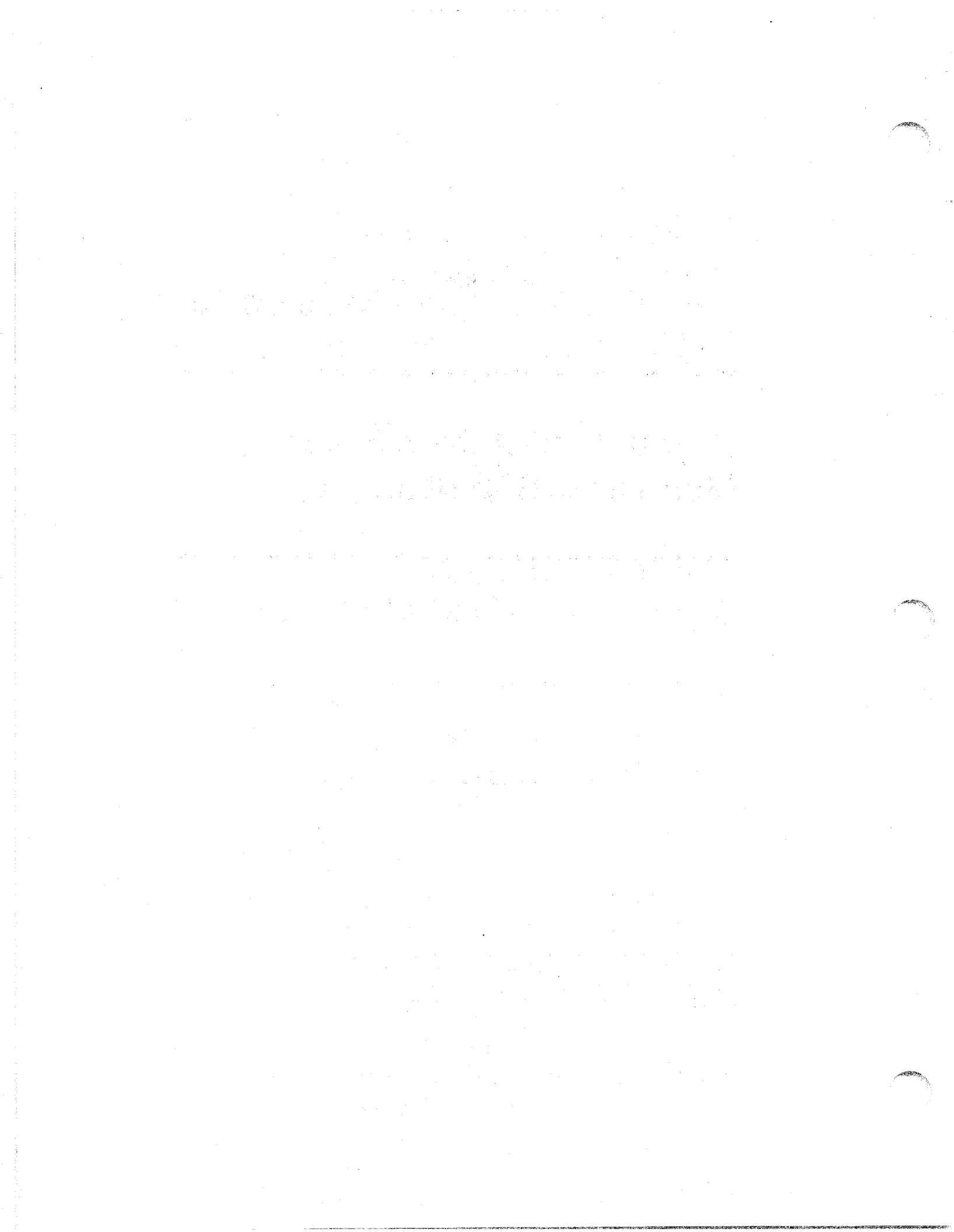
**Stress Absorbing Membrane Interlayer (SAMI)**—a membrane beneath an overlay designed to resist the stress/strain of reflective cracks and delay the propagation of the crack through the new overlay. The membrane is often a spray application of asphalt rubber binder and cover aggregate.

**Wet Process**—any method that blends crumb rubber modifier with the asphalt cement prior to incorporating the binder in the asphalt paving project.

**Figure 2-20. The relationship of crumb rubber modifier terminology**

HEITZMAN





## **Session 3.0**

---

# **Production of Crumb Rubber Modifier (CRM) Material**

---

**by**

**Baker Rubber Inc.**

## **3.0 Contents**

---

<b>3.1</b>	<b>Executive Summary</b>	<b>3-3</b>
<b>3.2</b>	<b>Introduction</b>	<b>3-4</b>
<b>3.3</b>	<b>Technical</b>	<b>3-9</b>
3.3.1	Raw Material Types	3-9
3.3.2	Chemical Composition	3-10
3.3.3	Sieve Analysis	3-16
3.3.4	Surface Characteristics	3-20
3.3.5	Quality Procedures	3-21
<b>3.4</b>	<b>Commercial</b>	<b>3-23</b>
3.4.1	Packaging, Shipping, Price	3-23
3.4.2	Additional Uses of CRM	3-24
3.4.3	Tire Material Sources	3-26
<b>3.5</b>	<b>References</b>	<b>3-28</b>

1. There are four (4) processes for producing CRM.

- Ambient Grinding (1/4" to 40 mesh)
- Ambient Granulating (1/4" to 30 mesh)
- Cryogenic Grinding (1/4" to 100 mesh)
- Wet Grinding (40 mesh to 100 mesh)

2. There are several types of raw material.

- Whole passenger and truck tires
- Tread peel from over the road vehicles
- Buffings generated as a byproduct of the retreading process

Note: Off road and airplane tires are not generally used for this application

3. Tires can be chemically analyzed by ASTM standards to define their composition. Analysis is performed for several constituents.

- Acetone Extract
- Ash
- Carbon Black
- Rubber Hydrocarbons
- Natural Rubber
- Moisture (external)

4. There is no ASTM standard for sieve analysis and hence no industry wide procedure. An ASTM standard has been proposed and this paper contains a version of that proposal.

5. A quality control lab utilizing statistical analysis is essential to detect and prevent problems with the end product. Items to be checked and concerned about are:

- High Ash Content
- Incorrect Rubber Feed Stock
- High Moisture Content
- Incorrect Particle Distribution

6. Packaging can be accomplished in several manners.

- 50# Paper Bags
- 25-50# Poly Bags
- 15-20,000# Bulk Dump Trucks
- 1000-2000# Gaylords
- 2200# Super Sacks

### 3.1 Executive Summary



7. Pricing for CRM varies depending on logistics, volumes, packaging and particle size.
  - 1/4" Material (\$0.10-0.22/#)
  - 10 Mesh Material (\$0.10-0.24/#)
  - 30/40 Mesh Material (\$0.17-0.35/#)
  - 80 Mesh Material (\$0.30-0.45/#)
  
8. Ground rubber is currently being used in a wide variety of applications.
  - Tires
  - Plastics
  - Bound Systems
  - Athletic & Specialty Surfaces
  - Brakes
  - Asphalt
  
9. Industry sources and capacities are detailed below.
  - 2-3 billion tires can currently be found in landfills and stockpiles across the U.S.
  - Americans generate approximately 250 million waste tires every year
  - CRM manufacturers produced an estimated 160 million pounds of material in 1992
  - Production capacity of the industry is approximately 50-100 percent greater than the 1992 demand
  - 80 percent of the current industry volume is being produced by five or six manufacturers
  - Approximately 230 million pounds of buffings are being produced annually, 120 million of which is currently being processed
  
10. Tire exchange programs can be set up to transport a specific city/county/State's waste tires to a CRM manufacturer. In exchange, a like amount of CRM would be returned to the region for use in asphalt paving projects.

### 3.2 Introduction

The purpose of this paper is to describe the general methods of producing crumb rubber modifier (CRM) material, the important technical and quality assurance/control aspects, and some of the commercial considerations such as price, shipping, etc.

The first section of the report will deal with the main processes used to produce CRM. This will be followed by a description of the technical

---

considerations including particle size, chemical analysis, types of raw materials, and the quality assurance/control considerations. Finally, a section on the commercial aspects will be presented.

## Process

There are several ways of producing CRM material depending on the desired end product mesh size and configuration. The most common ways are:

Ambient grinding  $\frac{1}{4}$ " to 40 mesh

Ambient granulating  $\frac{1}{4}$ " to 40 mesh

Cryogenic Grinding  $\frac{1}{4}$ " to 100 mesh

Wet Grinding 40 mesh to 100 mesh

Each of these processes has its advantages and disadvantages in terms of economics and particle size distributions.

## Raw Material

Each of the above processes requires a basic feed stock of tires, tire parts or other types of surplus rubber material. A detailed description of these materials is given in the technical portion of this paper. The focus of this paper is on tires. The tire feed stocks are basically in the form of buffings, tread rubber pieces/chunks or shredded whole tire chips from  $\frac{1}{2}$ " to several inches in size.

Buffings are produced when tires are prepared for retreading. The resulting particles are of various sizes from very small to long thin strips. The bulk of the particles are acicular in shape and may be about  $\frac{1}{8}$ " to 1" long. The exact configuration depends on the buffing method. There is essentially no metal or fiber in this material.

In some operations larger pieces of tread rubber result. For example, they may be in long strips or in larger but elongated chunks. Often this is called tread peel. There is little or no tire cord, although sometimes the peeling operation may cut into the cord material in the tread area. This is not intentional.

Whole tires are processed in many different ways. A common method is to run the whole tire through a shredder of some type, then through a chopper or granulator to reduce the material to a suitable size feed stock of about 1/2" to 3" size. It is common to cut up the tire bead and all other parts of the tire together. In some operations the bead is removed first and disposed of in various ways. During these preliminary stages some wire and fabric is removed.

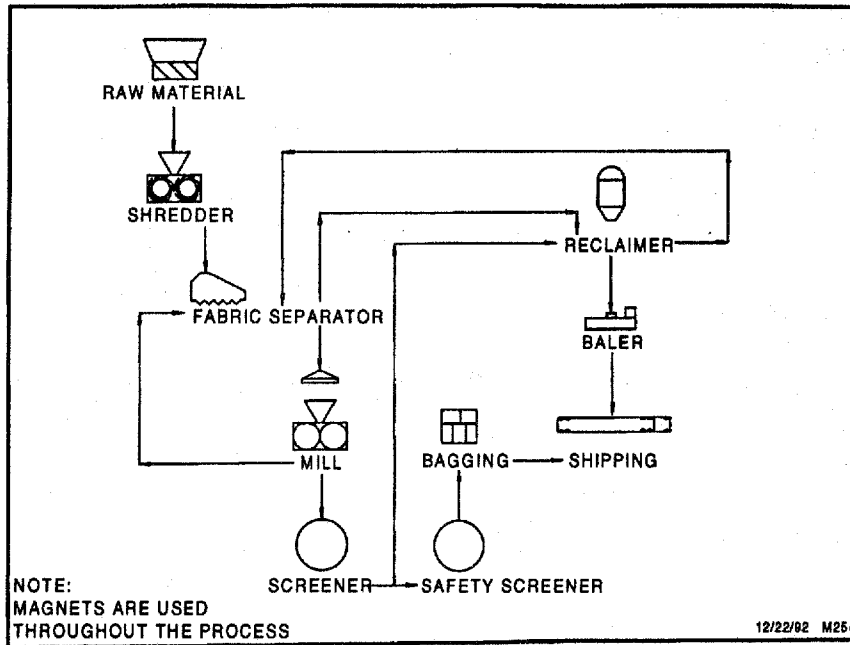
### **Basic Screening**

In some instances, when processing buffings, grinding is not required. For example, if the desired end product is of a coarse enough mesh size, the particles only need to be classified into relatively large particle sizes; thus, only screening is required. However, these products are not generally used in asphalt paving products.

### **Ambient Grinding and Granulating**

The ambient grinding/granulating process is usually accomplished by cracker mills or granulators. All size reduction takes place at room temperature. The actual particle reduction is accomplished by a tearing or shearing action. This creates a particle with a rough surface, perhaps described as spongy. A schematic of a typical cracker mill grinding system appears in Figure 3-1.

**Figure 3-1. Basic ambient tire grinding process**



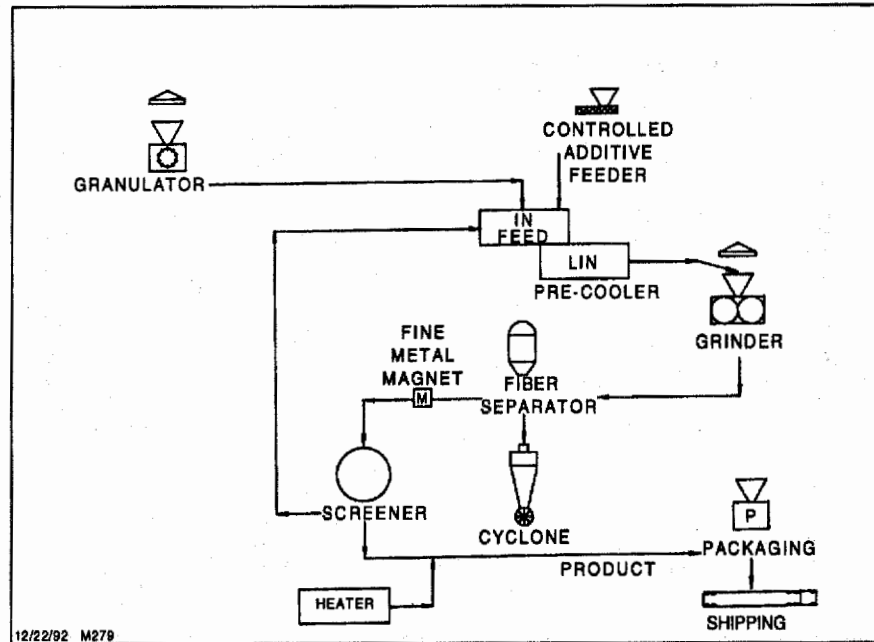
The ambient process consists of a series of cracker mills or granulators, screeners, conveyors and various types of magnets to remove any steel wire or other steel particles if the material starts out as whole tire chunks. A fabric removal system is also required. In addition, there may also be stone removal equipment in the overall system.

This process is very efficient for the production of the coarser mesh products and usually results in the lowest cost for coarser than 50 mesh materials.

### **Cryogenic Grinding**

In this process the rubber is cooled by the use of liquid nitrogen, often called LIN. This causes the rubber to become very brittle and it, in turn, is easily fractured in a hammer mill. Reportedly the surface is very "clean faceted" and, thus, has much less surface area than ambiently ground material. A schematic of a basic cryogenic grinding process appears in Figure 3-2. This process consists of a pre-cooler to chill the material, a grinder, appropriate screens and conveyors and steel and fiber separation systems.

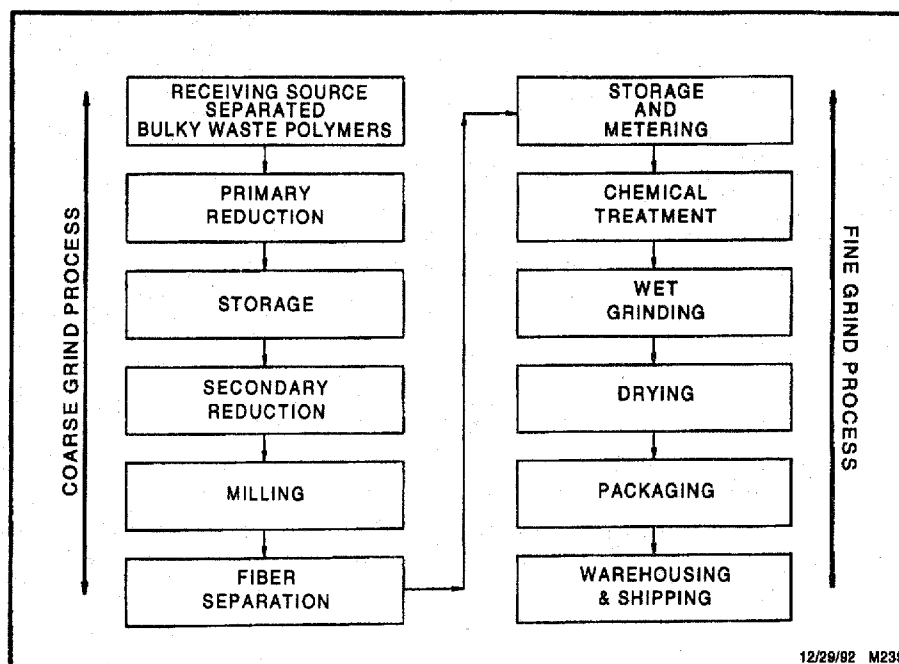
Figure 3-2. Basic cryo grinding system



### Wet/Stone Grinding<sup>17</sup>

In this process a coarse CRM is placed in a wet slurry and is ground between grinding stones, producing a particle that may be similar to an ambient ground material. A schematic of a basic stone grinding system appears in Figure 3-3<sup>17</sup>. Before the material is processed in the wet grinding system it must be reduced in size using another process as stated above, typically ambient grinding. The wet grind process requires a very effective drying system which is not required for the other two processes, ambient and cryogenic.

Figure 3-3. Basic wet grinding system



Production of recycled rubber involves reducing scrap rubber to a *desired particle size* distribution. A properly designed product will have a distribution based on the end usage of that product. There are several different types of ground rubber products based on the parent rubber from which it was derived. The type of ground rubber produced is limited only by these parent compounds in the raw materials used. The most common types used in rubber compounding and other applications may be simply classified into the following general categories:

#### *Over the Road Tire Rubber*

1. *Whole tire* ground rubber is prepared from over the road tires (including the carcass, sidewall, tread, and bead) from which the fiber and metal have been removed and/or from whole tire buffings generated in the retreading process that grinds or "buffs" the sidewalls as well as the tread. The rubber is then ground to the desired particle size distribution. Some common examples of these are 10, 12, and 10/20 mesh products.

### 3.3 Technical

#### 3.3.1 Raw Material Types

2. *Tread* ground rubber is prepared from truck, bus, and/or passenger treads in the form of peelings (peel) and/or by utilizing buffing particles generated from over the road tire retreading operations. The material is then processed to desired particle sizes. Some common examples of these are 10, 20, 30, and 80 mesh products.

#### ***Non-Over the Road Tire Rubber***

1. *Specialty polymer* ground rubber is prepared from materials other than tires. Examples are: Neoprene (CR), Nitrile Elastomer (NBR), Styrene-Butadiene (SBR), Ethylene Propylene Rubber (EPDM).
2. *Airplane/off-road tire* ground rubber is prepared from airplane tires or tires for on road use, such as heavy equipment tires. The airplane tire rubber typically comes in the form of buffings. Both of these tire types can have chemical contents significantly different from over the road tires.

### **3.3.2 Chemical Composition**

For the purposes of this presentation we will discuss the chemical composition of ground rubber based on two major groupings, over the road tire rubber and non-over the road tire rubber. This grouping is important to asphalt applications because in general these applications have been predominantly limited to over the road tire rubber (i.e. CRM).

Non-over the road tire rubber is produced from the raw material mentioned previously in the specialty polymer classification or from airplane/off road tires. This material will typically show different results from those obtained for over the road tire rubber in the testing areas of *acetone extract, ash, carbon black, rubber hydrocarbon*. This difference in results can be used by suppliers and users to evaluate materials when attempting to determine whether or not a correct source of raw material (i.e., over the road tire rubber) was used. It can also be used to a limited degree to check finished product for possible contamination even when the correct raw material has been used. These materials, when tested in the same manner as over the road tire rubber, yield results different from those described later in this presentation.

#### ***Chemical Identification of Recycled Tire Rubber***

The chemical identification of components in recycled over the road tire rubber (herein after referred to simply as tire rubber) and other types of CRM involves the application of testing methods described in ASTM standards D297[2], "Standard Test Methods for Rubber Prod-

ucts—Chemical Analysis” and D3677[3], “Standard Test Methods for Rubber—Identification by Infrared Spectrophotometry.” These methods are designed to identify chemical components in a rubber compound, and are widely used in recycled tire rubber analysis. It is a common practice that only some components, which are most important for the application purposes, are tested. It is common to test for *acetone extract, ash, carbon black, rubber hydrocarbon* and *natural rubber*. These parameters are expressed as the weight percentage of the tested sample.

An additional test result of importance to the asphalt application is moisture content (i.e., loss on heating). Since the moisture is not a part of the compound but is found on the recycled rubber, it will typically be listed in a specification with an upper limit between 0.5 percent and 0.75 percent. Because the moisture is not a part of the compound it is not listed in the discussion in this section. Potential problems from excessive moisture are discussed later.

### ***Description of Testing Methods***

Industry test methods have been developed from ASTM test methods, with varying degrees of modifications. Modifications have been made to create the most practical test methods for our laboratories while retaining a high degree of repeatability and reproducibility. These testing methods for tire rubber analysis are listed briefly as follows:

#### ***A. Acetone Extraction Test***

This test method covers the determination of the percentage of acetone extract, which is a measure of the amount of oils used in the tire rubber compound. By acetone extraction we mean that the acetone removes mineral oils or waxes, free sulfur, acetone-soluble plasticizers, processing aids, acetone-soluble antioxidants and organic accelerators or their decomposition products, and fatty acids from the tire rubber compound. It also may remove part of bituminous substances, high molecular mass hydrocarbons and soaps.

A brief description of the experimental procedure for the acetone extraction test is as follows: A weighed specimen of approximately 2 grams is placed in a filter paper and the filter paper is folded to make a sample to fit the extraction cup (a thimble). The sample is placed in the thimble and the thimble into a condenser. The sample is extracted for 16 hours to obtain the acetone extraction solution, in which the processing oils and other acetone soluble materials are dissolved. The acetone is evapo-



rated off over a hot plate to obtain the weight of acetone extract. The percentage of acetone extract is calculated as:

$$\text{Acetone extract \%} = (\text{grams of extract/grams of sample}) \times 100$$

#### *B. Ash Content Test*

The ash content test covers the determination of the amount of inorganic fillers such as zinc oxide, clays, and other foreign contaminants such as dirt and metals in recycled tire rubber. A weighed specimen of approximately 2 grams is placed in a crucible and ashed or burned in a muffle furnace set at 750 degrees C and allowed to run for eight hours (overnight). The mass of residue in the crucible represents the ash content. The percentage of ash content is calculated as:

$$\text{Ash content \%} = (\text{grams of ash/grams of sample}) \times 100$$

#### *C. Carbon Black Test (Nitric Acid Digestion Test Method)*

This carbon black test method covers the determination of carbon black in tire rubber by a nitric acid digestion/oxidation method. The principle of this method is that tire rubber is digested in hot nitric acid and oxidized into fragments soluble in water. The carbon and the acid insoluble fillers are filtered off, washed, dried, and weighed. The carbon is then burned off and the loss of mass represents carbon black. The percentage of carbon black is calculated as:

$$\text{Carbon black \%} = (\text{grams of carbon black/grams of sample}) \times 100$$

#### *D. Determination of Rubber Hydrocarbon Content*

The rubber hydrocarbon content (RHC) refers to the percentage of high molecular weight polymers such as vulcanized natural rubber (NR), synthetic natural rubber (polyisoprene or IR), polystyrene-butadiene (SBR), polybutadiene (BR) and butyl rubber (IIR) that is insoluble in acetone. Symbolically, this can be represented as  $\text{RHC} = \text{NR} + \text{SBR} + \text{R} + \text{etc.}$  It can be determined by using the following calculation formula:

$$\text{RHC\%} = 100\% - \text{ash\%} - \text{acetone extract\%} - \text{carbon black\%}$$

#### *E. Natural Rubber Test*

Two methods for the natural rubber test are described in ASTM D297, "Standard Test Methods for Rubber Products—Chemical Analysis" and in D3677[3], "Standard Test Methods for Rubber—Identification by In-

---

frared Spectrophotometry," respectively. In ASTM D297, the principle for testing natural rubber and/or synthetic natural rubber (polyisoprene) is to digest/oxidize the rubber compound in chromic acid. The double bonds in the rubber polymer are oxidized into acetic acid. The acetic acid formed is separated by distillation and determined by titration of distillate after carbon dioxide has been removed by aeration. The natural rubber content is calculated based on the quantitative oxidation of polyisoprene.

This test method has a significant limitation when used for polymer determination in the testing of tire rubber. Tire rubber usually contains more than one double bond polymer, such as natural rubber, polybutadiene, polystyrene-butadiene, and butyl rubber, although not necessarily limited to just these. The limitation is that when natural rubber, polybutadiene, polystyrene-butadiene and/or butyl rubber, in any combination, coexist in a rubber compound at the same time, the results do not reflect the actual natural rubber content correctly. This is due to the probable oxidation of all double bonds in the polymer system. *This oxidation testing method detects but cannot differentiate natural rubber from other double bond polymers.* In this situation, we think that the natural rubber test method described in ASTM standard D297 is not appropriate for tire rubber compounds analysis for the determination of actual natural rubber content.

The testing method for natural rubber content described in ASTM standard D3677 is more appropriate for recycled tire rubber compounds.

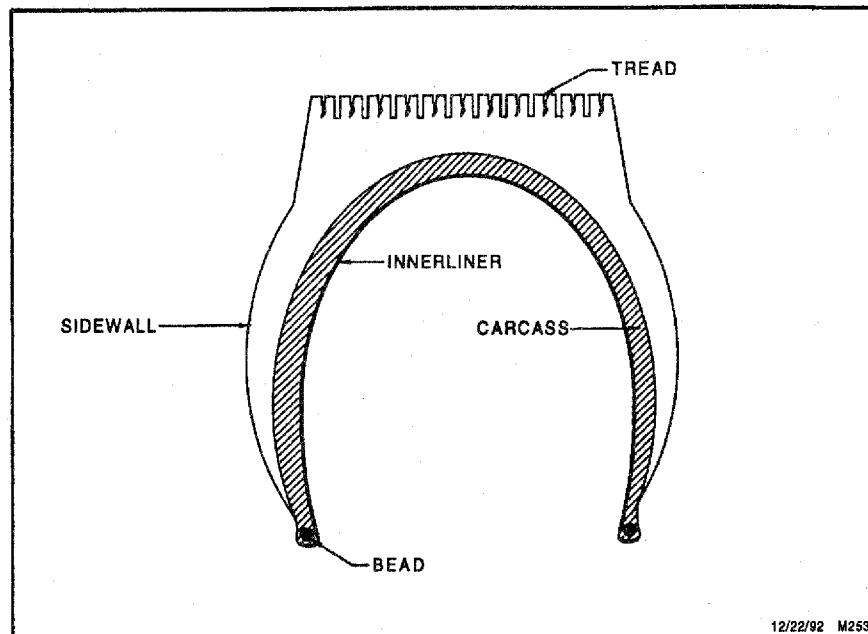
"Standard Test Methods for Rubber—Identification by Infrared Spectrophotometry" described in ASTM standard D3677 involves the use of an infrared spectrometer and the examination of infrared absorption diagrams of rubber films or pyrolysis products (pyrolyzates). Comparisons between the infrared absorption values of characteristic bonds and groups for known standard samples and the unknown rubber sample lead to the natural rubber content determination. The methods can also be used to identify other polymers such as polybutadiene, polystyrene-butadiene and butyl rubber, etc..

### ***CRM Chemical Composition***

Tire rubber is primarily a composite of a number of blends of natural rubber, synthetic rubber, carbon black and other additives. Tire rubber, fiber, and steel belting comprise the key elements of today's tire. Various parts of the tire construction (see Figure 3-4) require specific rubber properties, i.e., flexible side walls, abrasion resistant tread, etc. These various parts of the tire contain rubber with different amounts of natural and synthetic components. Natural rubber provides elastic properties

while synthetic rubbers improve the compound's thermal stability. In addition, there are also differences between types of tires such as passenger tire/light truck tire and heavy truck tire. The composition of CRM depends not only on the original chemistry of tire rubber, but also on the source of the discarded tires. When dealing with recycled tire rubber, the contamination by foreign objects, such as stone, sand, clay, fiber and even metals, exists. These foreign objects may affect the composition and quality of the CRM.

**Figure 3-4. Typical tire cross-section**



Producers have used chemical analysis of tire rubber for many years as an effective means of quality control. A large number of test results have been accumulated and a database of the chemical analysis data has been compiled. In Table 3-1 are listed chemical compositions for tire tread rubber from passenger/light truck tires. In Table 3-2 are listed chemical compositions for tire tread rubber from heavy truck tires. In Table 3-3 are listed chemical compositions for whole tire rubber from whole tires, a combination of passenger/light truck tires and heavy truck tires.

The data in Table 3-1 through Table 3-4 is based on the statistical analysis of test results collected by Baker Rubber, Inc. The tables are based on a recent year in a database of chemical analysis of the recycled tire stream for passenger/light truck tread tire rubber, heavy truck tread tire

rubber and whole tire rubber. The mean value can be viewed as a typical value. The standard deviation provides a basis for estimation of variation in tire rubber composition and testing procedures. The maximum and minimum values obtained during testing determine the possible range of composition variation.

With the data listed in these four tables, a general knowledge of chemical composition of CRM is presented. Comparing these data, we found that acetone extract for passenger/light truck tread rubber is higher than that for heavy truck tread rubber and whole tire rubber. The rubber hydrocarbon content for passenger/light truck tread rubber is lower than that for heavy truck tread rubber and whole tire rubber. Data for natural rubber test results have intentionally been omitted for previously discussed reasons with regard to lack of reliability of ASTM D297 test results to yield polymer identification information. Until more definitive studies are completed this data should provide a reasonable estimate of chemical analysis for CRM from the general recycled tire stream.

**Table 3-1. Chemical compositions for passenger/light truck tread rubber**

Composition	Mean (%)	Standard deviation (%)	Min. (%)	Max. (%)
Acetone extract	17.2	1.12	15.5	19.1
Ash	4.81	0.51	3.9	5.4
Carbon black	32.7	1.72	30.4	35.5
Rubber hydrocarbon	42.9	1.45	41.5	44.4

**Table 3-2. Chemical compositions for heavy truck tread rubber**

Composition	Mean (%)	Standard deviation (%)	Min. (%)	Max. (%)
Acetone extract	11.4	1.1	10.0	16.1
Ash	5.1	0.54	3.7	6.6
Carbon black	33.2	1.45	30.0	36.9
Rubber hydrocarbon	50.2	2.01	45.0	54.9

**Table 3-3. Chemical compositions for whole tire rubber**

Composition	Mean (%)	Standard deviation (%)	Min. (%)	Max. (%)
Acetone extract	15.1	1.33	13.1	17.5
Ash	5.0	0.60	4.0	6.1
Carbon black	32.0	1.03	30.5	33.2
Rubber hydrocarbon	47.9	1.33	44.9	49.7

**Table 3-4. Chemical compositions—comparison of means**

Chemical composition	Passenger/ light truck tread rubber (%)	Heavy truck tread rubber (%)	Whole tire rubber (%)	Range (%)
Acetone extract	17.2	11.4	15.1	5.8
Ash	4.8	5.1	5.0	0.29
Carbon black	32.7	33.2	32.0	1.2
Rubber hydrocarbon	42.9	50.2	47.9	7.3

### 3.3.3 Sieve Analysis Procedure

Particle size, particle shape, and particle size distribution of CRM materials may affect their handling, processing characteristics, and applications.<sup>1</sup> Therefore, how to analyze and characterize the particle size distribution of the CRM is obviously important for the rubber recycling industry and for their customers. Many methods<sup>5-9</sup> have been developed for particle size analysis. Sieving is probably the easiest and certainly the most popular method of particle size analysis. Several ASTM standards for sieve analysis<sup>12-14</sup> can be found. However, these ASTM standards are not designed specifically for CRM or other forms of ground rubber materials. They are not appropriate to use in the particle size analysis of these materials because the particles develop or contain static electrical charges during the sieving process. A universally accepted standard for particle size analysis by the producers or users of ground rubber products such as CRM does not exist now.

Several of the suppliers of CRM have long been engaged in the manufacture of ground rubber products. During the many years of this commitment, they have obtained considerable experience in the field. Systematic and renewable techniques for particle size characterization

of ground rubber products like CRM using sieve analysis have been developed in the laboratory. These characterization techniques are based on adopting as much of existing ASTM procedures as possible where appropriate, and are supported by statistical analysis. In this paper we will introduce a developed particle size characterization technique—sieve analysis for ground rubber products—to help the producers or users to become familiar with this workable method. This procedure covers the determination of the particle size distribution of ground rubber products.

### *Recommended Sieve Analysis Procedure*

*According to the discussion above, we have developed a sieve analysis procedure. The recommended procedure is as follows:*

#### *A. Apparatus*

- 1. Ro-Tap Sieve Shaker (Model 8, C.E. Tyler)—a mechanically operated sieve shaker as described in ASTM D1511<sup>15</sup> and described in "Testing Sieves and Their Uses" handbook<sup>16</sup>*
- 2. Sieves—U.S. Standard Sieves conforming to ASTM Specification E11<sup>16</sup>*
- 3. Bottom Receiver Pan and Top Sieve Cover*
- 4. Scale with a sensitivity of 0.1 gram*
- 5. Soft Brush*
- 6. Jar, capacity of one pint with large opening*
- 7. Rubber balls with 1.5 inch diameter, enough for two balls per screen*

#### *B. Procedure*

- 1. Select test screens appropriate to the particle size distribution of the individual sample being tested.*
- 2. Clean screens with brush, making sure all particles are removed.*
- 3. Stack test screens in order of increasing mesh size with smallest number (coarsest sieve) on top, and largest number (finest sieve) on bottom.*
- 4. Add bottom receiver pan to stack.*

5. *Prepare 100.0 grams of sample as follows:*
  - 5.1. *Weigh 100.0 grams of ground rubber sample.*
  - 5.2. *Weigh 5 grams of talc for products designated coarser than 50 mesh, and 25 grams of talc for products designated 50 mesh or finer (this will yield a total final sample weight of 105.0 or 125.0 grams).*
  - 5.3. *Add the talc to sample, and mix thoroughly by placing talc and sample in a pint size jar and shake by hand until particle agglomerates are broken, and talc is uniformly mixed (for a minimum of 1 minute).*
6. *Introduce the above prepared sample into the top sieve pan and place the sieve cover on the stack.*
7. *Place the stack in the Ro-Tap Sieve Shaker.*
8. *Activate the Ro-Tap Sieve Shaker for 10 minutes for products designated coarser than 50 mesh, and for 45 minutes for products designated 50 mesh or finer.*
9. *After Ro-Tap Sieve Shaker completes the appropriate cycle, remove stack.*
10. *Starting with the top sieve and taring the weighing dish to account for its weight, remove the screened fraction by gently tapping its contents to one side, pouring the contents on the scale, and recording its weight to the nearest 0.1 gram. Repeat this procedure for each pan.*
11. *Any material adhering to the bottom of the screen shall be brushed into the next finer screen.*
12. *As a Quality Assurance measure, the sum of the weights of each fraction shall not be less than the original weight of the rubber sample plus 70.0 percent of the talc added, or greater than the original weight of the rubber sample plus 100.0 percent of the talc added. Repeat the test if either of these conditions occur.*
13. *To calculate the weight of the contents of the bottom pan, empty its contents on the scale and record. Sum total weight of the contents of each sieve tray including the bottom pan and subtract 100. The remainder is to be subtracted from the bottom pan*

---

*contents. This is the adjusted bottom pan contents weight, accounting for the talc used.*

Experiments were performed and the results obtained by using different sieve analysis procedures and sieving conditions were compared. Based on the experimental data and industry experience, it was found that the results of the sieve analysis are subject to the choice of screens, the weight of the samples, the use of an antistatic agent, and the cycle time of the mechanical shaker device. The elimination of error sources is important to get true information on particle size distribution. For particle size designations of 35 mesh CRM or coarser, 100 grams of sample mixed with 5 grams of talc and a 10 minute cycle time of the Ro-Tap Sieve Shaker gives the best sieve analysis results. For a 40 mesh product, 100 grams of sample mixed with 15 grams of talc and a 10 minute cycle time of the shaker gives the most dependable data. The use of rubber balls has very little influence on the experimental results for these products with mesh size designations coarser than 50 mesh.

For reproducibility of sieve analysis procedures for CRM products with a designated mesh size smaller than 40 mesh, additional talc, ro-tap sieve shaker time and use of rubber balls is needed. For finer than 40 mesh products, 100 grams of sample mixed with 25 grams of talc and a 45 minute cycle time of the Ro-tap shaker with two rubber balls, such as Rotex balls, on each sieve screen is required. The balls must be small enough in diameter to allow freedom of movement on the sieve screen during the sieving process.

#### ***Product Designation Based on Particle Distribution***

This procedure is used, among other reasons, for the purpose of assigning a product mesh size designation. The product mesh size designation will be based on the first sieve which allows an upper limit specification within the range of 5.0 percent to 10.0 percent on that sieve. Each product so designated will also have a sieve with a designated larger screen opening size on which no percent retention is allowed. Additional screens up to a total of six screens (including these two previous) can be specified as agreed to between the vendor and customer to obtain a particular particle size distribution. For example: a material with no percentage retained allowed by specification on the 20 sieve and from 0.0 percent to 5.0 percent retained allowed on the 30 sieve would be classified as a 30 mesh product. Table 3-5 shows several typical classifications of products by particle size designations according to the above definition.



**Table 3-5. Typical product designations for 10 mesh, 30 mesh, and 40 mesh in percent retained**

Sieve sizes	Whole tire 10 mesh	Tread rubber 30 mesh	Tread rubber 40 mesh
8	0.0		
10	0.0-5.0		
16	25.0-Open		
20		0.0	0.0
30		0.0-5.0	0.0-1.0
40		25.0-50.0	0.0-10.0
50		20.0-35.0	
60			25.0-Open
PAN	Open	Open	Open

*Shown as percent retained on individual sieves.*

**3.3.4 Surface Characteristics**

Currently, the impact of the type of processing on the surface characteristics of the CRM rubber are unknown. For example, material that is produced through cryogenic grinding is assumed to be "clean faceted." Material that is ambiently ground is assumed to be rough surfaced. One of the problems with these generalities comes from the possibility of more than one process being used on the material. For example, a product that goes through rough particle size reduction by ambient grinding followed by cryogenic grinding will likely display both of the previously described types of surface characteristics. Some research is being conducted at this time to attempt to more adequately define the surface characteristics of CRM produced by different methods.

**3.3.5 Quality Procedures**

*Supplier Quality Assurance Audits*

A standard practice for assuring the quality of incoming raw materials is to perform a supplier audit. This is also recommended for the CRM user as a quality procedure to ensure the incoming quality of the CRM purchased. The purpose of the audit is to verify that the supplier (i.e., the CRM producer) has the necessary controls in place to produce the CRM. During the audit such things as quality control procedures for the process and testing areas, shipping and release procedures, and non-conforming material identification, segregation, and disposition need to be verified. Discrepancies, if any, would be noted and corrective action

---

procedures implemented to prevent users from receiving discrepant material.

### ***Testing and Certification***

Written procedures for the testing of chemical and physical properties need to be established and in use. They should be collected into a manual that is readily available to those performing the testing, and upon request, to customers and auditors. Appropriate information regarding the method for the recording of the results should be included. Distribution of these results is made in the form of either Certification of Compliance or Certification of Analysis, depending on the requirements of the customer. These certifications are kept on file and also distributed to the customer in a manner and at intervals agreed upon between the customer and producer.

### ***Statistical Analysis***

Data should be compiled regarding particle size distribution for performing statistical analyses to determine the consistency of the process in manufacturing the CRM. Basic statistical calculations are performed from this data, such as the mean, range, and standard deviation. These calculations provide information on within lot, lot to lot, and between production site variation. Additional statistical analysis can be performed as deemed necessary by the producer and/or the user to provide such information as process capabilities or other product related information. This data is then compiled and reported at intervals and in such a manner as agreed to between the user and producer. This may include such things as X-bar and R control charts, histograms, or process capability summary reports.

### ***Laboratory Quality Assurance***

It is necessary to have procedures in place to assure that the laboratory test results are reliable. This requires procedures that document test results, chemicals used and their sources, and regular periodic (such as weekly) testing of a known standard or material to use as a reference. The reference material should be obtained by random selection of a known lot of production of CRM. From this lot a random sample is selected. By testing the same material again and again over time, determination of the ability of a particular test to give consistent results is possible. If more than two testing facilities are involved and they test material from the same sample, by comparing the results between labs it can be determined if there is significant variation between them in the results obtained. Finally, by running this testing each week, the results

can be used to help detect if there is a problem when unexpected results are obtained during testing of the finished product.

### **Potential Problems**

Several areas exist for potential problems with CRM. We shall attempt to address four of the most common here.

#### ***High Ash Content***

It is possible to have material that yields a high ash test result. This can happen for several reasons. The ash result can be high due to contamination of the feed stock material with sand, dirt, or other inorganic material. This result can also be obtained if the material is produced from or contaminated by the wrong feed stock. Some rubber compounds are heavily loaded with clays and therefore yield a higher ash test result than is typical from CRM made from relatively clean tire type raw materials. An unusually high ash result may have a negative effect on the user's finished product characteristics and/or cause equipment maintenance problems.

#### ***Incorrect Rubber Feed Stock***

It is also possible that the product delivered to the user could have been manufactured from the wrong feed stock rubber material. The use of an incorrect raw material feed stock such as natural rubber mats may be detected through chemical analysis. This will appear in the form of test results either outside of specification limits or established statistical process control limits. For example, the use/mixture of high gravity rubber material with or instead of tire rubber will produce a higher ash result than the process typically produces and/or the specification limit may allow.

#### ***High Moisture Content***

High moisture content as revealed by moisture testing can be a significant problem. When CRM is added to a medium that is at a high temperature, moisture in the form of steam can be rapidly liberated. For example, when mixing with hot asphalt, high moisture content can result in a "boil over" situation. High moisture can result from improper processing, storing, packaging, and/or shipping of the CRM. It can also be a problem in the handling and storage of raw materials or work in process at the producer's site. High moisture problems can also be the result of mishandling and/or poor storage procedures by the user.

### ***Incorrect Particle Distribution***

Incorrect particle distribution may create problems for users. This can happen as a result of undetected process failure or the running of the process outside of statistical control but, according to test results, within specification limits. Since this can lead to unacceptable user end product characteristics, it is essential for the user to *require and verify the use of adequate Quality Control and Quality Assurance procedures* by the producers from whom they purchase material.

The remainder of this presentation will discuss basic commercial aspects of dealing with CRM. This will include sections on shipping, packaging, pricing, MSDS specifications, uses of ground rubber, tire material sources and major CRM source locations.

### ***Packaging***

Packaging of CRM can be accomplished in most any manner desired by the end user. The following five methods are most common:

- A. 50# paper bags stretch-wrapped on 2750# skids
- B. 25–50# poly bags stretch-wrapped on 2200# skids (these poly bags are of the low-melt variety (~220 F) so that the pre-measured package can be blended in a mixing process)
- C. 1000–2000# Gaylord boxes
- D. 2200# Super Sacks (either returnable or recyclable)
- E. 15,000–20,000# Bulk dump trucks (not typically used due to handling problems). CRM is handled in bulk with either a bobcat with a scoop attachment or a forklift using dump tubs. A forklift is tedious when trying to transfer to bulk trucks and a bobcat may introduce foreign material into the batch during scooping operations.

Pneumatically conveying CRM into specially modified trucks is a future handling alternative.

## **3.4 Commercial**

### **3.4.1 Packaging, Shipping, Price**

***Shipping***

Transportation to the user is typically accomplished by semi-trailer trucks. The most economical freight rates are obtained when shipping truckload quantities, usually 40,000# to 45,000# of ground rubber. Less than truckload quantities can also be accommodated. Overseas containers are used when shipping out of the country.

***Price Ranges***

The price of CRM can vary from region to region. The product price is primarily determined by the customer's particular specification. Other factors that influence product prices include order quantities, total volume, packaging requirements and other services. Packaging in bulk is more economical than smaller poly or paper packages. From the initial design stage to project completion an experienced CRM producer will save you time and money. It is both beneficial and cost effective to develop a close working relationship with your CRM producer.

Below are some representative prices for volume purchases of CRM.

1/4" material	\$0.10-0.22/#
10 mesh material	\$0.10-0.24/#
30/40 mesh material	\$0.17-0.30/#
80 mesh material	\$0.30-0.45/#

***MSDS***

A Material Safety Data Sheet can be obtained from the CRM producer.

**3.4.2 Additional Uses of Ground Rubber**

Ground rubber is currently being used in a wide variety of applications. These markets are outlined below. Each description is followed by an approximate percentage of how much of the current ground rubber produced is sold into these individual markets.

***Tires***

Ground rubber is used as a high-grade extender in passenger, truck and other pneumatic tires. Though used only in small quantities, it is a significant market due to the large number of tires produced each year. Market Share Estimate: 25%

### ***Plastics***

Ground rubber can be added in large quantities to extend or modify the properties of polymeric materials. Most often used in a thermoplastic vehicle, end products including injection molded parts and extruded sheets goods and hoses. Market Share Estimate: 10%

### ***Bound***

Compression molded materials can be formed using ground rubber and a binder. Applications using this method include carpet and flooring underlayment, flooring and outdoor tiles, mats, construction materials and railroad crossings. Market Share Estimate: 15%

### ***Athletic and Specialty Surfaces***

Ground rubber is ideal for a resilient additive to running tracks, playgrounds, and tennis court surfaces. Similar poured-in-place surfaces can be applied to public, industrial and roofing situations. Loose ground rubber is used as a cushioning ground cover for walkways, landscaping, equestrian arenas and around playground equipment. Market Share Estimate: 20%

### ***Brakes***

Friction brake materials incorporate ground rubber in their makeup as a property modifier in brake pads and brake shoes. Market Share Estimate: 5%

### ***Asphalt***

Ground rubber in the form of CRM is blended with asphalt to modify the properties of this material when used for highway construction, crack and joint sealant, roofing materials, liners and covers for containment ponds and waste disposal facilities. Market Share Estimate: 25%

Approximately 2-3 billion tires can already be found in landfills and stockpiles across the country. State governments and private collection enterprises continue to stockpile and landfill approximately 254 million tires per year based on the 1992 Modern Tire Dealer Folder, roughly one tire per year for every American.

The 1992 ground rubber industry sales volume is estimated to be 160 million pounds. Most of this volume consists of processed tire buffings, rather than whole tire material. Many in the industry do not have the technical capability to reduce whole tires (steel removal and fabric re-

### **3.4.3 Tire Material Sources and CRM Capacity**

duction complicate the procedure). The increased emphasis on recycling and the growing demand for CRM has heightened the interest in ground rubber made from whole tire material, since this eliminates the need to landfill any portion of the tire.

The production capacity of the industry is approximately 50 percent to 100 percent greater than the 1992 demand level. Close to 80 percent of the current industry volume is being produced by 5 or 6 manufacturers.

Shredders collect tires and reduce them to chips of 1/2" to 3" size. These chips are then sold as tire derived fuel (TDF) or to ground rubber manufacturers. Some shredding operations simply downsize the tires in order to fit more material into limited landfill and tire stockpile space.

Another source of scrap rubber (tire buffings) comes from retreaders. When an old tire is fitted for a new tread the old tread is shaved off into short or long stringy particles called buffings. These buffings are then sold to ground rubber producers. Approximately 230 million pounds of buffings are produced annually, about 120 million of which are currently being processed by ground rubber manufacturers. Over 20 percent of this 230 million pounds is unavailable for further processing due to loss or contamination during the buffing process. Significant portions of the buffings offered in the market have been unacceptable as a ground rubber feed stock, because of the additional processing required to dry or clean the material. We estimate the supply of acceptable buffings to be 170 million pounds annually.

Above ground tire piles and road worn tire supplies from tire dealers are the best source for ground rubber producers. Tires caked with mud and other refuse from landfills are difficult to process. These "dirty" tires will have an ash content that is too high for most customers' applications unless thoroughly cleaned. This additional handling and processing can add to the cost.

### **Special Services**

Tire/Rubber Exchange programs have been offered on a selected basis. The objective of a Tire/Rubber Exchange program is to remove tires from the solid waste stream of the sponsoring agency and demonstrate that scrap tires can be put to beneficial use. Through this type of program the sponsoring agency is able to show that local tires have been removed from the waste stream in amounts equivalent to the pounds of ground rubber used in local projects.

This type of program is most often requested and funded by a solid waste or environmental agency working with the highway department.

Typically, the agency will arrange for whole tires to be collected and removed from landfills and tire piles or accepted from independent collectors to be delivered to an approved shredder. The shredder is then paid a fee to reduce these whole tires to chips acceptable to a ground rubber manufacturer. The shredder certifies the receipt and processing of the tires and the fact that the material from those tires was delivered to a legitimate processor, not a landfill.

1. Gerald W. Holland, Benfei Hu, Mark A. Smith, "Particle Size Analysis for Granulated Rubber," *Rubber & Plastics News*, October 12, 1992
2. ASTM Standard D297, "Standard Test Methods for Rubber Products—Chemical Analysis," Annual book of ASTM Standards, Vol. 09.01, Philadelphia, PA, 1991
3. ASTM Standard D3677, "Standard Test Methods for Rubber—Identification by Infrared Spectrophotometry," Annual book of ASTM Standards, Vol. 09.01, Philadelphia, PA, 1991
4. Fernley G. Smith and William B. Klingen-Smith, "Tires as a Consumer and Source of Recycled Materials," Paper No. 15 ACS Rubber Division, Washington, October 1990
5. R. R. Irani and C.F. Callis, "Particle Size: Measurement, Interpretation and Application," Wiley, New York, 1963
6. Brian H. Kaye, "Direct Characterization of Fine Particles," John Wiley & Sons, New York, 1981
7. N. Stanley-Wood and T. Allen, "Particle Size Analysis," John Wiley & Sons, New York, 1982
8. Howard G. Barth, "Modern Methods of Particle Size Analysis," John Wiley & Sons, New York, 1984
9. T. Allen, "Particle Size Measurement," Chapman and Hall, New York, 1990
10. "Manual on Test Sieving Methods," ASTM Committee E-29 on Particle Size Measurement, Dec. 1985, Philadelphia, PA.

### 3.5 References



11. ASTM C 136, "Standard Method for Sieve Analysis of Fine and Coarse Aggregates," Annual Book of ASTM Standards, Vol. 04.02, 1991
12. ASTM D 1921, "Standard Test Methods for Particle Size (Sieve Analysis) of Plastic Materials," Annual Book of ASTM Standards, Vol. 08.02, 1991
13. ASTM E 105, "Standard Recommended Practice for Probability Sampling of Materials," Annual Book of ASTM Standards, Vol. 14.02, 1991
14. ASTM E 122, "Standard Practice for Choice of Sample Size to Estimate a Measure of Quality for a Lot or Process," Annual Book of ASTM Standards, Vol. 14.02, 1991
15. ASTM D 1511, "Standard Test Method for Carbon Black—Pellet Size Distribution," Annual Book of ASTM Standards, Vol. 09.01, 1991
16. ASTM E 11, "Standard Specification for Wire-Cloth Sieves for Testing Purposes," Annual Book of ASTM Standards, Vol. 14.02, 1991
17. Information on Wet Grinding Process supplied courtesy of Rouse Rubber Industries

## **Session 4.0**

---

# **Historical Development**

---

**by**

**Ray Brown  
National Center for Asphalt Technology**

## **4.0 Contents**

---

<b>4.1</b>	<b>McDonald Technology . . . . .</b>	<b>4-3</b>
<b>4.2</b>	<b>PlusRide Technology . . . . .</b>	<b>4-5</b>
<b>4.3</b>	<b>Generic Dry Technology . . . . .</b>	<b>4-6</b>
<b>4.4</b>	<b>Continuous Blending Technology . . . . .</b>	<b>4-6</b>
<b>4.5</b>	<b>References . . . . .</b>	<b>4-7</b>

## History of Use of Crumb Rubber in Asphalt Paving Materials

The potential benefits of adding rubber to asphalt cement have been discussed for many years however its use was delayed due to lack of technology and equipment to economically mix the rubber in asphalt cement. The use of natural rubber in asphalt cement was first introduced in the 1840's.<sup>1</sup> The concept of adding tire rubber to asphalt cement was developed in the 1950's.<sup>2</sup> Flintseal Corporation and U.S. Rubber Reclaiming reacted crumb rubber and asphalt cement in the laboratory in the early 1960's.<sup>3</sup> But it was not until 1964 that the use of crumb rubber modifier (CRM) in asphalt mixtures was first applied on an existing pavement.

In 1964 Charles McDonald who worked for the city of Phoenix developed a method to add small ground scrap rubber to asphalt cement.<sup>2</sup> The waste tires used vulcanized rubber to provide a material that would provide desirable properties in the asphalt cement. These techniques allowed the rubber to be processed and added to asphalt cement at a lower cost than had earlier been practical.

A "band-aid" test patch of asphalt rubber was placed in 1964 at Sky Harbor Airport in Phoenix and on U.S. Route 666.<sup>4</sup> Extensive field testing was performed at Sky Harbor Airport in 1965. This mixture, which was placed by hand, appeared to perform satisfactory and encouraged the city to continue to evaluate this material. The primary use of this "band-aid" patch was to delay or prevent cracks from reflecting through the asphalt rubber surface. This material did seal the existing cracks and provided a waterproof seal for many years.

After placing the section in 1964 in Phoenix, no more asphalt rubber was placed until 1967.<sup>4</sup> During this time the original sections were monitored to evaluate potential performance. The performance of these sections was satisfactory for three years and additional sections were placed by hand in 1967.

In 1968 the first asphalt rubber sections were placed with a slurry seal machine.<sup>4</sup> During this year the liquid asphalt rubber was also applied with an asphalt distributor followed by an application of chips. This is commonly referred to as a stress absorbing membrane (SAM). Use of the slurry seal machine and asphalt distributor improved the quality of the application and also greatly increased the production capacity. This

### 4.1 McDonald Technology

allowed the construction cost of the asphalt rubber section to drop considerably. At this time the supplier of SAMs was the Sahuaro Petroleum and Asphalt Company.

The biggest problem with most surface treatments is loose aggregate,<sup>4</sup> and the same is true with SAMs. Partly because of this loose aggregate problem, some of the SAMs were overlaid with Hot Mix Asphalt (HMA) to minimize the problem. When a SAM is used prior to an overlay, it is called a Stress Absorbing Membrane Interlayer (SAMI). The first SAMI was placed in 1971 by the city of Phoenix. Arizona DOT placed its first SAMI in 1972 on I-40 along with several other test sections followed by a second section in 1975 again on I-40.

The consistency of the asphalt rubber was initially very thick.<sup>5</sup> It had to be heated to a higher temperature than conventional asphalt cement and was still difficult to pump and spray. In 1972 kerosene began to be added to the asphalt rubber to lower the viscosity. This addition of kerosene improved the workability of the asphalt rubber and thus improved quality of construction.

In 1974 this mixture of asphalt cement and crumb rubber began to be used as a crack sealer.<sup>4</sup> Previous work had shown this material to be very elastic and flexible, two primary properties of a crack sealer. In 1992, a survey of states to determine types of crack sealers being used showed that approximately 10 states were using asphalt rubber as their primary sealant.<sup>6</sup>

Arizona Refinery Company (ARCO) in 1975 developed an asphalt rubber mixture to compete with that of the Sahuaro mix. The ARCO mix used 80 percent asphalt cement and 20 percent crumb rubber, including de-vulcanized CRM, along with an extender oil instead of kerosene.<sup>4</sup> These two technologies eventually merged between 1983-1985 and became known as the McDonald technology.

Some initial problems with the SAMI were caused by the roughness of the existing pavement being overlaid. When the surface is rough the SAMI is difficult to construct with consistent quality resulting in less than desirable performance. In 1975 a three-layer system was developed and constructed to help solve the roughness problem.<sup>4</sup> This three-layer system consisted of a level course followed by the SAMI and overlaid with a HMA. it was effective in improving performance but the cost of a three-layer system often prohibits its use.

The first use of asphalt rubber in HMA in Arizona was in 1975. Two sections of asphalt rubber in an open-graded friction course were placed on State Route 87. One section contained 10.5 percent binder having 25 percent vulcanized rubber and the other section contained 8.5 percent binder having 20 percent devulcanized rubber. In 1978 three additional sections of HMA with asphalt rubber were placed. These three sections consisted of an open-graded friction course with three different blends of CRM and asphalt.<sup>7</sup> A blender was developed to premix the CRM and asphalt in 1981-1982.<sup>7</sup>

Most asphalt rubber work in the U.S. has been performed in Arizona. Between 1972 and 1978 approximately 30 miles of SAM per year were placed. Since that time, very little has been used probably because of the loose aggregate problem. Between 1975 and 1980 approximately 50 miles of SAMI were placed per year. Since that time, approximately 10 miles per year have been placed. Until 1989, approximately 55 percent of all asphalt rubber work in Arizona had been SAMI, 40 percent SAM, 6 percent moisture membrane, 3 percent open graded friction course with asphalt rubber 1 percent three-layer system, and 1 percent low volume road construction.<sup>4</sup>

California first began using McDonald's asphalt rubber in 1978.<sup>9</sup> During the ten years after 1978 California placed approximately 20 overlay projects using asphalt rubber. This work has been done with dense-graded mixes, as well as gap-graded mixes.

California first began using the asphalt rubber to improve the durability of HMA.<sup>9</sup> With additional experience, California developed a design guideline in 1992 that allows for reduced overlay thickness for a gap-graded HMA with asphalt rubber on specific types of applications.

The original concept was developed by two Swedish companies, Skega AB and AB Vaegfoerbaetringar, in the late 1960's, as a product named Rubit. The Swedish incorporated 3 to 4 percent CRM (by weight of total mix) into a HMA surface mixture. The rubber particles were 1.6 to 6.4 mm (No. 16 to 1/4-inch sieve), which were relatively large compared to CRM used in McDonald mixtures. This is a dry process which considers the crumb rubber as part of the aggregate. The Swedish technology was patented for use in the United States in 1978 under the trade name PlusRide.<sup>8</sup> The mix design was refined in the mid-1980's establishing the gap-graded mix now commonly used. This method has

## 4.2 PlusRide Technology

been used in Alaska, Washington, Minnesota, Oregon, Arizona, and California as well as other locations.

Four corporations have marketed the PlusRide technology since it was introduced in the United States, originally All Seasons Surfacing Corp., then PlusRide Asphalt Inc., PaveTech Corp., and presently EnvirOtire Inc. All of these companies were based in the Seattle, Washington, area. EnvirOtire Inc.\* retains all patent rights and establishes specific licensing agreements with contractors on a project-by-project basis.<sup>2</sup> Two United States Patent Nos. 4,086,291 and 4,548,962 cover this technology. EnvirOtire, Inc. markets this technology as PlusRide II.

### 4.3 Generic Dry Technology

The first generic dry technology system for adding crumb rubber to HMA was developed by Takallou in 1986 as a result of his research on RUMAC at Oregon State University. This system selects a grading of crumb rubber to best fit the gradation of the aggregate to be used. This generic dry technology system is sometimes referred to as generic RUMAC or the TAK system.<sup>10</sup> The first field evaluation sections of this system were placed on two projects in the State of New York in 1989. These projects placed generic dry technology RUMAC sections with 1 percent, 2 percent, and 3 percent CRM, as well as a control section and PlusRide section. It has also been examined in a number of other places including Ontario, Oregon, Illinois, and California.

Other designs using generic dry technology are also being developed. Some agencies (like Iowa and Oregon) are examining the generic RUMAC system while others are combining the theory of wet process-continuous blending with dry process construction practices. This latter system might be defined as a generic dry technology asphalt rubber system. It was first examined in Florida and is also being evaluated in Kansas.

### 4.4 Continuous Blending Technology

In 1988 the Florida Legislature passed Senate Bill 1192 on Solid Waste Management<sup>11</sup>. This Bill required the state DOT to consider the use of CRM in HMA. Florida DOT funded a study to the National Center for Asphalt Technology (NCAT) to look at the feasibility of using scrap tires in HMA.<sup>12</sup> The study was completed, Florida built test sections in

\*EnvirOtire, Inc., 1904 Third Avenue, Seattle, Washington 98101  
(Phone 206-587-6018)

---

1990 and 1991, and they have been using scrap tires in some of their mixes since that time. This was the initial development of the wet process-continuous blending technology. Since that time other states including Kansas and Iowa have used this process.

1. M.A. Heitzman, "State of the Practice—Design and Construction of Asphalt Paving Materials with Crumb Rubber Modifier," FHWA Report No. FHWA-SA-92-022, May 1992.
2. Milton F. Masters, "Cost Comparisons Using Conventional Methods of Rehabilitation Versus Methods Using Asphalt-Rubber Systems," Asphalt Rubber Producers Group National Seminar on Asphalt Rubber, Federal Highway Administration, 1989.
3. Russell H. Schnormeier, "Recycled Tire Rubber in Asphalt," paper prepared for presentation at the 1992 Annual TRB meeting.
4. Larry Scofield, "The History, Development, and Performance of Asphalt Rubber at ADOT," Asphalt Rubber Producers Group National Seminar on Asphalt Rubber, Federal Highway Administration, 1989.
5. Joe O. Cano and Equabalali Charania, "The Phoenix Experience Using Asphalt Rubber," Asphalt Rubber Producers Group National Seminar on Asphalt Rubber, Federal Highway Administration, 1989.
6. Robert Eaton and Jane Ashcraft, "State-of-the-Art Survey of Flexible Pavement Crack Sealing Procedures in the United States," U.S. Army Corps of Engineers, CRREL Report 92-18, September 1992.
7. John P. Zaniewski "Summary of Arizona Department of Transportation Experience with Asphalt Rubber," Arizona Department of Transportation, FHWA-AZ88-818, August 1988.
8. K.D. Stuart and W.S. Mogawer, "Laboratory Evaluation of Vergilimit and PlusRide," FHWA, Report No. FHWA-RD-91-013, March 1991.
9. Jack Van Kirk, "CALTRANS Experience with Asphalt-Rubber Concrete—An Overview and Future Direction," Asphalt Rubber

## 4.5 References



---

Producers Group National Seminar on Asphalt Rubber, FHWA, 1989.

10. M.B. Takallou and A. Sainton, "Advances in Technology of Asphalt Paving Materials Containing Used Tire Rubber," Transportation Research Record 1339, 1992.
11. G.C. Page, "Florida's Initial Experience Utilizing Ground Tire Rubber in Asphalt Concrete Mixes," Asphalt Rubber Producers Group National Seminar on Asphalt Rubber, FHWA, 1989.
12. F.L. Roberts, P.S. Kandhal, E.R. Brown, and R.L. Dunning, "Investigation and Evaluation of Ground Tire Rubber in Hot Mix Asphalt," NCAT Report No. 89-3, August 1989.

## **Session 5.0**

---

# **Crumb Rubber Modifier (CRM) Technologies**

---

by

**Prithvi Kandhal  
Doug Hanson  
National Center for Asphalt Technology**

## 5.0 Contents

---

5.1	McDonald Technology . . . . .	5-3
5.1.1	Description . . . . .	5-3
5.1.2	Details . . . . .	5-4
5.1.3	Mix Design . . . . .	5-6
5.1.4	Modification to Equipment . . . . .	5-7
5.1.5	Modification to Procedures . . . . .	5-7
5.2	Continuous Blending Technology . . . . .	5-8
5.2.1	Description . . . . .	5-8
5.2.2	Details . . . . .	5-8
5.2.3	Mix Design . . . . .	5-8
5.2.4	Modification to Equipment . . . . .	5-8
5.2.5	Modification to Procedures . . . . .	5-9
5.3	PlusRide Technology . . . . .	5-9
5.3.1	Description . . . . .	5-9
5.3.2	Details . . . . .	5-9
5.3.3	Mix Design . . . . .	5-12
5.3.4	Modification to Equipment . . . . .	5-13
5.3.5	Modification to Procedures . . . . .	5-14
5.4	Generic Technology . . . . .	5-15
5.4.1	Description . . . . .	5-15
5.4.2	Details . . . . .	5-15
5.4.3	Mix Design . . . . .	5-16
5.4.4	Modification to Equipment . . . . .	5-19
5.4.5	Modification to Procedures . . . . .	5-19
5.5	References . . . . .	5-20

Wet and dry processes have been used to incorporate rubber in hot mix asphalt (HMA). Two technologies which use wet processes are: the McDonald (batch) technology and the continuous blending technology. Two technologies which use dry processes are: the PlusRide technology and the generic dry technology.

In the wet process the Crumb Rubber Modifier (CRM) is blended with asphalt cement before mixing the CRM modified binder with the aggregate. In McDonald technology the CRM is mixed in a blending tank and reacted in a holding tank before introduction into the mix. In continuous blending technology the CRM and the asphalt cement can be mixed just before the binder is introduced into the mix or it can be mixed and placed in a storage tank for use later. Fifteen to twenty-two percent (by weight of binder) of a 10-30 mesh CRM is generally used in McDonald technology. The continuous blending technology uses a finer grind of CRM in amounts ranging from five to twenty percent (by weight of binder).

In the dry process the crumb rubber materials are blended with the aggregate before adding the asphalt cement to the blended mixture. The mix production practices for the dry process are similar to those practices used for the construction of conventional HMA. The CRM is added directly to the mixture. In a drum plant it is added at the RAP opening. In a batch plant it is added to the dry aggregate at the pugmill.

A detailed discussion of the four different technologies (two wet processes and two dry processes) follows.

The wet process is any process that blends CRM with asphalt cement before mixing the blended binder with the aggregate. The result is a modified binder having significantly different properties than the original asphalt cement<sup>1</sup>. The process is the result of early work done by Charles McDonald. Per telephone conversation with Carl Jacobson, CRAFCO, there are no current patents covering the wet process.

In McDonald technology, typically 15 to 22 percent ground rubber (No. 16 sieve to a No. 30 sieve) is mixed with an asphalt (usually an AC-10 or AC-20) and reacted for one-half hour to one hour. The result is a thick elastic material called asphalt rubber (AR) binder.<sup>1</sup>

## **5.1 McDonald Technology**

### **5.1.1 Description**

### 5.1.2 Details

A primary purpose for adding CRM to an asphalt cement is to provide an improved binder. The following paragraphs will discuss the uses of AR binders using the McDonald technology and the claimed benefits from the use of AR binders.

#### *Uses of AR Binders (McDonald Technology)*

The AR binders have been used for many applications to include the following:

1. **Crack and joint sealant**
2. **Seal Coats.** This is a Stress Absorbing Membrane (SAM) and generally consists of a spray application of AR binder at the rate of approximately 0.50 gsy with approximately 35 psy of chips.
3. **Stress Absorbing Membrane Interlayer (SAMI).** This is a SAM placed between layers of HMA generally during an overlay project. The purpose is to retard the development of reflection cracks and to reduce water penetration into the underlying layers.
4. **Hot Mix Asphalt.** This is a HMA that uses the AR binder in lieu of a conventional asphalt cement. It can be either an open-graded, gap-graded or dense-graded HMA.
5. **Subgrade seals.** This is a spray application of AR binder similar to a SAM. It could be used to keep moisture out of a subgrade or to provide an impermeable liner for a water retention basin.

#### *Claimed Advantages for McDonald Technology*

The following advantages are claimed for AR binders<sup>2</sup>:

1. **Reduces aging.** Asphalt cement that contains CRM shows the effects of reduced oxidation or aging. This is because of the antioxidants and carbon black from the tire that are in the AR binder.
2. **Increases flexibility of the mix.** Mixtures containing AR binders are more flexible than standard conventional asphalt mixes.
3. **Softening point.** The use of CRM in a binder will increase the softening point of the resultant binder by 20 to 50°F.

4. **Improved temperature susceptibility.** The use of a AR binder results in improved cold weather performance characteristics and improved hot weather performance characteristics than its base conventional asphalt.

### **Gradations**

When using the McDonald technology the rubber content should be a minimum of 15 percent by weight of the binder and should meet the gradations from Table 5-1. The aggregate gradation of dense-graded HMA mixtures should be maintained on the coarse side of the gradation band to accommodate AR binder.

**Table 5-1. Suggested rubber gradations for a dense-graded HMA (Ref 3)**

Sieve size	Percent passing
No. 10	100
No. 16	98-100
No. 30	70-200
No. 50	10-40
No. 200	0-5

A recommended aggregate gradation for an open-graded HMA containing AR binder is shown in Table 5-2. An open graded mix made with AR binder will have a higher binder content than the same mix with a conventional binder.

When using McDonald technology the CRM should meet the gradation requirements shown in Table 5-3.

**Table 5-2. Suggested aggregate gradations for open-graded CRM HMA (percent passing) (Ref 3)**

Sieve size	$\frac{3}{8}$ inch	$\frac{1}{2}$ inch
$\frac{3}{4}$ " (19.0 mm)	100	100
$\frac{1}{2}$ " (12.5 mm)	100	90-100
$\frac{3}{8}$ " (9.5 mm)	85-100	75-95
No. 4 (4.75 mm)	25-55	20-45
No. 8 (2.36 mm)	5-15	5-15
No. 30 (600 $\mu$ m)	0-10	0-10
No. 200 (75 $\mu$ m)	0-5	0-5

**Table 5-3. Suggested CRM gradations for an open-graded HMA (Ref 3)**

Sieve size	Percent passing
No. 10	100
No. 16	75-100
No. 30	25-60
No. 50	0-20
No. 200	0-5

### 5.1.3 Mix Design

#### *Dense-graded HMA*

Marshall and Hveem mix design methods can be used to design dense-graded HMA<sup>3</sup> with McDonald asphalt rubber. Modifications are made to the procedures to account for the AR binder. As previously noted, the aggregate gradation needs to be on the coarse side of the band. If the gradation is too fine, or the rubber particles too large, compaction problems may result. Because of the replacement of a portion of the asphalt cement by rubber, the binder content for a mix with AR will be higher than the binder content would be for a conventional HMA. The asphalt cement and CRM used to make the McDonald AR binder for the mix design needs to be mixed in a very controlled manner. The lab specimens should be mixed and compacted at elevated temperatures.

After the specimens have been made both the standard Marshall and Hveem test procedures can be used. However, because of the increased viscosity, elasticity and softening point of the asphalt rubber binder, the target level for the design parameters are adjusted. The target level for the VTM (voids in total mix) should be set at 3 to 4 percent rather than 3 to 5 percent. Also the flow requirements should be raised. For the Hveem procedure, the VTM should be similar to the Marshall procedure. The Hveem stability should be 20 to 30 when using aggregate that normally produces 35 to 40 stabilities with conventional asphalt cement binder.

#### ***Open-Graded Friction Courses (OGFC)***

In open-graded mixes with McDonald AR binder, the higher viscosity of the binder will allow the use of binder contents higher than those used in standard open-graded mixes. Binder contents of 10 to 11 percent have been used without experiencing excessive drain down. The procedures outline in the FHWA report FHWA-RD 74-2 "Design of Open Graded Asphalt Friction Courses" should be used as a general guideline for the design of these mixes.

The major difference between production of a McDonald HMA and a conventional hot mix asphalt is the pre-blending and reaction of the CRM with asphalt cement to produce an AR binder for the resultant HMA mixture. The reaction is accomplished in insulated trucks and/or tanks. When the CRM is added to the asphalt, the temperature of the asphalt cement is between 176°C to 204°C (350°F to 400°F). The asphalt cement and CRM are combined and mixed in a blender unit and then pumped into the agitated storage tank for reaction. The reaction tank has a mechanical agitating system that will keep the mixture dispersed. The temperature is maintained between 162°C and 190°C (325°F and 375°F) during the minimum 45 minutes reaction time. The required amount of AR binder is added at the mixing chamber of the HMA production plant.

The construction of HMA with McDonald AR binder is very similar to constructing conventional mix. The temperature of the AR binder is between 162°C and 190°C (325°F and 375°F). The mixing temperature is generally 143°C and 162°C (290°F to 325°F), laydown temperature is generally higher, and compaction should be accomplished while the material is "hot" because the viscosity of AR binder increases rapidly.

#### **5.1.4 Modification to Equipment**

#### **5.1.5 Modification to Procedures**



## 5.2 Continuous Blending Technology

### 5.2.1 Description

The wet process is any process that blends CRM with asphalt cement before mixing the blended binder with the aggregate. The result is a modified binder. The differences between the McDonald technology and the continuous blending technology is the manner in which the CRM and the asphalt cement are blended and reacted. Also, the McDonald technology uses a coarser CRM than the continuous process. Typically in the continuous blending technology, 5 to 20 percent ground rubber is blended with an AC-5 or AC-10 asphalt. The idea is that the use of the fine rubber gradation will shorten the reaction time between CRM and asphalt cement.

### 5.2.2 Details

The continuous blending technology differs from the McDonald technology in that the CRM material used for the binder is a finer grind material. Table 5-4 presents a typical gradation of the CRM used.<sup>5</sup> The Florida DOT recommended CRM contents by weight of binder are: 12 to 16 percent for open-graded mixes, 5 to 12 percent for dense graded mixes and 15 to 20 percent for surface treatments.

**Table 5-4. Continuous blending technology CRM gradation<sup>2</sup>**

Screen	Percent passing
No. 60	98 to 100%
No. 80	88 to 100%
No. 100	75 to 100%

### 5.2.3 Mix Design

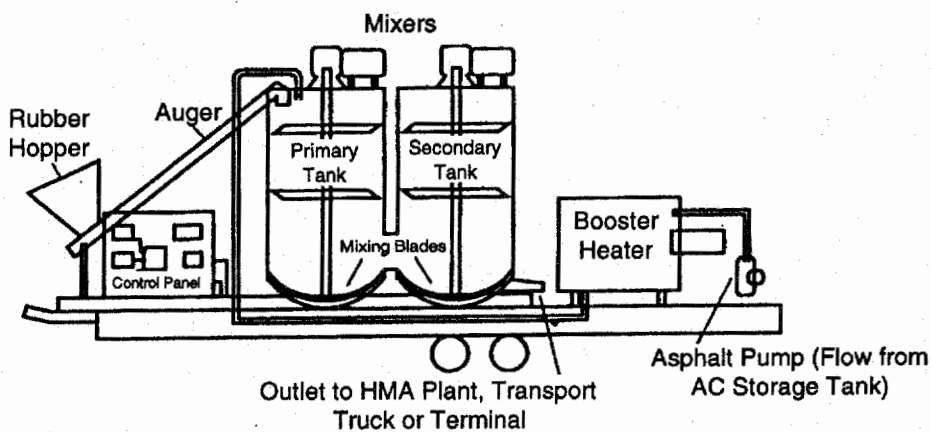
The mix design procedures for the continuous blending technology will be similar to those for the McDonald technology.

### 5.2.4 Modification to Equipment

The mixing of the CRM and the asphalt cement is accomplished in a self-contained portable blending/metering unit as show in Figure 5-1. The system can be set up at the HMA plant site and interlocked into the existing asphalt binder feed system. Some asphalt terminals and refineries are examining this technology for large quantity production.

The construction practices for the continuous blending technology are similar to those described for the McDonald technology.

**Figure 5-1. Continuous blending technology portable blending/metering unit<sup>2</sup>**



## 5.2.5 Modification to Procedures

## 5.3 PlusRide Technology

### 5.3.1 Description

This process primarily uses CRM as a rubber aggregate which is incorporated into a gap-graded aggregate prior to mixing with asphalt cement, producing a rubber modified hot mix asphalt concrete (RUMAC). The coarse rubber particles act as elastic aggregates which flex on the pavement surface under traffic and break ice.<sup>6</sup> The mix design was refined in the mid 1980's establishing the gap-graded mix now commonly called PlusRide. EnvirOtire, Inc.\* markets this technology at the present time as PlusRide II.

The CRM used in PlusRide is predominantly a granulated crumb rubber passing the 6.4 mm ( $\frac{1}{4}$ " ) sieve with the fraction passing the 2 mm (No. 10) sieve supplemented with granulated buffings or ground CRM. Like

### 5.3.2 Details

the mineral aggregate, the gradation of the CRM follows a specific band as follows:

<u>Sieve Size</u>	<u>Percent Passing</u>
1/4"	100
No. 4	76-100
No. 10	28-42
No. 20	18-24

By specifying a granulated CRM, the smooth sheared surfaces of a particle are less reactive (lower surface area than ground CRM) and its cubical shape can be factored into the combined gradation of CRM and aggregate. The CRM is ambient granulated from ground whole passenger or truck tires (heavy equipment tires are not permitted). It is free of wire and free-flowing. Calcium carbonate or talc can be added to maintain its free-flowing condition. CRM in a PlusRide mixture can range from 1 percent to 6 percent by weight of the total mix. However, 3 percent has most commonly been used.<sup>7</sup>

The mineral aggregates used in the PlusRide system should conform to the physical requirements for those aggregates used in the conventional HMA surface courses. The aggregate should have a minimum fracture requirement of 75 percent with at least one mechanically fractured face for all material retained on the No. 10 sieve and above.<sup>8</sup>

Three aggregate gradations which reflect different maximum aggregate sizes, are specified in the PlusRide II system as shown in Table 5-5. The PlusRide II mixtures must be gap-graded to allow space for the CRM. For the PlusRide II 12 and PlusRide II 16 mixtures, this gap grade restricts the amount of aggregate passing the 6.4 mm (1/4") sieve and retained on the No. 10 sieve to be 12 percent maximum. Failure to provide a sufficient gap grading would cause the coarse rubber to resist compaction and result in a low-density pavement with high air voids. The mix also contains a higher minus-200 content compared to conventional HMA mixtures to fill air voids.

---

\* EnvirOtire, Inc. 1904 Third Avenue, Seattle, Washington 98101  
(Phone 206-587-6018)

**Table 5-5. Mix composition of PlusRide II (after Ref. 3)**

Property	PlusRide 8	PlusRide 12	PlusRide 16
% passing 3/4"	—	—	100
% passing 5/8"	—	100	—
% passing 3/8"	100	60-80	50-62
% passing 1/4"	60-80	30-44	30-44
% passing No. 10	23-38	20-32	20-32
% passing No. 30	15-27	13-25	12-23
% passing No. 200	8-12	8-12	7-11
Asphalt content, % by weight of mix	8.0-9.5	7.5-9.0	7.5-9.0

The asphalt cement binder chosen for the PlusRide mix is usually the same grade as used for conventional HMA in the project area. The asphalt content generally varies from 7.5 to 9.0 percent which is substantially higher than conventional HMA. The target air void content is 2 to 4 percent.

The CRM is handled like an aggregate, and is dry mixed with the hot mineral aggregate prior to mixing with the asphalt cement. Generally, a mix design using this concept will include a percentage of ground CRM passing No. 20 sieve which produces a partially reacted modified binder. Evidence of this reaction has been noted by the "swelling" which occurs in the laboratory mix.

The limited reaction time allows the surface of the coarse rubber particle to react with the asphalt cement, but does not permit sufficient time for the reaction to penetrate the entire rubber mass. This creates an asphalt/rubber interface which bonds the two materials together.<sup>7</sup>

The following advantages have been claimed when PlusRide RUMAC is used.

**Increased fatigue life.** This is attributed to the modified asphalt binder and elastomeric aggregate. Laboratory fatigue tests conducted by Takalou et al.<sup>9</sup> indicate such improvements are possible.

**Resistance to reflective, shrinkage and thermal cracking.** When the stress at the tip of a crack reaches a rubber particle, the particle is likely to absorb the stress, delaying the advance of the crack. Laboratory studies<sup>6</sup> have indicated increased resistance to low temperature cracking.

**Ice disbonding.** Rubber granules exposed at the RUMAC surface compress slightly when subjected to traffic wheel loads. This creates a small area of flexibility that will not retain ice when it begins to crystallize. Obviously this will only happen when the surface is loaded continuously and when the ice is relatively thin.

**Greater resistance to rutting.** This is attributed to greater resiliency of the RUMAC course, which results in reduced permanent deformation. Repeated load permanent deformation tests conducted by Takallou et al.<sup>9</sup> indicate this trend. However, Stuart and Mogawer<sup>6</sup> have reported decreased resistance to rutting in their laboratory evaluation, which was directly related to the rubber and the associated 1.5 percent increase in asphalt content.

### 5.3.3 Mix Design

Since PlusRide II is a resilient/elastic RUMAC mixture, the conventional properties of stability and flow do not apply for the mix design. The objective of the design is to determine the gradation of aggregates, asphalt content and rubber content that yield a mix having:

1. A high-coarse aggregate content, gap-graded to provide space for the rubber granules to form a dense, durable and stable mixture upon compaction.
2. A rich asphalt/filler ratio. Asphalt cement and filler are used to fill voids. The mix must have a high asphalt content to ensure a workable mixture and durable pavement.
3. A low void content in the compacted mix. The voids should be in the range of 2 percent to 4 percent, with 3 percent being the normal.

One of the three specified, gap-graded aggregate gradation bands (as shown in Table 5-5) are used depending on the desired maximum aggregate size. The gapping within the specified aggregate gradation band is critical. The 12 percent (maximum) aggregate fraction passing the 6.4 mm ( $\frac{1}{4}$ " ) sieve and retained on the No. 10 sieve must be maintained within specified tolerance during production. A mineral filler is usually required to meet the high minus 200 requirements. When a mineral filler is needed, the type and quantity to be used in production must be used in the mix design. The asphalt cement content should range from 7.5 percent to 9.0 percent by weight of total mix. A guide for selecting the trial contents is the rule of thumb that PlusRide II requires approxi-

mately 2 percent more asphalt than a conventional mixture of similar size and type aggregates.<sup>8</sup>

A sieve analysis must be performed on a representative sample of CRM to ensure that it meets the specified gradation (reported earlier).

A mixing temperature of 160°C (320°F) is used to prepare various mixtures of different asphalt contents. To prevent expansion of the compacted specimen, the base plate must be removed immediately and the specimen set over a 98 mm (3 7/8") diameter x 25 mm (1") thick wood plug. Another wood plug should be placed on top of the specimen, weighted and allowed to cool.

The theoretical maximum specific gravity may be determined by several methods, the Rice method being the most common. If the theoretical maximum specific gravity is calculated, a value of 1.19 should be used for the specific gravity of the rubber, or the specific gravity should be measured.

After the specimens have cooled to room temperature, the bulk specific gravity is determined and percent air voids calculated. If the percent air voids are not within the design tolerance (2-4%), the amount of asphalt and filler is adjusted and/or the aggregate gradation is adjusted, and another set of trial mixtures prepared. The primary criterion for an acceptable mix design is the percentage of air voids.

If the aggregate does not contain enough minus 200 material, then it will necessary to add mineral filler to the RUMAC mix. This might require a separate silo for mineral filler.

For batch mix facilities CRM is delivered to the site in 22 to 27 kilogram (50 to 60 pound) plastic bags. The bags are made of a low melting point material which allows the operator to charge the mixing chamber with the entire bag of CRM. The process and equipment required for introducing RAP (reclaimed asphalt pavement) into a drum mix facility can also be used to introduce CRM into the drum.

EnviroTire, Inc. has now developed a CRM proportioning and feed system conveniently mounted on a trailer, which automatically proportions the correct amount of ground and granulated rubber and introduces it into both batch and drum HMA facilities.

No modifications are needed to conventional hauling, placing, and compaction equipment.

### 5.3.4 Modification to Equipment

### 5.3.5 Modification to Procedures

Only a few modifications to the construction practices are needed for PlusRide RUMAC. The CRM is added directly to the HMA facility. This will require a separate CRM feed system tied into the aggregate feed system. On a batch facility, this is presently accomplished by manually feeding the pugmill with a predetermined number of sacks of CRM. On drum mix facilities, the CRM feed system introduces the CRM at the RAP hopper and must be tied to the cold-feed aggregate weigh system. A sensitive weigh system is necessary to monitor the small amount (3 percent by weight of mix) of CRM being introduced into the drum. As mentioned earlier, EnvirOtire, Inc. has a portable mix and feed system which can introduce the required amounts of CRM into the HMA mix produced by both batch and drum mix facilities. Except for an extended dry mix cycle during batch plant production, the only other modification to mix production is mix temperature. The temperature of PlusRide RUMAC mixture should be 150 to 175°C (300 to 350°F) after mixing.

The PlusRide RUMAC mixture occupies about 10 percent greater volume in the pugmill than a conventional mix for the same weight. Since PlusRide mix uses approximately 2 percent more asphalt cement, the limiting factor on batch size may be the capacity of the asphalt cement bucket.<sup>8</sup>

Quality control is very important for PlusRide RUMAC. The mix is very sensitive to variations in the materials' gradations and proportions. Poor production, placement, or compaction control have resulted in premature failure of the pavement. Extraction methods will not provide accurate means of monitoring CRM content nor binder content. Similarly, asphalt content gauges will measure all the CRM in the sample as a part of the binder content. Therefore, proper calibration of the equipment which measures the materials fed into the HMA facility is critical.<sup>7</sup>

Compaction control is also very important for PlusRide RUMAC. The materials should be compacted while hot to achieve density before the binder stiffens as the mat cools. Hand work should be held to a minimum. The use of rubber-surfaced equipment, particularly pneumatic rollers, should be avoided. Only detergent-based release agents should be used on the haul trucks and rollers. In addition to these modifications, the finish roller must continue to compact the PlusRide mat until it cools below 60°C (140°F). Because the CRM is only partially "reacted," the material in the compacted lift continues to react at elevated temperatures. The reaction causes the crumb rubber to swell and expand the mixture. The additional rolling retains the mat density until the increasing binder viscosity can counteract the reaction's decreasing potential to expand.<sup>7</sup>

The first generic dry technology system, generic RUMAC (also known as the "TAK" system), uses an equivalent or slightly lower percentage of CRM compared to PlusRide. The CRM is also finer than that used in PlusRide. A conventional dense-graded aggregate is used with only slight modification. The gradation of CRM is adjusted to suit the aggregate gradation. It is a two component system in which the fine crumb rubber interacts with asphalt cement, and the coarse crumb rubber performs as an elastic aggregate in the HMA mixture. The combination of modifying the asphalt binder and increasing the elasticity of the HMA mixture has been claimed to increase the fatigue life, reduce thermal and reflective cracking, and increase the adhesion of the modified binder to the aggregate. However, this system has been described somewhat generally in the literature.<sup>10</sup> No significant information is available as to how the amount and the gradation of CRM is determined for a specific mineral aggregate.

Another type of generic dry technology system uses lower amounts of CRM and smaller size (No. 80 mesh) CRM as compared to generic RUMAC. It is believed that the fine CRM modifies the asphalt binder during the mixing process and subsequent storage and transportation of the HMA to the job site.

These systems are in the public domain and, therefore, no royalty payments are involved. Experimental field applications of the generic dry process have been made in New York, Illinois, Florida, Kansas, Iowa, Oregon, California and Ontario, Canada. Construction reports<sup>4,11,12</sup> are available from the Department of Transportation of some States.

#### ***Generic RUMAC System***

As mentioned earlier, generic RUMAC is a two component system. The CRM passing No. 20 sieve reacts with the asphalt cement producing a modified binder. A pre-reaction may be needed to achieve the optimum modification. The coarse CRM replaces a portion of the aggregate in the HMA mixture, and acts as an elastic aggregate.

One to three percent crumb rubber by weight of the HMA mixture is generally added. The crumb rubber is ambient granulated or ground from whole passenger and/or light truck tires. Heavy equipment tires are not permitted. The crumb rubber greater than 10 mesh in size must

## **5.4 Generic Technology**

### **5.4.1 Description**

### **5.4.2 Details**



be produced from ambient granulation. The crumb rubber passing the 10 mesh sieve may be produced from either ambient granulation or ambient grinding. Uncured or devulcanized rubber is not acceptable. Rubber tire buffings, from either recapper or tire manufacturers must not be used as supplement to the granulated rubber mixture unless they are further processed by granulation or grinding. The rubber granulate must be processed by ambient granulation to maintain the structural integrity, particle shape and minimum surface area. The first stage of the whole tire processing can use other methods to remove steel and fabric.

Aggregate gradation is examined to see the sieve sizes wherein the CRM can be incorporated. Consideration is given to the fact that CRM swells after it comes in contact with asphalt cement during mixing, hauling, placement, and compaction. The size of the CRM should be smaller (by one sieve size) than the gap existing in the mineral aggregate.

Since conventional aggregate gradations are used, it is necessary to determine the appropriate CRM gradation. However, the grading flexibility in most CRM plants is rather limited at the present time. The cost of CRM will increase if unusual CRM grading requirements are specified.<sup>7</sup>

Generic RUMAC has been successfully constructed in New York, Oregon and Ontario; mix composition and construction details for New York and Ontario are given in References 11 and 12, respectively.

#### *Asphalt Rubber System*

In Florida, an experimental project constructed in June 1989 used CRM in one section utilizing generic dry process technology different from generic RUMAC system. Number 80 mesh CRM was used in an open-graded friction course (nominal maximum aggregate size of 9.5 mm or  $\frac{3}{8}$  inch) at 10 percent by weight of binder. Little information is available regarding the details of this new generic technology system.

### **5.4.3 Mix Design**

#### *Generic RUMAC System*

Preliminary tests are performed to establish the CRM content. The maximum CRM content which meets the agency's minimum stability requirement is selected. Generally, up to 2 percent CRM is used in surface courses and up to 4 percent in base courses. The cubical shape of granulated CRM is factored into the combined gradation of CRM and

aggregate. The specific gravity differences between CRM particles and aggregate require a weight adjustment factor of 2.3 for the CRM to determine the composite gradation.

After the amount and the gradation of CRM are selected, trial specimens are made with 75 blows of Marshall hammer. Optimum asphalt content is selected based on the air voids. The voids should be in the range of 2 to 4 percent, with 3 percent being the normal. The selected mix must meet the minimum stability requirement like the control mix without CRM. Marshall flow should not exceed 20. Very limited data is available on the complete mix design procedure.

Some mix design information from the initial New York projects is given below.

*New York Projects:* Three generic dry technology designs ("TAK" systems) were constructed using 1, 2 and 3 percent CRM by weight of total mix. A control section (no rubber) and a PlusRide section were also constructed for comparison. The CRM supplied on the project is given in Table 5-6. The gradation specified for aggregate plus CRM for the New York Type 6F surface course mix is given in Table 5-7.

**Table 5-6. CRM gradation—New York projects**

Sieve size	Percent passing	
	Specified	Supplied
1/4"	100	—
No. 4	—	100
1/8"	75-85	—
No. 10	45-55	51
No. 20	30-40	44
No. 40	0-10	19

**Table 5-7. Mix gradation—New York projects**

Sieve size	Percent passing	Tolerance
1"	100	—
1/2"	95-100	—
1/4"	65-85	±7
1/8"	36-65	±7
No. 20	15-39	±7
No. 40	8-27	±7
No. 80	4-16	±4
No. 200	2-6	±2

The design asphalt contents and air void contents obtained for the two projects in New York are given in Table 5-8. These are based on 75-blow Marshall hammer compaction.

**Table 5-8. Design asphalt contents and air voids—New York projects**

Mix type	Percent rubber	Region 1		Region 9	
		% AC	% voids	% AC	% voids
6 F (control)	0	6.0	3.0	6.2	3.0
6 F rubber	1	6.4	3.1	6.2	2.6
6 F rubber	2	6.8	3.2	6.8	3.0
6 F rubber	3	7.2	3.0	7.4	3.5
PlusRide	3	7.2	2.2	7.4	2.2

An AC-20 asphalt cement was used in all test sections. Asphalt contents for the control and RUMAC mixes were selected to obtain a target air void content of 3 percent. PlusRide mixes were designed for 2 percent air void content.

The temperature of the RUMAC mixtures was specified between 149°C (300°F) and 177°C (350°F) at the point of discharge. The target mat density was specified between 95–9 percent of the maximum theoretical specific gravity.

### ***Asphalt Rubber System***

Dense-graded HMA using this dry process technology is usually designed by the same Marshall design criteria as used for conventional HMA.

Similar to PlusRide RUMAC, arrangements have to be made to introduce CRM in the batch and drum mix HMA facilities. Generic dry technology has used bulk feeding systems for the CRM on projects in Illinois, Oregon and Kansas.

No modifications are needed to conventional hauling, placing, and compaction equipment.

Same as PlusRide RUMAC except that pneumatic tired rollers have been used without any problems.

1. Heitzman, Michael, "An Overview of the Design and Construction of Asphalt Paving Materials with Crumb Rubber Additives." Paper presented at 71st Annual Meeting of Transportation Research Board, Washington, D. C., January 1992
2. Schnormeier, R. H. "Recycled Tire Rubber in Asphalt." Presented at the 71st Annual Meeting of the Transportation Research Board, 1992
3. Chehovits, J.G., "Design Methods for Hot-Mixed Asphalt-Rubber Concrete Paving Materials." Asphalt Rubber Producers Group National Seminar on Asphalt Rubber, Federal Highway Administration, 1989
4. Page, G. C., "Florida's Experience Utilizing Ground Tire Rubber in Asphalt Concrete Mixes." Asphalt Rubber Producers Group National Seminar on Asphalt Rubber, Federal Highway Administration, 1989
5. Rouse, M. "UltraFine Asphalt Cements." Brochure 628, Rouse Rubber Industries, Inc. 1992
6. K.D. Stuart and W.S. Mogawer. Laboratory Evaluation of Verglimit and PlusRide. FHWA. Report No. FHWA-RD-91-013, March 1991

#### **5.4.4 Modification to Equipment**

#### **5.4.5 Modification to Procedures**

### **5.5 References**

7. M.A. Heitzman. State of the Practice—Design and Construction of Asphalt Paving Materials with Crumb Rubber Modifier. FHWA. Report No. FHWA-SA-92-022, May 1992
8. PlusRide II Asphalt User's Manual. EnvirOtire, Inc., June 1992
9. H.B. Takallou, J. McQuillen, and R.G. Hicks. Effect of Mix Ingredients on Performance of Rubber-Modified Asphalt Mixtures. FHWA. Report No. FHWA-AK-RD-85-05, May 1985
10. M.B. Takallou and A. Sainton. Advances in Technology of Asphalt Paving Materials Containing Used Tire Rubber. TRB. Transportation Research Record 1339, 1992
11. J.F. Shook. Experimental Construction of Rubber-Modified Asphalt Pavements in New York State. New York Department of Transportation Research Report, May 16, 1990
12. C.E. Lawrence, B.J. Killackey, and D.F. Lynch. Experimental Hot Mix Pavement With Scrap Tire Rubber at Thamesville, Ontario. Ontario Ministry of Transportation, Report #1, November 1991 Appendix

## **Session 6.0**

---

# **Cost Factors**

---

by

**Mary Stroup-Gardiner  
University of Minnesota**

## 6.0 Contents

---

6.1	Introduction . . . . .	6-3
6.2	Crack and Joint Sealants . . . . .	6-5
6.3	Wet Process . . . . .	6-6
6.4	Dry Process . . . . .	6-12
6.5	Summary . . . . .	6-15
6.6	References . . . . .	6-15

## General First and In-Place Costs Associated with Asphalt Paving Products with Crumb Rubber Modifier

The use of crumb rubber products varies widely throughout the United States. Hot pour crack and joint sealants are currently the most commonly used asphalt cement products with crumb rubber modifier. Over twenty States rank their use of asphalt rubber (AR) crack and/or joint sealants as routine (Figure 6-1a).<sup>1</sup> At least six other States are currently either experimenting with or have pending specifications for these sealants.

The second most common usage of crumb rubber modifier (CRM) is in the production of asphalt rubber binder used in the construction of either chip seals or interlayers. Figure 1b shows that while only two States routinely use asphalt rubber binders for chip seals, another 20 States are either using these binders experimentally (18 States) or have pending specifications (2 States).<sup>1</sup> Figure 6-1c shows that three States routinely use asphalt rubber binder for interlayers, 24 have either experimental sections (22 States) or pending specifications (2 States).

Lastly, crumb rubber can be included in hot mix asphalt (HMA) in the following forms: (1) binder modification accomplished through the addition of crumb rubber into the asphalt cement (asphalt rubber binder (AR)), (2) as an aggregate or mineral filler substitute through the addition of rubber during the asphalt-aggregate mixing process (rubber modified asphalt concrete (RUMAC), or (3) both. Figures 6-1d and 6-1e indicate States using either AR and/or RUMAC<sup>1</sup>. It can be seen that Arizona is the only State that routinely modifies HMA with asphalt rubber binders (Figure 6-1d). However, four States have pending specifications, and at least 25 have used some form of modified dense-graded asphalt concrete. Significantly fewer States (Figure 6-1e) have tried modified open-graded friction course (OGFC). Again, only Arizona routinely uses some form of CRM mixtures; only 10 States have either experimental sections or pending specifications.

The cost of incorporating CRM into any of the above products varies widely. Generally, factors that impact cost are established usage of product, capital costs, increased material costs, and increased operational costs. Additional factors that influence individual project costs are project size, patent royalty fees, and the contractor's "fear factor" associated with unknown impacts on plant processes such as increased fuel costs for higher temperatures, plant/equipment damage, down time changing between modified and unmodified jobs. The purpose of this

### 6.1 Introduction



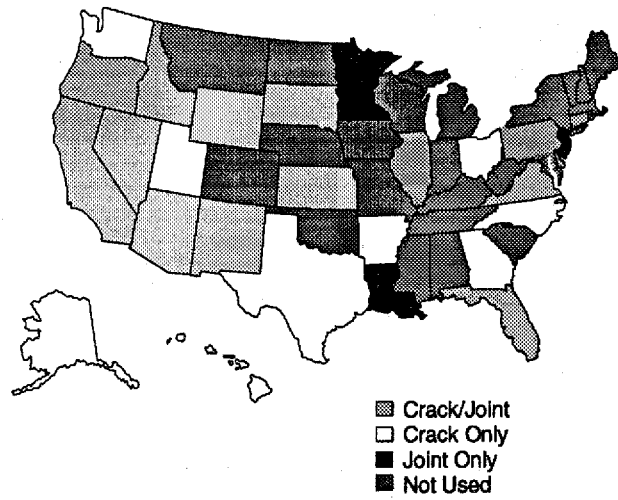


Figure 6-1a. Routine use of rubberized joint and crack sealant

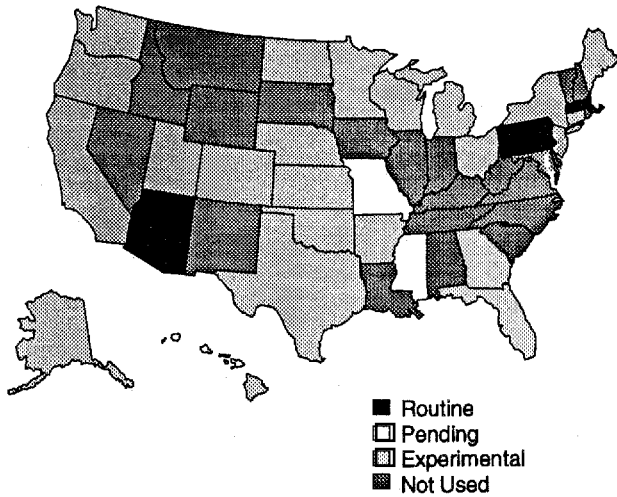


Figure 6-1b. Use of asphalt rubber binders in interlayers

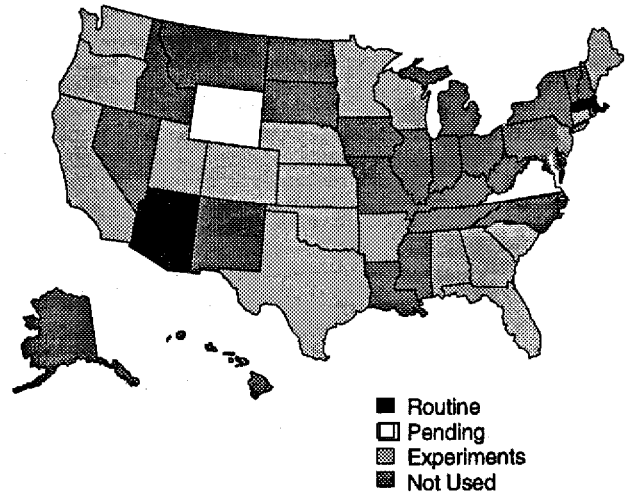


Figure 6-1c. Use of asphalt rubber binders in chip seals

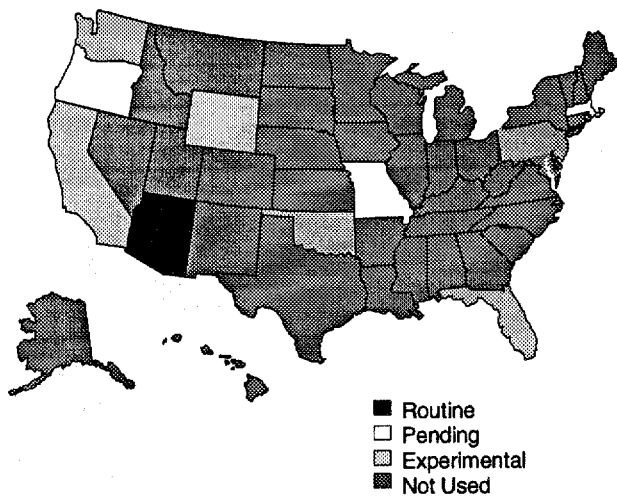


Figure 6-1d. Use of CRM in OGFC

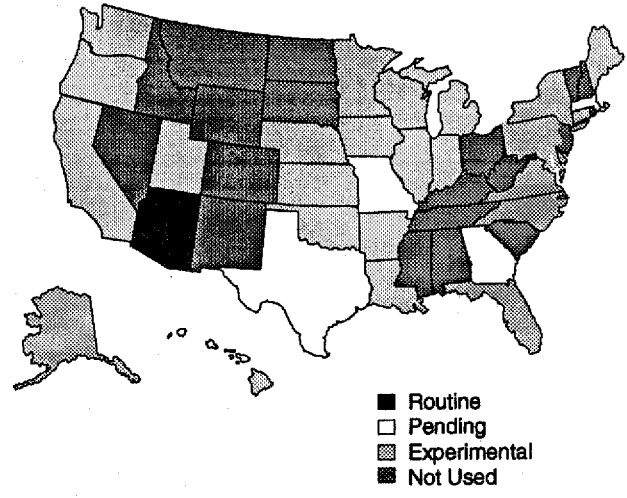


Figure 6-1e. Use of CRM in HMA

paper is to provide the reader with some insight into the costs associated with the various asphalt cement products with crumb rubber modifier.

The majority of hot pour sealants used for joint and crack maintenance are some type of modified asphalt cement product. These modified sealants are a blend of asphalt cements, extender oils, tackifiers, rubbers and/or polymers, antioxidants, and fillers.<sup>2</sup> One of the most common rubber components in these sealants is CRM. Asphalt rubber crack sealants are approximately 15 to 20 percent CRM, which translates into about 200 pounds of crumb rubber used (approximately 15 to 20 tires) for every 1,000 pounds of sealant.

### **Material Costs**

Rubberized crack and joint sealants run from about 15 to 35 cents a pound. Costs depend upon the type of product selected. Asphalt rubber sealants are at the lower end of the range, while either polymer modified or polymer-crumb rubber modified sealants are at the higher end of the range.

By comparison, unmodified sealants (i.e., emulsions, neat asphalt cements) run from 5 to 10 cents a pound. While this might seem to be a significant difference in material costs, these costs are only about 10 to 20 percent of the in-place cost.

### **Equipment and Operation Costs**

The preparation and placing of hot sealants require a melting kettle with a heated oil jacket, good internal agitation, and a suitable pumping system for applying the sealant. This description fits the majority of the sealant equipment already in use. Older equipment with only minor agitation capabilities and no pump are not suitable for placing modified sealants.

New equipment costs, depending upon the capacity and options, range from \$10,000 to \$35,000. Kettles can be either propane or diesel powered. Operating costs range from about \$10/day (approximately 10 gal/fuel/day) for diesel powered equipment to about \$25/day for propane.

## **6.2 Crack and Joint Sealants**

In addition to kettle costs, it is desirable to have some method of routing cracks prior to sealing. Pavement routers for this purpose are typically under \$10,000. Operation costs are around 2 cents a foot for just cutting, or about 5 cents a foot for entire routing operation.

Manpower requirements are usually a three to five person crew. A crew of this size can seal, on the average, 1.5 to 3 lane miles (2,000 to 3,000 pounds of sealant) per day, dependent upon equipment capacity, traffic, and severity of cracking.

### **In-Place Costs**

Typical in-place costs which include site preparation, materials, equipment, and operation, typically run from 15 to 40 cents a foot. This price reflects both the type of materials used as well as the size of the project; smaller jobs are typically more expensive. For example, a pavement in need of an overlay is estimated to need about one ton of sealant per lane mile at a cost of about \$2,000/lane mile in-place. The use of unmodified sealants (assuming a cost of 10 cents/pound) would result in a cost savings of only \$200/lane mile in-place as compared to rubberized sealants (assuming 20 cents/pound) or 10 percent of the total cost.

## **6.3 Wet Process**

Asphalt rubber binders can be used in the construction of chip seals and interlayers, as well as dense-graded, open-graded, and gap-graded mixtures. There are two methods of obtaining asphalt rubber binders. The first is to purchase it from a supplier such as International Surfacing Inc. (ISI), or Rouse Rubber Industries Inc. The second is to retrofit existing plants for the blending and reaction of the asphalt and CRM.

### **Supplier-Produced Asphalt Rubber Binders**

Suppliers of modified binders not only provide the modified binder, but may include other services such as mix designs, plant connections, delivery of material to the plant, and in some cases, quality control services. The price of modified binder per ton reflects these services. The range of services provided by the supplier as well as the costs vary among companies. The cost of supplier-produced asphalt rubber binder ranges from \$200 to \$500 per ton.

### ***Patent Royalties***

Until recently, there were patents on the use of the wet process. The patent covering the use of extender oil as an additive will be in effect for another three years. A typical royalty for using the process is around \$10/ton of asphalt cement. The patent covering the use of diluent as an additive expired in December, 1992. In general, the affect of the patents is not widely known at this time, but should be considered as needed for specific projects.

### **Contractor-Produced Asphalt Rubber Binders**

In order to retrofit existing plants for the on-site modification of asphalt cements, some form of blending, or a combination of blending and reaction tanks are required. Components that need to be added are rubber storage, rubber feed, heated blending tanks (290 to 400°F), and (optional) a heated reaction tank (350 to 400°F).

Rubber storage requirements will depend upon the method used for adding the rubber. Bagged rubber usually comes in 50 to 70 pound kraft paper bags on pallets which are added to the tanks manually. Bulk rubber can be stockpiled (covered) and fed into the tanks via loading buckets, hopper and conveyer systems.

### ***Continuous Blending Systems***

Figure 6-2 shows a general schematic for a metering and blending unit for a continuous blending system.<sup>3</sup> This wet process technology uses a blending unit with agitators and two 500 gallon retention tanks. The unit is also equipped with a booster heater and can be operated in either continuous or batch mode. The output capacity for this size of a system ranges from 100 to 150 gpm of 2 to 20 percent crumb rubber modifier (based on fine rubber gradation). A system of this size can be operated by one person. Operating costs including operator, electricity, maintenance, testing and fuel for booster heater are around \$25/hour. No modifications to the hot-mix plant are required.

Figure 6-2. Continuous blending technology—typical blending unit<sup>3</sup>

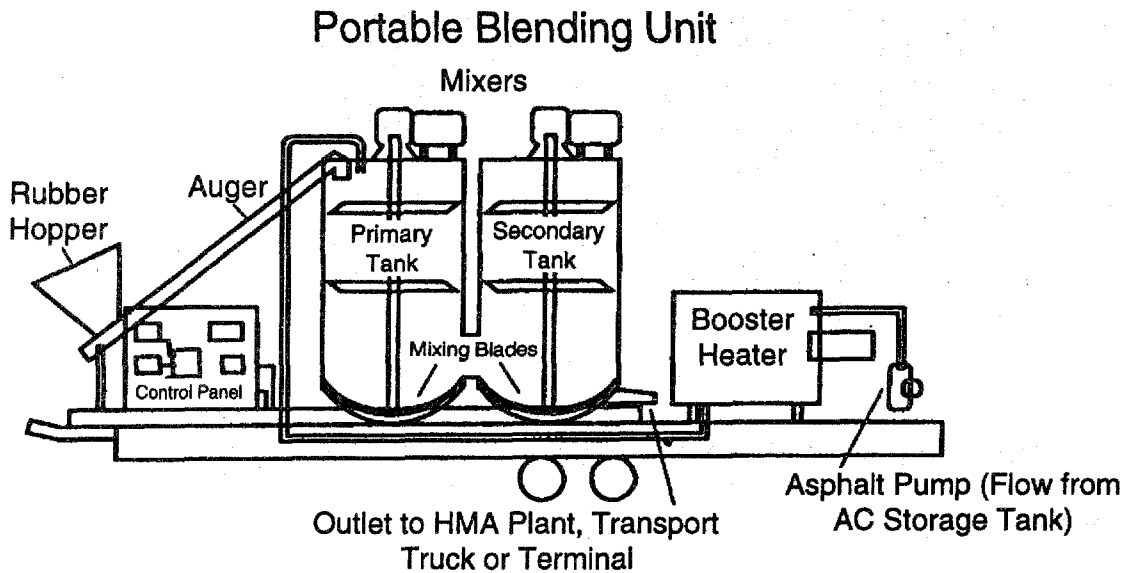
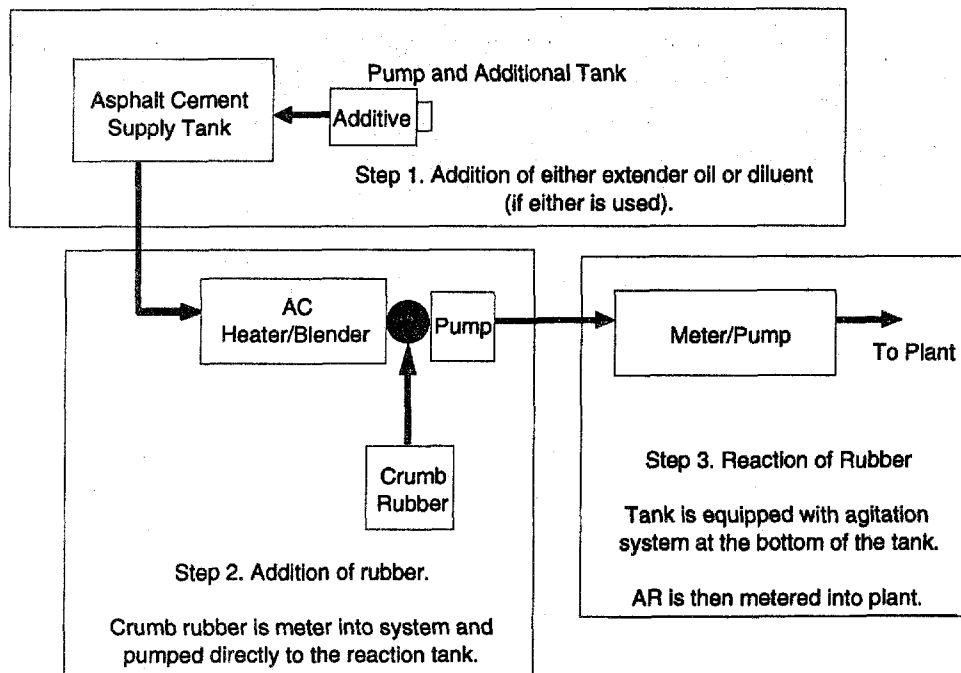


Figure 6-3. McDonald technology—typical blending/reaction system



### ***Blending/Reaction Systems***

For modifying asphalts with a blending/reaction system (McDonald technology), the schematic in Figure 6-3 would be required. All equipment can be trailer-mounted for mobility. The reaction tanker is usually a heated asphalt tanker with a modified agitation system and heat system. A heavy duty pump is required to handle the higher viscosity material; an abrasion-resistant pump is needed to withstand the wear from suspended carbon black particles. Costs associated with the construction of this equipment range from \$100,000 to \$400,000. Costs will vary based on capacity of system, and whether the method of adding rubber is mechanized. Operations of this type of system usually require a three- to four-person crew.

### **Energy Requirements and In-Place Costs**

#### ***Chip Seals and Interlayer***

One of the characteristics of asphalt rubber binders in these types of applications are their ability to be applied at greater quantities per square yard thereby increasing the embedment depth of the aggregate without runoff or puddling problems. Conventional unmodified paving grade binders are placed at quantities of 0.35 to 0.45 gal/yd<sup>2</sup> while asphalt rubber binders are typically placed at quantities of at least 0.60 gal/yd<sup>2</sup> (typical range 0.5 to 0.75 gal/yd<sup>2</sup>). This difference in gallons of binder per square yard is a factor in comparing the cost of unmodified to modified products. In general, unmodified binders range from \$80 to \$150/ton while asphalt rubber binders range from \$200 to \$500/ton. The difference in quantities typically used for each type of material enhances any comparison between project costs (Table 6-1).

**Table 6-1. Typical in-place costs and energy requirements for chips seals and interlayers (assumed local job)**

Category	Typical costs per square yard (\$) (After Ref. 4)		Energy requirements (BTU's/yd <sup>2</sup> ) (After Ref. 4)	
	Asphalt cement (0.45 gal/yd <sup>2</sup> )	Asphalt-rubber (0.60 gal/yd <sup>2</sup> )	Asphalt cement (0.45 gal/yd <sup>2</sup> )	Asphalt-rubber (0.60 gal/yd <sup>2</sup> )
<b>Materials</b>				
Asphalt cement	\$0.26	\$0.22	1,370	1,745
Rubber	NA	\$0.15	NA	1,260 (Grinding of Rubber)
Additive	NA	\$0.03	NA	NA
Aggregate, distribution, traffic control	\$0.35	\$0.35	1,909 (Crushed agg.)	1,909 (Crushed agg.)
<b>Subtotal</b>	<b>\$0.61</b>	<b>\$0.75</b>	<b>3,279</b>	<b>4,914</b>
<b>Binder application</b>				
Asphalt-rubber reaction	NA	\$0.07	NA	40
Asphalt distribution	\$0.09	\$0.12	195	225
<b>Total</b>	<b>\$0.70</b>	<b>\$0.94</b>	<b>3,474</b>	<b>5,179</b>

### **Hot-Mix Asphalt**

A general formula for computing the cost of HMA mixtures with asphalt rubber binder is:<sup>5</sup>

$$Cost_{HMAR} = Cost_{HMA} - (Cost_{AC} \times P_B) + (Cost_{AR} \times P_{AR})$$

Where:

- $Cost_{HMAR}$  = Cost per ton of hot mix with asphalt rubber
- $Cost_{HMA}$  = Cost per ton of conventional hot mix
- $Cost_{AC}$  = Cost per ton of unmodified asphalt cement
- $P_B$  = Percent of asphalt cement binder by total weight of mix (decimal form)
- $Cost_{AR}$  = Cost per ton for asphalt rubber binder
- $P_{AR}$  = Percent of asphalt rubber binder by total weight of mix (decimal form)

The cost per ton for asphalt rubber binder modified by an established supplier ranges between \$200 and \$500/ton. The cost of contractor-supplied asphalt rubber binder is unknown at this time.

Table 6-2 presents examples of the impact of using asphalt rubber binders in typical dense-graded, gap-graded, and open-graded mixtures. Please note that this equation is only a general form and does not reflect any increased costs due to increased mixing and storage temperatures. However, it also does not include any cost savings resulting from the inclusion of mix designs and some quality control work done by the supplier.



**Table 6-2. Examples of estimated costs of HMA, conventional binder, and asphalt rubber binder (using supplier-produced asphalt rubber binder)**

Mixture type	\$/Ton unmodified mixture ( $Cost_{HMA}$ )	\$/Ton unmodified mixture ( $Cost_{AC}$ )	% AC, unmodified mixture ( $P_B$ )	\$/Ton modified binder ( $Cost_{AR}$ )	% AC, modified mixture ( $P_{AR}$ )	Total est. cost of asphalt rubber hot mix ( $Cost_{HMAR}$ )
Dense-graded	\$35	\$100	5.5	\$400	6.5	\$55.50
Gap-graded	\$45	\$100	6.5	\$400	8.0	\$70.50
Open-graded	\$50	\$100	7.5	\$400	9.0	\$78.50

From the highway agency perspective, this increase in cost must be compared to the expected benefit of using the modified binder. Life cycle costs of the HMA needs to be compared to that of conventional mixtures.

## 6.4 Dry Process

The dry process adds CRM as either a mineral filler or aggregate substitute in HMA applications (i.e., dense-graded, gap-graded, and open-grade mixtures). At this time, EnviroTire is the only supplier-produced rubber modified hot-mix asphalt concrete (RUMAC). RUMAC can also be contractor-produced.

### Supplier-Produced RUMAC

PlusRide is currently the only supplier-produced RUMAC product. PlusRide, a method patent, uses a stone mastic aggregate gradation with a combination of coarse and fine CRM. Approximately 60 pounds of CRM are used per ton of RUMAC.

The impact on plant operations is minimal. The cold feed of mineral filler is required and assistance is provided by the supplier for plants not equipped with fine aggregate feed equipment. Any increased operat-

ing costs would be limited to minimal increases in discharge temperature requirements (approximately 20°F above conventional).

### ***Patent Royalties***

Typical royalty fees range from \$20 to \$30 more per ton than conventional HMA. As with the supplier-produced AR, this cost increase includes engineering fees associated with mix design, technical consultation, on-site monitoring, the CRM, and equipment for adding rubber. Typical in-place costs range from \$40 to \$70 per ton.

## **Contractor-Produced RUMAC**

### ***Equipment***

Unlike the extensive equipment costs required with the wet process, the addition of rubber in the dry process requires only a means of storing and feeding the rubber into the plant. A rap hopper can be used for adding CRM, providing that the conveyer belt is capable of weighing the material being added. Assuming that a plant is already fitted with some form of weight-monitored rap feed system, no other equipment modifications are required.

Some trouble has been noted with being able to accurately meter the rubber in this manner. Other difficulties have been noted in segregation when a graded rubber is used. Some additional equipment modification is usually required to remedy these problems. Specific equipment that provides a more accurate blending and addition of rubber (i.e., PlusRide metering system) have been developed to address these problems.

No changes are needed in the construction process, assuming that steel wheel rollers are available.

### ***RUMAC Cost In-Place***

A general formula for estimating the influence of modifying mixtures on in-place cost is:

$$Cost_{RUMAC} = Cost_{HMA} + Cost_{AC}(P_{RUMAC} - P_{HMA}) + Cost_{Rubber}$$

Where:

- $Cost_{RUMAC}$  = Cost per ton of RUMAC  
 $Cost_{HMA}$  = Cost per ton of conventional hot mix asphalt  
 $Cost_{AC}$  = Cost per ton of unmodified asphalt cement  
 $P_{HMA}$  = Percent of asphalt cement binder by total weight of mix (decimal form) for unmodified binder  
 $P_{RUMAC}$  = Percent of asphalt cement binder by total weight of mix (decimal form) for RUMAC  
 $Cost_{Rubber}$  = Raw material costs plus the labor costs involved in adding rubber

Table 6-3 shows three examples for estimating the cost of RUMAC in-place. As with the wet process, this increase in cost must be compared to the expected benefit of using the modified binder. The life cycle costs of the RUMAC need to be compared to those of conventional mixtures.

**Table 6-3. Examples of estimated costs of RUMAC compared to unmodified HMA**

Mixture type	\$/Ton Unmodified	\$/Ton Asphalt	%AC, Unmodified	%AC, Modified	\$/Rubber/Ton HMA* (Cost <sub>Rubber</sub> )			\$/Ton RUMAC (Cost <sub>RUMAC</sub> )		
					1%	2%	3%	1%	2%	3%
Dense-graded	\$35	\$100	5.5	6.5	\$6	\$12	\$18	\$42.00	\$48.00	\$54.00
Gap-graded	\$45	\$100	6.5	7.5	\$6	\$12	\$18	\$52.00	\$58.00	\$64.00
Open-graded	\$50	\$100	7.5	8.5	\$6	\$12	\$18	\$57.00	\$63.00	\$69.00

\* Percentages of rubber based on total weight of mixture. Cost assumed \$0.15/pound for the crumb rubber and \$0.15/pound for labor/handling at plant.

Using asphalt rubber crack and joint sealants will add about 10 percent to the cost of these maintenance operations compared to unmodified sealants. Asphalt rubber modified sealants are one of the lower cost modified sealants.

Use of asphalt rubber binder in the construction of chip seals and inter-layers is approximately 25 percent more expensive; however, this is more of a reflection of the increased binder contents (i.e., from 0.45 to 0.60 gal/yd<sup>2</sup>) than of increased operational costs. These figures are based on relative costs of materials and generic changes in plant operations for contractor-produced materials. Based on current market prices of supplier produced asphalt-rubber binders, the in-place cost would be increased over 30 percent.

The use of asphalt rubber binders (i.e., wet process) in AR can result in a cost increase of approximately 60 percent when supplier-produced modified binder is used. It would seem reasonable that as this material becomes more widely used, free market competition will improve the cost.

The use of RUMAC (generic) would add approximately 15 to 55 percent to the cost of hot mix asphalt concrete, depending upon the percentage of CRM added. Using patented materials would increase the differences in costs compared to unmodified mixtures as well as smaller-sized projects typical of experimental construction projects.

1. Epps, Jon A., Univeristy of Nevada, Surveys of 50 States 1990-1991.
2. CrafcO, Inc., Chandler, Arizona, "Asphalt Crack Sealing, the 'ins' and the 'outs' as well as the 'whys, whens, hows, what with' and the 'should I's'," 1990.
3. Rouse Rubber Industries, Inc., "Suggested Contractor Interconnects for Modular UltraFine™ Metering/Blending Unit," Brochure # 1403—5/5/92.
4. Epps, J.A., Galloway, B.
5. Morris, G.R., Hansen, K.R., "Cost Considerations of Asphalt-Rubber Hot Mix," 4R 1990 Compendium.
6. Caltrans, "Asphalt Rubber Hot-Mix, Gap-Graded Thickness Determination Guide (Interim), March, 1992.
7. "PlusRide II, Asphalt User's Manual," EnvirOtire, Inc., Seattle, Washington, Dec. 1992.

## 6.5 Summary

## 6.6 References



# **Session 7.0**

---

## **Specification Guidelines**

---

**by**

**Michael Heitzman  
Federal Highway Administration**

## 7.0 Contents

---

7.1	Crumb Rubber Modifier . . . . .	7-3
7.2	Asphalt Rubber Binder . . . . .	7-6
7.3	Surface Treatments With Asphalt Rubber Binder . . . . .	7-10
7.4	Hot-Mix Asphalt With Asphalt Rubber Binder . . . . .	7-14
7.5	Rubber Modified Hot-Mix Asphalt . . . . .	7-17

*This specification is intended to be a guide for highway agencies. Appropriate modifications should be made to reflect local conditions and contracting requirements.*

## 1.0 Scope

This specification covers scrap tire crumb rubber for use as a modifier in asphalt paving applications.

## 2.0 Applicable Documents

### AASHTO Standards

- M 17 Mineral Filler for Bituminous Paving Mixtures
- T 2 Sampling Aggregates
- T 27 Sieve Analysis of Fine and Coarse Aggregate
- T 255 Total Moisture Content of Aggregate by Drying

### ASTM Standards

- D 242 Mineral Filler for Bituminous Paving Mixtures
- C 136 Sieve Analysis
- D 297 Methods for Rubber Products—Chemical Analysis (natural rubber content)

## 3.0 General Characteristics

Crumb rubber modifier (CRM) is scrap tire rubber which has been processed by ambient grinding or granulating methods, reducing the rubber to particles which generally pass the 4.75-millimeter (No. 4) sieve. The CRM may be obtained from any combination of passenger and truck tires which meet this specification. It shall be free of injurious amounts of steel, fabric or other deleterious substances as specified in Deleterious Substances below.

## 4.0 Physical Requirements

**4.1 Grading**—The gradation of the CRM shall conform to one of the following gradations.

## 7.1 Crumb Rubber Modifier



Sieve Size	CRM-I	CRM-II	CRM-III	CRM-IV	CRM-V	CRM-VI
	percent of weight passing					
6.3 mm (¼ in.)	100					
4.75 mm (No. 4)	75-100	100				
2.36 mm (No. 8)	35-50	80-100	100			
1.18 mm (No. 16)	20-30	40-70	80-100	100		
600 μm (No. 30)		0-20	40-60	70-100	100	
300 μm (No. 50)			0-20	20-40	40-60	100
150 μm (No. 100)						50-80

A mineral powder (such as calcium carbonate) meeting AASHTO M17 may be added, up to a maximum of 4% by weight, to reduce sticking and caking of the crumb rubber particles.

**4.2 Deleterious Substances**—The fiber content shall be less than 0.1% by weight for spray applications and less than 0.5% by weight for all other applications. The CRM shall contain no metal particles. The moisture content shall be less than 0.75% by weight. Mineral contaminants (prior to the addition of mineral powder) shall not be greater than 0.25% by weight.

## 5.0 Supplementary Requirements

**5.1 Specific Gravity**—The specific gravity of the CRM shall be  $1.15 \pm 0.05$ .

**5.2 Chemical Analysis**—The CRM shall meet the following limits:

natural rubber	15% – 30%
carbon black	25% – 38%
ash	8% maximum
acetone extract	10% – 18%
rubber hydrocarbon	40% – 50%

**5.3 Packaging**—The method of packaging shall take into consideration the proposed CRM production method and the degree to which the gradation of the CRM affects the final paving product. Segregation may occur during shipment, therefore the size of the packaging unit (bag or bulk) shall be approved by the Engineer.

---

When the proposed production method specifies adding whole units of CRM into a batch facility mixing chamber (pugmill), the containers shall be a low density polyethylene material having a melting point of less than 115°C (240°F).

## **6.0 Methods of Sampling and Testing**

The gradation shall be tested in accordance with ASTM C136 using a 50 gram sample.

Fiber content shall be determined by weighing fiber balls which are formed during the gradation test procedure. Rubber particles shall be removed from the fiber balls before weighing.

The metal content shall be determined by thoroughly passing a magnet through a 50 gram sample.

The moisture content shall be determined in accordance with AASHTO T255, using a controlled temperature oven at 60°C (140°F) and 50 gram sample.

The mineral contaminant content shall be determined by saline float separation. Stir a 50 gram sample into a 1 liter glass beaker filled with saline solution (1 part table salt into 3 parts distilled water) and allow the sample to stand for 30 minutes. The mineral contaminant is that material which does not float to the top of the beaker.

## 7.2 Asphalt Rubber Binder

*This specification is intended to be a guide for highway agencies. Appropriate modifications should be made to reflect local conditions and contracting requirements.*

*Asphalt rubber may be covered by patents 4,609,182; 4,085,078; 4,068,023; 3,891,585; 4,166,049. Any use of this technology should include a determination of the validity of the patent rights and risk of infringement.*

### 1.0 Scope

This specification covers asphalt rubber binder graded by climate zones for use in asphalt paving construction.

### 2.0 Applicable Documents

#### Crumb Rubber Modifier Material Specification

#### AASHTO Standards

M226	Viscosity Graded Asphalt Cement
M20	Penetration Graded Asphalt Cement
T49	Penetration of Bituminous Materials
T51	Ductility of Bituminous Materials
T179	Effect of Heat and Air on Asphalt Materials (Thin-Film Oven Test)

#### ASTM Standards

D2994	Standard Test Methods for Rubberized Tar
D36	Standard Test Methods for Softening Point of Bitumen (Ring and Ball)
D3407	Standard Test Methods for Joint Sealants, Hot-Poured, for Concrete and Asphalt Pavements
D88	Standard Test Method for Saybolt Viscosity
D92	Standard Test Method for Flash and Fire Points by Cleveland Open Cup
D2007	Test Method for Characteristic Groups in Rubber Extender and Processing Oils by the Clay-Gel Absorption Chromatographic Method

### 3.0 General Characteristics

Asphalt rubber binder is an asphalt cement binder modified with crumb rubber modifier (CRM). An extender oil may be added to supplement the composition of the binder. The blend of asphalt and CRM is allowed to interact prior to incorporation into the construction.

### 4.0 Binder Requirements

**4.1 Asphalt Cement**—The asphalt cement shall meet the requirements of AASHTO M226 or M20. The selected source and grade shall be compatible with the CRM to provide a uniform blend meeting the specified asphalt rubber binder properties.

**4.2 Crumb Rubber Modifier**—The CRM shall meet the requirements of the CRM Material Specification. The selection of the CRM properties, particularly the gradation, shall be established in the job mix formula (JMF) design.

**4.3 Asphalt Extender Oil**—The extender oil shall be a resinous, high flash point, aromatic hydrocarbon meeting the following test requirements:

viscosity, SSU, 38°C (100°F) ASTM D88	2500 min.
flash point, COC, ASTM D92	199°C (390°F) min.
asphaltenes, % by weight, ASTM D2007	0.1 max.
aromatics, % by weight, ASTM D2007	55.0 min.

**4.4 Asphalt Rubber Binder**—The asphalt rubber binder shall conform to the requirements given in Table 7-1.

### 5.0 Manufacturing Requirements

Asphalt rubber binder shall be prepared by blending and reacting the materials in accordance with the conditions and the proportions established by the designed JMF. The equipment shall be capable of preheating the asphalt cement to the reaction temperature, accurately proportioning the materials, blending the materials into a uniform mix-

ture and maintaining circulation and even heat distribution at the reaction temperature during the reaction phase.

### **6.0 Methods of Sampling and Testing**

Measuring the apparent viscosity of the asphalt rubber binder may be determined using a portable rotational shear viscometer in lieu of a Brookfield (ASTM 2994). The portable viscometer shall be correlated against the Brookfield for each modified binder developed. A standard test procedure shall be established for the particular portable viscometer.

Table 7-1. Requirements for asphalt rubber binder grades

Grade	ARB-1	ARB-2	ARB-3
	Climate Zone		
	Hot	Moderate	Cold
Test Method			
Highest mean weekly temp. °C (°F)	>38 (>100)	26 to 38 (80 to 100)	<26 (<80)
Lowest mean monthly temp. °C (°F)	>0 (>30)	-12 to 0 (10 to 30)	<-12 (<10)
Apparent viscosity (P) 175°C (347°F) ASTM D2994 spindle 3, 12 rpm	1000 min  4000 max	1000 min  4000 max	1000 min  4000 max
Penetration (1/10 mm) 25°C (77°F) AASHTO T49 100 gram, 5 sec	25 min  75 max	50 min  100 max	75 min  150 max
Penetration (1/10 mm) 4°C (39.2°F) AASHTO T49 200 gram, 60 sec	15 min	25 min	40 min
Softening point °C ASTM D36 (°F)	54 min (130 min)	49 min (120 min)	43 min (110 min)
Resilience (percent) 25°C (77°F) ASTM D3407	20 min	10 min	0 min
Ductility (cm) 4°C (39.2°F) AASHTO T51 1 cm/min	5 min	10 min	20 min
Tests on thin film oven residue, AASHTO T179			
Penetration (percent of original retained) 4°C (39.2°F) AASHTO T49 200 gram, 60 sec	75 min	75 min	75 min
Ductility (percent of original retained) 4° (39.2°F) AASHTO T51 1 cm/min	50 min	50 min	50 min

*Note: The binder measured for compliance shall include the extender oil and any other additive proposed in the job mix formula.*

### 7.3 Surface Treatments With Asphalt Rubber Binder

*This specification is intended to be a guide for highway agencies. Appropriate modifications should be made to reflect local conditions and contracting requirements.*

#### 1.0 Description

This work shall consist of the application of asphalt rubber binder followed by an application of cover aggregate.

#### 2.0 Materials

The materials for this work shall meet the following requirements:

**2.1 Asphalt Rubber Binder**—The asphalt rubber binder shall meet the requirements of the Asphalt Rubber Binder Material Specification. The selection of the grade of asphalt rubber binder shall be determined as a part of the job mix formula (JMF) design.

**2.2 Cover Aggregate**—Aggregates shall be crushed stone, crushed slag, crushed gravel or natural gravel. Only one type of aggregate shall be used. Aggregates shall meet the requirements of AASHTO M283. If specified in the JMF, the aggregate shall be precoated with asphalt.

The aggregate shall have a retained asphalt film above 95 percent when tested in accordance with AASHTO T182. Aggregates that do not meet this requirement may be considered if a satisfactory anti-stripping additive is used.

**2.3 Binder Diluent**—The binder diluent shall be a kerosene-type diluent compatible with all other materials as determined in the JMF design. The kerosene shall meet the following additional requirements:

Flash Point (ASTM D92)	27°C (80°F) minimum
Initial Boiling Point (ASTM D850)	177°C (350°F) minimum
Dry Point (ASTM D850)	232°C (450°F) maximum

*NOTE: All kerosene may not meet these requirements.*

**2.4 Job Mix Formula**—The job mix formula (JMF) shall specify the source, composition and proportion of the aggregate, asphalt rubber binder and additives for each surface treatment to be supplied for the

contract. Only the materials approved in the JMF may be used. All surface treatment materials incorporated into the project shall conform to the individual tests' tolerance ranges established in the JMF.

The JMF shall be established by the Contractor and approved by the Engineer in accordance with the mix design specifications. At least 30 days prior to production, the Contractor shall submit to the Engineer a JMF for each mixture, the supporting test data, and samples of materials from each source. The JMF for each surface treatment shall be in effect until a modification is approved by the Engineer.

### 3.0 Construction Requirements

**3.1 Weather Limitations**—The application of an asphalt rubber surface treatment shall only be permitted under the following minimum conditions and when weather conditions will permit proper construction.

ambient air temperature	15°C (60°F) and rising
surface temperature	15°C (60°F) minimum
surface condition	dry

**3.2 Delays**—When a delay in surface treatment application occurs, the asphalt rubber binder shall be allowed to cool. Just prior to use, the asphalt rubber shall be slowly reheated to the specified JMF mixing temperature, thoroughly mixed, and the viscosity checked. If the viscosity is outside the JMF specification, the asphalt rubber binder in question shall not be accepted for further use.

### 3.3 Equipment

**Distributor.** The distributor shall be capable of uniformly applying the asphalt rubber binder at the temperature and application rate specified in the JMF. The distributor shall be equipped to maintain the specified temperature and provide continuous circulation of the binder in the tank and distributor bar to maintain binder homogeneity. The distributor shall be equipped with appropriate gauges and meters for monitoring the operation.

**Aggregate Spreader.** The aggregate spreader shall be self-propelled and of sufficient capacity to apply the aggregate within the specified time. The spreader shall have positive controls



to deposit the quantity of material required in the JMF uniformly over the full width of the binder application.

**Rollers.** The rollers shall be self-propelled, pneumatic tire and capable of reversing without backlash. Each tire shall be inflated to a minimum of 700 kPa (100 psi) and carry a minimum 1,360 kg (3,000 lb). The number of rollers and speed of operation shall be approved by the Engineer.

**3.4 Surface Preparation**—The entire surface shall be cleaned using approved methods until the surface is acceptable to the Engineer. After cleaning, the surface shall receive a tack coat as directed in the JMF.

**3.5 Preparation of Asphalt Rubber Binder**—Production of the binder shall conform to the Asphalt Rubber Binder Material Specification. The binder shall be maintained at the specified mixing temperature without local overheating and shall be circulated to maintain uniformity until it is applied to the pavement surface.

**3.6 Application of the Binder**—The rate of application shall be specified in the JMF. The amount of binder applied shall not exceed the capability of the aggregate spreader and rollers to immediately cover the application and properly embed the aggregate.

The binder viscosity may be adjusted to improve the spray application by adding a kerosene diluent. The type and amount of diluent shall be established in the JMF. The addition of the diluent should occur in the distributor immediately prior to the spray application. The blending process should achieve a uniform viscosity in the minimum possible time. When a diluent is used, the binder temperature for spraying shall not exceed 150°C (300°F).

Building paper shall be used at the beginning and end of each application of the binder. Proper construction techniques shall be used for longitudinal and construction joints.

**3.7 Application of the Cover Aggregate**—The application of the cover aggregate shall immediately follow the application of the binder. Spreading shall be accomplished so the tires of the trucks and aggregate spreader do not contact the uncovered binder. The rate of aggregate spread shall comply with the JMF.

The entire application of cover aggregate shall be rolled immediately after the aggregate is placed. The rolling pattern shall properly embed the

---

cover aggregate into the binder. A minimum of three passes of the pneumatic roller shall be obtained.

After the rolling is completed, the entire surface shall be lightly swept to remove any loose cover aggregate. Traffic will not be permitted on the surface until the asphalt rubber binder has cured sufficiently to minimize any dislodging of cover aggregate.

#### **4.0 Method of Measurement**

#### **5.0 Basis of Payment**

## 7.4 Hot-Mix Asphalt With Asphalt Rubber Binder

*This specification is intended to be a guide for highway agencies. Appropriate modifications should be made to reflect local conditions and contracting requirements.*

### 1.0 Description

This specification provides general requirements that are applicable to all types of hot mix asphalt concrete using asphalt rubber binder (HMAR) irrespective of aggregate type and gradation, type and amount of binder or pavement use.

This work shall consist of one or more courses of HMAR constructed on a prepared foundation.

### 2.0 Materials

The materials for this work shall meet the following requirements:

**2.1 Asphalt Rubber Binder**—The asphalt rubber binder shall meet the requirements of the Asphalt Rubber Binder Material Specification. The selection of the grade of asphalt rubber binder shall be determined as a part of the job mix formula (JMF) design.

**2.2 Coarse Aggregate**—Coarse aggregate (retained on the 2.36 mm (No. 8) sieve) shall be crushed stone, crushed slag, or crushed gravel meeting the requirements of AASHTO M283.

**2.3 Fine Aggregate**—Fine aggregate (passing the 2.36 mm (No. 8) sieve) shall consist of stone screenings, slag screenings, manufactured sand, natural sand, or a combination thereof, meeting the requirements of AASHTO M29.

**2.4 Mineral Filler**—Mineral filler shall meet the requirements of AASHTO M17.

**2.5 Additives**—Anti-stripping and/or other additives (in addition to crumb rubber) shall be approved in the JMF. Additives shall be added at the specified rate using appropriate in-line blending or other approved method.

**2.6 Job Mix Formula**—The job mix formula (JMF) shall specify the source, composition and proportion of the aggregates, mineral filler,

asphalt rubber binder and additives for each mixture to be supplied for the contract. Only the materials approved in the JMF may be used. All mixtures incorporated into the project shall conform to the individual tests' tolerance ranges established in the JMF.

The JMF shall be established by the Contractor and approved by the Engineer in accordance with the mix design specifications. At least 30 days prior to production, the Contractor shall submit to the Engineer a JMF for each mixture, the supporting test data, and samples of materials from each source. The JMF for each mixture shall be in effect until a modification is approved by the Engineer.

### 3.0 Construction Requirements

**3.1 Weather Limitations**—The HMAR shall only be placed under the following minimum conditions and when weather conditions will permit proper construction.

For compacted thickness less than 1½ inches:

ambient air temperature	15°C (60°F) and rising
surface temperature	15°C (60° F) minimum
surface condition	dry

For compacted thickness 1½ inches and greater:

ambient air temperature	10°C (50°F) and rising
surface temperature	10°C (50°F) minimum
surface condition	dry

**3.2 Delays**—When a delay in HMAR production occurs, the asphalt rubber binder shall be allowed to cool. Just prior to use, the asphalt rubber shall be slowly reheated to the specified JMF mixing temperature, thoroughly mixed and the viscosity checked. If the viscosity is outside the JMF specification, the asphalt rubber binder in question shall not be accepted for further use.

**3.3 Equipment**—Equipment used for the production, placement and compaction of HMAR shall conform to the AASHTO Guide Specifications for Highway Construction with the following modifications:

The hot mix asphalt mixing facility shall have automatic controls that coordinate the proportioning, timing and discharge of the mixture.

The hauling equipment and compaction rollers may be thinly coated with a light application of a non-petroleum based wetting agent to reduce sticking of the mixture to the equipment. Oiling the surfaces with kerosene or diesel fuel will not be permitted.

Pneumatic-tired rollers will not be used.

**3.4 Surface Preparation**—Surface preparation shall conform to the AASHTO Guide Specifications for Highway Construction.

**3.5 Preparation of Asphalt Rubber Binder**—Production of the binder shall conform to the Asphalt Rubber Binder Material Specification. The binder shall be maintained at the specified mixing temperature without local overheating and shall be circulated to maintain uniformity until it is metered into the hot mix facility mixing chamber.

**3.6 Mixing, Placing and Compacting**—Mixing, placing and compaction shall conform to the JMF and the AASHTO Guide Specifications for Highway Construction.

#### **4.0 Method of Measurement**

#### **5.0 Basis of Payment**

*This specification is intended to be a guide for highway agencies. Appropriate modifications should be made to reflect local conditions and contracting requirements.*

*Rubber modified hot mix asphalt concrete may be covered by patents 4,086,291 and 4,548,962. Any use of this technology should include a determination of the validity of the patent rights and risk of infringement.*

## **1.0 Description**

This specification provides general requirements that are applicable to all types of rubber modified hot mix asphalt concrete (RUMAC) irrespective of aggregate type and gradation, crumb rubber type and gradation, type and amount of asphalt binder, or pavement use.

This work shall consist of one or more courses of RUMAC constructed on a prepared foundation.

## **2.0 Materials**

The materials for this work shall meet the following requirements:

**2.1 Asphalt Binder**—The asphalt binder shall meet the requirements of the AASHTO M266 or M20. The selection of the grade of asphalt binder shall be determined as a part of the job mix formula (JMF) design.

**2.2 Coarse Aggregate**—Coarse aggregate (retained on the 2.36 mm (No. 8) sieve) shall be crushed stone, crushed slag, or crushed gravel meeting the requirements of AASHTO M283.

**2.3 Fine Aggregate**—Fine aggregate (passing the 2.36 mm (No. 8) sieve) shall consist of stone screenings, slag screenings, manufactured sand, natural sand, or a combination thereof, meeting the requirements of AASHTO M29.

**2.4 Mineral Filler**—Mineral filler shall meet the requirements of AASHTO M17.

**2.5 Crumb Rubber**—Crumb rubber shall meet the requirements of the Crumb Rubber Modifier Material Specification. The selection of the

## **7.5 Rubber Modified Hot-Mix Asphalt**

CRM properties, particularly process method and gradation, shall be determined as a part of the JMF design.

All crumb rubber retained on the 2.36 mm (No. 8) sieve shall be cubical in shape and individual particles shall have a flat or elongation ratio no greater than 2:1.

**2.6 Additives**—Anti-stripping and/or other additives shall be approved in the JMF. Additives shall be added at the specified rate using appropriate in-line blending or other approved method.

**2.7 Job Mix Formula**—The job mix formula (JMF) shall specify the source, composition and proportion of the aggregates, mineral filler, crumb rubber, asphalt binder and additives for each mixture to be supplied for the contract. Only the materials approved in the JMF may be used. All mixtures incorporated into the project shall conform to the individual tests' tolerance ranges established in the JMF.

That JMF shall be established by the Contractor and approved by the Engineer in accordance with the mix design specifications. At least 30 days prior to production, the Contractor shall submit to the Engineer a JMF for each mixture, the supporting test data, samples of materials from each source, and a production work plan. The work plan shall detail the equipment and sequence for adding the crumb rubber into the mixing process. The JMF for each mixture shall be in effect until a modification is approved by the Engineer.

### 3.0 Construction Requirements

**3.1 Weather Limitations**—The RUMAC shall only be placed under the following minimum conditions and when weather conditions will permit proper construction.

For compacted thickness less than 1½ inches:

ambient air temperature	15°C (60°F) and rising
surface temperature	15°C (60°F) minimum
surface condition	dry

For compacted thickness 1½ inches and greater:

ambient air temperature	10°C (50°F) and rising
surface temperature	10°C (50°F) minimum
surface condition	dry

**3.2 Equipment**—Equipment used for the production, placement and compaction of RUMAC shall conform to the AASHTO Guide Specifications for Highway Construction with the following modifications:

The hot mix asphalt mixing facility shall have automatic controls that coordinate the proportioning, timing and discharge of the mixture. The facility shall be capable of uniformly feeding and measuring the amount of crumb rubber placed into the mixing chamber.

Transporting RUMAC on rubber belts is prohibited.

Drum mixing facilities shall not add the crumb rubber to the aggregate cold feed system. The crumb rubber must be added beyond the aggregate drying and heating section of the mixing chamber.

The hauling equipment and compaction rollers may be thinly coated with a light application of a non-petroleum based wetting agent to reduce sticking of the mixture to the equipment. Oiling the surfaces with kerosene or diesel fuel will not be permitted.

Pneumatic-tired rollers will not be used.

**3.3 Surface Preparation**—Surface preparation shall conform to the AASHTO Guide Specifications for Highway Construction.

**3.4 Mixing, Placing and Compacting**—Mixing, placing and compacting shall conform to the JMF and AASHTO Guide Specifications for Highway Construction with the following modifications:

When the production method uses units of CRM for proportion at a batch facility, the batch size and CRM unit size shall be adjusted to use whole units of CRM. Adding partial units of CRM into the mixing chamber will not be permitted.

Finish rolling shall continue until the temperature of the mat drops below 60°C (140 °F).



---

**4.0 Method of Measurement**

**5.0 Basis of Payment**

## **Session 8.0**

---

# **Pavement Applications**

---

**by**

**Freddy Roberts  
Louisiana Tech University**

## 8.0 Contents

---

8.1	Asphalt Rubber—Crack/Joint Sealant . . . . .	8-3
8.2	Asphalt Rubber—SAM . . . . .	8-4
8.3	Asphalt Rubber—SAMI . . . . .	8-5
8.4	Asphalt Rubber—Dense-graded HMA . . . . .	8-6
8.5	Asphalt Rubber—Gap-graded HMA . . . . .	8-7
8.6	Asphalt Rubber—OGFC . . . . .	8-8
8.7	Gap-graded RUMAC . . . . .	8-9
8.8	Dense-graded RUMAC . . . . .	8-10

*CRM Product:* Asphalt Rubber

*Paving Product:* Crack/Joint Sealant, ASTM D3405, D3406, D5078

*Pavement Applications:*

	New construction	Rehabilitation
Surface course		X
Base course		X

*Principal Distress Countered:* moisture

*Mechanism to Achieve Performance:*

This material is designed to seal cracks and joints to prevent penetration of water and surface debris into the pavement structure. If not kept sealed, distresses such as spalling, pumping, etc., may develop.

*Precautions/Applications Limitations:*

- A. Choose a sealant that is consistent with the environment, pavement type, movement of the opening being sealed, shape/size of the opening, life required of sealant, and traffic-construction considerations. Asphalt rubber sealant is not recommended for new PCC pavements.
- B. Properly prepare the pavement to ensure that the manufacturer's recommendations are followed on such items as shape factor, application temperatures, pot life, etc.

## 8.1 Asphalt Rubber— Crack/Joint Sealant

## 8.2 Asphalt Rubber—SAM

*CRM Product:* Asphalt Rubber

*Paving Product:* Stress Absorbing Membrane (SAM)

*Pavement Applications:*

	New construction	Rehabilitation
Surface course	X	X
Base course		

*Principle Distress Countered:* reflective cracking, moisture

*Mechanism to Achieve Performance:*

An asphalt rubber spray-applied membrane forms an elastic, impermeable layer capable of stretching with the crack movement without rupturing.

*Precautions/Application Limitations:*

- A. No structural strength added to pavement.
- B. Works best for cracks that do not open and close much, i.e.,
  - Fatigue cracks that do not rock (move) under load and have not deteriorated (spalling).
  - Block cracks that are narrow which have not deteriorated (spalling).
- C. Does not work well for reflect;on cracks caused by:
  - PCC slab Joints or cracks where spacing >15 ft.
  - Faulted PCC slabs.
  - Badly deteriorated (spalling) thermal or block cracks.
  - Cement treated base reflection cracks.
  - Soil cement base reflection cracks.
  - Transverse thermal cracks in AC pavements.
- D. Construction process is critical—must achieve design binder spray rate and design aggregate spread rate, followed by proper embedment.

*CRM Product:* Asphalt Rubber

*Paving Product:* Stress-absorbing Membrane Interlayer (SAMI)

*Pavement Applications:*

	New construction	Rehabilitation
Surface course		
Base course		X

*Principal Distress Countered:* reflective cracking

*Mechanism to Achieve Performance:*

Intercept crack tip with an elastic membrane material that can absorb the stress and delay cracking.

*Precautions/Application Limitations:*

- A. Works best for cracks that do not open and close much, i.e.,
  - Fatigue cracks that do not rock (move) under load and have not deteriorated (spalling).
  - Block cracks that are narrow which have not deteriorated (spalling).
- B. Does not work well for reflection cracks caused by:
  - PCC slab joints or cracks where spacing >15 ft.
  - Faulted PCC slabs
  - Badly deteriorated (spalling) thermal or block cracks—should consider milling deteriorated material and/or in-place recycling to break up distress patterns.
  - Cement treated base reflection cracks.
  - Soil cement base reflection cracks.
  - Transverse thermal cracks in AC pavements.
- C. Construction process is critical—must achieve design binder spray rate and design aggregate spread rate, followed by proper embedment.
- D. Applications have involved placing the interlayer near the surface of the existing pavement. May be placed directly on non-deteriorated pavements. Should be placed on top of a thin leveling course over a deteriorated pavement.
- E. Applications which involve the addition of a diluent to the asphalt rubber binder to reduce spray viscosity must be allowed to cure prior to overlaying.

### 8.3 Asphalt Rubber— SAMI

## 8.4 Asphalt Rubber— Dense-graded HMA

*CRM Product:* Asphalt Rubber

*Paving Product:* Dense-graded Hot-mix Asphalt

*Pavement Applications:*

	New construction	Rehabilitation
Surface course	X	X
Base course	X	X

*Principal Distresses Countered:* fatigue cracking, rutting, and reflective cracking.

*Mechanisms to Achieve Performance:*

Improved binder properties—elasticity increases fatigue life, reduced temperature susceptibility increases rutting resistance and/or reduces low temperature cracking, and durability reduces aging.

*Precautions/Application Limitations:*

- A. Mixtures designed with asphalt rubber binder require slight modifications to design procedures, criteria for field control, and construction practices.
- B. Works best for improved fatigue life and resistance to reflection cracking from non-working cracks (fatigue cracks, block cracking). Can improve rutting resistance when proper aggregate gradations are selected.
- C. Will not improve resistance to reflective cracking from working cracks/joints (faulting, thermal cracking, >15' joint spacing).

*CRM Product:* Asphalt Rubber

*Paving Product:* Gap-graded Hot-mix Asphalt

*Pavement Applications:*

	New construction	Rehabilitation
Surface course	X	X
Base course	X	X (like SAMI)

*Principal Distress Countered:* fatigue cracking, rutting, and reflection cracking

*Mechanisms to Achieve Performance:*

- Improved binder properties—elasticity increases fatigue life, reduced temperature susceptibility reduces low temperature cracking, and durability reduces aging.
- Increased binder content—more elastic binder to retard reflective cracking and thicker binder films to retard aging.
- Gap-graded aggregate—increases stability to resist rutting.

*Precautions/Application Limitations:*

- A. Mixtures designed with asphalt rubber binder and gap graded aggregate require modifications to design procedures, criteria for field control, and construction practices. Present mix designs are trial and error to determine maximum allowable binder content.
- B. Works best for resistance to reflection cracking from non-working cracks (fatigue cracks, block cracking) and minor working cracks. Will not improve resistance to reflective cracking from major working cracks and joints.
- C. Could replace SAM's in urbanized areas to eliminate loose aggregate particles.

**8.5 Asphalt Rubber—Gap-graded HMA**



**8.6 Asphalt Rubber—OGFC**

*CRM Product:* Asphalt Rubber

*Product Application:* Open-graded Friction Course (OGFC)

*Pavement Applications:*

	New construction	Rehabilitation
Surface course	X	X
Base course		

*Principal Distress Countered:* surface texture, splash and spray

*Mechanisms to Achieve Performance:*

- Increased viscosity increases film thickness which enhances aggregate retention, reduces draindown which increases resistance to moisture damage, and reduces aging which extends the life of the OGFC.
- Open graded aggregate gradation provides a porous surface to remove water and reduce splash and spray.

*Precautions/Application Limitations:*

- A. OGFC mixture designs with asphalt rubber binder require modifications to the design procedures, criteria for field control, and construction practices. Optimum mixing and placement temperatures will increase because of the higher viscosity of the CRM binder.
- B. Friction characteristics are not affected by binder type.
- C. OGFC could replace SAM's in urbanized areas.

*CRM Product:* RUMAC—Rubber-modified Hot-mix Asphalt Concrete

*Paving Product:* Gap-graded Hot-mix Asphalt

*Pavement Applications:*

	New construction	Rehabilitation
Surface course	X	X
Base course	X (large stone)	X (like SAMI)

*Principal Distresses Countered:* rutting, reflective cracking

*Mechanisms to Achieve Performance:*

- Gap graded aggregate increases stability to resist rutting.
- Increased binder content provides thicker binder films to retard aging.
- Rubber aggregate particles retard reflective cracking.

*Precautions/Application Limitations:*

- A. Mixture design procedure does not follow either Marshall or Hveem procedures but rather uses air voids criteria (2 to 4 percent). Field control and construction practices are also modified.
- B. Aggregate and CRM gradations are a recipe type specification or designed for each mixture.
- C. Compaction must continue until mat cools to 140°F to reduce the effect of rubber partial swell at elevated temperatures.
- D. This gap graded mixture is more sensitive to proper design and construction.

## 8.7 Gap-graded RUMAC

**8.8 Dense-graded RUMAC**

*CRM Product:* RUMAC—Rubber-modified Hot-mix Asphalt Concrete

*Paving Product:* Dense-graded Hot-mix Asphalt

*Pavement Applications:*

	New construction	Rehabilitation
Surface course		
Base course	X	X

*Principal Distresses Countered:* reflective cracking

*Mechanisms to Achieve Performance:* rubber aggregate particles may retard reflective cracking.

*Precautions/Application Limitations:*

- A. Mixture design procedures for dense graded RUMAC require modified design procedures, field control, and construction practices.
- B. Aggregate and CRM gradations are designed for each mixture.
- C. Compaction must continue until mat cools to 140°F to reduce the effect of rubber partial swell at elevated temperatures.
- D. This dense graded mixture is more sensitive to proper design and construction.

**Session 9.0**

---

**Binder Design  
Procedures**

---

by

**James G. Chehovits  
Crafco, Inc.**

## 9.0 Contents

---

9.1	Introduction . . . . .	9-3
9.2	Reaction Between Asphalt Cement and Tire Rubber . . . . .	9-3
9.3	Measurement of Physical Properties . . . . .	9-6
9.4	Factors Which Influence Asphalt Rubber Properties . . . . .	9-10
9.5	Design Process for Asphalt Rubber Blends . . . . .	9-19
9.6	Various Highway Applications . . . . .	9-21
9.7	Summary . . . . .	9-25
9.8	References . . . . .	9-26

## Design of Asphalt and Crumb Rubber Modifier Blends for Highway Applications

Tire rubber has been used as an additive to asphalt cement in various applications in highways for over 40 years. Generally, the tire rubber has been ground to a particulate or crumb form prior to use. This form of tire rubber is designated as Crumb Rubber Modifier (CRM). When the CRM is added to asphalt cement, the rubber particles will interact with the asphalt and swell. The swelling process is dependent on many factors such as the physical and compositional characteristics of the asphalt and CRM, temperature, time and mixing conditions. The Federal Highway Administration (FHWA) defines Asphalt Rubber (AR) as "asphalt cement modified with CRM".<sup>1</sup> If a sufficient quantity of CRM is added to the asphalt, and the blend is subjected to conditions that facilitate the swelling process, the properties of the mixture will change significantly. The FHWA definition does not indicate ranges of applicable rubber contents and, therefore, can be applied to any blend of asphalt and CRM. The ASTM definition of asphalt rubber<sup>2</sup> requires a minimum of 15 percent rubber which will achieve a binder with modified properties. For purposes of the paper, the FHWA definition of AR is being used. The properties and use of AR materials for various paving and maintenance applications have been documented in the literature. Properties of AR materials have been extensively studied and are reported in references 3 through 14. Reported uses include: (1) stress absorbing membranes (SAM) and interlayers (SAMI),<sup>15-27</sup> (2) binder for hot-mixed paving applications,<sup>28-37</sup> and (3) pavement crack and joint sealants.<sup>37, 38</sup>

The objective of this paper is to provide an understanding of factors that need to be considered during the binder design process for AR blends for various highway applications. Specific areas covered include: (1) the interaction between asphalt cement and CRM, (2) test methods that can be used to determine material properties, (3) factors that influence the interaction between asphalt cement and CRM, (4) the design process for asphalt and CRM, and (5) asphalt and CRM blends for various highway applications.

Asphalt cements are composed of a variety of petroleum fractions. Standard classification of these fractions are: (1) asphaltenes, (2) resins, (3) cyclics, and (4) saturates. Compositional ranges for the fractions can vary widely for asphalts from different crudes and refining techniques. Typical variations are: (1) asphaltenes are from 5 to 25 percent, (2) res-

### 9.1 Introduction

### 9.2 Reaction Between Asphalt Cement and Tire Rubber

ins from 10 to 35 percent, (3) cyclics from 40 to 65 percent, and (4) saturates from 5 to 20 percent.<sup>39</sup> Asphalt cement also varies in physical properties such as stiffness, temperature susceptibility, and aging for various sources and grades available.

Tire rubber is composed of a variety of rubber compounds that are used in different portions of tires. Additionally, differing rubber compounds are used in different tire types. The compositional analysis method that is typically used for tire rubber is ASTM D297.<sup>40</sup> Applicable portions of this method can be used to analyze the five typical fractions of tire rubber such as: (1) acetone extractables, (2) ash, (3) carbon black, (4) synthetic rubber, and (5) natural rubber. Lagrone<sup>41</sup> has reported that rubber composition from differing types of tires can vary.

CRM is produced by processing the rubber raw materials into the desired particle size and then removing undesirable contaminants. Two basic processes are used. Ambient processing is performed mechanically by ripping and shredding the rubber at ambient temperature. This process results in a shredded, rough surface texture. Cryogenic processing first subjects the rubber to very low temperatures at which the rubber becomes brittle. Then, the rubber is subjected to impact to fracture it to the desired particle size. Cryogenic processing results in a smooth, glassy surface texture. Particle sizes typically used in highway applications vary from maximum sizes of approximately 1/4 inch down to 100 mesh.

When CRM is added to asphalt cement, the rubber particles will generally become swollen in the asphalt. The extent and rate of swelling have been found to be dependent on many factors including temperature of the mixture, time, and physical and compositional characteristics of the asphalt and rubber. Tolonen and Green<sup>3</sup> studied and characterized the swelling process. As the rubber particles swell, the interparticle distance between them is reduced which results in an increase in the viscosity of the blend. Tolonen and Green<sup>3</sup> also determined that rubber swells due to absorption of the oil or asphalt fluid that it is immersed in and that different oils are absorbed to greater or lesser degrees. Absorption of fractions of the asphalt by the rubber was hypothesized to result in an increase in viscosity of the unabsorbed asphalt by approximately four times at 15 percent rubber, and six times at 20 percent rubber.<sup>3</sup> Swelling of CRM in asphalt is defined as reaction.

To illustrate changes that occur to the asphalt when the rubber swells, several sets of tests were performed. First, whole tire CRM of which 100 percent passed the number 16 sieve and 0 percent passed the number 30 mesh sieve was mixed into AC-30 asphalt at 10 and 15 percent by total weight and then stored with intermittent stirring at  $350 \pm 10^\circ\text{F}$ .

Physical properties of the mixtures are shown in Table 9-1. Data shows an increase in viscosity during the storage period indicating that the rubber swelled. Following the 90 minute storage period, the mixtures were placed on a number 40 sieve and allowed to drain at 300°F for 30 minutes to separate the asphalt and the swollen CRM particles. The separated asphalt from the mixes had lost some of its components due to absorption by the rubber. Test data for the separated asphalt is shown in Table 9-2. The data shows that the separated asphalt from the 10 and 15 percent CRM mixtures has become stiffer. The residue from the 15 percent mixture was 2.3 times higher in absolute viscosity than the original asphalt. The penetration dropped 38 percent, and the ductility was reduced to 30cm. from 100cm. Another mixture using a 120/150 asphalt from a different source was subjected to the same procedure using 15 percent of the same whole tire CRM. Results are shown in Table 9-3. The data shows that the separated asphalt had a viscosity at 140°F which was 2.0 times the original asphalt and a penetration decrease of 37 percent.

A third set of experiments was performed using a similar process with the same source of whole tire CRM except that it was 100 percent passing a 16 mesh and 0 percent passing a 20 mesh sieve and an AC-10 asphalt. Additionally, the chemical analysis of the asphalt was determined using an Iatroscan both before and after separation. Data is shown in Table 9-4. These data show a viscosity increase at 140°F of 2.0 times and a reduction in penetration of 37 percent. These results are very similar to the other two sets of results reported in Tables 9-1, 9-2 and 9-3. The chemical analysis data also shows that the asphalt composition changed. Increases in a compositional fraction amount after separation would indicate a tendency towards reduced absorption of the fraction while a decrease would indicate an increased tendency to absorb that fraction. The data shows an increase of 25 percent in asphaltenes, 11 percent in resins, and 4 percent in saturates. The cyclics experienced a decrease of 5 percent. This information indicates that there is preferential absorption of asphalt components by rubber with the greatest tendency to absorb cyclics and the least tendency to absorb asphaltenes.

As previously described, when CRM is added to asphalt cement, it will tend to swell in a time and temperature dependent manner. For ease of mixing, CRM is generally added to hot, fluid asphalt at a temperature between 250 and 450°F. Figure 9-1 illustrates a typical plot of the viscosity increase of an asphalt and CRM blend with time. The amount of viscosity increase and rate depends on a wide variety of factors as previously discussed. After the CRM swells in the asphalt, if temperature



is high enough and the AR is stored at the elevated temperature long enough, viscosity will begin to be reduced. This reduction in viscosity occurs as the swollen CRM particles experience depolymerization and melt into the asphalt. CRM depolymerization will proceed quickly (within several hours) when temperature is above 400°F, and more slowly at temperatures of 300 to 375°F.

As the rubber swells and the mixture increases in viscosity, the physical properties of the mixture change. Typical changes that can occur are: 1) an increase in high temperature viscosity, 2) an increase in high in-service temperature stiffness and softening resistance, 3) an increase in elastic characteristics, 4) improvements in low temperature properties, and 5) improvements in aging resistance. The degree of changes in properties that occur depends on the physical and chemical characteristics of the asphalt and rubber, the amount of rubber, the mixing conditions, time and temperature.

### 9.3 Measurement of Physical Properties

The physical properties of AR have been shown in a variety of studies to be substantially different from unmodified asphalt cement.<sup>3-14</sup> Many of these studies investigated the use of standard asphalt cement testing procedures such as penetration, absolute viscosity, ring and ball softening point, etc., as well as a variety of procedures used for other materials and several research procedures such as the Schwyer Rheometer,<sup>4,5</sup> sliding plate viscometer,<sup>5</sup> force ductility,<sup>4,5,10,12</sup> torque fork viscosity,<sup>4,5,10,12</sup> mechanical spectrograph or dynamic mechanical analysis,<sup>3</sup> and several others. Each of these procedures provides an indication of certain characteristics of AR materials.

For any application that an AR blend will be used in, there are several general characteristics of the blend that should be considered for appropriateness in the specific application.

- Pumping consistency at the placement temperature
- Consistency (stiffness) at the high range of the in-use temperature that the material will be subjected to
- Consistency at moderate in-use temperatures
- Elastic characteristics
- Elongation properties

- Stiffness or fracture characteristics at the low range of the in-use temperature which the material will be subjected to

Several types of testing methods have been and can be used to evaluate these characteristics.

### **Pumping Consistency for Placement**

Pumping consistency at typical placement temperatures (250–400°F) can be monitored using rotational type viscometers such as a Haake hand-held, portable viscometer<sup>12</sup> or a Brookfield viscometer (ASTM D2669).<sup>42</sup> While these tests are being performed, it is important to ensure that the rotating probes are conditioned to the test temperature, and that readings are taken at specific intervals because of a tendency with some blends and for viscosity readings to reduce due to rubber particle migration away from the probe while it is rotating. The viscosity range at placement temperatures for AR blends is mainly affected by the rubber type, content, and degree of rubber swelling, and can vary from 100 to 20,000 centipoise for various applications.

### **High In-Use Temperature Stiffness**

High in-use temperature stiffness at typical high-range pavement surface temperatures of 120–170°F can be indicated by several different testing procedures. The Ring and Ball Softening Point (ASTM D36) procedure provides an indication of relative stiffness of materials. Higher softening point temperature results indicate materials that are more resistant to softening at high temperatures. Results for AR will vary from approximately 110°F to 180°F. Results are mainly influenced by asphalt grade, rubber type and content, and degree of reaction.

The ASTM D5329 flow procedure is specified for indicating the ability of pavement crack and joint sealants to resist flowing along a 75 degree slope at 140°F. Lesser amounts of flow indicate materials with increased resistance to migration at 140°F. Typical specification limits using this type of procedure for sealants are 3, 5, or 10 millimeters of flow in five hours. Some AR blends can experience much greater amounts of flow in this test. However, the test procedure can be modified for use with AR blends by using a lower angle such as 45 degrees, or lowering the test temperature to 120°F.

Penetration testing at higher temperatures than the standard 77.0°F can provide an indication of high temperature stiffness. Testing can be performed at temperatures such as 115 or 122°F using the ASTM D5 procedure with the standard needle, or with a cone as specified in ASTM D5329. Lower penetration values indicate stiffer materials at that temperature.

The absolute viscosity procedure (ASTM D2171) at 140°F has been used to indicate high temperature viscosity of AR materials. Some testing has also been performed using a modified version of the test with a lower vacuum. Since the test requires flow of the material through an orifice, it is most applicable for use with smaller particle size CRM (less than 30 mesh) due to flow interference that can occur with larger particle size CRM. Results can vary from the result for the unmodified asphalt cement (typically 500 to 4,000 poise) to readings of over 100,000 poise for high rubber content AR. When testing AR, large size tubes should be used to reduce CRM particle flow interference.

Asphalt and CRM blends have been previously tested using the mechanical spectrograph (Dynamic Mechanical Analyzer)<sup>3</sup> to determine characteristics over a wide temperature range. The DMA procedure is being used to specify asphalt stiffness at high pavement surface temperatures in the Strategic Highway Research Project's asphalt cement specification that is currently being developed. This procedure could be adapted for use with AR.

### **Moderate Temperature Consistency (77°F)**

Moderate temperature consistency (77°F) can be evaluated using the standard ASTM D5 penetration test or by using the cone penetration test as specified in ASTM D5329. The standard D5 test with the needle is most appropriate with finer rubber particles (minus 20 mesh) while the cone penetration test is more appropriate with larger rubber particles (10 mesh). Testing has shown that results for the two types of penetration tests (needle, 100 grams, 5 seconds and cone, 150 grams, 5 seconds) typically agree within approximately 10 percent for tests at 77°F. The addition of CRM to asphalt cement decreases the penetration at 77°F. Typical penetration results range from approximately 30 for high CRM content materials with stiff asphalts to 150 for lower CRM content materials with soft asphalts.

---

## **Elastic Characteristics**

The elastic characteristics of asphalt and CRM blends can easily be evaluated using the ASTM D5329 resilience procedure. This procedure indicates the percentage of rebound of the material at 77°F under a 75 gram load after the material was compressed. Typical results for asphalt cement vary from approximately 0 to 5 percent for AC-20 or 30 grades to approximately -50 percent for AC-5. Addition of CRM to asphalt increases resilience up to approximately a result of 40 to 50 percent above the original asphalt result for high CRM contents.

Other procedures that can provide an indication of elastic properties of AR include: (1) a ductility rebound test in which standard ductility specimens are extended a certain distance, movement is stopped, the specimen cut in the center, and rebound is measured after a defined interval, and (2) the DMA analysis of storage modulus of the material. Both of these procedures can provide indications of elastic characteristics at a variety of temperatures.

## **Elongation Properties**

The elongation properties of AR can be indicated using the standard ASTM D113 ductility procedure. The addition of CRM to asphalt tends to reduce ductility at 77°F, but may increase ductility at low temperatures. Results at 77°F for higher rubber content blends can vary between approximately 10 and 40 centimeters depending on the CRM type, asphalt physical and chemical characteristics, and degree of reaction. The ductility test can also be easily performed at lower temperatures to provide an indication of elongation properties at low temperatures.

## **Low Temperature Stiffness or Fracture Characteristics**

Low temperature stiffness or fracture characteristics can be measured using several different types of procedures. Types of procedures that can be used include: (1) needle or cone penetration at low temperatures of 32 or 39.2°F (ASTM D5 or D5329), (2) ductility at 39.2°F (ASTM D113), (3) flexibility at a specific low temperature using the ASTM C711 flexibility procedure, or, with modifications, (4) DMA testing at low temperatures, (5) the SHRP proposed bending beam procedure, or

## 9.4 Factors Which Influence Asphalt Rubber Properties

(6) the Fraas brittle point procedure. CRM additions to asphalt cement have been shown to be capable of offering some improvements in low temperature properties. The major manner of improving low temperature properties, however, is to use softer grades of asphalt that offer improved low temperature properties, and then to add CRM to increase the high temperature stiffness to the desired level.

The interaction that occurs between asphalt cement and CRM and the physical properties which result have been shown through many research studies to be dependent on a variety of factors including: 1) asphalt cement physical and chemical properties, 2) CRM physical and Chemical properties, 3) reaction time and temperature, 4) mixing conditions, and 5) use of additives.<sup>43</sup> When developing an AR blend for a specific use, the effect of each of these factors needs to be considered to assure that an appropriately functioning material is produced.

### Asphalt Cement

The physical properties of the asphalt cement influence the properties of AR blends. The stiffness, temperature susceptibility and aging characteristics of the asphalt will affect the high temperature and low temperature performance of the blend. Typical grades of asphalt that are used with CRM for various applications and climates range from AC-2.5 to AC-30 (or AR-1000 to AR-4000). Use of stiffer asphalts will produce AR materials that have greater high temperature stiffness than obtained with softer asphalts. However, stiffer asphalts will produce AR materials that are harder at low temperatures than those made with softer asphalts.

The effects of asphalt grade on modulus determined from tensile creep testing<sup>44</sup> are shown in Figures 9-2, 9-3 and 9-4. These figures show the relations between AR made using 16 to 17 percent of a whole tire 20 mesh CRM and three grades of asphalt (AC-20, AC-5, and AC-5 with 5 percent extender oil). Additionally, for comparative purposes the data for the unmodified AC-5, AC-20 and AC-40 are shown. It is noted that due to the lower degree of temperature susceptibility of the AR, the AC-5 AR blend is stiffer than the AC-20 at 77°F, but softer by approximately one order of magnitude at 22°F.

Physical test properties of the base asphalts and AR blends from Figures 9-2, 9-3 and 9-4 are shown in Table 9-5. Data shows that the AR

materials have modified high temperature, moderate temperature, and low temperature characteristics compared to the unmodified asphalt cements. These data also show that stiffer asphalts produce stiffer AR materials and that softer asphalts produce softer AR materials with improved low temperature properties.

Chemical properties of the asphalt cement can also influence the characteristics of the AR by affecting reaction of the rubber. Asphalts that have lower levels of components which are absorbed by the rubber can tend to produce AR materials with lower viscosities and lesser degrees of modification of properties. Table 9-6 shows chemical analysis of two AC-20 asphalts and viscosity data during a 180 minute heating period using 15 percent whole tire 10 to 20 mesh CRM. It is noted that asphalt A produces higher viscosities than asphalt B throughout the 180 minute heating period. The Ring and Ball softening point data, however, is similar.

### **Crumb Rubber Modifier (CRM)**

Many of the characteristics of the CRM can influence properties of AR. Previous research has reported on the effects of rubber quantity in the blend and particle size distribution.<sup>5</sup> Additional effects include: (1) CRM surface area, (2) grinding process, (3) CRM chemical composition, and (4) contaminants such as water, fiber, mineral, or metal.

### **CRM Quantities**

The amount of CRM added to the asphalt will influence blend properties with higher amounts providing greater changes in properties. Table 9-7 shows properties of an AC-20 asphalt when blended with from 0 to 21 percent of a minus 16 mesh whole tire CRM and stored for 90 minutes at  $350 \pm 10^\circ\text{F}$ . From these data, it can be seen that as rubber content increases, that: (1) the viscosity of the material at  $350^\circ\text{F}$  increases, (2) the resilience increases, (3) the softening point increases, and (4) the cone penetration at  $77^\circ\text{F}$  decreases.

### **CRM Particle Size Distribution (Gradation)**

The particle size distribution of the CRM has previously been shown to influence the physical properties of asphalt and CRM blends. Gener-

ally, small differences in the particle sizes do not affect blend properties significantly, but large differences in CRM size can produce larger differences. Finer sized CRM materials will generally experience quicker swelling due to their increased surface area, and will produce higher viscosities than CRM with larger particle sizes. Additionally, very small particle size CRM will tend to more quickly experience viscosity reductions during heating due to its quicker and more thorough swelling and subsequent depolymerization.

Table 9-8 shows differences in physical properties of AR blends made using a 20 mesh tire rubber that was sieved and then recombined to a coarser and finer gradation by 10 percent on the No. 40 screen. The calculated surface areas<sup>46</sup> vary from .0047 to .0073 m<sup>2</sup>/gram based on gradation. Physical property data indicates only slight, if any, changes in properties. This tends to indicate that minor changes in gradation with a rubber source should not significantly influence physical properties of the AR.

Physical property data for three different sizes of rubber with a 120/150 penetration asphalt are shown in Table 9. Rubber sizes in Table 9-9 are a 10 to 20 mesh, a minus 20 mesh, and a minus 80 mesh which can be referred to as coarse, medium and fine. Data in Table 9 shows that during the 120 minute heating period, that the 20 mesh rubber mixture produced the highest viscosity and softening point. The finer 80 mesh rubber, however, produced the highest ductility and the lowest resilience and softening point. Low temperature fracture characteristics of the 80 mesh material were improved compared to the 10 to 20 or the minus 20 mesh.

### **CRM Surface Area**

Surface area of the CRM can influence physical properties. In some ways, this is similar to gradation; however, surface area differences can exist even for CRM with similar gradations. The surface area of CRM can be measured using the BET gas absorption analytical procedure. Test results using this procedure with krypton gas have shown surface areas that vary between 0.04 and 0.10 m<sup>2</sup>/gram for typical 20 mesh ambient grind CRM. Surface area calculations based on the MS-2 gradation procedure<sup>46</sup> (which assumes spherical shaped particles) typically shows surface areas that are approximately one-tenth that of the BET results for 20 mesh ambient grind CRM produced from tires. Testing was also performed using a 40 mesh, hard, non-tire rubber product that only contained 14.7 percent rubber hydrocarbon and had an ash

content of 57.6 percent. The calculated surface of this material was  $0.030 \text{ m}^2/\text{gram}$  and the surface area that was measured by BET was  $0.024 \text{ m}^2/\text{gram}$ . This shows a much closer agreement between surface area results with this harder rubber. On the basis of these results, it is anticipated that cryogenically ground rubber will have surface areas that are more similar to the value calculated from gradation.

Table 9-10 shows test data for two CRM products that were manufactured by the same company using truck tire tread rubber from different sources at two different production plants. It is noted that the chemical analysis is very similar, that there are some minor differences in gradation, and that the BET surface area of material 2 is 59 percent greater than for material 1. Physical properties of AR materials using these CRM materials at 16 percent are shown in Table 9-11. The data shows that CRM source 2 produces approximately twice the viscosity and greater resilience than CRM source 1 with other properties being similar. To attempt to identify differences, CRM source 1 was sieved and recombined to match the source 2 gradation. This data is also shown in Table 9-11. This gradation modification did not result in changed AR properties. The differences in AR properties between CRM sources appears to not be related to chemical or gradation differences, but to the surface area differences of the two CRM materials.

### CRM Grinding Process

As previously discussed, the CRM production process can influence the physical shape and surface area characteristics of the rubber particles. Additionally, ambient temperature size reduction results in rough shredded particle surfaces, while cryogenic size reduction results in smoother glassy surfaces. A sample of cryogenically produced 20 mesh CRM was tested for surface area using the BET procedure and compared to results for the same gradation of an ambient ground whole tire rubber. The ambient grind CRM calculated surface area was  $0.0068 \text{ m}^2/\text{gram}$  and the BET result was  $0.030 \text{ m}^2/\text{gram}$ . The cryogenic CRM calculated surface area was  $.0064 \text{ m}^2/\text{gram}$  and the BET result was  $0.017 \text{ m}^2/\text{gram}$ .

Table 9-12 shows AR properties for the ambient and cryogenic produced CRM materials at a 17 percent content in 120/150 asphalt. These results show that the cryogenic produced CRM produces viscosity increases at a lesser rate than the ambient CRM. As could be expected, the physical properties of the cryogenic CRM AR are not modified to as great a degree as with the ambient CRM as indicated by lower softening points and ductilities.



### CRM Chemical Composition

As previously discussed, tires are composed of several different types of rubber compounds. The major variations are in the synthetic rubber content, natural rubber content, total rubber hydrocarbon content, and acetone extractables. Ash and carbon black contents are typically similar for different tire rubber compounds. The major CRM compositional effect on AR physical properties is the total rubber hydrocarbon content of the rubber with additional effects from the natural rubber content. When using CRM, it is important to comprehend that tire rubber is typically composed only of about one-half of actual rubber polymer that will swell in the asphalt. The other major ingredients (carbon black, ash, oil) do not swell when added to hot asphalt. Therefore, the effective rubber hydrocarbon content (the AR rubber content times the rubber hydrocarbon content of the rubber) becomes a factor that should be considered during the AR design process.

Table 9-13 shows gradation and compositional properties of a 20 mesh, whole-tire rubber and a 20 mesh, high-rubber hydrocarbon-content rubber from a non-tire source. It is noted that the gradations and BET surface areas are similar, but that the non-tire source has a higher rubber hydrocarbon content (62.2 percent versus 49.8 percent) and a higher natural rubber ratio (88.6 percent versus 48.8 percent). Table 9-14 shows AR data for these CRM materials at a 16 percent content in AC-5 asphalt. Data shows that the high RHC source produces a much higher viscosity and other properties related to rubber reaction than the whole tire source. When the CRM content is lowered to 12.5 percent for the high RHC source which yields a comparable value for effective rubber content (7.97 percent versus 7.78 percent), AR mixture results are similar to the 16 percent whole tire AR mixture. Data in Table 9-13 also shows that the high RHC CRM produces material that is affected to a greater degree by extended heating than whole tire rubber CRM mixtures. Additionally, the AR material with the high RHC CRM produces high ductilities. This is believed to be due to the greater natural rubber content of the high RHC CRM.

Additionally, it is important to note that adjustments of the chemical composition of CRM by blending with additional CRM with a different composition may not produce the same results in AR blends as a normal, unblended CRM with the same composition.

---

## Contaminants

Various types of contaminants may be present in CRM. Typical contaminants are moisture, tire cord and belt fiber, particulate minerals, and fine metal particles. The effect of moisture in CRM is to cause foaming and swelling of the asphalt when moist CRM is added to the hot asphalt. Foaming causes a volume expansion of the blend just after the CRM is added to the asphalt that can cause production or storage vessels to overflow. Moisture contents of CRM can simply be determined by loss on heating procedures that dry the rubber particles at 230°F until a constant weight is achieved. The presence of even small amounts of moisture in the CRM can cause foaming to occur. Experience has shown that moisture amounts over 1 percent by weight can cause excessive foaming. The amount of foaming which can be tolerated is somewhat dependent on the production equipment, process, and rate of CRM addition. It is suggested that moisture contents be kept at less than 0.75 percent by weight to minimize foaming.

## Fiber

Fiber from tire cords and belts can be produced during the rubber production process. Many CRM producers have developed processes that reduce the fiber content of the CRM to low levels. In some applications of asphalt and CRM, fiber contaminants can create problems, while in other applications, fiber presence is not as great of an effect. For spray applied uses of asphalt and CRM blends (chip seals, interlayers, and membranes), fiber presence can create problems with the uniformity of the spray application. Crack sealing and hot mix applications can tolerate higher fiber amounts. Table 9-15 shows properties of an AC-5 based AR mixture with added tire fiber amounts from 0.1 to 1.0 percent (which is 0.6 to 6.7 percent of weight of CRM). Data shows with added fiber, that viscosity, softening point, and resilience tends to increase, and that penetration and ductility tend to decrease.

## Mineral and Metal Contaminants

Mineral and metal contaminants are sometimes found in CRM. Metal can come from tire bead wire, belts, or the grinding equipment. Mineral matter can come from stones being caught in the tire tread or inside the carcasses. CRM manufacturers have procedures to remove metal and mineral contaminants. The presence of excess mineral or metal particles

typically does not influence asphalt and CRM blend properties but can create quick wear of pumps and other application equipment. Metal and mineral contaminants should be kept to a minimum. It is suggested that mineral contaminants be kept less than 0.25 percent by weight, and that no metal be allowed.

### **Mixing Conditions**

The intensity of mixing during the interaction time period can influence AR properties. Differences in mixing and shearing intensity can vary from low speed agitation that gently keeps the rubber particles in suspension to high speed shearing that can mechanically break down the rubber particles. With low speed agitation, the asphalt components are simply absorbed as the rubber particles swell with little dispersion of the rubber polymer into the asphalt. During high intensity mixing, the rubber particles swell and soften due to asphalt absorption, and the high energy mixing tends to shear off the softened rubber outer surfaces and produces a dispersed rubber component in the asphalt phase of the material.

Table 9-16 shows AR test results and properties of drained asphalt from a 21 percent whole tire AR blend using 120/150 pen asphalt for materials which were mixed using: (1) oven storage with intermittent stirring, (2) the ASTM D5167 melter, and (3) the Torque Fork at 500 rpm. Test data for the AR shows that similar properties were produced using the Torque Fork and D5167 melter. Drained asphalt physical characteristics were also similar. The oven storage procedure produced AR material with slightly lower viscosity and softening point results, and less changes in the drained asphalt than the melter or Torque Fork procedure. Chemical analysis results for the drained asphalt showed increases in asphaltenes and resins, and decreases in cyclics and saturates for each mixing method. Asphalt drained from the Torque Fork and melter-mixed AR materials showed greater changes than the asphalt drained from the oven-heated mixture. These results indicate that the melter and Torque Fork mixing procedures resulted in a higher degree of interaction between the CRM and asphalt than the oven heating procedure. These results support the AR physical property and drained asphalt physical property data.

## Time and Temperature

The reaction process of rubber particles in asphalt is both time and temperature dependent. Higher temperatures result in quicker reaction and may result in greater amounts of swelling. These effects have been well documented in the literature.<sup>3, 4, 23, 24, 37</sup> Typical temperatures that are used with AR materials range from 325 to 400°F. AR materials made with tire derived CRM generally maintain their physical properties for at least 24 hours at temperatures of up to 350°F. At higher temperatures (375 to 400°F), the CRM can begin to depolymerize within three to six hours to such an extent that physical properties are affected.

Table 9-17 shows physical properties of AC-5 AR mixtures with 17 percent of a 20 mesh, whole-tire CRM that are heated at 300, 325 and 350°F. Data shows that higher viscosities, penetrations at 77 and 39.2°F, resilience, softening points, and ductilities are obtained as temperatures increase from 300 to 350°F. Data also indicates that 24 hours of heating at 300°F did not achieve properties of the 350°F mixture at 90 minutes of heating.

## Extender Oil Additives

Various extender oil additives can be added to AR materials to modify the properties of the blend. Extender oil addition tends to soften the asphalt and decrease low temperature stiffness of the blend. Depending on the chemical characteristics of the asphalt, certain extender oil types may be preferentially absorbed by the CRM. Generally, aromatic or naphthenic oils are preferred. The effects of extender oil addition on modulus variation with temperature are illustrated in Figures 9-2, 9-3 and 9-4. Physical properties of blends are shown in Table 9-5.

High amounts of aromatic oils have been used in conjunction with high temperature and intense mixing to aid in breaking down rubber particles in high CRM content asphalt blends to produce low viscosity materials for certain applications.<sup>47</sup>

## Non-Tire Rubber Additives

Various types of non-tire specialty rubber additives have been used in AR materials to modify or enhance properties of the blend. Typically,

these types of materials are high natural rubber content products that depolymerize and melt into the asphalt at lower temperatures than tire rubber. Incorporating up to approximately one-fourth of these types of rubber as a substitute for tire rubber can result in AR materials that have increased adhesiveness, flexibility and elongation, but which are more sensitive to heating than standard tire rubber CRM blends.

### **Surfactant Additives**

Various surfactant type additives that are used as paving liquid anti-stripping additives can be added to AR blends to improve adhesion characteristics if required for the specific application. Use of 0.5 percent liquid anti-stripping agent has improved the film retention results to 100 percent in boiling stripping tests from values of 10 to 30 percent without the additive.<sup>48</sup> Additional testing using the Vialit Chip Retention procedure<sup>49</sup> has shown that use of 0.5 percent anti-stripping additive in the AR binder has improved chip retention from 67.1 to 98.3 percent.<sup>48</sup> Additionally, in a gap-graded AR concrete design, use of 0.5 percent liquid anti-stripping agent improved the TSR value<sup>50</sup> from 73 to 87 percent thus providing increased resistance to moisture.

### **Polymeric Additives**

Polymeric materials that are commonly used in production of polymer modified asphalt cements can be used in conjunction with CRM for specific applications where different physical properties are desired. Usage of polymers in AR blends produces materials in which the asphalt phase of the blend that binds the swollen rubber particles together is modified with the polymeric additive. Using these combinations, physical properties that are not attainable with asphalt cement and CRM only may be achieved. In some applications, these types of blends and the physical characteristics attainable are desirable. Generally, use of polymeric additions produces increased high-temperature stiffness with lower placement temperature viscosity. Also, elasticity can be increased.

The physical properties of an AR mixture depend on the physical and chemical properties of the materials used, the reaction between these materials, and the interaction conditions. Therefore, to obtain desired properties, appropriate materials and interaction conditions which will produce desired properties need to be identified. Specific items which need to be addressed are: (1) asphalt cement source and grade, (2) CRM source and gradation, (3) CRM content, (4) interaction conditions of time, temperature, and mixing intensity, and (5) the need for additives, if required.

Since the characteristics of AR vary depending on heating time and temperature, it is important that the characteristics of the blend be evaluated at a variety of heating times and temperatures and mixing intensities that the material will be exposed to during the usage period. In general, it is recommended that the physical characteristics of AR be evaluated using the planned mixture temperature and mixing intensity, and at short, medium and long interaction time periods which would be appropriate for the specific application.

Mixing intensity for lab design operations should be correlated with the actual production unit and usage equipment characteristics. Several types of mixing conditions can be used to attempt to simulate actual conditions. The first consists of simply performing the reaction in a one-gallon, round, open-top can that is placed in a forced-draft oven to maintain the desired temperature. Agitation can consist of intermittent stirring with a spatula at specified intervals (typically 30 minutes) during the interaction period. Further details for this procedure are contained in Reference 43. This procedure simulates low speed mixing with gentle agitation with minimal shearing of the rubber particles.

The second procedure consists of using an oil-jacketed, removable-can type melter as shown in Figure 9-3 of ASTM D5167. This device can uniformly control the temperature of the mixture through indirectly heated oil while constantly stirring at 30 rpm. This procedure provides a higher degree and continuous agitation of the mixture during the interaction period and simulates typical crack and joint sealing and other typical field mixing operations.

The third procedure consists of using a research device that is termed a "Torque Fork," as described in Reference 5. This device consists of an adjustable speed electric motor that stirs the asphalt and CRM blend at a constant speed. The device can monitor the electrical current level required to maintain the desired stirring speed as the viscosity of the mixture increases. In previous research studies<sup>4,5</sup> this type of device has been used with stirrer speeds of 500 to 750 rpm. The mixing vessel size

## 9.5 Design Process for Asphalt Rubber Blends

has been approximately 3000 milliliter (0.8 gallons) with sample weights of 1000 grams. The Torque Fork, when operated at speeds of 500 to 750 rpm, imparts a high degree of mixing intensity to the mixture.

Tests which are performed during the design process should be selected to provide an indication of required characteristics of the AR blend. When specifications for the specific application are available, testing required by the specification should be performed as a minimum. For any AR material the testing program for the specific use should be designed to provide the suppliers and users with the following information:

1. Placement temperature viscosity
2. High in-use temperature stiffness or consistency
3. Moderate in-use temperature consistency
4. Elastic characteristics
5. Elongation properties
6. Low in-use temperature consistency
7. Variation of properties with typical heating times which may be encountered during use

Once a design blend of asphalt, CRM and additives is verified for the application, along with defined mixing and production times, temperatures and mixing process, the design process may be complete. For some applications such as chip seals and hot mixes, additional performance testing may be required to verify the appropriateness of the designed binder for the application, or to determine if additives for improved adhesion are necessary.

The completed design for an AR material should consist of the following documentation as a minimum:

1. Asphalt source, grade, and specification test results
2. Rubber source, type, and specification test results
3. Additive identification, if required
4. Percentage blend (by weight) for each ingredient
5. Mixing temperature and times considered during the design
6. Mixing system used during the design
7. Test results for the designed blend at the various mixing times considered in accordance with the desired blend specification requirements
8. Additional tests and results used to verify performance in the final application, if required

It is important to realize that since asphalt cement and rubber specifications do not currently address all the factors related to the reaction process and blend characteristics (such as chemical composition, surface area, etc.), that whenever the source of any of the design ingredients changes, or there is a change in the composition or properties of the specified asphalt or rubber, that the design should be re-verified. This concept is similar to that of hot-mixed, asphalt-concrete mix designs in which new designs are required when using different sources of asphalt or aggregate which meet the same specifications due to variations which can occur for materials within the specification limits.

A wide variety of physical properties can be achieved by adding CRM to asphalt cement. Different applications of AR materials require different physical properties, and therefore differing formulations. Factors which must be considered when specifying and designing an AR material for a specific use include:

- Climatic conditions and temperature ranges the material will be subjected to
- Ranges of viscosity at placement temperature which are appropriate for the production equipment
- Constraints on CRM particle size for the intended use
- The desired performance level of the AR material in the specific application

Even though a wide variety of performance levels can be achieved by using CRM, there are limits. Performance characteristics of increased high temperature stiffness and reduced low temperature stiffness are achieved by using asphalt cement bases which have appropriate low temperature properties for the intended use, and then adding CRM of the appropriate type and quantity to yield required high temperature and elastic characteristics. The maximum amount of CRM which can be added (and thus the degree of modification of high temperature properties) is dependent on the maximum application temperature viscosity that can be used.

## 9.6 Various Highway Applications



---

### **Low CRM Content Binder for Hot-Mixed Asphalt (HMA)**

When the usage objective is to use CRM in asphalt to produce a binder for HMA mixtures in which there will be minimal effects on the design and construction of the HMA, the amounts and size of CRM used should be small. For this application, CRM contents should be less than 5 percent of the binder by weight to minimize changes in the binder physical properties. Particle sizes that are appropriate for the CRM will vary depending on the gradation of the aggregate. The reason for this is that the CRM particles may interfere with compaction and aggregate interlock if the particles are too large for void spaces in the aggregate. For very dense HMA, very fine CRM (such as less than 50 mesh) may be most appropriate, while for open graded mixtures, coarser CRM (such as 16 mesh) can be used.

In this application, asphalt cement grade can usually be the same as normally used, however, the possibility of using a slightly softer asphalt grade should be investigated because of the asphalt absorption process by the CRM and possible improvements in low temperature characteristics. Table 9-18 shows data for an AC-20 asphalt which is modified with 5 percent of a minus 50 mesh rubber. It is noted that viscosity, penetration, and ductility of the asphalt change due to additions of the CRM. The viscosities at 350 and 140°F, however, remain within ranges of typical AC-30 or 40 asphalt cements.

### **High CRM Content Binder for HMA**

When a high amount (10 to 25 percent) of CRM is used in the asphalt cement, the physical properties of this binder are significantly modified over the entire temperature range the material will be subjected to during construction and in place usage. These changes in characteristics require modifications in the design and construction of the pavement and can result in performance improvements compared to conventional asphalt cement binders.

With dense HMA, finer CRM particles (typically smaller than 20 mesh) are appropriate, while with open graded mixtures, larger particles (such as 10 mesh) can be used. Due to the amounts of asphalt absorption that occur as the CRM swells, the base asphalt can and should be of a softer grade than would typically be used in the same application if unmodified. The exact amount softer can vary between one and three grades and depends on the specific use.

The CRM content and reaction conditions should be selected so that viscosity at the anticipated binder temperature used during mixing with aggregate does not exceed 6000 centipoise for use with gap or open graded mixtures, or 4000 centipoise for use with dense graded mixtures. The reason for this is that if viscosities are higher, aggregate coating problems may develop during the mixing process.

Test results for a typical AR blend for an open or gap-graded mixture using an AC-5 asphalt and a minus 16 mesh CRM are shown in Table 9-19. This blend used 18 percent CRM and an AR-2000 asphalt. During the heating period, viscosity increased to 3700 centipoise at 120 minutes, softening point was 142°F, and resilience was 35 percent. During extended heating to 6 and 24 hours, additional viscosity increases were noted to 6000 to 7000 centipoise.

A similar blend using a 30 mesh rubber that is more appropriate for dense graded HMA mixtures is shown in Table 9-20. Data shows a relatively stable viscosity after 60 minutes of heating and stability of properties at 6 and 24 hours of heating.

Specifications for these types of uses are currently being considered by ASTM and several other organizations. Specifications that have been proposed by the FHWA<sup>1</sup> are shown in Table 9-21. These specifications include three different grades for different climatic zones, and consider physical characteristics of high and low temperature consistency, elasticity and aging.

### **Spray Applied Membranes for Chip Seals or Interlayers**

For these types of applications, generally a high application rate of between 0.5 and 0.7 gallons per square yard is used to provide a thick elastomeric membrane seal for the pavement surface. At these high application rates, sufficient AR binder stiffness is required to resist bleeding and shoving. Additionally, the materials need to be capable of being spray applied in a uniform manner. Generally, in these uses, high rubber contents (between 20 and 25 percent) are required and rubber particles are typically large (minus 10 mesh). Fiber content should be less than 0.1 percent by weight to produce acceptable spray uniformity. Asphalt grades which are appropriate are typically one to two grades softer than the normal paving grade used for that area. Even softer asphalts can be used for interlayer applications since the surface is covered with an additional wearing coarse layer.

For some applications, extender oils can be used to soften the asphalt and reduce AR mixture viscosity. Solvent diluent additions can also be used to aid in reducing viscosity for ease of spray application.

Generally, specialized spraying and application equipment is required to appropriately apply AR membranes. This is due to the high viscosity of the AR material. Even when using the specialized equipment, viscosity should not exceed 4000 centipoise.

Test results for a typical AR spray applied membrane material are shown in Table 9-22. This mix used an AC-10 asphalt with 18 percent 10 to 30 mesh CRM with an added 3 percent of a high natural rubber content additive for improved adhesion. Results show viscosity increases along with high resilience and softening point.

Specifications for these types of uses are currently being developed by several organizations. As with specifications for HMA applications (Table 9-21), varying stiffnesses of AR materials are required for different climatic areas. Specifications being considered are similar to those shown in Table 9-21; however, it is suggested that increased high temperature stiffness as indicated by softening point be provided.

### **Crack Sealing Materials**

Crack sealing applications of AR require sufficient high temperature stiffness to resist tracking at warm summer temperatures. Additionally, this material must be flexible enough at low temperatures to resist cracking as the crack opens as the pavement contracts. These requirements suggest use of softer asphalts and high CRM contents to produce a highly modified AR material.

Due to the wide variety of climates encountered throughout the United States, different stiffnesses of AR are required for appropriate performance. Suggested specifications for three grades of AR crack sealing materials for use in cold, moderate and hot climates are shown in Table 9-23. Additionally, ASTM D5078, "Crack Filler, Hot-Applied, for Asphalt Concrete and Portland Cement Concrete Pavements," can be used to specify the performance requirements of a single grade of AR material as shown in Table 9-23. A variety of State specifications are also used to specify AR crack sealing materials.

AR crack sealing materials typically have high viscosities at placement temperature and are not self-leveling. Viscosity at application tempera-

ture should not exceed 20,000 centipoise or difficulties in application could result. Typical CRM contents used are between 18 and 25 percent, and the CRM typically ranges in size from 10 to 30 mesh.

When CRM is added to hot asphalt cement, the CRM swells and modifies the proportions and physical properties of the asphalt cement. The amount of modification is dependent on a variety of factors including physical and chemical properties of the asphalt and CRM, quantities, time, temperature, mixing conditions and additives. Various types of testing methods can be used to determine the degree of modification of properties.

When designing an AR material for a specific use, the specific asphalt, CRM, and additives need to be selected, along with quantities, heating times and temperatures, and mixing method. In order to appropriately make these selections, one must understand the interactions which occur between the asphalt cement and CRM, and other factors which influence AR properties. Additionally, the required physical characteristics of the binder for the specific application must be understood.

This paper provides an understanding of factors which need to be considered during the AR binder design process. Properties of typical AR blends for use in HMA, spray-applied membranes, and crack sealing materials are provided along with typical specifications.

1. Heitzman, M.A., "State of the Practice—Design and Construction of Asphalt Paving Materials with Crumb Rubber Modifier," Federal Highway Administration, Report No. FHWA-SA-92-022, May 1992.
2. *Compilation of ASTM Standard Definitions*, Seventh Edition, 1990, American Society for Testing and Materials.
3. Green, E.L., and Tolonen, W.J., "The Chemical and Physical Properties of Asphalt-Rubber Mixtures—Basic Material Behavior" Report No. ADOT-R5-14(162), Arizona Department of Transportation, July 1977.
4. Pavlovich, R.D., Shuler, T.S. and Rosner, J.C., "Chemical and Physical Properties of Asphalt-Rubber-Phase II-Product Specifications and Test Procedures," Report No. FHWA/AZ-79/121, Arizona Department of Transportation, November 1979.

## 9.7 Summary

## 9.8 References

5. Rosner, J.C., and Chehovits, J.C., "Chemical and Physical Properties of Asphalt-Rubber Mixtures—Phase III Summary Report" and Volumes 1–5, Report HPR 1–19 (159), Arizona Department of Transportation, July 1981.
6. Piggot, M.R., and Woodhams, R.T., "Recycling of Rubber Tires in Asphalt Paving Materials," Department of Chemical Engineering and Applied Chemistry, University of Toronto, Toronto, Ontario, March 1979.
7. Oliver, J.W.H., "A Critical Review of the Use of Rubbers and Polymers in Bitumen and Paving Materials," Report A1R 1037-1, Australian Road Research Board, 1977.
8. Oliver, J.W.H., "A Limited Laboratory Evaluation of a Bituminous Plant Mix Material Containing Scrap Rubber," Report A1R 178-8, Australian Road Research Board, 1976.
9. Oliver, J.W.H., "Preliminary Investigation of the Elastic Behavior of Digestions or Comminuted Type Tread Rubber in a Bitumen," Australian Road Research Board, November 1978.
10. Shuler, T.S., "An Investigation of Asphalt-Rubber Binders for Use in Pavement Construction," Ph.D. Dissertation, Graduate School, Texas A&M University, College Station, Texas, August 1985.
11. Oliver, J.W.H., "Modification of Paving Asphalts by Digestion with Scrap Rubber," *TRR 821*, Transportation Research Board, Washington, DC, 1981, pp. 27–44.
12. Schuler, S., Adams, C., and Lamborn, M., "Asphalt-Rubber Binder Laboratory Study," Research Report FHWA A/TX-85-71 + 347-1F, Texas A&M University, College Station, Texas, August 1985.
13. Lalwani, S., Abushihada, A., and Halasa, A., "Reclaimed Rubber-Asphalt Blends Measurement of Rheological Properties to Assess Toughness, Resiliency, Consistency, and Temperature Sensitivity," *PROCEEDINGS, AAPT*, Volume 51, 1982, pp. 562–579.
14. Way, G., "Prevention of Reflective Cracking in Arizona Minnetoka-East (A Case Study)", Report No. 11, HPR-1-13 (224), Arizona Department of Transportation, May 1976.

15. Olsen, R.E., "Rubber Asphalt Binder for Seal Coat Construction," Federal Highway Administration Implementation Package 73-1, February 1973.
16. Huffman, J.E., "The Use of Ground Vulcanized Rubber in Asphalt," *Asphalt Pavement Construction: New Materials and Techniques*, ASTM, STP 724, J.A., Scherocman, Ed, 1980, pp. 3-12.
17. Gonzales, G.F.D., "Evaluation of Road Surfaces Utilizing Asphalt-Rubber, 1978," Report No. 1979 GG3, Arizona Department of Transportation, November 1979.
18. Schnormeier, R.H., "Eleven-Year Pavement Condition History of Asphalt-Rubber Seals in Phoenix, Arizona," *Asphalt Pavement Construction: New Materials and Technologies*, ASTM, STP. 724, J.A., Scherocman, Ed, 1980, pp. 13-21.
19. Scott, J.L.M., "Use of Rubber Asphalt Binder with Graded Aggregates for Seal Coats," Technical Report 28, Saskatchewan Highways and Transportation, January 1979.
20. Morris, G.R., and McDonald, C.H., "Asphalt-Rubber Stress Absorbing Membrane, Field Performance and State-of-the-Art," *Transportation Research Record 595*, 1976, pp. 2-58.
21. Verdos, P., "Evaluation of the Effectiveness of Membranes for Prevention of Crack Reflection in Thin Overlays," presented at *First Asphalt-Rubber User-Producer Workshop*, Scottsdale, Arizona, May 7-8, 1980.
22. Schnormeier, R.H., "Fifteen Year Pavement Condition History of Asphalt-Rubber Membranes in Phoenix, Arizona," presented at 1986 Meeting of the Transportation Research Board, January 1986, Washington, DC.
23. Epps, J.A., and Galloway, B.M., Editors, *Proceedings, First Asphalt-Rubber User-Producer Workshop*, May 7-8, 1980, Scottsdale, Arizona.
24. Epps, J.A., Editor, *Proceedings, National Seminar on Asphalt-Rubber*, Federal Highways Administration, Demonstration Projects Division, San Antonio, Texas, October 27-29, 1981.
25. Chen, N.J., DiVito, J.A., and Morris, G.R., "Finite Element Analysis of Arizona's Three Layer Overlay System of Rigid

- Pavements to Prevent Reflective Cracking," *Proceedings, AAPT*, Vol. 51, 1982, pp. 150-168.
26. Coetzee, N.F., and Montsmith, C.L., "Analytical Study of Minimization of Reflective Cracking in Asphalt Concrete Overlays by Use of a Rubber Asphalt Interlayer," *Transportation Research Record 700*, 1979, pp. 100-108.
  27. McCullough, F.R., and Foppe, L.E., "A Five Year Evaluation of Arizona's Three Layer System on the Durango Curve in Phoenix," *Proceedings AAPT*, Vol. 54, 1985, pp. 76-90.
  28. Jimenez, R.A., "Laboratory Measurements of Asphalt-Rubber Concrete Mixtures," *Transportation Research Record 843*, 1982, pp. 4-11.
  29. Criteria for Asphalt-Rubber Concrete in Civil Airport Pavements, DOT/FAA/PM86/39.11, Program Engineering and Maintenance Service, Washington, DC 20591.
  30. Stephens, J.E., and Mokryewski, "The Effect of Reclaimed Rubber on Bituminous Paving Mixtures," Report CE74-75 School of Engineering, Civil Engineering Department, University of Connecticut, March 5, 1974.
  31. Stephens, J.E., "Field Evaluation of Rubber Modified Bituminous Concrete," *Transportation Research Record 843*, 1982, pp. 11-21.
  32. DeLaubenfels, L., "Effectiveness of Rubberized Asphalt in Stopping Reflection Cracking of Asphalt Concrete (Interim Report)," California Department of Transportation, Report No. FHWA/CA/TL-85/09, January 1985.
  33. VanKirk, J.L., "The Effect of Fibers and Rubber on the Physical Properties of Asphalt Concrete," California Department of Transportation, Report No. CA/TL-85/18, June 1986.
  34. Piggot, M.R., George, J.D., and Woodhams, R.T., "Toronto Experience with Rubber Asphalts," *Proceedings, First Asphalt-Rubber User-Producer Workshop*, Scottsdale, Arizona, May 7-8, 1980, pp. 66-77.
  35. Silent Asphalt, Research Project: "Noise Level Reduction through Highly Elastomeric Asphalts," Federal Ministry of Public Works and Technology, Austria.

36. Hugo, F., and Nachenius, Rheinard, "Some Properties of Bitumen-Rubber Asphalt and Binders," *Proceedings, AAPT*, Vol. 58, February 20-22, 1989.
37. *Proceedings, National Seminar on Asphalt-Rubber*, Kansas City, Missouri, October 30-31, 1989, Asphalt Rubber Producers Group, Phoenix, Arizona.
38. Chehovits, J.G., and Manning, M., "Materials and Methods for Sealing Cracks in Asphalt Concrete Pavements," *Transportation Research Record* 990, 1984, pp. 21-30.
39. *The Shell Bitumen Handbook*, Shell Bitumen, U. K., Riversdell House, Chertsey, 1991.
40. *1992 Annual Book of ASTM Standards*, "American Society for Testing and Materials," Volume 9.01.
41. LaGrone, D.D., "What is Reclaimed Rubber?" *Proceedings, First Asphalt-Rubber User-Producer Workshop*, Scottsdale, Arizona, May 7-8, 1980.
42. *1992 Annual Book of ASTM Standards*, "American Society for Testing and Materials," Volume 5.02.
43. Chehovits, J.G., "Design Methods for Hot-Mixed Asphalt-Rubber Concrete Paving Materials," *Proceedings, National Seminar on Asphalt Rubber*, Kansas City, Missouri, October 30-31, 1989, Asphalt Rubber Producers Group, Phoenix, Arizona.
44. Hansen, K.R., and Stonex, A., "Tensile Creep Comparison of Asphalt Cement and Asphalt Rubber Binders," Asphalt Rubber Producers Group, Phoenix, Arizona, October 1991.
45. Anderten, G., "Physical Properties and Aging Characteristics of Asphalt Rubber Binders," Asphalt Rubber Producers Group, Phoenix, Arizona, February 1992.
46. "Mix Design Methods for Asphalt Concrete," The Asphalt Institute, Manual Series No. 2 (MS-2).
47. U.S. Patent No. 2,470,141.
48. "Laboratory Testing for Aggregate Chip Precoating and Chip Retention for Asphalt Rubber Chip Seals," Western Technologies, Inc., Phoenix, Arizona, September 1985.



49. Boudreault, Jacques, "Study of Adhesiveness by the Vialit Test," *Canadian Technical Asphalt Association Proceedings*, 1989, pp. 75-97.
50. VTM-13, Virginia Test Method for Anti-Stripping Additive, Virginia Department of Highways and Transportation, Richmond, Virginia, May 20, 1986.

**Table 9-1. Physical properties of AC-30 asphalt and 10 and 15 percent whole tire rubber (16 to 30 mesh) after 90 minutes of storage at 350± 10°F**

Property	Rubber content, % by weight		
	0%	10%	15%
Brookfield viscosity, 350°F, cp	107	700	2050
Haake viscosity, 350°F, cp		650	1900
Cone penetration, 77°F, (ASTM D5329)		33	28
Needle penetration, 77°F, (ASTM D5)	59	44	37
Needle penetration, 39.2°F, 200g, 5 sec, (ASTM D5)	21	17	15
Resilience, 77°F, (ASTM D5329), %	2	33	36
Ductility, 39.2°F, 1cm/min (ASTM D113)		10	9
Softening point, °F (ASTM D36)	127	140	156
Fracture temperature, 1" dia, 10 sec, 90° bend, °F	28	26	28

**Table 9-2. Physical properties of original AC-30 and AC-30 drained from 10 and 15 percent whole tire rubber mixtures**

Property	Original AC-30	AC-30 residue from 10% rubber mix	AC-30 residue from 15% rubber mix
Absolute viscosity, 140°F, (ASTM D2171)	3,634	5,569	8,565
Needle penetration, 77°F, (ASTM D5)	59	51	36
Needle penetration, 39.2°F, 200g, 5 sec, (ASTM D5)	21	19	13
Ductility, 77°F, 5m/min (ASTM D113), cm	100+	98	30
Softening point, °F (ASTM D36)	127	131	137

**Table 9-3. Properties of 120/150 asphalt,  
15 percent asphalt rubber blend and drained asphalt  
residue from the asphalt rubber blend**

Property	Original 120/150 asphalt	15% rubber blend (1) (4)	120/150 residue from the 15% rubber mix (2)
Absolute viscosity, 140°F, (ASTM D2171), poise	772	10,876	1,548
Needle penetration, 77°F, (ASTM D5)	126	72	79
Softening point, °F (ASTM D36)	108	136	112

## Notes:

- (1) Material subjected to 90 minutes of heating at  $350 \pm 10^\circ\text{F}$ .
- (2) Material drained over a No. 40 sieve for 30 minutes at  $300^\circ\text{F}$ .
- (3) Asphalt chemical analysis (latroscan method)  
A=8.6%, R=31.2%, C=55.5%, S=4.7%.
- (4) Rubber is 16 to 30 mesh whole tire ambient grind.

**Table 9-4. Physical and chemical properties of  
AC-10 asphalt before and after mixing  
with 15 percent whole tire rubber (1)**

Property	Original asphalt	Asphalt residue
Penetration, 77°F, (ASTM D5), 1/10 mm	106	67
Absolute viscosity, 140°F, (ASTM D2171), poise	1,071	2,174
Chemical Analysis (latroscan), %		
Asphaltenes	8.6	10.8
Resins	13.8	15.2
Cyclics	74.5	70.7
Saturates	3.1	3.3

## Notes:

- (1) Material was subjected to two hours of heating at  $350 \pm 10^\circ\text{F}$ .
- (2) Rubber was 100% passing 16 mesh and 0% passing 20 mesh.
- (3) Asphalt residue was obtained by draining over a 30 mesh screen for 30 minutes at  $300^\circ$ .

**Table 9-5. Physical properties of asphalts and asphalt rubber blends using several asphalt grades (reference 45)**

Test	AC-5	AC-20	AC-40	AC-5RE	AC-5R	AC-20R
Kin vis, 275°F (cSt)	141	265	358	NT	NT	NT
Abs vis, 140°F (P)	654	2,390	4,575	2,027	3,221	5,773
Brookfield vis (P)						
194°F	40	135	173	570	1,980	1,040
211°F	18	20	30	215	243	233
250°F	4	8	7	170	155	185
275°F	3	4	6	83	88	93
Haake vis (P)						
194°F	10	40	80	350	150	350
211°F	3	18	25	175	125	180
250°F	2	6	9	125	112	137
275°F	1	4	8	100	105	125
Penetration (0.1mm)						
200g, 60 sec., 39°F	40	15	14	63	39	20
100g, 5 sec., 77°F	114	44	27	125	85	40
Cone pen (0.1mm)						
200g, 60 sec., 39°F	63	27	10	94	58	25
150g, 5 sec., 77°F	101	35	21	111	71	38
Ductility (cm)						
5 cm/min., 39°F	0	0	0	25.4	22.5	0.9
5 cm/min., 77°F	150+	150±	150+	18.7	20.2	35.0
Softening point (°F)	112	129	134	133	143	151
Resiliency (% rec.)	-40	-9	-4	-20	11	32

## Notes:

- (1) NT=No Test.
- (2) All AR materials used a 20 mesh whole tire ambient ground rubber.
- (3) AC-5RE contained 16% rubber and 5% extender.
- (4) AC-5R contained 17% rubber.
- (5) AC-20R contained 16% rubber.
- (6) All AR materials were pre-reacted at 350°F for two hours and reheated for testing.

**Table 9-6. Chemical analysis of AC-20 asphalts and test data for 15 percent CRM AR mixtures**

Asphalt chemical analysis (Iatrascan)	A	B
Asphaltenes	11.1	8.2
Resins	17.4	29.0
Cyclics	68.1	59.9
Saturates	3.4	2.9

Asphalt physical properties	A	B
Penetration, 77°F (ASTM D5)	76	65
Softening point (ASTM D36)	122°F	124°F

AR properties	A	B
Viscosity, 350°F (Haake), centipoise		
0 minutes	300	200
30 minutes	400	250
60 minutes	700	300
90 minutes	1,000	550
120 minutes	1,000	550
150 minutes	1,500	800
180 minutes	1,500	900
Softening point, °F (ASTM D36)		
0 minutes	126	123
30 minutes	139	131
60 minutes	144	141
90 minutes	148	146
120 minutes	149	142
150 minutes	150	154
180 minutes	152	156

Note: All reactions performed at 350±5°F using whole tire rubber 100% passing 10 mesh and 0% passing 20 mesh.

**Table 9-7. The effect of crumb rubber modifier on AR properties (reference 43)**

Binder property	Percent rubber (by weight of binder)						
	0	6	9	12	15	18	21
Viscosity at 176°C (cp) (350°F)	60	550	800	900	1,500	2,500	6,000
Cone penetration at 25°C (77°F)	48	40	43	44	40	30	27
Resilience at 25°C (77°F)	-1	-1	12	19	23	40	47
Softening point, °C (°F)	50 122	52 126	58 136	60 140	61 142	63 146	72 162

Notes:

- (1) Asphalt is AC-20, rubber is a 1.18-millimeter (No. 16 sieve) nominal maximum size.
- (2) Interaction (reaction) period is 90 minutes at 176°C (350°F).

**Table 9-8. Variations in AR physical properties with varying gradations of the same 20 mesh tire rubber at a 16 percent content**

Sieve sizes	Rubber gradation		
	Original	Coarse	Fine
No. 10	100.0	100.0	100.0
No. 16	99.8	99.8	99.8
No. 20	91.6	85.0	95.0
No. 30	50.7	35.0	65.0
No. 40	30.2	20.0	40.0
No. 50	7.7	5.0	20.0
No. 80	3.4	1.4	7.0
No. 100	2.6	1.1	5.3
No. 200	0.7	0.3	1.5

Calculated surface area (m <sup>2</sup> /gram)	.0056	.0047	.0073
--	-------	-------	-------

AR physical properties	Rubber gradation		
	Original	Coarse	Fine
Brookfield viscosity 350°F, centerpoise	1,700	1,500	1,700
Needle penetration 77°F, 100g, 5s	87	87	83
39.2°F, 200g, 60s	31	29	32
Resilience, 77°F	13	13	14
Softening point, °F	131	131	129
Ductility, 30.2°F, cm	20	19	23

## Notes:

- (1) Asphalt in an AC-5, penetration = 125, softening point = 106°F.
- (2) AR properties are after 90 minutes of heating at 350°F.
- (3) Surface area calculated using the procedure described in MS-2 (46).

**Table 9-9. AR properties with different rubber gradations**

AR property	Original asphalt	Rubber gradation		
		10-20	-20	-80
Brookfield viscosity, 350°F, cp	80	—	—	—
15 minute	—	550	2,400	1,500
30 minute	—	700	2,900	2,000
60 minute	—	1,200	4,000	2,400
120 minute	—	1,700	4,400	2,900
Needle penetration, 77°F (ASTM D5)	133	60	54	69
Resilience, 77°F (ASTM D5329)	-18	33	36	18
Ductility, 77°F (ASTM D113)	100+	14	26	45
Softening point, °F (ASTM D36)	108°F	141°F	143°F	132°F
Fracture temperatures	20°F	20°F	20°F	16°F

Rubber properties	Percent passing		
	10-20	-20	-80
Gradation, sieve size			
No. 10	100.0	100.0	100.0
No. 16	19.0	100.0	100.0
No. 20	1.8	94.4	100.0
No. 30	0.6	55.0	100.0
No. 40	0.4	35.0	100.0
No. 50	0.4	18.8	99.2
No. 80	0.2	7.6	76.8
No. 100	0.2	4.0	63.6
No. 200	0.1	0.8	10.2
Calculated surface area, m <sup>2</sup> /gram	0.002	0.0068	0.0230
BET surface area, m <sup>2</sup> /gram	N.D.	0.030	0.096

## Notes:

- (1) Asphalt chemical properties are:  
A=11.1%, R=17.4%, C=68.1%, S=3.4%.
- (2) Rubber contents were all 17%.
- (3) Material properties were determined after two hours of heating.



**Table 9-10. Gradation, surface areas, and chemical properties of two sources of ambient grind truck tread rubber**

Gradation, percent passing	CRM source	
	1	2
No. 10	100.0	100.0
No. 16	99.8	99.8
No. 20	91.6	96.4
No. 30	50.7	58.2
No. 40	30.2	31.4
No. 50	7.7	16.4
No. 80	3.4	3.4
No. 100	2.6	0.8
No. 200	0.7	0.2
Calculated surface area, m <sup>2</sup> /gram	0.006	0.006
BET surface area, m <sup>2</sup> /gram	0.0475	0.0756

Chemical properties	CRM source	
	1	2
Acetone extract	13.8	13.6
Ash	4.9	4.2
Carbon black	32.8	33.3
Natural rubber	24.2	23.0
Synthetic rubber	24.4	25.9
Rubber hydrocarbon content	48.6	48.9
Natural rubber ratio	49.8	47.0

**Table 9-11. AR properties for two sources  
of truck tread CRM (CRM data from Table 9-10)**

Test performed	CRM source 1			CRM source 2			CRM source 1 with source 2 gradation		
	90	360	1440 <sup>4</sup>	90	360	1440	90	360	1440
Brookfield viscosity at 350°F	1,700	2,300	2,000	4,500	4,800	4,800	1,500	2,300	2,500 <sup>1</sup>
Haake viscosity at 350°F	1,500	1,900	1,700	4,300	4,500	4,600	1,500	1,900	2,300
Cone penetration at 77°F in 1/10mm 150g, 5 seconds	80	78	84	78	76	80	80	82	78
Needle penetration at 77°F in 1/10mm 100g, 5 seconds	87	84	91	81	78	82	84	85	79
Needle penetration at 39.2°F in 1/10mm 200g, 60 seconds	31	30	31	27	31	34	32	33	29
Resilience at 77°F, %	13	14	16	28	20	17	13	17	17
Ductility at 39.2°F, 1cm per minute, -cm	20	24	27	25	30	33	23	30	27
Softening point, °F	131	139	134	135	137	131	130	132	134
Fracture temperature °F lowest passing	20	18	18	18	18	20	20	22	22
°F fracture	18	16	16	16	16	18	18	20	20

## Notes:

- (1) Asphalt used is an AC-5, softening point=106°F, penetration=125.
- (2) Each AR blend is at 16% CRM.
- (3) Heating is at 350±10°F.
- (4) 90, 360, and 1440 are heating times in minutes.

**Table 9-12. Physical properties of AR containing 17 percent ambient and cryogenic processed 10 mesh CRM**

AR property	Original asphalt	Rubber type	
		Ambient	Cryogenic
Brookfield viscosity, 350°F, cp	80	—	—
15 minute	—	2,400	800
30 minute	—	2,900	1,000
60 minute	—	4,000	1,500
120 minute	—	4,400	2,700
Needle penetration, 77°F (ASTM D5)	133	54	59
Resilience, 77°F (ASTM D5329)	-18%	36%	36%
Ductility, 77°F (ASTM D113)	100+	26	14
Softening point, °F (ASTM D36)	108°F	143°F	134°F
Fracture temperatures	20°F	20°F	22°F

Rubber properties	Original asphalt	Percent passing	
		Ambient	Cryogenic
Gradation, sieve size			
No. 16	—	100.0	100.0
No. 20	—	94.4	94.0
No. 30	—	55.0	54.0
No. 40	—	35.0	34.0
No. 50	—	18.8	17.4
No. 80	—	7.6	6.0
No. 100	—	4.0	3.2
No. 200	—	0.8	0.4
Calculated surface area, m <sup>2</sup> /gram	—	0.0068	0.0064
BET surface area, m <sup>2</sup> /gram	—	0.030	0.017

## Notes:

- (1) Asphalt chemical properties are:  
A=11.1%, R=17.4%, C=68.1%, S=3.4%.
- (2) Material properties were determined after two hours of heating.

**Table 9-13. Whole tire and high rubber hydrocarbon content CRM properties**

Gradation	Whole tire	High RHC
Sieve size		
No. 10	100.0	100.0
No. 16	99.8	99.4
No. 20	96.4	96.0
No. 30	58.2	53.4
No. 40	31.4	33.0
No. 50	16.4	19.6
No. 80	3.4	9.6
No. 100	6.8	8.4
No. 200	0.2	3.2
BET surface area, m <sup>2</sup> /gram	0.076	0.090

Composition	Whole tire	High RHC
Acetone extract	13.8	6.2
Ash	6.3	6.3
Carbon black	30.1	25.2
Natural rubber	24.3	55.1
Synthetic rubber	25.5	7.1
Rubber hydrocarbon content	49.8	62.2
Natural rubber ratio	48.8	88.6

**Table 9-14. AR properties with whole tire and high rubber hydrocarbon CRM (CRM data from Table 9-13)**

Property	16% whole tire			16% high RHC			12.5% high RHC		
	90	360	1440	90	360	1440	90	360	1440
Viscosity, 350°F, cp	5,300	4,300	4,300	12,000	12,000	ND	3,500	5,100	1,300
Needle penetration, 77°F	76	72	70	70	107	125	79	121	124
Resilience, 77°F	22	20	19	50	27	8	36	12	0
Ductility, 39.2°F	23	22	18	28	32	35	28	43	50
Softening point, °F	136	139	135	155	154	128	140	138	123
Fracture, °F	22	20	18	18	16	12	20	20	20
Effective rubber content	7.97%			9.95%			7.78%		

## Notes:

- (1) Asphalt used is an AC-5, softening point=106°F, penetration=125.
- (2) Mixtures were heated at 350±10°F.
- (3) ND=Not Determined.
- (4) 90, 360, and 1440 are heating times in minutes.

**Table 9-15. AR physical properties with added tire fiber**

Rubber content	16	15.9	15.5	15.0
Fiber content	0	0.1	0.5	1.0
Viscosity, 350°F, cp	1,500	1,900	2,400	2,800
Penetration, 77°F	77	84	74	72
Softening point, °F	128	130	130	134
Resilience, 77°F	11	15	17	21
Ductility, 39.2°F	19	22	15	15
Added fiber content as a proportion of CRM, %	0	0.6	3.2	6.7

## Notes:

- (1) Asphalt used is an AC-5, penetration=125, softening point=106°F.
- (2) Materials were heated at 350±10°F for 90 minutes.

**Table 9-16. Physical and chemical properties of AR and drained asphalt from a 21 percent whole tire AR mixture**

Property	Original asphalt	Mixing method		
		Oven storage	ASTM D5167 melter	500RPM torque fork
<b>Asphalt rubber</b>				
Viscosity, 350°F, cp peak	—	5,000	6,000	5,500
minimum	—	1,800	2,500	3,200
Softening point, °F	107	145	156	154
Resilience, 77°F, %	—	45	53	44
Penetration, 77°F	132	62	58	50
Ductility, 77°F	—	10	10	11
Fracture, 77°F	—	24	22	22

Drained asphalt	Original asphalt	Mixing method		
		Oven storage	ASTM D5167 melter	500RPM torque fork
Composition, %				
Asphaltenes	11.2	15.6	16.5	16.7
Resins	17.2	18.2	18.5	20.3
Cyclics	67.4	62.4	61.9	59.5
Saturates	4.2	3.8	3.1	3.5

Drained asphalt physical properties	Original asphalt	Mixing method		
		Oven storage	ASTM D5167 melter	500RPM torque fork
Penetration, 77°F	125	68	64	63
Absolute viscosity, 140°F	839	3,436	3,914	4,000
Softening point, °F	113	125	132	131
Ductility rebound, 60 min.	18%	21%	23%	27%

**Notes:**

- (1) Asphalt is a 120/150 penetration.
- (2) Rubber is a 10 to 16 mesh.
- (3) Mixing and heating was at 350±10°F for two hours.
- (4) Drainage was performed on a 20 mesh screen.

**Table 9-17. Physical properties of AR mixtures  
heated at 300, 325, and 350°F**

Test performed	Heating temperature								
	300°F			325°F			350°F		
	90	360	1440	90	360	1440	90	360	1440
Brookfield viscosity, cp	3,600	4,000	4,200	3,300	4,600	4,300	4,400	4,800	4,800
Haake viscosity, cp	3,000	3,600	3,600	3,000	4,300	4,000	4,200	4,600	4,500
Cone penetration, 77°F	43	50	52	49	58	48	58	56	57
Needle penetration, 77°F, 100g, 5 seconds	44	51	50	50	62	51	62	59	60
Needle penetration, 39.2°F, 200g, 60 seconds	18	14	16	14	16	17	19	24	22
Resilience at 77°F, %	16	22	24	28	31	30	34	31	32
Ductility at 39.2°F, 1cm per minute, cm	11	11	11	12	16	18	16	21	20
Softening point, °F	129	130	130	136	138	140	136	137	137
Fracture temperature									
°F lowest passing	26	26	26	26	26	26	26	26	26
°F fracture	24	24	24	24	24	24	24	24	24

## Notes:

- (1) Asphalt used is an AC-10, penetration=76, softening point=117°F.
- (2) All mixtures contained 17% 20 mesh whole tire CRM.
- (3) 90, 360, and 1440 are heating times in minutes.
- (4) Viscosities were performed at the heating temperatures of 300, 325 and 350°F.

**Table 9-18. Physical properties of AC-20 asphalt cement with 5 percent fine CRM**

Property	AC-20 asphalt	AC-20+ 5% CRM
Brookfield viscosity, 350°F, centerpoise	84	—
15 minutes	—	124
30 minutes	—	144
60 minutes	—	136
120 minutes	—	116
Needle penetration, 77°F (ASTM D5)	74	61
Softening point, °F (ASTM D36)	116	124
Absolute viscosity, 140°F (ASTM D2171)	1,996	3,657
Ductility at 77°F (ASTM D113)	100+	33

## Notes:

- (1) AR properties are determined at 120 minutes of heating.
- (2) CRM gradation is 100% passing No. 50, 77% passing No. 80, 64% passing No. 100, 100% passing No. 200.

**Table 9-19. Test results for AR binder for open-graded HMA**

Test performed	Heating period					
	30	60	90	120	6 hrs	24 hrs
Haake viscosity, 350°F, cp	2,000	2,600	3,400	3,700	7,000	6,000
Cone penetration, 77°F	—	—	—	43	48	52
Resilience at 77°F, %	—	—	—	35	38	33
Ductility at 77°F, cm	—	—	—	19	—	—
Softening point, °F	137	139	138	142	152	143
Fracture temperature						
°F lowest passing	—	—	—	24	22	24
°F fracture	—	—	—	22	20	22

## Notes:

- (1) Asphalt used is an AR-2000, penetration=66, softening point=117°F.
- (2) CRM content is 18%.
- (3) Heating is at 350±10°F.
- (4) CRM gradation is 100% passing No. 16, 34% passing No. 30, 4% passing No. 50.



**Table 9-20. Test results for AR binder for dense-graded HMA**

Test performed	Heating period					
	30	60	90	120	6 hrs	24 hrs
Haake viscosity, 350°F, cp	2,000	2,500	2,600	2,500	3,200	3,300
Cone penetration, 77°F	—	—	—	38	39	39
Resilience at 77°F, %	—	—	—	27	27	26
Ductility at 77°F, cm	—	—	—	37	—	—
Softening point, °F	140	142	143	145	147	145
Fracture temperature						
°F lowest passing	—	—	—	26	26	24
°F fracture	—	—	—	24	24	23

## Notes:

- (1) Asphalt used is an AC-10, penetration=72, softening point=120°F.
- (2) CRM content is 17%.
- (3) CRM gradation is 100% passing No. 16, 84% passing No. 30, 25% passing No. 50.
- (4) Heating is at 350±10°F.

**Table 9-21. Proposed specifications for AR binder  
for HMA (Reference 1)**

Test parameter	Climate usage		
	Hot	Moderate	Cold
Apparent viscosity, 347°F (175°C) min.	1,000	1,000	1,000
Spindle 3, 12rpm, cps (ASTM D2669) max.	4,000	4,000	4,000
Penetration, 77°F (25°C), 100g, 5 seconds min.	25	50	75
1/10mm (ASTM D5) max.	75	100	150
Penetration, 39.2°F (4°C), 200g, 60 seconds, 1/10mm (ASTM D5) min.	15	25	40
Softening point, °F (ASTM D36) min.	130	120	110
Resilience, 77°F (25°C), % (ASTM D3407) min.	20	10	0
Ductility, 39.2°F (4°C) 1cm/min, cm (ASTM D113) min.	5	10	15
<b>Thin-film oven residue (ASTM D1754):</b>			
Penetration retention, 39.2°F (4°C) % of original min.	75	75	75
Ductility retention, 39.2°F (4°C) % of original min.	50	50	50

**Table 9-22. Test results for AR binder for hot applied membrane application**

Test performed	Heating period					
	30	60	90	120	6 hrs	24 hrs
Haake viscosity, 350°F, cp	1,600	2,200	2,200	4,000	5,000	4,500
Cone penetration, 77°F	—	—	—	23	26	30
Resilience at 77°F, %	—	—	—	47	53	47
Ductility at 77°F, cm	—	—	—	8.5	—	—
Softening point, °F	146	146	148	156	166	167
Fracture temperature						
°F lowest passing	—	—	—	20	16	16
°F fracture	—	—	—	18	14	14

Notes:

- (1) Asphalt used is an AC-10, penetration=92, softening point=122°F.
- (2) CRM content is 18% 10 to 30 mesh and 3% of high natural additive.
- (3) 10 to 30 CRM gradation was 100% passing No. 10, 56% passing No. 16, 7% passing No. 20.
- (4) High natural gradation was 100% passing No. 16, 43% passing No. 30, 11% passing No. 50.
- (5) Heating is at 350±10°F.

**Table 9-23. AR crack sealing suggested specifications**

Test parameter	Climate usage		
	Hot	Moderate	Cold
Brookfield viscosity, centipoise	20,000 cp max	20,000 cp max	20,000 cp max
Softening point, °F	170°F min	150°F min	150°F min
Cone Penetration, 77°F	15-35	70 max	70 max
39.2°F	—	15 min	25 min
Resilience, 77°F	40% min	30% min	30% min
Asphalt compatibility	pass	pass	pass

Notes:

- (1) Viscosity is at safe heating temperature.
- (2) Tests are performed as specified in ASTM D5078.
- (3) Moderate climate parameters are the ASTM D5078 requirements except for viscosity.

Figure 9-1. Typical Viscosity Curve for AR

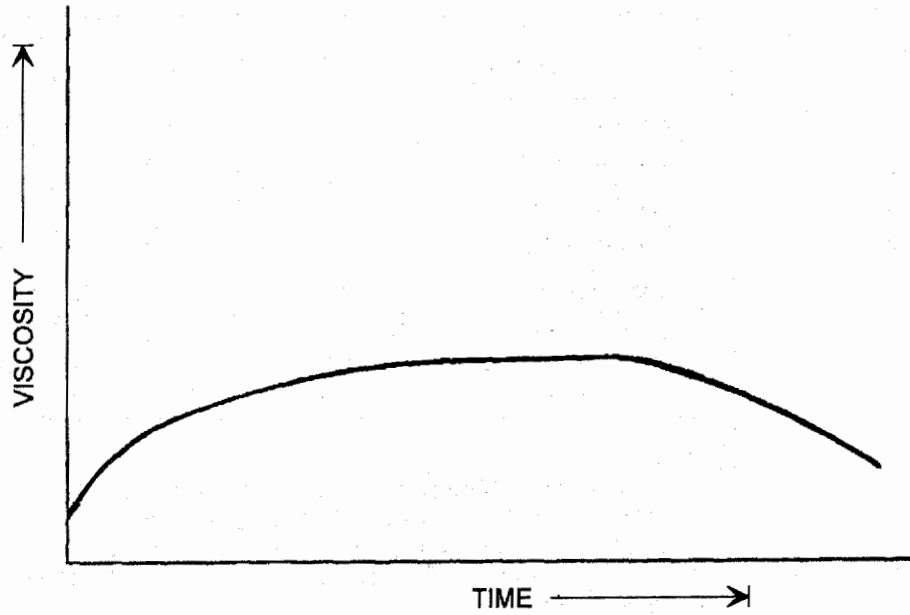


Figure 9-2. Stiffness Modulus vs. Temperature

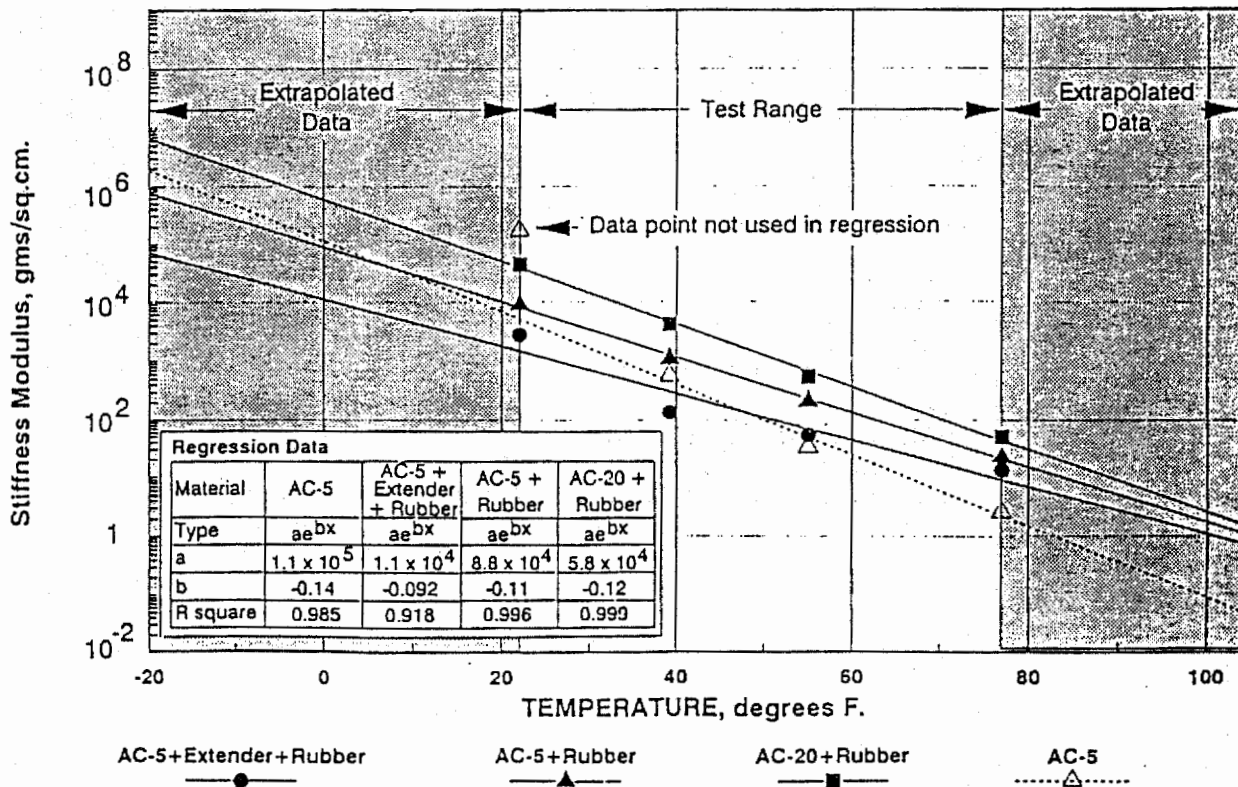


Figure 9-3. Stiffness Modulus vs. Temperature

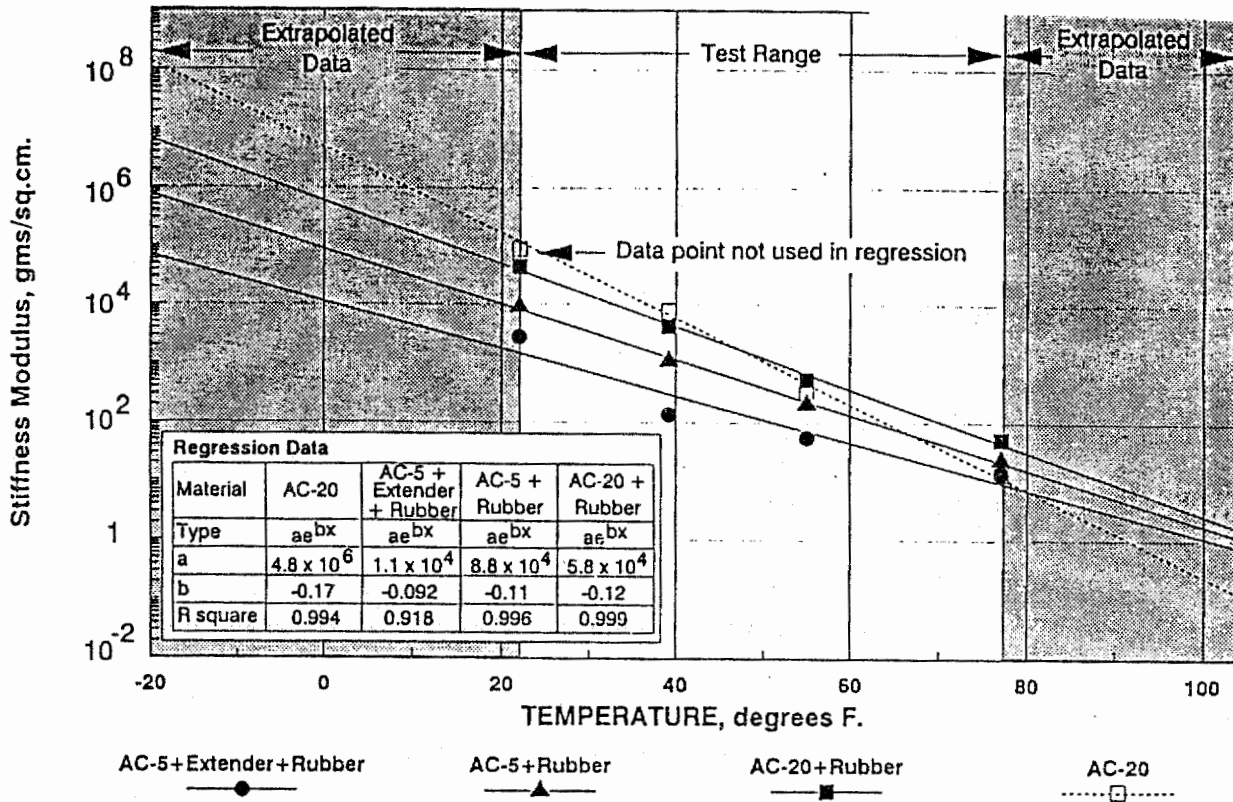
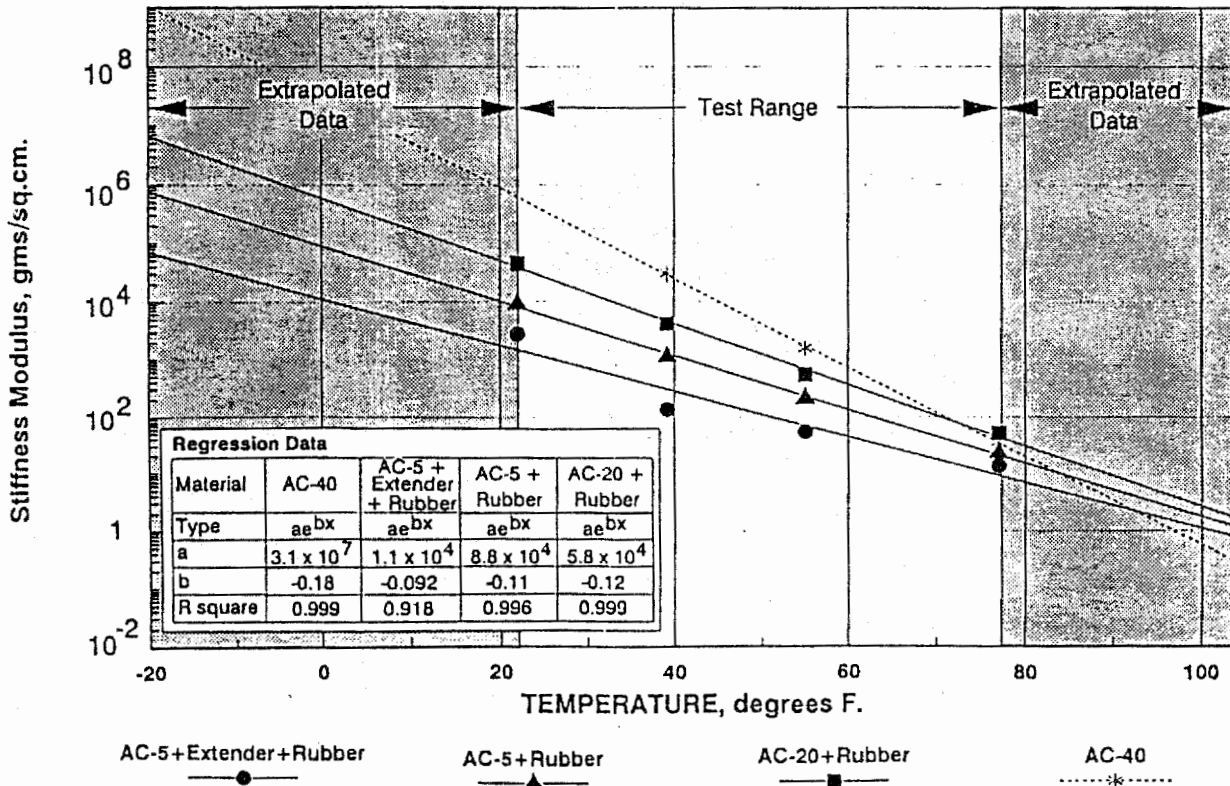


Figure 9-4. Stiffness Modulus vs. Temperature



# **Session 10.0**

---

## **Mix Design Procedures**

---

by

**James G. Chehovits  
Crafco, Inc.**

**R. Gary Hicks  
James Lundy  
Oregon State University**

## 10.0 Contents

---

10.1	Introduction for AR Mixtures . . . . .	10-3
10.2	Design of Dense-Graded HMA Using AR . . . . .	10-4
10.3	Design of Gap-Graded HMA Using AR . . . . .	10-13
10.4	Design of OGFC Using AR . . . . .	10-15
10.5	Design of Surface Treatments Using AR Binder . . . . .	10-20
10.6	Summary . . . . .	10-28
10.7	AR References . . . . .	10-28
10.8	Introduction for RUMAC Mixtures . . . . .	10-31
10.9	Material Selection . . . . .	10-33
10.10	Aggregate Design . . . . .	10-36
10.11	Binder Design . . . . .	10-39
10.12	Mix Design Process . . . . .	10-39
10.13	Typical Laboratory Mixture Properties . . . . .	10-42
10.14	Summary . . . . .	10-42
10.15	RUMAC References . . . . .	10-44

## Design Methods for Paving Mixtures Using Wet Process Asphalt-Rubber

Asphalt rubber (AR) produced using the wet process<sup>1</sup> in which the crumb rubber modifier (CRM) is pre-mixed and reacted with the hot asphalt cement can be used in a variety of paving mixtures and applications. These applications include (1) surface treatments, (2) open, gap, and dense-graded hot-mixed asphalt (HMA), and (3) crack and joint sealants.

AR typically has significantly different physical characteristics than unmodified asphalt cements. These differences include (1) higher viscosity, (2) reduced temperature susceptibility, (3) increased aging resistance, and (4) increased elasticity. Appropriate use of AR in paving applications requires that the binder be designed and formulated for the specific application, and that the final mixture with aggregate be correctly designed. The differing physical properties of AR may require that normal mixture design procedures be modified to account for these differences in binder characteristics. High CRM contents can produce AR binders with physical properties that are modified to the extent that they may be used in manners and applications not possible with conventional asphalt cement.

The objective of this paper is to present mixture design concepts and methods that can be used to design surface treatments, and HMA in open, gap, and dense-graded applications when using AR produced using the wet process.

### Wet Process Asphalt Rubber

Wet Process AR is defined by the FHWA<sup>1</sup> as "any method that blends crumb rubber modifier with the asphalt cement prior to incorporating the binder in the asphalt paving project." When CRM is blended with hot asphalt cement, the rubber particles absorb components of the asphalt and swell to several times their original volume.<sup>2</sup> The absorption of asphalt components by the CRM results in stiffening of the asphalt cement. This absorption and CRM swelling process is referred to as reaction between the asphalt and CRM.

The reaction process causes an increase in the viscosity of the AR due to the increase in the CRM volume and changes in the asphalt. As the CRM swells and the mixture increases in viscosity, the physical properties of the AR mixture change. Changes that occur include (1) increase

## 10.1 Introduction



in high temperature viscosity, (2) increase in high in-service temperature stiffness, (3) increase in elastic characteristics, (4) improvements in low temperature properties, and (5) improvements in aging resistance.<sup>3</sup>

Many factors influence the degree of changes in physical properties. Materials related factors include asphalt cement compositional and physical properties, and CRM gradation, surface area, composition, and content in the AR. Additional influencing factors include heating time and temperature, the mixing method used, and use of additives.

Types of changes in properties of AR that can occur using high (10 to 25%) CRM contents include the following:

<b>Property</b>	<b>Change</b>
Placement Temperature Viscosity	Increases up to 100 times above the original value for asphalt cement
High Service Temperature Stiffness	Softening Point increases up to 60°F <sup>4</sup> Absolute Viscosity (140°F) increases up to 100,000 cp or greater <sup>4</sup>
Elastic Characteristics	Resilience increases up to 50 percent over the value for asphalt cement <sup>3</sup>
Low Temperature Stiffness	Reduction in stiffness at low temperatures <sup>5</sup> Increases in ductility at 39°F
Aging	Increase in retained penetration from 65 to 90 percent in TFOT aging <sup>6</sup>

The degree of modification of properties (especially viscosity) can be of such an extent that normal procedures that are used for designing, producing, and constructing pavements may need to be modified when using AR.

## AR Binder for HMA Applications

AR blends can be used as the binder for open, gap and dense-graded HMA. For appropriate use in each of these mixture types, the characteristics of the AR binder need to be considered during the design process. For each HMA mixture type, special consideration needs to be given to the particle size of the CRM and the viscosity of the AR binder. For any type of HMA mixture, if the rubber particles are larger than the void spaces between the compacted aggregate particles, there will be interference with the aggregate particle-to-particle contact that can result in mixtures that have a somewhat unstable or spongy tendency during and immediately after compaction. This tendency is the result of the swollen CRM particles interfering with the normal mixture compaction process. With typical CRM sizes used (minus No. 10 mesh), this tendency is of most concern with dense-graded mixtures because gap and open-graded mixtures generally have sufficient void space to accommodate the rubber particles.

AR binder with high CRM contents (10 to 25%) will have a much higher viscosity than conventional asphalt cement. The increased viscosity can have an effect on mixing and compaction temperatures, aggregate particle coating, and mixture drainage characteristics. The effect of viscosity needs to be considered during the HMA mixture design process.

AR binder for use in various HMA applications consists of the appropriate grades and quantities of asphalt cement, CRM, and additives for the specific performance characteristics required for that application. Details on binder design are contained elsewhere.<sup>3,7</sup> There are two general manners of using wet-process AR in HMA. The first manner is to use AR binders that do not have significantly modified properties so that there will be minimal effects on design and construction of HMA. AR binder for this type of use will typically be composed of the normal grade of paving asphalt used in that area and a maximum of 5 percent of the binder weight of CRM. For dense-graded mixtures, the CRM particle size should be fine (such as less than 50 mesh) while for open-graded mixtures, coarser CRM (such as 16 mesh) can be used. It is suggested that the viscosity of the AR material produced in this manner not exceed 500 centipoise at the temperature it is added to the aggregate for mixing.

The second manner is to use AR that has highly modified properties to provide a binder with increased performance characteristics. The high degree of modification is accomplished by using higher CRM contents of 10 to 25 percent. Typically, asphalts used are one to three grades

softer than the normal grade for that application. This type of AR will have significantly modified physical properties over the entire temperature range that the material will be subjected to during construction and in-place usage. Therefore, design and construction methods may need to be adapted to account for these modified properties. For dense-graded HMA, finer CRM particles (typically less than 20 mesh) are appropriate, while with open-graded mixtures, larger particles (such as 10 mesh) can be used. Specifications for these grades of AR with significantly modified properties as proposed by the FHWA<sup>1</sup> are shown in Table 10-1. With open and gap-graded mixtures, viscosities of up to 6000 centipoise have been used as opposed to the 4000 centipoise maximum in Table 10-1. The 4000 centipoise maximum is recommended for use with dense-graded mixtures due to the possibility of aggregate coating difficulties which can occur at higher viscosities.

## 10.2 Design of Dense-Graded HMA Using AR

It has been determined that both Marshall and Hveem methods<sup>8</sup> with slight modifications can be used for design of dense-graded HMA using AR.<sup>9</sup> Both procedures essentially consist of selecting aggregates and binder, compacting mixes at varying binder contents, analyzing compacted specimen voids, mechanical testing, and then selecting the binder content based on data obtained. The following discussions when using AR can be applied to both Marshall and Hveem procedures.

### Aggregate

Dense-graded HMA using AR is composed of typical dense-graded type aggregates and appropriate AR binder. Aggregate should meet the same quality requirements as for conventional asphalt concrete that would be used in similar applications. When using AR with less than 5 percent of fine CRM (minus 50 mesh), usual dense-graded aggregate gradations can be used. With higher CRM content AR binder, the aggregate gradation for dense-graded mixtures should be maintained on the coarse side of the gradation band. Gradations which plot between the maximum density line and the upper limit of the band should be avoided. Maintaining the gradation on the coarse side of typical dense-graded bands is important to provide sufficient void spaces in the aggregate for the rubber particles. If the aggregate gradation is too fine, or the rubber particles are too large, compaction problems resulting from rubber interference between aggregate particles can result. This effect is indicated by two observations during the mixture design procedure. First, immediately after compaction and while hot, the mix-

Table 10-1. Requirements for asphalt rubber binder grades<sup>1</sup>

Grade	ARB-1	ARB-2	ARB-3
Test method	CLIMATE ZONE		
	Hot	Moderate	Cold
Highest mean weekly temp. °C (°F)	>38 (>100)	26 to 38 (80 to 100)	<26 (<80)
Lowest mean monthly temp. °C (°F)	>0 (>30)	-12 to 0 (10 to 30)	<-12 (<10)
Apparent viscosity (P) 175°C (347°F) ASTM D2994 spindle 3, 12 rpm	1000 min  4000 max	1000 min  4000 max	1000 min  4000 max
Penetration (1/10 mm) 25°C (77°F) AASHTO T49 100 gram, 5 sec	25 min  75 max	50 min  100 max	75 min  150 max
Penetration (1/10 mm) 4°C (39.2°F) AASHTO T49 200 gram, 60 sec	15 min	25 min	40 min
Softening point °C ASTM D36 (°F)	54 min (130 min)	49 min (120 min)	43 min (110 min)
Resilience (percent) 25°C (77°F) ASTM D3407	20 min	10 min	0 min
Ductility (cm) 4°C (39.2°F) AASHTO T51 1 cm/min	5 min	10 min	20 min
Tests on thin film oven residue, AASHTO T179			
Penetration (percent of original retained) 4°C (39.2°F) AASHTO T49 200 gram, 60 sec	75 min	75 min	75 min
Ductility (percent of original retained) 40°F AASHTO T511 1 cm/min	50 min	50 min	50 min

ture will appear to have a somewhat unstable and "spongy" characteristic if coarse aggregate particles are pressed into the mix. Second, a relatively level trend in mixture air voids data may be noticed with increasing AR contents, instead of the typical decrease in air voids. Both of these effects can generally be reduced and eliminated by coarsening the gradation or by reducing rubber particle size used. Suggested gradation limits for  $\frac{3}{8}$  inch,  $\frac{1}{2}$  inch, and  $\frac{3}{4}$  inch maximum sized dense-graded mixtures for use with high CRM content AR binders are shown in Table 10-2.<sup>10</sup>

**Table 10-2. Dense-graded HMA aggregate requirements<sup>10</sup>**

Sieve size	Gradation, % passing		
	$\frac{3}{8}$	$\frac{1}{2}$	$\frac{3}{4}$
1 in.	100	100	100
$\frac{3}{4}$ in.	100	100	90-100
$\frac{1}{2}$ in.	100	90-100	70-90
$\frac{3}{8}$ in.	90-100	75-95	60-80
No. 4	60-80	50-70	40-60
No. 8	40-60	35-50	30-45
No. 30	18-30	15-25	12-22
No. 50	8-18	6-16	5-14
No. 200	2-8	2-8	2-6

**Additional Requirements**

Fractured Faces (plus 8, 1 face)	90% minimum
Abrasion Loss (ASTM C131)	40% maximum
Sand Equivalent (ASTM D2419)	50 minimum

**Trial AR Contents**

Due to replacement of a portion of the asphalt by CRM in the AR (up to 25%), the AR contents to be investigated during the dense-graded mixture design may need to be up to approximately 25 percent higher than with conventional asphalt cement. As a general rule, the increase

in required binder content will be proportional to the CRM content of the binder.<sup>1</sup> During the design procedure, the CRM in the asphalt should be considered as an integral part of the overall binder. For specimen evaluation and analysis, the CRM can be accounted for by measuring the AR specific gravity (ASTM D70), or by calculating the combined specific gravity of the AR by proportion. With typical asphalt cement (specific gravity of 1.00 to 1.02) and CRM (specific gravity of 1.15 to 1.20) the combined result for AR can be between 1.01 and 1.05 at 60°F.

### **Specimen Mixing**

When using high CRM content (10–25%) AR binder, it is recommended that the AR be heated to  $350 \pm 10^\circ\text{F}$ , and the aggregate to  $300 \pm 5^\circ\text{F}$ . The  $350^\circ\text{F}$  temperature for AR can be used for each grade shown in Table 10-1. The AR should be heated using an indirect method such as a forced-draft oven to maintain temperature and the AR should be stirred to assure uniformity immediately before adding to the heated aggregate. For AR binder with a low CRM content (less than 5 percent), mixing temperatures can be more similar to those used for the base asphalt cement.

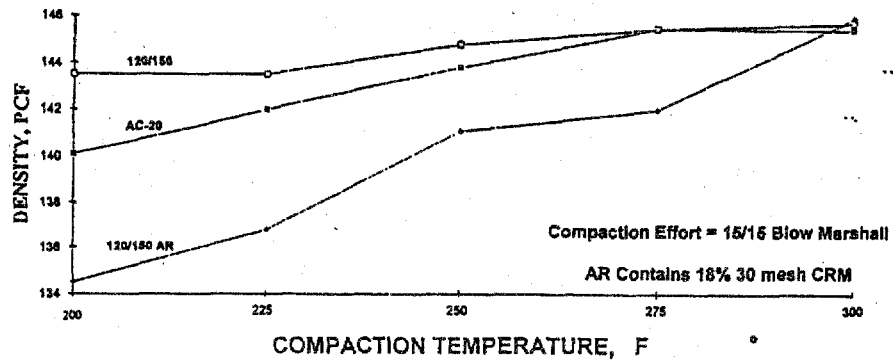
Mixing of the AR with the aggregate should be performed using standard types of mechanical mixers such as whips or paddles. Mixing should be performed immediately after addition of the AR to the aggregate and should continue for at least 30 seconds beyond the time required to obtain complete aggregate coating. Total mix time should not exceed two minutes. If complete aggregate coating is not achieved in two minutes (which may be due to very fine or dusty mixes), the AR content should be increased, or the viscosity of the AR reduced by increasing temperature or lowering CRM content. Following completion of mixing, the mixture should be split into appropriate portions (approximately 1100 to 1200 grams) for compaction of specimens. If Hveem compaction will be used, the mixture should be subjected to the standard  $140^\circ\text{F}$  curing procedure for 15 hours.

### **Specimen Compaction**

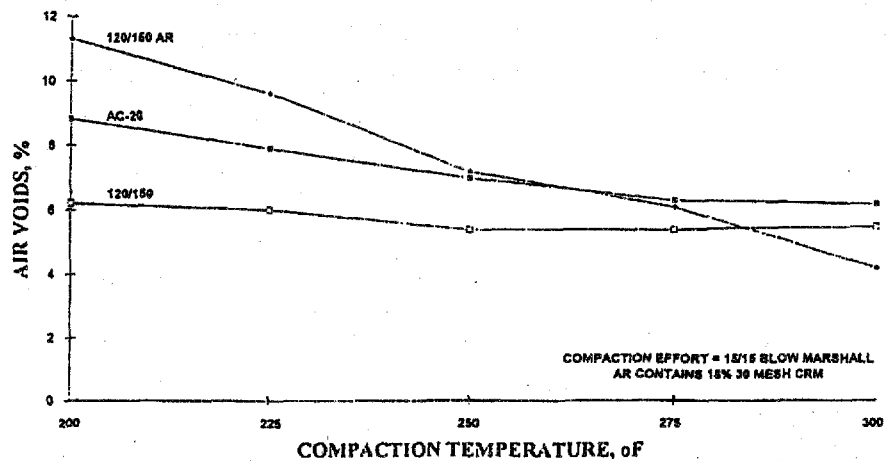
Due to the high viscosity of AR at high temperatures, AR mixtures can be more sensitive to compaction temperature than conventional mixtures. Figures 10-1 and 10-2 show density and air void plots for dense-graded HMA mixtures containing AC-20 and 120/150 asphalt ce-

ment, and AR made using 18 percent 30-mesh CRM with the 120/150 asphalt. Specimens were mixed at 300°F and then compacted at 200, 225, 250, 275 and 300°F using 15 blows per side with a handheld Marshall hammer to attempt to simulate initial field compaction levels. Figures 10-1 and 10-2 show that the compaction levels achieved with the AR mixture were affected to a much greater degree by temperature than the AC-20 or 120/150 mixtures. This information indicates that compaction temperature uniformity during the mixture design process needs to be of even greater concern than with standard HMA.

**Figure 10-1. Density vs. compaction temperature for HMA with AC-20, 120/150, and AR**



**Figure 10-2. Air voids vs. compaction temperature for HMA with AC-20, 120/150, and AR**



During the mix design, when using Marshall compaction, the loose mixture should be stored in a forced-draft oven maintained at the compaction temperature to ensure that the appropriate temperature is achieved. This can be accomplished by storing the mixture for one to two hours in the oven and verifying actual mixture temperature with an accurate thermometer placed in the mixture. For low CRM-content AR mixtures, compaction temperature can be the same as that which is used for normal HMA. For high CRM-content AR mixtures, the recommended compaction temperature can be between 275 and 300°F. Use of a 300°F compaction temperature can result in design binder contents that are as much as 0.5 percent lower than if compaction is performed at 275°F. Whatever compaction temperature is chosen, it is important to maintain that temperature within  $\pm 5^\circ\text{F}$  to achieve uniform, repeatable results in the laboratory.

Specimen compaction consists of removing the specimen from the oven, placing it into heated Marshall molds, spading 15 times, and compacting using standard Marshall procedures. Compaction level can be 35, 50, or 75 blows per side as dictated for the anticipated traffic level. Compaction should be completed within three minutes following removal of specimens from the oven.

Compaction temperature, when using the Hveem procedure, should also be within the 275 to 300°F range. Some agencies and research studies have used 300°F.<sup>9</sup> After the curing period at 140°F, the specimens should be heated to within  $+5^\circ\text{F}$  of the designated compaction temperature and then compacted.

For both the Marshall and the Hveem procedures, specimens should be allowed to cool to ambient laboratory temperature (minimum of four hours) prior to removing from the molds. The reason for this is that if specimens are removed while still warm, deformation due to rebound from the rubber particles may occur, which could distort results.

### Specimen Testing

For both Marshall and Hveem procedures, following removal from the molds, specimens are tested using standard procedures to evaluate stability, flow, stabilometer value, density, voids, etc.

**Marshall Procedure:** Test results should be reported using standard procedures and methods. The design binder content should be selected to provide a mixture with appropriate air voids while providing appropriate stability, flow and VMA as indicated for conventional mixtures



in the MS-2 manual.<sup>8</sup> Two modifications in design criteria should be used for AR dense-graded HMA. First, due to the increased viscosity, elasticity, and softening point of the AR, HMA mixtures tend to experience less compaction and densification from traffic after construction. Therefore, for dense-graded mixtures containing AR binder, the design air-void level can be set at the lower end of the 3-to-5 percent range.

The second modification in analysis of results for determining design binder content is that maximum flow values can be raised to 24 for light traffic, 22 for medium traffic, and 20 for heavy traffic due to the higher binder contents that are typically required,<sup>9</sup> and due to the flatter slope of the load versus deformation curve during the Marshall stability procedure.<sup>1</sup>

Typical design AR contents for dense-graded HMA range from 6.0 to 7.5 percent by mixture weight. Generally, HMA mixtures containing high CRM content (10–25%) AR will have increased VMA and flow results, and may have decreased stability results. For lower CRM content (0–5%) AR, mixture results are typically more similar to conventional HMA.

**Hveem Procedure.** As with the Marshall procedure, test results should be reported using standard procedures and methods. HMA containing AR binder with a high CRM content (10–25%) will typically yield lower stabilometer values than conventional mixtures. This is a result of increased lateral deformation per given load that is obtained with the presence of AR.<sup>9</sup> Typical stabilometer results when using high CRM content AR binder in dense-graded HMA range from 20 to 30 when using aggregate which produces 35 to 40 stabilities with conventional asphalt cement. As with the Marshall procedure, typical binder contents range from 5.5 to 7.0 percent. Hveem mix design procedures will generally result in slightly lower binder contents compared to Marshall designs.

### **Moisture Resistance**

After the AR content of the mixture has been determined, the moisture resistance of the mixture should be verified. Conventional procedures such as Immersion Compression (ASTM D1075) or Tensile Strength Ratio (ASTM D4867)<sup>11</sup> can be used. Specification limits should be the same as for normal dense-graded HMA. Additives such as cement, hydrated lime, or liquid anti-strip can be incorporated if improved moisture resistance is needed.

## Mixture Design Documentation for Dense-Graded Mixtures

The completed mixture design for dense-graded HMA with AR binder should document the properties of materials used, testing performed, designed mixture characteristics, and specifications. As a minimum, the following items should be included in the design:

1. **Aggregate**—gradation, specific gravities, fractured faces, abrasion loss, sand equivalent, other quality requirements
2. **AR Binder**—asphalt cement, CRM, percentages, specification tests, reaction results, specific gravity
3. **Specimen Mixing**—binder contents, mixing and compaction temperatures, compaction methods
4. **Specimen Testing**—maximum specific gravity, bulk specific gravity, stability and flow (Hveem stability)
5. **Calculations**—air voids, voids filled, VMA, absorbed asphalt, density, effective asphalt
6. **Moisture Resistance Testing**—use of additives if needed
7. **Design Recommendations**—
  - AR Binder Content
  - Field Density Targets
  - Production and Compaction Temperature Ranges

Gap-graded HMA is a variation of dense-graded HMA in which the aggregate gradation is coarsened to provide a greater amount of coarse aggregate contact and to increase VMA to permit increased binder contents.<sup>13</sup> Coarsening of the aggregate gradation provides space for the CRM particles and permits use of larger sized CRM than with dense-graded mixtures. Gap-graded HMA using high CRM content AR has been found to offer increased performance.<sup>12</sup> Suggested gradations for gap-graded HMA are shown in Table 10-3. Aggregate should meet all other typical quality requirements for use in HMA. Gap-graded mixtures are very similar in concept to Stone Mastic (SMA) mixtures. When using AR binder in this application, modifiers for drainage reduction may not be required due to the increased viscosity of AR and resulting reduction in drainage characteristics.

## 10.3 Design of Gap-Graded HMA Using AR

**Table 10-3. Gap-graded HMA aggregate requirements<sup>10</sup>**

Sieve size	Gradation, % passing		
	$\frac{3}{8}$	$\frac{1}{2}$	$\frac{3}{4}$
1 in.	100	100	100
$\frac{3}{4}$ in.	100	100	90-100
$\frac{1}{2}$ in.	100	90-100	65-85
$\frac{3}{8}$ in.	78-92	70-90	50-70
No. 4	28-42	24-42	22-42
No. 8	15-25	15-25	15-25
No. 30	5-15	5-15	5-15
No. 200	3-7	3-7	3-7

**Additional Requirements**

Fractured Faces (plus 8, 1 face)	90% minimum
Abrasion Loss (ASTM C131)	40% maximum
Sand Equivalent (ASTM D2419)	50 minimum

Both Marshall and Hveem procedures can be used to design gap-graded HMA with AR binder. The modified compaction and testing procedures used should be the same as for dense-graded mixtures as previously discussed. The design binder content should be chosen to satisfy 3 to 5 percent air voids and 20 percent minimum VMA. Both Marshall and Hveem stabilities are typically lower than conventional dense-graded mixtures by as much as 50 percent. Typical design AR binder contents range from 6.5 to 9.0 percent by mixture weight. Gap-graded mixtures will typically have higher VMA and flow values, and lower stabilities than dense-graded HMA. As with dense-graded designs, differences may occur between Hveem and Marshall designs. Design documentation should consist of the same items as for dense-graded HMA.

The modified physical properties of high CRM content AR permit its use in a variety of manners with open-graded HMA (OGFC). Due to the increased viscosity of AR, binder contents of up to approximately 10 percent can be used without experiencing excessive drain off. The higher binder contents produce thicker binder films which increase mixture aging resistance and durability. Additionally, higher mix temperatures can be used which assist with construction in cooler temperatures or if long hauls are needed.

Design procedures for OGFC generally consist of (1) selecting the aggregate gradation, (2) determining the binder content, (3) evaluating mixture drainage versus temperature characteristics, and (4) determining moisture resistance properties. The following design procedure adapts procedures specified in FHWA Report No. FHWA-RD-74-2, "Design of Open-Graded Asphalt Friction Courses,"<sup>14</sup> and FHWA Technical Advisory-Open Graded Friction Course, T5040.31<sup>15</sup> for use with AR binder.

When using high CRM-content AR binder, a much wider range of binder contents is possible than with conventional asphalt cement. Use of binder contents at the high end of the possible range will provide mixtures with thicker binder films and thus increased durability, but at a greater cost. The designer must decide on the appropriate cost versus performance balance for specific projects.

### **Aggregate**

Aggregate for use with OGFC using AR binder should meet the same quality requirements as for conventional OGFC mixtures. Suggested gradations are shown in Table 10-4.

### **AR Binder Content**

The suggested method for determining the AR binder content for open-graded mixtures is to first follow the FHWA T-5040.31 procedure for asphalt content of conventional mixtures, and then to adjust the asphalt content for the AR binder being used and the specific project application. The procedure is as follows:

*Step 1.* Determine the surface constant  $K_c$  of the aggregate using the FHWA T-5040.31 procedure (oil soaking and drain off).<sup>15</sup> This procedure is also contained in the Asphalt Institute MS-2 manual.<sup>8</sup>

## **10.4 Design of Open-Graded Friction Courses Using AR**

**Table 10-4. Open-graded HMA aggregate requirements<sup>10</sup>**

Sieve size	Gradation, % passing	
	$\frac{3}{8}$	$\frac{1}{2}$
$\frac{3}{4}$ in.	100	100
$\frac{1}{2}$ in.	100	95-100
$\frac{3}{8}$ in.	85-100	75-95
No. 4	25-55	20-45
No. 8	5-15	5-15
No. 30	0-10	0-10
No. 200	0-5	0-5

**Additional Requirements**

Factured Faces (plus 8, 1 face)	90% minimum
Abrasion Loss (ASTM C131)	40% maximum
Sand Equivalent (ASTM D2419)	50 minimum

**Step 2.** Calculate the required asphalt cement content using the following formula:<sup>15</sup> Percent Asphalt (aggregate weight) =  $(2.0 K_c + 4.0) \times 2.65/SG_{AGG}$ .

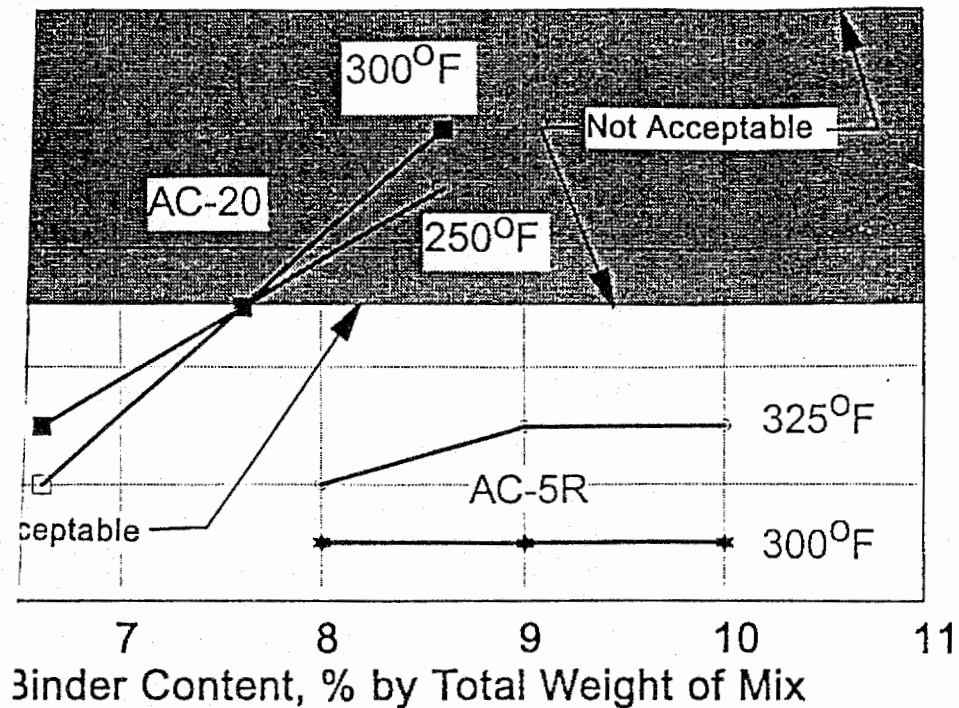
**Step 3.** Determine the base AR content by dividing the percentage of asphalt from step 2 by the fractional asphalt cement (and extender oil if used) content of the AR. This provides an asphalt cement content in the AR which is equivalent to that determined in step 2.

The base AR content determined with the above procedure should be regarded as the minimum which should be considered for use in OGFC. Mixtures which are produced at this AR binder content will exhibit high air voids (15 to 20%) and VMA (greater than 20%) and will have high permeabilities.

With high CRM-content (10 to 25%) AR binder, viscosity at mixture temperatures will be significantly higher than for conventional asphalt cement. This results in greatly reduced binder drainage characteristics. Figure 10-3 is a plot of drainage characteristics of OGFC with AC-20 asphalt and AC-5 based AR which used 17 percent of a 24 mesh CRM.

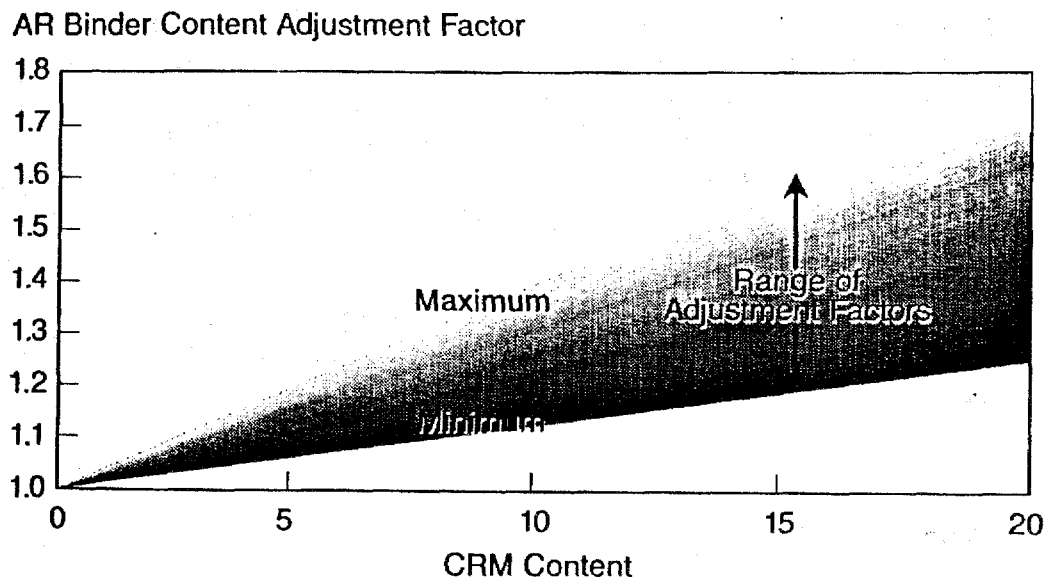
Data shows the reduced drainage of the AR mixtures even at binder contents of 10 percent by mix weight.

Figure 10-3. Open-graded mix drain-off comparison<sup>16</sup>



Generally, the maximum binder content which can be considered for use in OGFC approximately 40 percent greater than the base AR content when high CRM-content (15-25%) AR is being used. At this binder content, the mixtures will typically contain 9 to 11 percent AR binder by mixture weight and will have lower air voids (8 to 12%). This high AR binder content will produce more durable mixtures. With AR binder with lower CRM contents, the maximum binder content which can be considered will be proportionally lower. Figure 10-4 shows approximate factors for minimum and maximum adjustments of the asphalt cement content which can be considered when using AR. Factors shown in Figure 10-4 would be multiplied by the asphalt cement content determined using the FHWA T-5040.31 procedure to show approximate ranges for AR binder content.

**Figure 10-4. Open-graded AR mixture binder content adjustment factors**



### Air Void Content

When using AR in OFGC, the air void content of the mixture should be verified. Voids can be analyzed by comparing specimens (50 blow Marshall at mixing temperature) and performing volumetric analyses using paraffin-coated specimens (ASTM).

With increased AR binder contents, if it is desired to maintain air voids, the FHWA T-5040.31 procedures for determining void capacity of the coarse aggregate and optimum fine aggregate content could be followed to adjust the mixture for the desired air void level. It is recommended that if fine aggregate content adjustments are made to produce desired air void levels, that adjustments be made within the gradation ranges shown in Table 10-4. Fines content (minus No. 8 mesh) should not be reduced below five percent because of the desired mixture "choking" characteristics.<sup>14</sup>

### Mixture Temperature Determination

After selection of the AR binder content, the mixture should be tested for drainage characteristics as outlined in FHWA T-5040.31. Due to the degree of modification of high temperature viscosity of AR binder, with high CRM contents, it may not be possible to select mixing temperature based entirely on drain down characteristics. Achieving desired drainage may require slight adjustments of the AR binder content within the

previously discussed minimum and maximum limits. Some drainage is desired to adhere the mixture to the underlying pavement. With high CRM-content AR, it is suggested that initial evaluations be performed at 290 to 300°F. If drainage is not appropriate, temperature can be increased or decreased to attempt to achieve the desired results. The mixture temperature for high CRM-content AR mixtures should not exceed 325°F. If appropriate drainage cannot be achieved below this temperature range, then slight AR binder content adjustments could be investigated.

With low CRM-content AR binder the mixture temperature determination process will be more similar to that with the base asphalt cement. The desired drainage characteristics remain the same.

### Moisture Resistance Testing

Due to the high degree of water permeability of OGFC, the mixture must have adequate moisture resistance for appropriate performance. The FHWA recommends using Immersion Compression Testing (ASTM D1075), with a modified molding pressure of 2000psi instead of 3000psi.<sup>15</sup> The specified result is a 50 percent minimum Index of Retained Strength. Additives such as heat stable liquids, cement, or hydrated lime can be used if improvements are needed. Some laboratories have problems with this procedure, particularly with specimen slumping during the conditioning period. Test modifications or other test procedures may be necessary to evaluate moisture resistance.

### Mixture Design Documentation for Open-Graded Mixtures

The completed mixture design for OFGC should document the properties of the materials used, testing performed, designed mixture characteristics, and specifications. As a minimum, the following items should be included in the design:

1. **Aggregate**—gradation, specific gravity, fractured faces, abrasion loss, sand equivalent, etc.
2. **AR Binder**—asphalt cement, CRM percentages, specification tests, reaction results, specific gravity.
3. **AR Binder Content Determination**—CKE results, adjustments for CRM content.



## 10.5 Design of Surface Treatments Using AR Binder

4. *Mixture Temperature*—drainage results.
5. *Compacted Specimen Characteristics*—voids, VMA, etc.
6. *Moisture Resistance Evaluation*—use of additives if needed.
7. *Design Recommendations:*
  - AR Binder Content
  - Production and Compaction Temperature Ranges

AR can be used as the binder for surface treatment applications. Typically, these applications consist of relatively high amounts (0.5 to 0.7 gallons per square yard) of high CRM content (20 to 25%) AR binder which is spray applied to the pavement surface and then covered with appropriate aggregate chips to provide a skid resistant wearing surface. This type of surface treatment is referred to as a "Stress Absorbing Membrane" (SAM).<sup>13</sup> If the SAM is covered with an additional layer of asphalt concrete, the SAM is referred to as a "Stress Absorbing Membrane Interlayer" (SAMI).<sup>13</sup> SAM and SAMI applications have been found to be capable of improving pavement performance by reducing reflective cracking, providing an impermeable membrane, and reducing aging asphalt cement in the underlying asphalt concrete.<sup>17</sup>

Design of a SAM or SAMI project should address the following items:

1. AR binder to be used
2. Aggregate specifications
3. Quantities of AR and aggregate
4. Verifying aggregate retention
5. Specifying construction guidelines

### AR Binder for Surface Treatment Applications

The AR binder for SAM or SAMI applications should have the following characteristics:

1. Adequate stiffness at high pavement temperatures to retain aggregate and resist bleeding under traffic loadings at the design application rate.
2. Adequate low temperature flexibility to retain aggregate in cold weather and resist cracking.
3. Adequate adhesion to aggregate.
4. Ability to be properly applied

To provide adequate high pavement surface temperature stiffness to resist bleeding at typical binder application rates (0.5 to 0.7 gallons per square yard), generally high CRM contents of 20 to 25 percent by total weight of the blend are required. CRM particle size is typically 10 or 16 mesh maximum.

Asphalt cements typically used for these applications vary according to climate as follows:

<b>Climate</b>	<b>Asphalt Cement Grade</b>
Cold	AC2.5 or AC5
Moderate	AC5 or AC 10
Hot	AC10 or AC20

The grade of asphalt cement used can also be influenced by traffic conditions. Stiffer asphalt may be needed for city streets with high traffic levels and starting and stopping. Softer asphalts may be more appropriate for lower traffic volumes with less starting and stopping.

The viscosity of the AR needs to be appropriate for proper spray application. The capabilities of spray application systems can vary significantly, therefore, the AR characteristics must be matched to the application equipment. Generally, specialized distributors which are designed for AR are used for the spray application. For acceptable results, AR viscosity at placement temperature should not exceed 4000 centipoise at time of use. If required, AR viscosity can be reduced for improved application characteristics by increasing temperature, adding small amounts of appropriate diluent, or by using an aromatic extender oil in the blend.<sup>1</sup> For SAMI's, diluent should only be used if adequate cure time is allowed prior to overlaying.

Specifications for high CRM-content AR binders for use in SAM or SAMI applications are being developed by several organizations. The specifications being considered are similar to those for HMA applications (Table 10-1); however, it is suggested that increased high temperature stiffness be provided due to the typical high application rates that are used.

The FHWA<sup>1</sup> has proposed limits on CRM particle size for use in surface treatments with various aggregate sizes. This concept appears reasonable and should aid in achieving appropriate aggregate embedment.

### Aggregate Requirements

Aggregate for use in SAM applications should be composed of high quality clean and durable crushed rock, crushed gravel, or crushed slag. It should also be free from deleterious substances such as organic material, clay balls or lumps, and should not have adhered dust coatings which could reduce adhesion. Suggested gradation and other quality requirements are contained in Table 10-5. The gradations shown in Table 10-5 are essentially "single size" gradations. It is important for appropriate aggregate retention that the gradation requirements be met. Use of more well-graded aggregates with increased intermediates and fines can tend to reduce embedment and adhesion to the AR binder.

**Table 10-5. SAM cover aggregate requirements<sup>18</sup>**

Sieve size	Gradation, % passing	
	$\frac{3}{8}$	$\frac{1}{2}$
$\frac{5}{8}$ in.	100	100
$\frac{1}{2}$ in.	100	95-100
$\frac{3}{8}$ in.	70-100	0-20
$\frac{1}{4}$ in.	0-10	0-5
No. 8	0-5	0-2
No. 200	0-1	0-1

#### Additional Requirements

Fractured Faces (plus 8, 1 face)	75% minimum
Abrasion Loss (ASTM C131)	40% maximum

When increased durability of the SAM application is desired, use of pre-coated aggregate can be considered. Typical precoatings are either hot asphalt cement, which is mixed with heated aggregate, or cold applied emulified asphalt coatings. Typical precoating amounts are approximately 0.5 percent by aggregate weight. Excessive amounts of precoating material may cause increased pick up of the aggregate during rolling. The precoating should be applied using the minimum amount necessary to bind any fines or dust coatings to the aggregate surface and to provide a film to adhere to the AR.

## AR Binder and Cover Aggregate Application Rates

For appropriate performance, the application rates for AR binder and cover aggregate need to be selected so that adequate aggregate embedment is achieved. If the application rates are not correctly designed, problems with loss of aggregate or bleeding may occur. It has been reported that inadequate SAM binder and aggregate application rate design procedures have resulted in flushing problems, and that use of an appropriate design process could result in improved performance.<sup>19</sup> The commonly practiced design process generally selected the application rate of the AR binder and then applied a sufficient quantity of aggregate to cover the binder and permit rolling without aggregate pick up. The problem with this method is that there is little control of aggregate embedment achieved other than what can be accomplished with minor permitted field adjustments. Once an agency gained sufficient experience with available aggregates, through a trial and error process, application rate quantities were adjusted to produce correct results. Use of these types of trial and error design procedures probably contributes to the belief by many that constructing good performing surface treatments is an art rather than a science.

The recommended method of designing AR surface treatment applications consists of following a procedure which provides for proper embedment of one layer of aggregate in the AR binder.<sup>19</sup> The procedure basically consists of determining the correct quantity of aggregate for a single layer thickness, and then determining the appropriate application rate for the AR binder considering aggregate voids, traffic conditions, and pavement surface conditions, to provide the desired aggregate embedment depth. The desired aggregate embedment depth has been found to be approximately 50 to 60 percent of the aggregate particle size when using high CRM content AR surface treatments compared to 40 percent for conventional asphalt cement.<sup>1,20</sup> The higher embedment depth with AR is possible due to the increased stiffness and softening resistance of the AR binder at high in-service temperatures. Additionally, the increased embedment depth is needed for adequate aggregate adhesion.

The FHWA has presented a suggested design procedure for surface treatments when using high CRM content AR in Publication No. FHWA SA-92-022.<sup>1</sup> This procedure first determines cover aggregate characteristics (specific gravity and dry, loose unit weight) and then requires determination of the aggregate quantity for single-stone depth coverage using a board test. The procedure suggests using a one-half square yard surface area board, covering with a single layer of aggregate, weighing and then converting that quantity into pounds per square

yard. The aggregate quantity thus determined is the design aggregate spread rate for the project.

For the project aggregate, the AR binder application rate is then determined by the following formula:

**Formula 1**

$$A = 5.61 ET \left( 1 - \frac{W}{62.4G} \right) + V$$

- Where A = Quantity of asphalt rubber (gallon/square yard at 60°F)
- E = Embedment depth from Figure 10-5 (inches)
- T = Traffic correction factor from Table 10-6
- G = Dry bulk specific gravity of aggregate
- V = Surface condition correction from Table 10-7  
(gallon/square yard)
- W = Aggregate dry, loose unit weight

**Table 6.  
Traffic Correction  
Factor for Surface  
Treatment Design<sup>1</sup>**

Vehicles per day per lane	Traffic factor (T)
Over 1000	1.00
500-1000	1.05
250-500	1.10
100-250	1.15
under 100	1.20

**Table 7.  
Pavement Condition  
Correction for Surface  
Treatment Design<sup>1</sup>**

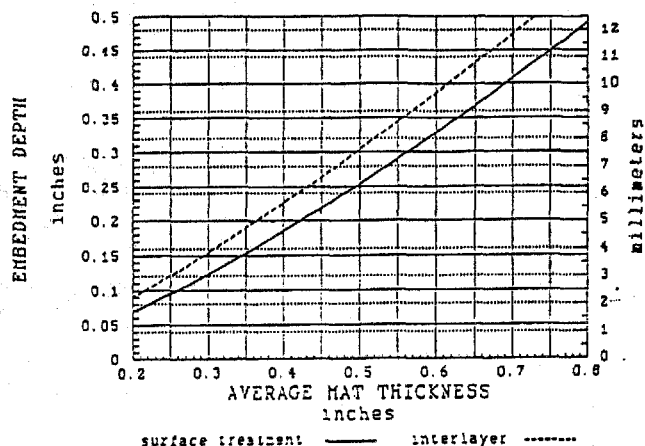
Pavement surface condition	Asphalt quantity correction (V)
flush asphalt surface	-0.06 gal./sq. yd.
smooth, nonporous surface	-0.03 gal./sq. yd.
slightly porous, oxidized	
porous, oxidized, slightly pocked	+0.03 gal./sq. yd.
porous, oxidized, badly pocked	+0.06 gal./sq. yd.

In Formula 1, embedment depths for SAM and SAMI applications are determined from Figure 10-5. It is noted that the desired embedment depth for SAM applications is approximately 50 percent of the average mat thickness, and that for SAMI applications, the desired embedment

is approximately 60 percent. Average mat thickness is the average depth of the aggregate particles applied to the pavement. For the nearly single sized aggregate gradations in Table 10-5, the average mat thickness is slightly less than either the  $\frac{3}{8}$  or  $\frac{1}{2}$  inch maximum size.

Formula 1 also corrects for traffic conditions by using the T factor from Table 10-6. The correction consists of increasing the application rate up to 20 percent for lanes with low traffic counts. The reason for this is to provide a greater amount of binder to aid in achieving desired embedment level with lower traffic loadings. Pavement surface condition is corrected for using Table 10-7 by using a lower application rate for flushed pavement surfaces and an increased application rate for porous pavement surfaces which would tend to absorb the applied binder. Variations in embedment and the design binder application rate will also occur within the lane because of greater traffic loadings in the wheel paths. Texas routinely corrects for these variations within the lane by varying application rate across the lane through the use of different distributor nozzle sizes on the spray bar.<sup>20</sup>

**Figure 10-5. Embedment depth factors for AR surface treatment design<sup>1</sup>**



As an example, a  $\frac{1}{2}$  inch maximum sized aggregate meeting requirements of Table 10-5, produced a board test single layer capacity result of 25.0 pounds per square yard. The material had a bulk specific gravity of 2.59 and a dry, loose unit weight of 88 pounds per cubic foot. The AR binder application rate for this aggregate for SAM use according to Formula 1 (using an average mat thickness of 0.45 inch) is 0.56 gallons per square yard. If this surface treatment was being used for a lower traffic (250–500 vehicles per day) road which was very porous and cracked, the binder application rate should be increased to 0.61 gallons per square yard. It is noted that these application rates are determined at

60°F. Actual spray application rates at application temperature (300 to 400°F) would need to be increased by an appropriate volume correction factor to adjust for volume expansion of the AR binder. At 350°F, the correction factor is approximately 10 percent. Conventional asphalt cement correction factors are currently being used.

### **Flush Coats**

For improved durability of SAM applications, flush coats may be used. Flush coats normally consist of an application of 0.10 to 0.14 gallons per square yard of a 50/50 diluted SS emulsion. This application tends to seal the surface and improve aggregate retention. Flush coats can be used with both uncoated or precoated aggregate.

### **Moisture Resistance**

The FHWA SA-92-022 surface treatment design procedure<sup>1</sup> recommends testing of the aggregate-AR ingredients according to AASHTO T 182 (ASTM D1664) for stripping potential using the cutback asphalt procedure with a 300°F binder temperature. Use of this procedure may be difficult due to attempting to coat aggregate at ambient temperature. A more appropriate procedure could be the T182 procedure for dry aggregate coated with semi-solid asphalt and tars which uses heated aggregate. These procedures visually evaluate coating retention when the aggregate which is coated with binder is immersed in water for 16 hours at 77°F. The percentage retained coating is estimated at greater or less than 95 percent only due to repeatability concerns when attempting to estimate lower retained coating amounts.

Several States have developed more accelerated procedures to indicate binder moisture resistance characteristics including Arizona Method 217, "Accelerated Stripping Test of Bitumen Aggregate Mixtures," which subjects coated aggregate particles to 150°F water and mechanical stirring at 2400 rpm.<sup>21</sup> Caltrans Method 302, "Standard Method of Test for Film Stripping," subjects coated aggregate to mechanical agitation at ambient temperature.<sup>22</sup> The Texas 530-C boiling test evaluates retained binder coating after subjecting the coated aggregate particles to boiling water for ten minutes.<sup>23</sup> These procedures could be adapted for use with AR surface treatments to provide an indication of moisture resistance characteristics. These procedures, however, do not necessarily simulate field conditions due to use of heated aggregate and the mixing and stirring action during aggregate coating. The Vialit Chip Retention

Procedure<sup>24</sup> provides an indication of chip retention characteristics by simulating a surface treatment application in the lab.

An additional procedure has been used by industry to indicate moisture resistance characteristics of AR surface treatments. The procedure consists of proportioning the surface treatment on a metal plate in a 7.5 inch diameter circular area at the design binder and aggregate application rates. Aggregate is compacted into place using a hand held ram. After cooling, the surface treatment specimen is subjected to mechanical brushing using an attachment to a Hobart mixer (similar to the slurry seal wet track abrasion method (ASTM D3910) but using a brush instead of rubber hose) for one minute to remove loose aggregate particles. The amount of aggregate retained can then be determined by weighing. Following the initial brushing, the surface treatment specimen is placed in water at 77°F for 24 hours, removed and then subjected to an additional one minute of brushing to remove any aggregate which has loosened as a result of water immersion. The specimen is then oven dried and reweighed to determine the water soaked aggregate retention amount. The percentage of retained aggregate can then be calculated.

If it is determined that moisture resistance needs to be improved, several methods can be used. First, liquid anti-stripping additives can be added to the AR binder.<sup>25</sup> Another method is to use specialized types of high natural rubber content additives to aid in increasing adhesiveness.<sup>7</sup> Other methods include use of precoated aggregate and flush coats.

### Design Documentation for Surface Treatments

The completed design for the surface treatment should document the properties of the materials used, testing performed, designed mixture characteristics and specifications. As a minimum, the following should be included in an AR surface treatment design:

1. **Aggregate**—gradation, specific gravity, fractured faces, abrasion loss, etc.
2. **AR Binder**—Asphalt cement, CRM percentages, specification tests, reaction results, specific gravity.
3. Aggregate Application Rate Determination
4. AR binder application rate determination for the aggregate and project conditions.
5. **Moisture Resistance Evaluation**—use of additives if needed, precoating, or flush coat.



## 10.6 Summary

### 6. *Design Recommendations:*

- AR Application Rate and Temperature
- Aggregate Application Rate
- Precoating, if specified
- Flush Coat, if specified

Wet process AR binders can have significantly modified physical properties compared to asphalt cement. Appropriate use of AR in paving applications requires that the AR binder be appropriately designed for the application, and that the final mixture with aggregate is correctly designed. The differing physical properties of AR require several modifications of mixture design procedures to account for these differences. Mixture design concepts and methods which can be used to account for the different properties of AR binders in open, gap, and dense-graded HMA designs, and in surface treatment designs are presented. Use of these design concepts and procedures will aid in the successful use of CRM in construction of AR surface treatments and HMA.

## 10.7 Asphalt-Rubber References

1. Heitzman, M.A., "State of the Practice—Design and Construction of Asphalt Paving Materials with Crumb Rubber Modifier," Federal Highway Administration, Report No. FHWA-SA-92-022, May 1992.
2. Green, E.L., and Tolonen, W.J., "The Chemical and Physical Properties of Asphalt-Rubber Mixtures—Basic Material Behavior," Report No. ADOT-R514 (162), Arizona Department of Transportation, July 1977.
3. Chehovits, J.G., "Design Methods for Hot-Mixed Asphalt-Rubber Concrete Paving Materials," *Proceedings. National Seminar on Asphalt Rubber*, Kansas City, Missouri, October 30-31, 1989, Asphalt Rubber Producers Group, Phoenix, Arizona.
4. Rosner, J.C., and Chehovits, J.C., "Chemical and Physical Properties of Asphalt-Rubber Mixtures—Phase III Summary Report and Volumes 1-5," Report HPR 1-19 (159), Arizona Department of Transportation, July 1981.

5. Hansen, K.R., and Stonex, A., "Tensile Creep Comparison of Asphalt Cement and Asphalt Rubber Binders," Asphalt Rubber Producers Group, Phoenix, Arizona, October 1991.
6. Anderton, G., "Physical Properties and Aging Characteristics of Asphalt Rubber Binders," Asphalt Rubber Producers Group, Phoenix, Arizona, February 1992.
7. Chehovits, J.C. "Design of Asphalt and Crumb Rubber Modifier Blends for Highway Applications," Workshops on Asphalt Rubber, Federal Highway Administration, Publication No. FHWA-SA-93-007.
8. "Mix Design Methods for Asphalt Concrete," The Asphalt Institute, Manual Series No. 2 (MS-2).
9. Stroup-Gardner, M., Krutz, N., and Epps, J., "Comparison of Mix Design Methods for Asphalt-Rubber Concrete Mixtures," Asphalt Rubber Producers Group, Phoenix, AZ 1992.
10. "Guide Specification for Open, Dense, and Gap Graded Asphalt Concrete Pavements with Asphalt-Rubber Binder," International Surfacing, Inc., Chandler, AZ 1992.
11. *1992 Annual Book of ASTM Standards*, American Society for Testing and Materials, Volume 4.03.
12. Cano, J. and Charania, E., "Gap-Graded Asphalt Rubber Hot Mix Used in the City of Phoenix, Arizona," 1992 International Public Works Congress and Exposition, Boston, Massachusetts, August 29-September 3, 1992.
13. Vallerga, B.A., Morris, G.R., Huffman, J.F., Huff, B.J., "Applicability of Asphalt Rubber Membranes in Reducing Reflection Cracking," Proceedings AAPT, Vol. 49, 1980, pp. 330-353.
14. Smith, R.W., "Design of Open-Graded Asphalt Friction Courses," Federal Highway Administration Report No. FHWA-RD-74-2, 1974.
15. Federal Highway Administration, Technical Advisory—Open Graded Friction Course, T-5040.31, December 1990.
16. Anderton, G., "Asphalt Rubber Open-Graded Friction Courses," Asphalt Rubber Producers Group, Phoenix, Arizona, 1992.

17. Cano, J.O., and Charania, E., "The Phoenix Experience Using Asphalt Rubber," *Proceedings National Seminar on Asphalt Rubber*, Kansas City, Missouri, October 30-31, 1989, Asphalt Rubber Producers Group, Phoenix, Arizona.
18. "Guide Specification for Asphalt Rubber Stress Absorbing Treatments (SAM or SAMI) for Highways, Roads, Streets and Airports," International Surfacing, Inc., Chandler, Arizona, 1991.
19. Shuler, T.S., Pavlovich, R.D., and Epps, J.A., "Field Performance of Rubber Modified Asphalt Paving Materials," *Transportation Research Record 1034*, Transportation Research Board, Washington, DC, 1985, pp. 96-102.
20. Holmgreen, R.J., "A Seal Coat Design Method," *Proceedings AAPT*, Volume 54, 1985, pp. 667-672.
21. *Materials Testing Manual*, Arizona Department of Transportation, Materials Section, ADOT M-XII-TWO-D, Phoenix, Arizona.
22. *Standard Test Methods*, Caltrans, Transportation Laboratory, Sacramento, California.
23. *Bituminous Section Manual of Testing Procedures*, Texas Department of Transportation, Austin, Texas.
24. Boudreault, Jacques, "Study of Adhesiveness by the Vialit Test," *Canadian Technical Asphalt Association Proceedings*, 1989, pp. 75-97.
25. "Laboratory Testing for Aggregate Chip Precoating and Chip Retention for Asphalt Rubber Chip Seals," *Report for International Surfacing, Inc., Western Technologies, Inc.*, Phoenix, Arizona, 1985.

## Mix Design for Rubber Modified Asphalt Mixtures: Dry Process

Mix design procedures and criteria used for conventional dense-graded asphalt mixtures are not necessarily applicable for mixtures which contain crumb rubber modifier (CRM). It is the purpose of this paper to discuss typical mixture proportions, tests and properties of crumb rubber modified mixtures using the "dry process."\*

Specific objectives of this paper are to discuss each of the following:

1. Design of the aggregate/CRM gradation for rubber modified asphalt mixtures (RUMAC).
2. Compare RUMAC aggregate gradations with conventional HMA aggregate gradations.
3. Determination of the binder content for each application.
4. Indicate the important binder and mixture properties for each mixture/application combination.
5. Identify appropriate mixing and compaction temperatures for mix design.
6. Indicate how the RUMAC affects the mix design procedure and mixture properties.
7. Compare CRM mixture properties with conventional HMA.

### Background

Several agencies have employed the dry process when introducing CRM into asphalt mixtures. The types of mixtures can generally be categorized into two groups as follows:

1. **Coarse CRM.** These mixture types, often referred to as rubber modified asphalt mixtures (RUMAC), contain coarse rubber particles ( $\frac{1}{4}$  to No. 20) which are designed to behave as rubber aggregate. Examples include PlusRide and the generic RUMAC (Lundy et al., 1992).
2. **Fine CRM.** These mixtures contain mainly rubber passing the No. 40 sieve and are designed to modify the binder properties. Examples include the generic dry asphalt rubber systems used in Florida and Kansas.

---

\***Dry Process**—any method that mixes the crumb rubber modifier with the aggregate before the mixture is charged with asphalt binder. This process only applies to hot mix asphalt production.

## 10.8 Introduction

Typical uses of each of these materials (described elsewhere in these workshop notes) include mixtures which can be used as a HMA surface or base material. Because of time and space constraints, this paper will focus its attention primarily to the dry processes which utilize coarse rubber.

### Testing Standards

Prior to reviewing the mix design processes, a review of appropriate testing standards to use with RUMAC was deemed appropriate. The following paragraphs briefly indicate the appropriate test standards for aggregates and binders used in RUMAC, as well as the resulting mixtures.

1. **Aggregates** used in RUMAC are expected to meet the same requirements as those used in conventional mixtures. About the only difference is in the aggregate gradations employed in the mixtures; that is, the gradation is altered to allow room for the CRM. Therefore, the standard AASHTO (or ASTM) test procedures used to evaluate aggregate characteristics and/or quality should be used for RUMAC.
2. **Asphalt binders** used in RUMAC should meet the same requirements as for those used in conventional mixtures such as standard AASHTO (or ASTM) test procedures. The only exception would be a test for compatibility between the binder and the rubber (generic mixture only). The standard tests may not work well on recovered binders owing to the presence of CRM in the binder. For example, vertical viscosity tubes will plug. Alternative methods to evaluate CRM binders include the DMA test proposed by SHRP (Anderson et al., 1991).

Test standards for RUMAC mixtures are nearly the same as those used for conventional mixtures. These include the following:

1. **Rice Gravity (AASHTO T 209)**. Used to determine maximum specific gravity.
2. **Bulk Gravity (AASHTO T 166)**. Used to determine air voids using T 269.
3. **Marshall Stability and Flow (AASHTO T 245) or Hveem Stability (AASHTO T 246)**. Used for mix design purposes.
4. **Moisture Induced Damage (AASHTO T 283)**. Used to determine potential stripping problems.

In addition, tests to evaluate mixture properties for modulus (ASTM D 4123) and for fatigue and rutting resistance have also been employed (Lundy et al., 1992). These performance-related tests, though not used in mix design, have been used to evaluate the relative benefits of employing CRM in asphalt mixtures.

The materials used in RUMAC consist of crumb rubber, aggregate (plus filler) and an asphalt binder. Guidelines for selecting these materials for RUMAC vary depending on the specific process used. The discussion which follows applies to the most common RUMAC technologies used in the U.S. today.

### Gap-Graded RUMAC

PlusRide is a typical gap-graded RUMAC which has been used in the United States since the late 1970s (EnviroTire, 1992). This patented technology will be used for illustrative purposes throughout this discussion of gap-graded RUMAC.

#### *Rubber*

Rubber used in PlusRide mixtures must conform to the gradation shown below:

Sieve size	% Passing sieve
1/4 in.	100
No. 4	76-88
No. 10	28-42
No. 20	16-42

The coarse rubber particles serve as an aggregate while the fine rubber particles tend to modify the asphalt binder. The CRM recommended for RUMAC is ambient temperature granulated passenger or truck tires which are free of steel wire. No other requirements are included for the rubber.

## 10.9 Material Selection

### Aggregate

Aggregates used in this process must possess one of the gradations given in Table 10-8. Other requirements include crushed aggregate content (min. of 75) and sand equivalent (min. of 50).

Items to note which are different than conventional asphalt mixtures include a gap gradation, a high filler content (7 to 12% passing the No. 200 sieve), and a high percentage retained on the  $\frac{3}{8}$  in. sieve (up to 50%). The significance of each is discussed later in this paper.

**Table 10-8. Example aggregate gradation for gap-graded CRM**

Sieve Size	PlusRide* 8	PlusRide* 12	PlusRide* 16
$\frac{3}{4}$ in.	—	—	100
$\frac{5}{8}$ in.	—	100	—
$\frac{3}{8}$ in.	100	60 to 80	50 to 62
$\frac{1}{4}$ in.	60 to 80	30 to 44	30 to 44
No. 10	23 to 38	20 to 32	20 to 32
No. 30	15 to 27	13 to 25	12 to 23
No. 200	8 to 12	8 to 12	7 to 11

\* Patented process

### Asphalt Binder

The binder used in PlusRide mixtures is a normal paving grade asphalt. The major difference in these mixtures is in the amount of binder used. Typically, the required asphalt content is  $1\frac{1}{2}$  to 3 percent higher than for conventional dense-graded mixtures. If PlusRide is used, the asphalt content must be within the following ranges:

PlusRide Mix Type	Asphalt content % of total mix
8	8 to 9.5
12	7.5 to 9
16	7.5 to 9

Because the rubber is used as an aggregate substitute, the compatibility between the rubber and the binder is not evaluated.

### Dense-Graded RUMAC

This mixture type was developed to incorporate CRM into conventional dense-graded asphalt mixtures. Because of the *finer* rubber gradation used, it is anticipated that greater modification of the binder will take place. This process has been used in New York, Oregon, and Illinois, as well as other States (Heitzman, 1992).

### Rubber

The rubber gradation used in these mixtures tend to be *finer* than that of gap-graded RUMAC. An example gradation used in Oregon (Zhou et al., 1992) is given below:

Sieve Size	% Passing Sieve
No. 4	100
No. 8	70 to 100
No. 16	40 to 65
No. 30	20 to 35
No. 50	5 to 15

The CRM retained on the No. 16 sieve should be ambient temperature granulated from passenger and/or light truck tires, and should be cube shaped and essentially free of fiber, metal, and moisture. The CRM passing the No. 16 sieve is a ground rubber.



### Aggregate

Aggregate used in this process are slightly modified from conventional dense gradations. Example gradings are given in Table 10-9. The gradation actually used needs to be on the coarse side of the limits to allow room for the CRM. Other properties for the aggregate are similar to those required for conventional mixtures.

**Table 10-9. Typical composition of dense-graded paving mixtures (after ASTM D 3515)**

Sieve Size	Mix designation—max. top size		
	¾ in.	½ in.	⅜ in.
1 in.	100	—	
¾ in.	90 to 100	100	
½ in.	—	90 to 100	100
⅜ in.	56 to 80	—	90 to 100
No. 4	35 to 65	44 to 74	55 to 85
No. 8	23 to 49	28 to 58	32 to 67
No. 16	—	—	—
No. 30	—	—	—
No. 50	5 to 19	5 to 21	7 to 23
No. 100	—	—	—
No. 200	2 to 8	2 to 10	2 to 10

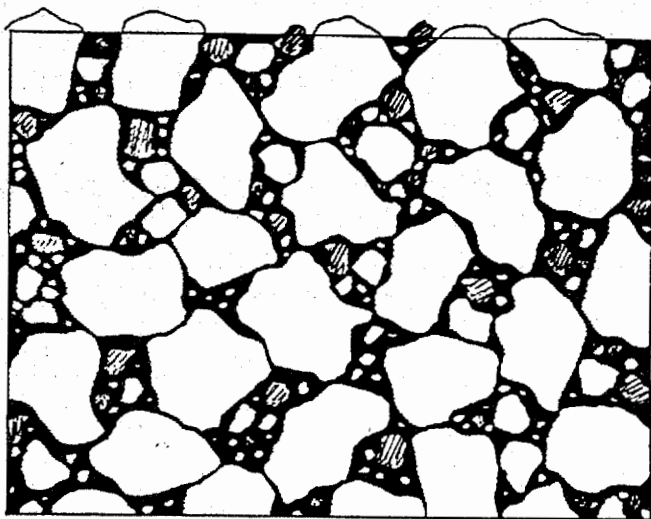
### Asphalt Binder

Normal paving grades can be used in these mixtures. A compatibility test is recommended. (Takallou, 1991); however, the actual test to be used is not defined. The binder content also tends to be higher (e.g., 6 to 7%) than conventional mixtures.

## 10.10 Aggregate Design

Aggregate gradation is the key to successful RUMAC projects. In all cases, the CRM should be considered part of the void space as shown in Figure 10-6. If the void space is inadequate for the CRM, early pavement performance problems have been experienced.

**Figure 10-6. Stone Filled Mix Structure  
Gap-Graded RUMAC**



### **Gap-Graded RUMAC**

Figure 10-7a shows the aggregate gradation used for one of the Plus-Ride II mixes. As indicated, the gap in gradation between the  $\frac{1}{4}$  in. and No. 30 sieve is designed to provide space for the rubber particles. The high fines content tends to reinforce the binder as well as increase the asphalt demand. Rut resistance is provided by the increased coarse stone content ( $>\frac{3}{8}$  in. sieve).

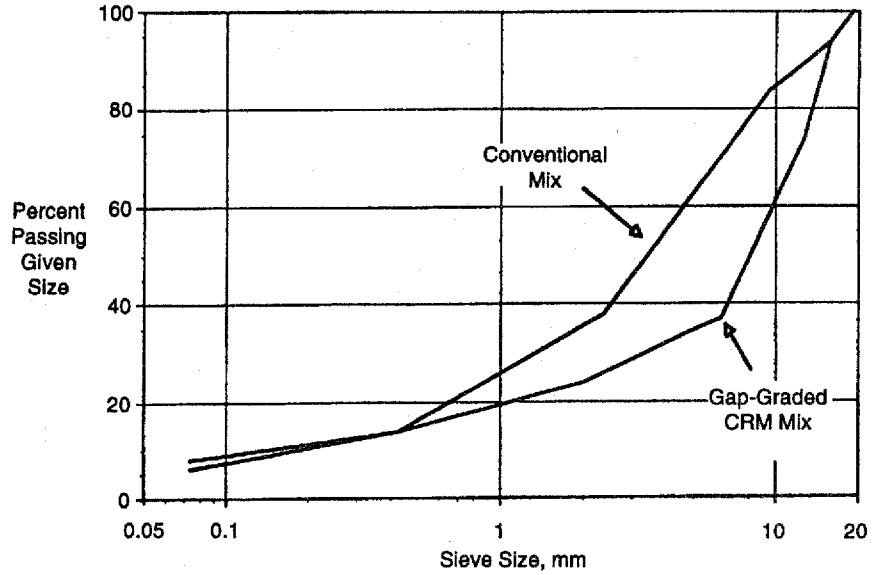
### **Dense-Graded RUMAC**

Figure 10-7b shows a typical gradation used for the dense-graded process (Furber, 1992). Note the change in the No. 4 to No. 10 sieve size to accommodate the rubber. If the rubber particles are too large (or the aggregate gradation too fine), it is difficult to achieve compaction as illustrated in Figure 10-8. Inadequate void space for the rubber particles can result in:

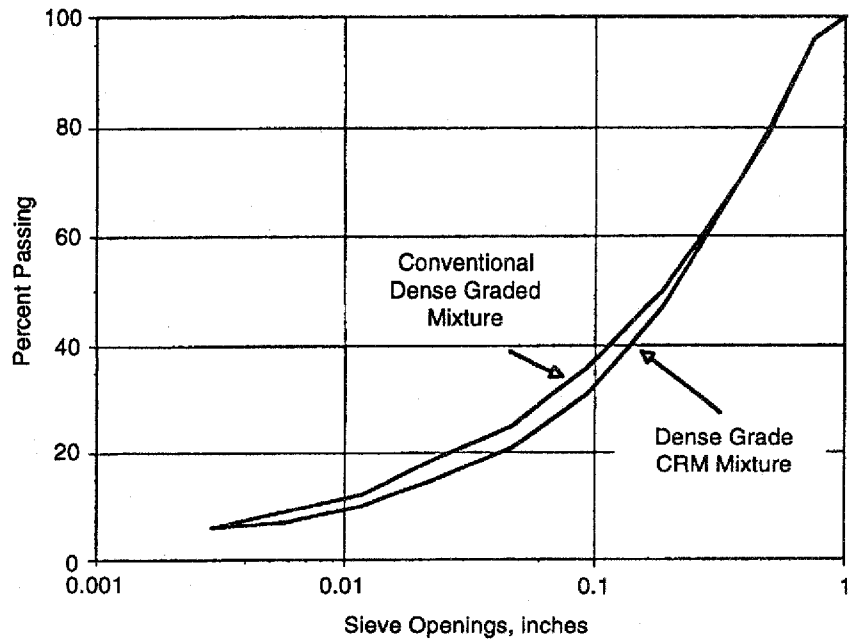
1. Large variations in void content at the same asphalt content.
2. Constant air voids with increasing asphalt content.
3. Expansion of specimen after compaction.

All these can be reduced by reducing the size of the crumb rubber or by opening up the aggregate gradation.

**Figure 10-7. Typical aggregate gradations used in RUMAC**

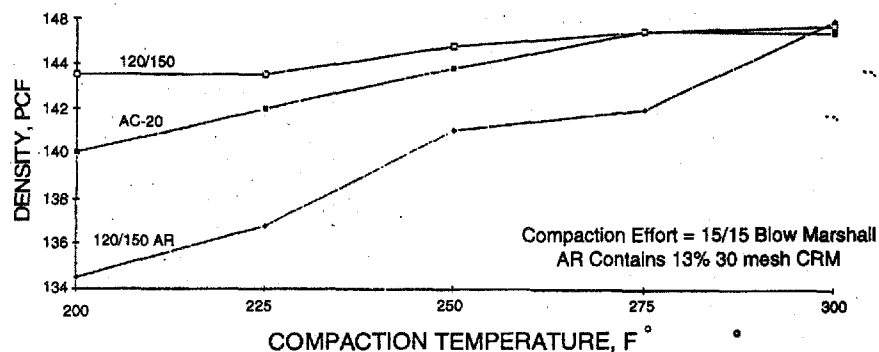


a) Gap-graded CRM



b) Dense-graded CRM

**Figure 10-8. Problems with improper aggregate gradation**



Binder design for RUMAC is not as important a consideration as in the asphalt rubber. Conventional binders can be used including penetration, AC, and AR graded. Though not required to check the asphalt/rubber for compatibility, some of the fine rubber will react with the CRM to modify the binder properties. Although compatibility can be evaluated, specific tests have not been identified (Takallou, 1991).

In the dry process, the rubber is first mixed dry with the heated aggregate (then wet mixed with the asphalt). Hence, there is less time for the asphalt/rubber combination to react together compared with the wet process.

Mix design using the dry process has evolved using test methods and procedures developed for conventional asphalt mixtures. Because of differences in mixture properties, many of the usual criteria have had to be modified. This section outlines briefly the types of procedures which have been used.

## 10.11 Binder Design

## 10.12 Mix Design Process

### Gap-Graded RUMAC

The mix design procedure used for PlusRide consists of the following basic steps (EnviroTire, 1992):

1. Preparation of mixtures
  - Weigh out ingredients
  - Heat aggregate and asphalt in 320°F\* oven (Temperature should vary with asphalt grade.)
  - Dry mix aggregate/rubber for 15 s
  - Wet mix for 2 min.
  - Cure loose mix @ 320°F for 1 hr.
2. Prepare compaction mold and hammer—need to lubricate with silicone grease to prevent sticking.
3. Compact using Marshall hammer (50 blows/side). Cool the confined specimen and remove it from the mold.
4. Determine void content.

One mixture criterion normally used is voids (2 to 4%); however, some agencies have added criteria such as minimum modulus (ASTM D4123) and/or index of retained strength (AASHTO T 283). Typical criteria are given in Table 10-10.

**Table 10-10. Example of mix design criteria for PlusRide type mixes**

Property	Value
Voids (%)	2-4%
Modulus (min)* psi—ASTM D 4123	100,000
IRS (%)—AASHTO T 283	75

\*at 25°C

## Dense-Graded RUMAC

The mix design procedure used for these mixes consists of the following steps:

1. Preparation of mixture
  - Weigh out ingredients
  - Heat aggregate @ 350°F and asphalt @ 300°F (Temperature should vary with asphalt grade.)
  - Dry mix aggregate and rubber for 15 s
  - Wet mix for 2 min.
2. Prepare compaction mold and hammer
3. Compact using Marshall hammer (50 blows/side) or using kneading compactor
4. Cool confined specimen and remove it from mold
5. Determine void content
6. Test for stability
  - Marshall
  - Hveem

Typical mixture criteria are given in Table 10-11 for mix designs using the Marshall method.

**Table 10-11. Example of mix design criteria for generic type mixes**

Property	Value
Marshall stability (min)	800 lbs
Flow (0.1 in)	8-20
VMA (% min)	17
Air voids (%)	3-5
IRS (%)—AASHTO T 283	> 75

### 10.13 Typical Laboratory Mixture Properties

The use of CRM does alter the mixture properties. Together with the higher asphalt contents, the following changes in laboratory mixture properties may be obtained:

1. Lower stabilities than conventional dense-graded mixtures.
2. Lower moduli than conventional dense-graded mixtures.
3. Improved water sensitivity (e.g., reduce stripping).
4. Improved fatigue resistance (see Figure 10-9) and low temperature properties.
5. Similar to or less rut resistance than dense-graded mixtures (see Figure 10-10).

Table 10-12 summarizes some typical properties of the two types of RUMAC discussed herein.

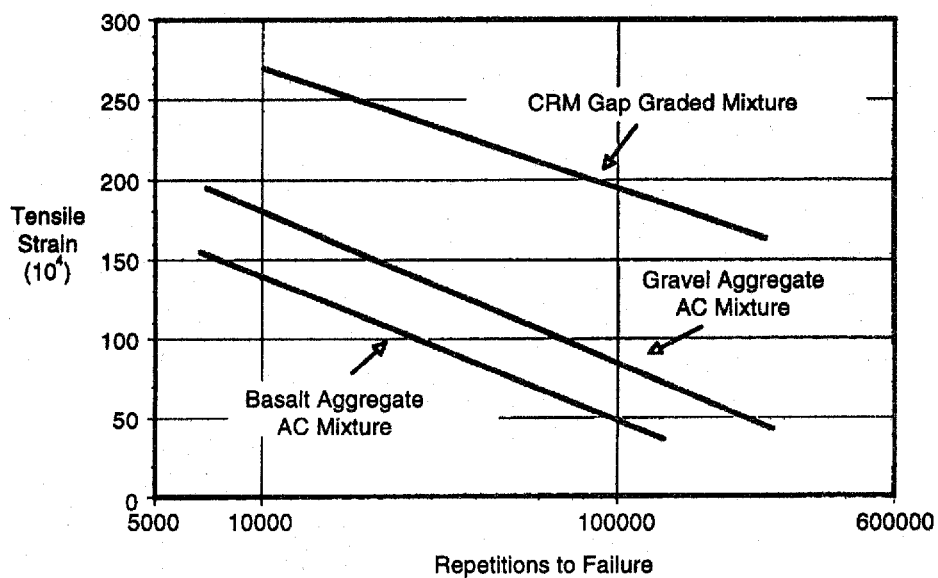
**Table 10-12. Typical mix properties for RUMAC**

	PlusRide	Generic
Hveem stability	< 5	30
Marshall stability (lbs)	500	2,500
IRS (%)	80	80

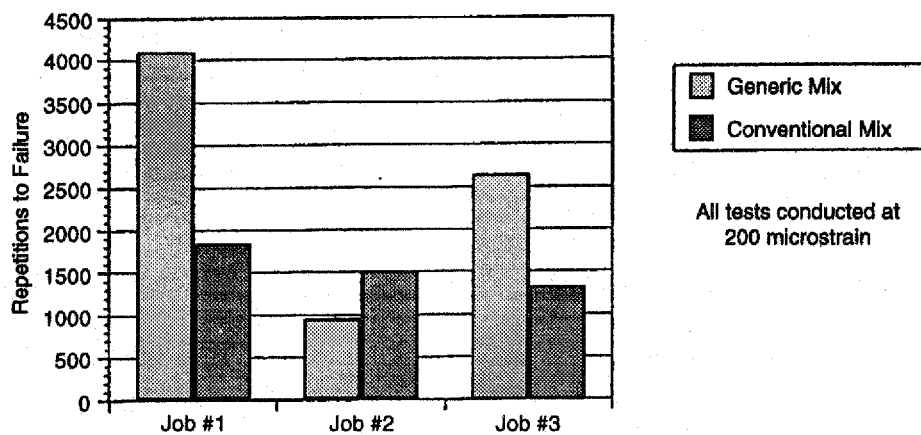
### 10.14 Summary

This paper has summarized several critical aspects of what is required to design RUMAC using the dry process. It emphasizes the key considerations in materials selection, aggregate design, binder design and mix design as well as identifying some of the effects of CRM on mixture properties. Other dry process technologies (e.g., CRREL, Rouse) also exist, but time and space prevented their inclusion in this paper.

**Figure 10-9. Fatigue resistance for CRM—  
diametral fatigue test (after Lundy et al., 1992)**



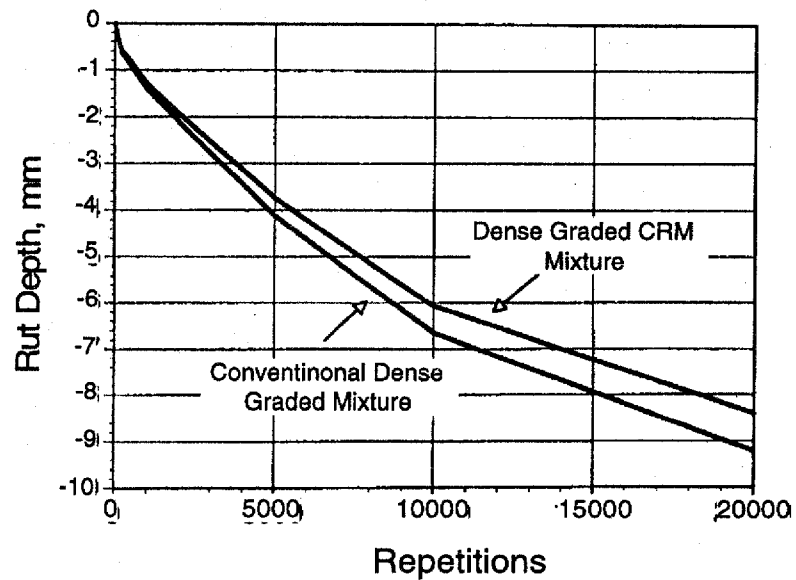
a) Gap-graded RUMAC (e.g., PlusRide)



b) Dense-graded RUMAC (e.g., generic)



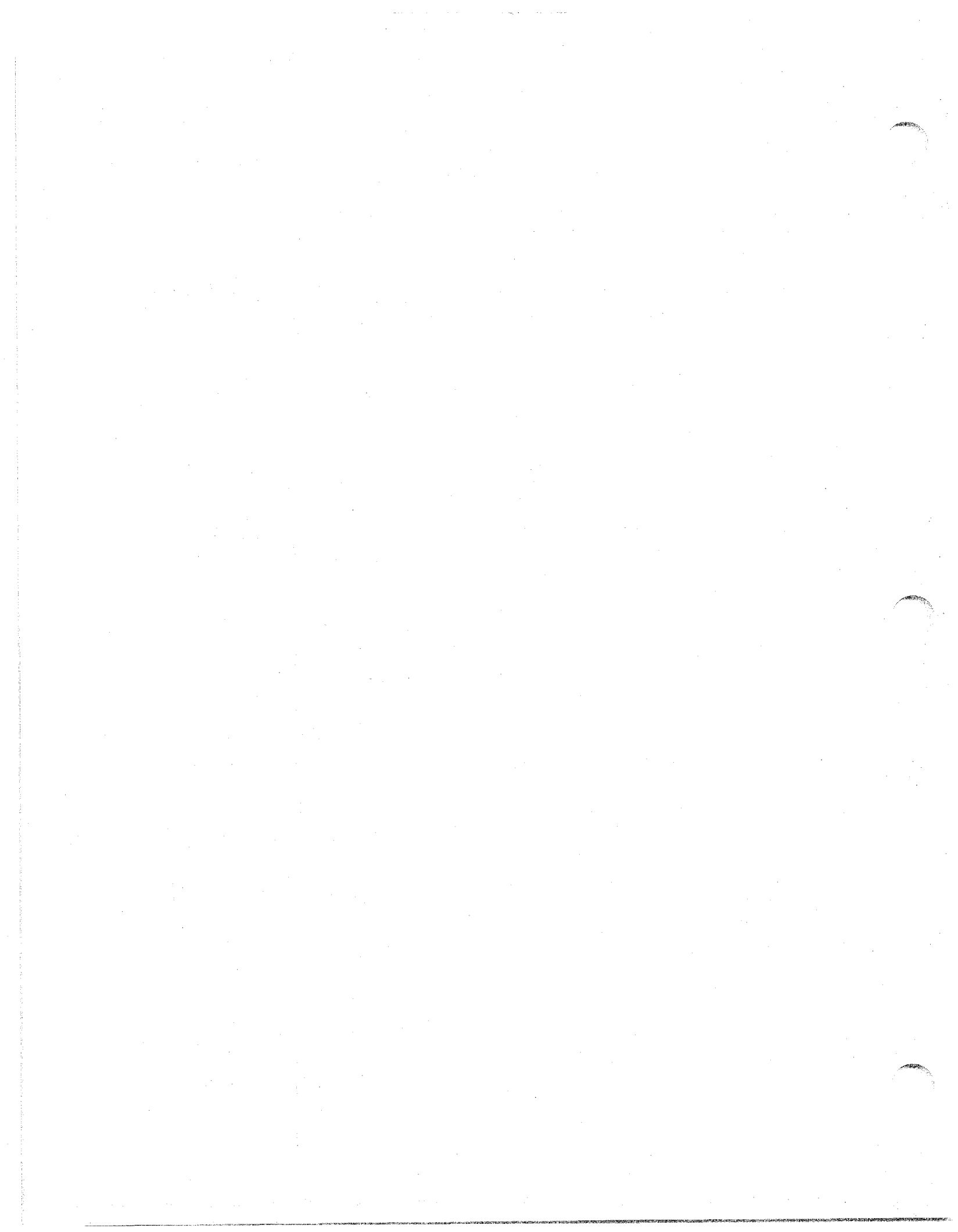
**Figure 10-10. Rut resistance for RUMAC using LCPC wheel tracking device—dense-graded generic mix (after Lundy et al., 1992)**



## 10.15 RUMAC References

1. Anderson, David A. et al., "Physical Properties of Asphalt Cement and the Development of Performance-Related Specifications," *Journal AAPT*, Vol. 60, 1991, pp. 437-532.
2. EnviroTire, Inc., *PlusRide II™ Asphalt User's Manual*, Seattle, WA, 1992.
3. Fuber, A.M., personal communication, 1992.
4. Heitzman, Michael A., "State of the Practice—Design and Construction of Asphalt Paving Materials with Crumb Rubber Modifier," FHWA-SA-92-022, May 1992.
5. Hicks, R.G. et al., "Evaluation of Rubber-Modified Asphalt Pavement Performance—Mt. St. Helen's Project," *Proceedings, AAPT*, pp. 573-598, 1987.
6. Lundy, J.R. et al., "Use of Ground Rubber Tires in Asphalt Concrete Mixtures," prepared for ASTM Symposium titled "A Critical Look at the Use of Waste Materials in Hot-Mix Asphalt," October 1992.

- 
7. Lundy, J.R., "Evaluation of RUMAC Projects in Oregon," Oregon State University report to Metro, May 1992.
  8. Takallou, Hossein B., "Evaluation of Mix Ingredients on the Performance of Rubber Modified Asphalt Mixtures," Ph.D. Dissertation, Oregon State University, 1987.
  9. Takallou, H. Barry, "Mix Design Guidelines for Rubber Modified Asphalt Concrete," Tak Associates, Portland, OR, 1991.



# **Session 11.0**

---

## **Construction Practices**

---

by

**Asphalt Rubber Producers Group  
EnviroTire, Inc.**

# 11.0 Contents

---

11.1	Wet-Process—Asphalt Rubber Construction . . . . .	11-3
11.1.1	Asphalt-Rubber Blending and Reaction . . . . .	11-3
11.1.2	Hot-mix Plant Production . . . . .	11-3
11.1.3	Laydown and Compaction . . . . .	11-4
11.1.4	Quality Assurance . . . . .	11-5
11.1.5	References . . . . .	11-6
11.2	Dry Process—Rubber Modified Hot-mix Asphalt Construction . . . . .	11-7
11.2.1	Materials Handling and Feed . . . . .	11-7
11.2.2	Hot-mix Plant Production . . . . .	11-8
11-2-3	Laydown and Compaction . . . . .	11-9

## **Construction Considerations for Production and Placement of Asphalt-Rubber Pavements**

Initially standard asphalt industry equipment was used to produce AR binders. The CRM was added to the hot asphalt cement by use of a crude conveyor system dumping the rubber into a spreader truck (or reaction vessel) through the dome lid. This conventional equipment did not contain internal augers or any other means of mixing the two components together. As a result, the consistency of the early asphalt rubber binder materials was, at best, questionable. However this equipment evolved rapidly and within a few years, specialty equipment was being fabricated with mixing augers and with the ability to handle the viscous and abrasive asphalt rubber material. Throughout the 1970's, the equipment evolved dramatically and many experimental devices were developed. In 1980 the most significant piece of equipment in the history of the asphalt rubber industry was developed, the AR blending unit. The new blending unit provided thorough and complete mixing (wetting) and constant agitation of the rubber particles with the asphalt cement, and thus a consistent and more predictable reaction. From the earlier prototype, this blender has evolved to the Heater-Blender units that are used today. Further, as the use of asphalt rubber binder has increased, special metering equipment has been developed to accurately deliver this high viscosity material to hot-mix plants (both drum and batch).

The fabrication of asphalt rubber equipment for use with hot-mix plants has developed to a point of turn key convenience for various contractors around the country. Asphalt rubber metering equipment can easily be hooked up to both drum and batch hot mix plants. When a drum plant is utilized, a two or three way valve is installed in the existing asphalt feed line on the output side of the asphalt pump. The asphalt-rubber metering equipment is then plumbed to the valve to feed the asphalt-rubber binder accurately (as per specifications) to the hot mix plant. When a batch plant is utilized the valve is again installed directly onto the supply line leading to the weigh bucket. If necessary, a separate supply line can be installed in the pug mill itself. However, the quick and easy installation into the supply line is the procedure gener-

### **11.1 Wet-Process— Asphalt Rubber Construction**

#### **11.1.1 Asphalt-Rubber Blending and Reaction**

#### **11.1.2 Hot-mix Plant Production**

ally preferred by most contractors. As with the drum plant, the asphalt rubber metering equipment is plumbed into the new valve. Special pumps are used by the AR supplier to prevent damage to conventional asphalt pumps. Depending on certain variables associated with individual projects, the binder supply lines, after plumbing is complete, may or may not need to be heated. Continuous run plants generally do not require heated lines. The capability exists to heat the lines on each project if necessary. There is little if any change to standard hot-mix plant operations when using AR binder instead of asphalt cement. Typically mixes with AR binder can be produced at plant operating temperatures similar to those of standard mixes. There are no reports of AR residue accumulating in hot plants, and there is no additional cleaning or flushing required when hot-mix with asphalt rubber binder is produced. After standard hot mix-production procedures are complete the asphalt rubber hot mix material can be stored in a heated or insulated silo. To date the longest time frame has seen a 36-hour storage period with no problems using the material.

The transport of the asphalt rubber hot mix material from the hot plant to the project site can be accomplished by the use of a number of different types of trucks, i.e., 10 wheel dump trucks, semi end dump trucks, transfers, or belly dumps. This, of course, depends on what type of paving operation is being utilized. Wetting agents for the truck beds should be either soapy water or silicone emulsion. No solvent based wetting agents will be allowed, due to deleterious effects on the asphalt rubber binder.

### 11.1.3 Laydown and Compaction

As the asphalt rubber hot mix is delivered to the construction site, it can be placed utilizing both conventional paving procedures or with a pick-up type of paving train. Standard paving specifications that refer to asphalt-rubber hot-mix materials are normally used to select mixing, laydown and compaction criteria. The following temperature ranges are common for asphalt-rubber hot-mix applications:

- (a) Hot Plant Mixing Temperature 280 to 310°F
- (b) Laydown Temperature 270 to 300°F
- (c) Compaction Temperature Above 240°F

The breakdown rolling should begin immediately. Breakdown rollers should stay as close as possible to the laydown machine without causing pickup or excessive movement. Two to four passes in the vibratory mode (full width of mat) with a double drum steel wheel roller, high fre-

quency, low amplitude should provide adequate density before the mix drops below 240°F. However, particularly for dense and gap-graded mixes, rolling patterns for each asphalt rubber hot mix should be determined on the construction site at the beginning of placement. As with standard asphalt concrete, the lower the temperature, the less compactive effort is achieved. Finish rolling may be delayed until the temperature of the mat has cooled to 250°F. The number of rollers required to achieve proper density is directly effected by the expected mix production schedules, width of paving lanes, mat thickness, surface condition and temperatures (surface, ambient, and materials). It is critical to achieve the desired density while the mat is still hot.

Pneumatic-tired rollers should not be used due to the increased adhesiveness of the AR binder to the rubber tires. Steel drums should be equipped with pads and a watering system. If the newly placed asphalt rubber HMA pavement must be opened to traffic prior to fully cooling, a blotter material may be required to prevent pick-up or tracking of the mix. Blotter material should consist of clean, dry washed fine aggregate or sand. A very light application rate of 1 to 3 pounds per square yard is typically used.

There are minor differences in the actual handling of the asphalt-rubber hot-mix materials. As the laydown crew gains experience and becomes accustomed to the different behaviors of AR HMA mixes, no major problems are associated with raking or shoveling of the mix in a timely manner. Again, as long as this type of work is done while the mix is at or above 240°F, there should be no problems associated with the workability of the asphalt-rubber hot mix.

It should also be noted that only minor differences may exist regarding the construction procedures for Dense, Gap or Open-Graded asphalt-rubber mixtures. Also, it should be noted, varied crumb rubber percentages do not affect construction procedures.

The quality, thus acceptance, of asphalt-rubber materials depends on three basic considerations:

1. **Equipment**—The equipment should be of quality manufacture and fabricated specifically to have the capability to heat, combine, and react the various components into a homogeneous mixture and to apply or supply these materials as to individual project specifications.

#### 11.1.4 Quality Assurance



2. **Asphalt-Rubber Binder Design**—The acceptance of component materials can be accomplished by any of three procedures.
  - a. Materials certification from materials suppliers.
  - b. Pre job laboratory testing.
  - c. Laboratory testing of field samples.

Pre-job testing is the most common way to establish criteria for comparable field testing. During the pre-job testing various physical properties are evaluated.

- A. Viscosity
- B. Softening Point
- C. Resilience
- D. Needle & Cone penetration
- E. Ductility
- F. Aged residue retention

Through the above evaluation a target viscosity is determined which is the control testing criteria for the asphalt-rubber binder in the field.

3. **Asphalt-Rubber Concrete (ARC) Mix Design.** After the A/R binder has been designed according to local climate and project specification criteria then the AR-HMA mix design is performed. Standard mix design methods may be used with minor modification to procedures. however, evaluation criteria OF mix design data often differs significantly from that of conventional asphalt concrete.

The developmental history of the asphalt-rubber industry has led to many advancements in modified pavement technology. This knowledge in turn, has led to the development of other systems also reacting recycled ground tire rubber with asphalt cement. These alternate systems show great promise and have been used on an experimental basis in many areas of the country.

### 11.1.5 References

1. ASTM D-8 Standard Definitions of Terms Relating to Materials for Roads and Pavements.
2. Gap-Graded asphalt-Rubber Mix in the City of Phoenix, Joe o. Cano, P.E., Equbalali Charania, Ph.D., P.E., Dong C. Wong,

P.E., *Proceedings of the 4th Annual 4R Conference and Road Show.*

3. Cal Trans—Asphalt Rubber Hot Mix-Gap Graded Thickness Determination Guide (Interim). Table 1—Structural Equivalencies, Table 2—Reflection Crack Retardation Equivalencies, February 28, 1992. Special Provision for ARHM-GG, March 1992.
4. International Surfacing Inc., Asphalt-Rubber for Highway Preservation, Corrective Maintenance, and Construction Procedures, November, 1992.
5. Summary of Arizona Department of Transportation Experience with Asphalt-Rubber State of the Art. Report #FHWA-AZ88-818

## **Construction Practices Using Dry Process— Rubber Modified Asphalt Concrete (RUMAC)**

### **CRM**

Varying types of mixes may be designed to incorporate dry CRM into paving materials.

All dry process technologies include handling and storage of crumb rubber at the hot mix production site. To date, rubber has been packaged either in polyethylene bags of approximately 60 lbs., or larger bulk sacks of approximately one (1) ton in capacity. Both forms of rubber packaging are palletized and require tied down plastic sheeting for additional moisture protection during storage.

Pallets are handled with fork lifts and standard conveyor belts are used for polyethylene bags or premixed crumb rubber.

## **11.2 Dry Process— Rubber Modified Hot-mix Asphalt Construction**

### **11.2.1 Materials Handling and Feed**

Crumb rubber is generally fed into the weigh hopper or pug mill of a batch plant or the RAP (recycled asphalt pavement) collar or RAP feed system on a drum plant. Where graded CRM is used, dispersion of the rubber throughout the hot mix must be ensured.

A calibrated conveying system for loose CRM must be established. As with any loose, granular material, the need for slatted conveyors to prevent rollback and material segregation will depend on the angle of incline and specific characteristics of the material.

Polyethylene bags can be added via conveyor belts to pug mill. When polyethylene bags are added directly into the pugmill, dry mix time should be increased to ensure thorough rubber distribution. Five to fifteen seconds is a typical batch cycle increase time. This time can be reduced or eliminated by improving efficiencies in the feed equipment.

#### ***Mineral Filler***

Where PlusRide mastic asphalt type mixes designed with CRM and mineral filled binders are being produced, mineral filler may be fed with lime feed equipment or storage silo's systems designed for this purpose.

#### ***Quality Assurance in CRM Feed***

For the PlusRide mastic asphalt gap graded mix, uniformity of rubber gradation is assured by premixing graded factions of rubber prior to conveying into the weigh hopper of a batch plant or the RAP feed collar or RAP feed device of the drum plant.

### **11.2.2 Hot-mix Plant Production**

#### ***Feed Control—Materials Proportioning***

Feed equipment for CRM should be interlocked with plant controls to assure correct proportioning. This is particularly important for the continuous material feed systems used for drum plants. Essential to proper proportioning of crumb rubber modifiers is an electronic interlock to plant controls. Because rubber is added by weight, no compensation needs to be made for the difference in specific gravity between rubber

and aggregate. A pneumatic feed system has been desired for use of PlusRide asphalt projects in 1993.

### ***Drum Plants***

Crumb rubber should be introduced far enough from the discharge end of the drum to ensure thorough mixing and coating of the rubber particles. In practice, configurations adequate for RAP introduction have been adequate to ensure homogeneous mixes when CRM is introduced.

### ***Batch Plants***

It may be necessary to increase the dry mix time when introducing CRM into batch mixes. Batch mix time could be optimized by introducing CRM uniformly along the axis of the auger.

### ***Quality Assurance***

The acceptability of mixing can be determined by extraction of the rubber from random samples to determine uniformity of distribution.

### ***Storage and Transport***

Once blended and mixed, rubber modified asphalt concrete's are stored and transported using conventional equipment. As with any mix, wetting agents used for truck beds should be non-petroleum based agents. Use of conveying belts made of rubber compounds is to be avoided to eliminate the possibility to sticking and segregation of mix. Mixes are generally handled at a slightly elevated temperature range as compared to conventional dense-graded mixes, temperature limits need to be strictly observed in order to ensure necessary compaction. Storage temperature should be maintained above the desired placement temperature.

Paving with RUMAC requires no modification to equipment or procedures. Standard transport equipment and pavers are used and no special instruction is required.

Because rubber modified asphalt concrete's are carefully designed mixes, compaction to specified voids should be assured.

### ***Equipment and Procedures***

Pneumatic tired rollers are generally not used for RUMAC as they are potentially more prone to material pick up. Soap solutions are recommended on steel wheeled roller drums. Steel wheeled rollers are used

## **11.2.3 Laydown and Compaction**

for both breakdown and finish rolling. Hand work should be carried out immediately while RUMAC paving materials are hot.

Although rolling to 140°F has been specified in the past for PlusRide mats, the rate of heat loss during compaction to stable density does not appear to differ measurably from that of unmodified paving mixtures. Experience has shown that maximum density is achieved with essentially the same rolling patters used for conventional dense-graded mixtures.

### ***Quality Control Sampling and Testing***

As with conventional asphaltic concrete, compactive effort should be monitored with nuclear density gauge during paving operations.

The rolling pattern required to achieve target density should be established with a test strip. Current PlusRide formulations are compacted in the same manner as dense-graded mixes. There is no minimum temperature to which PlusRide must be rolled, rather rolling should continue in accordance with the established rolling pattern.

The relative accuracy of nuclear density gauges is not affected by the presence of rubber in RUMAC mixes. The accuracy of nuclear density gauges are, however, greatly affected by surface texture. Where textured surfaces, such as that exhibited by PlusRide mixes, are being sought, density should be confirmed by core sampling, with nuclear density gauges being used during paving only to establish that maximum compactive effort has been achieved.

## NOTICE

The contents of this report reflect the views of the authors who are responsible for the facts and accuracy of the data presented herein. The contents do not necessarily reflect the official policy of the Department of Transportation.

The United States Government does not endorse the products or manufacturers. Trademarks or manufacturers' names appear herein only because they are considered essential to the objective of this document.

This report does not constitute a standard, specification, or regulation.

