

U.S. Department  
of Transportation

Publication No. FHWA-HIF-07-033  
June 2007

**Federal Highway  
Administration**

---

**DESIGN FOR FISH PASSAGE AT  
ROADWAY-STREAM CROSSINGS:  
SYNTHESIS REPORT**

---

Federal Highway Administration  
Office of Infrastructure Research and Development  
Turner-Fairbank Highway Research Center  
6300 Georgetown Pike  
McLean, Virginia 22101

**Technical Report Documentation Page**

1. Report No. FHWA-HIF-07-033 June 2007		2. Government Accession No.		3. Recipient's Catalog No.	
4. Title and Subtitle  DESIGN FOR FISH PASSAGE AT ROADWAY-STREAM CROSSINGS: SYNTHESIS REPORT			5. Report Date June 2007		
			6. Performing Organization Code		
7. Author(s) Rollin H. Hotchkiss and Christopher M. Frei			8. Performing Organization Report No.		
9. Performance Organization Name and Address  Washington State University Pullman, WA  Brigham Young University Provo, UT			10. Work Unit No. (TRAIS)		
			11. Contract or Grant No.		
			13. Type of Report and Period Covered  Final Report September 2004 – June 2007		
12. Sponsoring Agency and Address  Office of Infrastructure Research and Development Federal Highway Administration 6300 Georgetown Pike McLean, VA 22101			14. Sponsoring Agency Code		
15. Supplementary Notes  Contracting Officer's Technical Representative: Bart Bergendahl					
16. Abstract  Cataloging and synthesizing existing methods for the design of roadway-stream crossings for fish passage began in January 2005 with an extensive literature review covering the topics of culvert design and assessment to facilitate fish passage. A survey was posted online to gather input from design professionals across the country, and a Culvert Summit Meeting was held in Denver Colorado from February 15-16, 2006, to allow presentation and discussion of state-of-practice design and assessment techniques. Following the Summit meeting, a Technical Advisory Committee was developed with individuals specifically knowledgeable in the topics of interest. Members were crucial in shaping and reviewing the direction of these guidelines.  This document places current culvert design techniques into four categories based on design premise and objectives. These categories include: No Impedance techniques, which span the entire stream channel and floodplain; Geomorphic Simulation techniques, which create fish passage by matching natural channel conditions within the culvert crossing; Hydraulic Simulation techniques, which attempt to closely resemble hydraulic diversity found in the natural channels through the use of natural and oversized substrate; and Hydraulic Design techniques, which may utilize roughness elements such as baffles and weirs to meet species specific fish passage criteria during periods of fish movement.  Preliminary chapters covering the topics of fish biology and capabilities, culverts as barriers, fish passage hydrology, and design considerations aid in the selection of appropriate design techniques based on hydraulic, biologic, and geomorphic considerations. A further section presents examples of design techniques fitting the defined design categories. Design examples and case histories for a selection of design techniques are presented next, and are followed by a discussion on construction, maintenance, monitoring, and future research needs.					
17. Key Words:  Fish passage, Culverts, Bridges, Culvert assessment, Design methods		18. Distribution Statement  No restrictions. This document is available to the public through the National Technical Information Service, Springfield, VA 22161			
19. Security Classif. (of this report)  Unclassified		20. Security Classif. (of this page)  Unclassified		21. No. of Pages  280	22. Price

## ACKNOWLEDGMENT

Dr. Rollin H. Hotchkiss and Mr. Christopher Frei are the primary authors of this document. Their work was guided by Mr. Bart Bergendahl, Senior Hydraulic Engineer, Central Lands Federal Highway Division. Significant and invaluable discussion, review, and input were provided by two review committees.

### Federal Highway Administration Technical Advisory Committee

Andrzej (“Andy”) Kosicki	Maryland State Highway Administration
Marcin Whitman	California Department of Fish and Game
Mark Miles (deceased)	Alaska Department of Transportation
Michael Furniss	United States Forest Service
Robert Gubernick	United States Forest Service
Scott Jackson	University of Massachusetts
Bryan Nordland	National Marine Fisheries Service
Charles Hebson	Maine Department of Transportation

### Federal Highway Administration Review Team

Larry Arneson	Resource Center, Hydraulic Engineer
Eric Brown	Resource Center, Hydraulic Engineer
Mark Browning	Federal Lands Highway Division, Hydraulic Engineer
Paul Garrett	Office of Environment, Ecologist
Mary Gray	Office of Environment, Environmental Specialist
Scott Hogan	Federal Lands Highway Division, Hydraulic Engineer
Kevin Moody	Office of Environment, Environmental Specialist
Jorge Pagan	Office of Infrastructure, Hydraulic Engineer
Melissa Schnier	Federal Lands Highway Division, Environmental Biologist

## **DEDICATION**

This document is dedicated to the memory of Mark Miles for his interest in promoting and preserving fish passage at roadway-stream crossings and his many overall contributions to the hydraulic engineering community. He is and will always be remembered as a valued source of knowledge, experience, and reason in his profession. His friendship, candor, and leadership will be sorely missed by all who knew him.

## BACKGROUND

Development of this publication began in January 2005 with a literature review covering the topics of culvert design and assessment to ensure fish passage. In February 2005 a project website was posted to keep others apprised of progress, as well as to enhance contact with professionals interested in fish passage design and assessment.

In May 2005, a fish-passage survey was posted online to gather input from design professionals, non-governmental organizations, and other interested parties. Through February 2006 there were 67 respondents from 29 states representing biologists, fisheries managers, hydraulic engineers, bridge engineers, drainage engineers, and environmental managers. All respondents were actively involved in roadway-stream crossing issues; their opinions can be assumed to be representative of their agencies. Of the states represented, only five reported fish passage to be of minor importance including New Hampshire, Florida, Oklahoma, Arizona, and Illinois. Furthermore, 13 states rated fish passage as an extremely important concern. Survey comments were used to shape the initial direction of the document.

A Fish Passage Summit Meeting was held on February 15<sup>th</sup> – 16<sup>th</sup>, 2006 in Denver, Colorado. This comprised of 3 sessions – over one and a half days – covering the topics of culvert assessment, design and retrofit, and culvert replacement case histories. Speakers were selected, with design professionals known to be knowledgeable in each of our session topics, and care was taken to ensure that information was presented from regions that are under-represented in fish passage literature. Panel discussions were conducted at the conclusion of each session to invite audience participation and gain perspective on the topics presented. Overall, there were 110 people in attendance, including 16 speakers. Affiliation ranged from non-governmental-organizations to state departments of transportation.

A Technical Advisory Committee Meeting was held at the conclusion of the Summit Meeting. Those in attendance are specifically knowledgeable in each of the topic areas, and were active in shaping this document. Members of the Technical Advisory Committee included:

Andrzej (“Andy”) Kosicki	Maryland State Highway Administration
Marcin Whitman	California Department of Fish and Game
Mark Miles (deceased)	Alaska Department of Transportation
Michael Furniss	United States Forest Service
Robert Gubernick	United States Forest Service
Scott Jackson	University of Massachusetts
Bryan Nordland	National Marine Fisheries Service

Mr. Hebson from the Maine Department of Transportation has since joined the Technical Advisory Committee.

In addition to the Culvert Summit Meeting, consultation with members of the Forest Service Technology and Development Center in San Dimas, California, as well as with Michael Love and Associates and Michael Furniss (key developers in USFS's FishXing) was important in shaping project scope and direction. These meetings included site visits to inspect completed fish passage restoration projects and tide gates.

The following document represents the culmination of an effort to gather and share information necessary to understand the current state of bridge and culvert design for fish passage.

This page intentionally left blank

## TABLE OF CONTENTS

	Page
ACKNOWLEDGMENT.....	ii
DEDICATION.....	iii
BACKGROUND.....	iv
TABLE OF CONTENTS.....	vii
LIST OF TABLES.....	xv
LIST OF FIGURES.....	xvii
GLOSSARY.....	xxi
GLOSSARY OF ACRONYMS.....	xxix
LIST OF SYMBOLS.....	xxx
1 INTRODUCTION.....	1-1
1.1 PURPOSE AND SCOPE.....	1-1
1.2 HIGHWAY PERSPECTIVE.....	1-2
1.3 ECOLOGICAL PERSPECTIVE.....	1-4
1.3.1 Importance of Animal Movement.....	1-5
1.3.2 Road Stream Interaction.....	1-5
1.3.3 Effects of Population Isolation.....	1-6
1.4 LEGISLATION AND REGULATION.....	1-7
1.4.1 Statutes and an Executive Order.....	1-8
1.4.1.1 Clean Water Act (CWA) 1948.....	1-8
1.4.1.2 Endangered Species Act (ESA) of 1973.....	1-9
1.4.1.3 Fish and Wildlife Coordination Act (FWCA) 1934.....	1-10
1.4.1.4 National Environmental Policy Act (NEPA) 1969.....	1-11
1.4.1.5 Rivers and Harbors Appropriations Act of 1899.....	1-12
1.4.1.6 Sustainable Fisheries Act 1996.....	1-12
1.4.1.7 Wild and Scenic Rivers Act 1968.....	1-13
1.4.1.8 Executive Order on Recreation Fisheries 1995.....	1-13
1.4.2 State and Local Regulations.....	1-13
1.5 MULTIDISCIPLINARY NATURE OF PROVIDING FOR FISH PASSAGE AT ROADWAY-STREAM CROSSINGS.....	1-14
1.6 RELATED FHWA PUBLICATIONS AND REPORT PREVIEW.....	1-14
2 FISH BIOLOGY.....	2-1
2.1 ANATOMY.....	2-1
2.2 CAPABILITIES AND ABILITIES.....	2-1
2.2.1 Swimming and Jumping.....	2-1
2.2.2 Species and Life Stages.....	2-2
2.2.3 Depth Requirements.....	2-4
2.2.4 Example of Fish Criteria.....	2-5
2.3 FISH MOVEMENT.....	2-6
2.3.1 Migration.....	2-6
2.3.2 Juvenile and Resident Movement.....	2-6
2.4 LOCAL FISH REQUIREMENTS.....	2-7



2.5	CONCLUSIONS.....	2-7
3	CULVERTS AS PASSAGE BARRIERS.....	3-1
3.1	STREAM FRAGMENTATION .....	3-1
3.2	HOW A CULVERT CAN BE A BARRIER.....	3-2
3.2.1	Drop at Culvert Outlet .....	3-3
3.2.2	Outlet Pool Depth.....	3-4
3.2.3	Excessive Velocity in Barrel .....	3-4
3.2.3.1	Boundary Layer Velocity.....	3-5
3.2.3.2	Average Velocity.....	3-5
3.2.3.3	Maximum Point Velocity .....	3-6
3.2.3.4	Inlet Transition Velocity.....	3-6
3.2.4	Insufficient Depth .....	3-6
3.2.5	Excessive Turbulence .....	3-7
3.2.6	Behavioral Barriers.....	3-7
3.2.7	Debris Accumulation .....	3-8
3.2.8	Summary.....	3-9
4	CULVERT INVENTORY, ASSESSMENT AND PRIORITIZATION .....	4-1
4.1	CULVERT INVENTORY.....	4-1
4.1.1	Knowledge of Crossing Location.....	4-1
4.1.1.1	Road-Based Inventory .....	4-1
4.1.1.2	Stream-Based Inventory .....	4-2
4.1.2	Inventory Goals .....	4-2
4.1.3	Data Collection.....	4-2
4.2	CULVERT ASSESSMENT .....	4-3
4.2.1	Overview .....	4-3
4.2.1.1	Criteria .....	4-3
4.2.1.2	Development .....	4-4
4.2.2	Criteria .....	4-4
4.2.2.1	Degree of Barrier .....	4-4
4.2.3	Existing Procedures .....	4-5
4.2.3.1	Coarse Filter .....	4-5
4.2.3.2	Regional Screen .....	4-6
4.2.3.3	Examples of Regional Screen Criteria.....	4-6
4.2.3.4	Flow Chart Filters.....	4-9
4.2.3.5	Matrix Filters .....	4-9
4.2.3.6	Hydraulic Analysis .....	4-9
4.2.4	Recommended Template.....	4-9
4.3	PRIORITIZATION OF ROAD CROSSING CULVERT RETROFITS/REPLACEMENTS .....	4-12
4.3.1	Overview .....	4-12
4.3.1.1	Objectives.....	4-12
4.3.1.2	Funding Source .....	4-12
4.3.2	Criteria .....	4-12
4.3.2.1	Cost .....	4-12
4.3.2.2	Ecological Significance .....	4-13

	4.3.2.3	Habitat Blocked.....	4-13
	4.3.2.4	Risk/Significance of Failure .....	4-14
4.3.3		Existing Prioritization Procedures.....	4-15
	4.3.3.1	California Department of Fish and Game .....	4-15
	4.3.3.2	Oregon Department of Fish and Wildlife.....	4-15
	4.3.3.3	Washington Department of Fish and Wildlife.....	4-16
4.3.4		Recommended Template.....	4-16
5		FISH PASSAGE HYDROLOGY .....	5-1
5.1		HYDROLOGIC CONSIDERATIONS FOR FISH PASSAGE DESIGN ....	5-1
	5.1.1	Seasonality.....	5-1
		5.1.1.1 Timing and Extent of Fish Presence .....	5-1
		5.1.1.2 Species and Life Stage.....	5-2
		5.1.1.3 Representing Seasonal Flows .....	5-2
	5.1.2	Extreme Events.....	5-3
		5.1.2.1 Fish Response.....	5-3
		5.1.2.2 Allowable Delay .....	5-3
		5.1.2.3 Migration Flows.....	5-4
5.2		DESIGN REQUIREMENTS.....	5-4
	5.2.1	High Fish Passage Flows.....	5-4
	5.2.2	Low Fish Passage Flows.....	5-5
	5.2.3	Bankfull Flow .....	5-5
	5.2.4	Streambed Stability and Crossing Capacity .....	5-6
	5.2.5	Tidal Influence.....	5-6
5.3		HYDROLOGIC PROCEDURES.....	5-7
6		DESIGN CONSIDERATIONS, METHODS AND TOOLS.....	6-1
6.1		OBJECTIVES.....	6-1
	6.1.1	Biological Considerations.....	6-2
		6.1.1.1 Fish Passage Requirements.....	6-2
		6.1.1.2 Ecological Significance .....	6-3
	6.1.2	Geomorphic Considerations.....	6-4
		6.1.2.1 Form and Key Features .....	6-4
		6.1.2.2 Stability .....	6-5
		6.1.2.3 Morphological Adjustment Potential/Ability .....	6-5
		6.1.2.4 Rigid Structure in Dynamic Environment .....	6-5
	6.1.3	Hydraulic Considerations .....	6-5
		6.1.3.1 Flood Flow Conveyance .....	6-5
		6.1.3.2 Culvert Flow Characteristics .....	6-5
		6.1.3.3 Targeted Fish Passage at Design Flows .....	6-5
		6.1.3.4 Passage for All Fish.....	6-6
		6.1.3.5 Sediment Transport .....	6-6
		6.1.3.6 Outlet Control .....	6-6
6.2		CONSTRAINTS .....	6-7
	6.2.1	Costs.....	6-7
	6.2.2	Right of Way.....	6-8
	6.2.3	Physical Constraints.....	6-8

6.2.4	Environmental Constraints .....	6-8
6.2.5	Regulatory Constraints.....	6-8
6.2.6	Alignment .....	6-9
6.3	DESIGN APPROACHES.....	6-10
6.3.1	No Impedance.....	6-10
6.3.2	Geomorphic Simulation (Category 1) .....	6-10
6.3.2.1	Biological Characteristics.....	6-10
6.3.2.2	Geomorphic Characteristics .....	6-10
6.3.2.3	Hydraulic Characteristics .....	6-11
6.3.2.4	Data Requirements.....	6-11
6.3.3	Hydraulic Simulation (Category 2).....	6-11
6.3.3.1	Biological Characteristics.....	6-12
6.3.3.2	Geomorphic Characteristics .....	6-12
6.3.3.3	Hydraulic Characteristics .....	6-13
6.3.3.4	Data Requirements.....	6-13
6.3.4	Hydraulic Design (Category 3) .....	6-13
6.3.4.1	Biological Characteristics.....	6-14
6.3.4.2	Geomorphic Characteristics .....	6-14
6.3.4.3	Hydraulic Characteristics .....	6-14
6.3.4.4	Data Requirements.....	6-14
6.3.4.5	Further Considerations .....	6-15
6.4	DESIGN SELECTION .....	6-15
6.4.1	Summary Matrix of Design Approaches.....	6-16
6.5	ANALYSIS TOOLS AND SOFTWARE .....	6-16
6.5.1	Channel Geometry .....	6-17
6.5.1.1	Channel Width .....	6-17
6.5.1.2	Channel Profile and Condition .....	6-18
6.5.2	Stream Classification .....	6-20
6.5.2.1	Montgomery and Buffington.....	6-20
6.5.2.2	Rosgen Stream Classification.....	6-22
6.5.2.3	Summary of Channel Classification .....	6-22
6.5.3	Stream Morphology .....	6-23
6.5.3.1	Gradient.....	6-23
6.5.3.2	Bed Material and Embedded Culverts .....	6-23
6.5.3.3	Key Roughness Elements .....	6-23
6.5.3.4	Subsurface Flows .....	6-24
6.5.4	Estimating Roughness with the Manning Equation .....	6-24
6.5.4.1	Limerinos Equation .....	6-24
6.5.4.2	Jarrett's Equation.....	6-25
6.5.4.3	Mussetter's Equation .....	6-26
6.5.5	Bed Mobility.....	6-26
6.5.5.1	Simulated Streambed Design .....	6-26
6.5.5.2	Modified Shield's Equation .....	6-27
6.5.5.3	Critical Unit Discharge Approach.....	6-29
6.5.5.4	Boundary Shear Threshold Analysis.....	6-31
6.5.5.5	U.S. Army Corps of Engineers Riprap .....	6-32

	6.5.5.6	Reference Reach Approach .....	6-33
	6.5.5.7	Unit-Discharge Bed Design .....	6-33
	6.5.5.8	Paleohydraulic Analysis.....	6-34
	6.5.5.9	Critical Shear Stress Method .....	6-35
6.5.6		Countermeasures for Channel Instability .....	6-36
	6.5.6.1	Scour Countermeasures.....	6-36
	6.5.6.2	Channel Modifications .....	6-37
	6.5.6.3	Roughened Channel.....	6-38
	6.5.6.4	Grade Control Structures.....	6-38
	6.5.6.5	Tailwater Control.....	6-39
	6.5.6.6	Broad Crested Weirs .....	6-40
6.5.7		Culvert Shapes and Standards .....	6-41
6.5.8		Simulation Software .....	6-42
	6.5.8.1	FishXing.....	6-43
	6.5.8.2	FishBase.....	6-43
	6.5.8.3	HY-8 v. 7.0.....	6-44
	6.5.8.4	HEC-RAS .....	6-44
	6.5.8.5	Commercial Programs .....	6-44
7		DESIGN METHODS .....	7-1
7.1		GEOMORPHIC SIMULATION (CATEGORY 1) .....	7-1
	7.1.1	U.S.F.S. Stream Simulation – DRAFT Manual.....	7-3
		7.1.1.1 Biological Characteristics.....	7-3
		7.1.1.2 Geomorphic Characteristics .....	7-3
		7.1.1.3 Hydraulic Characteristics .....	7-4
		7.1.1.4 Data Requirements.....	7-4
		7.1.1.5 Design Procedure .....	7-7
	7.1.2	WDFW Stream Simulation .....	7-8
		7.1.2.1 Biological Characteristics.....	7-8
		7.1.2.2 Geomorphic Characteristics .....	7-8
		7.1.2.3 Hydraulic Characteristics .....	7-9
		7.1.2.4 Data Requirements.....	7-9
		7.1.2.5 Design Procedure .....	7-12
	7.1.3	No-Slope and Active Channel Design .....	7-13
		7.1.3.1 Biological Characteristics.....	7-13
		7.1.3.2 Geomorphic Characteristics .....	7-13
		7.1.3.3 Hydraulic Characteristics .....	7-14
		7.1.3.4 Data Requirements.....	7-14
		7.1.3.5 Design Procedure .....	7-15
	7.1.4	Summary of Geomorphic Simulation Procedures .....	7-16
7.2		HYDRAULIC SIMULATION (CATEGORY 2) .....	7-17
	7.2.1	Oregon Department of Fish and Wildlife Stream Simulation ..	7-18
		7.2.1.1 Biological Characteristics.....	7-18
		7.2.1.2 Geomorphic Characteristics .....	7-18
		7.2.1.3 Hydraulic Characteristics .....	7-18
		7.2.1.4 Data Requirements.....	7-19

7.2.2	Alaska DF&G and DOT Stream Simulation.....	7-23
	7.2.2.1 Biological Characteristics.....	7-23
	7.2.2.2 Geomorphic Characteristics .....	7-23
	7.2.2.3 Hydraulic Characteristics .....	7-23
	7.2.2.4 Data Requirements.....	7-24
	7.2.2.5 Design Procedure .....	7-24
7.2.3	Browning et al. 1990 .....	7-25
	7.2.3.1 Biological Characteristics.....	7-25
	7.2.3.2 Geomorphic Characteristics .....	7-25
	7.2.3.3 Hydraulic Characteristics .....	7-26
	7.2.3.4 Data Requirements.....	7-26
7.2.4	Maryland .....	7-29
	7.2.4.1 Biological Characteristics.....	7-29
	7.2.4.2 Geomorphic Characteristics .....	7-29
	7.2.4.3 Hydraulic Characteristics .....	7-29
	7.2.4.4 Data Requirements.....	7-30
	7.2.4.5 Design Procedure .....	7-31
7.2.5	Summary of Hydraulic Simulation Procedures .....	7-32
7.3	HYDRAULIC DESIGN (CATEGORY 3) .....	7-33
7.3.1	General Hydraulic Design .....	7-35
	7.3.1.1 Biological Characteristics.....	7-35
	7.3.1.2 Geomorphic Characteristics .....	7-35
	7.3.1.3 Hydraulic Characteristics .....	7-36
	7.3.1.4 Data Requirements.....	7-36
	7.3.1.5 Design Procedure .....	7-37
7.3.2	Baffle Configurations.....	7-39
	7.3.2.1 Biological Characteristics.....	7-42
	7.3.2.2 Geomorphic Characteristics .....	7-42
	7.3.2.3 Hydraulic Characteristics .....	7-42
	7.3.2.4 Data Requirements.....	7-43
7.3.3	Maine .....	7-47
	7.3.3.1 Biological Characteristics.....	7-47
	7.3.3.2 Geomorphic Characteristics .....	7-47
	7.3.3.3 Hydraulic Characteristics .....	7-47
	7.3.3.4 Data Requirements.....	7-47
	7.3.3.5 Design Procedure .....	7-48
7.3.4	Roughened Channel Design .....	7-49
	7.3.4.1 Biological Characteristics.....	7-49
	7.3.4.2 Geomorphic Characteristics .....	7-49
	7.3.4.3 Hydraulic Characteristics .....	7-50
	7.3.4.4 Data Requirements.....	7-50
	7.3.4.5 Design Procedure .....	7-53
7.3.5	Oregon Department of Fish and Wildlife Hydraulic Design ....	7-54
	7.3.5.1 Biological Characteristics.....	7-54
	7.3.5.2 Geomorphic Characteristics .....	7-54
	7.3.5.3 Hydraulic Characteristics .....	7-54

	7.3.5.4	Data Requirements.....	7-54
7.3.6		Maine DOT Culvert Design for Rehabilitation.....	7-59
	7.3.6.1	Biological Characteristics.....	7-59
	7.3.6.2	Geomorphic Characteristics .....	7-59
	7.3.6.3	Hydraulic Characteristics .....	7-59
	7.3.6.4	Data Requirements.....	7-59
	7.3.6.5	Design Procedure .....	7-60
7.3.7		Summary of Hydraulic Design Procedures.....	7-61
7.3.8		A Detachable Fishway for Steep Culverts.....	7-62
	7.3.8.1	Biological Characteristics.....	7-62
	7.3.8.2	Geomorphic Characteristics .....	7-62
	7.3.8.3	Hydraulic Characteristics .....	7-62
	7.3.8.4	Data Requirements.....	7-63
	7.3.8.5	Design Procedure .....	7-63
7.3.9		Fishways.....	7-65
	7.3.9.1	Biological Characteristics.....	7-66
	7.3.9.2	Geomorphic Characteristics .....	7-66
	7.3.9.3	Hydraulic Characteristics .....	7-66
	7.3.9.4	Data Requirements.....	7-66
7.3.10		Floodplain Culverts .....	7-67
	7.3.10.1	Biological Characteristics.....	7-67
	7.3.10.2	Geomorphic Characteristics .....	7-67
	7.3.10.3	Hydraulic Characteristics .....	7-67
	7.3.10.4	Data Requirements.....	7-67
7.3.11		Two-Cell Installations .....	7-68
	7.3.11.1	Biological Characteristics.....	7-70
	7.3.11.2	Geomorphic Characteristics .....	7-70
	7.3.11.3	Hydraulic Characteristics .....	7-70
	7.3.11.4	Data Requirements.....	7-70
7.3.12		Tide Gates.....	7-71
	7.3.12.1	Biological Characteristics.....	7-74
	7.3.12.2	Geomorphic Characteristics .....	7-74
	7.3.12.3	Hydraulic Characteristics .....	7-74
8		CASE STUDIES AND DESIGN EXAMPLES .....	8-1
8.1		GEOMORPHIC SIMULATION .....	8-1
	8.1.1	USFS Stream Simulation Design Example .....	8-1
	8.1.2	USFS Stability Check Design Example.....	8-4
	8.1.3	WDFW Stream Simulation Design Example .....	8-7
	8.1.4	Unit Discharge Design Example.....	8-9
	8.1.4.1	Paleohydraulic Analysis.....	8-9
	8.1.5	WDFW No-Slope Design Example.....	8-11
	8.1.6	Embedded Pipe Case History .....	8-12
8.2		HYDRAULIC SIMULATION.....	8-15
	8.2.1	Culvert with Floodplain Relief Case History .....	8-15
8.3		HYDRAULIC DESIGN.....	8-20
	8.3.1	John Hatt Creek Case History.....	8-20

8.3.2	WDFW Roughened Channel Design Example.....	8-28
8.3.2.1	Fish Passage Velocity .....	8-29
8.3.2.2	Turbulence.....	8-31
9	CONSTRUCTION, MAINTENANCE AND INSPECTION .....	9-1
9.1	CONSTRUCTION .....	9-1
9.1.1	Timing .....	9-1
9.1.2	Constructability.....	9-1
9.1.3	Bed Mix Specification .....	9-1
9.1.4	Sealing Voids .....	9-2
9.1.5	Compaction .....	9-3
9.2	MAINTENANCE AND INSPECTION.....	9-3
10	MONITORING.....	10-1
10.1	PURPOSE AND SCOPE.....	10-1
10.2	METHODS .....	10-2
10.2.1	Inventory and Assessment.....	10-4
10.2.2	Surveying and Field Inspection .....	10-4
11	FUTURE RESEARCH NEEDS .....	11-1
11.1	SEDIMENT MOVEMENT AND STABILITY.....	11-1
11.2	FLOW HYDRAULICS.....	11-1
11.3	LIFE CYCLE COSTS .....	11-1
11.4	FISH MOVEMENT AND RESPONSE .....	11-2
11.5	MONITORING.....	11-2
11.5.1	Hydraulic Simulation Structures .....	11-2
11.5.2	Hydraulic Design Structures.....	11-2
APPENDIX A	.....	A-1
	METRIC SYSTEM, CONVERSION FACTORS, AND WATER PROPERTIES .....	A-1
REFERENCES	.....	R-1

## LIST OF TABLES

	<b>Page</b>
Table 1.1 Possible Geomorphic Responses and Impacts of a Stream Channel to an Undersized Culvert (adapted from Bates et al. 2006) .....	1-3
Table 1.2 FHWA Culvert Design Technologies and Supporting Guidance .....	1-15
Table 1.3 Report Preview .....	1-16
Table 2.1 Movement Type as It Relates to Muscle System Utilization (adapted from Bell 1986) .....	2-2
Table 2.2 Minimum Depth Criteria for Successful Upstream Passage of Adult Salmon and Trout, Customary Units (Everest et al. 1985).....	2-5
Table 2.3 Fish-Passage Design Criteria for Culvert Installations, Customary Units (Bates et al. 2003) .....	2-6
Table 3.1 State Fish Passage Depth Requirements .....	3-6
Table 3.2 Description of Barriers to Fish Passage and Possible Effects.....	3-9
Table 4.1 Specific Culvert Characteristics Useful in Assessment, Including Possible Barrier Types (Coffman 2005).....	4-3
Table 4.2 Fish Passage Barrier Types and Their Potential Impacts (Taylor and Love 2003).....	4-5
Table 5.1 State and Agency Guidelines for High Fish Passage Flows, Customary Units (adapted from Clarkin et al. 2003) .....	5-4
Table 5.2 State and Agency Guidelines for Low Fish Passage Flows, Customary Units (adapted from Clarkin et al. 2003) .....	5-5
Table 5.3 Flows Used in Determining Adequate Streambed Stability (adapted from Clarkin et al. 2003) .....	5-6
Table 6.1 Summary of Geomorphic, Biologic and Hydraulic Characteristics of Various Crossing Options .....	6-16
Table 6.2 Stream Classification by Montgomery and Buffington (from Bunte and Abt 2001) .....	6-21
Table 6.3 Morphological Characteristics of the Major Rosgen Stream Types (Bunte and Abt 2001).....	6-22
Table 6.4 Angle of Repose, Shield's Parameter and Critical Shear Stress Values for Gravel-, Cobble- and Boulder-Sized Particles (Bates et al. 2006) .....	6-29
Table 6.5 Prediction of Water Depth for a Given Maximum Particle Size that Has Been Moved (Bates et al. 2003) .....	6-35
Table 6.6 Comparison of Channel Profile Design Structures Used to Control Grade either Upstream or Downstream of a Culvert (adapted from Bates et al. 2003 with additional comments from other sources).....	6-38
Table 6.7 Advantages and Disadvantages of Different Culvert Shapes for Fish Passage Installations (from White 1997; Norman et al. 2005; Bates et al. 2003; Robison et al. 1999).....	6-42
Table 7.1 Design Recommendations Based on Channel Types (adapted from Bates et al. 2006).....	7-5
Table 7.2 Comparison of Geomorphic Simulation Techniques .....	7-16
Table 7.3 Flow Capacity for Non Embedded Circular and Pipe-Arch Culverts, Customary Units*† (Robison et al. 1999) .....	7-20



Table 7.4 Comparison of Percent of Culvert Diameter or Rise with Baffles or Embedding and Corresponding Cross-Sectional Area Loss for the Culvert (Robison et al. 1999) .....	7-21
Table 7.5 Comparison of Hydraulic Simulation Design Techniques .....	7-32
Table 7.6 Baffle Hydraulics (Bates et al. 2003).....	7-43
Table 7.7 Water Velocity Requirement for Culvert Installations in Oregon, Customary Units (Robison et al. 1999) .....	7-54
Table 7.8 Comparison of Hydraulic Design Techniques .....	7-61
Table 8.1 Modeled Hydraulic Conditions at Fish Passage Design Flows for John Hatt Creek (Customary Units).....	8-22
Table 10.1 Types of Monitoring (adapted from Collins 2003) .....	10-1
Table 10.2 Monitoring Questions, Parameters, Effectiveness, Criteria and Field Methods (adapted from Harris 2005) .....	10-3
Table A.1 Overview of SI.....	A-2
Table A.2 Relationship of Mass and Weight.....	A-2
Table A.3 Derived Units with Special Names.....	A-2
Table A.4 Useful Conversion Factors.....	A-2
Table A.5 Prefixes.....	A-4
Table A.6 Physical Properties of Water at Atmospheric Pressure in SI Units...	A-5
Table A.7 Physical Properties of Water at Atmospheric Pressure (Customary Units).....	A-6
Table A.8 Sediment Particles Grade Scale.....	A-7
Table A.9 Common Equivalent Hydraulic Units.....	A-8
Table A.10 Common Equivalent Hydraulic Units (continued).....	A-8

## LIST OF FIGURES

	Page
Figure 1.1 Scour downstream from culvert “perches” the barrel above the streambed, making it inaccessible to many fish species (United States Forest Service 2006b) .....	1-3
Figure 1.2 Downstream channel degradation causing culvert to become perched, and presenting a low flow barrier to fish passage (Furniss 2006)	1-4
Figure 1.3 Multiple culvert installation located at a slope break where sediment is likely to deposit, creating a debris barrier (United States Forest Service 2006b) .....	1-4
Figure 2.1 Relative swimming abilities of adult fish, in customary units (Bell 1986) .....	2-3
Figure 2.2 Relative swimming abilities of young fish, in customary units (Bell 1986) .....	2-4
Figure 2.3 Minimum water depths for fish passage in Alaska (Alaska Department of Fish and Game and Alaska Department of Transportation 2001) .....	2-5
Figure 3.1 Changes in fish habitat use over time after roadway fragmentation (Jackson, Personal Communication) .....	3-2
Figure 3.2 Barriers to fish passage (Natalie Cabrera and the FishXing Team)	3-3
Figure 3.3 Perched outlet, leap barrier (Alaska Department of Fish and Game 2005) .....	3-4
Figure 3.4 Drop and velocity barrier (Alaska Department of Fish and Game 2005) .....	3-5
Figure 4.1 Longitudinal profile survey points (Clarkin et al. 2003) .....	4-3
Figure 4.2 Example of a coarse filter and regional screen in customary units (from Clarkin et al. 2003) .....	4-7
Figure 4.3 Alaskan fish-passage evaluation criteria, United States Forest Service Region 10, customary units (Flanders and Cariello 2000) .....	4-8
Figure 4.4 Flow chart for culvert assessment (adapted from Clarkin et al. 2003) .....	4-11
Figure 4.5 The erosional consequences of diverting stream flow onto non-stream slopes (Furniss et al. 1997).....	4-14
Figure 4.6 Fill in the blank regional screen based on the California model (Clarkin et al. 2003) .....	4-17
Figure 5.1 Peak spawning periods for a selection of freshwater fish in Virginia, based on biological data from Scott and Crossman (1973) (adapted from Hudy 2006) .....	5-2
Figure 5.2 Synthetic flow duration curves from May Creek, customary units (Lang et al. 2004).....	5-3
Figure 6.1 Range of ecological solutions at culvert installations (adapted from Gubernick 2006) .....	6-4
Figure 6.2 Culverts under outlet control (Norman et al. 2005) .....	6-7
Figure 6.3 Alignment options for a skewed roadway-stream crossing (Bates et al. 2006).....	6-9
Figure 6.4 Depiction of bankfull channel width compared to active channel width (Taylor and Love 2003).....	6-18

Figure 6.5 Critical bank height is inherently unstable and will result in bank failure and stream widening (Castro 2003) .....	6-19
Figure 6.6 Downstream riprap will dissipate energy and reduce scour, but must be placed with fish utilization in mind (USFS 2005) .....	6-37
Figure 6.7 Downstream grade control (Bates et al. 2003).....	6-39
Figure 6.8 Upstream regrade channel-steepening options (Bates et al. 2003)....	6-39
Figure 6.9 Notch weirs downstream of a culvert installation, acting to properly backwater the culvert, while maintaining manageable drops (United States Forest Service 2005) .....	6-40
Figure 7.1 Low flow channel in an open bottom structure (Bates et al. 2006)...	7-7
Figure 7.2 Washington Department of Fish and Wildlife Stream Simulation approach for low slope situations, where bed slope < 4.0% (Bates et al. 2003) .....	7-10
Figure 7.3 Washington Department of Fish and Wildlife High-Slope Stream Simulation Approach (Bates et al. 2003) .....	7-11
Figure 7.4 WDFW No-Slope option (Bates et al. 2003) .....	7-15
Figure 7.5 Steps in Hydraulic Design (Robison et al. 1999).....	7-33
Figure 7.6 Hydraulic Design option, customary units (Bates et al. 2003).....	7-35
Figure 7.7 (a) Offset baffle; (b) slotted weir baffle; (c) weir baffle; (d) spoiler baffle; (e) Alberta fishweir; and (f) Alberta fishbaffle (Ead et al. 2002).....	7-40
Figure 7.8 Culvert options (b) slotted weir and (c) weir baffle configurations (adapted from Ead et al. 2002) .....	7-41
Figure 7.9 Recommended styles of baffles for round and box culverts in Washington (Bates et al. 2003).....	7-42
Figure 7.10 Variation of Darcy-Weisbach friction factor (Bates et al. 2003)....	7-45
Figure 7.11 Energy coefficients for various baffle arrangements (adapted from Bates et al. 2003).....	7-45
Figure 7.12 Roughened-channel culverts using fish rocks and bed retention sills (Bates et al. 2003) .....	7-52
Figure. 7.13 Baffle configurations endorsed in Oregon in customary units (Trevis, Personal Communication).....	7-56
Figure 7.14 8 inch plastic baffle used in Oregon, customary units (Trevis, Personal Communication) .....	7-57
Figure 7.15 12 inch plastic baffle used in Oregon, customary units (Trevis, Personal Communication) .....	7-58
Figure 7.16 Detachable fishway design for culvert retrofit, customary units (Clancy 1990) .....	7-64
Figure 7.17 Fishway installed on Peacock Creek, California (Llanos 2004) ...	7-65
Figure 7.18 Example detail of low-flow channel sills, customary units (Twisdale, Personal Communication) .....	7-69
Figure 7.19 Lateral schematic of a culvert with a top-hinged tide gate attached to downstream end of culvert (Giannico and Souder 2005).....	7-71
Figure 7.20 Tide gate operation cycle: (A) tide gate begins to open when water pressure in culvert overcomes pressure of water on downstream side during ebb tide; (B) tide gate is wide open during ebb tide; (C) tide gate begins to	

shut when upstream water level drops and tide begins to rise; and (D) tide gate is shut during flood tide (Giannico and Souder 2004) .....	7-72
Figure 7.21 Bottom-hinged pet door (Giannico and Souder 2005) .....	7-73
Figure 8.1 Example cumulative distribution curve for bed mix gradation using Fuller-Thompson method using $n = 0.7$ and $n = 0.45$ .....	8-2
Figure 8.2 Example cumulative distribution curve for the Fuller-Thompson method using $n = 0.55$ and $n = 0.45$ .....	8-3
Figure 8.3 Pre-project barrier culvert (United States Forest Service 2006b)...	8-12
Figure 8.4 Replacement culvert (United States Forest Service 2006b) .....	8-13
Figure 8.5 Pre-project channel condition (1992) .....	8-16
Figure 8.6 Upstream of pre-existing structure looking downstream .....	8-17
Figure 8.7 Downstream of pre-existing structure looking upstream .....	8-17
Figure 8.8 Downstream of culvert, shortly after project completion in 1994....	8-18
Figure 8.9 Upstream of current crossing in 2005 .....	8-18
Figure 8.10 Upstream of current crossing during high-flow event.....	8-19
Figure 8.11 Example detail of culvert rehabilitation and corner baffle retrofit, John Hatt Creek (customary units) .....	8-22
Figure 8.12 Downstream view of culvert retrofit, John Hatt Creek .....	8-24
Figure 8.13 Pre-existing outlet of John Hatt Creek culvert perched at 0.46 m (1.5 ft) blocks migrating steelhead .....	8-25
Figure 8.14 Steel corner baffles welded to the pipe and spaced 1.22 m (4 ft) apart, John Hatt Creek.....	8-26
Figure 8.15 Baffles slowing water velocities at high flows while producing minimal turbulence, John Hatt Creek.....	8-26
Figure 8.16 Culvert outlet after installation, John Hatt Creek.....	8-27

This page intentionally left blank

## GLOSSARY

**Active channel:** A waterway of perceptible extent that periodically or continuously contains moving water. It has definite bed and banks, which serve to confine the water and includes stream channels, secondary channels, and braided channels. It is often determined by the “ordinary high water mark” which means that line on the shore established by the fluctuations of water and indicated by physical characteristics such as clear, natural line impressed on the bank, shelving, changes in the character of soil, destruction of terrestrial vegetation, the presence of litter and debris, or other appropriate means that consider the characteristics of the surrounding areas.

**Aggradation:** The geologic process by which a streambed is raised in elevation by the deposit of material transported from upstream. (Opposite of degradation.)

**Apron:** A flat or slightly inclined slab up- or downstream of culvert or weir that provides for erosion protection. A downstream apron may also produce hydraulic characteristics suitable for energy dissipation or fish exclusion.

**Anadromous fish:** Fish which mature and spend much of their adult life in the ocean, returning to inland waters to spawn. Examples include salmon and steelhead.

**Armor:** A surficial layer of coarse grained sediments, usually gravel or coarser, that are underlain by finer grained sediments.

**Backwater:** Water backed-up or retarded in its course as compared with its normal open channel flow condition. Water level is a function of some downstream hydraulic control.

**Baffle:** Wood, concrete or metal mounted in a series on the floor and/or wall of a culvert to increase boundary roughness and thereby reduce the average water velocity in the culvert.

**Bankfull discharge:** The discharge corresponding to the state at which the floodplain of a particular stream reach begins to be flooded. The bankfull discharge is a morphological indicator that is related to the formation, maintenance, and dimensions of a stream channel, as it exists under modern climatic conditions. The bankfull discharge, often, has a flood frequency of approximately 1.5 years on the annual series, but the frequency can vary widely depending on the particular watershed and stream reach characteristics (FISRWG 1998).

**Bankfull width:** The point on a streambank at which overflow into the floodplain begins. The floodplain is a relatively flat area adjacent to the channel constructed by the stream. If the floodplain is absent or poorly defined, other

indicators may identify bankfull. These include the height of depositional features, a change in vegetation, slope or topographic breaks along the bank, a change in the particle size of bank material, undercuts in the bank, and stain lines or the lower extent of lichens and moss on boulders. Field determination of bankfull should be calibrated to known stream flows or to regional relationships between bankfull flow and watershed drainage area (FISRWG 1998).

**Bed:** The land below the channel bed width.

**Bedform:** Elements of the stream channel that describe channel form (e.g. pools, riffles, steps, particle clusters).

**Bedload:** The part of sediment transport not in suspension consisting of coarse material moving on or near the channel bed.

**Bed roughness:** Irregularity of streambed material that contributes resistance to streamflow. Commonly characterized using Manning's roughness coefficient.

**Bridge:** A crossing structure with a combined span (width) greater than 20 ft.

**Burst speed:** See "Swimming speed."

**Cascade:** Tumbling flow with continuous jet-and-wake flow over and around individual large clasts (Montgomery and Buffington 1997). Cascades may be natural or constructed.

**Channel:** A natural or constructed waterway that has definite bed and banks that confine water.

**Channel bed slope:** Vertical change with respect to horizontal distance within the channel (Gradient).

**Channel-bed width:** The distance from the bottom of the left bank to the bottom of the right bank. The distinction between bed and bank are determined by examining channel geometry and the presence/absence of vegetation.

**Channelization:** Straightening or diverting a waterway into a new channel.

**Countersink:** Place culvert invert below stream grade.

**Critical depth:** The unique depth of flow in a channel that is characteristic only of discharge and slope. Often referred to as a flow control location.

**Culvert:** A conduit or passageway under a road, trail or other obstruction. A culvert differs from a bridge in that it usually consists of structural material around its entire perimeter and has a total span (width) of less than 6.1 m (20 ft).

**Debris:** Includes trees and other organic detritus scattered about or accumulated near a culvert by either natural processes or human influences.

**Degradation:** Erosional removal of streambed material that results in a lowering of the bed elevation throughout a reach. (Opposite of aggradation.)

**Deposition:** Settlement of material onto the channel bed.

**Design flood:** The probabilistic estimate of a flood whose magnitude is equaled or exceeded within a given frequency.

**Dewatering:** Removal of water from an area.

**Embedded culvert:** A culvert installation that is countersunk below the stream grade. It may or may not be filled with natural sediment or a design mix.

**Entrainment:** The process of sediment particle lifting by an agent of erosion.

**Entrenchment:** The vertical containment of a river and the degree to which it is incised in the valley floor.

**Filter fabric:** A natural or synthetic fabric used to block sediment and water from flowing to a subsurface or surface area such as through a revetment of riprap along channel beds.

**Fish passage:** The ability of fish to move both up and downstream through a bridge or culvert.

**Fishway:** A system that may include special attraction devices, entrances, collection and transportation channels, a fish ladder, exit and operation and maintenance standards to facilitate passage through bridges or culverts.

**Fishway weir:** A term frequently used to describe the partition between adjacent pools in a fishway.

**Flood frequency:** The frequency with which a flood of a given discharge has the probability of recurring. For example, a “100-year” frequency flood refers to a flood discharge of a magnitude likely to occur on the average of once every 100 years over a very long time span or, more properly, has a 1 percent chance of being exceeded in any year. Although calculation of possible recurrence is often based on historical records, there is no guarantee that a “100-year” flood will occur at all within the 100-year period or that it will not occur several times.

**Floodplain:** The area adjacent to the stream constructed by the river in the present climate and inundated during periods of high flow.



**Flow duration curve:** A statistical summary of river flow information over a period of time that describe cumulative percent of time for which flow exceeds specific levels (exceedance flows), exhibited by a cumulative frequency curve that shows the percentage of time that specified discharges are equaled or exceeded. Flow duration curves are usually based on daily streamflow and describe the flow characteristics of a stream throughout a range of discharges without regard to the sequence of occurrence.

**Fork length:** The length of a fish measured from the most anterior part of the head to the deepest point of the notch in the tail fin.

**Geomorphology:** The study of physical features associated with landscapes and their evolution. Includes factors such as stream gradient, elevation, parent material, stream size, valley bottom width.

**Geomorphic Simulation:** Culvert design to replicate or maintain natural stream geomorphic elements including gradient, width, bedform, bed material and key features for approximately bankfull conditions. Fish passage requirements are assumed to be met when structures provide natural channel continuity.

**Grade stabilization or Grade control:** Stabilization of the streambed elevation against degradation. Usually a natural or constructed hard point in the channel that maintains a set elevation. In some cases it may require elevating or steepening a channel.

**Head-cutting:** Channel bottom erosion moving upstream through a basin, which may indicate a readjustment of the stream's flow regime (slope, hydraulic control, and/or sediment load characteristics).

**Headwater:** The water upstream from a structure or point on a stream.

**Headwater depth:** The depth of water at the inlet of a culvert.

**High passage design flow:** The maximum discharge used for fish passage design. Usually specified by agency policy.

**Hydraulic Design:** Design options utilizing natural or artificial flow control structures (including weirs, baffles, oversized substrate) to create hydraulic conditions passable for target fish species during specific periods of fish movement.

**Hydraulic jump:** Hydraulic phenomenon in open channel flow, where supercritical flow changes to sub-critical flow. This will result in an abrupt rise in the water surface elevation.

**Hydraulic Simulation:** Design techniques that attempt to closely match natural stream flow characteristics by using embedded culvert structures, avoiding most channel constriction, and utilizing natural and oversized sediment in the barrel.

**Incision:** The resulting change in channel cross-section from the process of degradation.

**Interstitial flow:** That portion of the surface water that infiltrates the streambed and moves through the substrate interstitial spaces.

**Invert:** The lowest point of the internal cross section of culvert or pipe arch.

**Large Woody Debris (LWD):** Any large piece of woody material such as root wads, logs and trees that intrude into a stream channel. LWD may occur naturally or be designed as part of a stream restoration project.

**Low passage design flow:** The minimum discharge used in fish passage design. Usually specified by agency policy.

**Manning's n:** Empirical coefficient for simulating the effect of wetted perimeter roughness used in determining water velocity in stream discharge calculations.

**Mitigation:** Actions to avoid or compensate for the impacts on fish resulting from a proposed activity.

**Normal depth:** The depth of flow in a channel or culvert when the slope of the water surface and channel bottom is the same and the water depth remains constant.

**Ordinary High Water Mark (OHW):** Generally, the lowest limit of perennial vegetation. There are also available definitions of OHW that include characteristics of erosion and sediment.

The OHW mark can usually be identified by physical scarring along the bank or shore, or by other distinctive signs. This scarring is the mark along the bank where the action of water is so common as to leave a natural line impressed on the bank. That line may be indicated by erosion, shelving, changes in soil characteristics, destruction of terrestrial vegetation, the presence of litter or debris or other distinctive physical characteristics.

Considerable judgment is required to identify representative OHW marks. It may be difficult to identify the mark on cut banks. In warm months grasses or hanging vegetation may obscure the OHW mark. Artificial structures (culverts, bridges or other constrictions) can affect the OHW mark by creating marks on the shore, which are consistent with OHW marks but above the elevation that is usually found in undisturbed river reaches.

**Perching:** The tendency to develop a scour hole at the outfall of a culvert due to erosion of the stream channel.

**Pipe:** A culvert that is circular (round) in cross section.

**Pipe arch:** A pipe that has been factory-deformed from a circular shape such that the span (width) is larger than the vertical dimension (rise).

**Plunging flow:** Flow over a weir or out of a perched culvert, which falls into a receiving pool.

**Porosity:** The percent of flow-through open area of a mesh, screen or streambed rack, relative to the entire gross area.

**Reference reach:** A stable section of stream beyond the influence of the crossing of interest, with channel characteristics and geomorphology representative of the channel that would exist in the absence of the culvert crossing. This reach provides a template for design of Geomorphic Simulation structures.

**Regrade:** The process of channel adjustment to attain a new "stable" bed slope. For example, following channelization, a stream bed will typically steepen upstream and flatten downstream.

**Resident fish:** Fish that migrate and complete their life cycle in fresh water.

**Riffle:** A reach of stream in which water flow is rapid and usually shallower than the reaches above and below. Natural streams often consist of a succession of pools and riffles.

**Riparian:** The area adjacent to flowing water (e.g., rivers, perennial or intermittent streams, seeps or springs) that contains elements of both aquatic and terrestrial ecosystems that mutually influence each other.

**Riprap:** Large, durable materials (usually rocks; sometimes broken concrete, etc.) used to protect a stream bank from erosion; may also refer to the materials used.

**Scour:** Localized erosion caused by flowing water.

**Shear strength:** The characteristic of soil, rock and root structure on a parallel submerged surface such as the channel bed or channel bank.

**Shear stress:** hydraulic force of water created by its movement on a parallel submerged surface such as the channel bed or channel bank.

**Substrate:** Mineral and organic material that forms the bed of a stream. In an armored channel, substrate refers to the material beneath the armor layer.

**Supercritical flow:** Occurs when normal depth is less than critical depth; rare for extended reaches in natural streams.

**Swimming speeds:** Fish swimming speeds can vary from essentially zero to over six meters per second, depending on species, size and activity. Three categories of performance are generally recognized:

**Sustained speed:** The speed a fish can maintain for an extended period for travel without fatigue. Metabolic activity in this mode is strictly aerobic and utilizes only red muscle tissues.

**Prolonged speed:** The speed that a fish can maintain for a prolonged period, but which ultimately results in fatigue. Metabolic activity in this mode is both anaerobic and aerobic and utilizes white and red muscle tissue.

**Burst (Darting) speed:** The speed a fish can maintain for a very short period, generally 5 to 7 seconds, without gross variation in performance. Burst speed is employed for feeding, escape and negotiating difficult hydraulic situations, and represents maximum swimming speed. Metabolic activity in this mode is strictly anaerobic and utilizes only white muscle tissue.

**Tailwater:** The water downstream from a structure or point on a stream.

**Tailwater depth:** Depth of water at a culvert outlet.

**Thalweg:** The longitudinal line of deepest water within a stream.

**Toe:** The break in slope at the foot of a bank where the bank meets the bed.

**Upstream fish passage:** Fish passage relating to upstream migration of adult and/or juvenile fish.

**Upstream passage facility:** A fishway system designed to pass fish upstream of a passage impediment, either by volitional or non-volitional passage.

**Velocity:** Time rate of motion; the distance traveled divided by the time required to travel that distance.

**Average velocity:** The discharge divided by the cross-sectional area of the flow in a culvert. Usually termed "average velocity."

**Boundary layer velocity:** Area of decreased velocity due to culvert boundary roughness. This region is restricted to only a few cm from the boundary.

**Maximum velocity:** The highest velocity within a cross-section of flow.

**Weir:** A short wall constructed on a stream channel that backs up water behind it and allows flow over or through it if notched. Weirs are used to control water depth and velocity.

**Wetted perimeter:** Across a channel section, the length of the channel surface in contact with water.

## GLOSSARY OF ACRONYMS

<b>Acronym</b>	<b>Definition</b>
<b>ADFG</b>	Alaska Department of Fish and Game
<b>ADOT</b>	Alaska Department of Transportation
<b>AOP</b>	Aquatic Organism Passage
<b>BMPs</b>	Best Management Practices
<b>CALTRANS</b>	California Department of Transportation
<b>CDFG</b>	California Department of Fish and Game
<b>CMP</b>	Corrugated Metal Pipe
<b>CWA</b>	Clean Water Act
<b>CU</b>	Customary Units
<b>DF&amp;G</b>	Department of Fish and Game
<b>DOT(s)</b>	Department(s) of Transportation
<b>EDF</b>	Energy Dissipation Factor
<b>EFH</b>	Essential Fish Habitat
<b>EO</b>	Executive Order
<b>ESA</b>	Endangered Species Act
<b>FDC</b>	Flow Duration Curves
<b>FHWA</b>	Federal Highway Administration
<b>FWCA</b>	Fish and Wildlife Coordination Act
<b>GAO</b>	General Accounting Office
<b>HDS</b>	Hydraulic Design Series
<b>HEC</b>	Hydraulic Engineering Circular
<b>HSPF</b>	Hydrological Simulation Program: Fortran
<b>MDOT</b>	Maine Department of Transportation
<b>NEPA</b>	National Environmental Policy Act
<b>NMFS</b>	National Marine Fisheries Service
<b>NOAA</b>	National Oceanic-Atmospheric Administration
<b>ODFW</b>	Oregon Department of Fish and Wildlife
<b>OHW</b>	Ordinary High Water
<b>QA/QC</b>	Quality Assurance and Quality Control
<b>SI</b>	International System of Units
<b>SPP</b>	Structural Plate Pipe
<b>SPPA</b>	Structural Plate Pipe Arch
<b>SWMM</b>	Storm Water Management Model
<b>TMDL</b>	Total Daily Maximum Load
<b>WDFW</b>	Washington Department of Fish and Wildlife
<b>USFS</b>	United States Forest Service

## LIST OF SYMBOLS

Symbol	Definition
A	area, m <sup>2</sup> (ft <sup>2</sup> )
b <sub>c</sub>	channel span across bars, m (ft)
C <sub>d</sub>	discharge coefficient
C <sub>e</sub>	dimensionless culvert exit head loss coefficient
C <sub>0</sub>	dimensionless culvert head loss coefficient (C <sub>e</sub> +K <sub>e</sub> )
d	particle size of interest, m (ft)
D <sub>i</sub>	particle size representing i% finer (Example, D <sub>16</sub> is the particle size representing 16% finer)
f	dimensionless Darcy Weisbach friction factor
g	acceleration due to gravity, m/s <sup>2</sup> (ft/s <sup>2</sup> )
h	bank height, m (ft)
HW	headwater elevation above the culvert entrance invert, m (ft)
K <sub>e</sub>	dimensionless culvert entrance head loss coefficient
L	length, m (ft)
h <sub>t</sub>	critical bank height, m (ft)
n	Fuller-Thompson coefficient for adjusting bed mixture gradation
n	Manning's roughness coefficient
Q	flow, m <sup>3</sup> /s (ft <sup>3</sup> /s)
q	unit discharge, m <sup>3</sup> /s/m (ft <sup>3</sup> /s/ft)
q <sub>c</sub>	critical unit discharge, m <sup>3</sup> /s/m (ft <sup>3</sup> /s/ft)
Q <sub>100</sub>	one hundred year flow, m <sup>3</sup> /s (ft <sup>3</sup> /s)
R	hydraulic radius, m (ft)
S	slope, m/m (ft/ft)
S <sub>f</sub>	friction slope, m/m (ft/ft)
V	velocity, m/s (ft/s)
y	depth of water, m (ft)
Z	baffle height, m (ft)
τ	shear stress, Pa (lb/ft <sup>2</sup> )
τ <sub>c</sub>	critical shear stress, Pa (lb/ft <sup>2</sup> )
γ	specific weight of water, Pa (lb/ft <sup>2</sup> )
τ*	dimensionless Shield's parameter
Φ	angle of repose (degrees)

This page intentionally left blank



# 1 INTRODUCTION

## HOW TO USE THIS CHAPTER

- ▶ Get a brief overview of the importance of providing for animal passage at culverts
- ▶ Introduction of how non-passable culverts can affect fish populations
- ▶ Introduction to barriers for fish passage at culverts
- ▶ Find relevant Federal legislation applying to providing for fish passage
- ▶ Learn the importance of assembling multidisciplinary teams for designing for fish passage

## 1.1 PURPOSE AND SCOPE

This document is a design reference for the classification, assessment, design or retrofit of a roadway-stream crossing to facilitate **fish** passage. It is the result of a comprehensive literature review completed to categorize design procedures, case histories, and culvert assessment techniques. No new recommendations for a universal design procedure are made; rather, a compilation of design options used in different geographic regions is included to allow the user to select the most appropriate design method for their unique situation. A collection of design examples and case histories is intended to add clarity to the design methodology selection.

In order to provide stream reach connectivity for all wildlife, removal of road barriers or the installation of a bridge spanning the floodplain are ideal; however, this report presumes that a narrower, fish-friendly, installation is both permitted and desirable for economical or logistical reasons. It is recognized that fish are not the only animals requiring habitat connectivity for long-term population viability, and future versions of this circular are intended to cover aquatic organism passage (AOP) in more detail. This report is intended solely as a reference for the design, retrofit, or replacement of a road stream crossing to meet fish passage requirements.

The scope of this report is also limited to culvert installations. If the total culvert span including all barrels and fill between barrels exceeds 6.1 m (20 ft), it is called a bridge according to the Federal Highway Administration code:

**Bridge.** A structure, including supports, erected over a depression or an obstruction, such as water, a highway, or a railway, having a track or passageway for carrying traffic or other moving loads, and having an opening measured along the center of the roadway of more than 6.1 m (20 ft) between undercopings of abutments or spring lines of arches, or extreme ends of the openings for multiple boxes; it may

include multiple pipes where the clear distance between openings is less than half of the smaller contiguous opening.

A logical progression is followed to guide the reader through the assessment and design process. Culvert analysis, design and retrofit techniques are then described, followed by case histories and design examples.

The increased biological, hydrological, and geomorphic sensitivity of a fish-passable structure requires that designers have access to a broad knowledge base. Proper assessment and design of a culvert installation or retrofit requires some expertise in hydraulic engineering, structural/geotechnical engineering, and hydrology; although, the level of experience needed varies depending on the preferred culvert installation/assessment method. Regional requirements for fish biology, hydrology, and geomorphology require that the design for fish passage be considered on a site-by-site basis, all but eliminating the possibility of a cookie-cutter design approach. Consultation with local engineers, stream ecologists and fish biologists will help ensure that the culvert selection, design, and alignment provide adequate stream reach connectivity, and that the most appropriate installation or retrofit strategy is selected based on ecological need, priority, cost, and site logistics.

## **1.2 HIGHWAY PERSPECTIVE**

Waterway crossings, including bridges and culverts, represent a key and expensive element in our overall transportation system. The design of crossing structures has traditionally used hydraulic conveyance and flood capacity as the main design parameters. Hydraulic Design Series - 5 *Hydraulic Design of Highway Culverts* (HDS-5) specifies a culvert design procedure to maintain acceptable headwater depth during design floods; this ensures efficient conveyance of water, but normally does not include provisions for fish passage through the culvert (Norman et al. 2005).

Design for hydraulic efficiency overlooks the impact of a roadway-stream crossing on the stream-channel aquatic ecosystem. Resulting structures often narrow the channel through the bridge opening or culvert barrel. Constricted reaches influence the characteristics of flow through and around the hydraulic structure, increasing velocities and scour potential (Johnson and Brown 2000). Augmented flow regimes may induce scour of the streambed through and downstream from the structure, and cause upstream progressing channel incision (Castro 2003). Table 1.1, from the Forest Service Stream Simulation Manual, lists a number of possible stream responses to altered hydraulic conditions caused by a traditionally sized crossing (Bates et al. 2006). In general, the effects of an undersized culvert can be described as a local destabilization of the stream channel (Johnson and Brown 2000).

**Table 1.1 Possible Geomorphic Responses and Impacts of a Stream Channel to an Undersized Culvert (adapted from Bates et al. 2006)**

<b>Geomorphic Response to Undersized Culvert</b>
Downstream erosion of bed and banks
Downstream channel incision
Disconnected floodplains
Direct habitat loss and degradation
Upstream aggradation
Increased risk of debris clogging
Barrier to fish and aquatic organism passage

Velocities resulting from traditionally sized culverts may exceed fish swimming ability, and scour at culvert outlets may prove too excessive for fish to leap into the structure (Venner Consulting and Parsons Brinkerhoff 2004). As a result, culverts act as barriers to juvenile and adult fish movement (Flanders and Cariello 2000; Wilder et al. 2004; Browning 1990). For example, Figures 1.1 and 1.2 depict outlet scour and channel degradation resulting in perching – the development of a falls or cascade at the culvert outfall due to erosion of the stream channel downstream of the drainage structure (Bates et al. 2003) - while Figure 1.3 illustrates the impact of debris deposition. Often, high quality upstream fish habitat is disconnected from downstream river and stream corridors by structures that are impassable for native fish (Trombulak and Frissell 2000).



**Figure 1.1 Scour downstream from culvert “perches” the barrel above the streambed, making it inaccessible to many fish species (United States Forest Service 2006b)**



**Figure 1.2 Downstream channel degradation causing culvert to become perched, and presenting a low flow barrier to fish passage (Furniss 2006)**



**Figure 1.3 Multiple culvert installation located at a slope break where sediment is likely to deposit, creating a debris barrier (United States Forest Service 2006b)**

(Flow is spread too thinly to allow fish passage)

Increased interest and work in providing for fish passage has resulted in a sufficient number of design procedures to merit the publication of this report.

### **1.3 ECOLOGICAL PERSPECTIVE**

River and stream corridors provide vital habitat for a wide range of animal species, many of which depend on the ability to move freely throughout their ecosystem in order to complete their life cycles (Jackson 2003). The importance of human transportation has led to roads that extend through much of the

country, inevitably crossing over streams and rivers (Schrag 2003). Structures designed to pass water under a road frequently do not consider animal movement, causing fragmentation of many riverine systems (Trombulak and Frissell 2000). Recognition of the need to restore habitat connectivity has added ecological consideration to the design and retrofit of road stream crossings (e.g. Jackson 2003; Bates et al. 2006). The following sections address issues associated with passage of all animals at roadway-stream crossings. The remainder of the report will focus on fish passage.

### **1.3.1 Importance of Animal Movement**

As a dynamic environment, the habitat within riverine ecosystems is in a constant state of flux, producing the need for animal movement (Amoros and Bornette 2005). The ability to move freely throughout a stream ecosystem allows wildlife to seek food and shelter, mating partners, escape predation, or move in response to seasonal or extreme natural disturbances (Jackson 2003). While some animals can live their entire life under a single rock, others require substantial room to travel. For example, the Florida Black Panther has been shown to occupy home ranges up to 1182 km<sup>2</sup> (734 mi<sup>2</sup>) (Cramer 1999), and salmon can travel hundreds of miles up rivers and streams to make their return from the ocean to headwater streams to spawn (Groot and Margolis 1991).

Freedom of movement allows wildlife to seek out habitat suitable to their life stage. Salamanders, for example, utilize headwater streams as adults, but seek out environments with more stable hydrology when breeding. The resulting larvae are weak swimming, and could not survive in the more dynamic riverine system occupied by adults (Jackson 2003). Adult salmon migrate to the ocean to grow, but return to the headwater streams of their birth to spawn (Groot and Margolis 1991). It has been observed that smaller resident salmonids move upstream and downstream, relying on more than a small stream reach for survival (Young 1995; Young 1996; Kahler and Quinn 1998).

Population dynamics are linked to movement, allowing many subpopulations to interact to increase genetic exchange and enhance biodiversity. Just as roads convey traffic from one point to another, streams and rivers provide an avenue for animals to seek out the resources they need to survive and enhance their genetic biodiversity. Disturbances in river continuity force animals to utilize smaller areas - blocking off spaces that were once an integral part of their range.

### **1.3.2 Road Stream Interaction**

Roads cover almost 2% of the landmass in the United States, leading to a seemingly unavoidable interaction of roadways and the environment (Schrag 2003). For example, a survey of Bureau of Land Management (BLM) and U.S. Forest Service land found 10,000 culvert crossings on fish bearing streams in Washington and Oregon alone (General Accounting Office 2001). And estimates

of road and railroad crossing affecting Massachusetts streams are as high as 28,500 (Venner Consulting and Parsons Brinkerhoff 2004). Such crossings impact aquatic organisms and fish, potentially causing barriers to passage, fragmentation, and a loss of ecological connectivity (Trombulak and Frissell 2000). Many of the roadway-stream culverts that are currently in place were designed and installed with hydraulic conveyance as the main criteria (Norman et al. 2005). Natural stream processes were not considered in favor of relatively inexpensive culverts that could pass a design flow without roadway overtopping. This design methodology ignored issues such as sediment transport, fish and wildlife passage, and generally had a significant impact on the stream's natural hydrology (Jackson 2003). For example, over half of the 10,000 culverts surveyed on Forest Service and BLM land in Washington and Oregon are considered to be barriers to juvenile salmon passage (General Accounting Office 2001).

Although much recent focus has been on the passage of fish, many other organisms are affected by improperly designed culverts, from small aquatic organisms such as salamanders to large terrestrial animals such as deer (United States Forest Service 2006a; Schrag 2003). In general, a culvert that is impassable for fish will also pose as a barrier to weaker swimming semi-aquatic organisms (Bates et al. 2006).

As increasing human population leads to an expansion of our infrastructure, the role of roads in habitat decline and fragmentation is the subject of increased scrutiny (e.g. Spellerberg 1998; Trombulak and Frissell 2000). The long-term ecological effects of roads include loss and change of habitat, changes in biological makeup of communities, and fragmentation – leading to population isolation (Spellerberg 1998).

### **1.3.3 Effects of Population Isolation**

The effects of isolation are most dangerous in smaller populations, although a variety of parameters are involved in analysis of population vulnerability (Mace and Lande 1991). With a smaller isolated group there will be an increase in genetic homogeneity, as well as higher susceptibility to natural or chance events (Mace and Lande 1991). This can mean local extinctions due to drought or fire, and the results of inbreeding, including genetic weakness, which makes the population susceptible to disease, decreased reproduction, high mortality, and possibly to extinction (McKelvey et al. 2002).

For both aquatic and terrestrial organisms, negative impacts of roadway interaction are manifest through a loss of population connectivity. The species most vulnerable to isolation are those with large home ranges and low population numbers, including bears, wolves, mountain lions, Florida panthers, lynx, snakes and desert tortoises (Hass 2000). The removal of these predators can have a significant impact throughout the food web, and many attempts to increase



connectivity have been undertaken in the United States, Canada and Europe, including underpasses and overpasses (Schrag 2003). Many of these wildlife-crossing case histories can be accessed through the U.S. Forest Services Wildlife Crossing Toolkit website at <http://www.wildlifecrossings.info/beta2.htm>.

Aquatic organism passage (AOP) was the focus of a short course developed by the U.S. Forest Service (2006b). To provide connectivity, roadway-stream crossings must provide a desirable passageway for aquatic organisms at a variety of flows. Culverts that mimic stream reach characteristics can provide favorable connectivity at a culvert crossing (Bates et al. 2006). Bridges, however, offer the most protection against habitat fragmentation (Robison et al. 1999). Organisms such as moles, salamanders, newts, and mussels depend on the ability to move between habitats at different life stages. For such organisms, the ability to reach vital rearing habitat is essential to survival, and fragmentation could spell the end of a localized population. With the recognition of the importance of ecological connectivity, limiting the disruption that roadway-stream crossings pose has received recent focus (e.g. United States Forest Service 2006a; Jackson 2003), and is even the subject of a lawsuit brought against the State of Washington by twenty of its Native American tribes (Wildlife Management Interactive 2001).

Without ecosystem connectivity, areas could remain void of species diversity, as new populations cannot move in to mitigate a local extirpation (e.g. Morita and Yamamoto 2002). The loss or disconnection of any portion of an ecosystem is undesirable but is not necessarily detrimental to a population (Farhig and Merriam 1985). Even in an undisrupted ecosystem individual animals are constantly in danger of death even as the larger population remains in tact. Persistence is the result of a constantly refreshing gene pool, which maintains genetic health. Connectivity ensures that wildlife is given the chance to move freely in order to complete life cycle functions and maintain long-term population viability.

The emphasis of this report is on fish passage. Future versions will address AOP as more information becomes available.

#### **1.4 LEGISLATION AND REGULATION**

Several statutes, regulations and Executive Orders may need to be coordinated during selection, design, installation, operation and maintenance of culverts, especially those in waters that support fish. Almost all of the relevant statutes delegate jurisdiction by statute or expertise to one or more regulatory or coordinating agencies.

These statutes and Executive Orders represent societal values and, in most cases, identify obligations of federal agencies that are as important to the public as is a safe and reliable road network. It is a fundamental engineering challenge

to collaborate with other disciplines and agencies to identify one or more culvert solutions that optimize as many of those societal values as possible. The information in this section is provided to encourage active and informed interdisciplinary and multiple agency discussions which will enhance the permitting process, improving cost, time, safety and ecosystem efficiencies.

Environmental regulatory agencies have greatly streamlined and simplified the permit application processes for installing, replacing or extending a culvert at a roadway-stream crossing, but there are still many occasions where the process does not go smoothly, or may be complex and seem frustrating. Regardless, a key to long-term success is ongoing good faith efforts to help all agencies and stakeholders attain their goals. Striving to meet transportation and environmental goals when roads cross streams requires routine use of common sense, and participation of interdisciplinary and multiple agency teams to support hydraulic, design, safety and structural engineering.

This section provides a brief description of some of the most frequently encountered federal environmental statutes and agencies. Negotiated agreements between State Departments of Transportation (DOTs) and regulatory agencies are preferred to mandated solutions.

#### **1.4.1 Statutes and an Executive Order**

##### **1.4.1.1 Clean Water Act (CWA) 1948**

###### **Source**

- United States Congress 1948

The Federal Water Pollution Control Act, also known as the Clean Water Act, is intended to restore and maintain the physical, chemical and biological integrity of waters of the United States. This law addresses the discharge of pollutants into water bodies. Pollutants can include concentration levels of dissolved oxygen, temperature, sediment and even color. This law is the source of each States' (and some Tribal) water quality standards, which always include an anti-degradation clause: discharge of pollutants can not degrade the waterway's designated uses. If aquatic life is a designated use, culvert installation, operation and maintenance should not cause physical, chemical or biological degradation or otherwise alter fish species composition and demographics, and habitat. The discharge should not impede fish movements, the movements of prey and forage, or symbiotic and commensal species.

In addition, all states support a list of non-attainment waters as required by CWA 303(d). The 303(d) list is generally linked to total Daily Maximum Load (TMDL) limitations.



Three sections of the CWA are relevant to culvert installation across the country: sections 401 (water quality certification), 402 (National Pollution Discharge Elimination System permits), and 404 (dredge and fill, also called “wetland” permits). In rare circumstances, Section 403 (ocean discharge permits) may be required. Permits or certification notices issued under sections 401 and 402 may be indistinguishable in practice. They address the project’s compliance with State water quality standards; most States, and many tribes, have assumed responsibility for these programs from the Environmental Protection Agency (EPA). Permits issued under Section 404 generally address the placement of fill material, including pipes and the pipe-soil matrix, into designated water bodies. The U.S. Army Corps of Engineers is the primary, on-the-ground jurisdictional agency, but the EPA has joint oversight of the program, and Section 404 permits, while most commonly associated with wetlands in the public mind, cover fill in streams, lakes and more.

The regulatory agencies at state and federal levels have established simplified permit processes for routine activities that do not degrade the environment. These may be nationwide, regional or state wide in scope.

#### **1.4.1.2 Endangered Species Act (ESA) of 1973**

##### **Source**

- United States Congress 1973

The ESA obligates all federal agencies to seek to conserve, or recover, federally listed species, and to use all their authorities and programs, including grants, loans, permit issuance and technical assistance, to do the same. The law’s purpose is to provide a means to conserve the ecosystems which federally listed species depend on, to conserve or recover those listed species, and to meet the Nation’s obligations under treaties and conventions. The law and implementing regulations and guidance dictate the process for listing species as threatened or endangered. Recognize that federally listed threatened and endangered species are jurisdictionally distinct from State listed species. International and other treaties and conventions may be relevant where certain transboundary fish restoration or invasive species control issues are in effect.

For current purposes, federally listed species fall into two categories. Endangered identifies those species which are in imminent risk of extirpation. Threatened identifies the next highest risk category, species or populations facing imminently imminent risk of extirpation. Species that fall under either of two additional categories, proposed and candidate, are not technically considered federally listed. Nevertheless, species that fall within these latter categories generally warrant special administrative procedures or protective measures. The ESA’s protections are limited to plants and animals

Two agencies, the Fish and Wildlife Service and the National Marine Fisheries Service (or National Oceanographic and Atmospheric Administration – Fisheries), collectively called the Services, have jurisdiction by law and expertise. The rationale used to allocate each species and life history stage to a Service is not always clear.

The law also requires the jurisdictional agencies to designate critical habitat for listed species. The rulemaking material must include a description of the constituent elements, including structures, processes and ecosystem attributes, that must be protected or restored for the habitat to support recovery. This can include geomorphic and hydrologic processes. Federal projects that adversely constrain or alter those constituent elements are said to adversely modify the designated critical habitat. This implies that the project will prevent recovery of the listed species, which no single agency head can allow.

Federal projects that may affect a listed animal must undergo a cooperative consultation under Section 7 of the ESA with the Fish and Wildlife Service or National Marine Fisheries Service to avoid violating Section 9 prohibitions. This consultation is intended to mitigate the adverse effects of the action on listed species to the extent practicable. Often, agencies that routinely conduct activities that may affect listed species develop a set of best management plans which preclude the need for formal consultation.

For non-federal entities carrying out an action that may take a listed species, the ESA includes alternate means of working cooperatively with the Services to minimize take and still implement the project without violating Section 9's prohibitions. Take is broadly defined to include harassing, killing, wounding or otherwise interfering with individuals, or disturbing habitat used for feeding, breeding, sheltering and, in the case of fish, spawning and rearing.

Decades of experience suggests that collaboration and ongoing discussions between agencies and disciplines offer the highest level of certainty that consultation for projects that may affect listed fish species will be completed in a timely and effective manner. Because the consultation process is both substantive and procedural, agencies like the Federal Highway Administration recommend using a collaborative, interdisciplinary problem-solving approach to consultation.

#### **1.4.1.3 Fish and Wildlife Coordination Act (FWCA) 1934**

##### **Source**

- United States Congress 1934

The FWCA recognizes the importance of wildlife resources to the nation. It requires federal agencies undertaking water resource projects to give equal consideration and coordination to fish and wildlife resource conservation.

Undertakings are generally accepted to include funding, permitting and more. The law originally targeted game and furbearing animals, and commercially and recreationally valuable fish and shellfish (reflecting the traditional concern for “fur, fins and feathers”). By dint of emerging scientific knowledge and well established practice, consideration is now given to ecosystem patterns, processes and the species therein.

The law is one of the vehicles that Fish and Wildlife Service, National Marine Fisheries Service, Department of Agriculture bureaus and State fish and game agencies use to provide cooperative assistance and reports on environmental effects of proposals to Federal action agencies. It authorizes the Fish and Wildlife Service to conduct investigations, including comment letters, to protect environmental resources, and allows Federal agencies to fund preparation of those reports.

#### **1.4.1.4 National Environmental Policy Act (NEPA) 1969**

##### **Source**

- United State Congress 1969

The NEPA encourages productive and enjoyable harmony between man and the environment as national policy. It is one of only a few statutes that include the word “ecosystem,” and the authors assert that it was introduced and passed to balance the effects of the Full Employment Act of 1948, which obligates Federal agencies to promote economic growth in all of their activities.

More important from the perspective of fish passage and culverts, the NEPA also established the requirement that Federal decisions be informed about the environmental consequences of those actions. These consequences encompass what is described as the human and natural environments. Coverage can be comprehensive when required; the implementing regulations, however, encourage a common sense approach.

The NEPA analytic documentation is differentiated by four categories, those that are: (1) statutorily excluded, which could include certain disaster response activities, (2) categorically excluded, which include activities that the evidence suggests individually and cumulatively have no significant, lasting effect on the environment, (3) Environmental Assessment and Finding of No Significant Impact, which is usually a cursory or preliminary evaluation of potential effects, with the obvious conclusion, and (4) Environmental Impact Statement and Record of Decision, which are activities that require more substantive analysis because they are likely or known to have significant environmental consequences, or high degrees of uncertainty and controversy.

The NEPA applies to Federal agencies that directly or indirectly implement projects, establish rules or enforce laws. The NEPA analysis is, for example,

conducted by the U.S. Army Corps of Engineers when that agency issues a Clean Water Act section 404 permit authorizing installation of a culvert. In many States, the regulatory and decision-making agencies have developed streamlined processes that allow them to join together and conduct a single NEPA analysis for the various agencies that must make decisions. Such streamlined processes provide for “one-stop shopping” to culvert placement proponents, regulatory agencies, environmental agencies and other stakeholders.

The NEPA, in practice, is the most important source for interdisciplinary approaches, public involvement and similar initiatives.

#### **1.4.1.5 Rivers and Harbors Appropriations Act of 1899**

##### **Source**

- United States Congress 1899

The Rivers and Harbors Act is concerned with navigation in the nations’ waters, and the regulation of interstate commerce related to that navigation. The law has two “permit” sections of interest when considering roadway-stream crossings.

The U.S. Coast Guard, a bureau of the Department of Homeland Security, has jurisdiction over Section 9. This section requires a permit or authorization for construction of bridges, dams, dikes or causeways over or in navigable waterways. An exception in the process exists for navigable waterways that are entirely within one State’s boundaries.

The U.S. Army Corps of Engineers has jurisdiction for permits issued under Section 10. Section 10 covers the building of any wharfs, piers, jetties and other structures, and excavation or fill within navigable waters. In practice, Section 10 permits are considered part and parcel of the Clean Water Act section 404 permit process; the popular reference is to a “Section 10/404 permit.”

#### **1.4.1.6 Sustainable Fisheries Act 1996**

##### **Source**

- United States Congress 1996

The Magnuson-Stevens Fishery Conservation and Management Act, also known as the Sustainable Fisheries Act, primarily directs States to work together through various commissions and councils to manage marine and Great Lakes commercial fisheries. Of interest for the present purposes is the requirement that those multiple state fishery management councils develop fishery management plans, using an ecosystem and ecological approach. The plans must identify Essential Fish Habitat (EFH) for all life stages of the target species and associated species and processes. Coastal waters that are designated EFH

under this statute may pose unique challenges when designing, installing, operating and maintaining culverts. The EFH is designated by councils or commissions comprised of state marine fish agencies or their equivalent; EFH within a State are protected by the relevant state agency and the National Marine Fisheries Service, also known as National Oceanographic and Atmospheric Administration – Fisheries. Those agencies review activities authorized or funded by Federal agencies, and coordinate to ensure that the functional integrity of the EFH is not degraded.

#### **1.4.1.7 Wild and Scenic Rivers Act 1968**

##### **Source**

- United States Congress 1968

The Wild and Scenic Rivers Act establishes a National Wild and Scenic Rivers System. This law is of interest here only in that special considerations apply when considering culvert installation or any road feature in or adjacent to a designated Wild and Scenic River.

#### **1.4.1.8 Executive Order on Recreation Fisheries 1995**

##### **Source**

- Clinton 1995

The Executive Order on Recreational Fisheries (EO), number 12962, directs federal agencies to support recreational fishing. Collaborative efforts are encouraged. Such efforts can include aquatic resource habitat conservation and restoration, implementation of programs in a manner that supports recreational fisheries, and more. The EO can be used to support federal agency involvement in partnerships that address fish passage through culverts.

#### **1.4.2 State and Local Regulations**

In addition to federal regulations, there may also be a number of regional, local or state regulations that apply to the design and installation of roadway-stream crossing structures. For example, the NOAA National Marine Fisheries Service (NMFS) has fish passage policies in place for several of their regions. Such regulations may dictate construction timing, allowable sediment levels, fish passage requirements, or preferred culvert design techniques. It is important to consult with local authorities before beginning any project.

## **1.5 MULTIDISCIPLINARY NATURE OF PROVIDING FOR FISH PASSAGE AT ROADWAY-STREAM CROSSINGS**

Historical culvert designs were most often performed exclusively by roadway-design or hydraulic engineers. Little, if any, consultation was required with other staff or agencies.

Providing for fish passage involves the additional disciplines of fisheries biology, geomorphology and possibly aquatic ecology. It will also require complying with legislative actions that are administered by multiple local, State and Federal agencies.

Design engineers must expand the design team to include experts from the additional disciplines and to communicate openly and consistently with regulatory agencies. The additional experts may be part of the State DOT staff or may be found in State or Federal natural resources agencies.

It is recommended that each State DOT roadway and hydraulics section assemble teams appropriate for the design of roadway-stream crossings for fish passage. This will provide (a) consistency in the application of design methods, and (b) will likely facilitate the establishment of general and regional permits with regulatory agencies.

## **1.6 RELATED FHWA PUBLICATIONS AND REPORT PREVIEW**

Table 1.2 summarizes related FHWA publications helpful when performing culvert design. For example, HDS-5 discusses the hydraulics of culverts in great detail, and HDS-6 provides detailed background and formulae for considering geomorphic aspects of river mechanics.

**Table 1.2 FHWA Culvert Design Technologies and Supporting Guidance**

<b>Title</b>	<b>Description of Technology</b>	<b>URL</b>
<i>HDS 2, Highway Hydrology</i>	Guidance on frequency analysis of rainfall and stream flow data; empirical methods for peak discharge estimation; and hydrograph analysis and synthesis	<a href="http://www.fhwa.dot.gov/engineering/hydraulics/library_arc.cfm?pub_number=2&amp;id=6">www.fhwa.dot.gov/engineering/hydraulics/library_arc.cfm?pub_number=2&amp;id=6</a>
<i>Memorandum – Pipe Selection Final Rule</i>	Amendment of FHWA material selection policies to support the competitive bidding principles in Section 112 of Title 23 U.S. Code	<a href="http://www.fhwa.dot.gov/engineering/hydraulics/policymemo/113006.cfm">www.fhwa.dot.gov/engineering/hydraulics/policymemo/113006.cfm</a>
<i>HDS 5, Hydraulic Design of Highway Culverts</i>	Comprehensive publication on the hydraulic design of culverts	<a href="http://www.fhwa.dot.gov/engineering/hydraulics/library_arc.cfm?pub_number=7&amp;id=13">www.fhwa.dot.gov/engineering/hydraulics/library_arc.cfm?pub_number=7&amp;id=13</a>
<i>FHWA-HRT-06-138, Effects of Inlet Geometry on Hydraulic Performance of Box Culverts</i>	Recommendations for design coefficients of several culvert inlet configurations not specifically covered in HDS 5	<a href="http://www.fhwa.dot.gov/engineering/hydraulics/pubs/06138/06138.pdf">www.fhwa.dot.gov/engineering/hydraulics/pubs/06138/06138.pdf</a>
<i>HY-8 Culvert Analysis Hydraulic Program, Version 7.0</i>	Culvert hydraulic analysis and design program	<a href="http://www.fhwa.dot.gov/engineering/hydraulics/software/hy8/">www.fhwa.dot.gov/engineering/hydraulics/software/hy8/</a>
<i>NHI Course 135056, Culvert Design</i>	Recommended procedures for the hydraulic design of culverts	<a href="http://www.nhi.fhwa.dot.gov/home.aspx">www.nhi.fhwa.dot.gov/home.aspx</a>
<i>Bottomless Culvert Scour Study: Phase I Laboratory Report</i>	Methodology for estimating scour in bottomless culverts, approach for determining stability of rock riprap, and testing of effectiveness of rock cross vanes and other measures to reduce foundation scour	<a href="http://www.fhwa.dot.gov/engineering/hydraulics/pubs/02078/">www.fhwa.dot.gov/engineering/hydraulics/pubs/02078/</a>
<i>Bottomless Culvert Scour Study: Phase II Laboratory Report</i>		<a href="http://www.fhwa.dot.gov/engineering/hydraulics/pubs/07026/07026.pdf">www.fhwa.dot.gov/engineering/hydraulics/pubs/07026/07026.pdf</a>
<i>HEC 14, Hydraulic Design of Energy Dissipators for Culverts and Channels</i>	Guidance for analyzing energy dissipation problems at culverts and open channels and designing dissipators	<a href="http://www.fhwa.dot.gov/engineering/hydraulics/pubs/06086/">www.fhwa.dot.gov/engineering/hydraulics/pubs/06086/</a>
<i>HEC 9, Debris Control Structures Evaluation and Countermeasures</i>	Procedures and guidelines for: estimating debris accumulation potential; analyzing and modeling debris accumulation; and general criteria and guidelines for selection and design of countermeasures	<a href="http://www.fhwa.dot.gov/engineering/hydraulics/pubs/04016/">www.fhwa.dot.gov/engineering/hydraulics/pubs/04016/</a>
<i>HDS 6, River Engineering for Highway Encroachments</i>	Guidance on identification and analysis of hydraulic geometry, fluvial processes, sediment mobility and transport, and channel stability	<a href="http://www.fhwa.dot.gov/engineering/hydraulics/library_arc.cfm?pub_number=8&amp;id=20">www.fhwa.dot.gov/engineering/hydraulics/library_arc.cfm?pub_number=8&amp;id=20</a>
<i>HEC 20, Stream Stability at Highway Structures</i>	Guidance on identifying stream instability problems at highway stream crossings and includes quantitative techniques for channel stability analysis	<a href="http://www.fhwa.dot.gov/engineering/hydraulics/library_arc.cfm?pub_number=19&amp;id=43">http://www.fhwa.dot.gov/engineering/hydraulics/library_arc.cfm?pub_number=19&amp;id=43</a>

A brief summary of the report chapters is listed in Table 1.3. The report need not be read sequentially; the reader can go directly to chapters of interest. Cross references are used to direct the reader to other essential sections.

**Table 1.3 Report Preview**

<b>Chapter</b>	<b>Description</b>
<b>2 Fish Biology</b>	Fish biological abilities and requirements for successful movement.
<b>3 Culverts as Barriers</b>	Details the types of barriers presented by culverts that were not designed with a fish's biological capacities in mind.
<b>4 Inventory/Assessment/Prioritization</b>	Importance of the hydraulic assessment, inventory and prioritization of road stream crossing projects. Includes a discussion of commonly used techniques, as well as synthesis and recommendations for future prioritization
<b>5 Hydrology</b>	Discussion and comparison of hydrology used in the design of culverts for fish passage. Available techniques and recommended methods are included.
<b>6 Design</b>	Necessary considerations for the design or retrofit of a new or existing roadway-stream crossing installation.
<b>7 Current Design Procedures</b>	Details the current state of fish passage design, including design scenarios from across the country. Covers new installations, culvert replacements, and retrofits.
<b>8 Case Studies/Design Examples</b>	Case studies and/or basic examples of culvert design, installation and retrofit have been included to clarify the design process.
<b>9 Construction/Maintenance</b>	Common scenarios and recommendations for culvert construction and maintenance.
<b>10 Monitoring</b>	Suggested monitoring considerations to ensure long term success of culvert installations, replacements or retrofits.
<b>11 Future Research Needs</b>	Recommendations based on literature review and perceived gaps in current knowledge.



This page intentionally left blank

## 2 FISH BIOLOGY

### **HOW TO USE THIS CHAPTER**

- ▶ Consult this chapter when using Hydraulic Design or some Hydraulic Simulation methods
- ▶ Introduction to fish swimming abilities
- ▶ Examples of fish passage requirements
- ▶ Introduction on determining presence of fish in stream reach and region

The capacity of fish to traverse physical obstacles will dictate the appropriate design of a culvert crossing. An understanding of resident fish biology and swimming ability will allow culvert designers to create a culvert design suitable for local conditions. This information is most commonly used when assessing fish passage at an existing culvert (Section 4.2), retrofitting an existing culvert for fish passage (Section 7.3), or designing a new culvert using the Hydraulic Design technique (Section 7.3) and some Hydraulic Simulation techniques (Section 7.2). Specific fish biological requirements are not needed for Geomorphic Design procedures. The following discussion outlines fish biology, swimming abilities, and requirements, providing a basic understanding of what fish need to successfully move throughout their environment. This brief introduction does not obviate the need to have a fisheries biologist on the design team.

### **2.1 ANATOMY**

Fish possess two muscle systems to accommodate different modes of travel: a red muscle system (aerobic) for low-intensity activities and a white muscle system (anaerobic) for shorter, high-intensity movements (Webb 1975). Extensive use of the white muscle system causes extreme fatigue, requiring extended periods of rest.

### **2.2 CAPABILITIES AND ABILITIES**

#### **2.2.1 Swimming and Jumping**

Fish movement can be divided into three categories based on speed and muscle use: sustained, prolonged or burst speeds (Bell 1986). A fish at sustained speed uses the red muscle system exclusively, allowing extended periods of travel at low speeds. Prolonged speed involves the use of both red and white muscle tissue, and allows the fish to reach quicker speeds for minutes at a time. Burst speed allows the fish to reach top speeds for a few seconds by exclusive utilization of white muscle tissue, requiring a significant rest period. Table 2.1 summarizes the muscle system use as it relates to fish movement.

**Table 2.1 Movement Type as It Relates to Muscle System Utilization (adapted from Bell 1986)**

<b>Movement Type</b>	<b>Description</b>	<b>Muscle System</b>	<b>Period</b>
Sustained	Used for long periods of travel at low speeds.	Red (purely aerobic)	Hours
Prolonged	Short periods of travel at high speeds	Red and White	Minutes
Burst	Maximum swimming speed or jumping, inducing fatigue.	White (purely anaerobic)	Seconds

Fish can fail to pass a culvert for a variety of reasons. An outlet drop or high velocity zone will act as a barrier when it exceeds the fish's darting ability, while a continuous section of culvert with relatively low velocity may require sustained swimming speeds to be maintained beyond a fish's natural ability. It is important to note that these criteria are not cumulative, and a fish that reaches exhaustion in any category will require a period of rest before continued movement.

A number of studies have been completed to ascertain the swimming and jumping ability of different fish species (e.g. Jones et al. 1974; Bainbridge 1959; Stuart 1962; Hinch and Rand 1998; Rand and Hinch 1998; Ellis 1974; Toepfer et al. 1999). An excellent database is maintained within the US Forest Service FishXing computer program (US Forest Service, 2006a). Before designing a particular culvert crossing using a Hydraulic Simulation (Section 7.2) or Hydraulic Design approach (Section 7.3) it will be necessary to check local conditions including fish species present and time periods/flows at which movement is required.

### **2.2.2 Species and Life Stages**

Swimming and jumping capabilities can vary greatly between species. The following examples are from Bell (1986). It should be noted that the original sources in the figures are not known nor cited. Designers should seek studies performed for the specific species of interest. The figures are only for comparative purposes. For example, Figure 2.1, taken from Bell's Fisheries Handbook, depicts the relative swimming abilities of adult fish. Burst speeds reaching 7.92 m/s (26 ft/s) give adult steelhead a velocity potential more than twice that of an adult brown trout, and almost four times that of an adult herring (Bell 1986).

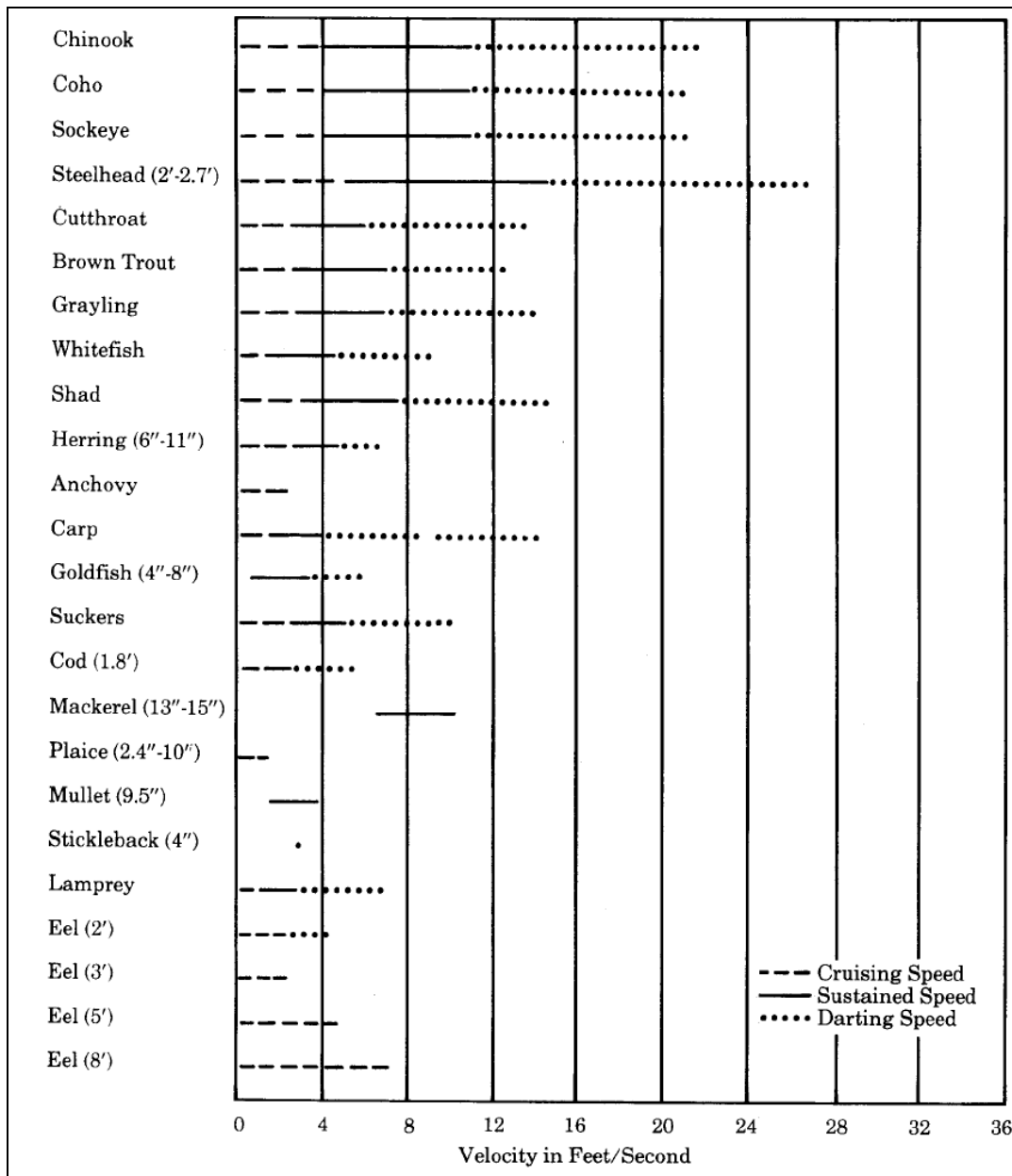


Figure 2.1 Relative swimming abilities of adult fish, in customary units (Bell 1986)

Even within a given species, there can exist a large variation between individual capabilities. This can be the result of life stage, condition or individual prowess. Figure 2.2 depicts a similar collection of swimming abilities for young fish. If passage for these life stages is required, velocities thresholds drop significantly. For example, a young Coho salmon can reach sustained speeds up to 0.6 m/s (2 ft/s), while an adult is able to sustain almost 3.35 m/s (11 ft/s) (Bell 1986). Individual fish will also exhibit dissimilar swimming capabilities, resulting in the velocity ranges depicted in Figures 2.1 and 2.2. This has serious ramifications for the selection of velocity criteria. Design for maximum swimming speed may create passage for the strongest swimmers, while maintaining a barrier to

average or weak swimming individuals. Design for the weakest swimming fish will create a structure that is quite conservative.

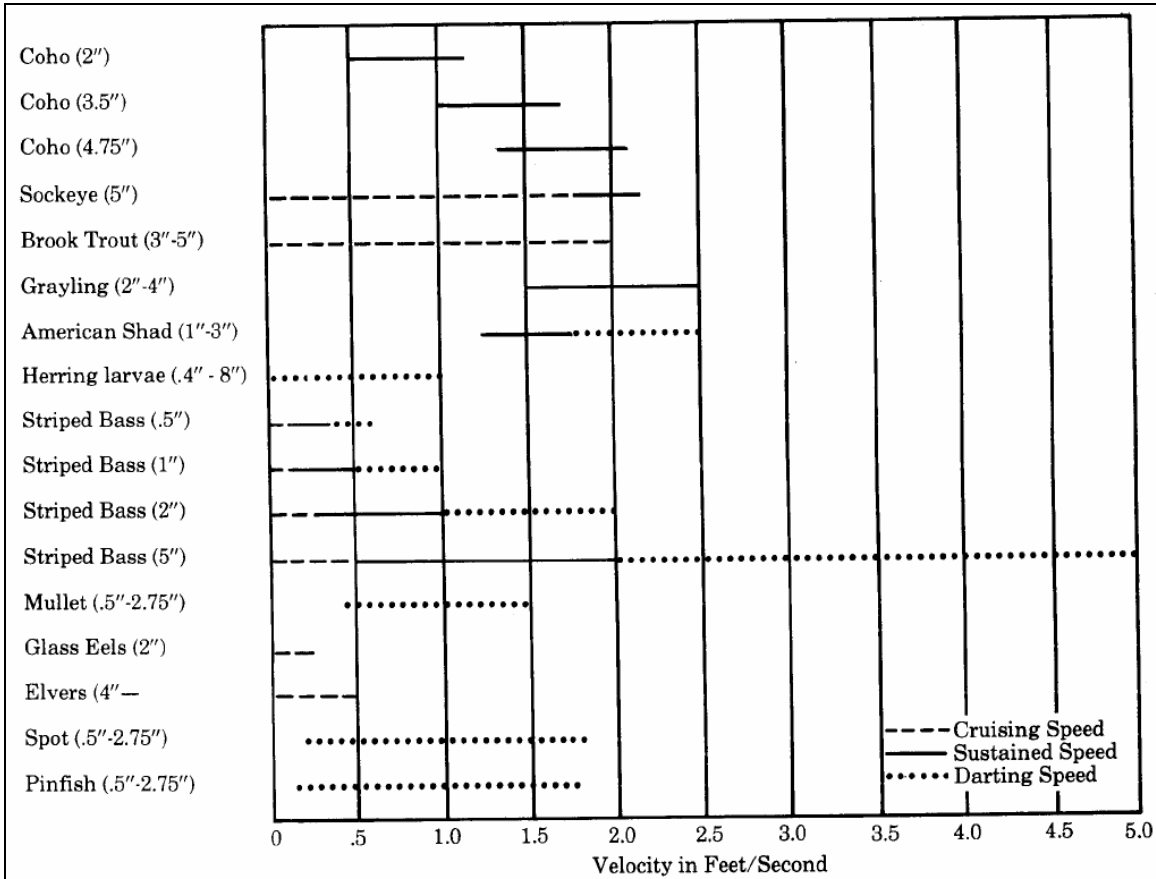


Figure 2.2 Relative swimming abilities of young fish, in customary units (Bell 1986)

### 2.2.3 Depth Requirements

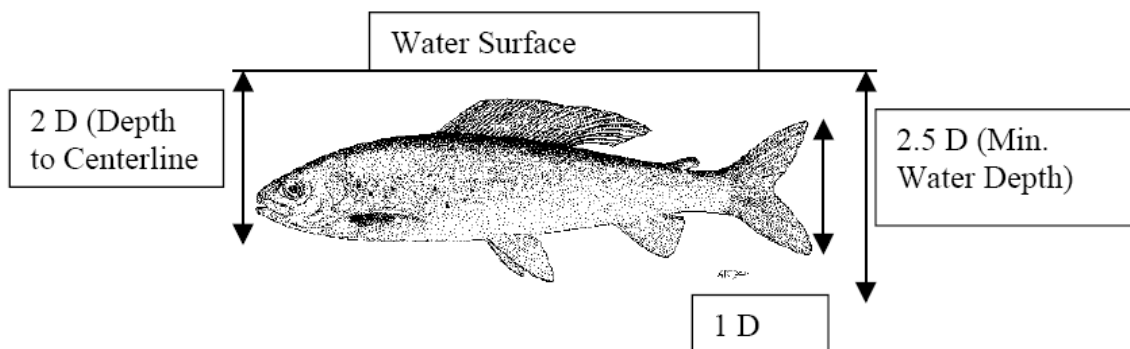
Fish require a minimum depth of flow to allow them to reach swimming potential (Dane 1978). Total submergence eliminates a fish's risk of oxygen starvation, allows the fish to create maximum thrust, and lowers the risk of bodily injury through contact with the culvert bottom (Forest Practices Advisory Committee on Salmon in Watersheds 2001). For example, Table 2.2 from Everest et al, summarizes depth requirements for a variety of salmonid and trout species from the Pacific Northwest (1985). Data for other species and regions is under development but not yet available.

**Table 2.2 Minimum Depth Criteria for Successful Upstream Passage of Adult Salmon and Trout, Customary Units (Everest et al. 1985)**

(Note – fish may not be able to migrate long distances at the depths listed; information is based on species found in Washington and Oregon)

Fish Species	Minimum Depth (ft)
Pink Salmon	0.59
Chum Salmon	0.59
Coho Salmon	0.59
Sockeye Salmon	0.59
Spring Chinook	0.79
Summer Chinook	0.79
Fall Chinook	0.79
Steelhead Trout	0.79

Specific depth requirements vary with species and life stage of concern, and are generally much more conservative than studies suggest. Alaska requires that depth be greater than 2.5 times the depth of a fish’s caudal fin, as depicted in Figure 2.3 (Alaska Department of Fish and Game and Alaska Department of Transportation 2001). The Washington Department of Fish and Wildlife specifies a minimum depth of 0.24 m (0.8 ft) for Adult Trout, Pink and Chum Salmon, and a depth of 0.30 m (1.0 ft) for adult Chinook, Coho, Sockeye or Steelhead (Bates et al. 2003). Maine employs a depth requirement of 1.5 times body depth (Maine Department of Transportation 2004).



**Figure 2.3 Minimum water depths for fish passage in Alaska (Alaska Department of Fish and Game and Alaska Department of Transportation 2001)**

(D = height of caudal fin)

### 2.2.4 Example of Fish Criteria

Exhaustion criteria have been experimentally derived for a variety of fish species, allowing the development of culvert velocity thresholds. Table 2.3 from Washington’s fish passage manual demonstrates how exhaustion and swimming speed criteria can be used to create relationships between allowable length and velocity based on fish species. In Washington State, adult trout represent a conservative lower design threshold, and are considered the species of concern

in any area where specific fish species presence has not been determined (Bates et al. 2003). Further discussion of culvert criteria is included in Chapter 3.

**Table 2.3 Fish-Passage Design Criteria for Culvert Installations, Customary Units (Bates et al. 2003)**

(Greater culvert lengths require lower velocity thresholds, while the increased swimming ability of larger fish (Adult Chinook, Coho, Sockeye and Steelhead) allows larger hydraulic drops and barrel velocities, but require a larger minimum depth.)

	<b>Adult Trout &gt;6 in. (150 mm)</b>	<b>Adult Pink or Chum Salmon</b>	<b>Adult Chinook, Coho, Sockeye or Steelhead</b>
<b>Culvert Length</b>	<b>Maximum velocity (fps)</b>		
<b>10 - 60 feet</b>	4.0	5.0	6.0
<b>60 - 100 feet</b>	4.0	4.0	5.0
<b>100 - 200 feet</b>	3.0	3.0	4.0
<b>Greater than 200 feet</b>	2.0	2.0	3.0
	<b>Minimum water depth (ft)</b>		
	0.8	0.8	1.0
	<b>Maximum hydraulic drop in fishway (ft)</b>		
	0.8	0.8	1.0

## 2.3 FISH MOVEMENT

### 2.3.1 Migration

Anadromous fish, such as salmon, migrate to the ocean to feed and grow, and return upstream as mature adults to spawn (Groot and Margolis 1991). Upstream movement is triggered by time of year, flow events and a number of environmental factors. For example, the upstream migration of spawning salmon is hypothesized to be in response to maturation, the changing length of days, and temperature regimes (Groot and Margolis 1991). Recognition of the importance of seasonal spawning runs to anadromous fish persistence led to the development of early fish passage guidance documents (e.g. Baker and Votapka 1990; Gebhards and Fisher 1972; Evans and Johnston 1972). These migrations often occur over large distances, and the physical prowess of the individual fish degrades substantially over the course of its migration.

### 2.3.2 Juvenile and Resident Movement

Of more recent concern is the migration of resident and juvenile fish (e.g. Bates et al. 2003; Bates et al. 2006; Robison et al. 1999; Admiraal and Schainost 2004). Previous knowledge held that resident populations remained fairly stationary throughout the year (Gerking 1959); however, movement of both juvenile salmon and resident trout has been observed in response to a variety of

environmental factors (Gowan et al. 1994). This includes up and downstream movement in response to extreme flows, stream temperatures, predation, lower population densities or search for food or shelter (Robison et al. 1999; Kahler and Quinn 1998; Schaefer et al. 2003).

Design to meet the needs of a spawning salmon will not necessarily guarantee that a culvert will allow passage of weaker swimming juveniles or resident fish. Although fish are capable of specific swimming energies, it does not mean that fish will choose to expend maximum swimming energy when confronted with specific obstacles (Behlke et al. 1991). This is consistent with observations of fish moving through culvert boundary layers, and holding in areas of low velocity between corrugations (Powers et al. 1997).

## **2.4 LOCAL FISH REQUIREMENTS**

The distribution of fish species, life stage and migration timing is available from sources such as State and Federal Agencies, Tribal governments, commercial landowners and non-profit organizations. Note that studies to ascertain fish presence may focus on larger waterways, providing low-resolution distribution maps that neglect smaller streams (Clarkin et al. 2003).

It is very important to conduct site visits to check for fish presence, and regional fish presence criteria may be useful (i.e. fish are assumed absent in streams with gradients above 20%). To ensure that fish presence is adequately understood, some guidelines begin with the default assumption that passage is required for the weakest swimming fish contained in their criteria (i.e. Bates et al. 2003; Robison et al. 1999). In Oregon, designers must contact a local biologist, or prove that fish passage is not required at a site, before less conservative design requirements can be utilized (Robison et al. 1999).

Although fish may not appear during a survey, it doesn't mean they don't inhabit the reach at some times of the year. Fish are often in areas where biologists do not expect them, and it is likely desirable to provide passage for native migratory fish that are or were historically present at the site (Clarkin et al. 2003). Assessments should be conducted when fish presence is most likely expected.

## **2.5 CONCLUSIONS**

A successful fish crossing will ensure passage for the weakest swimming fish species of concern. Before beginning the Hydraulic Simulation or Hydraulic Design process, it will be necessary to ascertain all fish species for which passage is desirable, including swimming ability and timing of fish migration. Many studies have been completed to understand the swimming abilities of particular fish species, and values or formulas can be found in fish passage



literature, through collections of data such as those provided for FishXing [www.stream.fs.fed.us/fishxing/](http://www.stream.fs.fed.us/fishxing/), or through online sources such as FishBase [www.fishbase.org](http://www.fishbase.org). It is important to consult the local fisheries biologists on your design team to understand the needs of fish in your area.

This page intentionally left blank

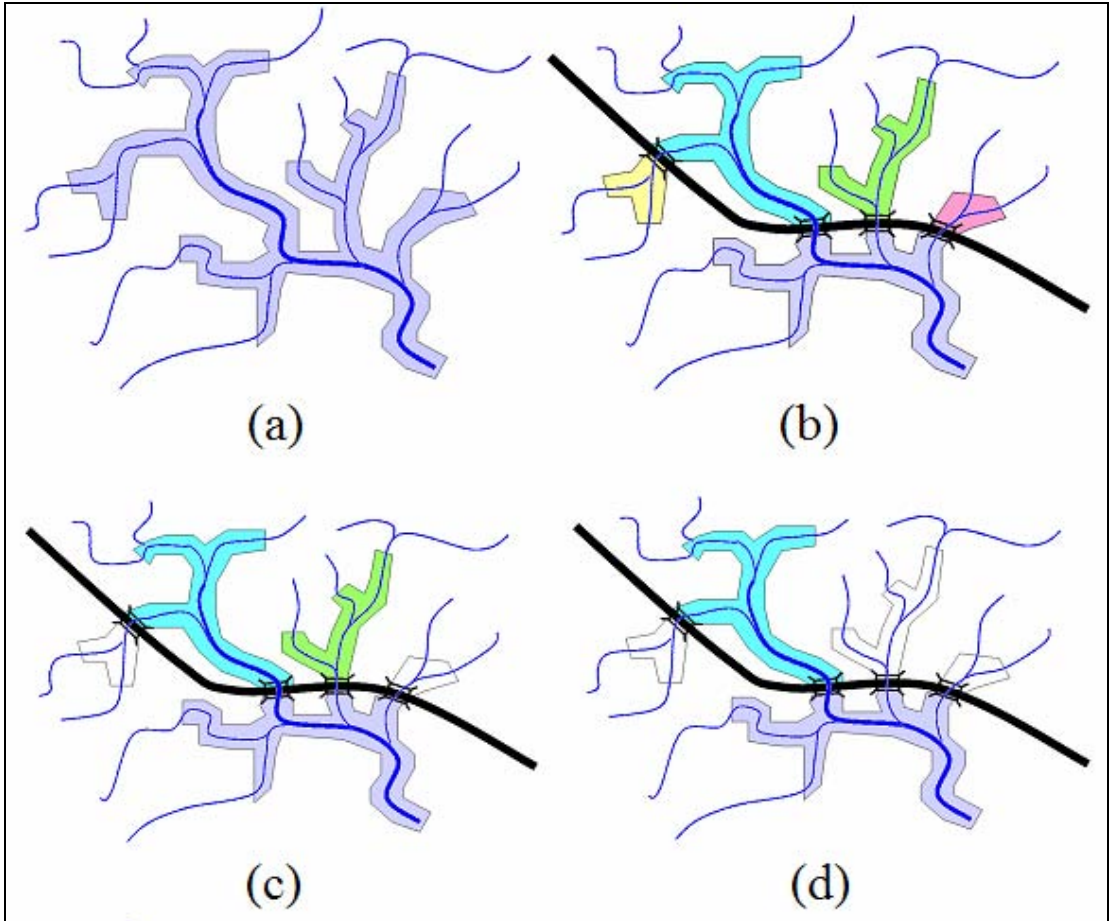
### 3 CULVERTS AS PASSAGE BARRIERS

#### **HOW TO USE THIS CHAPTER**

- ▶ Learn how non-passable culverts can affect fish populations
- ▶ Learn the categories of barriers for fish passage at culverts
- ▶ Examples of fish passage barriers
- ▶ This chapter is most likely to be consulted when using the Hydraulic Design method

#### **3.1 STREAM FRAGMENTATION**

Culvert installations can significantly decrease the probability of fish movement between habitat patches (Schaefer et al. 2003). Figure 3.1 depicts the possible results of ineffective roadway-stream culverts on fish populations. In the undisturbed case, fish are free to use the entire stream system as habitat. After a road interrupts stream continuity, fragmented populations are forced to survive independently. Over a short time, smaller populations are more likely to die of chance events (Farhig and Merriam 1985), but over the long-term, genetic homogeneity and natural disturbances are also likely to extirpate larger populations (Jackson 2003). Figure 3.1 shows this process sequentially from top left to bottom right.

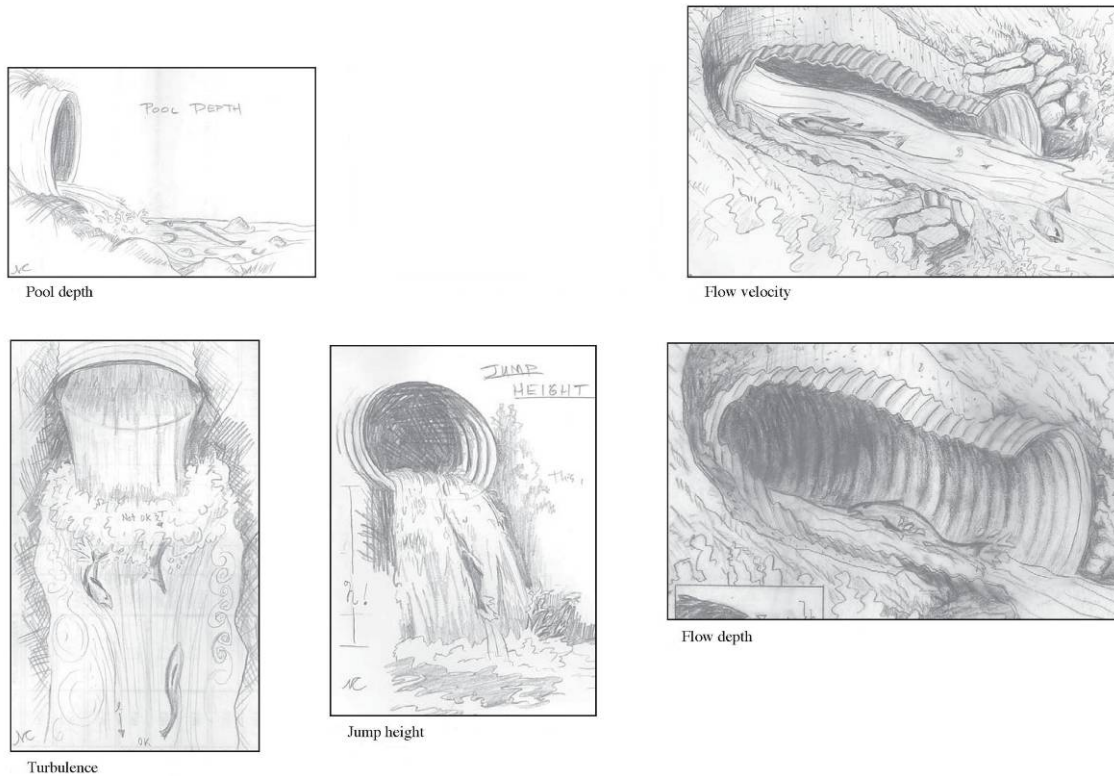


**Figure 3.1 Changes in fish habitat use over time after roadway fragmentation (Jackson, Personal Communication)**

(From top left to bottom right: (a) undisturbed habitat, with fill representing habitat in use; (b) habitat with ineffective culverts causing fragmentation; (c) fragmented system after a few years, areas with no fill represent population extirpation; (d) fragmented system after many years)

### **3.2 HOW A CULVERT CAN BE A BARRIER**

A culvert becomes a barrier to fish passage when it demonstrates conditions exceeding fishes' biological ability. Common obstructions to fish passage include excessive water velocities, drops at culvert inlets or outlets, physical barriers such as weirs, baffles, or debris caught in the culvert barrel, excessive turbulence caused by inlet contraction, and low flows that provide too little depth for fish to swim. Figure 3.2, from Natalie Cabrera and the FishXing Team, depicts five common barrier types.



**Figure 3.2 Barriers to fish passage (Natalie Cabrera and the FishXing Team)**

The severity of obstacles to fish passage compounds when a series of obstacles cause fish to reach exhaustion before successfully navigating the structure. For example, fish have been observed successfully passing an outlet drop, but having insufficient white muscle capacity to traverse a drop upon reaching the culvert inlet (Behlke et al. 1989). As noted in Chapter 2, fish swimming abilities are not cumulative, and a fish that reaches exhaustion in any category of muscle use will require a period of rest before continued movement (Bell 1986).

### **3.2.1 Drop at Culvert Outlet**

Drops in water surface will create passage barriers when they exceed fish jumping ability. Drops can occur at any contiguous surface within the culvert, but they are most commonly seen at the culvert outlet (see Figure 3.3), where scour and downstream erosion leads to culvert perching (Forest Practices Advisory Committee on Salmon in Watersheds 2001). At existing sites, drops will need to be addressed through culvert replacement, retrofit, or channel modification, such as backwatering the culvert outlet. See Chapter 2 for examples of species-specific jumping abilities.



**Figure 3.3 Perched outlet, leap barrier**  
(Alaska Department of Fish and Game 2005)

### **3.2.2 Outlet Pool Depth**

Fish require a jump-pool to gain the momentum necessary to jump into the structure. Early field observations suggested that successful fish passage at falls occurs when the ratio of drop height to pool depth is greater than or equal to 1:1.25 (Stuart 1962). Aaserude and Orsborn later correlated fish passage to fish length and the depth that water from the falls penetrates the pool (1985). For practical application, jump pool requirements are generally specified based on a ratio of drop height to pool depth. Oregon, for example, uses 1.5 times jump height, or a minimum of 0.6 m (2 ft) depth (Robison et al. 1999). An adequate jump-pool neither guarantees that a fish has the ability to make the required leap, or once in the culvert, has the energy to overcome the water velocity in the culvert barrel.

### **3.2.3 Excessive Velocity in Barrel**

Figure 3.4 depicts a culvert outlet presenting a drop and velocity barrier to fish passage. There are many categories of velocity that impact fish passage within a culvert crossing. These include boundary layer velocity, maximum point velocity, average cross-sectional velocity, and inlet transition velocity. The importance of each is discussed below.



Figure 3.4 Drop and velocity barrier (Alaska Department of Fish and Game 2005)

### 3.2.3.1 Boundary Layer Velocity

Due to the no-slip condition in fluid mechanics, water velocity at all points of contact with the culvert is zero. The velocity increases away from the boundary, forming a so-called boundary layer. Boundary roughness increases the depth of reduced velocity. Fish have been observed to use this area to hold and rest, or swim upstream through culverts (Behlke et al. 1989; Powers et al. 1997). Investigation of the development of low velocity zones has quantified velocity reduction in round culverts for use in fish passage design (Barber and Downs 1996). However, variability in flow patterns and fish utilization are likely too great for this phenomenon to be consistently accounted for in design standards (Lang et al. 2004). To ensure passage, Powers recommended that design be based on average cross-sectional velocity - without direct considerations of roughness (1997). Although the impacts of roughness have not been directly correlated to fish passage success in the field, using corrugated pipe and large corrugations is still common practice to increase roughness and decrease boundary layer velocity (e.g. Maine Department of Transportation 2004; Bates et al. 2003; Robison et al. 1999).

### 3.2.3.2 Average Velocity

Average cross-sectional velocity is the most common velocity parameter used in culvert design. Although the characteristics of a fish's chosen path may not be well represented by average velocity (Powers et al. 1997; Barber and Downs 1996), little is understood about the utilization and development of boundary layers within a culvert, and average velocity represents a conservative design parameter (Lang et al. 2004).

### 3.2.3.3 Maximum Point Velocity

Points of maximum velocity will also occur within the culvert as water flows over or around constrictions such as weirs or baffles. While average design velocity will likely be based on a fish's prolonged swimming ability, fish may be required to use their white muscle tissue to burst through zones of maximum velocity (Rajaratnam et al. 1991).

### 3.2.3.4 Inlet Transition Velocity

The culvert inlet requires special consideration, as it is the last barrier for a fish traversing a culvert. Velocity at the inlet may be higher than in the barrel if bedload deposits upstream from the entrance increase the local slope. Inlet conditions are especially important in long installations, or when successful navigation through a series of other obstacles has required significant use of fishes' white muscle tissue. The addition of tapered wingwalls may significantly reduce the severity of an inlet transition (Behlke et al. 1991). Finally, a skewed entrance will produce higher entrance velocities than a non-skewed entrance.

### 3.2.4 Insufficient Depth

Insufficient depth can be a barrier within the culvert or on any continuous flow area before or after the culvert installation. Insufficient depth will impair fishes' ability to generate maximum thrust, increase fishes' contact with the channel bottom, and reduce the fishes' ability to gather oxygen from the water (Dane 1978). Combined, these effects reduce a fish's swimming potential and increase the risk of bodily injury and predation. Criteria for sufficient depth vary from state to state, and although species specific depth requirements can be found, it may also be desirable to provide a "fish factor of safety" (Gebhards and Fisher 1972). State criteria for fish passage depth are included in Table 3.1, and comparison with literature values will show that most criteria are conservative.

**Table 3.1 State Fish Passage Depth Requirements**

<b>State</b>	<b>Depth Criteria</b>
Maine	1.5 times fish thickness
Alaska	2.5 times caudal fin height
Washington	0.24 m (0.8 ft) adult trout, 0.30 m (1.0 ft) adult salmon and steelhead
California	0.15 m (0.5 ft) juvenile salmonids, 0.20 m (0.67 ft) adult non-anadromous salmonids, 0.30 m (1.0 ft) adult anadromous salmonids
Oregon	0.30 m (1 ft) adult steelhead and Chinook salmon 0.25 m (10 in) other salmon, sea run cutthroat trout and trout over 0.51 m (20 in) in length 0.20 m (8 in) for trout under 0.51 m (20 in), Kokanee and migrating juvenile salmon and steelhead



### 3.2.5 Excessive Turbulence

Treatments used to reduce culvert velocity or increase depth may also increase turbulence, and dissuade fish from entering or traversing the structure or confuse their sense of direction. Although little is understood about the effects of turbulence on fish passage, recent studies at University of Idaho have found that fish prefer to hold in zones of low turbulence (Smith and Brannon 2006). Washington and Maine design guidelines suggest fish turbulence thresholds, quantifying turbulence with an Energy Dissipation Factor (EDF) (Bates et al. 2003; Maine Department of Transportation 2004):

$$EDF = \gamma QS/A$$

Equation 3.1 (Bates et al. 2003)

where:

- EDF= Energy Dissipation Factor, m-N/m<sup>3</sup>/s (ft-lb/ft<sup>3</sup>/s)
- $\gamma$  = unit weight of water, N/m<sup>3</sup> (lb/ft<sup>3</sup>)
- Q = fish-passage design flow, m<sup>3</sup>/s (ft<sup>3</sup>/s)
- S = dimensionless slope of the culvert, m/m (ft/ft)
- A = cross-sectional flow area at the fish-passage design flow, m<sup>2</sup> (ft<sup>2</sup>)  
(For baffled installations flow area is taken between baffles, and for roughened channels large roughness elements are excluded.)

Washington State suggests the EDF be less than 335 (7.0) for roughened channels, 191 (4.0) for fishways, and 144-239 (3.0-5.0) for baffled culvert installations. These criteria are based on experience in Washington, and will be modified with future research and evaluations (Bates et al. 2003). Maine DOT has similar guidelines (Maine Department of Transportation 2004).

### 3.2.6 Behavioral Barriers

Certain conditions at or within a culvert may dissuade fish from entering or attempting passage, even when passage is possible. These conditions include long culverts, darkness, confined culverts and shallow depths. Longer culvert installations require fish to maintain speed for extended periods of time, leading to increased energy expenditure. For this reason, maximum allowable velocity thresholds decrease with increasing culvert length (Bates et al. 2003; Robison et al. 1999). Longer culverts with natural substrate may not represent a barrier if fish can rest in reduced velocity zones.

Extreme length can also cause a culvert to be dark. Research has noted behavioral differences in light vs. dark passage of fish species (Welton et al. 2002; Kemp et al. 2006; Stuart 1962), suggesting that darkness may dissuade certain fish from entering a structure (Weaver et al. 1976). This theory has yet to

be accepted as common knowledge (Gregory et al. 2004), but deserves consideration when installations require long structures. The NMFS Southwest Region, for example, requires consideration of lighting in culverts exceeding 150 ft in length (2001). It is important to consult with the appropriate natural resource agency before considering the addition of lighting to a culvert installation.

Some culverts have reduced flow areas due to excessive sediment accumulation or damage at the entrance or exit. These confined conditions may dissuade fish from attempting passage.

### **3.2.7 Debris Accumulation**

Culverts with baffles, large roughness elements, or small diameters may have a high propensity to collect debris. This debris can include natural materials such as Large Woody Debris (LWD) and warrants specific consideration in areas where anthropogenic or natural debris accumulation is likely. The designer cannot assume that debris at culverts will be removed on a regular or timely basis. A monitoring and maintenance program can identify culverts that require more attention than others (Forest Practices Advisory Committee on Salmon in Watersheds, 2001).

Table 3.2 summarizes the impact of each of the aforementioned barriers on fish.

**Table 3.2 Description of Barriers to Fish Passage and Possible Effects**

<b>Barrier Type</b>	<b>Description</b>	<b>Impact</b>
<b>Drop</b>	Drop at outlet exceeds fish jumping ability, or jump pool is insufficient to generate sufficient thrust.	Fish cannot enter structure, can be injured, or will expend too much energy entering the structure to traverse other obstacles.
<b>Velocity</b>	High velocity exceeds fish swimming ability.	Fish tire before passing the crossing.
<b>Turbulence</b>	Turbulence within culvert prevents fish from entering, or confuses sense of direction	Fish do not enter culvert, or are unable to successfully navigate the waterway.
<b>Length</b>		Fish may not enter structure due to darkness. Fish may fatigue before traversing the structure.
<b>Depth</b>	Low flow depth causes fish not to be fully submerged.	Fish will be unable to swim efficiently or unable pass the structure.
<b>Debris</b>	Caught within a culvert, debris can block flow, or portions of flow.	Fish may not be able to pass by debris, or constricted flow may create a velocity or turbulence barrier within the culvert.
<b>Cumulative</b>	Series of culverts, each of which stresses fish during passage.	Group of culverts, each marginally passable, may be a combined barrier.

### **3.2.8 Summary**

Culverts can act as barriers to fish passage by presenting any number or combination of impassable obstacles. Treatments designed to treat one barrier must ensure that another is not created in the process. For example, localized treatments, such as moderately sloped aprons, may eliminate a drop, but can present a low flow or velocity barrier (Whitman, Personal Communication). Rock weirs designed to backwater a culvert may create a drop or debris barrier if not properly installed. Successful installations will consider all possible obstacles in terms of local fish requirements and crossing context.

This page intentionally left blank

## 4 CULVERT INVENTORY, ASSESSMENT AND PRIORITIZATION

### **HOW TO USE THIS CHAPTER**

- ▶ Learn the importance of developing a culvert inventory database
- ▶ Learn how to assess the ability of existing culverts to pass fish of interest
- ▶ Understand the importance of prioritizing how barrier culverts are to be addressed
- ▶ See examples of assessment and prioritization schemes

### **4.1 CULVERT INVENTORY**

A culvert inventory can provide knowledge of location, adequacy, and potential cost of replacement/retrofit of roadway-stream crossings within a watershed context. With such knowledge, planners can begin to prioritize and plan for fish passage restoration on a watershed scale. A robust inventory will be invaluable in planning efforts, and many assessment schemes have been created to collect information necessary for the prioritization of crossing replacement (i.e. Clarkin et al. 2003; Taylor and Love 2003; Washington Department of Fish and Wildlife 2000).

#### **4.1.1 Knowledge of Crossing Location**

The first step in a program of fish passage restoration is awareness of the problem, including location and condition of waterway crossings. An inventory can be as simple as a listing of the locations of existing roadway-stream crossings, and will ideally include basic survey information. There are two standard methods for completing a culvert inventory, including road- and stream-based approaches. Departments of transportation typically use road-based inventories, while stream-based inventories are usually performed by resource agencies.

##### **4.1.1.1 Road-Based Inventory**

A road-based inventory follows a particular road system to identify and evaluate all road stream crossings. This type of inventory is useful to managers requiring knowledge of highway impact on fish passage, and will allow highway dollars to be efficiently spent on the mitigation of fish passage barriers. For example, minor adjustment to culvert inlet or outlet conditions, such as debris jams, rock placement, backwatering, etc., can be made during routine road maintenance. Known barriers can be addressed as part of rehabilitation or reconstruction projects.

Road-based approaches can be very complete, although following a road will invariably miss a number of barriers that exist on side streams or barriers created

by minor roads, man made dams, or diversions (Washington Department of Fish and Wildlife 2000).

#### **4.1.1.2 Stream-Based Inventory**

A stream-based inventory follows the entire fish bearing system within a watershed or ownership, noting all constructed obstacles (e.g. dams, culverts, water diversions). Further evaluation of these structures provides an understanding of fish passage barriers in a watershed context. This type of inventory will allow analysis of the amount of stream habitat that can be opened up by repairing/replacing a particular culvert. This knowledge will help ensure that program dollars are spent for maximum ecological benefit. These efforts will require cooperation amongst the agencies that have jurisdiction along a stream corridor.

#### **4.1.2 Inventory Goals**

To allow prioritization for replacement, more specific site information will be required. A national inventory process created by the Forest Service was designed to answer two questions (Clarkin et al. 2003):

- Does the crossing provide adequate passage for the species and life-stage of concern?
- What is the approximate cost of replacement?

Such knowledge allows a basic understanding of fish impediments, as well as the requirements/plausibility of replacement. Additional information, such as environmental risk, may also be beneficial to planners attempting to prioritize corrections of roadway-stream treatments. Risk assessments may be coupled with fish passage assessment and inventories, but will require additional time and expense. Methods for determining environmental risk are outlined in *Methods for Inventory and Environmental Risk Assessment of Road Drainage Crossings* (Flanagan et al. 1998).

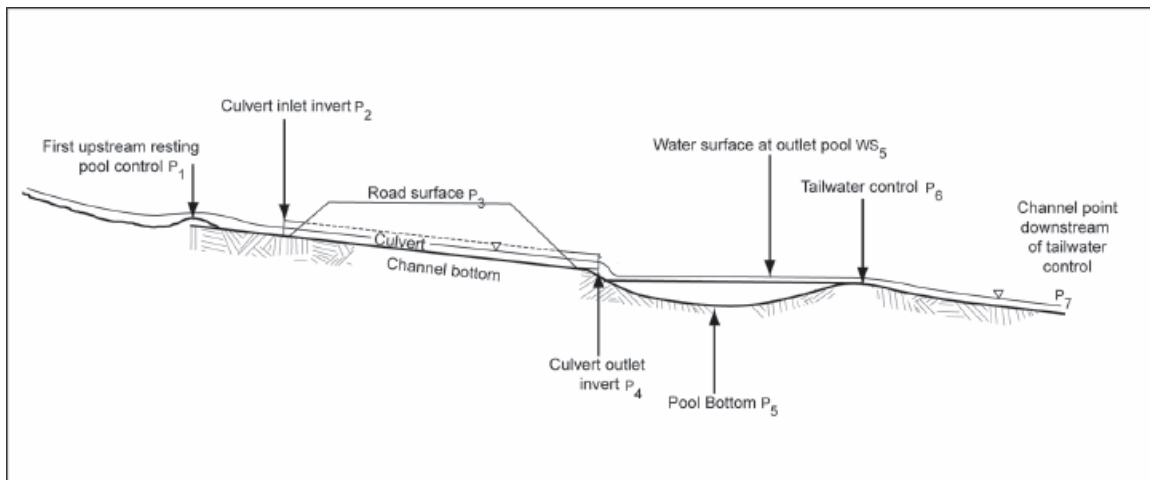
#### **4.1.3 Data Collection**

An initial survey of the culvert and adjoining stream reach will allow a basic understanding of current crossing conditions. This survey will cover a number of site characteristics including culvert and channel measurements and classification, flow data, and watershed conditions. Specific culvert characteristics of interest may include those listed in Table 4.1 from Coffman 2005. It will be useful to have a standardized survey collection method that incorporates collection of all pertinent parameters.

**Table 4.1 Specific Culvert Characteristics Useful in Assessment, Including Possible Barrier Types (Coffman 2005)**

Culvert Characteristic	Possible Barrier
Outlet drop and outlet perch	Jump barrier
Culvert slope	Velocity barrier
Culvert slope times length	Exhaustion barrier
Presence of natural stream substrate	Depth barrier
Relationship of tailwater control elevation to culvert inlet elevation	Depth and velocity barrier

Basic survey techniques are included in *Stream Channel Reference Sites: An Illustrated Guide to Field Technique* (Harrelson et al. 1994). Examples of fish passage survey application, including forms, explanations of survey points, and data collection are included in Appendix E of *National Inventory and Assessment Procedure* (Clarkin et al. 2003). Figure 4.1 depicts some typical longitudinal survey points used in a culvert survey.



**Figure 4.1 Longitudinal profile survey points (Clarkin et al. 2003)**

## 4.2 CULVERT ASSESSMENT

### 4.2.1 Overview

#### 4.2.1.1 Criteria

Before crossing assessment can begin, it is necessary to have a clearly defined set of assessment criteria. Much like culvert design criteria, assessment criteria show regional variability, and generally consider the following elements in order to determine fish passability:

- Depth of flow

- Flow velocity
- Drop heights
- Pool depths
- Culvert length
- Substrate

#### **4.2.1.2 Development**

Development of procedures and criteria for culvert assessment should be done by a group of knowledgeable individuals, recognizing program/project goals. Properly designed culvert assessment will provide adequate knowledge of a crossing location and ultimately lead to a robust inventory that will aid in crossing prioritization.

Agreements between State DOTs and Resource agencies can greatly expedite the design and assessment procedure, ensuring that the requirements of all parties are met satisfactorily through a common vision. For example, Alaska and Oregon currently have agreements between their respective resource agencies to expedite permit applications for culvert installations. They also have a shared priority of replacement/repair of fish passage barriers (Venner Consulting and Parsons Brinkerhoff 2004).

#### **4.2.2 Criteria**

Assessment criteria will vary depending on fish species present as well as the timing and duration of fish movement. Criteria for adult salmon, for example, will be significantly different from that used for juveniles or trout species (e.g. Robison et al. 1999; Washington Department of Fish and Wildlife 2000).

It is recommended that assessment criteria be developed separately from design criteria (Lang et al. 2004). Typically, design criteria are conservative, so as to provide passage for the weakest swimming individual during a range of design flows. Assessment criteria however, seek to determine the degree to which a crossing is a barrier to fish passage. Crossings that would be labeled inadequate by design standards may only provide a partial barrier to fish passage. As a result, criteria for design and assessment are slightly different, and generally not interchangeable.

##### **4.2.2.1 Degree of Barrier**

Assessment allows crossings to be grouped into broad categories of adequacy such as "Passable," "Impassable," and "Indeterminate." Category definitions are expounded to clearly place barriers within a matrix. In California, a culvert that can pass all salmonids during the entire migration period earns a "green" classification, while a culvert that does not meet requirements of strongest swimming fish and life stage present over the entire migration period is classified



as “red,” analogous to traffic signalization (Taylor and Love 2003). Culverts that cannot be placed in these categories remain in the “gray” or “indeterminate” area, where the crossing may present impassable conditions to some species and life stages at some flows. Further analysis is required in order to ascertain the extent of the barrier.

It is likely that initial surveys will show many culverts to be “indeterminate,” where adequacy cannot be determined without a detailed hydraulic analysis (Clarkin et al. 2003). Furthermore, a great number of “impassable” crossings typically ensure that “indeterminate” crossings are never properly analyzed (Furniss 2006).

Culverts falling into the “indeterminate” area are likely barriers to some fish species and life stage. The extent of this barrier incorporates further categorization. Table 4.2 shows barrier categories used in California (Taylor and Love 2003). Assessment criteria are used to prioritize culvert crossings for future replacement, and the degree of barrier is one of many factors used to determine the urgency of culvert replacement/retrofit. Most culverts will present a partial or temporal barrier to fish passage, and an understanding of the degree is useful in assessing the impact of a culvert on the surrounding ecosystem, and in determining the need and urgency of culvert replacement (Furniss 2006).

**Table 4.2 Fish Passage Barrier Types and Their Potential Impacts (Taylor and Love 2003)**

<b>Barrier Category</b>	<b>Definition</b>	<b>Potential Impacts</b>
Temporal	Impassable to all fish at certain flow conditions (based on run timing and flow conditions)	Delay in movement beyond the barrier for some period of time
Partial	Impassable to some fish species, during part or all life stages at all flows.	Exclusion of certain species during their life stages from portions of a watershed
Total	Impassable to all fish at all flows	Exclusion of all species from portions of a watershed.

### **4.2.3 Existing Procedures**

In most situations, site survey and inspection alone will not determine barrier status. While drop heights, substrate, inlet contraction, and slope can be examined, hydraulic analysis will likely be required in order to ascertain flow velocities, flow-depth and pool-depths during design conditions. Assessment is therefore broken into a series of “screens” or “filters”, using regionally or locally defined criteria.

#### **4.2.3.1 Coarse Filter**

A first pass or “coarse filter” can be used to determine the transparency of the crossing to fish in the natural reach. The basis of this analysis is the presumption

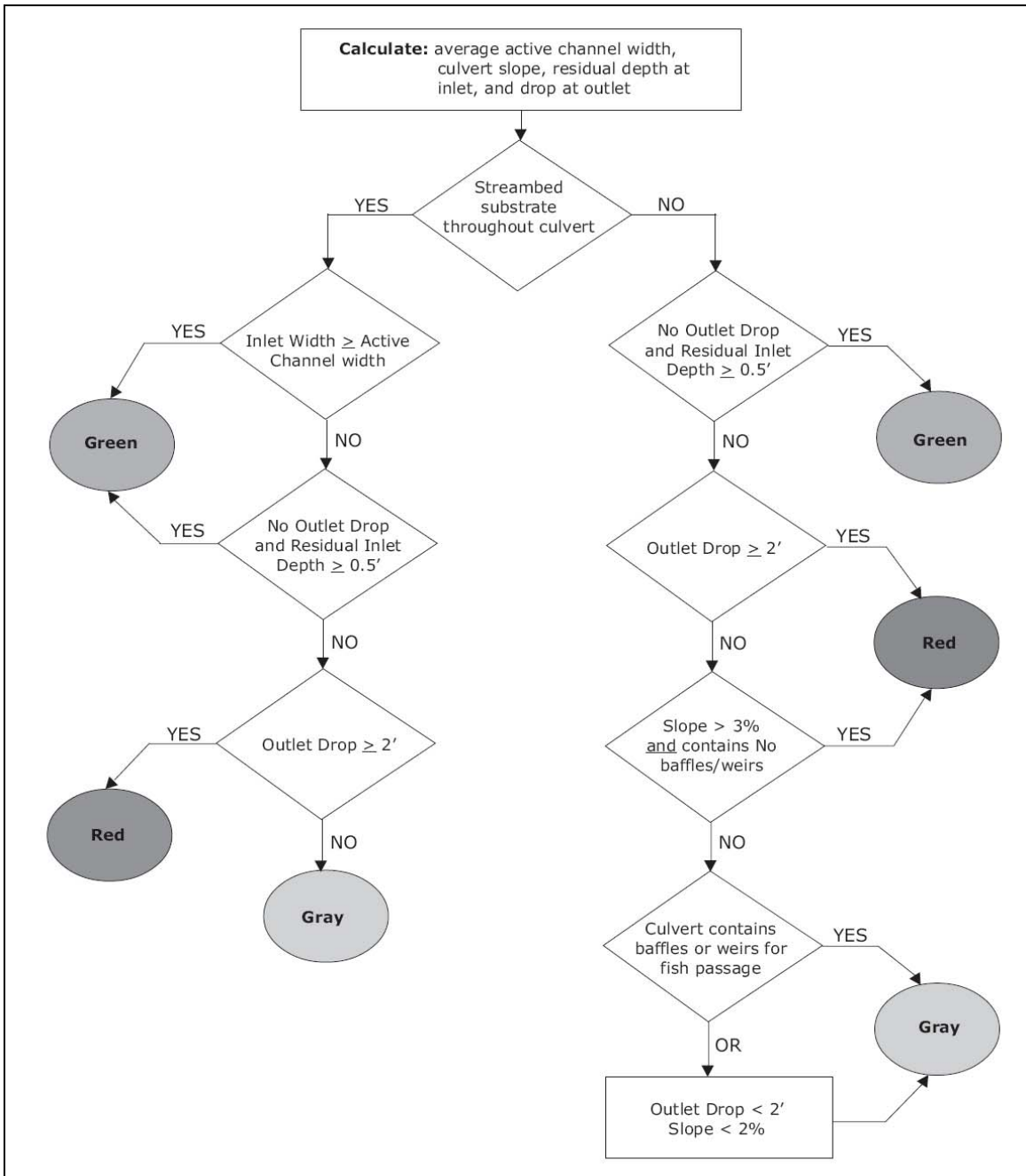
that crossings successfully replicating the surrounding natural stream channel conditions will exhibit similar hydraulic conditions, allowing passage for all fish at the flows at which they would be traveling in the natural stream reach. A passable culvert will match natural stream reach characteristics including width, substrate and slope. The coarse filter may also be used to quickly identify obvious barriers such as excessive perching or extreme slope.

#### **4.2.3.2 Regional Screen**

If a culvert cannot be clearly categorized as adequate or inadequate using a coarse filter, a subset of regionally defined criteria is used to further clarify culvert adequacy. At this level of analysis, specific fish species criteria are examined to understand culvert impact on the local biota.

#### **4.2.3.3 Examples of Regional Screen Criteria**

California's Salmonid Stream Habitat Restoration Manual contains a culvert categorization scheme covering adult and juvenile anadromous salmonids (Taylor and Love 2003). This method combines coarse filter and regionally defined criteria. A flow-chart model (Figure 4.2) helps surveyors place culvert passability into one of three categories: green, gray, and red.



**Figure 4.2 Example of a coarse filter and regional screen in customary units (from Clarkin et al. 2003)**

(Green-Gray-Red screen developed for California's anadromous adult and juvenile salmonids)

	<b>Structure</b>	<b>Green</b>	<b>Grey</b>	<b>Red</b>
1	Bottomless pipe arch or countersunk pipe arch, substrate 100% coverage, invert depth greater than 20% of culvert rise.	Installed at channel grade (+/- 1%), culvert span to bankful width ratio of 0.9 to 1.0, no blockage.	Installed at channel grade (+/- 1%), culvert span to bankful width ratio of 0.5 to 0.9, less than 10% blockage.	Not installed at channel grade (+/- 1%), culvert span to bankful width ratio less than 0.5, greater than 10% blockage.
2	Countersunk pipe arches (1x3 corrugation and larger). Substrate less than 100% coverage, invert depth less than 20% of culvert rise.	Grade less than 0.5%, no perch, no blockage, culvert span to bedwidth ratio greater than 0.75.	Grade between 0.5 -2.0%, less than 4" perch, less than 10% blockage, culvert span to bedwidth ratio of 0.5 to 0.75.	Grade greater than 2.0%, greater than 4" perch, greater than 10% blockage, culvert span to bedwidth ratio less than 0.5.
3	Circular CMP 48 inch span and smaller, spiral corrugations, regardless of substrate coverage.	Culvert gradient less than 0.5%, no perch, no blockage, culvert span to bedwidth ratio greater than 0.75	Culvert gradient 0.5 to 1.0%, perch less than 4 inches, less than 10% blockage, culvert span to bedwidth ratio of 0.5 to 0.75.	Culvert gradient greater than 1.0%, perch greater than 4 inches, blockage greater than 10%, span to bedwidth ratio less than 0.5.
4	Circular CMPs with annular corrugations larger than 1x3 and 1x3 spiral corrugations (>48" span), substrate less than 100% coverage, invert depth less than 20% culvert rise.	Grade less than 0.5%, no perch, no blockage, culvert span to bedwidth ratio greater than 0.75.	Grade between 0.5 -2.0%, less than 4" perch, less than 10% blockage, culvert span to bedwidth ratio of 0.5 to 0.75.	Grade greater than 2.0%, greater than 4" perch, greater than 10% blockage, culvert span to bedwidth ratio less than 0.5.
5	Circular CMPs with 1x3 annular corrugations (all spans) and 1x3 spiral corrugations (>48" span), 100% substrate coverage, substrate depth greater than 20% of culvert rise.	Grade less than 1%, no perch, no blockage, culvert span to bedwidth ratio greater than 0.75	Grade 1.0 to 3.0%, perch less than 4 inches, less than 10% blockage, culvert span to bedwidth ratio of 0.5 to 0.75.	Culvert gradient greater than 3.0%, perch greater than 4 inches, blockage greater than 10%, culvert span to bedwidth ratio less than 0.5.
6	Circular CMPs with 2x6 annular corrugations (all spans), 100% substrate coverage, substrate depth greater than 20% of culvert span.	Grade less than 2.0%, no perch, no blockage, culvert span to bedwidth ratio greater than 0.75	Grade 2.0 to 4.0%, less than 4" perch, less than 10% blockage, culvert span to bedwidth ratio of 0.5 to 0.75.	Grade greater than 4.0%, greater than 4 inch perch, greater than 10% blockage, culvert span to bedwidth ratio less than 0.5.
7	Baffled or multiple structure installations		All	
8	Log stringer or modular bridge	No encroachment on bedwidth.	Encroachment on bedwidth (either streambank).	Structural collapse.

Figure 4.3 Alaskan fish-passage evaluation criteria, United States Forest Service Region 10, customary units (Flanders and Cariello 2000)

- Green: Condition assumed adequate for passage of all salmonids and lifestages during the entire period of migration.
- Gray: Conditions may not be adequate for all salmonid species or life stages presumed present. Additional analyses are required to determine extent of the barrier for each species and lifestage.
- Red: Conditions fail to meet passage criteria over the entire range of migration flows for even the strongest swimming species and lifestage (adults) presumed present.

#### **4.2.3.4 Flow Chart Filters**

Flow-chart categorization has the advantage of providing a simple step-by-step method with variables that are easily interchangeable to meet program needs (Clarkin et al. 2003). Although California addresses all culverts and fish in one chart, additional charts could easily be created to address different species and lifestages of concern. The simplicity of this type of analysis may create a propensity for culverts to fall into the “gray” area (Clarkin 2003).

It should also be recognized that other characteristics not covered in the filter may cause culverts to pose potential barriers, and need to be examined. Examples include breaks in slope, inlet and outlet aprons, crushed inlets or damage to the crossing invert (Taylor and Love 2003).

#### **4.2.3.5 Matrix Filters**

Alaska and Oregon compile regional criteria and coarse filter information into a set of criteria that depend on installation type and culvert embedment (Robison et al. 1999; Flanders and Cariello 2000). For example, Alaska’s filter for juvenile coho, shown in Figure 4.3, provides a matrix of criteria depending on structure type. This added level of scrutiny may ensure that fewer culverts fall into the “indeterminate” area of passability (Clarkin et al. 2003).

#### **4.2.3.6 Hydraulic Analysis**

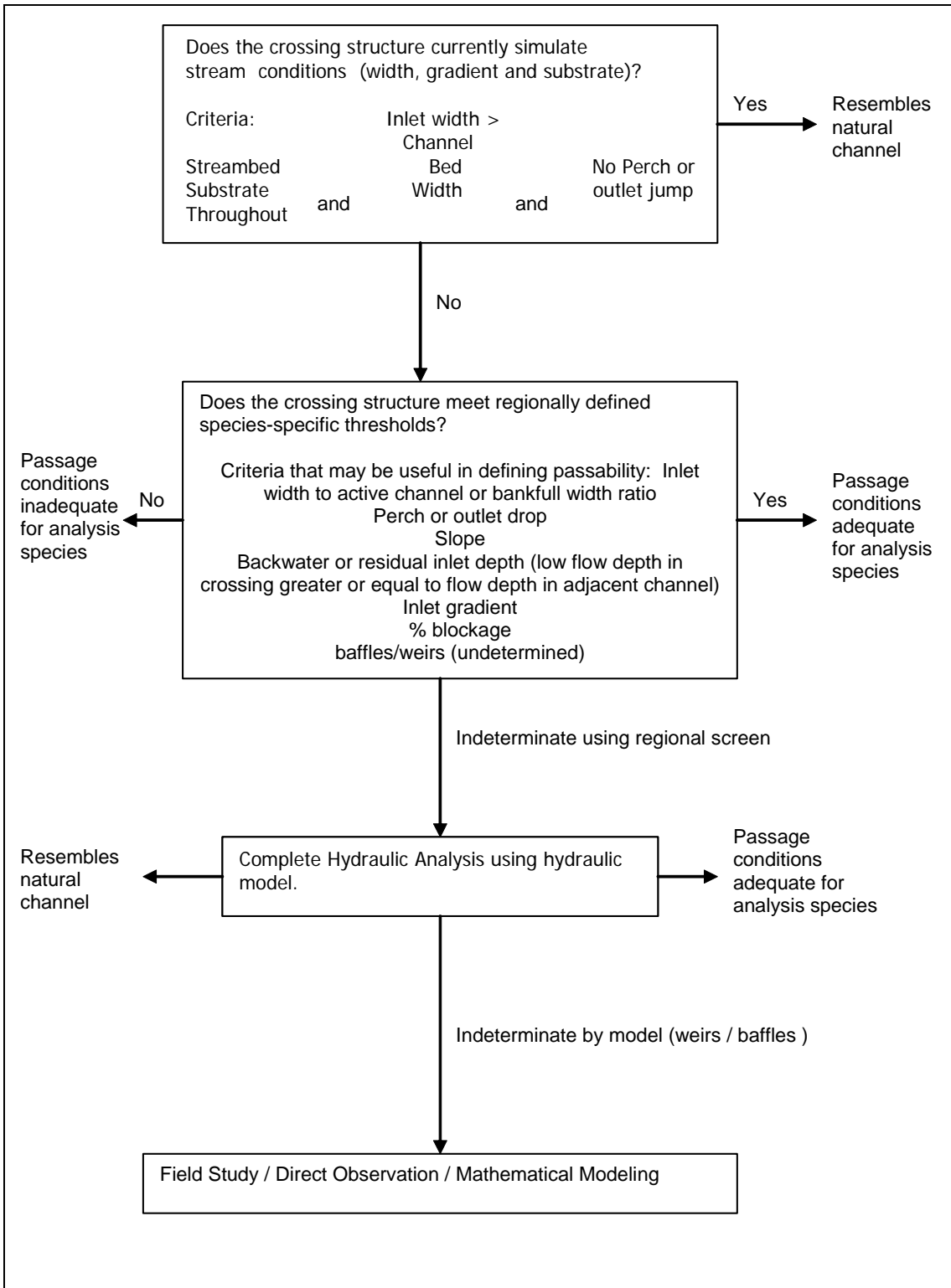
When barrier status of a culvert cannot be determined after a coarse filter or regional screen, a hydraulic analysis, including a field study, mathematical modeling or direct observation should be completed. This may include situations where baffles or weirs are present. The goal of these studies will be to determine if culverts meet the requirements of target fish species and lifestage.

#### **4.2.4 Recommended Template**

Most of the existing criteria were developed from studies focusing on one or two target species, or anadromous species such as Pacific salmon (Bunt et al. 1999; Belford and Gould 1989). This resulted in species-specific guidelines tailored to local fish populations, and resulting inventories and criteria are only truly

applicable for the region in which they were developed. For national applicability, a general guidance document has been created to aid in the development of regionally specific inventories.

*A National Inventory and Assessment Procedure* was produced by the United States Forest Service San Dimas Technology and Development Center (Clarkin et al. 2003). This included a review of current State procedures and a synthesis of techniques into a standardized, and generally applicable method for assessment and prioritization development. Figure 4.4 depicts a flow chart of a culvert assessment technique. Although the specifics of each level of assessment change slightly depending on regional guidance, the general sequence remains the same. In the first stage, conditions within the culvert are compared to conditions in the undisturbed natural channel. If the culvert does not sufficiently maintain natural reach characteristics, a second pass is conducted, in which surveyors analyze the crossing based on regionally defined passage criteria. If the passability is still not determined, a hydraulic analysis of the crossing is employed.



**Figure 4.4 Flow chart for culvert assessment (adapted from Clarkin et al. 2003)**

(Coarse filter determines if the culvert matches stream reach characteristics; if not, regionally defined criteria determine whether the culvert is appropriate for the fish species and life stage of concern; if not, hydraulic modeling software is utilized)

## **4.3 PRIORITIZATION OF ROAD CROSSING CULVERT RETROFITS/REPLACEMENTS**

### **4.3.1 Overview**

#### **4.3.1.1 Objectives**

The objective of a prioritization inventory is not necessarily to rank fish barriers in the order that they should be addressed. However, a basic understanding of culvert barrier location and degree, status, and cost estimates will allow culverts to be addressed in an efficient manner. The following section outlines common criteria, and provides a good starting point for the development of a regionally specific prioritization scheme.

#### **4.3.1.2 Funding Source**

Funding source may impact the way that project prioritization is best utilized. Highway dollars may be most efficiently spent by performing a road based inventory and assessment to understand how a particular highway impacts fish passage. With an understanding of culvert barriers in context, fish passage can be addressed in conjunction with other road maintenance, ensuring efficient spending of highway dollars. In the case of project based funding, money may be most efficiently spent on culverts with the greatest ecological impact, and a watershed based inventory may ensure efficient spending.

### **4.3.2 Criteria**

Prioritization criteria should be developed by a group of interdisciplinary experts, and regional criteria will likely vary slightly. Some factors to consider at each crossing include: cost of replacement, fish species present and status, amount and quality of habitat blocked, degree of barrier (total, partial, temporal), proximity to other barrier structures and possibility/cost of crossing failure. There may also be unique characteristics to consider, such as barriers that serve to keep out invasive species, and existing barrier structure that have created habitat upstream. The benefit of replacement will need to be weighed against the possible consequences of no action. An explanation of possible considerations follows.

#### **4.3.2.1 Cost**

Cost of replacement/retrofit includes:

- Diversion
- Traffic control, including potential detours
- Design
- Installation
- Maintenance



Crossings may be less costly to replace as roadwork or maintenance occurs near the crossing site, or when other crossings are repaired in the same area.

#### **4.3.2.2 Ecological Significance**

The ecological significance of a crossing will include consideration of species present, as well as amount and quality of habitat blocked. A culvert that is blocking an endangered species will require more attention than a comparable barrier that impedes the passage of non-listed species. On the other hand, a barrier culvert might be acting to keep invasive species or diseases from reaching undisturbed native populations.

It is important to understand potential costs and benefits before removing a barrier to connectivity, as impassable crossings may occasionally provide an ecological function that outweighs the benefits of replacement. For example, culverts in a vertically unstable channel may provide elevational control by creating a rigid boundary past which channel incision cannot progress. Removal of a grade control culvert could allow channel incision to progress upstream, possibly affecting fish passage at the structure and habitat quality throughout the reach (Castro 2003). Also, a culvert that is impassable to an invasive species protects upstream species from predation.

#### **4.3.2.3 Habitat Blocked**

The quantity of habitat blocked by a particular crossing will be combined with considerations of habitat value to understand the benefits of a potential replacement or retrofit. A culvert blocking access to critical spawning habitat, for example, may require urgent consideration.

The degree of barrier (partial, temporal, total) will also determine the urgency of replacement. All other considerations being equal, a culvert that poses a complete barrier will require more urgent attention than a culvert providing a partial or temporal barrier.

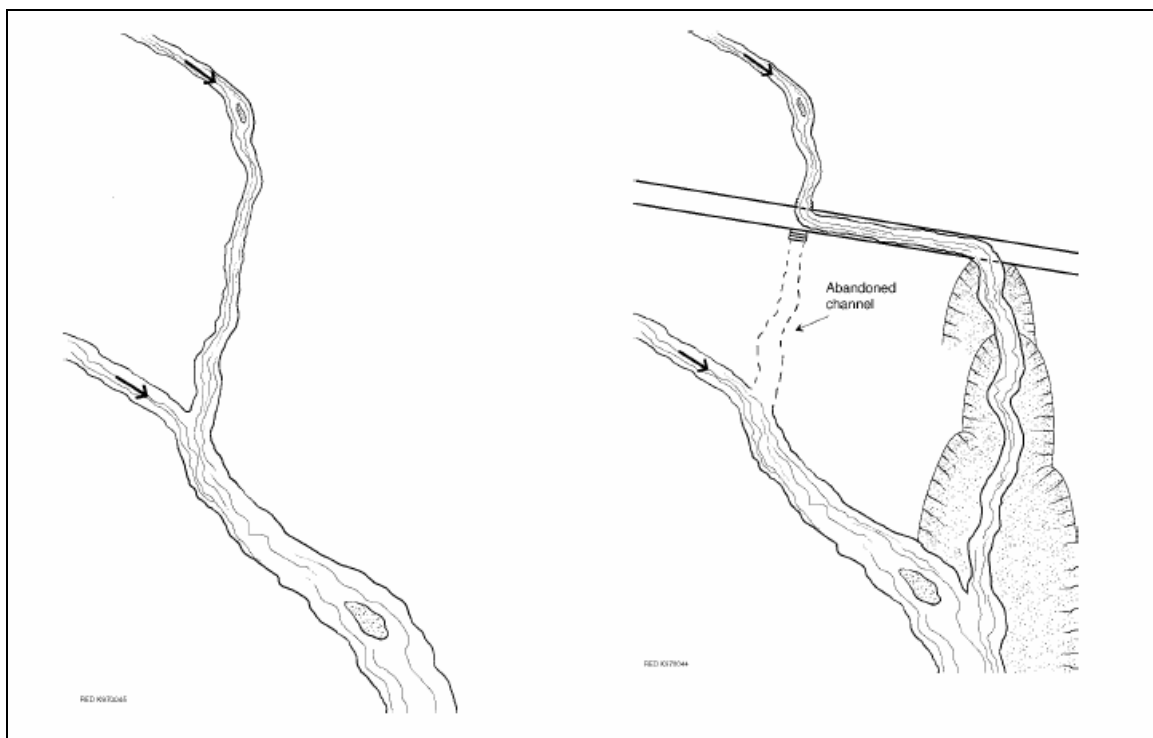
In a situation where anadromous fish spawning access is a concern, a culvert replacement opening 10 km (6.2 mi) of high quality spawning habitat will be made ineffective by a single barrier culvert downstream. In general, it is recommended that culvert replacement progress from downstream to upstream, although in some situations benefits may still be significant for resident fish populations.

A series of partial barriers may combine to effectively block fish from reaching their final destination. Although a culvert that presents a short duration barrier during fish migration may seem like a small problem, a series of delays may mean that spawning fish cannot reach their destination. Regional experience

must be used to determine acceptable delay. When prioritizing retrofit and replacement projects, it will be important to establish a crossings context within the watershed.

#### 4.3.2.4 Risk/Significance of Failure

A culvert that is in disrepair or that is severely undersized may have large ecological or hydraulic significance associated with failure. For example, a culvert in Oregon became plugged with debris, causing water to wash out fill, run parallel to the road, and eventually scour out an entire valley wall as it found its own path to the river below (Furniss 2006). Figure 4.5, from Furniss et al, depicts this type of failure, know as diversion (1997).



**Figure 4.5 The erosional consequences of diverting stream flow onto non-stream slopes (Furniss et al. 1997)**

(Often landslides or debris flows can be triggered by the loading of non-stream slopes with excess water and undermining of slope support by gully erosion)

An understanding of environmental risk requires additional analysis. *Methods for Inventory and Environmental Risk Assessment of Road Drainage Crossings* (Flanagan et al. 1998), provides a discussion of the potential environmental impacts of culvert failure. This includes a review of past assessment procedures including recommended assessment procedures.

The economic cost of doing nothing can be calculated by many methods including:

- *Some Applications of Flood Frequency and Risk Information in Forest Management* (Hansen 1987)
- *Evaluation of Uncertainty of Flood Magnitude Estimation on Annual Expected Damage Costs of Hydraulic Structures* (Bao et al. 1987)

In addition to monetary expense, culvert failure can have significant impacts on habitat quality, possibly allowing a sediment slug to progress downstream, covering spawning habitat or useable areas with fines or silt. Studies of the response of road stream crossings to large flood events in the Pacific Northwest showed that additional failure mechanisms include debris flow, woody debris lodgment and hydraulic exceedance (Furniss et al. 1998).

### **4.3.3 Existing Prioritization Procedures**

State resource agencies in California, Oregon and Washington have implemented prioritization procedures for addressing culvert replacement and rehabilitation. The following examples may not be directly applicable to State DOTs, whose first obligation is to protect the traveling public.

#### **4.3.3.1 California Department of Fish and Game**

California Department of Fish and Game employs a ranking system for determining the priority of road stream crossings. Points are awarded to a crossing based on species diversity, extent of barrier, habitat value, risk of failure and current conditions. For example, priority based on species diversity is broken into the following rankings:

- Endangered Species – 4 points
- Threatened or Candidate – 2 points
- Not listed – 1 point

Barrier status is responsible for up to 5 points, high habitat value can result in up to 10 points, and risk of failure up to 5. The result of this prioritization is not intended to provide a list and order of culverts to be addressed (i.e. 30 points fixed first, 28 points fixed second), but gives a list of severity and spatial distribution of crossings to aid planning decisions (Taylor and Love 2003).

#### **4.3.3.2 Oregon Department of Fish and Wildlife**

Oregon uses degree of fish blockage and risk of crossing failure to group culverts into one of five categories of prioritization. This allows a general categorization of crossing from Type 1 culverts – which block passage of coho salmon habitat,

or have high risk of catastrophic failure, to Type 5 installations – which are on non-fish bearing streams with moderate to high risk of failure (Robison et al. 1999).

#### **4.3.3.3 Washington Department of Fish and Wildlife**

Washington Department of Fish and Wildlife's *Fish Passage Barrier and Surface Water Diversion Screening Assessment and Prioritization Manual* (2000) outlines a Priority Index (PI) ranking system similar to California. Values are assigned to various factors affecting barrier severity, including potential benefits of replacement. Priority is based on barrier status, production potential, habitat blocked, condition of fish stock, projected project cost, and species-specific values. Information is input into a database where prioritization is calculated and culvert inventories are ranked and stored. Since 1991, Washington has inventoried over 4000 km (2500 mi) of state routes, and opened up 595 km (369 mi) of habitat once blocked by barrier culverts (Wilder et al. 2004).

#### **4.3.4 Recommended Template**

The Forest Service's *National Inventory and Assessment Procedure* (Clarkin et al, 2003) has an in-depth discussion of culvert assessment, inventory and prioritization that provides adequate guidance for the development of regional criteria, and this is the recommended reading for those wishing to develop a regional fish passage inventory or culvert assessment procedure. A blank template from Clarkin et al, has been included (Figure 4.6) that allows regional criteria to form a simple coarse filter and regional screen (based on Taylor and Love 2003) (2003).

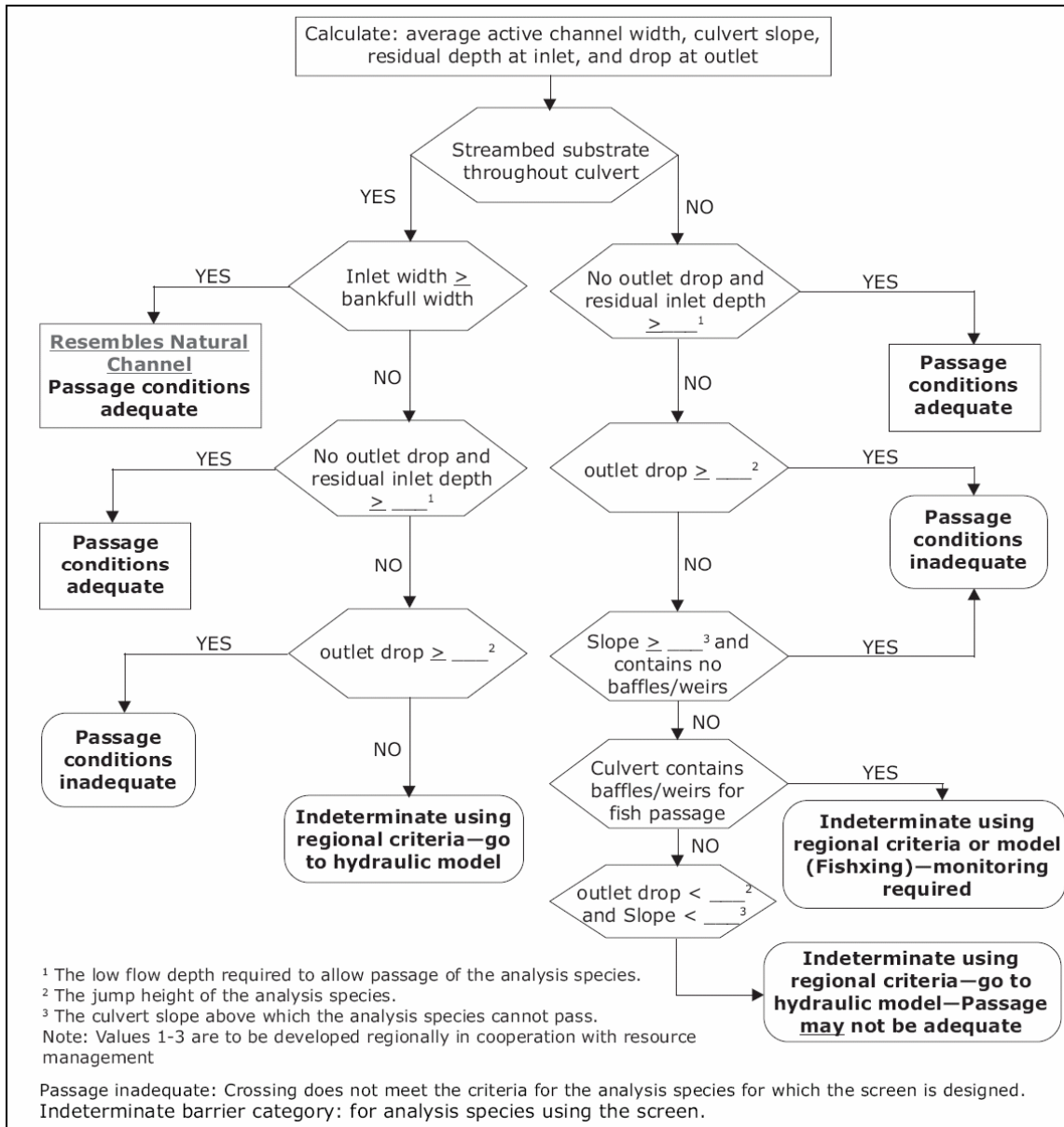


Figure 4.6 Fill in the blank regional screen based on the California model (Clarkin et al. 2003)

This page intentionally left blank

## 5 FISH PASSAGE HYDROLOGY

### **HOW TO USE THIS CHAPTER**

- ▶ This chapter is used most when using Hydraulic Design methods for culvert retrofits
- ▶ Understand the difference between determining design discharge for flood events and fish passage
- ▶ Learn the importance of timing and seasonality
- ▶ Find common methods used to determine fish passage design discharge

### **5.1 HYDROLOGIC CONSIDERATIONS FOR FISH PASSAGE DESIGN**

Crossings should allow fish passage at a range of flows corresponding to the timing and extent of fish movement within the channel reach. The use of Hydraulic Design techniques tailored to specific fish species and life stages and the need to assess existing culverts for fish passage requires knowledge of fish swimming ability and site hydrology in order to create a passable structure. This process necessitates a more thorough understanding of site flow characteristics than is provided by a typical hydraulic analysis for structure stability. The following discussion details typical design requirements, including state-of-practice hydrology.

#### **5.1.1 Seasonality**

##### **5.1.1.1 Timing and Extent of Fish Presence**

The timing of fish presence, including migration if important, must be considered when determining appropriate hydrology for fish passage design. Fish presence can vary from watershed to watershed (Scott and Crossman 1973), and in-stream flows may show great disparity with timing of fish migration .

In addition, the presence of multiple fish species can quickly convolute evaluation of fish passage hydrology. Figure 5.1 depicts the general timing of fish spawning migrations for a number of freshwater species in Virginia. Determining species presence and sensitivity within a stream reach requires site-specific knowledge, and consultation with a local fisheries biologist is essential.

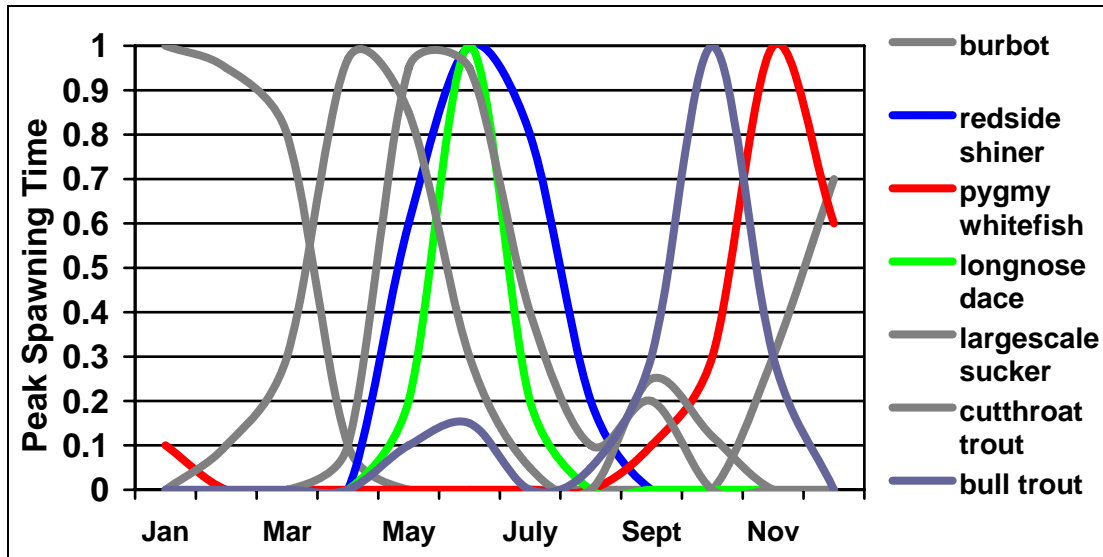


Figure 5.1 Peak spawning periods for a selection of freshwater fish in Virginia, based on biological data from Scott and Crossman (1973) (adapted from Hudy 2006)

### 5.1.1.2 Species and Life Stage

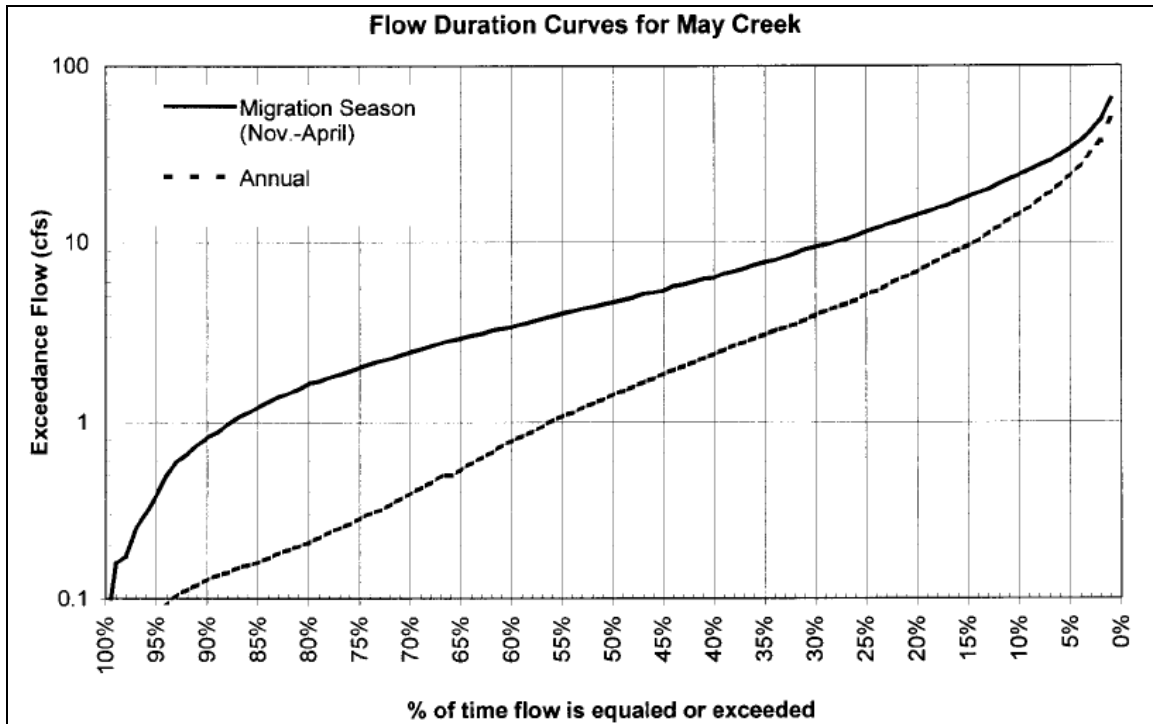
Timing and movement of regional fish populations will depend on fish species and life stage. In the Pacific Northwest, for example, adult salmon and steelhead migrate in the fall and winter months, while juvenile salmon migrate in the spring as fry and in the fall as fingerlings (Bates et al. 2003). Culverts designers in Maine must consider spawning movement of Atlantic salmon from May to November (Maine Department of Transportation 2004). In addition, resident fish may require movement at any time of the year (Kahler and Quinn 1998; Gowan et al. 1994). Due to variable abilities and periods of migration, each fish species and life stage may necessitate a different set of hydrologic constraints.

### 5.1.1.3 Representing Seasonal Flows

While predictions of instantaneous peak discharges with return periods of between 25 and 100 years are used for flood conveyance design, fish passage is considered at much smaller flows, less than bankfull discharges. Consequently, flow duration curves (FDC) are useful tools for determining fish flows. For example, a high fish passage discharge may be the discharge exceeded 10% of the time during migration or fish movement season (see Figure 5.1), while a low-flow requirement may be the flow that is equaled or exceeded 90% of the time.

However, the FDC used in analysis of fish passage flows, such as in Figure 5.2, represent averages and fail to account for annual variations in hydrology. A study in Northern California found a culvert using specified low-flow criteria (90% migration period exceedance) created a 1-day migration delay in WY99 (a “wet” year) but a 10-day delay in WY2001 (a “dry” year) (Lang et al. 2004).





**Figure 5.2 Synthetic flow duration curves from May Creek, customary units (Lang et al. 2004)**

(Calculations were based on flows occurring from November through April (Migration Season) and October through September (Annual); curves were created using the regional flow duration curve; the annual flow ( $Q_{ave}$ ) for May Creek was estimated to be 5.9 cfs)

## 5.1.2 Extreme Events

### 5.1.2.1 Fish Response

Even within a period of fish migration, design is not intended to provide fish passage at all flows. In a natural stream reach, fish respond to high flow events by seeking out shelter until passable conditions resume (Robison et al. 1999). During extreme low flows, shallow depths may cause the channel itself to become impassable (Clarkin et al. 2003; Lang et al. 2004). Generally, upper and lower thresholds bound the flow conditions at which fish passage must be provided.

### 5.1.2.2 Allowable Delay

Fish may be able to handle a short interruption to upstream migration without negative consequences. The extent of this “allowable delay” depends on the timing and motivations for fish movement. A resident fish may be able to tolerate a short delay without extreme consequences, while a delay of a few days may be detrimental to spawning salmon, whose migrations involve significant physical changes, including a rapid depletion of fat and protein reserves (Groot and Margolis 1991). The delay caused by a single culvert can be compounded by a series of culverts that present short delays, making it imperative to understand a

crossing's place in the overall watershed context. Delay has a number of negative consequences including stress and physical damages, susceptibility to disease and predation, and reduction in spawning success (Ashton 1984).

### 5.1.2.3 Migration Flows

As discussed in Chapter 2, fish movement is triggered by time of year, flow events and a number of environmental factors. For example, the upstream migration of spawning salmon is hypothesized to be in response to maturation, the changing length of days, and temperature regimes (Groot and Margolis 1991). Consultation with local fisheries biologists will help ensure that hydrology is properly matched to requirements of local fish populations.

## 5.2 DESIGN REQUIREMENTS

Flood design discharge is estimated for all culverts. For Hydraulic Design and assessment of existing culverts, two additional discharges are required: high and low fish passage flows. These are often compared to bankfull discharge.

### 5.2.1 High Fish Passage Flows

A high fish passage flow captures the upper bound at which fish are believed to be moving within the stream. Fish passage requirements should be met at all discharges up to and including the high fish passage flow. This may exclude flows falling below a lower threshold, known as the low fish passage flow.

Table 5.1 shows a comparison of available State and agency guidelines for high fish passage flows. Many states use an exceedance flow between 1 and 10% of the annual flow duration curve (a 10% exceedance flow is met or surpassed 10% of the year). It has been suggested that spawning adults should be delayed no more than 3 days during the average annual flood, or 7 days during the 50-yr flood (Ashton 1984).

**Table 5.1 State and Agency Guidelines for High Fish Passage Flows, Customary Units (adapted from Clarkin et al. 2003)**

( $Q_2$  refers to the 2-year flood)

Alaska	Washington	Oregon	NMFS SW Region	California Dept of Fish and Game	NMFS NW Region	Idaho
$Q_2d_2$ : the discharge 24 hours before the 2-yr flood.	10% exceedance flow during migration period – species specific	10% exceedance flow during migration period: species specific. Approximate by $Q_{10\%} = 0.18*(Q_2)+36$ where $Q_2 > 44$ cfs. Where $Q_2 < 44$ cfs, use $Q_2$ .	For adult salmon and steelhead 1% annual exceedance flow or 50% $Q_2$ . For juveniles, 10% annual exceedance flow.	Standards vary from 1-10% exceedance flow for various groups of fish.	5% exceedance flow during period of upstream migration	<2 day delay during period of migration

+High flows are for Hydraulic Design Approaches only, with the exception of Alaska and Idaho.

## 5.2.2 Low Fish Passage Flows

Low fish passage flows define the lower bound at which fish passage is required. This flow condition is used to ensure that depth and velocity barriers are not created within a crossing. Flows below this threshold may cause the channel itself to present a depth barrier to fish movement (Clarkin et al. 2003).

Specific depth requirements vary with the species and life stage of concern. Alaska requires that depth be greater than 2.5 times the depth of a fish's caudal fin (Alaska Department of Fish and Game and Alaska Department of Transportation 2001). For example, a 60 mm (0.2 ft) juvenile Coho Salmon requires a water depth of approximately 48 mm (1.9 in). Washington State specifies a minimum depth of 0.24 m (0.8 ft) for Adult Trout, Pink and Chum Salmon, and a depth of 0.30 m (1.0 ft) for adult Chinook, Coho, Sockeye or Steelhead (Bates et al. 2003).

Table 5.2 depicts available current state guidelines for low flow analysis of fish crossings. Many current design manuals specify design based on a 2-yr 7-day low flow, roughly corresponding to the 95% exceedance flow.

**Table 5.2 State and Agency Guidelines for Low Fish Passage Flows, Customary Units (adapted from Clarkin et al. 2003)**

Alaska	Washington	Oregon	NMFS SW Region	California Dept of Fish and Game	NMFS NW Region
None	2-yr, 7-day low flow (WAC 220-110-070) Natural bed culverts must be maintained to ensure low flow channels are ok	2-yr, 7-day low flow or 95% exceedance flow for migration period: species specific	Adult Salmon – Greater of 3 cfs or 50% exceedance flow Juveniles – Greater of 1 cfs or 95% annual exceedance flow	Standards vary from 50-95% exceedance flow for various groups of fish.	95% exceedance flow during months of upstream migration

+ Low flows are for Hydraulic Design approaches only, with the exception of Alaska.

## 5.2.3 Bankfull Flow

Bankfull flow is the discharge at which flow from the main channel begins to spill over into the floodplain (see Glossary). Generally, this discharge is referenced as the 1- to 2-yr flood event (Leopold and Wolman 1957), although this does not always correspond to field observations (Mussetter 1989). Bankfull is an important parameter in alluvial channels, as it is the discharge that effectively transports the most sediment, impacting long-term channel form, function, and stability (Harrelson et al. 1994). Although bankfull flow is rarely calculated for fish passage analysis, the concept of bankfull width is an important design parameter for fish passable structures. This concept will be discussed further in Chapter 6.

## 5.2.4 Streambed Stability and Crossing Capacity

Although design for fish passage will generally control structure size, culverts must still comply with flood flow conveyance requirements. At any road crossing, structure stability must be maintained up to and including a design flood (Norman et al. 2005). An outline of the hydrologic cycle, and methods for determining extreme flows are included in HDS-2 (Federal Highway Administration 2002).

Occasionally, design methods will also require that streambed material be sized for stability during a specific design flood (e.g. Alaska Department of Fish and Game and Alaska Department of Transportation 2001; Bates et al. 2003). Generally, this stability analysis corresponds to the discharge used to check culvert capacity – on the order of a 50-year event. Table 5.3 includes design flows used for streambed stability in fish culverts.

**Table 5.3 Flows Used in Determining Adequate Streambed Stability (adapted from Clarkin et al. 2003)**

( $Q_{50}$  and  $Q_{100}$  refer to the 50-year and 100-year floods, respectively)

Alaska	Washington	Oregon	NMFS SW Region	California Dept of Fish and Game
$Q_{50}$ or $Q_{100}$ *	$Q_{100}$ with Debris *	$Q_{100}$	$Q_{100}$ at headwater/rise = 1	$Q_{100}$ at headwater/rise = 1.5

\* Streambed stability check required

## 5.2.5 Tidal Influence

The hydrology of culverts in tidal areas requires consideration of both upland flow and tidal impact (Zevenbergen et al. 2004). Methods for determining culvert outflow with changes in tidal elevation must account for stream flow as well as tidal outflow as an ebbing tide causes water to return to the ocean. Successfully meeting fish passage provisions may require tidal data in appropriate time increments and a continuous hydrologic simulation model for tidal elevations and stream flow. Examples include the U.S. Environmental Protection Agency's Hydrological Simulation Program – Fortran (HSPF) or Storm Water Management Model (SWMM) (Bates et al. 2003). Observed and predicted tidal elevations, including information on benchmarks for tidal stations, are available on NOAA's internet site at <http://tidesandcurrents.noaa.gov/>.

A detailed discussion of tidal patterns, influence, and references are provide in Hydraulic Engineering Circular 25, available at <http://www.fhwa.dot.gov/>, and the Army Corps of Engineers has a number of publications on construction in coastal areas, available at [www.usace.army.mil](http://www.usace.army.mil).

### **5.3 HYDROLOGIC PROCEDURES**

Procedures for determining flood conveyance and streambed stability discharges are well defined and can be found in State drainage design manuals.

Procedures for determining high and low discharges for fish passage are not as well established. For culvert locations at or near long-term stream gages, statistical analyses will yield estimates for (1) 7-day low flows for return periods of interest and (2) discharges associated with the percent time exceeded during the year, based on the flow duration curve.

Most culverts are located at ungaged sites. Determination of high and low fish passage flows will likely be based on statistical regression methods using local or regional stream gages (Rowland et al. 2003; Powers and Saunders 1996).

This page intentionally left blank

## 6 DESIGN CONSIDERATIONS, METHODS AND TOOLS

### HOW TO USE THIS CHAPTER

- ▶ Understand important biological, geomorphic and hydraulic considerations when providing for fish passage
- ▶ Appreciate the constraints to providing for fish passage at culverts
- ▶ Learn of the three main categories of design for fish passage: Geomorphic Simulation, Hydraulic Simulation and Hydraulic Design
- ▶ Refer to assembled computational procedures for determining flow depth and the stability or mobility of streambed material
- ▶ Learn what computer software is readily available to assist in assessment and design

### 6.1 OBJECTIVES

A culvert designed for fish passage must also meet applicable flood conveyance requirements, such as allowable headwater elevations during the design flood and local Federal Emergency Management Agency (FEMA) regulations.

Many factors will determine the suitability of any particular set of fish passage design criteria for a culvert installation, replacement or retrofit. With fish passage as the overall goal, economics, site logistics, regulatory requirements and roadway characteristics may dictate a particular design procedure. The following categories have been developed to aid in the classification and selection of design approaches based on project goals. These goals are based on biological, geomorphic and hydraulic considerations.

**Category 1: Geomorphic Simulation**, also known as stream simulation, approaches recreate or maintain natural stream reach geomorphic elements including slope, channel-bed width, bed materials and bedform by using the reference reach. The approaches are based on the assumption that crossings approximately matching natural conditions will readily pass fish that are moving in the natural channel. This approach has five benefits: (1) it will provide passage for fish more readily than for much narrower spans; (2) it may provide passage for other aquatic and some terrestrial organisms; (3) for discharges less than approximate bankfull values, it will not increase downstream channel velocities; (4) for discharges exceeding bankfull values, it will increase downstream velocity less than for culverts with narrower spans, and (5) maintenance requirements (debris clearing, streambed manipulation) should be less than for narrower spans.

**Category 2: Hydraulic Simulation** techniques utilize embedded culverts, natural or synthetic bed mixes and natural roughness elements such as oversized rock to provide hydraulic conditions conducive to fish passage. These techniques operate on the assumption that providing hydraulic diversity similar, but not identical, to that found in natural channels will create a fish passable structure without checks for excessive velocity or turbulence. Hydraulic Simulation will generally have the benefit

of creating smaller spanning structures that have a reduced cost when compared to Geomorphic Simulation.

**Category 3: Hydraulic Design** techniques create water depths and velocities that meet the swimming abilities of target fish populations and life stages during specific periods of fish movement. Hydraulic Design is most often used in retrofit projects. General considerations include the effect of culvert slope, size, material and length. Flow control structures such as baffles, weirs, or oversized substrate are commonly utilized to create acceptable hydraulic conditions. This technique generates a smaller diameter culvert that keeps cost of materials to a minimum. Installation costs, however, are highly variable due to unique designs of baffles, weirs, steps or other controls. Hydraulic Design produces a less conservative design for fish passage than Geomorphic or Hydraulic Simulation.

All of the fish passage design methods seek to allow passage when fish are believed to be moving in the natural stream system. Note that none of the methods provide for unaltered flow hydraulics during flood events used for design by state DOTs.

### **Infrastructure Safety and Service Life**

Culverts must also be built with consideration of safety and service life. Larger span culverts will have a greater cross-sectional area for passing flood events. Hydraulically designed culverts will have a smaller initial cost, but require additional maintenance and monitoring to avoid debris accumulation (Bates et al. 2003).

## **6.1.1 Biological Considerations**

### **6.1.1.1 Fish Passage Requirements**

Crossing designs create different levels of stream reach connectivity. In general, Geomorphic Simulation creates the greatest connectivity, followed by Hydraulic Simulation and Hydraulic Design. In all cases, passage is presumed not to occur for discharges exceeding approximately bankfull conditions. The emphasis for fish passage design, therefore, is for discharges much smaller than those used in flood conveyance checks. A few pertinent questions can significantly narrow design option selection based on project goals.

#### **What are the species of fish and life stages for which passage should be provided?**

This question requires consultation with the fisheries biologist team member and likely consultation with natural resource agencies. The answer may depend upon, for example, regulations (e.g., Endangered Species Act), the desire to exclude invasive species, or economics (sport fishing considerations).

Hydraulic Designs can be completed to cater to a particular fish species and life stage; however, such a structure may provide a barrier to weaker swimming fishes at some or all flows.



**What is the weakest swimming fish species and life stage for which passage is required?**

**Example:** Adult Salmon; Juvenile Salmon; resident trout; benthic fish; all species and life stages present.

All techniques are designed to ensure fish passage; however, Geomorphic and Hydraulic Simulation approaches will allow passage for a wider variety of fish species and other aquatic organisms.

**Do we know the swimming abilities, behaviors and timing of these species?**

See Section 2.2.

**At what flows, and time periods are these fish migrating? What is the allowable delay?**

Design may depend on the timing of fish migration and relative flows. Delay impacts may be less crucial for resident fish than a spawning salmon. This problem can be compounded, for example, by several culverts in series or culverts that provide passage only after short delays.

#### **6.1.1.2 Ecological Significance**

Further consideration should be paid to the ecological significance of the roadway-stream crossing. The only way to truly preserve habitat at a crossing is to use a bridge or open bottom structure. Figure 6.1 shows a representation of the range of ecological solutions available at a roadway-stream crossing. Extreme ends of the spectrum include traditional design for flood capacity, and bridges or road removals that will permit valley and floodplain processes.

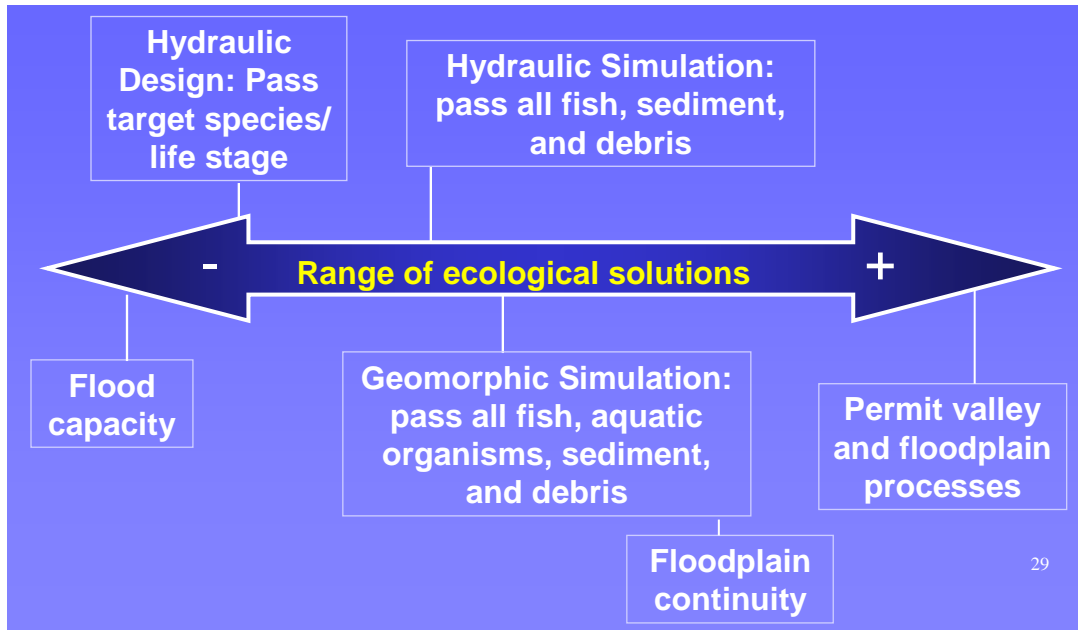


Figure 6.1 Range of ecological solutions at culvert installations (adapted from Gubernick 2006)

It is recommended that new culvert designs incorporate auxiliary barrels on the floodplains at the roadway crossing. Adding barrels at an elevation higher than bankfull will provide a flowpath for waters when discharge exceeds bankfull values. Such relief will decrease the main channel velocity and scour potential. This procedure is described in more detail in sections 7.2.4, 7.3.7 and 8.2.1.

## 6.1.2 Geomorphic Considerations

Site geomorphology is another important consideration in design for fish passage. Slope, channel location, channel stability and bed material are all examples of geomorphic elements that affect design selection. For example, installations located at slope breaks or in sediment sensitive areas may have a high propensity to degrade, aggrade or elicit a change in channel conditions, eventually creating another barrier or destroying valuable habitat (Bates et al. 2006).

### 6.1.2.1 Form and Key Features

Channel form and key features can aid in understanding channel processes including sediment transport, channel stability, and channel migration (Bunte and Abt 2001). Key features describe stream elements such as large woody debris (LWD), rock, vegetation, or channel confinement, all of which can play a large part in channel form and stability (Montgomery and Buffington 1998). While features such as LWD may be prominent in some channels, exact placement and development of such influences, and associated features, may be fairly unpredictable (Montgomery and Buffington 1993), and an understanding of overall influence and importance will be essential.

### **6.1.2.2 Stability**

Channel stability refers to the likelihood that a channel will retain its current placement, gradation, shape and form over time. Channels in highly entrenched mountain streams will be less likely to show lateral or vertical changes over time, while meandering valley streams may show great variation both laterally and vertically in response to minimal inputs (Montgomery and Buffington 1993; Rosgen 1994).

### **6.1.2.3 Morphological Adjustment Potential/Ability**

A crossing can be built to buffer for slight lateral and vertical channel adjustments. Although this can increase the size and initial cost of a structure, benefits can include decreased maintenance requirements and increased design life.

### **6.1.2.4 Rigid Structure in Dynamic Environment**

Bates et al. provide a detailed discussion about managing the stream profile at crossing. All culverts act as constraints in a dynamic environment, remaining at a specific location and elevation, and prevent channels from maintaining their natural processes (2006). By attempting to understand the possible impacts of a crossing on the channel, it is possible to select design options that provide optimum fish passage while ensuring acceptable design life and maintenance requirements.

## **6.1.3 Hydraulic Considerations**

### **6.1.3.1 Flood Flow Conveyance**

Flood flow capacity must be considered at all roadway-stream crossings. Each state has established flood flow requirements for culverts as a function of roadway category. Typical values of required flood capacity range from the 4% chance flood (25-yr) to the 1% chance flood (100-yr). If designing for fish passage, culvert size is often larger than that required for flood conveyance; however, hydraulic capacity must still be checked to ensure adequate flood flow conveyance.

### **6.1.3.2 Culvert Flow Characteristics**

Slope and span will have a large impact on culvert flow characteristics. Crossings that are designed to create passage for specific fish and lifestages may require additional hydraulic considerations such as low and high fish passage flows and induced turbulence.

### **6.1.3.3 Targeted Fish Passage at Design Flows**

Hydraulic Design options require detailed hydrologic information in order to ensure fish passage at specific periods of fish migration, while Geomorphic and Hydraulic

Simulation methods attempt to match (or closely mimic) natural stream reach characteristics, and require little to no additional hydrologic information.

#### **6.1.3.4 Passage for All Fish**

Geomorphic and Hydraulic Simulation techniques are intended to provide passage for all fish species within the reach through any period during which they are moving. It may be difficult, or very costly, to provide passage for all fish by designing for specific hydraulic conditions.

#### **6.1.3.5 Sediment Transport**

Culverts that maintain a natural bed will be sized to retain natural reach sediment transport properties (Bates et al. 2003; Bates et al. 2006; National Marine Fisheries Service Southwest Region 2001). If crossings constrict flow, there will likely be associated impacts on sediment transport including aggradation upstream and increased velocities, scour and degradation downstream from the structure (Castro 2003).

#### **6.1.3.6 Outlet Control**

For fish passage velocities and depths to be met, it is recommended that flow remain subcritical through the culvert and at the outlet, requiring that culverts be designed to maintain outlet control (Alaska Department of Fish and Game and Alaska Department of Transportation 2001; Behlke et al. 1991; Bates et al. 2003). Characteristics governing outlet control include culvert inlet area and shape, barrel area and shape, barrel slope, barrel length, barrel roughness, and water surface elevation at the culvert outlet (Norman et al. 2005). Depressed inverts, or artificial roughness created by weir baffles, and deep corrugations can also be used to slow velocities within the culvert barrel (Behlke et al. 1991). Figure 6.2 from Hydraulic Design Series 5 depicts a culvert under outlet control with an unsubmerged entrance. Outlet control may also exhibit a submerged entrance with part of the barrel or the entire barrel flowing full.

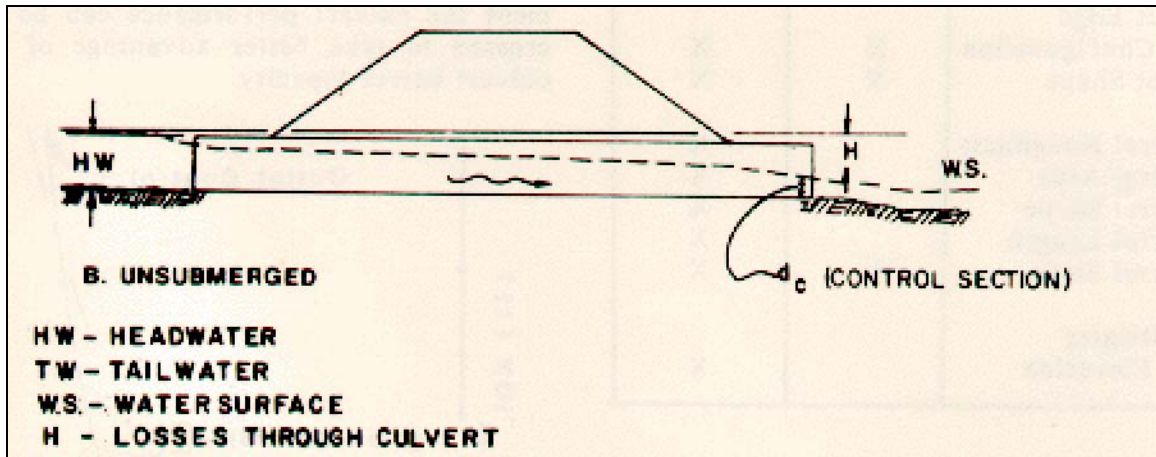


Figure 6.2 Culverts under outlet control (Norman et al. 2005)

## 6.2 CONSTRAINTS

Other than biological, geomorphic and hydraulic considerations, a number of project and site constraints will help determine the appropriateness of a particular design technique. These include, but are not limited to, funding, cost, right-of-way, and physical, environmental, and regulatory issues. Most of these issues apply to all roadway-stream crossings but have unique aspects when applied to fish passage.

### 6.2.1 Costs

Culvert barrel cost increases with span. If this were the only parameter used to compare the cost of design methods, Geomorphic Simulation techniques would be more costly than Hydraulic Simulation. Span cost is even less applicable to Hydraulic Design, where baffle, weir and other appurtenances can cost more than the culvert barrel.

Total roadway-stream crossing cost includes several other capital and recurring items such as installation and long-term maintenance. To date there are insufficient case histories to conclusively state that Geomorphic Simulation techniques incur greater life cycle costs than Hydraulic Simulation or vice versa. Limited experience in Alaskan rivers indicates that there is about a 20-30% capital cost reduction for Hydraulic Simulation installations when stream slopes exceed 3%, and little difference for stream slopes less than 3% (Gubernick, Personal Communication). These costs do not include long-term maintenance, posited to be inversely related to culvert span.

The cost of replacement may be prohibitively high due to deep fill or location (Interstate highway, for example). These cases may favor Hydraulic Design techniques.

Total life cycle cost for fish passage culverts is therefore difficult to compare for different design methods. It should not be assumed, for example, that one method

is more costly than another based on culvert span. A complete cost analysis must be made for each crossing.

Many design techniques are still considered experimental, and long-term monitoring is still required to understand the true impacts and implications of a selected method (Chapter 10). Careful consideration of goals and requirements should be taken before selecting design criteria.

### **6.2.2 Right of Way**

Right of way will affect the ability of designers to modify the channel outside of the culvert structure. Some design situations will require hydraulic control structures to ensure adequate backwatering, or to control channel slope, scour, and incision. Right of way costs may limit options on small retrofit projects with limited budgets. Clear communication with local landowners will provide an understanding of right of way, and innovative agreements and easements may extend access beyond existing rights of way.

### **6.2.3 Physical Constraints**

In addition to right of way, a number of physical barriers or obstacles could force the designer to consider the costs of moving those obstacles vs. a change in design direction. Examples include utility crossings, extreme gradient changes, and incised or degrading channels. A roughened channel (Hydraulic Design, Section 7.3.4), for example, may be required instead of a Geomorphic Simulation procedure when protecting a utility. Correcting a perched culvert may also dictate a method that protects the streambed from incision.

### **6.2.4 Environmental Constraints**

Environmentally sensitive areas will require a high degree of design consideration. For example, at a new crossing in a salmon spawning area, it may be pertinent to design an open bottom structure that allows natural substrate to remain relatively undisturbed through the crossing. To illustrate, a culvert barrier replacement in northern California utilized natural substrate and experienced salmon spawning within the structure only two years after installation (Furniss, Personal Communication).

### **6.2.5 Regulatory Constraints**

Regulatory requirements, like those discussed in Chapter 1 may reduce design options. For example, the presence of endangered or threatened fish species will require specific and immediate consideration, and if passage for weak swimming fish is required, Hydraulic or Geomorphic Simulation may be the best option.

## 6.2.6 Alignment

Proper culvert alignment requires consideration of channel shape, morphology, and culvert length. Installations that run perpendicular to the road will allow the shortest installations. In addition, flow exiting a culvert at an angle is likely to induce scour (Baker and Votapka 1990; White 1997), requiring wider culverts or channel treatments to protect against stream movement (Bates et al. 2006). Highway alignment should avoid sharp stream bends, severe meanders, confluences or other areas of converging and diverging flow (Maryland State Highway Administration 2005). When situations require installation at a skew, Figure 6.3 depicts a series of alignment options. Following the current channel form will require a longer culvert. Straightening the channel will shorten the crossing but require channel protection. Creating a wider crossing will provide a slight buffer for channel migration but may also significantly increase material and construction costs (Bates et al. 2006). Also, the aligned culvert might result in the greatest direct habitat loss, and the perpendicular culvert might result in the greatest overall disturbance and the greatest risk due to the skew of the culvert to the stream. For locations at skews or bends, all three options should be considered, and the final design is often a combination of the three.

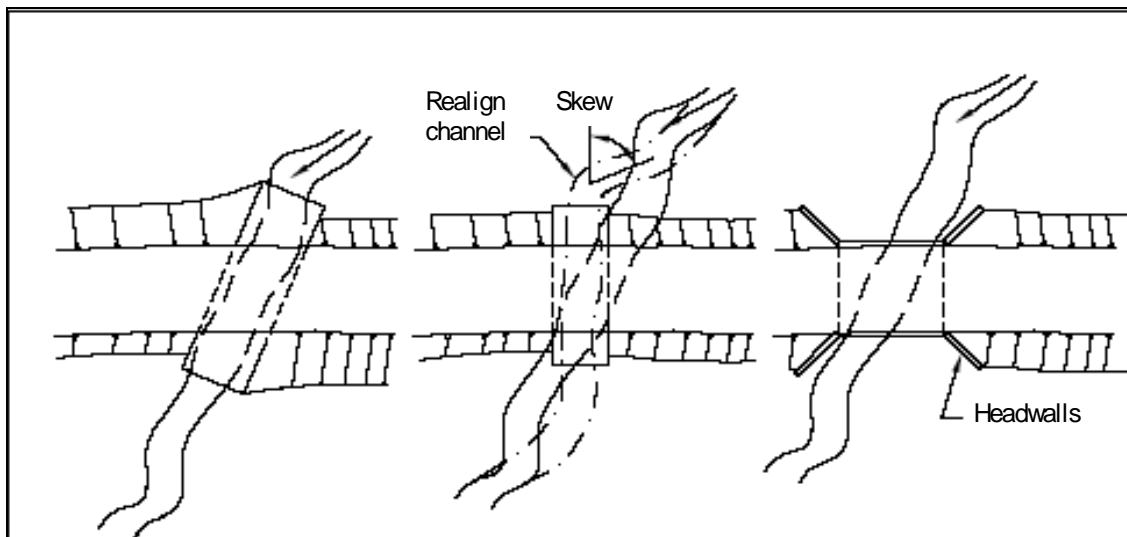


Figure 6.3 Alignment options for a skewed roadway-stream crossing (Bates et al. 2006)

Treatments recommended for minimizing culvert length include adding headwalls, steepening embankments, and narrowing and lowering the road (Bates et al. 2003; Maryland State Highway Administration 2005). Specifications for such options are included in HDS-5 (Norman et al. 2005).

## **6.3 DESIGN APPROACHES**

### **6.3.1 No Impedance**

DEFINED – No Impedance – Crossing design produces no impedance to aquatic organism passage by spanning both the channel and floodplain.

Aside from road removal or relocation, bridges provide optimum biological, geomorphic and hydraulic connectivity (Robison et al. 1999). Often bridges will be more expensive to install and have shorter effective lives than culverts (Venner Consulting and Parsons Brinkerhoff 2004). The No Impedance procedure will not be described further.

### **6.3.2 Geomorphic Simulation (Category 1)**

DEFINED – Geomorphic Simulation approaches are based on recreating or maintaining natural stream reach geomorphic elements including slope, channel-bed width, bed materials, and bedform.

The basis of these methods is the presumption that crossings matching natural conditions will readily pass fish that are moving in the natural channel. For this reason, analysis of fish passage flows is not required. Design methods are based on a reference reach (see Glossary). Geomorphic Simulation is also known as Stream Simulation (Bates 2006; WDFW 2000). This method has expedited regional permitting in some regions of the country (Bates, Personal Communication).

#### **6.3.2.1 Biological Characteristics**

Successful installations should pass fish, debris, and sediment at rates very closely resembling the natural stream reach. Geomorphic Simulation assumes passage is provided for all fish species and life stages moving through the natural channel for all flows at which they are moving. Culverts spans wider than the bankfull width can provide dry bank margins that can serve to provide passage for aquatic and terrestrial organisms.

#### **6.3.2.2 Geomorphic Characteristics**

To allow natural processes to occur within the culvert, the crossing slope must remain close to that of the natural channel. A review of such culverts in Washington State found that installations remaining within 25% of natural channel slope successfully replicated natural channel conditions (Barnard 2003). New open bottomed and embedded installations can be placed to minimize disturbance of bed material, or laid below grade and backfilled with natural material to maintain natural channel grade.



Geomorphic Simulation creates wide spanning culverts that exceed channel bed width. For example, in Washington, Barnard found that these structures should be 1.3 times the channel bankfull width in order to replicate stream processes (2003). In new installations, wide spanning culverts allow crossings to maintain natural bed material.

The wide-spanning culverts and open bottom structures needed to meet such requirements will allow a slight buffer against lateral and vertical stream adjustments (Bates et al. 2006). Although success has been achieved in high gradient situations, methods simulating the natural stream have been limited to gravel and cobble beds with only a few applications in sand bed streams (Bates et al. 2006).

### **6.3.2.3 Hydraulic Characteristics**

Geomorphic Simulation avoids the need for consideration of target species/life-stage, timing of fish migration, or fish passage hydrology. Since crossings are generally much larger than culverts designed for hydraulic capacity alone, Geomorphic Simulation will typically control design (hydraulic capacity must still be checked to meet the required headwater-flood policy).

### **6.3.2.4 Data Requirements**

Channel and valley type (Section 6.5.2)  
Channel longitudinal profile and control points such as rock outcroppings, ledges and immobile bed features  
Channel and floodplain cross sections  
Reference reach characteristics  
    Channel geomorphic characteristics  
    Bedforms  
    Bed and bank material  
Adjustment potential (vertical and horizontal) and alignment  
Peak flow for culvert flow capacity  
Sediment size distribution in upstream channel  
Flood design flow

Geomorphic Simulation is illustrated in Section 7.1.

### **6.3.3 Hydraulic Simulation (Category 2)**

DEFINED – Hydraulic Simulation techniques utilize embedded culverts, natural or synthetic bed mixes, and natural roughness elements such as oversized rock, to provide hydraulic conditions conducive to fish passage. These techniques operate on the assumption that providing hydraulic diversity similar, but not identical, to that found in natural channels will create a fish passable structure without checks for excessive velocity or turbulence. Many techniques are based on regional design experience.

Regardless of specific criteria, Hydraulic Simulation will generally create smaller spanning structures that have a reduced capital cost but higher maintenance requirements (debris removal) when compared to Geomorphic Simulation.

#### **6.3.3.1 Biological Characteristics**

By creating a crossing that resembles natural stream slope and substrate, passage is assumed adequate for fish in the stream reach. This assumption is often based on regional experience and project monitoring (Alaska Department of Fish and Game and Alaska Department of Transportation 2001; Maryland State Highway Administration 2005; Robison et al. 1999; Miles, Personal Communication; Browning 1990). In Alaska, experience has found that culverts following Hydraulic Simulation, they call it "Stream Simulation," criteria adequately pass fish, and permitting has been expedited (Alaska Department of Fish and Game and Alaska Department of Transportation 2001). Techniques developed by Maryland State Highway Administration (2005) and Browning (1990) check channel velocities for compliance with local stream flows. Although structures aren't specifically oversized to provide stream bank margins, low flows may provide dry bank areas that will allow terrestrial organisms to pass (Miles, Personal Communication).

#### **6.3.3.2 Geomorphic Characteristics**

Hydraulic Simulation creates hydraulic roughness, low flow paths, and resting areas conducive to fish passage by utilizing natural or artificial bed material (Robison et al. 1999; Browning 1990), or oversized substrate that remains stable during design floods (Alaska Department of Fish and Game and Alaska Department of Transportation 2001). Bed structures and key pieces are used to create flow diversity and resting areas, ideally matching bed characteristics of the natural channel.

Culvert span is generally close to or slightly less than bankfull (Alaska Department of Fish and Game and Alaska Department of Transportation 2001; Browning 1990; Robison et al. 1999; Maryland State Highway Administration 2005), allowing sediment and debris flow to continue through the crossing at flows up to bankfull. Substrate does not necessarily mimic stream reach substrate and form as in Geomorphic Simulation.

Some Hydraulic Simulation approaches create a stable channel within the culvert (i.e. Alaska Department of Fish and Game and Alaska Department of Transportation 2001; Bates et al. 2003). In such a case, bed load and suspended load still move through the culvert, but foundation bed material is not scoured out at high flows (i.e. a 50-yr event). This requires less flow area within the culvert barrel, as higher flows can pass through the culvert without scouring the bed material (Miles, Personal Communication).

In situations where a mobile bed is created, or allowed to develop within the crossing, sediment and debris movement is similar up to bankfull flows. Bed material can be washed out during a flood event, leaving a bare culvert, and, without upstream grade control, lead to upstream progressing channel incision. Recruitment may replace material that is scoured out, but it cannot be relied upon to do so. Regardless of bed stability, fines must be part of the bed material mixture to seal voids and avoid flows going subsurface, which would create a low flow barrier.

### **6.3.3.3 Hydraulic Characteristics**

Culvert spans designed for Hydraulic Simulation are generally very close to, or slightly less than, bankfull width. Methods that call for increased bed sizing and roughness will decrease flow velocity but increase turbulence.

Hydraulic capacity must be checked to ensure adequacy.

### **6.3.3.4 Data Requirements**

Channel and valley type (Section 6.5.2)

Channel longitudinal profile and control points such as rock outcroppings, ledges and immobile bed features

Channel and floodplain cross sections

Sediment size distribution in upstream channel

Adjustment potential (vertical and horizontal) and alignment

Flood design flow

Hydraulic Simulation is illustrated in Section 7.2.

### **6.3.4 Hydraulic Design (Category 3)**

DEFINED – Hydraulic Design techniques create water depths and velocities that meet the swimming abilities of target fish populations during specific periods of fish movement. General considerations include the effect of culvert slope, size, material, and length. Flow control structures such as baffles, weirs, formal fishways or oversized substrate are commonly utilized to create adequate hydraulic conditions.

Hydraulic Design is most applicable to retrofits, but can be used for new and replacement culverts. This technique generates a smaller diameter culvert, while still meeting fish passage criteria including leap height, average cross-sectional velocity, flow depth, and drop height. Hydraulic Design is specifically tailored to meet target fish species requirements, but produces a less connected design than Geomorphic or Hydraulic Simulation. These designs are applicable for slopes up to 5% (Robison et al. 1999; Bates et al. 2003; Katopodis 1992).

#### **6.3.4.1 Biological Characteristics**

Hydraulic Designs have been shown to aid in upstream migration by providing resting pools, low velocities, and deep flow (Gregory et al. 2004). These techniques utilize the swimming abilities of target fish populations in order to develop hydraulic criteria necessary to ensure fish passage. The target fish species and lifestage should be determined through consultation with fisheries biologists, and will generally focus on the weakest swimming fish known to require passage during specific periods of fish movement. Designs to meet specific hydraulic criteria are likely to constrict flow, disrupt ecosystem connectivity, and require a more rigorous design and permitting process than geomorphic or Hydraulic Simulation (i.e. Alaska Department of Fish and Game and Alaska Department of Transportation 2001; Bates et al. 2003). Hydraulic Design does not account for ecosystem requirements or the movement of non-target species.

#### **6.3.4.2 Geomorphic Characteristics**

Hydraulic Design is applicable over a range of slopes. Installations on mild slopes may create fish passable conditions without grade control structures, while moderately sloped (1-3.5%) installations and retrofits may require weirs or baffles to attain fish passable conditions (Bates et al. 2003; Alaska Department of Fish and Game and Alaska Department of Transportation 2001).

The structures created by Hydraulic Design are more likely to affect flow through and around the structure than those designed by Geomorphic or Hydraulic Simulation. Localized aggradation and degradation due to channel constriction may have to be addressed (Castro 2003), and regular debris maintenance is generally required for Hydraulic Design culverts. This can be especially important in retrofit situations where structure modifications, such as baffles or weirs, have the propensity to catch and hold debris, increasing the risk of debris clogging (Bates et al. 2003).

#### **6.3.4.3 Hydraulic Characteristics**

Low and high fish-passage flows must be determined to ensure that hydraulic criteria are met during periods of fish movement (Chapter 5). This requires knowledge of the times of the year and flow regimes at which fish move within the natural channel. In new installations, fish passage considerations will generally control structure size, but flood conveyance must still be checked. Smaller diameters, especially when combined with the effects of baffles, or other roughness elements, can restrict passage of water and debris through the culvert, decreasing the flood flow capacity while increasing the likelihood of plugging and culvert failure.

#### **6.3.4.4 Data Requirements**

Channel longitudinal profile

Target fish species and requirements such as swimming and leaping ability, depth requirements and time of year for movement  
Channel cross sections  
    Channel geomorphic characteristics  
    Bed and bank material  
Adjustment potential (vertical and horizontal) and alignment  
Low fish passage flow  
High fish passage flow  
Flood design flow

Hydraulic Design is illustrated in Section 7.3.

#### **6.3.4.5 Further Considerations**

This design approach is often recommended as a last alternative, when other possibilities are found to be unfavorable (Alaska Department of Fish and Game and Alaska Department of Transportation 2001; Bates et al. 2003; Flosi et al. 1998; Robison et al 1999; Maine Department of Transportation 2004). In Washington for example, design guidelines recommend that use of Hydraulic Design be limited to culvert retrofits, producing inexpensive, short-term, benefits until the crossing can be replaced (Bates et al. 2003).

Baffles have a much larger failure rate than other techniques. They are prone to clogging, and are difficult to prefabricate as settling may cause the baffles to pop out leading to damage to the culvert itself and to culvert failure (Robison et al. 1999; Gardner 2006). Hydraulically designed structures will have a shorter design life, increased maintenance needs, and a more intensive permitting process than Geomorphic or Hydraulic Simulation culverts.

### **6.4 DESIGN SELECTION**

The selection of an appropriate design technique will be the result of project goals and the design techniques applicable to a particular situation or region of the country. In Chapter 7, design techniques from across the country are explained within the context of the design categories listed above. Design examples are included in the Chapter 8 to further clarify the design process.

A first step in the decision process is to verify the necessity of a road crossing. Abandonment or removal of a crossing may be a plausible and desirable solution for fish passage problems, especially on forest land where road use is intermittent or logging and fire traffic can be rerouted with little consequence (Robison et al. 1999). Temporary structures and fords might also be considered.

It is recommended that State DOTs meet with State natural resource agencies and appropriate federal agencies (for example, U.S. Army Corps of Engineers) to discuss these methods for general applicability for a region.

Agreements between State Departments of Transportation and Resource agencies can greatly expedite the design and permitting process, ensuring that the requirements of all parties are met satisfactorily through a common vision. For example, Alaska and Oregon currently have agreements between their respective resource agencies aimed at more timely approval of permit applications for culvert installations, and recognizing the priority of replacement/repair of current fish passage barriers (Venner Consulting and Parsons Brinkerhoff 2004).

A comparison table of the design categories is presented in Table 6.1.

#### 6.4.1 Summary Matrix of Design Approaches

Table 6.1 Summary of Geomorphic, Biologic and Hydraulic Characteristics of Various Crossing Options

Category	Description	Relative Width	Characteristics		
			Biological	Geomorphic	Hydraulic
NA	No Impedance	≥100-yr floodplain	Pass all fish and aquatic organisms	Unchanged	Q <sub>100</sub> unconstricted
1	Geomorphic Simulation	≥bankfull	Pass all fish and aquatic organisms	Natural Substrate; Mobile bed; Stability of substrate usually not checked	Unaltered for Q slightly above bankfull; Check Q <sub>100</sub>
2	Hydraulic Simulation	≤bankfull	Reported to pass all fish and aquatic organisms	Oversized substrate; Stationary bed; Stability of bed usually checked	Similar for Q slightly less than bankfull; Check Q <sub>100</sub>
3	Hydraulic Design	variable; usually <bankfull	Pass target species at target life stage	Artificial channel	Must meet target species and life stage requirements; Check for Q <sub>100</sub>

#### 6.5 ANALYSIS TOOLS AND SOFTWARE

Analysis tools and computer software can be useful in the design of fish passable structures. The programs/websites are recommended or specified for use by many design/assessment documents. In addition, reference to Table 1.2 will be helpful for accessing other pertinent FHWA publications.

## **6.5.1 Channel Geometry**

### **6.5.1.1 Channel Width**

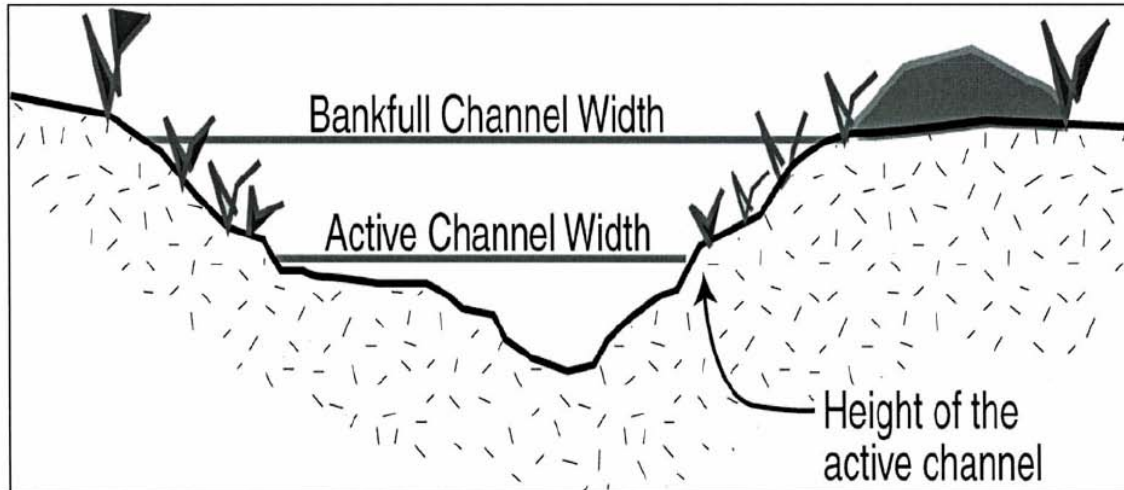
The correct determination of channel width is an important prerequisite for many of the design techniques described in this report. Width measurements should describe stable, straight channel conditions between bends and outside the influence of a culvert or an artificial or unique constriction (Bates et al. 2003). Two common design parameters include bankfull width and active channel width. Bankfull width is the result of geomorphic processes, while active channel width is more related to an ordinary discharge. In entrenched and non-adjustable systems bankfull and active channel width may be very similar, while evaluation in other areas, such as meandering valley streams, might show great discrepancies (Bates et al. 2006).

#### **Active Channel Width:**

The “active channel” describes the stream width at current and recent discharges, beyond which permanent features such as terrestrial vegetation begin to dominate (Hedman and W.M.Kastner 1977). For engineering purposes, the active channel can be distinguished by the ordinary high water (OHW) mark – the elevation delineating the highest water level that has been maintained for a sufficient period of time to leave evidence on the landscape (Taylor and Love 2003). Representations may also include erosion, shelving or terracing, change in soil characteristics, a break or destruction of terrestrial vegetation, moss growth on rocks along stream margins, vegetation changes from predominantly aquatic to predominantly terrestrial, or the presence of organic litter or debris (Taylor and Love 2003; Bates et al. 2003).

#### **Bankfull Width:**

Bankfull width describes stream characteristics during channel forming events. Bankfull flow is thought to mark the condition of incipient motion, with impacts on long-term form, function and stability of the channel (Williams 1978). This is typically recognized as a 1- to 2-year event, when flow within the channel just begins to spill over into the active floodplain (Leopold et al. 1964). When floodplains are absent or difficult to ascertain, as in entrenched mountain streams, markers used to determine bankfull and active channel show little variation (Bates et al. 2003). Difficulty in determining bankfull flow in the field prompts some to provide guidelines for estimation of bankfull width based on surveyed cross sections and return period flow (i.e. Maine Department of Transportation 2004). This type of estimation may show great disparity when compared with field observations of channel-bed width (Mussetter 1989).



**Figure 6.4 Depiction of bankfull channel width compared to active channel width (Taylor and Love 2003)**

(Note that in certain systems bankfull and active channel can be very similar, and active channel indicators are often used to describe bankfull flow when a floodplain is not present as in entrenched systems)

### 6.5.1.2 Channel Profile and Condition

It is extremely important to understand structure impacts on the channel over time including incision, scour, headcut and regrade (Bates et al. 2006). This requires an accurate survey of the longitudinal profile (River and Stream Continuity Partnership 2004). A longitudinal profile should include the culvert site and 20 channel widths or a minimum of 61-91 m (200-300 ft) up- and downstream of the structure (Castro 2003; Bates et al. 2003). Recent experience shows this distance to be a minimum. Maryland DOT surveys 152 m (500 ft) on each side of the culvert (Kosicki, Personal Communication 2007). This will allow an understanding of the final channel bottom elevation resulting in the vicinity of the replacement structure, ensuring proper invert elevations, embedment, and slope. A good survey is also useful in assessing the potential for downstream flooding, alteration of upstream and downstream habitat, potential for erosion and headcutting, and stream stability in general (River and Stream Continuity Partnership 2004).

#### **Channel Evolution:**

Although a crossing may seem stable, there are various levels of stability, natural or anthropogenic, and it is important to examine upstream and downstream channel conditions to understand the current channel condition. Figure 6.5 depicts channel evolution after an initial channel incision moved the stream from a stable state.



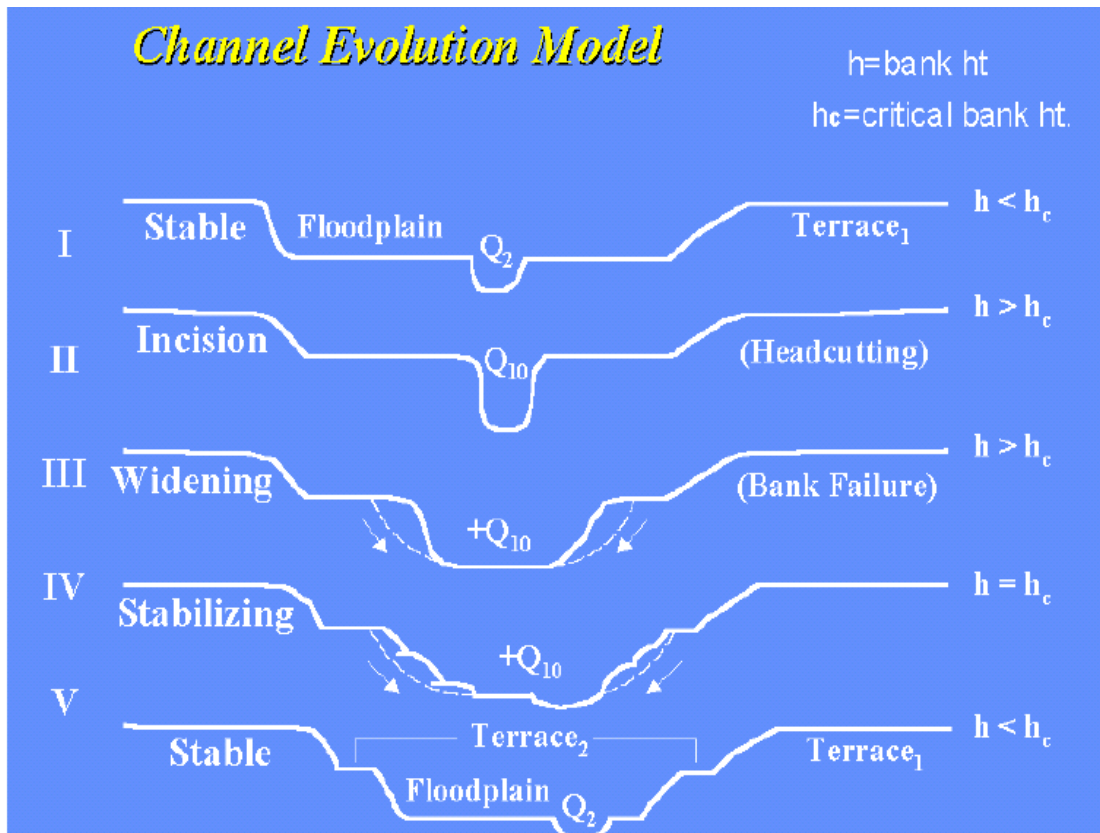


Figure 6.5 Critical bank height is inherently unstable and will result in bank failure and stream widening (Castro 2003)

### Channel Incision, Headcut and Regrade:

As channels continually evolve and migrate, channel adjustment can lead to structure failure. Installations that fail to recognize channel processes may compromise fish passage and alter the quantity and quality of stream corridor habitat (Castro 2003).

In situations where a current culvert installation is acting as a control point, removal, replacement with a larger structure, or lowering may allow channel incision to progress upstream uncontrollably, or until another control point is reached. Regrade will be more immediate and pronounced in sand bed streams (Bates et al. 2003). Stream reaches actively aggrading or incising will cause Geomorphic Simulation culverts to be ineffective, and Hydraulic Design or Simulation incorporating channel grade controls (Section 6.5.6.4) may be more suitable.

## **6.5.2 Stream Classification**

Classifying a stream containing a crossing or the site of a crossing impels the design team to collect meaningful data and discuss the stream dynamics before choosing a design procedure.

Systems for stream classification are useful tools in building awareness of stream form and function. Methods describe the channel in terms of cross-sectional shapes, morphological parts of the stream, and interactions between flow and sedimentation (Bunte and Abt 2001). The following section is intended to introduce the user to popular methods in stream classification and geomorphology, but is not sufficient for structure design. Coordination with a local geotechnical engineer and geomorphologist is necessary for ensuring structure performance. For more information it will be useful to examine references included below and Hydraulic Engineering Circular No. 20 (Lagasse et al. 2001).

### **6.5.2.1 Montgomery and Buffington**

Montgomery and Buffington created a stream classification system based on channel systems in the Pacific Northwest that is applicable to similar regions elsewhere. Their methodology follows changes in channel morphology as steep headwater streams run through steep valleys and hillslopes, gentle valleys, and eventually low gradient valleys (Bunte and Abt 2001). As water flows to the ocean, channel types generally transition from cascade, step-pool, plane bed, pool-riffle and dune-ripple, as shown in Table 6.2. Channel bedform is described by the type and size of sediment, sediment transport capabilities, and hydraulic conditions within a stream reach. Table 6.2 from Bunte and Abt summarizes this classification system with respect to channel geomorphic and hydraulic conditions.

**Table 6.2 Stream Classification by Montgomery and Buffington (from Bunte and Abt 2001)**

Stream gradient, range and mode (m/m)	Stream type	Typical bed material	Dominant sediment source	Dominant sediment storage	Typical pool spacing*
0.03 - 0.20 (0.08 - 0.20)	Cascades	Cobble-boulder	Fluvial, hillslopes, debris flows	Around flow obstructions	< 1
0.02 - 0.09 (0.04 - 0.08)	Step-pool	Cobble-boulder	Fluvial, hillslopes, debris flows	Bedforms	1 - 4
<0.02 - 0.05 (0.02 - 0.04)	Plane-bed, forced pools	Gravel-cobble	Fluvial, bank failure, debris flows	Overbank	None
<0.001- 0.03 (0.01)	Pool-riffle	Gravel	Fluvial, bank failure	Overbank, bedforms	5 - 7
< 0.001	Dune-ripple	Sand	Fluvial, bank failure bedforms	Overbank,	5 - 7

*Values in parentheses are the modes of the observed stream gradient distribution; \* in terms of channel widths*

A reach-scale categorization allows streams to be categorized based on relative positions within the watershed and sediment transport characteristics. This type of analysis is useful in understanding the potential response of a channel reach to a crossing installation. Montgomery and Buffington define reach level morphologies as source, transport and response reaches (Montgomery and Buffington 1993).

Source reaches contain as much or more sediment than the stream can transport. Transport reaches are high gradient supply-limited channels, which are unlikely to respond quickly or severely to disturbance. This includes bedrock, cascade and step-pool channels. Response reaches are lower gradient transport-limited channels with a high potential for morphological adjustment in response to sediment input. This general classification covers plane-bed, pool-riffle and braided channels. The transition from transport to response reach is where the impacts of increased sediment supply will have the largest impact, as sediment supplied by the transport reach will readily settle out at the first reach that cannot maintain sediment transport capacity (Montgomery and Buffington 1993).

A crossing location within a particular reach, as well as the proximity of other reaches will help a designer ascertain the potential impacts and geomorphic response of the stream. Crossings that fall at the intersection of two different channel types, for example, could indicate channel incision, or that the crossing is located at a point of geomorphic transition (Bates et al. 2006). Crossings placed in a response reach typically will require extra consideration of channel processes and morphological impacts (channel aggradation and lateral movement).

### 6.5.2.2 Rosgen Stream Classification

Rosgen channel classification is based on five morphometric parameters of the channel and its floodplain: entrenchment ratio, width-depth ratio at bankfull flow, sinuosity, stream gradient and mean bed particle size (Rosgen 1996). These characteristics are used to distinguish seven stream types, represented by capital letters A to G. Table 6.3 lists the morphological characteristics of Rosgen's stream types.

**Table 6.3 Morphological Characteristics of the Major Rosgen Stream Types (Bunte and Abt 2001)**

Stream Type	Morphological characteristics
A	<b>Step-pool, or cascading:</b> plunge and scour pools, high energy, low sediment storage, stable;
B	<b>Riffles and rapids:</b> some scour pools, bars rare, stable;
C	<b>Pool-riffle sequences:</b> meandering, point bars, well developed floodplain, banks stable or unstable;
D	<b>Braided:</b> multiple channels, shifting bars, scour, deposition, high sediment supply, eroding banks;
DA	<b>Anastomosing:</b> multiple channels, pool-riffle, vegetated floodplain, adjct. wetlands, stable banks;
E	<b>Meadow meanders:</b> well-developed floodplain, riffle-pool, relative high sediment conveyance;
F	<b>Valley meanders:</b> incised into valleys, poor floodplain, pool-riffle, banks stable or unstable;
G	<b>Gullies:</b> incised into hillslopes and meadows, high sediment supply, unstable banks, step-pool.

Channels can be further distinguished using numbers to represent bed material and particle size, and lowercase letters to represent deviation from expected channel slopes. For example, a stream classified as C4b is a C-type stream with a gravel bed and gradient within the range of 0.02-0.039, which is more typical of a B-type stream (Rosgen 1994). Accurate classification requires a longitudinal and cross-sectional channel survey and sediment sample analysis.

### 6.5.2.3 Summary of Channel Classification

All stream classification systems can be useful in understanding basic channel reach geometry and dominant geomorphic processes. This can be valuable in predicting channel response to modification or culvert replacement. Certain channel types can carry specific design challenges. For example, risk of floodplain constriction and/or lateral adjustment is associated with Rosgen C, D and E channels (Bates et al. 2006). As mentioned above, plane bed, pool-riffle, and dune-ripple channels are associated with response reaches, and are likely to show the most dramatic response to disturbance (Montgomery and Buffington 1993).

For further discussion of stream classification and applicability to channel crossing design, it is useful to review the original documents by Rosgen (1994; 1996), Montgomery and Buffington (1993; 1998), Bunte and Abt (2001), and Bates (2006).

It is important to note that these design techniques or classification systems are not well tested outside the regions for which they were created. Installations in low gradient, highly mobile sand bed streams may require special consideration.

### **6.5.3 Stream Morphology**

As a rigid structure in a dynamic environment, culverts must be designed with channel processes in mind. Effective designs consider the channel and watershed context of the crossing location. Channels are continually evolving, and an understanding of stream adjustment potential must be addressed. Without consideration, well intended plans could have detrimental or completely ineffective results/impacts on the stream system and related habitat (Castro 2003; Furniss 2006).

#### **6.5.3.1 Gradient**

Past channel degradation can require channel modification, or considerations of the impact of increased slope on channel stability, substrate and future conditions (Robison et al. 1999; Bates et al. 2006; Bates et al. 2003). A true Geomorphic Simulation can only be completed when culvert bed slopes very closely match the slopes of the adjacent stream channel. Oversized sediment utilized in Hydraulic Simulations provides more leeway with regards to stream slope, but also require that crossing slopes be close to the adjacent channel.

#### **6.5.3.2 Bed Material and Embedded Culverts**

The benefits of natural streambeds and embedded culverts are widely recognized in fish passage applications (e.g. Venner Consulting and Parsons Brinkerhoff 2004; Bates et al. 2003; Taylor and Love 2003; Clarkin et al. 2003). Bed material provides barrel roughness, which provides areas of low velocity that may be conducive to fish passage, mimics natural hydraulics, and is self sustaining when designed properly (White 1997).

#### **6.5.3.3 Key Roughness Elements**

In order to provide fish migration paths and resting areas many design techniques utilize key roughness elements to create diversity in flow velocity, depth, and energy dissipation (Robison et al. 1999; Bates et al. 2006; Browning 1990). Key roughness elements describe any number of materials that can be used to provide hydraulic roughness and diversity to a crossing including oversized substrate, constructed channel features including banks, stone sills, boulder clusters, log sills, and baffles. Such features are intended to increase bed stability and provide resting areas and hydraulic diversity conducive to fish passage.

#### 6.5.3.4 Subsurface Flows

Crossings that are filled with a coarse simulated bed mix may allow low flows to seep between rocks – and move solely in the subsurface – until interstitial spaces have been sealed with fine particles. To limit streambed permeability, an appropriate proportion of fine material must be included in the bed mix (5-10%) (United States Forest Service 2006a; Bates et al. 2006). During channel construction, placement of a sediment barrier fabric, mud or straw wattles (Browning 1990; Gubernick, Personal Communication), or washing fines into the streambed during construction can effectively seal the voids (Bates et al. 2006).

#### 6.5.4 Estimating Roughness with the Manning Equation

Estimating roughness with the Manning equation (Equation 6.1, Chow, 1959) is most often used to estimate uniform flow depth given a design discharge:

$$Q = \frac{KAS^{1/2}R^{2/3}}{n} = VA$$

Equation 6.1

where:

- K = 1.0 for SI and 1.486 for CU units, respectively
- Q = Channel discharge, m<sup>3</sup>/s (ft<sup>3</sup>/s)
- S = Channel slope, m/m (ft/ft)
- R = Hydraulic radius (cross-sectional area/wetted perimeter), m (ft)
- A = Cross-sectional area, m<sup>2</sup> (ft<sup>2</sup>)
- V = Average channel velocity, m/s (ft/s)
- n = Manning's "n" (channel roughness coefficient)

Of primary importance is to determine the Manning's "n" value, or channel roughness coefficient, for low and high values of discharge and for flood discharges. This will govern sediment stability and the hydraulic properties within the culvert barrel. Estimates for Manning's "n" may be found in HEC-20 (Lagasse et al. 2001), Chow (1959) or as determined at U.S. Geological Survey stream gage sites (Barnes 1967). For coarse streambed material, the procedures described in Chapter 7 use the following specialized equations.

##### 6.5.4.1 Limerinos Equation

###### Source

- Limerinos 1970 (as discussed in Bates et al. 2003)

### Applicability

- Experience shows a more accurate prediction in higher-velocity situations.

### Limitations

- Equation is based on data where  $0.9 < R/D_{84} < 6.9$  and  $0.02 < n < 0.107$ .
- The error range for  $n/R^{1/6}$  is +42.9% to -33.7%.

$$N = \frac{KR^{1/6}}{1.16 + 2\log(R/D_{84})}$$

Equation 6.2

where:

- $K =$  0.1129 for SI and 0.0926 for CU units, respectively
- $R =$  hydraulic radius, m (ft)
- $D_{84} =$  the dimension of the intermediate axis of the 84<sup>th</sup> percentile particle, m (ft)

### 6.5.4.2 Jarrett's Equation

#### Source

- Jarrett 1984 (as discussed in Bates et al. 2003)

#### Applicability

- Average velocity is less than 0.9 m/s (3 ft/s)
- Based on data where slope is between 0.2% and 4%
- May be applicable up to an 8.25% slope where  $0.4 < R/D_{84} < 11$  and  $0.03 < n < 0.142$

#### Limitations

- Error range of  $n$  on the test data is wide, +44% to +123%
- It is implied that, as slope increases, sediment size increases and so does roughness.

$$N = K S_f^{0.38} R^{-0.16}$$

Equation 6.3

where:

- $K =$  0.32 for SI and 0.39 for CU units, respectively
- $S_f =$  the friction slope of the channel
- $R =$  hydraulic radius of the channel, m (ft)

### 6.5.4.3 Mussetter's Equation

#### Source

- Mussetter 1989 (as discussed in Bates et al. 2003)

#### Applicability

- Derived from data in Colorado mountain streams, with sediment distributions similar to those recommended by WDFW guidelines.
- Fish passage velocity calculations

#### Limitations

- Derived from data where slope is between 0.54% and 16.8%,  $0.25 < R/D_{84} < 3.72$ , and  $0.001 < f < 7.06$  ( $0.036 < n < 4.2$ )
- Error range is between +3.8% to +12%.
- Accuracy decreases when velocity is greater than 0.9 m/s (3 ft/s).

$$1.49R^{0.17} / (n)(g)^{0.5} = (8/f)^{1/2} = 1.11(y/D_{84})^{0.46} (D_{84}/D_{50})^{-0.85} S_f^{-0.39}$$

Equation 6.4

where:

y is the mean depth, ft

Note: If Equation 6.4 is used in metric units, the constant 1.49 will equal 1.0.

### 6.5.5 Bed Mobility

The design engineer must understand the basic concepts of particle sizing and stream stability in order to specify a sediment mixture for the proposed culvert that is appropriate for the selected design approach. For example, Geomorphic Simulation seeks to mimic the natural streambed sediment mixture, while Hydraulic Design usually uses a coarser mix of sediment in the culvert barrel than found in the adjacent stream channel. Nine methods are here presented to assist the engineer in determining the stability of the streambed within the culvert barrel. These are taken from the USFS Stream Simulation design, the WDFW Stream Simulation design and the Roughened Channel design, as illustrated in sections 7.1.1, 7.1.2 and 7.3.4, respectively. Consultation with team members familiar with these procedures will be beneficial. These tools may be used to test the sensitivity of substrate mixes to entrainment.

#### 6.5.5.1 Simulated Streambed Design

#### Source

- USFS Stream Simulation – DRAFT Manual (Bates et al. 2006)



When natural bed material cannot be used, a well-graded mix of materials should be created to closely approximate the particle size distribution of the reference reach. The most important elements of a constructed bed are large particles to provide bed structure, and fines to limit bed permeability and bind the bed mix together. Analysis of bed material can be done through a sieve analysis, but is most commonly done through a pebble count. When distribution is calculated by a pebble count,  $D_{100}$ ,  $D_{84}$ ,  $D_{50}$  of the reference reach are taken directly from the surface pebble count, and smaller grain sizes are determined through use of the Fuller-Thompson equation (6.5).

Fuller-Thompson equation:

$$P=(d/D_{100})^n$$

**Equation 6.5**

where:

- d = particle size of interest, mm (ft)
- P= percentage of the mixture smaller than d
- $D_{100}$ = largest size material in the mix, mm (ft)
- n = parameter that determines how fine the resulting mix will be.  
A value of 0.5 produces a maximum density mix when particles are round

This equation can be rearranged to find any particle size, for example:

$$D_{16} = 0.32^{1/n}D_{50}$$

$$D_5 = 0.10^{1/n}D_{50}$$

When distribution is calculated by a pebble count,  $D_{100}$ ,  $D_{84}$ ,  $D_{50}$  of the reference reach are taken directly from the surface pebble count, and smaller grain sizes are determined through use of the Fuller-Thompson equation (6.5). This is based on  $D_{50}$ , and creates a simulated bed mix. (This application has not been field tested, and professional judgment is recommended).

### 6.5.5.2 Modified Shield's Equation

#### Source

- USFS Stream Simulation – DRAFT Manual (Bates et al. 2006)

#### Applicability

- Riffles and plane-bed channels with channel-bed gradients less than 5%
- Sand and gravel bed streams with low relative roughness (flow depth considerably greater than streambed particle size)

- Poorly graded streambed (particles represent a narrow range of class sizes)

### Limitations

- $D_{84}$  between 10 and 250 mm (2.5 to 10 inches)
- Particle size of interest  $\leq 20$ -30 times  $D_{50}$ .

The modified Shield's equation is used to determine particle stability based on critical shear stress. Particle stability is compromised when boundary shear stress in the channel is greater than a critical stress threshold. Boundary shear stress is calculated using Equation 6.6.

$$\tau = \gamma RS$$

#### Equation 6.6

where:

- $\tau$  = average boundary shear stress, Pa (lb/ft<sup>2</sup>)
- $\gamma$  = specific weight of water, N/m<sup>3</sup> (lb/ft<sup>3</sup>)
- $R$  = hydraulic radius (Cross-Sectional Area of Flow divided by Wetted Perimeter – calculated at design flow), m (ft)
- $S$  = slope, m/m (ft/ft)

Once boundary shear stress has been calculated, a critical stress threshold is calculated using Equation 6.7.

$$\tau_{ci} = \tau^*_{D50} (\gamma_s - \gamma) D_i^{0.3} D_{50}^{0.7}$$

#### Equation 6.7

where:

- $\tau_{ci}$  = critical shear stress at which the sediment particle of interest begins to move, Pa (lb/ft<sup>2</sup>)
- $\tau^*_{D50}$  = dimensionless Shield's parameter for  $D_{50}$  particle size (this has been experimentally derived for a number of particle sizes, see Table 6.4)
- $D_{50}$  = diameter of the median or 50<sup>th</sup> percentile particle size of the channel bed, m (ft)
- $D_i$  = diameter of the particle size of interest (typically  $D_{84}$  or  $D_{95}$  for stream simulation), m (ft)

**Table 6.4 Angle of Repose, Shield's Parameter and Critical Shear Stress Values for Gravel-, Cobble- and Boulder-Sized Particles (Bates et al. 2006)**

Particle size classification	Particle size, $D_i$ (mm)	Angle of repose ( $\Phi$ ), $f$ (degrees)	Shield's parameter <sup>a</sup> , $\tau^*$	Critical shear stress, $\tau_c$ (lb/ft <sup>2</sup> )
very large boulders	> 2048	42	0.054	37.37
large boulders	1024-2048	42	0.054	18.68
medium boulders	512-1024	42	0.054	9.34
small boulders	256-512	42	0.054	4.67
large cobbles	128-256	42	0.054	2.34
small cobbles	64-128	41	0.052	1.13
very coarse gravels	32-64	40	0.05	0.54
coarse gravels	16-32	38	0.047	0.25
medium gravels	8-16	36	0.044	0.12
fine gravels	4-8	35	0.042	0.057
very fine gravels	2-4	33	0.039	0.026

<sup>a</sup> equation used to determine Shield's parameter for gravel-, cobble-, and boulder-sized particles:  $\tau^* = 0.06 \tan\Phi$

### 6.5.5.3 Critical Unit Discharge Approach

#### Source

- USFS Stream Simulation – DRAFT Manual (Bates et al. 2006)

#### Applicability

- Channels with gradients exceeding 10%
- Flow depth is shallow with respect to channel-bed particle diameter (situations where discharge is much easier to determine than depth).

This approach is based on unit discharge, and a value of critical unit discharge will be compared to channel unit discharge to determine particle entrainment (particle lifting into flow).

Equation 6.8 is used to calculate channel unit discharge.

$$Q = Q/w$$

Equation 6.8

where:

q= Unit discharge, m<sup>3</sup>/s/m (ft<sup>3</sup>/s/ft)

Q= Discharge, m<sup>3</sup>/s (ft<sup>3</sup>/s)

w= the width of the channel at a given cross section, defined by active channel width, m (ft)

Equation 6.9 is used to predict the entrainment of the particle size of interest.

$$q_{cD_{50}} = \frac{0.15g^{0.5}D_{50}^{1.5}}{S^{1.12}}$$

**Equation 6.9**

where:

$q_{c-D_{50}}$  = the critical unit discharge to entrain the  $D_{50}$  particle size,  $m^2/s$  ( $ft^2/s$ )  
 $D_{50}$  = the median or 50<sup>th</sup> percentile particle size, m (ft)  
 $g$  = gravitational acceleration,  $m/s^2$  ( $ft/s^2$ )  
 $S$  = slope, m/m (ft/ft)

More generally,

$$q_{ci} = q_{cD_{50}} \left( \frac{D_i}{D_{50}} \right)^b$$

**Equation 6.10**

where:

$q_{ci}$  = the critical unit discharge to entrain the particle size of interest,  $m^2/s$  ( $ft^2/s$ )  
 $D_i$  = the particle size of interest, m (ft)  
 $D_{50}$  = the median or 50<sup>th</sup> percentile particle size, m (ft)  
 $b$  = measure of the range of particle sizes that make up the channel bed (quantifies the effects on particle entrainment of smaller particles being hidden and of larger particles being exposed to flow)

$$b = 1.5 \left[ \frac{D_{84}}{D_{16}} \right]^{-1}$$

**Equation 6.11**

where:

$D_{84}$  = the 84<sup>th</sup> percentile particle size, mm (ft)  
 $D_{16}$  = the 16<sup>th</sup> percentile particle size, mm (ft)

Steps:

1. Equation 6.8 is used to calculate the unit discharge for bankfull flow

2. Equation 6.9 is used to find the critical unit discharge ( $q_{c-D50}$ ) needed to entrain the  $D_{50}$  particle size at the given cross section.
3. Equation 6.11 is used to calculate the sorting of the channel bed (b).
4. Equation 6.10 is used to calculate the critical discharge ( $q_{ci}$ ) needed to entrain the particle of interest at any given cross section.
5. Compare the critical unit discharge ( $q_{ci}$ ) to the unit discharge ( $q$ ) in the channel at the specified flow. If the unit discharge is less than the critical discharge the particle size of interest will not be entrained (particle will remain immobile). If unit discharge is greater than critical discharge the particle size of interest will be entrained.

#### 6.5.5.4 Boundary Shear Threshold Analysis

##### Source

- Williams 1983 (as discussed in USFS Stream Simulation – DRAFT Manual, Bates et al. 2006)

##### Applicability

- Williams equations indicate the upper and lower thresholds in boundary shear stress required to initialize movement of a given particle size.

##### Limitations

- Equation 6.12 was developed from particles between 15 to 900 mm (0.05 to 2.73 ft).
- Equation 6.13 was developed from particles between 10 to 3300 mm (0.03 to 10 ft).
- Both equations express shear stress in customary units ( $\text{lb}/\text{ft}^2$ ).

$$\tau_{ci-u} = 0.0814D_i$$

Equation 6.12

$$\tau_{ci-l} = 0.00355D_i$$

Equation 6.13

where:

- $\tau_{c-u}$  = is the upper critical shear stress value ( $\text{lb}/\text{ft}^2$ ) for determining particle mobility and immobility for the particle size of interest.
- $\tau_{c-l}$  = is the lower critical shear stress value ( $\text{lb}/\text{ft}^2$ ) for determining particle mobility and immobility for the particle size of interest
- $D_i$  = is the particle size of interest, mm (ft)

Steps:

1. Calculate the average boundary shear stress using Equation 6.6 for the flow of interest (e.g. bankfull).
2. Using Equations 6.12 and 6.13, calculate the upper and lower critical shear stress values for the particle size of interest at any given cross sections (e.g.  $D_{84}$ ).
3. To determine if the particle will be immobile, mobile, or potentially mobile, compare the average boundary shear stress for a particular flow to the upper and lower critical shear stress values for the particle size of interest.

If the average shear stress ( $\tau$ ) is greater than the upper critical shear stress ( $\tau_{c-u}$ ), the particle will be mobile at this flow. If the average boundary shear stress ( $\tau$ ) is less than the lower critical shear stress ( $\tau_{c-l}$ ), then the particle will be immobile for these flow conditions. If the average boundary shear stress is between the upper and lower critical shear stress values, then the particle has potential to move at these flow conditions.

#### **6.5.5.5 U.S. Army Corps of Engineers Riprap**

##### **Source**

- USFS Stream Simulation – DRAFT Manual (Bates et al. 2006)
- Roughened Channel Design, WDFW (Bates et al. 2003)

##### **Applicability**

- $D_{84}/D_{15}$  ratio typically less than 3-7 in practice
- Sizing immobile key pieces

##### **Limitations**

- Considers angular rock (not specifically applicable to round rock)
- Rock may move as smaller rocks surrounding key pieces move. Similar-sized rock should be used to support key pieces.

The U.S. Army Corps of Engineers has developed two riprap models for designing riprap bank protection. These were developed through laboratory and analytical work, and consider angular rock, which is resistant to sliding and rolling. Note that round rock may have to be significantly larger than angular rock to achieve similar levels of stability (Abt, 1988).

Manuals are available at <http://www.usace.army.mil/publications/eng-manuals/em1110-2-1601>.

For slopes from 2-20%

$$D_{30} = \frac{1.95S^{0.555} (1.25q)^{2/3}}{g^{1/3}}$$

**Equation 6.14**

where:

- D<sub>30</sub>= dimension of the intermediate axis of the 30<sup>th</sup> percentile particle, m (ft)
- S= the bed slope, m/m (ft/ft)
- q= the unit discharge, m<sup>2</sup>/s (ft<sup>2</sup>/s)
- g= acceleration due to gravity, m/s<sup>2</sup> (ft/s<sup>2</sup>)

1.25 is a safety factor that may be increased, and designers are cautioned against using this method for rock sizes greater than 0.15 m (6 in).

The U.S. Army Corp of Engineers recommends angular rock with a uniform gradation (D<sub>85</sub>/D<sub>15</sub> = 2). This is not preferred for fish passage situations due to porosity issues. An approximate factor for scaling D<sub>30</sub> of a uniform riprap gradation to one that is appropriate for stream channels is 1.5, so that:

$$D_{84} = 1.5D_{30}$$

**Equation 6.15**

where:

- D<sub>84</sub> = dimension of the intermediate axis of the 84<sup>th</sup> percentile particle, m (ft)

#### **6.5.5.6 Reference Reach Approach**

##### **Source**

- WDFW Stream Simulation (Bates et al. 2003)

Maximum particle size and appropriate sediment size distribution can be determined by examining reaches directly upstream from the culvert, or nearby reaches with similar characteristics to the design channel (e.g. unit discharge, slope, geometry and relative stability).

#### **6.5.5.7 Unit-Discharge Bed Design**

##### **Source**

- WDFW Stream Simulation (Bates et al. 2003)

J.C. Bathurst developed the following equation to predict the size of  $D_{84}$  particles that would be on the threshold of motion for a given critical discharge in high gradient streams with heterogeneous beds (1987).

$$D_{84} = 3.54S^{0.747}(1.25q_c)^{2/3}/g^{1/3}$$

**Equation 6.16**

where:

- $D_{84}$  = intermediate axis of the 84<sup>th</sup> percentile particle in the sediment distribution, m (ft)
- $S$  = energy slope of the proposed channel
- $q_c$  = the critical unit discharge (total design discharge divided by the width of the bankfull channel) at which incipient motion of  $D_{84}$  occurs,  $m^2/s$  ( $ft^2/s$ )
- $g$  = the acceleration due to gravity,  $m/s^2$  ( $ft/s^2$ )

This is recommended as a starting point for development of sediment mixes in high gradient streams. Two design categories are recommended based on slope.

1. If channel slope is less than 4%, bed-changing flows may vary greatly. J.E. Costa's paleohydraulic analysis (described below) may be used to determine the magnitude of the bed changing flow for a given particle size.
2. If channel slope is greater than 4%, 100-year flood is used for design flow. This will closely predict the same size particle as that found in natural channels with similar  $Q_{100}$  and  $W_{ch}$ . This is the goal of stream simulation.

These methods generally agree, but should both be checked. These are mobile or nearly mobile particles at these flows. If it is advisable to create a bed that is more stable, particle sizes should be increased. If bed slope approaches or exceeds 1.25 times the natural reach slope, it may not be possible to simulate stream conditions, and a Hydraulic Simulation approach or a Hydraulic Design approach, such as Roughened Channel may be considered (Section 7.3.4).

#### **6.5.5.8 Paleohydraulic Analysis**

##### **Source**

- WDFW Stream Simulation (Bates et al. 2003)

Paleohydraulic analysis uses the maximum particle size and flood depth to determine the discharge of flash floods. An equation developed by Costa (1983) to understand velocity based on particle size is useful in substrate sizing for stream channel design. Users should consult Costa (1983) to supplement their understanding of this procedure. This equation and the accompanying table (6.5) are in customary units.



For determining depth, velocity (ft/s) is given by:

$$V = 9.57(D_{84})^{0.487}$$

Equation 6.17

where:

$D_{84}$  = is arrived at by an iterative procedure, ft

Steps:

1.  $D_{84}$  is assumed, allowing velocity to be calculated by Equation 6.17.
2. Divide design flow by velocity to get cross-sectional area of flow.
3. Find depth from proposed channel cross section.
4. Use Table 6.5 to find the associated particle size.
5. When the resulting particle size agrees with the initial estimate, the particle design is considered suitable for design.

**Table 6.5 Prediction of Water Depth for a Given Maximum Particle Size that Has Been Moved (Bates et al. 2003)**

(Data has been converted to English Units; some values are log-interpolated)

Slope ->	0.005	0.01	0.02	0.03	0.04	0.05	0.06	0.07	0.08	0.09	0.1
Particle Size, ft	Depth, ft										
0.2	1.2	0.9	0.6	0.5	0.5	0.4	0.4	0.4	0.4	0.4	0.4
0.5	3	2.1	1.5	1.3	1.2	1	1	0.9	0.9	0.9	0.8
1	6	4.1	2.9	2.5	2.2	1.9	1.8	1.8	1.7	1.6	1.5
1.5	8.8	5.9	4.1	3.6	3.1	2.7	2.6	2.5	2.4	2.2	2.1
2	11.3	7.4	5.2	4.5	3.9	3.4	3.2	3.1	2.9	2.8	2.7
2.5	13.6	8.9	6.2	5.4	4.7	4.1	3.9	3.7	3.5	3.3	3.2
3	15.6	10.2	7.1	6.1	5.3	4.6	4.4	4.2	4	3.8	3.6
3.5	17.6	11.4	7.9	6.9	6	5.2	4.9	4.7	4.5	4.3	4.1
4	19.5	12.6	8.7	7.5	6.6	5.7	5.4	5.2	4.9	4.7	4.5
4.5	21.3	13.7	9.4	8.2	7.2	6.2	5.9	5.7	5.4	5.1	4.9
8.1	36.4	23.1	15.6	13.5	11.7	10.1	9.6	9.1	8.6	8.2	7.8
10.5	45.6	28.9	19.4	16.7	14.4	12.5	11.8	11.2	10.6	10	9.5

At higher slopes, the Costa equation predicts smaller particle sizes than the Bathurst equation, all other conditions being equal (Bates et al. 2003).

### 6.5.5.9 Critical Shear Stress Method

#### Source

- Roughened Channel Design, WDFW (Bates et al. 2003)

Critical shear stress methods are used to estimate the initial movement of particles. Particles movement occurs when the maximum shear stress,  $\tau_{0max}$ , within the channel exceeds a calculated critical shear stress,  $\tau_c$ . Critical shear stress is the shear stress required to cause movement of a given particle size (see Sections 6.5.5.2 and 6.5.5.4). The maximum shear stress is 1.5 times  $\gamma RS$ , where  $\gamma$  is the unit weight of water,  $R$  is the hydraulic radius, and  $S$  is the slope. Data used to derive these equations are largely from low-gradient situations, although design charts show slopes up to 10% and particle sizes up to 0.58 m (1.9 ft) (Bates et al. 2003).

### **6.5.6 Countermeasures for Channel Instability**

As a rigid structure in dynamic environment, culverts may require consideration of riprap and channel modification to address scour and channel degradation or incision (Bates et al. 2003; Robison et al. 1999; Maryland State Highway Administration 2005). An undersized culvert will destabilize the adjacent stream reach. A number of alternatives are available to protect the impacted channel. Modification of the channel both up- and downstream of the structure can decrease the slope required at the culvert installation, helping to meet velocity, gradient and embedment requirements.

#### **6.5.6.1 Scour Countermeasures**

##### **Riprap:**

Riprap refers to oversized rock strategically placed within the channel to control scour and erosion. Application of riprap for energy dissipation is outlined in Hydraulic Engineering Circular 14 – Hydraulic Design of Energy Dissipators for Culvert and Channels (Thompson and Kilgore 2006). Figure 6.6 depicts improper use of riprap for a fish passage situation. When utilized, voids in riprap should be filled with fines to prevent flows from going subsurface (Maine Department of Transportation 2004).



**Figure 6.6 Downstream riprap will dissipate energy and reduce scour, but must be placed with fish utilization in mind (USFS 2005)**

(Note - riprap at this culvert exit effectively blocks fish passage)

### **Energy Dissipation Pool:**

The state of Maine requires an energy dissipation pool at culvert outlets (Maine Department of Transportation 2004). These pools allow fish to rest before attempting to enter a structure, ensuring proper culvert outlet hydraulics and backwatering. General requirements include a pool width greater than or equal to 2 times the culvert span, and a pool length greater than or equal to 3 times the culvert span. Weirs are used to maintain the appropriate flow elevation and flow capacity. If the pool does not backwater the culvert outlet during the design period, the Energy Dissipation Factor (Section 3.2.5) is checked to ensure that it is less than or equal to  $4\text{ft}\cdot\text{lb}/\text{ft}^3/\text{s}$  (Maine Department of Transportation 2004).

### **6.5.6.2 Channel Modifications**

Downstream channel modifications may be necessary to ensure proper culvert backwatering or to control crossing slope. Upstream channel modification can include erosion or grade control structures (detailed below), or a tapering of channel banks to smooth out the impacts of an inlet constriction (Robison et al. 1999). Such grade controls are frequently an element of a cost-effective retrofit; they are also used on replacement projects. A number of techniques for channel modification are included in Table 6.6.

**Table 6.6 Comparison of Channel Profile Design Structures Used to Control Grade either Upstream or Downstream of a Culvert (adapted from Bates et al. 2003 with additional comments from other sources)**

<b>Grade Control</b>	<b>Advantages</b>	<b>Disadvantages</b>	<b>Limitations</b>
Log Sills	Downstream bed-elevation control	Limited to <5% final gradient (affects length to catch channel grade)	Minimum spacing of 15 ft. Limited to <5% gradient. Allowable drop depends upon fish requiring passage. No wet/dry cycles between.
Baffles	Increase hydraulic roughness	Turbulence, hydraulic profile raised, debris and structural problems. No small fish passage.	Slope less than or equal to 3.5%.
Plank Sills	Hand Labor	Less durability	Limited to <5% gradient streams, small streams.
Roughened Channel	Natural appearance, flexible, can provide passage for all fish.	Technical expertise required. Technical fish-passage analysis required.	Limited to <3% gradient streams.
Boulder Controls	Flexible, allowing channel to regrade slowly	Should only be used for downstream use if culvert is sufficiently embedded.	Maximum drop of 0.75 ft.
Fishway	Can provide passage for most fish	Expensive. Technical expertise and site-specific, flow-regime data required. Debris and bedload problems.	Narrow range of operating flow. Difficult to provide passage for all fish, all of the time.

### **6.5.6.3 Roughened Channel**

Roughened channels can be constructed within the natural channel to control channel shape, slope and form. This may be especially pertinent in areas where past degradation causes a culvert installation to be placed at a severe slope. Methods and equations used in the design of roughened channels can be found in Section 7.3.

### **6.5.6.4 Grade Control Structures**

Grade control structures may be necessary upstream or downstream of a culvert to control longitudinal profile and water surface elevations. Downstream of a culvert these installations typically backwater the culvert and stabilize steepened reaches. Figure 6.7 depicts the placement of downstream grade control. Such structures have been shown to cause problems with fish passage (Browning 1990), and a clearance of 20 ft between the culvert outlet and the first downstream control is recommended (Bates et al. 2003; Robison et al. 1999). Upstream of a culvert, grade control is used to stabilize a reach and protect against current or future headcutting.

This type of structure, depicted in Figure 6.8, should end no closer than 35-50 ft from the culvert inlet (Bates et al. 2003).

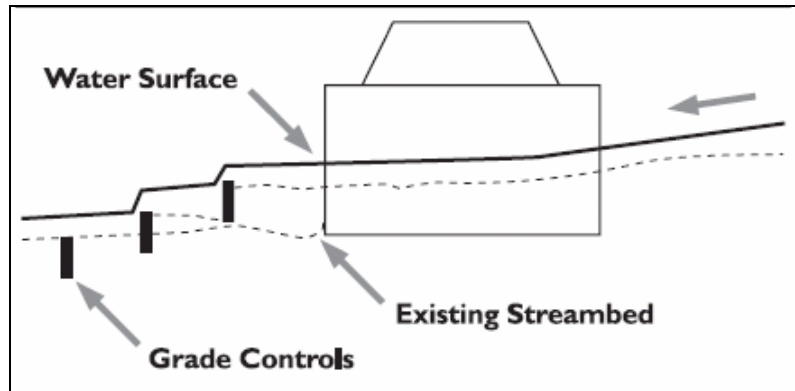


Figure 6.7 Downstream grade control (Bates et al. 2003)

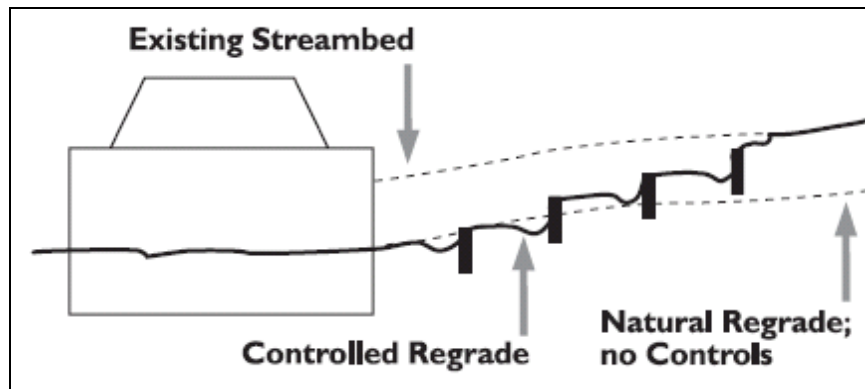


Figure 6.8 Upstream regrade channel-steepening options (Bates et al. 2003)

#### 6.5.6.5 Tailwater Control

It may also be necessary to raise the tailwater elevation in order to backwater the culvert and provide minimum flow depths. Sometimes this is all that's required to retrofit a flat, short culvert. Many methods are available including:

- Weirs
- Sills
- Constructed tailwater pools
- Full or partial channel restoration
- Riffle grade control structure/Roughened Channel

Flow over weirs can create velocity and depth barriers, and it may be necessary to design a series of weirs to provide fish passage and backwatering the culvert.

### 6.5.6.6 Broad Crested Weirs

The Maine Department of Transportation describes the following method for the design of a rectangular notch weir - Broad Crested Weir (Maine Department of Transportation 2004). This is a channel-spanning structure at the culvert outlet, which can be used to ensure proper water surface elevation and backwatering. When the drop over a weir will create a barrier to fish passage, it will be necessary to include further control structures to create a series of manageable step pools while maintaining adequate culvert backwater. A series of notch weirs is depicted in Figure 6.9.



Figure 6.9 Notch weirs downstream of a culvert installation, acting to properly backwater the culvert, while maintaining manageable drops (United States Forest Service 2005)

#### Design Procedures are as follows:

At first pass, the weir height can be set at the desired water height (ignores the depth of flow over the weir).

$$Q = C_d(2/3)(2g/3)^{1/2}b_c h_1^{3/2}$$

Equation 6.18

where:

$C_d$  = discharge coefficient (0.9 assumed)  
 $b_c$  = channel width across the bar, m (ft)

$h_1 =$  water elevation upstream of the bar (referenced to bar elevation), m (ft)

Solving for  $h_1$

$$h_1 = [Q/(C_d(2/3)(2g/3)^{1/2}b_c)]^{2/3}$$

**Equation 6.19**

(Note the assumption 0.9 is in view of the uncertainty and variability in the weirs contemplated here.)

Flow over the weir will be critical, and velocity ( $v_c$ ) must be checked for fish swimming ability:

$$v_c = (gh_1)^{1/2}$$

**Equation 6.20**

where:

$v_c =$  critical velocity, m/s (ft/s)

This procedure uses constructed materials. Consultation with appropriate State and Federal agencies should occur to determine the acceptability of this design.

Channel regrade promoted by an undersized culvert installation can be a concern with culvert replacement or removal. Grade control structures can be used up and/or downstream of the structure to help protect against catastrophic channel regrade.

### **6.5.7 Culvert Shapes and Standards**

A number of culvert shapes are available to meet the specific needs of a culvert site. Selection will be the result of site conditions including depth of cover, limited allowable headwater elevations, clogging potential, need for natural stream bottom, or structural and hydraulic requirements (Ballinger and Drake 1995). Common shapes for fish passage design include round and elliptical pipes, box culverts, and open-bottom arches. All types of culvert shapes have been used for fish passage, and selection is likely the result of site conditions and personal preference (Bates et al. 2003). Table 6.7 is a collection of noted advantages and disadvantages of culvert shapes and materials.

**Table 6.7 Advantages and Disadvantages of Different Culvert Shapes for Fish Passage Installations**  
(from White 1997; Norman et al. 2005; Bates et al. 2003; Robison et al. 1999)

<b>Shape</b>	<b>Advantages</b>	<b>Disadvantages</b>
<b>Bridge</b>	Usually the best alternative for fish passage.	Cost
<b>Circular</b>	Structurally and hydraulically efficient. Greater depth of fill allowable for given span, and easier installation (in reference to Arch or Pipe Arch installations).	More prone to clogging at high flows. Flexible walls in large culverts require special care during backfill construction.
<b>Pipe-Arch and Elliptical</b>	Wider section available for low flows with less height.	For buried culverts, installation can be difficult.
<b>Arch</b>	Very good fish passage when sized adequately. Allow natural streambed material to be maintained in new installations.	Expensive installation. Not practical when stable footings cannot be created.
<b>Structural plate (Round or Arched)</b>	Can be placed on the bedding and partially backfilled with top plates left off.	Distortion during compaction can lead to problems joining final pieces. Structural plate pipes should not be backfilled until all plates are completed and bolts tightened.
<b>Box</b>	Easily adaptable to a variety of situations.	Not as structurally and hydraulically efficient as other shapes due to angled corners.
<b>Multi Cell</b>	Allow adequate capacity in low profile situations. Lower road bed elevation.	Prone to clogging due to area between the barrels and smaller individual culvert size.

Corrugated metal culverts are commonly used in fish passage design. These structures provide boundary roughness that may be conducive to fish passage (Powers et al. 1997; Barber and Downs 1996; Behlke et al. 1989), as well as aiding in retention of bed materials (Bates et al. 2003). Culvert embedment is also commonly called for, with some exceptions in hydraulically designed culverts. When new installations utilize natural bed material, bottomless structures have the advantage of allowing natural substrate to remain in place.

Standards for bridges, culverts, foundations and backfill can be found in “Standard Specifications for Highway Bridges, 17<sup>th</sup> edition” (AASHTO HB-17, AASHTO, 01-Sept, 2002).

### **6.5.8 Simulation Software**

Several computer programs exist to assist the engineer in the design process. FishXing is most often used to assess culverts for fish passability and is often used in conjunction with FishBase. HY-8 v. 7.0 is used to analyze the detailed hydraulics of culvert flow and for design. HEC-RAS is used for design on larger rivers and for culverts in series where the water surface elevation of one culvert is affected by another. All of these programs predict average cross-sectional velocities within the culvert barrels.



### 6.5.8.1 FishXing

FishXing (pronounced “fish crossing”) is a fish passage analysis tool developed by the United States Forest Service. According to product description, FishXing provides the following features (United States Forest Service 2006a):

- Allows for comparison of multiple culverts designs within a single project
- Calculates hydraulic conditions within circular, box, pipe-arch, open-bottom arch, and embedded culverts
- Contains default swimming abilities for numerous North American fish species
- Contains three different options for defining tailwater elevations
- Calculates water surface profiles through the culvert using gradually varied flow equations, including hydraulic jumps
- Outputs tables and graphs summarizing the water velocities, water depths, outlet conditions, and lists the limiting fish passage conditions for each culvert

This software is free and available for download at <http://www.stream.fs.fed.us/fishxing/>.

Noted limitations include:

- Incomplete fish swimming ability data (although the program does provide the option for user input of swimming values)
- Roughness coefficient selections limited and not always practical
- Steep learning curve
- Validation issues

This program has been recommended as a first cut analysis tool, but for concrete prioritization, design or analysis site visits and analysis should be completed (Cahoon et al. 2005). Analysis with field assessment and study has found FishXing to match results between 71-100% of the time (Rajput 2003; Cahoon et al. 2005). A powerful use for FishXing is in a culvert assessment of “indeterminate” designated crossings. The software may be able to move a designation to “passable” or “impassable.”

### 6.5.8.2 FishBase

FishBase is a searchable relational database catering to different professionals including research scientists, fisheries managers, zoologists and many more. It contains information on over 28,500 fish species, including pictures, data on swimming speeds, distribution, biology, and references. It is available on CD or on the web at <http://filaman.ifm-geomar.de/home.htm>.

### 6.5.8.3 HY-8 v. 7.0

The HY-8 v. 7.0 Culvert Analysis program was developed by FHWA in order to automate some of the information contained within HDS-5, "Hydraulic Design of Highway Culverts," HEC-14, "Hydraulic Design of Energy Dissipaters for Culverts and Channels," and HEC-19, "Hydrology." It is intended for hydraulic capacity design, but is useful in evaluating design flood stability, scour potential, and culvert barrel velocity. Maryland suggests the use of other programs for the calculation of tailwater rating curves (Maryland State Highway Administration 2005).

This software is free, and available for download at <http://www.fhwa.dot.gov/engineering/hydraulics/software/softwaredetail.cfm>.

Noted limitations include:

- Cannot be used for horizontal or adversely sloped culverts
- Cannot explicitly simulate embedded culverts (user must approximate modified shape)

### 6.5.8.4 HEC-RAS

The Hydrologic Engineering Center River Analysis System (HEC-RAS) is a river modeling program developed by the U.S. Army Corps of Engineers. HEC-RAS can be used to perform hydraulic calculations for a full network of natural and constructed channels. Users have the ability to place culverts within channel context and perform analyses of one-dimensional steady and unsteady flow. The steady flow component is capable of modeling subcritical, supercritical and mixed flow regimes, while the unsteady flow component was developed primarily for subcritical flow calculations.

HEC-RAS is free and available for download at <http://www.hec.usace.army.mil/software/hecras/hecras-download.html>.

Noted limitations include:

- Very steep learning curve

### 6.5.8.5 Commercial Programs

There are many commercial programs available for analysis and design of culverts, but their applicability has not been evaluated for this publication. A short discussion of many of these programs is available in *Environmental Stewardship Practices, Procedures, and Policies for Highway Construction and Maintenance*. Final Report for NCHRP Project 25-25, Task 4, National Cooperative Highways Research

Program Transportation Research Board (Venner Consulting and Parsons Brinkerhoff 2004).

The FishPass Website is a sponsored project of the Bioengineering Section of the American Fisheries Society. FishPass is a forum for professional discussion of the biological and engineering science of upstream and downstream fish passage. Areas of discussion include fish passage technologies, projects, swimming capabilities and behavior and biological and engineering studies and events.

Subscription details are available at <http://www.fishpass.org>.

#### **6.5.8.6**

This page intentionally left blank

## 7 DESIGN METHODS

### **HOW TO USE THIS CHAPTER**

- ▶ See specific design procedures in each Design Category as currently used by State DOTs and State and Federal natural resource agencies
- ▶ Learn what data are needed for each of the selected methods
- ▶ Compare and contrast methods and procedures
- ▶ Learn about auxiliary components that can improve design: fishways, floodplain relief culverts and two-cell installations
- ▶ Learn about the use of tide gates in coastal areas for fish passage

The design methods summarized in this chapter represent the spectrum of techniques that are currently available to meet fish passage. Variability is in part due to the conditions under which criteria were developed, and in part due to specific agency policies and regulatory thresholds. It is not clear from the source materials which guidelines are based on physically tested field conditions or different mandates, conservatism and local practice. More research is required to provide a better basis for the methods described in this chapter (see Chapter 11, Future Research Needs). Applicability may be limited to specific geomorphic and hydraulic conditions. Careful attention should be paid to applicability and limitations, and engineering judgment is required. It is recommended that the featured agencies be contacted directly with questions as these methods evolve.

Equations provided are based on the recommendations of design manuals for States or local areas. Designers should be familiar with the source, derivation, and limitations of these equations before using them. A review of method applicability was not conducted as part of the development of HEC-26, and engineering judgment must be used when applying state-of-practice technologies, remembering the importance of monitoring in the future refinement of these methods.

All of these methods require careful attention to the project alignment and profile. To ensure that the project layout is properly aligned with the eventual channel profile, a two-dimensional plan view, connecting the upstream and downstream channels, must be combined with a streambed profile, connecting vertically stable points upstream and downstream of the crossing. This will provide insight into channel degradation and eventual channel elevation.

### **7.1 GEOMORPHIC SIMULATION (CATEGORY 1)**

As defined in Chapter 6, Geomorphic Simulation approaches are based on recreating or maintaining existing channel geometry for approximately bankfull conditions. These design techniques attempt to mimic (or maintain) natural stream reach characteristics including slope, channel-bed width, bedform, and

bed materials. The basis of these methods is the presumption that crossings matching natural conditions will readily pass fish that are moving in the natural channel.

The three examples of Geomorphic Simulation included in Section 7.1 represent the spectrum of design techniques available. The USFS takes a stream reference reach approach, while Washington State utilizes a specific set of general culvert-span criteria. Both methods are very similar and describe different procedures to achieve the same objective. Massachusetts (River and Stream Continuity Partnership 2006) has recently established similar procedures that have proven helpful in obtaining general permits for fish and aquatic-organism passage culverts. Washington's No Slope and NMFS's Active Channel technique, combined due to their similarity, provide simple and conservative design approaches that are applicable in very limited situations. A summary of design approaches is included in Table 7.2 at the conclusion of Section 7.1.

Although maintaining stream continuity through the structure is the goal, these techniques are subject to the constraints of existing channel conditions, including slope, available bed material and others identified in Section 6.2. The USFS and WDFW criteria for stream simulation provide equations that allow for adjustment of bed mobility and stability. If substantially larger substrate is required, the design becomes a Hydraulic Simulation approach (Section 7.2).

## **7.1.1 U.S.F.S. Stream Simulation – DRAFT Manual**

### **Source**

- Bates et al 2006

### **Applicability**

- New and replacement installations
- Passage required for all fish and aquatic organisms

### **Limitations**

- Slope of crossing resembles slope of natural channel or representative reach
- Limited examples for cohesive soils

The United States Forest Service recently produced a draft manual of their “Stream Simulation” design technique. This methodology utilizes a reference reach approach to understand bed material, channel morphology and structures found within the natural channel. A crossing structure is then designed to match reference reach characteristics. This ideally creates a crossing that is self-sustaining and free to adjust similarly to the natural channel.

This approach is simplest for new installations, where open bottom structures can be placed to span the stream channel, leaving natural bed material and bedforms in place. In replacement installations, past channel degradation may require a culvert to be steeper than the natural channel.

Although the following discussion summarizes design procedures, adequate understanding of channel processes and site characteristics is necessary to complete a viable fish passage culvert. The draft manual is quite comprehensive, but appropriate designs will require a skilled group of design professionals with breadth of knowledge covering engineering, hydrology, biology, and geomorphology. For further details refer to Bates et al 2006. Note - many criteria, such as slope, width and applicability are largely left to the discretion of design professionals who work as a team to find the appropriate combination of variables to meet project objectives.

#### **7.1.1.1 Biological Characteristics**

This design allows for passage of all fish and aquatic organisms.

#### **7.1.1.2 Geomorphic Characteristics**

The slope of the crossing resembles the slope of the natural channel or reference reach, ideally creating a crossing that is self-sustaining and free to adjust to the natural channel.

In new installations, where open bottom structures can be placed to span the stream channel, natural bed material and bedforms will be left in place, although significant disturbance may occur during construction. Replacement installations may require a culvert to be steeper than the natural channel due to past channel degradation.

Ideally natural bed material will be used. If not, a well-graded mix of materials should be created to closely approximate the natural streambed, especially with respect to mobility and particle size distribution. Angular rock may be necessary to simulate large wood structures of the reference reach. A basic V-shaped low flow channel should be constructed within the culvert barrel to provide a continuous channel thalweg. The culvert should accommodate anticipated widening or narrowing of incising channels.

### **7.1.1.3 Hydraulic Characteristics**

Analysis of flows for aquatic organism passage is not required. Hydraulic capacity must be checked to meet required headwater-flood policy for the responsible agency.

### **7.1.1.4 Data Requirements**

#### **Channel Type:**

Table 7.1 depicts a number of design recommendations based on channel type. Channel types are based on Montgomery and Buffington, described in Section 6.5.2.1 (1997).



Table 7.1 Design Recommendations Based on Channel Types (adapted from Bates et al. 2006)

REFERENCE CHANNEL TYPE	TYPICAL CONDITIONS					RECOMMENDED DESIGN STRATEGIES
	Bed Material	Dominant roughness & structural elements	Slope	Entrenchment	Streambed mobility	
Dune-ripple	Sand to medium gravel	Sinuosity, bedforms, banks. Small debris may provide structure	<0.1	Slight	Termed "live bed"; significant sediment transport at most flows	<ul style="list-style-type: none"> <li>• Simulated bed can be native bed material or imported dense mix based just on <math>D_{100}</math> of reference reach.</li> <li>• Bands or clusters of material added to simulate diversity from wood.</li> <li>• Banklines designed to be immobile</li> </ul>
Pool-riffle	Gravel, often armored	Bars, pools, grains, sinuosity, banks	0.1-2	Slight	Armored beds usually mobilize near bankfull	<ul style="list-style-type: none"> <li>• Simulated bed <math>D_{100}</math>, <math>D_{84}</math>, <math>D_{50}</math> and <math>D_{max}</math> same as reference reach.</li> <li>• Material smaller than <math>D_{50}</math> is dense mix based on <math>D_{50}</math>.</li> <li>• Bands or clusters of material added for diversity.</li> <li>• Key features, banklines designed to be immobile.</li> </ul>
Plane-bed	Gravel to cobble, usually armored	Grains, banks	1-3	Slight to entrenched	Near bankfull	<ul style="list-style-type: none"> <li>• Simulated bed <math>D_{100}</math>, <math>D_{84}</math>, <math>D_{50}</math> and <math>D_{max}</math> same as reference reach.</li> <li>• Smaller material size distribution is dense mix based on <math>D_{50}</math>.</li> <li>• Key features, banklines designed to be immobile.</li> </ul>
Step-pool	Cobble to boulder	Steps, pools, banks. Debris may add significant structure	3-10	Moderately entrenched to entrenched	Fine material moves over larger grains at frequent flows depending on size; often $>Q_{30}$	<ul style="list-style-type: none"> <li>• Steps are spaced same as reference reach</li> <li>• Step-forming rocks are sized to be immobile.</li> <li>• Smaller material size distribution is dense mix based on <math>D_{50}</math> of material other than steps in reference reach</li> <li>• Banklines designed to be immobile.</li> </ul>
Cascade	Boulder	Grains, banks	8-30	entrenched	Small bed material moves at moderate frequencies (floods higher than bankfull). Larger rocks are immobile in flows smaller than $\sim Q_{50}$	<ul style="list-style-type: none"> <li>• Simulated bed <math>D_{100}</math>, <math>D_{84}</math>, <math>D_{50}</math> and <math>D_{max}</math> same as reference reach.</li> <li>• Smaller material size distribution is dense mix based on <math>D_{50}</math>.</li> <li>• Key features, banklines designed to be immobile.</li> </ul>
Bedrock	Rock with sediment of various sizes in transport over rock surface	Bed and Banks	any	any	Bedload moves over bedrock at various flows depending on its size. May be thin layer of alluvium over bedrock. Wood can strongly affect sediment mobility.	<ul style="list-style-type: none"> <li>• Stream simulation bed is bedrock.</li> <li>• Banklines and roughness elements are important and must be designed for stability, which requires embedding, clustering or anchoring boulders.</li> <li>• Condition, extent, and shape of bedrock are important.</li> <li>• Bottomless structure reduces rock removal compared to full pipe and can be anchored and shaped to rock.</li> </ul>
Channels in cohesive material	Silt to Clay	Sinuosity, banks, bed irregularities	any	any	Fine sediment moves over immobile bed at moderate flows depending on its size. May be thin layer of alluvium over immobile bed.	<ul style="list-style-type: none"> <li>• Stable cohesive bed and banks cannot be constructed in culvert.</li> <li>• Culvert walls may simulate smooth natural clay banks.</li> <li>• Bottomless structure might leave clay bed undisturbed.</li> </ul>

**Bed Material:**

When natural bed material cannot be used, a well-graded mix of materials should be created to closely approximate the particle size distribution of the reference reach. The most important elements of a constructed bed are large particles to provide bed structure, and fines to limit bed permeability and bind the bed mix together. Analysis of bed material can be done through a sieve analysis, but is most commonly done through a pebble count. When distribution is calculated by a pebble count,  $D_{100}$ ,  $D_{84}$ ,  $D_{50}$  of the reference reach are taken directly from the surface pebble count, and smaller grain sizes are determined through use of the Fuller-Thompson equation (Section 6.5.5.1) or some other method.

**Channel Width:**

Considerations of channel width will affect the culvert sizing and material selection. Channel width should consider channel entrenchment, key features and incision. In general, it is recommended that channel width be greater than or equal to:

1. Bankfull width of the reference reach, or
2. Four times the diameter of the largest particle in the simulated bed.

In situations where the channel is incising, culverts should be designed to accommodate anticipated widening or narrowing.

**Bed Structure:**

At a minimum, a basic V-shaped low flow channel should be constructed within the culvert barrel (Figure 7.1), providing a continuous channel thalweg until the channel is reshaped by higher flows. Temporary bed structures can also be used in low gradient channels to provide channel form until natural processes can shape the channel. Recommended structures include rock bands and clusters (to replicate the shape of dune-ripple and pool-riffle channels), marginal features to simulate the reference reach banklines and edge diversity, and key features to simulate specific structural features in the reference channel. Specific design of these features is included in the Stream Simulation Manual (Bates et al. 2006).

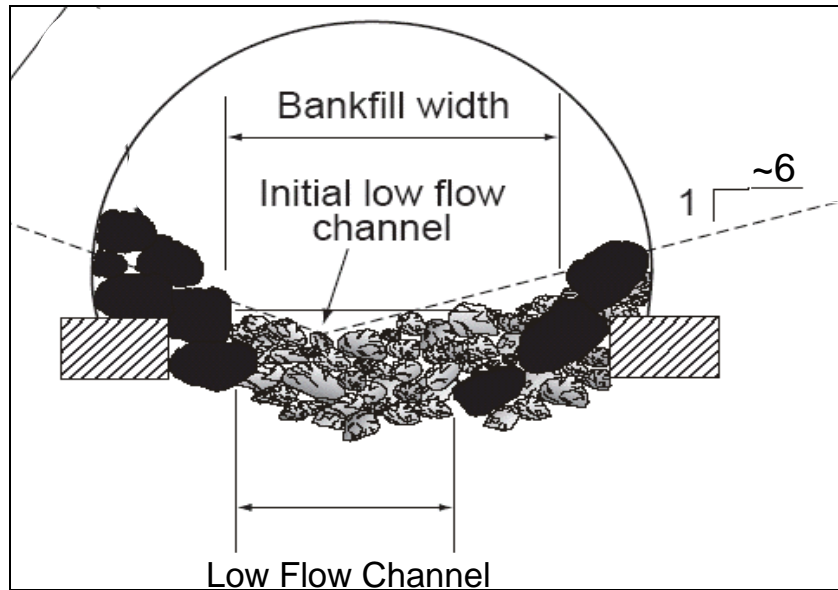


Figure 7.1 Low flow channel in an open bottom structure (Bates et al. 2006)

**Culvert Span:**

Culvert span is determined through a combination of bankfull width calculations and provisions for banklines and overbank surfaces. This should also incorporate channel width considerations. If banklines are desirable, an initial estimate of culvert width could be bankfull width plus 2 to 4 times the diameter of the largest mobile particle in the bed is suggested. A minimum barrel width of 1524-1830 mm (5-6 ft) is recommended to allow placement of sediment within the barrel.

**Bed Mobility and Stability:**

Checks can be made to ensure that bed material is mobile when channel material is mobile, and that banklines and key features remain stable at high design flows. Typically, analysis is conducted on the particle size that provides structure ( $D_{84}$ ). Bathurst's unit discharge equation, the modified Shield's equation and U.S. Army Corps of Engineers riprap-sizing equation (see Section 6.5.5.5) are recommended for this analysis. Designers should have a thorough understanding of the source, derivations, and limitations of these equations before use. Further discussion of these methods is included in the Stream Simulation Manual Appendix E (Bates et al. 2006).

**7.1.1.5 Design Procedure**

1. Perform site assessment to determine the reference reach.
2. Determine project alignment and profile (see Introduction to Chapter 7).
3. Design bed material and arrangement.
4. Select structure size and elevation.
5. Verify mobility / stability of simulated streambed.

## **7.1.2 WDFW Stream Simulation**

### **Source**

- Bates et al 2003

### **Applicability**

- New and replacement installations
- Passage allowed for all species

### **Limitations**

- Culvert slope does not exceed 125% of channel slope

In new installations, it is desirable to use open bottom structures placed at stream grade to allow natural bed material and form to remain undisturbed if possible. In replacement installations, culvert slope should be within 125% of the upstream channel slope. In the case that natural bed material must be disturbed during construction, Washington's manual considers two design scenarios – outlined in Section 7.1.2.4.

#### **7.1.2.1 Biological Characteristics**

This design allows for passage of all aquatic organisms.

#### **7.1.2.2 Geomorphic Characteristics**

In new installations, the use of open bottom structures placed at stream grade allows natural bed material and form to remain undisturbed, if channel widths exceed about 5 m (16.4 ft). In replacement installations, the culvert slope should be within 125% of the upstream channel slope. One design scenario applies to streams of grades lower than 4%. Natural bed material is interspersed with bands of coarse material to control initial grade and cross-sectional shape, providing a low flow channel for fish passage and addressing slow channel formation in low-gradient streams with much fine sediment. The channel thalweg forms toward the culvert center, and in wide lower-gradient culverts, the low flow channel should meander.

In the second scenario, for slopes greater than 4%, coarser sediment found in streams is assumed adequate to control bed stability and create paths for fish passage.

When culvert bed slope matches natural channel slope, sediment supplied to the structure will rebuild the culvert bed after extreme flooding. When the slope ratio approaches upper limits, coarse bed materials will not be recruited and finer materials lost over time. Bed stability must be addressed. If greatly oversized bed material is needed, the culvert will not resemble the natural channel.

### 7.1.2.3 Hydraulic Characteristics

This design avoids the need for analysis of flows for aquatic organism passage. The culvert must be checked for adequate flood capacity. If channel slope is greater than 4%, the 100-yr flood is used as design flow in determining bed stability.

### 7.1.2.4 Data Requirements

#### Site Suitability:

- The ratio of culvert bed slope to channel slope (slope ratio) must be less than 1.25. Channel slope is generally taken as the upstream channel slope, but downstream slope can be used if it is representative of channel slope.
- The culvert itself should be placed as flat as possible to reduce shear stress between the culvert bottom and the bed material. Long installations will likely require the culvert to be placed with slope.
- Channel susceptibility to vertical changes should be assessed, and taken into account with culvert size and countersink elevation. Larger culverts will be required if material is likely to aggrade, and a lower countersink will be required in situations where channel degradation could undermine culvert stability.

#### Adjacent Stream Reach:

For most new and replacement installations, a representative reach will be used to determine the proper bed sizing and culvert span. This reach is typically found upstream, with considerations of slope ratio mentioned above ( $S_{\text{culvert}}/S_{\text{channel}} \leq 1.25$ ).

Two design scenarios are considered for these structures. The first scenario is applicable in low-gradient alluvial channels matching pool-riffle channel forms, or exhibiting the characteristics of Rosgen C, E or F-type channels. A second scenario applies in higher gradient streams with step-pool or cascade-type channels that are likely to be more stable - corresponding to Rosgen's stream classifications of A, B, F or G. In Washington, a somewhat arbitrary 4% threshold is used to divide these two methods.

#### Culvert Type and Size:

Minimum bed width in any culvert should be determined by:

$$W_{\text{culvert bed}} = 1.2W_{\text{ch}} + K$$

Equation 7.1

where:

$$K = 0.6 \text{ m (2 ft)}$$

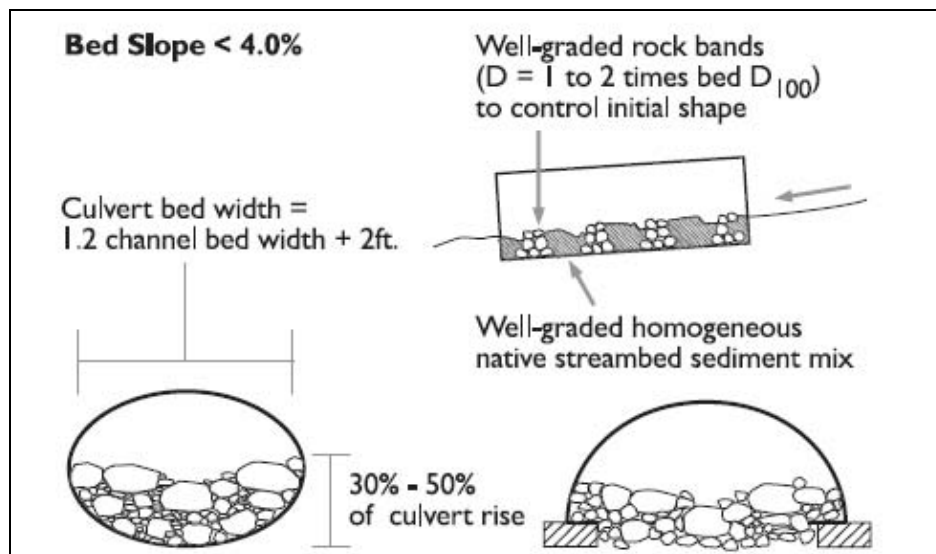
$W_{ch}$  = the width of the bankfull channel, m (ft)

Equation 9.1 applies to confined and moderately confined coarse-bedded channels. Future channel widening (of an incised channel) should be taken into account. A full discussion of reasoning for these width criteria is included in the WDFW manual, and should be addressed before deviating from Equation 9.1.

### Culvert Bed Configuration:

The decision to use a particular slope scenario (Figure 7.2 and 7.3) is based on channel assessment. Channel-bed composition should be described by a sample of the bed material or by a surface pebble count. In situations where large wood or roots dominate the reach, a representative reference reach (exhibiting similar slope and width) should be used as a design template.

The first design scenario, depicted in Figure 7.2, is utilized when slopes are less than 4% in the natural reach. Natural bed material is interspersed with bands of coarse material (1 to 2 times  $D_{100}$ ) to control initial grade and cross-sectional shape. This provides a low flow channel desirable for fish passage, and addresses the likelihood of excessively slow channel formation in low-gradient streams with a large proportion of fine sediments. This also ensures that the channel thalweg forms towards the culvert center, reducing the probability of channel formation along culvert boundaries. In wider, low-gradient culverts, the low flow channel should meander to match natural conditions.



**Figure 7.2 Washington Department of Fish and Wildlife Stream Simulation approach for low slope situations, where bed slope < 4.0% (Bates et al. 2003)**

(Structure is filled with native streambed material and bands of well-graded rock to control initial shape of the culvert bed)

### Spacing and Sizing of Rock Bands:

The distance between rock bands should be the lesser of five times channel width or the distance necessary to provide a drop between bands of less than or equal to 0.24 m (0.8 ft). The first and last rock bands in the structure should be distanced from the culvert inlet and outlet by more than 2 channel widths or 7.62 m (25 ft), whichever is less.

For slopes greater than 4%, native or engineered bed material is used without bed-control structures. Coarser sediment found in streams is assumed adequate to control bed stability and create paths for fish passage. Figure 7.3 depicts this culvert configuration.

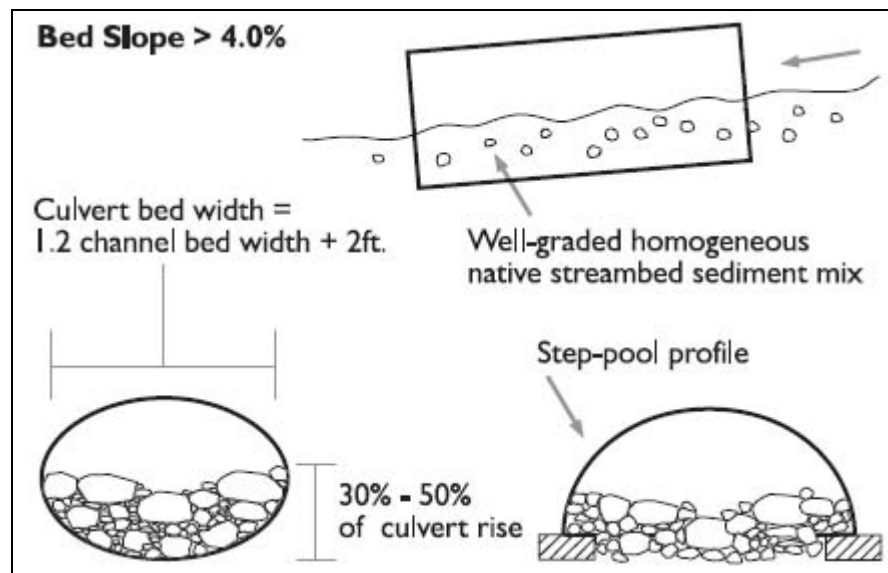


Figure 7.3 Washington Department of Fish and Wildlife High-Slope Stream Simulation Approach (Bates et al. 2003)

(Span and embedment criteria remain the same, but bed material consists of native sediment mix)

### Culvert-Bed Design:

Bed mix requirements vary with slope considerations:

- When culvert bed slope matches natural channel slope, sediment supplied to the structure will allow the bed in the culvert to rebuild after large flood events. Appropriately sized culverts will have bed material matching that found in the natural channel.
- When the slope ratio approaches the limits of Geomorphic Simulation (1.25), coarse bed material required to maintain the slope will not be recruited, and finer materials will be lost over time. In this situation, a number of approaches aid in bed stability design: Reference Reach Approach, Unit-Discharge Bed Design and Paleohydraulic Analysis (see sections 6.5.5.6, 6.5.5.7 and 6.5.5.8, respectively). The method producing

the coarsest  $D_{84}$  should be used. When stability requires bed material to be greatly oversized, it will no longer look or respond like the natural channel, and the resulting design may be more appropriately classified as Hydraulic Simulation.

**Bed Material:**

Once the largest material ( $D_{84}$ ) has been sized, the rest of the bed mixture should be well graded to minimize permeability. If material is imported, a synthetic streambed mix should be used. Relations for gradation are given as a starting point, and may be refined according to the availability of materials. Typical relations for gradation include:

$$\begin{aligned} D_{84}/D_{100} &= 0.4 \\ D_{84}/D_{50} &= 2.5 \\ D_{84}/D_{16} &= 8.0 \end{aligned}$$

Note – When ratios indicate impractical sizing, the adjacent channel should be looked at for guidance. For example, a  $D_{84}$  of 1.8 ft requires a  $D_{100}$  of 4.5 ft that is likely not represented in the natural channel (Bates et al. 2003).

Gradations are not overly restrictive so as to be practical and economical. Bed material comprised entirely of fractured rock is inappropriate for stream simulation, as jagged edges will interlock and dissuade appropriate migration of channel bed material.

Sediment finer than fine sand should account for 5-10% of the mix to prevent low flows from traveling through coarse voids.

**Bed Retention Sills:**

Although WDFW does not consider this a desirable option, the application of bed retention sills can be considered (as a last resort) to hold bed material within the culvert when slopes approach 1.25 times the reach slope. These sills can be steel or concrete placed at the bottom of the culvert to hold bed material within the barrel.

If desired, the crest of bed-retention sills should be V-shaped with a 10:1 slope laterally. These are placed at 20% of the culvert diameter below the streambed as constructed in the culvert. The maximum drop between sills should not exceed 0.24 m (0.8 ft), ensuring that each sill backwaters the next in the case that the bed material is scoured out.

**7.1.2.5 Design Procedure**

Washington State has developed a preliminary design process for stream simulation design based on local experience. Because of the relatively small amount of field experience, after consulting WDFW personnel for suggested updates, this procedure should be applied conservatively.



### **7.1.3 No-Slope and Active Channel Design**

#### **Source**

- Bates et al 2003
- National Marine Fisheries Service Southwest Region 2001

#### **Limitations**

- Stream reach slope <3%
- Culvert length <30.5 m (100 ft), or product of slope times length < 0.2D subject to requirements in “Culvert Length” section below
- Embedment requirements can be met

#### **Applicability**

- New and replacement installations
- Passage required for all species
- Low risk crossings

The No-Slope design specifies a culvert that is installed flat, and sized sufficiently large to allow natural movement of bed material and the formation of a stable bed within the barrel. This method avoids the need for detailed survey information or fish passage hydrology.

Aside from span requirements, NMFS’s Active Channel design is almost identical to WDFW’s No-Slope design. In Washington’s guidelines, the culvert span must exceed 1.25 times channel bankfull width, while NMFS recommends 1.5 times active channel width. California guidelines suggest that the active channel is generally less than bankfull width (Taylor and Love 2003). Entrenched streams in Washington may show little variation between active channel and bankfull widths (Bates et al. 2003). Discrepancies in regional manifestation of bankfull and active channel indicators likely lead to a similarly sized structure, although it would be conservative to take the larger of bankfull and active channel width.

#### **7.1.3.1 Biological Characteristics**

This design allows passage for all aquatic organisms.

#### **7.1.3.2 Geomorphic Characteristics**

The No-Slope and Active Channel designs are appropriate for streams with less than 3% slope. Culvert size is sufficient to allow the natural movement of bed material and the formation of a stable bed within the barrel.

### **7.1.3.3 Hydraulic Characteristics**

This design is intended for use where detailed survey information on high and low fish passage flow is not available. Hydraulic capacity must meet the required headwater-flood policy.

### **7.1.3.4 Data Requirements**

#### **Channel Slope:**

Natural stream channel slope should not exceed 3%. For all installations, future channel elevation and slope should be predicted using unaffected stream reaches both up and downstream. This should be projected for the project lifetime.

#### **Culvert Span:**

Structure span is 1.25 times channel-bed width<sup>†</sup> (minimum 1830 mm (6 ft)). WDFW recommends that this be taken as the average of at least 3 typical cross sections (Bates et al. 2003). Pipe, pipe-arch, and elliptical culverts are applicable for this design. Round culverts have the advantage of providing additional vertical clearance for a given span.

<sup>†</sup> Washington uses bankfull width as a design standard.

#### **Embedment:**

The bottom of the culvert is buried no less than 20% and no greater than 40% of the culvert height. If bottomless structures are used, footings are designed for the largest anticipated scour depth, and the culvert should be placed so as to minimize the disturbance of the natural bed.

#### **Culvert Length:**

Due to embedment requirements, the product of slope times length must be less than or equal to 20% of the culvert diameter. In general, installations should not exceed 30.5 m (100 ft) in length.

#### **Culvert Slope:**

Culvert is laid flat within the stream reach.

#### **Upstream Headcut Potential and Impacts:**

Evaluation of upstream headcut potential and impacts should be completed. This is necessary because if the substrate is washed out of the barrel as a result of degradation from downstream, the headcut can continue upstream past the culvert and endanger the crossing.

### 7.1.3.5 Design Procedure

No detailed design procedure is provided by the guidelines, but this method is intended for simple design situations, avoiding detailed survey information or high and low fish passage flow data. The No-Slope design option is depicted in Figure 7.4.

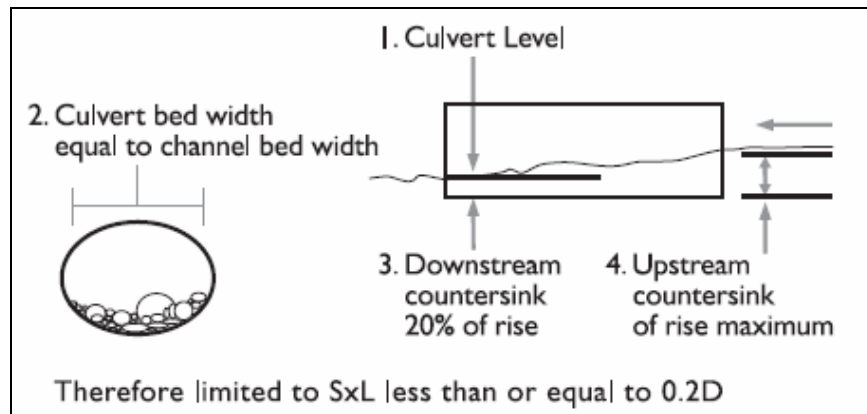


Figure 7.4 WDFW No-Slope option (Bates et al. 2003)

### 7.1.4 Summary of Geomorphic Simulation Procedures

Table 7.2 provides a summary of Geomorphic Simulation techniques.

**Table 7.2 Comparison of Geomorphic Simulation Techniques**

Criteria	USFS	Washington	Washington	NMFS
	Stream Simulation	Stream Simulation	No-Slope	Active Channel
<b>Culvert Span</b>	Wider of bankfull width or 4x largest particle size in simulated bed	$\geq 1.2$ times Bankfull + 0.6 m (2 ft)	$\geq 1.25$ times Bankfull	1.5 Active Channel Width (Bankfull)
<b>Culvert Slope</b>	When channel degradation requires slopes greater than natural channel, find representative reference reach or consider channel restoration.	Slope ratio $\leq 1.25$ ; Culvert may be installed flat or at grade.	Culvert placed at 0% slope	Culvert placed at 0% slope.
	No slope limitations provided	Gradients up to 6% recommended. Installations as high as 10% have been completed.	Suitable for streams $\leq 3\%$ slope	Suitable for streams $\leq 3\%$ slope
<b>Substrate</b>	Substrate in reach just upstream from culvert must be similar to reference reach.	$< 4\%$ slope, natural substrate with bands of coarse material ( $D = 1$ to 2 times $D_{100}$ ). Culvert embedded 30-50% rise.	Culvert buried into the streambed $\geq 20\%$ of culvert height at outlet, $< 40\%$ at inlet	Culvert is buried into the streambed $\geq 20\%$ of culvert height at outlet, $< 40\%$ at inlet.
	Simulate the natural substrate found in the stream.	$\geq 4\%$ slope, native or engineered material without bed control structures. Culvert embedded 30-50% rise.	Uses natural substrate	Natural substrate is used
<b>Bank Considerations</b>	Designer can increase culvert span if bank margins are desired.	Culvert is wide enough to allow some bank margins to form.	Not applicable	Not applicable
<b>Culvert Shape</b>	Not applicable	All types of culverts (box, round, concrete, CMP) have been used. Open bottom structures are desirable because they allow natural substrate to be maintained.	Not applicable	Not applicable
<b>Hydrology Required</b>	Design Flood for culvert stability and hydraulic capacity check	Design Flood for culvert stability and hydraulic capacity check	Design Flood for culvert stability and hydraulic capacity check	Design Flood for culvert stability and hydraulic capacity check
<b>Geomorphic Elements</b>	Constructed bedforms match those found in reference reach. Low flow channel constructed in replacement installations.	Not applicable	Low flow channel constructed in replacement installations.	Not applicable
<b>Length</b>	Not applicable	Not applicable	Slope times Length less than or equal to 0.2D.	$\leq 30.5$ m (100 ft) due to embedment requirements.
<b>Reference</b>	Bates et al. 2006	Bates et al. 2003	Bates et al. 2003	NMFS 2001

## **7.2 HYDRAULIC SIMULATION (CATEGORY 2)**

As defined in Chapter 6, Hydraulic Simulation techniques utilize embedded structures, natural or synthetic bed mixes, and roughness elements to create hydraulic conditions conducive to fish passage. Structure design is optimized to provide and sustain existing substrate. These techniques represent the middle-ground between Geomorphic Simulation, which closely matches natural channel geomorphology, and Hydraulic Design, which sizes a culvert for specific fish species. Table 7.5 (end of Section 7.2) provides a summary of Hydraulic Simulation techniques.

More research is required to better substantiate the methods used to determine streambed stability (Section 6.5.5). Users are encouraged to use best engineering judgment when employing Hydraulic Simulation procedures.

## **7.2.1 Oregon Department of Fish and Wildlife Stream Simulation**

### **Source**

- Oregon Department of Fish and Wildlife (Robison et al. 1999)

### **Limitations**

- Moderate gradients: 1.5-8%
- Stream width  $\leq$  4.6 m (15 ft)
- Valley fill must be adequate to allow adequate countersinking

### **Applicability**

- New and replacement installation
- Fish passage required for all species

#### **7.2.1.1 Biological Characteristics**

This design reportedly allows for passage of all fish species, even with a channel velocity and turbulence regime (see 9.2.1.3).

#### **7.2.1.2 Geomorphic Characteristics**

This design is appropriate for streams with channel slopes from 1.5-8% and stream widths of less than about 4.6 m (15 ft). Natural and oversized bed material is used to create hydraulic roughness, low flow paths and resting areas conducive to fish passage. Sediment and debris flow is allowed to continue through the crossing at flows up to bankfull.

Channel impacts should be considered, hydraulic controls may be required to improve structure entrance and exit conditions (beveled inlet configuration; providing resting pools at entrance and exit, etc...); concentrate low flows; prevent erosion of the streambed and banks; and allow passage of bedload material (this provision is designed with ODFW consultation).

A recommended bed mix consists of 30% fines (to seal voids to avoid sub-surface flow), 30% small rock, 30% large rock and 10% shadow rock (to simulate undercut banks, large wood and boulders, and to remain stable during flood events).

#### **7.2.1.3 Hydraulic Characteristics**

In this design, the culvert span should match the channel bed width (defined as the active channel width).

The use of increased bed sizing or roughness will decrease flow velocity but increase turbulence.

Hydraulic capacity must be checked to ensure adequate culvert size. Culvert capacity must pass the 50-yr flood.

Channel velocities must be checked to ensure compliance with local stream velocities.

#### **7.2.1.4 Data Requirements**

##### **Watershed Information:**

Channel slopes must be between 1.5-8%. Bridges are suggested if stream width is greater than about 4.6 m (15 ft). Valley fill should be adequate for sinking the culvert into the streambed. The barrel should be sunk more than 20% of the culvert rise, or 0.46 m (18 in), for pipe arches and box culverts, and a minimum of 40% of the diameter, or 0.6 m (2 ft), for round culverts.

##### **Culvert Size:**

The culvert span should match that of the channel bed width (defined as active channel width). Multiple width measurements should be made above and below the culvert, as well as areas outside the influence of the culvert installation. This width should represent stream reach conditions prior to the impacts of the existing structure. Table 7.3, in customary units, aids in the selection of appropriate structure so that the span or diameter matches that of the stream channel. Data from the columns labeled, "MAX FLOW in Culvert," is not to be used in fish passage designs. It was computed assuming a thin edge projecting pipe under inlet control with HW/D equal to 1.0. For pipe-arch culverts not covered in Table 7.3, approximations of culvert area can be found using Equation 7.2, in customary units.

$$\text{Area (ft}^2\text{)} = \text{Rise (inches)} * \text{Span (inches)} * 0.005472$$

**Equation 7.2**

**Table 7.3 Flow Capacity for Non Embedded Circular and Pipe-Arch Culverts, Customary Units\*† (Robison et al. 1999)**

CIRCULAR CULVERTS			PIPE ARCH CULVERTS		
Diameter (inches)	Cross-Sectional Flow Area Culvert (ft <sup>2</sup> )	MAX FLOW in Culvert (cfs)	SPAN times RISE (feet and/or inches)	Cross-Sectional Area Culvert (ft <sup>2</sup> )	MAX FLOW in Culvert (cfs)
15	1.2	3.5	22 in x 13 in	1.6	4.5
18	1.8	5	25 in x 16 in	2.2	7
21	2.4	8	29 in x 18 in	2.9	10
24	3.1	11	36 in x 22 in	4.3	16
27	4	15	43 in x 27 in	6.4	26
30	4.9	20	50 in x 31 in	8.5	37
33	5.9	25	58 in x 36 in	11.4	55
36	7.1	31	65 in x 40 in	14.2	70
42	9.6	46	72 in x 44 in	17.3	90
48	12.6	64	6 ft 1 in x 4 ft 7 in	22	130
54	15.9	87	7 ft 0 in x 5 ft 1 in	28	170
60	19.6	113	8 ft 2 in x 5 ft 9 in	38	240
66	23.8	145	9 ft 6 in x 6 ft 5 in	48	340
72	28.3	178	11 ft 5 in x 7 ft 3 in	63	470
78	33.2	219	12 ft 10 in x 8 ft 4 in	85	650
84	38.5	262	15 ft 4 in x 9 ft 3 in	107	930
90	44.2	313			
96	50.3	367			
102	56.7	427			
108	63.6	491			
114	70.9	556			
120	78.5	645			
132	95	840			
144	113.1	100			

\* Data from the columns labeled, "MAX FLOW in Culvert," is not to be used in fish passage designs. It was computed assuming a thin edge projecting pipe under inlet control with HW/D equal to 1.0.

† If culvert embedment is considered, oversizing is completed as detailed below.

**Countersink:**

Appropriate countersink depth should be created according to the following criteria, assuming a minimum span of 1524-1830 mm (5-6 ft):

- (a) Circular culverts: 0.4 times diameter or 600 mm (2 ft), whichever is greater
- (b) Pipe-arch culverts: 0.2 times rise or 460 mm (18 in), whichever is greater
- (c) Box culverts: 0.2 times width, or 460 mm (18 in), whichever is greater



For channel slopes 0-4%: The outlet and inlet inverts are sunk at the same depth.

For channel slopes 4-8%: Use circular and pipe-arches only. Countersink the outlet according to the above criteria, (a) and (b). Determine the outlet invert elevation relative to some datum, and determine the depth to countersink the inlet using Equation 7.3.

$$\text{Elevation inlet invert} = (\text{culvert length}) * [(\text{channel slope} - 1.5\%) / 100] + \text{elevation outlet invert. Note - use the inlet countersunk values in calculating the effective cross-sectional area.}$$

Equation 7.3

**Effective Cross-Sectional Area (ECSA):**

Calculate “effective cross-sectional area” and the flow capacity of the culvert using Equation 7.4 and Table 7.4.

$$\text{ECSA} = (\text{Culvert cross-sectional area for chosen culvert}) * (\% \text{ loss in cross-sectional area} / 100)$$

Equation 7.4

**Table 7.4 Comparison of Percent of Culvert Diameter or Rise with Baffles or Embedding and Corresponding Cross-Sectional Area Loss for the Culvert (Robison et al. 1999)**

Percent of rise or diameter with baffle or embedding inside culvert	Percent loss in cross-sectional area	
	Round culvert	Pipe arch culvert
10	5	8
15	9	14
20	14	20
25	20	26
30	25	33
35	31	39
40	37	45
45	44	51
50	50	57
55	56	63
60	63	69
65	69	74
70	75	79

Flow capacity is determined by comparing the cross-sectional area to the corresponding maximum flow in the culvert on Table 7.3. It may be necessary to interpolate to find cross-sectional areas for odd-sized culverts.

**Culvert Capacity:**

Culvert capacity must also be checked to ensure that it passes the 50-yr flood in order to meet Oregon Department of Transportation standards for culverts.

**Bed Material Specification:**

A bed mix is recommended based on local experience. Shadow rocks, 50-100% larger than the natural  $D_{100}$ , are placed to protrude 30-50% above the final streambed elevation. Large rocks, small rocks and fines should be mixed before placing, and the final surface should be washed into interstitial spaces to ensure a good seal.

## **7.2.2 Alaska DF&G and DOT Stream Simulation**

### **Source**

- Alaska Department of Fish and Game and Alaska Department of Transportation 2001

### **Limitations**

- Natural channel slope  $\leq 6\%$
- Culvert slope is within 1% of the natural channel slope (natural slope  $\pm 1\%$ )
- Stable channels

### **Applicability**

- New and replacement installations
- Passage required for all fish species present

When the following criteria have been met, fish passage is assumed to be adequate without further hydraulic calculations. This design methodology has worked well in Alaska, and fish have been observed successfully passing structures that have been in place (Miles, Personal Communication). A memorandum of agreement between ADOT and ADF&G ensures that permitting goes quickly, and structures are designed to be smaller than Geomorphic Simulation, resulting in smaller initial cost.

#### **7.2.2.1 Biological Characteristics**

This design allows for the passage of all present fish species.

#### **7.2.2.2 Geomorphic Characteristics**

This design uses oversized substrate, sized to be stable up to and including the 50-yr flood, to create hydraulic roughness, low flow paths and resting areas conducive to fish passage by matching the bed characteristics of the natural channel. This creates a stable channel within the culvert, where bed load and suspended load still move through, but bed material is not scoured out at 50-yr flood.

The design applies to streams with gradient less than or equal to 6%. The culvert slope will be within 1% of the natural channel slope.

#### **7.2.2.3 Hydraulic Characteristics**

Hydraulic capacity of the culvert must be checked to ensure adequate size.

When the design procedure is followed, analysis of fish passage flow levels is not required.

Culvert span is greater than or equal to 90% of the channel width at Ordinary High Water stage, unless the channel slope is less than 1%, and the culvert is installed with a slope of less than 0.5%, in which case the span may be greater than or equal to 75% of the channel width at Ordinary High Water stage.

#### **7.2.2.4 Data Requirements**

**Stream Gradient:**

Stream gradient is less than or equal to 6%.

**Culvert Span:**

Culvert span is greater than or equal to 90% of the channel width at Ordinary High Water stage.

Where the channel slope is less than 1%, culverts may be installed at slopes less than 0.5%, with a span of at least 75% of the channel width at Ordinary High Water stage.

**Culvert Slope:**

Culvert slope is within 1% of the natural channel slope (i.e., 4% channel slope, 3-5% culvert slope).

**Bed Material:**

Bed material is sized to be stable up to and including the 50-yr flood (possibly requiring sediment retention baffles).

**Embedment:**

Circular culverts should be buried at least 40% of the culvert diameter, while pipe arches must be buried 20% of the culvert rise.

#### **7.2.2.5 Design Procedure**

Although no specific design procedure is provided, fish passage is assumed when the above data requirements are met.

### **7.2.3 Browning et al. 1990**

#### **Limitations**

- Slope  $\leq 2-5\%$  (see discussion below)
- Stable Stream Systems

#### **Applicability**

- New and Replacement
- Passage required for all species

A 1990 survey of culverts in Oregon had the primary goal of determining which type of culvert provided the best fish passage, and if current design practices would have produced that type of culvert. It was also hoped that results would resolve current disagreements surrounding fish passage requirements. This study included collection of field data and hydrologic and hydraulic analysis of each of the selected sites. A comparison was made between culvert velocities and velocities present in the natural channel during the 2-yr and 50-yr flood events.

Adult salmon passage was a main concern at many sites, although trout were included as important species in many cases (Browning 1990). Study sites were largely located in stable stream systems that had reached dynamic equilibrium (Browning, Personal Communication). Based on the results of this survey, Browning recommends a design procedure that utilizes Hydraulic Simulation to create a fish passable structure.

This method is unique in that it does not require determination of channel bed width. Channel bed width is difficult to measure consistently, and boundary roughness in slightly constricted culvert installations may actually increase flow depth and slow velocities during fish movement (Browning, Personal Communication).

#### **7.2.3.1 Biological Characteristics**

This design allows for passage of all species, though it was derived from sites where passage of adult salmon was primarily of concern. Trout were also considered important in many cases.

#### **7.2.3.2 Geomorphic Characteristics**

This design uses natural bed material to create hydraulic roughness, low flow paths and resting areas conducive to fish passage. Cohesive soils should be replaced with fine gravels in the likelihood that cohesion will be disrupted when installation occurs. To keep flows from going subsurface, placement of a non-permeable barrier between the culvert bed materials and foundation

materials can be considered. Small boulders can be included in the bed mix to increase roughness and reduce downstream scour, where the installer cannot match velocity and scour conditions. If structures for reducing scour are improperly placed, they could pose a barrier to fish passage (see Section 6.5.6.1 on riprap).

Study sites were largely located in stable stream systems that had reached dynamic equilibrium. Recommendations were based on installations on grades of 1-2%, with very few sites exceeding 3%.

Where system wide degradation is possible, the installation may require lowering to match the anticipated stream surface lowering.

### **7.2.3.3 Hydraulic Characteristics**

Culvert span is determined by keeping the headwater to depth ratio at the 50-yr flood less than or equal to 1.0.

Average barrel velocity remains within 25% of the natural stream velocity during discharges less than the 2-yr flood. When stream gauge data is not available, barrel velocity calculations should be done for a number of flows, ideally covering the range at which fish are moving, including analysis of depth and velocity in the culvert and natural channel at each discharge.

Outlet scour depth must be less than 150 mm (0.5 ft) during the 2-yr flood event. It is recommended that outlet scour potential be computed at each of the discharges used for velocity analyses.

### **7.2.3.4 Data Requirements**

#### **Culvert Span:**

Headwater to depth ratio at the 50-yr flood should not exceed 1.0. This is intended to ensure that the culvert does not excessively constrict the stream reach.

#### **Bed Slope:**

Although no specific limitations are given for slope applicability, recommendations were based on installations on grades of 1-2%, with limited sites approaching 5%.

#### **Embedment:**

Culverts less than 3.2 m (10 ft) diameter are buried a minimum of 150-300 mm (0.5-1.0 ft) below the natural stream slope. Culverts with diameters greater than 3.2 m (10 ft) are buried a minimum of 1/5<sup>th</sup> the culvert rise. In situations where system wide degradation is possible, the installation may require lowering to match the anticipated stream surface lowering.

**Barrel Velocity and Depth:**

Barrel velocity remains within 25% of the natural stream velocity during discharges less than the 2-yr flood.

When stream gauges were not available at sites, U.S.G.S. regression equations were used to determine 2- and 50-yr flows for hydraulic analysis. Manning's equation was used to compute velocities in a typical section of the stream and compared to culvert cross section. Stream channels were approximated by using topographic data of the stream site to create a representative trapezoidal cross section. Slope was based on typical slopes in the vicinity of the culvert and a roughness value ( $n$ ) is based on local streambed materials. For the study, Manning's "n" values were taken from:

Chow, V. T., 1959. "*Open-Channel Hydraulics*." McGraw-Hill Book Company, Inc, New York, NY.

Barrel velocity calculations should be done for a number of flows, ideally covering the range of flows at which fish are moving. This includes analysis of depth and velocity in the culvert and natural channel at each discharge.

**Outlet Scour:**

Outlet scour should be limited to 150 mm (0.5 ft) during the 2-yr event. Analysis was conducted based on the method in "Hydraulic Engineering Circular No. 14" (Thompson and Kilgore 2006), with specific methods depending on the bed-material present. It is recommended that outlet scour potential be computed at each of the discharges used for velocity analyses.

If it is determined that outlet scour is likely to be a problem, boulders can be placed just downstream of the culvert outlet to reduce stream energy and potential scour depth.

**Bed Material:**

Bed material should be similar to the natural stream reach placed to match stream reach conditions. At the time of writing (1990), Browning said cohesive soils should be replaced with fine gravels since cohesion will likely be disrupted during installation. He also said to keep flows from going subsurface, placement of a non-permeable barrier between the culvert bed materials and foundation materials can be considered. More recent procedures recommend washing fines and silts into the streambed to seal voids instead of using a barrier blanket (Bates et al. 2003).

**Culvert Slope:**

The culvert barrel should be placed on as flat a slope as possible (in general less than 2%). Culverts placed on a slope greater than 2% may require consideration of bed retention baffles.

**Roughness:**

In situations where the installer cannot match velocity and scour conditions, small boulders can be included in the bed mix to increase roughness, and reduce downstream scour. These should be embedded, and not protrude more than 0.30 m (12 in).

**Culvert Capacity:**

Culvert headwater-to-rise ratio is not to exceed 1.0 (i.e. during 50-yr event).



## **7.2.4 Maryland**

### **Source**

- Maryland 2005

Maryland culvert design incorporates the use of a main-channel culvert to maintain stream characteristics during bankfull flow, with floodplain culverts to handle overbank flows when practicable. Rather than creating “standard” design methods, Maryland addresses considerations surrounding the culvert design process.

### **7.2.4.1 Biological Characteristics**

This design allows for passage of all species.

### **7.2.4.2 Geomorphic Characteristics**

The main-channel culvert span matches stable bankfull flow of the upstream approach channel in order to maintain natural stream characteristics, allowing sediment and debris flow to continue through the crossing.

The main-channel culvert outlet is designed to minimize impacts to the downstream channel and stabilize flow conditions for fish passage. Modifications may be considered, such as baffles or downstream grade control structures, such as cross vanes or w-weirs designed to match the stable bankfull geometry.

The upstream transition section should be designed to achieve continuity of flow and maintain sediment transport characteristics of velocity and shear, avoiding deposition and scouring. Cross vanes and w-weirs may be necessary upstream.

### **7.2.4.3 Hydraulic Characteristics**

Bankfull flows are determined based on field investigation and stream morphology surveys. For a stable riffle within the reach, the bankfull flow is computed either by using a Manning’s equation (Equation 6.1) or by setting up a gradually varied flow model. Bankfull geometry is measured and then verified using a sediment mobility analysis based on the largest mobile particle size and the critical boundary stress for that particle.

Hydraulic capacity must be checked to ensure adequacy.

#### **7.2.4.4 Data Requirements**

##### **Main-Channel Culvert Size:**

A main-channel culvert should accommodate bankfull flow with minimum change in the hydraulic characteristics of unit discharge, width, depth and velocity. When applicable, bankfull flow should be accommodated in a single pipe, up to 4.9 m span (16 ft), or a single box culvert cell, up to 6.1 m (20 ft).

Sizing should be done by a trial and error solution using HEC-RAS and HY-8 to aid in the iterative design process. HY-8 is used to select efficient culvert sizes, with downstream tailwater elevations taken from the water surface (HEC-RAS) hydraulic model. Results of culvert selections should be reviewed to ensure that they are reasonable.

##### **Two-Cell Installations:**

When two culverts are required, box culverts are suggested to minimize the distance between spans. W-weirs may be included upstream of a multiple cell installation to reduce bar deposition and scour, increase competence of bed material transport and reduce debris accumulation at the center wall.

##### **Embedment:**

Culverts should be depressed a minimum of 20% below the existing channel bed, and allowed to fill naturally with bed material. In two culvert installations, the stream is expected to form a natural thalweg in one of the cells to accommodate low flows - minimizing fish passage problems.

##### **Slope, Type, Roughness, and Dimensions:**

Determine a composite “n” value based on bankfull flow, streambed materials, and culvert material above the streambed. Use HEC-RAS to run water surface profiles while attempting to match continuity of bankfull flow widths, depths, and velocities through the culvert. Plot bankfull depths in channel and adjust culvert invert elevations to maintain selected depression.

##### **Main-Channel Culvert Outlet:**

The main-channel culvert outlet should be designed to minimize impacts to the downstream channel and stabilize flow conditions for fish passage. When bankfull flow velocities are significantly higher in the culvert than in the channel, or the channel bed may be swept out, modifications such as baffles or downstream grade control structures may be considered.

##### **Upstream Transition:**

The upstream transition section should be designed to achieve continuity of flow and maintain sediment transport characteristics of velocity and shear - avoiding deposition and scouring.

This transition is likely less important for stable stream systems such as Rosgen type B, C, and E, but may be very important for A, D, DA, F or G channels. Special considerations are covered in more detail in Maryland's design manual.

**Culvert Silting:**

Maryland addresses culvert silting but design guidelines were not available for this document.

**7.2.4.5 Design Procedure**

**Floodplain Culverts** - Floodplain culverts can be added in situations where a single culvert would overly constrict flow for discharges exceeding bankfull, and lead to effects on downstream morphology. Floodplain culverts can be installed to collect and convey flood plain flows, reducing the impact of the main channel culvert. This may exclude situations where the culvert is on a small ephemeral stream, short culvert installations, locations where fish passage is not required, crossings on streams with small floodplains that convey little flow and crossings where a larger main channel crossing is desirable for debris passage.

Floodplain culverts should be positioned on the floodplain, well beyond the influence of the main culvert. This will avoid channel undermining, degradation or migration into the area of the floodplain culvert. It will also avoid clogging due to debris carried in the main channel.

## 7.2.5 Summary of Hydraulic Simulation Procedures

Table 7.5 provides a summary of Hydraulic Simulation techniques.

**Table 7.5 Comparison of Hydraulic Simulation Design Techniques**

Criteria	Oregon DFW	Alaska	Browning	Maryland
	Stream Simulation	Stream Simulation	WFLHD Recommendation	Culvert Design Procedure
Culvert Span	Active Channel Width up to 4.6 m (15 ft)	≥90% Bankfull (OHW), for culverts on slopes up to 6%	Culvert inlet should not excessively constrict the stream.	Match stable bankfull width of the upstream approach channel.
		≥75% Bankfull (OHW) is allowed for culverts on slopes <1%, installed at slopes ≤0.5%		Single culvert for main channel flows, Floodplain culverts for floodplain flows.
Culvert Slope	1.5-8%	Gradients up to 6%	Culvert placed as flat as possible, generally <2%	Not applicable
Substrate	Embedment for (a) Circular culverts: 0.4 times diameter or 600 mm (2 ft), whichever is greater (b) Pipe-arch culverts: 0.2 times rise or 460 mm (18 in), whichever is greater (c) Box culverts: 0.2 times width, or 460 mm (18 in), whichever is greater  Substrate should be 10% "shadow rock" (50-100% larger than natural D <sub>100</sub> ); 60% small and large rock, and 30% fines	Sized to be stable up to and including the 50-year design flood.  Gravel retention baffles may be used. They should be 0.5 times the culvert invert burial depth.	Similar to natural channel substrate, placed to match natural reach conditions	Allow culvert to fill with natural substrate.
			Culvert <3048 mm (10 ft) diameter buried min 300-600 mm (12-24 in) below natural stream slope.	Culvert depressed 0.30-0.60 m (1-2 ft)
			Culvert >3048 mm (10 ft) diameter buried min 1/5  (Cohesive soils replaced with fine gravels)	Transition section may be required between upstream channel and culvert. Riprap may be needed.
Hydrology Required	50-yr flood	50-yr flood for substrate stability	Headwater-to-rise Ratio not to exceed 1.0 during design event (i.e. 50-yr)	1.5-yr to 500-yr flood frequency plot for crossing site
Hydraulic Considerations	Not applicable	Not applicable	Barrel velocity is within 25% of the natural stream velocity during discharges less than the 2-yr flood.	W-weirs suggested upstream of 2-cell box culvert installations
Geomorphic Elements	Shadow rock provides stability	Not applicable	Small boulders included to increase roughness and reduce downstream scour	Not applicable
Reference	Robison et al. 1999	ADOT & ADF&G MOA 2001	Browning 1990	Maryland 2004

### 7.3 HYDRAULIC DESIGN (CATEGORY 3)

Hydraulic Design creates water depths and velocities that meet the swimming abilities of target fish populations during period of fish movement. This design option is most often used in retrofit projects, but can be used in new or replacement projects if Geomorphic Simulation and Hydraulic Simulation are not appropriate. General considerations include the effect of culvert slope, size, material and length. Hydraulic Design can include adding baffles to a culvert, adding sediment or sediment catching devices inside the culvert, backwater through crossing by installing downstream weirs, or modification of the culvert inlet or inlet approach to remove a constriction (Robison et al. 1999). Figure 7.5, from Robison et al., depicts the general flow of hydraulically designed structures (1999).

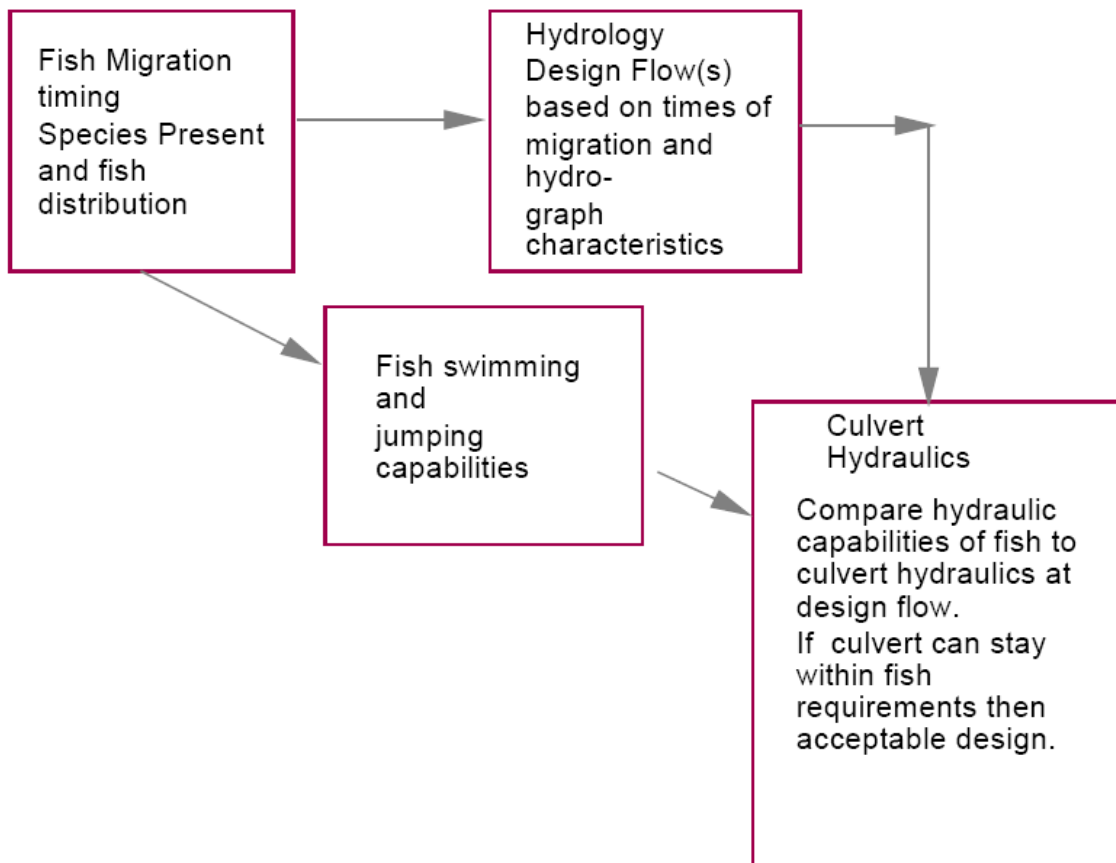


Figure 7.5 Steps in Hydraulic Design (Robison et al. 1999)

#### Note - Weirs vs. Baffles

Weirs act as small dams which control water depth within a culvert, while still passing the necessary design flow. Multiple weirs can create a series of drops and pools, allowing fish passage through a steeper structure (Zrinji and Bender 1995). A series of baffles work together to increase the hydraulic roughness of a

culvert, thereby reducing the cross-sectional velocity (Bates et al. 2003). Baffles provide flow diversity, adding both ineffective flow areas for fish to hide/rest in, and areas of increased flow velocity (and turbulence) in the constricted flow section.

### 7.3.1 General Hydraulic Design

#### Source

- The Washington Department of Fish and Wildlife (WDFW) provides a general design procedure for Hydraulic Design that will be described below (Bates et al. 2003). Additional weir/baffle configurations and culvert methodologies are included to expand upon the WDFW method.

#### Applicability

- New and replacement installations (when other options are precluded)
- Retrofit
- Fish passage required for target species

#### Limitations

- Requires knowledge of fish movement timing and swim speeds.
- May require additional monitoring due to propensity for roughness elements to catch debris.
- The addition of baffles will decrease culvert capacity (especially important in retrofit situations).

A generalized installation without baffles is shown in Figure 7.6.

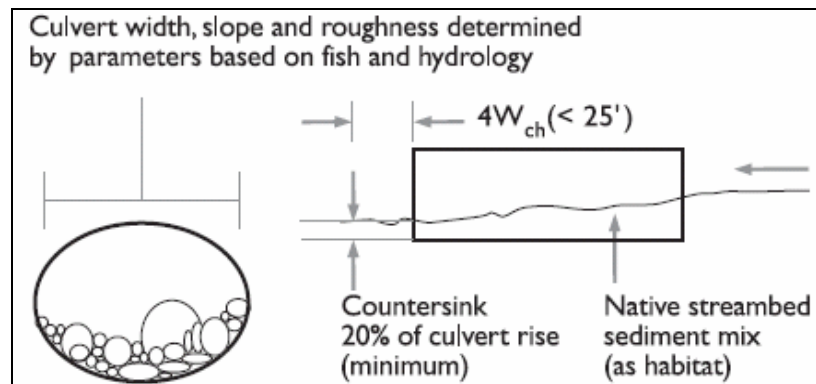


Figure 7.6 Hydraulic Design option, customary units (Bates et al. 2003)

#### 7.3.1.1 Biological Characteristics

This design allows for passage of target fish species.

#### 7.3.1.2 Geomorphic Characteristics

Products of this design may affect flow through and around the structure, possibly leading to localized aggradation and degradation through channel constriction. Retrofitted roughness elements may have the propensity to catch debris, increasing the risk of clogging.

Backwater elevations of the downstream channel will be greater than or equal to the water surface of the culvert.

Upstream and downstream channel profiles may be adjusted in order to match culvert elevation.

### **7.3.1.3 Hydraulic Characteristics**

Fish-passage flows must be determined in order to provide adequate hydraulics for passage, in accordance with knowledge of fish-passage timing and corresponding flow regimes of the natural channel.

Adequate flood-flow capacity must be verified. Roughness elements may catch debris, decreasing capacity.

### **7.3.1.4 Data Requirements**

#### **Length of Culvert:**

Find the length of culvert based on geometry of the road fill.

#### **Fish Passage Requirements:**

Determine the target species, swimming capabilities and sizes of fish requiring passage. Use this to determine allowable barrel depth and velocity.

#### **Hydrology:**

Determine fish passage design flows at which the fish-passage criteria must be satisfied.

#### **Velocity and Depth:**

Determine size, shape, roughness and slope of the culvert to satisfy velocity criteria, assuming open channel flow and a bare culvert bottom. Verify that the flow is subcritical through the range of fish passage flows.

Velocity and depth requirements can be met through a number of alternatives, including baffles or channel modifications, weirs, sediment catching devices, or roughened channels.

Acceptable velocity and depth are determined through appropriate selection of culvert size, material and slope. Many types of analyses are acceptable, but the simplest is Manning's equation (see Section 6.5.4) with a "n" value appropriate for baffles (if used). Such values may be estimated using techniques in HEC-14 (Thompson and Kilgore 2006).

#### **Channel-Backwater Depth:**

Determine backwater elevation at the culvert outlet for fish passage at both low and high fish passage design flows.



**Culvert Elevation:**

Set the culvert so that channel-backwater elevations are at least as high as the water surface in the culvert.

**Channel Backwater:**

The downstream culvert invert elevation at the outlet is determined by matching the water-surface profile at the culvert outlet to the backwater elevation of the downstream channel. Downstream water surface elevation can be determined by observation of the water surface at flows near fish passage design flow, or by calculating the water surface profile in a uniform flow condition. This may require several iterations, and modifications may be required to establish the culvert slope and roughness to match the profile to the downstream channel backwater.

Backwatering may also be accomplished by using structures to raise and steepen the channel to an appropriate elevation.

**Calculated Backwater:**

Channel backwater can be calculated using an open-channel flow calculation such as Manning's equation. WDFW recommends that this be calibrated with at least one high water-surface observation or high water mark (Bates et al. 2003). Selection of the appropriate Manning's  $n$  is very significant because it affects calculated water depths. The ' $n$ ' value depends on a number of variables including surface roughness, vegetation, channel irregularities, channel alignment, scour and deposition, obstructions, the size and shape of the channel, stage and discharge, suspended material, and bedload. Methods for combining these variables are included in

Chow, V. T. (1959). "*Open-Channel Hydraulics*." McGraw-Hill Book Company, Inc, New York, NY.

In situations where the project will affect the downstream channel, either as part of the design, or as the channel evolves after installation, the new channel slope, roughness and cross-sectional shape should be used for backwater calculations.

**Flood Flow Capacity:**

Verify that the flood-flow capacity of the culvert is adequate.

**Channel Profile:**

If necessary, adjust the upstream and/or downstream channel profiles to match the culvert elevation. Channel modifications (as discussed in Section 6.5.6) may be appropriate to control backwater elevation.

**7.3.1.5 Design Procedure**

1. **Length of Culvert** - Find the length of culvert based on geometry of the road fill.

2. **Fish Passage Requirements** - Determine the target species, sizes and swimming capabilities of fish requiring passage. Use this to determine allowable barrel depth and velocity.
3. **Hydrology** - Determine fish passage design flows at which the fish-passage criteria must be satisfied.
4. **Velocity and Depth** - Determine size, shape, roughness and slope of the culvert to satisfy velocity criteria, assuming open channel flow and a bare culvert bottom. Verify that the flow is subcritical through the range of fish passage flows.

Velocity and depth requirements can be met through a number of alternatives including baffles or channel modifications, weirs, sediment catching devices, or roughened channels.

5. **Channel-Backwater Depth** - Determine backwater elevation at the culvert outlet for fish passage at both low and high fish passage design flows.
6. **Culvert Elevation** - Set the culvert so that channel backwater elevations are at least as high as the water surface in the culvert.
7. **Flood Flow Capacity** - Verify that the flood-flow capacity of the culvert is adequate.
8. **Channel Profile** - If necessary, adjust the upstream and/or downstream channel profiles to match the culvert elevation. Channel modifications (as discussed in Section 6.5.6) may be appropriate to control backwater elevation.

Several iterations of steps 4 through 8 may be required to achieve the optimum design.

Acceptable velocity and depth are determined through appropriate selection of culvert size, material and slope. Many types of analysis are acceptable, but the simplest is Manning's equation (see Section 6.5.4).

### 7.3.2 Baffle Configurations

Baffles are intended to create allowable velocities during fish passage flows, while not exceeding fish turbulence thresholds. Baffles divide the culvert into a series of cells and bays, creating resting areas between the baffles, and points of high velocity at the baffles (Ead et al. 2002). Fish are assumed to use their prolonged swimming speed along lower velocity areas and in between baffles, and use their burst speed to navigate around baffles (Rajaratnam et al. 1991).

#### **Rajaratnam Et Al.**

Some of the most comprehensive baffle information available comes from a number of studies completed at the University of Alberta at Edmonton, Canada. The hydraulics of six fishway baffle configurations were analyzed, resulting in a series of five papers completed by Rajaratnam et al (Rajaratnam et al. 1988; Rajaratnam et al. 1989; Rajaratnam and Katopodis 1990; Rajaratnam et al. 1990; Rajaratnam et al. 1991). Figure 7.7 depicts tested baffles including offset baffles, slotted weir baffles, weir baffles, spoiler baffles, Alberta fishweirs, and Alberta fishbaffles.

Tests were conducted on slopes from 0.5-5% covering baffle heights ( $h/D$ ), where  $h$  is baffle height and  $D$  is culvert diameter, of 0.1-0.15, and baffle spacing up to 1.2 culvert diameters. Spacing wider than one culvert diameter was found to decrease velocity while increasing depth (Ead et al. 2002). Culvert material in the majority of these tests was smooth, with the exception of tests conducted on the Alberta fishweir and Alberta fishbaffle, when corrugated pipe was used.

From the baffle systems analyzed, weir and slotted weir baffles are recommended based on effectiveness and simplicity (Ead et al. 2002). Figure 7.8 shows the general layout of these two alternatives.

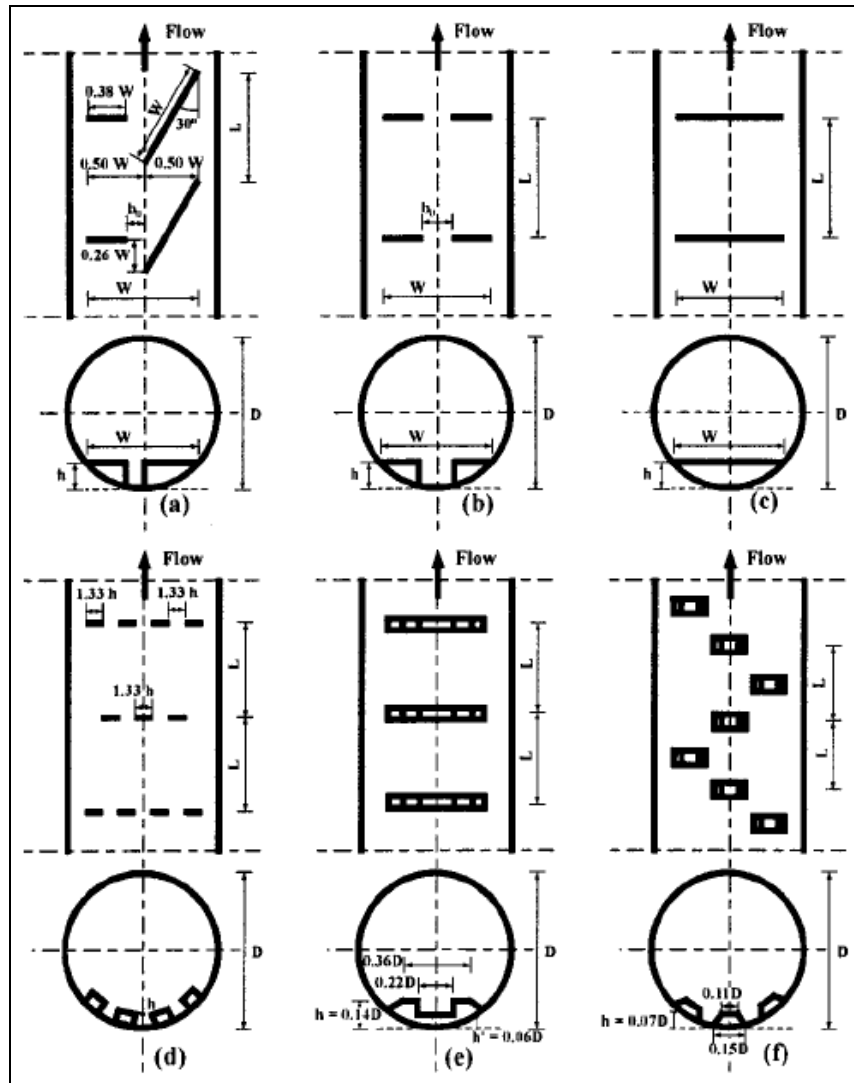
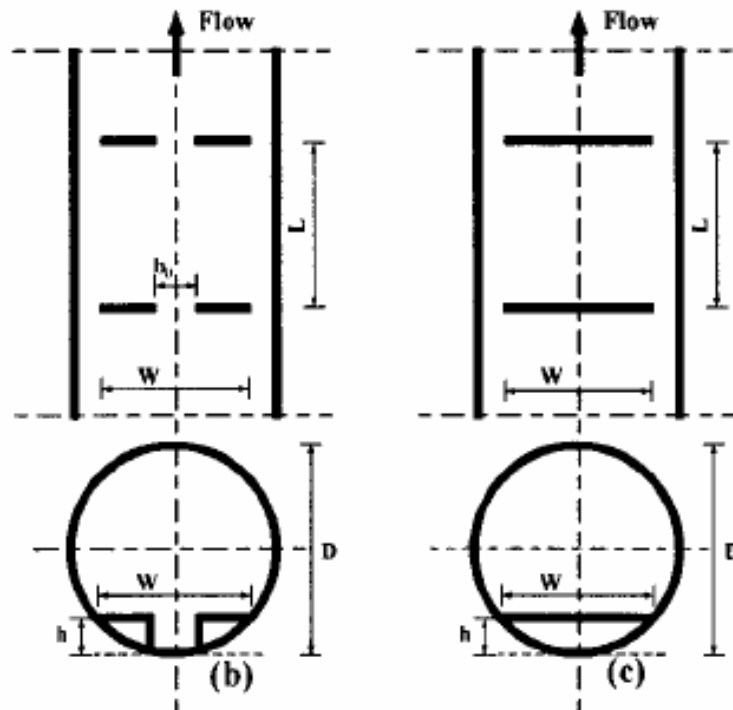


Figure 7.7 (a) Offset baffle; (b) slotted weir baffle; (c) weir baffle; (d) spoiler baffle; (e) Alberta fishweir; and (f) Alberta fishbaffle (Ead et al. 2002)



**Figure 7.8 Culvert options (b) slotted weir and (c) weir baffle configurations (adapted from Ead et al. 2002)**

(These are recommended for installation in fish passage situations due to simplicity and effectiveness)

Design techniques may be found in the Introduction to Fishway Design (Katopodis 1992).

### **WDFW Baffles**

Washington Department of Fish and Wildlife has three recommended baffle configurations - two for circular culverts, and one for box culverts, see Figure 7.9 (Bates et al. 2003). In each case, drop between baffles should be less than 0.06 m (0.2 ft). Notches are aligned to allow an uninterrupted line of fish passage along one or both sides. The continuously sloped baffle configuration in box culverts is generally used for juvenile fish passage in culverts 1800 mm (6 ft) wide or less. Corner baffles are recommended for use on slopes between 1-2.5%, with notched baffles being used between 2.5-3.5%. Direct observation of baffle systems have lead to the recommendation that they not be used on slopes greater than 3.5%, with steeper slopes requiring stream simulation or fishway design (Bates et al. 2003).

To avoid inlet contraction that can lead to reduced culvert capacity, the upstream baffle should be placed at least one culvert diameter downstream of the inlet, and be high enough to ensure subcritical flow at the high design flow. It is also recommended that the designer use a mitered end or wing walls to improve hydraulic efficiency.

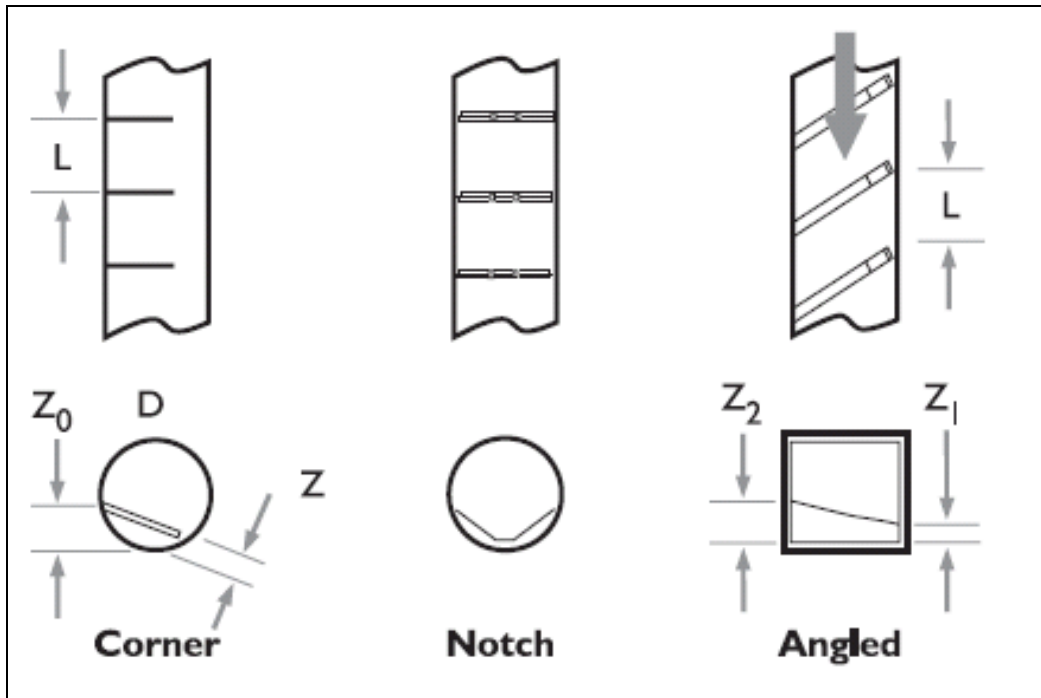


Figure 7.9 Recommended styles of baffles for round and box culverts in Washington (Bates et al. 2003)

### 7.3.2.1 Biological Characteristics

Baffle configurations allow passage for target species.

### 7.3.2.2 Geomorphic Characteristics

Rajaratnam et al. recommend baffle configurations for slopes of 0.5-5%, while WDFW recommends them for slopes less than or equal to 3.5%.

Baffle configurations may affect flow through and around the structure. Localized aggradation and degradation may occur due to channel constriction.

### 7.3.2.3 Hydraulic Characteristics

Velocities for fish passage must be determined.

Flood capacity must be adequate for the structure. WDFW recommends designing the upstream baffle to avoid inlet contraction and subsequent reduced culvert capacity, and to ensure subcritical flow at high design flow. Debris clogging the culvert may reduce flood-flow capacity.

Baffle spacing greater than one culvert diameter was found to decrease velocity while increasing depth.

An energy-dissipation factor must be calculated to ensure that turbulence and sediment deposition do not impede fish passage.

### 7.3.2.4 Data Requirements

#### Velocity for Baffles in Round Culverts:

Velocity is calculated by the flow equations developed by Rajaratnam and Katapodis (Rajaratnam et al. 1989; Rajaratnam and Katapodis 1990). Washington utilizes sloping baffles, and although weir baffles from the studies were horizontal, they provide the most reliable information for predicting roughness of baffles. Data within these papers were simplified to create Equation 7.5 and Table 7.6, aiding in WDFW's baffle design procedure.

$$Q = C(y_0/D)^a(gS_0D^5)^{1/2}$$

Equation 7.5

where:

- C = dimensionless coefficient that depends on baffle configuration
- D = diameter of the culvert, m (ft)
- a = exponent depending on baffle configuration
- Q = discharge, m<sup>3</sup>/s (ft<sup>3</sup>/s)
- y<sub>0</sub> = depth of water, m (ft)
- g = gravitational acceleration, m/s<sup>2</sup> (ft/s<sup>2</sup>)
- S<sub>0</sub> = dimensionless slope
- Z<sub>0</sub> = height of the baffle (as depicted in Figure 7.9)

**Table 7.6 Baffle Hydraulics (Bates et al. 2003)**

(Limits shown are the limits of experimental data or valid correlation for the coefficients and exponents; the designations in the first column refer to the specific experiment; the fourth row is extrapolated from WB-1; the seventh row is extrapolated from WB-4)

	Z <sub>0</sub>	L	C	a	Limits
<b>WB-2</b>	0.15D	0.6D	5.4	2.43	0.25 y <sub>0</sub> /D < 0.8
<b>WB-1</b>	0.15D	1.2D	6.6	2.62	0.35 y <sub>0</sub> /D < 0.8
	0.15D	2.4D	8.5	3.0	
<b>WB-3</b>	0.10D	0.6D	8.6	2.53	0.35 y <sub>0</sub> /D < 0.8
<b>WB-4</b>	0.10D	1.2D	9.0	2.36	0.20 y <sub>0</sub> /D < 0.8
	0.10D	2.4D	9.6	2.5	

Equation 7.5 should be used to calculate the depth of flow, allowing velocity to be found by dividing the flow by the resulting cross-sectional area.

### Velocity for Baffles in Box Culverts:

The hydraulics of baffles in box culverts are described by Shoemaker (1956). This study utilized the Darcy-Weisbach friction equation as a hypothetical model for culverts with baffles (Equation 7.6).

$$HW = (K_e + C_e + fL_c/D)V^2/2g + P - S_0L_c$$

Equation 7.6

where:

- f = dimensionless friction coefficient
- $L_c$  = length of the culvert, m (ft)
- D = the diameter of the pipe (four times the hydraulic radius of noncircular pipes), m (ft)
- $V^2/2g$  = the gross cross section velocity head in the culvert where V is the average velocity, m (ft)
- $S_0$  = dimensionless slope of the culvert
- $K_e$  = dimensionless culvert entrance head loss coefficient
- $C_e$  = dimensionless culvert exit head-loss coefficient
- HW = headwater elevation above the invert at the culvert entrance, m (ft)
- P = distance from culvert invert to center of flow over a baffle, m (ft)

In Shoemaker's model, baffles were full width and level, with rounded leading edges at a radius equal to one tenth of the culvert height. Baffles heights of 0.10, 0.20 and 0.30 times the culvert rise and spacings of 1.0, 2.0, and 4.0 times the culvert rise were studied. The culvert had inlet and outlet aprons extending 2.5 times the culvert span, and wing walls flared at 34 degrees from the culvert sides, mitered at a 2:1 slope. The baffle furthest downstream from the culvert entrance was placed at the edge of the apron.

Shoemaker's variation of the Darcy-Weisbach friction factor is depicted in Figure 7.10.



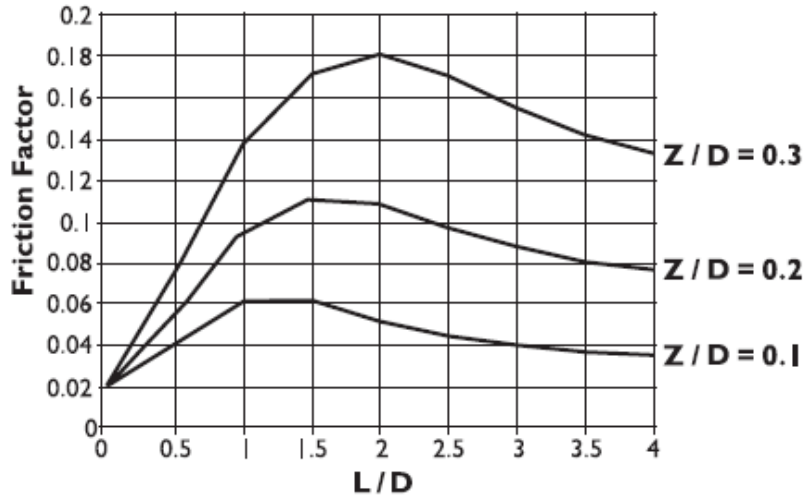


Figure 7.10 Variation of Darcy-Weisbach friction factor (Bates et al. 2003)

(L is the baffle spacing; Z is the baffle height, and D is the culvert diameter)

Culvert capacity analysis assumes that entrance, outlet and friction losses are proportional to the velocity head. Equation 7.6 can be used with  $C_0 = K_e + C_e$  (from Figure 7.11), and other parameters as previously defined. According to Shoemaker, P can be approximated as the distance from the culvert invert to the center of the flow at the opening above a baffle (Shoemaker 1956).

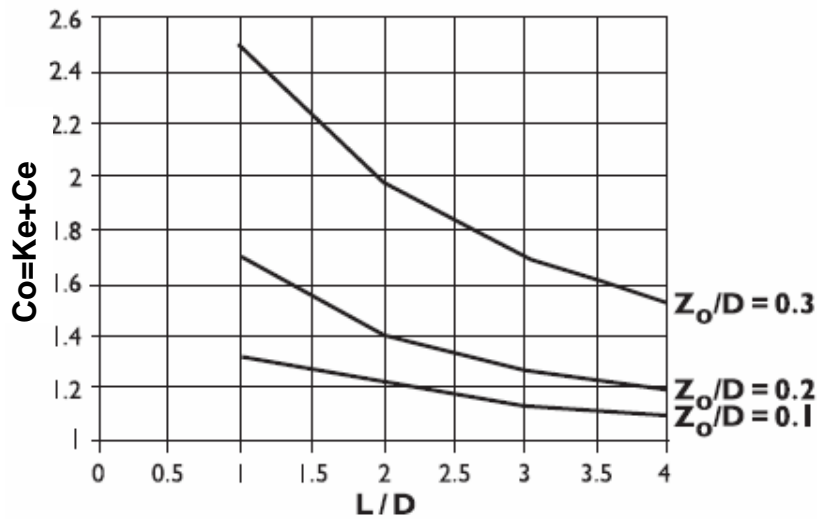


Figure 7.11 Energy coefficients for various baffle arrangements (adapted from Bates et al. 2003)

( $K_e$  and  $C_e$  have been combined into a single head loss coefficient  $C_0$ , depicted here as a function of baffle spacing and height)

**Energy Dissipation:**

In order to ensure that turbulence does not prevent fish passage ability, an energy-dissipation factor (EDF) is calculated (see Section 3.2.5). For baffled fishways, WDFW recommends a value of 240 m-N/m<sup>3</sup>/s (5 ft-lb/ft<sup>3</sup>/s). It is further specified that the EDF should remain above 144 m-N/m<sup>3</sup>/s (3 ft-lb/ft<sup>3</sup>/s) at the high fish passage design flow to ensure that sediment deposition does not make the baffles ineffective or create a direct fish passage barrier.

### 7.3.3 Maine

#### Source

- Maine Department of Transportation 2004
- U.S. Army Corps of Engineers 2005

#### 7.3.3.1 Biological Characteristics

This design allows for passage of all species.

#### 7.3.3.2 Geomorphic Characteristics

Hanging outlets are avoided when possible, and the installation is allowed to fill with natural material. Streambed characteristics are maintained as much as practical.

Corrugated elliptical pipe arches with the largest feasible corrugation are used to maximize roughness.

The culvert slope will not exceed the natural gradient, and the culvert should match natural stream depth and width at  $Q_{1.5}$ . Span is equal to 1.2 times bankfull width.

Culverts are to be embedded (Section 7.3.3.4) and are allowed to fill with natural material.

#### 7.3.3.3 Hydraulic Characteristics

Maximizing roughness will decrease flow velocity and increase turbulence.

Culvert capacity is checked using  $Q_{50}$ , and must be checked to allow for 100-yr flood. Flow depth during species-specific periods of movement must allow for fish passage.

#### 7.3.3.4 Data Requirements

##### **Bed Material:**

Eliminate hanging outlets where practical, and allow installation to fill with natural material. Allow streambed characteristics to be maintained as much as practical.

##### **Culvert Material:**

Use corrugated elliptical pipe arches with largest feasible corrugations to maximize roughness.

**Culvert Slope:**

Culvert slope is not to exceed natural gradient.

**Embedment:**

- a. When culvert diameter is less than 1.22 m (48 in) the culvert should be embedded 150 mm (6 in) into the stream bottom.
- b. When culvert diameter is greater than 1.22 m (48 in) the embedment should be embedded 0.30 m (12 in) into stream bottom.

**Culvert Capacity:**

Culvert capacity is checked using  $Q_{50}$ , and the culvert should match natural stream depth and width at  $Q_{1.5}$ .

**Fish Passage Flow:**

Check flow depth during species-specific periods of movement.

**Flood Capacity:**

Check 100-year flood.

**7.3.3.5 Design Procedure**

The Maine Department of Transportation (2004) Design Guide lists four general design steps:

1. Identification of valuable habitat for specific species and need for passage by fisheries biologists in MDOT, resource agencies, and regulatory agencies
2. Determination of calendar periods when passage must be provided
3. Estimation of design flows during passage periods
4. Culvert design
  - a. New pipe: size pipe according to natural stream bankfull cross-section; check for extreme flow capacity and passage performance by hydraulic analysis
  - b. Rehabilitated pipe: hydraulic analysis to check performance of proposed rehabilitation; design mitigation measures (e.g., weirs, baffles, outlet notch ramps) if fish passage is inadequate

Specific guidelines are given for

- Downstream energy dissipation pools
- End treatments for retrofitted culverts
- Downstream gage control weirs
- Interior weirs
- Fish passage flows

### **7.3.4 Roughened Channel Design**

#### **Source**

- Washington Department of Fish and Wildlife (Bates et al. 2003)

#### **Applicability**

- Over-steepened channel sections (as in replacement installations with past channel degradation)
- Slopes up to 10% (according to design charts)
- Passage required for target species
- Limited work area or right-of-way

#### **Limitations**

- Washington State still considers the “Roughened Channel” an experimental technology requiring more research and monitoring to be a viable design option.
- Velocity and turbulence checks are required to ensure that they do not exceed fish thresholds.
- This technique requires special design expertise, hydrology, and survey information.

#### **Overview**

The 2003 Washington Department of Fish and Wildlife fish passage guidelines include criteria for the creation of a roughened channel, either within or upstream of a culvert. Oversized substrate is designed for stability during the 100-year flood, allowing installation on over-steepened channel sections and moderate to high slopes. Roughness elements control depth and velocity, providing passage conditions adequate for the targeted fish species. Average cross-sectional velocity and turbulence are checked against species-specific allowable value.

Culverts designed using this technique are reported to have mixed results in Washington, and are considered experimental at this time, requiring special design expertise, hydrology and survey information (Bates et al. 2003).

#### **7.3.4.1 Biological Characteristics**

This design allows for the passage of desired species, although passage requirements of non-target species should be considered in culvert sizing.

#### **7.3.4.2 Geomorphic Characteristics**

The Roughened Channel design uses oversized substrate to stabilize over-steepened channel sections or moderate to high slope, allowing passage conditions for target species. Roughness elements control depth and velocity.

Bed material is designed to be stable for the 100-yr flood, with the largest bed particles being less than one-quarter the culvert span. Bed material is graded to control porosity.

In practice, bed retention sills and engineered substrate have filled culverts to 30% of the rise, the sills keeping bed material in place. Large boulders are added for fish passage. A downstream control structure should be added to protect against the creation of an outlet drop.

#### **7.3.4.3 Hydraulic Characteristics**

Velocity and turbulence must be checked to ensure adequacy for fish passage.

The culvert must be checked for adequate extreme-flood capacity (i.e. 100-yr event).

#### **7.3.4.4 Data Requirements**

##### **Culvert Span:**

Assume a culvert span, beginning with bankfull width. Considerations of debris and sediment transport, habitat, and passage requirements of non-target species should be included. According to WDFW, culvert span should be at least the width of the natural stream channel.

Note - As gradient and unit discharge increase, WDFW recommends an increase in culvert span as the best way to achieve stability and passability, while reducing the risk of scour and extreme hydraulic conditions.

##### **Bed Material Stability:**

Size the bed material for stability based on unit discharge for the 100-yr event ( $Q_{100}$ ).

For roughened channel design, bed material should remain in the culvert as placed. Bed material may shift slightly, but should not move an appreciable distance or leave the culvert. For this reason, bed material stability should be calculated before consideration of fish passage velocity. Unlike Stream Simulation design, roughened channels increase hydraulic forces due to increased slope. WDFW considered four methods for sizing bed material for stability (Bates et al 2003). For two of the methods, The U.S. Army Corps of Engineers Riprap Design and the Critical Shear Stress Method, see sections 6.5.5.5 and 6.5.5.9, respectively.

There also exist a number of alternatives for sizing bed material, including those covered in WDFW section on Stream Simulation Design (Section 7.1.2).

**Bed Material Size:**

Check to see that the largest bed-particle size, as determined by stability, is less than one quarter the culvert span. If not, increase the culvert span, which decreases the unit discharge and, in turn, the particle size.

**Bed Material Gradation:**

Create a bed-material gradation to control porosity (see WDFW Stream Simulation Design).

**Velocity:**

Calculate the average velocity at the fish-passage design flow on the basis of culvert span and the bed  $D_{84}$  from gradation. Three equations (see Section 6.5.4), Limerinos equation, Jarrett's equation and Mussetter's equation, are used to find roughness and velocity in order to calculate fish passage velocity. The three equations were derived from data in natural streams and account for roughness characteristics of natural channels. Constructed channels must be designed in such a way to maximize channel roughness and emulate natural channel planform and profile, otherwise the following equations will likely overpredict roughness and lead to an ineffective approximation of constructed channel velocities.

In general the relationship between velocity and roughness is given by:

$$V/(gRS_f)^{1/2} = 1.486R^{1/6}/ng^{1/2} = (8/f)^{1/2}$$

Equation 7.7

where:

- $V$  = the average velocity, m/s (ft/s)
- $g$  = the acceleration due to gravity, m/s<sup>2</sup> (ft/s<sup>2</sup>)
- $R$  = the hydraulic radius, m (ft)
- $n$  = dimensionless Manning's roughness factor
- $f$  = dimensionless Darcy-Weisbach friction factor
- $S_f$  = the friction slope of the channel

The use of  $n$  or  $f$  depends upon convention, but the Darcy-Weisbach equation accounts for the reduction in roughness with increasing depth, whereas Manning's equation does not (Bates et al. 2003).

**Turbulence:**

Washington State quantifies the impact of turbulence through the calculation of an energy dissipation factor (EDF), see Equation 3.1 for the EDF equation. Calculate the EDF at the fish-passage design flow on the basis of culvert span and the bed  $D_{84}$  from gradation. For roughened channels, the EDF must be less

than 7.0. This is based on experience in Washington, and will be modified with future research and evaluations (Bates et al. 2003).

### **Culvert Capacity:**

Check culvert capacity for extreme flood capacity (i.e. 100-yr event).

### **Fish Rocks and Bed Retention Sills:**

In practice, installation of roughened channels has included bed retention sills and engineered substrate filling the culvert to 30% of the rise. Large boulders are then added to provide shadow as a safety factor for fish passage. The sills act to keep bed material in place. Further field experience is expected to eliminate the need for these structures (Bates et al. 2003).

A downstream control structure should be constructed to ensure that the lowest point of the bed elevation at the culvert outlet matches the elevation of a downstream control point. The control structure can be a stable natural feature or a permanent constructed control placed no closer than 6.1 m (20 ft) from the culvert outlet. This protects against the creation of an outlet drop by ensuring that sills do not become exposed.

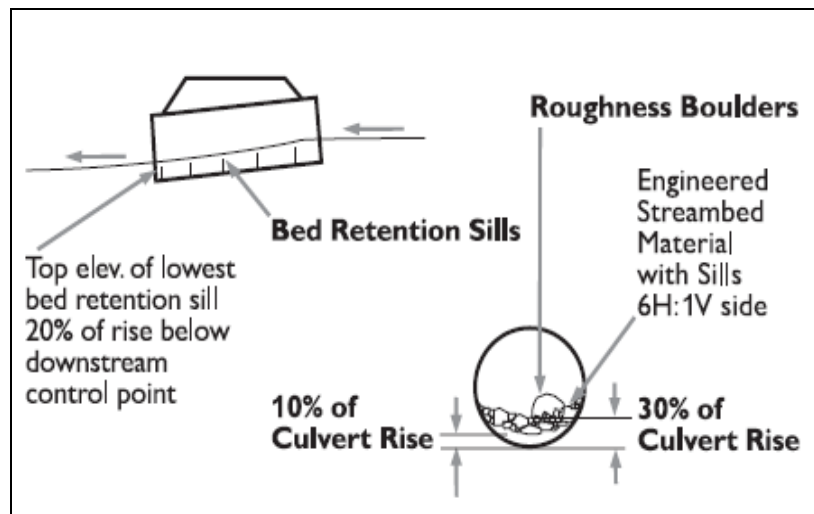


Figure 7.12 Roughened-channel culverts using fish rocks and bed retention sills (Bates et al. 2003)

**Bed Retention Sills** - Bed retention sills are typically made of the same material as the culvert, and are attached directly to the culvert.

**Bed Material** - In low gradient situations, bed material creates the primary source of roughness, and is included to act as a factor of safety. In high gradient situations, the specified bed material may contain elements that will act as boulders.

**Fish Rocks/Boulders** - Rocks should be no greater than one quarter the culvert span to prevent overly constricting the flow. Boulders are embedded one-third of their diameter (measured along the intermediate axis).



**Depth of Flow** - The water depth at the fish passage design flow should be less than or equal to two thirds of the exposed height of the boulders. The combination of these constraints should lead to a boulder diameter that is roughly twice the depth of water.

#### 7.3.4.5 Design Procedure

Roughened channel design consists of the following steps:

1. **Culvert Span** - Assume a culvert span, beginning with bankfull width. Considerations of debris and sediment transport, habitat, and passage requirements of non-target species should be included. According to WDFW, culvert span should be at least the width of the natural stream channel.
2. **Bed Material Stability** - Size the bed material for stability based on unit discharge for the 100-yr event ( $Q_{100}$ ), as outlined in Step 3.
3. **Bed Material Size Check** - Check to see that the largest bed-particle size, as determined by stability, is less than one quarter the culvert span. If not, increase the culvert span, which decreases the unit discharge and, in turn, the particle size.
4. **Bed Material Gradation** - Create a bed-material gradation to control porosity (see WDFW Stream Simulation Design).
5. **Check Turbulence and Velocity** - Calculate the average velocity and EDF at the fish-passage design flow on the basis of culvert span and the bed  $D_{84}$  from gradation in Step 4 above. If the velocity or EDF exceed the criteria, increase the culvert span.
6. **Culvert Capacity** - Check culvert capacity for extreme flood capacity (i.e. 100-yr event).

Note - As gradient and unit discharge increase, WDFW recommends an increase in culvert span as the best way to achieve stability and passability, while reducing the risk of scour and extreme hydraulic conditions.

Steps 2-3 can be completed using a variety of recommended methods/equations. Included are the U.S. Army Corps of Engineers Riprap Design and the Critical-Shear Stress Method.

There also exist a number of alternatives for sizing bed material, including those covered in WDFW section on Stream Simulation Design (Section 7.1.2).

### 7.3.5 Oregon Department of Fish and Wildlife Hydraulic Design

#### Source

- Oregon Department of Fish and Wildlife (Robison et al. 1999)

#### 7.3.5.1 Biological Characteristics

Fish passage allowed for target species. Velocity requirements are listed for salmon, steelhead, adult trout and juvenile salmonids.

#### 7.3.5.2 Geomorphic Characteristics

This design procedure is appropriate for slopes up to 12%.

Flow through and around the structure may be affected. If the channel is constricted, localized aggradation and degradation may have to be addressed. Retrofitted roughness elements such as weirs and baffles may increase the risk of clogging the structure.

#### 7.3.5.3 Hydraulic Characteristics

Design flows and minimum water depth must be determined for target species.

Flood capacity must be adequate for 100-yr flow. Applied channel width constriction or roughness elements may restrict passage of water and debris, decreasing flood-flow capacity and increasing the likelihood of plugging and culvert failure.

#### 7.3.5.4 Data Requirements

##### Design Flows:

See Fish Passage Hydrology section, Chapter 5.

##### Water Velocity:

**Table 7.7 Water Velocity Requirement for Culvert Installations in Oregon, Customary Units (Robison et al. 1999)**

Culvert Length (ft)	Salmon & Steelhead	Adult Trout (>6")	Juvenile Salmonids
Under 60'	6.0	4.0	2.0
60-100'	5.0	4.0	2.0
100-200'	4.0	3.0	<i>see Note below</i>
200-300'	3.0	2.0	<i>see Note below</i>
Over 300'	2.0	1.0	<i>see Note below</i>

Note – Hydraulic Design is not allowable in culvert installations longer than 100 ft when juvenile salmonids require passage.

**Minimum Water Depth:**

Minimum water depth is specified by species and lifestage. For example,

- 0.30 m (12 in) for adult steelhead and Chinook
- 0.25 m (10 in) for salmon other than Chinook, sea-run cutthroat trout, or other trout over 0.51 m (20 in)
- 0.20 m (8 in) for trout under 0.51 m (20 in), Kokanee, juvenile steelhead and salmon

**Maximum Jump Height:**

- 0.30 m (12 in) adult steelhead and salmon
- 0.15 m (6 in) trout, Kokanee, juvenile steelhead and salmon

**Jump Pool Depth:**

Jump pool depth must be the greater of 1.5 times jump height or 0.61 m (24 in).

**Slope of Structure:**

- Less than 0.5% if not embedded, baffled, or backwatered
- Up to 5% if baffled.
- 5-12% if installed with a fish ladder or integral weirs

**Span of Structure:**

The span of the structure is not applicable.

**Length of Structure:**

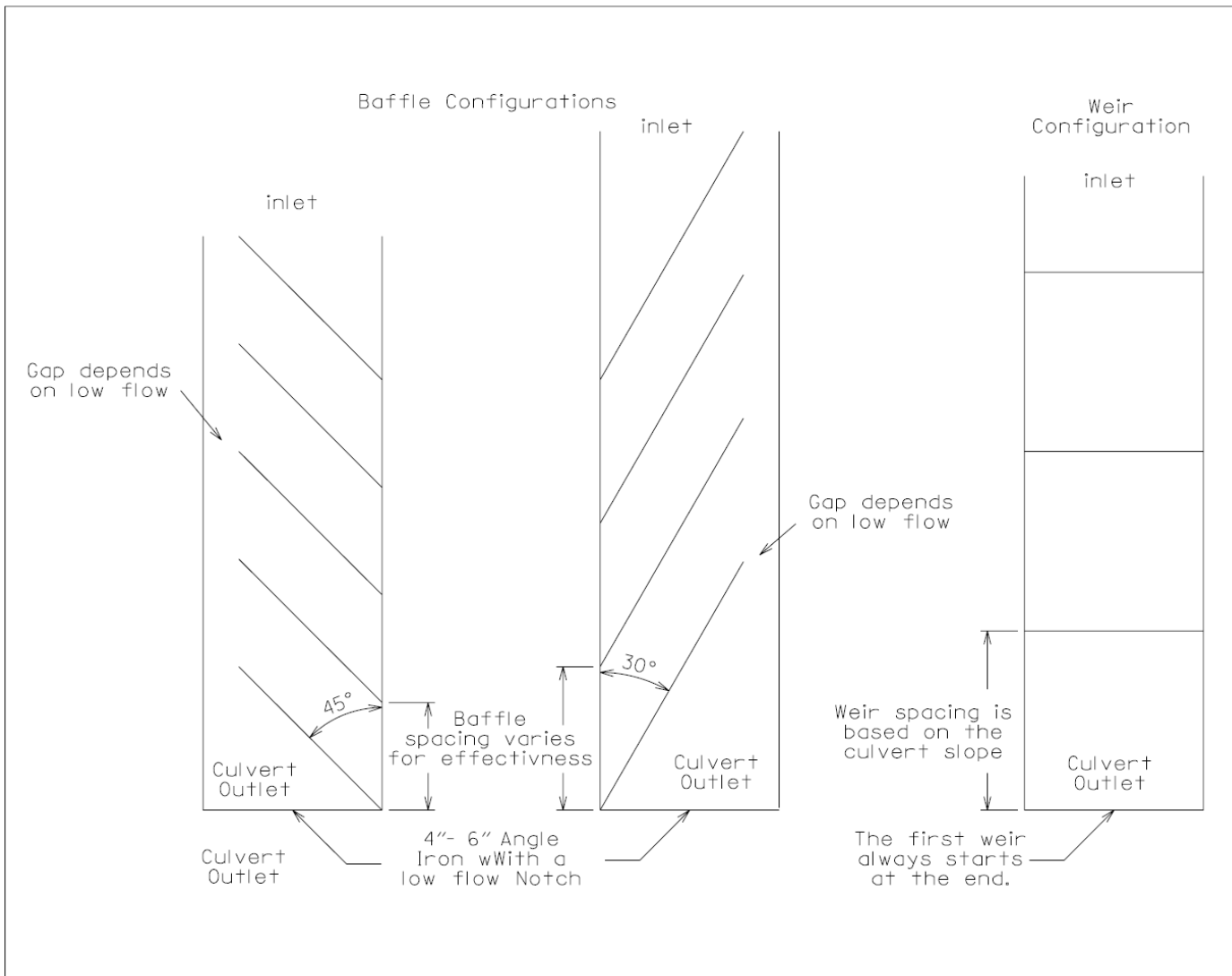
The length of the structure must be less than or equal to 30.5 m (100 ft) if juvenile passage is required.

**Flood Capacity:**

Flood-flow capacity must be adequate to pass the 100-yr flood.

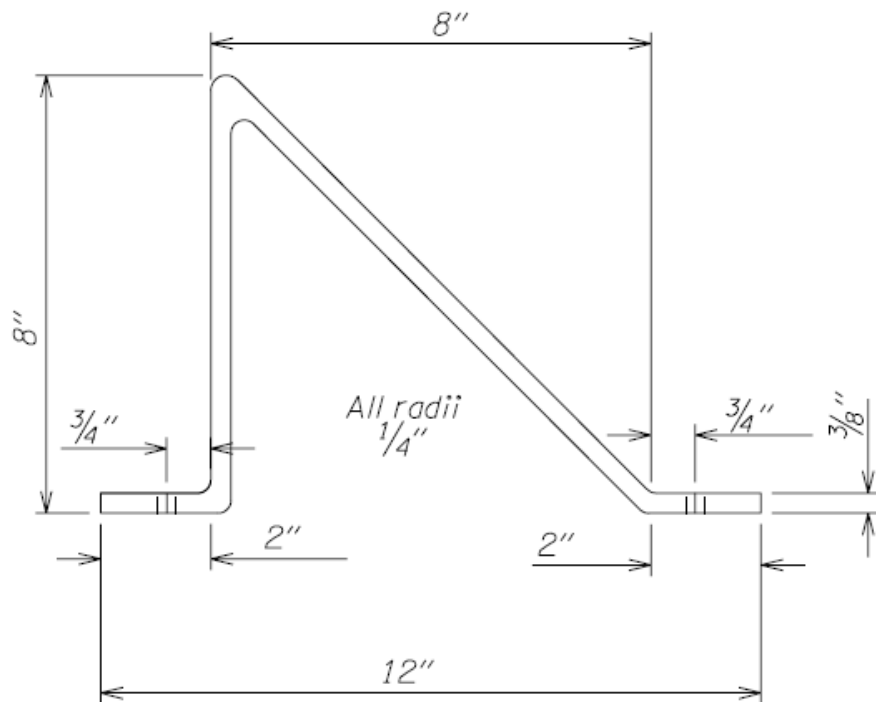
**Design Procedure:**

Oregon baffle configurations are shown in Figure 7.13-7.15.



**Figure. 7.13 Baffle configurations endorsed in Oregon in customary units (Trevis, Personal Communication)**

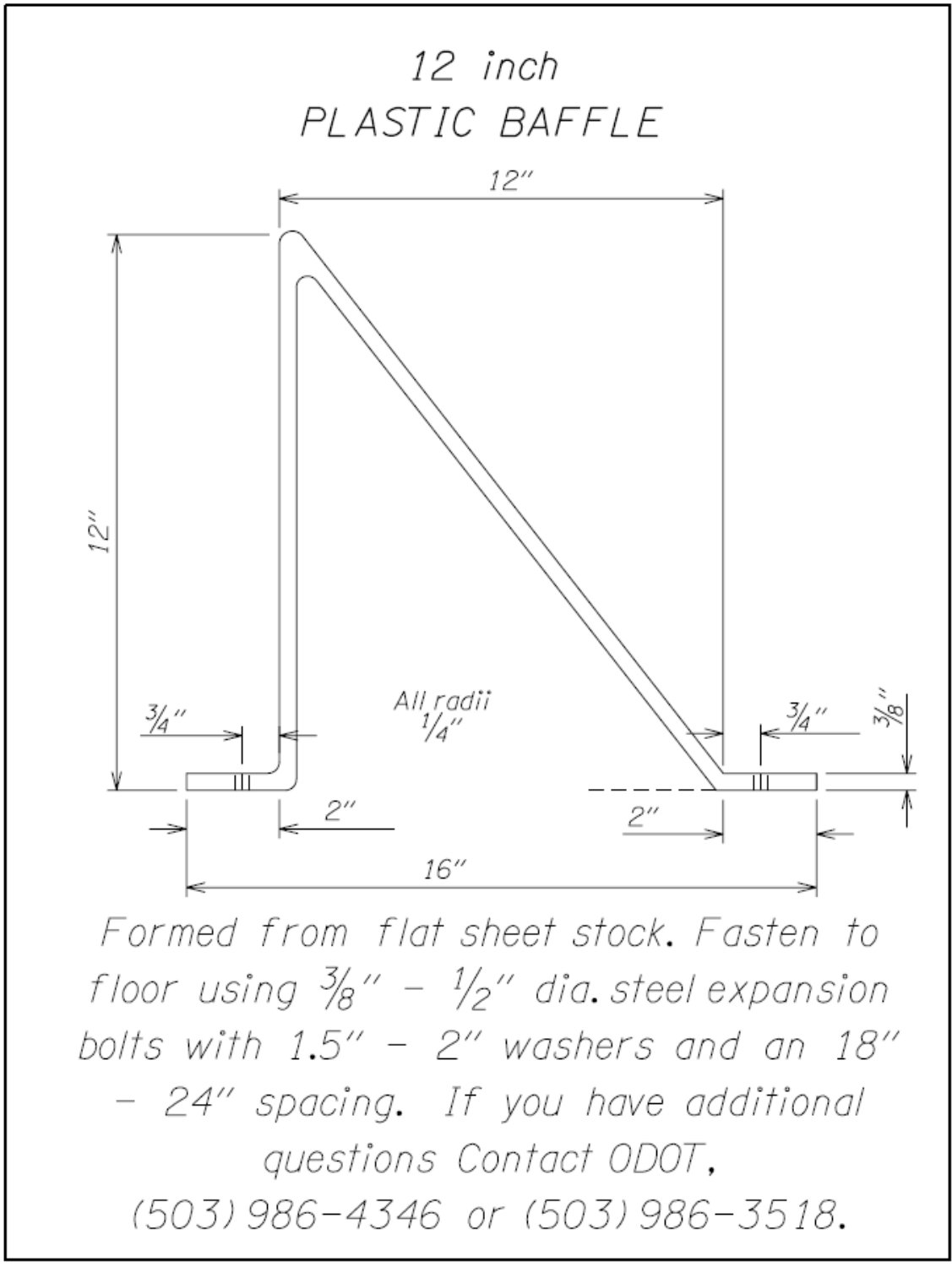
8 inch  
PLASTIC BAFFLE



*Formed from flat sheet stock. Fasten to floor using  $\frac{3}{8}$ " -  $\frac{1}{2}$ " dia. steel expansion bolts with 1.5" - 2" washers and an 18" - 24" spacing. If you have additional questions Contact ODOT, at (503) 986-3860 or (503) 986-3518.*

Figure 7.14 8 inch plastic baffle used in Oregon, customary units (Trevis, Personal Communication)

(Flow is from right to left)



**Figure 7.15 12 inch plastic baffle used in Oregon, customary units (Trevis, Personal Communication)**

(Flow is from right to left)

### **7.3.6 Maine DOT Culvert Design for Rehabilitation**

#### **Source**

- Maine Department of Transportation 2004

For culvert rehabilitations, the following objectives are desirable

- Eliminate hanging outlets
- Preserve minimum flow depth during critical periods of species-specific movement.
- Do not exceed maximum flow velocity during periods of species-specific upstream movement.

#### **7.3.6.1 Biological Characteristics**

Fish passage provided for target species. Generic design standards are provided when species-specific criteria are not available.

#### **7.3.6.2 Geomorphic Characteristics**

Where channel width is constricted, the rehabilitation may affect flow through and around the structure. Localized aggradation and degradation due to such constriction may need to be addressed. Retrofitted roughness elements have the propensity to catch and hold debris, increasing the risk of clogging.

#### **7.3.6.3 Hydraulic Characteristics**

Determine design flows adequate for fish passage, preserving minimum flow depth during critical periods of species-specific movement, and not exceeding maximum flow velocity during periods of upstream movement.

When species-specific criteria are not available, the structure must be designed for fish passage during low flow periods, maintaining a minimum depth at design low flows. The average of median September and October flows are to be used as design flows.

Flood conveyance must be checked, with consideration that retrofitted roughness elements may decrease capacity while increasing risk of plugging or failure.

#### **7.3.6.4 Data Requirements**

##### **Water Depth:**

Maintain at least 0.20 m (8 in) of water depth throughout the length of the culvert at design low flows.

**Velocity:**

Limit flow velocity to no more than 0.60 m/s (2 ft/s).

**Water Surface Elevation Drop at Outlet:**

Limit drop in water surface elevation at the outlet to 0.05 m (2 in).

**Design Flow:**

Use average of median September and October flows as design flow.

**Water Level Drop:**

Limit water level drop across grade control structures to 0.20 m (8 in).

**Weir Dimensions:**

When weirs are employed, weir notches should be at least 0.20 m (8 in) wide by 0.20 m (8 in) deep. Calculated dimensions should be rounded to the nearest 0.05 m (2 in) increment.

**7.3.6.5 Design Procedure**

When species-specific criteria are not available, the structure must be designed for fish passage during the low flow period. Other generic design standards are provided by the Data Requirements section.



### 7.3.7 Summary of Hydraulic Design Procedures

Table 7.8 provides a summary of Hydraulic Design techniques.

**Table 7.8 Comparison of Hydraulic Design Techniques**

Criteria	Maine	Washington	Oregon Dept of Fish and Wildlife	Maine
	Hydraulic Geometry Matching	Roughened Channel	Hydraulic Design	Culvert Design for Rehabilitation
<b>Culvert Span</b>	1.2 times bankfull	Start with Bankfull width and iterate.	Not applicable	Not applicable
<b>Culvert Slope</b>	Equal to natural stream	Use on culverts that are steeper than natural slope $\leq 10\%$ .	$\leq 0.5\%$ : if no embedment $< 5\%$ : with baffles 5-12%: fish ladders or weirs	Not applicable
<b>Substrate</b>	Allowed to fill with natural substrate	Stable up to and including $Q_{100}$ . $D_{100} < 25\%$ span	Not applicable	Not applicable
	Embed 0.15 m (0.5 ft) for culvert rise $< 1220$ mm (4 ft); 0.30 m for rise $> 1220$ mm (4 ft).	Bed retention sills may be placed at 10% culvert height. Downstream control point ensures that sills are not exposed. Culvert embedment of 30% -circular, 20% bottomless.		
<b>Culvert Shape</b>	Corrugated metal pipe arch	Not applicable	Not applicable	Not applicable
<b>Hydrology Required</b>	$Q_{50}$ design flood; check $Q_{100}$	$Q_{100}$ for culvert stability	$Q_{100}$ design flood; minimum and maximum fish passage flows	Return period of design flood not specified
<b>Hydraulic Considerations</b>	Match natural stream depth and width at $Q_{1.5}$ ; downstream grade control and interior weirs if necessary. Depth during passage period must be sufficient	Check velocity within the culvert to ensure that it is adequate for fish passage. EDF $< 7$ . Depth $< 2/3$ largest boulder.	Velocity, depth dependent upon fish, Section 7.3.5.4	$\geq 0.20$ m (0.67 ft) depth $\leq 0.60$ m/s (2 ft/s) velocity Outlet drop $\leq 0.05$ m (0.17 ft) Drop between baffles $\leq 0.20$ m (0.67 ft)
<b>Geomorphic Elements</b>	Allowed to fill with natural material	Large Boulders can be included to increase diversity. Stable low-flow path must be provided.	Not applicable	Not applicable
<b>Length</b>	Not applicable	Not applicable	$< 30$ m (100 ft) for juvenile salmonids Others see Table 7.7	Not applicable
<b>Reference</b>	Maine DOT 2004	Bates et al. 2003	Robison et al. 1999	Maine DOT 2004

### **7.3.8 A Detachable Fishway for Steep Culverts**

#### **Source**

- Clancy 1990

#### **Applicability**

- Culverts with spans close to that of the natural channel
- Successfully used in culverts with slopes of 4.4% and lengths of 45 m (148 ft)
- Culvert capacity is adequate to withstand a reduction in cross-sectional area without compromising design flood flow conveyance.

#### **Limitations**

- Culvert capacity must be adequate to buffer the impact of added sediment, which was shown to reduce culvert capacity by approximately 15%.

A detachable fishway for culvert retrofits was designed to be inexpensive and easily constructed in the field. Hand-placed rock is held in place by steel crossbars, creating a roughened channel that provides resting areas and low velocity paths within the culvert. The total cost of this retrofit (in 1990 dollars) was \$2200 for a culvert that was 45 m (148 ft) long and 1890 mm (6.2 ft) in diameter. Fish passage was observed within the first year. A site visit eight years after culvert installation showed that fish passage remained intact and that bed material had washed between large roughness elements.

#### **7.3.8.1 Biological Characteristics**

This design allows for the passage of target species, and creates resting areas and low-velocity paths for passage within the culvert.

#### **7.3.8.2 Geomorphic Characteristics**

Culvert spans are close to that of the natural channel. The installation has been successfully completed at sites with slopes of 4.4%. A site visit showed that natural bed material washed between roughness elements.

In installations in which the structure constricts the natural channel, localized aggradation and degradation may occur, especially given the fishway's propensity to catch and hold debris and clog the channel.

#### **7.3.8.3 Hydraulic Characteristics**

Culvert capacity should adequately buffer impact of added sediment, and should not compromise design flood flow conveyance. Flood conveyance must be checked.

Design flows for target species passage must be determined.

#### **7.3.8.4 Data Requirements**

##### **Culvert Span:**

Culvert span should be close to the width of the natural channel.

##### **Culvert Capacity:**

Capacity must be adequate to buffer the impact of added sediment, which was shown to reduce culvert capacity by approximately 15%.

##### **Culvert Slope:**

Successful installation was performed in culverts with slopes of 4.4%.

##### **Culvert Length:**

Successful installation was performed in culverts with lengths of 45 m (148 ft).

#### **7.3.8.5 Design Procedure**

1. Angle iron and reinforcing bar (as shown in Figure 7.16) is prefabricated in segments and assembled on site.
2. The upstream end of the fishway is anchored to the concrete headwall.
3. Downstream sections are bolted together
  - Cross members welded in place every 1.21 m (4 ft)
  - Rock holder and hold-downs are angled upstream so that water pressure holds structure in place.
  - Large rocks are hand placed on the upstream side of each cross member.

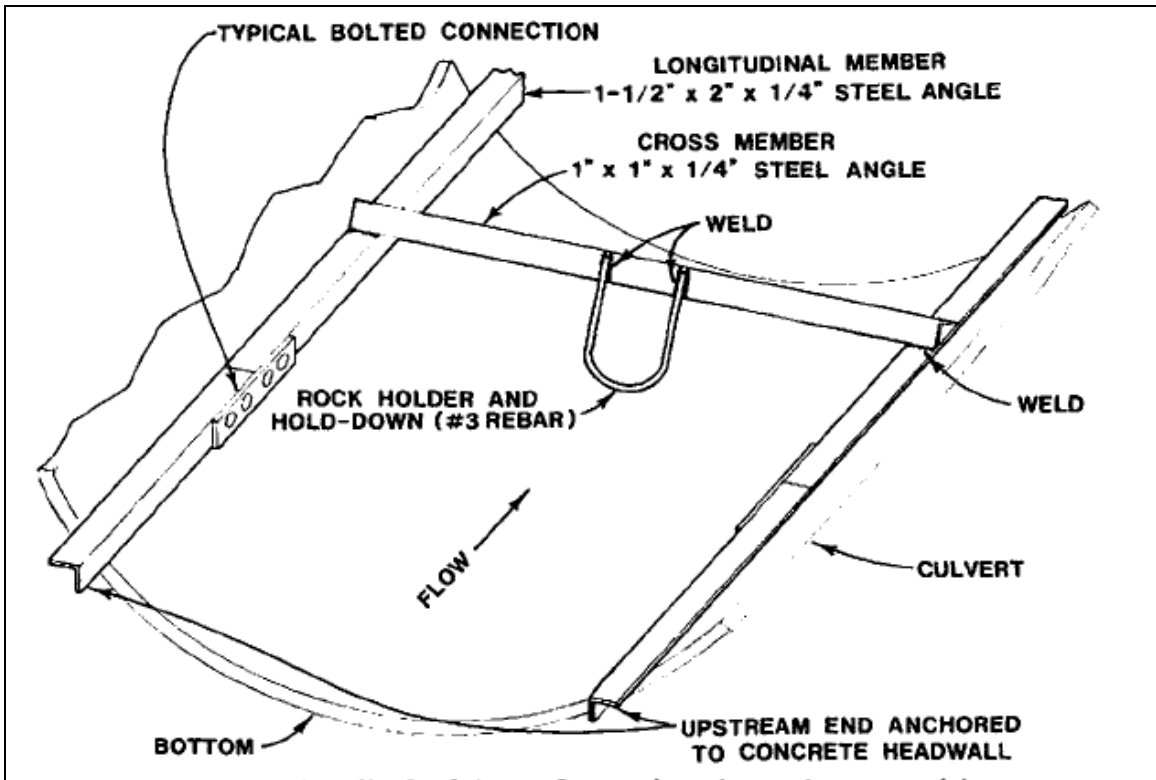


Figure 7.16 Detachable fishway design for culvert retrofit, customary units (Clancy 1990)

### 7.3.9 Fishways

Fishways are designed on a case-by-case basis. Each design is based on local conditions, policy and custom. Pictured below in Figure 7.17 is a fishway installed on Peacock Creek in California.



**Figure 7.17 Fishway installed on Peacock Creek, California (Llanos 2004)**

(View is looking downstream towards the culvert entrance)

#### **Applicability**

- Excessive drop at outlet cannot be mitigated by downstream grade control.
- Right-of-way is unavailable for developing downstream grade control.
- Steep culvert slope would require numerous closely spaced internal weirs.
- Slopes from 10-25% depending on fish species and life stage requiring passage
- Often built downstream from outlet to avoid debris accumulation or reduced capacity in barrel

#### **Limitations**

- Long-term maintenance obligations

Occasionally, weirs and baffles will be either be unfeasible, or will not produce the hydraulics conditions necessary for fish passage (Maine Department of Transportation 2004). Fishways such as the Vertical Slot Fishway, Denil

Fishway and Steeppass Fishway are structures consisting of a sloping channel partitioned by flow control devices such as baffles, weirs or vanes with openings to allow fish to swim through. Further discussion of such devices is in *Introduction to Fishway Design* (Katopodis 1992).

#### **7.3.9.1 Biological Characteristics**

Fishways provide hydraulic conditions to allow for target species passage.

#### **7.3.9.2 Geomorphic Characteristics**

Fishways are applicable on steep slopes of 10-25%. The fishway may affect flow through and around the structure. When the natural channel is constricted, localized aggradation and degradation may occur. The structure has the propensity to catch and hold debris, and will require long-term maintenance.

#### **7.3.9.3 Hydraulic Characteristics**

Design flows for target species passage must be determined.

Flood conveyance must be checked. The potential to catch and hold debris may decrease the structure's flood flow capacity and increase the likelihood of plugging and failure.

#### **7.3.9.4 Data Requirements**

##### **Slope:**

This design is recommended on slopes from 10-25% depending on fish species and life stage requiring passage.

##### **Design Flow:**

Flows must be adequate to provide for species-specific fish passage.

##### **Flood Capacity:**

Capacity must be adequate to pass design flood flows.

### **7.3.10 Floodplain Culverts**

As described in Section 7.2, Maryland design guidelines contain specification for floodplain culverts in situations where a single culvert would overly constrict flow (Maryland State Highway Administration 2005). Floodplain culverts can be installed to collect and convey flood plain flows, reducing the impact of the main-channel culvert. Floodplain culverts should be positioned on the floodplain well beyond the influence of the main culvert to avoid channel undermining, degradation or migration into the area of the floodplain culvert. This position also avoids clogging due to debris carried in the main channel.

#### **7.3.10.1 Biological Characteristics**

A main-channel culvert allows for target species passage by providing resting pools, low velocities and deep flow.

#### **7.3.10.2 Geomorphic Characteristics**

By conveying flood flows, the floodplain culvert reduces the impact of the main-channel culvert on the natural channel. Positioning the floodplain culvert on the floodplain, and away from the influence of the main-channel culvert, also protects local morphology. The main-channel culvert outlet should minimize impacts to the downstream channel and stabilize flow for passage.

#### **7.3.10.3 Hydraulic Characteristics**

Design flows for target species passage in the main-channel culvert must be determined. The floodplain culvert increases capacity for flood-flow. The structure must be checked for flood-flow conveyance.

#### **7.3.10.4 Data Requirements**

##### **Flood Capacity:**

Floodplain culverts must adequately convey design flood flow levels.

### **7.3.11 Two-Cell Installations**

Two-cell fish culverts provide one cell for fish passage and another to ensure flood capacity. Maryland and Maine utilize two-cell installations as described in Section 7.2 (Maryland State Highway Administration 2005; Maine Department of Transportation 2004). For two-cell installations, upstream w-weirs may be included to reduce bar deposition and scour, increase the competence of bed material transport and reduce debris build-up at the center wall. As noted elsewhere, w-weirs can alleviate the accumulation of debris between spans of multi-cell installations. North Carolina has criteria for two-cell culvert installations (Figure 7.18) utilizing a lowered fish passage culvert that creates a sinuous low flow travel path in the lower culvert (Twisdale, Personal Communication). Lang et al discourages two-cell installations due to the likelihood of debris collecting on the area between spans (Lang et al. 2004).



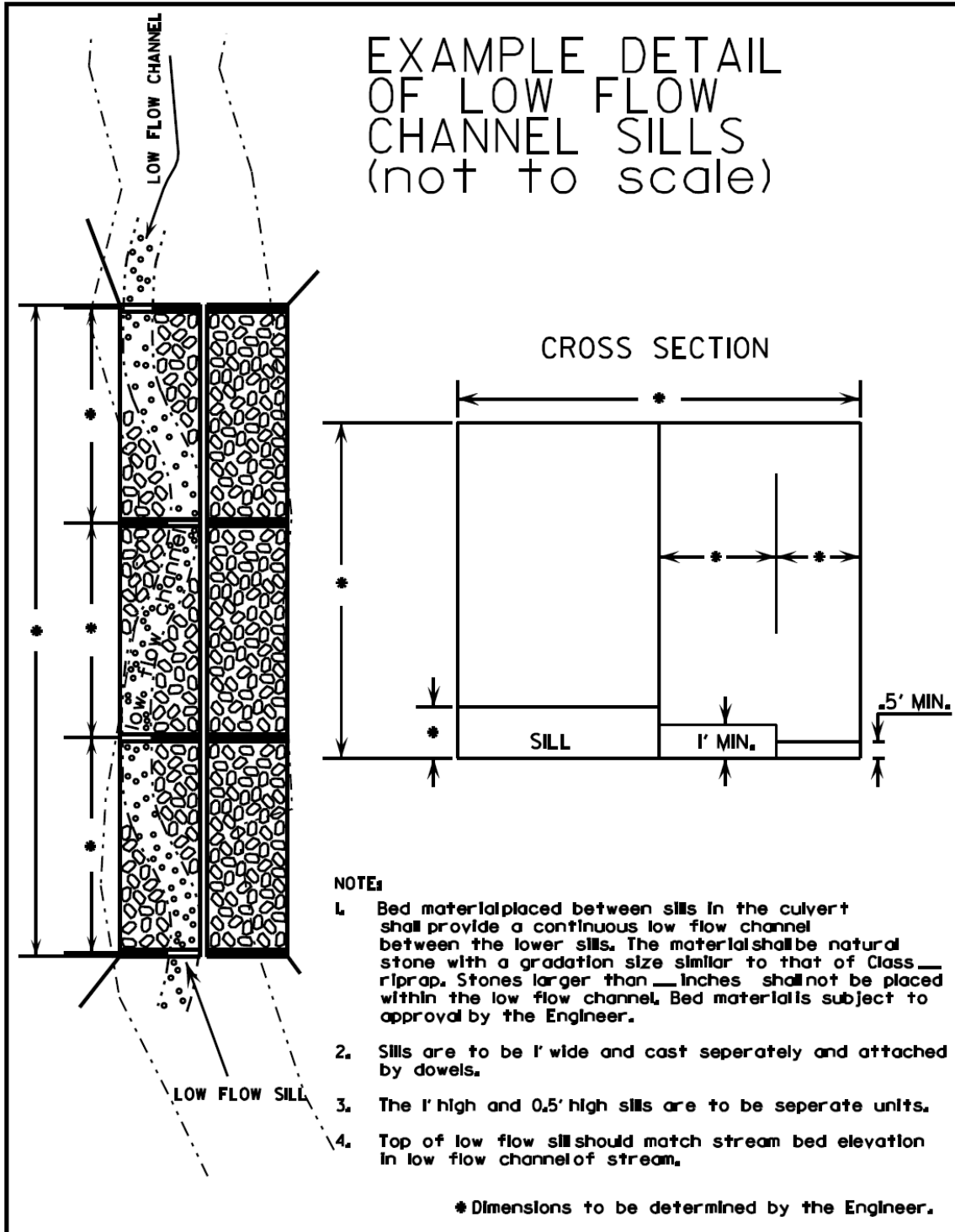


Figure 7.18 Example detail of low-flow channel sills, customary units (Twisdale, Personal Communication)

#### **7.3.11.1 Biological Characteristics**

One cell allows for passage of target species by creating adequate hydraulic conditions.

#### **7.3.11.2 Geomorphic Characteristics**

Generally the cell which allows for fish passage is designed to maintain a low flow channel with natural bed material. Maryland recommends upstream “W” weirs to reduce bar deposition and scour, increase the competence of bed material transport and reduce debris build-up at the center wall, and designs the main-channel culvert outlet to minimize impacts to the downstream channel and stabilize flow for passage.

The propensity for the center wall to catch debris increases the likelihood this structure will influence characteristics of the natural channel.

#### **7.3.11.3 Hydraulic Characteristics**

Design flows for target species passage must be met in the corresponding cell.

The two-cell installation provides one cell for flood-flow capacity. Flood-flow conveyance for the structure must be checked. The potential for debris build-up may decrease flood-flow capacity and increase plugging and failure.

#### **7.3.11.4 Data Requirements**

##### **Hydrology:**

Adequate hydraulic conditions for target species passage must be determined for the fish-passage cell.

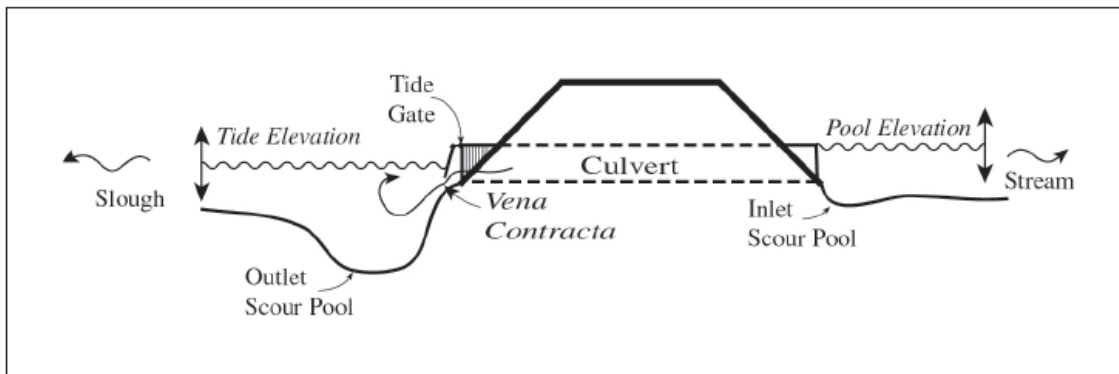
##### **Flood Capacity:**

Culvert capacity must be sufficient to convey design flood flows.

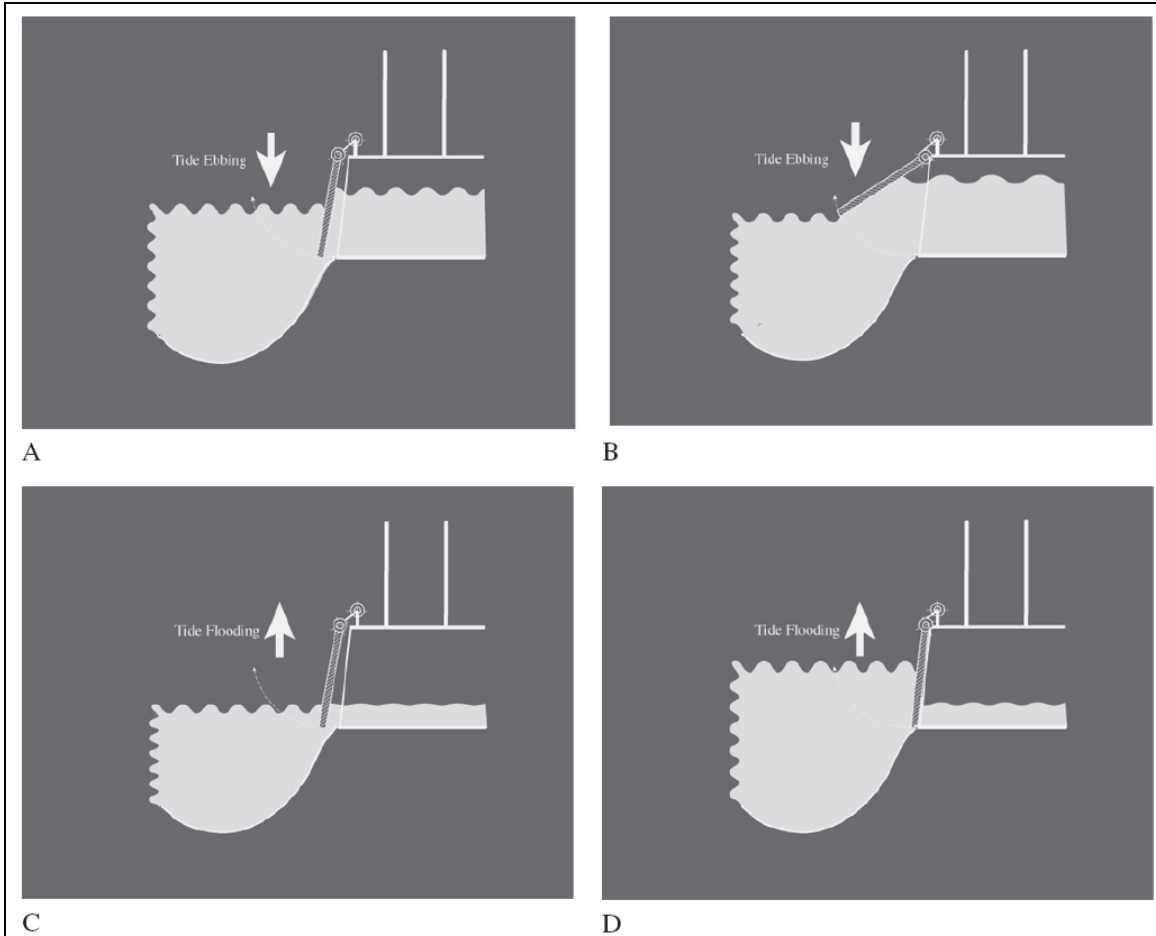
### 7.3.12 Tide Gates

In tidal situations, tide gates are used to allow freshwater to flow into estuaries while ensuring that brackish waters are kept from moving upstream. Such structures have been part of a system of dikes used to allow the drainage and development of marshland (Giannico and Souder 2005).

Tide gates (or tide flaps) are attached to culvert outlets as depicted in Figure 7.19, and are controlled by the elevational difference of water levels on either side of the culvert. In a process shown sequentially in Figure 7.20, culverts open as ebbing tides allow fresh water to flow to the estuary side of the culvert, and close as flood tides attempt to bring tidal waters upstream and upland. Fish passage at tide gates is focused on extending the period of time that tide gates remain open, thereby increasing the range of flows over which a fish will be able to pass the structure.

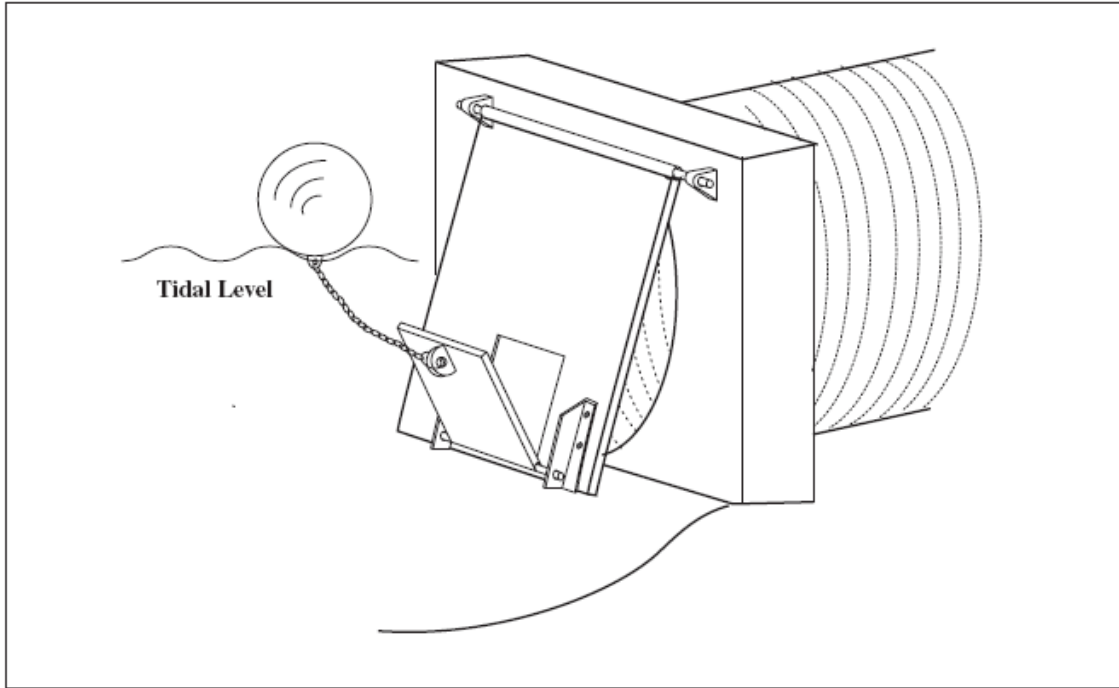


**Figure 7.19** Lateral schematic of a culvert with a top-hinged tide gate attached to downstream end of culvert (Giannico and Souder 2005)



**Figure 7.20** Tide gate operation cycle: (A) tide gate begins to open when water pressure in culvert overcomes pressure of water on downstream side during ebb tide; (B) tide gate is wide open during ebb tide; (C) tide gate begins to shut when upstream water level drops and tide begins to rise; and (D) tide gate is shut during flood tide (Giannico and Souder 2004)

Advances in tide gate technology include gates with permanent holes, aluminum or plastic gates, fiberglass doors, side hinged gates, rubber gates, and fish passage appurtenances such as “pet doors” (Figure 7.21). These technologies are largely unvalidated, and have questionable effects on fish passage and stream ecology (Giannico and Souder 2004).



**Figure 7.21 Bottom-hinged pet door (Giannico and Souder 2005)**

(The floater allows a small area of the gate to open during periods when water elevations would keep the gate closed; this is intended to allow a longer period of fish movement)

Tide gates impact freshwater/brackish water interaction, and can have a profound effect on channel characteristics including flooding and water flow, channel geometry, water temperature, Ph, salinity, plant communities and fish and fish habitat (Giannico and Souder 2005). The authors warn that there is no such thing as a fish friendly tide gates, only a “fish friendlier” tide gate.

#### **Note on State Guidelines for Design in Tidal Areas**

Because of the difficulty in creating fish passage criteria in tidal areas, Washington Department of Fish and Wildlife promotes removal of tidal culverts as the preferred restoration technique (Bates et al. 2003). Maryland culverts are commonly designed for low tide conditions, ensuring that the culvert is accessible in a worst-case scenario (Kosicki, Personal Communication 2006).

#### **7.3.12.1 Biological Characteristics**

Designing tide gates for fish passage increases the time the gate remains open, thereby increasing the range of flows over which a fish will be able to pass the structure. Tide gates' impact on the interaction of freshwater and brackish water can profoundly affect fish and fish habitat.

#### **7.3.12.2 Geomorphic Characteristics**

Tide gates allow freshwater to flow into estuaries and keep brackish water from moving upstream. Their impact on the interaction of freshwater and brackish water can profoundly affect channel characteristics, including flooding and water flow, channel geometry, temperature, Ph and plant communities.

#### **7.3.12.3 Hydraulic Characteristics**

The impact of tide gates on freshwater and brackish water interaction can influence the flood conveyance and water flow of the channel.

This page intentionally left blank

## 8 CASE STUDIES AND DESIGN EXAMPLES

### HOW TO USE THIS CHAPTER

- ▶ Study worked out examples of culverts designs using selected design methods
- ▶ Review case studies for completed projects

## 8.1 GEOMORPHIC SIMULATION

### 8.1.1 USFS Stream Simulation Design Example

A survey of the existing channel, and a surface pebble count conducted on a representative reference reach, determined the following channel characteristics:

*Channel width ( $W_{ch}$ ) = 1.95 m (6.4 ft)*

*Channel slope ( $S_{ch}$ ) = 2.0%*

*Culvert length ( $L_{culv}$ ) = 30.5 m (100 ft)*

*$D_{100}$  = 180 mm (0.591 ft)*

*$D_{84}$  = 85 mm (0.279 ft)*

*$D_{50}$  = 50 mm (0.164 ft)*

*The stream slope is constant in a reach extending more than 20 channel widths up- and downstream from the crossing site.*

The culvert is sized assuming that bank margins are desirable.

*Culvert bed width ( $W_{culv}$ ) =  $W_{ch} + 4 * D_{100}$*

*$W_{culv}$  = 2.67 m (8.76 ft)*

The culvert should span a minimum of 2.70 m (8.9 ft), which would be rounded up to 2.75 m (9 ft).

Bed mix gradation includes  $D_{100}$ - $D_{50}$  determined from the surface pebble count, with  $D_{16}$  and  $D_5$  determined by the Fuller-Thompson equation (6.5).

$$P = \left( \frac{d}{D_{100}} \right)^n \quad (\text{Equation 6.5})$$

The Fuller-Thompson 'n' value can be varied approximately between 0.45 and 0.7 to control gradation until an appropriate proportion of fines (5-10%) has been attained. To start, compare the effects of an n value of 0.7 vs. and n value of 0.45. The results of these calculations have been plotted in Figure 8.1.



Using  $n = 0.7$

$$D_{16} = 0.32^{1/n} * D_{50}$$

$$D_{16} = 0.32^{1/(0.7)} * 50 \text{ mm}$$

$$D_{16} = 10 \text{ mm} \quad (6.5 \times 10^{-3} \text{ ft})$$

$$D_5 = 0.10^{1/n} * D_{50}$$

$$D_5 = 0.10^{1/(0.7)} * 50 \text{ mm}$$

$$D_5 = 2 \text{ mm} \quad (6.1 \times 10^{-3} \text{ ft})$$

Using  $n = 0.45$

$$D_{16} = 0.32^{1/n} * D_{50}$$

$$D_{16} = 0.32^{1/(0.45)} * 50 \text{ mm}$$

$$D_{16} = 4 \text{ mm} \quad (0.013 \text{ ft})$$

$$D_5 = 0.10^{1/n} * D_{50}$$

$$D_5 = 0.10^{1/(0.45)} * 50 \text{ mm}$$

$$D_5 = 0.3 \text{ mm} \quad (9.8 \times 10^{-4} \text{ ft})$$

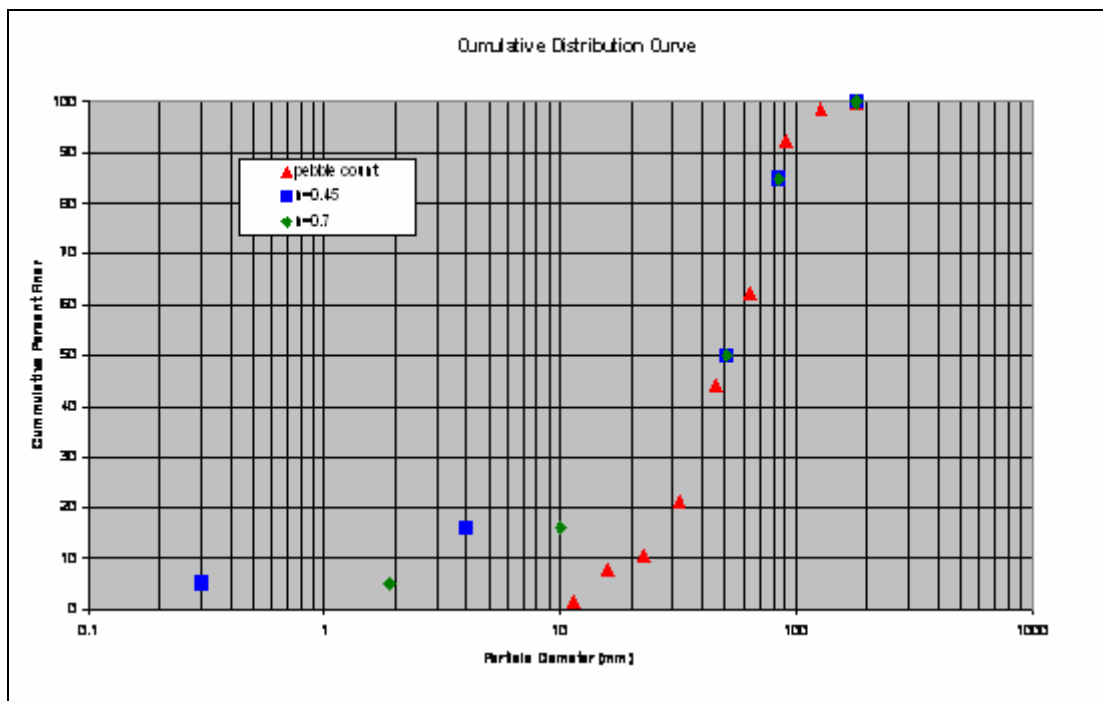


Figure 8.1 Example cumulative distribution curve for bed mix gradation using Fuller-Thompson method using  $n = 0.7$  and  $n = 0.45$

It can be seen that an n value of 0.45 will lead to gradation of approximately 12-13% fines (2 mm or less).

Refining further, using n = 0.55

$$D_{16} = 0.32^{1/n} * D_{50}$$

$$D_{16} = 0.32^{1/(0.55)} * 50 \text{ mm}$$

$$D_{16} = 6.3 \text{ mm} \quad (0.021 \text{ ft})$$

$$D_5 = 0.10^{1/n} * D_{50}$$

$$D_5 = 0.10^{1/(0.55)} * 50 \text{ mm}$$

$$D_5 = 0.75 \text{ mm} \quad (2.49 \times 10^{-3} \text{ ft})$$

This distribution is plotted in Figure 8.2.

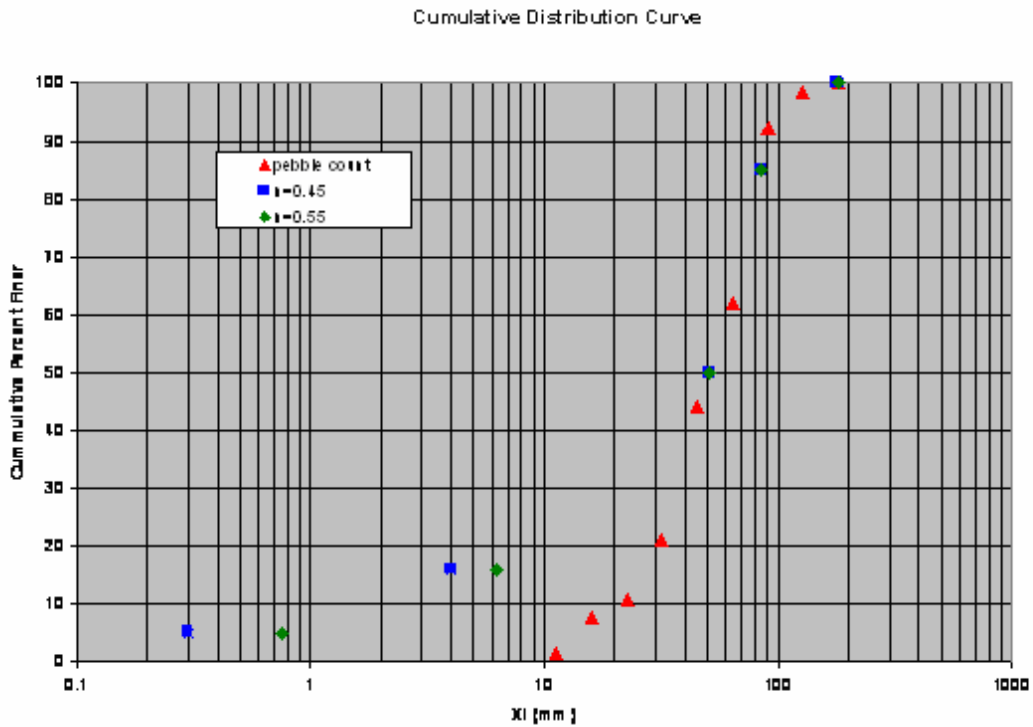


Figure 8.2 Example cumulative distribution curve for the Fuller-Thompson method using n = 0.55 and n = 0.45

An n value of 0.55 leads to a bed mix gradation with between 5-10% fines (smaller than 2 mm). The following gradation should be used for design.

$$\begin{aligned}
 D_{100} &= 180 \text{ mm } (0.59 \text{ ft}) \\
 D_{84} &= 85 \text{ mm } (0.28 \text{ ft}) \\
 D_{50} &= 50 \text{ mm } (0.164 \text{ ft}) \\
 D_{16} &= 6.4 \text{ mm } (0.021 \text{ ft}) \\
 D_5 &= 0.76 \text{ mm } (2.5 \times 10^{-3} \text{ ft})
 \end{aligned}$$

### 8.1.2 USFS Stability Check Design Example

The following stability check example is taken (almost verbatim) from Bates et al. 2006. It is included here for clarification of the USFS Stream Simulation Design.

#### Determining if $D_{84}$ moves at bankfull flow (example from Bates et al. 2006)

Channel parameters are as follows:

$$\begin{aligned}
 D_{84} &= 120 \text{ mm } (0.39 \text{ ft}) \\
 D_{50} &= 52 \text{ mm } (0.17 \text{ ft}) \\
 D_{16} &= 27 \text{ mm } (0.089 \text{ ft}) \\
 \text{Bankfull flow } (Q_{bf}) &= 3 \text{ m}^3/\text{s } (106 \text{ cfs}) \\
 \text{Bankfull width } (W_{bf}) &= 5.7 \text{ m } (18.7 \text{ ft}) \\
 \text{Active channel width } (W) &= 5.0 \text{ m } (15.3 \text{ ft}) \\
 \text{Slope } (S) &= 0.0142 \text{ m/m } (\text{ft/ft})
 \end{aligned}$$

Determine whether the  $D_{84}$  particle moves at bankfull flow in the stream using the **modified critical shear stress** equation for  $D_{84}$  (Equation 6.7).

$$\begin{aligned}
 \tau_{ci} &= \tau_{D_{50}}^* (\gamma_s - \gamma) D_i^{0.3} D_{50}^{0.7} \text{ (Equation 6.7)} \\
 \tau_{D_{50}}^* &= 0.050 \text{ (From Table 6.4), with } \gamma_s = 2.65\gamma \text{ and } \gamma = 9810 \frac{\text{N}}{\text{m}^3} \\
 \tau_{cD_{84}} &= 16817(0.050)(0.12 \text{ mm})^{0.3} (0.052 \text{ mm})^{0.7} \\
 \tau_{cD_{84}} &= 54 \text{ Pa } (1.12 \text{ lb/ft}^2)
 \end{aligned}$$

Find the average boundary shear stress in the reference reach at bankfull flow ( $\tau_{bf}$ ) using Equation 6.6 with a hydraulic radius of 0.30 m (1 ft).

$$\begin{aligned}
 \tau_{bf} &= \gamma RS \text{ (Equation 6.6)} \\
 \tau_{bf} &= \left( 9810 \frac{\text{N}}{\text{m}^3} \right) (0.30 \text{ m}) (0.0142) \\
 \tau_{bf} &= 42 \text{ Pa} < 54 \text{ Pa} \quad \left( 0.886 \frac{\text{lb}}{\text{ft}^2} < 1.12 \frac{\text{lb}}{\text{ft}^2} \right)
 \end{aligned}$$

Therefore, the  $D_{84}$  particle size is stable bankfull flow

How well does the modified critical shear stress equation apply here?

- $D_{84}/D_{50} = 2.3$ , which is much less than 30
- Slope < 5%
- Channel unit is a riffle
- $D_{84}$  particle size of 120 mm is between the range of 10 and 250 mm.

Conclusion: The modified critical shear stress equation is applicable to this stream

### Critical unit discharge equation

Find the critical unit discharge for  $D_{50}$  ( $q_{cD50}$ ) using Equation 6.9.

$$q_{c-D_{50}} = \frac{0.15g^{0.5}D_{50}^{1.5}}{S^{1.12}} \quad (\text{Equation 6.9})$$

$$q_{cD50} = \frac{0.15g^{0.5}(0.52\text{ m})^{1.5}}{0.0142^{1.12}} = 0.65 \frac{\text{m}^2}{\text{s}} \quad \left(7 \frac{\text{ft}^2}{\text{s}}\right)$$

Calculate  $b$  (which quantifies the range in particle sizes) using Equation 6.11.

$$b = 1.5 \left[ \frac{D_{84}}{D_{16}} \right]^{-1} \quad (\text{Equation 6.11})$$

$$b = 1.5 \left( \frac{120\text{ mm}}{27\text{ mm}} \right)^{-1} = 0.338$$

Find critical unit discharge for  $D_{84}$  ( $q_{cD84}$ ) using Equation 6.10.

$$q_{ci} = q_{cD50} \left( \frac{D_i}{D_{50}} \right)^b \quad (\text{Equation 6.10})$$

$$q_{cD84} = 0.65 \frac{\text{m}^2}{\text{s}} \left( \frac{120\text{ mm}}{27\text{ mm}} \right)^{0.338} = 1.07 \frac{\text{m}^2}{\text{s}} \quad \left(11.6 \frac{\text{ft}^2}{\text{s}}\right)$$

$$q = \frac{Q_{bf}}{W} = \frac{3\text{ m}^3/\text{s}}{5.0\text{ m}} = 0.6 \frac{\text{m}^2}{\text{s}} \quad \left(6.46 \frac{\text{ft}^2}{\text{s}}\right)$$

Both  $D_{50}$  and  $D_{84}$  are stable at bankfull flow in this example. These results agree with those of the modified critical shear stress equation.

Is the Bathurst equation appropriate for this stream?

*Slope > 1%*

*$D_{84}$  is small cobble*

*$R_{bf}/D_{50} = 5.9$ , which is  $< 10$  (low relative submergence)*

### **Predicting the range of potential particle movement**

Find the average boundary shear stress in the reference reach at bankfull flow ( $\tau_{bf}$ ) using Equation 6.6.

$$\tau_{bf} = \gamma RS \text{ (Equation 6.6)}$$

$$\tau_{bf} = \left( 9810 \frac{N}{m^3} \right) (0.30 \text{ m}) (0.0142)$$

$$\tau_{bf} = 42 \text{ Pa} \quad \left( 0.88 \frac{lb}{ft^2} \right)$$

Find the upper critical shear stress for the  $D_{84}$  particle size using Equation 6.12.

$$\tau_{ci-u} = 0.0814 D_i \text{ (Equation 6.12)}$$

$$\tau_{cD_{84,u}} = 0.0814 \cdot (120 \text{ mm}) = 468 \text{ Pa} \quad \left( 9.77 \frac{lb}{ft^2} \right)$$

Find the lower critical shear stress for the  $D_{84}$  particle size using Equation 6.13.

$$\tau_{ci-l} = 0.00355 D_i \text{ (Equation 6.13)}$$

$$\tau_{cD_{84,l}} = 0.00355 \cdot (120 \text{ mm}) = 20 \text{ Pa} \quad \left( 0.426 \frac{lb}{ft^2} \right)$$

$\tau_{bf} = 42 \text{ Pa}$  ( $0.90 \text{ lb/ft}^2$ ) is less than  $\tau_{cD_{84,u}} = 468 \text{ Pa}$  ( $9.77 \text{ lb/ft}^2$ ) and greater than  $\tau_{cD_{84,l}} = 20 \text{ Pa}$  ( $0.426 \text{ lb/ft}^2$ ), indicating that the  $D_{84}$  particle has the potential to be mobile at bankfull flow.

**Summary:** Both the modified critical shear stress and critical unit discharge equations predict that the  $D_{84}$  will be stable at bankfull conditions. The Williams equations (Equations 6.12 and 6.13) indicate potential movement of the  $D_{84}$ .

**Judgment:**  $D_{84}$  is likely stable at bankfull conditions.

### 8.1.3 WDFW Stream Simulation Design Example

Stream properties are determined from a channel survey and analysis of multiple representative cross sections.

$$\text{Channel width } (W_{ch}) = 1.95 \text{ m } (6.4 \text{ ft})$$

$$\text{Channel slope } (S_{ch}) = 2.0\%$$

$$\text{Culvert Slope } (S_{culv}) = 2.2\%$$

$$\text{Culvert length } (L_{culv}) = 30.5 \text{ (100 ft)}$$

Check Applicability

$$S_{ch} = 2\% < 6.0\%$$

$$\text{Slope Ratio} = \left( \frac{S_{culv}}{S_{ch}} \right) = 1.1$$

*Channel has been assessed to have little susceptibility to vertical changes*

Conclusion: WDFW Stream Simulation is applicable in this situation

Culvert span is determined according to Equation 7.1.

$$\text{Culvert bed width } (W_{culv}) = 1.2 W_{ch} + 0.6 \text{ m}$$

$$W_{culv} = 3 \text{ m } (9.64 \text{ ft})$$

Culvert should span a minimum of 3000 mm, which would likely be rounded up to 3048 mm (10 ft).

Culvert bed configuration is based on slope scenarios. Since slope is less than 4%, design scenario I is employed, meaning that rock bands will be used to control the initial channel shape. This creates a situation that may be more adequately described as Hydraulic Simulation.

Bands spacing should be the lesser of  $5 \cdot W_{ch}$  and  $0.24 \text{ m}/S_{culv}$ , or

$$5 \cdot W_{ch} = 9.75 \text{ m } (32 \text{ ft})$$

$$\frac{0.24 \text{ m}}{S_{culv}} = 10.9 \text{ m } (35.8 \text{ ft})$$

Therefore, spacing will be 9.75 m (32 ft).

Bands are separated from the entrance and exit by the lesser of:

$$2 \cdot W_{ch} = 3.9 \text{ m } (12.7 \text{ ft}) \quad \text{or} \quad 7.62 \text{ m } (25 \text{ ft})$$

Therefore, spacing should be at least 3.9 m (13 ft) from culvert inlet and outlet. With a 30.5 m (100 ft) structure this leaves room for 3 rock weirs at a spacing of 9.75 m (32 ft) apart, and 5.5 m (18 ft) from the culvert entrance and exit.

Sizing of rock band material is based on a surface pebble count of the reference reach.

$$D_{100} = 180 \text{ mm } (0.591 \text{ ft})$$

$$D_{84} = 85 \text{ mm } (0.279 \text{ ft})$$

$$D_{50} = 50 \text{ mm } (0.164 \text{ ft})$$

Rock bands are comprised of well-graded material within the following range.

$$D_{100} = 180 \text{ mm } (0.59 \text{ ft}) \quad \text{to} \quad 2 \cdot D_{100} = 360 \text{ mm } (1.2 \text{ ft})$$

Since channel slope is less than 4%, Paleohydraulic Analysis can be used to check the bed changing flow, ensuring that bed mix gradation is adequate.

$$D_{84} = 85 \text{ mm } (0.279 \text{ ft}) \quad (\text{from above})$$

$$V = 9.57 \cdot D_{84}^{0.487} \quad (\text{Equation 6.17, customary units})$$

$$V = 5.14 \cdot \frac{\text{ft}}{\text{s}} \quad (1.57 \frac{\text{m}}{\text{s}})$$

Using Table 6.5, slope (2.2%) and particle size 85 mm (0.28 ft) are used to find depth of flow

$$\text{Depth} = 0.25 \text{ m } (0.81 \text{ ft})$$

With known depth, cross-sectional area can be computed from the proposed triangular cross section with 6:1 side slopes. (Area of a triangle is 0.5\*base\*height)

$$\text{Area} = 0.5 \cdot \text{Depth} \cdot (12 \cdot \text{Depth})$$

$$\text{Area} = 0.37 \text{ m}^2 \quad (3.94 \text{ ft}^2)$$

Using the proposed cross-sectional area, this corresponds to a flow of

$$Q = A \cdot V$$

$$Q = 0.58 \text{ m}^3/\text{s} \quad (20.5 \text{ cfs})$$

### 8.1.4 Unit Discharge Design Example

When slopes are greater than 4%, the Unit-Discharge method is suggested for finding a stable bed material gradation. Necessary parameters include:

$$100 \text{ year exceedance flow } (Q_{100}) = 3.54 \text{ m}^3/\text{s} \quad (125 \text{ cfs})$$

$$\text{Culvert slope } (S_{culv}) = 5.0 \%$$

$$\text{Channel width } (W_{ch}) = 2.44 \text{ m} \quad (8.0 \text{ ft})$$

Solving for Critical Discharge ( $q_c$ ):

$$q_c = \frac{Q_{100}}{W_{ch}}$$

$$q_c = 1.45 \frac{\text{m}^2}{\text{s}} \quad (15.6 \frac{\text{ft}^2}{\text{s}})$$

Using the Critical Discharge equation (6.16) to solve for  $D_{84}$ :

$$D_{84} = 3.45 S^{0.747} (1.25 q_c)^{2/3} / g^{1/3} \quad (\text{Equation 6.16})$$

$$D_{84} = \frac{3.45 \cdot S_{culv}^{0.747} \cdot (1.25 q_c)^{2/3}}{g^{1/3}} = 256 \text{ mm} \quad (0.84 \text{ ft})$$

So a D84 of 256 mm (0.84 ft) will create the necessary stability, and a gradation can be created based on D84. This can also be checked using the Paleohydraulic analysis shown above.

#### 8.1.4.1 Paleohydraulic Analysis

$$D_{84} = 256 \text{ mm} \quad (0.84 \text{ ft})$$

$$V = 9.57 \cdot D_{84}^{0.487} \quad (\text{Equation 6.17, customary units})$$

$$V = 8.79 \frac{\text{ft}}{\text{s}} \quad (2.68 \frac{\text{m}}{\text{s}})$$

Using Table 6.5, find flow depth

$$\text{Depth} = 1.6 \text{ ft} \quad (0.49 \text{ m})$$



Using the proposed channel dimensions (6:1 side slope, triangular channel)

$$Area = 0.5 \cdot Depth \cdot (12 \cdot Depth)$$

$$Area = 1.44 \text{ m}^2 \quad (15.5 \text{ ft}^2)$$

$$Q = V \cdot A$$

$$Q = 3.86 \text{ m}^3/\text{s} \quad (136.0 \text{ cfs})$$

This is consistent with the trend of Co'ta's equation to predict smaller particle sizes than Bathu'st's equation at higher slopes (Bates et. al 2003). Both equations show this  $D_{84}$  to be stable at  $Q_{100}$  (125 cfs).

### 8.1.5 WDFW No-Slope Design Example

#### Stream Properties Needed

$$\text{Channel width } (W_{ch}) = 1.95 \text{ m } (6.4 \text{ ft})$$

$$\text{Channel slope } (S_{ch}) = 2\%$$

$$\text{Culvert Slope } (S_{culv}) = 2.2\%$$

$$\text{Culvert length } (L_{culv}) = 30.5 \text{ m } (100 \text{ ft})$$

#### Channel Type and Size

$$\text{Culvert bed width } (W_{culv}) = 1.25 \cdot W_{ch}$$

$$W_{culv} = 2.44 \text{ m } (8 \text{ ft})$$

Culvert should span a minimum of 2.44 m (8 ft).

To check the applicability of No Slope Design, ensure that the product of channel slope times length is less than 0.2D.

$$L_{culv} \cdot S_{culv} = 0.67 \text{ m } (2.2 \text{ ft})$$

$$0.2 \cdot D = 0.49 \text{ m } (1.6 \text{ ft})$$

Since slope times length is  $> 0.2D$ ,  $0.67 \text{ m} > 0.49 \text{ m}$  ( $2.2 \text{ ft} > 1.6 \text{ ft}$ ), No-Slope method is not applicable in this situation due to the inability to meet embedment requirements.

### 8.1.6 Embedded Pipe Case History

The following example of stream simulation is taken from the USFS FishXing website (United States Forest Service 2006b), maintaining the format and content developed by the authors. It is reproduced here with permission from Mike Furniss of the USFS.

#### Location

- Mad River Basin, Northern California
- Mather Creek

#### Project Type

- Embedded Structural Plate Pipe
- Geomorphic Simulation

#### Pre-Project Barrier

- Undersized Corrugated Metal Pipe (Overtopped at 5-yr flow)
- 1800 mm (6 ft) diameter CMP
- 41.1 m (135 ft) long at 0.4 % slope
- Cascade over rock apron at outlet



Figure 8.3 Pre-project barrier culvert (United States Forest Service 2006b)

### Channel Characteristics

- 100-year Flow: 16.1 cms (570 cfs)
- Drainage Area: 4.4 km<sup>2</sup> (1.7 mi<sup>2</sup>)
- Bankfull Width: 3.4 m (11 ft)

### Ecological Value

- Provide access to 4.2 km (2.6 mi) of rearing habitat for coho salmon, steelhead and cutthroat trout. Upstream habitat is low gradient, marshy, and maintains good year-round flows.

### Project Characteristics

- Culvert Diameter: 4.9 m (16 ft)
- Length: 32.0 m (130 ft)
- Depth Embedded: 0.6-0.9 m (2-2.5 ft)
- Slope of Bed in Culvert: 0.75 %



**Figure 8.4 Replacement culvert (United States Forest Service 2006b)**

(Note: headwall recommended for State DOT projects)

### Challenges

- Protecting buried water line

- Stabilizing side slopes during excavation to set culvert at desired depth for embedding

**Project Funding**

- Humboldt County
- California Dept. Fish and Game

**Completion Date**

- October, 2002

**Total Project Cost**

- \$234,544

**Project Description**

When installed in the 1970s, the downstream channel was realigned and channelized. Subsequently, a rock apron spanning the channel had been placed below the culvert outlet. A fish passage assessment conducted in 1999 found the sloping rock apron created a complete barrier to juvenile salmonids and a low-flow barrier to larger fish. The original culvert also had inadequate flood capacity and was in poor condition, with the bottom rusted-through.

An embedded 4900 mm (16 ft) diameter culvert was selected as the replacement crossing. The new culvert is designed to pass a 100-year flood at Headwater-to-Diameter ratio (HW/D) of 0.6 and is 145% wider than the upstream bankfull channel. The appropriate slope and elevation for constructing the streambed within the culvert was determined from a 137 m (450 ft) long channel profile. Since the road was closed and no traffic bypass was needed during construction, the project took only four weeks to complete.

This project experienced many construction challenges. Although originally designed to be embedded 1.8 m (6 ft), problems with buried utilities, groundwater and slope stability during excavation resulted in only embedding the culvert approximately 0.9 m (2.5 ft).

## 8.2 HYDRAULIC SIMULATION

### 8.2.1 Culvert with Floodplain Relief Case History

The following case history was provided by Andrzej (“Andy”) Kosicki of the Maryland State Highway Administration.

#### Location

- MD Route 25 over Beaverdam Run, Baltimore County, Maryland, USA

#### Project Type

- Main channel Structure Plate Pipe Arch (SPPA)
- Floodplain culverts (one SPPa. and on SPP)
- Hydraulic Simulation

#### Pre-project Barrier

- Single span slab bridge with a 6.1 m (20 ft) long invert which was paved in the 1960s due to scour and poor structural condition. A single 3.05 m (10 ft) diameter structural plate pipe was added in 1972 after hurricane Agnes washed away a roadway approach on the north side. See Figures 8.5-8.7.
- Fish blockages included an upstream earth and debris dam, a 0.15 m (6 in) drop at the downstream outlet, and a 0.025-0.05 m (1-2 in) flow depth under low flow conditions. No aquatic life has been observed within 15.2 m (50 ft) upstream of the bridge.

#### Channel Characteristics

- 100-year Design Flow: 70.3 m<sup>3</sup>/s (2482 cfs)
- High Flow Velocity: 3.05 m/s (10 ft/s)
- Mannings n: 0.034
- Drainage Area: 16.4 km<sup>2</sup> (5.9 mi<sup>2</sup>)
- Low Flow: 0.2 m<sup>3</sup>/s (7 cfs)
- Low Flow Velocity: 0.58 m/s (1.9 ft/s)
- Mannings n: 0.030

#### Ecological Value

- Department of Natural Resources stream classification is a Class III (Natural Trout Stream)

#### Project Characteristics

- 2-12'4"x7'9" Structural Plate Pipe Arches (SPPA)
- 1-10'0" Structural Plate Pipe (SPP) with end walls
- Culvert length: 10.76 m (35.5 ft)
- Culvert slope: 0.56%
- One of the two SPPAs was placed in the channel 0.6 m (2.0 ft) below the existing stream invert (low flow cell). The other SPPA and the round pipe



were placed at bankfull elevations, approximately 0.9 m (3.0 ft) higher than the low flow cell.

- Buried riprap aprons, each 7.62 m (25 ft) long were placed at both upstream and downstream ends.

### **Post Project Observations and Lessons Learned**

No formal monitoring program was set up since monitoring was not required by the permitting agency. Periodic field trips showed beneficial changes in the channel and within the structure:

- Aquatic life that was not seen before
- Various water bugs and good sediment movement resulting in clear water, whereas the pre-1994 structure passed water that was dark and murky
- Side cells have displayed wildlife tracks (probably small mammals)



**Figure 8.5 Pre-project channel condition (1992)**



**Figure 8.6 Upstream of pre-existing structure looking downstream**



**Figure 8.7 Downstream of pre-existing structure looking upstream**





**Figure 8.8 Downstream of culvert, shortly after project completion in 1994**



**Figure 8.9 Upstream of current crossing in 2005**



**Figure 8.10 Upstream of current crossing during high-flow event**

## **8.3 HYDRAULIC DESIGN**

### **8.3.1 John Hatt Creek Case History**

#### **Source**

- FishXing Case Studies (United States Forest Service 2006b)
- Study from Sebastian Cohen P.E., California Dept. of Transportation

#### **Location**

- Navarro River Watershed, Northern California, USA

#### **Project Type**

- Culvert Rehabilitation with Metal Insert
- Corner Baffle Retrofit
- Hydraulic Design
- Placement of Concrete Weirs Below Outlet

#### **Pre-Project Conditions**

- 1700 mm (5.5 ft) diameter CSP, 52.4 m (172 ft) long, at 2.4% slope
- Culvert distorted (out of round) and deteriorating
- Culvert bottom lined with concrete
- Concrete drop structure at culvert inlet

#### **Pre-Project Barrier**

- Insufficient depth, high velocities, excessive leap (Figure 8.11)
- Partial barrier to adult steelhead trout
- Total barrier to juvenile salmonids

#### **Hydrologic Characteristics**

- Drainage Area: 1.6 km<sup>2</sup> (0.6 mi<sup>2</sup>)
- 2-year Peak Flow: 1.7 cms (60 cfs)
- Design Capacity (100-year Flow): 7.5 cms (266 cfs)
- Headwater-to-diameter ratio at 7.5 cms (266 cfs) = 2.5
- Adult Steelhead Passage Design Flows:
  - Upper = 0.85 cms (30 cfs), 50% of 2-yr peak flow
  - Lower = 0.08 cms (3 cfs)
- Juvenile Salmonid Passage Design Flows:
  - Upper = 0.17 cms (6 cfs), 10% of 2-yr peak flow
  - Lower = 0.03 cms (1 cfs)

#### **Ecological Value**

- Provide access to 0.9 km (0.6 miles) of upstream spawning and rearing habitat for steelhead trout

### **Project Characteristics**

- Insert a 9.6 mm (3/8 in) thick welded steel pipe, 1500 mm (5 ft) diameter and 52.4 m (172 ft) long into existing culvert
- Weld 43 steel corner baffles into pipe insert
- Baffles 0.21 m (8.3 in) tall at center and spaced 1.2 m (4 ft) apart
- 3 precast concrete weirs with wooden low-flow notches below culvert outlet
- 0.23 m (9 in) drops between concrete weirs

### **Challenges and Lessons Learned**

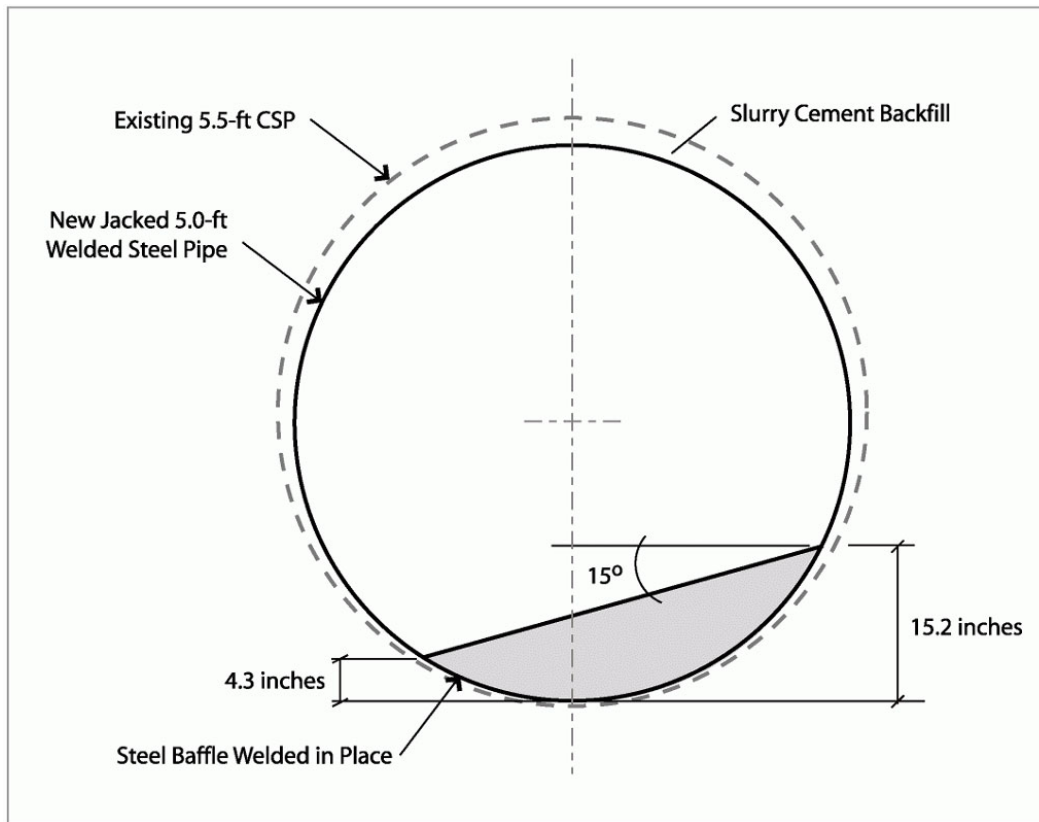
- Bedrock surrounding culvert made “jacking” a larger pipe through the fill impractical
- Existing culvert was out-of-round so smaller culvert had to be inserted
- Only 7.5 m (25 ft) right-of-way available below culvert outlet for grade control weirs
- Lack of rock armoring, and weirs not sufficiently keyed into banks resulted in flanking
- Wooden low flow notch in center of concrete weir causes plunging water to strike concrete lip at low flow.
- Need for inspection by personnel familiar with fish passage design concepts and objectives

### **Project Description**

The existing 1700 mm (5.5 ft) diameter corrugated steel pipe (CSP) was deteriorated and identified as a depth barrier at low flow and a velocity barrier at high flow for adult and juvenile steelhead. The culvert required rehabilitation due to its deteriorated conditions. Retrofitting involved inserting a 1500 mm (5 ft) diameter, 52.4 m (172 ft) long, welded steel pipe (WSP) into the existing culvert at a 2.4% slope. This design was selected after removing the fill to replace the culvert was deemed too costly.

Baffles were designed to satisfy, as best as possible, State and Federal velocity and depth criteria for fish passage while avoiding excessive turbulence. Hydraulics of corner baffles at fish passage flows were modeled using empirical equations developed by Rajaratnam and Katopodis (1990) and provided by WDFW (2003). The energy dissipation factor (EDF) was calculated as a measure of turbulence.





**Figure 8.11 Example detail of culvert rehabilitation and corner baffle retrofit, John Hatt Creek (customary units)**

(Tops of the 9 in tall baffles were placed at 15 degrees to horizontal. The left and right edges are 4.3 in and 15.2 in above the invert, respectively.)

**Table 8.1 Modeled Hydraulic Conditions at Fish Passage Design Flows for John Hatt Creek (Customary Units)**

<b>Species/Lifestage:</b>	<b>Juvenile Salmonids Passage Flows</b>		<b>Adult Steelhead Passage Flows</b>	
<b>Fish Passage Flow:</b>	Lower	Upper	Lower	Upper
Flow:	1 cfs	6 cfs	3 cfs	30 cfs
Water Depth:	0.6 ft	1.1 ft	0.8 ft	2.0 ft
Ave. Water Velocity:	0.9 ft/s	1.9 ft/s	1.4 ft/s	4.1 ft/s
Turbulence (EDF):	1.5 lb-ft/s/ft <sup>3</sup>	3.0 lb-ft/s/ft <sup>3</sup>	2.2 lb-ft/s/ft <sup>3</sup>	6.0 lb-ft/s/ft <sup>3</sup>

A total of 43 corner baffles were welded into the pipe prior to insertion. Baffles constructed of 9.6 mm (3/8 in) thick steel and spaced 1.2 m (4 ft) apart. The 0.23 m (9 in) tall baffles were rotated 15 degrees from horizontal, resulting in the low and high sides of the baffle located 0.11 m and 0.39 m (4.3 and 15.2 in) above the invert, respectively. The gap between the existing and new pipes was filled with concrete slurry to prevent seepage.

The existing culvert outlet was perched nearly 0.5 m (1.5 ft) above the downstream water surface and the channel below the culvert was steep. To improve fish passage conditions at the outlet, three precast concrete weirs were installed within the 7.5 m (25 ft) right-of-way below the outlet. The concrete weirs were spaced 2.5 m (8 ft) apart with 0.23 m (9 in) drops. The weirs were keyed into the bank approximately 0.6 m (2 ft). Although facing class rock was to be placed on both banks between the weirs for scour protection, the contractor only placed rock on the left bank.

### **Post Project Observations and Lessons Learned**

The baffles appear to be effective at reducing water velocities and increasing water depth within the pipe. The weir crest elevations below the outlet were placed within design tolerances.

Rock was only placed on the left bank below the outlet which allowed for rapid bank erosion, resulting in flanking of the weirs. The bank was rocked later to prevent further erosion. Placing rock along both banks, as designed, and keying the weirs further into the banks may have prevented flanking.

A design problem with the wooden low-flow notch was also discovered. The wood is not set flush with the downstream edge of the weir. Instead of plunging directly into the downstream pool at low flows, the water strikes the lip of the concrete weir. Installing a steel low-flow notch flush with the downstream edge of the concrete weir would create the desired plunging conditions at low-flow.

A steep slab of existing concrete at the culvert inlet was to be removed as part of the project. However, it was left in place. Using inspectors familiar with the project's fish passage objectives may have avoided some of these problems.

### **Completion Date**

- October 2003

### **Total Project Cost**

- Construction: \$140,000



**Figure 8.12 Downstream view of culvert retrofit, John Hatt Creek**

(A 1524 mm (5 ft) diameter welded steel pipe was inserted into the pre-existing culvert; concrete slurry was used to fill the gaps)



**Figure 8.13 Pre-existing outlet of John Hatt Creek culvert perched at 0.46 m (1.5 ft) blocks migrating steelhead**





**Figure 8.14 Steel corner baffles welded to the pipe and spaced 1.22 m (4 ft) apart, John Hatt Creek**

(Baffle height provides 0.15 m (6 in) of water depth at the juvenile low flow passage design flow of 0.028 cms (1 cfs))



**Figure 8.15 Baffles slowing water velocities at high flows while producing minimal turbulence, John Hatt Creek**

(Along the low side of the baffles, velocities are swift, improving passage of debris and sediment, while the high side of the baffle experiences slower velocities suitable for both adult and juvenile fish)



**Figure 8.16 Culvert outlet after installation, John Hatt Creek**

(Weirs below outlet were precast and lowered into place; weirs were keyed into the bank roughly 0.6 m (2 ft) and the contractor neglected to rock the left bank; the inspector failed to enforce this oversight)

### 8.3.2 WDFW Roughened Channel Design Example

Stream properties needed:

$$\begin{aligned} \text{Channel width } (W_{ch}) &= 2.13 \text{ m } (7 \text{ ft}) \\ \text{Channel slope } (S_{ch}) &= 1.7\% \\ \text{Culvert slope } (S_{culv}) &= 2.3\% \\ \text{Culvert length } (L_{culv}) &= 27.4 \text{ m } (90 \text{ ft}) \\ \text{100 year exceedance flow } (Q_{100}) &= 3.54 \text{ m}^3/\text{s} (125 \text{ cfs}) \\ \text{Fish passage flow } (Q_{fp}) &= 0.27 \text{ m}^3/\text{s} (9.7 \text{ ft}^3/\text{s}) \end{aligned}$$

Slope ratio

$$\text{Slope Ratio} = \left( \frac{S_{culv}}{S_{ch}} \right) = 1.35$$

This is a situation where slope ratio exceeds 1.25 (typical upper range for Stream Simulation Design in Washington).

Culvert span is an iterative parameter beginning with channel bed width.

$$\text{Width of Culvert Bed } (W_{culv}) = W_{ch} = 2.13 \text{ m } (7 \text{ ft})$$

Culvert bed configuration by U.S. Army Corps of Engineers Riprap Design, requiring computation of unit discharge as follows:

$$\begin{aligned} q &= \frac{Q_{100}}{W_{ch}} \\ q &= 1.66 \frac{\text{m}^2}{\text{s}} \quad (17.9 \frac{\text{ft}^2}{\text{s}}) \end{aligned}$$

This allows the  $D_{30}$  particle size to be calculated by Equation 6.14 for riprap sizing (other methods, such as those included in WDFW Stream Simulation design can also be used for bed sizing, and may be preferable over Equation 6.14, however, 6.14 is used here for illustrative purposes):

$$\begin{aligned} D_{30} &= \frac{(1.95 \cdot S_{culv}^{0.555}) \cdot (1.25 \cdot q)^{2/3}}{g^{1/3}} \\ D_{30} &= 183 \text{ mm } (0.60 \text{ ft}) \end{aligned}$$

Note - it may be pertinent to increase the factor of safety (1.25) since rock sizing is greater than 152 mm (0.5 ft).

Use  $D_{30}$  to find  $D_{84}$ , using the approximate scaling factor provided for riprap, Equation 6.15:

$$D_{84} = 1.5 \cdot D_{30} \text{ (Equation 6.15)}$$

$$D_{84} = 0.90 \text{ ft}$$

This particle size is checked to ensure that it does not exceed 1/4 of the culvert span

$$4 \cdot D_{84} = 3.584 < 7 \text{ ft}$$

A gradation can now be created based on  $D_{84} = 0.9 \text{ ft}$ .

### 8.3.2.1 Fish Passage Velocity

Fish passage velocity is now calculated to ensure that fish are able to traverse the structure. In this case, design is for juvenile Coho salmon, and velocity cannot exceed 4 ft/s according to WDFW Hydraulic Design criteria (based on 90 ft structure). Additional parameters required include fish passage velocity and hydraulic radius:

$$\text{Allowable Velocity } (V_{fish}) = 4 \text{ ft/s}$$

$$\text{Hydraulic Radius } (R) = 0.35 \text{ ft}$$

For use with Limerinos and Jarrett's equations, velocity will be based on a Manning's n value, and will be calculated according to Equation 7.7.

$$V = \frac{1.486 \cdot R^{1/6}}{(n \cdot g)^{0.5}} \cdot (g \cdot R \cdot S_{culv})^{0.5}$$

Limerinos equation is solved as follows (Equation 6.2)

$$n = \frac{0.0926 \cdot R^{1/6}}{1.16 + 2 \log \left( \frac{R}{D_{84}} \right)} = 0.12$$

which can be used into Equation 7.7 to solve for velocity

$$V_l = \frac{1.486 \cdot R^{1/6}}{n \cdot (g)^{0.5}} \cdot (g \cdot R \cdot S_{culv})^{0.5}$$

$$V_l = 1.20 \text{ ft/s} < 4.0 \text{ ft/s}$$

So, according to the Limerinos equation, this would be an acceptable velocity

Jarrett's equation is solved as follows

$$n = 0.32 \cdot S_{culv}^{0.38} \cdot R^{-0.16}$$

$$n = 0.10$$

Using n to solve for velocity

$$V_j = \frac{1.486 \cdot R^{1/6}}{n \cdot g^{0.5}} \cdot (g \cdot R \cdot S_{culv})^{0.5}$$

$$V_j = 1.42 \text{ ft/s} < 4.0 \text{ ft/s}$$

Mussetter's equation utilizes the Darcy-Weisbach friction factor, and is solved according to Equation 6.4.

$$\left(\frac{8}{f}\right)^{0.5} = 1.11 \left(\frac{\text{depth}}{D_{84}}\right)^{0.46} \left(\frac{D_{84}}{D_{50}}\right)^{-0.85} \cdot (S_{culv})^{-0.39} \quad (\text{Equation 6.4})$$

For this equation  $D_{50}$  is needed, and can be solved for according to the relations provided in Washington's Stream Simulation Design.

$$\left(\frac{D_{84}}{D_{50}}\right) = 2.5$$

$$D_{50} = \left(\frac{D_{84}}{2.5}\right) = 0.36 \text{ ft}$$

Channel depth is also needed, taken from analysis based on a 6:1 triangular channel at the fish passage design flow.

$$\text{depth} = 1.1 \text{ ft}$$

$$R = 0.52 \text{ ft}$$

$$\left(\frac{8}{f}\right)^{0.5} = 1.11 \left(\frac{\text{depth}}{D_{84}}\right)^{0.46} \left(\frac{D_{84}}{D_{50}}\right)^{-0.85} \cdot (S_{culv})^{-0.39}$$

$$V_m = 1.11 \left(\frac{\text{depth}}{D_{84}}\right)^{0.46} \left(\frac{D_{84}}{D_{50}}\right)^{-0.85} \cdot (S_{culv})^{-0.39} \cdot (g \cdot R \cdot S_{culv})^{0.5}$$

$$V_m = 1.48 \text{ ft/s} < 4.0 \text{ ft/s, which is acceptable for fish passage}$$

### 8.3.2.2 Turbulence

Turbulence is then checked through the calculation of channel EDF.

$$EDF = \frac{\gamma Q_{fp} S_{culv}}{A} \quad (\text{Equation 3.1})$$

$$\gamma = 62.4 \frac{lb}{ft^3}$$

$$S_{culv} = 0.023$$

$$Q_{fp} = 9.7 \text{ cfs}$$

$$A = 6.53 \text{ ft}^2 \quad (\text{based on a triangular low flow channel with 6:1 side-slopes})$$

$$EDF = 2.13 \frac{ft \cdot lb}{ft^3 \cdot s} < 7.0, \text{ and is acceptable for fish passage design}$$

This page intentionally left blank

## 9 CONSTRUCTION, MAINTENANCE AND INSPECTION

### HOW TO USE THIS CHAPTER

- ▶ Introduction to construction aspects unique to culverts designed for fish passage
- ▶ See an example of Best Management Practices (BMPs)

### 9.1 CONSTRUCTION

The following construction topics have unique applications in culverts designed for fish passage. Topics are not covered in-depth; however, links to pertinent references are included. No specific discussion of slip lining issues is included, because no mature guidelines existed at the time of this report.

#### 9.1.1 Timing

Timing of in-stream work will need to correspond to specific periods allowable by resource agencies. An in-stream work permit will be required.

#### 9.1.2 Constructability

It is important to consider constructability of any culvert installation. The successful construction of culverts utilizing natural bed material is contingent on the ability of crews to place rock within the structure. In general, this leads to the requirement that culverts span a minimum of 1800 mm (6 ft) (i.e. Bates et al. 2003), although 1500 mm (5 ft) installations are reportedly placed routinely in Alaska (Gubernick, Personal Communication). Depending on size of pipe and bed materials, placement has been done by a number of methods including Dingo Loaders, rock chutes, wheel barrows and trail building equipment. Due to the difficulty involved with mixing bed materials on site, it is also recommended that material be mixed prior to placement, except when backfilling large key elements with fines. Rock bands and banks must be placed by hand (United States Forest Service 2006a).

Quality assurance and quality control (QA/QC) are very important for all vertical controls, especially for the placement of all interim rock bands, baffles and key sediment.

#### 9.1.3 Bed Mix Specification

When specifying engineered bed material, the design engineer should ensure that materials and compositions are appropriate for the design. This should include a “pit run” where the design engineer examines the composition of rock piles to ensure adequacy.



When a pit cannot specifically guarantee the composition of a pile, it will be necessary to verify the adequacy of the material. WDFW recommends the following techniques:

- Count and measure all of the particles within a pile or a random sample (similar to a stream pebble count).
- Measure the largest and smallest particles present, and gage the distribution of intermediate sizes by eye to ensure that the mix is well graded.

The following example from Washington Department of Fish and Wildlife is intended to help clarify the process of material gradation for stream simulation (Bates et al. 2003).

For our example site, the required bed gradation has been determined to be:

$$D_{100} = 0.381 \text{ m (1.25 ft)}$$

$$D_{84} = 0.15 \text{ m (0.5 ft)}$$

$$D_{50} = 0.06 \text{ m (0.2 ft)}$$

$$D_{16} = 0.02 \text{ m (0.06 ft)}$$

What this means is that 16% of the material is less than 0.019 m (0.75 in), including roughly equal proportions of small gravel, sand and silt. Sixteen percent is between 0.15-0.381 m (0.5-1.25 ft), which, when viewed from above, will compose 1/6th of the channel surface. The remaining 68% is basically well-graded gravel and cobble. If a gravel pit is making up this mixture, then piles of material need to be assembled in proportions that approximate the desired gradation. One approach is to use parts or “scoops” of a given component. For the example mixture here, a very simple recipe could be: five scoops of 0.15 m-minus (6-in-minus) pit run with fines, plus one scoop of 0.2-0.38 m (8-15 in) rock. Care should be taken to ensure that the fines within the 0.15 m-minus (6-in-minus) pit run are appropriate for sealing voids and interstices. A third class designation for fines may be necessary.

#### **9.1.4 Sealing Voids**

In culverts with placed sediments, especially those involving the use of oversized sediment mixes, it is important to limit permeability. Without such considerations, a significant portion of flow may seep through interstitial voids, causing the stream to go subsurface. Methods to limit permeability include placement of filter fabric (Browning 1990), and including an adequate proportion of fine sediments in bed mixes (Bates et al. 2003; Bates et al. 2006). During construction, fines can be power-washed into voids to ensure, and expedite, bed sealing. This washing procedure will also decrease the sediment concentration entering the stream system after the first flow event.

### **9.1.5 Compaction**

For constructed bed culvert installations, bed material is placed in thin layers with thickness appropriate for the slope and for the size of the mix, compacted, and covered with filler material to be washed into voids (United States Forest Service 2006a). Smaller material should be well compacted around larger elements (Bates et al. 2006).

## **9.2 MAINTENANCE AND INSPECTION**

Culverts that qualify as bridges, total span exceeds 6.1 m (20 ft), must be inspected every two years using 23 CFR 650 Subpart C of the National Bridge Inspection Standards as a guide (FHWA 2004). This inspection includes checks of all underwater elements, and fill and scour at the crossing.

Unfortunately, there are few if any documented schedules for culvert inspection and maintenance. Standard culvert problems and treatments are listed in the Federal Highway Administration *Culvert Repair Practices Manual Volume I* (Ballinger and Drake 1995), and CALTRANS has supplemental guidelines for use in their transportation system (CALTRANS 2006).

Inspection is advisable at regular intervals and ideally during flood events. This may be especially important at installations in areas with significant amounts of LWD, or at crossings with a propensity to collect debris (baffled culverts, fishways). Properly designed and constructed fish passage culverts will still require regular maintenance and monitoring to ensure continued performance, especially in the first few years to evaluate the potential to collect debris or to scour/aggrade the streambed.

This page intentionally left blank

## 10 MONITORING

### **HOW TO USE THIS CHAPTER**

- ▶ Introduction to the importance of monitoring the performance of culverts designed for fish passage
- ▶ Learn of the three types of monitoring
- ▶ Learn important questions to ask when establishing monitoring programs

Although much research has been done to understand the requirements of fish passage, gaps in knowledge, nuances in fish behavior, and lack of adequate hydraulic and hydrological data result in criteria that are likely quite conservative (Furniss 2006). A monitoring program will help ensure that structure impact on fish passage is more clearly understood, allowing future criteria for assessment and design to be more effective, and aiding in reducing future expenditures for fish passage (General Accounting Office 2001).

### **10.1 PURPOSE AND SCOPE**

The four types of monitoring listed in Table 10.1 can be carried out on a fish passage project (adapted from Collins 2003).

Table 10.1 Types of Monitoring (adapted from Collins 2003)

Type of Monitoring	Description
Implementation	Determination of whether culvert is installed as planned, providing a baseline for future monitoring.
Effectiveness	Evaluation of whether a proper installation is having the desired effects.
Validation	The evaluation of a model's ability to predict events or performance.
Life Cycle	Evaluation of physical condition of culvert and adjacent streambed.

For the purposes of fish passage monitoring, implementation and effectiveness monitoring are the most pertinent consideration (Collins 2003). Barnard's study of stream simulation culverts in western Washington is an example of effectiveness monitoring, and has allowed a better understanding of variables (i.e. width ratio and slope ratio) leading to successful stream simulation (2003).

For fish passage installations, implementation and effectiveness monitoring protocols might be used to answer the following questions (Collins 2003):

- Are restoration projects being carried out as proposed?
- Are restoration projects having the intended results?
- Are fish and other aquatic organisms responding in a positive way to the restoration treatments?

Monitoring may take place completely within a State DOT or may be the product of a multi-agency regional agreement. The latter approach would ensure consistent communications between all agencies responsible for fish passage.

## **10.2 METHODS**

Monitoring should begin with clear project goals that will allow the development of measurable parameters to allow “success” to be quantified (Committee on Restoration of Aquatic Ecosystems 1992). Ideally, monitoring might include direct observation of fish movement and utilization, but should at least focus on project compliance with design specifications such as substrate retention and the ability to maintain fish passable conditions (Furniss 2006).

Beginning with project goals in mind, parameters and field methods should be aimed at comparing current physical conditions to design performance criteria. Building upon this type of analysis, Harris (2005) developed the following criteria (Table 10.2) for fish passage installation effectiveness monitoring in California.

**Table 10.2 Monitoring Questions, Parameters, Effectiveness, Criteria and Field Methods (adapted from Harris 2005)**

Monitoring Question	Effectiveness Criteria	Parameters	Field Methods
<b>1. Is the project still functioning as designed?</b>		Fish passage restoration project is within DFG passage guidelines.	
a. Is there still a sufficient jump pool depth for targeted species and life stages?	Residual pool depth at downstream outlet (if culvert outlet is perched or has entry leap)	If there is a jump, pool depth is appropriate for leap height. (Not required for no entry leap.)	Thalweg profile through culvert plus water depths
b. Are leap heights still within jumping ability for targeted species and life stages?	Leap height (residual pool water surface elevation to passage outlet)	Leap height is below critical heights for targeted species and life stage. (Not applicable for no entry leap.)	Thalweg profile through culvert
c. Is stream velocity in critical flow areas still within the swimming ability of the target species and life stages?	Stream velocity in critical area	Stream velocity is equal to or less than swimming ability of target species and life stage.	Stream velocity/discharge measurements
d. Is upstream inlet of the passage area/structure still at grade or below the channel bed?	Bed elevation at inlet and inlet elevation	Culvert inlet matches grade of the natural channel bed.	Thalweg profile through culverts
e. Is the passage area/structure still at grade?	Slope	Passage structure is at specific designed slope or the slope relative to the natural channel.	Thalweg profile through culvert
f. Can sediment bed load still pass through the restored area?	Slope (top riffle to opening), active channel width, hydraulic capacity.	Passage inlet shows no signs of clogging or deposition.	Thalweg profile through culverts, Cross section surveys
g. Can the structure pass the design flood discharge and meet headwater policies?	Hydraulic capacity	Passage passes 100-yr flows and watershed products.	Cross section surveys
h. Does the passage project show signs of imminent failure?	Structural integrity	Structure shows no signs of collapsing.	Inspection of all culvert structural elements
<b>2. Have channel or bank adjustments impaired the function of the passageway?</b>	Slope, head-cutting, sediment deposition	Channel adjustments have not impaired passage or habitat values.	Thalweg profile through culverts
<b>3. Did the project have adverse effects on upstream or downstream habitat?</b>	Bank erosion, channel incision/head-cutting, debris accumulation or sediment deposition	Passage project has not adversely affected up and downstream habitat.	Thalweg profile through culverts, Cross section surveys
<b>4. Is upstream habitat still suitable for the targeted fish species and life stages?</b>	Habitat types and quality in upstream reaches	Area is still suitable for targeted species and life stages.	Habitat monitoring

### **10.2.1 Inventory and Assessment**

Inventory and assessment, as outlined in Chapter 4 is a form of effectiveness monitoring that will allow designers to gain design experience through an understanding of the impact that structures have on a stream reach and fish populations. Many design techniques, such as those described in Browning's survey of culverts in Oregon (1990), were derived from field observations of existing structures, and can continue to be modified as monitoring provides insight into the sustainability and impact of specific culvert design elements.

### **10.2.2 Surveying and Field Inspection**

Monitoring, surveying and field inspection should focus on many of the same elements described in Chapter 4. This can include consideration of channel slope and elevation, culvert slope, crossing inlet and outlet conditions, existing bed material, and debris accumulation. Photos, benchmarks, monumented cross sections, and floodplain and terrace elevations can be useful in determining the culvert impact on the surrounding stream, and to determine if channel incision has occurred (Castro 2003). A major question to ask while in the field is - Is this culvert functioning as intended? (Furniss 2006).

This page intentionally left blank



## 11 FUTURE RESEARCH NEEDS

### HOW TO USE THIS CHAPTER

- ▶ Learn what the remaining knowledge gaps are in the design of culverts for fish passage

### 11.1 SEDIMENT MOVEMENT AND STABILITY

Coarse sediments commonly collect and deposit upstream from culverts that have experienced a flood sufficiently large to be constricted at the entrance and raise the water-surface elevation. The following issues are unknown for this case:

- Impact of deposits on scour at the culvert entrance and headwater elevations during floods
- Ability of the stream to mobilize the sediment deposit and transport it through the culvert

Methods for predicting the stability or movement of sediment through culvert barrels are based on greatly simplified assumptions, such as unconstricted, open channel flow and clear water conditions. The impacts of constricted (accelerated) flow, pressure flow and sediment-laden conditions are not well understood and need basic research to better describe the hydraulics of flow for Hydraulic Simulation.

### 11.2 FLOW HYDRAULICS

The variation of velocity and turbulence in culvert barrels is not well understood, even for such a simple condition as a non-embedded corrugated metal culvert. Recent work by Richmond et al. (2007) begins to describe the flow complexities in such a culvert. More work is required.

Even less work has been done on velocity and turbulence characteristics in baffled culverts (Morrison 2006). Each proposed baffle configuration would benefit from standardized hydraulic testing to establish locations of both reduced and increased velocity and turbulence zones for a range of discharges.

### 11.3 LIFE CYCLE COSTS

There are insufficient data available that describe the total life cycle costs of culverts. For example, there are only qualitative statements in this report that state wider-span culvert expenses may be offset by lower maintenance and stream-channel protection costs following construction. Work is required to populate a database with standardized costs for culvert operations on a life cycle

basis. This will require State DOTs to cooperate in following consistent procedures for describing all costs, including both design and maintenance of the culvert and the local stream reach.

#### **11.4 FISH MOVEMENT AND RESPONSE**

To allow specific engineering of fish passage structure, further studies of fish response to turbulence, darkness, velocity, and varying water depths and substrates are necessary.

#### **11.5 MONITORING**

Monitoring of current installations is an important step in understanding the impact of state-of-practice design techniques on stream structure, function, maintenance and biology. Development of case histories will allow others to learn from the successes and failures of current fish passage installations. Such studies can contribute to techniques for adaptive management.

##### **11.5.1 Hydraulic Simulation Structures**

As fish swimming capabilities and movement requirements are better understood, it will be possible to better engineer these structures. However, variations in dynamic stream systems and in local hydrology, sediment and debris loads will ensure that a conservative approach is required.

The Hydraulic Simulation procedures described in this report can be better documented with additional research on sediment transport and flow hydraulics (see sections 11.1 and 11.2).

##### **11.5.2 Hydraulic Design Structures**

Gregory (2004) recommends the incorporation of before and after studies at Hydraulic Design-based structures. This could include field and test bed experimentation with live fish, or comparison of fish passage within the natural reach to passage through retrofitted culverts (Gregory et al. 2004). Studies should compare performance results with assumptions inherent in passage criteria.

Research is also necessary in the emerging practice of slip lining culverts in retrofit situations. Such practice can reduce or eliminate fish passage at structures formerly capable of passing fish. Work is needed in methods to provide for fish passage for these cases.

This page intentionally left blank

## APPENDIX A

### METRIC SYSTEM, CONVERSION FACTORS, AND WATER PROPERTIES

The following information is summarized from the Federal Highway Administration, National Highway Institute (NHI) Course No. 12301, "Metric (SI) Training for Highway Agencies." For additional information, refer to the Participant Notebook for NHI Course No. 12301.

In SI there are seven base units, many derived units and two supplemental units (Table A.1). Base units uniquely describe a property requiring measurement. One of the most common units in civil engineering is length, with a base unit of meters in SI. Decimal multiples of meter include the kilometer (1000 m), the centimeter (1m/100) and the millimeter (1 m/1000). The second base unit relevant to highway applications is the kilogram, a measure of mass that is the inertia of an object. There is a subtle difference between mass and weight. In SI, mass is a base unit, while weight is a derived quantity related to mass and the acceleration of gravity, sometimes referred to as the force of gravity. In SI the unit of mass is the kilogram and the unit of weight/force is the Newton. Table A.2 illustrates the relationship of mass and weight. The unit of time is the same in SI as in the Customary (English) system (seconds). The measurement of temperature is Centigrade. The following equation converts Fahrenheit temperatures to Centigrade,  $^{\circ}\text{C} = 5/9 (^{\circ}\text{F} - 32)$ .

Derived units are formed by combining base units to express other characteristics. Common derived units in highway drainage engineering include area, volume, velocity, and density. Some derived units have special names (Table A.3).

Table A.4 provides useful conversion factors from Customary to SI units. The symbols used in this table for metric (SI) units, including the use of upper and lower case (e.g., kilometer is "km" and a Newton is "N") are the standards that should be followed. Table A.5 provides the standard SI prefixes and their definitions.

Table A.6 provides physical properties of water at atmospheric pressure in SI units, A.7 in customary units. Table A.8 gives the sediment grade scale and Table A.9 and A.10 give some common equivalent hydraulic units.

Table A.1 Overview of SI

		Units	Symbol
<b>Base units</b>	length	meter	m
	mass	kilogram	kg
	Time	second	s
	temperature*	kelvin	K
	electrical current	ampere	A
	luminous intensity	candela	cd
	amount of material	mole	mol
<b>Derived units</b>		**	
<b>Supplementary units</b>	angles in the plane	radian	rad
	solid angles	steradian	

\* Use degrees Celsius (°C), which has a more common usage Kelvin.

\*\* Many derived units exist; several will be discussed in this session.

Table A.2 Relationship of Mass and Weight

	Mass	Weight or Force of Gravity	Force
<b>Customary</b>	slug	pound	pound
	pound-mass	pound-force	pound-force
<b>Metric</b>	kilogram	newton	newton

Table A.3 Derived Units with Special Names

Quantity	Name	Symbol	Expression
Frequency	hertz	Hz	s <sup>-1</sup>
Force	newton	N	Kg · m/s <sup>2</sup>
Pressure, stress	pascal	Pa	N/m <sup>2</sup>
Energy, work, quantity of heat	joule	J	N · m
Power, radiant flux	watt	W	J/s
Electric charge, quantity	coulomb	C	A · s
Electric potential	volt	V	W/A
Capacitance	farad	F	C/V
Electric resistance	ohm	Ω	V/A
Electric conductance	siemens	S	A/V
Magnetic flux	weber	Wb	V · s
Magnetic flux density	tesla	T	Wb/m <sup>2</sup>
Inductance	henry	H	Wb/A
Luminous flux	lumen	lm	cd · sr
Illuminance	lux	lx	lm/m <sup>2</sup>

Table A.4 Useful Conversion Factors

Quantity	From English Units	To Metric Units	Multiplied by*
Length	mile	km	1.609
	yard	m	0.9144
	foot	m	<u>0.3048</u>
	inch	mm	<u>25.4</u>

\* 4 significant figures; underline denotes exact conversion

Table A.4 Useful Conversion Factors (continued)

Quantity	From English Units	To Metric Units	Multiplied by*
Area	square mile	km <sup>2</sup>	2.590
	acre	m <sup>2</sup>	4047
	acre	hectare	0.4047
	square yard	m <sup>2</sup>	0.8361
	square foot	m <sup>2</sup>	0.092 90
	square inch	mm <sup>2</sup>	645.2
Volume	acre foot	m <sup>3</sup>	1 233
	cubic yard	m <sup>3</sup>	0.7646
	cubic foot	m <sup>3</sup>	0.028 32
	cubic foot	L (1000 cm <sup>3</sup> )	28.32
	100 board feet	m <sup>3</sup>	0.2360
	gallon	L (1000 cm <sup>3</sup> )	3.785
	cubic inch	cm <sup>3</sup>	16.39
Mass	lb	kg	0.4536
	kip (1000 lb)	metric ton (1000 kg)	0.4536
Mass/unit length	plf	kg/m	1.488
Mass/unit area	psf	kg/m <sup>2</sup>	4.882
Mass density	pcf	kg/m <sup>3</sup>	16.02
Force	lb	N	4.448
	kip	kN	4.448
Force/unit length	plf	N/m	14.59
	klf	kN/m	14.59
Pressure, stress, modulus of elasticity	psf	Pa	47.88
	ksf	kPa	47.88
	psi	kPa	6.895
	ksi	MPa	6.895
Bending moment, torque, moment of force	ft-lb	N A m	1.356
	ft-kip	kN A m	1.356
Moment of mass	lb · ft	kg · m	0.1383
Moment of inertia	lb · ft <sup>2</sup>	kg · m <sup>2</sup>	0.042 14
Second moment of area	In <sup>4</sup>	mm <sup>4</sup>	416 200
Section modulus	In <sup>3</sup>	mm <sup>3</sup>	16 390
Power	ton (refrig)	kW	3.517
	Btu/s	kW	1.054
	hp (electric)	W	745.7
	Btu/h	W	0.2931
Volume rate of flow	ft <sup>3</sup> /s	m <sup>3</sup> /s	0.028 32
	cfm	m <sup>3</sup> /s	0.000 471 9
	cfm	L/s	0.4719
	mgd	m <sup>3</sup> /s	0.0438
Velocity, speed	ft/s	m/s	<u>0.3048</u>
Acceleration	f/s <sup>2</sup>	m/s <sup>2</sup>	<u>0.3408</u>
Momentum	lb · ft/sec	kg · m/s	0.1383
Angular momentum	lb · ft <sup>2</sup> /s	kg · m <sup>2</sup> /s	0.042 14
Plane angle	degree	rad	0.017 45
		mrاد	17.45

\* 4 significant figures; underline denotes exact conversion

Table A.5 Prefixes

Submultiples			Multiples		
deci	$10^{-1}$	d	deka	$10^1$	da
centi	$10^{-2}$	c	hector	$10^2$	h
milli	$10^{-3}$	m	kilo	$10^3$	k
micro	$10^{-6}$	$\mu$	mega	$10^6$	M
nano	$10^{-9}$	n	giga	$10^9$	G
pica	$10^{-12}$	p	tera	$10^{12}$	T
femto	$10^{-15}$	f	peta	$10^{15}$	P
atto	$10^{-18}$	a	exa	$10^{18}$	E
zepto	$10^{-21}$	z	zeta	$10^{21}$	Z
yocto	$10^{-24}$	y	yotto	$10^{24}$	Y

Table A.6 Physical Properties of Water at Atmospheric Pressure in SI Units

Temperature		Density	Specific Weight	Dynamic Viscosity	Kinematic Viscosity	Vapor Pressure	Surface Tension <sup>1</sup>	Bulk Modulus
Centigrade	Fahrenheit	kg/m <sup>3</sup>	N/m <sup>3</sup>	N · s/m <sup>2</sup>	m <sup>2</sup> /s	N/m <sup>2</sup> abs.	N/m	GN/m <sup>2</sup>
0°	32°	1,000	9,810	1.79 x 10 <sup>-3</sup>	1.79 x 10 <sup>-6</sup>	611	0.0756	1.99
5°	41°	1,000	9,810	1.51 x 10 <sup>-3</sup>	1.51 x 10 <sup>-6</sup>	872	0.0749	2.05
10°	50°	1,000	9,810	1.31 x 10 <sup>-3</sup>	1.31 x 10 <sup>-6</sup>	1,230	0.0742	2.11
15°	59°	999	9,800	1.14 x 10 <sup>-3</sup>	1.14 x 10 <sup>-6</sup>	1,700	0.0735	2.16
20°	68°	998	9,790	1.00 x 10 <sup>-3</sup>	1.00 x 10 <sup>-6</sup>	2,340	0.0728	2.20
25°	77°	997	9,781	8.91 x 10 <sup>-4</sup>	8.94 x 10 <sup>-7</sup>	3,170	0.0720	2.23
30°	86°	996	9,771	7.97 x 10 <sup>-4</sup>	8.00 x 10 <sup>-7</sup>	4,250	0.0712	2.25
35°	95°	994	9,751	7.20 x 10 <sup>-4</sup>	7.24 x 10 <sup>-7</sup>	5,630	0.0704	2.27
40°	104°	992	9,732	6.53 x 10 <sup>-4</sup>	6.58 x 10 <sup>-7</sup>	7,380	0.0696	2.28
50°	122°	988	9,693	5.47 x 10 <sup>-4</sup>	5.53 x 10 <sup>-7</sup>	12,300	0.0679	
60°	140°	983	9,643	4.66 x 10 <sup>-4</sup>	4.74 x 10 <sup>-7</sup>	20,000	0.0662	
70°	158°	978	9,594	4.04 x 10 <sup>-4</sup>	4.13 x 10 <sup>-7</sup>	31,200	0.0644	
80°	176°	972	9,535	3.54 x 10 <sup>-4</sup>	3.64 x 10 <sup>-7</sup>	47,400	0.0626	
90°	194°	965	9,467	3.15 x 10 <sup>-4</sup>	3.26 x 10 <sup>-7</sup>	70,100	0.0607	
100°	212°	958	9,398	2.82 x 10 <sup>-4</sup>	2.94 x 10 <sup>-7</sup>	101,300	0.0589	

<sup>1</sup>Surface tension of water in contact with air



Table A.7 Physical Properties of Water at Atmospheric Pressure (Customary Units)

Temperature		Density	Specific Weight	Dynamic Viscosity	Kinematic Viscosity	Vapor Pressure	Surface Tension <sup>1</sup>	Bulk Modulus
Fahrenheit	Centigrade	Slug/ft <sup>3</sup>	Weight lb/ft <sup>3</sup>	lb-sec/ft <sup>2</sup>	ft <sup>2</sup> /sec	lb/in <sup>2</sup>	lb/ft	lb/in <sup>2</sup>
32°	0°	1.940	62,416	0.374 x 10 <sup>-4</sup>	1.93 x 10 <sup>-5</sup>	0.09	0.00518	287,000
39.2	4.0°	1.940	62,424	0				
40°	4.4°	1.940	62,423	0.323	1.67	0.12	0.00514	296,000
50°	10.0°	1.940	62,408	0.273	1.41	0.18	0.00508	305,000
60°	15.6°	1.939	62,366	0.235	1.21	0.26	0.00504	313,000
70°	21.1°	1.936	62,300	0.205	1.06	0.36	0.00497	319,000
80°	26.7°	1.934	62,217	0.180	0.929	0.51	0.00492	325,000
90°	32.2°	1.931	62,118	0.160	0.828	0.70	0.00486	329,000
100°	37.8°	1.927	61,998	0.143	0.741	0.95	0.00479	331,000
120°	48.9°	1.918	61,719	0.117	0.610	1.69	0.0466	332,000
140°	60°	1.908	61,386	0.0979	0.513	2.89		
160°	71.1°	1.896	61,006	0.0835	0.440	4.74		
180°	82.2°	1.883	60,586	0.0726	0.385	7.51		
200°	93.3°	1.869	60,135	0.0637	0.341	11.52		
212°	100°	1.847	59,843	0.0593	0.319	14.70		

<sup>1</sup>Surface tension of water in contact with air

Table A.8 Sediment Particles Grade Scale

Size		Approximate Sieve Mesh Opening per Inch			Class	
Millimeters		Microns	Inches	Tyler	U.S. Standard	
4000-2000	-	-	160-80	-	-	Very large boulders
2000-1000	-	-	80-40	-	-	Large boulders
1000-500	-	-	40-20	-	-	Medium boulders
500-250	-	-	20-10	-	-	Small boulders
250-130	-	-	10-5	-	-	Large cobbles
130-64	-	-	5-2.5	-	-	Small cobbles
64-32	-	-	2.5-1.3	-	-	Very coarse gravel
32-16	-	-	1.3-0.6	-	-	Coarse gravel
16-8	-	-	0.6-0.3	2 ½	-	Medium gravel
8-4	-	-	0.3-0.16	5	5	Fine gravel
4-2	-	-	0.16-0.08	9	10	Very fine gravel
2-1	2.00-1.00	2000-1000	-	16	18	Very coarse sand
1-1/2	1.00-0.50	1000-500	-	32	35	Coarse sand
1/2-1/4	0.50-0.25	500-250	-	60	60	Medium sand
1/4-1/8	0.25-0.125	250-125	-	115	120	Fine sand
1/8-1/16	0.125-0.062	125-62	-	250	230	Very fine sand
1/16-1/32	0.062-0.031	62-31	-	-	-	Coarse silt
1/32-1/64	0.031-0.016	31-16	-	-	-	Medium silt
1/64-1/128	0.016-0.008	16-8	-	-	-	Fine silt
1/128-1/256	0.008-0.004	8-4	-	-	-	Very fine silt
1/256-1/512	0.004-.0020	4-2	-	-	-	Coarse clay
1/512-1/1024	0.0020-0.0010	2-1	-	-	-	Medium clay
1/1024-1/2048	0.0010-0.0005	1-0.5	-	-	-	Fine clay
1/2048-1/4096	0.0005-0.0002	0.5-0.24	-	-	-	Very fine clay

Table A.9 Common Equivalent Hydraulic Units

Volume								
Unit	Equivalent							
	cubic inch	liter	U.S. gallon	cubic foot	cubic yard	cubic meter	acre-foot	sec-foot-day
liter	61.02	1	0.264 2	0.035 31	0.001 308	0.001	810.6 E - 9	408.7 E - 9
U.S. gallon	231.0	3.785	1	0.1337	0.004 951	0.003 785	3.068 E - 6	1.547 E - 6
cubic foot	1728	28.32	7.481	1	0.037 04	0.028 32	22.96 E - 6	11.57 E - 6
cubic yard	46,660	764.6	202.0	27	1	0.746 6	619.8 E - 6	312.5 E - 6
meter <sup>3</sup>	61,020	1000	264.2	35.31	1.308	1	810.6 E - 6	408.7 E - 6
acre-foot	75.27 E + 6	1,233,000	325,900	43 560	1.613	1 233	1	0.504 2
sec-foot-day	149.3 E + 6	2,447,000	646,400	86 400	3 200	2 447	1.983	1

Table A.10 Common Equivalent Hydraulic Units (continued)

Discharge (Flow Rate, Volume/Time)						
Unit	Equivalent					
	gallon/min	liter/sec	acre-foot/day	foot <sup>3</sup> /sec	million gal/day	meter <sup>3</sup> /sec
gallon/minute	1	0.063 09	0.004 419	0.002 228	0.001 440	63.09 E - 6
liter/second	15.85	1	0.070 05	0.035 31	0.022 82	0.001
acre-foot/day	226.3	14.28	1	0.504 2	0.325 9	0.014 28
feet <sup>3</sup> /second	448.8	28.32	1.983	1	0.646 3	0.028 32
million gal/day	694.4	43.81	3.068	1.547	1	0.043 82
meter <sup>3</sup> /second	15,850	1000	70.04	35.31	22.83	1

## REFERENCES

- Aaserude, R., and Orsborn, J., 1985. "New Concepts in Fish Ladder Design, Volume II of IV; Results of Laboratory and Field Research on New Concepts in Weir and Pool Fishways." *Rep. No. DOE/BP-36523-3*, Bonneville Power Administration.
- Admiraal, D., and Schainost, S., 2004. "Fish Passage for Warm Water Fish Species." World Water and Environmental Resources Congress, 6-27-2004, Salt Lake City, Utah.
- Alaska Department of Fish and Game, 2005. "Fish Passage Improvement Program." <http://www.sf.adfg.state.ak.us/SARR/fishpassage/fishpass/cfm,01-25-2006>.
- Alaska Department of Fish and Game and Alaska Department of Transportation. Memorandum of Agreement Between Alaska Department of Fish and Game and Alaska Department of Transportation and Public Facilities for the Design, Permitting, and Construction of Culverts for Fish Passage. 2001. Juneau Alaska, Alaska Department of Fish and Game, Alaska Department of Transportation.
- Amoros, C., and Bornette, G., 2005. "Connectivity and Biocomplexity in Waterbodies of Riverine Floodplains." *Freshwater Biology*, 47, 761-776.
- Ashton, W. S., 1984. "Determination of Seasonal, Frequency and Durational Aspects of Streamflow with Regard to Fish Passage Through Roadway Drainage Structures." *Rep. No. AK-RD-85-06*, State of Alaska Department of Transportation and Public Facilities Division of Planning and Programming. Fairbanks, AK, University of Alaska, Fairbanks.
- Bainbridge, R., 1959. "Speed and Stamina in Three Fish." *Journal of Experimental Biology*, 37(1), 129-153.
- Baker, C. O., and Votapka, F. E., 1990. "Fish Passage Through Culverts." *Rep. No. FHWA-FL-90-006*, San Dimas, California, Forest Service Technology and Development Center.
- Ballinger, C. A., and Drake, P. G., 1995. "Culvert Repair Practices Manual: Volume I." *Rep. No. FHWA-RD-94-096*, Federal Highway Administration.
- Bao, Y., Tung, Y., and Hasfurther, V. R., 1987. "Evaluation of Uncertainty in Flood Magnitude Estimator on Annual Expected Damage Costs of Hydraulic Structures." *Water Resources Research*, 23(11), 2023-2029.

- Barber, M. E., and Downs, R. C., 1996. "Investigation of Culvert Hydraulics Related to Juvenile Fish Passage." *Rep. No. WA-RD 338.1*, Washington State Transportation Center (TRAC).
- Barnard, B., 2003. "Evaluation of the Stream Simulation Culvert Design Method in Western Washington, a preliminary study - DRAFT." Washington Department of Fish and Wildlife.
- Barnes, Harry H. Jr., 1967. "Roughness Characteristics of Natural Channels." *U.S. Geological Survey Water Supply Paper 1849*. U.S. Government Printing Office, Washington, D.C.
- Bates, K. K., Barnard, B., Heiner, B., Klavas, P., and Powers, P. D., 2003. "Design of Road Culverts for Fish Passage." Washington Department of Fish and Wildlife.
- Bates, K. K., Cenderelli, D., Gubernick R., Jackson, S., Johansen, K., Clarkin, K., Crane, B., Furniss, M., Riggers, B., Sanchez, J., Sylte, T., and Weinhold, M., 2006. "Stream Simulation: An Ecological Approach to Road-Stream Crossings - Peer Review DRAFT." United States Forest Service.
- Bates, K. K., Washington Department of Fish and Wildlife, Personal Communication, 1-18-2007.
- Bathurst, J. C., Graf, W. H., and Cao, H. H., 1987. "Bed Load Discharge Equations for Steep Mountain Rivers." *Sediment Transport in Gravel-bed Rivers*, C. R. Thorne, J. C. Bathurst, and R. D. Hey, eds., John Wiley & Sons Ltd.
- Behlke, C. E., Kane, D. L., McClean, R. F., and Travis, M. D., 1989. "Field Observations of Arctic Grayling Passage Through Highway Culverts." *Transportation Research Record*,(1224), 63-66.
- Behlke, C. E., Kane, D. L., McClean, R. F., and Travis, M. D., 1991. "Fundamentals of Culvert Design for Passage of Weak-Swimming Fish." *Rep. No. FHWA-AK-RD-90-10*, U.S. Department of Transportation Federal Highway Administration.
- Belford, D. A., and Gould, W. R., 1989. "An Evaluation of Trout Passage through Six Highway Culverts in Montana." *North American Journal of Fisheries Management*, 9(4), 437-445.
- Bell, M. C., 1986. "Fisheries Handbook of Engineering Requirements and Biological Criteria." U.S. Army Corps of Engineers, Fish Passage Development and Evaluation Program, Portland, OR.

- Browning, M., 1990. "Oregon Culvert Fish Passage Survey." Western Federal Lands Highway Division, Federal Highway Administration, Vancouver, WA.
- Browning, M., Western Federal Lands Highway Division, Personal Communication, 6-20-2006.
- Bunt, C. M., Katapodis, C., and McKinley, R. S., 1999. "Attraction and Passage Efficiency of White Suckers and Smallmouth Bass by Two Denil Fishways." *North American Journal of Fisheries Management*, 19(3), 793-803.
- Bunte, K., and Abt, S. R., 2001. "Sampling Surface and Subsurface Particle-Size Distributions in Wadable Gravel- and Cobble-Bed Streams for Analyses in Sediment Transport, Hydraulics, and Streambed Monitoring." *Rep. No. RMRS-GTR-74*, United States Department of Agriculture Forest Service, Rocky Mountain Research Station.
- Cahoon, J., Stein, O., and Blank, M., 2005. "Fish Passage at Road Crossings in a Montana Watershed." *Rep. No. FHWA/MT-05-002/8160*, Federal Highway Administration.
- CALTRANS, 2006. "Design Information Bulletin No. 83-01," *CALTRANS Supplement to FHWA Culvert Repair Practices Manual*.
- Castro, J., 2003. "Geomorphic Impacts of Culvert Replacement and Removal: *Avoiding Channel Incision*." USFWS - Oregon Fish and Wildlife Office, Portland, OR.
- Chow, V.T., 1959. "Open-Channel Hydraulics." McGraw-Hill Book Co., New York, NY.
- Clancy, C. G., 1990. "A Detachable Fishway for Steep Culverts." *North American Journal of Fisheries Management*, 10(2), 244-246.
- Clarkin, K., Connor, A., Furniss, M. J., Gubernic, B., Love, M., Moynan, K., and Musser, S. W., 2003. "National Inventory and Assessment Procedure For Identifying Barriers to Aquatic Organism Passage at Road-Stream Crossings." USFS San Dimas Technology and Development Center, San Dimas, CA.
- Clinton, W.J., 1995. "Executive Order 12962: Recreational Fisheries." *Federal Register*, 60(111).
- Coffman, J. S., 2005. "Evaluation of a Predictive Model for Upstream Fish Passage Through Culverts." Master of Science Biology, James Madison University.

- Collins, B., 2003. "California Coastal Salmonid Restoration Monitoring and Evaluation Program: Interim Restoration Effectiveness and Validation Monitoring Protocols." California Department of Fish and Game.
- Committee on Restoration of Aquatic Ecosystems, 1992. "Restoration of Aquatic Ecosystems: Science, Technology, and Public Policy." National Research Council, Washington, D.C.
- Costa, J. E., 1983. "Paleohydraulic Reconstruction of Flash-Flood Peaks from Boulder Deposits in the Colorado Front Range." *Geological Society of America Bulletin*, 94(8), 986-1004.
- Cramer, P., 1999. "Modeling Florida Panther Movements to Predict Conservation Strategies in North Florida." Doctor of Philosophy, University of Florida.
- Dane, B. G., 1978. "A Review & Resolution of Fish Passage Problems at Culvert Sites in British Columbia." *Fisheries and Marine Service Technical Report No. 810*, Department of Fisheries and Environment.
- Ead, S. A., Rajaratnam, N., and Katopodis, C., 2002. "Generalized Study of Hydraulics of Culvert Fishways." *ASCE Journal of Hydraulic Engineering*, 128(11), 1018-1022.
- Ellis, J. E., 1974. "The Jumping Ability and Behavior of Green Sunfish (*Lepomis cyanellus*) at the Outflow of a 1.6-ha Pond." *Transactions of the American Fisheries Society*, 103(3), 620-623.
- Evans, W. A., and Johnston, F. B., 1972. "Fish Migration and Fish Passage: A Practical Guide to Solving Fish Passage Problems." U.S.D.A. Forest Service - Region 5.
- Everest, F. H., Sedell, J. R., Armantrout, N. B., Nickerson, T. E., Keller, S. M., Johnson, J. M., Parante, W. D., and Haugen, G. N., 1985. "Salmonids." *Management of Wildlife and Fish Habitats in Forests of Western Oregon and Washington - Part 1*, Brown E.R., ed., U.S.D.A. Forest Service, 199-230.
- Farhig, L., and Merriam, G., 1985. "Habitat Patch Connectivity and Population Survival." *Ecology*, 66(6), 1762-1768.
- Federal Highway Administration, 2002. "Hydraulic Design Series No. 2: Highway Hydrology." *Rep. No. FHWA-NHI-02-001 HDS-2*.
- Federal Highway Administration, 2004. "National Bridge Inspection Standards." *Federal Register*, 69(239), 74419-74439.

- FISRWG, 1998. "Stream Corridor Restoration: Principles, Processes, and Practices, 10/98, by the Federal Interagency Stream Restoration Working Group (FISRWG)." *GPO Item No. 0120-A; SuDocs No. A 57.6/2:EN 3/PT.653.*
- Flanagan, S. A., Furniss, M., Ledwith, T. S., Thiesen, S., Love, M., Moore, K., and Ory, J., 1998. "Methods for Inventory and Environmental Risk Assessment of Road Drainage Crossings." *Rep. No. 9877 1809P - SDTDC*, USDA Forest Service.
- Flanders, L. S., and Cariello, J., 2000. "Tongass Road Condition Survey Report." *Rep. No. 00-7*, Alaska Department of Fish and Game.
- Flosi, G., Downie, S., Hopelain, J., Bird, M., and Collins, B., 1998. "California Salmonid Stream Habitat Restoration Manual, 3rd edition." California Department of Fish and Game.
- Forest Practices Advisory Committee on Salmon in Watersheds, 2001. "Section A: Fish Passage Restoration."
- Furniss, M., 3200 SW Jefferson Way, Corvallis, OR 97331, Personal Communication, 10-22-2005.
- Furniss, M., 2006. "Recognizing and Avoiding Errors in Culvert AOP Practice." Fish Passage Summit Meeting, 2-16-2006, Denver, CO.
- Furniss, M., Love, M., and Flanagan, S., 1997. "Diversion Potential at Road-Stream Crossings." *Rep. No. 9777 1814-SDTDC*, USDA Forest Service.
- Furniss, M. J., Ledwith, T. S., Love, M., McFadin, B. C., and Flanagan, S., 1998. "Response of Road-Stream Crossings to Large Flood Events in Washington, Oregon, and Northern California." *Rep. No. 9877 1806 - SDTDC*, U.S.D.A. Forest Service Technology and Development Program.
- Gardner, A., 2006. "Fish Passage Through Road Culverts." Master of Science Biological and Agricultural Engineering, North Carolina State University.
- Gebhards, S., and Fisher, J., 1972. "Fish Passage and Culvert Installations." Idaho Fish & Game Department.
- General Accounting Office, 2001. "Restoring Fish Passage Through Culverts on Forest Service and BLM Lands in Oregon and Washington Could Take Decades." *Rep. No. GAO-02-136*, General Accounting Office.
- Gerking, S. D., 1959. "The Restricted Movement of Fish Populations." *Cambridge Biological Society Biological Review*, 34, 221-242.



- Giannico, G., and Souder, J. A., 2004. "The Effects of Tide Gates on Estuarine Habitats and Migratory Fish." *Rep. No. ORESU-G-04-002*, Oregon Sea Grant, Oregon State University.
- Giannico, G., and Souder, J. A., 2005. "Tide Gates in the Pacific Northwest: Operation, Types, and Environmental Effects." *Rep. No. ORESU-T-05-001*, Oregon Sea Grant, Oregon State University.
- Gowan, C., Young, M. K., Fausch, K. D., and Riley, S. C., 1994. "Restricted Movement in Resident Stream Salmonids: A Paradigm Lost?" *Canadian Journal of Aquatic Science*, 51(11), 2626-2637.
- Gregory, S., McEnroe, J., Klingeman, P., and Wyrick, J., 2004. "Fish Passage Through Retrofitted Culverts." *Rep. No. FHWA-OR-RD-05-05*, Federal Highway Administration.
- Groot, C., and Margolis, L., 1991. "Pacific Salmon Life Histories." University of British Columbia Press, Vancouver, B.C.
- Gubernick, R., 2006. "Stream Simulation Design Process for AOP: Geomorphic Assessment and Stream Simulation Design." Culvert Summit Meeting, 2-16-2006, Denver, CO.
- Gubernick, R., Tongass National Forest, Personal Communication, 1-24-2007.
- Hansen, W.F., 1987. "Some Applications of Flood Frequency and Risk Information in Forest Management." *Applications of Frequency and Risk in Water Resources*, Singh, V.P., ed. D. Reidel Publishing Co., Dordrecht, The Netherlands.
- Harrelson, C. C., Rawlins, C. L., and Potyondy, J. P., 1994. "Stream Channel Reference Sites: An Illustrated Guide to Field Technique." *Gen. Tech. Rep. No. RM-245*. USDA Forest Service, Rocky Mountain Forest and Range Experiment Station, Fort Collins, CO.
- Harris, R. R., 2005. "Monitoring the Effectiveness of Culvert Fish Passage Restoration - Final Report." Center for Forestry, University of California, Berkeley.
- Hass, D., 2000. "Distribution, Relative Abundance and Roadway Underpass Responses of Carnivores throughout the Puente-Chino Hills." Master of Science, California State Polytechnic University, Pomona, CA.
- Hedman, E. R., and W.M.Kastner, 1977. "Streamflow Characteristics Related to Channel Geometry in the Missouri River Basin." *Jour. Research U. S. Geol. Survey*, 5(3), 285-300.

- Hinch, S. G., and Rand, P. S., 1998. "Swim Speeds and Energy Use of Upriver-Migrating Sockeye Salmon (*Oncorhynchus nerka*): Role of Local Environment and Fish Characteristics." *Canadian Journal of Fisheries and Aquatic Science*, 55(8), 1821-1831.
- Hudy, M., 2006. "A Need for Coarse Filters?" CD Rom Proceedings, Fish Passage Summit Meeting, 2-16-2006, Denver, Colorado.
- Jarrett, H.E. and Peterson, D.F., 1984. "Hydraulic of High-Gradient Streams." *Journal of Hydraulic Engineering*, 110 (11), 1519-1539.
- Jackson, S., 2003. "Design and Construction of Aquatic Organism Passage at Road-Stream Crossings: Ecological Considerations in the Design of River and Stream Crossings." 20-29 International Conference of Ecology and Transportation, Lake Placid, New York
- Jackson, S., Dept. of Natural Resources Conservation, University of Massachusetts, Personal Communication, 08-01-2006.
- Johnson, P., and Brown, E., 2000. "Stream Assessment for Multicell Culvert Use." *Journal of Hydraulic Engineering*, 126(5), 381-386.
- Jones, D. R., Kiceniuk, J. W., and Bamford, O. S., 1974. "Evaluation of the Swimming Performance of Several Fish Species from the Mackenzie River." *Journal of the Fisheries Research Board of Canada*, 31, 1641-1647.
- Kahler, T., and Quinn, T., 1998. "Juvenile and Resident Salmonid Movement and Passage through Culverts." *Rep. No. WA-RD 457.1*.
- Katopodis, C., 1992. "Introduction to Fishway Design." Freshwater Institute Department of Fisheries and Oceans.
- Kemp, P. S., Gessel, M. H., Sandford, B. P., and Williams, J. G., 2006. "The Behaviour of Pacific Salmonid Smolts During Passage Over two Experimental Weirs Under Light and Dark Conditions." *River Research and Applications*, 22(4), 429-440.
- Kosicki, Andrzej, Maryland State Highway Administration, Personal Communication, 5-17-2006.
- Kosicki, Andrzej, Maryland State Highway Administration, Personal Communication, 1-18-2007.
- Lagasse, P.F., Schall, J.D., and Richardson, E.V., 2001. "Hydraulic Engineering Circular No. 20: Stream Stability at Highway Structures." *Rep. No. FHWA-NHI-01-002*, Federal Highway Administration.

- Lang, M., Love, M., and Trush, W., 2004. "Improving Stream Crossings for Fish Passage." *Rep. No. 50ABNF800082*, National Marine Fisheries Service.
- Leopold, L. B., and Wolman, M. G., 1957. "River Channel Patterns: Braided, Meandering, and Straight." United States Government Printing Office, Washington, D.C.
- Leopold, L. B., Wolman, M. G., and Miller, J. P., 1964. "Fluvial Processes in Geomorphology." Freeman, San Francisco, CA.
- Limerinos, J. T., 1970. "Determination of the Manning Coefficient From Measured Bed Roughness in Natural Channels." *Geological Survey Water-Supply Paper 1898-B*, United States Government Printing Office, Washington, D.C.
- Llanos, A., 2004. "Peacock Creek Pool and Weir Fishway." *United States Forest Service*  
<http://www.stream.fs.fed.us/fishxing/case/Peacock/PeacockPoster.pdf>, 4-27-2007.
- Mace, G. M., and Lande, R., 1991. "Assessing Extinction Threats: Toward a Reevaluation of IUCN Threatened Species Categories." *Conservation Biology*, 5(2), 148-157.
- Maine Department of Transportation, 2004. "Fish Passage Policy and Design Guide: 2nd Edition." Maine Department of Transportation.
- Maryland State Highway Administration, 2005. "Culverts, Guidelines for the Selection and Design of Culvert Installations." *Manual for Hydrologic and Hydraulic Design*, Office of Bridge Development.
- McKelvey, K. S., Schwartz, M. K., and Ruggiero, L. F., (2002). "Why Is Connectivity Important for Wildlife Conservation?" *Wildlife Crossings Website*, <http://www.wildlifecrossings.info/sa001.htm>.
- Miles, M., Alaska Department of Transportation, Personal Communication, 3-14-2006.
- Montgomery, D. R., and Buffington, J. M., 1993. "Channel Classification, Prediction of Channel Response, and Assessment of Channel Condition." *Rep. No. TFW-SI-110-93-002*.
- Montgomery, D. R., and Buffington, J. M., 1997. "Channel-Reach Morphology in Mountain Drainage Basins." *GSA Bulletin*, 109(5), 596-611.
- Montgomery, D. R., and Buffington, J. M., 1998. "Channel Classification, Processes, and Response." *Ecology and Management in Pacific Northwest Rivers*.

- Morrison, R., 2006. "Measurement of Turbulence in Corrugated Metal Culverts." Master of Science Thesis, Washington State University, September.
- Morita, K., and Yamamoto, S., 2002. "Effects of Habitat Fragmentation by Damming on the Persistence of Stream-Dwelling Charr Populations." *Conservation Biology*, 16(5), 1318-1323.
- Mussetter, R. A., 1989. "Dynamics of Mountain Streams." Doctorate of Philosophy, Colorado State University.
- National Marine Fisheries Service Southwest Region, 2001. "Guideline for Salmonid Passage at Stream Crossings." National Oceanic and Atmospheric Administration.
- Norman, J. M., Houghtalen, R. J., and Johnston, W. J., 2005. "Hydraulic Design Series No. 5, 2nd Edition, rev.: Hydraulic Design of Highway Culverts." *Rep. No. FHWA-NHI-01-020*, Federal Highway Administration.
- Powers, P., Bates K., Gowen, B., and Whitney, R., 1997. "Culvert Hydraulics Related to Upstream Juvenile Salmon Passage." Washington State Department of Transportation, Olympia, WA.
- Powers, P., and Saunders, C., 1996. "Fish Passage Flows for Ungaged Catchments in Washington." *Washington Department of Fish and Wildlife* <http://wdfw.wa.gov/hab/engineer/flowdsgn.htm>, 4-23-2007.
- Rajaratnam, N., and Katopodis, C., 1990. "Hydraulics of Culvert Fishways III: Weir Baffle Culvert Fishways." *Canadian Journal of Civil Engineering*, 17(4), 558-568.
- Rajaratnam, N., Katopodis, C., and Fairbairn, M. A., 1990. "Hydraulics of Culvert Fishways V: Alberta Fish Weirs and Baffles." *Canadian Journal of Civil Engineering*, 17(6), 1015-1021.
- Rajaratnam, N., Katopodis, C., and Lodewyk, S., 1988. "Hydraulics of Offset Baffle Culvert Fishways." *Canadian Journal of Civil Engineering*, 15(6), 1043-1051.
- Rajaratnam, N., Katopodis, C., and Lodewyk, S., 1991. "Hydraulics of Culvert Fishways IV: Spoiler Baffle Culvert Fishways." *Canadian Journal of Civil Engineering*, 18(1), 76-82.
- Rajaratnam, N., Katopodis, C., and McQuitty, N., 1989. "Hydraulics of Culvert Fishways II: Slotted-Weir Culvert Fishways." *Canadian Journal of Civil Engineering*, 16(3), 375-383.

- Rajput, S., 2003. "The Effects of Low-Water Bridges on Movement, Community Structure and Abundance of Fishes in Streams of the Ouachita Mountains." Master of Science, Arkansas Tech University.
- Rand, P. S., and Hinch, S. G., 1998. "Swim Speeds and Energy Use of Upriver-Migration Sockeye Salmon (*Oncorhynchus nerka*): Simulating Metabolic Power and Assessing Risk of Energy Depletion." *Canadian Journal of Fisheries and Aquatic Science*, 55(8), 1832-1841.
- Richmond M.C., Deng, Z., Guensch, G.R., Tritico, H., and Pearson, W.H., 2007. "Mean-Flow and Turbulence Characteristics of a Full-Scale Spiral Corrugated Culvert with Implications for Fish Passage." *Ecological Engineering* (in press).
- River and Stream Continuity Partnership, 2004. "Massachusetts River and Stream Crossing Standards: Technical Guidelines."
- River and Stream Continuity Partnership, 2006. "Massachusetts River and Stream Crossing Standards."  
[http://www.streamcontinuity.org/pdf\\_files/MA\\_Crossing\\_stds\\_3-1-06.pdf](http://www.streamcontinuity.org/pdf_files/MA_Crossing_stds_3-1-06.pdf), 4-24-2007.
- Robison, E. G., Mirati, A., and Allen, M., 1999. "Oregon Road/Stream Crossing Restoration Guide: Spring 1999."
- Rosgen, D. L., 1994. "A Classification of Natural Rivers." *Catena*, 22(3), 169-199.
- Rosgen, D. L., 1996. "Applied River Morphology." Wildland Hydrology Press, Pagosa Springs, CO.
- Rowland, E.R., Hotchkiss, R.H., and Barber, M.E., 2003. "Modeling Hydrology for Fish Passage." *Rep. No. WA-RD 545.1*, Washington State Department of Transportation, Olympia, WA.
- Rowley, B. J., Thiele, E. A., Hotchkiss, R. H., and Nelson, E. J., 2006. "Numerical Modeling of Culvert Hydraulics: Modernization of Existing HY8 Software." CD Rom Proceedings, World Environmental and Water Resources Congress, 5-21-2006, Omaha, NE.
- Schaefer, J. F., Marsh-Matthews, E., Spooner, D. E., Gido, K. B., and Matthews, W. J., 2003. "Effects of Barriers and Thermal Refugia on Local Movement of the Threatened Leopard Darter, *Percina pantherina*." *Environmental Biology of Fishes*, 66(4), 391-400.
- Schrag, A. M., 2003. "Highways and Wildlife: Review of Mitigation Projects throughout Europe, Canada and the United States." Masters of Science, California State Polytechnic University, Pomona, CA.

- Scott, W. B., and Crossman, E. J., 1973. "Freshwater Fishes of Canada." Fisheries Research Board of Canada, Ottawa.
- Shoemaker, R. H., 1956. "Hydraulics of Box Culverts with Fish-Ladder Baffles." Thirty-Fifth Annual Meeting, Highway Research Board, 1-20-1956, Washington, D.C.
- Smith, D. L., and Brannon, E. L., 2006. "Use of Average and Fluctuating Velocity Components for Estimation of Volitional Rainbow Trout Density." *Transactions of the American Fisheries Society*, 135, 431-441.
- Spellerberg, I. F., 1998. "Ecological Effects of Roads and Traffic: A Literature Review." *Global Ecology and Biogeographical Letters*, 7(5), 317-333.
- Stuart, T. A., 1962. "The Leaping Behaviour of Salmon and Trout at Falls and Obstructions." Department of Agriculture and Fisheries for Scotland.
- Taylor, R. N., and Love, M., 2003. "Part IX Fish Passage Evaluation at Stream Crossings." California Department of Fish and Game.
- Thompson, P.L., and Kilgore, R.T., 2006. "Hydraulic Engineering Circular No. 14, 3rd Edition: Hydraulic Design of Energy Dissipators for Culverts and Channels." *Rep. No. FHWA-HHI-06-086*, Federal Highway Administration.
- Toepfer, C. S., Fisher, W. L., and Haubelt, J. A., 1999. "Swimming Performance of the Threatened Leopard Darter in Relation to Road Culverts." *Transactions of the American Fisheries Society*, 128(1), 155-161.
- Trombulak, S. C., and Frissell, C. A., 2000. "Review of Ecological Effects of Roads on Terrestrial and Aquatic Communities." *Conservation Biology*, 14(1), 18-30.
- Twisdale, J. W., North Carolina Department of Transportation, Personal Communication, 4-10-2006.
- United States Army Corps of Engineers, 2005. "Department of the Army Programmatic General Permit, State of Maine." <http://www.nae.usace.army.mil/reg/meall.pdf>, 4-25-2007.
- United States Congress, 1899. "Rivers and Harbors Appropriation Act." 33 *U.S.C. 403; Chapter 425, March 3, 1899; 30 Stat. 1151*. Washington: GPO.
- United States Congress, 1934. "Fish and Wildlife Coordination Act." 16 *U.S.C. 661-667e; the Act of March 10, 1934*. Washington, GPO.
- United States Congress, 1948. "Federal Water Pollution Control Act." CWA; 33 *U.S.C. 1251-1376*. Washington: GPO.

- United States Congress. 1968. "Wild and Scenic Rivers Act." *16 U.S.C. 1271-1287 -- Public Law 90-542, approved October 2, 1968, (82 Stat. 906).* Washington: GPO.
- United States Congress, 1969. "National Environmental Policy Act." *Public Law 91-190, 42 U.S.C. 4321-4347, January 1, 1970.* Washington: GPO.
- United States Congress, 1973. "Endangered Species Act." *16 U.S.C. 1531-1544, 87 Stat. 884, as amended.* Washington: GPO.
- United States Congress, 1996. "Magnuson-Stevens Fishery Conservation and Management Act." *PL 94-265 (16 U.S.C.), as amended.* Washington: GPO.
- United States Forest Service, 2005. "Course Notes." Designing for Aquatic Organism Passage at Road-Stream Crossings Short Course, 6-20-2005, Machias, Maine.
- United States Forest Service, 2006a. "Course Notes." Designing for Aquatic Organism Passage at Road-Stream Crossings Short Course, 2-6-2006, Pacific City, OR
- United States Forest Service, 2006b. "FishXing Case Histories." <http://www.stream.fs.fed.us/fishxing/case/index.html>, 10-5-2005.
- Venner Consulting and Parsons Brinkerhoff, 2004. "Environmental Stewardship Practices, Procedures, and Policies for Highway Construction and Maintenance." Final Report for NCHRP Project 25-25, Task 4, National Cooperative Highways Research Program Transportation Research Board.
- Washington Department of Fish and Wildlife, 2000. "Fish Passage Barrier and Surface Water Diversion Screening Assessment and Prioritization Manual."
- Weaver, C. R., Thompson, C. S., and Slatick, E., 1976. "Fish Passage Research at the Fisheries-Engineering Research Laboratory May 1965 to September 1970." *Rep. No. 32*, North Pacific Division, U.S.Army Corps of Engineers.
- Webb, P. W., 1975. "Hydrodynamics and Energetics of Fish Propulsion Bulletin 190." Ottawa, Ontario.
- Welton, J. S., Beaumont, W. R. C., and Clarke, R. T., 2002. "The Efficacy of Air, Sound and Acoustic Bubble Screens in Deflecting Atlantic Salmon, *Salmo salar* L., Smolts in the River Frome, UK." *Fisheries Management and Ecology*, 9(1), 11-18.

- White, D., 1997. "Hydraulic Performance of Countersunk Culverts in Oregon." Master of Science, Oregon State University.
- Whitman, M., Hydraulic Engineer, California Department of Fish and Game, Personal Communication, 2006.
- Wilder, E., Caudill, D., Johnson, G., Barber, M., and Kanzler, S.C., 2004. "WSDOT Fish Passage Inventory, Progress Performance Report."
- Wildlife Management Interactive, 2001. "Tribes Sue over Fish Blocked in Culverts." <http://www.wminteractive.org/Articles/01wa1-17.htm>, 4-25-2007.
- Williams, G. P., 1978. "Bank-Full Discharges of Rivers." *Water Resources Research*, 14(6), 1141-1154.
- Williams, G. P. 1983. "Paleohydrological Methods and Some Examples from Swedish Fluvial Environments. I. Cobble and Boulder Deposits. " *Geografiska Annaler. Series A, Physical Geography* 65[3/4], 227-243. 1983.
- Young, M. K., 1995. "Resident Trout and Movement: Consequences of a New Paradigm." *Fish Habitat Relationships Technical Bulletin*,(18).
- Young, M. K., 1996. "Summer Movements and Habitat Use by Colorado River Cutthroat Trout (*Oncorhynchus clarki pleuriticus*) in Small, Montane Streams." *Canadian Journal of Aquatic Science*, 53, 1403-1408.
- Zevenbergen, L. W., Lagasse, P. F., and Edge, B. L., 2004. "Hydraulic Engineering Circular No. 25: Tidal Hydrology, Hydraulics and Scour at Bridges." *Rep. No. FHWA-NHI-05-077*, Federal Highway Administration.
- Zrinji, Z., and Bender, M., 1995. "Experimental Risk Evaluation for Baffled Culvert Fishway Design." The University of Manitoba Department of Civil Engineering.