

BUREAU OF TRANSPORTATION STATISTICS  
UNITED STATES DEPARTMENT OF TRANSPORTATION

A high-angle, aerial photograph of a large suspension bridge, likely the San Francisco-Oakland Bay Bridge, showing multiple lanes of traffic moving across it. The bridge's massive steel towers and suspension cables are prominent. The background shows a cityscape and water.

# JOURNAL OF TRANSPORTATION AND STATISTICS

# JOURNAL OF TRANSPORTATION AND STATISTICS

JOHN V. WELLS Editor-in-Chief  
PEG YOUNG Associate Editor  
MARSHA FENN Managing Editor  
DORINDA EDMONDSON Desktop Publisher  
ALPHA GLASS Editorial Assistant  
LORISA SMITH Desktop Publisher  
MARTHA COURTNEY Editor  
DARCY HERMAN Editor

## **EDITORIAL BOARD**

KENNETH BUTTON George Mason University  
TIMOTHY COBURN Abilene Christian University  
STEPHEN FIENBERG Carnegie Mellon University  
GENEVIEVE GIULIANO University of Southern California  
JOSE GOMEZ-IBANEZ Harvard University  
DAVID GREENE Oak Ridge National Laboratory  
KINGSLEY HAYNES George Mason University  
DAVID HENSHER University of Sydney  
PATRICIA HU Oak Ridge National Laboratory  
RICHARD JOHN Volpe National Transportation Systems Center, USDOT  
T.R. LAKSHMANAN Boston University  
TIMOTHY LOMAX Texas Transportation Institute  
PETER NIJKAMP Free University  
KEITH ORD Georgetown University  
ALAN PISARSKI Consultant  
JEROME SACKS National Institute of Statistical Sciences  
TERRY SHELTON U.S. Department of Transportation  
KUMARES SINHA Purdue University  
ROBERT SKINNER Transportation Research Board  
CLIFFORD SPIEGELMAN Texas A&M University  
MARTIN WACHS University of California at Berkeley  
C. MICHAEL WALTON The University of Texas at Austin

The views presented in the articles in this journal are those of the authors and not necessarily the views of the Bureau of Transportation Statistics. All material contained in this journal is in the public domain and may be used and reprinted without special permission; citation as to source is required.

JOURNAL OF TRANSPORTATION  
AND STATISTICS

**Volume 5 Numbers 2/3, 2002**  
**ISSN 1094-8848**

## **U.S. DEPARTMENT OF TRANSPORTATION**

NORMAN Y. MINETA  
Secretary

MICHAEL P. JACKSON  
Deputy Secretary

## **BUREAU OF TRANSPORTATION STATISTICS**

RICK KOWALEWSKI  
Acting Director

WILLIAM J. CHANG  
Associate Director for  
Information Systems

JOHN V. WELLS  
Chief Economist

### **Bureau of Transportation Statistics**

**Our mission:** To lead in developing transportation data and information of high quality and to advance their effective use in both public and private transportation decisionmaking.

**Our vision for the future:** Data and information of high quality supporting every significant transportation policy decision, thus advancing the quality of life and the economic well-being of all Americans.

**The *Journal of Transportation and Statistics* releases three numbered issues a year and is published by the**

Bureau of Transportation Statistics  
U.S. Department of Transportation  
Room 7412  
400 7th Street SW  
Washington, DC 20590  
USA  
journal@bts.gov

### **Subscription information**

To receive a complimentary subscription or a BTS Product Catalog:

mail     Product Orders  
           Bureau of Transportation Statistics  
           U.S. Department of Transportation  
           Room 7412  
           400 7th Street SW  
           Washington, DC 20590  
           USA  
phone    202.366.DATA [press 1]  
fax       202.366.3197  
internet  www.bts.gov

### **Information Service**

email     answers@bts.gov  
phone    800.853.1351

Cover and text design   Susan JZ Hoffmeyer

Cover photo   © Media Bakery/Eyewire

The Secretary of Transportation has determined that the publication of this periodical is necessary in the transaction of the public business required by law of this Department.

**Contents**

**Letter from the Editor-in-Chief** ..... v

**Papers in This Issue**

Household-Provided Transportation: An Extension of the Transportation Satellite Accounts  
*Duanjie Chen, Bingsong Fang, Xiaoli Han, and Brian W. Sloboda* ..... 1

A Nested Logit Model of Commuters' Activity Schedules  
*Sachin Gangrade, Ram M. Pendyala, and Robert G. McCullough* ..... 19

Robust Estimation of Origin-Destination Matrices  
*Byron J. Gajewski, Laurence R. Rilett, Michael P. Dixon, and Clifford H. Spiegelman* ..... 37

Calibration of Intercity Trip Time Value with a Network Assignment Model:  
A Case Study for the Korean NW-SE Corridor  
*Iljoon Chang and Gang-Len Chang* ..... 57

Efficiency Through Accountability: Some Lessons from Kentucky's Improved Medicaid Transit Service  
*Lenahan O'Connell, Ted Grossardt, Bruce Siria, Scott Marchand, and Maureen McDorman* ..... 73

An Application for Measuring Vehicle Travel by Visitors  
*Xuehao Chu and Steven E. Polzin* ..... 83

**Guidelines for Manuscript Submission** ..... 91

**Reviewers for 2001 and 2002** ..... 93

**Author Index for Volumes 1-5** ..... 97

**Complete Index for Volumes 1-5** ..... 103

# Letter from the Editor-in-Chief

Dear JTS Readers,

With this issue, we complete our fifth volume of publication. We are (as academic journals are sometimes apt to do) a little behind in our publication schedule, but we are working hard at returning to a regular thrice-yearly publication frequency. We have had some turnover in the position of Editor-in-Chief, first with the departure of David Banks and then the regrettably brief tenure of Mary Lynn Tischer. I have now been responsible for the Journal for most of the past year, and I am enjoying the intellectual stimulation of working with an excellent staff, a first-rate Editorial Board, and creative, diligent contributors. Peg Young is doing yeoman work as Associate Editor, Marsha Fenn continues to be the glue that holds the staff (and the Journal) together as Managing Editor, and Alpha Glass has joined us very helpfully as Editorial Assistant. My research analyst, Jennifer Brady, also now assists with the Journal's work. Finally, there would be no printed document without the proofreading and editing skills of Martha Courtney and Darcy Herman and the accomplished desktop publishing team of Dorinda Edmondson and Lorisa Smith.

I want to mention especially two members of our Editorial Board who were honored recently. Genevieve Giuliano earlier this year became the Chairman of the Executive Committee of the Transportation Research Board, and Marty Wachs received the W.N. Carey, Jr., Distinguished Service Award at TRB's meetings in January. Our congratulations to them both.

I would like to call your attention to the enclosed Call for Papers for a special JTS issue on forecasting, which is scheduled for publication in mid-2004. Keith Ord and Peg Young will be co-editors. Articles are due by August 1. Initial responses have been excellent, and I expect the issue will be packed with good articles.

We are also updating our subscribers list, so please return the enclosed card asking you to reaffirm your interest in continuing to receive the Journal. Please ask your colleagues who would like to receive the Journal to contact us.

The Bureau of Transportation Statistics continues to pursue its mission of making the best possible transportation data available to improve the quality of transportation decisionmaking. JTS authors play a key role in this process by providing high-quality statistical analysis applied to transportation issues. We are particularly interested in bringing our readers original ideas and articles that contribute to the field of transportation statistics, and we hope this issue's articles provide valuable information that you can use in your work.

**JOHN V. WELLS**  
Editor-in-Chief

# Household-Provided Transportation: An Extension of the Transportation Satellite Accounts

**DUANJIE CHEN**

**BINGSONG FANG**

**XIAOLI HAN**

MacroSys Research  
and Technology

**BRIAN W. SLOBODA**

Bureau of Transportation Statistics  
U.S. Department of Transportation

## **ABSTRACT**

Currently, transportation statistics provide estimates for household demand for transportation services. Though important, there is a missing link to the household supply of transportation services. Incorporating the household supply with household demand provides a complete analytical model for understanding the effects of household use of transportation services. The household production of transportation services is incorporated into the analytical framework of the Transportation Satellite Accounts, which maintain strong ties to the U.S. Input-Output Accounts and the National Income and Product Accounts. Our results indicate that the contribution of transportation activities to total gross domestic product, including the household sector, is 11.6% compared with 5.0% by the Transportation Satellite Accounts and 3.1% by the U.S. Input-Output Accounts. These results for household-provided transportation reveal the importance of this sector in transportation services.

## **INTRODUCTION**

Transportation statistics often treat households as users rather than producers of transportation services. In reality, the household production of transportation

---

Brian W. Sloboda, Bureau of Transportation Statistics, U.S. Department of Transportation, 400 7th Street, SW, Room 3430, Washington, DC 20590. Email: brian.sloboda@bts.gov.

services (HPTS) is ubiquitous in our economy, as people drive automobiles (including rental cars) to commute to work or school, go shopping, or obtain commercial and government services.<sup>1</sup> Consequently, households produce transportation services to meet their transportation needs, which include their purchase of for-hire transportation services such as ground passenger transportation (including taxicab) and railroad services.

Without an adequate evaluation of household production, or supply of transportation services, the conventional statistics on household demand for transportation services are not complete. Moreover, HPTS has a strong tie not only to the for-hire transportation industry (in both a complementary and substitutive manner) but also to other transportation-related industries ranging from auto manufacturing to the entertainment sector (mostly in a complementary manner). Therefore, a well-defined HPTS industry and properly estimated economic value of HPTS are critical to a better understanding of the overall level of transportation activities and their interaction with other sectors of the economy.

Many efforts have been made to better understand the true magnitude of overall transportation production in the economy. For example, the Bureau of Economic Analysis (BEA) in the U.S. Department of Commerce publishes personal consumption expenditures (PCEs) on user-operated transportation

<sup>1</sup> In this paper, we focus on HPTS through automobiles and ignore household production through private planes and other household-operated transportation vehicles such as boats, which should be included for a complete estimate of HPTS.

through the National Income and Product Accounts (NIPA)(USDOC BEA 2002, tables 2.4 and 2.5), and the Bureau of Transportation Statistics of the U.S. Department of Transportation publishes vehicle-miles traveled (vmt) by passenger cars (USDOT BTS 2002, table 1-28). A concise presentation of major measures of transportation's economic importance can be found in Han and Fang (2000). Unfortunately, none of these statistics or measures looks at households from a producer's perspective. As such, they do not provide an adequate measure for HPTS that is consistent and hence comparable to the for-hire transportation industries and other productive components of our economy.

Existing statistics either overlook the labor input to household transportation activities (i.e., time spent driving); make no distinction between household capital expenditures on automobiles such as the purchase of vehicles, and household operation and maintenance expenditures for automobiles such as repairs, oil changes, and other related expenditures; or provide no direct monetary value for comparison across economic sectors (e.g., vmt by passenger cars do not imply the same economic value across different type of motor vehicles). These statistics, nevertheless, provide helpful ideas and basic data for measuring HPTS as an "industry" so as to make it comparable to transportation industries that are accounted for in the NIPA. By measuring HPTS as an industry, we are able to extend the existing Transportation Satellite Accounts (TSAs; see box) to include another source of transportation services—HPTS—which is a step further toward

#### **Transportation Satellite Accounts**

In general, satellite accounts are frameworks designed to expand the analytical capacity of the basic economic accounts without overburdening them with details or interfering with their general-purpose orientation. Satellite accounts are meant to supplement rather than to replace existing accounts and organize information in an internally consistent way that suits a particular analytical focus, while maintaining links to the existing national accounts. They typically expand a particular segment of existing accounts with more details and additional dimensions of information, including nonmonetary information. They also may use definitions and classifications that differ from those in the existing accounts. Depending on the analytical focus, the production boundary of the national accounts can be maintained or modified

(USDOT BTS 1999). The existing Transportation Satellite Accounts (TSAs), as a supplement to the U.S. Input-Output (I-O) Accounts, are developed to cover both for-hire transportation services (identified as transportation industries within the U.S. I-O Accounts) and in-house transportation services conducted by businesses for their own use (not separately identified as transportation in the I-O Accounts). Therefore, compared with the U.S. I-O Accounts, the existing TSAs provide a more comprehensive measure of transportation services provided by the business sector of our economy. Hence, the household production of transportation services extends this measure to transportation services by the nonbusiness sector of the economy, namely households.



estimating the true magnitude of overall transportation in our economy. In the present analysis, transportation services in the form of driving by the household sector are considered regardless of what is transported (e.g., passengers or freight.) We then estimate the economic value of the for-hire transportation industries that provide transportation services either as intermediate inputs to other business sectors or as a final product used by consumers. We present the methodology for this estimation as well as the results for measuring HPTS as an industry, which is an extension of the existing TSAs.

## MEASURING HPTS AS AN INDUSTRY

Measuring HPTS as an industry expands the production boundary. To count HPTS as an industry requires an estimation of the labor and capital inputs, which are likely to increase the total value added or gross domestic product (GDP). More specifically, households' driving time that currently has no value in the national accounts needs to be counted as labor input to HPTS.<sup>2</sup> Furthermore, household purchases of automobiles, which are identified as PCEs in the national accounts, need to be redefined as fixed capital expenditures to derive the capital input to HPTS. While the capital input to HPTS may be estimated on the basis of national wealth data, which mainly involves a technical rearrangement, estimating labor input requires major conceptual clarifications.

The following clarifications are aimed at answering two questions. First, why is household driving, apart from general household traveling, considered a productive activity? Second, how should this productive activity be valued as a labor input to HPTS?

**Using the third-person criterion.** Horrigan et al. (1999) define the third-person criterion as an activity deemed productive if it can be delegated to another person and still achieve the desired result. According to this criterion, driving is considered productive and hence may be assigned values; in contrast, riding as a passenger is not productive (i.e.,

<sup>2</sup> Similar treatment has been applied in national accounts to certain forms of nonmarket household activities (e.g., imputing and counting the value of owner-occupied residences and farm products consumed on farms). In other words, what we are doing for HPTS has a precedent in existing national accounting practice.

it cannot be delegated to someone else) and hence should not be valued.

**Using the input approach to estimate the value of driving time.** The two conventional approaches to measuring nonmarket work are the input approach and the output approach. The output approach requires directly assigning a monetary value to an output, based on the price at which the output can be sold in the market. This approach is impractical in our case because there is no obtainable price in the market for HPTS; that is, transportation services produced by households are for their own use, not traded in the market.

The input approach is simpler and requires only an estimate of the amount of time a nonmarket activity takes and the selection of an appropriate wage for the specified activity. In our case, the driving time may be estimated on the basis of statistics of average driving speed and the total vmt by household-operated automobiles. Such statistics are available from several government publications as detailed in the appendix table A1.

**Using a "generalist" wage as the wage rate.** There are three possible wage rates that can be used to estimate the value of household driving time. They are: 1) the individual's occupational wage rate (e.g., the average wage rate for a lawyer, a secretary, or a construction worker), 2) a specialist wage rate (e.g., a racing car driver's rate), and 3) a generalist wage rate (e.g., a taxi driver's rate).

Out of the three types of wage rates, an individual's occupational wage rate serves as the best measure of the driver's true opportunity cost. However, treating the individual's occupational wage as his true opportunity cost not only imposes a very stringent data requirement but also implies strong assumptions concerning optimality in the individual's time allocation and the flexibility of market demand for any type of working hours. In other words, to use the individual's wage rate, one has to obtain a complete occupational profile of household drivers that is also classified by driving time. Furthermore, this approach assumes that the individual driver would desire to spend any time saved from driving on making additional income at his/her occupational wage rate (and that would be permitted by a horizontal demand curve for each occupation). Obviously, both the data requirements and

the stringency of the conceptual assumptions required make this approach impractical.

It should be noted that using a generalist wage rate such as a taxi driver's average hourly earning poses a conceptual problem similar to the case of using an individual's occupational wage rate. That is, it is not likely that time saved from individual driving would be used to earn extra income at a generalist wage rate. However, using a generalist wage rate imposes far less difficulty in terms of data requirements. It also makes our estimate of labor input to HPTS relatively conservative since a taxi driver's average earnings are typically below average earnings of nonfarm production workers.<sup>3</sup>

### **Procedures for Estimating HPTS**

We took a two-step approach to the estimation process. The first step estimates the intermediate inputs and the second, the value added. All the data sources used for our estimate are summarized in the appendix.

**Step 1. Estimating the Intermediate Inputs for HPTS.** Inputs for HPTS may be grouped into three categories: capital inputs, labor inputs, and intermediate inputs. Capital inputs represent the depreciation of transportation equipment such as household-owned automobiles. Labor inputs are the value of the driver's time. Finally, the intermediate inputs are the goods and services consumed in the process of providing transportation services, including PCEs on tires, accessories, and other parts; repair, greasing, washing, parking, storage, rental, and leasing; gasoline and oil; bridge, tunnel, ferry, and road tolls; and insurance. In the national Input-Output (I-O) Accounts, such PCE items are considered part of final demand, reflecting the general national income accounting practice that they are purchases for the purpose of consumption rather than production. In order to generate an HPTS sector within the production boundary of the national accounts, we must reclassify these PCE items as intermediate inputs to the HPTS sector.

**Step 2. Estimating the Value-Added Inputs for HPTS.** Generally, value-added inputs include the

<sup>3</sup> Based on the Bureau of Labor Statistics (<http://www.bls.gov>), in 2001, the average hourly earnings for the private nonfarm industry were well above \$14 while that for taxi drivers and chauffeurs were well below \$10.

value of labor services, indirect taxes, and other value added, mainly value of capital services. The value of labor services is the compensation paid to labor; the indirect taxes include any taxes paid during the process of production, such as import tariffs and license fees; and the value of capital services consists mainly of two parts: capital depreciation and the return to capital.

The value added by labor services, as discussed earlier, is estimated by applying the generalist wage rate (e.g., taxi drivers' average hourly earnings) to driving time. The driving time component of HPTS is estimated as the total household vmt divided by the household vmt per hour, both of which are based on data from the 1995 Nationwide Personal Transportation Survey (see Hu and Young 1999) and other highway statistics (e.g., vmt by type of vehicle).

The indirect tax and nontax liabilities component of HPTS (e.g., motor vehicle license fees) can be obtained from the Personal Income and Outlays data in the NIPA. However, it should be noted that, in the I-O Accounts, indirect taxes such as license fees related to HPTS are not presented explicitly but are contained in the "compensation of employees" by industry. Therefore, to avoid double counting, the indirect taxes component of HPTS is set to zero.

Finally, the return to capital is set to zero to recognize households as a nonprofit sector. This treatment also ignores the time value (i.e., interest income or cost) of money spent by the households on their investment in motor vehicles. Therefore, the value added through capital used for HPTS is mainly the annual depreciation of household-owned automobiles. This depreciation estimate is obtained from BEA, and the exact source is provided in the appendix.

### **TRENDS IN HPTS**

Figure 1 illustrates the magnitude of HPTS in comparison with the business sector of highway transportation (including both for-hire and in-house industries). Figures 2 through 4 compare HPTS with for-hire transportation industries in total output, relative shares within the transportation sector, and annual growth rate. For-hire transportation industries consist of railroads and related services, motor

**FIGURE 1 Relative Shares of Household and Business Sector Vehicle-Miles Traveled and Some Related Statistics: 2000**

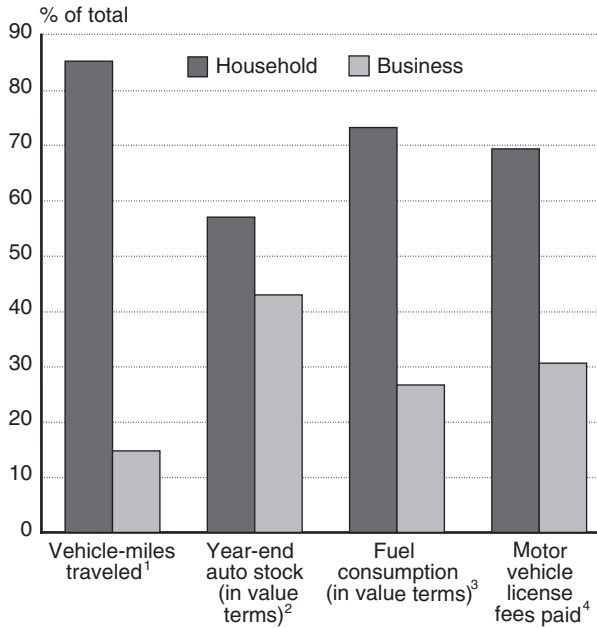

<sup>1</sup> Our estimate; see text for details.

<sup>2</sup> Based on Industry and Wealth Data published by the Bureau of Economic Analysis.

<sup>3</sup> For 1997, based on the 1997 Input-Output Accounts and 1996 TSAs, excluding trade margins.

<sup>4</sup> Based on NIPA tables 3.4 and 3.5.

freight and warehousing, water transportation, air transportation, and pipelines and related services. Figure 5 compares the annual growth rate of HPTS with that of government capital stock in highways

**FIGURE 2 Total Transportation Services in For-Hire Industries vs. Household Production: 1991–2000**

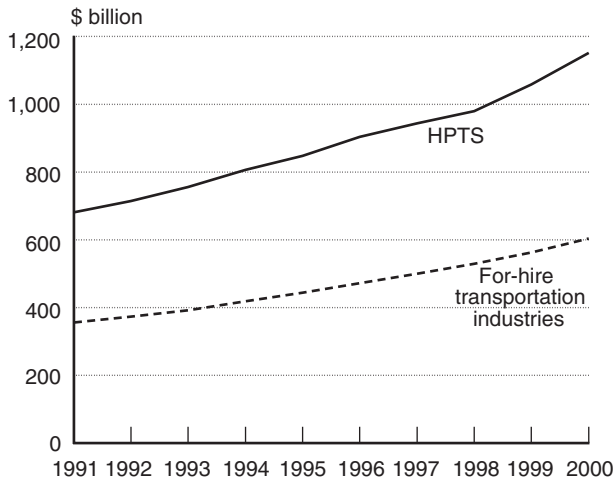

**FIGURE 3 Share in Total Transportation Services in For-Hire Industries vs. Household Production: 1991–2000**

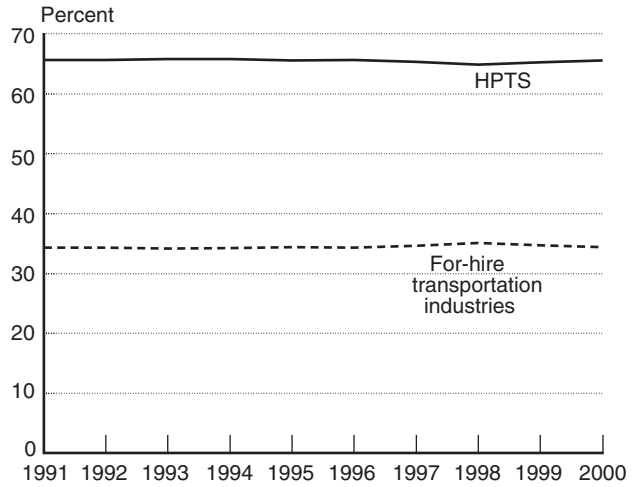

and streets, educational buildings, hospitals, and other government structures. Figure 6 compares the annual growth rate of HPTS with selected categories of GDP.

Several interesting observations can be drawn from these figures. First, HPTS accounted for a significant portion of total highway transportation services in the economy. As figure 1 shows, in 1999 total vmt by household-owned motor vehicles accounted for over 85% of total vmt by all motor vehicles in operation (including trucks and buses).<sup>4</sup> Figure 1 further provides the split between the household and business sectors in net automobile stock (in value terms), fuel consumption, and the motor vehicle license fees paid to governments. This comparison indicates a significant household portion in overall highway transportation activities. Further estimates in figures 2 and 3 show that the value of HPTS was about 1.9 times that of all for-hire transportation industries

<sup>4</sup> The estimate of household vmt is based on the 1995 NPTS *Summary of Travel Trends* and the annual growth rate of vmt by total passenger car, motorcycle, and other 2-axle, 4-wheel vehicles. Business vmt is the gap between total vmt through motor vehicles and household vmt. Caution should be taken in that vmt tells only a partial story of transportation services through motor vehicles and should not be taken as a summary measurement of transportation services through motor vehicles. For example, a given amount of vmt accomplished by a trucking company would probably indicate a significantly higher value of transportation services than that for a household driver.

**FIGURE 4 Annual Growth in Transportation Services in For-Hire Industries vs. Household Production: 1992–2000**

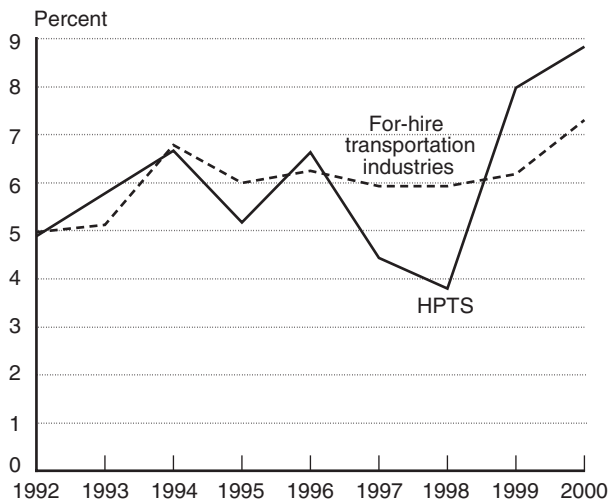

between 1991 and 2000. Obviously, ignoring HPTS means a significant underestimate of the overall transportation services produced and used in the economy.

Second, household-produced and for-hire transportation services shared a similar growth pattern (figure 4). Figure 4 shows that the growth rates went up and down concurrently. However, the growth rate of HPTS displayed more volatility in comparison to the for-hire transportation sector, especially after 1996. A plausible explanation is that household-produced transportation is more of a discretionary expenditure to the household and more responsive to the ups and downs of the overall economy. On the other hand, for-hire transportation involves more freight movements that are often necessities to the economy and less responsive to the short-term (year-to-year) changes in the growth rate of the economy.

Third, HPTS relies heavily on government investment in transportation infrastructure. To that extent, HPTS is unique among other forms of household production such as food preparation, childcare, and entertainment, because these other forms of household production do not rely on a government supplied infrastructure. It is obvious that HPTS directly consumes the transportation infrastructure as a public good. That is, without government investment in highways and streets, the rapid growth in HPTS would not be possible. Furthermore, HPTS is often

related to the household consumption of other major public goods (e.g., schools, hospitals, electric and gas facilities, transit systems, and police and fire stations) through urban sprawl. In other words, urban sprawl fostered the growing need for HPTS. Urban sprawl and hence the need for HPTS might not have grown so rapidly without the government investment in major public goods other than roads (e.g., water and sewer systems). As figure 5 shows, the average annual growth rate in HPTS has closely followed the annual growth rate in government capital stock in highways and streets, education, hospitals, and other nonmilitary structures funded by the government.

Finally, HPTS is one of a few forms of household production that is solidly linked, backward and forward, to many industries. It is obvious that HPTS would not play such a significant role in average people’s daily lives if our economy were not equipped with a mature auto manufacturing industry and an efficient system for gasoline distribution. On the other hand, many commercial centers (e.g., clustered consumer centers grouping shopping and recreational facilities) might not have emerged so rapidly without a well-developed system of HPTS. Figure 6 shows that the average annual growth rate of HPTS has been in line with that of manufacturing, retail trade, hotels and other lodging places, and amusement and recreation services. Such illustrations are of course preliminary; a more

**FIGURE 5 Average Annual Growth Rate in HPTS vs. Net Capital Stock in Selected Public Goods: 1992–2000**

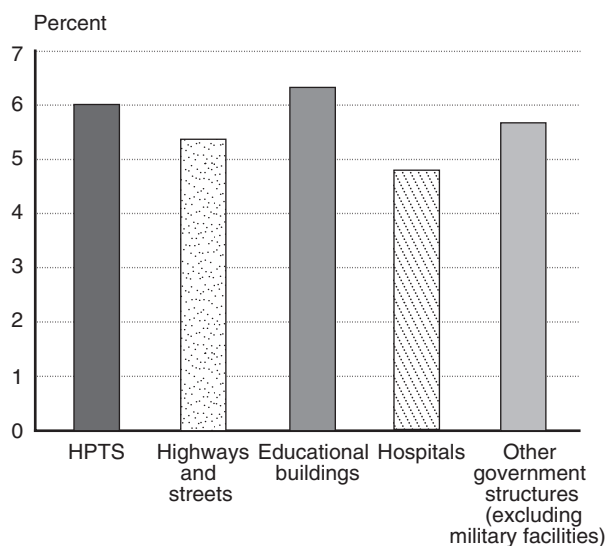

**FIGURE 6 Average Annual Growth Rate in HPTS vs. GDP for Selected Industries: 1991–2000**

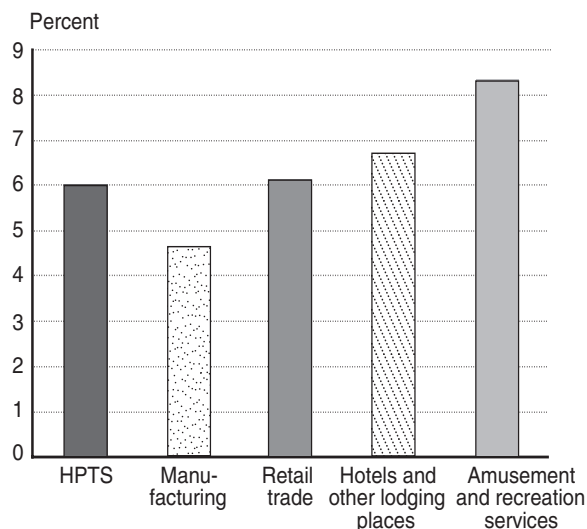

precise estimate of the economic linkage between HPTS and many industries requires the inclusion of HPTS in the TSAs. As an I-O Account, TSAs facilitate a complete characterization of the interrelationship between one sector and the rest of the economy. To do that for HPTS, however, the TSAs first have to be extended to include HPTS. The next section delves into this.

### EXTENSION OF THE TSAs INTO HPTS

As mentioned in the introduction, the existing TSAs, as a supplement to the U.S. I-O Accounts, are developed to cover both for-hire transportation services (identified as transportation industries within the U.S. I-O Accounts) and in-house transportation services conducted by businesses for their own use (not separately identified as transportation in the I-O Accounts). Therefore, compared with the U.S. I-O Accounts, the existing TSAs provide a more comprehensive measure of transportation services provided by the business sector of our economy.<sup>5</sup> Extending the existing TSAs to incorporate HPTS will allow analysts to measure transportation services provided not only by the business sector but also by the household sector of our economy. In other words, this

<sup>5</sup> See Fang et al. (1998), Fang et al. (2000), and USDOT BTS (1999) for details.

extension can be seen as a further step toward providing a comprehensive measure of transportation services.

Due to the differences in methodology and data sources between the I-O Accounts and the NIPA,<sup>6</sup> certain technical procedures are necessary for the integration of HPTS into the TSAs and for consistency and comparability between the TSAs and the U.S. I-O Accounts. (The details of these procedures are presented in USDOT BTS (Forthcoming)). The following illustrates the structural expansion of the TSAs and the estimated HPTS as additions to each of four TSA tables (i.e., Make, Use, Direct Requirements, and Total Requirements Tables).

### Expansion of the TSAs: A Structural Illustration

As mentioned earlier, the inclusion of HPTS as an industry in the TSAs will result in an expansion of the production boundary in the sense that the total value added will be greater than the official GDP. Diagram 1 illustrates such an expansion. The extended coverage of costs and benefits of transportation services enables more accurate analyses of transportation's role in and its contribution to the economy. It also makes it possible to directly link data sources and analysis to the monetary accounting system of U.S. national accounts, which will facilitate transportation analyses in the context of the national economy.

Constructing an HPTS sector within the TSAs follows some basic I-O accounting practices. The overall industry and commodity classification system and the special definitions and conventions in

<sup>6</sup> As stated in Yuskavage (2000), BEA relies on the income and expenditure approach or the gross product originating (GPO) approach for the NIPA. Although the GPO by industry and value added from the I-O Accounts are conceptually equivalent, "GPO is based primarily on BLS data for labor income and on IRS data for capital income, whereas I-O is based primarily on Census data. Differences in the industry classifications among these major data sources lead to inconsistencies. In addition, I-O value added is a residual that is critically dependent on good data for purchased goods and services by industry, which are limited. The GPO estimates of capital income depend on the assumption that corporate profits and other company-based income components can be allocated to the establishment level by industry."

**DIAGRAM 1 Expansion of the Production Boundary Due to the Inclusion of HPTS in the TSAs: An Illustration within the Framework of the Input-Output Accounts Use Table**

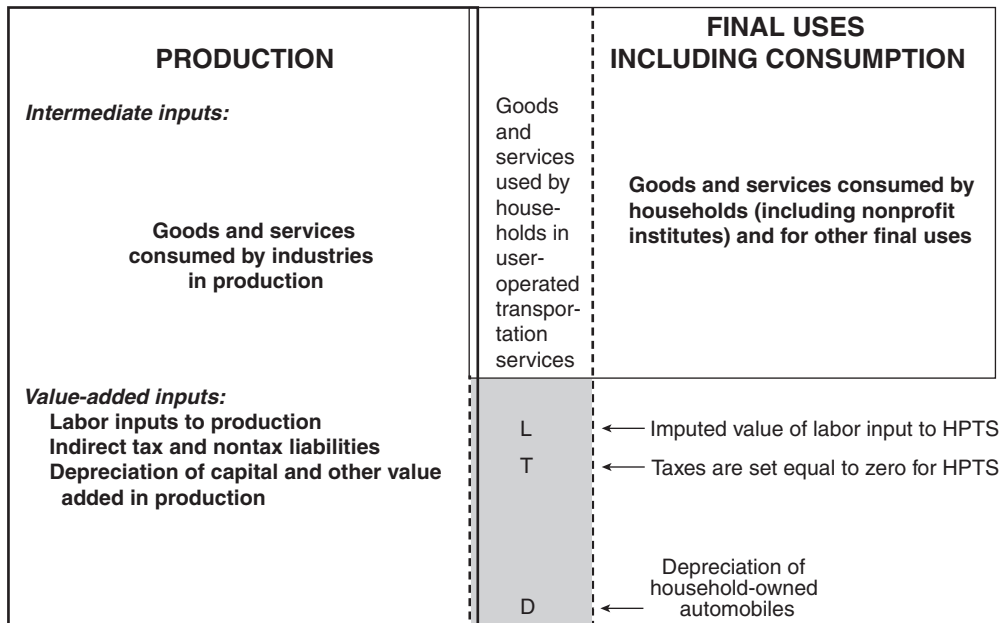

**Notes:**

1. The second and third vertical lines in this chart, dotted or solid, should be seen as an overlapped single line.
2. The thick solid line is the production boundary defined in the System of National Accounts (SNA).
3. The thinner solid line contains the final uses including personal consumption expenditures (PCE) in the U.S. Input-Output Accounts.
4. The dotted panel excluding the shaded part indicates the PCE on user-operated transportation to be

- reclassified as intermediate inputs to HPTS being constructed in the TSAs.
5. The shaded part reflects the value-added inputs to HPTS that present an addition to gross domestic product.
6. The area between the thick solid line and the dotted line (including both shaded and unshaded parts) reflects the expansion of the production boundary defined in the SNA.

the I-O Accounts<sup>7</sup> are used except that HPTS itself forms a new industry and a new commodity category in the TSAs. The general valuation conventions used in constructing HPTS in the TSAs are consistent with those in the I-O Accounts: all transactions including both intermediate inputs and final uses are valued in producers' prices.

Diagrams 2 and 3 illustrate such a relationship more intuitively. Diagram 2, with the shaded indus-

try row and commodity column, depicts the simple fact that the inclusion of HPTS will slightly modify the classification of the existing I-O Accounts. That is, a new industry and a new commodity, both named HPTS, are added to the existing TSAs.

Diagram 3, with further elaborations on how the HPTS industry and commodity are created, shows the expansion of the production boundary resulting from the inclusion of HPTS. More specifically, the user-operated transportation expenditures under PCE in the I-O Accounts and existing TSAs are reclassified from the final demand section to the intermediate inputs section, and GDP is increased by the amount of the total value added of the HPTS industry. For PCE reclassification, user-operated transportation expenditures are treated as either intermediate inputs for the HPTS industry or additions to gross private fixed investment (GPFI), depending on whether they are durable or nondurable goods.

<sup>7</sup>An example of the special definitions and conventions used in the I-O Accounts, according to the *Personal Consumption Expenditures* monograph (USDOC BEA 1990), is "the accounting for imputed transactions," which "serves the purpose of keeping GDP, PCE, and other NIPA aggregates invariant to whether 1) housing and institutional structures and equipment are rented or owned; 2) employees are paid in cash or in kind; 3) farm products are sold or consumed on the farm; 4) saving, lending, and borrowing are direct or are intermediated; and 5) intermediated financial transactions involve an explicit or implicit service charge." More examples follow later in this paper.

**DIAGRAM 2 The TSA Make Table of Commodities by Industries**

INDUSTRIES	COMMODITIES										TOTAL INDUSTRY OUTPUT
	Agriculture	Mining	Construction	Manufacturing	Transportation—business	HPTS	Trade	Finance	Services	Other	
Agriculture											
Mining											
Construction											
Manufacturing											
Transportation—business											
HPTS						<b>Total output of HPTS</b>					<b>Additional industry output</b>
Trade											
Finance											
Services											
Other											
<b>TOTAL COMMODITY OUTPUT</b>						<b>Additional commodity output</b>					<b>Increased by total output of HPTS</b>

The change in GDP has two sources. First, the value of labor input to HPTS is imputed as a new value-added input. Second, the depreciation of household-owned motor vehicles used for HPTS, which is not counted in the I-O Accounts but contained in the industry and wealth data of the national accounts system, is included as the value of capital services. We discuss these procedures in more detail below.

**Addition of HPTS to Each Component of the TSAs**

The structure of the TSAs is consistent with the U.S. I-O Accounts. That is, both accounts are presented

in four tables: the Make (production) table, the Use (consumption) table, the Direct Requirements table, and the Industry-by-Commodity Total Requirements table. The addition of the HPTS industry and commodity was made in each of these four tables as one of the three major transportation sectors (i.e., for-hire, in-house, and HPTS). Table 1 provides an overview of major components of the transportation industry and industry output used in the TSAs.

Diagram 2, a TSA Make table, has an additional column for HPTS as a commodity and an additional row for HPTS as an industry. See appendix table A2 where the cell value at the intersection of the

**DIAGRAM 3 The TSA Use Table of Commodities by Industries**

COMMODITIES	INDUSTRIES		FINAL USES					TOTAL COMMODITY OUTPUT
	Business sector	Household sector	Total intermediate use	Personal consumption expenditures	Gross private fixed investment	Other	GDP	
	Goods-producing industries	HPTS						
Business, including government enterprises		Increased by user-operated transportation expenditures excluding purchases of autos	Increased by total intermediate inputs for HPTS	Reduced by user-operated transportation expenditures	Increased by personal purchases of automobiles: new, used, and other		Reduced by total intermediate inputs for HPTS that were originally a part of PCE on user-operated transportation	
Household: HPTS		Zero		= total output of HPTS			= total output of HPTS	= total output of HPTS
Total intermediate inputs		Total intermediate inputs for HPTS	Increased by total intermediate inputs for HPTS					
Value added by labor input, actual or imputed		Imputed value						
Other value added		Depreciation of household-owned motor vehicles						
Total value added		Total value added of HPTS					<b>Increased by total value added of HPTS</b>	
<b>TOTAL INDUSTRY OUTPUT</b>		<b>Total output of HPTS</b>						<b>Increased by total output of HPTS</b>

**TABLE 1 Components of Transportation Industry and Industry Output**

Industry	Industry components	Industry output
<p><b><i>For-hire transportation industries</i></b>                      Railroads and related services; passenger ground transportation</p>	Railroads, including AMTRAK Switching and terminal companies Freight car rental Private local and suburban passenger transportation Intercity, rural, and other bus services, including charter and school buses Bus terminal and service facilities Taxicabs	Total operating revenues Less: Rental receipts
Motor freight transportation and warehousing	Trucking and courier services, except air Public warehousing and storage Trucking terminal facilities	Total operating revenues Plus: Trucking receipts of construction firms Warehousing revenues of wholesalers Delivery and storage charges of retailers Less: Merchandise sales Rental receipts
Water transportation	Deep sea and other water transportation of freight Water transportation of passengers Services incidental to water transportation, including marinas and other services	Total operating revenues Plus: Docking, boat cleaning, and maintenance at retailers Federal excise tax on cruise ship receipts Less: Merchandise sales Boat repair at marinas
Air transportation	Domestic and international passenger and freight air transportation Airport terminal services	Total operating revenues Plus: Federal taxes on airfares, air freight, and air facilities Aircraft storage and services by wholesaler and retailers Less: Rental receipts Flight training and instruction
Pipelines, freight forwarders, and related services	Refined petroleum pipelines Other pipelines, including crude petroleum and natural gas Arrangement of freight and passenger transportation, including freight forwarding Miscellaneous services incidental to transportation	Total operating revenues Plus: Pipeline receipts by wholesalers Less: Rental receipts
State and local government passenger transit	State and local government passenger transit	Total operating revenues Less: Operating subsidies
<b><i>In-house highway transportation</i></b>	Private trucking and bus operations in all nontransportation industries	Total operating expenses of highway motor vehicles and overhead expenses Less: Expenses on advertising, depository institutions, security and commodity brokers, and other services unrelated to own-account transportation operations
<b>Household production of transportation services</b>	<b>Household production of transportation services</b>	<b>Total personal consumption expenditures on user-operated transportation</b> Less: PCE on new autos, net purchases of used autos and other motor vehicles Plus: Imputed value added by household labor input corresponding to estimated driving time and annual total depreciation of motor vehicles owned by consumers



column and row of HPTS, under the heading HPTS, equals the total output of HPTS; all other cell entries in the HPTS row and column are zero because no other industries conduct HPTS and the HPTS industry produces nothing but HPTS. The data shown in other parts of the TSA Make table are the same as those provided in the 1992 TSAs, which indicate that the total output of HPTS is a pure addition to the Make table of TSA accounts.

Diagram 3, a TSA Use table, has an additional row for HPTS as a commodity and an additional column for HPTS as an industry (see also appendix table A3, p. 16–18). The entries in the HPTS column are redefined or imputed intermediate and value-added inputs for HPTS. While total intermediate inputs for HPTS are part of the original user-operated transportation expenditures under PCE in the I-O Accounts and TSAs, value-added inputs for HPTS are our imputation as additions to GDP. In this table, the use of the HPTS commodity is shown in the HPTS row. Since the HPTS output is produced and consumed at the same time by households, it is not used by any industries including the HPTS “industry.” Therefore, all the cell values in the HPTS row are equal to zero except the one at the intersection of the HPTS row and PCE column in the final uses section.

Besides the additional row and column for HPTS, Diagram 3 also differs from the Use table in the existing TSAs and I-O Accounts in that the part of PCE related to automobile purchases is put under GPFI. Therefore, GPFI shown in Diagram 3 is greater than its counterpart in the I-O Accounts and the existing TSAs. This switch reduces total PCE and increases total GPFI simultaneously and hence does not affect the total output and GDP shown in the I-O Accounts.

As a consequence of these additions to the TSA Make and Use tables, the TSA Direct Requirements and Total Requirements tables also have an additional row and columns for the HPTS commodity and industry. The TSA Direct Requirements table is derived from the TSA Use table by dividing each industry’s commodity and value-added inputs by that industry’s total output. This table, however, does not include the final use section of the Use table. In the table, each column shows, for the industry named at the head of the column, the input coefficients for the commodities

and the value-added components that an industry directly requires to produce a dollar’s worth of its output.

The TSA Industry-by-Commodity Total Requirements table shows the total requirements for each industry’s output that are directly and indirectly required to deliver a dollar’s worth of goods and services to consumers and other final users. Each column shows the commodity delivered to final users, and each row shows the demand for an industry’s output in response to a dollar increase in the final demand for a commodity. The coefficients in the table are referred to as industry-by-commodity total requirement coefficients. This table is derived from both the TSA Make and the TSA Use tables.

In summary, the redefined intermediate inputs for HPTS are part of PCE in the existing TSAs and I-O Accounts while the imputed value-added inputs for HPTS are additions. The sum of the intermediate and value-added inputs consumed by the HPTS industry is the total output of the industry, which is consumed by households and hence forms a new category of PCE. As a result, the total output in the expanded TSAs will be greater than the total output of I-O Accounts by the amount of HPTS output plus the in-house transportation industry output, and the GDP in the expanded TSAs will be greater than the GDP of I-O Accounts by the amount of HPTS value added.

## MAJOR FINDINGS

The expansion of the TSAs to include HPTS provides a different picture of the magnitude of transportation activities in relation to the economy. Based on the 1992 benchmark I-O Accounts and the 1992 TSAs, three major findings concerning HPTS can be summarized as follows.

### True Magnitude of Transportation in the Economy

The magnitude of transportation in the economy can be measured from two perspectives: as a share of the total output of the economy and as a share in GDP. GDP is the net output of the economy, while total output represents the sum of GDP and all of its intermediate inputs. The share in total output tells more about the size of production, while the share

in GDP tells more about its real contribution to the national economy.

The total output of HPTS in 1992 was approximately \$710 billion, which is about 1.28 times the total output of business transportation services, including both the for-hire and in-house sectors. Including HPTS in the TSAs would increase the estimate of total output of our economy by about 6.5% and GDP by 7.4%. And the share of transportation (business plus HPTS) in the expanded GDP would be 11.6%.

### **Use of Major Commodities by HPTS**

Counting HPTS as an industry and commodity in the TSAs helps improve the estimate of use of major commodities and services by HPTS. For example, the NIPA counts total PCE on automobiles as a direct expenditure on user-operated transportation. With HPTS treated as a separate industry, the capital input to user-operated transportation can be counted more precisely as the annual replacement portion, or depreciation cost, of the household-owned auto stock that includes current-year purchases.

In the meantime, including all the commodities and services as intermediate inputs to HPTS enables a better understanding of the composition of transportation services provided and consumed by households. For example, within the existing I-O Accounts and the NIPA, one cannot gain any understanding of the services of wholesale and retail trade used by households to meet their needs for user-operated transportation. With the formation of HPTS, services provided by the wholesale and retail trade sector can be shown to account clearly for 26% of total intermediate inputs to HPTS, thus indicating the true significance of the wholesale and retail trade sector in supporting HPTS.

### **Multiplier Effect of Major Commodities on HPTS**

The multipliers derived from the TSAs including HPTS capture the direct and indirect dependence of HPTS on the rest of the economy. For example, to

meet a \$1 increase in the final demand for HPTS would require an additional 17.6¢ in total manufacturing output. The next major items for supporting a \$1 increment in the final demand for HPTS are services (17.3¢), wholesale and retail trade (10.9¢), finance and insurance (7.7¢), and business transportation services including both for-hire and in-house (3.0¢). These estimates come to light only when HPTS as an industry and commodity is formed within the TSAs. These estimates show a more accurate picture of the household sector in relation to the overall economy.

### **ACKNOWLEDGMENT**

We are grateful to David Chesser and William Mallett, whose expertise in transportation statistics helped refine our estimate of driving speed, which is critical to estimating the value added by labor service related to HPTS.

### **REFERENCES**

- Fang, B., X. Han, A.M. Lawson, and S.K.S. Lum. 1998. U.S. Transportation Satellite Accounts for 1992. *Survey of Current Business* 78(4).
- Fang, B., X. Han, S. Okubo, and A.M. Lawson. 2000. U.S. Transportation Satellite Accounts for 1996. *Survey of Current Business* 80(5).
- Han, X. and B. Fang. 2000. Four Measures of Transportation's Economic Importance. *Journal of Transportation and Statistics* 3(1):15-30.
- Horrigan, M., D. Herz, M. Joyce, E. Robison, J. Stewart, and L. Stinson. 1999. A Report on the Feasibility of Conducting a Time-Use Survey, presented at the Workshop on Measurement of and Research on Time Use, May 27-28.
- Hu, P.S. and J.R. Young. 1999. *Summary of Travel Trends: 1995 Nationwide Personal Transportation Survey*. Washington, DC: U.S. Department of Transportation, Federal Highway Administration.
- U.S. Department of Commerce (USDOC), Bureau of Economic Analysis (BEA). 1990. *Personal Consumption Expenditures, Methodology Paper Series MP-6*. Washington, DC: U.S. Government Printing Office. June.
- \_\_\_\_\_. National Income and Product Accounts Tables. 2002. Available at <http://www.bea.gov/dn/nipaweb/SelectTable.asp?Selected=N>, as of Mar. 27, 2003.

U.S. Department of Transportation (USDOT), Bureau of Transportation Statistics (BTS). 1999. *Transportation Satellite Accounts: A New Way of Measuring Transportation Services in America*, BTS99-R-01. Washington, DC. February.

\_\_\_\_\_. 2002. *National Transportation Statistics 2002*. Washington, DC. Also available at <http://www.bts.gov>.

\_\_\_\_\_. Forthcoming. *Household Production of Transportation Services Through Automobiles: An Expansion of the Transportation Satellite Accounts*. Washington, DC.

Yuskavage, R.E. 2000. Priorities for Industry Accounts at BEA, presented at the meeting of the Bureau of Economic Analysis Advisory Committee, Nov. 17, 2000. Available at <http://www.bea.gov/bea/papers/priority.pdf>.

## APPENDIX

**TABLE A1 Principal Data Sources**

Data	Sources
Input-Output Accounts, 1992 and 1996	U.S. Department of Commerce (USDOC), Economic and Statistics Administration, Bureau of Economic Analysis (BEA), Benchmark Input-Output Accounts for the U.S. Economy, 1992; Input-Output Accounts for the U.S. Economy, 1996; detailed underlying data files for these accounts.
Transportation Satellite Accounts (TSAs), 1992 and 1996	U.S. Department of Transportation (USDOT), Bureau of Transportation Statistics (BTS), <i>Transportation Satellite Accounts: A New Way of Measuring Transportation in America</i> , 1999; detailed underlying data files for the TSAs.
Gross output by industry	USDOC, BEA, Gross Domestic Product by Industry data, <a href="http://www.bea.doc.gov/bea/dn2/go7700.exe">http://www.bea.doc.gov/bea/dn2/go7700.exe</a> .
Gross domestic product by industry	USDOC, BEA, Industry Accounts Data, <a href="http://www.bea.doc.gov/bea/dn2/gpoc.htm">http://www.bea.doc.gov/bea/dn2/gpoc.htm</a> .
Annual total depreciation of motor vehicles owned by consumers	USDOC, BEA, Fixed Asset tables, table 8.4 (and table 2.4 for private fixed assets by type).
Motor vehicle licenses	USDOC, BEA, National Income and Product Accounts tables, tables 3.4 and 3.5, <a href="http://www.bea.doc.gov/bea/dn/nipaweb">http://www.bea.doc.gov/bea/dn/nipaweb</a> .
Median earnings for taxicab drivers	U.S. Department of Labor, Bureau of Labor Statistics, Division of Monthly Industry Employment Statistics, unpublished data. (202) 691-6555.
Vehicle-miles of travel (vmt) by type of vehicles and highway total	USDOT, BTS for 1992, <i>National Transportation Statistics 1998</i> , chapter 1, table 1-9; for 1996–1997, <i>National Transportation Statistics 1999</i> , table 1-28; and for 2000, USDOT, Federal Highway Administration, <i>Highway Statistics</i> , <a href="http://www.fhwa.dot.gov/ohim/hs00/">http://www.fhwa.dot.gov/ohim/hs00/</a> .
Household vmt (1995)	Based on Hu and Young (1999), <i>Summary of Travel Trends: 1995 Nationwide Personal Transportation Survey</i> , <a href="http://www.cta.ornl.gov/npts/1995">http://www.cta.ornl.gov/npts/1995</a> , table 1.
Average motor vehicle speed	Based on Hu and Young (1999), <i>Summary of Travel Trends: 1995 Nationwide Personal Transportation Survey</i> , <a href="http://www.cta.ornl.gov/npts/1995">http://www.cta.ornl.gov/npts/1995</a> , table 28.
Personal consumption expenditure on user-operated transportation services excluding purchases for automobiles	USDOC, BEA, National Income and Product Accounts tables, table 2.4: Personal Consumption Expenditures by Type of Expenditure, <a href="http://www.bea.doc.gov/bea/nipaweb">http://www.bea.doc.gov/bea/nipaweb</a> .

**TABLE A2 The TSA Make Table of Commodities by Industries: 1992**

Millions of dollars at producers' prices

Industry	TRANSPORTATION									
	Agriculture, forestry, and fisheries	Mining	Construction	Manufacturing	For-Hire					In-house transportation
					Railroad and passenger ground	Motor freight and warehousing	Water	Air	Pipelines and freight forwarders	
Agriculture, forestry, and fisheries	235,591	0	0	1,022	0	11	0	0	0	0
Mining	0	147,001	0	9,716	0	0	0	0	0	0
Construction	0	0	679,330	0	0	0	0	0	0	0
Manufacturing	0	561	0	2,879,654	0	0	0	0	0	0
Railroads and related services; passenger ground transportation except transit	0	0	0	0	55,576	174	0	0	0	0
Motor freight transportation and warehousing	0	0	0	0	0	155,590	0	0	0	0
Water transportation	0	0	0	0	0	0	32,440	0	0	0
Air transportation	0	0	0	0	0	0	0	94,141	0	0
Pipelines, freight forwarders, and related services	0	0	0	0	542	1,320	194	2,632	28,928	0
State and local passenger transit	0	0	0	0	5,876	0	0	0	0	0
In-house transportation	0	0	0	0	0	0	0	0	0	165,461
HPTS	0	0	0	0	0	0	0	0	0	0
Communications and utilities	0	0	0	0	0	0	0	0	0	0
Wholesale and retail trade	0	0	0	0	0	0	0	0	0	0
Finance, insurance, and real estate	0	0	0	0	0	0	0	0	0	0
Services	0	0	0	8	0	15	0	0	38	0
Other	0	0	0	37	64	0	1,713	2,046	0	0
<b>Total commodity output</b>	<b>235,591</b>	<b>147,562</b>	<b>679,330</b>	<b>2,890,437</b>	<b>62,058</b>	<b>157,110</b>	<b>34,347</b>	<b>98,819</b>	<b>28,966</b>	<b>165,461</b>

*continues*

**TABLE A2 The TSA Make Table of Commodities by Industries: 1992 (continued)**

Millions of dollars at producers' prices

Industry	TRANSPORTATION						Total industry output
	HPTS	Communications and utilities	Wholesale and retail trade	Finance, insurance, and real estate	Services	Other <sup>1</sup>	
Agriculture, forestry, and fisheries	0	0	0	0	1,038	0	237,662
Mining	0	0	0	0	0	0	156,717
Construction	0	0	0	0	0	0	679,330
Manufacturing	0	43	0	0	69,509	1,536	2,951,303
Railroads and related services; passenger ground transportation except transit	0	0	0	0	0	4	55,754
Motor freight transportation and warehousing	0	11,363	0	0	0	0	166,953
Water transportation	0	0	0	0	0	0	32,440
Air transportation	0	0	0	0	0	0	94,141
Pipelines, freight forwarders, and related services	0	0	0	0	0	0	33,616
State and local passenger transit	0	0	0	0	0	0	5,876
In-house transportation	0	0	0	0	0	0	165,461
HPTS	709,962	0	0	0	0	0	709,962
Communications and utilities	0	491,312	0	0	28,838	538	520,688
Wholesale and retail trade	0	0	1,091,489	0	0	0	1,091,489
Finance, insurance, and real estate	0	0	0	1,629,618	25,114	0	1,654,732
Services	0	0	0	666	2,226,302	521	2,227,550
Other	0	48,012	3,659	9,132	3,301	846,432	914,396
<b>Total commodity output</b>	<b>709,962</b>	<b>550,730</b>	<b>1,095,148</b>	<b>1,639,416</b>	<b>2,354,102</b>	<b>849,031</b>	<b>11,698,070</b>

<sup>1</sup> "Other" consists of government enterprise (except state and local government passenger transit) and other input-output special industries. See A.M. Lawson, "Benchmark Input-Output Accounts for the U.S. Economy, 1992: Make, Use, and Supplementary Tables," *Survey of Current Business* 77:58-62, November 1997.

**TABLE A3 The TSA Use Table of Commodities by Industries: 1992**

Millions of dollars at producers' prices

Commodity	Agriculture, forestry, and fisheries	Mining	Construction	Manu- facturing	TRANSPORTATION					
					For-Hire					
					Railroad and passenger ground	Motor freight and warehousing	Water	Air	Pipelines and freight forwarders	State and local passenger transit
Agriculture, forestry, and fisheries	55,569	43	4,027	123,104	1	3	6	1	0	2
Mining	298	25,985	5,445	94,010	0	0	9	0	83	0
Construction	2,877	2,655	552	18,050	2,465	736	30	239	574	1,664
Manufacturing	36,994	11,446	199,947	1,017,125	7,174	12,818	3,208	13,201	1,475	3,460
Railroads and related services; passenger ground transportation except transit	1,515	1,039	1,294	14,759	2,368	442	19	128	33	69
Motor freight transportation and warehousing	3,231	917	10,302	44,955	368	28,810	104	233	209	50
Water transportation	436	427	723	4,261	78	209	4,282	164	56	29
Air transportation	457	413	963	11,485	214	622	77	6,064	233	1
Pipelines, freight forwarders, and related services	81	14	4	4,788	442	4,966	1,407	7,820	763	24
In-house transportation	13,177	3,870	38,950	21,806	0	0	0	0	0	0
HPTS	0	0	0	0	0	0	0	0	0	0
Communications and utilities	3,954	7,218	4,343	74,295	596	5,499	192	1,636	1,444	643
Wholesale and retail trade	11,131	2,600	53,758	163,845	1,706	5,824	520	1,505	326	303
Finance, insurance, and real estate	15,528	19,183	11,224	48,672	1,849	6,108	1,990	3,157	1,769	116
Services	5,949	5,037	64,747	165,357	3,771	16,423	4,836	8,903	6,635	214
Other	156	1,172	696	24,581	332	1,122	2,964	8,924	392	4
Total intermediate inputs	151,352	82,021	396,974	1,831,093	21,364	83,582	19,644	51,975	13,992	6,579
Compensation of employees	25,870	27,777	219,347	688,213	23,458	55,533	7,140	32,761	10,710	9,018
Indirect business tax and nontax liability	5,206	8,164	3,246	37,864	1,006	2,615	583	5,696	993	0
Other value added	55,234	38,755	59,762	394,134	9,926	25,223	5,073	3,709	7,921	-9,721
Total value added	86,310	74,696	282,356	1,120,210	34,390	83,371	12,796	42,166	19,624	-703
<b>Total industry output</b>	<b>237,662</b>	<b>156,717</b>	<b>679,330</b>	<b>2,951,303</b>	<b>55,754</b>	<b>166,953</b>	<b>32,440</b>	<b>94,141</b>	<b>33,616</b>	<b>5,876</b>

*continues*

**TABLE A3 The TSA Use Table of Commodities by Industries: 1992 (continued)**

Millions of dollars at producers' prices

Commodity	TRANSPORTATION		Communications and utilities	Wholesale and retail trade	Finance, insurance, and real estate	Services	Other <sup>1</sup>	Total intermediate inputs	Personal consumption expenditures
	In-house transportation	HPTS							
Agriculture, forestry, and fisheries	0	0	61	894	6,714	6,861	315	197,601	27,054
Mining	0	0	54,440	30	6	32	2,688	183,026	107
Construction	680	0	30,084	7,246	52,996	19,287	19,484	159,618	0
Manufacturing	14,760	56,981	20,577	44,062	16,886	227,662	8,714	1,696,491	670,593
Railroads and related services; passenger ground transportation except transit	211	277	4,937	881	971	2,674	1,113	32,729	18,072
Motor freight transportation and warehousing	790	3,486	1,029	3,459	5,759	9,102	1,339	114,142	20,701
Water transportation	183	999	838	169	52	473	390	13,770	5,228
Air transportation	10	14	1,476	4,144	3,674	8,021	1,648	39,516	36,353
Pipelines, freight forwarders, and related services	112	585	523	311	67	1,212	11	23,129	2,889
In-house transportation	0	0	1,187	42,819	899	42,035	718	165,461	0
HPTS	0	0	0	0	0	0	0	0	709,962
Communications and utilities	4,503	0	55,863	33,509	28,152	53,421	8,506	283,773	221,574
Wholesale and retail trade	6,787	66,051	4,537	18,588	4,180	44,012	829	386,502	523,511
Finance, insurance, and real estate	1,323	28,598	13,890	71,101	229,746	153,929	4,560	612,743	931,480
Services	13,990	90,128	49,673	124,604	123,478	302,923	7,783	994,452	1,322,966
Other	582	2,282	7,823	11,064	16,653	19,311	2,593	100,651	1,147
Total intermediate inputs	43,931	249,401	246,938	362,881	490,234	890,954	60,690	.....	.....
Compensation of employees	84,160	290,611	84,298	425,306	285,305	935,987	730,160	.....	.....
Indirect business tax and nontax liability	3,870	0	31,844	173,188	182,984	48,332	-	.....	.....
Other value added	33,501	169,950	157,609	130,114	696,209	352,278	123,546	.....	.....
Total value added	121,531	460,561	273,750	728,608	1,164,498	1,336,596	853,706	.....	.....
<b>Total industry output</b>	<b>165,461</b>	<b>709,962</b>	<b>520,688</b>	<b>1,091,489</b>	<b>1,654,732</b>	<b>2,227,550</b>	<b>914,396</b>	.....	.....

Key: - = value too small to report.

<sup>1</sup> "Other" consists of government enterprise (except state and local government passenger transit) and other input-output special industries. See A.M. Lawson, "Benchmark Input-Output Accounts for the U.S. Economy, 1992: Make, Use, and Supplementary Tables," *Survey of Current Business* 77:58-62, November 1997.*continues*

**TABLE A3 The TSA Use Table of Commodities by Industries: 1992 (continued)**

Millions of dollars at producers' prices

Commodity	Gross private fixed investment	Change in business inventories	Exports of goods and services	Imports of goods and services	Government expenditures	GDP	Total commodity output
Agriculture, forestry, and fisheries	0	4,847	19,857	-14,601	833	37,990	235,591
Mining	73	-107	8,202	-43,527	-212	-35,464	147,562
Construction	360,278	0	77	0	159,357	519,712	679,330
Manufacturing	453,634	3,566	342,980	-485,599	208,772	1,193,946	2,890,437
Railroads and related services; passenger ground transportation except transit	2,112	135	3,973	-164	5,201	29,329	62,058
Motor freight transportation and warehousing	5,916	629	10,161	-2,059	7,620	42,968	157,110
Water transportation	40	36	9,695	3,530	2,048	20,577	34,347
Air transportation	1,576	137	23,317	-8,544	6,464	59,303	98,819
Pipelines, freight forwarders, and related services	0	8	2,700	0	240	5,837	28,966
In-house transportation	0	0	0	0	0	0	165,461
HPTS	0	0	0	0	0	709,962	709,962
Communications and utilities	5,065	11	4,476	-695	36,526	266,957	550,730
Wholesale and retail trade	102,856	2,658	44,746	18,317	16,558	708,646	1,095,148
Finance, insurance, and real estate	28,407	0	39,510	-1,412	28,688	1,026,673	1,639,416
Services	19,226	-37	19,530	-4,027	1,992	1,359,650	2,354,102
Other	-10,550	-6,453	73,385	-92,856	783,707	748,380	849,031
Total intermediate inputs	.....	.....	.....	.....	.....	.....	.....
Compensation of employees	.....	.....	.....	.....	.....	.....	.....
Indirect business tax and nontax liability	.....	.....	.....	.....	.....	.....	.....
Other value added	.....	.....	.....	.....	.....	.....	.....
Total value added	.....	.....	.....	.....	.....	6,694,466	.....
<b>Total industry output</b>	.....	.....	.....	.....	.....	.....	<b>11,698,070</b>



# A Nested Logit Model of Commuters' Activity Schedules

**SACHIN GANGRADE**

ZS Associates

**RAM M. PENDYALA**

University of South Florida

**ROBERT G. McCULLOUGH**

Florida Department of Transportation

## **ABSTRACT**

This paper presents a nested logit model of activity scheduling behavior that can be used to predict a daily activity pattern for commuters. The behavioral paradigm embodied in the model suggests a two-stage decision process in which commuters first plan or identify the nonwork activities that need to be undertaken during the day, and second, schedule these activities in relation to the work activity schedule. Three possible scheduling periods are considered in the model: before work, at work, and after work. Alternative nested logit model structures are estimated on the 1996 San Francisco Bay Area activity survey sample to identify a plausible and statistically acceptable structure. Numerical examples are presented to show how the model, when combined with a Monte Carlo simulation and simple heuristics, can be used to generate daily activity schedules for commuters.

## **INTRODUCTION**

The conceptual deficiencies of the conventional four-step trip-based travel demand modeling procedure, combined with the shift in transportation planning and policy initiatives from transportation infrastructure development to transportation

---

Ram M. Pendyala, University of South Florida, ENB 118, Department of Civil and Environmental Engineering, 4202 East Fowler Avenue, Tampa, FL 33620-5350. Email: pendyala@eng.usf.edu.

systems management, have led to the emergence of activity-based approaches to modeling individual travel behavior (Jones et al. 1983; Kitamura 1988; Axhausen and Gärling 1992). Activity-based analysis follows the premise that travel demand is a derived demand and the resulting travel demand models are applicable to a wider range of situations than the conventional four-step trip-based procedure (Ettema and Timmermans 1997). The activity-based perspective of travel can also reliably be used to evaluate travel demand management policies, because it explicitly models activity patterns and considers these patterns to be the fundamental influence on individual travel decisions (Golob 1998; Kuppam and Pendyala 2001).

The activity-based approach has seen substantial development in the past few years (Kitamura and Fujii 1998). Bhat and Koppelman (1999) broadly classified these developments into activity time allocation studies and activity episode analysis studies. Activity time allocation studies classify activities into one of the several categories available and then examine the time allocated to these activity types based on socioeconomic and demographic characteristics of individuals (Kitamura 1984). However, these approaches ignore the context in which individuals pursue activities; that is, these approaches do not consider the time of day of the activity performance, the sequence in which activities are performed in a continuous temporal domain, and the location characteristics of activity participation (Kitamura et al. 1997b).

Activity episode analysis is closer to the original theory behind activity-based approaches. This approach analyzes activities and trips and their associated spatial and temporal constraints in a comprehensive model framework. These studies describe in detail the sequence, context, and duration of activity participation, thus leading to more detailed models of activity choice and travel behavior. Many of the earlier activity episode analysis studies focused on participation of individuals in one or more activity episodes, along with one or more accompanying characteristics of the episodes such as duration, location, or time window of activity participation (Damm 1982; Hamed and Mannering 1993; Bhat 1996, 1998; Bhat et al. 1999).

Over the last decade, several researchers have developed models that attempt to microsimulate the daily activity participation and trip schedules of individuals (Chen et al. 1999). Examples include, but are not limited to, STARCHILD (Recker et al. 1986), SCHEDULER (Gärling et al. 1994), and AMOS (Kitamura et al. 1995; Pendyala et al. 1998). The development of such models has been further accelerated by the availability of data that capture household activity scheduling behavior (Doherty and Miller 2000). Development of tour-based model frameworks is another line of research in activity-based modeling, where “tours” are considered to be the basic unit of travel. These approaches use a combination of multinomial logit and nested logit models to simulate activity-travel patterns in the context of tours (Bowman and Ben-Akiva 1997; Wen and Koppelman 1999, 2000).

Activity-based approaches are the foundation of the next generation of travel demand models in the United States and other countries. The objective of this paper is to contribute to the operationalization of the activity-based approach by proposing a simple analysis framework to generate weekday activity engagement and trip scheduling patterns of commuters. Using data from the 1996 San Francisco Bay Area activity survey, nested logit models of activity scheduling behavior were developed and estimated. The proposed nested logit models, though not comprehensive or exhaustive, are practical, provide a plausible behavioral basis, and present activity scheduling and travel behavior of commuters in a simple model system. We believe that the nested logit models of activity scheduling behavior proposed in this paper can be effectively combined with other models of activity behavior (e.g., models of activity frequency and activity duration) and rule-based algorithms (e.g., Pendyala et al. 1998) to develop a full-fledged activity-based model system.

The remainder of this paper is organized as follows. First, we provide a brief description of the survey sample. We then describe the overall modeling approach and nested logit methodology, respectively. Descriptions of the nested logit model specification and estimation results follow. We then present an example of how the nested logit model can be used to predict a commuter’s activity pattern. Conclusions are drawn in the final section.

## SAMPLE DESCRIPTION

This research paper utilizes activity and trip information collected as part of the 1996 San Francisco Bay Area activity survey. Gangrade et al. (2000) provide a detailed description of the survey and sample characteristics. Only a brief summary is provided here. A two-day activity-based time-use and travel survey was conducted in the nine counties of the San Francisco Bay Area in 1996. Detailed information on both in-home and out-of-home activities and trips undertaken by an individual were recorded.<sup>1</sup> Information was requested for all out-of-home activities and trips but only in-home activities of 30 minutes or more. However, many respondents provided detailed information on all in-home activities regardless of their duration.

The original survey dataset includes a sample of 8,817 individuals residing in 3,919 households who provided detailed activity and trip information over a 48-hour period. After extensive data checking, cleaning, and merging/organizing, the final dataset obtained for use in this study included 7,982 individuals residing in 3,827 households. The dataset identified 4,331 persons as commuters (3,651 persons were noncommuters).

### Sample Profile

Table 1 presents the demographic characteristics of households in the sample. The average household size was 2.3 persons per household, while the average number of workers was 1.4 per household. Forty percent of the households were single-worker households, while another 43% were multiple-worker households.

The income variable, which categorized households into low (less than \$30,000), medium (\$30,000–\$75,000), and high (greater than \$75,000) income groups, showed as expected that a large percentage of the households in the survey fell into the medium income bracket. Average car ownership in the sample was 1.9 vehicles per household, and 86% of the households in the survey sample have vehicle ownership levels greater than or equal to the total

<sup>1</sup> The survey also collected data on Bay Bridge usage in connection with a peak-period toll study; however, variables in the dataset related to this aspect of the study are not used in this paper.

**TABLE 1 Household and Person Demographic Characteristics**

<b>Household attributes</b>		
Sample size	3,827	
Household size	2.3	
1 person	32.2%	
2 persons	34.5%	
3+ persons	33.3%	
Income		
Low (<30k)	19.6%	
Medium (30k–75k)	43.3%	
High (>75k)	22.5%	
Vehicle ownership	1.9	
0 car household	5.6%	
1 car household	34.4%	
2 cars household	39.4%	
3+ cars household	20.5%	
% vehicles ≥ commuters	86.4%	
Number of workers	1.4	
0 worker	16.5%	
1 worker	40.4%	
2 workers	37.0%	
3+ workers	6.0%	
Number of bicycles	1.3	
Owning home of residence	63.0%	
Years at current residence	4.7	
<b>Person attributes</b>		
	<b>Commuter</b>	<b>Noncommuter</b>
Sample size	4,331	3,651
Gender		
Male	54.4%	42.8%
Female	45.5%	56.9%
Age (in years)	41.5	32.4
Young (≤29)	18.8%	54.0%
Middle (30–49)	53.8%	14.5%
Old (≥50)	27.4%	31.5%
Employment status		
Full time	81.5%	N/A
Part time	12.1%	N/A
Licensed	95.3%	48.6%
Student	13.3%	44.8%

Note: Some percentages do not add to 100 due to missing data.

number of commuters in the household. This is indicative of a high level of commuter auto availability.

Person characteristics (provided separately for commuters and noncommuters) of the sample are also shown in table 1. Respondents were categorized into young (29 years or less), middle (30–49 years), and old (50 years or more) age groups. More than 50% of the commuter sample fell into the middle age bracket, while over 50% of the noncommuter samples fell into the young age group (the noncommuter

group includes children). More than 80% of the commuters were full-time workers. Also, as expected, the percentage of licensed drivers in the commuter sample was substantially higher than that in the noncommuter sample (95% vs. 49%).

Clearly, the noncommuter sample is quite different from the commuter sample. In light of these differences, one would expect noncommuters to have substantially different activity and time-use patterns than commuters. These differences call for the development of separate models of activity scheduling behavior for commuters and noncommuters. In this paper, out-of-home nonwork activity engagement and trip scheduling behavior is modeled only for the commuter sample, and thus the remainder of this paper focuses exclusively on the commuter sample.

### Activity Participation and Trip Frequency Analysis

The original dataset had more than 30 categories of activities broadly aggregated into 11 activity types in order to study activity and trip frequencies by purpose. Average frequencies (including both in-home and out-of-home activities) for the commuter sample are presented in table 2. As mentioned earlier, the Bay Area travel survey was conducted over a 48-hour

time period. The activity and trip frequencies presented in the table are two-day averages.

The average number of work and work-related activities was 1.6 activity episodes per day for the Bay Area commuter. This value is along expected lines, because many commuters undertake two work activity episodes in a day—one before lunch and one immediately after lunch.

As expected, eating/meal preparation (eat/meal), in-home entertainment, personal care and childcare, and sleep/nap activities averaged one or more activity episodes per day. On the other hand, shopping and personal business, out-of-home entertainment, and out-of-home other activities averaged less than one activity episode per day.

With respect to travel, commuters, on average, took 4.8 trips per day. Table 2 shows trip rates by purpose for both commuter and noncommuter samples in the dataset. Work/work-related and return home trips comprise almost 50% of the trips taken by commuters over a day. The average trip frequency for out-of-home shopping/personal business, entertainment, and maintenance/other related activities was found to be about 0.5 trips per day for each purpose. The average trip frequency associated with childcare was rather low at 0.1 trips per day.

**TABLE 2 Daily Activity and Trip Frequencies**

Activity	Commuters (N = 4,331)	Noncommuters (N = 3,651)
Work/work-related	1.6	NA
Eating/meal preparation	1.7	2.0
Shopping/personal business	0.6	0.7
Out-of-home entertainment	0.5	0.6
In-home entertainment	1.2	1.8
Personal care and childcare	1.2	1.2
Sleep/nap	1.0	1.1
In-home maintenance/other	0.7	1.1
Out-of-home other	0.4	0.4
School	0.1	0.7
Travel (total trips)	4.8	3.5
Work/work-related	1.3	NA
Return home	1.6	1.3
Meal (out-of-home)	0.4	0.2
Shopping/personal business	0.5	0.6
Out-of-home entertainment	0.5	0.5
Childcare	0.1	0.1
Out-of-home other	0.4	0.4
School	0.1	0.4
Total activities and trips	13.9	13.1

Note: Averages for a 48-hour period.

Overall, work activity was shown to be a major part of a commuter's daily activity and travel pattern. In the case of commuters, one may conjecture that other discretionary activities (e.g., shopping, personal business, recreation, and childcare) are scheduled and performed around relatively fixed work schedules. This hypothesis, which is consistent with the literature on activity-based approaches (see, e.g., Damm 1982) forms the basis for the nested logit model of activity scheduling developed in this paper.

## FRAMEWORK FOR ACTIVITY SCHEDULING BEHAVIOR

In this paper, nested logit models are formulated with a view to predict activity and trip schedules of commuters over a one-day period. This section provides the behavioral framework underlying the specification of the nested logit models of commuter activity scheduling behavior.

There is increasing interest in applying microsimulation approaches to forecast activity-based travel demand (Kitamura et al. 1997a; Pendyala et al. 1998). In microsimulation approaches, the researcher is often attempting to simulate, at the level of the individual traveler, an entire activity schedule and travel itinerary over the course of a day. This involves modeling a series of choices that travelers make, including those related to activity type, duration, timing and scheduling, location and destination, and path. Considering that many of these choices are made under constrained situations, the argument can be made that there are finite spatio-temporal action spaces or space-time prisms within which one can engage in activities and travel (Pendyala et al. 2002).

Space-time prisms provide a means of representing the spatial and temporal constraints that influence activity and travel patterns. For example, from a spatial standpoint, one can conjecture that home and work locations are potential anchors that constrain the potential range of destinations a person can visit. Because of data limitations, this paper does not consider the spatial aspect of commuter activity scheduling behavior.

From a temporal standpoint, several events in time may constrain the range of activity-travel patterns that an individual can pursue. These events and their

associated beginning and ending times can play an important role in determining how individuals schedule, sequence, and plan their activities and trips. Six temporal events that might dictate how a commuter schedules and plans activities are identified here.

1. Wake-up time
2. First time of departure from home
3. Work start time
4. Work end time
5. Final time of arrival at home
6. Sleep time

Gangrade et al. (2000) have provided detailed descriptions of these temporal events for the commuter and noncommuter groups in the survey sample. These six events potentially define five temporal prisms<sup>2</sup> within which commuters schedule their activities. For example, wake-up time and first time of departure from home define an "initial at-home prism." Similarly, work start time and end time define an "at-work prism." In reality, these events may not truly describe the temporal dimension of a prism. The real vertices (or extremities) of a prism are unobserved (e.g., earliest wake-up time, latest possible work arrival time, earliest possible work departure time, latest possible sleep time), and therefore the observed events are used as surrogates to represent the temporal dimensions of prisms.

A commuter can engage in out-of-home activities within prisms that lie between the first time of departure from home and the final time of arrival at home. Only in-home activities can be pursued prior to the first home departure and following the last home arrival. The period between the first home departure and the final home arrival may be further subdivided into:

- *Before-work time period:* This time period comprises time available between the first departure from home and work start time. During this period, a commuter may pursue activities on the way to work and/or pursue activities and return home prior to departing for work.
- *During-work time period:* This time period is defined by the work start time and end time. On average, work accounts for approximately 30% of

<sup>2</sup> The term *prisms*, in the context of activity-based travel behavior, has been widely used to represent the limited time and spatial accessibility travelers typically have.

a commuter's day and 50% of the waking hours. As such, this prism is likely to be an important determinant of a commuter's daily activity pattern. Commuters are often temporally constrained by their work schedules. Nonwork activity engagement typically occurs during the lunch break (about one hour for most commuters).

- *After-work time period:* The time period available to a commuter after work ends and prior to the final time of arrival at home constitutes the after-work time period. During this time period, a commuter may undertake nonwork activities such as shopping, running errands, recreation, etc., either on the way home from work or separately after a temporary stop at home. The latter choice of activity engagement would generate another set of trips before the commuter finally returns home.

Within the framework adopted in this paper, we postulate that commuters choose to engage in out-of-home nonwork activities within one or more of these broad prisms. For example, a commuter may choose to shop before work, during work, or after work, including the possibility of multiple shopping activities in the same or different time prisms. By scheduling out-of-home nonwork activities in various prisms (periods of the day), a commuter's activity schedule can be identified.

For purposes of model development and estimation, we aggregated the various out-of-home nonwork activities undertaken by commuters in the 1996 Bay Area survey sample broadly into eat/meal preparation, shopping/personal business, and entertainment/social recreation. In addition, in an attempt to capture temporary trips home that occur between the first home departure and last home arrival, an additional activity category called "return home" is included in the model formulation. It should be noted, however, that return home really represents in-home activity engagement by commuters in the survey sample. Previous research has clearly shown that there are significant tradeoffs and complementarity between in-home and out-of-home activity engagement (Kitamura 1984; Kupam and Pendyala 2001). Within the model framework of this paper, relationships between in-home and out-of-home activities and the identification of

specific activities pursued during trips home are not explicitly included. Future efforts will involve the integration of such models with the model developed in this paper. However, the inclusion of return trips home as an explicit category in the model framework helps determine the activity sequencing and trip chaining behavior of commuters (e.g., does a commuter shop on the way home from work or after returning home from work?).

In summary, the behavioral framework adopted in this paper takes the form of a two-stage process. In the first stage, commuters choose among activities to be pursued (outside home and work) and in the second stage, they choose when the activity will occur. Such a two-step process may be conveniently represented using nested logit model structures. For example, in one postulated structure, the various out-of-home nonwork activities pursued by individuals, namely eat/meal preparation, shopping/personal business, entertainment/social recreation, and return home comprise the upper level (composite) alternatives. The three time periods available to pursue these activities form the lower level (elemental) alternatives available to an individual. Figure 1 provides a visual depiction of this postulated behavioral structure.

It should be noted that the two-stage behavioral paradigm suggested in this paper is not necessarily the only factor motivating the adoption of a nested logit modeling methodology. A nested logit model is usually adopted when there is a potential for shared unobservable attributes across alternatives, if these attributes were to be arranged in a simple multinomial structure. The potential for shared unobserved attributes across alternatives, coupled with the two-stage behavioral paradigm, motivated us to adopt the nested logit methodology in this paper.

Because the behavioral framework adopted in this paper does not include in-home vs. out-of-home activity substitution, and instead uses an aggregate activity-type categorization, it is not comprehensive in its treatment of commuter activity and travel behavior and thus simplifies the behavioral process underlying activity and travel pattern formation. Nevertheless, it provides a practical and convenient way to extract activity schedules and sequences and trip chains of commuters given standard socioeconomic variables.

**FIGURE 1 Activity Schedule Structure 1**

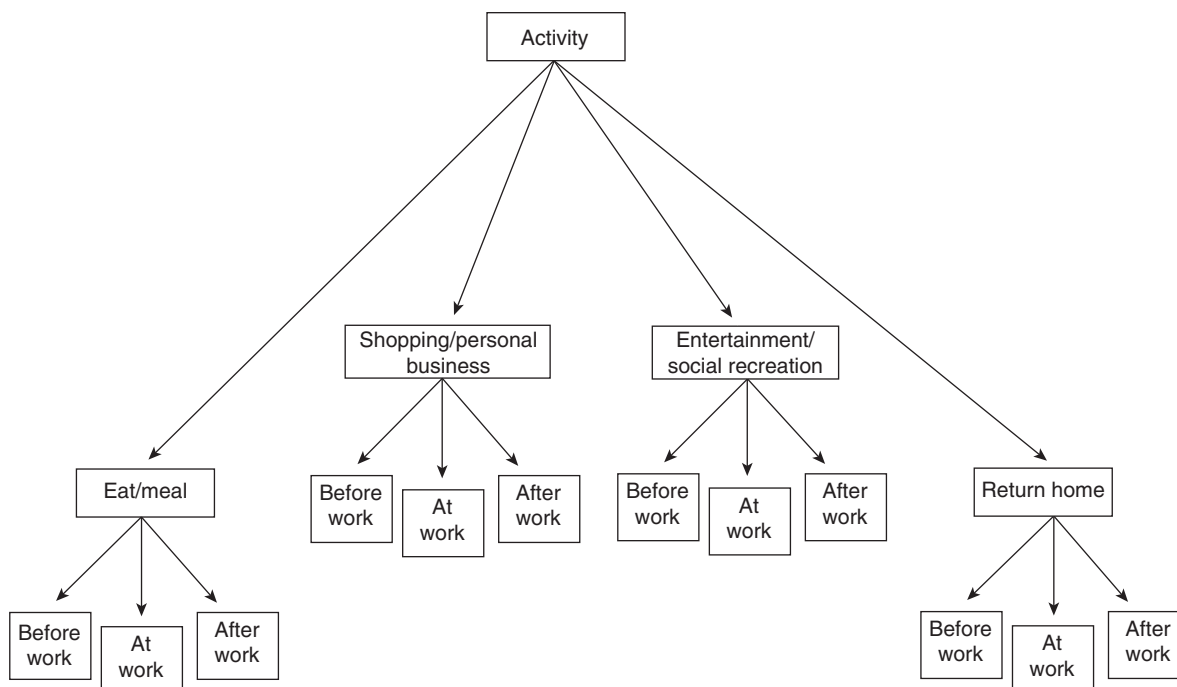

**NESTED LOGIT MODELING METHODOLOGY**

The nested logit model is a widely used form of the discrete choice model and has been extensively presented and described in the literature (see e.g., Ben-Akiva and Lerman 1985; Lerman 1984; Train 1986; Ortuzar and Willumsen 1994). There are at least two ways to express the nested logit structure, namely, the Non-Normalized Nested Logit model (NNNL, described by Daly 1987) and the Utility Maximizing Nested Logit model (UMNL, described by McFadden 1978). A detailed discussion of both model structures is beyond the scope of this paper; however, the merits and demerits of the two model structures have recently been discussed in the literature (Koppelman and Wen 1998; Hensher and Greene 2000).

Despite the potentially more appealing nature of the UMNL model, the NNNL model specification is used in this research primarily because of the availability of convenient software to estimate it (e.g., LIMDEP). Also, from a behavioral interpretation standpoint, it was considered sufficient to adopt the NNNL modeling methodology.

The lower level choice in a nested logit model is a multinomial logit choice and can be expressed as

$$P(k|i) = \frac{e^{V_{ik}}}{\sum_{l \in D_i} e^{V_{il}}} = \frac{e^{\beta'_{il}x_{il}}}{\sum_{l \in D_i} e^{\beta'_{il}x_{il}}}$$

where

- $P(k|i)$  is the probability of alternative  $k$  from subset  $D_i$  to be chosen on the condition that alternative  $i$  on the upper level has been chosen,
- $D_i$  is the lower level choice set, which is associated with alternative  $i$  on the upper level,
- $V_{ik}$  is the deterministic portion of the utility associated with choice  $k$  in nest  $i$ ,
- $\beta$  is a vector of model parameters,
- $x$  is a vector of exogenous variables.

An inclusive value  $I_i$  (or logsum) associated with the upper level alternative  $i$  is defined as

$$I_i = \ln \sum_{l \in D_i} e^{\beta'_{il}x_{il}}$$

The upper level choice probability is then expressed as

$$P(i) = \frac{e^{\delta'_i z_i + \tau_i I_i}}{\sum_{j \in C} e^{\delta'_j z_j + \tau_j I_j}}$$

where

$P(i)$  is the probability of choosing alternative  $i$ ,

$\delta$  is a vector of model parameters,

$z$  is a vector of exogenous variables.

The parameter  $\tau$  is referred to as the inclusive value parameter. The value of this parameter should lie between zero and one. When the parameter equals unity, the structure collapses to a multinomial logit model without a nested structure. The levels are separated and present independent and separate choice situations if the value of the parameter is equal to zero. If  $\tau < 0$ , an increase in the utility of an alternative in the nest (which should increase the probability of the nest being chosen), actually diminishes the probability of selecting the nest. In virtually all choice modeling situations, this is implausible. If  $\tau > 1$ , an increase in the utility of an alternative in the nest not only increases its selection probability but also the selection probability of the rest of the alternatives in the nest. That is, improvements in one alternative could increase not only the probability of that alternative being chosen, but some other alternatives would also gain a bigger share (Ortuzar and Willumsen 1994). While this may be plausible under certain limited conditions, it is generally not applicable to a wide variety of choice modeling situations. Therefore, the nesting structure that provides inclusive value parameter estimates between zero and one is generally adopted as long as the structure offers a plausible behavioral framework and interpretation.

## NESTED LOGIT MODEL ESTIMATION RESULTS

Several possible alternative nesting structures may describe the activity scheduling behavior of commuters. This section discusses the alternative nested logit model structures that were tested and presents model estimation results for the structure that provided desirable statistical and plausible behavioral indications.

Figure 1 illustrates the nested logit model structure that is most consistent with the behavioral framework postulated earlier in the paper. This structure suggests that a commuter, in formulating an activity schedule, first chooses the out-of-home nonwork activities to be pursued in a day. The choice of the appropriate time period in which to undertake each of the chosen activities comprises the second step in the choice process.

Nested logit model estimation results for this structure are found to offer plausible coefficient estimates, except for those associated with the inclusive value parameters. Because the model did not offer acceptable inclusive value parameter coefficients, it was not adopted, and therefore detailed model estimation results and parameter estimates are not included in the paper. The inclusive value parameter estimate for the nest comprising eat/meal alternatives was 1.45, while that for the nest comprising shopping/personal business alternatives was 1.09 (significantly different from one). These two inclusive value parameter estimates suggest that when the probability of a commuter pursuing either an eat/meal activity or a shopping/personal business activity in one of the three time periods increases, then the probability that the commuter undertakes the same activity in a different time period (on the same day) also increases simultaneously. While this result may hold true for a few commuters, it is not likely to hold true across the sample. The inclusive value parameter estimate for the nest comprising entertainment/social recreation activities was 0.51. This value indicates that a potential tradeoff is involved when pursuing entertainment/social recreation activities during different time periods in a day. This inclusive value is certainly behaviorally intuitive as one would expect commuters to trade off the pursuit of entertainment activities across different time periods.

Because the nested structure shown in figure 1 provided counter-intuitive inclusive value coefficient estimates for two nests, an alternative structure was developed (shown in figure 2). This framework proposes a bottom-up decisionmaking process where a commuter first breaks up the day into various periods (prisms) and then chooses the activity (or activities) to be undertaken in each period. In figure 2, the before-work, at-work, and after-work time periods comprise the three composite alternatives



**FIGURE 2 Activity Schedule Structure 2**

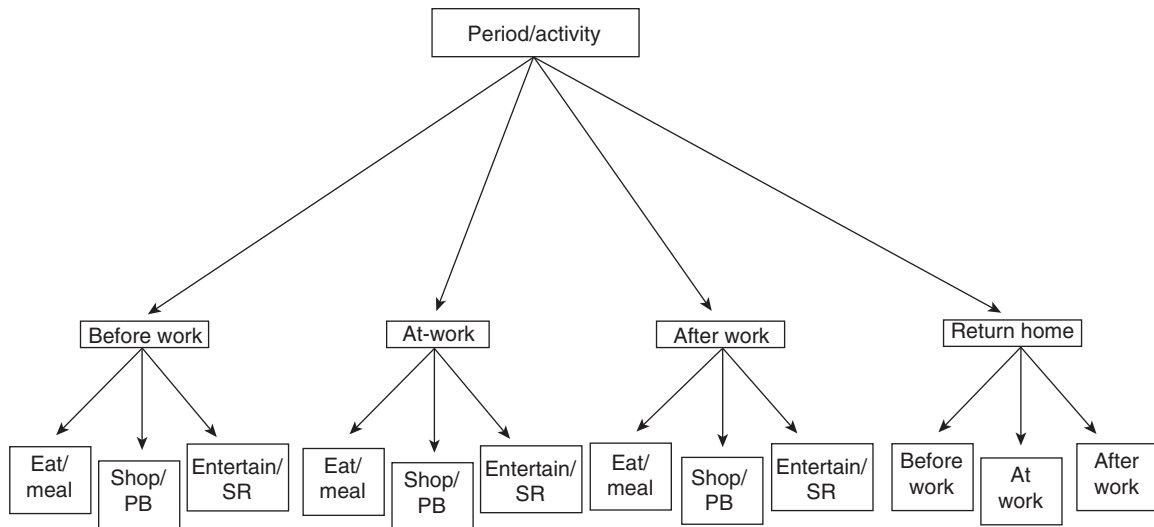

placed at the upper level in the nest structure. The various out-of-home nonwork activities undertaken by individuals (eat/meal, shopping/personal business, and entertainment/social recreation) comprise the elemental alternatives in each nest. However, return home is still retained as an upper level choice as this alternative pertains to the choice to return home temporarily during the day. Because it was considered appropriate to distinguish between out-of-home activity scheduling (in the other three nests) and trip scheduling (for in-home activities), return home was retained in a manner similar to that in the first nesting structure in figure 1.

This model offered plausible coefficient estimates and acceptable goodness-of-fit measures. However, similar to the first structure, the inclusive value coefficient estimates for two nests significantly exceeded one. For the nest comprising activities undertaken before work, the inclusive value coefficient estimate was 1.40, while that for the nest comprising activities pursued after work was 1.29. These inclusive values imply that commuters who are likely to engage in a nonwork activity before work or after work are also likely to simultaneously engage in other activity types during the time period under consideration.

One could posit that these model results are plausible, particularly in the context of the after-work period. During the after-work periods (typically in the evenings), quite a few commuters engage in multiple activities, suggesting that elemental choice

alternatives in the after-work nest are not competing but complementary in nature. However, in the presence of household, work, and other institutional and temporal constraints, it is unlikely that this will apply across the entire sample. Also, with respect to the before-work period (typically in the morning), it is very unlikely that commuters treat activities as complementary to one another (with possibly a few exceptions). If this is the case, then, the inclusive value parameter estimate for the before-work nest should be less than one, even if that for the after-work period is acceptable.

In addition, the inclusive value coefficient estimate for the nest comprising activities undertaken while at work was 1.03. This was not significantly different from one at the 95% confidence level, suggesting that activities undertaken while at work are independent of one another (no tradeoffs) and do not belong in a nesting structure. Similarly, the inclusive value for the nest comprising return home trips was also one, suggesting that various return-home trips undertaken by commuters over a day are independent of one another. Again, neither of these findings is consistent with behavioral expectations. Even if the finding that activities undertaken while at work are independent of one another is potentially acceptable, the finding that return-home trips are independent across time periods is behaviorally inconsistent. For a commuter, work and other temporal constraints would undoubtedly result in interdependence (and therefore tradeoffs) among various

time periods for undertaking return-home trips. This would call for the nest comprising return-home trips to have an inclusive value coefficient estimate of less than one. The behaviorally inconsistent inclusive value coefficient estimates prompted us to reject this structure and search for a structure that was both behaviorally plausible as well as statistically acceptable.

After an extensive exploratory analysis of commuter activity engagement patterns in the dataset, we found that the most prevalent activity participation behavior included an eat/meal activity pursued while at-work, shopping/personal business pursued (in the evening) after work, and entertainment/social recreation pursued after work. Other types of activity participation behavior before work or while at work occur less frequently in the sample possibly because constraints do not allow the scheduling of activities during those periods for most commuters or simply because those activity patterns are less preferred.

This activity scheduling behavior of commuters may be captured by placing the more prevalent alternatives as separate and independent choices. All of the less-prevalent activity scheduling alternatives may be combined into a single nest to represent their rare nature and the fact that, if a commuter does participate in one of these alternatives, the likelihood of that person participating in another less prevalent alternative (in the same nest) is virtually none. Eat/meal activities while at work,

shopping/personal business activities (in the evening) after work, and entertainment/social recreation activities (in the evening) after work are the more prevalent alternatives. They are all treated as separate and independent choice alternatives. Once again, as in the previous case, return-home trips are placed in a separate nest to distinguish between activities and trips. Figure 3 shows the nesting structure for representing the activity scheduling behavior of commuters.

Variables used in this nested logit model are defined in table 3. They include a series of socioeconomic variables describing the individual and the household. There are two inclusive value parameters for this nesting structure, one associated with the “less frequent” nest and the other associated with the “return home” nest. Model estimation results for the proposed structure are presented in table 4. This model offered plausible and behaviorally sound coefficient estimates for the inclusive value parameters. In addition to this, it offered the same level of goodness-of-fit as the prior two structures we considered and provided coefficient estimates on all other explanatory variables according to expectations. Although several coefficients had low *t*-statistics from a statistical standpoint, they were retained in the model as they offered behaviorally plausible interpretation and sensitivity. This model structure was finally chosen to represent activity scheduling behavior of commuters in the San Francisco survey sample.

**FIGURE 3 Trip Activity Schedule Structure 3**

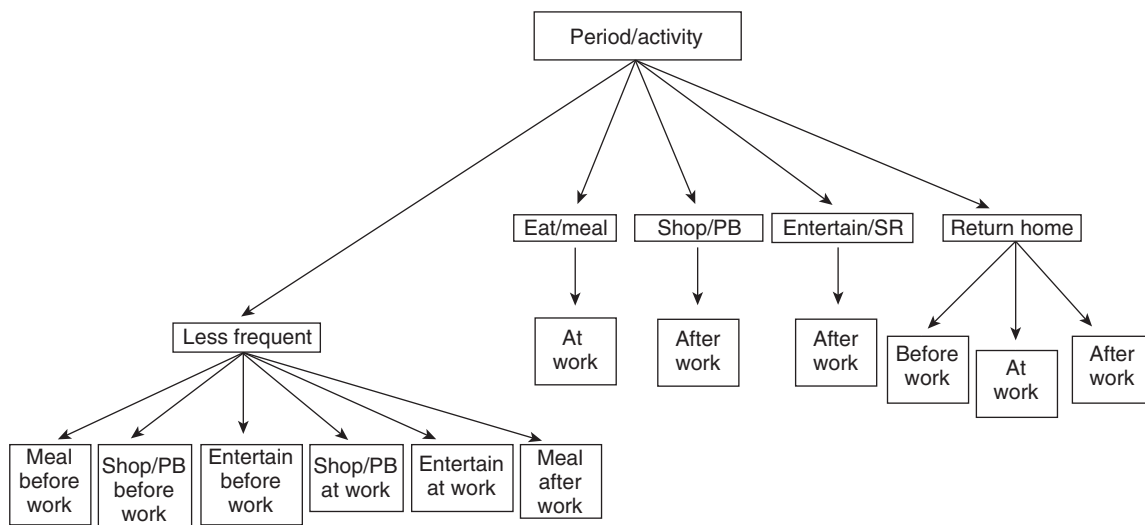

**TABLE 3 Definition of Explanatory Variables**

Variable	Definition	Descriptive statistic (N = 4,188)
Male	1 if male; 0 otherwise	54.3%
Young	18 ≤ age ≤ 29	18.8%
Middle	30 ≤ age ≤ 55	54.4%
License	1 if licensed; 0 otherwise	94.4%
Jbfull	1 if employed full time; 0 otherwise	82.6%
Student	1 if student; 0 otherwise	13.4%
Single	1 if single; 0 otherwise	20.1%
SinPar	1 if single parent; 0 otherwise	4.3%
Couple	1 if couple with no children; 0 otherwise	27.8%
Cwkid	1 if couple with children; 0 otherwise	28.1%
Linc	\$5,000 ≤ income ≤ \$29,999	19.6%
Minc	\$30,000 ≤ income ≤ \$74,999	43.3%
Hinc	Income ≥ \$75,000	22.5%
Drvwk	1 if drive to work; 0 otherwise	67.4%
White	1 if white; 0 otherwise	69.2%
CGC	1 if no. cars ≥ no. commuters in hhld	86.4%
Const	Constant	
IV	Inclusive value parameter for nest	
Eat/meal	Eat/meal activity	
Shp/PB	Shopping/personal business/serve child activity	
Ent	Entertainment/social recreation	
Return home	Return home trip	
Before work	Activity undertaken before work start	
At work	Activity undertaken during work	
After work	Activity undertaken after work end	

Note: The descriptive statistics presented here are derived from a sample of 4,188 commuters who provided complete information on all variables included in the nested logit model. Therefore, the values presented here may differ from those in table 1, where person characteristics were derived from the full sample of 4,331 commuters who responded to the survey.

The inclusive value coefficient estimate of the nest comprising the less frequent activities was 0.80, while that for the nest comprised of return home trips was 0.72. Both of these inclusive value parameter estimates were statistically significant at the 99% confidence level and significantly less than one. The inclusive value parameter estimate of 0.80 for the nest comprising rare and less frequent activities indicates that the activities in this nest share unobservable attributes and considerable tradeoffs are involved when pursuing these activities. The inclusive value parameter estimate of 0.72 for the nest comprising return home trips indicates that these trips, typically undertaken over a day, share unobserved attributes. If a commuter returns home temporarily during a certain time period during the day, then the same commuter would show less pref-

erence to again return home temporarily at some other time period in the day. This inclusive value is consistent with behavioral expectations that commuters are temporally constrained and are rarely inclined to make multiple return trips home during the day.

With respect to socioeconomic variables, the model offers very consistent coefficient estimates. In general, males in the sample were more likely to engage in the eat/meal activity while at work. On the other hand, females were more likely to engage in shopping/personal business activities after work. However, more males pursued entertainment and other social recreation activities after work compared with their female counterparts. These findings are consistent with traditional gender-based differences in household roles and obligations. Strangely, males also exhibited a greater tendency to return home while at work, which clearly shows the importance of integrating models of in-home activity engagement with models of out-of-home activity engagement. Furthermore, the reasons for males' return-home trips while at work merits further investigation.

Younger commuters in the sample were more likely to eat while at work and undertake entertainment/recreation activities after work. It appears that they were more likely to undertake their after work activities after a temporary trip home as indicated by the positive coefficient associated with the return home after work alternative. Licensed individuals, who presumably have access to an automobile, were more likely to pursue shopping/personal business activities during the day and more likely to return home in the middle of the workday. As expected, commuters employed full time were less inclined to return home during the day, but were more inclined to engage in an eat/meal activity while at work. Students were more likely to participate in activities in the period prior to work (they are more often part-time workers who have the flexibility to undertake before-work activities).

Single people showed a greater propensity to engage in entertainment/social recreation activities in the after-work period than other household types. Single parents were more likely to return home during the day, presumably because of childcare or other household obligations. Commuters in households with children showed a negative propensity to engage

TABLE 4 Estimation Results for Activity Schedule Structure 3

Episode	Const	Male	Young	Middle	License	JbFull	Student	Single	SinPar	Couple	Cwkid	Hinc	CGC	Wht	Drvwk	IV
<b>LESS FREQ</b>																
Meal before work	-1.58 (-12.7)						2.0 (7.5)		-1.82 (-1.8)							0.80 (8.8)
Shp/PB before work		0.14 (1.4)				-0.45 (-4.4)	0.4 (1.4)		0.68 (3.3)						-0.18 (-1.9)	
Ent before work	-1.49 (-12.3)						1.4 (4.4)									
Shp/PB at work	-1.30 (-3.0)		-0.59 (-3.1)	-0.25 (-2.4)	1.18 (2.8)		-1.0 (-1.6)			0.26 (2.3)	-0.27 (-2.1)					
Ent at work					-1.41 (-10.8)						-0.52 (-2.8)					
Meal after work	-0.43 (-3.8)						1.1 (4.0)				-0.67 (-5.1)					
<b>MEAL</b>																
At work		0.12 (2.0)	0.48 (5.4)			0.71 (9.8)		-0.16 (-2.3)				-0.14 (-2.4)				1.00
<b>SHP/PB</b>																
After work		-0.36 (-5.1)	-0.03 (-0.3)		0.06 (0.5)								0.08 (0.8)	0.13 (1.75)	0.26 (3.5)	1.00
<b>ENT</b>																
After work		0.16 (1.9)	0.78 (5.7)	0.26 (2.5)			0.5 (2.6)	0.19 (1.9)			-0.24 (-2.4)	0.10 (1.1)	0.11 (1.0)	0.12 (1.3)		1.00
<b>RETURN HOME</b>																
Before work						-0.93 (-11.8)	1.64 (7.9)		0.57 (2.4)							
At work	-0.72 (-2.5)	0.22 (2.5)	-0.26 (-1.6)		0.68 (2.4)	-0.09 (-0.8)					-0.23 (-2.4)				0.40 (3.9)	
After work			0.30 (2.2)													
<b>L(0): -17,805.3</b>																
<b>L(β): -16,663.7</b>																
<b>χ<sup>2</sup> (df): 2,283.1 (56)</b>																
<b>ρ<sup>2</sup> [1-L(β)/L(0)]: 0.06</b>																
<b>N: 4,188</b>																

Notes: Values in parentheses are t-statistics. See table 3 for definition of explanatory variables.

**TABLE 5 Characteristics of Six Hypothetical Individuals**

Person number	Male	Female	Young	Middle age	Low income	High income	Single	Single parent	Couple, no child	Activity frequency <sup>1</sup>
1	1		1		1		1			2
2	1		1			1	1			5
3		1	1		1			1		3
4		1	1			1		1		6
5	1			1	1				1	3
6	1			1		1			1	6

<sup>1</sup> Activity frequency refers to the number of out-of-home nonwork activities undertaken by an individual in a day including return trips home. These frequencies were obtained from a Poisson regression model of activity frequency not presented in this paper.

in recreation and other out-of-home nonwork activities during the day. This is presumably because they devote much time in-home to childcare activities and other household obligations. As expected, high income commuters and commuters in households with high car availability were more prone to participate in entertainment activities in the after-work period (while these coefficients were not statistically significant at the 95% confidence level, they were retained because of their behaviorally intuitive interpretation). Those who drive to work appeared to have the flexibility and therefore positive propensity to return home during the day (while at work) and undertake shopping/personal business activities after work (possibly on the way home from work).

In summary, the final adopted model structure provides model parameter estimates consistent with behavioral and empirical expectations. Most of the model coefficients are statistically significant at the 95% confidence interval. The inclusive value parameter estimates are also behaviorally plausible. Therefore, we may conjecture that this nesting structure provides a reasonable representation of activity scheduling for commuters. However, we draw this conclusion with caution, because this nested logit structure generated consistent inclusive value parameter estimates in the context of the 1996 San Francisco Bay Area survey sample. Alternate nesting structures estimated on several different sample datasets should be examined and tested before drawing conclusions about the behavioral paradigm underlying commuter activity scheduling behavior.

**NESTED LOGIT MODEL APPLICATION**

The previous section described a nested logit model structure intended to represent commuters’ activity scheduling behavior. In this section, a sample numer-

ical simulation is provided to show how the model can be used to predict activity scheduling patterns of commuters.

For the purpose of this exercise, six hypothetical individuals are considered. Their characteristics in relation to the socioeconomic variables included in the nested logit model are shown in table 5. In general, the six hypothetical individuals cover a range of socioeconomic characteristics thus providing a means of examining whether the model is truly sensitive to differences among individuals. Prior to the application of the nested logit model of activity scheduling behavior, the total number of out-of-home nonwork activities (including temporary return trips home) pursued by each commuter was predicted using Poisson- and negative-binomial regression-based activity frequency models similar to those developed by Ma and Goulias (1999). These activity frequency models provided a basis for determining the number of activities that need to be drawn and included in the commuters’ activity schedules. The predicted activity frequency for each individual is shown in the last column of table 5.

The nested logit model includes a total of 12 different alternatives as shown in the first column of table 6. In this table, predicted probabilities associated with each alternative are shown for person number 4 from table 5. This person is a young, high-income female single parent. The predicted probabilities for the 12 alternatives are shown in the second column of table 6. In order to determine the activities that need to be included in this person’s schedule, a simple Monte Carlo simulation method was adopted. Using a random number generation process, random numbers between 0 and 1 were repeatedly drawn to determine the choices according to the predicted probability distribution of the

**TABLE 6 Predicted Activity Episode Probabilities and Simulation Draws for Person Number 4**

Activity	Predicted probability	Activity draws
Meal—before work	0.01	
Meal—at work	0.11	X
Meal—after work	0.09	X
Shop/PB—before work	0.14	X
Shop/PB—at work	0.01	
Shop/PB—after work	0.08	X
Entertain—before work	0.04	
Entertain—at work	0.01	
Entertain—after work	0.12	X
Return home—before work	0.32	X
Return home—at work	0.03	
Return home—after work	0.05	

alternatives for each individual. The number of draws is equal to the predicted activity frequency as provided by the Poisson- or negative-binomial regression-based activity frequency model.

For this individual, the activities that were drawn in the simulation included return home before work, shop/personal business before work, entertainment after work, eat/meal at work, eat/meal after work, and shop/personal business after work. In order to develop the pattern, we started at the beginning of the day and assumed that the person is at home (initial location). According to the model, this person undertakes shop/personal business before work. During the aggregation of activity types, serve-child activities were combined with shopping and personal business activities. Because this person is a single parent, we conjectured that this must be a serve-child activity. Also, the person returns home before work. Then, it appears that this person drops off a child and then returns home prior to work. So far, the pattern is as follows: home → child drop → (return) home.

Next the individual goes to work. While at work, the individual undertakes an eat/meal activity. No other activities are undertaken while at work. The individual presumably returns to work after the eat/meal activity. The pattern thus far has become: home → child drop → return home → work → eat/meal → work.

There are a total of three activities undertaken in the after-work period. They are shopping/personal business (presumably serve or pickup child), enter-

tainment, and eat/meal. There is no temporary return home trip in the after-work period. Thus, it appears that this individual undertakes all of these activities after work prior to returning home. The question then becomes: how are these three activities sequenced? Many factors influence the sequencing of activities and one would need richer preference data and possibly rule-based heuristics to determine activity sequencing (Pendyala et al. 1998). At this point in the model development, we adopted a simplified heuristic rule to determine the activity sequence. Using the values of predicted probabilities in table 6 as an ordering mechanism, the individual would first proceed to an entertainment activity, then turn to an eat/meal activity, and finally pick up the child (shop/personal business after work) prior to returning home. The final pattern then becomes: home → child drop → return home → work → eat/meal → work → entertainment → eat/meal → child pickup → home.

Figure 4 shows the activity scheduling patterns generated for the six hypothetical individuals considered in table 5. The model offers very plausible and reasonable activity schedules. For example, person number 2 is a high-income single male. Consistent with expectations, this person undertakes several after-work activities including eating out, shopping/personal business, and entertainment/recreation. On the other hand, person number 1, who is a low-income single male, undertakes fewer activities and does not engage in out-of-home entertainment. Person number 3 is very similar to person number 4, except she is a low-income individual. The difference between their activity patterns reflects their income difference: whereas person number 4 eats out and pursues entertainment after work, person number 3 does not.

The model may predict activity scheduling patterns that are not possible due to situational or institutional constraints (Kitamura et al. 2000). For example, an individual may be constrained to pick up a child prior to engaging in other after-work activities. These aspects of activity pattern generation need to be incorporated by combining this model with other models of activity behavior, including rule-based, econometric, or behavioral decision approaches. By combining this model with

**FIGURE 4 Predicted Trip Activity Patterns for Six Hypothetical Individuals**

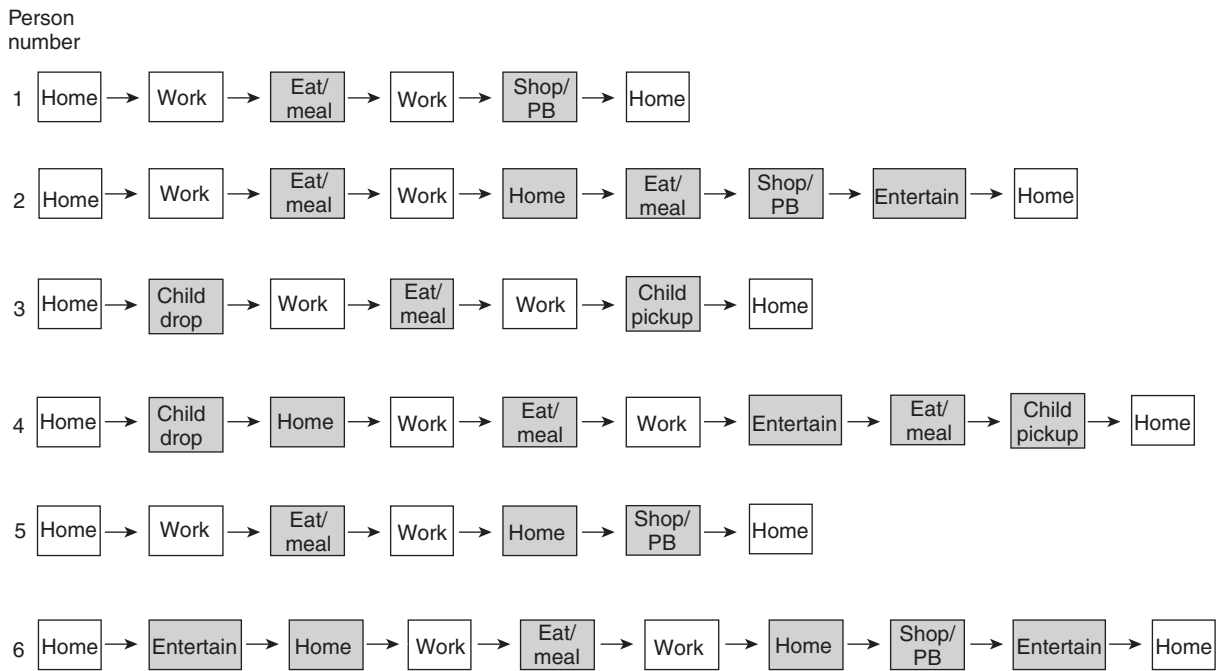

Note: Shaded boxes represent activities predicted in the simulation.

models of activity sequencing and prioritization, activity duration, departure time choice, prism constraints, etc., realistic and plausible activity patterns (with detailed time-of-day information) that do not violate various constraints can be generated.

**CONCLUSIONS AND FUTURE RESEARCH**

This paper presents a simple and practical nested logit model that can be used to predict the daily activity schedule of a commuter. The model schedules nonwork activities in relation to the work activity, thus explicitly recognizing the limited spatial and temporal flexibility associated with the work schedule. The model schedules various nonwork out-of-home activities in three possible time periods (or prisms), namely, before work, at work, and after work. In addition to scheduling out-of-home nonwork activities, the model includes the capability of scheduling temporary return-home trips, thus facilitating the identification of both home-based and work-based trip chains for commuters.

The behavioral paradigm suggested in this paper is that individuals first plan the nonwork activities that they need to accomplish in a day and then schedule these activities in relation to their work activity. Several alternative nested logit structures

were estimated on the 1996 San Francisco Bay Area activity survey sample dataset in an attempt to operationalize the behavioral paradigm. The two-stage decision process embodied in the behavioral paradigm was supported by the estimation results, albeit with some modifications to account for the fact that some activity scheduling patterns are far more prevalent than others.

The paper includes a numerical example to illustrate how the model can be used to predict a daily activity schedule for commuters. The model includes the capability of scheduling return trips home that may occur during the day, thus facilitating the identification of home-based trip chains (in addition to work-based trip chains). Six hypothetical individuals with different socioeconomic characteristics were considered and their activity schedules simulated using the nested logit model. This was done by combining the application of the nested logit model with a Monte Carlo simulation method and simple heuristics that facilitated the identification and sequencing of activities in the schedule. A quick check in which predicted schedules were compared against actual observed schedules of very similar (but not always identical) individuals in the dataset showed that the model predictions were virtually identical to observed schedules.

The model presented in this paper is only a small piece of an overall activity-based model system. The model needs to be combined with other models of activity behavior including activity sequencing, activity frequency, activity duration, activity timing, and in-home vs. out-of-home activity substitution/complementarity to fully identify and describe an individual's activity-travel pattern. In addition, appropriate rule-based heuristics need to be incorporated to ensure that the predicted pattern is plausible, feasible, and satisfies all constraints.

The nested logit model presented in this paper may itself be improved in several ways both from an empirical as well as a methodological standpoint. In this effort, several activity purposes were aggregated into composite categories (e.g., shopping/personal business/serve child). However, it would be preferable to retain the differentiation among activity categories so that their unique characteristics may be better reflected in the model and the identification of specific activities in the pattern is easier. The inclusion of accessibility variables would be another important enhancement to the model, because activity generation and time-of-day scheduling are highly influenced by spatio-temporal activity accessibility. In addition, it would be helpful to test and estimate alternative structures on different datasets to see whether a more robust and unified theory of activity scheduling behavior can be developed.

The assumptions implicit in the nested logit model (for example, that the Independence from Irrelevant Alternatives (IIA) assumption holds at each level of the nested structure) should be tested to ensure that the nested logit modeling methodology and the nested structure adopted are appropriate for modeling activity scheduling behavior. Also, the nested logit model structure proposed in this paper does not accommodate multiple episodes of the same activity type in one time period. Some individuals will pursue multiple episodes of the same activity (say, shopping) in one time period (this was found to be extremely rare in the San Francisco Bay Area dataset, but nevertheless worthy of accommodation in the model structure). Finally, another issue that merits improvement concerns the use of the nested logit model in the presence of interrelated choice alternatives.

From an application standpoint, the model should be enhanced to incorporate the capability of responding to a range of transportation policy scenarios. A major benefit of the activity-based approach is that it offers a behaviorally robust framework in which the impacts of transportation policies on individual travel behavior can be assessed (Pendyala et al. 1997). Increases in congestion, travel demand management strategies, transportation control measures, or new transportation investments (highway or transit expansion) may lead to adjustments in daily activity schedules. In its current form, the model is not wholly sensitive to such variables. Either the model needs to incorporate such variables so that it is sensitive to the changes brought about by alternative transportation policies or it needs to be combined with another model capturing such sensitivities (e.g., a stated preference model). The development of such models would, however, also place greater demands on data requirements.

## ACKNOWLEDGMENT

The authors thank the Florida Department of Transportation for providing funding for the research described in this paper. The authors also thank Ken Vaughn and Chuck Purvis of the San Francisco Bay Area Metropolitan Transportation Commission for providing the data used in this study and taking the time to answer many questions. The contents of this paper reflect the views of the authors who are responsible for the facts and the accuracy of the information presented here. The contents do not necessarily reflect the official views or policies of the Florida Department of Transportation.

## REFERENCES

- Axhausen, K. and T. Gärling. 1992. Activity-Based Approaches to Travel Analysis: Conceptual Frameworks, Models, and Research Problems. *Transport Reviews* 12:323–41.
- Ben-Akiva, M. and S.R. Lerman. 1985. *Discrete Choice Analysis: Theory and Application to Travel Demand*. Cambridge, MA: The MIT Press.
- Bhat, C.R. 1996. A Hazard-Based Duration Model of Shopping Activity with Nonparametric Baseline Specification and Nonparametric Control for Unobserved Heterogeneity. *Transportation Research* 30(3):189–207.



- \_\_\_\_\_. 1998. A Post-Home Arrival Model of Activity Participation Behavior. *Transportation Research* 32B:361–71.
- Bhat, C.R. and F.S. Koppelman. 1999. A Retrospective and Prospective Survey of Time-Use Research. *Transportation* 26(2):119–39.
- Bhat, C.R., J.P. Carini, and R. Misra. 1999. Modeling the Generation and Organization of Household Activity Stops. *Transportation Research Record* 1676:153–161.
- Bowman, J.L. and M. Ben-Akiva. 1997. Activity-Based Travel Forecasting. *Activity-Based Travel Forecasting Conference Proceedings, June 2–5, 1996: Summary, Recommendations and Compendium of Papers*. Edited by L.J. Engelke. Washington DC: U.S. Department of Transportation, Travel Model Improvement Program. Also available at <http://tmip.fhwa.gov/clearinghouse/docs/abtf>.
- Chen, C., R. Kitamura, and J. Chen. 1999. Multimodal Daily Itinerary Planner: Interactive Programming Approach. *Transportation Research Record* 1676:37–43.
- Daly, A. 1987. Estimating “Tree” Logit Models. *Transportation Research* 21B:251–67.
- Damm, D. 1982. Parameters of Activity Behavior for Use in Travel Analysis. *Transportation Research* 16A(1):135–148.
- Doherty, S.T. and E.J. Miller. 2000. A Computerized Household Activity Scheduling Survey. *Transportation* 27(1):75–97.
- Ettema, D. and H. Timmermans. 1997. Theories and Models of Activity Patterns. *Activity-Based Approaches to Travel Analysis*. Edited by D.F. Ettema and H.J.P. Timmermans. Oxford, England: Elsevier Science Ltd.
- Gangrade, S., K. Kasturirangan, and R.M. Pendyala. 2000. A Coast-to-Coast Comparison of Time Use and Activity Patterns. *Transportation Research Record* 1718:34–42.
- Gärling, T., M. Kwan, and R. Golledge. 1994. Computational Process Modelling of Household Activity Scheduling. *Transportation Research* 28B:355–64.
- Golob, T.F. 1998. A Model of Household Choice of Activity Participation and Mobility. *Theoretical Foundations of Travel Choice Modeling*. Edited by T. Gärling, T. Laitila, and K. Westin. New York, NY: Elsevier.
- Hamed, M.M. and F.L. Mannering. 1993. Modeling Travelers’ Postwork Activity Involvement: Toward a New Methodology. *Transportation Science* 27(4):381–94.
- Hensher, D.A. and W.H. Greene. 2000. Specification and Estimation of the Nested Logit Model: Alternative Normalizations. Working Paper, Stern School of Business, New York University, NY.
- Jones, P.M., M.C. Dix, M.I. Clarke, and I.G. Heggie. 1983. *Understanding Travel Behavior*. Aldershot, England: Gower Publishing.
- Kitamura, R. 1984. A Model of Daily Time Allocation to Discretionary Out-of-Home Activities and Trips. *Transportation Research* 18B(3):255–66.
- \_\_\_\_\_. 1988. An Evaluation of Activity-Based Approaches. *Transportation* 15:9–34.
- Kitamura, R. and S. Fujii. 1998. Two Computational Process Models of Activity-Travel Behavior. *Theoretical Foundations of Travel Choice Modelling*. Edited by T. Gärling, T. Laitila, and K. Westin. New York, NY: Elsevier.
- Kitamura, R., R.M. Pendyala, E.I. Pas, and D.V.G.P. Reddy. 1995. Application of AMOS, an Activity-Based TCM Evaluation Tool to the Washington, DC, Metropolitan Area. *Proceedings of the 23rd Summer Annual Meeting*, PTRC Ltd., Glenthorne House, Hammersmith Grove, London, England.
- Kitamura, R., C. Chen, and R.M. Pendyala. 1997a. Generation of Synthetic Daily Activity-Travel Patterns. *Transportation Research Record* 1607:154–162.
- Kitamura, R., S. Fujii, and E.I. Pas. 1997b. Time-Use Data, Analysis and Modeling: Toward the Next Generation of Transportation Planning Methodologies. *Transport Policy* 4(4):225–35.
- Kitamura, R., T. Yamamoto, K. Kishizawa, and R.M. Pendyala. 2000. Stochastic Frontier Models of Prism Vertices. *Transportation Research Record* 1718:18–26.
- Koppelman, F.S. and C-H. Wen. 1998. Alternative Nested Logit Models: Structure, Properties and Estimation. *Transportation Research* 32B(5):289–98.
- Kuppam, A.R. and R.M. Pendyala. 2001. A Structural Equations Analysis of Commuters’ Activity and Travel Patterns. *Transportation* 28(1):33–54.
- Lerman, S.R. 1984. Recent Advances in Disaggregate Demand Modeling. *Transportation Planning Models*. Edited by M. Florian. Amsterdam, The Netherlands: North-Holland.
- McFadden, D. 1978. Modeling the Choice of Residential Location. *Spatial Interaction Theory and Planning Models*. Edited by A. Karlquist, L. Lundquist, F. Snickars, and J.W. Weibull. Amsterdam, The Netherlands: North-Holland.
- Ma, J. and K.G. Goulias. 1999. Application of Poisson Regression Models to Activity Frequency Analysis and Prediction. *Transportation Research Record* 1676:86–94.
- Ortuzar, J.D. and L.G. Willumsen. 1994. *Modelling Transport*. New York, NY: John Wiley & Sons.
- Pendyala, R.M., R. Kitamura, C. Chen, and E.I. Pas. 1997. An Activity-Based Microsimulation Analysis of Transportation Control Measures. *Transport Policy* 4(3):183–92.
- Pendyala, R.M., R. Kitamura, and D.V.G.P. Reddy. 1998. Application of an Activity-Based Travel Demand Model Incorporating a Rule-Based Algorithm. *Environment and Planning B: Planning and Design* 25:753–72.
- Pendyala, R.M., T. Yamamoto, and R. Kitamura. 2002. On the Formulation of Time-Space Prisms To Model Constraints on Personal Activity-Travel Engagement. *Transportation* 29(1): 73–94.
- Recker, W.W., M.G. McNally, and G.S. Root. 1986. A Model of Complex Travel Behavior: Part I, Theoretical Development. *Transportation Research* 20A:307–18.

- Train, K. 1986. *Qualitative Choice Analysis: Theory, Econometrics, and an Application to Automobile Demand*. Cambridge, MA: The MIT Press.
- Wen, C.H. and F.S. Koppelman. 1999. Integrated Model System of Stop Generation and Tour Formation for Analysis of Activity and Travel Patterns. *Transportation Research Record* 1676:136-144.
- \_\_\_\_\_. 2000. A Conceptual and Methodological Framework for the Generation of Activity-Travel Patterns. *Transportation* 27(1):5-23.

# Robust Estimation of Origin-Destination Matrices

**BYRON J. GAJEWSKI**

The University of Kansas

**LAURENCE R. RILETT**

Texas A&M University

and

Texas Transportation Institute

**MICHAEL P. DIXON**

University of Idaho

**CLIFFORD H. SPIEGELMAN**

Texas A&M University

and

Texas Transportation Institute

## ABSTRACT

The demand for travel on a network is usually represented by an origin-destination (OD) trip table or matrix. OD trip tables are typically estimated with synthetic techniques that use observed data from the traffic system, such as link volume counts from intelligent transportation systems (ITS), as input. A potential problem with current estimation techniques is that many ITS volume counters have a relatively high error rate. The focus of this paper is on the development of estimators explicitly designed to be robust to outliers typically encountered in ITS. Equally important, standard errors are developed so that the parameter reliability can be quantified.

This paper first presents a constrained robust method for estimating OD split proportions, which are used to identify the trip table, for a network. The proposed approach is based on a recently developed statistical procedure known in the literature as the  $L_2$  error ( $L_2E$ ). Subsequently, a closed-form solution for calculating the asymptotic variance associated with the multivariate estimator is derived. Because the solution is closed form, the computation time is significantly reduced as compared with computer-intensive standard error calculation methods (e.g., bootstrap methods), and

---

Byron Gajewski, Schools of Allied Health and Nursing, 3024 SON, University of Kansas Medical Center, 3901 Rainbow Blvd., Kansas City, KS 66160. Email: Bgajewski@kumc.edu.

therefore confidence intervals for the estimators in real time can be calculated. As a further extension, the OD estimation model incorporates confirmatory factor analysis for imputing origin volume data when these data are systematically missing for particular ramps. The approach is demonstrated on a corridor in Houston, Texas, that has been instrumented with ITS automatic vehicle identification readers.

## INTRODUCTION

The demand for travel on a network is usually represented by an origin-destination (OD) trip table or matrix. A trip is a movement from one point to another, and each cell,  $OD_{kj}$  in the table represents the number of trips starting at origin  $k$  and ending at destination  $j$ . An OD trip table is a required input to most traffic operational models of transportation systems. In addition, demand estimates are useful for real-time operation and management of the system. While it would be possible to directly measure the travel volume between two points, it is a very expensive and time-consuming process to identify the trip matrix for an entire network. Consequently, OD trip volume tables are typically estimated with synthetic techniques that use observed data from the traffic system, such as link volume counts from inductance loops, as input. Over the past 20 years, numerous methodologies have been proposed for estimating OD movements within an urban environment (Bell 1991; McNeil and Henderickson 1985; Cascetta 1984). A common approach for estimating OD volumes is based on least squares (LS) regression where the unknown parameters are estimated based on the minimization of the Euclidean squared distance between the observed link volumes and the estimated link volumes. Deriving OD trip tables from intelligent transportation systems (ITS) volume data is the focus of this paper.

Nihan and Hamed (1992) demonstrated that outlier data can have a significant impact on OD estimate accuracy, but most OD estimation techniques assume that the input data are reliable. Furthermore, it has been shown that unless inductance loops are maintained and calibrated at regular intervals, the data received from them are prone to error rates of up to 41% (Turner et al. 1999).

Faulty volume counts can occur because of failures in traffic monitoring equipment, communication failure between the field and traffic management, and failure in the traffic management archiving system. The first two failure types may be difficult to detect because they occur in isolated detectors. Other detector problems include stuck sensors, chattering, pulse breakup, hanging, and intermittent malfunctioning. Consequently, there is a need to account for the input error in the estimation process. Historically, detector malfunctions have been addressed by “cleaning” the datasets prior to the estimation step. This is problematic for ITS applications, because the data manipulation takes time and the use of these techniques is limited in a real-time environment. Even for off-line applications, cleaning the data is problematic, because it is not always clear which data need to be cleaned and how this can best be accomplished. This paper examines a robust approach whereby the data error associated with the faulty input data is accounted for explicitly within the estimation of the OD trip table.

The development of OD estimators that are robust to detector malfunction has been largely ignored in OD estimation research, with the exception of an approach proposed using a least absolute norm (LAN) estimator (Sherali et al. 1997). LAN is intuitively more robust to outliers than LS, because the errors are not squared as they are in LS (Cascetta 1984; Maher 1983; Robillard 1975), nor are the data treated as constraints as they are in many maximum entropy and information minimization approaches (Cascetta and Nguyen 1988; Van Zuylen 1980). This paper follows on their work by using estimators explicitly designed to be robust to outliers typically encountered in an ITS environment. Equally important, standard errors will be developed so that parameter reliability can be quantified.

This paper first presents a constrained robust method for estimating OD split proportions, which are used to identify the trip table, for a network. The traffic volumes are assumed to come from an Advanced Traffic Management System (ATMS), and the traditional assumption that the data are “reliable” is relaxed to allow the possibility of missing or faulty detector data. The proposed

approach is based on a recently developed parametric statistical procedure known in the literature as the  $L_2$  error ( $L_2E$ ).<sup>1</sup> Subsequently, a closed-form solution for calculating the asymptotic variance associated with the multivariate estimator is derived. Because the solution has a closed form, the computation time is significantly reduced as compared with the computer-intensive calculation of the standard errors (e.g., bootstrap methods and off-line methods based on the LS (Ashok 1996)), and therefore confidence intervals for the estimators in real time can be calculated. As a further extension, the OD estimation model incorporates confirmatory factor analysis (Park et al. 2002) for imputing volume data when this information is systematically missing for particular ramps.

While the techniques demonstrated here are motivated using inductance loop data, they are easily generalized to other detectors, models, and data. The approach is demonstrated on a corridor in Houston, Texas, that has been instrumented with automatic vehicle identification (AVI) readers. The AVI volumes are used to estimate an AVI OD matrix. The benefit to this test bed is that the actual AVI OD table can be identified and, therefore, provides a unique opportunity for directly measuring the accuracy of the different techniques. The OD matrix can be obtained using a linear combination of the split proportion matrix and the origin (entrance) volume vector.

It should be noted that because the input volumes are dynamic, the estimated OD matrix is also dynamic. However, because the split proportion is assumed constant, the OD matrices by time slice are linear functions of each other.

Also note that while the method is acceptable for freeway networks with relatively short trips between interchanges, such as the example in this paper, an application to a larger network would raise the question as to when the trips began or ended. Caution should be exercised when applying this method to a large proportion of trips that begin and end during different time periods.

<sup>1</sup> Basu et al. (1998) and Scott (1999) contributed the idea to the parametric literature.  $L_2$  refers to the squared distance between two points. The  $L_2E$  was originally used in kernel density estimation (see, e.g., Terrell 1990).

## THEORY

The objective of this paper is to estimate the OD split proportion matrix and its associated distribution properties. The split proportion  $P_{kj}$  is defined as the proportion of vehicles that exit the system at destination ramp  $j$  given that they enter at origin ramp  $k$ . While the split proportions are estimated using only the volumes observed at the origins and destinations, the approach can easily be extended to the case where general lane volumes are observed as well. Once the OD split proportion matrix is identified, the OD table can be derived. See the appendix for a notation list and all proofs of the theorems.

## Methodology

A desirable feature of an OD estimator is the ability to calculate a closed-form limiting distribution. This is particularly important for ITS applications, so that confidence intervals about the estimate can be calculated in real time. The estimator will be defined and distributional properties of the estimator will be derived following the steps below.

1. Define the multivariate constrained regression model and objective functions.
2. Obtain distributional properties.
  - a. Stack the variables to obtain a univariate constrained regression model.
  - b. Use the equality constraints to obtain a univariate *unconstrained* regression model.
  - c. Apply asymptotic theory to derive the distributions of the estimated split proportions for the LS and the  $L_2E$  estimation techniques.
  - d. Transform the model back to its original form.

### Step 1: Define the Model and Objective Functions

A traffic network can be represented by a directed graph consisting of arcs (or links) representing roadways and vertices (or nodes) representing intersections. There are  $q$  origin (entrance) ramps and  $p$  destination (exit) ramps, and the analysis period is broken down into  $T$  time periods of equal length  $\Delta t$ . Figure 1 shows an example of a traffic system in Houston, Texas, along the inbound (east-

FIGURE 1 Eastbound Interstate 10 in Houston, Texas

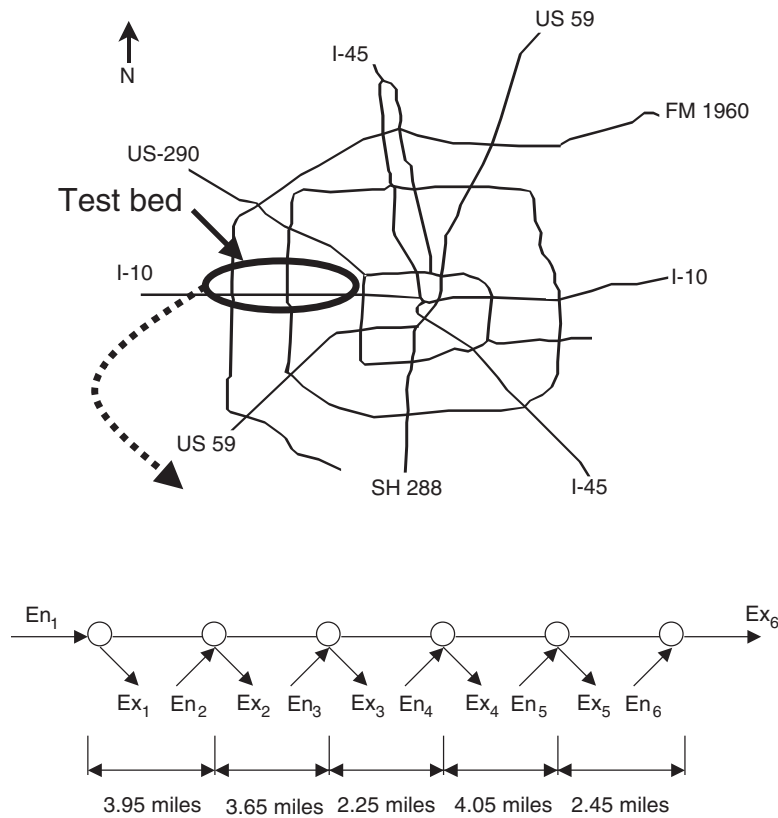

bound) Interstate 10 (Katy Freeway) corridor and a schematic diagram of the corridor.

The underlying assumption of the OD model developed here is that mass conservation holds. In essence, it is assumed that the traffic entering the system also exits the system within a specified time period. This assumption is appropriate as long as the time intervals are long and/or the traffic is in a steady state. For time period  $t$ ,  $t = 1, 2, \dots, T$ ,  $D_{tj}$  denotes the destination volume at destination ramp  $j$ ,  $j = 1, 2, 3, \dots, p$  and  $O_{tk}$  denotes the origin volume at origin ramp  $k$ ,  $k = 1, 2, 3, \dots, q$ .

The first assumption is that the split proportion  $P_{kj}$  is constant over the entire analysis period. The second assumption is that the number of vehicles entering the system equals the number of vehicles exiting the system so that the split proportions at each origin during the period sum to 1 ( $\sum_j P_{kj} = 1$ ). The expectation of the destination volumes during

each time period  $t$  is a linear combination of the split proportions weighted by the origin volumes

$$D = OP + \varepsilon. \quad (1)$$

The term  $\varepsilon$  is the error.

Intuitively, some of the split proportions are not feasible ( $P_{kj} = 0$ ) because of the structure of the traffic network, and this needs to be incorporated in the estimation process. Note that in some cases the nonfeasible parameters may simply represent unlikely cases. The zeros are exact in the applications presented later.

It is assumed in this paper that the errors in each column are independently and identically distributed with mean zero and constant variance. This means that the error associated with the volume measurement at destination  $j$  is uncorrelated with the volume measurement at destination  $j'$ . Note that all assumptions will be checked in the applications section of the paper.

Because the OD problem structure is implicit rather than explicit, and because it is also over-specified, the synthetic approaches attempt to estimate the split proportion matrix based on the minimization of an objective function (Dixon 2000). The objective function in equation 2 is based on an LS approach, which is a common way to estimate the split proportions (Robillard 1975).

$$\min_P F_{LS} = \min_P \sum_{t=1}^T \sum_{j=1}^p (D_{tj} - O_t P_j)^2 \quad (2)$$

Note that if  $\varepsilon_t$  is distributed normally then the LS is equivalent to the maximum likelihood estimator.

The central hypothesis of this paper is that the LS method is inappropriate for ITS applications because of the high error rate of the measured volumes. In contrast, the  $L_2E$  objective function is defined as the integrated squared difference between the true probability density function and the estimated density function. Therefore, it is theoretically more robust, relative to the LS, when the data have outliers such as those caused by detector malfunctions. A more specific discussion of this follows.

As an example, consider a sample of size  $T$ . If the goal is to estimate the location parameter, or the central tendency,  $O_t P_0$  (suppose  $P_0$  is the true unknown split proportion, estimated with  $P$ ), then the minimization of the integrated squared error is shown in equation 3 and derived in the appendix,

$$\min_P F_{L_2E} = \min_P \left\{ \int_{-\infty}^{\infty} [f(D_{tj}|O_t P_j)]^2 dD_{tj} - \frac{2}{Tp} \sum_{t=1}^T \sum_{j=1}^p f(D_{tj}|O_t P_j) \right\} \quad (3)$$

The normal distribution,  $D_{tj} \sim N(O_t P_{0j}, \sigma^2)$ , replaces  $f(D_{tj}|O_t P_{0j})$  resulting in the objective function displayed as equation 4,

$$\min_P F_{L_2E} = \min_P \left\{ \frac{1}{2\sqrt{\pi}\sigma} - \frac{2}{Tp} \sum_{t=1}^T \sum_{j=1}^p N(D_{tj} - O_t P_j, \sigma^2) \right\} \quad (4)$$

The  $L_2E$  minimizes the sum of probability density functions (pdfs) while the MLE (or LS) mini-

mizes the negative product of pdfs. In the presence of an outlier, the MLE objective function will multiply a zero and the  $L_2E$  objective function would add a zero. The relative effect of the outlier on the objective function is much more severe in the case of the MLE. This is because of the multiplicative effect of the zeros on the MLE objective function. Because ITS data often contain outliers, it is hypothesized that the  $L_2E$  objective function will provide better estimates. For a more detailed discussion of the  $L_2E$  properties, see Basu et al. (1998) or Gajewski (2000).

When calculating the  $L_2E$ , an estimate of the variance is required. In this paper, the estimate of the variance is identified using a two-step process. First  $\hat{P}$  is calculated using the median of the squared residuals so that an initial estimate of the standard deviation,  $\hat{\sigma}$ , may be obtained by calculating the median absolute deviation (MAD) from the set of estimated residuals, where the  $t^{\text{th}}$  estimated residual is  $\hat{\varepsilon}_t = D_t - O_t \hat{P}$ . The median of the squared residuals is used because it has been shown to have a high breakdown point (Hampel et al. 1986). In general, the breakdown point is the percentage of outliers in the data at which the estimator is no longer robust (Huber 1981). For example, if the breakdown point is 50% then the estimator is robust to datasets that contain less than 50% outliers.

### Steps 2a-b: Stack and Define the Unconstrained Univariate Regression Model

Through reparameterization, the split proportion model shown in equation 1 can be translated into an unconstrained univariate regression model. The first step is to stack the split proportion matrix  $P$ , where

$$P^v = \text{vec}(P).$$

For example,

$$\begin{bmatrix} 1 & 2 \\ 3 & 4 \end{bmatrix}^v = \begin{bmatrix} 1 \\ 3 \\ 2 \\ 4 \end{bmatrix}.$$



The equality constraints are subsequently defined relative to  $P^v$  using  $GP^v = g$ , where the matrices

$$G = \begin{pmatrix} 1'_p & \otimes I_q \\ M & \end{pmatrix} \text{ and } g = \begin{pmatrix} 1_q \\ 0_r \end{pmatrix}.$$

The matrix  $M$  ( $r$  by  $qp$ ) maps the nonfeasible values of  $P^v$  to zero. The value  $r$  is the number of split proportions equal to zero.

$$\text{As an example, define } P = \begin{pmatrix} P_{11} & P_{12} \\ P_{21} & P_{22} \end{pmatrix}$$

where  $P_{11} = 0$  and  $P_{21} = 0$ .

Therefore, the product of the  $M$  and  $P^v$  matrix maps the nonfeasible elements to zero

$$M = \begin{pmatrix} 1 & 0 & 0 & 0 \\ 0 & 1 & 0 & 0 \end{pmatrix}.$$

where

$$GP^v = [G_1 G_2] \begin{bmatrix} P_1^v \\ P_2^v \end{bmatrix} \quad (5)$$

The first  $q$  rows of each  $G$  and  $g$  are used to normalize the split proportions as shown in equation 5.

Given the constraints defined above and the stacked model, the reduced model may be obtained by solving equation 5. Because  $G_1$  is trivially full rank ( $q + r$ ):

$$P_1^v = G_1^{-1}(g - G_2 P_2^v) \quad (6)$$

Equation 1 is placed in univariate form by defining  $Y$  to be the stacked columns of  $D$  and at the same time letting  $X^* = I_p \otimes O$ . When equation 6 is substituted into the stacked model the unconstrained model is obtained. The substitution is done with the portion of the stacked model that corresponds to the

$$X^* = [X_1^* X_2^*] \text{ regression parameters. If}$$

$$\text{then } Y = X_1^* P_1^v + X_2^* P_2^v + \varepsilon^v$$

and the new regression model, which describes in univariate form the multivariate regression problem, is defined in equation 7.

$$Y_2 = W_2 P_2^v + \varepsilon^v \quad (7)$$

where

$$Y_2 = Y - X_1^* G_1^{-1} g$$

$$W_2 = (X_2^* - X_1^* G_1^{-1} G_2).$$

### Step 2c-d: Variance Estimates for the Reparameterized Model and Distributions

These next steps produce distributions for the estimators under the reparameterized model, in particular that both  $L_2E$  and LS produce estimators that consistently estimate the true  $P^v$  (or  $\hat{P}^v \xrightarrow{p} P^v$ ), and that  $\hat{P}^v$  is asymptotically normally distributed, under certain assumptions. The asymptotic normality directly produces variance estimates of  $\hat{P}^v$ .

The asymptotic properties follow directly from the reparameterized model discussed in Steps 2a-b. Then the asymptotic theorems from Huber (1981) from the objective functions (or derivatives of them called  $M$ -estimators) are applied, written in an unconstrained form.

The only additional assumptions for these asymptotic results are that the errors in equation 1 have a mean of zero and a variance of  $\sigma^2 I_{Tp}$  and are iid. This assumption encompasses many distributions that include heavier tails than the normal distribution. The specific calculations for the asymptotic variances are  $Var(\hat{P}_2^{vLS}) = (U'U)^{-1}$  and,

$$Var(\hat{P}_2^{vL_2E}) = \frac{E[\psi^2]}{(E[\psi'])^2} (U'U)^{-1},$$

where  $\psi$  and  $U$  are defined in the appendix.

One result of this is when the errors are normally distributed the ratio of the variances of the  $L_2E$  estimator and the LS estimator of any element of

$$P_2^v \text{ is } \frac{8}{3\sqrt{3}} = 1.54,$$



which says that the variance under the  $L_2E$  estimator is 1.54 times as high as the LS estimator. Therefore, the  $L_2E$  estimator is actually less efficient than its LS estimator counterpart. However, by applying a heavy-tailed distribution, the result reverses and the  $L_2E$  estimator is better than the LS estimator. In the subsequent sections, a simulation demonstrates this result.

## Conclusion of Theory

The derivation of the asymptotic distributions has shown that explicit closed-form variance estimates exist and that associated standard errors of the split proportions can be calculated in real time. Notice that these theorems can be extended to other types of  $M$ -estimators, in addition to the  $L_2E$ , as long as the assumptions are met.

Note that if the assumptions to derive the closed-form standard errors are not appropriate, then bootstrap methods will be required. The bootstrap is a computer-intensive procedure that uses resamples of the original data to obtain properties such as standard errors. One can use various algorithms to do this, such as case resampling or model-based resampling (Davison and Hinkley 1997).

## APPLICATION

### Test Bed

The test bed is an eastbound section of Interstate 10 (I-10) located in Houston, Texas, as shown in figure 1. This section of I-10 is monitored as a part of the Houston Transtar Transportation Management Center (TMC) (operated by the Texas Department of Transportation), the Metropolitan Transit Authority of Harris County (METRO), the City of Houston, and Harris County. There are six automatic vehicle identification readers located in the test bed. As instrumented vehicles pass under an AVI reader, a unique vehicle identification number is recorded and sent to a central computer over phone lines. From this information, the average link travel time is calculated and presented to drivers through various traveler information systems. It may be seen in figure 1 that the I-10 test corridor is made up of five AVI links consisting of six “ori-

gins” and six “destinations.” Note that each destination may consist of several destination ramps and each origin may consist of several origin ramps, because the AVI links are defined by the location of the AVI readers and not the physical geometry of the corridor.

The OD methodology developed in this paper was motivated by the assumption that the TMC has access to volume information obtained from point detectors (i.e., inductance loops). However, the models are tested using data obtained from an AVI system because both AVI volumes and split proportions can be identified. This provides a unique opportunity for comparing the accuracy of the OD estimates that are based on volumes obtained at point sources with observed OD split proportions. In this situation, the split proportions are estimated using only the OD volumes from the AVI data.

Based on a preliminary analysis, 18 days in 1996 were used for the analysis (October 1, 2, 4, 5, 15–19, 22–26, 30, and November 1, 6, and 8).<sup>2</sup> The AVI vehicles detected at the origin and destination ramps during the AM peak period (7 am to 9 am) were aggregated into 4 volume counts of 30-minute duration. Therefore, the number of time periods ( $T$ ) is equal to 72, the number of destinations ( $p$ ) is 6, and the number of origins ( $q$ ) is 6. The AVI volumes were used as input to the LS and the  $L_2E$  estimators and the resulting estimates are presented in table 1.

The assumption that the split proportion matrix was constant, which was used in the derivation of the LS and the  $L_2E$  estimators, was verified by examining the observed AVI split proportion differences across all days and all time periods of the study. Because these observed split proportion differences were within 0.1 for 95% of the estimates, it was judged that the assumption was reasonable for this test case. The observed mean AVI split proportions for the AM peak are shown in table 1.

The correlation coefficients between the observed mean AVI split proportions and the estimated split proportions by the LS and the  $L_2E$  esti-

<sup>2</sup> See Dixon (2000) for specific data extraction techniques.

**TABLE 1 Estimated Split Proportions by OD Pair for the Peak Period (7–9 a.m.)**

$OD_{kj}$	$P_{kj}$	$\hat{P}_{kj}^{LS}$	$\hat{P}_{kj}^{L_2E}$
1-1	0.18	0.18	0.16
1-2	0.56	0.48	0.59
1-3	0.08	0.10	0.03
1-4	0.03	0.00	0.00
1-5	0.06	0.01	0.00
1-6	0.08	0.23	0.22
2-2	0.74	0.86	0.73
2-3	0.10	0.08	0.18
2-4	0.04	0.00	0.00
2-5	0.07	0.05	0.08
2-6	0.05	0.01	0.00
3-3	0.33	0.32	0.31
3-4	0.15	0.21	0.19
3-5	0.22	0.33	0.41
3-6	0.31	0.14	0.10
4-4	0.36	0.41	0.41
4-5	0.31	0.43	0.37
4-6	0.33	0.16	0.22
5-5	0.70	0.58	0.57
5-6	0.30	0.42	0.43
6-6	1.00	1.00	1.00

Key:

$OD_{kj}$  Vehicles depart from origin node  $k$  and arrive at destination node  $j$

$P_{kj}$  Observed split proportion matrix between origin node  $k$  and destination node  $j$

$\hat{P}_{kj}^{LS}$  Estimated split proportion between origin node  $k$  and destination node  $j$  using least squares estimator

$\hat{P}_{kj}^{L_2E}$  Estimated split proportion between origin node  $k$  and destination node  $j$  using the  $L_2E$  estimator

mators are 0.961 and 0.960, respectively. These results indicate that both estimators are successful at estimating the OD split proportions. However, the mean absolute percent error (MAPE) between the mean observed split proportion and the estimated split proportions using the LS and the  $L_2E$  estimators were 44.5% and 51.3%, respectively. These results indicate each method has an approximate error of 50% with respect to individual OD split proportion estimates.

A further analysis of the absolute percent error (APE) at the individual OD level showed that the APE decreases as the size of the OD split proportion increases. For example, the MAPE for OD pairs that have observed split proportions in the range of 0–0.10, 0.10–0.30, and greater than 0.48 are 78.1%, 31.2% and 11.9%, respectively, for the

LS estimator. The  $L_2E$  analysis had similar results in that the percentage error for cells that have split proportions in the range of 0–0.10, 0.10–0.30, and greater than 0.48 were 91.5%, 38.8%, and 6.3%, respectively. As would be expected from their objective functions, the estimators tend to have more accurate results for the more “important” OD pairs as measured by split proportion or relative volume. In general, these results are encouraging because the estimates for the OD pairs that have higher split proportions, which will in all likelihood be the more important ones for ITS applications, will tend to be more accurate.

The asymptotic variance calculated using the closed-form solutions developed in this paper and variance estimators calculated using a bootstrap technique are shown in table 2. The bootstrap estimate of the standard error was calculated using 999 estimates of the split proportion. These estimates were calculated from realizations produced from resampling the rows of  $D$  and  $O$  (Davison and Hinkley 1997). The APE between the asymptotic standard deviation and the bootstrap standard deviation ranged quite a bit. However, the APE tended to be lower for the OD pairs with higher observed OD split proportions, which was similar to that of the previous analysis.

For the  $L_2E$  analysis, the APE between the asymptotic standard deviation and the bootstrap standard deviation also ranged quite a bit. Similar to the LS analysis, the standard deviation of the APE tended to decrease as the size of the observed split proportion increased. In general the  $L_2E$  asymptotic standard deviation gave better results in 13 of the 21 parameters, as compared with the bootstrap standard deviation the LS produced. The asymptotic standard deviation for both the LS and the  $L_2E$  estimators were, on average, higher than the bootstrap method and can therefore be used as a conservative estimate of the standard deviation in real-time applications.

Based on the estimated split proportions and the variance shown in table 2, it can be shown that there are no statistically significant differences among the observed split proportion values and the estimated values using either the  $L_2E$  or the LS methods when tested at the 95% level of confi-

**TABLE 2 Standard Deviation of the LS and the L<sub>2</sub>E Estimators for the Peak Period (7–9 a.m.)**

$OD_{kj}$	$P_{kj}$	Asymptotic STD $STD(\hat{P}_{kj}^{LS})$	Bootstrap STD $STD(\hat{P}_{kj}^{LS})$	Absolute percent error (APE)	Asymptotic STD $STD(\hat{P}_{kj}^{L_2E})$	Bootstrap STD $STD(\hat{P}_{kj}^{L_2E})$	Absolute percent error (APE)
1-1	0.18	0.01	0.01	0	0.01	0.01	0
1-2	0.56	0.05	0.07	29	0.06	0.07	14
1-3	0.08	0.08	0.11	27	0.10	0.11	9
1-4	0.03	0.06	0.04	50	0.07	0.04	75
1-5	0.06	0.08	0.06	33	0.10	0.04	150
1-6	0.08	0.08	0.05	60	0.09	0.05	80
2-2	0.74	0.06	0.01	500	0.07	0.00	0
2-3	0.10	0.08	0.01	700	0.10	0.04	150
2-4	0.04	0.10	0.08	25	0.12	0.13	8
2-5	0.07	0.07	0.06	17	0.09	0.09	0
2-6	0.05	0.06	0.02	200	0.08	0.01	700
3-3	0.32	0.11	0.07	57	0.13	0.09	44
3-4	0.15	0.10	0.08	25	0.12	0.12	0
3-5	0.23	0.08	0.05	60	0.10	0.06	67
3-6	0.30	0.08	0.05	60	0.10	0.08	25
4-4	0.37	0.06	0.04	50	0.08	0.05	60
4-5	0.31	0.11	0.01	1000	0.13	0.06	117
4-6	0.33	0.10	0.05	100	0.12	0.09	33
5-5	0.70	0.08	0.06	33	0.10	0.10	0
5-6	0.30	0.08	0.05	60	0.10	0.08	25
6-6	1.00	0.00	0.00	0	0.00	0.00	0

Key:

$OD_{kj}$  Number of vehicles departing from origin node  $k$  that arrive at destination node  $j$

$P_{kj}$  Observed split proportion matrix between origin node  $k$  and destination node  $j$

$STD(\hat{P}_{kj}^{LS})$  Estimated standard error of split proportion between origin node  $k$  and destination node  $j$  using the LS estimator

$STD(\hat{P}_{kj}^{L_2E})$  Estimated standard error of split proportion between origin node  $k$  and destination node  $j$  using the L<sub>2</sub>E estimator

APE Difference between bootstrap STD and asymptotic STD divided by bootstrap STD

dence. This result indicates that either method would be appropriate for this dataset. It is important to note, however, that the AVI volume data are of very high quality with a low error rate, which is not the case for inductance loop data.

The standard deviations of the residuals for columns 1 through 6 are 10.70, 11.92, 7.34, 10.43, 9.13, and 11.26, respectively, which are relatively close. The residuals viewed using a normal probability plot indicate that the hypothesis that the errors are normal can be accepted. Lastly, the off-diagonals of the sample correlation matrix indicated a small correlation between the columns of the residuals. The average absolute value of the correlations is 0.33. Based on these observations, the assumption that the errors are independent and have the same normal distribution (i.e.,  $\varepsilon_t^{iid} \sim N(0, \sigma^2 I_T)$ ) appears valid for this example.

Checking the assumptions allowed us to apply the input-output model presented in this paper to the Houston AVI data. While the AVI example helped validate the methods developed in this paper, it does not illustrate the robustness of the L<sub>2</sub>E relative to the LS estimator because of the generally high quality of the AVI data. Therefore, robustness is illustrated using a Monte Carlo simulation study motivated from the AVI test bed example. A binomial distribution, with probability parameter  $H$ , which represents the proportion of contamination, was used to sample the destination volume matrix across the 72 time periods and 6 destinations. Two separate scenarios were examined. In the first scenario, the chosen cells are set to zero, which mimics a detector failure. In the second scenario, the chosen cells are inflated to mimic chatter in the data. The inflated values were set to

**FIGURE 2 Simulation MSE Results for Contaminated Data**

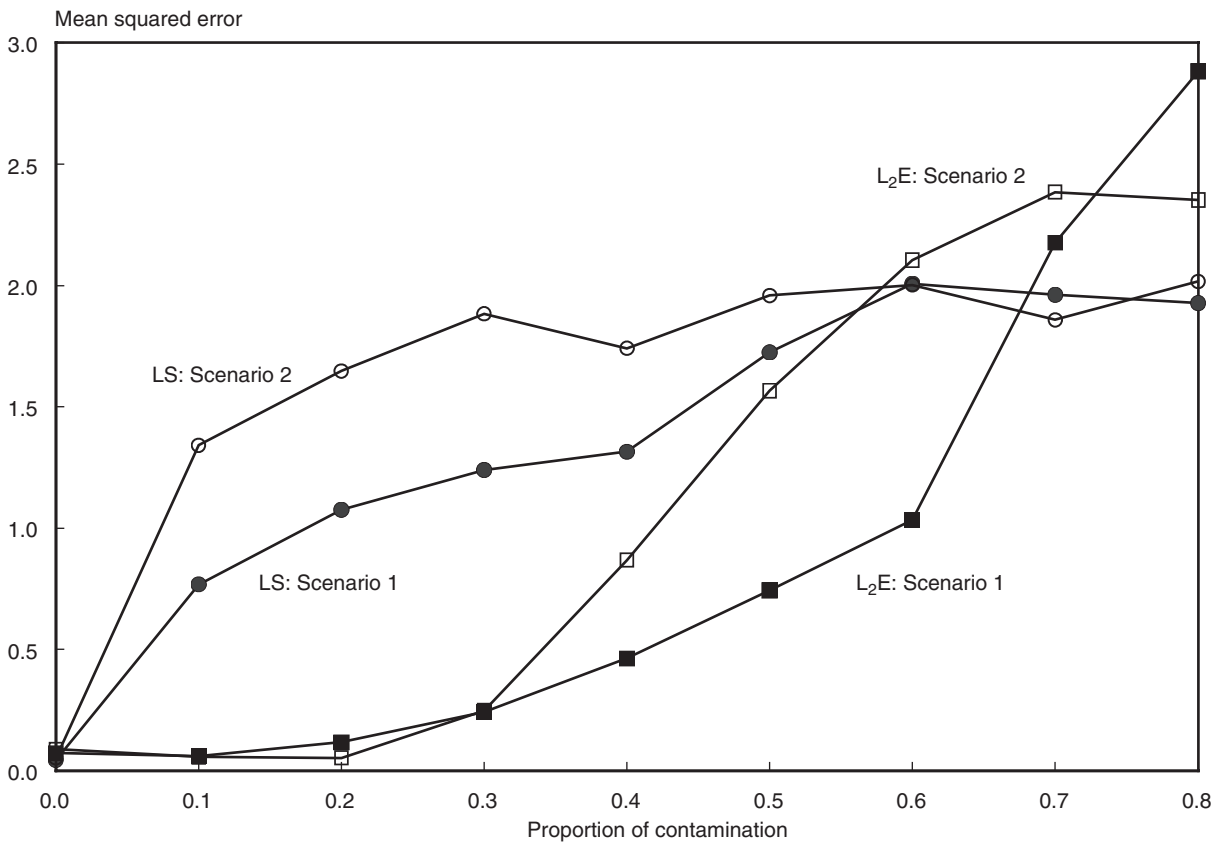

3,240 vehicles per half-hour, which is higher than capacity and consequently the values are not feasible. A Monte Carlo experiment was performed 100 times for each scenario for levels of  $H$  ranging from 0 to 0.80 in increments of 0.1.

The mean squared error (MSE) as a function of the probability of destination detector failure for both scenarios is shown in figure 2. It can be seen that as proportion of contamination ( $H$ ) increases, the MSE for both estimators also increases under each scenario. Note that for both scenarios the rate of increase in MSE for the  $L_2E$  estimator is much lower than that of the LS estimator. For example, when the percentage contamination is 20% the MSE for the  $L_2E$  estimator is approximately 0.1, which is only 10% and 7% of the MSE for the LS estimator under scenarios 1 and 2, respectively. It can also be seen that while the  $L_2E$  estimator is more robust than the LS estimator for lower values of  $H$ , after the probability of contamination reaches a certain point both estimators are comparably poor (or approximately flat due to Monte Carlo error).

The sum of the MSE, which may be considered a surrogate for the variance, was subsequently calculated using the simulated data and the asymptotic equations using the uncontaminated data (i.e.,  $H = 0$ ). The sums of the MSE for the LS estimator were 0.053 and 0.059 for the simulation and asymptotic analyses, respectively. The sums of the MSE for the  $L_2E$  analyses were 0.088 and 0.090 for the simulation and asymptotic analyses, respectively. Thus, the values derived using the asymptotic theory approximately equal the values derived from the simulation results and demonstrate the theory derived earlier in this paper.

To study the effects of errors that are not as severe as those in scenarios 1 and 2, and consequently harder to detect, a second sensitivity analysis was performed. In this case the percentage error was varied between  $-75\%$  and  $75\%$  and, as before, a binomial distribution was used to perturb the destination matrix volume measurements. A sensitivity analysis was performed on the percentage contamination, which ranged from 0.1 to 0.6 in increments of 0.1. As in the earlier experiments, the

**FIGURE 3 Efficiency of the L<sub>2</sub>E to the LS versus Percentage Error of Detector Accuracy**

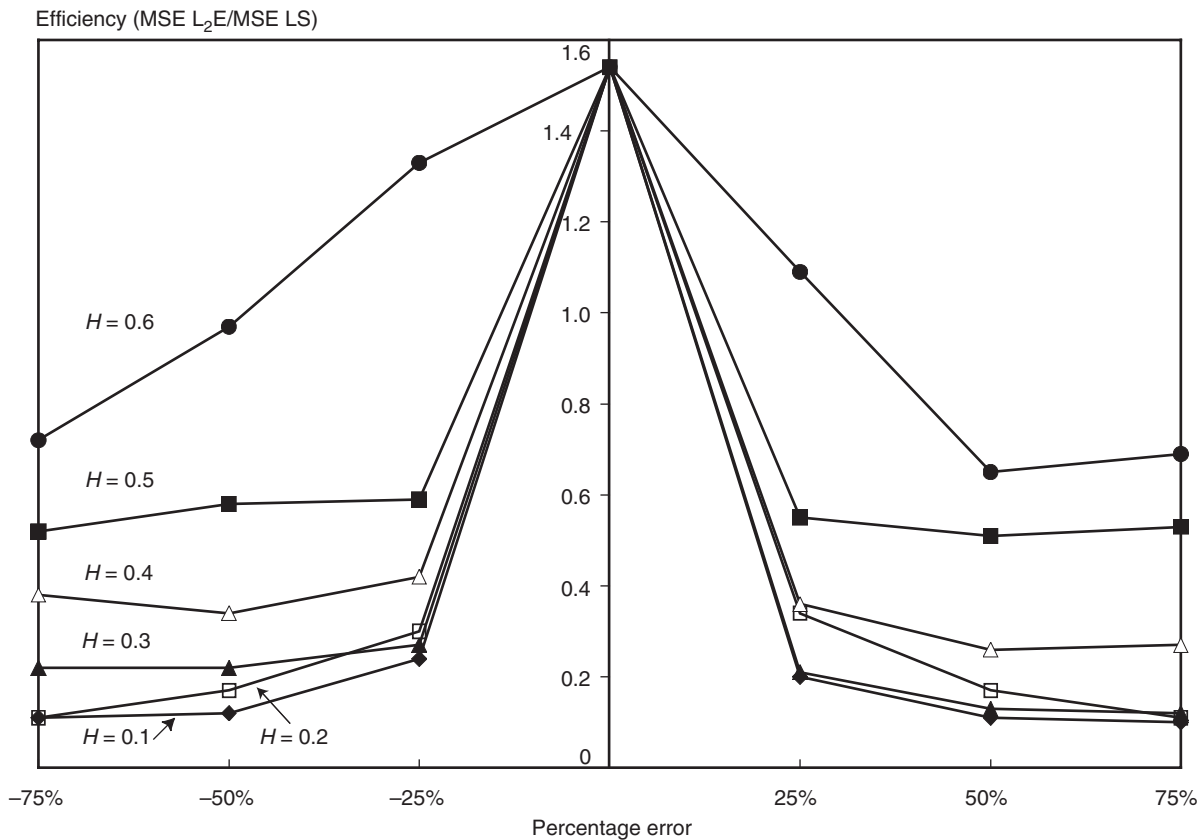

Monte Carlo simulation was carried out 100 times for each simulation. The results are presented in figure 3, which shows the ratio of the L<sub>2</sub>E estimator MSE divided by the LS estimator MSE as a function of the percentage of detectors experiencing errors. For example, it can be seen that when the detector error rate is 25% and the probability of a given detector experiencing difficulty is 50% ( $H = 0.5$ ), the relative efficiency is 0.5. That is, the L<sub>2</sub>E estimator MSE is approximately half of the LS estimator MSE, indicating that the L<sub>2</sub>E estimator is more robust to detect error for this scenario.

The second point to note about figure 3 is that when there is no data contamination the MSE of the L<sub>2</sub>E estimator is approximately 60% larger than the MSE of the LS estimator. It can be seen that as the detector percentage error grows, the efficiency of the L<sub>2</sub>E estimator relative to LS estimator rises at an increasing rate before it plateaus at approximately an absolute value of 50%. In addition, the choice of when to use the L<sub>2</sub>E estimator is a function of the expected contamination rate and the expected percentage error in detector accuracy.

As shown in figure 3, whenever the relative efficiency dips below 1.0 the L<sub>2</sub>E estimator would be preferred. For this example, when the percentage error of detector accuracy is less than approximately 15% the LS would be chosen. However, when the detector percentage error is greater than 15%, it can be seen that the L<sub>2</sub>E estimator would be preferred for all values of  $H$  less than 0.5.

At this point, it should be emphasized that the L<sub>2</sub>E approach is a statistical technique that is not limited to an input-output model but can be generalized to any number of OD problem formulations. In the case of this particular problem, other detectors (main lanes with volume recorders that provide additional volume information) could be accounted for by substituting the input-output model with a general link volume model where the output is modified to include mainline volumes. In this way, the L<sub>2</sub>E estimator would be robust to malfunctions in any of the detectors.

In addition, confirmatory factor analysis can be used when other detectors in the system fail by imputing the missing data (Park et al. 2002). The

unknown volumes at each origin are mathematically equivalent to the unknown scores in confirmatory factor analysis. Therefore, when a loop failure occurs, some of the origin volumes are observed and some are not. Therefore, confirmatory factor analysis and the models developed in this paper can be combined to form a mixed model. The observed destination volumes are contained in matrix  $D$ , the observed origin volumes are in matrix  $O_2$ , the unobserved origin volumes are in matrix  $O_1$ , and the split proportions are placed in matrix  $P$ . The mixed model is thus  $D = [O_1 | O_2] P + \varepsilon$ , where the split proportions are

$$\text{partitioned } P = \begin{bmatrix} P_1 \\ P_2 \end{bmatrix}.$$

For instance, consider the AVI example previously discussed. Suppose the volume counts at origin one or origin six cannot be observed because of detector failure. Therefore, origins two through five correspond to  $O_2$  and origins one and six correspond to  $O_1$ .

Under the notation described above, the least squares objective function becomes

$$\hat{P}^{MLS} = \min_{P, Ex_1} \sum_{t=1}^T (D_t - [O_{1t}P_1 + O_{2t}P_2]) (D_t - [O_{1t}P_1 + O_{2t}P_2])'$$

Next we solve for  $O_1$  and minimize the objective function with respect to  $P$ . The unknown portion of  $O$  is  $O_1$ , thus  $\hat{O}_{1t} = (D_t - O_{2t}P_2)P_1'(P_1P_1')^{-1}$ . Therefore the objective function is

$$\begin{aligned} \hat{P}^{MLS} &= \min_P \sum_{t=1}^T \left( D_t - \left[ (D_t - O_{2t}P_2)P_1'(P_1P_1')^{-1}P_1 + O_{2t}P_2 \right] \right) \\ &\quad \left( D_t - \left[ (D_t - O_{2t}P_2)P_1'(P_1P_1')^{-1}P_1 + O_{2t}P_2 \right] \right)' \\ &= \min_P \sum_{t=1}^T \left( D_t \left( I - P_1'(P_1P_1')^{-1}P_1 \right) - O_{2t}P_2 \left( I - P_1'(P_1P_1')^{-1}P_1 \right) \right) \\ &\quad \otimes \left( D_t \left( I - P_1'(P_1P_1')^{-1}P_1 \right) - O_{2t}P_2 \left( I - P_1'(P_1P_1')^{-1}P_1 \right) \right)' \\ &= \min_P \sum_{t=1}^T \left( (D_t - O_{2t}P_2) \left( I - P_1'(P_1P_1')^{-1}P_1 \right) \right) \\ &\quad \left( (D_t - O_{2t}P_2) \left( I - P_1'(P_1P_1')^{-1}P_1 \right) \right)' \\ &= \arg \min_P \sum_{t=1}^T (D_t - O_{2t}P_2) \left( I - P_1'(P_1P_1')^{-1}P_1 \right) (D_t - O_{2t}P_2)'. \end{aligned}$$

Estimates from this objective function produce a sequence that converges to the fixed but unknown true parameter (Gajewski 2000).

*Remark:* Confirmatory factor analysis occurs when all of the regressors are unknown resulting in  $P_2$  being empty. The objective function, similar to confirmatory factor analysis, is

$$\hat{P} = \arg \min_P \sum_{t=1}^T O_t P O_t'$$

where

$$P = \left( I - P'(P P')^{-1}P \right).$$

Ordinary least squares regression occurs when  $P_1$  is empty and

$$\hat{P} = \arg \min_P \sum_{t=1}^T (D_t - O_t P) P (D_t - O_t P)'$$

In most cases, model identifiability of the parameters holds because of the number of nonfeasible OD pairs. The biggest challenge is meeting the assumption where  $P_1^{(k)}$  is full rank, assuming  $P_1^{(k)}$  is the matrix composed of the columns containing the assigned zeros in the  $k$ th row with those assigned zeros deleted. The nonfeasible OD pairs arise from the fact that a vehicle cannot have certain origin or destination combinations. Details of model identifiability and rank are found in Park et al. (2002).

Note that the LS method is used to demonstrate the approach, because the AVI data were found to be well behaved. It should be noted that under the conditions presented in the theory section of this paper  $\hat{P}^{MLS} \xrightarrow{p} P_0$ . That is, as  $T$  goes to infinity the estimator under the mix model using least squares converges to the true split proportions (Gajewski 2000).

A test of the imputation technique on data from the test bed was subsequently performed. It was assumed that the volume from the first origin and the last origin are missing and the techniques from confirmatory factor analysis were used to impute the missing origin volumes. Table 3 shows the



**TABLE 3 Estimated AM Peak Origin Ramp Volume Using Imputation Methodology**

Origin 1 observed volume	Origin 1 estimated volume	Percentage error	Origin 6 observed volume	Origin 6 estimated volume	Percentage error
25	40	-61	197	175	11
23	26	-14	194	201	-4
42	48	-15	211	202	4
23	37	-62	193	194	0
77	85	-11	220	208	6
25	0	NA	173	169	2
29	38	-29	195	200	-2
29	34	-16	188	177	6
48	50	-4	182	162	11
36	22	40	185	182	2
31	41	-33	176	164	7
33	32	4	189	167	12
17	51	-203	200	181	9
17	20	-18	183	181	1
30	43	-44	209	206	1
21	31	-47	173	166	4
21	33	-57	211	212	0
28	30	-8	178	179	-1
13	15	-14	194	203	-5
22	36	-61	157	154	2
19	33	-73	210	192	9
26	36	-38	208	215	-3
14	13	9	216	198	8
27	42	-54	169	173	-2
28	55	-95	191	171	11
16	13	20	187	195	-4
19	29	-53	214	200	7
17	13	23	174	168	4
16	5	67	203	176	13
34	47	-39	217	198	9
15	12	21	198	195	2
16	24	-53	172	158	8
23	52	-125	193	161	17
17	23	-37	203	196	3
23	41	-78	185	178	4
14	7	51	192	196	-2
16	41	-158	215	189	12
24	28	-17	185	184	0
17	18	-6	200	205	-2
26	29	-12	183	192	-5

*Continues*

results, and it can be seen that the average percentage error for origins one and six are -30% and 3%, respectively. It can also be seen that the APE was lowest for the origin ramps that had the highest volume.

The important feature of the above technique is that it provides a consistent estimator for the split proportions despite missing a portion of the input information. While there are other imputation techniques (Chin et al. 1999; Gold et al. 2001), it is not clear if these techniques provide consistent esti-

matoms. Therefore, the above algorithm can be used when input information is missing or in situations where the input information is known a priori to be faulty. In this latter case, the faulty input volume would be removed prior to the estimation of the split proportions.

*Remark:* The formulation derived in this paper was presented in OD format. Alternatively, in the data imputation format, the origins,  $O$ , can be treated as output parameters and the model formulated as  $O = DP + \varepsilon$ . This is a DO formulation

**TABLE 3 Estimated AM Peak Origin Ramp Volume Using Imputation Methodology (continued)**

Origin 1 observed volume	Origin 1 estimated volume	Percentage error	Origin 6 observed volume	Origin 6 estimated volume	Percentage error
19	40	-109	160	128	20
28	33	-17	180	193	-7
26	35	-35	223	200	10
26	35	-34	175	180	-3
17	39	-130	195	170	13
24	32	-34	199	201	-1
27	32	-20	216	221	-2
18	7	60	192	209	-9
18	30	-68	184	192	-4
37	33	10	190	193	-2
22	16	26	196	184	6
21	37	-75	185	164	11
20	28	-42	213	181	15
22	18	18	204	204	0
31	58	-88	193	176	9
23	32	-39	187	179	4
36	21	43	226	226	0
23	27	-15	169	183	-8
67	65	3	244	257	-5
25	0	NA	207	200	3
21	63	-199	227	194	15
25	27	-9	188	187	1
25	34	-34	222	215	3
22	28	-26	204	197	4
16	40	-151	218	193	11
28	28	-1	214	211	1
24	28	-16	225	225	0
24	40	-68	200	192	4
29	39	-35	203	198	3
42	38	8	167	175	-5
43	51	-19	191	189	1
41	41	0	199	216	-9
	<b>Average error</b>	<b>-30</b>		<b>Average error</b>	<b>3</b>

where the split proportion  $P_{kj}$  represents the proportion of vehicles exiting at  $k$  and entering at  $j$ .

The OD matrix was calculated for the full AVI data under both formulations. The OD matrix, under the DO formulation, was calculated using the LS estimator. The correlation between the OD matrix calculated from the DO model and the OD matrix calculated from the OD model is 0.9018; the correlation between the OD matrix calculated from the DO model and the true OD matrix is 0.9514; and the correlation between the OD matrix from the OD model and the true OD matrix is 0.9293. Therefore, the OD matrices from both formulations were approximately equal for this test example.

### CONCLUDING REMARKS

Origin-destination matrices are an integral component of off-line traffic models and real-time advanced traffic management centers. The recent deployment of ITS technology has resulted in the availability of a large amount of data that can be used to develop OD estimates. However, these data are subject to inaccuracies from a variety of sources. In this situation, the data may be “cleaned” and then used with existing OD estimators. Alternatively, OD estimators may be developed that are robust to the outliers characteristic of ITS data. This latter approach was the focus of this paper.

A robust estimator based on the  $L_2E$  theory was first derived and compared with a traditional least



squares estimator. In addition, closed-form asymptotic distributions for the variance were derived for both estimators. This is an important contribution because it allows variances, and therefore standard errors, to be calculated for the estimates. It was shown that while the  $L_2E$  estimator was less efficient than the LS estimator, it was more statistically robust to bad data.

The models were applied to a corridor on Interstate 10 in Houston, Texas. The test bed was instrumented with AVI technology and therefore both AVI volumes and split proportions are available. This test bed provides a unique opportunity for comparing the estimators because an observed OD matrix is available, which is extremely rare for these types of studies. The asymptotic variance estimates were found to be slightly conservative as compared with the estimates derived using a bootstrap method. It was shown that while the LS and the  $L_2E$  estimators had average mean absolute error ratios of approximately 50%, both replicated the observed OD at the 95% level of confidence. In addition, the accuracy of the estimates was highest for the OD pairs with higher relative volumes.

A Monte Carlo simulation was carried out to test the robustness of the techniques under different error types and error rates. It was found that the  $L_2E$  estimator was much more robust than the LS estimator to outliers. However, after a certain threshold, which was 50% on the I-10 test network, the models were found to perform equally poorly. Lastly, a method for imputing missing origin data was developed and illustrated using the LS estimator.

It should be noted that the  $L_2E$  approach is not limited to the input-output model used in this paper, but rather can be generalized to any number of OD problem formulations. For example, information from other detectors, such as those commonly found on main lanes, could also be added as a dependent variable and a consistent OD estimator could be formulated. In this way, the  $L_2E$  estimator would be robust to malfunctions in any of the detectors. In addition, it was assumed in the model derivation that there was no prior information regarding the split proportion matrix. The model can also be generalized to incorporate prior information, which would help add “structure” to

the over-parameterized model and could potentially reduce the percentage error of the estimates.

## REFERENCES

- Ashok, K. 1996. Estimation and Prediction of Time-Dependent Origin-Destination Flows, Ph.D. Dissertation. Massachusetts Institute of Technology, Cambridge, MA.
- Basu, A., I. Harris, N. Hjort, and M. Jones. 1998. Robust and Efficient Estimation by Minimising a Density Power Divergence. *Biometrika* 85(3):549–59.
- Bell, M.G.H. 1991. The Real Time Estimation of Origin-Destination Flows in the Presence of Platoon Dispersion. *Transportation Research B* 25(2/3):115–25.
- Cascetta, E. 1984. Estimation of Trip Matrices from Traffic Counts and Survey Data: A Generalized Least Squares Estimator. *Transportation Research B* 22(4/5):289–99.
- Cascetta, E. and S. Nguyen. 1988. A Unified Framework for Estimating or Updating Origin/Destination Matrices from Traffic Counts. *Transportation Research B* 22(6):437–55.
- Chin, S., D.L. Greene, J. Hopson, H. Hwang, and B. Thompson. 1999. Towards National Indicators of VMT and Congestion Based on Real-Time Traffic Data. Paper presented at the 78th Annual Meetings of the Transportation Research Board, Washington, DC.
- Davison, A. and D. Hinkley. 1997. *Bootstrap Methods and Their Applications*. New York, NY: Cambridge University Press.
- Dixon, M. 2000. Incorporation of Automatic Vehicle Identification Data into the Synthetic OD Estimation Process, Ph.D. Thesis. Texas A&M University, College Station, TX.
- Gajewski, B. 2000. Robust Multivariate Estimation and Variable Selection in Transportation and Environmental Engineering, Ph.D. Thesis. Texas A&M University, College Station, TX.
- Gold, D.L., S.M. Turner, B.J. Gajewski, and C.H. Spiegelman. 2001. Imputing Missing Values in ITS Data Archives for Intervals Under Five Minutes. Paper presented at the 80th Annual Meetings of the Transportation Research Board, Washington, DC.
- Hampel, F., E. Ronchetti, P. Rousseeuw, and A. Werner. 1986. *Robust Statistics: The Approach Based on Influence Functions*. New York, NY: John Wiley and Sons.
- Huber, P. 1981. *Robust Statistics*. New York, NY: John Wiley and Sons.
- Maher, M.J. 1983. Inference on Trip Matrices from Observations on Link Volumes: A Bayesian Statistical Approach. *Transportation Research B* 17(6):435–47.
- McNeil, S. and C. Henderickson. 1985. A Regression Formulation of the Matrix Estimation Problem. *Transportation Science* 19(3):278–92.

Nihan, N.L. and M.M. Hamed. 1992. Fixed Point Approach to Estimating Freeway Origin-Destination Matrices and the Effect of Erroneous Data on Estimate Precision. *Transportation Research Record* 1357:18–28.

Park, E.S., C.H. Spiegelman, and R.C. Henry. 2002. Bilinear Estimation of Pollution Source Profiles and Amounts by using Multivariate Receptor Models (with discussions). *Environmetrics* 13:775–98.

Robillard, P. 1975. Estimating the OD Matrix from Observed Link Volumes. *Transportation Research* 9:123–28.

Scott, D.W. 1999. Parametric Modeling by Minimum  $L_2$  Error, Technical Report 98-3. Department of Statistics, Rice University, Houston TX.

Sherali, H.D., N. Arora, and A.G. Hobeika. 1997. Parameter Optimization Methods for Estimating Dynamic Origin-Destination Trip-Tables. *Transportation Research B* 31(2):141–57.

Terrell, G.R. 1990. The Maximal Smoothing Principle in Density Estimation. *Journal of the American Statistical Association* 85:470–7.

Turner, S., L. Albert, B. Gajewski, and W. Eisele. 1999. Archived ITS Data Archiving: Preliminary Analyses of San Antonio TransGuide Data. *Transportation Research Record* 1719:85–93.

Van Zuylen, H. 1980. The Most Likely Trip Matrix Estimation from Traffic Counts. *Transportation Research B* 16(3):281–93.

## APPENDIX

### Notation

The following notation serves as a reference guide throughout this paper:

$T$	Number of time periods. Each time period is of duration $\Delta t$ .
$p$	Number of destinations in the system.
$q$	Number of origins in the system.
$r$	Number of nonfeasible elements of $P$ .
$O$	Matrix of observed volumes from $q$ origins over $T$ time periods ( $T$ by $q$ ).
$D$	Matrix of observed volumes from $p$ destinations over $T$ time periods ( $T$ by $p$ ).
$O_t$	Row vector of observed volumes from $q$ origins from the $t^{\text{th}}$ row, $t = 1, 2, 3, \dots, T$ .

$D_t$	Row vector of observed volumes from $p$ destinations from the $t^{\text{th}}$ row, $t = 1, 2, 3, \dots, T$ .
$O_{tk}$	Element $(t, k)$ of the matrix $O$ , $t = 1, 2, 3, \dots, T$ ; $k = 1, 2, 3, \dots, q$ .
$P$	Split proportion matrix between $q$ origins and $p$ destinations ( $q$ by $p$ ).
$P_{kj}$	Proportion of vehicles that enter at origin $k$ and exit at destination ramp $j$ where $k = 1, 2, 3, \dots, q$ , and $j = 1, 2, 3, \dots, p$ .
$P_j$	Column vector of $q$ split proportions from the $j^{\text{th}}$ destination, $j = 1, 2, 3, \dots, p$ .
$\varepsilon$	Matrix of random errors with $n$ rows and $p$ columns.
$A^v$	Vectorization of matrix $A$ . The operator $A^v$ takes the columns of $A$ and stacks them on top of each other. For example,
	$\begin{bmatrix} 1 & 2 \\ 3 & 4 \end{bmatrix}^v = \begin{bmatrix} 1 \\ 3 \\ 2 \\ 4 \end{bmatrix}$
$\varepsilon^v$	Stacked version of $\varepsilon$ .
$\varepsilon_t$	Row vector of $p$ elements from the $t^{\text{th}}$ row of $\varepsilon$ , $t = 1, 2, 3, \dots, T$ .
$P^v$	Stacked version of $P$ .
$M$	Matrix that maps the elements of $P^v$ that are nonfeasible to zero. $M$ is of size $r \times qp$ .
$O^v$	Stacked version of the matrix $O$ .
$\otimes$	Kronecker product $A \otimes B = (a_{ij}B)$ .
$X^*$	The regressors used in the stacked model, $X^* = (I_p \otimes O)$ , $X^*$ is $Tp \times qp$ .
$G$	Equality constraint matrix.
$G = [G_1 G_2]$	Partition of $G$ into matrices $G_1$ and $G_2$ , where $rank(G) = rank(G_1) = q + r$ , and $G_1$ is $(q + r) \times (q + r)$ . $G_2$ is $(q + r) \times (pq - q - r)$ $G = \begin{bmatrix} 1'_p \otimes I_q \\ M \end{bmatrix}$
	Note that $G$ is permuted until $G_1$ is full rank.

$G_1$	The nonsingular portion of the constraint matrix $G$ .
$G_2$	The “left over” portion of the constraint matrix $G$ .
$P^\nu = \begin{bmatrix} P_1^\nu \\ P_2^\nu \end{bmatrix}$	Partition of $P^\nu$ such that the elements correspond to $[G_1 G_2]$ . The size of $P_1^\nu$ and $P_2^\nu$ are $r + q$ and $pq - r - q$ , respectively.
$P_1^\nu$	The portion of $P^\nu$ that corresponds to $G_1$ .
$P_2^\nu$	The portion of $P^\nu$ that corresponds to $G_2$ .
$X^* = [X_1^* X_2^*]$	Partition of $X^*$ such that the elements correspond to $[G_1 G_2]$ .
$1_q$	Column vector of $q$ ones.
$0_r$	Column vector of $r$ zeros.
$g$	$GP^\nu = g$ , where $g = \begin{pmatrix} 1_q \\ 0_r \end{pmatrix}$ .
$\sigma^2 I_p$	Variance for each row of $\varepsilon$ .
$Y_2$	$Y_2 = Y - X_1^* G_1^{-1} g \cdot (Tp \times 1)$ .
$Y_{2t}$	The $t^{\text{th}}$ element of $Y_2$ .
$W_2$	$W_2 = (X_2^* - X_1^* G_1^{-1} G_2) \cdot (Tp \times (pq - q - r))$ .
$W_{2t}$	The $t^{\text{th}}$ row vector of $W_2$ .
$Z$	$Z = Y_r / \sigma \cdot (Tp \times 1)$ .
$Z_t$	The $t^{\text{th}}$ element of $Z$ .
$U$	$U = \frac{W_2}{\sigma} \cdot (Tp \times (pq - q - r))$ .
$U_t$	The $t^{\text{th}}$ row vector of $U$ .
$W_{2tk}$	The $(t,k)$ element of $W_2$ .
$\delta$	$\delta = \frac{\varepsilon^\nu}{\sigma} \cdot (Tp \times 1)$ .
$\hat{P}_2^{\nu \text{LS}}$	Estimated vector of $\hat{P}_2^\nu$ using least squares.
$\hat{P}_2^{\nu \text{L}_2\text{E}}$	Estimated vector of $\hat{P}_2^\nu$ using $\text{L}_2\text{E}$ .
$\psi(\cdot)$	Influence function (see Hampel et al. 1986).
$\rho(x)$	$\rho(x) = \int_{-\infty}^x \psi(z) dz$
$N(\mu, \sigma^2)$	Normal distribution with mean $\mu$ and variance $\sigma^2$ .

## Detail Theory

### Step 1

*Condition 1.* The split proportions ( $P$ ) are positive for all feasible origin and destination combinations and equal to zero for all nonfeasible combinations.

Therefore the general model is written algebraically as follows:

$$D = OP + \varepsilon$$

where  $P \in \{P_{kj} \geq 0, \sum_j P_{kj} = 1 \text{ and condition 1}\}$

and

$$\varepsilon_t^{iid} \sim (0, \sigma^2 I_p).$$

The detailed derivation of the  $\text{L}_2\text{E}$  objective function is

$$\begin{aligned} \min_P F_{L_2E} &= \min_P \left\{ \int_{-\infty}^{\infty} [f(D_{ij}|O_t P_j) - f(D_{ij}|O_t P_0)]^2 dD_{ij} \right\} \\ &= \min_P \left\{ \int_{-\infty}^{\infty} f^2(D_{ij}|O_t P_j) dD_{ij} - 2E[f(D_{ij}|O_t P_j)] + \int_{-\infty}^{\infty} f^2(D_{ij}|O_t P_0) dD_{ij} \right\} \\ &\approx \min_P \left\{ \int_{-\infty}^{\infty} [f(D_{ij}|O_t P_j)]^2 dD_{ij} - \frac{2}{Tp} \sum_{t=1}^T \sum_{j=1}^p f(D_{ij}|O_t P_j) \right\}. \end{aligned} \quad (\text{A1})$$

Because the third component in the second line of equation A1 does not have the optimization parameter  $P$  (but only the true parameter  $P_0$ ), it can be taken as a constant and ignored during optimization. The empirical density function is used to estimate the expectation in the second line of equation A1 (Scott 1999).

Details of the following results appear in Gajewski (2000). The error structure for the reduced problem is shown in equation A2.

$$\varepsilon^\nu \sim (0, \sigma^2 I_{Tp}) \quad (\text{A2})$$

Therefore, equation A3 provides the estimate of the reduced regression parameters under LS, and it can be seen that it is unbiased.

$$\begin{aligned}\hat{P}_2^{\nu LS} &= (W_2'W_2)^{-1}W_2'Y_2 \\ E(\hat{P}_2^{\nu LS}) &= (W_2'W_2)^{-1}W_2'W_2P_2^\nu = P_2^\nu\end{aligned}\quad (A3)$$

The variance of this estimate is shown in equation A4.

$$\begin{aligned}Var(\hat{P}_2^{\nu LS}) &= Var((W_2'W_2)^{-1}W_2'Y_2) \\ &= Var((W_2'W_2)^{-1}W_2'(Y - X_1^*G_1^{-1}g)) \\ &= (W_2'W_2)^{-1}\sigma^2\end{aligned}\quad (A4)$$

Note that equations A3 and A4 are based on the assumption that  $W_2$  is full rank. Lemma 1 relates the rank of the origins,  $O$ , to that of the rank of  $W_2$ .

*Lemma 1:* If  $O$  is full rank, then  $W_2$  is full rank. (See Gajewski (2000) for proof.)

Note that it is assumed that there will be multiple days' worth of data and multiple time periods in each day. Therefore, the variation of volume between days and within days causes  $O$  to be full rank and therefore  $W_2$  is full rank.

Similar to the variance of the estimates in equation A4, the variance estimates for  $\hat{P}_1^{\nu LS}$  are presented in equations A5 and A6.

$$\begin{aligned}Var(\hat{P}_1^{\nu LS}) &= Var(G_1^{-1}(g - G_2P_2^{\nu LS})) \\ &= G_1^{-1}G_2Var(P_2^{\nu LS})G_2'G_1^{-1}\end{aligned}\quad (A5)$$

The covariance between the estimates  $\hat{P}_2^{\nu LS}$  and  $\hat{P}_1^{\nu LS}$  are shown in equation A6.

$$\begin{aligned}Cov(\hat{P}_1^{\nu LS}, \hat{P}_2^{\nu LS}) &= Cov(G_1^{-1}g - G_1^{-1}G_2\hat{P}_2^{\nu LS}, \hat{P}_2^{\nu LS}) \\ &= -G_1^{-1}G_2Var(\hat{P}_2^{\nu LS}) \\ &= -G_1^{-1}G_2(W_2'W_2)^{-1}\sigma^2\end{aligned}\quad (A6)$$

Notice that the reparameterization causes the problem to be unconstrained except for the non-negativity constraints. When deriving the asymptotic distributions of the estimators  $P_2^\nu$ , it is

assumed to be in the interior of the parameter space. From a physical viewpoint, this means that the true split proportion over the long term would never lie on the boundary (i.e., be equal to zero) for a feasible OD pair. It is assumed that this assumption is valid on the highway networks where most ITS traffic monitoring devices are located. In addition, if this assumption is violated, the origins and destinations can be combined to alleviate the problem. Regardless, this assumption will need to be checked when applying the model.

The asymptotic distributions for the two estimation methods are derived using properties of  $M$ -estimators (Huber 1981). Equation A7 shows the  $L_2E$  model. As discussed,  $\sigma$  is estimated prior to using equation A7. Let  $N(A, B^2)$  be the normal probability density function with a mean of  $A$  and variance  $B^2$ , then

$$\begin{aligned}\arg \min_p F_{L_2E} &= \\ \arg \min_p \left\{ \frac{1}{2\sqrt{\pi}\sigma} - \frac{2}{Tp} \sum_{t=1}^T \sum_{j=1}^p N(D_{ij} - O_t P_j, \sigma^2) \right\} & \quad (A7) \\ = \arg \min_p \left\{ -\frac{2}{Tp} \sum_{t=1}^T \sum_{j=1}^p N(D_{ij} - O_t P_j, \sigma^2) \right\}\end{aligned}$$

with

$$P \in \{P_{kj} \geq 0, \sum_i P_{kj} = 1 \text{ and condition 1}\}$$

A reparameterized model may be obtained by using the variance to standardize the model. Let  $Z = Y_2/\sigma$  and  $U = W_2/\sigma$ . Therefore, the reparameterized reduced model will be  $Z = UP_2^\nu + \delta$  where  $\delta \sim (0, I_{Tp})$  where and the objective function, is shown below:

$$\min_{P_2^\nu} F_{L_2E} = \min_{P_2^\nu} \sum_{i=1}^{Tp} \left\{ -\exp\left(-\frac{Z_i - U_i P_2^\nu}{2}\right) \right\} \quad (A8)$$

Because the  $L_2E$  is an  $M$ -estimator, the distribution properties are straightforward to derive and will be useful in the derivations of the distribution.

*Definition 1:* (Huber 1981): For a sample  $x_1, x_2, \dots, x_T$  from the sample space  $F$ , the  $M$ -estimate corresponding to  $\psi$  is the “statistical function”  $\psi(F_t)$ , that is, a solution  $V_T$  of the equation:

$$\sum_{t=1}^{T_p} \psi(x_t, V_T) \quad (A9)$$

The  $L_2E$  estimator is an  $M$ -estimator because of a calculation of the derivative of the objective function.

*Property 1:*  $F_{L_2E}$  is an  $M$ -estimator (see Gajewski (2000) for proof).

Huber (1981, p. 165) proves the asymptotic properties for the reduced model of the form  $Z = UP_2^v + \delta$ . Note that this proof assumes  $\delta_i \stackrel{iid}{\sim} (0,1)$  and the three regularity conditions, referred to as RC1 to RC3, are met.

*Property 2:* Regularity conditions RC1 to RC3 hold for the OD problem (see Gajewski (2000) for proof).

Theorem 1 shows the distribution of the LS estimator in a linear model setting is asymptotic normal.

*Theorem 1:* (Huber 1981, p. 159)

If  $h = \max_i h_i \rightarrow 0$ , then all the LS estimates

$$\hat{\alpha} = \sum_{j=1}^p a_j \hat{P}_{2j}^{vLS} = a' \hat{P}_2^{vLS} \quad \text{are asymptotically normal.}$$

Theorem 1 states that asymptotic normality holds for both objective functions in this paper. Therefore, the identification of the mean and variance define the asymptotic distribution.

Using Theorem 1, the LS variance is calculated as shown in equation A10.

$$\text{Var}(\hat{P}_2^{vLS}) = (U'U)^{-1} \quad (A10)$$

Similarly, the variance for the  $L_2E$  is shown in equation A11.

$$\text{Var}(\hat{P}_2^{vL_2E}) = \frac{E[\psi^2]}{(E[\psi'])^2} (U'U)^{-1} \quad (A11)$$

Note that, in order to use equation A11, the errors need to be identified. For example, if it is assumed that the error distribution is normal,

Property 3 shows the exact value of the ratio  $\frac{E[\psi^2]}{(E[\psi'])^2}$ .

*Property 3:* Suppose  $\delta \sim N(0, I_{T_p})$ , then

$$\text{a) } E[\psi^2] = \frac{1}{3\sqrt{3}} E(\psi^2) = 1 / (3\sqrt{3}).$$

$$\text{b) } E[\psi'] = \frac{1}{2\sqrt{2}}$$

$$\text{and therefore } \frac{E[\psi^2]}{(E[\psi'])^2} = \frac{8}{3\sqrt{3}}$$

(See Gajewski (2000) for proof.)

If the error distribution is non-normal then an approximation is used, as shown in the Remark.

*Remark:* The nonparametric estimation of the above equation is:

$$\frac{E[\psi^2]}{(E[\psi'])^2} = \frac{\sum_{t=1}^T \psi_i^2 / T}{\left(\sum_{t=1}^T \psi_i' / T\right)^2} = T \frac{\sum_{t=1}^T \psi_i^2}{\left(\sum_{t=1}^T \psi_i'\right)^2}$$

(See Gajewski (2000) for proof.)

The asymptotic distributions are stated in Corollary 1 for completeness.

*Corollary 1:* Let  $a$  be a fixed vector. Under the conditions of the above models and the regularity conditions RC1–RC3, equations A12 and A13 are

the asymptotic distributions for the LS and L<sub>2</sub>E objective functions, respectively:

$$a' \hat{P}_2^{\nu LS} \sim N\left(a' P_2^\nu, \sigma^2 a' (W_2' W_2)^{-1} a\right) \quad (A12)$$

$$a' \hat{P}_2^{\nu L_2E} \sim N\left(a' P_2^\nu, \sigma^2 a' \frac{E[\psi^2]}{(E[\psi'])^2} (W_2' W_2)^{-1} a\right) \quad (A13)$$

(See Gajewski (2000) for proof.)

Based on the distributional properties shown in Corollary 1, the L<sub>2</sub>E method is less efficient than the LS method as shown in Corollary 2.

*Corollary 2:* When  $\varepsilon_1 \sim N(0, \sigma^2 I_p)$ , then for every  $b$  (fixed vector),

$$\text{Var}(b' \hat{P}^{\nu LS}) \leq \text{Var}(b' P^{\nu L_2E}) \quad (A14)$$

(See Gajewski (2000) for proof.)

Note that the nonparametric formula shown in the Remark is preferred when the parametric distribution of the error is not known.

# Calibration of Intercity Trip Time Value with a Network Assignment Model: A Case Study for the Korean NW-SE Corridor

ILJOON CHANG

GANG-LEN CHANG

University of Maryland, College Park

## ABSTRACT

This paper presents an innovative method for estimating the value of time (VOT) for intercity travelers with aggregate mode choice and origin-destination distribution data. The proposed method employs a network structure to capture the temporal and spatial interrelations of daily intercity trips among competing transportation modes. It is grounded on the assumption that the current trip and mode distributions in a regional corridor are close to a “user-optimum” state, where all tripmakers have nearly perfect information about the fares and schedules of all competing transportation modes and mostly employ the criterion of minimum total trip cost in their tripmaking decision. One can thus compare the current market share of each transportation mode with the estimated results to identify the best-fit VOT distribution. To realistically capture the competing environment for intercity trip decisions, the proposed method has incorporated not only the system performance factors (e.g., speed, capacity, and fare) in the modeling structure, but has also formulated the VOT as a distribution rather than a constant value across all system users. With the data from the northwest-southeast corridor of Korea, we have demonstrated that our proposed method has the potential to

---

Gang-Len Chang, Department of Civil Engineering, University of Maryland, College Park, MD 20742. Email: gang@glue.umd.edu.



circumvent the need to estimate time value with disaggregate surveys.

## INTRODUCTION

Despite the well-recognized role of value of time (VOT) in tripmaking decisions (e.g., departure time, route choice, and the selection of transportation modes), finding a reliable method for estimating VOT for a target population remains a challenging task. Over the past several decades, a large body of research has focused on this issue, mostly addressing it in terms of tripmaking behavior (Bruzelius 1979; Watson 1974; Moses and Williamson 1963; Hensher 1977; Earp et al. 1976) or from a microeconomic perspective (Jara-Diaz 1998; Gonzalez 1997; Gronau 1976; Senna 1994; Stopher 1976). For instance, one popular method for contending with this issue is to use stated preference and/or revealed preference from the disaggregate survey data. Such approaches, although theoretically appealing, are difficult to put in practice because of the high survey cost and potentially significant sampling as well as nonsampling survey errors. The quality of behavior-related surveys is difficult to control in developing countries due to low response rates and sample sizes that are insufficient for rigorous and unbiased analysis.

In contrast to the lack of data at a disaggregate level, aggregate data such as trip origin-destination (OD), fare, and travel time are mostly available from the operating agency of each transportation mode. For instance, we found in the study of high-speed rail (HSR) in Korea that market share information for each transportation mode for each OD is quite complete and reliable at the aggregate level. Thus, to circumvent the difficulties and costs associated with performing new disaggregate surveys, we developed a network-based method that can take full advantage of these valuable data for VOT estimation as well as HSR market share prediction. This paper will focus on our proposed network-based method for the calibration of VOT for tripmakers in the northwest-southeast (NW-SE) corridor of Korea.

## BACKGROUND AND SYSTEM CHARACTERISTICS OF THE KOREAN TRANSPORTATION NETWORK

The NW-SE transportation network is in the most populous region of Korea, which is to be served by

FIGURE 1 Korean Transportation Network

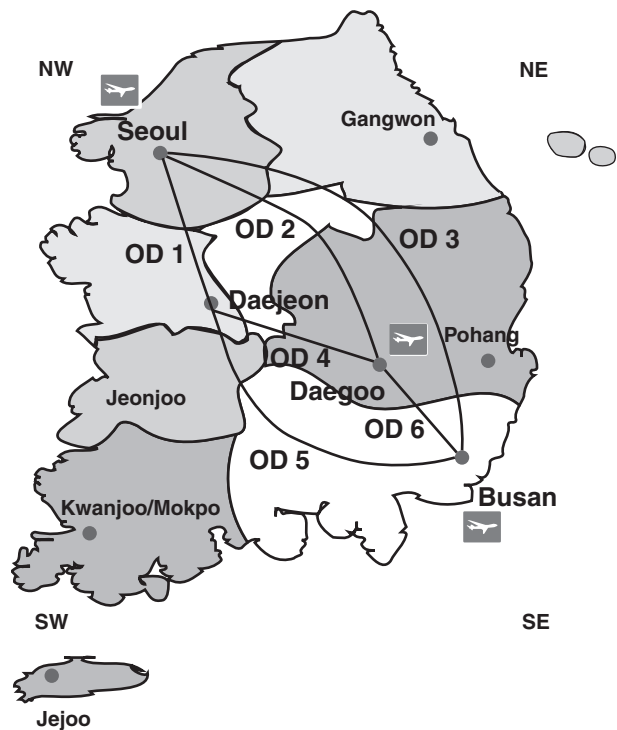

the new HSR system. As shown in figure 1, the NW-SE corridor connects major cities in Korea, including Seoul, Daejeon, Daegoo, and Busan. Between each city pair along this corridor, both the highway and the conventional rail networks are available. The airline system, however, is available only between Seoul, Daegoo, and Busan.

As shown in table 1, the total length of the NW-SE highway network along this corridor is 267.50 miles. Seoul and Daejeon are connected through a 95.25-mile-long highway. From Daejeon to Daegoo, a four-lane highway runs about 88 miles (table 2). The last segment, from Daegoo to Busan, is a four-lane highway of 83.94 miles. The NW-SE railway network is mostly parallel to the highway network and has about the same trip distance.

All the aggregate datasets for the calibration of time values are available including current market share, fare, trip distance, capacity, and travel speed. Each dataset is presented briefly below. For more convenient comparison, table 3 converts the trip segments into OD pair numbers, and figure 2 shows the current weekday market shares of the airline, highway, and conventional rail modes along the NW-SE corridor for three OD pairs from Seoul. Among those three OD pairs, we consider three dis-



**TABLE 1 The Distribution of Highway Link Lengths Between Major Cities in the NW-SE Corridor of Korea (In miles)**

	Seoul	Daejeon	Daegoo	Busan
Seoul	—	95.25	183.56	267.50
Daejeon	95.25	—	88.31	172.25
Daegoo	183.56	88.31	—	83.94
Busan	267.50	172.25	83.94	—

**TABLE 2 Distribution of Lanes of the NW-SE Highway Network**

	Number of lanes
Seoul to Daejeon	6
Daejeon to Daegoo	4
Daegoo to Busan	4

Note: All lanes are one direction only and the reverse directions have the same numbers of lanes.

tances: short distance, middle distance, and long distance. The shortest distance trip from Seoul in the network is OD pair 1. The long-distance trip is OD pair 3, and the mid-distance trip is OD pair 2. Some trips such as OD pairs 4 and 6 are shorter than OD pair 1, but those trips are not considered in this market share comparison for the moment. As can be seen in figure 2, about the same percentage of tripmakers use the highway and the conventional rail modes for OD pair 1. As the trip distance increases, travel by air becomes increasingly attractive to tripmakers. In contrast, for long-distance trips (i.e., OD 3), tripmakers rarely use the highway system, and about 78% of the total trips are by air.

The current fare for each transportation mode by OD pair is shown in table 4 and in figure 3, which show that the highway fare is about 31% of the fare of the airline system, and the fare for conventional rail is about 52% of that of the air mode for OD 3. Although transportation system operators may charge different fares according to travel times and ages of travelers, this research focuses on the non-discounted regular fare of each mode.

Table 5 summarizes travel time and daily capacity of conventional rail and air by trip segment. The capacity of the highway mode is assumed to be 2,200 passenger cars per hour per lane, and if one

assumes that the highway is in use 18 hours per day from 6 am until midnight then the capacity is 39,600 passenger cars per day per lane. We further assume, for convenient computation, that each car carries one passenger. The capacity of the airline system is based on its actual service schedules and the available types of aircraft.

### BASIC ASSUMPTIONS OF THE MODEL

This paper presents an innovative method for estimating VOT distribution among the competing transportation mode users along the NW-SE corridor of Korea. We assumed several key factors in this new method:

- Every trip began at 6 am and finished by midnight.
- Those who could not finish their trips within a one-day period were stored in a dummy city for new trips on the following day.
- Time periods (or time intervals) were established for every two-hour period, and a one-day trip had a total of nine time periods.
- For the highway system, we assumed that all vehicles were passenger cars and one passenger was in each vehicle. Buses and other modes available along the highway system were excluded in this research but can be added in subsequent research.
- Highway mode users were only concerned about their toll costs and ignored expenditures for fuel, maintenance, and other costs in making their modal choices. This assumption may distort the estimation, but the main purpose of our research is to introduce a new method to investigate VOT distribution, not to investigate the actual VOT distribution among tripmakers in a proposed area.

**TABLE 3 OD Pair Numbers and Trip Segment of the NW-SE Corridor**

Trip segment	Seoul–Daejeon	Seoul–Daegoo	Seoul–Busan	Daejeon–Daegoo	Daejeon–Busan	Daegoo–Busan
OD	OD 1	OD 2	OD 3	OD 4	OD 5	OD 6

**FIGURE 2 Current Weekday Market Share of the Korean Network**

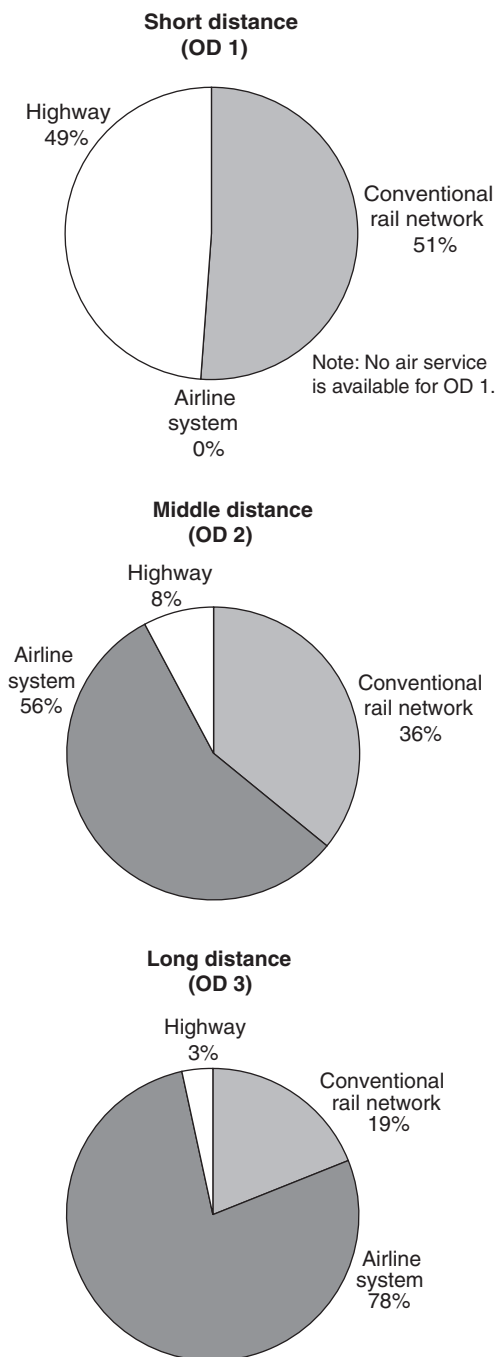

Although the assumptions above may hinder the ability to accurately capture real modal choice decisions on the proposed network, the purpose of our research is rather to introduce a new method to estimate VOT distribution of tripmakers. Once the network-based model is established, however, it is very easy to add or drop networks, transportation modes, and other variables such as gas, tolls, insurance, and maintenance costs.

**TABLE 4 Fare (or Toll) of Each Transportation Mode by OD Pair (U.S. \$/trip)**

	OD 1	OD 2	OD 3
Highway <sup>1</sup>	5.25	9.50	12.92
Air	N/A	34.17	42.08
Conventional rail	8.25	16.17	21.92

<sup>1</sup> The highway "fare" only includes tolls. It does not include other highway costs such as fuel, insurance, depreciation etc.

Note: All fares are for one-way trips.

### CALIBRATION OF VOT DISTRIBUTION FOR CURRENT MODE USERS

Because VOT is one of the key unknown factors that determine a tripmaker's modal choice decision, we developed a network-based method for VOT calibration based on the current distribution of trips among available transportation modes.

Our method is based on the assumption that all tripmakers intend to minimize their own travel costs, which consist of both fares and travel times. Thus, the current market distribution among available transportation modes for all OD demands can be viewed as a "user-optimum" state similar to that in a traffic assignment context. The method described below employs the "user-equilibrium" notion from traffic assignment but uses a time-space network to capture temporal and spatial interactions among different competing transportation modes and OD demands.

More specifically, our proposed model was developed to capture the following key features of a regional corridor offering several competing transportation modes for travelers making intercity trips:

- tradeoff between travel time and fare for each transportation mode and among all competing transportation modes;
- capacity and operational constraints of each transportation mode in the model formulation;
- generalized trip costs, such as speed, access time, and competition among the modes, based on the performance level of all transportation modes;
- temporal and spatial relationships of trips departing at different origins at different times of a day; and
- variation of the VOT across the population rather than viewing it as a constant.

**FIGURE 3 Fare Comparison of Each Mode by Trip Segment**

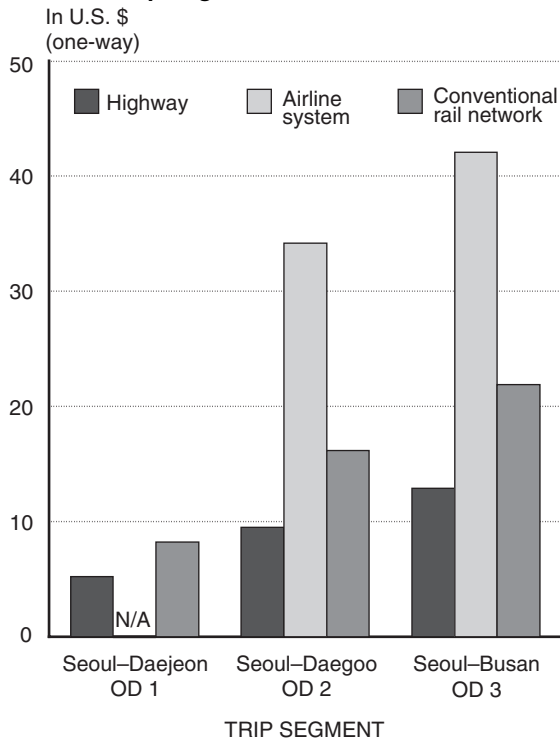

A detailed discussion of the proposed method for VOT calibration in the Korean NW-SE corridor is presented below.

**Steps in Calibrating VOT Distributions**

- Step 1:* Select the initial VOT parameters for the target population.
- Step 2:* Construct a time-space operations model within each transportation mode and between competing transportation modes to estimate the current trip distribution.
- Step 3:* Design a set of experimental scenarios with a list of candidate VOT parameters.
- Step 4:* Estimate the user-optimum state of trip distribution among current transportation modes with the existing software (T-2)

under each experimental scenario (see appendix).

*Step 5:* Compute the VOT parameters for current users, based on the discrepancies between the projected and actual market shares of all transportation modes over all OD pairs under all experimental scenarios.

**Selection of Initial VOT Parameters**

Although it is fully recognized that VOT theoretically should be a marginal wage rate (Gonzalez 1997), there is no standard tool for its estimation without a reliable representation of the total income and budget for the entire economy. As an initial step in determining the optimal mean VOT parameter, we assumed that it must lie within the 10<sup>th</sup> and the 90<sup>th</sup> percentile range of the resident income distribution of the Korean residents in the NW-SE corridor.

Data from the Korean Statistics Bureau indicated that the mean monthly income of the Korean population along the NW-SE corridor was \$2,248 in 1999, equivalent to an average income of 20¢ per minute. The 10<sup>th</sup> percentile of resident income is \$563 per month, about 5¢ per minute, and the 90<sup>th</sup> percentile of resident income is \$5,295 per month, or about 46¢ per minute.

**Construction of the Time-Space Operations Network**

Based on the datasets illustrated earlier, this step develops a time-space operations network of all available transportation modes in the regional corridor. As shown in figure 4, three transportation modes (air, highway, and conventional rail) and three airports (nodes 5, 6, and 7) are available in the NW-SE corridor of Korea. Station nodes 5, 8, and 12 are located in the same city (Seoul), denoted as city node 1 in the figure.

**TABLE 5 Air and Conventional Rail Travel Time and Daily Capacity by OD Pair**

	OD 1	OD 2	OD 3	OD 4	OD 5	OD 6
Conventional rail	91 (13,564)	182 (27,128)	250 (38,316)	90 (13,564)	158 (24,752)	66 (11,188)
Air	N/A (N/A)	55 (1,726)	65 (9,500)	N/A (N/A)	N/A (N/A)	N/A (N/A)

Note: The top number in each cell is travel time in minutes.  
The bottom number in parentheses in each cell is daily capacity (persons per day).  
Air capacity is based on actual service schedules and types of aircraft.

**FIGURE 4 Korean Transportation Network Configuration**

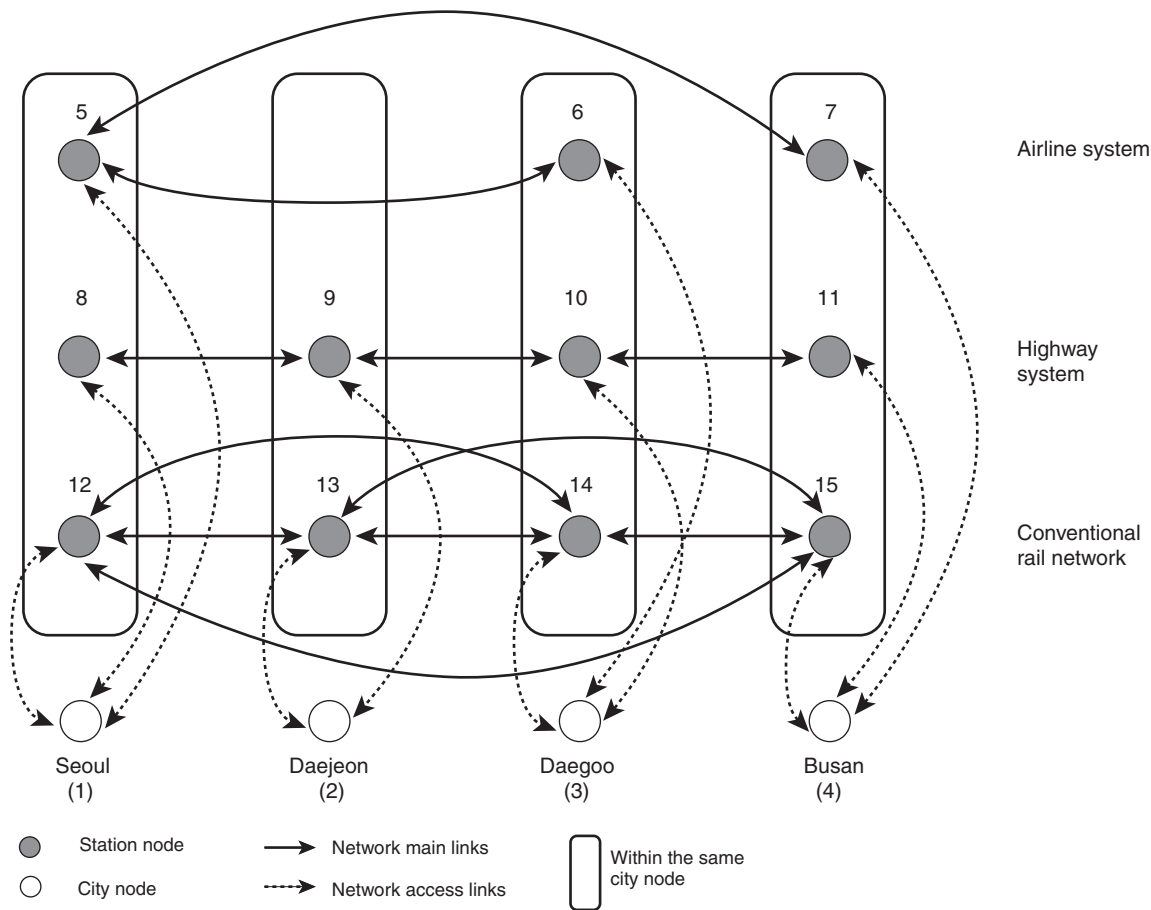

By incorporating the time-varying demand and the capacity constraint for each transportation mode over each link, it is possible to convert figure 4 into a time-space network that represents the supply-demand relationships within each transportation mode and between competing modes. Note that the demand constraints are based on the collected trips for each OD pair and the link capacity constraints are based on the capacity of each available transportation mode during each time interval. The time-space network can be illustrated in a two-dimensional plane where the x-axis stands for the location and the y-axis for time. The core modeling concepts of the time-space operations network are summarized as follows:

- **Nodes** along the horizontal axis show different locations of stations or cities in the network, while the vertical axis shows the lapse of time. Thus, connections along the horizontal axis represent the movements between different locations within the same two-hour time period. Connections along the vertical axis illustrate the move-

ments between different time periods at the same location. Connections in the diagonal direction represent movements between different locations and across different time periods.

- **Access and main links** are specified in the network. Access links are used to connect trips from origin cities to station cities, including waiting times, and main links are used for connecting trips between station nodes.
- **Link cost** is considered as the general cost (i.e., fare and travel time) of the transportation mode on a main link and is computed as the sum of the out-of-pocket cost and the travel time cost (see equation 2 later in this paper). Cost of the access links captures waiting time before departure.
- **Link capacity** reflects the physical capacity constraint of each transportation mode at different time intervals and locations during its operation.
- **Origin nodes** capture those trips originating from each city and terminating at a set of potential destination cities over a time horizon.

**FIGURE 5 Korean Airline System Time-Space Diagram for Three Time Periods**

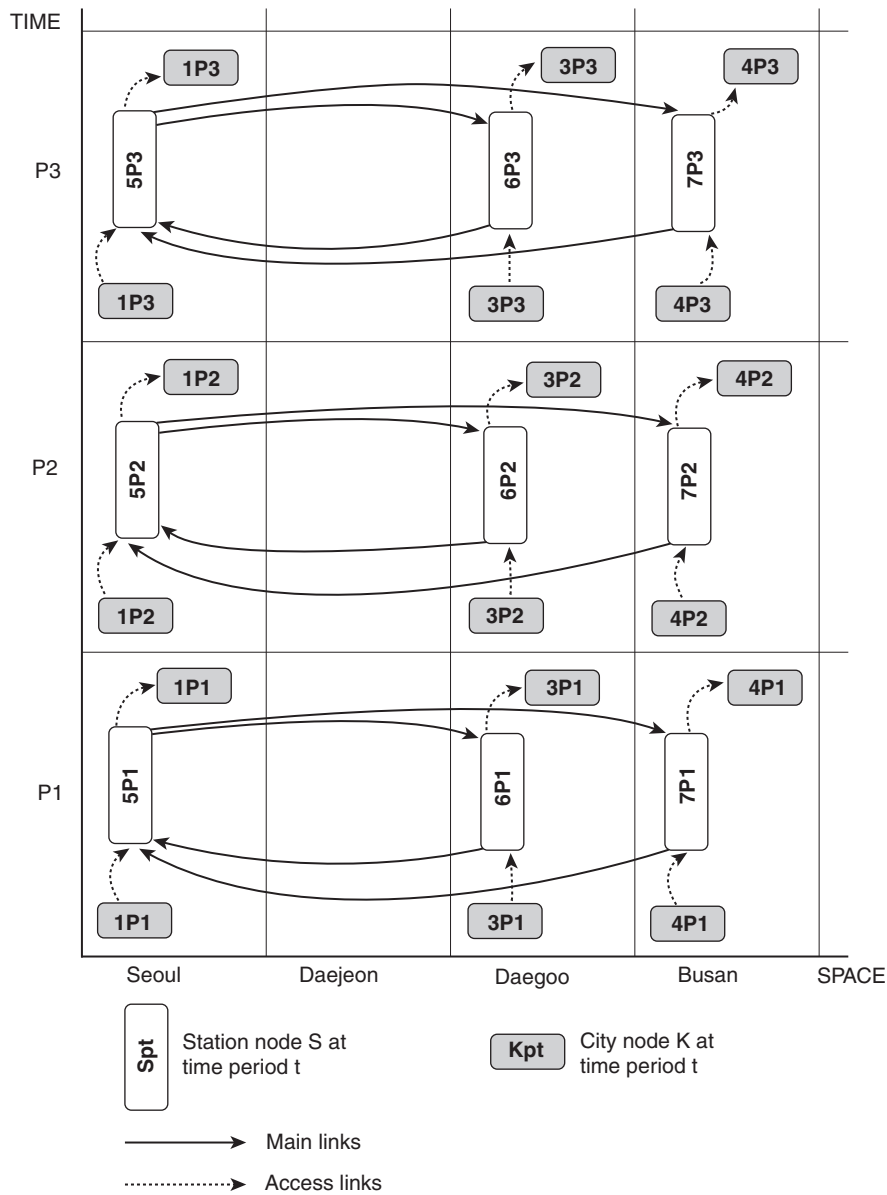

■ **Dummy nodes** capture trips that cannot be finished within a one-day time period and serve as a supplemental set of origin nodes for tripmakers continuing their journeys the next day.

With these standard network formation concepts, we constructed the time-space operational relation between competing transportation modes. An example of the time-space operations network for the air mode for three time periods is presented in figure 5. Node 1P1 stands for city node 1 (in Seoul) at time period 1. Trips are generated from the city node (i.e., 1P1), and waiting times in the air mode are captured in the access link connecting city node 1P1 and station node 5P1. The main link from

the station node in Seoul at time period 1 (5P1) to the station node in Daegoo at time period 1 (6P1) represents the trips from Seoul to Daegoo by air. Since this service is scheduled and takes less than two hours, all such trips can be finished within the same time period. Tripmakers arriving at station node 6 in time period 1 will finish their trips at city node 3 (3P1) in the same time period.

Note that for the airline network, its time-space interrelations are identical during all periods, because all trips using this mode can be finished within one two-hour time period. In this research, each time period covers two hours (as stated earlier), based on the available aggregation of the OD

**FIGURE 6 Conventional Rail System Time-Space Diagram for Three Time Periods**

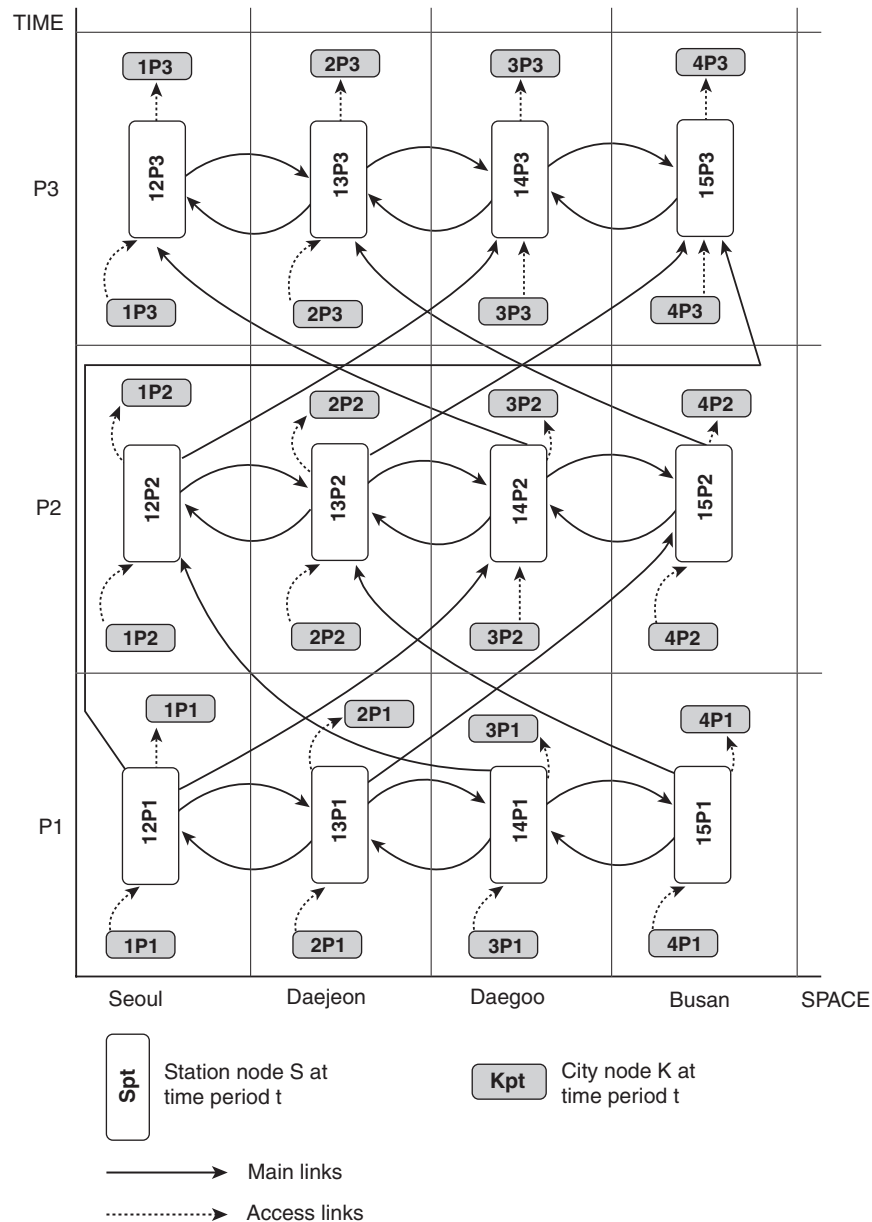

demand data. Certainly, one can further divide the time period into 30-minute segments, for instance, if OD demand data are available for such short intervals.

Most trips via conventional rail cannot be completed within one time period due to this mode's slower travel speed; thus, its time-space operations vary from one period to the next as shown in figure 6. Trips are generated from the city node in Seoul at time period 1 (1P1). Just as in the air case, waiting times are captured in the access link connecting 1P1 and 12P1, which is the conventional rail station node in Seoul at time period 1. Because travel time from Seoul to Daegoo (OD 2) by the rail mode

takes 182 minutes (as shown in table 5), the traveler will end up in Daegoo at time period 2 (14P2). Trips from Seoul to Busan take more than four hours, so trips starting from Seoul in time period 1 will arrive at Busan in time period 3 (15P3). One can follow the same procedures to construct the time-space operations network for the highway system as shown in figure 7.

All three sub-networks are then connected through their common demand nodes, as illustrated in figure 8, and constitute the entire operational network for the three transportation modes. For convenience, figure 8 only shows the demand from time period 1 and location node 1. Combining those

**FIGURE 7 Highway System Time-Space Diagram for Three Time Periods**

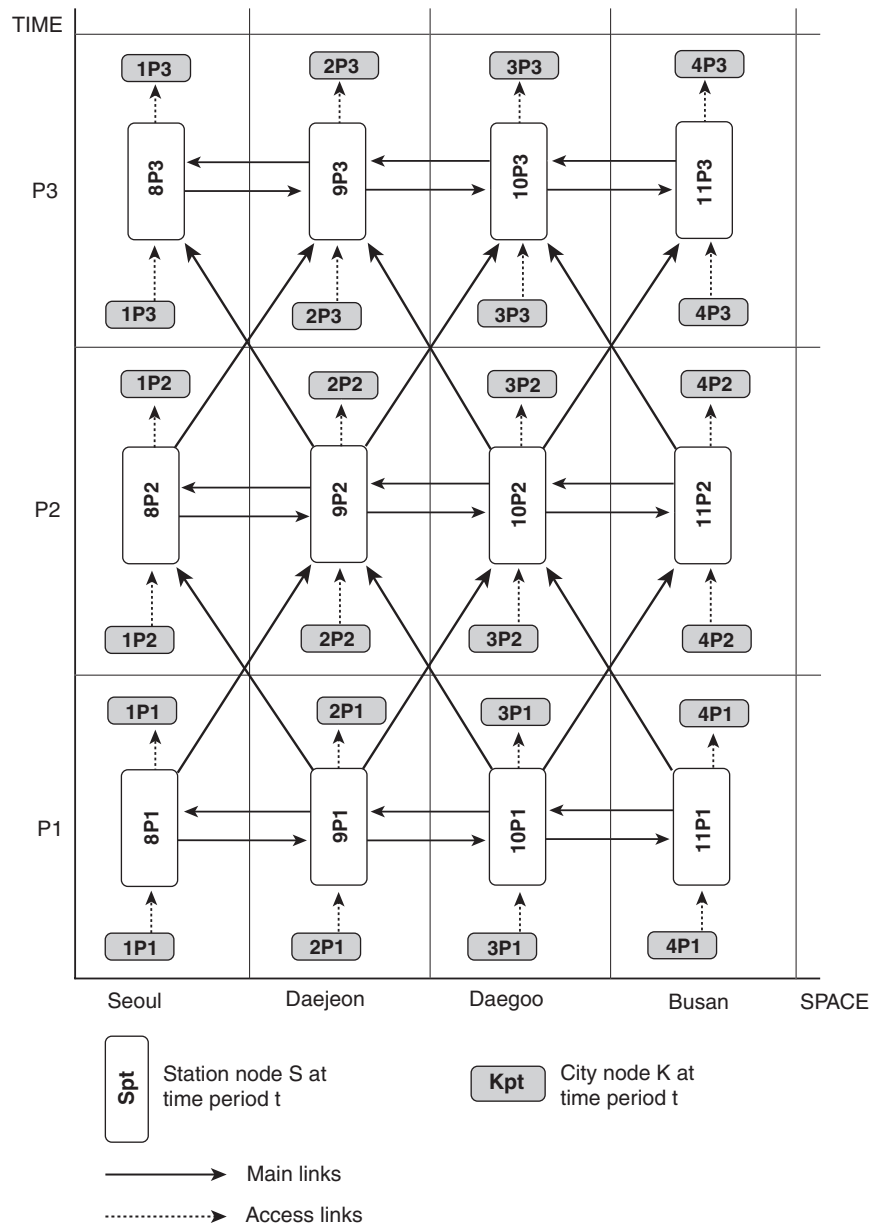

three sub-networks reflects the fact that travelers in each OD pair can choose any of the three available transportation modes. In brief, the time-space network model is constructed with the following data:

- network topology;
- fare for each transportation mode;
- current trip demand between every OD pair;
- capacity of each transportation mode; and
- VOT probability density function (PDF) of the current travelers.

Note that a normal PDF starts with its parameters set to initial values, and these values are evaluated

and redefined through the calibrating process. Also note that the demand node of figure 8 is an artificial node that simply generates demands.

As mentioned previously, with our time-space network relationship, current intercity trip distribution among transportation modes can be viewed as similar to the user-optimum state in the context of urban traffic assignment. Hence, similar algorithms for a user-optimal solution can be employed to solve the large time-space network and compute all estimated market shares between all OD pairs and transportation modes. The objective function of the proposed operational network is specified as follows:

FIGURE 8 Connection of Sub-networks for Time Period 1 and Location Node 1

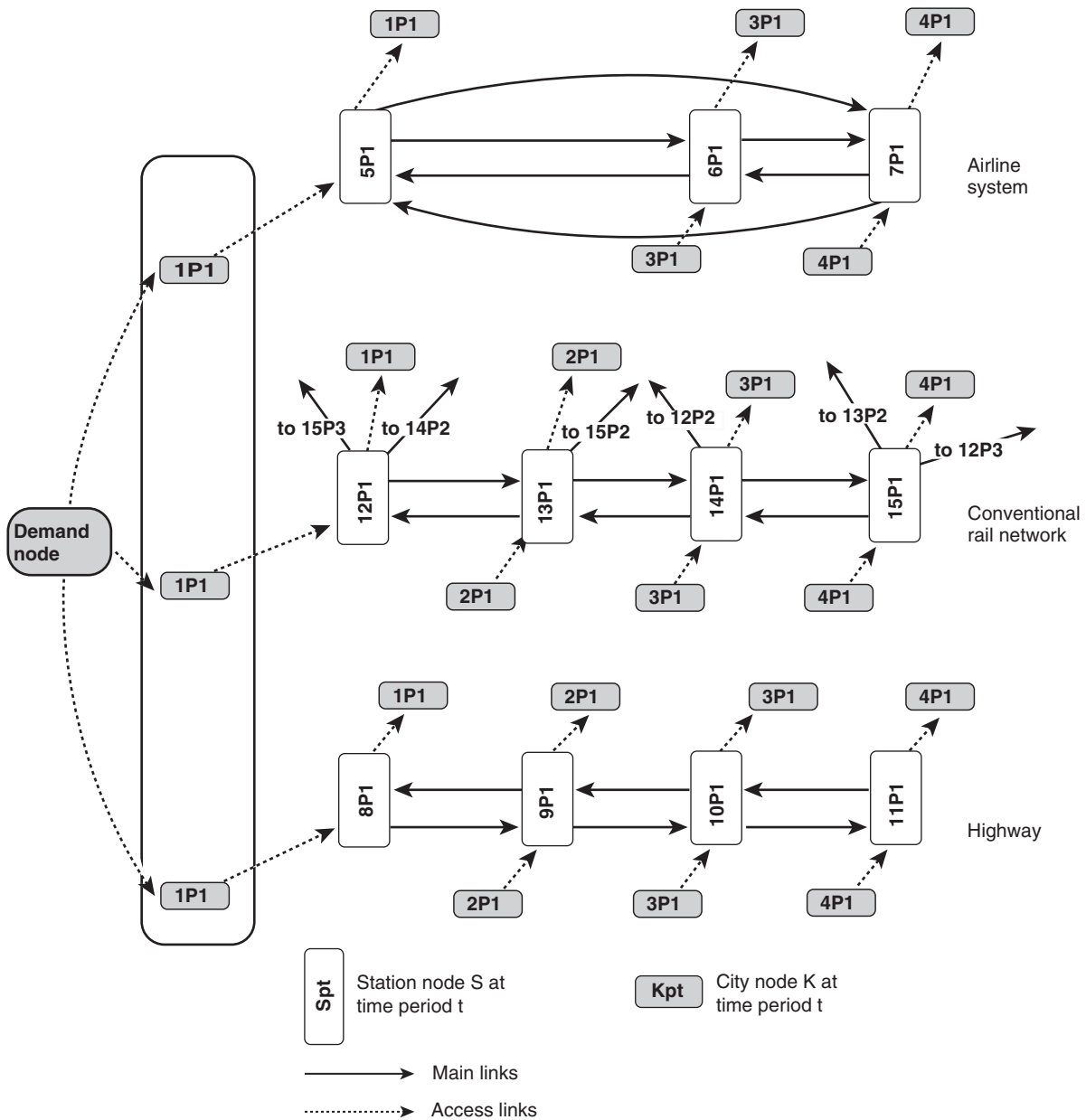

$$\text{Min}_{[AllTrips]} [\text{Total Generalized Cost}] \quad (1)$$

It can further be expressed mathematically as

$$\text{Min}_{x_{i,j}^{r,s}} \int_{\alpha} \sum_{r,s} \sum_{i,j} (c_{i,j}^{r,s} + \alpha t_{i,j}^{r,s} (x_{i,j}^{r,s})) d\alpha \quad (2)$$

where  $x = x(\alpha)$ ;

$c_{i,j}^{r,s}$  = out-of-pocket cost (or fare) from origin  $r$  to destination  $s$  using the path between  $i$  and  $j$ ;

$\alpha$  = VOT;

$t_{i,j}^{r,s}$  = travel time from origin  $r$  to destination  $s$  using the path between  $i$  and  $j$ ;

$x_{i,j}^{r,s}$  = total number of trips from origin  $r$  to destination  $s$  using the path between  $i$  and  $j$ .

Note that each path in the time-space network actually represents the transportation mode selected by tripmakers, the passage of time from one time period to another, and the change in physical position from their origin point to their destination.

The constraints of the objective function are as follows:



- 1) Non-negative flow conditions:  $x_{i,j}^{r,s} \geq 0$
- 2) [Trips on Link]  $\leq$  [Total Outflow]:  $x_{i,j}^{r,s} \leq x^{r,s}$
- 3) [Total Trips]
 
$$\int \sum_u = [\text{Trips over Each Link on the Designated Link Path}]$$
- 4) Link Usage Condition:  $\delta_{i,j}^{r,s} = 1$  or  $0$
- 5) Continuity Conditions:

$$x_{r,i}^{r,s} = x_{i,j}^{r,s} = x_{j,s}^{r,s} \text{ for } \forall i, j, r, s;$$

$$x_{r,i} = \sum_s \delta_{r,i}^{r,s} \cdot x_{r,i}^{r,s} \text{ for } \forall i;$$

$$x_{j,s} = \sum_r \delta_{j,s}^{r,s} \cdot x_{j,s}^{r,s} \text{ for } \forall j$$

To ensure that the proposed model can realistically capture intercity mode choice behavior, we further tested the performance of our proposed model against three hypotheses.

### Hypotheses for Performance Tests

Based on the collected dataset for the NW-SE corridor, it is expected that:

1. When mean VOT of the system users is high, most tripmakers will take the faster but more expensive transportation modes (e.g., air), especially for long-distance trips.
2. When mean VOT of the system users is low, most tripmakers will take the slowest but least expensive transportation mode (i.e., highway).
3. Mean VOT of tripmakers who prefer to take the conventional rail system is expected to lie between that of the air and the highway system users, because the direct cost and travel speed of the conventional rail system is between those of air and highway.

The following experimental scenarios were used to evaluate whether the proposed model's performance was consistent with those hypotheses. To test the hypotheses, we used the initial VOT distribution and a standard deviation of 0.02, which is currently the standard deviation of resident income distribution in the target area.

Case 1: Mean VOT of the system users is 5¢/min (the 10<sup>th</sup> percentile of the average resident income in the proposed area) with a standard deviation of 0.02.

Case 2: Mean VOT of the system users is 10¢/min with a standard deviation of 0.02.

Case 3: Mean VOT of the system users is 20¢/min (the average resident income in the proposed area) with a standard deviation of 0.02.

Case 4: Mean VOT of the system users is 25¢/min with a standard deviation of 0.02.

Case 5: Mean VOT of the system users is 35¢/min with a standard deviation of 0.02.

Case 6: Mean VOT of the system users is 40¢/min with a standard deviation of 0.02.

Case 7: Mean VOT of the system users is 46¢/min (the 90<sup>th</sup> percentile of the average resident income in the proposed area) with a standard deviation of 0.02.

Note that VOT in all cases was assumed to be normally distributed with a standard deviation of 0.02, based on the wage distribution in the target service area.

### Test Results

Using our proposed network model in the aforementioned scenarios, the results, as expected, indicated that most tripmakers travel by air when their VOT is assumed to be high (Cases 5, 6, and 7) for long-distance (OD 3) trips. On the other hand, tripmakers use the highway mode when their VOT is assumed to be relatively low (Cases 1 and 2). This is consistent with our first hypothesis, and a graphical illustration of such relationships is presented in figures 9 and 10. In the case of conventional rail, figure 11 shows that some tripmakers are using this mode for long-distance trips (OD 3) when their VOT is assumed to be between 10¢/min (Case 2) and 20¢/min (Case 3). In contrast, travelers on short-distance trips prefer to take this mode when their VOT is assumed to be between 20¢/min (Case 3) and 25¢/min (Case 4). The results are also consistent with the second hypothesis; that is, low-income travelers tend to select slow and inexpensive transportation modes.

### ESTIMATION OF OPTIMAL PARAMETERS FOR VOT DISTRIBUTION

Note that with the same assumptions for trip choice behavior and with identical system performance

**FIGURE 9 Mean VOT vs. Number of Trips:  
Airline System**

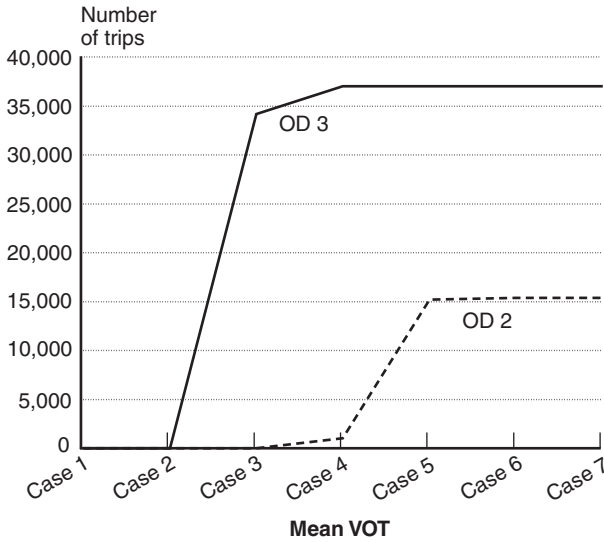

Note: For Cases 1 and 2, the values are zero.

**FIGURE 10 Mean VOT vs. Number of Trips:  
Highway**

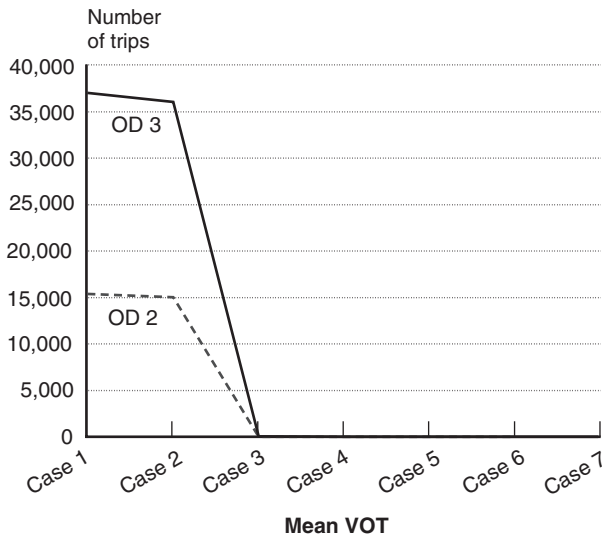

Note: For Cases 4-7, the values are zero.

data (i.e., fare, travel speed, travel time, trip distance, and capacity), the scenario that yields the best fit for the current demand distribution must best capture the actual VOT distribution among trip-makers. Thus, by employing the network-based method presented in the previous section, we performed the preliminary search of the optimal parameters for the VOT distribution with those well-selected experimental cases.

**FIGURE 11 Mean VOT vs. Number of Trips:  
Conventional Rail**

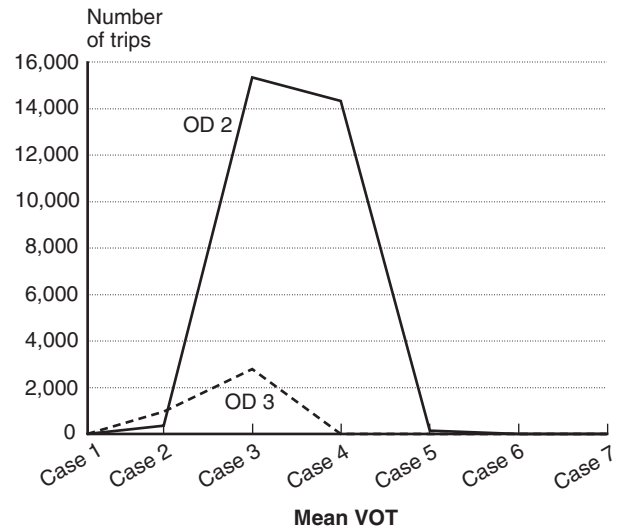

Note: For OD 2, Cases 1, 6, and 7 are zero. For OD 3, Cases 1 and 4-7 are zero.

**Selection Criterion**

To identify the best-fit VOT, we employed the weighted-average error of estimation as the criterion to compute the discrepancy between the estimated market and the current market shares. The computed value allowed us to select the set of mean VOT that best captured the current trip distribution among all available transportation modes. It is defined as follows:

- weighted-average error for mode  $m$  on OD pair  $i$  in scenario

$$[Error]_{i,m} = \frac{ABS(\bar{V}_{i,m} - V_{i,m})}{\bar{V}_{i,m}} \quad (3)$$

where  $i$  = OD pair  $i$ ;  
 $m$  = transportation mode;  
 $\bar{V}_{i,m}$  = actual volume of transportation mode  $m$  on OD pair  $i$ ;  
 $V_{i,m}$  = estimated volume of mode  $m$  on OD pair  $i$  in scenario; and  
 $ABS$  = absolute value.

As such, the total weighted-average error in the scenario can be expressed as

$$[Error] = \frac{\sum_m [\sum_i [Error]_{i,m} * \bar{V}_{i,m}]}{\bar{V}} \quad (4)$$

where  $\bar{V}$  = total actual volume of the entire system, denoted as

$$\bar{V} = \sum_m \sum_i \bar{V}_{im}$$

### Experimental Results

As shown in figure 12, among all candidate parameters Case 4 (mean VOT equal to 25¢/min) yielded the lowest weighted-average error of estimation. To further identify the best-fit mean VOT, we divided the range between Cases 3 (mean VOT = 20¢/min) and 4 (mean VOT = 25¢/min) into the following four additional cases:

- Case 3-1: VOT is normally distributed with a mean of 21¢/min and a standard deviation of 0.02.
- Case 3-2: VOT is normally distributed with a mean of 22¢/min and a standard deviation of 0.02.
- Case 3-3: VOT is normally distributed with a mean of 23¢/min and a standard deviation of 0.02.
- Case 3-4: VOT is normally distributed with a mean of 24¢/min and a standard deviation of 0.02.

With the same estimation procedures, we found that Case 3-4 (mean VOT 24¢/min) yielded the low-

FIGURE 12 VOT vs. Weighted Error: Total

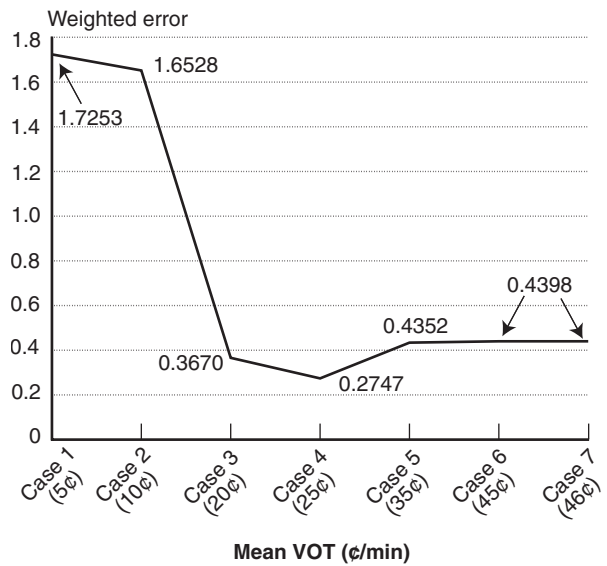

est estimation error, as presented in figure 13. Thus, for the purpose of market share prediction, it seems that a mean VOT of 24¢/min can reasonably represent the travel time value of transportation system users in the NW-SE corridor of Korea.

### Estimation of the Best-Fit Standard Deviation

Given the best-fit mean VOT of 24¢/min, this section focuses on identifying the best-fit standard deviation for system users along the NW-SE corridor with five carefully identified cases: Cases A, B,

FIGURE 13 VOT vs. Weighted Error: Total

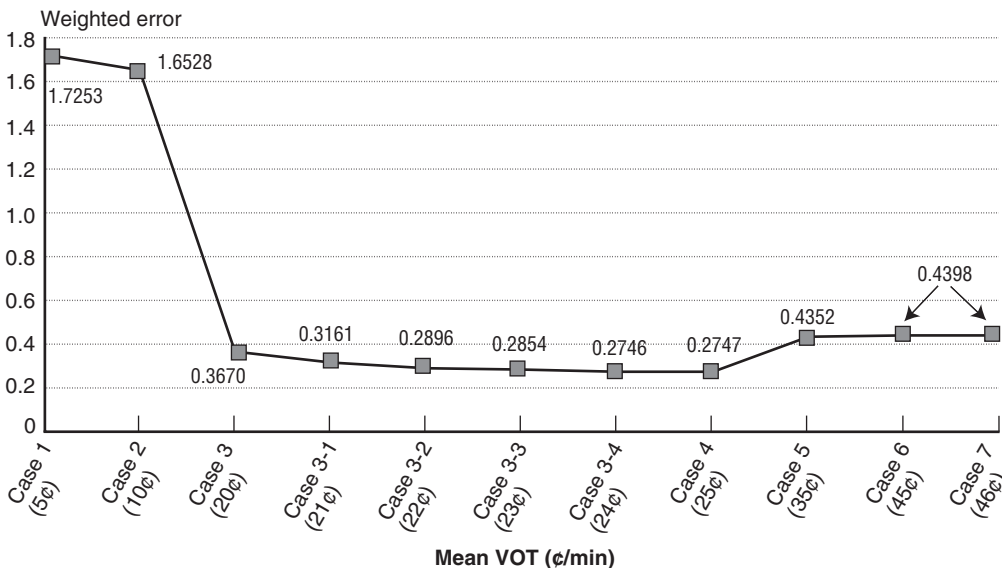
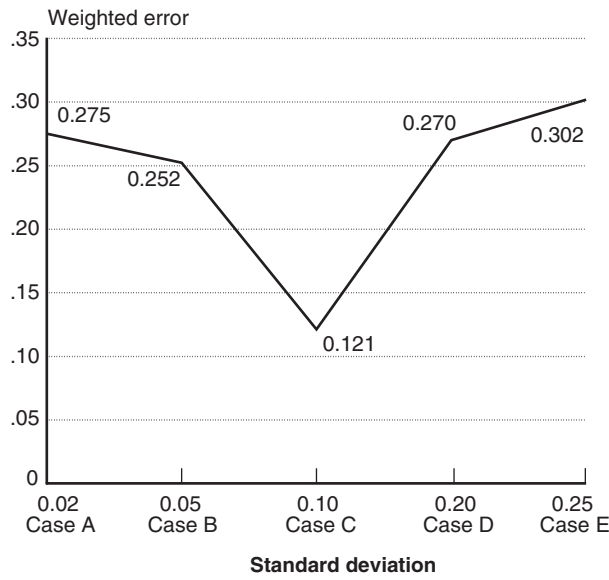

**TABLE 6 VOT Distribution Tests with Different Standard Deviations**

	Case A <sup>1</sup>	Case B	Case C	Case D	Case E
Mean VOT	24¢/min	24¢/min	24¢/min	24¢/min	24¢/min
Standard deviation	0.02	0.05	0.10	0.20	0.25

<sup>1</sup> Base case.

**FIGURE 14 Standard Deviation vs. Weighted-Average Error**



C, D, and E summarized in table 6. The collected dataset shows that the standard deviation of the residential income of the proposed area is 0.02. Thus, we chose 0.02 as an initial standard deviation, and the upper bound becomes 0.25. As shown in table 6, Case A is the base case, with a standard deviation of 0.02, which is identical to Case 3-4 in figure 13. The estimation results of all five cases are illustrated in figure 14. It is apparent that Case C (standard deviation = 0.10), compared with the initial and other cases, yields the lowest weighted-average error of estimation for all system users.

In light of the above exploration, we conclude that tripmakers' VOT along the NW-SE corridor of the Korean transportation network is best approximated by a distribution with a mean of 24¢/min (Case 3-4, figure 13) and standard deviation of 0.10 (Case C, table 6). The estimated trip distributions of all transportation modes and OD pairs with the best-fit VOT parameters along with their weighted-average errors are presented in table 7.

**TABLE 7 Estimated Daily Trip Distribution and Weighted-Average Error with Best-Fit VOT**

	Conventional			Total
	Air	rail	Highway	
OD 1	0 (0.000)	5,711 (0.2557)	1,369 (0.1267)	7,080
OD 2	6,794 (0.7387)	5,604 (0.1614)	2,970 (0.2698)	15,368
OD 3	26,496 (0.7081)	3,384 (0.0950)	7,157 (0.7644)	37,037
OD 4	0 (0.000)	1,176 (0.0409)	181 (0.0167)	1,357
OD 5	0 (0.000)	1,674 (0.1654)	401 (0.0405)	2,075
OD 6	0 (0.000)	4,443 (0.1464)	787 (0.0027)	5,230
Total	33,290 (0.1104)	21,992 (0.0292)	12,865 (0.3745)	68,147 (0.1212)

Note: Numbers in parentheses are the weighted-average error of estimation.

Note that with the estimated VOT distribution, one can now reconstruct the entire corridor network with HSR and employ the same solution procedures to estimate the market share of HSR as well as other existing transportation modes. The same network relationship can also be employed to explore the impact of various operating policies, such as fare structure, on the potential market share of all competing transportation modes.<sup>1</sup>

### CONCLUDING COMMENTS

This paper presents a network-based method for estimating the VOT distribution for intercity transportation users. The proposed method is unique in its capability to take full advantage of available aggregate market share data and in its flexibility to incorporate all system performance factors as well as the competing nature of available transportation modes in the modeling structure. With such a

<sup>1</sup> For a detailed presentation of this topic, see Chang (2000).

method, it is possible to circumvent the need to perform costly disaggregate surveys at an individual level. It is often quite difficult to maintain quality control in such surveys, especially over the inevitable nonsampling errors that result from a variety of social and behavioral factors in developing countries. We expect that the proposed method will enable researchers to explore the complex interactions between all competing and/or new transportation modes from either a demand or system performance perspective with relatively reliable and available aggregate data.

## REFERENCES

- Bruzelius, N. 1979. *The Value of Travel Time: Theory and Measurement*. London, England: Croom Helm.
- Chang, I.J. 2000. Optimizing Time-Varying Multiple Origin-Destination Trips Among Competing Modes in a Regional Corridor. Ph.D. dissertation. University of Maryland.
- Earp, J.H., R.D. Hall, and M. McDonald. 1976. Model Choice Behaviour and the Value of Travel Time: Recent Empirical Evidence. *Model Choice and the Value of Travel Time*. Edited by I.G. Heggie. Oxford, England: Clarendon.
- Gonzalez, R.M. 1997. The Value of Time: Theoretical Review. *Transportation Reviews* 17(3):245–266.
- Gronau, R. 1976. Economic Approach to Value of Time and Transportation Choice. *Transportation Research Record* 587:1–11.
- Hensher, D.A. 1977. *Value of Business Travel Time*. New York, NY: Pergamon.
- Jara-Diaz, S.R. 1998. Time and Income in Travel Choice: Towards a Microeconomic Activity-Based Theoretical Framework. *Theoretical Foundations of Travel Choice Modeling*. New York, NY: Elsevier.
- Moses, L.M. and H.F. Williamson, Jr. 1963. Value of Time, Choice of Mode, and the Subsidy Issue in Urban Transportation. *Journal of Political Economy* 71:247–264.
- Senna, L.A.D.S. 1994. The Influence of Travel Time Variability on the Value of Time. *Transportation* 21:203–228.
- Stopher, P.R. 1976. Derivation of Values of Time from Travel Demand Models. *Transportation Research Record* 587:12–18.
- Watson, P.L. 1974. *The Value of Time: Behavioral Models of Modal Choice*. Lexington, MA: Lexington Books.

## APPENDIX

### T-2 Traffic Assignment Model

The T-2 traffic assignment model consists of the following principal components:

1. minimum path assignment,

2. probability of taking the mode,
3. bicriterion equilibrium assignment, and
4. T-2 algorithm.

**1. Minimum-Path Assignment.** The primary function of the model is to assign trips with a stochastic VOT on a network for fixed link times and costs.

Given:

trip matrix  
network topology,

let

$R_+$  = {positive real numbers}

$N$  = {nodes in the network}

$E$  = {links in the network}

Ground set:

$A = \{\text{VOT}\} \subseteq R_+$ ,

$v_{od}(\alpha)$  = number of trips going from origin node  $O$  to destination node  $D$  with a VOT  $\alpha$ , and

$x_{oe}(\alpha)$  = flow on link  $e$  of trips that originated at origin node  $O$  with VOT  $\alpha$ .

Then, total flow on link of trips that originated from every possible origin with VOT  $\alpha$  is

$$x_e(\alpha) = \sum_o x_{oe}(\alpha)$$

Now, the feasible traffic assignment for a given trip matrix is

$$v_{od}(\alpha) = \sum_{\{e|j_e = d\}} x_{oe}(\alpha) - \sum_{\{e|i_e = d\}} x_{oe}(\alpha) \quad (1)$$

Also, equation (1) is rewritten as

$$v_{od}(\alpha) = v_{od} \bullet f_{od}(\alpha)$$

where  $f_{od}(\alpha)$  is the PDF of VOT  $\alpha$  for trips going from origin node  $O$  to destination node  $D$ .

**2. Probability of Taking the Mode.** The main purpose of the module is to compute the probability of taking one mode over all available transportation modes in a network corridor. The first step is to determine the range of the VOT parameter based on all feasible paths and then to determine the probability of taking each transportation mode, as follows:

$$Prob [m] = Prob[L \leq \alpha \leq U] = \int_L^U f_{od}(\alpha) d\alpha$$

where

$L$  = lower limit of VOT

$U$  = upper limit of VOT and

$f_{od}(\alpha)$  = PDF of VOT  $\alpha$  of trips from origin to destination.

**3. Bicriterion Equilibrium Assignment.** For a given topology, VOT, PDF, and OD matrices, the objective function is to minimize the total generalized cost function.

Objective:

$$\text{Min} \int \sum_{\alpha} (c_e + \alpha t_e(x_e)) x_e(\alpha) d\alpha$$

The decision variable of the objective function is the total number of trips using link  $e$  that originate at node  $O$ , and is written as follows:

$x_e$  = trips using link  $e$  that originate at origin node  $O$

One needs the list of constraints to solve the objective function, and those constraints are summarized below.

Constraints:

$$1. v_{od}(\alpha) = \sum_{\{e|j_e=d\}} x_{oe}(\alpha) - \sum_{\{e|i_e=d\}} x_{oe}(\alpha)$$

$$2. x_e(\alpha) = \sum_o x_{oe}(\alpha)$$

$$3. x_e \geq 0$$

$$4. x_e = \int_{\alpha} x_e(\alpha) d\alpha$$

$$5. t_e \geq 0$$

$$6. t_e(\alpha) = \sum_o t_{oe}(\alpha)$$

$$7. t_e \geq 0$$

The first constraint ensures the feasibility of the assignment. The second constraint is to ensure that the total trips on link  $e$  is the sum of all trips originating from different origins on the network but that use the same link. The third, fifth, and seventh constraints hold the positive trip numbers and travel times. The total number of trips on link  $e$  is the integral of all trips under different VOT scenarios. Lastly, constraint six shows that the travel time on link  $e$  is the sum of travel times on the link from different origins.

**4. T-2 Algorithm.** The T-2 algorithm used to determine the optimum mode choice and trip distribution is presented below.

Step A. Initialization

Do a T-2 minimum-path assignment to obtain

$$\bar{x}^0 = \arg \text{Min}_{\bar{X} \in X} G[\bar{X} | \bar{c}^0, \bar{t}^0]$$

$$x_e^0 \leftarrow \int_A x_e(\alpha) d\alpha, \text{ and } u_e^0 \leftarrow \int_A \alpha x_e(\alpha) d\alpha$$

Step B. Ascent direction

Fix all link costs and times

$$c_e^0 \leftarrow c_e(x_e^0), \text{ and } t_e^0 \leftarrow t_e(x_e^0)$$

and perform a T-2 min-path assignment to obtain

$$\bar{X} = \arg \text{Min}_{\bar{y} \in X} G[\bar{y} | \bar{c}^0, \bar{t}^0]$$

$$\Delta x_e \leftarrow \left( \int_A x_e(\alpha) d\alpha - x_e^0 \right), \text{ and } \Delta u_e \leftarrow \left( \int_A \alpha x_e(\alpha) d\alpha - u_e^0 \right)$$

Step C. Termination test

Let

$$L[\lambda, (x_e), (u_e)]$$

$$= \sum_e [c_e(x_e^0 + \lambda \Delta x_e) x_e + t_e(x_e^0 + \lambda \Delta x_e) u_e]$$

If

$$\frac{L[0, (\Delta x_e), (\Delta u_e)]}{L[0, (x_e), (u_e)]} < \epsilon$$

Quit

$(x_e^0)$  implies the  $\epsilon$ -approximate T-2 equilibrium traffic assignment.

Otherwise, go to Step D.

Step D. Determining step size

$$\text{Let } \lambda^* \leftarrow 1$$

$$\text{If } [1, (\Delta x_e), (\Delta u_e)] \leq 0$$

$$L[\lambda, (\Delta x_e), (\Delta u_e)] = 0, \text{ otherwise}$$

Step E. Improved solution

Update all  $(x_e^0)$  and  $(u_e^0)$ ;

$$x_e^0 \leftarrow x_e^0 + \Delta x_e^0, \text{ and } u_e^0 \leftarrow u_e^0 + \Delta u_e^0$$

and return to Step B.

# Efficiency Through Accountability: Some Lessons from Kentucky's Improved Medicaid Transit Service

LENAHAN O'CONNELL

TED GROSSARDT

BRUCE SIRIA

SCOTT MARCHAND

MAUREEN McDORMAN

Kentucky Transportation Center

University of Kentucky

## ABSTRACT

The cost of providing nonemergency transportation to Medicaid and other transportation-eligible people has escalated sharply in the United States. In response, many states have reformed their human services transportation delivery systems. In this paper, we assess the results of Kentucky's comprehensive reform of its transit system, including the impact on the quality of transit service for Medicaid-eligible users. With three sources of data—financial and other service data, a sample of Medicaid-eligible residents, and a sample of the transit providers—we assess the effectiveness of the new system. The data show that patronage levels increased dramatically under the new process, while unit costs declined substantially. Further, despite measures taken to increase efficiency, passengers still expressed satisfaction with the service. We attribute these positive results to an improved structure of accountability. The conclusion contains implications for future reforms.

## INTRODUCTION

Across the United States, there is a rising demand for transportation services for the poor, disabled, and elderly, many of whom live in rural areas not

---

Lenahan O'Connell, Kentucky Transportation Center, University of Kentucky, 343 Waller Avenue, Ste. 300, Lexington, KY 40504. Email: locon0@engr.uky.edu.

served by fixed-route public transit (Bernier and Seekins 1999). Medicaid transportation demand and expenses, for example, have been escalating sharply in recent years. As the population ages and as welfare recipients are required to work, this demand for transportation will grow apace. The anticipated expansion in demand for transportation services could exacerbate current financial and other strains on the system.

In response to this trend, many states have begun to reform their transportation delivery systems, especially those providing nonemergency medical transportation, the most frequently provided type of transportation (Raphael 1997; 2001). To be sure, there is room for reform. Many states maintained systems plagued with fraud and abuse as well as poor organization and overlapping services of different agencies providing transportation (Raphael 2001; HCFA and NASMD 1998). But it is also possible that attempts to reform such systems will fail to restrain costs or only do so by sacrificing the quality of service.

In this paper, we evaluate the results of a wide-ranging, 1998 reform of the transportation system in Kentucky. One of our goals is to assess the possibility that the reform effected cost savings through reductions in service. The Kentucky reform package combined two of the more popular strategies for transportation reform—capitation and a broker system—and did so in a uniquely comprehensive manner designed to enhance the accountability of the four main players in the system: the state, the brokers, the transportation providers, and the riders.

This research assesses Kentucky's comprehensive approach to reform as a model for other states. Specifically, we address these questions:

1. Did reform reduce the unit cost of providing services?
2. Did it maintain or raise the quality of service?
3. Did it reduce waste, fraud, and inefficiency?

If the reform succeeded in doing all three, then Kentucky's approach to building accountability into its system may be of use to other states. We describe the current approach to reform and then the specifics of Kentucky's transformation of its human services transportation system. After assessing the approach in terms of its impact on the ability of the state to hold the providers of services accountable, we describe the research design and data. Three pri-

mary sources of data were considered: a sample of Medicaid-eligible Kentucky residents; a sample of transportation providers; and financial and service data on the number of passengers conveyed each month, the average length of trips, and the average cost. We also conducted interviews with 15 brokers.

## Recent Reforms

To reduce Medicaid transportation expenditures, many states have turned to two reforms in particular—transportation brokerages and capitated rates. These can take a variety of forms, may be combined into one reform package, or may be applied across an entire state or only in specific portions of it (Raphael 2001).

Brokerages and systems of capitation have their respective strengths and weaknesses. Under a brokerage, one broker is given the responsibility of assigning riders to providers. The broker is encouraged to select the most appropriate provider for a particular rider. Brokers can monitor the providers to eliminate waste and fraud, but their effectiveness at doing so is dubious. Some brokers are paid a fee for each ride they broker and some are paid a capitated rate for all the potential riders in their area.

Capitated rates are explicitly designed to encourage cost reduction. Brokers are given a set amount of money for each person in a region who qualifies for a specific type of transportation service, whether or not the qualified person actually uses it. It seems likely, therefore, that brokers under systems of capitation will work harder to reduce costs than brokers who are paid a fee.

Capitated rates may produce their own set of problems. In most states, capitation is operated through Medicaid health maintenance organizations (HMOs). As a condition of receiving a Medicaid contract, the HMO must provide transportation services. This has the advantage of shifting the risk of excessive cost to the HMO. It does, however, present a problem associated with managed health-care—reductions in quality or access to service. Obviously, states do not want to reduce costs by reducing either the quantity or quality of service. So a means must be found to ensure that service providers continue to make appropriate, timely, and comfortable transportation available to all who need it.



From the limited amount of research on some of these reform efforts (Raphael 1997; 2001), the turn to brokerages and capitated rates may be reducing costs in the states. Logically, the reforms can save money through three distinct means: 1) improvements in the organization and delivery of services, 2) reductions in the amount of fraud, and 3) reductions in the quality of the service provided.

### **TRANSIT DELIVERY BEFORE AND AFTER REFORM**

Kentucky's set of state reforms is considered very comprehensive. It divided the entire state into 16 mutually exclusive brokerages so that all transportation-eligible Kentuckians in all the state's 120 counties had access to transportation for the first time (Michels and Bogren 1998). It then devised a capitation system based on the number of transportation-eligible citizens in each region. The capitated rate per person, which varies from program to program, is multiplied by a percentage of the potential users to arrive at a lump sum, which is agreed on in the contract with the broker. This places a limit on the state's financial liability, but it also places limits on the broker's capacity to pay the providers. To remain solvent, the brokerage must avoid paying the providers more money in total than it receives from the state.

In addition to the Medicaid-eligible, the Human Services Transportation Delivery Program (HSTDP) covers most other programs with a transportation component, including Temporary Assistance to Needy Families (TANF), vocational rehabilitation, and services for the blind. Each broker is allocated a lump sum to provide transportation in its area. After paying providers, the broker keeps the remainder. Unlike other states with capitated rates, Kentucky does not rely on HMOs to broker services.

The HSTDP is a significant departure from the prior transportation delivery system. Previously, transportation services were funded separately by the various government transportation programs affiliated with Medicaid, TANF, Vocational Rehabilitation, or the Department for the Blind. Most of the actual transportation was provided by private companies and in some cases by not-for-profit organizations such as Community Action Agencies. This fragmented approach proved expensive; the cost of

providing nonemergency transportation in Kentucky increased 270% between 1991 and 1998 (Planning and Technology Solutions Team 2000).

Before the broker program, the official policy required a customer to access service by calling the local Community-Based Service Office, which would then provide a voucher to the recipient for a trip. In reality, however, people needing transportation to a doctor's office, training center, hospital, or other legitimate destination often called a private transportation provider directly. The provider (e.g., a cab company) determined eligibility and then conveyed the recipient to his or her destination. Subsequently, the provider was compensated by the state.

By law, many other types of trips were not covered by Medicaid and other governmental programs, including those to the pharmacy and supermarket. In general, Medicaid recipients were allowed to obtain rides only to approved medical facilities and TANF recipients only to approved training facilities and work sites. For other types of rides, riders had to pay out of pocket. It was difficult, however, for authorities to monitor the actual services rendered, and it was feared that taxpayers were paying for numerous unauthorized trips (e.g., to a pharmacy or hairdresser).

Under the new HSTDP capitated-broker program, the recipient calls the broker, who determines eligibility and then assigns the rider to a transportation provider. Preauthorization is required for the service rendered, and the broker pays the provider for the specific service authorized.

Under the new HSTDP broker program, it is in the brokers' monetary interest to keep the payments to their transportation providers as small as possible. Cost control can be accomplished in a variety of legitimate ways: 1) by reducing the incidence of payment for unauthorized rides, 2) by carrying more than one rider on a specific trip, and 3) by reducing the length of rides. The brokers are also rewarded for minimizing payment to providers for trips to unauthorized destinations, such as the drugstore and supermarket.

These changes in the structure of financial incentives, though in theory an improvement, also set up some possible disincentives. Since the brokers receive a lump sum payment, they may attempt to make ends meet by limiting the number of legitimate trips outright or by filling the vehicle, thus increasing pas-

sengers' ride time or time spent waiting to be picked up while additional passengers are picked up. It is therefore possible that financial savings may be purchased at the price of rider satisfaction.

### STRUCTURE OF ACCOUNTABILITY

Most definitions of accountability focus on its essential characteristic: answerability (Rosen 1998; Miller 1991; O'Connell et al. 1990; Dwivedi and Jabbar 1989; Caiden 1989; Romzek and Dubnick 1987; Frink and Ferris 1998).

Building accountability into government institutions is no easy task, as an individual or entity can be answerable to more than one party and for more than one task. All these can conflict in various ways. For example, accountability to customers for the quality of service can conflict with accountability to taxpayers for cost-effectiveness.

Under the old system for transportation, there appeared to be a breakdown in the structure of accountability. Working from a variety of offices in the state capital, state agencies were ill-positioned to monitor and regulate the providers. As a result, transportation providers seemed to be giving unauthorized rides to customers and/or charging for more miles than necessary (Michels and Bogren 1998). Although the customers were happy with the services paid for by the government, many of these services were inappropriate.

The capitated broker system was designed to increase accountability and alleviate these problems. Under this system, each broker is responsible for rides provided in a specific region. Presumably, to keep expenditures below the lump sum established by the system of capitated payments, brokers are motivated to maximize the efficiency of service delivery in their region.

Accountability cannot be guaranteed, however. There is always the possibility that the broker and provider will cut corners in ways that lower the quality of service. For that reason, Kentucky's reform also calls for a mechanism for transit users to register complaints with their brokers and/or the state. The state keeps a record of these complaints, and they can lead to a loss of contract in future years. Thus, the brokers can be held accountable by the state for lapses in service. Figure 1 shows the

**FIGURE 1 The Structure of Accountability Under the Capitated Broker System**

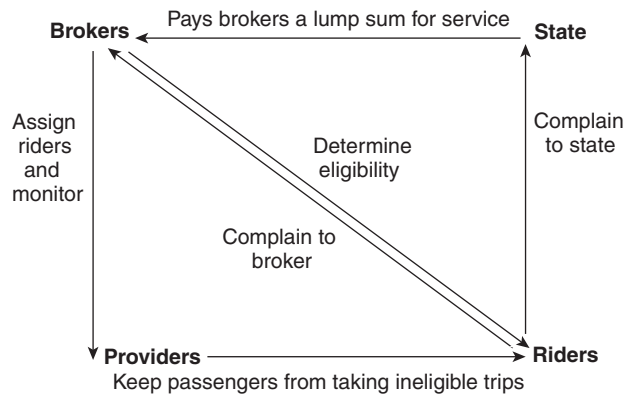

four principle players in the accountability structure: brokers, providers, riders, and the state. The state holds brokers accountable through the contract to broker all rides in a region in return for the capitated payment. This motivates brokers to minimize costs. Brokers in turn hold riders and providers accountable by determining rider eligibility and assigning riders to a provider. Brokers are motivated to eliminate all forms of waste and fraud in order to minimize their expenditures. With broker payments limited to eligible trips only, providers will be motivated to deny ineligible trips to riders. Riders, for their part, will hold the state and the brokers accountable by filing complaints about service quality, which will motivate brokers to maintain the quality of service and access to care.

In another phase of this research, the 15 active HSTDP brokers were interviewed (a lawsuit over which company would broker the 16th region delayed its entry into the program). The brokers indicated much concern for the needs of the users: several reported a policy of routine spot checks of their providers to see that pickups were punctual; most reported a policy of inspecting the providers' vehicles to see that they were up to the safety codes. Brokers also indicated that the complaint system was working. Users of the services had access to both the state and their regional broker should they have cause for concerns regarding the system. The positive statements of the brokers notwithstanding, there is still a chance that the broker system may not be providing satisfactory service. A complete assessment of the new system requires, therefore, a dual focus: one on costs; the other on customer satisfaction.

## **METHODS**

To assess the ability of the new system to hold the various parties accountable, several types of data were needed: 1) before and after statistics on costs and ridership, 2) surveys of transportation users, and 3) surveys of transportation providers. Rider assessments of the service after reform are critical. Presumably, if riders are indeed satisfied with a service after reform, the cost savings of that reform did not come at the expense of quality service.

Our estimate of the reduction of fraud or waste is necessarily indirect. Clearly, reform has the potential to reduce the income of some providers more than others. Presumably, the brokers will shift business to the more efficient providers when assigning riders. The inefficiencies of the old system may be most likely among for-profit providers who specialized in Medicaid transportation and were quite small. If this was the case, we would expect to find that, under the new system, brokers shift riders to the larger providers, especially those providers that can cluster rides.

### **Financial, Mileage, and Usage Data**

Financial, mileage, and usage data were examined in order to compare conditions before and after implementation of the HSTDTP broker system. Data representing “before” conditions were obtained from the Kentucky Cabinet of Health Services. For each month in federal fiscal year 1997 (October 1996–September 1997) and for each county, information was provided on the total miles of service, the number of trips, and the total amount of payment for Medicaid transportation. This period was selected because it was the last full federal fiscal year before onset of the reform. Individual county data were then aggregated into totals based on the new regions under control of a broker. Fiscal year totals and monthly averages of miles, trips, and payments were summarized and average monthly cost-per-trip, cost-per-mile, and miles-per-trip indices were calculated for each region.

Data representing “after” conditions were obtained from the Kentucky Transportation Cabinet (KYTC). In order to assess the actual changes experienced in the various indices of efficiency of performance, broker data for 1999 were compared with the comparable calendar months of federal fiscal year

1997. For each broker region, data were provided on the amount paid to the broker by KYTC, the aggregate amount paid to subcontractors by the broker, total Medicaid transportation trips provided within the region, and the total miles for these trips.

### **User Survey**

The Urban Studies Institute at the University of Louisville, with the assistance of the University of Kentucky Transportation Center, developed a telephone questionnaire of approximately 100 questions. The survey instrument probed the experiences of Medicaid transportation clients with the services they received before and after the start of the HSTDTP. Survey participants were queried about their frequency of usage of HSTDTP transportation services, the type of vehicle on which they are most often a passenger, and their judgment of the transportation service in terms of driver helpfulness and courtesy; trip safety, timeliness, and dependability; and vehicle cleanliness, comfort, and maintenance.

The broker in each of the 15 participating HSTDTP regions supplied current lists of persons eligible for Medicaid transportation service in that region. Where telephone numbers were not included on the lists, survey researchers at University of Louisville attempted to find them using various techniques. Next, the researchers randomly called users. In order to obtain approximately 100 completed surveys in each HSTDTP region, the interviewers had to place two telephone calls for each completed survey. Unfortunately, the University of Louisville Survey Research Center did not compute a true response rate, because many of those calls were second calls to the same phone number. Thus, the true response rate, though unknown, was greater than 50 percent. Since we are concerned with before and after comparisons across the entire state, we did not adjust the sample for population size within regions.

### **Provider Survey**

We sent a written survey to all the providers in the state. Some were small, private sector companies, some were nonprofits, and some were brokers who also provided transportation. Since most of the providers were active in the previous system, the survey instrument was designed to elicit assessments of change. Specifically, we wanted to see if the providers

**TABLE 1 Variables and Related Questions from the Provider Survey**

---

**Group trips.** "I have been able to group trips effectively with the new broker system." Strongly agree = 5; agree = 4; neutral = 3; disagree = 2; strongly disagree = 1.

**Quality.** "The overall quality of service I provide to my Medicaid riders has improved under the new system." Strongly agree = 5; agree = 4; neutral = 3; disagree = 2; strongly disagree = 1.

**Brokers are fair.** "The broker has a fair procedure for allocating trips among all the providers in my region." Strongly agree = 5; agree = 4; neutral = 3; disagree = 2; strongly disagree = 1.

**More second riders.** "My organization's average number of second passengers (of all kinds) per trip under the broker system has:" increased = 3; remained the same = 2; decreased = 1.

**Revenue change.** "My organization's revenue for Medicaid transportation services under the broker system has:" increased = 3; remained the same = 2; decreased = 1.

**Share of trips are Medicaid.** "What share of your trips is for Medicaid?" Nearly all = 4; three-fourths = 3; one-half = 2; one-fourth or less = 1.

**Companies with vans and buses.** All companies with vans or buses were coded 1; all others were coded 0.\*

**Small taxi companies with no vans and buses.** All providers with 10 or fewer cabs and no vans or buses were coded 1; all others were coded 0.\*

---

\*The two variables about organization type and size were based on responses to this question: "How many of each type of vehicle do you have: buses, taxis, minivans, and other?"

were adding passengers on each run. We also wanted to see if the brokers were referring riders to the small companies, especially those without vans and buses. We also asked about assessments of the fairness of the brokers' allocation of rides. Of 160 providers, 102 returned useable surveys. The taxi companies were less likely to return a questionnaire—58% versus 69% of the other providers. The variables from the provider survey and their wording are in table 1.

## FINDINGS

### Accountability for Costs

Did the new HSTDP capitated broker program cut costs? The answer is an unequivocal yes. The before and after comparisons summarized in table 2 show that even though the average number of monthly

trips (i.e., the number of passengers conveyed) rose to 94,615 from 59,904, an increase of almost 58% in just 2 years, the average monthly mileage went from 1,464,516 to 1,180,189, a decrease of 19.4%. The average trip per passenger carried dropped from 24.5 miles to 12.5 miles.

Table 2 also shows a marked decline in the amount paid per trip, from \$29.03 to \$23.86, a decrease in average cost of 17.8%. This, of course, is proportionately less than the decline in mileage per trip. One reason for this is the costs associated with running the broker service. We estimate that the statewide administrative cost of a typical broker operation is \$4.34 per trip, or approximately 18% of the total cost per trip. A rise in the number of trips was expected for several reasons: 1) prior to the broker program, 12 of the 120 counties in Kentucky had no transportation service, 2) the new program was heavily advertised by the state, 3) demand for Medicaid service was rising throughout the 1990s, and 4) the implementation of the program coincided with the imposition of work requirements under welfare reform.

How were costs reduced? There are several possibilities. One is trip grouping. This can be inferred when data show changes in miles-per-trip, which was the case as mentioned at the beginning of this section. Trip grouping can also be inferred from the type of vehicle in which the survey respondent usually travels while receiving Medicaid transportation service (car, taxi, 7 to 15 passenger van, or bus). Table 3 shows a reduction in the use of automobiles for Medicaid transportation service and an increase in the use of vans and buses—a finding in line with greater trip grouping. We put taxis and autos in one category and buses and vans in the other to create a 2 by 2 contingency table. The shift from taxis and autos to vans and buses after the onset of the broker program is statistically significant (Chi-square = 6.55, *d.f.* 1, *p* < .05).

**TABLE 2 Comparison of Monthly Financial Mileage Data Before and After the Start of the New HSTDP (Broker) Program**

	FY97 (before)	FY99 (after)	% change
\$ paid per trip	\$29.03	\$23.86	-17.8
Number of trips	59,904	94,615	57.9
Total monthly mileage	1,464,516	1,180,189	-19.4
Average mileage per trip	24.5	12.5	-49.0

**TABLE 3 Type of Vehicle Used for Medicaid Transportation**

Vehicle type	Before HSTDP	After HSTDP
Car	18.3%	10.6%
Taxi	35.1%	37.3%
Van	35.7%	40.7%
Bus	10.2%	10.9%
Did not recall	0.7%	0.4%

n = 1,036

Note: Columns do not necessarily sum to 100% due to rounding.

### Accountability for Quality

This section addresses the possibility that the observed reduction in cost per trip was gained at the expense of user satisfaction. A series of questions in the telephone survey of Medicaid-eligible individuals covered the degree of user satisfaction with the HSTDP. For comparison with the previous program, respondents were also asked to estimate their level of satisfaction prior to the HSTDP.

Table 4 presents the wording of the questions that concern quality and the percentage of respondents answering “always” or “usually” to them before and after the start of the broker program. Survey respondents expressed the highest satisfaction levels with drivers, vehicles, broker representatives, and service punctuality in that order. Table 4 indicates that before and after declines in punctuality of service and broker courtesy, although small, are statistically significant.

The greatest decline was in punctuality of pickup. Prior to the HSTDP, 91.5% of the survey respon-

dents reported that they always (or usually) were picked up on time; now 83.6% say that. This decline in punctuality could be a consequence of increased trip grouping.

The key question then is this: are riders less satisfied with the new system? Although the before and after differences are not great, they are statistically significant, which suggests a decline in quality of service. However, when asked if they had had a particularly bad experience with the old and new systems, 17 percent of respondents reported a bad experience when discussing the new system and 18 percent when discussing the old.

### Accountability for Efficient Allocation

The decrease in cost per ride suggests that the brokers are allocating rides to the most efficient providers. Indicators of efficient allocation would be: more trip grouping, an increase in revenue reported by providers grouping rides, and a shift toward those providers with vans and buses in their fleets.

The survey responses of the providers suggest that all three have been occurring. Thirty-eight percent of the providers say they have increased the number of second passengers on vehicles. The correlation matrix in table 5 shows that the transit providers indicating more second passengers per vehicle are more likely to report they are receiving increased revenues from Medicaid ( $r = .37, p < .01$ ). Medicaid revenues are also shown to have increased for those

**TABLE 4 User Satisfaction Before and After the Start of the New HSTDP Program (Percentage responding “Always” or “Usually”)**

Question	Before	After	% change	Significance level
Are the broker representatives helpful when you call?	90.8	87.8	-3.0	$p < .05$
Are the broker representatives courteous when you call?	92.3	88.9	-3.4	$p < .01$
Are you picked up on time?	91.5	83.6	-7.9	$p < .01$
Do you get to where you need to go on time?	93.4	90.0	-3.4	$p < .01$
Are the drivers helpful?	93.1	93.0	-0.1	NS
Are the drivers courteous?	93.9	93.7	-0.2	NS
Do they drive safely?	94.8	94.5	-0.3	NS
Is the vehicle clean?	93.4	92.8	-0.6	NS
Is the vehicle comfortable?	92.8	94.2	1.4	NS
Does the vehicle seem to be well maintained?	92.7	93.8	1.1	NS

n = 1,036

**TABLE 5 Pearson Correlation Coefficients**

	1	2	3	4	5	6	7
1. Revenue change							
2. More second riders	.37**						
3. Group trips	.45**	.37**					
4. Share of trips are Medicaid	-.10	-.21*	-.28*				
5. Quality	.43**	.22*	.58**	-.35**			
6. Small taxi companies and no vans and buses	.15	-.34**	-.28**	.20*	-.04		
7. Companies with vans and buses	.18	.39**	.28	-.25	.17	-.38**	
8. Brokers are fair	.36**	.40**	.65**	-.32**	.55**	-.27**	.36**

\*  $p < .05$

\*\*  $p < .01$

n = 102

who report they have been able to group trips effectively ( $r = .45, p < .01$ ). As expected, the companies with vans and buses in their fleets are more likely to report an increase in second riders ( $r = .37, p < .01$ ). However, the relationship between having large vehicles and revenue change is not significant. Similarly, small taxi companies (those with 10 or fewer vehicles and no vans and buses) are not more likely than the other providers to report a decrease in Medicaid revenues. However, the correlation between small taxi companies and adding a second passenger is negative ( $r = -.34, p < .01$ ) and small taxi companies are less likely to report success at grouping passengers ( $r = -.28, p < .05$ ).

The correlation between small companies and reliance on Medicaid for passengers ( $r = .20, p < .05$ ) implies that small taxi companies without vans and buses will lose Medicaid revenue. Yet, the correlation between change in Medicaid revenue and small taxi companies is insignificant.

We also asked about perceptions of the fairness of allocation of riders by brokers. Providers with the greatest dependence on Medicaid were less likely to see the brokers' assignments of riders as fair. Those who said the procedures were fair were likely to say they could group trips ( $r = .65, p < .01$ ), had added second riders ( $r = .40, p < .01$ ), had increasing Medicaid revenue ( $r = .36, p < .01$ ), and thought the quality of service had gone up ( $r = .55, p < .01$ ). Smaller providers were less likely to say the brokers were fair ( $r = -.27, p < .01$ ) but not more likely to see service quality as having declined.

**DISCUSSION AND CONCLUSION**

The reform appears to be successful. Despite the rise in the number of riders, there has been a decrease in

total mileage, which seems to be due in part to a significant increase in trip grouping. Overall, the unit cost per trip dropped 18% and the length of the average trip went down. Kentucky's reform has produced a true rarity in government—an increase in the quantity of service at lower cost per unit.

Under the new system of accountability, the broker is in a better position geographically to estimate the appropriate mileage and to arrange trip grouping. As was the case before the broker system, transportation providers are paid by the mile and the number of passengers. However, now they are watched more closely to ensure they do not drive more miles than necessary. The finding that there has been a 20% drop in the total miles reported despite the large upsurge in riders is perhaps most suggestive of less fraud and waste.

The interviews we conducted with the brokers also support the above speculations. Brokers told us they were tracking trip length, and they were convinced that providers could no longer claim more mileage or get paid for trips to unauthorized destinations. A slight increase in the use of vans to transport passengers (with a commensurate decrease in the number of riders being transported in automobiles) is also consistent with the placing of more than one passenger on many of the transit vehicles.

Because each of the four parties can be sanctioned by one or more of the other parties, the structure of accountability is seamless. With the ability to file complaints, Medicaid riders have the power to sanction. Taken together, the findings imply that region-based, capitated broker systems can reduce costs. The implications for improving accountability in transit seem clear: 1) give brokers a financial incentive to economize by, for instance, the use of lump sum capitated payments; 2) facilitate the mon-

itoring of providers by keeping the region over which each broker is responsible of manageable size; 3) provide all customers with a means to report poor quality of service to an outside party. The likely result is more efficiency and less waste with only a modest decline in rider satisfaction.

## NOTE AND ACKNOWLEDGMENTS

This is a substantially revised version of a paper presented at the Transportation Research Board Annual Meetings, January 8, 2001, in Washington, DC. We thank the editor and reviewers for their helpful comments.

## REFERENCES

- Bernier, B. and T. Seekins. 1999. Rural Transportation Voucher Program for People with Disabilities: Three Case Studies. *Journal of Transportation and Statistics* 2(1):62-9.
- Caiden, G. 1989. The Problem of Ensuring the Public Accountability of Public Officials. *Public Service Accountability*. Edited by J. Jabbara and O.P. Dwivedi. West Hartford, CT: Kumerian Press. pp. 17-38.
- Health Care Financing Administration (HCFA) and National Association of State Medicaid Directors (NASMD). 1998. Designing and Operating Cost-Effective Medicaid Non-Emergency Transportation Programs.
- Dwivedi, O.P. and J. Jabbara. 1989. Public Service Responsibility and Accountability. *Public Service Accountability*. Edited by J. Jabbara and O.P. Dwivedi. West Hartford, CT: Kumerian Press. pp.1-16
- Frink, D.D. and G.R. Ferris. 1998. Accountability, Impression Management, and Goal Setting in the Performance Evaluation Process. *Human Relations* 51:1259-84.
- Michels, T. and S. Bogren. 1998. Kentucky's Great Experiment. *Community Transportation* 16:6-10.
- Miller, G. 1991. *Government Financial Management Theory*. New York, NY: Marcel Dekker.
- O'Connell, L., M. Betz, and J. Shepard. 1990. Social Control and Legitimacy: The Contribution of Accountability Mechanisms. *Perspectives on Social Problems* 2:261-77.
- Planning and Technology Solutions Team. 2000. *Evaluation of Medicaid Transportation Service Delivery in Kentucky Human Service Transportation Regions*. Kentucky Transportation Center.
- Raphael, D. 1997. Medicaid Transportation and Managed Care. *Community Transportation* 15(5):7-16.
- \_\_\_\_\_. 2001. *Medicaid Transportation: Assuring Access to Health Care*. Washington, DC: Community Transportation Association of America.
- Romzek, B. and M. Dubnick. 1987. Accountability in the Public Sector: Lessons from the Challenger Tragedy. *Public Administration Review* 47:227-38.
- Rosen, B. 1998. *Holding Government Bureaucracies Accountable*. Westport, CT: Praeger.





# An Application for Measuring Vehicle Travel by Visitors

XUEHAO CHU

STEVEN E. POLZIN

University of South Florida

## ABSTRACT

This paper develops a simple approach to estimating annual vehicle travel by visitors to individual states. Domestic and foreign visitors are considered separately. The approach uses local or national surveys for domestic visitors but federal surveys for foreign visitors. The approach is applied to Florida for the 15-year period from 1984 through 1998. Visitors accounted for about 9.8% to 12.7% of all vehicle travel in the state during this period. Variations over time result from changes in the number of visitors and their characteristics such as the length of stay and party size.

## INTRODUCTION

Understanding visitor travel trends is important for predicting future demands for transportation. Visitor travel has different temporal and geographic distributions, and its growth pattern may differ from resident or freight travel. These differences are relevant to a discussion of how to fund transportation infrastructure and service investments such as equity issues. A good understanding of visitor travel has implications for safety, traveler security, signage, and other aspects of how transportation facilities are designed and operated.

---

Xuehao Chu, Center for Urban Transportation Research, University of South Florida, 4202 E. Fowler Avenue, CUT 100, Tampa, FL 33620. Email: xchu@cutr.eng.usf.edu.

One motivation for this paper is that visitor travel is often not considered in the transportation planning processes in this country. In recent years, freight has increasingly been incorporated into planning, despite the fact that it may actually account for a smaller proportion of total vehicle-miles of travel. Between 1994 and 1998, heavy trucks accounted for 7.3% to 8.2% of all vehicle travel on freeways and arterials in Florida (CUTR 2001b). The most recent study on tourism travel is a National Cooperative Highway Research Program project that examines the extent of cooperation between state departments of transportation and state travel offices (Frechtling et al. 1998).

Our research was also motivated by a desire to put the seemingly large numbers of visitors into perspective. For example, the estimated annual number of visits to Florida by nonstate residents increased from 29.9 million in 1984 to 52.7 million in 1998 (CUTR 2001a), a 76% increase during this 15-year period. This tremendous increase in the number of visitors is often cited as contributing to transportation problems in Florida. At face value, one might quickly conclude that tourists must play a large role in the state's transportation problems. After all, Florida's population was no more than 15 million in 1998 and its increase since 1984 has been about half as fast as that of its visitors (from 10.9 million to 14.9 million) (BEBR 1985–1999).

Finally, our research is motivated by a desire to understand the potential negative impacts of visitors. While tourism may have many positive impacts on local economic development, tourism can also result in many negative impacts on the environment of the host areas. One of these negative impacts is air pollution from automobile emissions. Information on how much visitors drive contributes to our understanding of the potential costs of tourism on the local environment. Local decisionmakers tend to focus on and emphasize the positive impacts but ignore the negative ones.

This paper is divided into three sections: details of the method being proposed for estimating vehicle travel by visitors; application of this method to Florida, including data sources used, and results, and the applicability of the proposed approach to other states; and conclusions.

## METHODS

The proposed approach measures annual vehicle travel by visitors by their origin and mode of entry. The estimations take advantage of annual surveys of domestic visitors as they leave the state after a visit and federal surveys of international travelers to individual states.

Visitors are those persons who travel to Florida for business or pleasure and stay at least one night but no more than a certain number of nights. By origin, domestic visitors are people who come from Canada or other U.S. states, while foreign visitors are all other visitors. Mode of entry includes those who come by car, air, or other public modes (e.g., intercity bus). The approach used here also separately considers vehicle travel by visitors at their destinations and on their way to and from the borders. Taking these factors into account, three types of visitors are considered: domestic air visitors, domestic auto visitors, and foreign air visitors. Domestic visitors who come by other public modes as well as foreign auto visitors are not considered separately because data are not readily available for them. According to the 1995 American Travel Survey, auto and air account for 97.7% of all visitors and intercity bus accounts for 1.6% (USDOT BTS 1997b).

### Domestic Air Visitors

For domestic air visitors, we used data on four of their travel characteristics and an estimate of their total numbers. Characteristics include the length of stay at major destinations ( $L$ ), party size ( $S$ ), the share traveling by car once they reached Florida ( $C$ ), and the average amount of daily driving per party ( $D$ ). For ease of reference, we use  $N$  to represent the annual number of domestic air visitors. The estimation for any given year is done in four steps:

1. Estimate the number of visitors who travel by car at their destinations, which is given by  $C*N$ .
2. Estimate the number of parties among the visitors who travel by car around their destinations, given by  $(C*N)/S$ . This number also represents the number of cars these domestic air visitors drive while they are in the state.
3. Estimate the average amount each vehicle is driven. This is given by  $L*D$ .

4. Put these different pieces together to yield the annual amount of driving by domestic air visitors in Florida:  $(L * D) / [(C * N) / S]$ .

This method may slightly underestimate vehicle travel in the state by domestic air visitors, because those visitors who drive to a bordering state on their way out are excluded in this measurement.

### **Domestic Auto Visitors**

For domestic auto visitors, their driving on the state's highways consists of two components. One component is driving at their destinations. All domestic auto visitors are assumed to travel by car at their destinations, that is,  $C = 1$ . The same procedure used to measure this component is used for those who come by air.

The second component of those who come by car is driving done on their way from the state's border to their destinations and back to the border. This component is the product of the total number of these cars by the average distance between their destinations and the border. This average distance may change from year to year because of changes in destinations chosen by these visitors.

### **Foreign Visitors**

The methodology used for domestic air visitors is also applied to foreign visitors. The underlying assumption is that foreign visitors to the state typically both arrive and leave the state by air. This assumption may lead to underestimating the amount of driving by foreign visitors for at least two reasons. First, some foreign visitors may enter the United States by air through another state and then drive to Florida. Second, just as in the case for domestic air visitors, some of them may drive to other states and leave from there.

### **Comparison to State Total Travel**

Once annual driving by each of these three groups is estimated, the total is then compared with the total amount of driving in the state. The total amount of driving in the state reflects all vehicle travel in the state on public roads, including those by visitors, residents, and freight. While a better comparison might be the total amount of passenger driving in the state, data may not be available to separate passenger and freight travel.

## **APPLICATION**

We applied the simple approach proposed above to Florida for the period from 1984 through 1998. The data sources are presented first, followed by the results and discussion of how the same approach can be applied to other states.

### **Data Sources**

For domestic visitors, data on  $L$ ,  $S$ ,  $C$ , and  $N$  are from the annual *Florida Visitor Study* (Florida DOC 1984–1995; Florida FTIMC 1996–1998). This document compiles data on the characteristics of Florida's domestic visitors and estimates aggregate statistics on the tourism industry in Florida. From 1984 to 1996, it was based on an annual survey that involved personal interviews of visitors as they completed their stay and left the state. It was published by the Tourism Division of the Florida Department of Commerce before 1996 and has been published by the Florida Tourism Industry Marketing Corporation since then. Both groups used the same survey methodology consistently. Since 1996, however, this document has been based on the *DIRECTIONS Travel Intelligence System* (DKS&A 2000). This system is a syndicated database that tracks traveler behavior in the United States, based on annual surveys of 540,000 traveling households.

For foreign visitors, data on  $L$  and  $S$  are available from the annual *Profile of Overseas Travelers to the U.S.* (USDOC ITA 1998), which is based on the monthly *Survey of International Air Travelers*. Unfortunately, data from earlier years were not available for this paper. As a result, 1998 survey data on the length of stay and party size for foreign visitors were used for the entire estimation period. While the survey asked what modes the respondents used while visiting the United States, the questions allow multiple modes to be chosen in the answer. Because of this, the data were unusable for our study. Instead, we assumed that  $C$ , the portion of visitors who travel at their destinations in Florida by car, is the same for foreign visitors as it is for domestic air visitors. This assumption may overestimate vehicle driving by foreign visitors if they are actually less likely to drive than domestic air visitors.

For foreign visitors, data on  $N$  are available from the annual *Overseas Visitors to Select U.S. States*

and Territories (USDOC ITA 1996–1995 and 1998–1997). The data are derived from the INS I-94 form that all noncitizens must complete to enter the United States. The basis of the derivation is the first intended address by these visitors. Because these visitors may visit more than one state, a direct estimate from the I-94 form will understate the total number of international travelers that visited any given state. This underestimate can be accounted for by using the monthly survey of international travelers.<sup>1</sup> Our data on the number of foreign visitors to Florida came from the abovementioned document for the years after 1994.

For the period before 1995, data on the annual number of foreign visitors from the *Florida Visitor Study* were adjusted to reflect differences between these series. The series in the *Florida Visitor Study* shows the direct count from form INS I-94 and underestimates the total number of foreign visitors to Florida. The numbers before 1995 were adjusted up by a factor that is the ratio of the 1995 number (5.345 million) from *Overseas Visitors to Select U.S. States and Territories* to the 1995 number (4.162 million) from the *Florida Visitor Study*. The resulting adjustment factor is 1.284.

We did not have data to get a direct estimate of  $D$  (average daily driving per party) for any of the three visitor types, and the annual surveys do not contain any information on how much a party of visitors drove at their destinations. As a result, the estimation relied on assumed values for  $D$ . We believe that the average daily driving by Florida resident households provides a good point estimate for  $D$ . Most domestic visitors come to Florida either for social (visiting relatives or friends) or recreational purposes. While both a typical household and a visitor party would need travel for basic life maintenance activities (shopping, eating), work-related driving by a typical household is replaced by visitors driving for social and recreational activities. The orientation of activities to lodging provides additional confidence as evidenced by accommodations adjacent to theme parks and beach areas throughout Florida. We estimated average daily driving by Florida resident households with data from the Nationwide Personal Transportation Survey (NPTS), which provides data

---

<sup>1</sup>More details about these are available from the source. See references.

for daily travel of Americans in this country (USDOT FHWA BTS 2003). The NPTS was conducted five times: 1969, 1977, 1983, 1990, and 1995. Using the NPTS Table Wizard, we got an estimate of about 52.65 daily vehicle-miles per Florida household for 1995 (USDOT BTS 1997a).

In addition to an estimate of the amount of daily driving by Florida households for a single year, we also needed to know how the amount of daily driving by each domestic party may have changed over time. For this, we examined the growth in the daily amount of driving for social and recreational purposes between 1983 and 1995 at the national level. National statistics were used here because data specific to Florida were unavailable for 1983. We found that the daily amount of per capita driving for social and recreational purposes grew at about 2.52% annually from 1983 to 1995 at the national level. Applying this growth rate to our 1995 estimate of  $D$ , we got a growth pattern for  $D$  from 1984 through 1998.

We applied the estimate of  $D$  for domestic visitors to foreign visitors simply because we did not have any other better information. It is likely that foreigners drive less while in their home countries. However, we had no information on how much less they drive as a group compared with U.S. residents. In addition, foreign visitors may drive more once in this country than they typically do at home.

We used two sets of numbers to estimate the average distance between the northern Florida border and the chosen destinations of domestic auto visitors. One set of numbers provided the distances between the border and each of the chosen destinations. These distances between city pairs were obtained using a Florida Department of Transportation's online tool (Florida DOT 2000). Because of the long border, we used three border cities to represent it: Pensacola for visitors entering the state on I-10 from the west, Jasper for those entering from I-75 in the middle, and Jacksonville for those entering on I-95 from the east. The largest city in each of the top 10 destination areas was used in the online tool to represent the area. For each destination area, the average of its distances to the three border cities was used.

The second set of numbers used is the distribution of these visitors by their chosen destinations from the annual *Florida Visitor Study*. For 1984 to 1996, the question on destination choice solicited all

destinations a respondent visited in Florida. For 1997 and 1998, however, that question was limited to the main destination of a respondent. As a result, the top 10 destinations from 1984 through 1996 typically accounted for over 90% of all visitors who came by car. For the last two years, they accounted for about 67%.

Using these two sets of numbers, the average distance between Florida's northern border and the chosen destinations was estimated for each year. From 1984 to 1996, this estimate of the average distance overstated the true value because some visitors visited more than one destination. To account for this overestimate, the distances were adjusted down by a correction factor. To obtain this factor, we calculated the percentage of all auto visitors who chose the top 10 destinations for each year. For any given year from 1984 to 1996, this factor was calculated as the ratio of the total percentage in that year to the total percentage in 1998.

For the annual amount of vehicle-miles traveled (vmt) in the state, we used the data in *Highway Statistics Summary to 1995* (USDOT FHWA 1996) for data from 1984 through 1995 and the annual *High-*

*way Statistics* report (USDOT FHWA 1996–1998) for the other years.

## RESULTS

Table 1 summarizes our results of the estimated amount of vmt by Florida's visitors on its highways and how this amount compares with the state's total vmt from 1984 through 1998. The annual vmt by Florida's visitors increased 86% from 8.4 billion in 1984 to 15.7 billion in 1998. Relative to total state vmt, these vehicle-miles accounted for about 9.8% at the beginning of this period and reached 12.7% in the early 1990s. Their share later declined to about 10.9% of the state total.

Among the three visitor types, the annual amount of driving by foreign visitors grew the most (figure 1). From 1984 to 1998, total vmt in the state grew by 61%. For the same period, driving by domestic air visitors grew by 40% and driving by domestic auto visitors grew by 83%. However, driving by foreign visitors grew 356%. These differences in relative growth are also reflected in the differences in the share of total state vmt contributed by visitor type as shown in table 1.

**TABLE 1 Vehicle Travel by Florida's Visitors and Share of State Total**

Year	Vehicle-miles traveled (millions)				As a percentage of state total			
	Domestic air	Domestic auto	Foreign	All visitors	Domestic air	Domestic auto	Foreign	All visitors
1984	2,699	5,184	524	8,406	3.2%	6.1%	0.6%	9.8%
1985	2,487	5,487	557	8,531	2.8%	5.8%	0.6%	9.2%
1986	2,853	5,435	675	8,963	3.3%	5.7%	0.8%	9.7%
1987	2,738	7,922	831	11,491	2.9%	7.8%	0.9%	11.7%
1988	3,514	8,707	1,084	13,306	3.3%	7.7%	1.0%	12.1%
1989	2,859	8,527	1,354	12,740	2.6%	7.3%	1.2%	11.2%
1990	2,929	8,415	1,469	12,813	2.7%	7.1%	1.3%	11.1%
1991	3,173	8,478	1,698	13,349	2.8%	6.9%	1.5%	11.2%
1992	3,370	9,407	1,968	14,744	2.8%	7.3%	1.6%	11.8%
1993	3,717	10,100	2,123	15,941	3.1%	7.8%	1.8%	12.7%
1994	3,775	9,186	1,913	14,874	3.1%	7.1%	1.6%	11.7%
1995	3,736	8,766	1,912	14,413	2.9%	6.4%	1.5%	10.8%
1996	3,912	8,309	2,138	14,359	3.0%	6.0%	1.6%	10.6%
1997	3,329	9,396	2,331	15,056	2.5%	6.5%	1.7%	10.7%
1998	3,775	9,489	2,387	15,652	2.7%	6.4%	1.7%	10.9%

**FIGURE 1 Growth in Vehicle-Miles Traveled: State Total and Visitor Types**

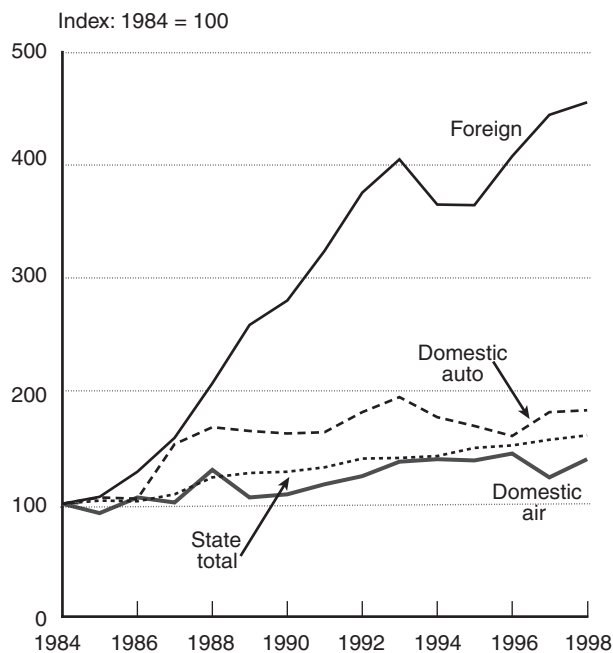

Much of the differential growth trend in vmt between domestic and foreign visitors results from the differential growth trends in their numbers. From 1984 to 1998, the number of foreign visitors grew by 253%, compared with 33% for domestic auto and 101% for domestic air visitors (figure 2).

However, increases in the number of visitors by visitor type do not fully account for the differences in

**FIGURE 2 Growth in Number of Visitors by Visitor Type**

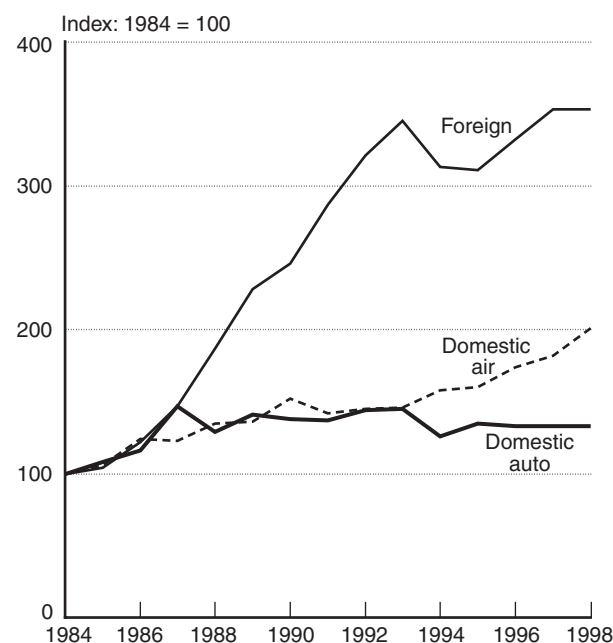

the amount of driving by visitor type. For example, while the number of domestic air visitors grew by 101%, the amount they drove only rose 40%. On the other hand, the number of domestic auto visitors grew by only 33%, while their vmt rose 83%. In addition, the number of foreign visitors grew by 253%, compared to a 356% increase in their vmt. The additional differences in driving by the visitor types reflect a variety of factors that determine how much they drive. These include the length of stay, party size, share traveling by car at their destinations, and the average amount of daily driving per party. Figures 3 through 5 show the changes in these parameters for domestic air visitors, domestic auto visitors, and foreign visitors, respectively.

**FIGURE 3 Changes in Determinants of Annual Driving by Domestic Air Visitors**

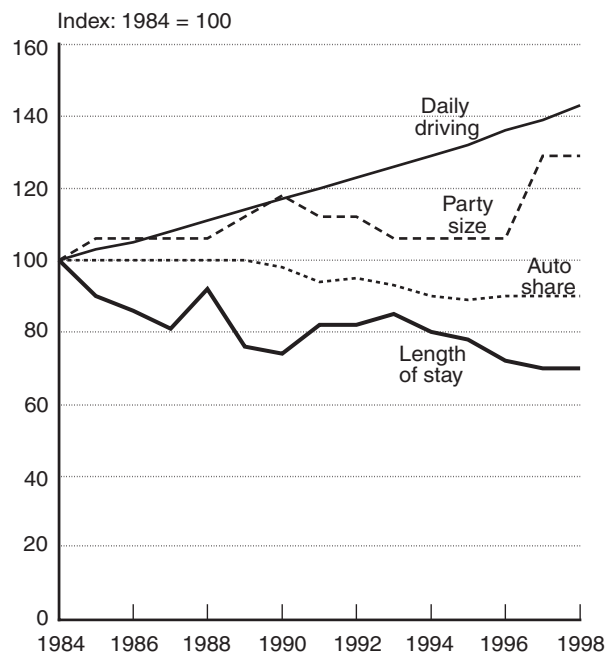

Changes in other factors explain the slower growth in driving for domestic air visitors in comparison with the number of visitors. From 1984 to 1998, the length of stays decreased by 30%, the share of domestic air visitors traveling by car at their destinations decreased by about 10% and the number of people per party increased by about 30%.

Domestic auto visitors data, in contrast to domestic air visitors, show that the growth in their driving is greater than the number of visitors. On the negative side, the number of people per party slightly

**FIGURE 4 Changes in Determinants of Annual Driving by Domestic Auto Visitors**

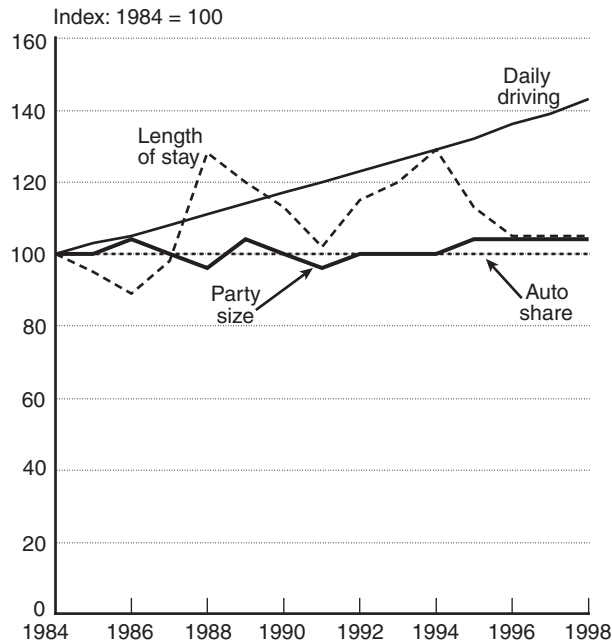

increased by about 4%. On the positive side, however, not only did the assumed growth in daily driving reinforce the growth in the number of visitors, but the length of stays also increased slightly by 5%.

Driving by foreign visitors also grew faster than the number of these visitors. Even though the share of these visitors traveling by car at their destinations decreased, the assumed growth in daily driving overcompensated for that decrease. In addition, we assumed, due to lack of data, that both the length of stays and the number of people per party of visitors remained the same.

### Applicability to Other States

The proposed approach may offer some guidance to other states attempting to measure vehicle travel by visitors. Applicability would be governed mainly by two issues. First, the proposed approach to measuring vehicle travel by visitors to a single state does not take into account through travel. Excluding through travel was intentional, because people who travel through a state are technically not visitors to that state. However, through travelers use infrastructure and hence are of interest to planners. While there is little through travel in Florida because of its geography, many states have a lot of this traffic and, thus, would find this far more relevant.

**FIGURE 5 Changes in Determinants of Annual Driving by Foreign Visitors**

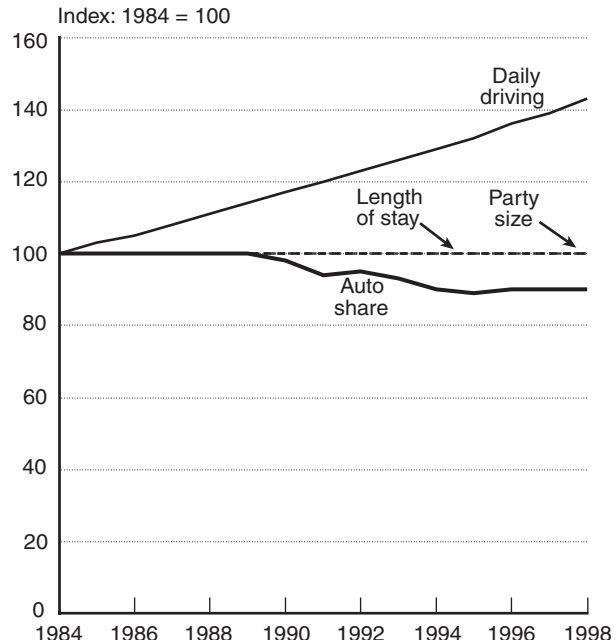

Note: Both length of stay and party size equal 100.

The other issue is the availability of similar data sources in other states. Our approach relies primarily on two datasets. One dataset has information on the annual number of foreign visitors and their characteristics, using federal data for estimating their driving. Since the federal data are available for every state, this approach is applicable to other states for measuring vehicle travel by foreign visitors.

The other dataset has information on the annual number of domestic visitors by entry mode and characteristics. The data on domestic visitors may come from different sources. The Florida application used two sources. One is an annual survey of these visitors as they complete their stay and leave Florida. This survey is specific to Florida. It is possible, however, that some other states have similar surveys. The other data source is the *DIRECTIONS Travel Intelligence System* mentioned earlier. This system is a syndicated database that tracks travel behavior for the entire country and is based on annual surveys of 540,000 traveling households. Most states can get the data needed for the proposed approach by using the subsample for their states.

In addition to those state-specific annual surveys or the *DIRECTIONS Travel Intelligence System*, individual states can also use the 2001 *National*

*Household Travel Survey* (NHTS) (USDOT FHWA BTS 2003). The 2001 NHTS was designed to include both local and long-distance travel. For each destination state, the survey data contain all the necessary information for applying the proposed approach. Specific information items from the survey include destination cities, group size, modes to and from destinations, modes used at destinations, duration of stay to be derived from information on departure and return dates, and the total number of visitors. One advantage of the 2001 NHTS is that it also gives information on the origin states of visitors. This information can potentially be used to determine where visitors may enter a destination state, which is particularly important if there are many bordering states and entering routes. Another advantage of the 2001 NHTS is that it provides a consistent source of data for all states. One interesting exercise would be to apply the proposed approach to individual states with the 2001 NHTS to measure vehicle travel by domestic visitors.

## CONCLUSION

This paper proposes a simple approach to estimating vehicle travel by visitors to individual states and applies it to Florida for the 15-year period from 1984 through 1998. Our findings for this period show a trend toward slower growth in driving by domestic visitors entering Florida by air and higher growth in driving for those visitors entering by auto and for foreign visitors. Changes in other factors—number of visitors entering the state, their length of stay, and the number of people traveling together in a party— affect these trends. The proportion of vehicle travel by visitors to a state can be significant and may exceed that by freight trucks. Proportions appear to be relatively stable over time with some variations depending on not only changes in the number of visitors but also changes in their characteristics. Estimates of vehicle travel by visitors are likely to be conservative, because several components of vehicle travel by visitors are omitted due to lack of data.

This approach is applicable to individual states that have access to information on domestic and foreign visitors, such as the number of visitors, their distribution among major destinations, average length

of stay, average party size, and the proportion traveling at their destinations by car.

## ACKNOWLEDGMENT

This research was funded by the Trends and Conditions Research Program, Office of Policy Planning, Florida Department of Transportation.

## REFERENCES

- Bureau of Economic and Business Research (BEBR). 1985–1999. *Florida Statistical Abstract*. Gainesville, FL.
- Center for Urban Transportation Research (CUTR). 2001a. *Trends in Vehicle Miles of Travel by Florida's Visitors on Its Highways*. Tampa, FL: University of South Florida.
- \_\_\_\_\_. 2001b. *Trends in Vehicle Miles of Travel by Trucks*. Tampa, FL: University of South Florida.
- D.K. Shifflet and Associates (DKS&A). 2000. *About DKS&A*. Available at <http://www.dksa.com/about.html>, as of Mar. 17, 2003.
- Florida Department of Commerce (DOC), Tourism Division. 1984–1995. *Florida Visitor Study*. Tallahassee, FL.
- Florida Department of Transportation (DOT). 2000. *Official Highway Mileage*. Available at <http://www3.dot.state.fl.us/mileage>, as of Mar. 17, 2003.
- Florida Tourism Industry Marketing Corporation (FTIMC). 1996–1998. *Florida Visitor Study*. Tallahassee, FL.
- Frechtling, D.C., M.D. Meyer, and A.E. Pisarski. 1998. *Tourism Travel and Transportation System Development*, NCHRP Report 419. Washington, DC: Transportation Research Board.
- U.S. Department of Commerce (USDOC), International Trade Administration (ITA), Tourism Division. 1996–1995 and 1998–1997. *Overseas Visitors to Select U.S. States and Territories*. Available at <http://tinet.ita.doc.gov>, as of Mar. 17, 2003.
- \_\_\_\_\_. 1998. *Profile of Overseas Travelers to the U.S.* Washington, DC.
- U.S. Department of Transportation (USDOT), Bureau of Transportation Statistics (BTS). 1997a. *1995 Nationwide Personal Transportation Survey, Table Wizard*. Available at <http://www-cta.ornl.gov/npts/1995/Doc/index.shtml>, as of Mar. 17, 2003.
- \_\_\_\_\_. 1997b. *American Travel Survey: Florida-Summary Travel Characteristics*, BTS/ATS95-ESTC/FL, Available at <http://www.bts.gov/programs/ats/pubs/states/estcfl.pdf>, as of Mar. 17, 2003.
- U.S. Department of Transportation (USDOT), Federal Highway Administration (FHWA). 1996. *Highway Statistics Summary to 1995*. Available at <http://www.fhwa.dot.gov/ohim/summary95/index.html>, as of Mar. 17, 2003.
- \_\_\_\_\_. 1996–1998. *Highway Statistics*. Available at <http://www.fhwa.dot.gov/ohim/ohimstat.htm>, as of Mar. 17, 2003.
- \_\_\_\_\_, Bureau of Transportation Statistics (BTS). 2003. *2001 National Household Travel Survey*. Available at <http://nhts.ornl.gov/2001/index.htm>, as of May 7, 2003.



## JOURNAL OF TRANSPORTATION AND STATISTICS

### Guidelines for Manuscript Submission

**Please note:** Submission of a paper indicates the author's intention to publish in the *Journal of Transportation and Statistics* (JTS). Submission of a manuscript to other journals is unacceptable. Previously published manuscripts, whether in an exact or approximate form, cannot be accepted. Check with the managing editor if in doubt.

**Scope of JTS:** JTS has two primary areas of focus. We publish articles that look at transportation from a statistical perspective. We also publish articles that do not use or discuss statistical techniques but present information on areas of transportation research that are of interest to JTS readers. Papers that do not use or discuss statistical techniques may be considered for the Research Notes section.

**Manuscripts** must be double spaced, including quotations, abstract, reference section, and any notes. All figures and tables should appear at the end of the manuscript with each one on a separate page. Do not embed them in your manuscript.

Because the JTS audience works in diverse fields, please **define terms** that are specific to your area of expertise. In addition, include a literature review that discusses previous efforts to address the problem you are investigating in your paper, and discuss how your approach improves on previous work. Also, please ensure that any statistical results are presented with relevant equations completely specified and with sufficient descriptive statistics that the reader can assess the significance of your results.

**The cover page** of your manuscript must include the title, author name(s) and affiliations, and the telephone numbers and surface and email addresses for all authors.

**Put the Abstract** on the second page. It should be about 100 words and briefly describe the contents of the paper including the mode or modes of transportation, the research method, and the key results and/or conclusions. Please include a list of keywords to describe your article.

**Graphic elements** (figures and tables) must be called out in the text. Graphic elements must be in black ink. We will accept graphics in color only in rare circumstances.

**References** follow the style outlined in the *Chicago Manual of Style*. All non-original material must be sourced.

**International papers** are encouraged, but please be sure to have your paper edited by someone whose first language is English and who knows your research area.

**Accepted papers** must be submitted electronically in addition to a hard copy (see below for information on electronic submissions). Make sure the hard copy corresponds to the electronic version.

**Page Proofs:** As the publication date nears, authors will be required to return article page proofs to the Managing Editor within 48 hours of receipt.

**Acceptable software** for text and equations is limited to Word, WordPerfect, and LaTeX. Data behind all figures, maps, and charts must be provided in Excel, Word, or DeltaGraph. Data in American Standard Code for Information Interchange (ASCII) text will be accepted but is less desirable. Acceptable software for graphic elements is limited to Excel, DeltaGraph, or Adobe Illustrator. If other software is used, the file supplied must have an .eps or .pdf extension. We do not accept PowerPoint files.

**Maps** are accepted in a variety of Geographic Information System (GIS) programs. Please save your GIS files using .eps or .pdf extensions. If this is not possible, maps may be provided in ArcView3.x project files (.apr), ArcGIS8.x map files (.mxd), or Arc/Info metafiles (.map). Send your files using the .apr or .mxd extensions on a CD-ROM via overnight delivery service.

**Electronic submissions** via email to the Managing Editor are strongly encouraged. We can accept PDF, Word, WordPerfect, Excel, and Adobe Illustrator files. If you cannot send your submission via email, you may send a disk or CD by overnight delivery service or send a hardcopy by the U.S. Postal Service (regular mail; see below). Do not send disks or CDs through regular mail.

**Hardcopy submissions** delivered to BTS by the U.S. Postal service are irradiated. Do not include a disk in your envelope; the high heat will damage it.

#### **Send all submission materials to:**

Marsha Fenn  
Managing Editor, *Journal of Transportation and Statistics*  
Bureau of Transportation Statistics  
U.S. Department of Transportation  
400 7th Street, SW, Room 7412, K-15  
Washington, DC 20590  
Email: marsha.fenn@bts.gov



## REVIEWERS for 2001 and 2002

### A

William Anderson Boston University, Boston, MA

### B

Sandy Balkin Pfizer Inc., New York, NY  
David Banks Food and Drug Administration, USDHHS, Rockville, MD  
William Bannister Bureau of Transportation Statistics, USDOT,  
Washington, DC  
Connie Borrer Arizona State University, Glendale, AZ  
Mark Bradford Bureau of Transportation Statistics, USDOT,  
Washington, DC  
Michael Bronzini George Mason University, Fairfax, VA  
Mark Burris Texas A&M University, College Station, TX  
Kenneth Button George Mason University, Fairfax, VA

### C

Amrut Champaneri Bureau of Transportation Statistics, USDOT,  
Washington, DC  
Promod Chandhok Bureau of Transportation Statistics, USDOT,  
Washington, DC  
David Chesser MacroSys Research and Technology, Washington, DC  
Lewis Clopton Federal Transit Administration, USDOT,  
Washington, DC  
Tim Coburn Abilene Christian University, Abilene, TX  
Michael Cohen Bureau of Transportation Statistics, USDOT,  
Washington, DC  
Sally Hill Cooper Consultant, Arlington, VA  
Ralph Craft Federal Highway Administration, USDOT,  
Washington, DC

### D

Gary Davis University of Minnesota, Minneapolis, MN  
Scott Dennis Bureau of Transportation Statistics, USDOT,  
Washington, DC  
Robert Dial Volpe National Transportation Systems Center,  
USDOT, Washington, DC

### E

Antonio Esteve Federal Highway Administration, USDOT,  
Washington, DC

### F

Vincent Fang MacroSys Research and Technology, Washington, DC  
Gary Feuerberg Bureau of Transportation Statistics, USDOT,  
Washington, DC  
Stephen Fienberg Carnegie Mellon University, Pittsburgh, PA  
Ignatius Fomunung Clark Atlanta University, Atlanta, GA

### G

Lee Giesbrecht Bureau of Transportation Statistics, USDOT,  
Washington, DC  
David Gillen Wilfrid Laurier University, Waterloo, Ontario, Canada  
Genevieve Giuliano University of Southern California, Los Angeles, CA  
José Gomez-Ibañez Harvard University, Cambridge, MA

Jason Goodfriend	Bureau of Transportation Statistics, USDOT, Washington, DC
Thea Graham	Bureau of Transportation Statistics, USDOT, Washington, DC
David Greene	Oak Ridge National Laboratory, Oak Ridge, TN
Michael Greenwald	University of Wisconsin, Milwaukee, WI
Richard Griffin	Colorado Department of Transportation, Denver, CO
Elizabeth Grossman	U.S. Environmental Protection Agency, Washington, DC
Richard Gruberg	Federal Highway Administration, USDOT, Washington, DC
William Gullickson	Office of Productivity and Technology, Washington, DC

## H

Mark Hallenbeck	Washington State Transportation Center, Seattle, WA
Ashad Hamideh	Purdue University, West Lafayette, IN
Susan Handy	University of California at Davis, Davis, CA
Kingsley Haynes	George Mason University, Fairfax, VA
Leonard Hearne	American University, Washington, DC
David Hensher	The University of Sydney, Sydney, Australia
Patricia Hu	Oak Ridge National Laboratory, Oak Ridge, TN

## K

Kazuya Kawamura	University of Illinois, Chicago, IL
-----------------	-------------------------------------

## L

T.R. Lakshmanan	Boston University, Boston, MA
Herbert Lee III	Duke University, Durham, NC
Jung-Taek Lee	University of Illinois, Chicago, IL
Janice Lent	Bureau of Transportation Statistics, USDOT, Washington, DC
Mark Levenson	U.S. Consumer Product Safety Commission, Bethesda, MD
Timothy Lomax	Texas Transportation Institute, College Station, TX

## M

Sue McNeil	University of Illinois, Chicago, IL
Paul Metaxatos	University of Illinois, Chicago, IL
Michael Meyer	Georgia Institute of Technology, Atlanta, GA
Gordan Morgan	Florida Department of Transportation, Tallahassee, FL

## N

Nagaraj Neerchal	University of Maryland, Baltimore County, MD
------------------	--

## O

Keith Ord	Georgetown University, Washington, DC
-----------	---------------------------------------

## P

Joel Palley	Federal Railroad Administration, USDOT, Washington, DC
Neil Pedersen	Maryland Department of Transportation, Baltimore, MD
Alan Pisarski	Consultant, Falls Church, VA

## R

Robert Raeside	Napier University, Edinburgh, Scotland
Nalini Ravishanker	University of Connecticut, Storrs, CT

**S**

Mitsuro Saito Brigham Young University, Provo, UT  
Rick L. Schmoyer Oak Ridge National Laboratory, Oak Ridge, TN  
Tom Seekins University of Montana, Missoula, MT  
Ashish Sen Bureau of Transportation Statistics, USDOT,  
Washington, DC  
Terry Shelton Federal Motor Carrier Safety Administration,  
USDOT, Washington, DC  
Qing Shen University of Maryland, College Park, MD  
Caesar Singh Bureau of Transportation Statistics, USDOT,  
Washington, DC  
Kumares Sinha Purdue University, West Lafayette, IN  
Brian Sloboda Bureau of Transportation Statistics, USDOT,  
Washington, DC  
Tony Smith University of Pennsylvania, Philadelphia, PA  
Siim Sööt University of Illinois, Chicago, IL  
Frank Southworth Oak Ridge National Laboratory, Oak Ridge, TN  
Clifford Spiegelman Texas A&M University, College Station, TX  
P.S. Sriraj University of Illinois, Chicago, IL

**V**

Sharada Vadali Texas A&M University, College Station, TX  
Kert Viele University of Kentucky, Lexington, KY

**W**

Martin Wachs University of California, Berkeley, CA  
Simon Washington University of Arizona, Tucson, AZ  
Lynn Weidman U.S. Census Bureau, USDOC, Washington, DC  
Mark Weihofen Federal Railroad Administration, USDOT,  
Washington, DC  
Herb Weinblatt Cambridge Systematics, Inc., Chevy Chase, MD  
David White Napier University, Edinburgh, Scotland  
William Woodall Virginia Polytechnic Institute and State University,  
Blacksburg, VA

**Y**

Theodore Younglove University of California, Riverside, CA

**Z**

Chris Zeilinger Community Transportation Association, Washington, DC  
Athanasios Ziliaskopoulous Northwestern University, Evanston, IL



## AUTHOR INDEX (for Vols. 1–5)

### A

- Armoogum, Jimmy  
personal transportation surveys, Vol. 1(3):53–64  
Awad, Wael  
truck accidents, freeway ramps, Vol. 1(1):75–92

### B

- Bachman, William  
motor vehicle emissions, Vol. 3(2):65–84  
Balkin, Sandy  
speed limit increases, fatal interstate crashes and,  
Vol. 4(1):1–16, 24–26  
Banks, David  
introductory statement, Vol. 3(1):v–vi  
Baradaran, Siamak  
accessibility performance measures,  
Vol. 4(2/3):31–48  
Barth, Matthew  
motor vehicle emissions, Vol. 3(2):29–38  
Bartin, Bekir  
New Jersey highway transportation costs,  
Vol. 4(1):81–103  
Bernier, Brad  
disabled persons, rural vouchers,  
Vol. 2(1):61–70  
Berechman, Joseph  
accessibility improvements, local employment and,  
Vol. 4(2/3):49–66  
New Jersey highway transportation costs,  
Vol. 4(1):81–103  
Berglund, Svante  
path-based accessibility, Vol. 4(2/3):79–91  
Blincoe, Lawrence  
motor vehicle crash risk, Vol. 2(1):19–43  
Blum, Ulrich  
infrastructure, externalities, Vol. 1(3):81–88  
Boarnet, Marlon  
Northridge earthquake, Vol. 1(2):21–36  
Button, Kenneth  
air transport statistics, Vol. 2(1):71–92

### C

- Calzada, Christian  
freight demand and mode choice,  
Vol. 2(2):149–158  
Cantos, Pedro  
railways, European, efficiency/output,  
Vol. 3(3):61–68  
Chang, Gang-Len  
intercity trip time using a network  
assignment model, Vol. 5(2/3):  
Chang, Iljoon  
intercity trip time using a network  
assignment model, Vol. 5(2/3):  
Chen, Duanjie  
household-provided transportation in the Trans-  
portation Satellite Accounts, Vol. 5(2/3):\_\_\_\_\_

- Chen, Haibo  
traffic forecasting, Vol. 5(1):47–56  
Chin, Shih-Miao  
trucking, state-level, Vol. 1(1):63–74  
Chu, Xuehao  
measuring vehicle travel by visitors, Vol. 5(2/3):\_\_\_\_\_
- Clark, Stephen D.  
traffic forecasting, Vol. 5(1):47–56  
Clifton, Kelly J.  
evaluating neighborhood accessibility,  
Vol. 4(2/3):67–78  
Coburn, Timothy  
introductory statement, Vol. 3(2):v–ix  
Cohen, Harry  
freeway incidents, travel time, Vol. 2(2):123–131  
Coindet, Jean-Paul  
transportation strikes, Vol. 1(2):43–51

### D

- Davis, Bill  
Northridge earthquake, Vol. 1(2):21–36  
Davis, Gary  
traffic volume estimates, Vol. 4(1):27–38  
Deaton, Michael  
vehicle emissions, ANCOVA analysis,  
Vol. 3(2):49–64  
Delucchi, Mark  
noise from motor vehicles, Vol. 1(3):1–24  
social costs of motor vehicle use, Vol. 1(1):15–42  
Dill, Jennifer  
vehicle license fees, Vol. 2(2):133–147  
Dixon, Michael P.  
estimation of origin-destination matrices,  
Vol. 5(2/3):\_\_\_\_\_

### E

- El-Fadel, Mustasem  
urban congestion, air pollution, Vol. 3(2):85–102  
Enns, Phil  
light-duty truck emissions, Vol. 3(2):39–47

### F

- Fang, Bingsong  
economic importance of transportation,  
Vol. 3(1):15–30  
household-provided transportation in the Trans-  
portation Satellite Accounts, Vol. 5(2/3):\_\_\_\_\_  
System of National Accounts, Vol. 1(1):93–102  
Ferguson, Erik  
Atlanta, parking management, Vol. 2(1):93–107  
congestion, demand management, and mobility  
enhancement, Vol. 4(1):51–73  
Fomunung, Ignatius  
motor vehicle emissions, Vol. 3(2):65–84

Fontaine, Michael D.  
speed limit increases, fatal interstate crashes and,  
Vol. 4(1):16–21

Fulton, Lewis  
induced travel demand, Mid-Atlantic,  
Vol. 3(1):1–14

## G

Gajewski, Byron J.  
estimation of origin-destination matrices,  
Vol. 5(2/3):\_\_\_\_\_

Gangrade, Sachin  
modeling commuters' activity schedules,  
Vol. 5(2/3):\_\_\_\_\_

Giuliano, Genevieve  
Northridge earthquake, Vol. 1(2):1–20

Goldman, Todd  
vehicle license fees, Vol. 2(2):133–147

Golob, Jacqueline  
Northridge earthquake, Vol. 1(2):1–20

Gordon, Peter  
Northridge earthquake, Vol. 1(2):21–36

Gould, Jane  
Northridge earthquake, Vol. 1(2):21–36

Grant-Muller, Susan M.  
traffic forecasting, Vol. 5(1):47–56

Greene, David  
Letter from the Editor, Vol. 1(3):v

Grossardt, Ted  
Kentucky's new Medicaid transit service,  
Vol. 5(2/3):\_\_\_\_\_

Guensler, Randall  
motor vehicle emissions, Vol. 3(2):65–84

## H

Han, Xiaoli  
economic importance of transportation,  
Vol. 3(1):15–30  
household-provided transportation in the Transportation Satellite Accounts, Vol. 5(2/3):\_\_\_\_\_

System of National Accounts, Vol. 1(1):93–102

Handy, Susan L.  
evaluating neighborhood accessibility,  
Vol. 4(2/3):67–78

Harris, Britton  
accessibility concepts and applications,  
Vol. 4(2/3):15–30

Harvey, Andrew  
speed limit increases, fatal interstate crashes and,  
Vol. 4(1):22–24

Henderson, Dennis  
home-based workers, Vol. 1(2):25–41

Hensher, David,  
urban transport fares, Vol. 1(1):43–62

Hopson, Janet  
trucking, state-level, Vol. 1(1):63–74

Hsu, Shi-Ling  
noise from motor vehicles, Vol. 1(3):1–24

Hummer, Joseph  
roadway inventory data acquisition,  
Vol. 3(3):33–46

Hwang, Ho-Ling  
trucking, state-level, Vol. 1(1):63–74

## J

Janson, Bruce  
truck accidents, freeway ramps, Vol. 1(1):75–92

Jiang, Fei  
freight demand and mode choice,  
Vol. 2(2):149–158

Johnson, Paul  
freight demand and mode choice,  
Vol. 2(2):149–158

Jorgenson, Darren  
speed of vehicles in traffic management,  
Vol. 3(3):69–81

## K

Seshasai, Kanchi  
road capacity and allocation of time,  
Vol. 5(1):25–45

Karimi, Hassan  
roadway inventory data acquisition,  
Vol. 3(3):33–46

Karlaftis, Matthew  
speed of vehicles in traffic management,  
Vol. 3(3):69–81  
transit costs, multiple serial correlation,  
Vol. 2(2):113–121

Khattak, Aemal  
roadway inventory data acquisition,  
Vol. 3(3):33–46

King, Jenny  
urban transport fares, Vol. 1(1):43–62

Knipling, Ronald  
motor vehicle crash risk, Vol. 2(1):19–43

Kockelman, Kara Maria  
impacts of bypasses on small- and medium-sized communities, Vol. 5(1):57–69  
light-duty trucks and passenger car use,  
Vol. 3(3):47–60

Kononov, Jake  
truck accidents, freeway ramps, Vol. 1(1):75–92

## L

Lakshmanan, T.R.  
introductory statement, Vol. 1(1):v–vi

Ledolter, Johannes  
speed limit increases, fatal interstate crashes and,  
Vol. 4(1):13–16

Lee, Herbert  
train waybill data models and statistics,  
Vol. 4(1):75–79

Levinson, David M.  
road capacity and allocation of time,  
Vol. 5(1):25–45



Limanond, Thirayoot  
chase car data, vehicle emissions, Vol. 3(2):15–28  
Liu, Guo Xin  
automatic vehicle classification, Vol. 1(3):89–93

## M

Madre, Jean-Loup  
personal transportation surveys (France),  
Vol. 1(3):53–64  
Marchand, Scott  
Kentucky's new Medicaid transit service,  
Vol. 5(2/3):\_\_\_\_  
McCarthy, Patrick  
transit costs, multiple serial correlation,  
Vol. 2(2):113–121  
McCullough, Robert G.  
modeling commuters' activity schedules,  
Vol. 5(2/3):\_\_\_\_  
McDorman, Maureen  
Kentucky's new Medicaid transit service,  
Vol. 5(2/3):\_\_\_\_  
Meszler, Daniel  
induced travel demand, Mid-Atlantic,  
Vol. 3(1):1–14  
Miller, Harvey J.  
measuring space-time accessibility,  
Vol. 4(2/3):1–14  
Mokhtarian, Patricia  
home-based workers, Vol. 1(2):25–41  
Monaco, Kristen  
trucking safety, Vol. 3(1):69–79  
Morey, Jennifer  
chase car data, vehicle emissions, Vol. 3(2):15–28  
Morris, Max D.  
traffic operations and management, computer  
simulation models, discussion of article,  
Vol. 5(1):18–22  
Murphy, James  
social costs of motor vehicle use, Vol. 1(1):15–42

## N

Najm, Majdi Abou  
urban congestion, air pollution, Vol. 3(2):85–102  
Niemeier, Debbie  
chase car data, vehicle emissions, Vol. 3(2):15–28  
Nijkamp, Peter  
European public transport demand,  
Vol. 1(1):1–14  
Noland, Robert  
induced travel demand, Mid-Atlantic,  
Vol. 3(1):1–14

## O

O'Connell, Lenahan  
Kentucky's new Medicaid transit service,  
Vol. 5(2/3):\_\_\_\_  
Ord, J. Keith  
speed limit increases, fatal interstate crashes and,  
Vol. 4(1):1–16, 24–26

Ozbay, Kaan  
New Jersey highway transportation costs,  
Vol. 4(1):81–103

## P

Paaswell, Robert  
accessibility improvements, local employment  
and, Vol. 4(2/3):49–66  
Park, Byungkyu (Brian)  
traffic operations and management, computer  
simulation models, Vol. 5(1):1–15  
traffic operations and management, computer  
simulation models, rejoinder, Vol. 5(1):23–24  
Pastor, Jos  
railways, European, efficiency/output,  
Vol. 3(3):61–68  
Pendyala, Ram  
modeling commuters' activity schedules,  
Vol. 5(2/3):\_\_\_\_  
Pepping, Gerard  
European public transport demand, Vol. 1(1):1–14  
Pickrell, Don  
motor vehicle ownership and use, Vol. 2(1):1–17  
Pinkerton, Brian  
truck accidents, freeway ramps, Vol. 1(1):75–92  
Polzin, Steven E.  
measuring vehicle travel by visitors, Vol. 5(2/3):\_\_\_\_

## Q

Qu, Tongbin Teresa  
speed limit increases, fatal interstate crashes and,  
Vol. 4(1):16–21

## R

Ramjerdi, Farideh  
accessibility performance measures,  
Vol. 4(2/3):31–48  
Richardson, Harry  
Northridge earthquake, Vol. 1(2):21–36  
Rietveld, Piet  
travel surveys, rounding of arrival and departure  
times, Vol. 5(1):71–82  
Rilett, Laurence, R.  
estimation of origin-destination matrices,  
Vol. 5(2/3):\_\_\_\_  
traffic operations and management, computer  
simulation models, discussion of article,  
Vol. 5(1):16–17  
Robles, Juan  
truck accidents, freeway ramps, Vol. 1(1):75–92  
Rocklife, Nigel  
freight travel time and reliability, Vol. 3(3):83–89  
Rouphail, Nagui M.  
traffic operations and management, computer  
simulation models, Vol. 5(1):1–15  
traffic operations and management, computer  
simulation models, rejoinder, Vol. 5(1):23–24

**S**

- Sacks, Jerome,  
 traffic operations and management, computer simulation models, Vol. 5(1):1–15  
 traffic operations and management, computer simulation models, rejoinder, Vol. 5(1):23–24
- Saito, Mitsuru  
 creating land-use scenarios, Vol. 4(1):39–49
- Saricks, Christopher  
 hazardous shipments, highways and railroads, Vol. 3(1):81–92
- Sbayti, Hayssam  
 urban congestion, air pollution, Vol. 3(2):85–102
- Schafer, Andreas  
 travel demand, country comparisons, Vol. 3(3):1–31
- Schimek, Paul  
 motor vehicle ownership and use, Vol. 2(1):1–17
- Schmitt, Rolf  
 Northridge earthquake, introductory statement, Vol. 1(2):v–vi
- Schulz, Daniel  
 motor vehicle emissions, Vol. 3(2):29–38
- Seekins, Tom  
 disabled persons, rural vouchers, Vol. 2(1):61–70
- Sen, Ashish  
 introductory statement, Vol. 2(2):v–vi
- Serrano, Lorenzo  
 railways, European, efficiency/output, Vol. 3(3):61–68
- Sharma, Satish  
 automatic vehicle classification, Vol. 1(3):89–93
- Sinha, Kumares  
 speed of vehicles in traffic management, Vol. 3(3):69–81  
 transit costs, multiple serial correlation, Vol. 2(2):113–121
- Singer, Brett  
 vehicle emissions, analysis of, Vol. 3(2):1–14
- Siria, Bruce  
 Kentucky's new Medicaid transit service, Vol. 5(2/3):\_\_\_\_\_
- Sloboda, Brian W.  
 household-provided transportation in the Transportation Satellite Accounts, Vol. 5(2/3):\_\_\_\_\_
- Slott, Robert  
 vehicle emissions, analysis of, Vol. 3(2):1–14
- Smith, Joshua  
 creating land-use scenarios, Vol. 4(1):39–49
- Smith, V. Kerry  
 highway construction costs and environmental regulation, Vol. 2(1):45–60
- Sorratini, Jose  
 truck trips, commodity flows and input-output, Vol. 3(1):53–67
- Southworth, Frank  
 freeway incidents, travel time, Vol. 2(2):123–131
- Spiegelman, Clifford H.  
 estimation of origin-destination matrices, Vol. 5(2/3):\_\_\_\_\_
- speed limit increases, fatal interstate crashes and, Vol. 4(1):16–21

- traffic operations and management, computer simulation models, discussion of article, Vol. 5(1):16–17
- Srinivasan, Sivaramakrishnan  
 impacts of bypasses on small- and medium-sized communities, Vol. 5(1):57–69
- Stokes, Charles J.  
 urban transit ridership, Letter to the Editor, Vol. 4(1):v

**T**

- Tessmer, Joseph  
 international crash statistics, Vol. 2(2):159–166
- Thakuriah, Piyushimita (Vonu)  
 introduction to issue, Vol. 4(2/3):v  
 traffic operations and management, computer simulation models, Vol. 5(1):1–15  
 traffic operations and management, computer simulation models, rejoinder, Vol. 5(1):23–24
- Thomas, John  
 induced travel demand, Mid-Atlantic, Vol. 3(1):1–14
- Thomas, Scott  
 automatic vehicle classification, Vol. 1(3):89–93
- Thoresen, Thorolf  
 freight travel time and reliability, Vol. 3(3):83–89
- Tompkins, Melanie  
 hazardous shipments, highways and railroads, Vol. 3(1):81–92
- Treyz, Fredrick  
 investment, macroeconomic analyses, Vol. 1(3):65–79
- Tsolakis, Dimitris  
 freight travel time and reliability, Vol. 3(3):83–89

**V**

- Viele, Kert  
 train waybill data models and statistics, Vol. 4(1):75–79
- Von Haefen, Roger  
 highway construction costs and environmental regulation, Vol. 2(1):45–60

**W**

- Wachs, Martin  
 vehicle license fees, Vol. 2(2):133–147
- Wang, Jing-Shiarn  
 motor vehicle crash risk, Vol. 2(1):19–43
- Washington, Simon  
 motor vehicle emissions, Vol. 3(2):65–84
- Weisbrod, Glen  
 investment, macroeconomic analyses, Vol. 1(3):65–79
- Wells, John V.  
 letter from the Editor-in-Chief, Vol. 5(2/3):v
- Wenzel, Tom  
 vehicle emissions, analysis of, Vol. 3(2):1–14
- Wigan, Marcus  
 freight travel time and reliability, Vol. 3(3):83–89

Williams, Emily  
trucking safety, Vol. 3(1):69–79  
Willson, Richard  
Northridge earthquake, Vol. 1(2):21–36  
Winebrake, James  
vehicle emissions, ANCOVA analysis,  
Vol. 3(2):49–64  
Wu, Yi-Hwa  
measuring space-time accessibility,  
Vol. 4(2/3):1–14

## **Y**

Yang, Shimin  
traffic volume estimates, Vol. 4(1):27–38  
Younglove, Theodore  
motor vehicle emissions, Vol. 3(2):29–38

## **Z**

Zhao, Yong  
light truck and passenger car use, Vol. 3(3):47–60  
Zhu, Wei  
highway construction costs and environmental  
regulation, Vol. 2(1):45–60  
Zimmerman, Karl  
speed limit increases, fatal interstate crashes and,  
Vol. 4(1):16–21



# COMPLETE INDEX (for Vols. 1–5)

## A

- Accessibility  
and employment, Vol. 4(2/3):49–66  
and road construction, Vol. 5(1):26  
business productivity, Vol. 1(3):69–76  
concepts and applications, Vol. 4(2/3):15–30  
definition of, Vol. 4(2/3):16  
demarcation area, Vol. 4(2/3):37  
European context, Vol. 4(2/3):38–40  
improving, Vol. 4(2/3):49–66  
indicators  
    composite approach, Vol. 4(2/3):35–36  
    constraints-based approach, Vol. 4(2/3):34–35  
    gravity approach, Vol. 4(2/3):33–34  
    opportunities approach, Vol. 4(2/3):33–34  
    travel-cost approach, Vol. 4(2/3):33  
    utility-based surplus approach, Vol. 4(2/3):35  
modeling, Vol. 4(2/3):15–30, 31–47  
    agglomeration effects, Vol. 4(2/3):37–38  
    and labor markets, Vol. 4(2/3):54–57, 63–64  
    measurement of attraction masses, Vol. 4(2/3):37  
    measurement of spatial separation, Vol. 4(2/3):36–37  
    path-based accessibility, Vol. 4(2/3):79–90  
    unimodality v. multimodality, Vol. 4(2/3):37  
neighborhood accessibility, Vol. 4(2/3):67–78  
space-time prisms, Vol. 4(2/3):1–14
- Accidents. *See also* Crashes, Safety  
air transportation, Vol. 2(1):79, 85  
costs, Vol. 4(1):87–90, 99–100  
free incidents, travel time, Vol. 2(2):123–131  
hazardous materials shipments by rail, Vol. 3(1):81–92  
high-risk sites, Vol. 1(1):75–91  
increased speed limits, Vol. 4(1):1–26  
trucks, Vol. 1(1):75–91
- AFV. *See* Alternative fuel vehicles
- Age. *See also* Demographic factors  
as a determinant of truck accidents, Vol. 3(1):69–73  
commuting, Vol. 2(1):104
- Agglomeration effects (accessibility modeling), Vol. 4(2/3):37–38
- Aggregation/disaggregation of data  
business interruption impacts, Northridge earthquake, Vol. 1(2):29  
freight demand and mode choice, Vol. 2(2):149–58  
investment, macroeconomic analyses, Vol. 1(3):65–79  
motor vehicle emissions, Vol. 3(2):25  
motor vehicle license fees, Vol. 2(2):139  
public transit demand in Europe, Vol. 1(1):3, 5, 13  
travel demand, country comparisons, Vol. 3(3):1–31  
truck trips, statewide, Vol. 3(1):53  
urban passenger transport, Vol. 1(1):44  
value of time data, Vol. 5(2/3):57–72
- Air pollution, Vol. 3(2):1–102  
air quality assessment, Vol. 3(2):85–101  
air transportation, Vol. 2(1):79–80, 85–86  
analysis of covariance model, Vol. 3(2):49–64  
chase car data, Vol. 3(2):15–28  
costs from highway transportation, Vol. 4(1):91–92, 100; Vol. 5(2/3):84  
light trucks and passenger cars, Vol. 3(3):48  
Mobile Emissions Assessment System for Urban and Regional Evaluation, Vol. 3(2):65–83  
Mobile Source Emission Factor Model, Vol. 3(2):39–47, 65, 66, 67, 71, 72, 74–83  
modal emissions models, Vol. 3(2):29–38, 67–71  
motor vehicles, Vol. 1(1):20, 23, 27–28, 30, 33, 48  
social costs of motor vehicle use, Vol. 1(1):20, 23, 27–28, 30, 33  
trips, relationship to value of time data, Vol. 5(2/3):2–72  
urban areas, Vol. 3(2):15–28, 65–102
- Air transportation statistics, Vol. 2(1):71–92  
infrastructure needs, Vol. 2(1):78–79, 84–85  
policy formation, Vol. 2(1):74–76, 81–82  
productivity analysis, Vol. 2(1):77–78, 83–84  
safety, Vol. 2(1):79, 85  
use in cost analysis, Vol. 2(1):77–78, 83–84  
use in demand forecasting, Vol. 2(1):76–77, 83–84  
use in environmental analysis, Vol. 2(1):79–80, 85–86
- Alabama  
time-use behavior model, Vol. 5(1):39  
truck flows, Vol. 1(1):69, 72
- Alaska, truck flows, Vol. 1(1):67, 69, 72
- Alternative and replacement fuels, Vol. 3(2):50–61
- Alternative fuel vehicles (AFV)  
emissions, Vol. 3(2):50, 57–61  
urban transportation, Vol. 3(1):35
- American Travel Survey, Vol. 5(2/3):84
- Analysis of covariance (ANCOVA)  
motor vehicle emissions, Vol. 3(2):49–64
- Analysis of variance (ANOVA), Vol. 2(2):49–63  
motor vehicle emissions, Vol. 3(2):24  
roadway inventory data collection, Vol. 3(3):36–42
- Atlanta, Georgia, parking, Vol. 2(1):93–107
- ARIMA. *See* Box-Jenkins ARIMA time series
- Arizona  
time-use behavior model, Vol. 5(1):39  
truck flows, Vol. 1(1):69, 72
- Arkansas  
time-use behavior model, Vol. 5(1):39  
truck flows, Vol. 1(1):69, 72
- Austin, Texas, neighborhood accessibility assessment, Vol. 4(2/3):70–71, 76–77
- Australia  
crash statistics, Vol. 2(2):159–166  
freight travel time, Vol. 3(3):83–89  
impacts of bypasses on communities, Vol. 5(1):58  
modeling transportation in urban areas, Vol. 3(1):31–52  
public transit fare elasticity, Vol. 1(1):43–57  
travel demand, Vol. 3(3):1–31
- Austria  
crash statistics, Vol. 2(2):159–166  
travel demand, Vol. 3(3):3–5, 13
- Automatic vehicle classification, Vol. 1(3):89–93

## B

- Bayesian approach, Vol. 4(1):27–38; Vol. 5(1):6, 13–14, 24, 77, 82
- Bayes theorem, estimating traffic volume, Vol. 4(1):27–38
- Belgium
  - crash statistics, Vol. 2(2):159–166
  - travel demand, Vol. 3(3):7
- Bicycling, accessibility and, Vol. 4(2/3):67–68, 73, 74–75
- Bootstrap methods
  - estimation of origin-destination matrices, Vol. 5(2/3):37, 43–44
  - validation of motor vehicle emissions, Vol. 3(2) 29–36
- Box-Jenkins ARIMA time series, Vol. 4(1):13–15
- forecasting traffic flows, Vol. 5(1):
  - speed limit changes and fatal highway crashes, Vol. 4(1):13–15, 25
- Bridge improvements, Vol. 1(3):65–78
- Bronx, New York, Vol. 4(1):51–53
- Buses, Vol. 1(2):4, 7, 11; Vol. 4(2/3):79–90. *See also*
  - Public transit
  - noise pollution, Vol. 1(3):10–11

## C

- California
  - Northridge earthquake, Vol. 1(1):v–73
- San Diego, increased roadway capacity, Vol. 5(1):27
- San Francisco, increased roadway capacity, Vol. 5(1):27
- San Francisco Bay Area Rapid Transit
  - customer satisfaction among riders, Vol. 4(2/3):71
  - employment growth, in relation to, Vol. 4(1):54
  - time-use behavior model, Vol. 5(1):39
  - travel behavior, home-based workers, Vol. 1(3):25–41
  - truck flows, Vol. 1(1):67, 69, 71, 72
- Canada
  - crash statistics, Vol. 2(2):159–166
  - freight imported from Canada into the U.S., Vol. 1(1):68–72
- Capital investment in highways
  - environmental regulation and, Vol. 2(1):45–60
  - macroeconomic analyses, Vol. 1(3):65–79
  - positive externalities, Vol. 1(3):81–88
- Carbon dioxide
  - air transportation, Vol. 2(1):80
  - motor vehicles, Vol. 1(1):28; Vol. 3(2):3–4, 7, 12, 29–32, 34
- Carbon monoxide
  - motor vehicles, Vol. 3(2):3–5, 7, 9–10, 12, 29–32, 34, 40, 44–45, 65–84, 86, 91–101
- Cargo transportation
  - train waybill data models and statistics, Vol. 4(1):75–79
- Cars. *See* Motor vehicles, Passenger cars
- Census Transportation Planning Package (CTTP), Vol. 4(2/3):67–78
- Chase car data
  - measuring vehicle emissions, Vol. 3(2):15–28
  - potential inaccuracy, Vol. 3(2):17–18
- Chicago streets, Vol. 5(1):1–15
- Clean Air Act emissions standards, Vol. 3(2):2–3, 5
- Climate change
  - air transportation, Vol. 2(1):79–80
  - motor vehicle emissions, Vol. 3(2):v
  - motor vehicles, social costs, Vol. 1(1):22
- Cluster analysis, land-use and transportation sketch planning, Vol. 4(1):39–49
- Colorado
  - time-use behavior model, Vol. 5(1):39
  - truck flows, Vol. 1(1):69, 72
- Commodities
  - estimating state-level truck traffic, Vol. 1(1):63–73; Vol. 3(1):53–66
  - movement after Northridge earthquake, Vol. 1(2):37–48
  - transportation as, Vol. 3(1):15–29
- Commodity Flow Survey, Vol. 3(1):53–66
  - estimating state-level truck activities, Vol. 1(1):63–74
- Commuters, Vol. 1(3):25–39
  - activities of, Vol. 5(2/3):19–36
  - demographics of, Vol. 2(1):93–107
  - transit strikes, Vol. 1(3):43–51
  - travel time, costs of freeway incidents, Vol. 2(2):123–130
- Commuting
  - impact of Northridge earthquake, Vol. 1(2):1–4, 8–19, 31–35, 50–51, 59–61
  - time spent, Vol. 5(1):25–45
- Congestion. *See* Traffic congestion
- Connecticut
  - time-use behavior model, Vol. 5(1):39
  - truck flows, Vol. 1(1):67, 69, 72
- Content analysis, Vol. 1(2):65–73
- Contextual stated preference methods, freight travel time and reliability, Vol. 3(3):83–89
- Correlation
  - accessibility measures, Vol. 4(2/3):20–30, 40–41, 87–88
  - multiple serial correlation, transit investment, Vol. 2(2):113–121
- Costs/cost-benefit analyses
  - accidents, Vol. 4(1):87–90
  - air transport statistics, Vol. 2(1):77–78, 83–84
  - disabled persons, rural vouchers, Vol. 2(1):68
  - environmental costs
    - air pollution, Vol. 4(1):91–92
    - impact on road construction, Vol. 2(1):45–60
    - motor vehicle noise, Vol. 1(3):1–23; Vol. 4(1):92–93
  - freeway incidents, travel time, Vol. 2(2):123–131
  - freight travel time, Vol. 3(3):83–89
  - highway construction, Vol. 2(1):45–60
  - highway transportation in New Jersey, Vol. 4(1):81–103
  - impact of Northridge earthquake on trucking, Vol. 1(2):37–48
  - infrastructure, Vol. 4(1):90–91
  - motor vehicle crashes, Vol. 1(1):20, 22–23, 33; Vol. 2(1):20–43; Vol. 2(2):123–131
  - motor vehicle license fees, Vol. 2(2):133–147
  - Northridge earthquake, Vol. 1(2):15–18, 19, 21, 37, 40, 44–46
  - parking pricing, Vol. 2(1):100–106
  - public transit, Vol. 2(2):113–121
  - road construction, Vol. 1(3):65–78
  - social costs of motor vehicle use, Vol. 1(1):15–42
  - traffic gestation, Vol. 2(2):123–130, Vol. 4(1):87–90

transit, multiple serial correlation, Vol. 2(2):113–121  
vehicle operating costs, 86–87  
Covariance matrix, and travel time budgets, Vol. 5(1):35  
Crashes, Vol. 2(1):19–43. *See also* Accidents, Safety  
annual mileage as determinant of truck accidents,  
Vol. 3(1):69, 71, 74  
economic costs of motor vehicle crashes,  
Vol. 2(1):23–32, 36–43  
fatalities, Vol. 2(2):159–166  
effect of speed limits, Vol. 4(1):1–26  
international statistics, Vol. 2(2):159–166  
types, Vol. 2(1):22, 27–32, 36–43  
CTPP. *See* Census Transportation Planning Package  
Commuter survey, Northridge, California, earthquake,  
Vol. 1(2):13–15, 31–33

## D

Delaware, truck flows, Vol. 1(1):69, 71, 72  
Demand  
demand management, Vol. 4(1):31–37, 51–73  
derived, Vol. 5(1):26  
elasticities, Vol. 5(1):27  
forecasting using air transport statistics,  
Vol. 2(1):76–77, 82–83  
induced, Vol. 5(1):25–27, 32  
transit demand elasticity, Vol. 1(1):1–14  
transportation-related final demand, Vol. 1(1):93–102  
Demographic factors. *See also* Age  
determinants of trucking safety, Vol. 3(1):69–79  
disabled persons, rural vouchers, Vol. 2(1):61–70  
employee demographics in relation to parking,  
Vol. 2(1):98, 104–105  
equity in motor vehicle license fees, Vol. 2(2):133–147  
motor vehicle ownership, Vol. 2(1):6–16  
Nationwide Personal Transportation Survey,  
Vol. 2(1):1–17  
race as determinant of truck crashes,  
Vol. 3(1):69, 71–72  
Denmark, crash statistics, Vol. 2(2):159–166  
DIRECTIONS Travel Intelligence System,  
Vol. 5(2/3):85, 89  
Disabled persons  
vouchers for transit use, Vol. 2(1):61–69  
Disaggregation. *See* Aggregation/disaggregation  
Disasters  
planning by trucking companies, Vol. 1(2):37–48  
research methodology, Vol. 1(2):19–20, 39–40  
District of Columbia. *See* Washington, DC  
Driver behavior and traffic flow, Vol. 5(1):3, 23  
Driver experience as determinant of truck accidents,  
Vol. 3(1):69, 71, 73–74

## E

Econometric analyses, Vol. 3(1):1–14  
modeling impacts of bypasses on communities,  
Vol. 5(1):59

Economic factors. *See also* Capital investment in  
highways, Costs/cost-benefit analysis, Demand, Employ-  
ment, Gross Domestic Product  
costs of traffic congestion, Vol. 2(2):123–130  
efficiency of European railways, Vol. 3(3):61–67  
equity of vehicle license fees by household location,  
Vol. 2(2):140–143  
equity of vehicle license fees by income,  
Vol. 2(2):135–140  
estimating marginal highway transportation costs,  
Vol. 4(1):81–102  
impacts of bypasses on communities, Vol. 5(1):57–69  
importance of transportation, Vol. 1(1):75–91;  
Vol. 3(1):15–30; Vol. 5(2/3):1–18  
induced travel demand, Vol. 3(1):1–14  
macroeconomic analysis of transportation investments,  
Vol. 1(3):43–51  
motor vehicles  
license fees, Vol. 2(2):133–147  
ownership and use, Vol. 2(1):1–17; Vol. 3(3):47–60  
social costs of owning, Vol. 1(1):15–42  
Northridge earthquake, Vol. 1(2):21–36, 49–64  
impact on goods movement, Vol. 1(2):37–48  
System of National Accounts, Vol. 1(1):93–102  
transportation related, Vol. 1(2):21–35  
Transportation Satellite Accounts, Vol. 5(2/3):1–18  
urban transportation, Vol. 3(1):31–52  
value of travel time, Vol. 2(2):123–130  
Efficiency measures, European railways, Vol. 3(3):61–68  
Elasticity  
cross elasticity, urban passenger transport fares,  
Vol. 1(1):1–14  
fares for urban passenger transport, Vol. 1(1):43–61  
modal choice, Vol. 2(2):156–157  
parking prices, Vol. 2(1):1–3  
Emissions control. *See* Air pollution, Environment  
Employment  
and accessibility improvements, Vol. 4(2/3):49–66  
and parking, Vol. 2(1):93–106  
impacts on employees due to Northridge earthquake,  
Vol. 1(2):21–35  
Northridge earthquake, Vol. 1(2):21, 23–33  
England, London, traffic flows Vol. 5(1):49–50  
Environment. *See also* Air pollution  
air transportation, Vol. 2(1):79–80, 85–86  
highway construction costs and regulation,  
Vol. 2(1):45–60  
impact of environmental protection measures on road  
construction costs, Vol. 2(1):45–60  
impacts of vehicle emissions, Vol. 3(2):1–13;  
Vol. 4(1):91–93  
policy and regulations, Vol. 2(1):45–59  
Europe  
accessibility measures, Vol. 4(2/3):31–48  
air transportation statistics, Vol. 2(1):71–92  
French National Personal Transportation Survey  
statistics, Vol. 1(3):53–63  
international crash statistics, Vol. 2(2):159–166  
public transportation strikes in France, Vol. 1(3):43–51,

railways, efficiency/output, Vol. 3(3):61–68  
transit demand elasticity, Vol. 1(1):1–14  
travel demand, Vol. 3(3):1–31  
European Community, crash statistics, Vol. 2(2):159–166

## F

FARS. *See* Fatality Analysis Reporting System  
Fatalities  
    effect of highway speed limits on, Vol. 4(1):1–26  
    hazardous material shipments, Vol. 3(1):83–85  
    international accident statistics, Vol. 2(2):159–166  
    motor vehicles, Vol. 2(1):19–43  
    rail, Vol. 3(1):85–86  
    trucking, Vol. 3(1):70, 83–85, 87–89  
Fatality Analysis Reporting System (FARS), Vol. 4(1):3  
Federal-aid highways, impact of environmental protection statutes on costs, Vol. 2(1):45–60  
Federal Test Procedure (emissions testing), Vol. 3(2):2, 16–17, 39–47, 57–58  
Finland  
    crash statistics, Vol. 2(2):159–166  
    elasticity studies of public transport, Vol. 1(1):1, 7, 10–12 (*passim*)  
Florida  
    Florida Visitor Study, Vol. 5(2/3):85–86  
    measuring vehicle travel by visitors, Vol. 5(2/3):83–90  
    time-use behavior model, Vol. 5(1):39  
    truck flows, Vol. 1(1):67, 69, 72  
Forecasting  
    air transportation supply and demand, Vol. 2(1):76–77, 82–83  
    traffic flow, Vol. 5(1):47–56  
    traffic volume, Vol. 4(1):28  
    urban demand, Vol. 1(3):26–28, 37  
Foreign countries. *See specific country*  
France  
    freight demand and mode choice, Vol. 2(2):149–158  
    National Personal Transportation Survey, Vol. 1(3):43–51  
    transit strikes, Vol. 1(3):43–51  
    travel demand, Vol. 3(3):1–31  
Freeways. *See* Highways  
Freight. *See also* Commodity Flow Survey, Trucks  
    comparison of long-haul and metropolitan trucking, Vol. 3(3):83–89  
    demand and mode choice, Vol. 2(2):149–158  
    rail, Vol. 4(1):75–79  
    shipper surveys, Vol. 3(3):83–89

## G

Gasoline  
    emissions reductions, Vol. 3(2):7, 29–30  
    price and motor vehicle use, Vol. 1(1):17; Vol. 4(1):101  
    reformulated gasoline (RFG), Vol. 3(2):57–58  
Geographic information systems (GIS)  
    used for evaluating neighborhood accessibility, Vol. 4(2/3):17, 29, 37, 38, 75–77

Georgia  
    Atlanta, parking, Vol. 2(1):93–107  
    time-use behavior model, Vol. 5(1):39  
    truck flows, Vol. 1(1):69, 72  
Ghana, travel demand, Vol. 3(3):1–31  
GIS. *See* Geographic information systems  
Goodness-of-fit statistics, Vol. 4(1):75–79; Vol. 5(1):48–49, 55; Vol. 5(2/3):27  
Goods movement after Northridge earthquake, Vol. 1(2):37–48  
Great Britain  
    Planning Policy Guidance, Vol. 4(2/3):76  
    travel demand, Vol. 3(3):1–31  
Greece, crash statistics, Vol. 2(2):159–166  
Gravity approach (accessibility modeling), Vol. 4(2/3):33–34  
Government revenues, vehicle license fees, Vol. 2(2):133–147  
Greenhouse gases. *See* Climate change  
Gross Domestic Product  
    importance of transportation, Vol. 3(1):15–30; Vol. 5(2/3):1–18  
    System of National Accounts, Vol. 1(1):93–102  
    transportation driven, Vol. 3(1):25–28  
    transportation related, Vol. 3(1):21–24

## H

Handicapped persons. *See* Disabled persons  
Hazardous materials, rail and truck shipment, Vol. 3(1):81–92  
Hawaii, truck flows, Vol. 1(1):67, 69, 71, 72  
    High-speed rail, value of time, Vol. 5(2/3):57–72  
Highways  
    capacity, Vol. 5(1):25–45  
    congestion and delays, Vol. 2(2):123–130  
    detours due to earthquake damage, Vol. 1(2):1–20  
    environmental regulation and costs, Vol. 2(1):45–60  
    federal-aid highways, Vol. 2(1):45–60  
    impacts of bypasses on communities, Vol. 5(1):57–69  
    improvements, Vol. 1(3):65–79  
    induced travel demand, Vol. 3(1):1–14  
    inventory, Vol. 3(3):33–45  
    Northridge earthquake, Vol. 1(2):1–73  
        goods movement after, Vol. 1(2):37–48  
        reconstruction after, Vol. 1(2):1–20  
    road construction and environmental statutes, Vol. 2(1):45–60  
    speed limits, effect on number of fatal accidents, Vol. 4(1):1–26  
    trips, relationship to value of time data, Vol. 5(2/3):58–72  
    transportation costs, Vol. 4(1):81–103  
    truck accidents on ramps, Vol. 1(1):75–91  
    user fees, New Jersey, Vol. 4(1):99–102  
Home-based workers, travel behavior, Vol. 1(3):25–39  
Hydrocarbons, motor vehicle emissions, Vol. 3(2):3–5, 7, 8, 12, 29–32, 34, 40, 44–45, 51–63, 65–84



**I**

- Idaho, truck flows, Vol. 1(1):69, 72
- Illinois
  - Chicago streets, Vol. 5(1):1–15
  - time-use behavior model, Vol. 5(1):39
  - truck flows, Vol. 1(1):69, 72
- Income, and equity of vehicle license fees, Vol. 2(2):133–147
- India, travel demand, Vol. 3(3):1–31
- Indiana
  - time-use behavior model, Vol. 5(1):39
  - truck flows, Vol. 1(1):69, 72
- Induced travel demand, Vol. 3(1):1–14; Vol. 5(1):25–27, 32
- Infrastructure
  - business losses due to infrastructure damage, Vol. 1(2):49–62
  - costs, Vol. 1(3):65–78, 81–88
    - highway, Vol. 4(1):90–91, 100
  - funding improvements, Vol. 5(2/3):83
  - improvements and safety, Vol. 3(1):81, 83, 90–91
  - use of air transport statistics, Vol. 2(1):78–79, 84–85
- Injuries
  - hazardous materials, Vol. 3(1):85–86
  - international accident statistics, Vol. 2(2):159–166
  - input-output coefficient, Vol. 3(1):53–66
  - motor vehicle, Vol. 2(1):19–43; Vol. 2(2):160–163
- Intelligent transportation systems (ITS), Vol. 4(1):61, Vol. 5(2/3):37–40, 43, 50
- Intermodal transportation, mode choice, Vol. 2(2):149–158
- International perspectives, *See also* Europe, *specific countries*
  - crash statistics, Vol. 2(2):159–166
  - motor vehicle noise, Vol. 1(3):9
  - travel demand, country comparisons, Vol. 3(3):1–31
  - urban congestion, air pollution, Vol. 3(2):85–102
  - urban transport modeling, Vol. 3(1):42–49
- International air transport statistics, Vol. 2(1):71–92
- International travel demand, Vol. 3(3):1–31
- Investment
  - macroeconomic analysis of transportation investments, Vol. 1(3):43–51
  - transportation improvements, Vol. 1(3):65–78
  - transportation in the economy, Vol. 1(1):93–102

**Iowa**

- impacts of bypasses on communities, Vol. 5(1):58
- time-use behavior model, Vol. 5(1):39
- truck flows, Vol. 1(1):67, 69, 72

Ireland, crash statistics, Vol. 2(2):159–166

Italy, crash statistics, Vol. 2(2):159–166

ITS. *See* Intelligent transportation systems

**J**

Jämtland, Sweden, accessibility measures, Vol. 4(2/3):83–89

**Japan**

- crash statistics, Vol. 2(2):159–166
- Kobe earthquake, Vol. 1(2):33–35
- travel demand, Vol. 3(3):1–31

**K****Kansas**

- impacts of bypasses on communities, Vol. 5(1):59
- time-use behavior model, Vol. 5(1):39
- truck flows, Vol. 1(1):67, 69, 72

**Kentucky**

- Medicaid transit service, Vol. 5(2/3):73–81
- time-use behavior model, Vol. 5(1):39
- truck flows, Vol. 1(1):69, 72

Korea, trip time in the NW-SE corridor, Vol. 5(2/3):57–72

**L**

Labor markets and accessibility modeling, Vol. 4(2/3):54, 57, 63–64

Labor supply, accessibility improvements, Vol. 4(2/3):49–66

**Land-use planning**

- cluster analysis, Vol. 4(1):39–49
- creating land-use scenarios, Vol. 4(1):39–49
- neighborhood accessibility, Vol. 4(2/3):67–78

**Least squares estimation**

- origin-destination matrices, Vol. 5(2/3):37–56
- travel time budgets, Vol. 5(1):35

Lebanon, urban congestion, air pollution, Vol. 3(2):85–102

**Legislation, federal**

- Clean Air Act, Vol. 3(2):2–3, 5
- Department of Transportation Act, Vol. 2(1):47–48
- Highway Safety Act, Vol. 3(3):71
- Intermodal Surface Transportation Efficiency Act, Vol. 3(3):71
- Motor Carrier Acts, Vol. 3(1):71–72, 84
- National Environmental Policy Act, Vol. 2(1):47–49
- Nuclear Waste Policy Act, Vol. 3(1):82
- Urban Mass Transportation Act, Vol. 2(1):62
- various, Vol. 2(1):48

**Licenses and licensing**

- vehicle license fees, Vol. 2(2):133–147

**Light trucks. *See also* Trucks/trucking**

- accidents risks, Vol. 2(1):27, 36–43
- emissions, Vol. 3(2):49–63
- ownership and use, Vol. 3(3):47–60

Linear captivity models, to determine demand elasticities, Vol. 5(1):27

Linear logit models, to determine demand elasticities, Vol. 5(1):27

**Logit models**

- freight travel time and reliability, Vol. 3(3):83–89
- vehicle type by driver, Vol. 3(3):56–58
- parking and travel behavior, Vol. 2(1):95

Loglinear models, Vol. 4(1):75–79

London, England, traffic flows, Vol. 5(1):49–50

Long-term memory model, forecasting traffic flows, Vol. 5(1):51

**Louisiana**

- time-use behavior model, Vol. 5(1):39
- truck flows, Vol. 1(1):69, 72

Luxembourg, crash statistics, Vol. 2(2):159–166

## M

- Macroeconomic analysis of transportation investments, Vol. 1(3):43–51
- Maine, truck flows, Vol. 1(1):67, 69, 71, 72
- Maintenance and repair, pollutant emissions, Vol. 3(2):6, 16, 92
- Maryland
- induced travel demand, Vol. 3(1):1–14
  - study of road capacity and VMT, Vol. 5(1):28
  - time-use behavior model, Vol. 5(1):39
  - truck flows, Vol. 1(1):69, 72
- Mass transit. *See* Transit
- Massachusetts
- time-use behavior model, Vol. 5(1):39
  - truck flows, Vol. 1(1):69, 72
- Maximum likelihood estimation, Vol. 5(1):63
- MEASURE (Mobile Emissions Assessment System for Urban and Regional Evaluation), Vol. 3(2):49–63
- Meta-analyses
- European public transport demand, Vol. 1(1):1–14
  - railway efficiency/output, Europe, Vol. 3(3):61–68
  - travel demand, country comparisons, Vol. 3(3):1–31
- Mexico, freight imported from Mexico into the U.S., Vol. 1(1):68–72
- Michigan
- time-use behavior model, Vol. 5(1):39
  - truck flows, Vol. 1(1):67, 69, 71, 72
- Mileage. *See also* Vehicle-miles of travel
- as a determinant of truck accidents, Vol. 3(1):69, 71, 74
- Minivans. *See* Light trucks
- Minnesota
- impacts of bypasses on communities, Vol. 5(1):558
  - time-use behavior model, Vol. 5(1):39
  - truck flows, Vol. 1(1):67, 69, 72
- Mississippi
- time-use behavior model, Vol. 5(1):39
  - truck flows, Vol. 1(1):69, 72
- Missouri
- time-use behavior model, Vol. 5(1):39
  - truck flows, Vol. 1(1):69, 72
- Mobile mapping system, Vol. 3(3):33–46
- MOBILE6 (Mobile Source Emissions Factor Model) vehicle emissions model, Vol. 3(2):39–47
- Mobility
- induced travel demand, Vol. 3(1):1–14
  - international travel demand, Vol. 3(3):1–31
  - mobility enhancement strategies, Vol. 4(1):51–73
- Mode choice, Vol. 1(1):43–57
- and freight demand, Vol. 2(2):149–158
  - during transit strikes, Vol. 1(3):43–51
  - models, Vol. 3(3):55–57
  - travel budgets, Vol. 3(3):1–31
- Models
- accessibility, Vol. 1(3):71–72; Vol. 4(2/3):31–47
  - analysis of covariance vehicle emissions (ANCOVA), Vol. 3(2):49–63
  - binomial regression, person-trips, Vol. 3(3):51–53
  - Box-Jenkins ARIMA time series, Vol. 4(1):13–15
  - forecasting traffic flows, Vol. 5(1):52, 54, 55
  - commuters' activity frequency, Vol. 5(2/3):19–36
  - CORSIM, traffic simulation, Vol. 5(1):1–22
  - discrete choice, Vol. 2(2):150
  - disaggregated choice, Vol. 1(1):1
  - dynamic congestion, Vol. 4(2/3):6–8
  - econometric model, impacts of bypasses on communities, Vol. 5(1):561
  - economic impacts of Northridge earthquake, Vol. 1(2):23–27
  - emissions, Vol. 3(2):65–84
  - emissions control deterioration, Vol. 3(2):39–47
  - fixed-effect
    - impacts of bypasses on communities, Vol. 5(1):61–62
    - induced travel demand, Vol. 3(1):6–9, 11  - general noise cost, motor vehicle use, Vol. 1(3):1–24
  - goodness-of-fit, Vol. 5(1):48–49, 55
  - gravity, freight, Vol. 3(1):63–64
  - heteroskedastic extreme value choice, Vol. 1(1):43, 46–47
  - input-output
    - freight, Vol. 3(1):53–66
    - origin-destination matrices, Vol. 5(2/3):47  - linear captivity, to determine demand elasticities, Vol. 5(1):27
  - linear logit, to determine demand elasticities, Vol. 5(1):27
  - linear regression, speed limits and fatal highway crashes, Vol. 4(1):2
  - linear trend, speed limits and fatal highway crashes, Vol. 4(1):3
  - logit, parking and travel behavior, Vol. 2(1):95
  - loglinear, Vol. 4(1):74–79
  - long-term memory, forecasting traffic flows, Vol. 5(1):51
  - MOBILE6 (Mobile Source Emissions Factor Model) vehicle emissions, Vol. 3(2):39–47
  - modal emissions, Vol. 3(2):31
  - mode choice, Vol. 3(3):53–54
  - motor vehicle noise costs, Vol. 1(3):3–7
  - motor vehicle ownership, Vol. 3(3):53–54
  - multinomial logit, Vol. 2(2):152–153
    - commuters' activity schedules, Vol. 5(2/3):20–36
    - freight travel time and reliability, Vol. 3(3):83–89
    - mode choice, Vol. 3(3):55–57  - MVEI7G vehicle emissions, Vol. 3(2):85–101
  - naïve, forecasting traffic flows, Vol. 5(1):51–52
  - neighborhood accessibility, Vol. 4(2/3):67–78
  - nested logit, commuters' activity schedules, Vol. 5(2/3):19–36
  - network assignment model, Vol. 5(2/3):57–72
  - nonlinear, for neural networks, Vol. 5(1):52
  - ordinary least squares, impacts of bypasses on communities, Vol. 5(1):67–68
  - path-based accessibility, Vol. 4(2/3):79–90
  - probit
    - ordered, to study vehicle occupancy, Vol. 3(3):53–55
    - determinants of trucking safety, Vol. 3(1):69–79  - rail freight shipments, Vol. 4(1):74–79
  - random-effects
    - impacts of bypasses on communities, Vol. 5(1):62–63, 67–68
    - highway construction costs, Vol. 2(1):50–57  - regression
    - trucking safety, Vol. 3(1):75
    - impacts of bypasses on communities, Vol. 5(1):61

- seemingly unrelated regression estimation (SURE)  
 impacts of bypasses on communities,  
 Vol. 5(1):62–64, 67–68  
 travel time budgets, Vol. 5(1):35–36  
 simultaneous equation, Vol. 4(1):49–66; Vol. 5(1):36  
 Southern California Planning Model (SCPM),  
 Vol. 1(2):21–35  
 spatial allocation, Vol. 1(2):21–35  
 statistical modeling of arrival and departure times,  
 Vol. 5(1):71–82  
 structural time series, speed limits and fatal highway  
 crashes, Vol. 4(1):1–7, 11–12, 13–15, 16–18,  
 22–23, 25  
 time series, Vol. 4(1):3–7  
 traffic flows, Vol. 5(1):47–56  
 traffic simulation, Vol. 5(1):1, 16  
 transportation in urban areas, Vol. 3(1):31–52  
 trips per vehicle, Vol. 3(3):51–52  
 urban passenger transport, Vol. 1(1):43–61  
 use of light-duty and passenger cars, Vol. (33):47–60  
 validation of, Vol. 5(1):1–2  
 vehicle emissions, Vol. 3(2):29–38  
 vehicle emissions with MEASURE (Mobile  
 Emissions Assessment System for Urban and  
 Regional Evaluation), Vol. 3(2):49–63  
 vehicle-miles of travel, Vol. 3(3):50–51  
 vehicle occupancy, Vol. 3(3):51–52  
 vehicle ownership, Vol. 3(3):57–59  
 weighted least squares model of vehicle-miles of travel,  
 Vol. 3(3):50  
 Montana, truck flows, Vol. 1(1):69, 72  
 Monte Carlo simulation  
 model of commuters' activities, Vol. 5(2/3):19, 31, 33  
 origin-destination matrices, Vol. 5(2/3):45–47, 51  
 Motorcycles  
 crashes, Vol. 2(1):19, 22, 25, 26, 29–31, 33, 36–43;  
 Vol. 2(1):36–43; Vol. 2(2):164  
 license fees, California, Vol. 2(2):133–147  
 noise pollution, Vol. 1(3):10–11  
 Motor vehicles. *See also* Passenger cars, Trucks/trucking  
 air pollution, Vol. 1(1):20, 23, 27–28, 33, 48;  
 Vol. 3(2):*v–ix*, 1–102  
 crashes, Vol. 1(1):20, 22–23, 27, 33; Vol. 2(1):19–43;  
 Vol. 2(2):123–131, 159–166  
 induced travel demand, Mid-Atlantic, Vol. 3(1):1–14  
 license fees, Vol. 2(2):133–147  
 light trucks and passenger cars, Vol. 3(3):47–60  
 models, Vol. 3(3):50–51  
 motor vehicle ownership and use, 11, 17, Vol. 2(1):3–7  
 Nationwide Personal Transportation Survey,  
 Vol. 2(1):1–17  
 noise, Vol. 1(1):20–21, 23, 33, 36–38; Vol. 1(3):1–23  
 occupancy models, Vol. 3(3):53–54  
 operating costs, Vol. 4(1):86–87  
 ownership and use, 14–16; Vol. 2(1):1–17; Vol. 2(1):6–7;  
 Vol. 3(3):47–60; Vol. 3(3):57–59; Vol. 4(2/3)  
 58, 65; Vol. 5(2/3):21  
 passenger car ownership and use, Vol. 3(3):47–60  
 social costs, Vol. 1(1):15–42  
 speed and speed limits, Vol. 3(3):69–81  
 vehicle-miles of travel, Vol. 3(1):1–14  
 crashes, Vol. 1(1):76, 77, 80, 83, 84–88;  
 Multinomial logit models, freight travel time and  
 reliability, Vol. 3(3):83–89  
 Multiple serial correlation, transit investment,  
 Vol. 2(2):113–121
- N**
- Naïve model, forecasting traffic flows, Vol. 5(1):51–52  
 National Bicycling and Walking Study, Vol. 4(2/3):73  
 National Cooperative Highway Research Program  
 research on bypasses, Vol. 5(1):59  
 tourism travel project, Vol. 5(2/3):84  
 National Household Travel Survey, Vol. 5(2/3):89–90  
 National Maximum Speed Limit, Vol. 3(3):69–81;  
 Vol. 4(1):2, 3, 16, 18  
 National Personal Transportation Survey, France,  
 Vol. 1(3):43–51  
 Nationwide Personal Transportation Survey (NPTS),  
 United States, Vol. 2(1):1–17; Vol. 2(2):134–146,  
 Vol. 3(3):47–60; Vol. 5(1):25, 26–28, 34  
 Nebraska, truck flows, Vol. 1(1):69, 72  
 Nevada  
 hazardous materials shipments, Vol. 3(1):82  
 truck flows, Vol. 1(1):68, 69, 72  
 Netherlands  
 crash statistics, Vol. 2(2):159–166  
 elasticity studies of public transport, Vol. 1(1):1, 7,  
 10–12 (*passim*)  
 travel demand, Vol. 3(3):1–31  
 travel surveys of arrival and departure times,  
 Vol. 5(1):71–82  
 New Hampshire, truck flows, Vol. 1(1):67, 69, 72  
 New Jersey  
 highway transportation costs, Vol. 4(1):81–103  
 highway user fees, Vol. 4(1):99–102  
 time-use behavior model, Vol. 5(1):39  
 truck flows, Vol. 1(1):69, 72  
 New Mexico, truck flows, Vol. 1(1):68, 69, 72  
 New York  
 Bronx, New York, Vol. 4(1):51–53  
 South Bronx, accessibility to jobs, Vol. 4(2/3):49–66  
 time-use behavior model, Vol. 5(1):39  
 truck flows, Vol. 1(1):69, 71, 72  
 New Zealand, crash statistics, Vol. 2(2):159–166  
 Noise costs  
 air transportation, Vol. 2(1):79, 85  
 motor vehicle use, Vol. 1(1):20–24, 33; Vol. 1(3):1–23  
 Nonlinear model, for neural networks, Vol. 5(1):52  
 Nonparametric statistics, Vol. 3(3):61–67  
 Nonparametric tests, traffic forecasting, Vol. 5(1):47–56  
 direction of change, Vol. 5(1):53  
 rank correlation, Vol. 5(1):53  
 signs test, Vol. 5(1):52  
 Wilcoxon test on location, Vol. 5(1):52–53, 54  
 Wilcoxon test on variance, Vol. 5(1):53

- North Carolina  
 induced travel demand, Vol. 3(1):1–14  
 study of road capacity and VMT, Vol. 5(1):28  
 time-use behavior model, Vol. 5(1):39  
 truck flows, Vol. 1(1):69, 72
- North Dakota, truck flows, Vol. 1(1):67, 69, 71, 72
- Northridge earthquake, Vol. 1(2):iv–vi, 1–73  
 buses, Vol. 1(2):4, 7, 11  
 businesses  
 losses by type of business, Vol. 1(2):56–59  
 impacts on employees, Vol. 1(2):21–35  
 interruptions, Vol. 1(2):21–35  
 survey of impacts, Vol. 1(2):49–62  
 commuter rail transportation, Vol. 1(2):4, 15–17, 69–7  
 commuter travel, Vol. 1(2):1–20, 31–35, 50–51, 59–60  
 comparison to Kobe earthquake, Vol. 1(2):33–35  
 costs, Vol. 1(2):16–18, 19, 21, 27–29, 35, 37, 44–46  
 detours due to damage by the earthquake,  
 Vol. 1(2):1–20  
 earthquake losses by company type, Vol. 1(2):56–59  
 economic impacts, Vol. 1(2):21–36, 49–64  
 goods movement after the earthquake, Vol. 1(2):37–48  
 highways, Vol. 1(2):1–73  
 reconstruction after the earthquake, Vol. 1(2):1–20  
 impact on construction sector, Vol. 1(2):3–7  
 impact on employees, Vol. 1(2):21–35  
 impact on urban areas, Vol. 1(2):1–73  
 media coverage, Vol. 1(2):65–73  
 modeling economic impacts, Vol. 1(2):21–35  
 parking, Vol. 1(2):19, 104–106, 96–100  
 public transit ridership, Vol. 1(2):1–20  
 road transport, Vol. 1(2):1–20  
 spatial allocation models, Vol. 1(2):21–36  
 surveys of business impacts, Vol. 1(2):49–62  
 surveys of economic impacts, Vol. 1(2):21–35  
 telecommuting, Vol. 1(2):35  
 traffic volume changes, Vol. 1(2):1–20  
 transit effects, Vol. 1(2):1–20  
 trucks and trucking, Vol. 1(2):37–48, 57, 58  
 costs/cost-benefit analyses, Vol. 1(2):37–48  
 wholesale/retail trade, Vol. 1(2):21–36, 55–60
- Norway  
 travel demand, Vol. 3(3):1–31  
 elasticity studies of public transport, Vol. 1(1):1, 7,  
 10–12 (passim)
- NPTS. *See* Nationwide Personal Transportation Survey
- O**
- Ohio  
 time-use behavior model, Vol. 5(1):39  
 truck flows, Vol. 1(1):69, 72
- Oil, motor vehicles and social costs, Vol. 1(1):25–27
- Oklahoma  
 time-use behavior model, Vol. 5(1):39  
 truck flows, Vol. 1(1):69, 72
- On-time performance of long-haul and metropolitan  
 freight, Vol. 3(3):83–89
- Opportunities approach (accessibility modeling),  
 Vol. 4(2/3):33–34
- Oregon  
 time-use behavior model, Vol. 5(1):39  
 truck flows, Vol. 1(1):69, 72
- Origin-destination, Vol. 4(1):84–85, 87, 93;  
 Vol. 5(2/3):37–56, 57–72
- Ozone layer and air transportation, Vol. 2(1):79–80
- P**
- Parking, Vol. 2(1):93–106  
 and office development, Vol. 2(1):93–106  
 Atlanta, parking management, Vol. 2(1):93–107  
 impact on travel behavior, Vol. 2(1):99–102  
 light trucks and passenger cars, Vol. 3(3):57  
 Northridge earthquake, Vol. 1(2):19  
 social costs of motor vehicles, Vol. 1(1):21–22, 29–30  
 subsidies, Vol. 2(1):103–104  
 zoning management, Vol. 2(1):96, 98–99, 104–105
- Particulate matter, motor vehicles, Vol. 3(2):86, 91–92, 94
- Passenger cars. *See also* Motor vehicles  
 accident risks, Vol. 2(1):27, 36–43  
 ownership and use, Vol. 3(3):47–60
- Path-based accessibility (accessibility modeling),  
 Vol. 4(2/3):79–91
- Pedestrians, accidents involving, Vol. 2(1):22, 26–32,  
 36–43; Vol. 2(2):164–165
- Pennsylvania  
 time-use behavior model, Vol. 5(1):39  
 truck flows, Vol. 1(1):69, 72
- Physically handicapped persons. *See* disabled persons
- Pickup trucks. *See* Light trucks
- Planning and policy  
 creating land-use scenarios, Vol. 4(1):39–49  
 mobility enhancement strategies, Vol. 4(1):51–73
- Police accident reports  
 international crash statistics, Vol. 2(2):162
- Policy  
 environmental policy, Vol. 2(1):45–59  
 use of air transport statistics, Vol. 2(1):74–76, 81–82  
 use of surveys and models in policy formation,  
 Vol. 3(1):31–52
- Pollution. *See* Air pollution
- Portland, Oregon, sidewalk inventory, Vol. 4(2/3):74–75
- Portugal, crash statistics, Vol. 2(2):159–166
- Probit estimation, determinants of safety in trucking  
 industry, Vol. 3(1):69–79
- Probit models  
 motor vehicle trip occupancy, Vol. 3(3):54–55
- Productivity analysis  
 transportation projects, Vol. 1(3):65–78  
 use of air transport statistics, Vol. 2(1):77–78, 83–84
- Public transportation. *See* Transit
- R**
- Railways  
 Car Waybill Sample, Vol. 4(1):76, 79  
 efficiency/output of European railways,  
 Vol. 3(3):61–68  
 freight demand and mode choice, Vol. 2(2):149–158

- hazardous materials shipment, Vol. 3(1):81–92  
 modeling freight shipments, Vol. 4(1):74–79  
 trips, relationship to value of time data,  
 Vol. 5(2/3):58–72
- Ramps, truck accidents on freeway ramps,  
 Vol. 1(1):75–91
- Random utility theory, Vol. 1(2):45–46
- Reformulated gasoline, Vol. 3(2):50–61
- Regression analysis, Vol. 2(1):101–103  
 crashes and traffic volume, Vol. 4(1):89–90  
 estimation of origin-destination matrices,  
 Vol. 5(2/3):37–56  
 impacts of bypasses, Vol. 5(1):59  
 induced travel demand, Vol. 3(1):10, 12–13  
 parking and travel behavior, Vol. 2(1):95, 101–103  
 vehicle license fees, Vol. 2(2):140–143  
 vehicle use and household characteristics,  
 Vol. 2(1):13–16
- Regression models  
 binomial  
 commuters' activity schedules, Vol. 5(2/3):31–32  
 person-trips, Vol. 3(3):51–53  
 multivariate constrained, Vol. 5(2/3):39–56  
 of person-trips per vehicle, Vol. 3(3):51–53  
 Poisson, Vol. 5(2/3):31–32  
 univariate constrained and unconstrained,  
 Vol. 5(2/3):39–56
- Remote sensing (emissions testing), Vol. 3(2):3–4
- RFG. *See* Reformulated gasoline
- Rhode Island, truck flows, Vol. 1(1):69, 72
- Road construction  
 affects of additional capacity on travel demand,  
 Vol. 5(1):25–45  
 impact of environmental protection statutes,  
 Vol. 2(1):45–60
- Roadway inventory data collection, Vol. 3(3):33–46
- Rough set analysis  
 European public transport demand, Vol. 1(1):1–14
- Rural areas  
 effects of speed limits on fatal accidents, 10,  
 Vol. 4(1):3–7  
 transit services to Medicaid recipients,  
 Vol. 5(2/3):73–81  
 transit vouchers for persons with disabilities,  
 Vol. 2(1):61–69
- S**
- Safety. *See also* Accidents, Crashes  
 aviation, Vol. 2(1):79, 85  
 determinants of truck crashes, Vol. 3(1):69–79  
 hazardous materials, rail and truck shipments,  
 Vol. 3(1):81–92  
 rail, Vol. 3(1):81–92  
 trucking, Vol. 3(1):69–79, 81–92
- Sampling  
 earthquake business losses, Vol. 2(2):54–55  
 freight travel time and reliability, Vol. 3(3):86, 88  
 home-based workers, Vol. 1(3):28–32  
 motor vehicle emissions, Vol. 3(2):1, 9–10, 28, 42, 55  
 travel demand, country comparisons, Vol. 3(3):6  
 urban transport fares, Vol. 1(1):47–49  
 selection bias, Vol. 1(2):54–55, Vol. 3(2):10–11
- San Diego, increased roadway capacity, Vol. 5(1):27
- San Francisco  
 commuters' activities, Vol. 5(2/3):19–36  
 increased roadway capacity, Vol. 5(1):27
- San Francisco Bay Area Rapid Transit  
 customer satisfaction among riders, Vol. 4(2/3):71  
 employment growth, in relation to, Vol. 4(1):54
- School bus ridership, Vol. 4(1):v
- Seemingly unrelated regression estimation (SURE) model,  
 and travel time budgets, Vol. 5(1):35–36
- Sensitivity analysis  
 air quality, Vol. 3(2):96  
 motor vehicle noise costs, Vol. 1(3):16–19  
 estimation of origin-destination matrices,  
 Vol. 5(2/3):46–47
- Serial correlation analysis, Vol. 2(2):113–121
- Signals, traffic, Vol. 5(1):2–7, 16–17, 24
- Simultaneity bias, induced travel demand, Vol. 3(1):1–14
- Singapore, travel demand, Vol. 3(3):1–31
- Sleep as a determinant of truck accidents, Vol. 3(1):69,  
 71, 74
- Social cost analysis, motor vehicle use (U.S.),  
 Vol. 1(1):15–42
- Social factors  
 disabled persons, rural vouchers, Vol. 2(1):61–70  
 motor vehicle use costs, Vol. 1(1) 15–42;  
 Vol. 1(3):1–24  
 urban transport fares, Vol. 1(1):47–61
- Socioeconomic status. *See also* Educational attainment  
 disabled persons, rural vouchers, Vol. 2(1):61–70  
 home-based workers, Vol. 1(3):30–32  
 induced travel demand, Mid-Atlantic, Vol. 3(1):7–13  
 light trucks and passenger cars, Vol. 3(3):47–60  
 motor vehicle emissions, Vol. 3(2):6  
 parking, zoning management, Vol. 2(1):96, 98–99,  
 104–105  
 travel demand, country comparisons, Vol. 3(3):1–31  
 vehicle license fees, Vol. 2(2):135–137
- South Bronx, New York, accessibility improvements and  
 local employment, Vol. 4(2/3):49–66
- South Carolina  
 time-use behavior model, Vol. 5(1):39  
 truck flows, Vol. 1(1):69, 72
- Southern California Planning Model (SCPM),  
 Vol. 1(2):21–35
- South Dakota, truck flows, Vol. 1(1):67, 69, 72
- Space-time prisms  
 accessibility within the transportation network,  
 Vol. 4(2/3):1–14  
 commuters' activity schedules, Vol. 5(2/3):23–34
- Spain, crash statistics, Vol. 2(2):159–166
- Spatial allocation models, Vol. 1(2):21–35; Vol. 1(2):21–36
- Spatial mismatch hypothesis, Vol. 4(2/3):54–54, 61
- Speed and speed limits. *See also* Traffic congestion  
 effect of highway speed limits on fatalities,  
 Vol. 4(1):1–26

- emissions and, Vol. 3(2):15–28, 34–37, 90–91, 92–93, 96–99
- hazardous materials shipments, Vol. 3(1):69, 78, 80, 88, 90
- in relation to funding, Vol. 3(3):69, 70–71
- monitoring in traffic management, Vol. 3(3):69–80
- noise level and, Vol. 1(3):6, 10, 11, 19–20
- personal transportation surveys, Vol. 1(3):58
- traffic management monitoring program, Vol. 3(3):69–81
- travel demand, country comparisons, Vol. 3(3):8–9, 27
- travel speed and time, Vol. 5(1):25, 33
- truck drivers, Vol. 3(1):69, 78, 81, 88, 90
- Sport utility vehicles. *See* Light trucks
- Stockholm, Sweden, accessibility measures, Vol. 4(2/3):83–89
- Strikes
- commuter impacts, Vol. 1(2):43–51
  - commuting during transit strikes France, Vol. 1(3):43–51
- Supply and demand. *See also* Sampling
- air transportation, Vol. 2(1):76–77, 82–83
  - European public transport demand, Vol. 1(1):1–14
  - final demand of transportation, Vol. 3(1):15, 19–21
  - freight demand and mode choice, Vol. 2(2):149–158
  - induced travel demand, Mid-Atlantic, Vol. 3(1):1–14
  - investment, macroeconomic analyses, Vol. 1(3):72
  - railways, European, efficiency/output, Vol. 3(3):61–68
  - System of National Accounts, Vol. 1(1):93–102
  - transit investment, serial correlation, Vol. 2(2):119–120
  - travel demand, country comparisons, Vol. 3(3):1–31
  - Commodity Flow Survey, trucking, Vol. 1(1):63–74; Vol. 3(1):53, 56–58
  - light trucks and passenger cars, Vol. 3(3):47–60
  - motor vehicle ownership and use, Vol. 2(1):1–17
  - urban transport, Australia, Vol. 3(1):31, 39, 42–51
  - urban transport fares, Vol. 1(1):47–61
- SURE. *See* Seemingly unrelated regression estimation model
- Surveys
- business impacts of Northridge earthquake, Vol. 1(2):49–62
  - Commodity Flow Survey, Vol. 3(1):43–48
  - commuters, Vol. 1(1):13–15, 31–33
  - DIRECTIONS Travel Intelligence System, Vol. 5(2/3):85, 89
  - economic impacts of Northridge earthquake, Vol. 1(2):21–35
  - Florida Visitor Study, Vol. 5(2/3):85–86
  - freight shippers, Australia, Vol. 3(3):83–89
  - Los Angeles area trucking companies, Vol. 1(2):37–48
  - Medicaid transit services, Vol. 5(2/3):77–81
  - National Personal Transportation Survey, France, Vol. 1(3):53–63
  - Nationwide Personal Transportation Survey (NPTS), United States, Vol. 2(1):1–17; Vol. 2(2):134–146; Vol. 3(3):47–60
  - role in policy formation, Vol. 3(1):31–52
  - selection bias, Vol. 1(2):54–55
  - transport during strikes, France, Vol. 1(3):43–51
  - travel surveys, Vol. 3(1):39–40, 43–51; Vol. 3(3):1–31
  - arrival and departure times, Vol. 5(1):71–82
  - behavior of home-based workers, Vol. 1(3):25–41
  - measuring tourist vehicle travel, Vol. 5(2/3):83–90
  - trucking companies after the Northridge, California, earthquake, Vol. 1(2):39–47
  - truck drivers, Vol. 3(1):69–79
  - urban transport experts, Vol. 3(1):43–48
  - value of time data, Vol. 5(2/3):57–72
- SUVs. *See* Light trucks
- Sweden
- accessibility measures, Jämtland, Vol. 4(2/3):83–89
  - crash statistics, Vol. 2(2):159–166
  - travel demand, Vol. 3(3):1–31
- T**
- Telecommuters' travel behavior, Vol. 1(3):25–39
- Telecommuting and Northridge earthquake, Vol. 1(2):35
- Tennessee
- time-use behavior model, Vol. 5(1):39
  - truck flows, Vol. 1(1):69, 72
- Texas
- estimation of origin-destination matrices, Vol. 5(2/3):37–56
  - impacts of bypasses on communities, Vol. 5(1):57, 59, 60
  - time-use behavior model, Vol. 5(1):39
  - truck flows, Vol. 1(1):68, 69, 72
- Time factors
- allocation of time, Vol. 5(1):25–45
  - and accessibility, Vol. 4(2/3):59, 65
  - accidents on freeways, Vol. 2(2):123–131
  - arrival and departure times, travel survey, Vol. 5(1):71–82
  - budgets, Vol. 3(3):1–31; Vol. 5(1):73
  - bus fares, time-based, Vol. 1(1):50–61
  - commuters' activities, Vol. 5(2/3):20, 22–36
  - costs of traffic congestion, Vol. 2(2):123–130
  - freight travel time and reliability, Vol. 3(3):83–89
  - home-based workers, Vol. 1(3):25–41
  - long-haul and metropolitan freight, Vol. 3(3):83–89
  - light trucks and passenger cars, Vol. 3(3):56
  - space-time accessibility measures, Vol. 4(2/3):1–14
  - motor vehicle emissions, Vol. 3(2):76–79
  - Northridge earthquake, Vol. 1(2):13, 14, 32–34, 38–39, 47, 59–60, 67–72
  - roadway inventory data acquisition, Vol. 3(3):33, 43–44
  - traffic flows, Vol. 5(1):49–52, 55
  - traffic signals, Vol. 5(1):3–15, 18, 20, 49
  - transit strikes, France, Vol. 1(3):43–51
  - transit, time-based fares, Vol. 1(1):43–61
  - travel demand, country comparisons, Vol. 3(3):1–31
  - travel-time calculations, Vol. 5(2/3):43–45
  - value of time, Vol. 5(2/3):57–72
- Time series analyses
- forecasting traffic flows, Vol. 5(1):51
  - induced travel demand, Mid-Atlantic, Vol. 3(1):1–14
  - transit costs, multiple serial correlation, Vol. 2(2):113–121
- Tourism, measuring vehicle travel, Vol. 5(2/3):83–90
- Traffic congestion
- aggregated time series analysis, Vol. 1(1):3
  - and air pollution, Vol. 3(2):85–101

- and vehicle emissions, Vol. 3(2):85–101
  - controlling, Vol. 4(1):51–73
  - costs, Vol. 1(1):18; Vol. 2(2):123–130; Vol. 4(1):87–90, 99–100
  - dynamic modeling, Vol. 4(2/3):1–14
  - effects of road construction, Vol. 5(1):26, 33
  - flows, Vol. 5(1):3, 5, 60–61
    - and driver behavior, Vol. 5(1):3
    - forecasting, Vol. 5(1):47–56
  - impacts of bypasses on communities, Vol. 5(1):57–69
  - modeling, vol. 4(2/3):6–8
  - reducing, Vol. 4(1):51–73
  - Roadway Congestion Index, Vol. 3(2):19–20
  - study of urban congestion, Vol. 5(1):28
  - volume, Vol. 4(1):27–38; Vol. 5(1):5
  - Traffic management, monitoring, Vol. 3(3):69–80; Vol. 5(2/3):38
  - Traffic volume
    - changes after Northridge earthquake, Vol. 1(2):1–20
    - estimating, Vol. 4(1):27–38
  - Trains. *See* Railways
  - Transit, Vol. 4(1):51–73
    - accessibility, Vol. 4(2/3):51–57, 71–73, 74
    - commuting during transit strikes, France, Vol. 1(3):43–51
    - costs, Vol. 2(2):113–121
    - demand elasticity, Europe, Vol. 1(1):1–14
    - emergency bus service, Vol. 1(2):1–20
    - fare elasticity, Vol. 1(1):43–57
    - Northridge earthquake, Vol. 1(2):1–3, 7, 9, 11, 15–20
    - response to Northridge earthquake, Vol. 1(2):1–20
    - ridership after Northridge earthquake, Vol. 1(2):1–20
    - services to Medicaid recipients, Vol. 5(2/3):73–81
    - strikes, Vol. 1(3):43–51
    - timetables, Vol. 5(1):79
    - travel demand, country comparisons, Vol. 3(3):1–31
    - urban transportation, Australia, Vol. 3(1):31–52
    - voucher programs for physically handicapped persons in rural areas, Vol. 2(1):61–69
  - Transportation Satellite Accounts, Vol. 5(2/3):1–18
  - Travel behavior
    - accidents on freeways, Vol. 2(2):123–131
    - and parking, Vol. 2(1):99–102
    - commuters, Vol. 1(3):25–39
    - data, Vol. 5(1):28
    - home-based workers, Vol. 1(3):25–39
    - in personal transportation surveys, Vol. 2(1):1–17
    - space-time accessibility, Vol. 4(2/3):1–14
    - telecommuters, Vol. 1(3):25–39
    - travel time budgets, Vol. 3(3):1–31
  - Travel budgets, Vol. 3(3):1–31; Vol. 5(1):26, 32
  - Travel demand
    - based on commuters' activities, Vol. 5(2/3):19–20, 34
    - country comparisons, Vol. 3(3):1–31
    - economic impact of transportation, Vol. 3(1):15–30
    - elasticity, Vol. 1(1):1–14
    - estimation of, Vol. 5(2/3):37–56
    - induced travel demand, Vol. 3(1):1–14
    - international perspective, Vol. 3(3):1–31
    - management, Vol. 4(2/3):51–73
    - trip length, Vol. 1(1):43–57
  - Trip chaining, Vol. 5(1):27; Vol. 5(2/3):24, 33
  - Trucks/trucking, Vol. 1(2):42–43
    - accident risk analyses, Vol. 1(1) 75–92; Vol. 2(1) 20, 26; Vol. 3(1):69–79, 36–43
    - determinants of accidents, Vol. 3(1):69–79
    - disaster planning, Vol. 1(2):37–48
    - estimating truck traffic, Vol. 3(1):53–66
    - methodology using automatic vehicle classification, Vol. 1(3):89–93
    - freight demand and mode choice, Vol. 2(2):149–158
    - hazardous materials shipments, Vol. 3(1):81–92
    - impact of Northridge earthquake, Vol. 1(2):37–48
    - light trucks
      - accidents, Vol. 2(1):27, 36–43
      - emissions, Vol. 3(2):49–63
      - ownership and use, Vol. 3(3):47–60
    - long-haul freight, Vol. 3(3):83–89
    - metropolitan freight, Vol. 3(3):83–89
    - Northridge earthquake, Vol. 1(2):37–48, 57, 58
    - safety, Vol. 3(1):69–79
    - state-level commodity flows, Vol. 1(1):63–73
    - surveys of Los Angeles area trucking companies, Vol. 1(2):37–48
- U**
- United Kingdom
    - crash statistics, Vol. 2(2):159–166
    - elasticity studies of public transport, Vol. 1(1):1, 7, 10–12 (*passim*)
  - Urban areas
    - air pollution at intersections, Vol. 3(2):85–101
    - earthquakes, Vol. 1(2), 1–73
    - effect of speed limits on fatal accidents, Vol. 4(1):7–11
    - induced travel demand, Mid-Atlantic, Vol. 3(1):1–14
    - motor vehicle emissions, Vol. 3(2):15–28, 65–102
    - motor vehicle noise, Vol. 1(1):20–21, 23, 24, 33; Vol. 1(3):1–24
    - public transport fares, Vol. 1(1):43–62
    - speed monitoring, Vol. 3(3):72–81
    - transportation models, Vol. 3(1):31–52
  - Utah
    - land-use scenarios and transportation sketch planning, Wasatch Front, Vol 4(1):39–49
    - truck flows, Vol. 1(1):68, 69, 72
  - Utility-based surplus approach (accessibility modeling), Vol. 4(2/3):35
- V**
- Vans. *See* Light trucks
  - Vehicle license fees. *See* Motor vehicles

- Vehicle-miles of travel (VMT), Vol. 3(1):1–14  
 accidents, Vol. 1(1):76, 77, 80, 83, 84–88;  
     Vol. 2(1):36–43  
 crash fatalities, Vol. 2(2):163–164  
 disabled persons, travel vouchers, Vol. 2(1):66–67  
 emissions and, Vol. 3(2):19, 39–47, 51–59, 67  
 general, Vol. 3(1):74–75, 78  
 hazardous materials, Vol. 3(1):87  
 households and businesses, Vol. 5(2/3):1–18  
 induced travel demand, Vol. 5(1):25, 27–28, 32, 36  
     Mid-Atlantic, Vol. 3(1):1–14  
 light trucks and passenger cars, Vol. 3(3):47–60  
 measuring vehicle travel by visitors, Vol. 5(2/3):83–90  
 models, Vol. 3(3):50–51  
 motor vehicle ownership and use,  
     Vol. 2(1):3–7, 11, 17,  
 National Personal Transportation Survey, Vol. 2(1):1–17  
 noise, Vol. 1(3):5–6, 19  
 railways, European, efficiency/output, Vol. 3(3):61–68  
 social costs, Vol. 1(1):19, 27  
 speed and speed limits, Vol. 3(3):69–81  
 travel demand, Vol. 3(3):1–31 (passim)  
 truck accidents on freeway ramps, Vol. 1(1):76, 77, 80,  
     83, 84–88  
 truck traffic estimates, Vol. 1(3):90  
 Vehicle occupancy models, Vol. 3(3):53–54  
 Vehicle ownership  
   household, Vol. 2(1):1–17  
   equity of vehicle license fees by income,  
     Vol. 2(2):135–140  
   equity of vehicle license fees by location,  
     Vol. 2(2):140–143  
   light trucks and passenger cars, Vol. 3(3):47–60  
   models, Vol. 3(3):57–59  
 Vermont, truck flows, Vol. 1(1):67, 68, 69, 71, 72  
 Virginia  
   study of road capacity and VMT, Vol. 5(1):28  
   time-use behavior model, Vol. 5(1):39  
   truck flows, Vol. 1(1):69, 72  
 VMT. *See* Vehicle-miles of travel
- W**  
 Walking, Vol. 4(2/3):67–68, 71–73, 74–75  
 Washington (state)  
   time-use behavior model, Vol. 5(1):39  
   truck flows, Vol. 1(1):67, 69, 72  
 Washington, DC  
   study of road capacity and VMT, Vol. 5(1):28  
   truck accidents on freeway ramps, 75–92  
   truck flows, Vol. 1(1):64, 69, 72  
 Water pollution, motor vehicle use, Vol. 1(1):26, 30, 36,  
   37, 38  
 West Germany, travel demand, Vol. 3(3):1–31  
 West Sussex, England, Vol. 5(1):51  
   West Virginia, truck flows, Vol. 1(1):69, 72  
 Wetlands, transportation's effects on, Vol. 2(1):48–50, 57  
 Wisconsin  
   impacts of bypasses on communities, Vol. 5(1):58  
   truck trips, Vol. 3(1):53–67  
   truck flows, Vol. 1(1):69, 72  
 Wyoming, truck flows, Vol. 1(1):68m 69, 72
- Z**  
 Zoning, parking management, Vol. 2(1):93–107





# JOURNAL OF TRANSPORTATION AND STATISTICS

Volume 5 Numbers 2/3, 2002  
ISSN 1094-8848



## CONTENTS

**CHEN, FANG, HAN + SLOBODA** Household-Provided  
Transportation: Extension of the Transportation Satellite Accounts

**GANGRADE, PENDYALA + MC CULLOUGH** A Nested Logit  
Model of Commuters' Activity Schedules

**GAJEWSKI, RILETT, DIXON + SPIEGELMAN** Robust Estimation of  
Origin-Destination Matrices

**CHANG + CHANG** Calibration of Intercity Trip Time Value  
with a Network Assignment Model: A Case Study for the Korean  
NW-SE Corridor

**O'CONNELL, GROSSARDT, SIRIA, MARCHAND + MC DORMAN**  
Efficiency Through Accountability: Some Lessons from Kentucky's  
Improved Medicaid Transit Service

**CHU + POLZIN** An Application for Measuring Vehicle Travel  
by Visitors