

SUBMITTED TO:



National Address Database Summit Report

AUTHORED BY APPLIED GEOGRAPHICS



JUNE 2015

24 SCHOOL STREET, SUITE 500 | BOSTON, MA | 02108 | 617.447.2400

INTENTIONALLY BLANK FOR DOUBLE-SIDED PRINTING.

1 CONTENTS

1	Contents.....	3
2	Executive Summary	5
3	Introduction and Overview.....	7
3.1	Summit Objectives	7
3.2	Role of the US DOT Administrations and Divisions.....	7
4	Current Situation	8
4.1	Unique moment in time.....	8
4.2	Existing work on definitions and requirements.....	9
5	Summit Overview	11
5.1	Attendee Overview	11
5.2	Agenda	12
6	Summary of Discussion Topics & Outcomes	15
6.1	Vision.....	15
6.2	What resources exist that can support this kind of initiative?	15
6.3	What is needed to successfully execute this kind of initiative?	16
6.4	Breakout topic discussions and findings.....	17
6.4.1	Business Justification	17
6.4.2	Leadership & Organizational Approach	18
6.4.3	Local Outreach & Assistance.....	20
6.4.4	Data & Technology.....	23
7	Key Points of Agreement	27
8	Where do we go from here? Next steps.....	28
8.1	Suggestions on Leadership.....	28
8.2	Suggestions on Approach.....	28
9	Initial feedback and input from other groups	31
9.1	National States Geographic Information Council (NSGIC).....	31
9.2	State Departments of Transportation and the GIS-T Conference	31
10	Conclusion.....	33

APPENDICES

Appendix 1: Attendee List	34
Appendix 2: Agenda & Speaker List.....	Error! Bookmark not defined. 38
Appendix 3: The Importance of Address Data	42
Appendix 4: The Complexity of Address Data	43
Appendix 5: Bibliography of Other National Address Database Resources.....	49

2 EXECUTIVE SUMMARY

The **National Address Database Summit** was held at The Conference Center at the Maritime Institute in Linthicum, MD on April 8-9, 2015. The Summit was sponsored by the United States Department of Transportation's (USDOT) Bureau of Transportation Statistics (BTS) and facilitated by Applied Geographics, Inc. and LEAD Alliance. The Summit provided a specialized forum for generating ideas and gathering input on the feasibility and format of a **shared address database for the nation**. The summit was attended by 58 participants and an additional 25 observers from across the federal, state, local government, tribal, non-profit and private sector stakeholders.

Objective:

The stated objective was to “identify and discuss possible options for developing a National Address Database” (NAD) and to answer these four questions:

1. Is development of an NAD a good idea?
2. Can an NAD be feasibly created?
3. Are there strong ideas for a technical and organizational approach?
4. Are there clear and productive next steps that can be taken?

Unique moment in time:

During the Summit the discussion reinforced the sponsor's belief that several factors are making the development of a NAD more feasible and realistic:

- Critical planning and benefits homework has been completed by the National Geospatial Advisory Committee (NGAC) in the form of two publicly available reports (see Bibliography)
- Increasing attention, including potential funding, on developing the Next Generation 911 system for the nation which has an important reliance on addressing information
- Recent efforts by USDOT and FCC that have resulted in the creation of publicly available, nationwide data sets for all roads and broadband availability have revealed a viable game plan of state and federal cooperation for this kind of effort
- The NAD is envisioned to be a publicly available national resource and is in-line with current trends for open government data and a 21st century digital government
- A recent report from the Government Accountability Office that identified issues with current governmental address data practices and identified a need for a NAD

Vision:

Summit participants endorsed the vision set forth in the initial, 2012 NGAC report titled *The Need for a National Address Database*. This vision states:

“The National Address Database is an authoritative and publicly available resource that provides accurate address location information to save lives, reduce costs, and improve service provision for public and private interests”.

Breakout topic discussions:

A key component of the Summit were smaller group breakout sessions that capitalized on the address subject matter expertise represented by the diverse and experienced stakeholder participants. The breakout discussion revolved around four key topics:

1. **Business justification** for a NAD
2. The appropriate **leadership and organizational approach** for a NAD
3. **Local government outreach and assistance** that needs to be a component of a NAD
4. The **data and technology** issues that must be resolved in building a NAD

Key points of agreement:

Following the discussions, Summit participants came to extremely broad agreement on **four key points** that can help guide the direction an NAD initiative may take:

1. **Local authorities are the authoritative source** for address assignment and are data set originators
2. **State authorities should be statewide aggregators of county and local data sets.**
3. Given the vast and complex nature of the United States it is critical to recognize the role of **non-state governmental entities** such as **Tribal Nations, US Territories** and the **District of Columbia** play in an NAD.
4. **Federal leadership and support is needed for there to be a sustainable national approach.**

Next steps:

One of the key discussions that took place at the Summit was group brainstorming on immediate, **actionable next steps** that can be pursued. These next steps fell into two broad categories:

- Suggestions on **leadership**:
 - Identify a high-level Federal champion to help spearhead messaging and advocacy
 - Identify appropriate champions from state, local, and tribal governments as well
 - Create **multi-sector working groups** to tackle key questions and components at a detailed level
 - Pursue a “just do it!” attitude that leverages existing planning and activity and emphasizes tangible actions over further “discussion”
- Suggestions on **approach**:
 - Conduct a **formal and thorough gap analysis** to identify what resources are already in place, as well as missing items that are “needed”
 - Capitalize on and leverage existing open government data and “21st century digital government” initiatives such as GSA’s 18F team
 - Craft a branding and messaging strategy, and supporting education material that can help articulate the need for, and benefits of a NAD to encourage participation
 - Pursue pilot projects as quickly as possible to both tackle unresolved issues and demonstrate feasibility

Conclusion:

The sponsor and all participants were satisfied with the NAD Summit. There was **broad and genuine engagement** from all who attended as well as productive brainstorming, relationship building and collaboration. There is a sincere hope that further **action and activity - beginning with embarking on pilot studies** – will follow the Summit.

3 INTRODUCTION AND OVERVIEW

3.1 SUMMIT OBJECTIVES

The stated Summit objective was to: “Identify and discuss possible options for developing a National Address Database” and determine if there was general agreement on the following notions:

- A public national address database (NAD) would meet needs of federal agencies and their partners...
- Creation of a NAD is feasible and practical...
- One or more strategies for creating a NAD are clear...
- Next steps are clear...

3.2 ROLE OF THE US DOT ADMINISTRATIONS AND DIVISIONS

USDOT held this summit due to business needs for national addressing information and to support federal responsibilities outlined by GAO. Specific considerations include the following:

- Addresses are often considered an attribute of roads and streets, and are thus a potential complement to Federal Highway Administration’s (FHWA) All Roads Network of Linear Referenced Data (ARNOLD).
- Addresses are often used to identify the location of accidents.
- Addresses are a key element in Next Generation 9-1-1 (NG911) planning: The National Highway Traffic Safety Administration (NHTSA) co-manages the National 911 Office – a joint program with the National Telecommunications and Information Administration (NTIA) at the U.S. Department of Commerce.
- Addresses are useful in surveys and in federally sponsored state, local, and tribal planning studies that link address-based data with highway data.
- The Government Accounting Office (GAO) has asked the Federal Geographic Data Committee (FGDC) to examine handling addresses in the same manner as other national data sets¹. In turn, FGDC has singled out and asked both USDOT and Census Bureau (DOC) to make a recommendation on a Federal leadership for this new national data theme.

¹ From page 72 of the GAO report: “Create an address data theme with associated subcommittees and working groups to assist in furthering a national address database.”

4 CURRENT SITUATION

4.1 UNIQUE MOMENT IN TIME

As the following factors describe, achieving a National Address Database is more feasible than ever before.

- The National Geospatial Advisory Committee (NGAC) has published two separate studies (see Appendix 5, Bibliography) that highlight the value and importance of addressing information to Federal, state, local and tribal governments as well as the private sector. In short, **NGAC has done important “homework”** to identify why addressing data are vitally important. In addition, when NGAC was briefed on this Summit at their June 2015 meeting, they continued their strong support for the development of a NAD by recommending that the Federal Geographic Data Committee (FGDC) make the NAD a top priority over the next 18 months. NGAC summarized the priority saying: “Develop and implement approach for a National Address Database. Ensure governance & funding models meet needs of major stakeholders.”
- The nation is in the midst of planning and initially deploying a greatly enhanced 911 system for emergency response. The new, Next Generation 9-1-1 (NG911) architecture has an increased need for detailed addressing information and indeed NG911 has catalyzed significant state level efforts to build detailed, statewide addressing databases. **NG911 represents a potential funding stream** that in combination with other partners can help usher in greatly improved address databases, and the benefits of a successful NG911 provide public safety benefits to all citizens.
- There are at least two other recent Federal success stories for building complex national geospatial databases. The USDOT has recently completed the second version of the All Roads Network of Linear Referenced Data (ARNOLD) that includes all public roads in the country. In addition, the FCC and NTIA successfully created the National Broadband Map (NBM) within a short period of time by working with states. Both of these initiatives followed a similar game plan with Federal funds flowing to states and states taking on the responsibility of building statewide data sets that adhere to standards. In turn, these statewide data sets were aggregated by the Federal government into national data sets. Both **ARNOLD and NBM demonstrate the feasibility of creating national data sets and reveal a viable game plan.**
- The NAD is envisioned to be a publicly available national resource. Such a data set dovetails into current **Federal priorities for “open government data”** that provides direct value to governments and additional value to the private sector which has a great need for address data. By example, a new “18F” governmental unit has been created within the General Services Administration (GSA) to “Build a 21st Century Digital Government” and focus on improving public services and delivering digital government in a more modern and agile fashion. A NAD would very likely resonate and align with 18F priorities by representing an open data source that would provide huge opportunities to, as the 18F web-site reports, “create great services for the public.”

- While the NAD will represent the location of where people and businesses reside, it will not contain the names of occupants of addresses. In addition, with tools such as Google Maps and a variety of personal navigation devices, there is a new **public expectation that one should be able to enter an address into a device or web-site in order to navigate to that exact location.** And there is an increased understanding that these databases already exist in the private sector. Indeed, **the convenience of using address data largely outweighs any privacy concerns.**
- Finally, there are new Federal studies and legislation that further highlight the importance and relevance of address data:
 - The National Geospatial Data Act, Senate Bill 740 (SB740), provides the legal framework for the National Geographic Advisory Committee (NGAC) and the National Spatial Data Infrastructure (NSDI). With the call to include address data in the NSDI, a national address database would be stewarded under the overarching national geospatial data governance and management framework proposed in the legislation.
 - The Government Accountability Office (GAO) recently released a report titled *Geospatial Data - Progress Needed on Identifying Expenditures, Building and Utilizing a Data Infrastructure, and Reducing Duplicative Efforts* that identified issues with current governmental address data practices and identified a need for a NAD. The report stated:
 - “Address data are collected and purchased multiple times by federal, state, and local entities, resulting in duplication of effort and resources.” (p. 56)
 - “Until there is increased focus on building a national address database and providing federal sponsorship for that effort, there will continue to be duplicative address datasets developed at every level of government.” (p. 65)

In combination, these factors help elevate the importance of addressing and make it more likely that a national effort can be feasibly executed.

4.2 EXISTING WORK ON DEFINITIONS AND REQUIREMENTS

There is a large body of existing work that documents the importance of addressing data to a variety of governmental and private sector stakeholders and organizations. In particular recent work, in the form of two reports from the National Geospatial Advisory Committee (NGAC) has helped outline both the needs for, and benefits of national addressing. Rather than re-stating these findings, the Summit was focused on extending the conversation to flesh out the next steps of starting a national addressing effort.

In addition to the existing literature, a variety of supporting materials were prepared for the Summit itself and these are available both through the Summit website² and through the following Appendix to this document. These materials cover the following “current situation” topics:

- The Importance of Address Data (**Appendix 3**)
- The Complexity of Address Data (**Appendix 4**)
- Bibliography of other National Address Database resources (**Appendix 5**)

² See: <https://sites.google.com/a/appgeo.com/nationaladdressdatasummit/home>

5 SUMMIT OVERVIEW

The National Address Database Summit was held at The Conference Center at the Maritime Institute in Linthicum, MD on April 8-9, 2015. The Summit was sponsored by the United States Department of Transportation's (USDOT) Bureau of Transportation Statistics (BTS) and facilitated by Applied Geographics, Inc. and LEAD Alliance. The Summit was envisioned and planned as a specialty forum for generating ideas and gathering input on the feasibility and format of a shared address database for the nation.



Figure 1. Participants at the Summit shown in the large group discussion.

5.1 ATTENDEE OVERVIEW

Multi-sector participation was a key component of the event and representatives from all levels of government (local, state, federal and tribal) as well as the private and nonprofit sectors were invited to attend and participate. While active participation was limited to invitees, attending organizations were permitted to bring observers to the 2-day event. In total, 58 participants and 25 observers attended the event. The chart below shows the sector distribution.

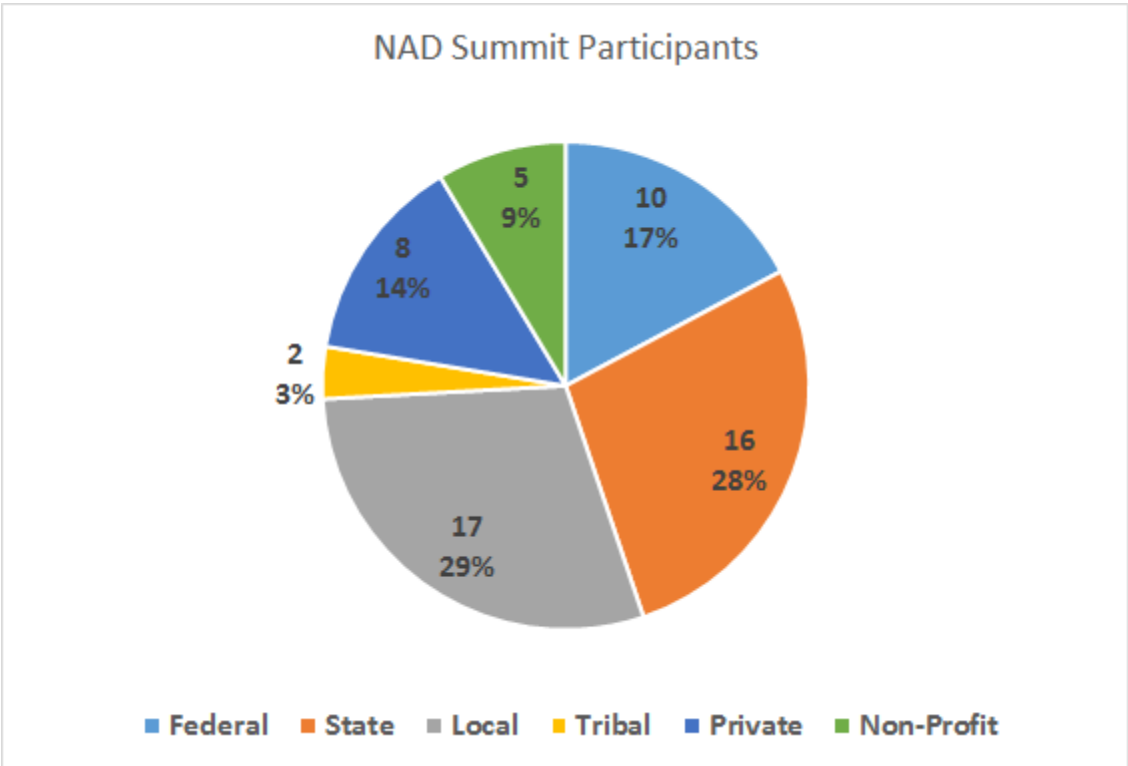

Figure 2. NAD Summit participants included: Federal (10), State (16), Local (17), Tribal (2), Private (8), and Non-profit (5).

5.2 AGENDA

The Summit agenda was designed to balance formal presentation content with facilitated discussion and brainstorming opportunities. A diverse set of guest speakers were invited to offer their perspective on the importance of a national address database, best practices, requirements, challenges and opportunities for moving forward. The full 2-day agenda can be viewed in **Appendix 2**.

Formal presentation content was intended to offer context and background information to seed interactive discussion. Presentations ranged from a high level federal perspective on the current state and importance of address data to a county sharing its experiences and thoughts on current and emerging best practices. Additionally, a moderated, interactive panel discussion tackled the challenges and opportunities for building a NAD.



Figure 3. A moderated panel discussion on key challenges: Laurie Flaherty (U.S. Department of Transportation), Christian Jacqz (Commonwealth of Massachusetts), Jack Maguire (Lexington County, SC), Larry Wahl (United Parcel Service), Michael Terner (AppGeo, Moderator)

Facilitated large group and small group discussions as well as informal “break time” discussions allowed participants to engage with and learn from one another, as well as share ideas and observations. At several points during the Summit, participants were asked to self-facilitate “table top” group discussions (small groups of 6-8 seated together) focused on a particular topic. Attendees were also divided into smaller “breakout groups” to discuss and brainstorm on key aspects of a NAD. Breakout group topics included:



Figure 4. Photo of participants in breakout group discussion.

- Business Justification
- Leadership and Organizational Approaches
- Local Outreach and Assistance
- Data and Technology

Discussion topics, including breakout group findings, are summarized in the next section.

6 SUMMARY OF DISCUSSION TOPICS & OUTCOMES

6.1 VISION

The Vision expressed in the NGAC reports resonated with the Summit participants:

“The National Address Database is an authoritative and publicly available resource that provides accurate address location information to save lives, reduce costs, and improve service provision for public and private interests”.

This simple vision reiterates some core tenets for a NAD initiative:

- The database should contain information from **authoritative sources**, i.e., sources that are involved in the original creation and management of address data
- It should be **publicly available** serving both public and private interests
- It should not just be a listing of addresses, but it should contain the **location of the address as a coordinate pair**

6.2 WHAT RESOURCES EXIST THAT CAN SUPPORT THIS KIND OF INITIATIVE?

The Summit content included presentations describing some of the existing Federal resources that can be applied to help create a NAD and the discussions uncovered additional, existing state and local government resources.

- Throughout the decade, in support of the Decennial Census, the U.S. Census Bureau creates a national address database for its own purposes and has a demonstrated ability to assemble these kinds of data. The **Census Bureau has extensive address data expertise** and oversees a program that aims to verify every address in the country every 10 years.
- The Federal Communications Commission (FCC) has strong **influence and rule making authority** that guides the behavior of telephone companies and the delivery of 911 calls, which may include address content, to 911 Public Safety Answering Points (PSAP). Through this kind of rule making, the FCC has the potential ability to influence behaviors involving the collection/delivery of address data, the format of address data submissions to specific government agencies and if, and how those data may be shared with other governmental entities.
- Numerous states, often catalyzed by NG911, have embarked on statewide addressing initiatives and the first generation of **statewide addressing databases** are beginning to come on-line. These efforts represent important trailblazing and will serve to establish best practices and lessons learned for other states to follow.
- As with states, increasing numbers of local governments are involved in creating citywide and countywide address databases. This includes best practices in **address assignment and local**

addressing database development that can serve as models for other localities to learn from, and follow.

6.3 WHAT IS NEEDED TO SUCCESSFULLY EXECUTE THIS KIND OF INITIATIVE?

During the Summit there was a lively group discussion aimed at identifying the variety of factors and efforts that would be needed to successfully build, sustain and maintain a NAD. Participants raised the following needs:

- **Defined achievable mission:** develop a clear set of realistic objectives and measures for successful completion.
- **Regulations and/or incentives:** are necessary to incentivize, and if necessary compel participation from an extremely large number of local, state and Federal participants.
- **Clarity on licensing, access, multi-directional data sharing:** are essential to make expectations clear for the large number of participants that will be working in concert and sharing data.
- **Trust:** will be essential to ensure that the large number of participants can work together while respecting agreements and obligations to share data
- **Communication & coordination – ability to overcome silos:** a key aspect to building trust and fostering sharing is clear communication and explicit efforts aimed at coordination. All participants in the NAD need to work as part of an articulated system and understand their role and connections to other participants in the system.
- **Sustainable funding linked to use cases:** the NAD will be a large and complex endeavor with a large set of benefits, but it will need significant funding to move forward.
- **Support for “have-not” jurisdictions:** while many jurisdictions have already begun to develop extensive and sophisticated addressing systems with their own resources, it will be particularly important to provide funding support for smaller and less affluent jurisdictions that have not been able to “self start”.
- **Training & tools (e.g., ETL, de-duplication, etc.):** in addition to funding, it will be beneficial to develop common tools and training that can be shared across jurisdictions that will ultimately have the same jobs to tackle in terms of creating, managing, updating and sharing address data.
- **Maintenance plan/workflow:** in addition to technical solutions there are important workflow aspects to address data creation and maintenance. As with tools, it will be important to make information on successful workflows available to jurisdictions that are starting the address database development process.
- **Standardization (content, accuracy, placement):** given the variety of data sources that will contribute to the national data set, it will be essential to have standards and documentation that help ensure the quality of the data, and facilitate the aggregation of disparate data sets.

- **Public outreach and messaging:** the NAD initiative needs to be put in the public mind so that people understand its importance (e.g., to public safety and public service provision) and are supportive of it. This type of outreach should also include efforts to name and brand the initiative beyond “NAD” to gain greater recognition.
- **Consider agnostic “Big Data” approaches:** in building the NAD, particularly the national, rolled-up incarnation, there is great room for innovative approaches including leveraging ongoing research and development and new “big data” approaches for this kind of initiative.

6.4 BREAKOUT TOPIC DISCUSSIONS AND FINDINGS

6.4.1 Business Justification

There are a great number of resources (see **Appendix 5**) that indicate address data is needed by all sectors to support a wide variety of use cases. There are also a number of sources for address data, but currently, no single definitive source. Typically, publicly owned addresses are originated at the local level, but are not consistently collected nor aggregated at the state or federal levels of government.

There will continue to be duplicate effort, a lack of consistency, and conflicting sources if the status quo prevails. And, due to the inadequacy of public sources in many places, the private sector expends resources of its own to collect and aggregate address data for business purposes.

The purpose of this breakout session was to capture the most compelling arguments for a nationally coordinated approach, and the business case for concentrating funds and resources to create a multi-purpose NAD. The participants in this breakout session were tasked with confirming the business need for a NAD and beginning to identify potential funding sources for building and maintaining a NAD.

Key questions that were posed to the group included:

- Why should this be done?
- Why should we focus our collective national resources on this?
- Who should pay for it? And how much might it cost?
- What are the strongest arguments for a multi-sectoral approach to NAD?
- Why should local entities want to cooperate?
- What will be the return on this investment?
- How will success be measured?
- Who are the players? Who is involved and what are their roles/responsibilities?

The group discussion identified several business needs for a definitive, public address resource. From a cost perspective, **the status quo is expensive to maintain**. There is duplication of spending and effort as local governments create and maintain data for local purposes (e.g. emergency response, tax assessment) and the federal government creates and maintains address data for national purposes (e.g. census data collection and dissemination). Taxpayers are forced to pay more than once for address data

due to lack of coordination and sharing as well as single-purpose implementations (i.e. the data format/content/schema is only useful for a single purpose).

Assuming that **local governments provide the best source of accurate and current address data**, discussion focused on their role as “data providers” in this initiative. While many municipalities and counties are actively investing in the creation and maintenance of address data for local purposes, the success of a NAD depends on their support and participation in a “rolled-up” national resource. The business case for a consistent, national database must be compelling to local governments in order to achieve their “buy in”. Many **local governments recognize that the local benefits are real and compelling** -- saved lives through improved multi-jurisdictional public safety response, expedited disaster recovery dollars, and support for economic development. But, others may view this initiative as an unwelcome burden that potentially exposes sensitive citizen information. A key element in a successful NAD will be dealing with these concerns and making the business case relevant and meaningful to all involved.

In addition to public, authoritative addressing data the discussion acknowledged extensive commercial and private address data resources (e.g., commercially available databases; corporate databases within package delivery companies or utilities, etc.). Ideally, the best possible NAD would involve collaboration across both the public and private sectors.

The group expressed the need for a multi-purpose solution that will:

- **Support multiple use cases.** While government entities and organizations will have unique requirements or sensitive elements that serve their specific use cases, the common address elements that support all address use cases should be gathered from authoritative sources, aggregated and made accessible to all.
- **Leverage and align the expertise and resources** already aimed at this effort. The NAD should garner these important resources, not replicate them.
- **Save money and time**, at all levels of government and across the nonprofit and private sectors, by eliminating duplication of effort.
- **Improve return on investment (ROI) through collaboration.** The greatest value and return on investment will be achieved through multi-sector collaboration, broad applicability and wide accessibility.

6.4.2 Leadership & Organizational Approach

Leadership is needed at the federal level to proceed with a nationally coordinated, multi-sectoral, multi-discipline approach for implementing NAD. A sustainable and nationally-embraced NAD requires **collaboration between multiple sectors** and a coalition of subject matter experts (SMEs) and stakeholders. An understanding of stakeholder needs, application requirements, and platform alternatives is important for leaders to make well-informed decisions.

A **partnership approach and funding** are also needed. Successful partnerships are based on trust, respect, and a common objectives. Partners need to be represented in more than just a token way for

the sincerity of the federal government to be believable. And partnerships depend on good communications and mutually beneficial outcomes for measuring success. There was agreement that **program “drivers” such as NG911 need to be leveraged.** NG911 emerged as the most prevalent and compelling driver, especially among local government participants. And, there was agreement that local sources are typically the authoritative source for address data; states are primarily aggregators, as is the federal government, although both may play a role in adding value in terms of standards and support where needed (e.g., for “have-nots”)

A few **key leadership decisions** need to be made, including:

- Who will be designated the lead federal agency for NAD?
- Who will provide the expertise and resources needed to implement and support it?
 - People
 - Funding
- What partnership model will be adopted?

The goal of the breakout session was to emerge with some ideas and “agreement points” for moving forward. Some were mentioned, above. The following set of questions was posed to the participants on the topic of Leadership and Organizational Approach, to facilitate further discussion:

- Are there existing models for governance that might fit the NAD and include all stakeholders (and if so, what are they)?
- If two federal agencies are co-leads for NAD, how would this work?
- Should NAD be a data theme under OMB A-16, or a data set under an existing theme? If the latter, where might it fit?
- Is enabling legislation or an Executive Order needed for the NAD?

Agreement Points and Related Discussion on the Questions Above:

Are there existing models for governance that might fit the NAD and include all stakeholders (and if so, what are they)?

Existing models that were recognized by the participants as exemplars for successful national efforts included the National Broadband Map and the All Roads Network Of Linear-referenced Data (ARNOLD) in support of both the Highway Performance Monitoring System (HPMS) and the goal of Transportation for the Nation (TFTN). These examples use:

- Federal funding provided to states to support data development and standardization
- Local data aggregated by a state authority and rolled-up to a specific federal agency to establish a national geospatial dataset

If two federal agencies are co-leads for NAD, how would this work?

There was general recognition of the importance of federal leadership to have a nationally coordinated program, but there were strong admonitions to “avoid too many hands on the steering-wheel.” A

suggestion was made to consider an “Advisory Board” approach -- but with a clear lead federal agency that could be held accountable.

Should NAD be a data theme under OMB A-16, or a data set under an existing theme? If the latter, where might it fit?

First-of-all, it was expressed at the Summit that “outside of involved federal agencies, there is not a lot of understanding about federal acronyms and processes (such as NSDI, FGDC, NGDA, and A-16)” -- so this is perhaps more of a question for federal leadership to answer, i.e., within the NSDI / A-16 framework, should addresses be:

1. A new theme?
 - a. A new “Location” theme that might include addresses, critical infrastructure, gazetteer information, etc.
 - b. Or, a new theme for just “Addresses”
2. Part of an existing theme?
 - a. Part of the “Transportation” theme
 - b. Part of “Cadastre”
 - c. Part of “Governmental Units, Administrative, and Statistical Boundaries”
 - d. Other?

Is enabling legislation or an Executive Order needed for the NAD?

Legislation can be good or bad, depending on its language and meaning. It can be a disabler, rather than an enabler – for example, Title 39 and Title 13 place constraints on the US Postal Service and US Census Bureau, respectively, to share address data. The general sense was that new enabling legislation is not needed for NAD.

However, if legislation or an Executive Order are not pursued, how can it be ensured that the program will be sustained when priorities, personnel, and budgets change? A key factor related to past “trust” issues is the ephemeral nature of many Federal programs and initiatives. Such program are often tied to the strengths of key individuals.

6.4.3 Local Outreach & Assistance

Addresses typically originate at the local level from thousands of individual sources. Thus, some degree of conformance to a national standard will be required to facilitate aggregation at state and federal levels of government. To achieve this, a broad-based outreach effort is needed to communicate with local authorities and provide them **guidance and support to help provision local addresses** for the contemplated NAD. This outreach will require identifying mutually beneficial outcomes that will serve as the basis for a sustainable, collaborative approach.

Within this context, this breakout group was tasked with discussing effective and agreeable approaches to local outreach and assistance with the goal of identifying current barriers to participation and specific

types of support that are needed to help local authorities collect and maintain address data in conformance with the contemplated NAD requirements.

Key questions posed to the group included:

- If locals are key source of address data, what do locals need to successfully contribute to a NAD?
 - What are the biggest barriers?
- What outreach programs have been successful? Why?
- How much demand will there be for assistance?
- What value is added to address data content with top-down coordination?
- What kind of messaging is important in public outreach?

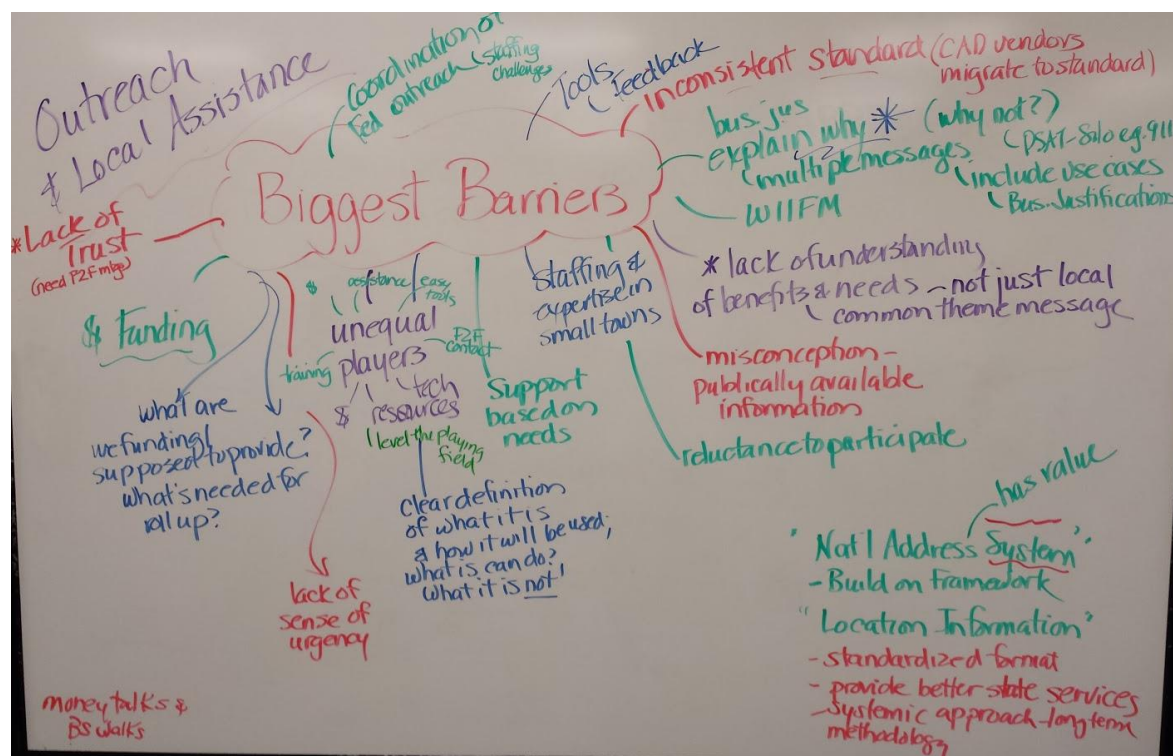

Figure 5. Brainstorming results from Local Outreach & Assistance breakout group.

The discussion and brainstorming largely focused on how best to overcome barriers for local participation. It is clear that barriers will vary depending on the state, local staffing, technical expertise, and access to funds. In many places, the largest barriers may simply stem from a lack of awareness of the benefits to local governments or misconceptions about how the data will be used by others. A successful outreach program will need to be tailored to address local concerns and challenges. Ideas for support include:

- **State contract vehicles** to facilitate coordination and data sharing
- **Funding** for supplemental staff and/or hiring address expertise

- **Training and tools** to help local governments in overcoming technical hurdles.

This support will be especially important in communities that are not already creating and maintaining address data and do not have the local resources to do so. The effort should “level the playing” field to a certain extent allowing all local governments to contribute and benefit from the NAD.

An important theme that was discussed at length revolves around the **issue of trust** between various levels of government and between sectors. “Lack of trust” was identified as a potentially significant barrier to success and one that could be overcome through effective outreach and education. This “mistrust” was characterized as the state and federal government not always respecting local authority for address data assignment and data management, and locals not always trusting that benefits will cycle back to them after feeding their data “up”. A number of suggestions were made that would help overcome the “mistrust” barrier:

- Local, state, tribal and federal entities should foster productive working relationships through **face to face meetings and interactions**. While this may be perceived as a time consuming, inefficient approach by state and federal entities that are coordinating with many local entities, the time invested in establishing these relationships and building trust will pay off in streamlined coordination and willing participation down the line.
- Once a federal lead agency has been identified for the NAD effort, federal requests for state and local address data should be funneled to that lead agency. **Duplicative requests from the federal government for the same data has fueled local mistrust** and aggravation in the past.
- **Create a “feedback loop”** that notifies local governments of data discrepancies or issues uncovered during state or national aggregation efforts. This will offer direct benefit to locals providing a source for ongoing data quality improvements and will also foster an environment of shared responsibility and trust at all levels of government. This feedback loop could be achieved through a carefully designed web interface that allows locals to upload data, see the status of integration and aggregation into a NAD, and receive specific feedback on content or format.

The discussion also focused on the importance of thoughtful and effective **“messaging” to local governments**. While funding, technical support and data management tools are essential elements in supporting local governments, these investments will not be effective if not paired with compelling messaging and education about the program. Some important recommendations were identified by the breakout group:

- The first question many local governments will ask in learning of this program will be “What’s in it for me?” The perception that this is yet another “ask” from the state or federal government with little or no local value must be addressed in meaningful, local terms. For instance:
 - The need for accurate, complete and stable addresses to serve NextGen 911 requirements is, and will continue to be a primary driver at the local and state levels. This urgent need resonates well at all levels of government and demonstrates tangible benefit that will stem from a NAD.

- Accurate Block Grant distributions which bring significant revenues to local governments based on the identification of population demographics during each Decennial Census.
- The NAD should be characterized as a framework and “system” that aims to deliver sustainable benefit for all levels of government. The **NAD is not just a “database”** that must be fed by locals, but a system that requires collaboration and participation by all.
- Effective messaging will need to explain the “Why?” question at various levels. County Supervisors and Mayors will be interested in public safety and economic development benefits, whereas technical staff will be concerned about impact on workload and workflow. Messaging will need to be tailored to each of these groups compelling them to participate in and support this important initiative.

6.4.4 Data & Technology

The NGAC National Address Database Report included a “Conceived as” Statement which listed several important data/technology principles for an address database, for which there was broad agreement during the “data and technology breakout”. This statement is repeated below:

“A continuously updated, nationwide, publicly available address database, with associated geographic coordinates, that meets the needs of Federal, Tribal, State and local stakeholders. The database stores all residential and non-residential structures and interior units, mailing addresses, plus other locations of critical interest (for example, highways, bridges, and landmarks). This database is an inventory and a standards based, distributed network of sources rather than a single, centralized database. Most address data are developed locally, with local and state custodians acting as regional integrators who merge local data into region-wide databases. The data are updated in a timely and quality-controlled manner. Federal stakeholders consume and use locally developed and aggregated address data stored in a standardized National Address Database.”

As an NAD initiative commences, this statement provides a solid framework that can be further refined and extended over time. As with the NGAC Vision Statement described above (in **Section 6.1**) this “conceived as” statement enumerates several core technical and data tenets for a NAD initiative:

- The NAD must be **nationwide** in scope, including tribal lands
- The resultant data must be **publicly available**
- Address data change frequently and must be **continuously updated**
- Address data must include **location coordinates**, not just the street name of the address
- The NAD must include all residential and non-residential addresses as well “interior units” (i.e., sub-addresses) such as apartments
- **Address data are developed locally** by a large number of widely distributed jurisdictions

- Given the widely **distributed network of sources** involved in an NAD it must be **standards-based**
- The data products of distributed sources are brought together by **regional integrators**
- State and Federal stakeholders are address data consumers and some State and Federal stakeholders may be actively involved in aggregation of statewide data into a national database
- Local government workflows must be minimally disrupted to help ensure the success of the NAD

During the technical discussion, one of the key observations on an omission from this statement was the reference to the NAD as a “database.” Summit participants strongly believed that it should be conceived of as a “**system**” that operates over time to both construct and maintain the database.

Other technical and data tenets that were identified and discussed during this breakout included:

- The NAD should be developed so as to be **vendor neutral, and maximally interoperable**. At the same time, it was recognized that the process would benefit from appropriate vendor participation.
- The NAD should be designed and developed to be inherently multi-purpose and to support multiple use cases.
- Plan for and expect an **iterative approach that can begin with simplicity and the definition of minimum common elements**, and proceed to iteratively add additional capability/complexity over time.
- **Acknowledgement of known challenges such as the limitations of some systems** that may require access to address data (e.g. CAD/911) to handle more complex data structures (e.g., relational tables) and the consumption of web services.
- Given that the NAD involves a recurring “system” to ensure that data are regularly updated, **feedback mechanisms are needed so that data quality issues can be reported** and find their way to the source data originator/custodian.
- The NAD should be thought of as “**national system**” as opposed to a “federal system” that is owned and operated by the federal government.

Other aspects of the data and technology breakout discussion included:

- An initial enumeration of the data flows between the various levels of government that will ultimately be involved in the NAD (see diagram below). There was a clear and unanimous recognition that the **data flows up from local address authorities and data providers to state and Federal data aggregators**. In addition, it was identified that there needs to be a **critical data flow down from Federal and state users and aggregators so that feedback on data quality or data issues can be provided to local data originators**.

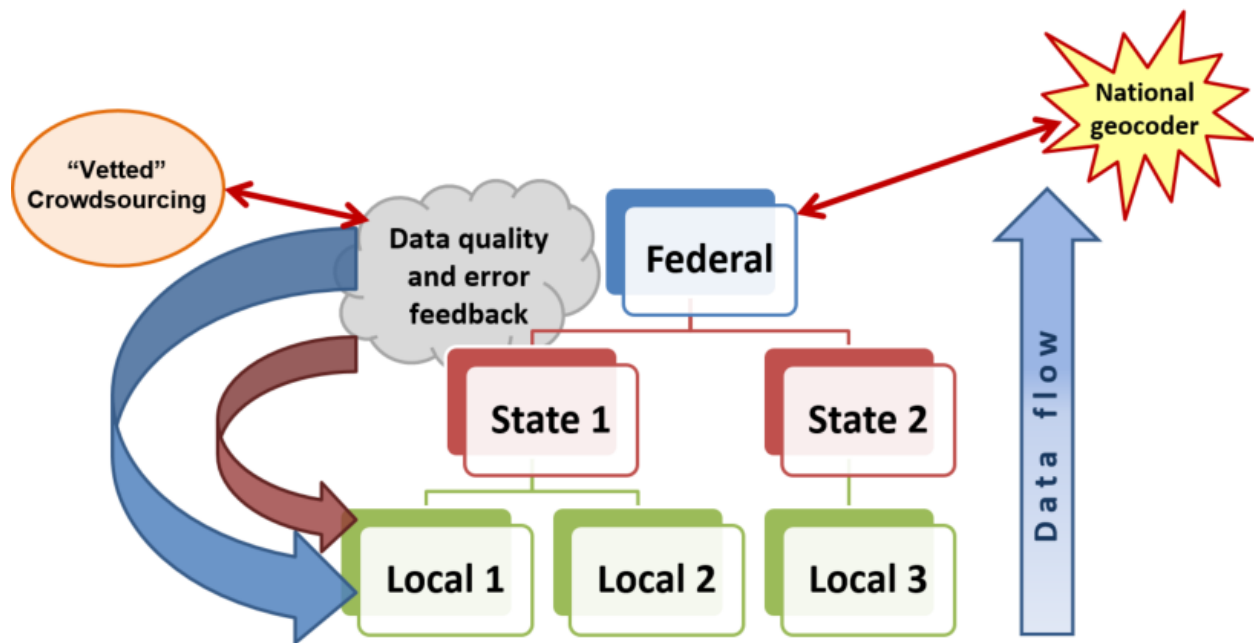

Figure 6. Potential feedback loop diagram. Please note, the terms “state” and “local” in the image above are generalizations that also encompass other forms of government including, but not limited to Tribal Nations, US Territories and the District of Columbia.

- Due to the multi-participant nature of a NAD, there needs to be a clear understanding of “ownership” and authority over the data. In short, someone using the NAD should be able to easily identify at least two pieces of information about an address:
 - Which jurisdiction has authority over the assignment of the address (i.e., which agency/entity/department assigned the address?)
 - Which agency/entity/department is responsible for creating and maintaining the database for the jurisdictional authority (i.e., the authority itself may, or may not be involved in the database management)

This information will help users fully understand the source and origin of the NAD data contents. This information is extremely important to know for two reasons:

- If there are any issues or errors identified with an address, then **users need to be able to identify which organization needs to be provided the feedback** (i.e., in the diagram above, the arrows leading “down” to the local tier).
- If there are any omissions in the data, for example a user finds an address that is not in the NAD, the user needs to know who to notify. This case may require a polygonal representation of jurisdictional boundaries so that a new address that may have a coordinate can be spatially linked to the jurisdiction which *appears* to have authority over that geography.

- There will be a strong **need to develop a unique address identifier or ID number**. Again, such an ID will be essential for a database that has this number of contributors and a high volume of change. The form and content of such an ID will likely require detailed technical planning to determine the best approach for the NAD. For example, there are a variety of approaches to creating globally unique ID numbers (GUID) which could fulfill this purpose.
- Given the scope of the NAD, as well as the existing Census Title 13 considerations, it is extremely likely that there will be some level of **privacy and security concerns from some stakeholders** and/or the public that will need to be addressed. The planning of the NAD should be cognizant of this likelihood and transparent in the strategy for potentially allaying these concerns.
- One near term initiative that would be useful to moving the NAD forward would be to **build a quick “national status map”** on addresses that are authoritative, publicly accessible, and multi-purpose. Such a resource would help articulate how close/far the NAD is from being completed, while also helping to readily advertise data availability and willing participants. To further emphasize the importance of address data, it will also be important to list entities that routinely create/acquire national address databases for proprietary, legal, and single-use purposes. This list will likely include Federal agencies (e.g., CFPB, Census, HUD, etc.) as well as private organizations (e.g., USPS, FedEx, UPS, Google, HERE, TomTom, etc.).
- Given the multi-participant nature of the NAD, there is a good opportunity to envision a variety of tools being developed/deployed to **assist in the common workflows and tasks** that all/many participants will encounter. Examples of potential tools include, but are not limited to:
 - Schema builders to begin address database creation
 - Change detection tools to identify if a data source is different from the last time it was accessed
 - ETL/translation/crosswalk tools to move data from one schema into different models or standards
 - Web-based tools to assist local agencies (particularly, less technically advanced ones) in curating their data (i.e., create, move and edit addresses)

The following presents some application principles that were identified during the tool discussion at the summit:

- Leverage existing tools whenever possible
- Tools should support interoperability
- When web based tools are involved, issues with access/connectivity, as well as security must be addressed

7 KEY POINTS OF AGREEMENT

Following the breakouts and through group discussions, Summit participants came to extremely broad agreement on **four key points** that can help guide the direction a NAD initiative may take:

- 1) **Local authorities are the authoritative source** for address assignment and are data set originators
- 2) **State authorities should be statewide aggregators of county and local data sets.** Indeed, many states are already in this role and have active statewide addressing initiatives that have often been catalyzed to support public safety and emergency response (e.g. NG911).
- 3) The United States is vast and complex and there are a variety of governmental entities that are not states. Governmental units such as **Tribal Nations, US Territories and the District of Columbia must be explicitly included in NAD data flows.** This may be particularly important on tribal lands where both the assignment authority and aggregators may differ depending on their location.
- 4) **Federal leadership and support is needed for there to be a sustainable national approach.** One key Federal role will be in helping to address the needs of “have nots” communities.

8 WHERE DO WE GO FROM HERE? NEXT STEPS.

One of the key discussions that took place at the Summit was group brainstorming on immediate, **actionable next steps** that can be pursued. The following listing is derived from that discussion:

8.1 SUGGESTIONS ON LEADERSHIP

Define and clearly articulate an overall leadership model. Identify who and which agencies are involved and who is leading the effort?

- Identify a **high-level Federal champion** to spearhead messaging and advocacy for moving the NAD forward. Two organizations indicated a willingness to take on championing the NAD:
 - USDOT Office of the Chief Information Officer
 - US Census Bureau's Geography Division
- In addition to a Federal champion, it is also important to identify **State, Local and Tribal Champions**. Indeed, the NAD will span a variety of levels of government and advocacy and support will be important from those user communities, including providing support for the Federal lead.
- As described above in the breakout discussion descriptions, moving forward on the NAD involves tackling some substantive issues at a detailed level. These kinds of issues include but are not limited to technology (e.g., aggregating approaches; globally unique identifier/GUIDs; etc.); standards; outreach/communication planning; governance details; etc. It was suggested that the formation of **multi-sector working groups to tackle key questions and components** of the NAD would be an important and productive step.
- At various junctures in the summit a *"Just do it!"* sentiment was expressed and endorsed by a variety of people. There seemed to be a sense that significant planning and activity already exists and that momentum is building. Fully understanding that proper planning is essential, the participants also recognized that movement and action should be prioritized. As such, there was strong encouragement that **work should commence in parallel and simultaneously on short, medium and long-term goals**; including rapid prototypes when feasible.
- Summit participants seemed encouraged and satisfied with the progress that was made at the Summit. In the spirit of continuing to build momentum, there was a suggestion that **the Summit, in some form, should be reconvened in 6-8 months to gauge progress**, continue the conversation and identify the next steps.

8.2 SUGGESTIONS ON APPROACH

- Capitalize on and continue to **build momentum** that was catalyzed by the Summit. At the Summit, numerous states (see pilot description below) said they were enthusiastic and "ready" to actively participate/coordinate with the Federal government in taking initial steps.

- Conduct a **more formal and thorough gap analysis** to more fully identify what resources are already in place, as well as what else is “needed” that does not yet exist.
- There is a new governmental unit within the General Services Administration (GSA) that is referred to as “18F”. This unit describes themselves as being charged with “Building the 21st Century Digital Government”. Further, the unit is described as “transforming government from the inside out, creating cultural change by working with teams inside agencies who want to **create great services for the public.**” Several of the Federal participants observed that “18F thinking” is on the minds of key Federal IT people, including within the current Administration. It was also observed that an initiative such as the NAD would potentially resonate with this kind of community and thinking. As such, there may be opportunities to reach out to **GSA and the 18F team** to make them aware of the NAD, and to gain guidance and support.
- Attempt to make a formal “NAD initiative” more real and prominent by crafting appropriate **branding and messaging** that will help inform and convince locals to participate, while also generating educational information and interest within the funding community (i.e., Federal agency leadership; Congress). Part of this approach is understanding that there may be “nay-sayers” with legitimate critiques that need to be addressed.
 - During the conference, several participants observed that the “National Address Database” and the NAD acronym were rather generic and didn’t convey a message. While nothing was decided, in order to explore the potential of a different brand several alternative names and acronyms were put forth including: **Standard Addresses for Everyone**, or **SAFE**.
- A key suggestion that was unanimously endorsed by Summit participants was to move forward by **conducting a pilot(s) to further document and validate the feasibility of an NAD initiative**. While initial brainstorming took place during the Summit, further discussions proceeded after the Summit and are reflected below.

First, there was a wide variety of willing states/jurisdictions that stepped forward and actively volunteered to participate in pilot efforts prior to any outreach. These states included: Arkansas, Arizona, Massachusetts, Montana, North Carolina, Ohio, Tennessee, Utah and Washington DC. In short, there is wide existing interest in a multi-jurisdictional pilot study.

During discussions it was identified that it would be **desirable to have a least two pilots** with one aimed at questions and issues that “Have” communities are facing, and another aimed at the different issues that “Have Not” communities are facing. The following identifies some of the issues that each of these two types of communities may be facing:

Pilot aimed at more technically advanced and experienced, aka “Have”, communities:

In “have” communities many of the questions are aimed at how to harvest, standardize and aggregate *existing address data* into larger units. Key questions that this type of pilot might examine include, but are not limited to:

- What kinds of state workflows are necessary to create state rollups of county/local based data?
- How can state rollups of county/local address data be identified as ready for “national harvesting”?
- What kind of “data harvesting” technology - including extract, transform and load (ETL) tools - is required for a national rollup? What kind of tools/technologies (commercial and open) are necessary for these tasks?
- Can a “minimum viable data model” be identified for a preliminary National Address Database? The goal of a pilot would be to keep the data model as reasonably simple as possible. The pilot might also explore the feasibility and approach for generating and maintaining a unique ID number as part of this data model.
- Can existing technologies/systems, such as OpenAddresses.io or “Community TIGER”, be used to demonstrate the potential for bringing disparate address data into a unified database? And, for providing a platform for regular data refreshes.
- Once assembled, how can the pilot database be refreshed/updated on a recurring basis?
- Can prototype tools (e.g., a national geocoder) be directed at the pilot database to show the potential of end-uses of the database?

Pilot aimed at less technically advanced and experienced, aka “Have not”, communities:

In “have not” communities many of the questions are aimed at how to get started and how to gain access to the technology and know-how for creating local address data. General approaches that this type of pilot might examine include, but are not limited to:

- Expedited methods for creating an initial, point-based address database for a community (e.g., small population counties or cities/towns). General approach may include obtaining an existing data source, such as TIGER, that includes address ranges and then obtaining address lists from various governmental databases (e.g., Motor Vehicles, Voter Registration, etc.) and then geocoding all addresses. This would create an initial, first draft “known addresses” database.
- Development and testing of tools that could be provided to communities that would enable them to improve their first draft database by:
 - Adding missing addresses
 - Correcting address information
 - Refining the location of geocoded points
- Working with the communities to help prepare them for making the data available for sharing with state/Federal address aggregators.

9 INITIAL FEEDBACK AND INPUT FROM OTHER GROUPS

9.1 NATIONAL STATES GEOGRAPHIC INFORMATION COUNCIL (NSGIC)

The National States Geographic Information Council (NSGIC) Address Committee requested a debrief on the initial findings from the Summit. Approximately 9 Committee members who participated in the debrief had also attended the Summit, so it was a good opportunity for input. There was **positive feedback on the Summit (e.g, the mix of people who participated) and the initial findings -- and, some helpful new suggestions and observations**, including the following:

- Military representation was missing, and addressing on military installations is an issue
- Tribal representation was very helpful, and “brought a lot to the discussion” on addressing issues
- Going forward, examine multiple use cases and user requirements -- “it’s about the use of the data, not just building it”
- Reach out to other groups (e.g., Health Care) besides Public Safety, although it was acknowledged that “NG911 is indeed a compelling use case”
 - But don’t burden locals with support for every use case
 - Think about “value added” up the supply chain
 - Strive for common elements, not all elements
- Given the wide variety of use cases, the standard setting/selection process needs to be disciplined and carefully documented. For example, in public safety use cases there may be a need for “multiple representations” of point locations for an address (e.g., front door; beginning of driveway, etc.)
- Guidance for locals on standards is important, and outreach to locals -- “addressing is ultimately done at the local level”
- A Unique ID “above and beyond” the address itself is needed

9.2 STATE DEPARTMENTS OF TRANSPORTATION AND THE GIS-T CONFERENCE

At the 2015 GIS for Transportation (GIS-T) Conference held in Des Moines, Iowa over the course of April 19 - 22, 2015, the USDOT had an opportunity to host a workshop that, among other topics also covered the NAD Summit. During this workshop a discussion with approximately 25 participants from a variety of state DOT organizations had an opportunity to hear and comment on some of the content and findings from the Summit. The bullets below summarize key elements of the GIS-T workshop discussion:

- State DOTs are concerned about having *primary* responsibility for address data collection and maintenance.

- Nevertheless, state DOTs definitely recognize the importance of addressing to their own organizations and other state agencies. Relevant quotes about the nexus between addressing and DOT work include (paraphrased):
 - “The addressing community is part of the DOT customer base”
 - “Addresses are the places people are going to on the roads.” In other words, roads don’t exist for their own sake. Rather, **the roads exist to get people to where they need to be, and most oftent those places are addresses of one sort or another.** Thus, the road network can be visualized as the infrastructure that connects addresses, and this has a tie in to detailed “origin-destination” information.
- State DOTs understand the opportunity that the Highway Performance and Monitoring System (HPMS) program represents given its extensive and regularly updated exchange of road information between the states and Federal government. There may be **parts of the HPMS program that could serve to support statewide addressing initiatives.** Such linkages may potentially require funding, and DOTs reiterated that “funded mandates” are acceptable and typical in DOT arena.
- Most state DOT representatives reiterated that they are **open to helping other agencies with address data creation and maintenance.** For example, many state DOTs have ongoing relationships with with local governments built around the exchange of roadway information. It may be possible to work with other entities to leverage and broaden these existing relationships with local governments to cover both address and road data sets.
- In the discussion it was also observed that **several states are already involved in collaborative efforts that cover both roads and addressing to some degree.** In Arkansas, Michigan and Utah the state DOT and the state GIS office are already collaborating on statewide roads, with address data connections. Indeed, there is great promise for further strong collaboration between state DOT and state GIS offices on both road and address data collection, aggregation and publication as statewide data sets.

10 CONCLUSION

In summary, the sponsor, BTS, and all participants were satisfied with the NAD Summit. There was **broad and sincere engagement** from all who attended as well as productive brainstorming, relationship building and collaboration. As documented earlier, there was also a palpable **sense of momentum building** and an emerging feeling that a “just do it” attitude should prevail. Such an attitude does not imply that important and detailed planning should not continue, rather it implies that **action and activity - beginning with embarking on pilot studies** - should accompany the discussions and planning. BTS determined that many additional steps beyond the BTS domain would be necessary to move forward, and encouraged the participants to work with their national partners to pursue the discussion. Many participants have continued these conversations in various forums, and as described earlier, there are hopes that a formal, follow-up session can be arranged to discuss progress and next steps sometime late in 2015, or early in 2016.

Appendix 1: Attendee List

<u>Type</u>	<u>Attendee</u>	<u>Representative</u>	<u>Email</u>
Federal	USDOT	Laurie Flaherty	Laurie.Flaherty@dot.gov
Federal	DHS	Mike Donnelly	Michael.Donnelly@hq.dhs.gov
Federal	FEMA	Nate Workman	Joseph.Workman@fema.dhs.gov
Federal	USPS	Jim Wilson	james.d.wilson@usps.gov
Federal	Census	Tim Trainor	timothy.f.trainor@census.gov
Federal	CFPB	Mike Byrne	Michael.Byrne@cfpb.gov
Federal	HUD	Jon Sperling	Jon.Sperling@HUD.GOV
Federal	EPA	David G. Smith	Smith.DavidG@epa.gov
Federal	FCC	Timothy May	Timothy.May@fcc.gov
Federal	DOJ	Marita Luby	marita.luby@ic.fbi.gov
State	Alabama	Philip Henderson	phillip.henderson@alea.gov
State	Arizona	Curtis Pulford	cpulford@azland.gov
State	Arkansas	Jonathan Duran	jonathan.duran@arkansas.gov
State	Colorado	Nathan Lowry	nathan.lowry@state.co.us
State	Delaware	Matthew Laick	Matthew.Laick@state.de.us
State	District of Columbia	Tim Abdella	Tim.Abdella@dc.gov
State	Maryland	Kenny Miller	ken.miller@maryland.gov
State	Massachusetts	Christian Jaqz	christian.jacqz@state.ma.us
State	Montana	Michael Fashoway	mfashoway@mt.gov
State	New Jersey	Andrew Rowan	andrew.rowan@oit.nj.gov
State	New York	Cheryl Benjamin	cheryl.benjamin@its.ny.gov
State	North Carolina	Joe Sewash	joe.sewash@nc.gov
State	Ohio	Jeff Smith	jeff.smith@ohio.gov
State	Rhode Island	Shane White	shane.white@doa.ri.gov

State	Tennessee	Andrew Griswold	andrew.griswold@tn.gov
State	Virginia	Dan Widner	dan.widner@vita.virginia.gov
Local/Regional	Franklin County, AL	Micheal Hughes	michael@virtualfranklincounty.org
Local/Regional	City of Yuma, AZ	Brian Brady	brian.brady@yumaaz.gov
Local/Regional	Washington County, AR	Daryl Pemberton	DPemberton@co.washington.ar.us
Local/Regional	Pueblo County, CO	Chris Markuson	markuson@co.pueblo.co.us
Local/Regional	Sussex County, DE	Mark Deao	mdeao@sussexcountyde.gov
Local/Regional	Washington County, MD	Joseph Rathvon	jrathvon@washco-md.net
Local/Regional	Town of Westwood, MA	Lynne Fielding	lfielding@townhall.westwood.ma.us
Local/Regional	Clark Cnty/City of Helena, MT	Jason Danielson	jdanielson@lccountymt.gov
Local/Regional	Morris County, NJ	Janice Peal	jpeal@co.morris.nj.us
Local/Regional	Tompkins County, NY	Greg Potter	gpotter@tompkins-co.org
Local/Regional	New York City, NY	Colin Reilly	creilly@doitt.nyc.gov
Local/Regional	Henderson County, NC	Stan Duncan	sduncan@hendersoncountync.org
Local/Regional	Stark County, OH	Brian Hall	bwhall@co.stark.oh.us
Local/Regional	Rhode Island DOT	Bill Lincourt	william.lincourt@dot.ri.gov
Local/Regional	Lexington County, SC and NGAC	Jack Maguire	jack.maguire.123@gmail.com
Local/Regional	Henry County, TN	Mark Archer	henrycoecd@gmail.com
Local/Regional	Albemarle County, VA	Damon Pettitt	dpettitt@albemarle.org
Tribal	Gila River Indian Community	Leslie Stovall	Leslie.Stovall@gric.nsn.us
Tribal	National Tribal Geographic Info Support Center	Garet Couch	gcouch@tribalgis.com
Private Sector	HERE	James Nenaber	james.nenaber@here.com
Private Sector	TomTom	Nathan Gile	Nathan.Gile@tomtom.com
Private Sector	Google	Aditya Gupta	adityagupta@google.com
Private Sector	UPS	Larry Wahl	lwahl@ups.com
Private Sector	Intrado	Bob Currier	bob.currier@intrado.com
Private Sector	Mapbox	Tom Lee	tlee@mapbox.com

Private Sector	GeoComm	Kathy Liljequist	kliljequist@geo-comm.com
Private Sector	MAPPS	Susan Marlow	Susan.Marlow@stantec.com
Non Profit	Open Address	Ian Dees	ian.dees@gmail.com
Non Profit	NAPSG	Peter O'Rourke	porourke@publicsafetygis.org
Non Profit	IAEM	Bruce Lockwood	lockwoodbruce@comcast.net
Non Profit	NENA	Ty Wooten	twooten@nena.org
Non Profit	NASNA	Scott Roper	sgroper@dpscs.state.md.us
Observers	FGDC	Ivan Deloatch	ideloatch@usgs.gov
Observers	NSGIC	Bill Burgess	william.burgess@comcast.net
Observers	USPS	Clayton Bonnell	CCBonnell@uspis.gov
Observers	GAO	Jessica Waselkow	waselkowj@gao.gov
Observers	GAO	Tina Torabi	torabit@gao.gov
Observers	USDOT	Richard McKinney	richard.mckinney@dot.gov
Observers	USDOT	Maria Roat	maria.roat@dot.gov
Observers	USDOT	Steve Lewis	steve.lewis@dot.gov
Observers	USDOT	David Winter	david.winter@dot.gov
Observers	USDOT	Tom Roff	thomas.roff@dot.gov
Observers	USDOT	Rolf Schmitt	rolf.schmitt@dot.gov
Observers	USDOT	Jamie Loughridge	jamie.loughridge@dot.gov
Observers	USDOT	Justyna Goworowska	justyna.goworowska@dot.gov
Observers	FCC	Haley Ramsauer	Haley.Ramsauer@fcc.gov
Observers	Census	Kaile Bower	kaile.h.bower@census.gov
Observers	Census	Stuart Irby	Stuart.C.Irby@census.gov
Observers	Census	Lynda Liptrap	lynda.a.liptrap@census.gov
Observers	Census	Brian Timko	Brian.Kevin.Timko@census.gov
Observers	DOJ	Tina Smith	Tina.R.Smith@usdoj.gov
Observers	TomTom	James Pardue	James.Pardue@tomtom.com

Observers	ESRI	Gary Waters	gwaters@esri.com
Observers	Michael Baker	Al Wainger	AWainger@mbakerintl.com
Observers	Spatial Focus	Martha Wells	mwells@spatialfocus.com
Observers	Lsi	Mary Brauer-Cox	mary.brauercox@lsi-gis.com
Observers	UPS	Jim Bloom	jimbloom@ups.com
Facilitator	AppGeo	Rich Grady	grady@appgeo.com
Facilitator	AppGeo	Micheal Turner	mgt@appgeo.com
Facilitator	AppGeo	Kate Hickey	khickey@appgeo.com
Facilitator	Lead Alliance	Tricia Gibbons	tgibbons@leadalliance.com

Appendix 2: Agenda & Speaker List

AGENDA

Purpose of the Summit: To identify and discuss possible options for developing a National Address Database (NAD).

Wednesday, April 8, 2015 (8:30 PM - 5:30 PM)

8:00AM Check-In

8:30AM Welcome & Summit Startup

Objective: Share status of the current state of address data and build a foundation for working together.

Welcome

Steve Lewis, U.S. Department of Transportation

Rolf Schmitt, U.S. Department of Transportation

Summit Overview & Purpose

Introductions, Ground Rules, & Opening Activity

State of Address Data: Review of Existing Conditions & Recent Developments

Ivan DeLoatch, Federal Geographic Data Committee

Richard McKinney, U.S. Department of Transportation

9:30AM Best Practices & Lessons Learned

Objective: Identify current and emerging best practices from diverse sectors

Sharing Best Practices - Short Talks

Jonathan Duran, State of Arkansas

Nathan Gile, TomTom

Ian Dees, OpenAddress

Colin Reilly, New York City

Garet Couch, National Tribal Geographic Info Support Center

Interactive Review/Summary

10:30AM ***15 MIN BREAK***

10:45AM Common Needs & Requirements

Objective: Identify common needs and understanding of minimum requirements.

Presentations & Group Discussion: What do people have?

Tim Trainor, U.S. Census Bureau

Tim May, Federal Communications Commission

Presentations & Table Group Discussions: What do people need?

Mike Byrne, Consumer Financial Protection Bureau

Cheryl Benjamin, State of New York

Debrief & Identify Minimum Requirements

12:30PM ***1 HOUR LUNCH***

1:30PM Known Challenges & Opportunities

Objective: Identify challenges and opportunities for developing a NAD

Moderated Panel Discussion: Key Challenges from Multiple Perspectives

Laurie Flaherty, U.S. Department of Transportation

Christian Jacqz, Commonwealth of Massachusetts

Jack Maguire, Lexington County, SC

Larry Wahl, United Parcel Service

Open Discussion with Participants

2:30PM Group Brainstorm: Key Implementation Questions

Objective: Identify the key implementation questions focusing on business justification, governance, partnerships, local outreach and communications to fill gaps, data and technology components

Critical Questions

Other Considerations

Prepare for Breakout Groups

3:00PM ***30 MIN BREAK***

3:30PM Breakout Groups: Session 1

Objective: Identify options for consideration

Topic A: Business Justification – Groups 1 & 2

Topic B: Leadership & Organizational Approaches – Groups 3 & 4

5:00PM Day 1 Wrap Up & Summary

5:30PM Adjourn Day 1

Thursday, April 9, 2015 (8:00AM - 4:00PM)

7:30AM Coffee & Conversation: Raggedy Start

8:00AM Breakout Session 1: Group Reports

Objective: Come to agreement on what's possible

Topic A: Business Justification - Group 1 & 2 Reports

Topic B: Leadership & Organizational Approaches - Group 3 & 4 Reports

Seeking Agreement

10:00AM Breakout Groups: Session 2

Objective: Identify options for consideration

Topic C: Local Outreach & Assistance - Groups 5 & 6

Topic D: Data & Technology - Groups 7 & 8

11:30AM ***1 HOUR LUNCH***

12:30PM Breakout Session 2: Group Reports

Objective: Come to agreement on what's possible

Topic C: Local Outreach & Assistance - Group 5 & 6 Reports

Topic D: Data & Technology - Group 7 & 8 Reports

Seeking Agreement

2:15PM Discussion: Where do we go from here?

Objective: Review agreements, decisions, and next steps

Actions & Decisions Moving Forward

Common Understanding of Issues / Components

Minimum Requirements on Which We Can Agree

Framing the Next Steps / Action Needed

3:15PM Wrap-Up Discussion

Communications & Elevator Messages

GUEST SPEAKERS

High Level Perspective

- **Ivan DeLoatch**, Executive Director, FGDC (Impact and perspective on GAO Report & SB740)
- **Richard McKinney**, Chief Information Officer, USDOT (Why USDOT's involvement in addressing?)

Best Practices

- **Jonathan Duran**, Addressing Lead, Arkansas Geographic Information Office (Rural state perspective)
- **Nathan Gile**, Project Manager, TomTom (Private sector perspective)
- **Ian Dees**, Founder, OpenAddress (Private non-profit/Crowdsourcing perspective)
- **Colin Reilly**, Sr. Director GIS, New York City (Big city perspective)
- **Garet Couch**, President, National Tribal Geographic Information Support Center (Tribal perspective)

Common Needs & Requirements

- **Tim Trainor**, Chief Geography Division US Census (Nationwide addressing program)
- **Tim May**, Analyst/Manager E911/NG911 projects, FCC (Influence over telcos/PSAPs)
- **Mike Byrne**, Operations Lead, Consumer Financial Protection Bureau (CFPB) (Demanding address consumer)
- **Cheryl Benjamin**, Addressing Lead, State of New York (Items to help statewide program)

Challenges & Opportunities

- **Christian Jacqz**, Director, MassGIS (Statewide program perspective)
- **Jack Maguire**, GIS Manager (retired), Lexington County, SC (Local government perspective)
- **Larry Wahl**, Director Package Project Management, UPS (Private sector perspective)
- **Laurie Flaherty**, Coordinator of National 911 Program, USDOT National Highway Traffic and Safety Administration (NHTSA), (Public safety perspective)

Appendix 3: The Importance of Address Data

The need and importance of a national address database has been well documented in existing resources (see Appendix 5: Bibliography of Other National Address Database Resources). Of particular relevance is “The Need for a National Address Database – Use Cases” published in 2014 by the National Geospatial Advisory Committee (NGAC).

The NGAC report provides a compelling argument for building a national address database as the basis for “essential services” with the public and private sectors.

“Street addresses are collected and used every minute of every day for emergency response; the consumption of commercial goods and services; mail and package delivery; public and private utility management; voting; taxation; licensing; financial lending and real estate transactions; road maintenance and transit services; market analysis; environmental stewardship; economic development and land use planning; and many other purposes.”³

The report goes on to demonstrate that at the federal level alone, addresses are needed to support daily workflows and tasks. The table below presents some of the federal use cases and represents only a fraction of the true need when other levels of government and sectors are considered.

Agency	Activity
Department of Transportation	Next Generation 911, construction design and notification, transportation planning
Federal Emergency Management Agency	Locating those impacted by disasters & critical infrastructure/assets
Department of Health and Human Services (including Centers for Disease Control)	Public health incident tracking, disease vector control and data-driven management of entitlement programs
Consumer Finance Protection Bureau	Home Mortgage Disclosure Act implementation
Census Bureau	Mailing Census forms, locating households for in-person visits, geocoding results
Social Security Administration	Providing Social Security payments
Department of Housing and Urban Development	Providing affordable housing, making sound and equitable land use and housing decisions, project notification

Figure 7. Sample Federal use cases for address data as presented in the NGAC 2014 report “The Need for a National Address Database - Use Cases”.

The discussion and findings from the Summit were predicated on the important body of work to date on the importance of address data.

³ National Geospatial Advisory Committee (NGAC). *The Need for a National Address Database – Use Cases*. 2014.

Appendix 4: The Complexity of Address Data

The following slides were presented during the NAD Summit to facilitate the discussion on address complexity. These slides demonstrate the the challenges with building a data model indended to capture and represent the variety of address use cases.

Addressing is more complex than it sounds

- Even a simple address point data set needs to handle multiple situations in a standard fashion
- Where do I put the points?
- How are the attributes structured?
 - To uniquely identify all addresses in all situations

National Address Database (NAD) Summit - 2015

Slide 25



Figure 8. Addressing is more complex than it sounds. Even a simple address point data set needs to handle multiple situations in a standard fashion.



Simplest case:
 One parcel, one structure, one address



Thanks MassGIS
 for the diagrams!



LOC_ID	ADDRPT_ID	FULL_ADDR
par1	MP1	1 CAMDEN WAY

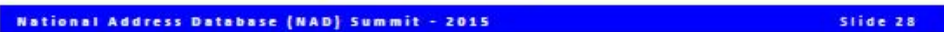
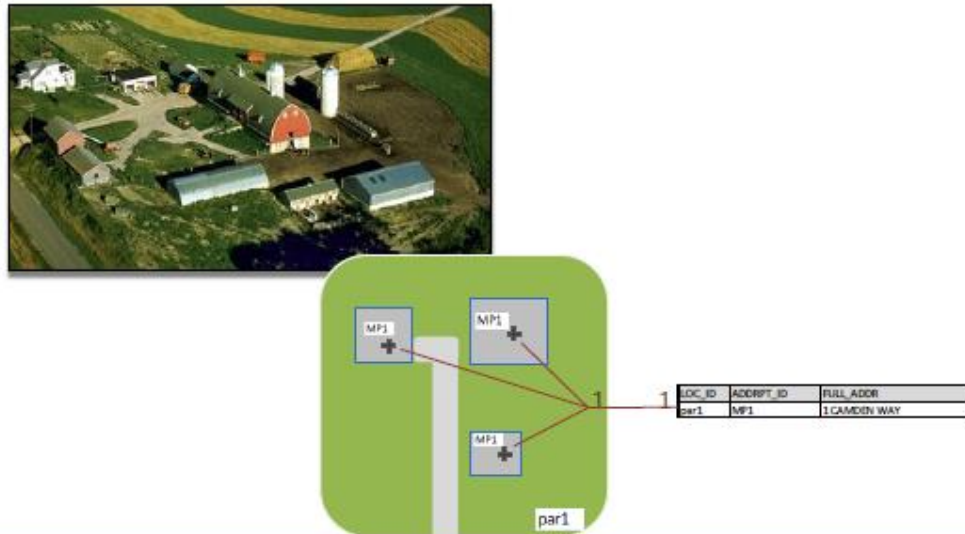

Figure 9. Commercial complexes can be complicated. The simplest case is one parcel, one structure, one address.

Another common case: Several structures, one address



National Address Database (NAD) Summit - 2015

Slide 29

Another common urban case: One building with many units

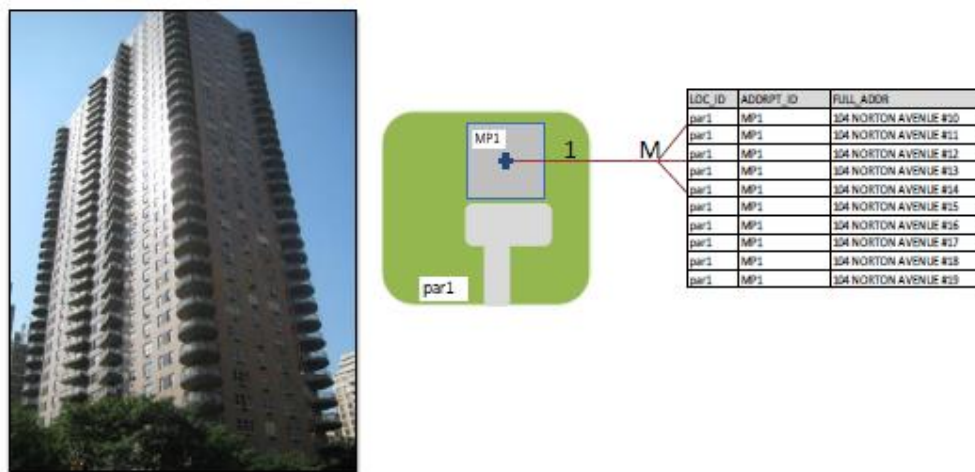

National Address Database (NAD) Summit - 2015

Slide 30

Figure 10. Other common cases include several structures with one address or one building with many units.

One building, multiple entries:
 This structure has three numbered addresses

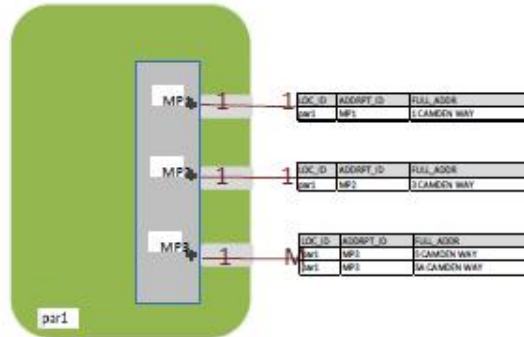

The Campus:
 "Site" with many structures, each must be named

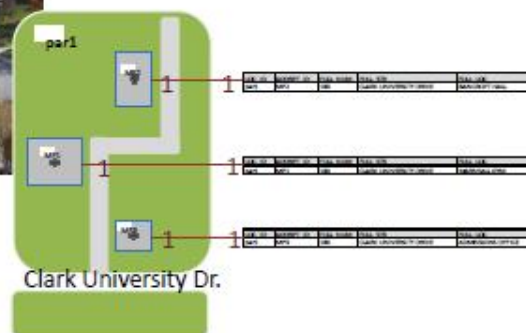

Clark University Dr.

Figure 11. Additional common cases include one building with multiple entry ways, or a campus site with many uniquely named structures.

Condo complex: “site” with many structures, each with multiple units

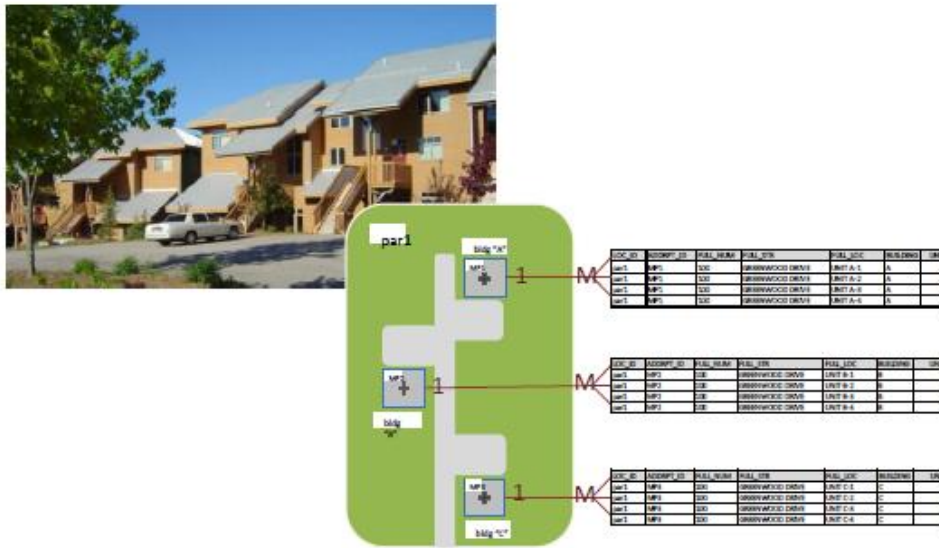

The tricky part



- This is not a one time deal
- Partners need to be in it for the long haul
- Continual improvement and maintenance
- Agree to standards
- Agree to sharing

Screen Shot 2015-04-07 at 9:16:47 AM.png

Having trouble viewing this?

MAR Data Load August 2014

TYPE	ADDRESSES	ALIASES	UNIT'S
NEW	215	225	42
UPDATED	164	237	8
DELETED	1	211	3
TOTALS	380	701	46
OVERALL	1127		

Dataset Numbers:

- Addresses: 144,628
- Residential Units: 215,000
- Aliases: 7,898
- Transactions: 18,445
- Blocks: 18,672
- Address / BSL Cross Reference: 242,229

Figure 12. The most challenging part is this must be continuously improved and maintained; Partners must be in it for the long term, agree to standards, and agree to sharing.

Appendix 5: Bibliography of Other National Address Database Resources

The following resources were compiled as “recommended reading” for attendees prior to the Summit:

National States Geographic Information Council (NSGIC). *Address Points for the Nation*. May, 2013.

National States Geographic Information Council (NSGIC). *A National Address Point Database Will Improve Government Services*. May 2014.

National States Geographic Information Council (NSGIC). *Report of Stakeholder Engagement*. April, 2014.

National Geospatial Advisory Committee (NGAC). *The Need for a National Address Database*. December, 2012.

National Geospatial Geospatial Advisory Committee (NGAC). *The Need for a National Address Database - Use Cases*. December, 2014.

National States Geographic Information Council (NSGIC). *This Isn't Private Information*. July, 2013.

US Census Bureau. *National Address Database: A Proposal for Creating and Maintaining the National Address Database for Use by All Levels of Government Including the Census Bureau's Statistical Programs and the 2020 Census*. July, 2013.

US Census Bureau. *2011 Census Address Summit Summary*.
http://www.census.gov/geo/gssi/2011_address_summit.html

US Census Bureau. *2013 Community Addressing Conference*.
http://www.census.gov/geo/gssi/add_conf.html

US Census Bureau. *Geographic Support System Initiative (GSS-I) Reports*.
<http://www.census.gov/geo/gssi/reports.html>

US Census Bureau. *Geographic Support System Initiative (GSS-I) Data Content Guidelines*.
<http://www.census.gov/geo/gssi/addgdln.html>

US Government Accountability Office (US GAO). *Geospatial Data - Progress Needed on Identifying Expenditures, Building and Utilizing a Data Infrastructure, and Reducing Duplicative Efforts*. February, 2015. (1 page summary)

US Government Accountability Office (US GAO). *Geospatial Data - Progress Needed on Identifying Expenditures, Building and Utilizing a Data Infrastructure, and Reducing Duplicative Efforts*. February, 2015. (full report)