

## FTA Low-Speed Urban Maglev Research Program: Updated Lessons Learned

NOVEMBER 2012

FTA Report No. 0026  
Federal Transit Administration

**PREPARED BY**

Roger Hoopengardner  
Science Applications International Corporation (SAIC)

Dr. Marc Thompson  
Thompson Consulting, Inc.



## COVER PHOTO

*MagneMotion, Inc. (MMI)*

## DISCLAIMER

*This document disseminated under the sponsorship of the U.S. Department of Transportation in the interest of information exchange. The United States Government assumes no liability for its contents or use thereof. The United States Government does not endorse products or manufacturers. Trade or manufacturers' names appear herein solely because they are considered essential to the objective of this report.*

# FTA Low-Speed Urban Maglev Research Program: Updated Lessons Learned

NOVEMBER 2012

FTA Report No. 0026

**PREPARED BY**

Roger Hoopengardner  
Science Applications International Corporation (SAIC)

Dr. Marc Thompson  
Thompson Consulting, Inc.

**SPONSORED BY**

Federal Transit Administration  
Office of Research, Demonstration and Innovation  
U.S. Department of Transportation  
1200 New Jersey Avenue, SE  
Washington, DC 20590

**AVAILABLE ONLINE**

<http://www.fta.dot.gov/research>

## Metric Conversion Table

SYMBOL	WHEN YOU KNOW	MULTIPLY BY	TO FIND	SYMBOL
<b>LENGTH</b>				
<b>in</b>	inches	25.4	millimeters	mm
<b>ft</b>	feet	0.305	meters	m
<b>yd</b>	yards	0.914	meters	m
<b>mi</b>	miles	1.61	kilometers	km
<b>VOLUME</b>				
<b>fl oz</b>	fluid ounces	29.57	milliliters	mL
<b>gal</b>	gallons	3.785	liters	L
<b>ft<sup>3</sup></b>	cubic feet	0.028	cubic meters	m <sup>3</sup>
<b>yd<sup>3</sup></b>	cubic yards	0.765	cubic meters	m <sup>3</sup>
NOTE: volumes greater than 1000 L shall be shown in m <sup>3</sup>				
<b>MASS</b>				
<b>oz</b>	ounces	28.35	grams	g
<b>lb</b>	pounds	0.454	kilograms	kg
<b>T</b>	short tons (2000 lb)	0.907	megagrams (or "metric ton")	Mg (or "t")
<b>TEMPERATURE (exact degrees)</b>				
<b>°F</b>	Fahrenheit	5 (F-32)/9 or (F-32)/1.8	Celsius	°C

REPORT DOCUMENTATION PAGE		Form Approved OMB No. 0704-0188	
Public reporting burden for this collection of information is estimated to average 1 hour per response, including the time for reviewing instructions, searching existing data sources, gathering and maintaining the data needed, and completing and reviewing the collection of information. Send comments regarding this burden estimate or any other aspect of this collection of information, including suggestions for reducing this burden, to Washington Headquarters Services, Directorate for Information Operations and Reports, 1215 Jefferson Davis Highway, Suite 1204, Arlington, VA 22202-4302, and to the Office of Management and Budget, Paperwork Reduction Project (0704-0188), Washington, DC 20503.			
1. AGENCY USE ONLY	2. REPORT DATE November 2012	3. REPORT TYPE AND DATES COVERED March 2009 - November 2012	
4. TITLE AND SUBTITLE FTA Low-Speed Urban Maglev Research Program: Updated Lessons Learned		5. FUNDING NUMBERS DTFT60-09-C-00006	
6. AUTHOR(S) Roger Hoopengardner, Science Applications International Corporation (SAIC) Dr. Marc Thompson, Thompson Consulting, Inc.			
7. PERFORMING ORGANIZATION NAME(S) AND ADDRESS(ES) Science Applications International Corporation (SAIC) 1710 SAIC Drive M/S T1-12-3 McLean, VA 22102		8. PERFORMING ORGANIZATION REPORT NUMBER FTA Report No. 0026	
9. SPONSORING/MONITORING AGENCY NAME(S) AND ADDRESS(ES) U.S. Department of Transportation Federal Transit Administration Office of Research, Demonstration and Innovation East Building 1200 New Jersey Avenue, SE Washington, DC 20590		10. SPONSORING/MONITORING AGENCY REPORT NUMBER FTA Report No. 0026	
11. SUPPLEMENTARY NOTES [http://www.fta.dot.gov/research]			
12A. DISTRIBUTION/AVAILABILITY STATEMENT Available from: National Technical Information Service (NTIS), Springfield, VA 22161. Phone 703.605.6000, Fax 703.605.6900, email [orders@ntis.gov]		12B. DISTRIBUTION CODE TRI-20	
13. ABSTRACT In 1999, the Federal Transit Administration (FTA) initiated the Low-Speed Urban Magnetic Levitation (Urban Maglev) Program to develop magnetic levitation technology that offers a cost-effective, reliable, and environmentally-sound transit option for urban mass transportation in the United States. Maglev is an innovative approach for transportation in which trains are supported by magnetic forces without any wheels contacting the rail surfaces. Maglev promises several attractive benefits, including the ability to operate in challenging terrain with steep grades, tight turns, all-weather operation, low maintenance, rapid acceleration, quiet operation, and superior ride quality, among others. This Urban Maglev program is essentially completed, and government program executives and managers desire a program review with an emphasis on lessons learned. The lessons learned in this report have been captured through a multi-faceted assessment of general project impressions, project execution, project conclusions and deliverables, project team performance, stakeholder participation, risk management, and project communications. The assessments are drawn from project documentation, discussions with the performing teams, and direct experience with the five Urban Maglev projects. This updated report provides lessons learned from the two projects that continued through 2011–2012.			
14. SUBJECT TERMS Low-speed urban magnetic levitation, maglev, urban mass transportation, lessons learned.		15. NUMBER OF PAGES 85	
16. PRICE CODE			
17. SECURITY CLASSIFICATION OF REPORT Unclassified	18. SECURITY CLASSIFICATION OF THIS PAGE Unclassified	19. SECURITY CLASSIFICATION OF ABSTRACT Unclassified	20. LIMITATION OF ABSTRACT

# TABLE OF CONTENTS

1	Executive Summary
3	Section 1: Introduction
4	Challenges in Low-Speed Urban Transit
5	Opportunities and Lessons Learned from High-Speed Maglev Programs
5	FTA Research Program Interests
7	Section 2: FTA Urban Magnetic Levitation Transit Technology Development Program
7	Three-Phase FTA Research Program
8	FTA Strategy for Implementing the Program
8	Independent Review Process and Periodic Performance Milestones
9	Section 3: Major Contributions from the Individual Urban Maglev Projects
9	MUSA (CHSST)
10	Colorado Department of Transportation (CDOT)
11	Maglev 2000
11	MagneMotion, Inc.
12	General Atomics
14	Section 4: Summary of Lessons Learned
14	General Project Impressions
14	MUSA
14	CDOT
15	Maglev 2000
15	MagneMotion, Inc.
15	General Atomics
16	Project Execution
16	Project Conclusions and Deliverables
17	Project Team Performance
18	Stakeholder Participation
19	Risk Management
19	Project Communications
20	Project Summaries and Lessons Learned
20	MUSA
20	CDOT
21	Maglev 2000
21	MagneMotion, Inc.
25	General Atomics

29	Section 5: System Cost Estimates
29	MMI System
30	General Atomics System
32	Appendix A: Brief Overview of Magnetic Levitation Technologies for Low-Speed Urban Transportation
34	Appendix B: FTA Urban Maglev Project Descriptions
61	Appendix C: MagneMotion Maglev M3 Cost Model

## LIST OF FIGURES

10	Figure 3-1:	Interstate 70 Route Alignment
12	Figure 3-2:	MMI I/7-Scale Low-Speed Prototype Showing Vehicle, Guideway, and Propulsion Coils
22	Figure 4-1:	MagneMotion Sled Mid-Test at Its Facility in Devens, MA
23	Figure 4-2:	MagneMotion System Installed on Guideway at ODU
24	Figure 4-3:	Magnetic Switch Concepts
30	Figure 5-1:	Dual Elevated Guideway – 12,000 pphpd
35	Figure B-1:	CHSST Maglev Rail and Module Cross-Section
36	Figure B-2:	CHSST Maglev Guideway
38	Figure B-3:	Interstate 70 Route Alignment
39	Figure B-4:	Precast Concrete U-Girder
39	Figure B-5:	Tubular Steel Space Truss
40	Figure B-6:	Proposed U-Girder for Colorado
40	Figure B-7:	Colorado 200 Vehicle
43	Figure B-8:	Vehicle on Guideway
43	Figure B-9:	Cross-section of Maglev Guideway Magnet System
44	Figure B-10:	Vehicle Permanent Magnets In Containers
44	Figure B-11:	Basic Two-Way Guideway Structure
45	Figure B-12:	Guideway Levitation/Propulsion Modules
45	Figure B-13:	Maglev Vehicle
46	Figure B-14:	Vehicle Chassis
50	Figure B-15:	Guideway Beam Designs: Hybrid and Steel
50	Figure B-16:	Cutaway Views of Preliminary Vehicle Design
51	Figure B-17:	Magnet-pod Suspension System
54	Figure B-18:	Schematic of Maglev 2000 Guideway
55	Figure B-19:	Maglev 2000 117-Ft Vehicle
55	Figure B-20:	Maglev 2000 Vehicle Internal Layout
56	Figure B-21:	Arrangement of Multiple Quadrupole Magnets on Maglev 2000 Vehicle
68	Figure C-1:	Dual Elevated Guideway – 3,000 pphpd
69	Figure C-2:	Dual Elevated Guideway – 6,000 pphpd
69	Figure C-3:	Dual Elevated Guideway – 12,000 pphpd



## LIST OF TABLES

29	Table 5-1:	MMI Cost Estimate for Dual Elevated Guideway 12,000 pphpd System
31	Table 5-2:	GA Cost Estimate for a 12,000 pphpd System
37	Table B-1:	Summary of System Characteristics (MUSA/CHSST)
38	Table B-2:	Contractor Estimated Costs
41	Table B-3:	Summary of System Characteristics (CDOT)
42	Table B-4:	Preliminary System Level Construction Costs
47	Table B-5:	Summary of System Characteristics (GA)
48	Table B-6:	Vehicle Capacity and Vehicle, Station, and Guideway Costs
48	Table B-7:	Costs for Electric System over 8.3 Miles (13.3 km)
52	Table B-8:	Summary of System Characteristics (MagneMotion)
53	Table B-9:	Guideway Costs per Two-way Mile
53	Table B-10:	Other System Costs per Two-way Mile
57	Table B-11:	Summary of System Characteristics (Maglev 2000)
58	Table B-12:	Guideway Cost Breakdown
59	Table B-13:	Vehicle Cost Breakdown
59	Table B-14:	Fixed Facility Cost Breakdown
60	Table B-15:	Operation and Maintenance Cost Breakdown
68	Table C-1:	M3 System Cost as a Function of Capacity and Station Spacing
70	Table C-2:	Dual Elevated Guideway – 3,000 pphpd
70	Table C-3:	Dual Elevated Guideway – 6,000 pphpd
71	Table C-4:	Dual Elevated Guideway – 12,000 pphpd

## FOREWORD

In 1999, the Federal Transit Administration (FTA) initiated the Low-Speed Urban Magnetic Levitation (Urban Maglev) Program to develop magnetic levitation technology that offers a cost-effective, reliable, and environmentally-sound transit option for urban mass transportation in the United States. Maglev is an innovative approach for transportation in which trains are supported by magnetic forces without any wheels contacting the rail surfaces. Maglev promises several attractive benefits, including the ability to operate in challenging terrain with steep grades, tight turns, all-weather operation, low maintenance, rapid acceleration, quiet operation, and superior ride quality, among others. For urban alignments, maglev potentially could eliminate the need for tunnels and noise abatement, resulting in significant cost savings. Five projects were selected for funding under the Urban Maglev program—General Atomics Urban Maglev Project; Maglev 2000 of Florida Corporation; Colorado Department of Transportation; Maglev Urban System Associates of Baltimore, MD; and MagneMotion, Inc.

The Urban Maglev program has used its allocated funding, and government program executives and managers desire a program review with emphasis on lessons learned. In 2009, a Lessons Learned Report, FTA-DC-26-7260-2009.01, was completed under contract DTFH61-06-D-00005. This updated report presents a summary of the lessons learned from each of the five projects and the program in general. It has been updated to reflect additional lessons learned as a result of continued work by General Atomics and MagneMotion, Inc., through the 2011–2012 timeframe. The lessons learned have been captured through a multi-faceted assessment of general project impressions, project execution, project conclusions and deliverables, project team performance, stakeholder participation, risk management, and project communications.

## ACKNOWLEDGMENTS

This report represents the final report submitted to the Federal Transit Administration under this contract DTFT60-09-C-00006.

The authors wish to thank Mr. Marcel Belanger, FTA Program Manager, and Mr. Walter Kulyk, Director, Office of Mobility Innovation at FTA, for their support of this work.

## EXECUTIVE SUMMARY

In January 1999, the Federal Transit Administration (FTA) published a notice in the *Federal Register* announcing the creation of the low-speed Urban Magnetic Levitation (UML) Transit Technology Development Program. This program is essentially completed, and government program executives and managers desire a program review with an emphasis on lessons learned. The lessons learned are captured through a multi-faceted assessment of the following categories: general project impressions, project execution, project conclusions and deliverables, project team performance, stakeholder participation, risk management, and project communications. The assessments are drawn from project documentation, discussions with the performing teams, and direct experience with the UML projects. Direct and indirect contributors include Dr. Marc Thomson, Mr. Frank Raposa, Mr. George Anagnostopoulos, Dr. Gopal Samavedam, Mr. Roger Hoopengardner, and Dr. David Keever.

The overall objective of FTA Low-Speed Urban Magnetic Levitation Program was to develop magnetic levitation technology that offered a cost-effective, reliable, and environmentally-sound transit option for urban mass transportation in the United States. Maglev is an innovative approach for transportation in which trains are supported by magnetic forces without any wheels contacting the rail surfaces. Maglev promises several attractive benefits, including the ability to operate in challenging terrain with steep grades, tight turns, all-weather operation, low maintenance, rapid acceleration, quiet operation, and superior ride quality, among others. Maglev typically is unmanned and operates on elevated guideway, although it can also operate at ground level or in tunnels if advantageous. For urban alignments, maglev potentially could eliminate the need for tunnels for noise abatement, resulting in significant cost savings. The FTA UML projects selected for funding were:

- The General Atomics Urban Maglev Project (General Atomics, San Diego, CA, as the lead company) was developing a system based on permanent magnets.
- Maglev 2000 of Florida Corporation was to establish the feasibility of a superconducting electrodynamic suspension (repulsive force) technology based on concepts from renowned electromagnetism scientists Drs. Gordon Danby and James Powell.
- The Colorado Department of Transportation partnered with Sandia National Laboratories, Colorado Intermountain Fixed Guideway Authority, and Maglev Technology Group, LLC, for the development of a low-speed maglev to link Denver International airport with Vail, about 140 miles away.
- Maglev Urban System Associates of Baltimore, MD, explored the viability of bringing to the United States a Japanese-developed low-speed maglev technology that has undergone more than 100,000 kilometers of testing.
- MagneMotion, Inc., was exploring the development of a key maglev technology for implementation in transportation systems serving traffic-

congested urban areas. A principal element of the MagneMotion urban maglev system was the use of the company's linear synchronous motor technology to propel bus-sized vehicles that can operate with short headway under automatic control.

The major findings from the lessons learned assessment are:

- The FTA urban maglev program has demonstrated that low-speed magnetic levitation systems are advanced enough to merit consideration as system alternatives in the United States, but the initial infrastructure costs and availability of safety and operationally-certified maglev technologies are intimidating. The efforts taken under this program have shown that low-speed maglev is feasible, but the results of multiple projects have indicated that substantial up-front costs exist.
- Most large urban areas in the United States have already invested in some type of mass transit system (subway or light rail), and urban maglev poses a fundamental change in technology that is viewed as being a major risk that is cost-prohibitive and incompatible with existing assets by transit agencies and investors.
- The lack of an actual system in place to demonstrate the projected savings in maintenance and operation costs contributes to a reluctance to embrace the technology. Systems under development in Japan and China may help demonstrate savings in the future.

The principal lesson learned from the perspective of the overall project execution was that, as with most research efforts, there will be unexpected challenges and obstacles during the course of the projects. Each project team identified different challenges, such as gaining cooperation with State, city, and local stakeholders for alignment issues; obtaining details on already-operating systems that were not considered proprietary; and underestimating the technical challenges of super-cooling magnets.

# Introduction

In January 1999, the Federal Transit Administration (FTA) published a notice in the Federal Register announcing the creation of the Urban Magnetic Levitation (UML) Transit Technology Development Program. The Transportation Equity Act for the 21st Century (“TEA-21”) authorized FTA to “support further development of magnetic levitation technologies for potential application in the U.S. mass transit industry.”<sup>1</sup> This authorization provided funds for FTA to oversee a research and development (R&D) program for low-speed magnetic levitation (maglev) technology, while the Federal Railroad Administration (FRA) continued to examine the application of magnetic levitation to a high-speed application between cities, an effort that had been under way in that agency for a number of years. The overall objective of FTA’s program was “to develop magnetic levitation technology that is a cost-effective, reliable, and environmentally-sound transit option for urban mass transportation in the United States.”<sup>2</sup> FTA organized its program to be conducted in three progressive phases: evaluation of proposed system concept, prototype subsystems development, and system integration and deployment planning. Based on the performance of researchers in each phase, FTA would authorize work to continue to the next phase. This program structure encouraged a competitive environment for participants in each phase of the UML, but also required performance-based independent assessments for the participants to advance.

For this program, FTA selected five project teams (out of 10 submissions) to work in Phase I of its Urban Low-Speed Maglev Program. A team led by General Atomics (GA) began its work in July 2000 on a system that it proposed for deployment at California University, Pennsylvania. A team from Sandia National Laboratory and the Colorado Department of Transportation (CDOT) looked at a new propulsion technology that could be applied to urban, or low-speed, maglev in the Denver area. Maglev 2000, Inc., evaluated the possibility of using superconducting quadrupole magnets as a modification to the original ideas for propulsion and levitation put forth by renowned electromagnetism scientists Drs. Gordon Danby and James Powell. The fourth team, Magnetic Urban Systems Associates, a consortium of Japanese and U.S. experts, examined the possibility of modifying the current Japanese low-speed maglev system for operation in the United States. A fifth Team, MagneMotion, Inc., examined a prototype system using linear synchronous motor propulsion and teamed with Old Dominion University for possible deployment of a prototype system at that campus. All of these projects focused their efforts in four main areas:

---

<sup>1</sup>*Federal Register*, Friday, January 29, 1999, Vol. 64, No. 19, Notices, p. 4772.

<sup>2</sup>*Ibid.*

- **Systems Studies** – The main effort of this task was to develop a system concept definition for a preferred urban maglev technical approach.
- **Base Technology Development** – This effort was to use state-of-the-art design and computational tools to identify and resolve technical risks associated with the selected technical approach.
- **Route-Specific Requirements** – This task evaluated key technical issues with respect to topographically varied alignments, if specific alignments have been identified.
- **Preliminary Design for a Full-Scale System Concept** – This effort focused on the development of a full-scale maglev system concept that includes a vehicle, guideway, and alignment based on the system concept definition. System performance was also to be estimated during this task and would include the development of some system prototype elements.

## Challenges in Low-Speed Urban Transit

While magnetic levitation trains are under development in other parts of the world, those systems are primarily high-speed test environment systems where speeds reach in excess of 250 miles per hour. Of those high-speed magnetic levitation systems, Germany and Japan have been considered to be most successful in the use of the maglev concept. Recent operation of the Shanghai Airport-to-Pudong magnetic levitation system can be classified as a variant of the German Transrapid production system.

Urban maglev faces a much different set of operating circumstances than high-speed magnetic levitation systems, and the successful introduction of such a system to an urban environment presents different challenges. Some of the challenges faced by urban maglev include the following:

- Speeds in an urban environment will normally be much slower than those required for the high-speed systems due to the short distances between stops. Urban maglev should only need to achieve a maximum speed of about 100 mph.
- Obtaining rights-of-way in an urban area will always be very challenging. Some of the planned high-speed systems will run near already-cleared train track rights-of-way, but in an urban environment such already-cleared areas may not be available.
- U.S. safety standards are, in many instances, much more demanding than standards in other countries. Adapting a foreign system to run in the United States will require careful scrutiny of all safety requirements to determine if it is economically feasible to actually adapt the system.

## Opportunities and Lessons Learned from High-Speed Maglev Programs

As noted earlier, high-speed systems are in operation in several other countries, and the United States has been pursuing its own high-speed maglev options through a program administered by FRA. That program focused on higher speeds (> 200 mph) over much longer distances than envisioned for urban maglev. FRA down-selected from its original list of proposals to two proposed systems in Pennsylvania and Maryland, and those two systems have not progressed forward primarily due to a lack of available funds from the U.S. Government. Some lessons learned from that FRA program include that:

- The American public seems inclined to like the maglev concept, as long as the system is not in their area.
- Finding segments of line on which it is possible to attain speeds of more than 200 mph has proven to be a challenge. That may be because the high cost per mile (estimates range from \$75 million to \$125 million per mile) of these systems makes it difficult to propose really long stretches of guideway.
- The need for tight tolerances on the guideway drive the cost per mile up. Large levitation gaps, a characteristic of some of the maglev technologies, may help reduce that cost since the same level of precision in construction and manufacture that is required for smaller gaps is not necessary.

## FTA Research Program Interests

In its original announcement of the Low-Speed Urban Maglev Program, FTA articulated the following technical objectives:

- (1) *Develop a base of knowledge on urban maglev low-speed technology supportive of eventual deployment, including a full system design and advanced technology hardware development and demonstration;*
- (2) *Enhance one or more of the ... critical maglev subsystems using advanced technologies ...;*
- (3) *Integrate a Maglev system design, including fleet operations, safety, inter-vehicle communications and control systems, and subsystems integration;*
- (4) *Evaluate and optimize a full scale demonstration system; and*
- (5) *Demonstrate low speed magnetic levitation technologies ...<sup>3</sup>*

A by-product of the work conducted under this program would also provide valuable lessons learned that could not only be applied to other maglev system

---

<sup>3</sup>*Ibid.*

ideas, but also be of benefit to all transit agencies, regardless of an agency's configuration.



SECTION  
2

# FTA Urban Magnetic Levitation Transit Technology Development Program

## Three-Phase FTA Research Program

The original FTA development program was designed to provide a three-phased flexible approach that would accommodate various concepts for designing, developing, or demonstrating maglev systems that would be appropriate for urban environments. As such, the program was created with a three-phased structure:<sup>4</sup>

- **Phase I – Evaluation of Proposed System Concept.** In this phase, FTA expected participants to prepare a) a projection of overall system performance and a preliminary design for the proposed full-scale demonstration system, b) documentation of all assumptions and methodology used to project and estimate the system performance, c) identification and analysis of key risk elements, and d) a “letter of interest” from a potential end-user.
- **Phase II – Prototype Subsystem(s) Development.** In this phase, participants were expected to complete the development of proposed advanced technology portions of their overall maglev system design. Anticipated activities in this phase included a) completion of a functional specification of the prototype advanced technology subsystem(s), b) completion of advanced technology hardware subsystems where improvements are proposed and warrant prototypes for testing and verification, c) demonstration of advanced technology hardware subsystems, and d) a commercialization plan with potential end-user involvement.
- **Phase III – System Integration and Deployment Planning.** In this phase, funding recipients were expected to integrate the completed advanced technology portions of their proposed design to create an overall urban maglev system. Expected activities for this phase were a) completion of functional specifications for a full-scale demonstration system, b) full-scale computer modeling and simulation to demonstrate and verify system operations, c) identification of a specific deployment site, and d) an Environmental Assessment for that site.

FTA allowed each participant team to propose its own schedule and milestones. Each team was also required to develop a project implementation plan with specific milestone dates that coincided with billing dates from the recipients.

---

<sup>4</sup>Elements of this program are paraphrased from the *Federal Register* announcement.

This allowed FTA to monitor progress of the efforts and provide a basis for the funding payments. When requested, FTA provided assistance in the development of these plans.

As programs reached logical milestones that would signal the transition point from one phase to the next, FTA required an independent review of the program and a formal decision on whether the recipient would be allowed to move to the next phase. Given the nature of research and development work, it was fully anticipated that some programs would not be allowed to continue on into the next logical phase because the recipient had not completed all of the expected steps. This allowed FTA to focus funds on teams that were making technical progress and to ensure that the available funds were allocated as effectively as possible.

## FTA Strategy for Implementing the Program

In selecting awardees for this program, FTA attempted to select a wide variety of approaches and ideas to ensure that all feasible approaches were considered. One of the teams selected (Maglev 2000, Inc.) was a team from the FRA high-speed program that was not selected by FRA for further funding, and this allowed the team to explore its ability to adapt and leverage the work it had already begun in the high-speed program. Two other teams (CDOT and MUSA) explored the idea of exploiting and adapting foreign technologies for use in the United States. Two teams proposing the use of superconducting technology (General Atomics and Maglev 2000) were selected to ensure that superconducting technology was evaluated and considered (a directive in the SAFETEA-LU legislation). And finally, teams proposing novel integration of key components (GA and MagneMotion) were selected to ensure that all unique ideas were considered. It was expected that some of these recipients would not move forward in the process, but the work they did complete would advance the state of knowledge in the maglev arena.

### Independent Review Process and Periodic Performance Milestones

For all of the selected programs, FTA initiated an independent review process with quarterly or milestone reviews. FTA used FTA staff members and contracted subject matter experts to assist in these reviews and to assist FTA in monitoring the progress of each program. These reviewers were also used to assist teams in the development of their project implementation plans and helped FTA ensure that these plans were being followed.

SECTION  
**3**

## Major Contributions from Individual Urban Maglev Projects<sup>5</sup>

Major contributions from each of the projects can be assessed by a number of factors, including:

- Technical insights (as described in technical memoranda)
- Technical demonstrations/prototypes
- Patents or patent pending
- Publications (referred technical journals, journals, others)
- Conference presentations (other than specific FTA-sponsored conferences)
- Stakeholder involvement

These criteria form the basis for the following summaries of the major contributions by project.

### MUSA (CHSST)

Earthtech in Baltimore assembled a team called MUSA with Chubu High-Speed Surface Transport (CHSST) as one of the subcontractors. MUSA adopted CHSST technology as the basis for its maglev system. The CHSST maglev system has been in development in Japan for more than 25 years and has evolved through several progressively more practical forms. Fundamentally, the CHSST maglev uses electromagnetic attractive forces between simple dual-pole magnets (analogous to two facing horseshoe magnets) to provide both levitation and guidance. With this technology, there are substantial technical documents that highlight the findings and modifications proposed by MUSA.

The CHSST technology is a matured technology currently deployed in revenue service in Japan. MUSA focused more on the application of the CHSST vehicle than on improvements in performance and cost reduction, redesigning the vehicle interior to accommodate Americans with Disabilities Act (ADA) requirements. Potential fire and smoke issues were also adequately addressed, as were egress and crashworthiness issues. By and large, the MUSA report presents a straight summary of the technical work developed by the Chubu HSST.

MUSA did not specify any specific route, nor did it generate sufficient interest among transit authorities. No deployment plans were developed. While the CHSST technology for low-speed maglev has many positive attributes and a

---

<sup>5</sup>This section draws from the FTA report "Comparative Analyses of FTA Urban Maglev Project," March 2004.

proven record of operation under deployment in Japan, MUSA has not exploited this technology for potential introduction in the United States. MUSA also did not add any significant improvements or innovation to the CHSST technology.

MUSA was not able to demonstrate its technology, conducting only comparative, analytic studies instead. These comparative studies were hampered by the substantial difference in regulatory and safety requirements, among others, between U.S.- and Japan-based urban transit systems.

## Colorado Department of Transportation (CDOT)

This project focused on the application of maglev technology along the I-70 route in Colorado, which connects Denver International Airport to Eagle County, covering a distance of about 140 miles. This particular alignment was appealing to the project team since it combined urban, steep terrain, and all-weather operating conditions. The following major subcontractors jointly performed this project:

- Colorado Department of Transportation
- Maglev Technology Group (MTG)
- Sandia National Laboratories (SNL)
- T. Y. Lin

The Interstate 70 alignment being considered by the CDOT team members is shown in Figure 3-1. This route has steep gradients and is challenging for any mode of transportation.

**Figure 3-1**  
Interstate 70  
Route Alignment

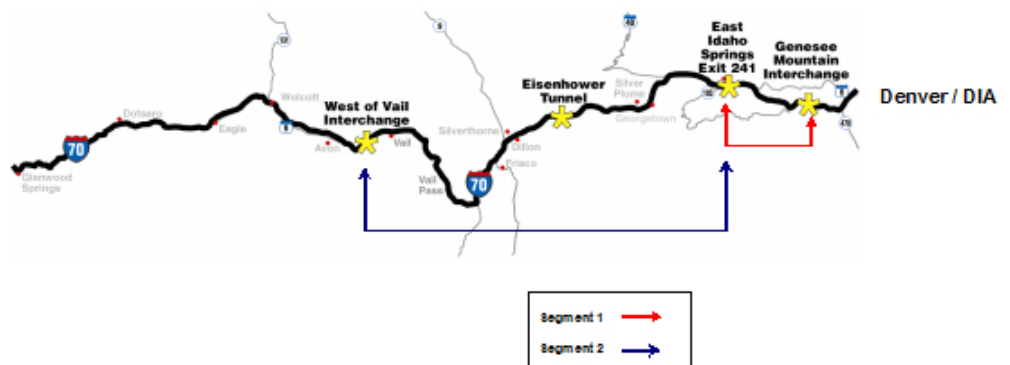

The CDOT team made useful contributions to the technology. The linear induction motor's design was improved to achieve higher propulsion power, providing improved grade climbing capability and a peak speed of >160 kph. A large number of technical reports, produced by the team partner at Sandia, documented much of the design, testing, and development of this motor. A subscale testing facility was developed at SNL to confirm design concepts and calibrate initial performance, although a full-scale motor model was never

developed. Several patentable concepts were developed; however, it is uncertain if any formal patent applications were made.

Another significant improvement proposed by the CDOT team was in the guideway design. The proposed guideway looks better aesthetically and is also significantly less expensive. This could result in a comparatively economical maglev system, but further evaluation via testing a full-scale guideway will be required to verify the benefits of the guideway concept.

The CDOT team made several presentations of its project to the research community. In the area of the motor design, several internal SNL seminars and discussions were offered. Professional (symposium) publications were produced as well.

Although CDOT is a very progressive organization for public participation, no public meetings of the urban maglev concept were held due to the immaturity of the concept and the fact the project was not on the metropolitan planning organization's (MPO) long-range plan. This contributed to the lack of progress, and the concept has not made any substantial progress.

## Maglev 2000

Maglev 2000 was a company incorporated in Titusville, Florida. Drs. James Powell and Gordon Danby, the early inventors of superconducting maglev systems based on null flux levitation, were principal members of the technical team of Maglev 2000. The Maglev 2000 system was designed for high-speed operations (~ 300 mph) and has been adapted to operate between 30–120 mph for low-speed urban transportation.

Maglev 2000 initially conceptualized its system for high-speed, long-distance application using a system similar to one that was developed (but has not yet been deployed due to costs and other reasons) in Japan over the last three decades. When it was not selected for FRA funding, Maglev 2000 altered its concept and proposed a similar system for low-speed maglev. Maglev 2000 made no specific innovation under the FTA project, nor was a reasonable design produced for low-speed test and applications.

## MagneMotion, Inc.

The MagneMotion, Inc. (MMI) system was developed by a team of scientists and engineers led by Dr. Richard Thornton in Devens, MA, and focused on levitation and propulsion with subcontract support from Earthtech and others for guideway structures. The MagneMotion maglev vehicles were smaller than some other system approaches and are planned to be operated in platoons to achieve the high capacity of ~ 12,000 passengers per hour per direction (pphpd) specified in the requirements document developed by FTA.

MagneMotion made an important innovation when it increased the magnetic and mechanical gap of the electromagnetic suspension EMS by using permanent magnets and controlling the gap by using coils. The magnetic and mechanical gaps are almost twice those achieved by the German Transrapid and the Japanese HSST, which should have a significant impact on the cost of the system. MMI demonstrated the levitation and propulsion of its system using a 1/7-scale model in the laboratory, which is pictured in Figure 3-2. As a result, it was selected for additional funding by FTA. Additional lessons from that follow-on work are reported later in this document.

**Figure 3-2**

*IMMI 1/7-Scale  
Low-Speed Prototype  
Showing Vehicle,  
Guideway, and  
Propulsion Coils*



## General Atomics

San Diego-based General Atomics (GA), along with its subcontractors, developed a low-speed maglev system initially with the idea of demonstrating the system at California University in Pennsylvania and later introducing the system as a circulator in downtown Pittsburgh. This alignment, however, would require substantial revisions and revisiting given the age of the alignment data. GA had identified the maglev requirements systematically, based on the route in Pittsburgh, resulting in a system requirement document that was the basis for a more generic document applicable to all urban maglev systems.

This program would have represented the world's first full-scale application of permanent magnet maglev technology for use in urban transportation systems. The technology adopted by General Atomics uses permanent magnets on the vehicle arranged in a Halbach array for "passive" EDS levitation. (See Appendix B for a description of this concept.) The permanent magnets on the vehicle interact with three-phase linear synchronous motor (LSM) windings on the guideway for

propulsion. The overall benefit of this technology is its inherent simplicity and robustness. There are no high-power components on the vehicle, resulting in relatively light vehicles compared to other maglev approaches; however, candidate power pick-up approaches have been identified but not yet demonstrated.

There were other “lessons learned,” ranging from maglev-specific findings resulting from the completion of the dynamic testing of the single test chassis on the GA test track in San Diego to potential benefits from this R&D program to the transportation field in general. The benefits are a result of the new technologies that were developed and matured under this program. Some specific technical innovations include:

- Modular guideway construction techniques to enable low-cost, rapid construction of the guideway. The GA guideway girder piers and foundation design and details are well-documented in technical memoranda and presentations given at selected worldwide conference on urban transportation systems.
- Low-cost, high-strength guideway construction materials, including fiber-reinforced concrete.
- An Automatic Train Protection (ATP) system that is safety-certified and is fully compatible with a levitated maglev system under all operational conditions.
- A vehicle propulsion control system capable of automated operation of multiple vehicles under challenging dynamic loading conditions (resulting from the program-imposed 10% grade and 1.6 m/s<sup>2</sup> acceleration requirements).
- A vehicle positioning system that is very accurate in its ability to sense and control the position of the vehicle on the track and accurately monitor its speed. Current position accuracy is 18mm; future planned system will be even more accurate, resulting in further efficiency improvements.

Of all the projects, the GA project was one of the most comprehensive and well-documented. Numerous technical documents, technical memoranda, summary briefs, refereed journal articles, and periodic peer-review sessions were conducted. As part of the environmental assessment process, public hearings were held in the borough of California, PA, to describe the proposed first-phase alignment (top of the hill) and the associated environment impact. As a result of this process and attention to public comments, a Finding of No Significant Impact (FONSI) was issued by the environmental reviewing agencies.



SECTION  
4

# Summary of Lessons Learned

## General Project Impressions

Overall, the urban maglev program has demonstrated that low-speed magnetic levitation systems are advanced enough to merit consideration as system alternatives in the United States. The initial infrastructure costs may seem intimidating for some of the technologies, although at least some of them are likely to have offsetting lower operating and maintenance costs. In addition, most large urban areas in the United States have already invested in some type of mass transit system (subway or light rail), and urban maglev poses a fundamental change in technology that is viewed as being a major risk, incompatible with existing systems, and cost-prohibitive. The efforts made under this program have shown that low-speed maglev is feasible but has substantial up-front costs. The lack of an actual system in place to demonstrate the projected savings in maintenance and operation costs also contributes to a reluctance to embrace the technology.

Given this context, the contributions and lessons learned would need to point to risk reduction and cost mitigation findings that would encourage investors, manufacturers, suppliers, and transit agencies to consider urban maglev. The discussion of each of the projects highlight those lessons learned which help to make such advances.

### MUSA

The project from MUSA examined the challenges of adapting foreign technology to U.S. standards and regulations and concluded that, with a number of suggested changes and recommendations, the Japanese “Chubu-HSST 100-L transportation system has the originality and technical competency to fulfill a need for [a] low-speed (60 mph max.) intra-urban area transportation system in the 21st century.” The costs associated with an urban maglev project and the fact that a heavy rail system is already in place made it difficult for MUSA to find a suitable location for creating a prototype. Moreover, there were substantial differences between Japanese and U.S. safety and operational design standards. These differences would necessitate substantial redesign of subsystems, in essence rendering the MUSA strategy of quick adaptation of a Japanese-based system to U.S.-based standards substantially more difficult than initially perceived.

### CDOT

The project overseen by CDOT originally looked at using propulsion technology that was under development at Sandia National Labs, but ended up focusing its



efforts on the development of the alignment for a potential low-speed maglev system in which terrain and weather conditions would favor the maglev technology. The project described the conceptual components of a steep terrain, all-weather system originating in the Denver area and stretching along the I-70 corridor towards Eagle, CO. The initial phase was to be tested in a segment of approximately 30 miles. The project concluded with some focused insights based on the Sandia-derived technology and preliminary engineering plans for lower cost guideway designs.

### Maglev 2000

The project run by Maglev 2000 of Florida attempted to demonstrate the feasibility of using superconducting magnets for its system. While this program had been initiated under the FRA High-Speed Maglev Program, it still struggled to create a prototype magnetic suspension system that would demonstrate the viability of using superconductivity. The project was never able to successfully levitate its chassis due to production difficulty with the cooling systems necessary for superconducting magnets. Additional funding was not available to see if this team could overcome some of those production issues.

### MagneMotion, Inc.

The MMI project features permanent magnets and LSM propulsion. The program focused on the development of a 1/7-scale system to demonstrate its concepts and showed promise for possible deployment at a test site. The permanent magnet concept allows for a relatively large 20mm gap, which should reduce required tolerances in guideway construction, thereby making them cheaper to construct. The program was awarded additional funding for further work in creating a demonstration site at Old Dominion University in Norfolk, VA. The site had a previously-constructed but unused guideway that MMI adapted its system to fit and moved a test sled to the site in early 2012. Testing was conducted on the test sled in May through November 2012.

### General Atomics

The system proposed by GA also uses permanent magnets, but they are configured in what is called a Halbach array and are used in conjunction with LSM propulsion. This program teamed with the California University of Pennsylvania to use the campus as a potential test site for the system. A full-scale chassis and limited test track were constructed for testing at the GA facilities in California, with the hope of moving directly to a full-scale operating system in Pennsylvania. Lack of funds for the construction of an on-campus system forced the project to close without deploying the system.

## Project Execution

The principal lesson learned in the overall project execution was that, as with most research efforts, there will be unexpected challenges and obstacles during the course of the projects. Each project team identified different challenges, such as gaining cooperation with State, city, and local stakeholders for alignment issues, obtaining details on already operating systems that were not considered proprietary, and underestimating the technical challenges of super cooling magnets.

In addition, while the very nature of research programs draws people who are interested in solving complex problems, experience has shown that sometimes such people are not as concerned about following federal guidelines and submitting required reports on time. The lesson learned from the program in this regard was the value of requiring someone on the project team to provide a project plan with enough detail that FTA could determine when the project had veered off-course and to provide them with enough details on project progress to determine whether a payment of funds was warranted. Eventually, all of the programs were able to provide interim milestone reports and deliverables in the context of a longer-term research program based on their individual strategies and concepts. As a result of these program plans, the researchers were able to better focus their resources and results, which allowed FTA program managers to assess progress and the need for continued investment.

## Project Conclusions and Deliverables

At the time of the initial Lesson Learned report in March 2009, only two of the five research teams were still engaged in urban maglev search efforts: General Atomics and MagneMotion, Inc. All teams provided reports and briefings of their work to FTA. Some of the team members made presentations at professional conferences or workshops associated with technology research (magnetic levitation) or with transportation system research (conceptual plans for Urban Maglev systems). No major patents or patent-pending applications were reported. These contributions have been highlighted in Section 3.

While individual teams have presented reports and briefings, there are no plans to compile a comprehensive summary of the research program. When the program concludes in 2012, this report will provide the only summary, which highlights the major contributions and outcomes. This report includes not only the individual team contributions but also the major findings, such as the general systems requirements, technological advances, programmatic innovations, and contributions to the literature.

## Project Team Performance

Two of the five teams, Maglev 2000 and MagneMotion, Inc., were organized and operated as small research teams, usually headed by one or two senior scientists with up to three or four associates. The remaining three teams used large-scale, system integration team models to assemble and operate their teams. The original solicitation allowed the responders to propose any type of project team configuration they wished to use, and these project team configurations were appropriately aligned to the type of research that each team was pursuing.

The Maglev 2000 strategy was focused on extending technical insights from the FRA high-speed maglev program to the urban maglev environment. Consequently, the two scientists who had conducted the high-speed rail work constituted the major team members for this project. MagneMotion, Inc., initially employed a “professor-graduate student” project model appropriate for the scale and scope of this research endeavor, namely an extension of known technologies to the urban maglev environment. As MMI progressed, its approach broadened to become similar to the larger-scale efforts of some of the other teams. These project team configurations allowed for relatively easy assessment of performance and more direct understanding of the advances and challenges. It also reduced the expenses for project management, allowed for an easier project execution/control/reporting structure, and enabled more funds to be applied to the technology-focused research goals.

The large-scale, systems integration project team configurations were directed at planning for and implementing full-scale experiments or demonstrations. Each team had a prime contractor with associated specialty subcontractors. On average, each team had six subcontractors in areas such as structures and guideways, urban transportation system design, control systems, environmental impact assessments, vehicle and chassis design, cost estimation, etc. While such a project team configuration does allow for improved coordination and integrated design, a larger portion of the research funding is necessarily spent on project management and project reviews.

Future FTA research projects of this type would benefit from either the small team project model (expert scientists with small staff support or “professor-student” model) or a phased implementation of the system integrator model. In the phased implementation project team model, specialty subcontractors are identified in the initial work plan, but are only engaged during the project at critical design reviews. This approach minimizes expenditures for those subcontractors whose expertise may not be needed until substantial maturation of the conceptual design and advanced technologies. This approach balances fixed costs with technical risk by keeping all key functional areas informed at critical design reviews to ensure there are no major design flaws or defects pertinent to their area of expertise.

## Stakeholder Participation

Three sets of major stakeholders exist for this research project: FTA, urban maglev users and operators, and the magnetic levitation research community. The general public would be represented and involved through the urban maglev user group, i.e., the transit agency, organization, or MPO involved in assessing and possibly employing the proposed system.

The relationship between FTA and the research team is twofold. The first is the traditional sponsor-performer relationship in which a contracted work plan is established, progress reports are provided, corrections are implemented, and administration of the contract is managed. The second is the oversight of the research and technological innovations as proposed and updated by the project team. In this program, FTA benefited from the availability of technical experts to periodically review and assess the technical performance of the teams. An enhancement of this approach would be to engage more technical experts in magnetic levitation and control system technologies earlier in the program to ensure that the fundamental technologies and advanced innovations were evolving constructively. While these reviews did take place eventually, approximately 16 months was allowed to pass before the first substantial technical review occurred, primarily due to multiple changes in project leadership at FTA early in the program. Moreover, this technical expertise need not be secured through a large support contract, but could be implemented through specific service agreements with known experts.

The systematic nature of the urban maglev technologies is addressed through the engagement of the users or operators of a candidate system. Phase I of the program was to demonstrate sufficient promise in the technology to warrant advancement to Phase II, in which more interaction with and influence from users and operators would be required for prototyping. Approximately one year passed on the program before a general systems requirements document was produced and made available to all teams. The requirements document covered all of the major areas of service characteristics, operations, safety, passenger comfort, and other critical factors. The effect of this document was to provide a benchmark for FTA stakeholders to assess the technical performance of the research teams. It also provided a common vernacular and perspective for the user and operator community by which they could make initial assessments of the value of the advanced magnetic levitation technology. Three of the five research teams used this requirements document to engage, at various levels, potential users and operators. The CDOT project involved CDOT engaging the Denver MPO in preliminary discussions about the potential application of urban maglev. MagneMotion, Inc., worked with Old Dominion University and others to explore potential applications of its technologies. General Atomics worked with California University of Pennsylvania and others to assess potential alignments and phased implementation of its technical solution. In future programs of this

type, a general systems requirement document, not overly constraining of the technology, should be made available early and updated, as appropriate, to guide researchers, provide benchmarks for the FTA review process, and to engage potential users and operators.

The third stakeholder group is the general magnetic levitation research community. FTA brokered three team meetings in which all research teams presented their interim findings and conclusions. These were helpful sessions but did not yield much inter-team cooperation or coordination. More generally, several team members presented papers or status reports at professional conferences. This updated report is an effort to provide a more comprehensive summary of all team accomplishments so that future research directors would understand the challenges of urban maglev and the accomplishments achieved through this program.

## Risk Management

Risk management is most appropriately applied when assembling component subsystems into a larger transportation system. Consequently, not much effort was devoted during Phase I when the basic magnetic levitation technologies were being explored and tested. During Phase I, risk management was developed and managed by individual researchers in the course of their studies and analysis, with little or no formal documentation other than in quarterly progress reports. In Phase II, more formal risk management practices were employed to ensure that interface controls and design risks were openly addressed.

After the benchmark system requirements were made available to all teams, FTA required risk management plans, allowing for monitoring of key technologies and critical path items. For example, in the case of General Atomics, the longitudinal position sensor is a critical technology for the operation of the entire levitation and propulsion system and chassis. The GA team identified this risk component early in the program, but it was slow to offer a technical solution, despite inquiries by FTA and various technical review teams. This example illustrates the benefits to FTA in having such a process in place to ensure that critical path risk items are resolved before embarking on other technical activities.

## Project Communications

Communications during projects of this nature are extremely critical to allow FTA to ensure that its funds are being used in the best way possible. Because of the extremely technical nature of the work, FTA found subject matter experts (SME) to assist in monitoring progress and asking the hard questions of the project team. FTA also insisted on conducting (as much as feasible) quarterly reviews with the various teams to allow for direct interaction between the research team and the FTA team. The complex nature of the activities in

which some of the teams were engaged made written communication difficult to understand at times. The quarterly reviews allowed for the face-to-face interaction that is so helpful in understanding just what was being accomplished (or not). FTA also gathered all of the teams for a two-day workshop in 2005 that allowed everyone to share their work and hear what other teams had been working on.

## Project Summaries and Lessons Learned

The summaries of lessons learned listed below have not been expanded for the first three teams—MUSA, CDOT and Maglev 2000—since the original Lessons Learned Report was completed in 2009. The main focus of this updated document is what was learned through the additional work completed by MMI and General Atomics through 2012.

### MUSA

The primary lesson learned from the MUSA project was that conversion of a foreign system to meet U.S. safety and ADA requirements would be a very difficult task. The Japanese system studied could reach approximately only 60mph, which did not meet the speed criteria set by FTA (100 mph), and it appeared that modifying the system to meet this requirement would be a major change that would drive already very high system costs even higher. Egress and emergency exiting requirements would also cause fundamental design changes that would also impact costs. The estimated cost for this system in 2005 dollars was approximately \$50 million per mile.

### CDOT

After initially focusing on adapting a linear motor developed at Sandia National Labs, the CDOT project ultimately looked at how it could change the Japanese HSST system to meet its alignment requirements. CDOT's main contributions, or lessons learned, were its concept designs for the elevated guideway and its linear induction motor (LIM) design, which would allow the system to reach top-speeds of approximately 100 mph. The team examined both a lightweight concrete guideway design and a tubular steel design. Both designs helped reduce estimated guideway costs down to approximately \$33 million per mile. Both concepts would appear to have possible applications in other transit systems that use elevated tracks. The modified LIM would not only allow the system to reach the desired top-end speeds, but would also allow the system to operate on the challenging seven-percent grade that this alignment required. The LIM design was based on experimental tests but was never prototyped and tested for actual performance measurements.

## Maglev 2000

One of the initial goals of the FTA program was to have a team examine the possibility of using superconducting magnets for a maglev application. The Maglev 2000 team was the only grantee to examine this concept and try to bring it to a successful demonstration phase. While FRA had provided initial funding for this team to begin its work, the FTA grant allowed it to continue with its magnet design in the hope of at least levitating the chassis that had already been designed. This demonstration was never accomplished, and the program drove home the difficulty of designing magnets that would be mounted on a guideway to provide the levitation for such a system. The team experienced one failure after another in its attempts to design and build a system that would cool the magnets to the required temperatures. These failures in a controlled laboratory environment indicated that the lesson learned from this grant was that use of superconducting magnets for an outdoor environment is still not a viable concept.

## MagneMotion, Inc.

The MMI team worked with a permanent magnet design that allowed its system to operate with a 20 mm air gap, more than twice the gap achieved by systems operating in Germany and Japan. By increasing the gap between the vehicle and the guideway, the construction of the guideway will not have to be as precise as on other systems, which should drive the cost of construction down. MMI's other main distinguishing characteristic is the design of its linear synchronous motor (LSM) propulsion system. The LSM design is based on an MMI technology that is already in commercial use in an industrial manufacturing facility. It provides very precise position sensing capability, greatly reduces power consumption, and is simpler to manufacture. This design has potential application in any scenario requiring linear motors.

Lessons learned from MMI's development, installation, and testing include the following:

1. *The position sensor is a key element in LSM-based systems, and early development of a working position sensor is a critical component for a successful test plan.* Ensuring reliable and efficient operation of the linear synchronous motor (LSM) first requires a precise sensor. Second, the position sensor should be designed early in the Maglev system design phase to allow for significant operational testing and debugging. MMI's LSM position sensor worked early in the design process, allowing it to automate test cycles; that is, it can run its suspension on a test track without an operator present. As of August 2012, MMI had run its system at its facility in Devens for more than 438 hours of run-time (67,000 cycles), for a total of 2,200 kilometers. Representative photographs of the system mid-test are shown in Figure 4-1.



**Figure 4-1**  
*MagneMotion Sled  
 Mid-test at its Facility  
 in Devens, MA*



2. *Having good instrumentation on the test sled early in the testing process is a requirement.* MMI planned early on to fully instrument the maglev sled to measure accelerations in all six degrees-of-freedom. Specifically, its test plan stated: “Characterize and collect data on ride quality in six degrees of freedom to compare acceleration in all three axes plus roll, pitch, and yaw to limits per ISO Standard 2631-1 and the Automated People Mover Standard Part 2. The emphasis at ODU will be on gathering this information during ‘steady-state’ periods of operation, notably running at constant forward speed.” This allowed MMI to test its control system, tune the suspension, and ensure it met good ride quality standards.
3. *Build extra time and budget to account for issues that crop up during testing into any deployment schedule.* The MMI suspension and motor seem to work well, but minor design issues were identified. For instance, weatherproofing and hardening need to be built in for any maglev system that will be subject to weather and wear-and-tear. MMI also had minor problems with water entering motor stator windings and electronics after rainstorms. These problems were mitigated by repairs and workarounds to enable testing and are believed to be addressable with application of design features



incorporating traditional water shielding, shedding, and sealing techniques, but must be addressed for long-term reliability. MMI also had minor problems with a Siemens power rectifier's software at ODU but, with help from Siemens, the suspension is up and running. Representative photographs of the installation at ODU are shown in Figure 4-2.

**Figure 4-2**  
*MagneMotion System  
Installed on Guideway  
at ODU*



4. *The Maglev guideway switch remains a technical challenge.* Designing a practical Urban Maglev switch is likely feasible. MMI has done some work on switching based in part on its work on products focused on material handling. Depictions of some of MMI's switch concepts are shown in Figure 4-3. However, no project in the Urban Maglev program allocated significant budget and time to this issue.

**Figure 4-3**

Magnetic Switch  
Concepts

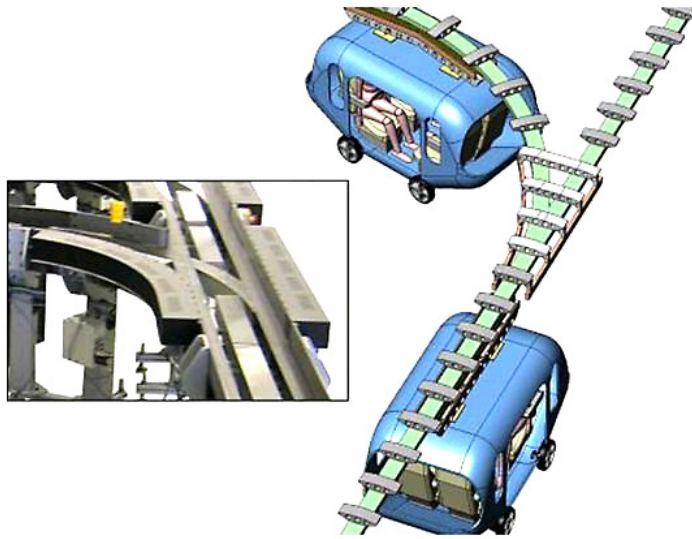

Source: R. Thornton, "The Future of Maglev," *Proceedings of International Conference on Electrical Machines and Systems*, October 8–11, 2007, Seoul, South Korea

5. Like any transportation system, Maglev systems have motions in six degrees-of-freedom (DOF), and a deployable system must have control in all axes to ensure good ride quality and safety. The MMI suspension uses a single magnet array per side for propulsion, lift, and lateral guidance control. Permanent magnets produce most of the lift and guidance forces, but multi-axis control of the propulsion controls allows stabilization of the lift axis as well as active lateral damping control. MMI has received US Patents #6,983,701 and #7,448,327 on this suspension. It also did significant work early in its design process to model the dynamics of the suspension via computer, including guideway deflections. Its lateral damping system appears to work well in limited quasi-static testing. It would be very useful to test the lateral damping in a curved section of guideway. The MMI system has no need for the lateral guide wheels used in the General Atomics and AMT systems.
6. New technical issues WILL crop up during higher speed testing. Due to the short sections of guideway built for the Urban Maglev prototypes, the MMI system has not been through full-scale, high-speed testing. MMI's 50-meter test track allows testing at a maximum speed of 9 m/sec. ODU's 75-meter section allows speeds up to approximately 11 m/s with 0.16 G acceleration. If further funding becomes available, MMI could extend the track at ODU and test at higher speeds. When operating at higher speeds, care must be taken to ensure that the systems meet ride quality and safety standards.
7. Challenging, but solvable, issues remain to be addressed in the development of a deployable Maglev system. These issues include:
  - Power transfer to the vehicle. Inductive power transfer can be used to transfer power from the wayside to the vehicle, but technical details need to be worked out and demonstrated. For instance, should vehicle batteries be charged in-station with magnetic induction or power-transfer "shoes"?

- *Guideway cost reduction.* The guideway is a major cost driver for a maglev system, expected to be in excess of 50 percent of the total cost.
8. *Several solvable manufacturing issues arose during installation of MMI's system at ODU.* Manufacturing issues to be resolved include:
- Spend more effort on securing components for transport, as they had some minor damage during transport from Massachusetts to ODU.
  - Spend effort on pre-mounting intelligent “pick points” on motor components. Time was spent in manufacturing and determining how to safely lift and turn heavy motor components. With judicious pick points (such as welded eye hooks, etc.) on the motor modules, it would have been much easier for a crane operator to safely move and flip the components for installation on the guideway.
  - Spend more effort ensuring quality of work in the vendor supply chain. MMI found some poor workmanship issues on some motor components. These issues were fairly minor, such as hit-or-miss paint jobs on some components and tolerance stack-ups.
  - The MMI/ODU team had some issues with water encroaching on the electronics and on stator windings. Potting, sealing, or venting critical electronics and guideway components can solve this.

### General Atomics

General Atomics (GA) originally considered the use of superconducting magnets for its levitation system, but ended up designing a permanent magnet system in what is known as a Halbach array. This concept, like MMI's permanent magnet design, allows the GA system to operate with a much larger air gap (20–30mm) than other current maglev designs. Again, one of the main advantages of the larger air gap is that the design and construction tolerances are not as rigid and precise, leading to lower guideway costs. GA also uses an LSM for propulsion and has built a full-scale chassis that was tested on a test track.

These lessons were obtained mostly as a result of reviewing the key engineering design elements and evaluating their readiness. The key areas where significant lessons learned exist are listed and discussed below. For a detailed discussion of these lessons, see the report submitted to FTA by General Atomics, FTA Report No. PA-15-X001-02, dated October 2009.

- *Significant levels of LSM electrical noise resulting from inverter switching action significantly affecting the electromagnetic position sensor design.* LSM noise presents a significant design challenge for electromagnetic position sensing. This is a result of the electrical noise resulting from the switching associated with the operation of the inverter (which provides power to the LSM), as well as the resultant high magnetic and electric fields near the LSM motor windings. This includes both magnetic field noise (due to the high currents in the motor windings) and electric field noise (due to the high frequency, high voltage switching). This noise covers a wide range of frequencies, ranging

from several kHz up to over 100 kHz. Earlier attempts to reduce the noise involved injecting frequencies in the range of 20–30 kHz into the pick-up windings (mounted on the track). It turned out that this frequency regime had very significant levels of noise harmonics associated with the inverter. Successful implementation required operating at much higher frequencies than previously envisioned, where the noise was diminished to a low level. Another significant finding was that use of multiple phases of pickup coils in the position sensor allowed cancellation and reduction of much of the LSM noise. This also required a novel signal detection system involving significant digital signal processing to distinguish the injected signal from the background noise.

- *The primary suspension stiffness affects the ride dynamics and the vehicle passenger capacity, with direct impact on the magnet design.* During testing of the first chassis, it became clear that the primary magnetic suspension was too soft, leading to large dynamic excursions of the levitation air gap. Varying the vehicle load resulted in significant changes in air gap, effectively reducing the vehicle passenger capacity for a deployed system. As part of the second chassis design and construction, GA optimized the vehicle's levitation magnet configuration to provide about twice the stiffness (the goal was to increase the stiffness from ~5 kN/mm to over 10 kN/mm for a full-scale chassis). This would reduce vehicle oscillations caused by irregularities in the track and external loads. In addition, changes in air gap would be reduced by a factor of about two. The optimized magnet array was one of the most important technical activities in this program. It significantly reduced the magnetic drag force and doubled the suspension stiffness. The vehicle now exhibits cruise power levels less than 100 kW, putting it on par with conventional people mover systems. In addition, the start-up power is about one-half of the original magnet configuration. There was, however, significant additional magnet weight and cost in the “optimized” array. The optimized magnet array is sufficiently developed and tested to be transitioned to the demonstration system.
- *Accurate LSM current control is critical in designing a propulsion control system that is able to properly follow the desired speed profile.* Quickly testing and iterating control strategies requires a system supporting Rapid Control Prototyping (RCP) on a real-time computer with real input/output devices. A typical RCP system comprises the following components:
  - A modeling program such as Simulink™ serving as a high-level programming tool.
  - Input/output (I/O) interface block-set for Simulink™ links the programming tool with external environment: actual input signals are received from sensors and the input signals are routed to Inverter and Rectifier control inputs. This constitutes the “real-time development environment.”
  - A real-time target processor. These are typically embedded computers with analog, digital, and/or serial inputs/outputs.
  - A host PC with communications link to the target processor.

- A Graphical User Interface (GUI) application to download and control the real-time process. Investigation of available hardware/software was narrowed down to two off-the-shelf rapid-prototype controllers, one supplied by National Instruments and the other by dSPACE. The systems were tested and evaluated on the GA Maglev system. Only the dSPACE-based controller met the requirements for real time control. In this case, “real time” is defined as fast enough to meet operational requirements. This system provided General Atomics with a control system deemed adequate for use in their prototype system at CAL-U.
- *Steel guideway modules are expensive and difficult to manufacture due to weld distortions.* Concrete hybrid girders are cheaper, can be manufactured on site, and are more accurate. The guideway structure for these systems is a significant portion of the total cost of the system. Reducing the capital cost of the guideway has the greatest effect in reducing the overall cost of grade-separated transit systems. GA, working with Mackin Engineering, developed advanced approaches for fabricating concrete guideways using steel fiber reinforced concrete (SFRC). SFRC structures are constructed with steel fibers dispersed throughout the concrete matrix prior to forming the part, rather than the conventional approach of pouring concrete around a mesh of long steel reinforcing bars. Structures can be either pre-cast or poured in place. SFRC has many potential advantages over conventional construction techniques. It is potentially lighter, stiffer, stronger, and less expensive than conventional concrete construction and can enable a smaller, less obtrusive cross-section. Its improved mechanical properties may enable SFRC to offer the potential to significantly reduce the cost of the guideway, resulting in lower capital cost for transit systems—both maglev and other types. GA originally developed SFRC more than 15 years ago under contract with the U.S. Air Force. In early 2004, GA and San Diego State University further optimized the mix design and although the one test that was performed on a full-size beam yielded mixed results, SFRC may still offer significant advantages over conventional concrete construction with further development.
- *The use of Litz wire for the track sections may be too costly for a deployed system.* In the original development of its prototype system, GA opted to use Litz wire (which consists of many thin wire strands, individually insulated and twisted or woven together, following one of several carefully-prescribed patterns often involving several levels) for its track ladder configuration. As the system evolved, there was very little incentive for GA to look for a cheaper alternative, and the system was developed and built using this expensive track. In the development of a fully-deployed system, there should be significant consideration given to identifying and using a cheaper alternative to the Litz wire track configuration, such as the “laminated track” or other types of ladder tracks. (Cost data for a potential system is provided by GA in Section 5 of this report.) Alternative track configuration is a promising area for reducing the overall cost of a deployed system using the General Atomics system design.

- *Increasing lateral stiffness and damping appears to be critical in reducing lateral movement of the vehicle in curves.* As described in its final report, GA built two separate test chasses for use in testing an articulated vehicle. The second chassis design was based on a very thorough examination of the wear and tear of the components of the first chassis and estimates by the design team of where complexity could be reduced. The mechanical lateral damping in the first chassis did not work very well. As a result, lateral damping mechanisms were removed from the second chassis in the belief that they were not needed to arrest lateral movement as the chassis moved through a turn. While measurements of comfort levels by GA of the overall ride quality indicate that the new chassis meets ride quality criteria (at least during their limited speed and acceleration range tested on the test track), members of the FTA review felt there was noticeable contact by the chassis on the sides of the track as it moved through the turn. The review team felt that this contact was noticeable enough to warrant designing some type of lateral movement control mechanism for a deployed system to improve both passenger comfort and ride experience, as well as wear and tear on the chassis and guideway.
- *It is critically important to understand motions in all degrees-of-freedom in a maglev system.* A maglev system has motions in all six degrees-of-freedom (3 translations and 3 rotations). To ensure a reliable, safe, and comfortable maglev system, it is imperative to understand and control vehicle movement in all six degrees-of-freedom under all conditions of acceleration, deceleration, loading, curves, and external disturbances such as wind and guideway irregularities.



# SECTION 5

## System Cost Estimates

In an effort to provide as much information as possible about the cost of an Urban Maglev system, FTA asked both GA and MMI to provide information summarizing their best estimates at what it would cost to field a small system. The information they provided is summarized here. In the case of MMI, its paper is included as an appendix. This section provides the reader with the most up-to-date cost estimates available. The initial requirements document developed by FTA called for an urban system capable of moving 12,000 people per hour. The information provided below is based on estimates to build a system capable of that throughput.

### MMI System

MMI provided a written paper identifying the cost estimates for its system (included as Appendix C). In addition to the paper, it also developed a detailed Statement of Work (SOW) for a proposed commercialization effort that was provided directly to FTA; MMI may be contacted directly for details about the commercialization SOW. MMI's paper provides cost estimates for three systems designed to carry 3,000, 6,000, and 12,000 people per hour per direction (pphpd). Table 5-1 provides a summary of the MMI cost estimates for a 12,000 pphpd system.

**Table 5-1**

*MMI Cost Estimate for  
Dual Elevated Guideway  
12,000 pphpd System*

Parameter	Units/km	\$k each	\$k/km	\$k/mile	% of cost
<b>Guideway Infrastructure (subtotal)</b>			<b>\$7,852</b>	<b>\$12,637</b>	<b>30%</b>
Guideway beams	67	\$42	2,789	4,488	11%
Guideway piers	67	20	1,340	2,157	5%
Track support structure	67	56	3,724	5,992	14%
<b>LSM /Position Sensing (subtotal)</b>		<b>0</b>	<b>4,695</b>		<b>18%</b>
LSM stators & position sensing	67	69	4,593	7,391	18%
Guideway installation and cables	67	2	103	166	0%
<b>Electrification/Control (subtotal)</b>		<b>0</b>	<b>2,192</b>	<b>3,528</b>	<b>8%</b>
Inverter station cabinets	16	97	1,559	2,509	6%
DC power system	1	633	633	1,018	2%
<b>Vehicles (subtotal)</b>	<b>11</b>	<b>810</b>	<b>9,001</b>	<b>14,486</b>	<b>35%</b>
Magnets	11	31	341	549	1.3%
<b>System (subtotal)</b>		<b>0</b>	<b>23,741</b>	<b>38,207</b>	
License fee	1	1,077	\$1,077	1,734	4%
Maintenance facility			1,187	1,910	5%
Contingency, 0%			\$0	0	0%
<b>Total</b>			<b>\$26,005</b>	<b>\$41,852</b>	<b>100%</b>

As can be seen in Table 5-1, MMI estimates that the cost for its system would run approximately \$42 million/mile, including vehicles. As with any cost estimate, there are probably some economies of scale that would be available by volume costing various components for the actual production of a system, but those economies have not been factored into this conservative estimate. For more details on how these costs were developed, see Appendix C.

Figure 5-1 provides the relative component cost for dual guideway elevated systems at the 12,000 pphpd capacity, with 1 km station spacing. The station costs have been excluded, as they can vary widely based on local requirements. The component costs are grouped to show their relative contribution to the total cost. In MMI's case, reducing the cost of the concrete beam, piers, and steel track structure will provide the greatest impact on system cost. MMI addressed cost reduction from the beginning with its M3 system design. For reference, the Transrapid guideway is four times the mass of the M3 system, and the mechanical tolerances for that system have to be much tighter as they require the control of two 8 mm magnetic gaps. In contrast, M3 has a single magnet gap of 17 mm nominally. The next biggest contributor to system cost is the LSM stators and position sense equipment. The design and construction of the LSM stators will be re-examined in the next phase to reduce their cost.

**Figure 5-1**  
Dual Elevated Guideway –  
12,000 pphpd

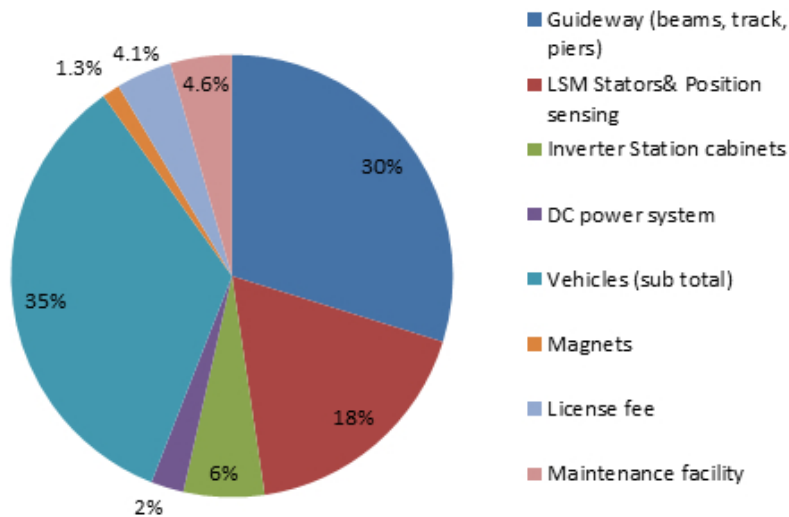

## General Atomics System

GA's cost estimate was developed and presented to FTA at a conference held in September 2005 at FTA headquarters. Table 5-2 is a summary from GA's presentation.



**Table 5-2**

GA Cost Estimate for  
12,000 pphpd System\*

	Cost per Mile (million)
<b>Guideway Structure Costs</b>	
Guideway Girders/Beams	\$9.2
Guideway Support Columns	\$0.9
Footings/Foundations	\$6.3
Subtotal	\$16.4
<b>Vehicle Costs</b>	
Vehicle Body/Bogie/Suspension	\$1.45
Levitation, Guidance, and Propulsion	\$11.8
Power Distribution and Conditioning	\$14.3
Communication and Control	\$6.4
<b>Energy Cost (per passenger mile)</b>	\$0.0035
<b>Operation &amp; Maintenance Costs (per vehicle mile)</b>	\$3.67

\* Costs are for double track system based on the “primary alignment at Cal-U” and have not been updated since the original 2005 estimate.

Using this table, the estimate for the GA system is \$48.9 million/mile, without the cost of trains. GA contends that the vehicle cost will be contingent on the length of the system and should not be included in the cost-per-mile estimate. In looking at a possible alignment through downtown Pittsburgh, GA did extensive simulation modeling to come up with an estimate of approximately 127 vehicles (this is the size of a fleet that includes spares) needed to service the 13.6 km system that was envisioned. Smaller systems with fewer stations would obviously need fewer vehicles and would change the cost-per-mile calculation. Over the past four years, GA has done some work on identifying ways to reduce this cost but has not had a chance to provide detailed estimates for their reductions.

# Brief Overview of Magnetic Levitation Technologies for Low-Speed Urban Transportation

Magnetic levitation (maglev) is a relatively new transportation technology in which non-contacting vehicles travel safely at speeds of a few miles per hour to several hundred miles per hour while suspended, guided, and propelled above a guideway by magnetic fields. The operating speed is determined by the system application, such as city-to-city passenger transportation, urban passenger use, or non-passenger applications such as freight transportation. The guideway is the physical structure along which maglev vehicles are levitated, guided, and propelled.

The primary functions basic to maglev technology include:

- Levitation or suspension of the transit vehicle from the guideway
- Forward or reverse propulsion
- Vehicle guidance

In most current concepts and designs, magnetic technologies are used for all three functions, although a non-magnetic source of propulsion could be used. No consensus exists on an optimum design to perform each of the primary functions.

## Magnetic Levitation Technologies

### *Suspension*

The two principal means of levitation are electromagnetic suspension (EMS) and electrodynamic suspension (EDS). EMS is an attractive force levitation system whereby electromagnets on the vehicle interact with and are attracted to magnetic-attractive components on the guideway. EMS is made especially practical by continuing advances in electronic control systems that precisely maintain the air gap between vehicle and guideway, preventing contact and optimizing power usage. An attractive feature of EDS is its inherent ability to compensate for variations in payload weight, dynamic loads, and guideway irregularities through rapid changes in the magnetic field (via the control system), resulting in the maintenance of the proper vehicle-guideway air gaps.

Electrodynamic suspension (EDS) employs magnets on the vehicle to induce currents in the guideway as a result of the relative motion between the vehicle and guideway. A key technical property of EDS is that the repulsive forces produced

are inherently stable because the magnetic repulsion increases as the vehicle-guideway gap decreases. Usually, the vehicle must be equipped with wheels or other forms of support for “takeoff” and “landing” because an EDS levitation design will not generate sufficient magnetic lift to levitate the vehicle at speeds below approximately 20 mph.

### ***Propulsion Systems***

Two types of electromagnetic propulsion systems are employed in maglev systems. They are differentiated by motor stator design and the principle of magnetic induction used to create propulsive physical forces:

- “Long-stator” propulsion uses an electrically-powered linear motor winding along the entire length of the guideway. This configuration is typically the more expensive of the two because of higher total guideway construction costs, although the vehicles are typically lighter and cheaper.
- “Short-stator” propulsion uses a linear induction motor (LIM) winding onboard the vehicle and a passive guideway with a magnetically “receptive” material (e.g., ferromagnetic aluminum, copper, etc.) installed along the rail surface. The LIM makes the vehicles heavy and reduces vehicle payload capacity, typically resulting in higher operating costs and lower revenue potential compared to the long-stator propulsion. However, the guideway costs are less.

### ***Guidance Systems***

Guidance systems are required in all degrees-of-freedom (forward and backward, left and right, pitch, yaw, and roll) to steer or guide the vehicle safely along the guideway under all operating speeds and conditions. The guidance system can be the result of direct application of the magnetic forces necessary to meet ride requirements and can be used in either an attractive or repulsive manner. Similarly, certain design concepts allow for the same magnets on board the vehicle that supply levitation to be used concurrently for guidance. This approach is more complicated, but it can reduce vehicle weight.

APPENDIX  
**B**

# FTA Urban Maglev Project Descriptions

## MUSA Project

Earthtech in Baltimore, MD, assembled a team called MUSA with Chubu High-Speed Surface Transport (CHSST) as one of the subcontractors. MUSA adopted CHSST technology as the basis for its Maglev system. A brief description of the technology is presented here.

### ***Principles of Levitation and Propulsion***

The high-speed surface transport (HSST) maglev system has been in development in Japan for more than 25 years and has evolved through several progressively more practical forms. Fundamentally, the Chubu high-speed surface transport (CHSST) maglev uses electromagnetic attractive forces between simple dual-pole magnets (analogous to two facing horseshoe magnets) to provide both levitation and guidance. The simplified diagram is shown in Figure B-1. The upper, or fixed, rail side is a simple steel (iron) section with two downward facing poles mounted on the guideway structure. The lower, upward-facing magnet is mounted on the vehicle and is an electromagnet whose intensity is varied continuously by a gap sensor to maintain a constant magnetic gap in the 8 mm range. This active control is required since, otherwise, the gap is unstable with the two magnets attracting each other. Lateral guidance is provided by the tendency of the two opposing magnet pole pairs to maintain their lateral alignment. Propulsion and braking are provided by a separate linear induction motor (LIM) system, with the active (energized) side being vehicle-mounted above the same steel rail used for levitation and guidance. An additional aluminum plate is fastened to the rail top to provide an optimum mix of materials for the LIM function. Finally, there are mechanical brakes and landing skids provided on the vehicle that also act on the outer flange and top, respectively, of the basic steel rail section.

**Figure B-1**

*CHSST Maglev Rail and  
Module Cross-Section*

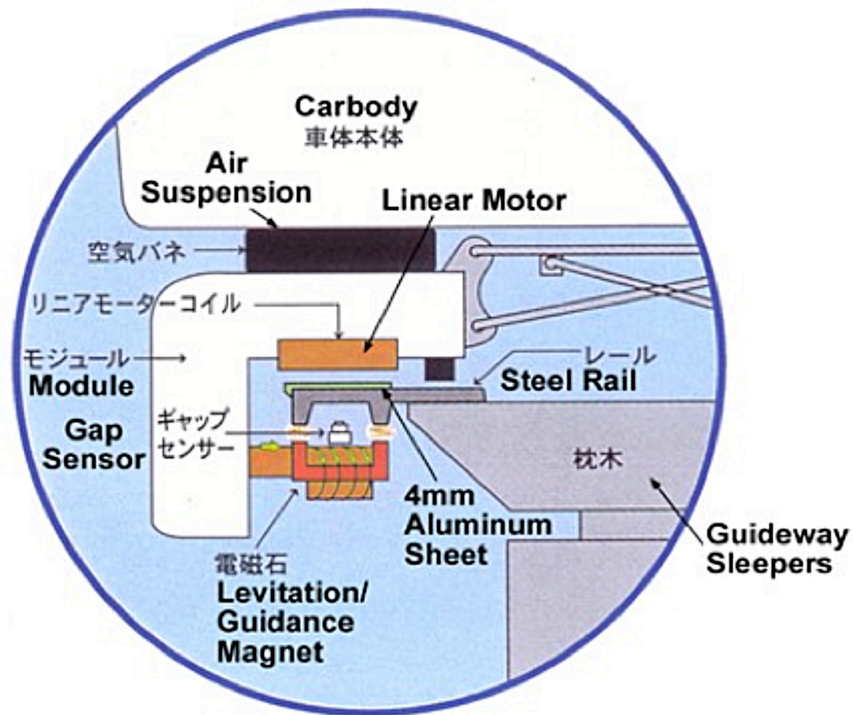

### **Guideway**

The baseline guideway in both the test track and in planned applications is elevated and comprises a simple box girder for each travel direction topped with transverse steel sleepers, which, in turn, support the maglev rails described above. Two-way elevated guideways comprise the two parallel guideway beams, supported on traditional crossbeams, pylons, and footings designed for local conditions and long-term stability (Figure B-2). All services, such as power transmission, signal and communication, etc., are located on the guideway. Rights-of-way of existing major streets can thus be used. Beam stiffnesses are claimed to be sufficiently high, with spans in the 20 m range, so that dynamic behavior under operating, off-design, and varied environmental conditions is adequately controlled. Also, ride quality requirements (G-spectra) are claimed to be met, and operations on the test track so far confirm this

**Figure B-2**  
CHSST Maglev Guideway

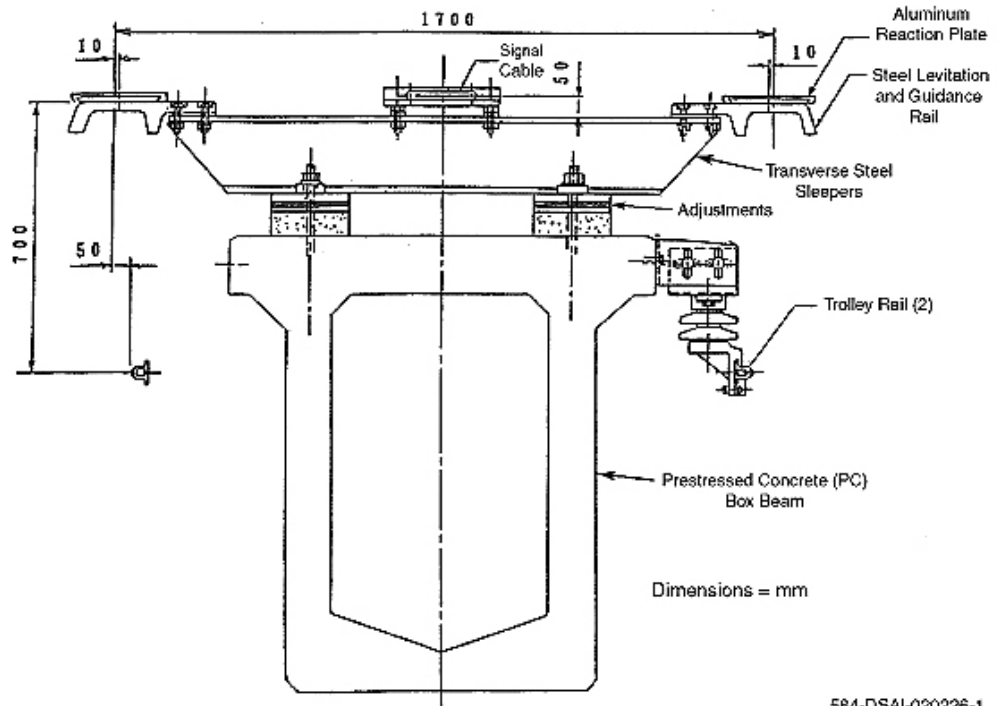

**Vehicle**

On the Tobukyu Line (TKL), three cars are used to form a train. Each car has five modules per side that support secondary suspension (air bags) and carry vehicle weights. The vehicles can remain levitated when stopped, such as at a station. Planned deployments would use these basic vehicles with updated exteriors, interiors, required equipment, etc.

**System Characteristics**

A summary of MUSA/CHSST system characteristics is presented in Table B-1.

**Table B-1***Summary of System Characteristics (MUSA/CHSST)*

System Item	Characteristic or Measurement
<i>I. Operational Characteristics</i>	
Max. operation speed	100 km/h (62.1 mph)
Max. initial acceleration	4.0 km/h/s (2.5 mph/s)
Max. deceleration service brake	4.0 km/h/s (2.5 mph/s)
Max. deceleration emergency brake	4.5 km/h/s (2.8 mph/s)
Max. gradient	7%
Min. horizontal curve radius	Side line track 50 m (164 ft), main line track 75 m (246 ft)
Min. vertical curve radius	1,500m (4,921 ft)
Max. super elevation angle	8°
Passenger capacity for 4-car train – seated	104
Passenger capacity for 4-car train – standing	144 (0.3 sq m/standee [465 sq in])
Passenger capacity for 4-car train – total	248
Temperature	10°C to 40°C (50°F to 104°F)
Max. wind velocity (operational)	25 m/sec (60 mph); structure designed for 50 m/sec (120 mph) wind
<i>II. Vehicle Configuration</i>	
Vehicle type	HSST-100L
Train formation	Cars: Mcl, M & Mc2
Car body length	14 m (45'11") – middle car; 13.5 m (44'4") – end cars
Width	2.6 m (8'6")
Height	3.45 m (11'3")
Rail gauge	1.7 m (5'7")
Empty weight	17,500 kg/car (32,580 lbs/car)
Fully-loaded weight (AW2)	28,000 kg/car (61,728 lbs/car)
Car body structure – material	High strength aluminum alloy
Car body structure – construction	Semi-monocoque
<i>III. Levitation System</i>	
Magnet	Ferro-magnet for levitation/guidance (electromagnets, not superconducting)
Levitation gap	6 mm (0.24") mechanical gap 8 mm (0.32") magnetic gap
<i>IV. Propulsion System</i>	
LIM (Linear Induction Motor)	10 LIMs per car
Quantity	1,800 mm (5'11") per one LIM
Secondary	Reaction plate (aluminum plate on rail)
Power supply	1,500 VDC from trolley rails
Inverter type	VVVF
<i>V. Suspension System</i>	
Suspension module	5 flexible pair-modules per car (module: levitation bogie trucks)
Module frame	Aluminum alloy
Secondary suspension	Air suspension
<i>VI. Brake System</i>	
Service brake	Combination of LIM brake (regenerative or reverse phase) and hydraulic brake (mechanical friction brake)
Emergency brake	Hydraulic brake
Parking brake	Skids (levitation cut off)
Hydraulic pressure	210 kg-f/sq. cm (2,986 psi)

**Contractor Estimated Costs**

The costs estimated by MUSA for CHSST are shown in Table B-2.

**Table B-2**  
Contractor Estimated Costs

System Item	Cost (million)
Basic guideway (2-way), elevated	~ \$50/mile
Vehicle	\$2.00
Signaling	\$7.78
Communication	\$2.04
Electric power to rail	\$5.56
Substation	\$18.00
Superstructure (rails, sleeper, etc.)	\$4.26
Maintenance depot	\$5.93
Stations (close pairs) (per station mile)	~ \$2.50

**CDOT Project**

This was a goal-oriented project with a focus on the application of maglev technology along the I-70 route in Colorado, which connects Denver International Airport to Eagle County and covers a distance of about 140 miles. The following major subcontractors jointly performed this project:

- Colorado Department of Transportation
- Maglev Technology Group (MTG)
- Sandia National Laboratories (SNL)
- T. Y. Lin

The interstate I-70 alignment being considered by CDOT team members is shown in Figure B-3. This route has steep gradients and is challenging for any mode of transportation.

**Figure B-3**  
Interstate 70  
Route Alignment

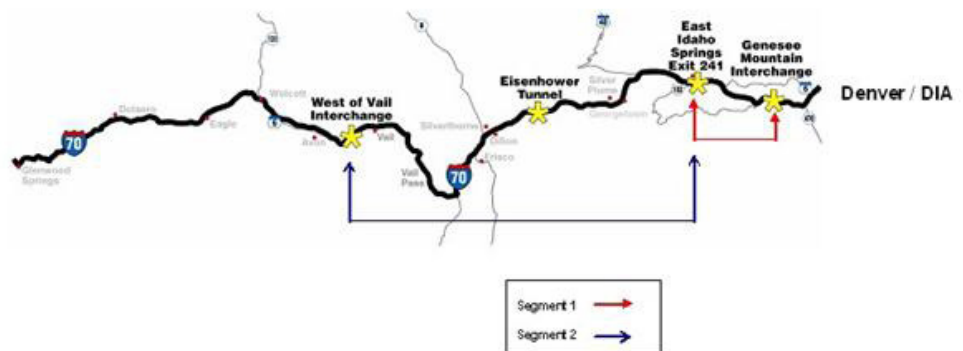



### ***Principle of Levitation and Propulsion***

The projected baseline technology for this project is the CHSST technology, which was briefly described earlier. However, significant design improvements were considered for improved speed and motor efficiency to meet the special requirements of the Colorado maglev route.

### ***Guideway***

MTG and T.Y. Lin proposed alternative guideway configurations to reduce the cost of the CHSST guideway system. These are shown in Figures B-4 and B-5. One concept uses a concrete slab integral to the girder to support the steel rail system of CHSST and eliminates the steel ties currently used on the Japanese TKL route. A second concept uses a steel truss guideway, which is very unconventional for maglev vehicles. It may be considered a high risk, but it looks very attractive and is simpler to erect. For the purpose of this document, it is assumed that the concrete guideway with reduced risk is the preferred approach for initial evaluations. The proposed U-girder for Colorado is shown in Figure B-6.

**Figure B-4**

*Precast Concrete U-Girder*



**Figure B-5**

*Tubular Steel Space Truss*



**Figure B-6**

Proposed U-Girder  
for Colorado

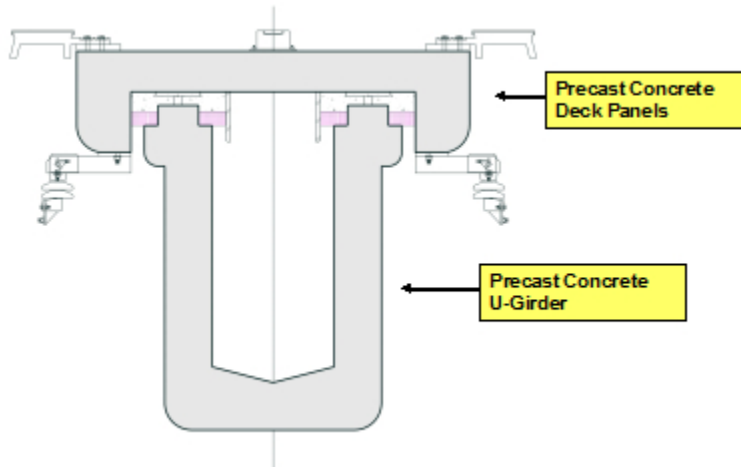

**Vehicle**

The CDOT concept vehicle is a higher-speed vehicle based on the early version of the CHSST vehicle 200 Series. The LIM design in the 100 Series was upgraded for higher performance by:

- Switching LIM to a constant slip mode after a certain speed, up to which constant slip frequency will be used for its operation.
- Using higher voltage.
- Increasing the number of poles.
- Increasing the number of modules per car to 10 on either side instead of 5, as in the earlier CHSST design.

As a result of these and other improvements, the vehicle thrust capacity will increase at higher speeds, up to 200 mph, allowing it no degradation in speed on 7 percent slopes under high wind gusts. Since the vehicle size would be 24 m, the minimum negotiable radius will be 150 m, which was within the requirements for CDOT maglev alignment. The CDOT 200 vehicle is shown in Figure B-7.

**Figure B-7**

Colorado 200 Vehicle



## System Characteristics

A summary of CDOT system characteristics is presented in Table B-3.

**Table B-3**

*Summary of System Characteristics (CDOT)*

System Item	Characteristic or Measurement
<i>I. Operational Characteristics</i>	
Max. operation speed	160 km/h (100 mph)
Max. initial acceleration	1.6 m/sec <sup>2</sup> (0.16 g)
Max. deceleration service brake	4.0 km/h/s (2.5 mph/s)
Max. deceleration emergency brake	0.32 g
Max. gradient	7% (no degradation) 10% (with degradation)
Min. horizontal curve radius	Side line track 50 m (164 ft.), main line track 150 m
Min. vertical curve radius	1000 m
Max. super elevation angle	8°
Passenger capacity for 4-car train – seated	197
Passenger capacity for 4-car train – standing	—
Passenger capacity for 4-car train – total	197
Temperature	10°C to 40°C (50°F to 104°F)
Max. wind velocity (operational)	50 km/h (30 mph); structure designed for 140 km/h wind
<i>II. Vehicle Configuration</i>	
Vehicle type	CO 200a
Train formation	Two Cars
Car body length	24.3m
Width	3.2 m
Height	3.4 m
Rail gauge	1.7 m (5'7")
Empty weight	25,370 kg/car
Fully-loaded weight (AW2)	41,600 kg/car
Car body structure – material	High strength aluminum alloy
Car body structure – construction	Semi-monocoque
<i>III. Levitation System</i>	
Magnet	Ferro-magnet for levitation and guidance (electromagnets)
Levitation gap	6 mm (0.24") mechanical gap 8 mm (0.32") magnetic gap
<i>IV. Propulsion System</i>	
LIM (Linear Induction Motor)	10 LIMs per car
Quantity	1,800 mm (5'11") per one LIM
Secondary	Reaction plate (aluminum plate on rail)
Power supply	3000V DC line
Inverter type	VVVF
<i>V. Suspension System</i>	
Suspension module	10 flexible pair-modules per car (module: levitation bogie trucks)
Module frame	Aluminum alloy
Secondary suspension	Air suspension
<i>VI. Brake System</i>	
Service brake	Combination of LIM brake (regenerative or reverse phase) and hydraulic brake (mechanical friction brake)
Emergency brake	Hydraulic brake
Parking brake	Skids (levitation cut off)

### Contractor Estimated Costs

Contractor-estimated system level construction costs are shown in Table B-4. Operating costs per passenger mile are not available; however, the total annual operation and maintenance costs are quoted at about \$2 million per mile.

**Table B-4**  
Preliminary System Level  
Construction Costs

System Item	Cost (million) <sup>1</sup>
Guideway	\$3,410 <sup>2</sup>
Stations	\$420 <sup>3</sup>
Switches, rails	\$264 <sup>4</sup>
Communications/controls	\$597 <sup>5</sup>
Power (substations/elec.)	Not provided <sup>6</sup>
Vehicles	\$455
Total with 25% contingency	\$6,434
Cost per mile	\$33

<sup>1</sup>Costs do not include right-of-way, engineering or construction management.

<sup>2</sup>156 miles.

<sup>3</sup>14 stations.

<sup>4</sup>14 switches, \$1.6 million/mile.

<sup>5</sup>\$2/mile com. controls.

<sup>6</sup>32 substations, \$1 million/mile.

## General Atomics Project

San Diego-based General Atomics (GA), along with its subcontractors in Pittsburgh and elsewhere, has been actively developing a low-speed maglev system initially with the idea of demonstrating the system at California University in Pennsylvania and later introducing the system as a circulator in downtown Pittsburgh.

### Principles of Levitation and Propulsion

GA uses an electro-dynamic system that gives lift to the vehicle when it reaches a minimum speed on wheels. The vehicle-mounted magnets produce the necessary lift by reacting with Litz wire in stainless steel tubes mounted on the guideway structure. The equilibrium lift is controlled by the permanent magnets under a Halbach arrangement. The vehicle is propelled by LSM windings on the guideway. The system is shown in Figures B-8 and B-9.

**Figure B-8**  
Vehicle on Guideway

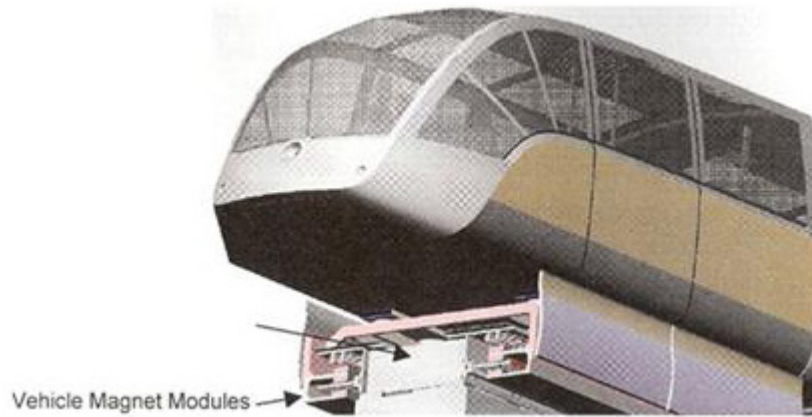

**Figure B-9**  
Cross-section of Maglev  
Guideway Magnet System

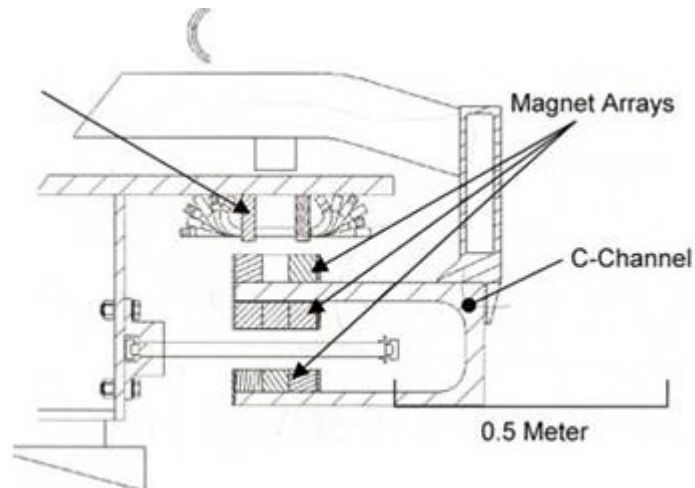

The magnet blocks consist of neodymium-iron-boron (NdFeB) rare-earth permanent magnets. The magnet blocks are subdivided into subassemblies that are loaded into the magnet cases, as shown in Figure B-10. The top set of magnet blocks interacts with the LSM to provide guidance and propulsion. This arrangement, combined with the LSM rails, is claimed to provide the passive guidance force to keep the vehicle aligned to the guideway. In each subassembly, the magnet blocks are placed with their magnetization vectors in the same direction and are contained in a welded, aluminum container. Along the length of the Halbach array, the magnetization vectors rotate in steps of 45 degrees per magnet container subassembly. This rotation of the magnetization vectors provides the Halbach effect, as discussed above, that concentrates the magnetic field lines to increase the lift forces. To complete the assembly of the Halbach arrays, the channels are then mounted to the chassis supports with removable fasteners.

**Figure B-10**

*Vehicle Permanent Magnets in Containers*

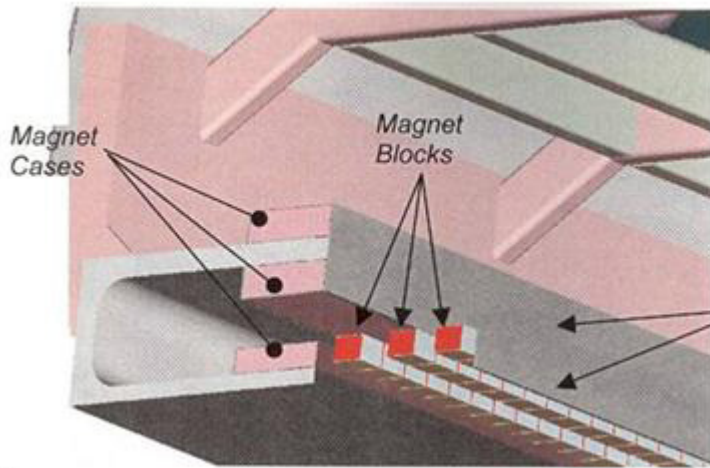

**Guideway**

The basic guideway structure uses guideway modules mounted on a deck that rests on a concrete box beam girder, as shown in Figure B-11. The guideway modules provide the LSM assembly and the required landing surface for the wheels at station locations and during emergencies. The guideway carries cantilevered elements of Litz wire for the vehicle's permanent magnets to generate reactive levitation forces. Research is also being carried out to replace the Litz wire with a laminated copper sheet track. Litz wire and laminated sheets are both generally considered to be expensive, contributing to the overall cost of the guideway structure.

**Figure B-11**

*Basic Two-Way Guideway Structure*

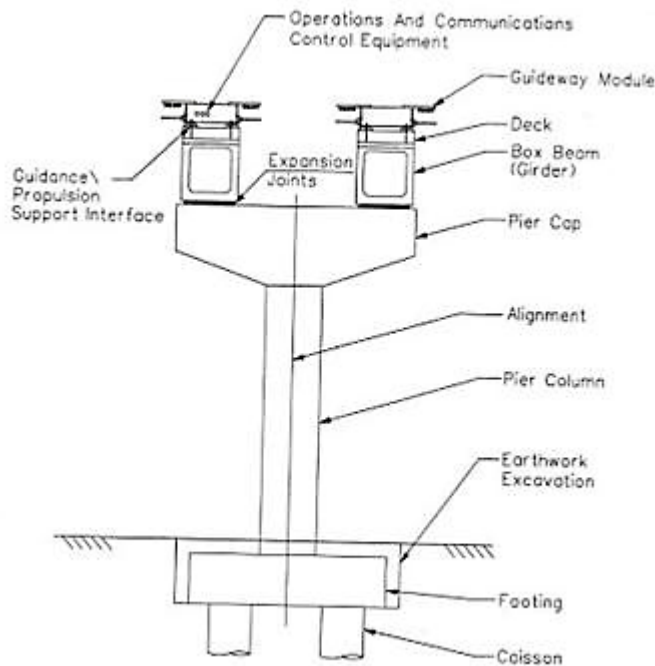



### Guideway Levitation/Propulsion Modules

As illustrated in Figure B-12, the guideway module assembly consists of two carbon-steel guideway top plates (1). These plates carry both the LSM assembly (2) and provide the landing surface for the station or emergency wheels. Also, the guideway levitation and propulsion module consists of two stainless steel angle brackets (3), which support the track assemblies (4). Both the LSM top plates and the angle brackets are interconnected with stainless steel guideway frames (5). Running the length of the module on both sides are two stainless steel guideway side plates (6), which are welded to the guideway frames and provide the mounting surface for the track assemblies.

**Figure B-12**  
Guideway Levitation/  
Propulsion Modules

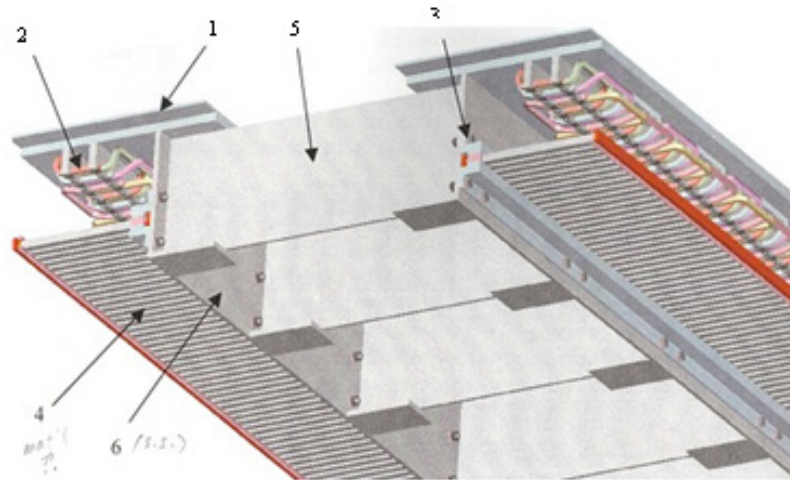

The levitation Halbach arrays, which are attached to the vehicle, move above and below the track. The interaction of these currents with the magnetic fields generates the lift forces.

### Vehicle

The vehicle, with a capacity of 100 passengers, is made of multiple modules—one articulation module and two nose modules—to create a vehicle that is 12 m (39.4 ft) long by 2.6 m (8.5 ft) wide and 3 m (9.8 ft) tall, as depicted in Figure B-13.

**Figure B-13**  
Maglev Vehicle

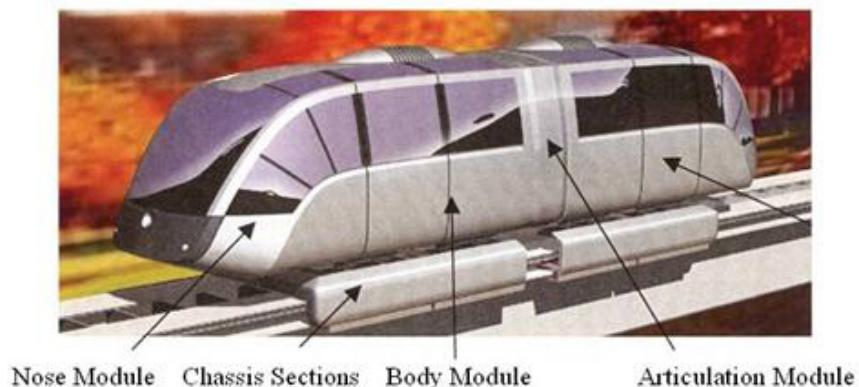

Nose Module    Chassis Sections    Body Module    Articulation Module

Under each body module there are chassis modules (Figure B-14) that provide levitation, propulsion, guidance, braking, and a secondary suspension. Each chassis is split into two sections to negotiate super-elevated curves. The split chassis also allows use of fixed instead of deployable landing wheels, thus minimizing cost, complexity, and weight while increasing safety and reliability.

**Figure B-14**

*Vehicle Chassis*

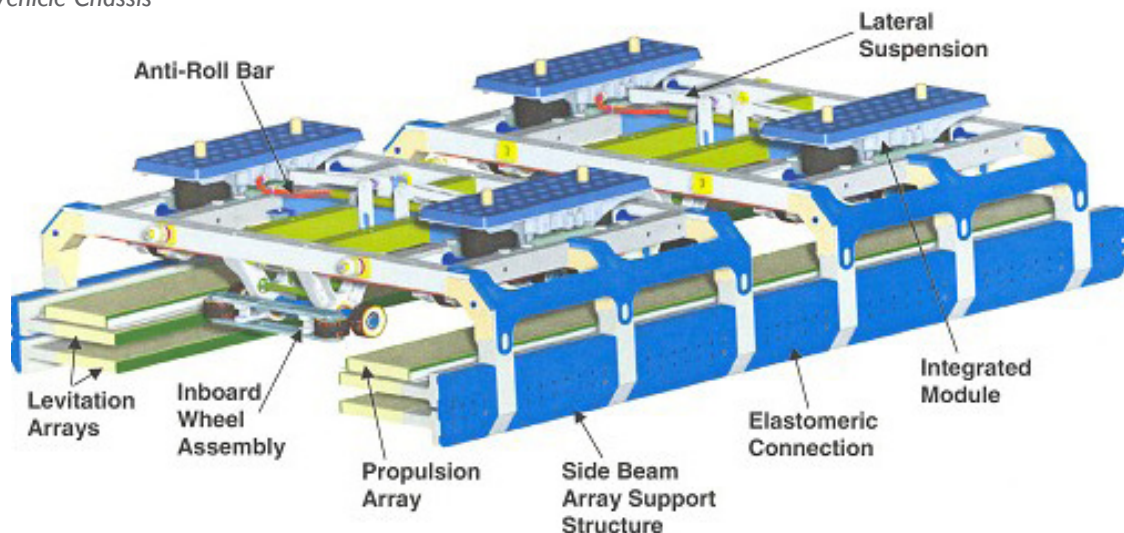

Since the active component of the motor is in the guideway, heavy on-board power conditioning equipment for propulsion is not required. Power pickup is required to provide 20 kW of housekeeping power for things such as HVAC, lighting, etc.

The levitated vehicle is equipped with three separate braking systems, as required on light-rail vehicles. They are the dynamic LSM service brake, an electromechanical friction service brake, and a permanent magnet fail-safe emergency track brake. Each system will provide up to 0.2 g deceleration. The two friction brakes react against the steel top surface of the guideway LSM supporting member.

The Halbach arrays concentrate the magnetic field on the active side, while canceling it on the opposite side. This magnet arrangement, along with other design features of the GA system, results in low magnetic fields in the passenger compartment.

### **System Characteristics**

A summary of the General Atomics system's characteristics is presented in Table B-5.



**Table B-5**

Summary of System Characteristics (GA)

System Item	Characteristic or Measurement
<i>I. Operational Characteristics</i>	
Max. operation speed	160 km/h (100 mph)
Max. initial acceleration	1.6 m/sec <sup>2</sup> (0.16 g)
Max. deceleration service brake	1.6 m/sec <sup>2</sup> (0.16 g)
Max. deceleration emergency brake	3.5 m/sec <sup>2</sup> (0.36 g)
Max. gradient	7% (no degradation) 10% (with degradation)
Min. horizontal curve radius	Side line track 18.3 m (62 ft), main line track 1000m
Min. vertical curve radius	1000 m
Max. super elevation angle	6°
Passenger capacity for 4-car train – seated	—
Passenger capacity for 4-car train – standing	—
Passenger capacity for 4-car train – total	400
Temperature	10°C to 40°C (50°F to 104°F)
Max. wind velocity (operational)	50 km/h (30 mph); structure designed for 160 km/h (100 mph) wind.
<i>II. Vehicle Configuration</i>	
Vehicle type	Modular (body, nose, and articulation)
Train formation	4 cars
Car body length	12 m
Width	2.6 m (8'6")
Height	3 m (9.8 ft)
Empty weight	11350 kg/car
Fully-loaded weight (AW2)	18350 kg/car
Car body structure – material	High strength aluminum alloy
Car body structure – construction	Semi-monocoque
<i>III. Levitation System</i>	
Magnet	Permanent magnet, Halbach array Litz wire track
Levitation gap	25 mm (1") mechanical gap, EDS; 8 mm (0.32") magnetic gap
<i>IV. Propulsion System</i>	
LSM (Linear Synchronous Motor)	600V DC
Power supply	Not provided
Inverter type	VVVF
<i>V. Suspension System</i>	
Suspension module	4 chassis frames, 8 secondary suspension units
Module frame	Aluminum alloy
Secondary suspension	Air suspension, dampers, struts
<i>VI. Brake System</i>	
Service brake	Electric brake and mechanical brake
Emergency brake	Mechanical brake
Parking brake	Skids (levitation cut off)

### Contractor Estimated Costs

Contractor-estimated costs are shown in Table B-6 and B-7.

**Table B-6**

*Vehicle Capacity and Vehicle, Station, and Guideway Costs\**

Item	Value
Vehicle size 15m, 4-vehicle train	Train capacity 400
Deluxe station cost	\$4.72 million
Capacity @ 1.5-min headway (10 hrs operation)	$= 400 \times 10 \times (60 / 1.5)$ $= 400 \times 10 \times 40$ $= 160,000$ per day $= 16,000$ pph
Dual guideway average cost/km	~ \$8 million
Dual guideway average cost/mile	\$12.8 million

\* These costs were pre-2005 estimates. Newer cost estimates are presented in the main body of the report.

**Table B-7**

*Costs for Electric System over 8.3 Miles (13.3 km)*

Item	Cost (million)
Energy supply	\$115.8
Substation	\$54.9
Power distribution	\$10.2
Wayside equipment	\$48.2
Total	\$229.1
Cost/mile	$= \sim 229 / 8.3$ $= \leq \$22$
<i>Total Cost per Mile</i>	$= 22 + 12.8$ $\$35$

## MagneMotion System

The MagneMotion system was developed by a team of scientists and engineers led by Dr. Richard Thornton in Devens, MA, and focused on levitation and propulsion with subcontract support from Earthtech and others on guideway structures. The maglev vehicles are small and are to be operated in platoons to achieve a high capacity of ~ 12,000 pph.

### Principles of Levitation and Propulsion

The levitation is based on electromagnetic suspension as in Transrapid or CHSST, but is reinforced with vehicle-mounted permanent magnets to achieve a larger gap, on the order of 25 mm, and reduce energy consumption. Control coils are used for stabilization of levitation as in the case of Transrapid and HSST. The guideway mount LSM provides the propulsion force to the vehicle, interacting with the permanent magnets.

The MagneMotion design uses a single set of magnets to provide all of the functions of suspension, guidance, and a field for the LSM propulsion. The

classic electromagnet-based EMS design has been replaced by one that uses a single set of permanent magnets to provide not only the lift and guidance forces, but also the field for the LSM. Coils wound around the magnets are driven from a feedback control system to stabilize the suspension. The vehicle magnets provide guidance without any active control.

MagneMotion projects that in using LSMs, the savings in propulsive power, vehicle weight, and vehicle cost more than make up for the added guideway cost resulting from the additional motor windings and inverters. Two motors, one on each side of each bogey, provide propulsion so that failure of a single motor can be tolerated for short periods of time, albeit with reduced acceleration capability. The use of regenerated power from a braking vehicle to help power a nearby vehicle is also planned. At operational speeds, the LSM is claimed to provide an ample reserve of acceleration compared to most transit systems. For a full-scale design, a conventional three-phase inverter that operates off of an 800 VDC bus drives the motor. The inverter uses IGBT power devices of the type used in variable speed drives operating off of 480 VAC power systems. The DC bus links all inverters on the guideway so that vehicles that are braking can supply their braking energy to other vehicles that are accelerating. In a typical installation, the DC bus receives power from 1.5 MW rectifier stations spaced about every 8 km. This compares with the same size rectifier located about every 2 km for light rail applications, and this is claimed to be one of the cost-saving features of the design.

### **Guideway**

The MagneMotion guideway is a trapezoidal cross-section guideway beam with steel plates on each outer upper lip to support the suspension rails. It is similar to but smaller and simpler than the German Transrapid guideway. Two examples of beams currently under consideration are a hollow pre-stressed concrete (with steel reaction plates) and an all-steel version (Figure B-15). Later cost estimates also show a composite version. These beams can be mounted on piers for elevated operation or the beam height can be reduced and the beams mounted on ties or pads for at-grade installations.

The aim of the design was to keep the guideway beams as small and light as possible without jeopardizing ride quality. The resulting design is based on stiffness and resonant frequency considerations; the strength of the structures is claimed to be greater than is necessary so there is no compromise with safety issues. If the vehicle is short compared with the pier spacing, MagneMotion asserts that beam precamber can help compensate for most of the beam deflection. This allows the use of lighter beams with greater deflection. The key compromise is between using beams that are too large and expensive and a guideway that does not provide good ride quality.

**Figure B-15**

Guideway Beam Designs:  
Hybrid (left)  
and Steel (right)

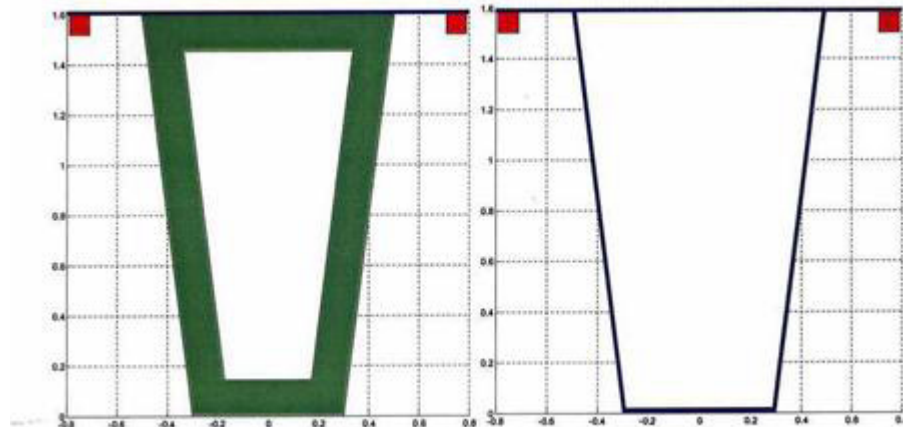

**Vehicle**

The MagneMotion baseline vehicle has the size of a small bus (Figure B-16). This vehicle seats 24 with room for 12 standees and uses modest streamlining to reduce drag at the top speed of 45 m/s (101 mph). The magnets are mounted on pivoting pods that allow 18.3 m (60 ft) horizontal turning radius and 250 m (820 ft) vertical turning radius. An initial vehicle design is based on fiberglass construction, but few structural details are available. The HVAC and other equipment is in the nose and tail where streamlining prevents use of that space for passengers.

**Figure B-16**

Cutaway Views of  
Preliminary Vehicle Design

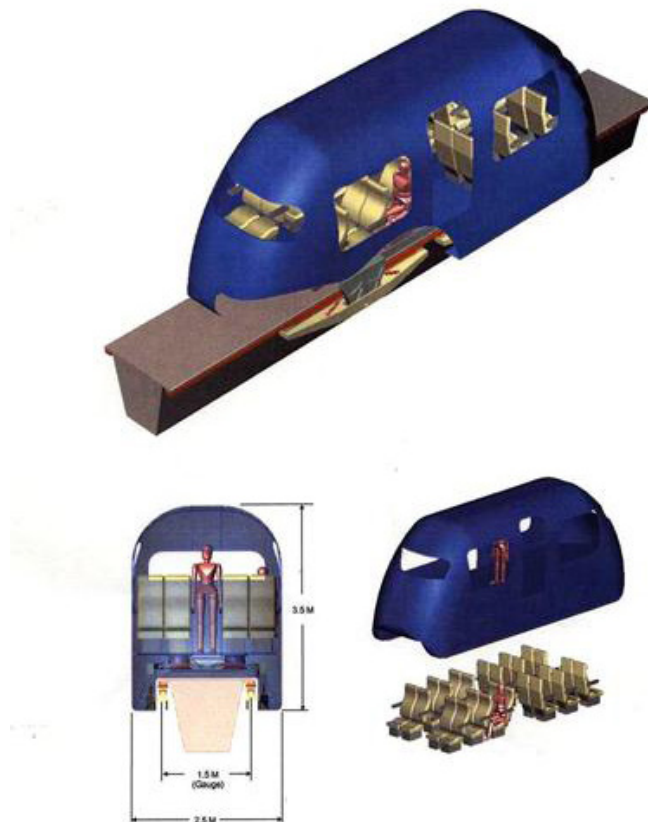

The magnets provide the primary suspension, but there is a secondary suspension that has two components. The magnet pods (Figure B-17) have pivots with dampers so as to allow tight turning radii in both horizontal and vertical directions. Pneumatic springs allow improved ride quality and can, if desired, provide active control of ride quality, including tilting. The mechanical details of this complex arrangement have not yet been provided.

**Figure B-17**

*Magnet-pod  
Suspension System*

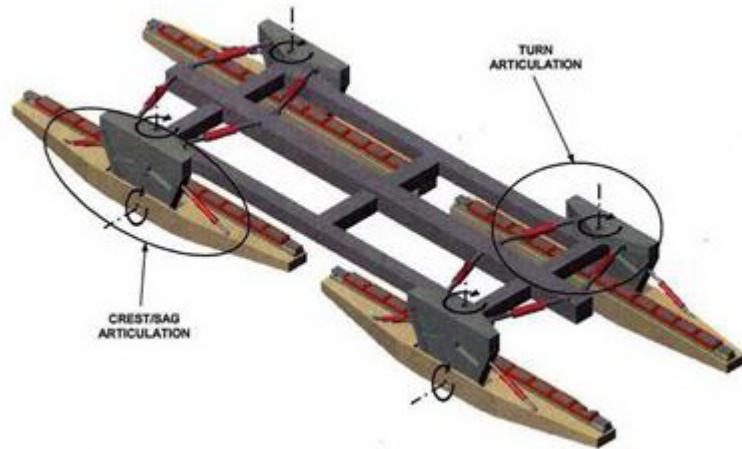

### **Vehicle Weight**

The empty vehicle weight is claimed to be less than twice the maximum passenger weight. This compares with steel-wheel suspended vehicles, which typically have an empty vehicle weight that is 3 to 4 times the maximum passenger weight.

### **System Characteristics**

A summary of the MagneMotion system characteristics is presented in Table B-8.

**Table B-8***Summary of System Characteristics (MagneMotion)*

System Item	Characteristic or Measurement
<i>I. Operational Characteristics</i>	
Max. operation speed	160 km/h (100 mph)
Max. initial acceleration	2 m/sec <sup>2</sup>
Max. deceleration service brake	4.0 km/h/s (2.5 mph/s)
Max. deceleration emergency brake	Not defined
Max. gradient	10%
Min. horizontal curve radius	18 m (60 ft)
Min. vertical curve radius	1000 m
Max. super elevation angle	15° includes vehicle tilting
I-car train passenger capacity – seated	24
I-car train passenger capacity – standing	12
I-car train passenger capacity – total	36
Temperature	Not defined
Max. wind velocity (operational)	Not defined
<i>II. Vehicle Configuration</i>	
Vehicle type	Composite body
Train formation	Cars in platoons, no couplers
Car body length	8.2 m
Car body width	2.5 m
Car body height	3.6 m
Rail gauge	1.5 m
Vehicle weight empty	5 tonnes
Vehicle weight 75% loaded (AW2)	7 tonnes
Car body structure – material	Composites (not defined)
Car body structure – construction	Not defined
<i>III. Levitation System</i>	
Magnet	Permanent magnets and electromagnets
Levitation gap	17 mm mechanical gap, 20 mm magnetic gap
<i>IV. Propulsion System</i>	
LSM (Linear Synchronous Motor)	Not provided
Power supply	480V AC Rectifier from 600V DC Lin
Inverter type	VVVF
<i>V. Suspension System</i>	
Suspension	4 magnet podss
Module frame	Unknown
Secondary suspension	No
<i>VI. Brake System</i>	
Service brake	Combination of LIM brake (regenerative or reverse phase) and hydraulic brake (mechanical friction brake)
Emergency brake	Hydraulic brake
Parking brake	Skids (levitation cut off)

### Contractor Estimated Costs

MagneMotion has provided some estimates. The level of detail is moderate in that individual major systems have been estimated, but a network was not used as a model. Capital costs provided by MagneMotion prior to 2005 are shown in Tables B-9 and B-10.

**Table B-9**

*Guideway Costs  
per Two-way Mile*

Item	Cost (million)
Concrete guideway structure/mile	\$8.8
Inverters/mile	\$2.1
LSM/mile	\$2.5
Electrification	\$2.0
System Control	\$3.5
<i>Total per Mile</i>	<i>\$19.2</i>

**Table B-10**

*Other System Costs  
per Two-way Mile*

Item	Cost (million)
Add \$3.6/mile for hybrid beams	\$22.8/mile total
Add \$9.4/mile for all-steel beams	\$28.6/mile total
Vehicles (24Pax)	\$0.25 each
Stations (each)	\$100 k to \$1 M each

A more detailed cost estimate was developed in 2012 by MMI and is presented in Appendix C.

## Maglev 2000 Project

Maglev 2000 was a company incorporated in Titusville, FL. Drs. James Powell and Gordon Danby, the early inventors of superconducting maglev systems based on null flux levitation, were principal members of the technical team of Maglev 2000. The Maglev 2000 system was designed for high-speed operations (~ 300 mph), and has been adapted to operate between 30–120 mph for low-speed urban transportation.

### Principles of Levitation and Propulsion

The system used vehicle-mounted superconducting magnets that interact with aluminum coils in the guideway to generate levitating and propulsive forces. The coils were completely encapsulated in polymer concrete panels that are attached to the guideway beam. A levitation of about 6 inches was anticipated between the guideway and the vehicle. Since the system works on the electrodynamic principle rather than the electromagnetic suspension principle, vehicle movement was required to generate levitation. Levitation speed was expected to be within the range of 15–30 mph. However, by using active levitation coils in the guideway instead of passive coils for normal running vehicles, levitation at zero speed was a goal.

Propulsion was to be provided by LSM coils on the guideway whose alternating fields interact with the vehicle's superconducting magnets. Guidance forces were also to be provided by the interaction of magnets with the guideway coils.

**Guideway**

The guideway was envisioned as a deep, narrow, reinforced, hollow, rectangular, 72-ft-long beam. The guideway coils were to be attached to the sides of the guideway. These consisted of propulsion coils, 8-shaped null flux levitation coils, and coils to provide guidance forces. The piers or supporting columns were to be 72 ft apart. No details were given on the required size of the columns and depth or size of the foundation. A schematic of the Maglev 2000 guideway is shown in Figure B-18.

**Figure B-18**

Schematic of  
Maglev 2000 Guideway

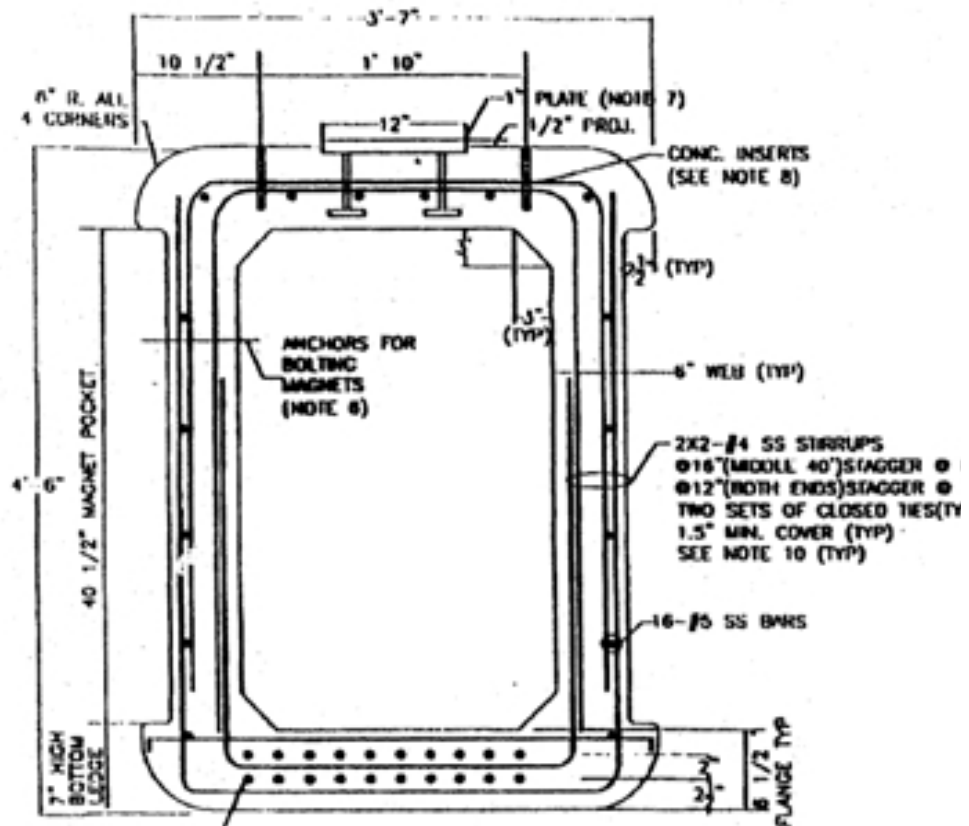

**Vehicle**

The vehicle is made of aluminum skin with stiffeners in both longitudinal and transverse directions. For suburban applications, a larger vehicle is proposed at a maximum operating speed of 150 mph. For urban operations, the vehicle runs at a maximum speed of 100 mph. The suburban maglev vehicle can carry 100 passengers, is 117 ft long, and weighs 80,000 lbs. The urban vehicle carries 50 passengers, weighs 55,000 lbs, and is 50 ft long. Both levitate at a speed



of 30 mph on a non-powered guideway, and both are apparently designed for 0.2 g acceleration and deceleration rates. Figure B-19 shows the long vehicle. The internal layout of the vehicle is shown in Figure B-20.

**Figure B-19**

*Maglev 2000 117-Ft Vehicle*

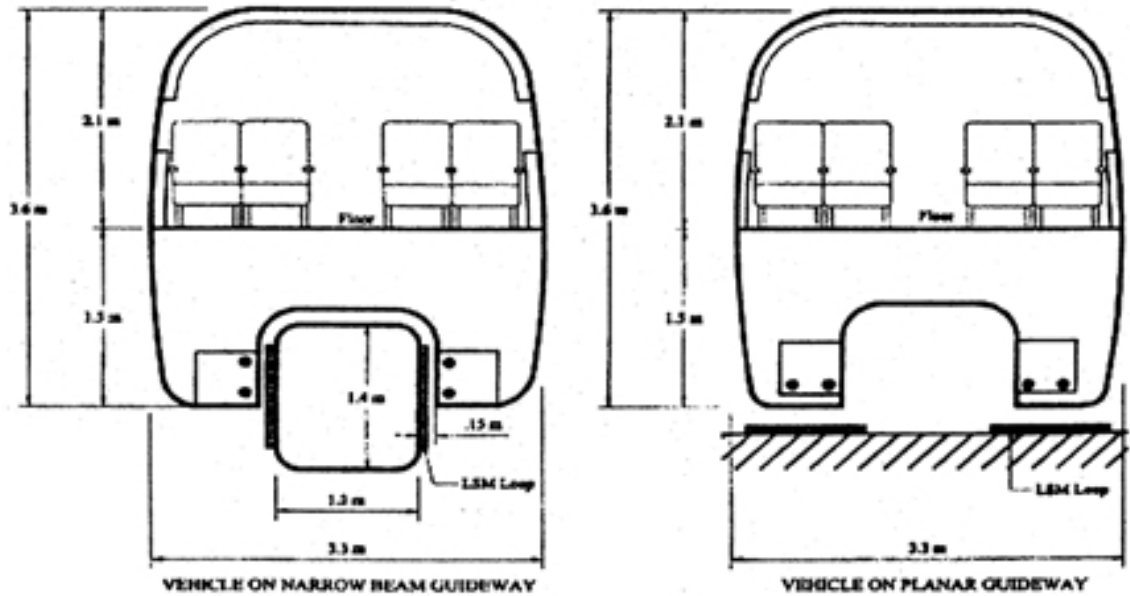

**Figure B-20**

*Maglev 2000 Vehicle Internal Layout*

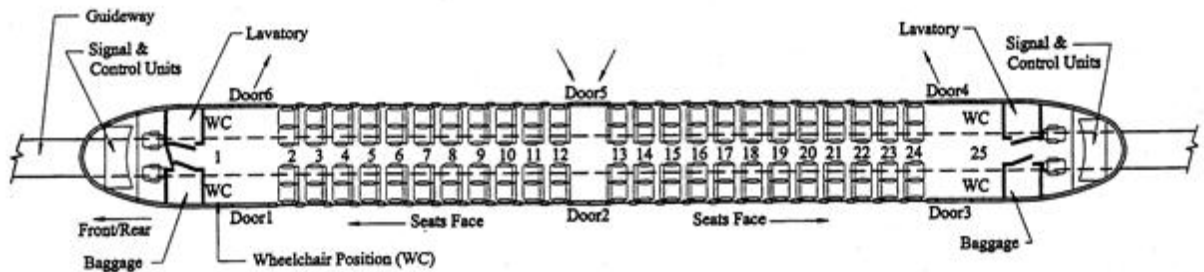

The vehicles carry superconducting quadrupoles on each side plus a central refrigeration system for a close operation of the liquid helium to keep the superconducting niobium-titanium magnet wire at about 4° K. A schematic of the quadrupole arrangement is shown in Figure B-21.

**Figure B-21**

*Arrangement of Multiple Quadrupole Magnets on Maglev 2000 Vehicle*

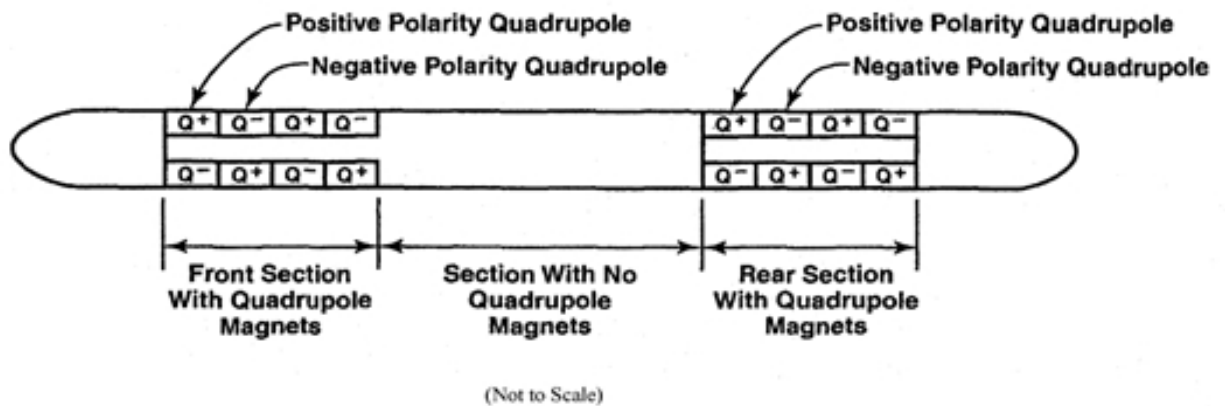

Although the repulsive system is supposed to be inherently stable, there can be roll and lateral oscillations due to the guideway irregularities or non-centered levitation coils on either side of the guideway. In such scenarios, active control may be required for stability, which is achieved by passing current through the 8-shaped levitation coils.

### **System Characteristics**

A summary of Maglev 2000 system characteristics is presented in Table B-II.

**Table B-11***Summary of System Characteristics (Maglev 2000)*

System Item	Characteristic or Measurement
<i>I. Operational Characteristics</i>	
Max. operation speed	100 mph (short vehicle), 150 mph (long vehicle)
Max. initial acceleration 4.0	0.2 g
Max. deceleration service brake	0.2 g
Max. deceleration emergency brake	Unknown
Max. gradient	Unknown
Min. horizontal curve radius	300 m reduced speed
Min. vertical curve radius	Unknown
Max. super elevation angle	Unknown
Passenger capacity for single-car train	50 (short vehicle), 100 (long vehicle)
Temperature	-10°C to 40°C (50°F to 104°F)
Max. wind velocity (operational)	> 50 mph
<i>II. Vehicle Configuration</i>	
Vehicle type	Ellipsoidal Aero shell with aluminum skin with stiffeners
Train formation	Single cars
Car body length	50 ft short vehicle, 117 ft long vehicle
Car body width	3.35 m (11 ft) long vehicle
Car height	3.96 m (13 ft) long vehicle
Rail gauge	1.21 m (3.97 ft)
Empty weight (long veh.)	27,300 kg (60,000 lbs)
Fully-loaded weight (AW2) (long veh.)	40,000 kg (88,000 lbs)
Car body structure – material	High strength aluminum alloy
Car body structure – construction	Skin/stringer
<i>III. Levitation System</i>	
Magnet	Liquid-helium-cooled superconducting electrodynamic system with 8-shaped sidewall levitation
Levitation gap	> 4 in.
<i>IV. Propulsion System</i>	
LSM (Linear Synchronous Motor)	100 ft block length
Power supply	5KV LVDC distribution line on guideway
<i>V. Suspension System</i>	
Suspension	5 flexible pair-modules per car (module: levitation bogie trucks)
Module frame	Aluminum alloy chassis
Secondary suspension	Air suspension
<i>VI. Brake System</i>	
Service brake	Combination of LSM brake (regenerative) and hydraulic brake
Emergency brake	Hydraulic brake
Parking brake	Skids (levitation cut off)

### Contractor Estimated Costs

Prior to 2005, Maglev 2000 provided estimated costs for fixed facilities, vehicles, and operating costs. A specific system and route network description was not provided, so all costs are for separate components; i.e., completed guideway per two-way mile, individual stations (without station spacing or a network description), two different styles of vehicles, etc. The operation and maintenance cost data reflects a high-speed (300 mph max) system, 240 miles in length with 6 stations, each having different choices for configurations. These choices arise out of Maglev 2000's statement that depending on capacity and demand, various combinations of off-line sidings, switches, etc. would need to be provided, making overall costing possible only with a defined system configuration. Further, no low-speed, urban-style maglev system configuration was identified, and this has a much different effect on costs due to frequent stations and slower speeds, but high demand and throughput.

### Guideway

Maglev 2000 provided the elements shown in Table B-12 for a two-way basic, narrow beam guideway.

**Table B-12**  
Guideway Cost Breakdown

Item	Cost/2 Way Mile (million)
Guideway beams	\$4.48
Loop panels (coil sets)	\$3.25
Footings & piers	\$1.11
Erection (structure)	\$0.84
Power & distribution	\$1.42
Safety systems	\$0.16
Communication & Control	\$0.11
<i>Total</i>	<i>\$11.37</i>

### Vehicles

Two different vehicles were costed: a 20-metric ton (MT), 50-passenger vehicle and a 40-MT, 100-passenger vehicle. The guideway above is costed for the larger vehicle, but the guideway cost for the smaller vehicle is only \$1 million less per mile. Which of these was intended for consideration was not specified. These apparently do not operate in consist. The construction is identified only as airplane-type, which is taken to mean aluminum sheet-stringer fuselage construction. The larger vehicle is 123 ft long, and the smaller vehicle is still on the order of 70 ft. With either, there is the issue of turn radius, especially with urban networks, that would seem to be inconsistent with that application. Again, the system for which this data was constructed seems to be a high-speed, long-distance network with gentle curves only. Table B-13 shows the vehicle cost breakdown.

**Table B-13**

Vehicle Cost Breakdown

Item	Cost/50 Passenger Vehicle (million)	Cost/100 Passenger Vehicle (million)
Vehicle body	\$0.19	\$1.14
Superconducting magnets	\$1.14	\$2.28
Cryo & refrigeration systems	\$0.74	\$1.13
Ride control systems	\$0.22	\$0.22
Safety systems	\$0.83	\$1.13
Communication & Control	\$0.07	\$0.07
<i>Total</i>	<i>\$3.74</i>	<i>\$5.97</i>

**Fixed Facilities**

Three different types of facilities were identified and costed: passenger stations, maintenance, and traffic control. Again, no specific low-speed, urban-style maglev system configuration system was identified, and the actual number of each facility type was not defined relative to guideway and vehicles. Additionally, the station size and costs were highly dependent on the combinations of off-line sidings, switches, etc., that would be needed, making overall costing possible only with a defined system configuration. The powered guideway sections (not costed) would need to be accounted for either in guideways or in stations.

Table B-14 presents the facilities costed as individual items.

**Table B-14**

Fixed Facility Cost Breakdown

Item	Cost/Facility (million)
Passenger/Freight Station	
No off-line guideway	\$14
Off-line guideway; higher turnout speeds	\$39
Station	\$64
Maintenance facility	\$3.4
Traffic control facility	\$1.88
<i>Total</i>	<i>\$122.28</i>

**Operation and Maintenance Costs**

These are provided for a high-speed system only: 240 miles long (two-way), average speed of 240 mph, and 5,000,000 passenger trips annually. This latter is an order-of-magnitude less than the urban, low-speed system. Also, since only six stations are included, the operating characteristics of this network are widely different than the low-speed, dense, urban network under consideration in this study.

The same two (50- and 100-passenger) vehicles were costed, as expressed in operating cost per vehicle mile with 60 percent load factor. Table B-15 presents the operations and maintenance cost breakdown.

**Table B-15**

*Operation and  
Maintenance Cost  
Breakdown*

Item	Cost/Mile 50 Passenger Vehicle (million)	Cost/ Mile 100 Passenger Vehicle (million)
Operating personnel	\$0.69	\$1.23
Energy	\$0.56	\$0.73
Materials & equipment	\$0 .20	\$2.40
<i>Total</i>	<i>\$2.45</i>	<i>\$4.36</i>

# MagneMotion Maglev M3 Cost Model

## Executive Summary

MagneMotion (MMI) is pleased to present this report for Task 3 related to furthering the development and deployment of the MagneMotion Maglev (M3) technology in the transit industry. This document includes the information required in Federal Transit Administration (FTA) sponsored Science Applications International Corporation (SAIC) Purchase Order for Task 3.

## M3 Cost Model

The cost model presented herein has evolved over the course of the Urban Maglev Program, Cooperative Agreement Project MA-26-7111. Herein, we provide the cost for commercialization of M3, the Operation and Maintenance cost estimate, and the capital costs for a variety of system configurations. The capital cost estimates are based on the actual Bill of Materials (BOMs) developed during the program.

In Phase I, MagneMotion designed, built, integrated, and tested 48 meters of track and a test sled for the indoor test facility at MMI. As a deliverable for Phase 2, we built, delivered, integrated, and tested 75 meters of track at ODU and a second test sled. In total, MagneMotion has built 123 meters of track, 2 rectifier cabinets, 5 inverter cabinets, 20 track-side position sense boxes, and 2 test sleds. The costs associated with these deliverables serve as the baseline for our cost model. Costs are provided for both an elevated system and an at-grade system for passenger capacities of 3,000, 6,000, and 12,000 people per hour per direction (pphd). Costs per km and per mile are provided for dual guideway systems.

## Commercialization Plan and Costs

MagneMotion has defined the project plan for completing development of the M3 system for commercial deployment. It is envisioned that this project will be executed in cooperation with another company or group of companies. The overall objective is to commercialize MMI's M3 system for the worldwide market. We have prepared a detailed program plan and Statement of Work for the commercialization of this technology.<sup>6</sup>

The commercialization plan consists of several major program elements, starting with overall program planning and concluding with operational test facilities that demonstrate all aspects required of a commercial system. Some of the program

---

<sup>6</sup>990000510 MMI Maglev [M3] Statement of Work for Commercialization, 2012.

elements will be sequential, others run in parallel, and still others have tasks that run through the entire project. A high level summary of the plan is provided in the following sections.

### ***Project Management and System Engineering***

The plan consists of a project management and system engineering function that includes project management, resource and facilities planning, trade studies, safety program implementation, safety standards and certification, test and reliability, sourcing, manufacturing strategy, and technology transfer.

### ***Design Updates***

It will also be necessary to update the M3 design based on lessons learned from our initial testing, and to design those elements that do not yet exist. Engineering tasks include, but are not limited to, wayside cabinet design, PCB and electronics update, straight and curved track design, switch design, ride quality modeling, vehicle suspension design, vehicle design, control architecture, and execution of a safety program. We will update and perform quality audits on control software and examine all components from a manufacturing perspective in an attempt to lower production costs.

### ***Test and Safety Certification***

Concurrent with the engineering effort, we will be building a test facility and several test tracks. The initial test facility will include three 30 m straight sections. The test guideway can accommodate more than one sled. This facility may be used to train engineers in the operation of the M3. The Straight Test Facility will not be certified for carrying passengers, as the safety and redundancy systems are not included. The initial Straight Test Facility will be augmented with a 50 m (164 ft) or smaller radius flat curve and a 1,000 m (3,280 ft) or smaller radius vertical curve for incline transition.

A larger Test Facility will be required for integrating and testing the super elevated curves and switches. It is envisioned that the longer and more comprehensive test track will be approximately 2 km (1.2 mi) and will be designed for peak speeds that support 12,000 pphpd capacity, though the peak speed obtainable will be dependent on the final guideway layout. The layout will have parallel guideways with turnaround loops at each end. At one end, the turnaround will be a gradually decreasing radius super-elevation loop. The other end will be a small radius flat curve (50 m). One of the parallel guideways will include an inclined element or "hill." The guideway will be built with U.S.-sourced beams.

It is estimated that the complete commercialization program including the test tracks, safety certification, and setting up manufacturing facilities will cost between \$100 and \$150 million USD and will require five years to complete.



## Operations and Maintenance Costs

Operation and maintenance cost for the M3 system is expected to be 30–50 percent of a traditional transit system. Manpower required to operate and maintain the vehicles is reduced, as are the needs for spares and power.

### **Operations Cost**

Labor cost for the system will be greatly reduced. No operators are required in the vehicles. We envision one operator at each station or group of stations to monitor traffic routing and vehicle status.

The largest cost of operation other than labor will be energy. We estimate that the M3 will require about 100 watt-hours per passenger mile, which is substantially below traditional rail. The energy intensity in Wh/pas-mi for commuter rail is 289, for heavy rail 344, and for light rail 410. These energy intensity values are for 2010,<sup>7</sup> with 1 Wh = 10.46 BTU based on an assumed efficiency of 33 percent in converting fossil fuel energy to electric energy. This reduced energy intensity is due to the use of smaller vehicles that allow better matching of supply to design, lighter weight and more streamlined vehicles, and efficient suspension and propulsion.

It is estimated that the complete commercialization program including the test tracks, safety certification, and setting up manufacturing facilities will cost between \$100 and \$150 million USD and will require five years to complete.

### **Maintenance Cost**

Since there is no need to transfer propulsion power to the vehicle, a high maintenance catenary or third rail power system is not required. Power for onboard HVAC, communication, and control is modest and can be provided by a non-contacting inductive power transfer system that is operative at all speeds.

Track maintenance should be limited to inspections and replacement of wayside electronics. Vehicle maintenance is limited to inspections and the occasional cleaning of the magnetic surfaces on the vehicles. There are no wheels, rotary motor bearings, or gears that require frequent and expensive maintenance.

Public transit organizations frequently spend at least 50 percent of their budgets on operational maintenance personnel. We believe that the total maintenance cost for M3 will be less than 10 percent of a comparable transit system. The equipment provider for Transrapid has stated that the Shanghai Transrapid equipment (material) maintenance requirements are less than 10 percent of what would be expected for a high speed rail system of similar length.

---

<sup>7</sup>U.S. Transportation Energy Book, July 2012.

## Cost Model – Basis of Estimate

As a baseline, we have used cost data from the Bill of Materials (BOM) and labor hours incurred for the components that we fabricated during both Phase 1 and Phase 2 of this project. For items that were not part of this project, we have included estimates from vendors. We discounted our actual BOM costs by 15 percent to reflect the benefits of a commercialization plan, including design for manufacture, and anticipated volume breaks. Obtaining cost data for a complete transit system is a challenge. Frequently, the cost figures reported in trade journals and popular press include civil works and station costs, and rarely is the passenger carrying capacity of the system revealed. We are presenting several options in the model below so the reader can readily compare our estimated costs with other systems on a system component basis.

In the following sections each component is estimated and assumptions are discussed. Note that the guideway is defined to be the concrete beam and the supporting track structure mounted to the beam. Note also that estimates provided for curves and switches are based on concept designs as that is all that exists for those components.

### **Beams**

Our beam estimate comes from two civil engineering companies that are familiar with bridge building and our design. During Phase I, we enlisted the services of Hoyle Tanner of Manchester, NH, to reverse engineer the design of the ODU beam so that we could manufacture two beams for our indoor test facility. During that process, we were able to share with Hoyle Tanner a beam design optimized for M3 and obtain an estimate for that beam. We also maintain a relationship with a bridge consultant now at Kiewit Engineering, who was able to give us a second opinion on beam costs as well as some metrics on what longer beams might cost and the scaling factors associated with using vehicles heavier than the base line M3 15 ton vehicle.

### **Track Structure**

The M3 track structure provides support for the LSM stators and touchdown surfaces for the M3 vehicle. It also provides provisions for cabling attachment points for the block switches. For this project, 12 and 15-meter track structures were developed in order to fit on the pre-existing beams at ODU. For the cost model, we have normalized on an “ideal” 30 m beam length.

### **Straight 30-Meter Guideway**

The guideway consists of a concrete beam and the supporting track structure mounted to the beam. The concrete beam could be replaced by steel for longer spans or other supporting material provided it was stiff enough to meet system requirements. A typical elevated 30 m guideway with concrete beam and track

structure would cost approximately \$117,000, not counting the piers that hold the beam. The same guideway at grade is estimated to cost \$109,000.

### **Switches**

The concept design for M3 switches is for a translating platform that holds two beams. The base plate is 14 m × 11 m, and the entire movable structure is estimated to have a mass of about 20 Mg. Two sets of LSM stators and magnets create enough force to move the base plate 3.5 m in 5–6 seconds, including time to disengage and engage mechanical locking mechanisms. This is comparable to the fastest railway switches. It is estimated that the cost of the switches will be 3 times the straight 30 m guideway section or approximately \$350,000.

### **Curves – Flat and Super Elevated**

The cost estimates for curves depend on whether they are at grade or elevated. A flat curve at grade is estimated to be 1.25 times the cost of a straight 30 m guideway beam at grade, or approximately \$137,000. An elevated flat curve is estimated to be 1.5 times the cost of a straight section of guideway, or approximately \$175,000, the cost increase being due to the to the complexity of the casting and the added piers that hold the beam. Super elevated curves are estimated to be two times the cost of a straight 30 m beam due to the complexity of the casting and track weldment, or approximately \$235,000.

### **Rectifier Cabinet – Power Requirement**

The rectifier cabinet and transformer cost is based on the MMI rectifier design used for our test systems scaled by the number of vehicles and stations served by the rectifier/transformer pair. The cost of an operational power system will depend on the system average load. The M3 vehicles operate in groups or clusters of at least two vehicles. The vehicles do not accelerate at the same time to minimize the peak load. The peak load can be approximated by calculating the vehicle maximum thrust times the maximum speed that thrust is applied. For our baseline vehicle, the maximum thrust is 14 kN and typically the maximum speed where that thrust is applied is 25 m/s. Hence, the peak load from one vehicle while accelerating out of a station is 350 kW. To account for transmission and stator losses, we estimated 400 kW for each direction per station. Decelerating vehicles regenerate power back onto the bus. In an installation with many vehicles, the peak and average power loads should approach one another because some vehicles will be accelerating and others decelerating at the same time.

Our model distributes the cost of the rectifier/transformer pair over a 5 km section of track. The number of rectifiers and locations along the track will depend on the load and the location of high voltage power lines. We have estimated that at cruise speed each vehicle will require 80 kW.

***Inverter Cabinet***

The inverter cabinets contain the inverters, filters, and motor controller electronics. We have added a 50 percent cost increase (relative to our present hardware) for higher power inverter and filter hardware. The higher power components are required to achieve the top design speed of 45 m/s. All other components in the cabinet reflect the current design.

***Position Sense and Block Switches***

The position sense boxes are mounted on each track section. In an operational system, the position sense functionality will most likely be combined in the same box as the block switch function. The position sense box BOM was used as a cost basis for that functionality, and a material estimate for block switching from another development effort at MMI of a similar power level was added to the estimate.

***Vehicle/Test Sleds***

The test sleds consist of an aluminum frame that supports the payload, the levitation pods, and the levitation and control electronics. It is envisioned that the aluminum structure that was fabricated for the test sleds will be integrated into the body of the operational passenger-carrying vehicle. Our cost model includes the cost for the levitation pods, control electronics, and batteries necessary for levitation and control. We have also included an estimate for a commercial vehicle that is based on discussions with vehicle manufacturing companies. The 40-passenger concept vehicle consists of 2 sections, each supported by a levitation pod.

***Civil Works***

For simplicity purposes, we have not included any civil works that would be required for excavation and preparation of an at grade system or for any pier shaft drilling of foundations. It is thought that these costs would be comparable with any dual way transit system. Our cost for a system at grade includes a beam, but not any fencing or signaling that would be required. We also have estimated the cost of an elevated system on 15-ft piers.

***Stations***

The cost of constructing a transit station varies widely independent of land acquisition costs. They depend, in part, on design, local labor rates, and volume of passengers. We have used a value of \$750 per sq ft, which is close to the average of two recent new LEED certified transit structures. Akron, Ohio's, intermodal transit station cost approximately \$1,000 per sq ft and Charlottesville's LEED certified transit center was estimated to cost \$458 per sq ft.

Our model consists of a simple station that has no interconnections with other transit systems. The simple elevated platform would span the gap between guideways and extend 12 ft beyond the guideway on either side. Passengers

would load from the 12-ft-wide platform on the outside of the guideway and disembark onto the 12-foot wide platform between the guideways. The station at vehicle level would be a total of  $(12+8+12+8+12) = 60$  ft wide by 36 ft long to accommodate each 32-ft-long vehicle plus 4 ft. The rough estimate for stations that could accommodate the 3,000 pphpd, 6,000 pphpd and 12,000 pphpd is calculated by multiplying the simple station by the number of vehicles expected in a cluster.

## Cost Data

In this section, we present the estimated costs for a variety of system configurations. The summary table below presents the cost per kilometer estimated for three different capacity systems with different station spacing.

The number of vehicles per km varies with capacity. System capacity is stated in units of pphpd, which is calculated by the equation:  $\text{pphpd} = \text{vehicle/km} \times \text{km/hr} \times \text{passenger/vehicle}$ , where km/hr is the average vehicle speed. The estimated average speed with a station every km is about 15 m/s, while with 5 km spacing the speed will be about 25 m/s. This means that, for capacity of 3,000 pphpd, the system would require 1.4 vehicles per km per direction, or 2.8 for a dual guideway.

As documented in our system approach, the system depends on clusters of vehicles moving as a virtual train. Our modeling indicates that with a cluster of four vehicles the highest capacity is about one cluster per minute. The limiting factor on this time is how fast people can get in and out of the vehicles. One cluster a minute gives a capacity of 9,600 pphpd. However, not all vehicles need stop at all stations. At peak times, the system employs a station skipping technique to achieve the required vehicles per hour. One could also increase vehicle size, but that has significant cost impact on the guideway and power electronics. Larger vehicles would be required for capacities greater than 12,000 pphpd.

The cost information below is presented for capacities of 3,000, 6,000, and 12,000 pphpd. The difference in the costs between these systems is due to changes in the number of vehicles, the number of inverter cabinets and control blocks, and the DC power supply which scales with the average power load.

For each capacity system, we have estimated the cost of 1 km of the system at-grade and on elevated piers. The at-grade guideway cost was estimated to be 40 percent of the elevated guideway costs. Estimates are provided for systems with stations that are 1 km and 5 km apart. In the case of the 12,000 pphpd system in a dense urban setting, an estimate with stations 0.5 km apart is provided.

**Table C-1**

System Cost as a Function of Capacity and Station Spacing (\$k USD per km)

	System Capacity								
	3,000		6,000		12,000				
Station spacing (km)	1	5	1	5	0.5	1	5		
At-grade (\$K)	\$14,621	\$13,661	\$17,890	\$16,083	\$25,021	\$22,992	\$22,486		
Elevated 20' (\$K)	\$17,634	\$16,674	\$20,903	\$15,696	\$27,476	\$26,005	\$21,926		
Vehicles per km both ways	3	2	6	3	11	11	7		
Station (ft <sup>2</sup> )	3332	3332	4996	4996	6660	6660	6660		
Estimated station cost (\$K)	\$2,499	\$2,499	\$3,747	\$3,747	\$4,995	\$4,995	\$4,995		

Figure C-1, C-2, and C-3 provide the relative component cost for dual guideway elevated systems at three different capacities, with 1 km station spacing. The station costs have been excluded as it can vary widely based on local requirements. The component costs are grouped together so that one can see their relative contribution to the total. The key to driving down total system cost is to reduce the cost of the most expensive items. In our case, we are able to reduce the cost of the concrete beam, piers, and steel track structure because of some very fundamental system design decisions we made early on, specifically, 1) use smaller vehicles with close headway to spread the weight of the vehicles and reduce the structural requirements of the guideway, and 2) use a permanent magnetic EMS technology that uses one magnetic structure with a 17 mm nominal gap to reduce the mechanical tolerances. In contrast, the Transrapid guideway is four times the mass of the M3 system since it supports much larger vehicles, and the mechanical tolerances for that system have to be much tighter as they require control of two 8 mm magnetic gaps. The next biggest contributor to system cost is the LSM stators and position sense equipment. We believe there are opportunities in the commercialization phase to reduce the cost of these components and the reason why we reduced our most recent buy activity by a conservative 15 percent.

**Figure C-1**

Dual Elevated Guideway – 3,000 pphpd

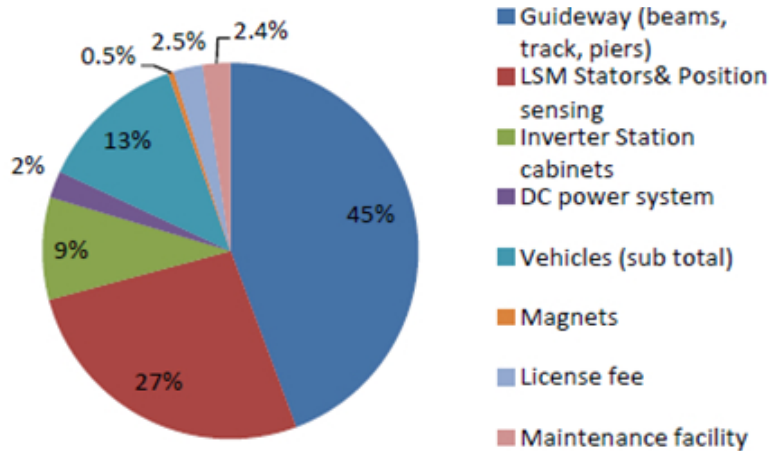

**Figure C-2**

Dual Elevated Guideway –  
6,000 pphpd

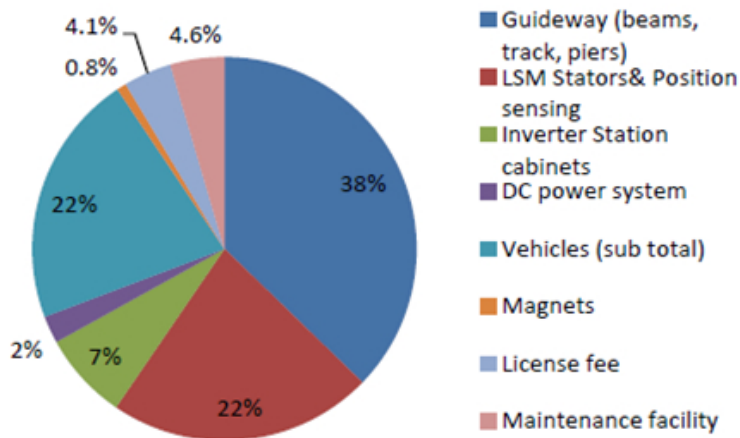

**Figure C-3**

Dual Elevated Guideway –  
12,000 pphpd

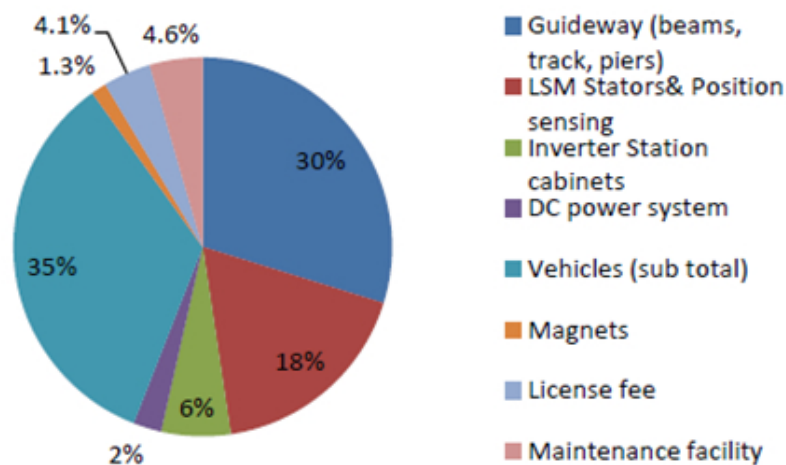

Note that as the systems are expanded to accommodate higher capacities the number of vehicles increase and the cost of vehicles as a percent of the total increases from 13–35 percent. We have broken out the magnet cost as it is often mentioned as an area of concern. From these data, one can see that the magnet cost is a very small percentage (1.3%) of the system cost, even for a system with 11 vehicles per kilometer of track.

The information in Tables C-2, C-3, and C-4 provides the details of component costs and their contribution to the system cost for 3,000, 6,000, and 12,000 pphpd systems with 1 km station spacing. The cost of the stations is not included as that will vary depending on local requirements, but the cost of the power electronics for the station is included. We are quoting a straight track only since every system will have a different composition of straights, turns, and switches, etc. We have provided information in later sections for others to configure their own price model based on different track configurations.



**Table C-2***Dual Elevated Guideway – 3,000 pphpd*

Parameter	Units/km	\$K each	\$K/km	\$K/mile	% of cost
<b>Guideway Infrastructure (sub total)</b>			<b>\$7,852</b>	<b>\$12,637</b>	<b>45%</b>
Guideway beams	67	42	2,789	4,488	16%
Guideway piers	67	20	1,340	2,157	8%
Track support structure	67	56	3,724	5,992	21%
<b>LSM/Position sensing (sub total)</b>			<b>4,695</b>	<b>7,557</b>	<b>27%</b>
LSM stators & position sensing	67	69	4,593	7,391	26%
Guideway installation and cables	67	2	103	166	1%
<b>Electrification/Control (sub total)</b>			<b>1,969</b>	<b>3,168</b>	<b>11%</b>
Inverter station cabinets	16	97	1,559	2,509	9%
DC power system	1	409	409	659	2%
<b>Vehicles (sub total)</b>	<b>2.8</b>	<b>810</b>	<b>2,252</b>	<b>3,625</b>	<b>13%</b>
Magnets	3	31	85	137	0.5%
<b>System (sub total)</b>			<b>16,769</b>	<b>26,987</b>	
License fee	1	446	446	717	3%
Maintenance facility			419	675	2%
Contingency, 0%			0	0	0%
<i>Total</i>			<i>17,634</i>	<i>28,379</i>	<i>100%</i>

**Table C-3***Dual Elevated Guideway – 6,000 pphpd*

Parameter	Units/km	\$K each	\$K/km	\$K/mile	% of cost
<b>Guideway Infrastructure (sub total)</b>			<b>\$7,852</b>	<b>\$12,637</b>	<b>38%</b>
Guideway beams	67	42	2,789	4,488	13%
Guideway piers	67	20	1,340	2,157	6%
Track support structure	67	56	3,724	5,992	18%
<b>LSM/Position sensing (sub total)</b>			<b>4,695</b>	<b>7,557</b>	<b>22%</b>
LSM stators & position sensing	67	69	4,593	7,391	22%
Guideway installation and cables	67	2	103	166	0%
<b>Electrification/Control (sub total)</b>			<b>2,043</b>	<b>10,538</b>	<b>10%</b>
Inverter station cabinets	16	97	1,559	2,509	7%
DC power system	1	484	484	779	2%
<b>Vehicles (sub total)</b>	<b>5.6</b>	<b>810</b>	<b>4,505</b>	<b>7,249</b>	<b>22%</b>
Magnets	6	31	171	275	0.8%
<b>System (sub total)</b>			<b>19,096</b>	<b>30,731</b>	
License fee	1	853	853	1,372	4%
Maintenance facility	1	0	955	1,537	5%
Contingency, 0%			0	0	0%
<i>Total</i>			<i>20,903</i>	<i>33,640</i>	<i>100%</i>

**Table C-4***Dual Elevated Guideway – 12,000 pphpd*

Parameter	Units/km	\$K each	\$K/km	\$K/mile	% of cost
<b>Guideway Infrastructure (sub total)</b>			<b>\$7,852</b>	<b>\$12,637</b>	<b>30%</b>
Guideway beams	67	42	2,789	4,488	11%
Guideway piers	67	20	1,340	2,157	5%
Track support structure	67	56	3,724	5,992	14%
<b>LSM/Position sensing (sub total)</b>			<b>4,695</b>	<b>7,557</b>	<b>18%</b>
LSM stators & position sensing	67	69	4,593	7,391	18%
Guideway installation and cables	67	2	103	166	0%
<b>Electrification/Control (sub total)</b>			<b>2,192</b>	<b>3,528</b>	<b>8%</b>
Inverter station cabinets	16	97	1,559	2,509	6%
DC power system	1	633	633	1,018	2%
<b>Vehicles (sub total)</b>	<b>11</b>	<b>810</b>	<b>9,001</b>	<b>14,486</b>	<b>35%</b>
Magnets	11	31	341	549	1.3%
<b>System (sub total)</b>			<b>23,741</b>	<b>38,207</b>	
License fee	1	1,077	1,077	1,734	4%
Maintenance facility		0	1,187	1,910	5%
Contingency, 0%			0	0	0%
<i>Total</i>			<i>26,005</i>	<i>41,852</i>	<i>100%</i>

## Summary

MagneMotion has addressed capital, operations, and maintenance costs from the very beginning of the Urban Maglev project. The choice of small lightweight vehicles traveling as a virtual train allows for reductions in the guideway costs, while meeting high passenger demand. LSM propulsion with permanent magnets allows for the use of a wider gap system, which lowers the mechanical tolerances that have to be held in the field, further lowering system costs. The vehicles require no wheels or brakes, which reduces the weight of the vehicles and the maintenance costs associated with these high wear items. No power has to be transferred to the vehicle so there is no third rail or catenary line, which are typically high maintenance items in most transit systems and in some maglev designs.

This project enabled us to build and test the prototype and develop a baseline cost structure. With a commercialization phase to improve manufacturing techniques, and greater volume associated with a commercial system, we have reduced our baseline number by a conservative 15 percent. We believe more savings could be realized. As an example, we could create a beam from standard bridge forms that is a little wider than the one used in our prototype. This would lower the price of the beam and allow us to reduce the cost of the steel track structure. A second example is in the construction and winding of the stators. The winding scheme

and the methods for constructing the stators can be improved to lower both the material and labor costs. A third example is the means to power track sections. Rather than providing an inverter per motor block (section of track), we can reduce the number of inverters by using relatively inexpensive thyristor switches to switch power between active and inactive stator blocks.

In conclusion, we believe the M3 system provides a high capacity urban transit system that uses less than half the energy of a comparable rail transit system<sup>8</sup> at a competitive price and with a vastly reduced O&M costs.

---

<sup>8</sup>Thornton, R.D., "Efficient and Affordable Maglev Opportunities in the United States," *Proceedings of the IEEE*, Volume 97, Number 11, November 2009.

## GLOSSARY

**Alignment** – The route or path of a maglev guideway.

**Electrodynamic suspension (EDS)** – A form of suspension that uses the repulsive force of magnets to suspend a vehicle above a track. Such systems are inherently stable and do not need active levitation control.

**Electromagnet** – A magnet comprised of a coil of insulated wire wrapped around a soft iron core that is magnetized only when current flows through the wire

**Electromagnetic suspension (EMS)** – A form of suspension that uses the attractive force of magnets to suspend a vehicle above a track. Such systems are inherently unstable and need active levitation control.

**Gap control** – The process of maintaining a constant nominal distance between the track and the magnets that are levitating the vehicle.

**Guideway** - A riding surface (including support structure) that physically guides vehicles specially designed to travel on it.

**Halbach array** – An arrangement of permanent magnets that augments the magnetic field on one side of the device while cancelling the field to near zero on the other side. The Halbach array repels buried loops of wire after the vehicle has been accelerated to a low speed, creating suspension of the vehicle.

**Hybrid girders** – Guideway girders that are made of a combination of reinforced concrete—which provides rigidity, noise absorption, and low cost—and structural steel which provides strength.

**Headway** – The interval between the arrival of the front ends of successive vehicles moving in the same direction along the same lane, track, or other guideway.

**Induction motor** – An type of motor in which an electric current flowing in the motor’s secondary member (the rotor) is induced by the alternating current flowing in its primary member (the stator). The power supply is connected only to the stator. The combined electromagnetic effects of the two currents produce the force to create rotation.

**Linear Induction Motors (LIM)** – A linear induction motor provides linear force and motion rather than rotational torque. See Induction motor.

**Linear Synchronous Motors (LSM)** – Long-stator motors driven by primary coils installed on the guideway, and energized in synchronization with the forward (linear) motion of the vehicle.

**Litz wire** – From the German word “litzendraht,” meaning woven wire. Generally, it is a wire constructed of individual film-insulated wires that are

bunched or braided together in a uniform pattern of twists and length of lay. This multi-strand configuration minimizes the power losses otherwise encountered in a solid conductor due to the tendency of radio frequency current to be concentrated at the surface of the conductor.

**Low-speed magnetic levitation** – A somewhat arbitrary concept (defined by FTA as below 100 mph top speed) referring to maglev systems optimized for an urban transit function rather than a long distance transport function.

**Maglev** – Magnetic levitation.

**Magnetic gap** – The distance between the magnet and the metal structure that is levitated by means of magnetic attraction or repulsion. The smaller the gap, the lower the current or the smaller the volume of magnetic material (permanent magnet or steel) needed to reach a given magnetic field, however tolerance requirements become more challenging and costly.

**Magnetic levitation** – Supporting and locating a vehicle above or below a guideway through the action of (electro)magnetic forces.

**Permanent magnets** – A magnet that retains its magnetism after being removed from a magnetic field.

**Propulsion coils** – Embedded in the guideways, these loops of superconducting wire allow an alternating current to flow through them, causing a continuously varying magnetic field. The coils can have a variety of shapes, and the current flowing through them induces magnetic poles in both the top and bottom halves, ensuring that the magnets on the maglev vehicle are repelled by the bottom half and attracted by the top half, resulting in levitation.



U.S. Department of Transportation  
Federal Transit Administration

---

East Building  
1200 New Jersey Avenue, SE  
Washington, DC 20590  
<http://www.fta.dot.gov/research>