



U.S. Department of Transportation  
Federal Highway Administration

Publication No. FHWA-NHI-10-034  
December 2009

---

# Technical Manual for Design and Construction of Road Tunnels — Civil Elements



NATIONAL HIGHWAY INSTITUTE

*Training Solutions for Transportation Excellence*

## **NOTICE**

**The contents of this report reflect the views of the authors, who are responsible for the facts and the accuracy of the data presented herein. The contents do not necessarily reflect policy of the Department of Transportation. This report does not constitute a standard, specification, or regulation. The United States Government does not endorse products or manufacturers. Trade or manufacturer's names appear herein only because they are considered essential to the objective of this document.**

**Technical Report Documentation Page**

|  |  |  |  |                            |           |
|--|--|--|--|----------------------------|-----------|
| 1. Report No.<br>FHWA-NHI-10-034   |  | 2. Government Accession No.                          |  | 3. Recipient's Catalog No. |           |
| 4. Title and Subtitle<br>TECHNICAL MANUAL FOR<br>DESIGN AND CONSTRUCTION OF ROAD TUNNELS –<br>CIVIL ELEMENTS   |  |  | 5. Report Date<br>December 2009                    |                            |           |
|  |  |  | 6. Performing Organization Code                    |                            |           |
| 7. Author(s)<br>Principal Investigators:<br>C. Jeremy Hung, PE, James Monsees, PhD, PE, Nasri Munfah,<br>PE, and John Wisniewski, PE   |  |  | 8. Performing Organization Report No.              |                            |           |
| 9. Performing Organization Name and Address<br>Parsons Brinckerhoff, Inc.<br>One Penn Plaza, New York, NY 10119  |  |  | 10. Work Unit No. (TRAIS)                          |                            |           |
|  |  |  | 11. Contract or Grant No.<br>DTFH61-06-T-07-001    |                            |           |
| 12. Sponsoring Agency Name and Address<br>National Highway Institute<br>U.S. Department of Transportation<br>Federal Highway Administration, Washington, D.C. 20590  |  |  | 13. Type of Report and Period Covered              |                            |           |
|  |  |  | 14. Sponsoring Agency Code                         |                            |           |
| 15. Supplementary Notes<br><i>FHWA COTR – Louisa Ward/ Larry Jones</i><br><i>FHWA Task Manager – Firas I. Sheikh Ibrahim, PhD, PE</i><br><i>FHWA Technical Reviewers – Jesús M. Rohena y Correa, PE; Jerry A. DiMaggio, PE; Steven Ernst, PE; and Peter Osborn, PE.</i><br><i>See Acknowledgement for List of Authors and Additional Technical Reviewers</i>   |  |  |  |                            |           |
| 16. Abstract<br><p>The increased use of underground space for transportation systems and the increasing complexity and constraints of constructing and maintaining above ground transportation infrastructure have prompted the need to develop this technical manual. This FHWA manual is intended to be a single-source technical manual providing guidelines for planning, design, construction and rehabilitation of road tunnels, and encompasses various types of road tunnels including mined, bored, cut-and-cover, immersed, and jacked box tunnels. The scope of the manual is primarily limited to the civil elements of road tunnels.</p> <p>The development of this technical manual has been funded by the National Highway Institute, and supported by Parsons Brinckerhoff, as well as numerous authors and reviewers.</p> |  |  |  |                            |           |
| 17. Key Words<br>Road tunnel, highway tunnel, geotechnical investigation, geotechnical baseline report, cut-and-cover tunnel, drill-and-blast, mined tunnel, bored tunnel, rock tunneling, soft ground tunneling, sequential excavation method (SEM), immersed tunnel, jacked box tunnel, seismic consideration, instrumentation, risk management, rehabilitation.   |  |  | 18. Distribution Statement<br><br>No restrictions. |                            |           |
| 19. Security Classif. (of this report)<br>UNCLASSIFIED   |  | 20. Security Classif. (of this page)<br>UNCLASSIFIED |  | 21. No. of Pages<br>702    | 22. Price |

## CONVERSION FACTORS

| Approximate Conversions to SI Units         |             |                           | Approximate Conversions from SI Units |             |                            |
|---|-------------|---------------------------|---------------------------------------|-------------|----------------------------|
| When you know                               | Multiply by | To find                   | When you know                         | Multiply by | To find                    |
| (a) Length                                  |             |                           |                                       |             |                            |
| inch  | 25.4        | millimeter                | millimeter                            | 0.039       | inch                       |
| foot  | 0.305       | meter                     | meter                                 | 3.28        | foot                       |
| yard  | 0.914       | meter                     | meter                                 | 1.09        | yard                       |
| mile  | 1.61        | kilometer                 | kilometer                             | 0.621       | mile                       |
| (b) Area                                    |             |                           |                                       |             |                            |
| square inches                               | 645.2       | square millimeters        | square millimeters                    | 0.0016      | square inches              |
| square feet                                 | 0.093       | square meters             | square meters                         | 10.764      | square feet                |
| acres                                       | 0.405       | hectares                  | hectares                              | 2.47        | acres                      |
| square miles                                | 2.59        | square kilometers         | square kilometers                     | 0.386       | square miles               |
| (c) Volume                                  |             |                           |                                       |             |                            |
| fluid ounces                                | 29.57       | milliliters               | milliliters                           | 0.034       | fluid ounces               |
| gallons                                     | 3.785       | liters                    | liters                                | 0.264       | gallons                    |
| cubic feet                                  | 0.028       | cubic meters              | cubic meters                          | 35.32       | cubic feet                 |
| cubic yards                                 | 0.765       | cubic meters              | cubic meters                          | 1.308       | cubic yards                |
| (d) Mass                                    |             |                           |                                       |             |                            |
| ounces                                      | 28.35       | grams                     | grams                                 | 0.035       | ounces                     |
| pounds                                      | 0.454       | kilograms                 | kilograms                             | 2.205       | pounds                     |
| short tons (2000 lb)                        | 0.907       | megagrams (tonne)         | megagrams (tonne)                     | 1.102       | short tons (2000 lb)       |
| (e) Force                                   |             |                           |                                       |             |                            |
| pound                                       | 4.448       | Newton                    | Newton                                | 0.2248      | pound                      |
| (f) Pressure, Stress, Modulus of Elasticity |             |                           |                                       |             |                            |
| pounds per square foot                      | 47.88       | Pascals                   | Pascals                               | 0.021       | pounds per square foot     |
| pounds per square inch                      | 6.895       | kiloPascals               | kiloPascals                           | 0.145       | pounds per square inch     |
| (g) Density                                 |             |                           |                                       |             |                            |
| pounds per cubic foot                       | 16.019      | kilograms per cubic meter | kilograms per cubic meter             | 0.0624      | pounds per cubic foot      |
| (h) Temperature                             |             |                           |                                       |             |                            |
| Fahrenheit temperature(°F)                  | 5/9(°F- 32) | Celsius temperature(°C)   | Celsius temperature(°C)               | 9/5(°C)+ 32 | Fahrenheit temperature(°F) |

Notes: 1) The primary metric (SI) units used in civil engineering are meter (m), kilogram (kg), second(s), newton (N) and pascal (Pa=N/m<sup>2</sup>).

2) In a "soft" conversion, an English measurement is mathematically converted to its exact metric equivalent.

3) In a "hard" conversion, a new rounded metric number is created that is convenient to work with and remember.

## FOREWORD

The FHWA Technical Manual for Design and Construction of Road Tunnels – Civil Elements has been published to provide guidelines and recommendations for planning, design, construction and structural rehabilitation and repair of the civil elements of road tunnels, including cut-and-cover tunnels, mined and bored tunnels, immersed tunnels and jacked box tunnels. The latest edition of the AASHTO LRFD Bridge Design and Construction Specifications are used to the greatest extent applicable in the design examples. This manual focuses primarily on the civil elements of design and construction of road tunnels. It is the intent of FHWA to collaborate with AASHTO to further develop manuals for the design and construction of other key tunnel elements, such as, ventilation, lighting, fire life safety, mechanical, electrical and control systems.

FHWA intends to work with road tunnel owners in developing a manual on the maintenance, operation and inspection of road tunnels. This manual is expected to expand on the two currently available FHWA publications: (1) Highway and Rail Transit Tunnel Inspection Manual and (2) Highway and Rail Transit Tunnel Maintenance and Rehabilitation Manual.

A handwritten signature in blue ink that reads "Myint Lwin". The signature is fluid and cursive, with the first name "Myint" and the last name "Lwin" clearly distinguishable.

M. Myint Lwin, Director  
Office of Bridge Technology

This page is intentionally left blank.

## PREFACE

The increased use of underground space for transportation systems and the increasing complexity and constraints of constructing and maintaining above ground transportation infrastructure have prompted the need to develop this technical manual. This FHWA manual is intended to be a single-source technical manual providing guidelines for planning, design, construction and rehabilitation of road tunnels, and encompasses various types of tunnels including mined and bored tunnels (Chapters 6-10), cut-and-cover tunnels (Chapter 5), immersed tunnels (Chapter 11), and jacked box tunnels (Chapter 12).

The scope of the manual is primarily limited to the civil elements of design and construction of road tunnels. FHWA intended to develop a separate manual to address in details the design and construction issues of the system elements of road tunnels including fire life safety, ventilation, lighting, drainage, finishes, etc. This manual therefore only provides limited guidance on the system elements when appropriate.

Accordingly, the manual is organized as presented below.

**Chapter 1** is an introductory chapter and provides general overview of the planning process of a road tunnel project including alternative route study, tunnel type study, operation and financial planning, and risk analysis and management.

**Chapter 2** provides the geometrical requirements and recommendations of new road tunnels including horizontal and vertical alignments and tunnel cross section requirements.

**Chapter 3** covers the geotechnical investigative techniques and parameters required for planning, design and construction of road tunnels. In addition to subsurface investigations, this chapter also addresses in brief information study; survey; site reconnaissance, geologic mapping, instrumentation, and other investigations made during and after construction.

**Chapter 4** discusses the common types of geotechnical reports required for planning, design and construction of road tunnels including: Geotechnical Data Report (GDR) which presents all the factual geotechnical data; Geotechnical Design Memorandum (GDM) which presents interpretations of the geotechnical data and other information used to develop the designs; and Geotechnical Baseline Report (GBR) which defines the baseline conditions on which contractors will base their bids upon.

**Chapter 5** presents the construction methodology and excavation support systems for cut-and-cover road tunnels, describes the structural design in accordance with the AASHTO LRFD Bridge Design Specifications, and discusses various other design issues. A design example is included in Appendix C.

Chapters 6 through 10 present design recommendations and requirements for mined and bored road tunnels.

**Chapters 6 and 7** present mined/bored tunneling issues in rock and soft ground, respectively. They present various excavation methods and temporary support elements and focus on the selection of temporary support of excavation and input for permanent lining design. Appendix D presents common types of rock and soft ground tunnel boring machines (TBM).

**Chapter 8** addresses the investigation, design, construction and instrumentation concerns and issues for mining and boring in difficult ground conditions including: mixed face tunneling; high groundwater pressure and inflow; unstable ground such as running sands, sensitive clays, faults and shear zones, etc.; squeezing ground; swelling ground; and gassy ground.

**Chapter 9** introduces the history, principles, and recent development of mined tunneling using Sequential Excavation Method (SEM), as commonly known as the New Austrian Tunneling Method (NATM). This chapter focuses on the analysis, design and construction issues for SEM tunneling.

**Chapter 10** discusses permanent lining structural design and detailing for mined and bored tunnels based on LRFD methodology, and presents overall processes for design and construction of permanent tunnel lining. It encompasses various structural systems used for permanent linings including cast-in-place concrete lining, precast concrete segmental lining, steel line plate lining and shotcrete lining. A design example is presented in Appendix G.

**Chapter 11** discusses immersed tunnel design and construction. It identifies various immersed tunnel types and their construction techniques. It also addresses the structural design approach and provides insights on the construction methodologies including fabrication, transportation, placement, joining and backfilling. It addresses the tunnel elements water tightness and the trench stability and foundation preparation requirements.

**Chapter 12** presents jacked box tunneling, a unique tunneling method for constructing shallow rectangular road tunnels beneath critical facilities such as operating railways, major highways and airport runways without disruption of the services provided by these surface facilities or having to relocate them temporarily to accommodate open excavations for cut and cover construction.

**Chapter 13** provides general procedure for seismic design and analysis of tunnel structures, which are based primarily on the ground deformation approach (as opposed to the inertial force approach); i.e., the structures should be designed to accommodate the deformations imposed by the ground.

**Chapter 14** discusses tunnel construction engineering issues, i.e., the engineering that must go into a road tunnel project to make it constructible. This chapter examines various issues that need be engineered during the design process including project cost drivers; construction staging and sequencing; health and safety issues; muck transportation and disposal; and risk management and dispute resolution.

**Chapter 15** presents the typical geotechnical and structural instrumentation for monitoring: 1), ground movement away from the tunnel; 2), building movement for structures within the zone of influence; 3), tunnel movement of the tunnel being constructed or adjacent tubes; 4), dynamic ground motion from drill & blast operation, and 5), groundwater movement due to changes in the water percolation pattern.

Lastly, **Chapter 16** focuses on the identification, characterization and rehabilitation of structural defects in a tunnel system.



## ACKNOWLEDGMENTS

The development of this manual has been funded by the National Highway Institute, and supported by Parsons Brinckerhoff, as well as numerous authors and reviewers acknowledged hereafter including the following primary authors from Parsons Brinckerhoff (PB), and Gall Zeidler Consultants, LLC:

|            |  |
|------------|--|
| Chapter 1  | Planning -Nasri Munfah/ Christian Ingerslev                                |
| Chapter 2  | Geometrical Configuration - Christian Ingerslev/ Jeremy Hung               |
| Chapter 3  | Geotechnical Investigation - Jeremy Hung/ Raymond Castelli                 |
| Chapter 4  | Geotechnical Report - Raymond Castelli/ Jeremy Hung                        |
| Chapter 5  | Cut-and-Cover Tunnels - John Wisniewski/ Nasri Munfah                      |
| Chapter 6  | Rock Tunneling – James Monsees/ Sunghoon Choi                              |
| Chapter 7  | Soft Ground Tunneling – James Monsees                                      |
| Chapter 8  | Difficult Ground Tunneling – James Monsees/ Terrence McCusker (Consultant) |
| Chapter 9  | Sequential Excavation Method - Vojtech Gall/Kurt Zeidler                   |
| Chapter 10 | Tunneling Lining - John Wisniewski   |
| Chapter 11 | Immersed Tunnels - Christian Ingerslev/Nasri Munfah                        |
| Chapter 12 | Jacked Box Tunneling - Philip Rice/ Jeremy Hung                            |
| Chapter 13 | Seismic Considerations – Jaw-Nan (Joe) Wang                                |
| Chapter 14 | Construction Engineering - Thomas Peyton                                   |
| Chapter 15 | Geotechnical and Structural Instrumentation – Charles Daugherty, and       |
| Chapter 16 | Tunnel Rehabilitation - Henry Russell                                      |

The Principal Investigators would like to especially acknowledge the support of the FHWA Task Manger, Firas Ibrahim, and the reviews and recommendations provided by the FHWA technical reviewers including Jesus Rohena, Jerry DiMaggio, Steven Ernst and Peter Osborn. Furthermore, the reviews and contributions of the following members of AASHTO T-20 Tunnel Committee are also acknowledged:

- Kevin Thompson, Chair, Caltrans
- Bruce Johnson, Vice Chair, Oregon DOT
- Donald Dwyer, New York State DOT
- Louis Ruzzi, Pennsylvania DOT
- Prasad Nallapaneni, Virginia DOT
- Michael Salamon, Colorado DOT
- Bijan Khaleghi, Washington DOT
- Alexander Bardow, Massachusetts Highway Department
- Dharam Pal, The Port Authority of New York and New Jersey
- Moe Amini, Caltrans, and
- Harry Capers, Arora and Associates, P.C.

The Principal Investigators and authors would like to express our special thanks to Dr. George Munfakh of PB for his continuing support, advice and encouragement.

We further acknowledge the support of Gene McCormick of PB, and the contributions and reviews from Sunghoon Choi, Joe O'Carroll, Doug Anderson, Kyle Ott, Frank Pepe, and Bill Hansmire of PB, Dr. Andrzej Nowak of University of Nebraska, and Tony Ricci and Nabil Hourani of MassHighway.

Chapter 8 is an update of the Chapter 8 "Tunneling in Difficult Ground" of the 2<sup>nd</sup> Edition Tunnel Engineering Handbook authored by Terrence G. McCusker (Bickel, et al., 1996). The Principal Investigators appreciate PB for providing the original manuscript for the chapter.

In addition, we appreciate the information provided by Herrenknecht AG, the Robbins Company, and several other manufacturers and contractors from the tunneling industry.

Lastly, the Principal Investigators and authors would like to extend our gratitude to the supports provided by a number of professionals from PB and Gall Zeidler Consultants, LLC. including Taehyun Moon, Kevin Doherty, Mitchell Fong, Rudy Holley, Benny Louie, Tim O'Brien and Dominic Reda for their assistance; Jose Morales and Jeff Waclawski for graphic support, and finally Amy Pavlakovich, Lauren Chu, Alejandra Morales, Mary Halliburton, and Maria Roberts for their assistance and overall word processing and compiling.

## TABLE OF CONTENTS

|  |            |
|--|------------|
| <b>LIST OF FIGURES .....</b>                                     | <b>xiv</b> |
| <b>LIST OF TABLES .....</b>                                      | <b>xxi</b> |
| <b>CHAPTER 1 - PLANNING .....</b>                                | <b>1-1</b> |
| 1.1 INTRODUCTION .....   | 1-1        |
| 1.1.1 Tunnel Shape and Internal Elements .....                   | 1-2        |
| 1.1.2 Classes of Roads and Vehicle Sizes .....                   | 1-4        |
| 1.1.3 Traffic Capacity .....                                     | 1-5        |
| 1.2 ALTERNATIVE ANALYSES .....                                   | 1-6        |
| 1.2.1 Route Studies .....  | 1-6        |
| 1.2.2 Financial Studies .....                                    | 1-6        |
| 1.2.3 Types of Road Tunnels .....                                | 1-7        |
| 1.2.4 Geotechnical Investigations .....                          | 1-9        |
| 1.2.5 Environmental and Community Issues .....                   | 1-10       |
| 1.2.6 Operational Issues .....                                   | 1-11       |
| 1.2.7 Sustainability .....                                       | 1-11       |
| 1.3 TUNNEL TYPE STUDIES .....                                    | 1-11       |
| 1.3.1 General Description of Various Tunnel Types .....          | 1-11       |
| 1.3.2 Design Process .....                                       | 1-13       |
| 1.3.3 Tunnel Cross-Section .....                                 | 1-13       |
| 1.3.4 Groundwater Control .....                                  | 1-13       |
| 1.3.5 Tunnel Portals .....                                       | 1-15       |
| 1.3.6 Fire-Life Safety Systems .....                             | 1-15       |
| 1.3.7 Tunnel Drainage .....                                      | 1-18       |
| 1.4 OPERATIONAL AND FINANCIAL PLANNING .....                     | 1-18       |
| 1.4.1 Potential Funding Sources and Cash Flow Requirements ..... | 1-18       |
| 1.4.2 Conceptual Level Cost Analysis .....                       | 1-19       |
| 1.4.3 Project Delivery Methods .....                             | 1-19       |
| 1.4.4 Operation and Maintenance Cost Planning .....              | 1-21       |
| 1.5 RISK ANALYSIS AND MANAGEMENT .....                           | 1-21       |
| <b>CHAPTER 2 - GEOMETRIC CONFIGURATION .....</b>                 | <b>2-1</b> |
| 2.1 INTRODUCTION .....   | 2-1        |
| 2.1.1 Design Standards .....                                     | 2-2        |
| 2.2 HORIZONTAL AND VERTICAL ALIGNMENTS .....                     | 2-2        |
| 2.2.1 Maximum Grades .....                                       | 2-3        |

|   |  |            |
|---|--|------------|
| 2.2.2   | Horizontal and Vertical Curves.....                                | 2-3        |
| 2.2.3   | Sight and Braking Distance Requirements .....                      | 2-3        |
| 2.2.4   | Other Considerations.....  | 2-3        |
| 2.3   | TRAVEL CLEARANCE .....   | 2-4        |
| 2.4   | CROSS SECTION ELEMENTS .....                                       | 2-6        |
| 2.4.1   | Typical Cross Section Elements .....                               | 2-6        |
| 2.4.2   | Travel Lane and Shoulder .....                                     | 2-8        |
| 2.4.3   | Sidewalks/Emergency Egress Walkway .....                           | 2-8        |
| 2.4.4   | Tunnel Drainage Requirements .....                                 | 2-9        |
| 2.4.5   | Ventilation Requirements .....                                     | 2-9        |
| 2.4.6   | Lighting Requirements.....   | 2-11       |
| 2.4.7   | Traffic Control Requirements .....                                 | 2-11       |
| 2.4.8   | Portals and Approach.....  | 2-12       |
| <b>CHAPTER 3 - GEOTECHNICAL INVESTIGATIONS.....</b> |  | <b>3-1</b> |
| 3.1   | INTRODUCTION.....  | 3-1        |
| 3.1.1   | Phasing of Geotechnical Investigations .....                       | 3-1        |
| 3.2   | INFORMATION STUDY .....  | 3-3        |
| 3.2.1   | Collection and Review of Available Information .....               | 3-3        |
| 3.2.2   | Topographical Data.....  | 3-4        |
| 3.3   | SURVEYS AND SITE RECONNAISSANCE .....                              | 3-4        |
| 3.3.1   | Site Reconnaissance and Preliminary Surveys .....                  | 3-4        |
| 3.3.2   | Topographic Surveys .....  | 3-6        |
| 3.3.3   | Hydrographical Surveys.....  | 3-7        |
| 3.3.4   | Utility Surveys .....  | 3-8        |
| 3.3.5   | Identification of Underground Structures and Other Obstacles ..... | 3-8        |
| 3.3.6   | Structure Preconstruction Survey.....                              | 3-9        |
| 3.4   | GEOLOGIC MAPPING.....  | 3-9        |
| 3.5   | SUBSURFACE INVESTIGATIONS .....                                    | 3-10       |
| 3.5.1   | General.....   | 3-10       |
| 3.5.2   | Test Borings and Sampling .....                                    | 3-15       |
| 3.5.3   | Soil and Rock Identification and Classification.....               | 3-19       |
| 3.5.4   | Field Testing Techniques (Pre-Construction) .....                  | 3-21       |
| 3.5.5   | Laboratory Testing.....  | 3-29       |
| 3.5.6   | Groundwater Investigation.....                                     | 3-31       |
| 3.6   | ENVIRONMENTAL ISSUES .....   | 3-33       |
| 3.7   | SEISMICITY.....  | 3-34       |
| 3.8   | ADDITIONAL INVESTIGATIONS DURING CONSTRUCTION .....                | 3-35       |

|  |  |            |
|--|--|------------|
| 3.8.1  | General.....   | 3-35       |
| 3.8.2  | Geologic Face Mapping.....                               | 3-36       |
| 3.8.3  | Geotechnical Instrumentation .....                       | 3-36       |
| 3.8.4  | Probing.....   | 3-37       |
| 3.8.5  | Pilot Tunnels .....                                      | 3-37       |
| 3.9  | GEOSPATIAL DATA MANAGEMENT SYSTEM.....                   | 3-38       |
| <b>CHAPTER 4 - GEOTECHNICAL REPORTS.....</b>   |  | <b>4-1</b> |
| 4.1  | INTRODUCTION.....  | 4-1        |
| 4.2  | GEOTECHNICAL DATA REPORT .....                           | 4-2        |
| 4.3  | GEOTECHNICAL DESIGN MEMORANDUM.....                      | 4-5        |
| 4.4  | GEOTECHNICAL BASELINE REPORT.....                        | 4-8        |
| 4.4.1  | Purpose and Objective.....                               | 4-8        |
| 4.4.2  | General Considerations .....                             | 4-9        |
| 4.4.3  | Guidelines for Preparing a GBR .....                     | 4-10       |
| <b>CHAPTER 5 - CUT AND COVER TUNNELS .....</b> |  | <b>5-1</b> |
| 5.1  | INTRODUCTION.....  | 5-1        |
| 5.2  | CONSTRUCTION METHODOLOGY .....                           | 5-1        |
| 5.2.1  | General .....  | 5-1        |
| 5.2.2  | Conventional Bottom-Up Construction.....                 | 5-2        |
| 5.2.3  | Top-Down Construction.....                               | 5-3        |
| 5.2.4  | Selection.....   | 5-4        |
| 5.3  | SUPPORT OF EXCAVATION .....                              | 5-5        |
| 5.3.1  | General .....  | 5-5        |
| 5.3.2  | Temporary Support of Excavation .....                    | 5-6        |
| 5.3.3  | Permanent Support of Excavation.....                     | 5-8        |
| 5.3.4  | Ground Movement and Impact on Adjoining Structures ..... | 5-11       |
| 5.3.5  | Base Stability.....                                      | 5-12       |
| 5.4  | STRUCTURAL SYSTEMS.....                                  | 5-12       |
| 5.4.1  | General .....  | 5-12       |
| 5.4.2  | Structural Framing.....                                  | 5-13       |
| 5.4.3  | Materials.....   | 5-13       |
| 5.4.4  | Buoyancy.....  | 5-16       |
| 5.4.5  | Expansion and Contraction Joints .....                   | 5-16       |
| 5.4.6  | Waterproofing .....                                      | 5-17       |
| 5.5  | LOADS.....   | 5-17       |
| 5.5.1  | General .....  | 5-17       |

|  |  |            |
|--|--|------------|
| 5.5.2                                  | Load Combinations .....  | 5-20       |
| 5.6                                    | STRUCTURAL DESIGN .....  | 5-24       |
| 5.6.1                                  | General .....  | 5-24       |
| 5.6.2                                  | Structural Analysis .....  | 5-25       |
| 5.7                                    | GROUNDWATER CONTROL .....  | 5-26       |
| 5.7.1                                  | Construction Dewatering.....   | 5-26       |
| 5.7.2                                  | Methods of Dewatering and Their Typical Applications .....                       | 5-27       |
| 5.7.3                                  | Uplift Pressures and Mitigation Measures .....                                   | 5-27       |
| 5.7.4                                  | Piping and Base Stability .....  | 5-27       |
| 5.7.5                                  | Potential Impact of Area Dewatering .....  | 5-28       |
| 5.7.6                                  | Groundwater Discharge and Environmental Issues.....                              | 5-28       |
| 5.8                                    | MAINTENANCE AND PROTECTION OF TRAFFIC .....                                      | 5-28       |
| 5.9                                    | UTILITY RELOCATION AND SUPPORT.....  | 5-28       |
| 5.9.1                                  | Types of Utilities.....  | 5-28       |
| 5.9.2                                  | General Approach to Utilities During Construction.....                           | 5-30       |
| <b>CHAPTER 6 - ROCK TUNNELING.....</b> |  | <b>6-1</b> |
| 6.1                                    | INTRODUCTION.....  | 6-1        |
| 6.2                                    | ROCK FAILURE MECHANISM.....  | 6-1        |
| 6.2.1                                  | Wedge Failure .....  | 6-2        |
| 6.2.2                                  | Stress Induced Failure.....  | 6-3        |
| 6.2.3                                  | Squeezing and Swelling.....  | 6-4        |
| 6.3                                    | ROCK MASS CLASSIFICATIONS.....   | 6-5        |
| 6.3.1                                  | Introduction.....  | 6-5        |
| 6.3.2                                  | Terzaghi's Classification.....   | 6-5        |
| 6.3.3                                  | RQD .....  | 6-6        |
| 6.3.4                                  | Q System.....  | 6-6        |
| 6.3.5                                  | Rock Mass Rating (RMR) System.....   | 6-10       |
| 6.3.6                                  | Estimation of Rock Mass Deformation Modulus Using Rock Mass Classification ..... | 6-12       |
| 6.4                                    | ROCK TUNNELING METHODS.....  | 6-13       |
| 6.4.1                                  | Drill and Blast .....  | 6-13       |
| 6.4.2                                  | Tunnel Boring Machines (TBM) .....   | 6-18       |
| 6.4.3                                  | Roadheaders .....  | 6-23       |
| 6.4.4                                  | Other Mechanized Excavation Methods .....  | 6-24       |
| 6.4.5                                  | Sequential Excavation Method (SEM)/ New Austrian Tunneling Method (NATM).....    | 6-24       |
| 6.5                                    | TYPES OF ROCK REINFORCEMENT AND EXCAVATION SUPPORT .....                         | 6-24       |
| 6.5.1                                  | Excavation Support Options .....   | 6-24       |
| 6.5.2                                  | Rock Bolts.....  | 6-25       |

|   |  |            |
|---|--|------------|
| 6.5.3   | Ribs and Lagging .....   | 6-29       |
| 6.5.4   | Shotcrete .....  | 6-29       |
| 6.5.5   | Lattice Girder .....   | 6-30       |
| 6.5.6   | Spiles and Forepoles .....   | 6-31       |
| 6.5.7   | Precast Segment Lining .....   | 6-31       |
| 6.6   | DESIGN AND EVALUATION OF TUNNEL SUPPORTS .....                             | 6-32       |
| 6.6.1   | Empirical Method .....   | 6-33       |
| 6.6.2   | Analytical Methods .....   | 6-39       |
| 6.6.3   | Numerical Methods .....  | 6-43       |
| 6.6.4   | Pre-Support and Other Ground Improvement Methods .....                     | 6-47       |
| 6.6.5   | Sequencing of Excavation and Initial Support Installation .....            | 6-48       |
| 6.6.6   | Face Stability .....   | 6-49       |
| 6.6.7   | Surface Support .....  | 6-49       |
| 6.6.8   | Ground Displacements .....   | 6-49       |
| 6.7   | GROUNDWATER CONTROL DURING EXCAVATION .....                                | 6-50       |
| 6.7.1   | Dewatering at the Tunnel Face .....  | 6-50       |
| 6.7.2   | Drainage Ahead of Face from Probe Holes .....                              | 6-51       |
| 6.7.3   | Drainage from Pilot Bore/Tunnel .....                                      | 6-51       |
| 6.7.4   | Grouting .....   | 6-51       |
| 6.7.5   | Freezing .....   | 6-52       |
| 6.7.6   | Closed Face Machine .....  | 6-52       |
| 6.7.7   | Other Measures of Groundwater Control .....                                | 6-52       |
| 6.8   | PERMANENT LINING DESIGN ISSUES .....                                       | 6-53       |
| 6.8.1   | Introduction .....   | 6-53       |
| 6.8.2   | Rock Load Considerations .....   | 6-53       |
| 6.8.3   | Groundwater Load Considerations .....                                      | 6-55       |
| 6.8.4   | Drained Versus Undrained System .....                                      | 6-59       |
| 6.8.5   | Uplift Condition .....   | 6-60       |
| 6.8.6   | Waterproofing .....  | 6-61       |
| <b>CHAPTER 7 - SOFTGROUND TUNNELING .....</b> |  | <b>7-1</b> |
| 7.1   | INTRODUCTION .....   | 7-1        |
| 7.2   | GROUND BEHAVIOR .....  | 7-1        |
| 7.2.1   | Soft Ground Classification .....   | 7-1        |
| 7.2.2   | Changes of Equilibrium during Construction .....                           | 7-3        |
| 7.2.3   | The Influence of the Support System on Equilibrium Conditions .....        | 7-5        |
| 7.3   | EXCAVATION METHODS .....   | 7-6        |
| 7.3.1   | Shield Tunneling .....   | 7-6        |
| 7.3.2   | Earth Pressure Balance and Slurry Face Shield Tunnel Boring Machines ..... | 7-8        |

|   |  |            |
|---|--|------------|
| 7.3.3   | Choosing between Earth Pressure Balance Machines and Slurry Tunneling Machines ..... | 7-12       |
| 7.3.4   | Sequential Excavation Method (SEM).....  | 7-14       |
| 7.4   | GROUND LOADS AND ground-SUPPORT interaction.....                                     | 7-15       |
| 7.4.1   | Introduction.....  | 7-15       |
| 7.4.2   | Loads for Initial Tunnel Supports .....  | 7-16       |
| 7.4.3   | Analytical Solutions for Ground-Support Interaction.....                             | 7-17       |
| 7.4.4   | Numerical Methods.....   | 7-17       |
| 7.5   | TUNNELING INDUCED SETTLEMENT .....   | 7-18       |
| 7.5.1   | Introduction.....  | 7-18       |
| 7.5.2   | Sources of Settlement.....   | 7-18       |
| 7.5.3   | Settlement Calculations.....   | 7-19       |
| 7.6   | IMPACT ON AND PROTECTION OF SURFACE FACILITIES.....                                  | 7-23       |
| 7.6.1   | Evaluation of Structure Tolerance to Settlement .....                                | 7-23       |
| 7.6.2   | Mitigating Settlement.....   | 7-24       |
| 7.6.3   | Structure Protection.....  | 7-25       |
| 7.7   | SOIL STABILIZATION AND IMPROVEMENT .....   | 7-25       |
| 7.7.1   | Purpose.....   | 7-25       |
| 7.7.2   | Typical Applications .....   | 7-25       |
| 7.7.3   | Reinforcement Methods.....   | 7-26       |
| 7.7.4   | Micropiles .....   | 7-27       |
| 7.7.5   | Grouting Methods .....   | 7-27       |
| 7.7.6   | Ground Freezing .....  | 7-28       |
| <b>CHAPTER 8 - DIFFICULT GROUND TUNNELING .....</b> |  | <b>8-1</b> |
| 8.1   | INTRODUCTION.....  | 8-1        |
| 8.1.1   | Instability .....  | 8-1        |
| 8.1.2   | Heavy Loading.....   | 8-1        |
| 8.1.3   | Obstacles and Constraints .....  | 8-1        |
| 8.1.4   | Physical Conditions .....  | 8-2        |
| 8.2   | INSTABILITY .....  | 8-2        |
| 8.2.1   | Non-Cohesive Sand and Gravel.....  | 8-2        |
| 8.2.2   | Soft Clay .....  | 8-4        |
| 8.2.3   | Blocky Rock.....   | 8-5        |
| 8.2.4   | Adverse Combinations of Joints and Shears.....                                       | 8-6        |
| 8.2.5   | Faults and Alteration Zones .....  | 8-7        |
| 8.2.6   | Water.....   | 8-8        |
| 8.2.7   | Mixed Face Tunneling .....   | 8-8        |
| 8.3   | HEAVING LOADING.....   | 8-10       |
| 8.3.1   | Squeezing Rock .....   | 8-10       |



|   |   |            |
|---|---|------------|
| 8.3.2   | The Squeezing Process.....  | 8-10       |
| 8.3.3   | Yielding Supports .....   | 8-12       |
| 8.3.4   | TBM Tunneling .....   | 8-14       |
| 8.3.5   | Steel Rib Support System .....  | 8-15       |
| 8.3.6   | Concrete Segments.....  | 8-16       |
| 8.3.7   | TBM Tunneling System.....   | 8-16       |
| 8.3.8   | Operational Flexibility .....   | 8-18       |
| 8.3.9   | Swelling .....  | 8-18       |
| 8.3.10  | Swelling Mechanism .....  | 8-18       |
| 8.3.11  | Other Rock Problems .....   | 8-18       |
| 8.4   | OBSTACLES AND CONSTRAINTS .....   | 8-19       |
| 8.4.1   | Boulders .....  | 8-19       |
| 8.4.2   | Karstic Limestone .....   | 8-19       |
| 8.4.3   | Abandoned Foundations .....   | 8-20       |
| 8.4.4   | Shallow Tunnels.....  | 8-20       |
| 8.5   | PHYSICAL CONDITIONS .....   | 8-21       |
| 8.5.1   | Methane.....  | 8-21       |
| 8.5.2   | Hydrogen Sulfide .....  | 8-21       |
| 8.5.3   | High Temperatures.....  | 8-21       |
| 8.5.4   | Observations .....  | 8-22       |
| <b>CHAPTER 9 - SEQUENTIAL EXCAVATION METHOD .....</b> |   | <b>9-1</b> |
| 9.1   | INTRODUCTION.....   | 9-1        |
| 9.2   | BACKGROUND AND CONCEPTS .....   | 9-2        |
| 9.3   | SEM REGULAR CROSS SECTION.....  | 9-5        |
| 9.3.1   | Geometry .....  | 9-5        |
| 9.3.2   | Dual Lining .....   | 9-6        |
| 9.3.3   | Initial Shotcrete Lining.....   | 9-7        |
| 9.3.4   | Waterproofing .....   | 9-7        |
| 9.3.5   | Final Tunnel Lining.....  | 9-9        |
| 9.4   | GROUND CLASSIFICATION AND SEM EXCAVATION AND SUPPORT CLASSES..                      | 9-11       |
| 9.4.1   | Rock Mass Classification Systems.....   | 9-11       |
| 9.4.2   | Ground Support Systems.....   | 9-11       |
| 9.4.3   | Excavation and Support Classes (ESC) and Initial Support.....                       | 9-12       |
| 9.4.4   | Longitudinal Tunnel Profile and Distribution of Excavation and Support Classes..... | 9-14       |
| 9.4.5   | Tunnel Excavation, Support, and Pre-Support Measures.....                           | 9-15       |
| 9.4.6   | Example SEM Excavation Sequence and Support Classes .....                           | 9-20       |
| 9.4.7   | Excavation Methods .....  | 9-24       |
| 9.5   | GROUND SUPPORT ELEMENTS.....  | 9-26       |

|  |  |             |
|--|--|-------------|
| 9.5.1                                  | Shotcrete.....   | 9-26        |
| 9.5.2                                  | Rock Reinforcement.....  | 9-30        |
| 9.5.3                                  | Lattice Girders and Rolled Steel Sets.....   | 9-35        |
| 9.5.4                                  | Pre-support Measures and Ground Improvement.....                                   | 9-36        |
| 9.5.5                                  | Portals.....   | 9-41        |
| 9.6                                    | STRUCTURAL DESIGN ISSUES.....  | 9-43        |
| 9.6.1                                  | Ground-Structure Interaction.....  | 9-43        |
| 9.6.2                                  | Numerical Modeling.....  | 9-44        |
| 9.6.3                                  | Considerations for Future Loads.....   | 9-48        |
| 9.7                                    | INSTRUMENTATION AND MONITORING.....  | 9-48        |
| 9.7.1                                  | General.....   | 9-48        |
| 9.7.2                                  | Surface and Subsurface Instrumentation.....  | 9-49        |
| 9.7.3                                  | Tunnel Instrumentation.....  | 9-49        |
| 9.7.4                                  | SEM Monitoring Cross Sections.....   | 9-50        |
| 9.7.5                                  | Interpretation of Monitoring Results.....  | 9-50        |
| 9.8                                    | CONTRACTUAL ASPECTS.....   | 9-52        |
| 9.8.1                                  | Contractor Pre-Qualification.....  | 9-52        |
| 9.8.2                                  | Unit Prices.....   | 9-53        |
| 9.9                                    | EXPERIENCED PERSONNEL IN DESIGN, CONSTRUCTION, AND CONSTRUCTION<br>MANAGEMENT..... | 9-53        |
| <b>CHAPTER 10 - TUNNEL LINING.....</b> |  | <b>10-1</b> |
| 10.1                                   | INTRODUCTION.....  | 10-1        |
| 10.1.1                                 | Load and Resistance factor Design (LRFD).....                                      | 10-3        |
| 10.2                                   | DESIGN CONSIDERATIONS.....   | 10-4        |
| 10.2.1                                 | Lining Stiffness and Deformation.....  | 10-4        |
| 10.2.2                                 | Constructability Issues.....   | 10-4        |
| 10.2.3                                 | Durability.....  | 10-5        |
| 10.2.4                                 | High Density Concrete.....   | 10-5        |
| 10.2.5                                 | Corrosion Protection.....  | 10-5        |
| 10.2.6                                 | Lining Joints.....   | 10-6        |
| 10.3                                   | STRUCTURAL DESIGN.....   | 10-6        |
| 10.3.1                                 | Loads.....   | 10-6        |
| 10.3.2                                 | Load Combinations.....   | 10-10       |
| 10.3.3                                 | Design Criteria.....   | 10-10       |
| 10.3.4                                 | Structural Analysis.....   | 10-13       |
| 10.4                                   | CAST-IN-PLACE CONCRETE.....  | 10-16       |
| 10.4.1                                 | Description.....   | 10-16       |

|  |  |             |
|--|--|-------------|
| 10.4.2                                     | Design Considerations.....                           | 10-18       |
| 10.4.3                                     | Materials.....                                       | 10-19       |
| 10.4.4                                     | Construction Considerations .....                    | 10-20       |
| 10.5                                       | PRECAST SEGMENTAL LINING.....                        | 10-20       |
| 10.5.1                                     | Description .....                                    | 10-20       |
| 10.5.2                                     | Design Considerations.....                           | 10-22       |
| 10.5.3                                     | Materials.....                                       | 10-27       |
| 10.5.4                                     | Construction Considerations .....                    | 10-28       |
| 10.6                                       | STEEL PLATE LINING.....                              | 10-28       |
| 10.6.1                                     | Design Considerations.....                           | 10-30       |
| 10.7                                       | SHOTCRETE LINING .....                               | 10-30       |
| 10.8                                       | SELECTING A LINING SYSTEM .....                      | 10-32       |
| <b>CHAPTER 11 - IMMERSED TUNNELS .....</b> |  | <b>11-1</b> |
| 11.1                                       | INTRODUCTION.....                                    | 11-1        |
| 11.1.1                                     | Typical Applications .....                           | 11-2        |
| 11.1.2                                     | Types of Immersed Tunnel.....                        | 11-2        |
| 11.1.3                                     | Single Shell Steel Tunnel .....                      | 11-3        |
| 11.1.4                                     | Double Shell.....                                    | 11-4        |
| 11.1.5                                     | Sandwich Construction.....                           | 11-5        |
| 11.1.6                                     | Concrete Immersed Tunnels.....                       | 11-7        |
| 11.2                                       | CONSTRUCTION METHODOLOGY .....                       | 11-8        |
| 11.2.1                                     | General .....  | 11-8        |
| 11.2.2                                     | Trench Excavation.....                               | 11-9        |
| 11.2.3                                     | Foundation Preparation .....                         | 11-10       |
| 11.2.4                                     | Tunnel Element Fabrication .....                     | 11-11       |
| 11.2.5                                     | Transportation and Handling of Tunnel Elements ..... | 11-12       |
| 11.2.6                                     | Lowering and Placing.....                            | 11-12       |
| 11.2.7                                     | Element Placement.....                               | 11-14       |
| 11.2.8                                     | Backfilling.....                                     | 11-16       |
| 11.2.9                                     | Locking Fill.....                                    | 11-16       |
| 11.2.10                                    | General Backfill .....                               | 11-17       |
| 11.2.11                                    | Protection Blanket.....                              | 11-17       |
| 11.2.12                                    | Anchor Release Protection .....                      | 11-17       |
| 11.3                                       | LOADINGS.....  | 11-17       |
| 11.3.1                                     | General .....  | 11-17       |
| 11.3.2                                     | Loads .....  | 11-18       |
| 11.3.3                                     | Ship Anchors .....                                   | 11-21       |
| 11.3.4                                     | Ship Sinking .....                                   | 11-22       |

|  |   |              |
|--|---|--------------|
| 11.3.5   | Load Combinations .....                                       | 11-23        |
| 11.3.6   | Loads during Fabrication, Transportation and Placement.....   | 11-24        |
| 11.4   | <b>STRUCTURAL DESIGN .....</b>                                | <b>11-25</b> |
| 11.4.1   | General .....   | 11-25        |
| 11.4.2   | Structural Analysis .....                                     | 11-27        |
| 11.5   | <b>WATERTIGHTNESS AND JOINTS BETWEEN ELEMENTS .....</b>       | <b>11-28</b> |
| 11.5.1   | External Waterproofing of Tunnels.....                        | 11-28        |
| 11.5.2   | Joints.....   | 11-29        |
| 11.5.3   | Design of Joints between Elements.....                        | 11-31        |
| <b>CHAPTER 12 - JACKED BOX TUNNELING.....</b>    |   | <b>12-1</b>  |
| 12.1   | INTRODUCTION.....   | 12-1         |
| 12.2   | BASIC PRINCIPLES .....  | 12-2         |
| 12.3   | CENTRAL ARTERY/TUNNEL (CA/T) PROJECT JACKED BOX TUNNELS ..... | 12-2         |
| 12.4   | LOAD AND STRUCTURAL CONSIDERATIONS.....                       | 12-7         |
| 12.4.1   | Ground Drag Load and Anti-Drag System (ADS).....              | 12-7         |
| 12.4.2   | Jacking Load .....  | 12-8         |
| 12.5   | GROUND CONTROL .....  | 12-10        |
| 12.5.1   | Ground Freezing for CA/T Project Jacked Tunnels.....          | 12-10        |
| 12.5.2   | Face Loss .....   | 12-13        |
| 12.5.3   | Over Cut.....   | 12-13        |
| 12.6   | OTHER CONSIDERATIONS .....                                    | 12-14        |
| 12.6.1   | Monitoring .....  | 12-14        |
| 12.6.2   | Vertical Alignment.....                                       | 12-14        |
| 12.6.3   | Horizontal Alignment .....                                    | 12-14        |
| <b>CHAPTER 13 - SEISMIC CONSIDERATIONS .....</b> |   | <b>13-1</b>  |
| 13.1   | INTRODUCTION.....   | 13-1         |
| 13.2   | DETERMINATION OF SEISMIC ENVIRONMENT .....                    | 13-1         |
| 13.2.1   | Earthquake Fundamental.....                                   | 13-1         |
| 13.2.2   | Ground Motion Hazard Analysis.....                            | 13-7         |
| 13.2.3   | Ground Motion Parameters .....                                | 13-11        |
| 13.3   | FACTORS THAT INFLUENCE TUNNEL SEISMIC PERFORMANCE .....       | 13-14        |
| 13.3.1   | Seismic Hazard.....   | 13-14        |
| 13.3.2   | Geologic Conditions.....                                      | 13-15        |
| 13.3.3   | Tunnel Design, Construction, and Condition .....              | 13-15        |
| 13.4   | SEISMIC PERFORMANCE AND SCREENING GUIDELINES OF TUNNELS ..... | 13-16        |
| 13.4.1   | Screening Guidelines Applicable to All Types of Tunnels ..... | 13-16        |

|  |   |             |
|--|---|-------------|
| 13.4.2   | Additional Screening Guidelines for Bored Tunnels .....                     | 13-16       |
| 13.4.3   | Additional Screening Guidelines for Cut-and-Cover Tunnels .....             | 13-19       |
| 13.4.4   | Additional Screening Guidelines for Immersed Tubes .....                    | 13-21       |
| 13.5   | SEISMIC EVALUATION PROCEDURES - GROUND SHAKING EFFECTS.....                 | 13-21       |
| 13.5.1   | Evaluation of Transverse Ovaling/Racking Response of Tunnel Structures..... | 13-22       |
| 13.5.2   | Evaluation of Longitudinal Response of Tunnel Structures.....               | 13-41       |
| 13.5.2.2   | Procedure Accounting for Soil-Structure Interaction Effects .....           | 13-43       |
| 13.6   | SEISMIC EVALUATION PROCEDURES - GROUND FAILURE EFFECTS.....                 | 13-45       |
| 13.6.1   | Evaluation for Fault Rupture .....  | 13-45       |
| 13.6.2   | Evaluation for Landsliding or Liquefaction .....                            | 13-50       |
| <b>CHAPTER 14 - TUNNEL CONSTRUCTION ENGINEERING.....</b> |   | <b>14-1</b> |
| 14.1   | INTRODUCTION .....  | 14-1        |
| 14.2   | CONSTRUCTABILITY .....  | 14-2        |
| 14.3   | CONSTRUCTION STAGING AND SEQUENCING.....                                    | 14-3        |
| 14.3.1   | Construction Staging .....  | 14-3        |
| 14.3.2   | Construction Sequencing.....  | 14-4        |
| 14.4   | MUCKING AND DISPOSAL .....  | 14-5        |
| 14.5   | HEALTH & SAFETY .....   | 14-8        |
| 14.6   | COST DRIVERS AND ELEMENTS .....   | 14-11       |
| 14.6.1   | Physical Costs.....   | 14-11       |
| 14.6.2   | Economic Costs.....   | 14-11       |
| 14.6.3   | Political Costs.....  | 14-12       |
| 14.7   | SCHEDULE .....  | 14-12       |
| 14.8   | CLAIMS AVOIDANCE AND DISPUTES RESOLUTION .....                              | 14-14       |
| 14.8.1   | Disputes Resolution.....  | 14-15       |
| 14.9   | RISK MANAGEMENT .....   | 14-16       |
| <b>CHAPTER 15 - INSTRUMENTATION.....</b>                 |   | <b>15-1</b> |
| 15.1   | INTRODUCTION.....   | 15-1        |
| 15.2   | GROUND MOVEMENTS – VERTICAL & LATERAL DEFORMATIONS.....                     | 15-2        |
| 15.2.1   | Purpose of Monitoring.....  | 15-2        |
| 15.2.2   | Equipment, Applications, Limitations.....                                   | 15-2        |
| 15.3   | MONITORING OF EXISTING STRUCTURES .....                                     | 15-15       |
| 15.3.1   | Purpose of Monitoring.....  | 15-15       |
| 15.3.2   | Equipment, Applications, Limitations.....                                   | 15-15       |

|   |  |             |
|---|--|-------------|
| 15.4  | TUNNEL DEFORMATION .....   | 15-25       |
| 15.4.1  | Purpose of Monitoring.....   | 15-25       |
| 15.4.2  | Equipment, Applications, Limitations.....                              | 15-26       |
| 15.5  | DYNAMIC GROUND MOVEMENT – VIBRATIONS .....                             | 15-31       |
| 15.5.1  | Purpose of Monitoring.....   | 15-31       |
| 15.5.2  | Equipment, Applications, Limitations.....                              | 15-31       |
| 15.6  | GROUNDWATER BEHAVIOR .....   | 15-33       |
| 15.6.1  | Purpose of Monitoring.....   | 15-33       |
| 15.6.2  | Equipment, Applications, Limitations.....                              | 15-33       |
| 15.7  | INSTRUMENTATION MANAGEMENT .....                                       | 15-37       |
| 15.7.1  | Objectives.....  | 15-37       |
| 15.7.2  | Planning of the Program.....   | 15-38       |
| 15.7.3  | Guidelines for Selection of Instrument Types, Numbers, Locations ..... | 15-39       |
| 15.7.4  | Remote (Automated) versus Manual Monitoring.....                       | 15-40       |
| 15.7.5  | Establishment of Warning/Action Levels .....                           | 15-40       |
| 15.7.6  | Division of Responsibility.....  | 15-42       |
| 15.7.7  | Instrumentation and Monitoring for SEM tunneling.....                  | 15-44       |
| <b>CHAPTER 16 - TUNNEL REHABILITATION .....</b> |  | <b>16-1</b> |
| 16.1  | INTRODUCTION.....  | 16-1        |
| 16.2  | TUNNEL INSPECTION AND IDENTIFICATION .....                             | 16-2        |
| 16.2.1  | Inspection Parameter Selection .....                                   | 16-2        |
| 16.2.2  | Inspection Parameters.....   | 16-2        |
| 16.2.3  | General Notes in Field Books .....                                     | 16-2        |
| 16.2.4  | Field Notes .....  | 16-3        |
| 16.2.5  | Field Data Forms .....   | 16-3        |
| 16.2.6  | Photographic Documentation .....                                       | 16-3        |
| 16.2.7  | Survey Control .....   | 16-3        |
| 16.3  | GROUNDWATER INTRUSION .....  | 16-6        |
| 16.3.1  | General .....  | 16-6        |
| 16.3.2  | Repair Materials .....   | 16-6        |
| 16.4  | STRUCTURAL REPAIR – CONCRETE.....                                      | 16-9        |
| 16.4.1  | Introduction .....   | 16-9        |
| 16.4.2  | Surface Preparation .....  | 16-11       |
| 16.4.3  | Reinforcing Steel.....   | 16-12       |
| 16.4.4  | Repairs.....   | 16-13       |
| 16.4.5  | Shotcrete Repairs.....   | 16-13       |
| 16.5  | STRUCTURAL INJECTION OF CRACKS .....                                   | 16-17       |

|                         |   |             |
|-------------------------|---|-------------|
| 16.6                    | SEGMENTAL LININGS REPAIR.....                               | 16-18       |
| 16.7                    | STEEL REPAIRS.....  | 16-20       |
| 16.7.1                  | GENERAL .....   | 16-20       |
| 16.8                    | MASONARY REPAIR .....                                       | 16-21       |
| 16.9                    | UNLINED ROCK TUNNELS .....                                  | 16-21       |
| 16.10                   | SPECIAL CONSIDERATIONS FOR SUPPORTED CEILINGS/ HANGERS..... | 16-23       |
| <b>GLOSSARY .....</b>   |   | <b>GL-1</b> |
| <b>REFERENCES .....</b> |   | <b>R-1</b>  |

**LIST OF APPENDICES**

|            |  |     |
|------------|--|-----|
| APPENDIX A | EXECUTIVE SUMMARY 2005 SCAN STUDY FOR THE UNDERGROUND<br>TRANSPORTATION SYSTEMS IN EUROPE..... | A-1 |
| APPENDIX B | DESCRIPTIONS FOR ROCK CORE SAMPLES .....   | B-1 |
| APPENDIX C | CUT-AND-COVER TUNNEL DESIGN EXAMPLE.....   | C-1 |
| APPENDIX D | TUNNEL BORING MACHINES .....   | D-1 |
| APPENDIX E | ANALYTICAL CLOSED FORM SOLUTIONS .....   | E-1 |
| APPENDIX F | SEQUENTIAL EXCAVATION METHOD EXAMPLE .....   | F-1 |
| APPENDIX G | PRECAST SEGMENTAL LINING DESIGN EXAMPLE.....   | G-1 |
| APPENDIX H | DEFICIENCY AND REFERENCE LEGENDS FOR TUNNEL INSPECTION .....                                   | H-1 |
| APPENDIX I | FHWA TECHNICAL ADVISORY T 5140.30.....   | I-1 |

This page is intentionally left blank.



## LIST OF FIGURES

|             |  |      |
|-------------|--|------|
| Figure 1-1  | Glenwood Canyon Hanging Lake Tunnels .....   | 1-1  |
| Figure 1-2  | Two Cell Rectangular Tunnel .....  | 1-2  |
| Figure 1-3  | Circular Tunnel .....  | 1-3  |
| Figure 1-4  | Horseshoe and Curvilinear (Oval) Tunnels.....  | 1-3  |
| Figure 1-5  | A-86 Road Tunnel in Paris, France.....   | 1-5  |
| Figure 1-6  | Chongming under the Yangtze River.....   | 1-7  |
| Figure 1-7  | Fort McHenry Tunnel in Baltimore, MD.....  | 1-8  |
| Figure 1-8  | Stacked Drift and final Mt Baker Tunnel, I-90, Seattle, WA.....  | 1-8  |
| Figure 1-9  | “Park on the Lid” Seattle, Washington .....  | 1-12 |
| Figure 1-10 | Preliminary Road Tunnel Type Selection Process .....   | 1-13 |
| Figure 1-11 | Gotthard Tunnel Fire in October 2001 .....   | 1-15 |
| Figure 1-12 | Emergency Exit.....  | 1-16 |
| Figure 1-13 | Emergency Alcove .....   | 1-17 |
| Figure 2-1  | H3 Tetsuo Harano Tunnels in Hawaii.....  | 2-1  |
| Figure 2-2  | Typical Two-Lane Tunnel Clearance Requirements.....  | 2-5  |
| Figure 2-3  | A Typical Horseshoe Section for a Two-lane Tunnel.....   | 2-6  |
| Figure 2-4  | Typical Two-Lane Road Tunnel Cross Section and Elements.....   | 2-7  |
| Figure 2-5  | Typical Tunnel Roadway with Reduced Shoulder Widths .....  | 2-9  |
| Figure 2-6  | Ventilation System with Jet Fans at Cumberland Gap Tunnel.....   | 2-10 |
| Figure 2-7  | “Black Hole” and Proper Lighting .....   | 2-11 |
| Figure 2-8  | Portal Structure for Cumberland Gap Tunnel .....   | 2-12 |
| Figure 3-1  | Water Boring Investigation from a Barge for the Port of Miami Tunnel, Miami, FL.....   | 3-2  |
| Figure 3-2  | Phased Geotechnical Investigations with Project Development Process .....  | 3-3  |
| Figure 3-3  | 3D Laser Scanning Tunnel Survey Results in Actual Scanned Points.....  | 3-7  |
| Figure 3-4  | Cumberland Gap Tunnel Geological Profile.....  | 3-10 |
| Figure 3-5  | Vertical Test Boring/Rock Coring on a Steep Slope.....   | 3-15 |
| Figure 3-6  | Horizontal Borehole Drilling in Upstate New York.....  | 3-17 |
| Figure 3-7  | Rotosonic Sampling for a CSO Tunnel Project at Portland, Oregon. ....  | 3-18 |
| Figure 3-8  | Rock Core Scanning Equipment and Result .....  | 3-30 |
| Figure 3-9  | Packer Pressure Test Apparatus for Determining the Permeability of Rock - Schematic<br>Diagram and Detail of Packer Unit ..... | 3-33 |
| Figure 5-1  | Cut and Cover Tunnel Bottom-Up Construction; Top-down Construction .....   | 5-1  |
| Figure 5-2  | Cut-and-Cover Tunnel Bottom-Up and Top-down Construction Sequence .....  | 5-2  |
| Figure 5-3  | Cut and Cover Construction using Side Slopes Excavation.....   | 5-5  |
| Figure 5-4  | Sheet Pile Walls with Multi Level-Bracing .....  | 5-6  |
| Figure 5-5  | Braced Soldier Pile and Lagging Wall.....  | 5-7  |
| Figure 5-6  | Tie-back Excavation Support Leaves Clear Access.....   | 5-8  |
| Figure 5-7  | Braced Slurry Walls .....  | 5-9  |
| Figure 5-8  | Tangent Pile Wall Construction Schematic.....  | 5-10 |

|             |   |      |
|-------------|---|------|
| Figure 5-9  | Tangent Pile Wall Support .....   | 5-10 |
| Figure 5-10 | Completed Secant Pile Wall Plan View .....  | 5-11 |
| Figure 5-11 | Tunnel Structure with Haunches .....  | 5-14 |
| Figure 5-12 | Cut and Cover Tunnel Loading Diagram – Bottom Up Construction in Soil .....                                   | 5-21 |
| Figure 5-13 | Cut and Cover Tunnel Loading Diagram Top-down Construction in Soil .....                                      | 5-22 |
| Figure 5-14 | Typical Street Decking.....   | 5-29 |
| Figure 6-1  | Progressive Failure in Unsupported Blocky Rock .....  | 6-3  |
| Figure 6-2  | Prevention of Progressive Failure in Supported Blocky Rock.....   | 6-3  |
| Figure 6-3  | A Relationship between Strain and Squeezing Potential of Rock Mass .....                                      | 6-4  |
| Figure 6-4  | Correlation between RQD and Modulus Ratio .....   | 6-12 |
| Figure 6-5  | Example of a Full-face Tunnel Blast.....  | 6-15 |
| Figure 6-6  | Complex Round Hook-up .....   | 6-16 |
| Figure 6-7  | Typical Blast Charges .....   | 6-17 |
| Figure 6-8  | Drilling for a Tunnel Blast .....   | 6-18 |
| Figure 6-9  | Chipping Process between Two Disc Cutters .....   | 6-18 |
| Figure 6-10 | Rock Tunnel Boring Machine Face with Disc Cutters for Hard Rock, Australia. ....                              | 6-19 |
| Figure 6-11 | Classification of Tunnel Excavation Machines.....   | 6-20 |
| Figure 6-12 | Typical Diagram for a Open Gripper Main Beam TBM.....   | 6-21 |
| Figure 6-13 | Typical Diagram for Single Shield TBM.....  | 6-21 |
| Figure 6-14 | Typical Diagram for Double Shield TBM .....   | 6-21 |
| Figure 6-15 | TBM Utilization on Two Norwegian Tunnels .....  | 6-23 |
| Figure 6-16 | AM 105 Roadheader, Australia.....   | 6-23 |
| Figure 6-17 | Temporary Rock Dowel; Schematic Function of a Rock Dowel under Shear.....                                     | 6-26 |
| Figure 6-18 | Typical Section of Permanent Rock Bolt .....  | 6-27 |
| Figure 6-19 | Steel Rib Support .....   | 6-29 |
| Figure 6-20 | Lattice Girder Configuration; Estimation of Cross Section for Shotcrete-encased<br>Lattice Girders.....       | 6-30 |
| Figure 6-21 | Spiling (Forepoling) Method of Supporting Running Ground.....   | 6-31 |
| Figure 6-22 | A Typical Seven Segment and a Key Segment Precast Segment Lining:<br>Circumferential Dowel; Radial Bolt ..... | 6-32 |
| Figure 6-23 | Support Pressures and Bolt Lengths Used in Crown of Caverns .....   | 6-35 |
| Figure 6-24 | Support Pressures and Bolt Lengths Used on Cavern Walls.....  | 6-36 |
| Figure 6-25 | Rock Support Requirement using Rock Mass Quality Q System .....   | 6-37 |
| Figure 6-26 | Ground Reaction Curves between Support Pressure and Displacement .....  | 6-39 |
| Figure 6-27 | A Reinforced Rock Arch.....   | 6-40 |
| Figure 6-28 | Support Systems: Concrete / Shotcrete Lining, Blocked Steel Set .....   | 6-42 |
| Figure 6-29 | UNWEDGE Analysis: Wedges Formed Surrounding a Tunnel; Support Installation....                                | 6-42 |
| Figure 6-30 | Design of Support System in FE Analysis .....   | 6-43 |
| Figure 6-31 | Strength Factor Contours from Finite Element Analysis .....   | 6-46 |
| Figure 6-32 | Graphical Result of Discrete Finite Element Analysis.....   | 6-47 |
| Figure 6-33 | Elastic Approximation of Ground Displacements around a Circular Tunnel in Rock....                            | 6-49 |

|             |  |      |
|-------------|--|------|
| Figure 6-34 | Ground Displacement Contours calculated by Finite Element Method.....  | 6-50 |
| Figure 6-35 | Rock Loads for Permanent Lining Design: Uniform Roof and Side Loads;<br>Eccentric Load .....   | 6-53 |
| Figure 6-36 | Unlined Rock Tunnel in Zion National Park, Utah.....   | 6-54 |
| Figure 6-37 | Empirical Groundwater Loads on the Underground Structures .....  | 6-56 |
| Figure 6-38 | Head Loss across the Lining and Surrounding Ground.....  | 6-56 |
| Figure 6-39 | Two Dimensional Finite Element Groundwater Flow Model Analysis.....  | 6-57 |
| Figure 6-40 | Drained Waterproofing System.....  | 6-58 |
| Figure 6-41 | Undrained Waterproofing System.....  | 6-59 |
| Figure 7-1  | Patent Drawing for Brunel’s Shield, 1818 .....   | 7-6  |
| Figure 7-2  | Digger Shield with Hydraulically Operated Breasting Plates on Periphery of Top<br>Heading of Shield used to Construct Transit Tunnel. ....   | 7-7  |
| Figure 7-3  | Cross-section of Digger Shield .....   | 7-7  |
| Figure 7-4  | Earth Pressure Balance Tunnel Boring Machine .....   | 7-10 |
| Figure 7-5  | Simplified Cross-section of Earth Pressure Balance Tunnel Boring Machine.....  | 7-10 |
| Figure 7-6  | Slurry Face Tunnel Boring Machine .....  | 7-10 |
| Figure 7-7  | Simplified Cross-section of Slurry Face Tunnel Boring Machine .....  | 7-11 |
| Figure 7-8  | Loads on a Concrete Lining Calculated by Finite Element Analysis: Axial Force,<br>Bending Movement, Shear Force.....   | 7-18 |
| Figure 7-9  | Typical Settlement Profile for a Soft Ground Tunneling .....   | 7-21 |
| Figure 7-10 | Assumptions for Width of Settlement Trough .....   | 7-22 |
| Figure 7-11 | Example of Finite Element Settlement Analysis for Twin Circular Tunnels under Pile<br>Foundations.....   | 7-23 |
| Figure 8-1  | Flowing Sand in Tunnel .....   | 8-3  |
| Figure 8-2  | Mixed Face Tunneling Example .....   | 8-9  |
| Figure 8-3  | Yielding Support in Squeezing Ground .....   | 8-13 |
| Figure 8-4  | Yielding Support Crushed to 20 cm.....   | 8-13 |
| Figure 9-1  | Schematic Representation of Stresses around Tunnel Opening.....  | 9-3  |
| Figure 9-2  | Schematic Representation of Relationships Between Radial Stress $\sigma_r$ , Deformation<br>of the Tunnel Opening $\Delta r$ , Supports $p_i$ , and Time of Support Installation T ..... | 9-4  |
| Figure 9-3  | Regular SEM Cross Section.....   | 9-6  |
| Figure 9-4  | Three-Lane SEM Road Tunnel Interior Configuration .....  | 9-7  |
| Figure 9-5  | Waterproofing System and Compartmentalization .....  | 9-8  |
| Figure 9-6  | Typical Shotcrete Final Lining Detail.....   | 9-10 |
| Figure 9-7  | Prototypical Excavation Support Class (ESC) Cross Section .....  | 9-13 |
| Figure 9-8  | Prototypical Longitudinal Excavation and Support Class (ESC).....  | 9-14 |
| Figure 9-9  | Prototypical Longitudinal Profile.....   | 9-15 |
| Figure 9-10 | Face Drilling for Drill-and-Blast SEM Excavation.....  | 9-24 |
| Figure 9-11 | Shotcrete Lining Installed at the Face in a SEM Tunnel Excavated by Drill-and-Blast.....   | 9-25 |
| Figure 9-12 | Road Header SEM Excavation in Medium Hard, Jointed Rock .....  | 9-25 |
| Figure 9-13 | Soft Ground SEM Excavation Tunnel Using Backhoes.....  | 9-26 |

|              |  |       |
|--------------|--|-------|
| Figure 9-14  | Typical Tunnel Excavation with Temporary Middle Wall .....   | 9-28  |
| Figure 9-15  | Spiling Pre-support by No. 8 Solid Rebars .....  | 9-37  |
| Figure 9-16  | Steel Pipe Installation for Pipe Arch Canopy.....  | 9-39  |
| Figure 9-17  | Pre-support by Pipe Arch Canopy, Exposed Steel Pipes .....   | 9-40  |
| Figure 9-18  | Pre-support at Portal Wall and Application of Shotcrete for Portal Face Protection .....   | 9-42  |
| Figure 9-19  | Shotcrete Canopy Construction after Completion of Portal Collar and Pre-support .....  | 9-43  |
| Figure 9-20  | Stress Flow around Tunnel Opening.....   | 9-44  |
| Figure 9-21  | SEM Tunneling and Ground Disturbance .....   | 9-45  |
| Figure 9-22  | Deformation Monitoring Cross Section Points .....  | 9-49  |
| Figure 9-23  | Typical Deformation Monitoring Cross Section .....   | 9-50  |
| Figure 9-24  | Prototypical Monitoring of a Surface Settlement Point Located above the Tunnel<br>Centerline in a Deformation vs. Time and Tunnel Advance vs. Time<br>Combined Graph ..... | 9-51  |
| Figure 9-25  | Engineering Geological Tunnel Face Mapping.....  | 9-54  |
| Figure 10-1  | Cumberland Gap Tunnel .....  | 10-1  |
| Figure 10-2  | Baltimore Metro Precast Segment Lining .....   | 10-2  |
| Figure 10-3  | Baltimore Metro Steel Plate Lining.....  | 10-2  |
| Figure 10-4  | New Lehigh Tunnel on Pennsylvania Turnpike Constructed with Final Shotcrete<br>Lining .....  | 10-3  |
| Figure 10-5  | Cumberland Gap Tunnel Lining .....   | 10-17 |
| Figure 10-6  | Cast-In-Place Concrete Lining, Washington DC .....   | 10-18 |
| Figure 10-7  | Precast Segments for One Pass Lining, Forms Stripped .....   | 10-22 |
| Figure 10-8  | Stacked Precast Segments for One-Pass Lining.....  | 10-22 |
| Figure 10-9  | Stacked Precast Segments for Two-Pass Lining .....   | 10-23 |
| Figure 10-10 | Steel Cage for Precast Segments for Two Pass Lining .....  | 10-23 |
| Figure 10-11 | Radial Joints, Baltimore, MD.....  | 10-24 |
| Figure 10-12 | Schematic Precast Segment Rings .....  | 10-25 |
| Figure 10-13 | Mock-up of Precast Segment Rings .....   | 10-26 |
| Figure 10-14 | Typical Steel Lining Section.....  | 10-29 |
| Figure 10-15 | Typical Shotcrete Lining Detail .....  | 10-31 |
| Figure 11-1  | Immersed Tunnel Illustration .....   | 11-1  |
| Figure 11-2  | Chesapeake Bay Bridge-Tunnel.....  | 11-2  |
| Figure 11-3  | Cross Harbour Tunnel Hong Kong .....   | 11-3  |
| Figure 11-4  | BART Tunnel, San Francisco .....   | 11-4  |
| Figure 11-5  | Double Shell - Second Hampton Road Tunnel, Virginia .....  | 11-5  |
| Figure 11-6  | Fort McHenry Tunnel, Baltimore.....  | 11-5  |
| Figure 11-7  | Schematic of Sandwich Construction.....  | 11-6  |
| Figure 11-8  | Bosphorus Tunnel, Istanbul, Turkey .....   | 11-6  |
| Figure 11-9  | Fort Point Channel Tunnel, Boston.....   | 11-7  |
| Figure 11-10 | Fabrication Facility and Transfer Basin Øresund Tunnel, Denmark .....  | 11-8  |
| Figure 11-11 | Sealed Clam Shell Dredge .....   | 11-9  |

|              |   |       |
|--------------|---|-------|
| Figure 11-12 | Hong Kong Cross Harbour Tunnel is Nearly Ready for Side Launching.....                              | 11-11 |
| Figure 11-13 | Osaka Port Sakishima Tunnel Transported to Site with Two Pontoon Lay Barges ....                    | 11-13 |
| Figure 11-14 | Catamaran Lay Barge .....   | 11-13 |
| Figure 11-15 | A Tunnel Element is Being Placed.....   | 11-15 |
| Figure 11-16 | Graph of Dynamic Load Factor Against $T_d / T$ .....  | 11-23 |
| Figure 11-17 | Gina-Type Seal .....  | 11-29 |
| Figure 11-18 | Omega Type Seal.....  | 11-29 |
| Figure 11-19 | Gina-type Immersion Gasket at Fort Point Channel, Boston, MA .....                                  | 11-30 |
| Figure 12-1  | Completed I-90 Tunnels .....  | 12-1  |
| Figure 12-2  | Typical Jacked Box Tunneling Sequence under an Existing Rail Track .....                            | 12-2  |
| Figure 12-3  | Generalized Subsurface Profile for the I-90 Jacked Box Tunnels .....                                | 12-3  |
| Figure 12-4  | Tunnel Structure Construction Operation.....  | 12-4  |
| Figure 12-5  | Excavation of the Frozen Ground at the Front of the Tunnel Shield by Roadheader ....                | 12-5  |
| Figure 12-6  | Scoop Tram Loading Excavated Material into Skip Bucket for Removal.....                             | 12-6  |
| Figure 12-7  | Close Up of High Capacity Hydraulic Jacks, Reaction Blocks, and Packers .....                       | 12-8  |
| Figure 12-8  | Installation of Packer Sections and Connecting Diaphragm Plates. ....                               | 12-9  |
| Figure 12-9  | Progressive Installation of Packer Sections and Connecting Diaphragm Plates.....                    | 12-9  |
| Figure 12-10 | Schematic Arrangement of Freeze Pipes to Freeze Ground Mass Prior to Tunnel<br>Jacking .....        | 12-10 |
| Figure 12-11 | Arrangement of an Individual Freeze Pipe showing Brine Circulation.....                             | 12-11 |
| Figure 12-12 | Ground Freezing System in Operation while Commuter Trains Run Through the<br>Area.....              | 12-12 |
| Figure 12-13 | Frozen Face Seen from Shield at Front of Jacked Box Structure .....                                 | 12-13 |
| Figure 13-1  | Major Tectonic Plates and Their Approximate Direction of Movement. ....                             | 13-2  |
| Figure 13-2  | Types of Fault Movement.....  | 13-5  |
| Figure 13-3  | Comparison of Earthquake Magnitude Scales .....   | 13-6  |
| Figure 13-4  | Definition of Basic Fault Geometry Including Hypocenter and Epicenter.....                          | 13-7  |
| Figure 13-5  | National Ground Motion Hazard Map by USGS.....  | 13-8  |
| Figure 13-6  | General Procedure for Probabilistic Seismic Hazard Analysis.....                                    | 13-10 |
| Figure 13-7  | Design Response Spectra Constructed Using the NEHRP Procedure.....                                  | 13-12 |
| Figure 13-8  | Highway Tunnel Lining Falling Off from Tunnel Crown .....   | 13-16 |
| Figure 13-9  | Summary of Observed Bored/Mined Tunnel Damage under Ground Shaking<br>Effects .....                 | 13-17 |
| Figure 13-10 | Fracture at Base of Columns of Cut-and-Cover Tunnel between Daikai and Nagata<br>Stations .....     | 13-18 |
| Figure 13-11 | Shear Failure of Top of Columns of Cut-and-Cover Tunnel Between Daikai and<br>Nagata Stations ..... | 13-19 |
| Figure 13-12 | Daikai Subway Station Collapse.....   | 13-19 |
| Figure 13-13 | Tunnel Transverse Ovaling and Racking Response to Vertically Propagating Shear<br>Waves .....       | 13-20 |
| Figure 13-14 | Tunnel Longitudinal Axial and Curvature Response to Traveling Waves .....                           | 13-21 |

|              |   |       |
|--------------|---|-------|
| Figure 13-15 | Shear Distortion of Ground – Free-Field Condition vs. Cavity In-Place Condition....                                     | 13-24 |
| Figure 13-16 | Lining Response Coefficient, K1 .....   | 13-27 |
| Figure 13-17 | Lining Response Coefficient, K2, for Poisson’s Ratio = 0.2.....   | 13-28 |
| Figure 13-18 | Lining Response Coefficient, K2, for Poisson’s Ratio = 0.35.....  | 13-28 |
| Figure 13-19 | Lining Response Coefficient, K2, for Poisson’s Ratio = 0.5 .....  | 13-29 |
| Figure 13-20 | Soil Deformation Profile and Racking Deformation of a Box Structure .....   | 13-31 |
| Figure 13-21 | Racking Coefficient $R_r$ for Rectangular Tunnels .....   | 13-34 |
| Figure 13-22 | Simplified Racking Frame Analysis of a Rectangular Tunnel.....  | 13-35 |
| Figure 13-23 | Example of Two-dimensional Continuum Finite Element Model in Pseudo-Dynamic<br>Displacement Time-History Analysis ..... | 13-38 |
| Figure 13-24 | Sample Dynamic Time History Analysis Model .....  | 13-39 |
| Figure 13-25 | Maximum Surface Fault Displacement vs. Earthquake Moment Magnitude, $M_w$ .....   | 13-44 |
| Figure 13-26 | Analytical Model of Tunnel at Fault Crossing .....  | 13-45 |
| Figure 13-27 | Tunnel-Ground Interaction Model at Fault Crossing .....   | 13-46 |
| Figure 13-28 | Analytical Model of Ground Restraint for Tunnel at Fault Crossing .....   | 13-47 |
| Figure 14-1  | Confined Worksite and Staging Area.....   | 14-3  |
| Figure 14-2  | Tunnel Portal.....  | 14-4  |
| Figure 14-3  | Horizontal Muck Conveyor.....   | 14-6  |
| Figure 14-4  | Muck Train Dumping at Portal .....  | 14-7  |
| Figure 14-5  | Surface Muck Storage Area .....   | 14-8  |
| Figure 14-6  | Fire in Work Shaft.....   | 14-10 |
| Figure 14-7  | Risk Management Process .....   | 14-17 |
| Figure 14-8  | Typical Project Risk Matrix .....   | 14-17 |
| Figure 14-9  | Risk Management throughout the Project Cycle.....   | 14-18 |
| Figure 15-1  | Deep Benchmark.....   | 15-43 |
| Figure 15-2  | Survey Point.....   | 15-4  |
| Figure 15-3  | Survey Point in Rigid Pavement Surface .....  | 15-5  |
| Figure 15-4  | Schematic of Borros Point.....  | 15-6  |
| Figure 15-5  | Schematic of Probe Extensometer with Magnet/Reed Switch Tansducer, Installed<br>in a Borehole .....                     | 15-7  |
| Figure 15-6  | Multiple Position Borehole Extensometer Installed from Ground Surface.....  | 15-8  |
| Figure 15-7  | Horizontal Borehole Extensometer Installed from Advancing Excavation .....  | 15-9  |
| Figure 15-8  | Triple Height Telltale or Roof Monitor.....   | 15-10 |
| Figure 15-9  | Heave Cage .....  | 15-11 |
| Figure 15-10 | Principal of Conventional Inclinometer Operation .....  | 15-12 |
| Figure 15-11 | In-Place Inclinometer .....   | 15-13 |
| Figure 15-12 | Tape Extensometer Typical Detail.....   | 15-14 |
| Figure 15-13 | Typical Convergence Bolt Installation Arrangement.....  | 15-14 |
| Figure 15-14 | Deformation Monitoring Point in Masonry or Concrete Slab.....   | 15-16 |
| Figure 15-15 | Structure Monitoring Point in Vertical Masonry or Concrete Surface.....   | 15-17 |
| Figure 15-16 | Robotic Total Station Instrument .....  | 15-18 |

|              |   |       |
|--------------|---|-------|
| Figure 15-17 | Target Prism for Robotic Total Station .....                                  | 15-19 |
| Figure 15-18 | Biaxial Tiltmeter .....   | 15-20 |
| Figure 15-19 | Horizontal In-Place Inclinometer .....  | 15-21 |
| Figure 15-20 | Multipoint Closed Liquid Level System .....                                   | 15-22 |
| Figure 15-21 | Open Channel Liquid Level System .....  | 15-23 |
| Figure 15-22 | Schematic of Electrolytic Level Tilt Sensor.....                              | 15-24 |
| Figure 15-23 | Grid Crack Gauge.....   | 15-25 |
| Figure 15-24 | Electrical Crack Gauge.....   | 15-25 |
| Figure 15-25 | Deformation Monitoring Point in Vertical Masonry or Concrete Surface .....    | 15-27 |
| Figure 15-26 | Inclinometer Casing in Slurry Wall.....                                       | 15-28 |
| Figure 15-27 | Surface Mounted Vibrating Wire Strain Gauge .....                             | 15-29 |
| Figure 15-28 | Schematic of Electrical Resistance Load Cell.....                             | 15-30 |
| Figure 15-29 | Schematic of Observation Well.....  | 15-34 |
| Figure 15-30 | Schematic of Open Standpipe Piezometer Installed in Borehole .....            | 15-35 |
| Figure 15-31 | Schematic of Multiple Full-Grouted Piezometers in One Borehole .....          | 15-37 |
| Figure 16-1  | Typical Cut and Cover Inspection Surfaces and Limits .....                    | 16-4  |
| Figure 16-2  | Delineation of Typical Circular Tunnel .....                                  | 16-4  |
| Figure 16-3  | Typical Injection Ports for Chemical Grout .....                              | 16-7  |
| Figure 16-4  | Leak Injection, Tuscarora Tunnel PA Turnpike.....                             | 16-7  |
| Figure 16-5  | Typical Location of Injection Ports and Leaking Crack Repair Detail .....     | 16-8  |
| Figure 16-6  | Negative Side Cementitious Coating, Tuscarora Tunnel PA Turnpike .....        | 16-10 |
| Figure 16-7  | Substrate After Hydro-demolition, Shawmut Jct. Boston .....                   | 16-12 |
| Figure 16-8  | Typical Mechanical Couple for Reinforcing Steel.....                          | 16-12 |
| Figure 16-9  | Shallow Spall Repair.....   | 16-14 |
| Figure 16-10 | Typical Sections at Concrete Repair .....                                     | 16-15 |
| Figure 16-11 | Nozzleman Applying Wet Process Shortcete, USPS Tunnel Chicago.....            | 16-16 |
| Figure 16-12 | Reinforcing Steel for Repair, Sumner Tunnel Boston.....                       | 16-16 |
| Figure 16-13 | Shotcrete Finishing, Shawmut Jct. Boston.....                                 | 16-17 |
| Figure 16-14 | Typical Structural Crack Injection .....                                      | 16-18 |
| Figure 16-15 | Steel Segmental Liner Repair.....   | 16-19 |
| Figure 16-16 | Cast Iron Segmental Segment Mock-up Filling with Shotcrete, MBTA Boston ..... | 16-20 |
| Figure 16-17 | Typical Framing Steel Repair at Temporary Incline.....                        | 16-20 |
| Figure 16-18 | Typical Masonry Repair.....   | 16-21 |
| Figure 16-19 | Rock Tunnel with Shotcrete Wall Repair and Arch Liner .....                   | 16-22 |
| Figure 16-20 | Rock Bolts Supporting Liner, I-75 Lima Ohio Underpass.....                    | 16-22 |
| Figure 16-21 | Typical Hanger Supports for Suspended Ceiling .....                           | 16-23 |
| Figure 16-22 | Typical Replacement Hanger Hardware .....                                     | 16-24 |
| Figure 16-23 | Typical Undercut Mechanical Anchors.....                                      | 16-24 |

This page is intentionally left blank.



## LIST OF TABLES

|            |  |      |
|------------|--|------|
| Table 3-1  | Sources of Information Data.....   | 3-5  |
| Table 3-2  | Special Investigation Needs Related to Tunneling Methods .....   | 3-12 |
| Table 3-3  | Geotechnical Investigation Needs Dictated by Geology .....   | 3-13 |
| Table 3-4  | Guidelines for Vertical/Inclined Borehole Spacing.....   | 3-16 |
| Table 3-5  | In-situ Testing Methods Used in Soil .....   | 3-23 |
| Table 3-6  | Common in situ Test Methods for Rock.....  | 3-25 |
| Table 3-7  | Applications for Geophysical Testing Methods .....   | 3-27 |
| Table 3-8  | Geophysical Testing Methods .....  | 3-28 |
| Table 3-9  | Common Laboratory Tests for Rock .....   | 3-30 |
| Table 4-1  | Sample Outline for Geotechnical Data Reports.....  | 4-4  |
| Table 4-2  | Sample Outline for Geotechnical Design Memorandum.....   | 4-6  |
| Table 4-3  | Checklist for Geotechnical Baseline Reports .....  | 4-11 |
| Table 5-1  | Cut and Cover Tunnel LRFD Load Combination Table .....   | 5-23 |
| Table 6-1  | Terzaghi's Rock Mass Classification .....  | 6-5  |
| Table 6-2  | Classification of Individual Parameters for Q System.....  | 6-7  |
| Table 6-3  | Rock Mass Rating System.....   | 6-11 |
| Table 6-4  | Estimation of Rock Mass Deformation Modulus Using Rock Mass Classification.....                              | 6-13 |
| Table 6-5  | Estimation of Disturbance Factor, D .....  | 6-14 |
| Table 6-6  | Types of Rock Bolts .....  | 6-27 |
| Table 6-7  | Typical Initial Support and Lining Systems Used in the Current Practice .....                                | 6-31 |
| Table 6-8  | Suggested Rock Loadings from Terzaghi's Rock Mass Classification .....                                       | 6-33 |
| Table 6-9  | Guidelines for Excavation and Support of 10 m Span Rock Tunnels in Accordance<br>with RMR Systems .....      | 6-34 |
| Table 6-10 | Excavation Support Ratio Values for Various Underground Structures .....                                     | 6-37 |
| Table 6-11 | Analytical Solutions for Support Stiffness and Maximum Support Pressure for<br>Various Support Systems ..... | 6-40 |
| Table 6-12 | Numerical Modeling Programs used in Tunnel Design and Analysis .....   | 6-44 |
| Table 7-1  | Tunnelman's Ground Classification for Soils .....  | 7-2  |
| Table 7-2  | Tunnel Behavior for Clayey Soils and Silty Sand .....  | 7-3  |
| Table 7-3  | Tunnel Behavior: Sands and Gravels .....   | 7-4  |
| Table 7-4  | Shield Tunneling Methods in Soft Ground.....   | 7-9  |
| Table 7-5  | Soft-ground Characteristics .....  | 7-13 |
| Table 7-6  | Initial Support Loads for Tunnels in Soft Ground.....  | 7-16 |
| Table 7-7  | Relationship between Volumes Loss and Construction Practice and Ground<br>Conditions .....                   | 7-20 |
| Table 7-8  | Limiting Angular Distortion .....  | 7-24 |
| Table 7-9  | Damage Risk Assessment Chart.....  | 7-32 |
| Table 7-10 | Ground Treatment Methods.....  | 7-26 |

|            |  |       |
|------------|--|-------|
| Table 7-11 | Summary of Jet Grouting System Variables and their Impact on Basic Design Elements.....                  | 7-29  |
| Table 9-1  | Elements of Commonly Used Excavation and Support Classes (ECS) in Rock .....                             | 9-16  |
| Table 9-2  | Elements of Commonly Used Soft Ground Excavation and Support Classes (ECS) in Soft Ground.....           | 9-18  |
| Table 9-3  | Example SEM Excavation and Support Classes in Rock .....   | 9-21  |
| Table 9-4  | Example SEM Excavation and Support Classes in Soft Ground.....   | 9-22  |
| Table 9-5  | Commonly used Rock Reinforcement Elements and Application Considerations for SEM Tunneling in Rock ..... | 9-32  |
| Table 10-1 | Load Factor and Load Combination Table .....   | 10-10 |
| Table 10-2 | Percentage of Lining Radius Change in Soil .....   | 10-15 |
| Table 11-1 | Permanent In-Service Load Combinations .....   | 11-24 |
| Table 11-2 | Construction Load Combinations .....   | 11-25 |
| Table 13-1 | Ground Motion Attenuation with Depth.....  | 13-13 |
| Table 16-1 | Common U.S. Descriptions of Tunnel Leakage .....   | 16-6  |
| Table 16-2 | Typical Grouts for Leak Sealing .....  | 16-9  |
| Table 16-3 | Comparison of Repair Materials.....  | 16-11 |

# CHAPTER 1 PLANNING

## 1.1 INTRODUCTION

Road tunnels as defined by the American Association of State Highway and Transportation Officials (AASHTO) Technical Committee for Tunnels (T-20), are enclosed roadways with vehicle access that is restricted to portals regardless of type of the structure or method of construction. The committee further defines road tunnels not to include enclosed roadway created by highway bridges, railroad bridges or other bridges. This definition applies to all types of tunnel structures and tunneling methods such as cut-and-cover tunnels (Chapter 5), mined and bored tunnels in rock (Chapter 6), soft ground (Chapter 7), and difficult ground (Chapter 8), immersed tunnels (Chapter 11) and jacked box tunnels (Chapter 12).

Road tunnels are feasible alternatives to cross a water body or traverse through physical barriers such as mountains, existing roadways, railroads, or facilities; or to satisfy environmental or ecological requirements. In addition, road tunnels are viable means to minimize potential environmental impact such as traffic congestion, pedestrian movement, air quality, noise pollution, or visual intrusion; to protect areas of special cultural or historical value such as conservation of districts, buildings or private properties; or for other sustainability reasons such as to avoid the impact on natural habit or reduce disturbance to surface land. Figure 1-1 shows the portal for the Glenwood Canyon Hanging Lake and Reverse Curve Tunnels – Twin 4,000 feet (1,219 meter) long tunnels carrying a critical section of I-70 unobtrusively through Colorado’s scenic Glenwood Canyon.

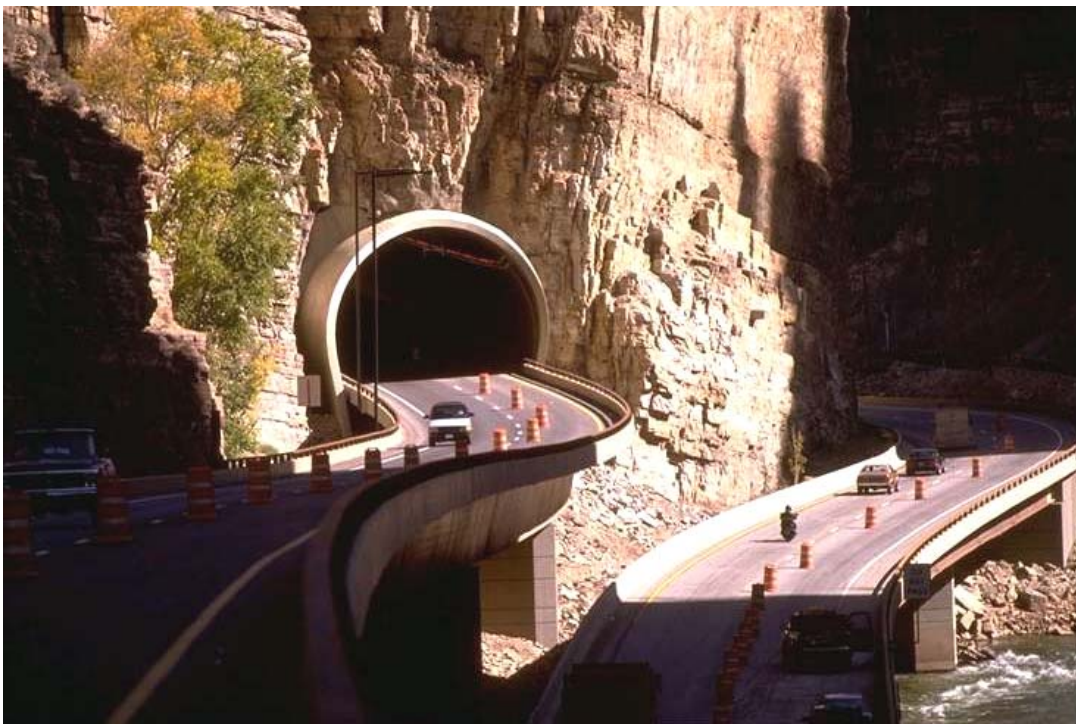

Figure 1-1 Glenwood Canyon Hanging Lake Tunnels

Planning for a road tunnel requires multi-disciplinary involvement and assessments, and should generally adopt the same standards as for surface roads and bridge options, with some exceptions as will be discussed later. Certain considerations, such as lighting, ventilation, life safety, operation and maintenance, etc should be addressed specifically for tunnels. In addition to the capital construction cost, a life cycle cost analysis should be performed taking into account the life expectancy of a tunnel. It should be noted that the life expectancies of tunnels are significantly longer than those of other facilities such as bridges or roads.

This chapter provides a general overview of the planning process of a road tunnel project including alternative route study, tunnel type and tunneling method study, operation and financial planning, and risk analysis and management.

### 1.1.1 Tunnel Shape and Internal Elements

There are three main shapes of highway tunnels – circular, rectangular, and horseshoe or curvilinear. The shape of the tunnel is largely dependent on the method used to construct the tunnel and on the ground conditions. For example, rectangular tunnels (Figure 1-2) are often constructed by either the cut and cover method (Chapter 5), by the immersed method (Chapter 11) or by jacked box tunneling (Chapter 12). Circular tunnels (Figure 1-3) are generally constructed by using either tunnel boring machine (TBM) or by drill and blast in rock. Horseshoe configuration tunnels (Figure 1-4) are generally constructed using drill and blast in rock or by following the Sequential Excavation Method (SEM), also as known as New Austrian Tunneling Method (NATM) (Chapter 9).

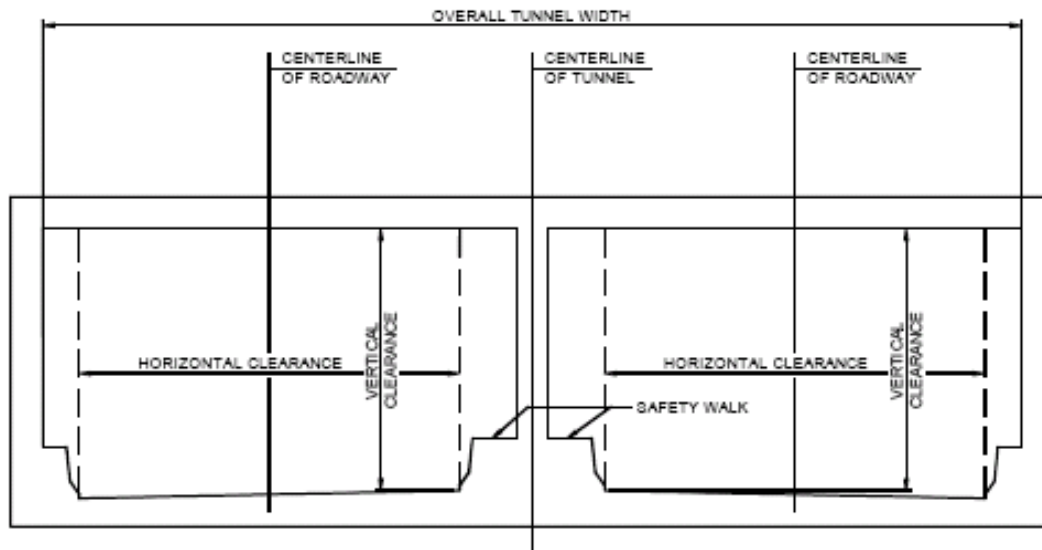

Figure 1-2 Two Cell Rectangular Tunnel (FHWA, 2005a)

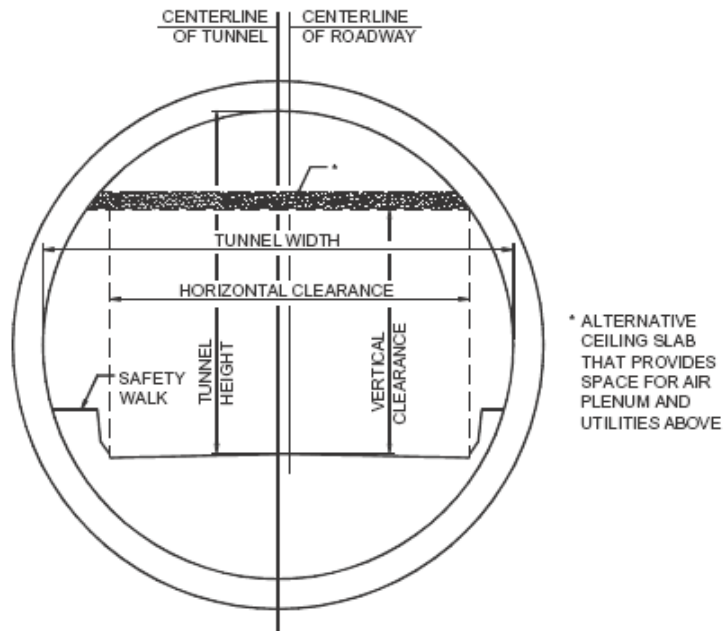
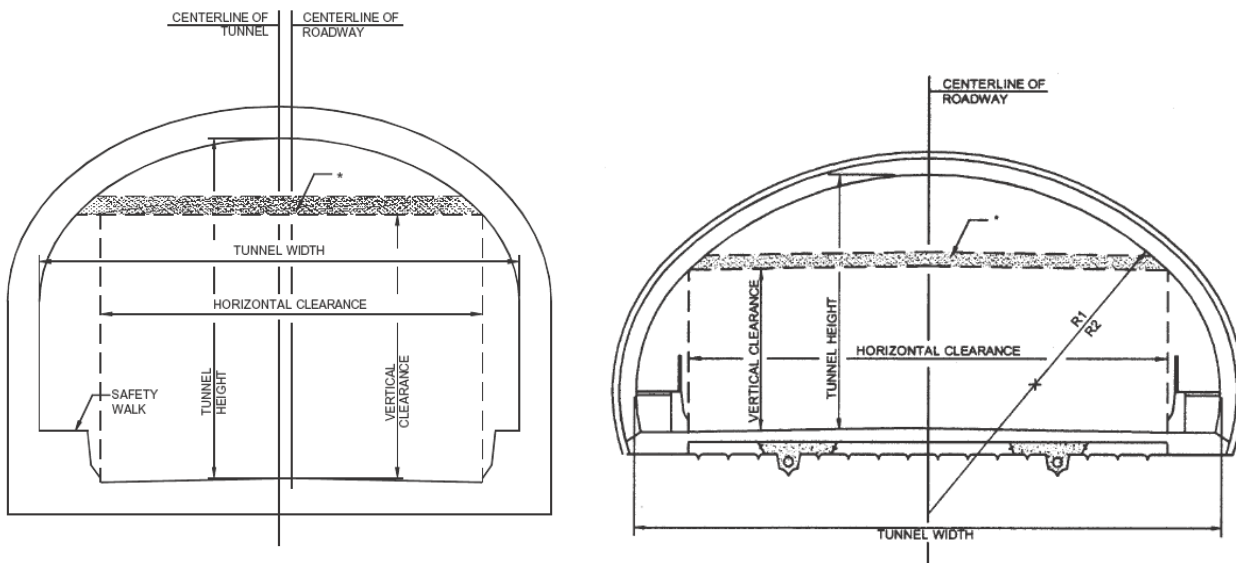

Figure 1-3 Circular Tunnel (FHWA, 2005a)



\* Alternate Ceiling Slab that Provides Space for Air Plenum and Utilities Above

Figure 1-4 Horseshoe and Curvilinear (Oval) Tunnels (FHWA, 2005a)

Road tunnels are often lined with concrete and internal finish surfaces. Some rock tunnels are unlined except at the portals and in certain areas where the rock is less competent. In this case, rock reinforcement is often needed. Rock reinforcement for initial support includes the use of rock bolts with internal metal straps and mine ties, un-tensioned steel dowels, or tensioned steel bolts. To prevent small fragments of rock from spalling, wire mesh, shotcrete, or a thin concrete lining may be used. Shotcrete, or sprayed concrete, is often used as initial lining prior to installation of a final lining, or as a local solution to instabilities in a rock tunnel. Shotcrete can also be used as a final lining. It is typically placed in layers with welded wire fabric and/or with steel fibers as reinforcement. The inside surface can be finished smooth and often without the fibers. Precast segmental lining is primarily used in conjunction with a TBM in soft ground and sometimes in rock. The segments are usually erected within the tail shield of the TBM. Segmental linings have been made of cast iron, steel and concrete. Presently however, all segmental linings are made of concrete. They are usually gasketed and bolted to prevent water penetration. Precast segmental linings are sometimes used as a temporary lining within which a cast in place final lining is placed, or as the final lining. More design details are provided in the following Chapters 6 through 10.

Road tunnels are often finished with interior finishes for safety and maintenance requirements. The walls and the ceilings often receive a finish surface while the roadway is often paved with asphalt pavement. The interior finishes, which usually are mounted or adhered to the final lining, consist of ceramic tiles, epoxy coated metal panels, porcelain enameled metal panels, or various coatings. They provide enhanced tunnel lighting and visibility, provide fire protection for the lining, attenuate noise, and provide a surface easy to clean. Design details for final interior finishes are not within the scope of this Manual.

The tunnels are usually equipped with various systems such as ventilation, lighting, communication, fire-life safety, traffic operation and control including messaging, and operation and control of the various systems in the tunnel. These elements are not discussed in this Manual, however, designers should be cognizant that spaces and provisions should be made available for these various systems when planning a road tunnel. More details are provided in Chapter 2 Geometrical Configuration.

### **1.1.2 Classes of Roads and Vehicle Sizes**

A tunnel can be designed to accommodate any class of roads and any size of vehicles. The classes of highways are discussed in *A Policy on Geometric Design of Highways and Streets* Chapter 1, AASHTO (2004). Alignments, dimensions, and vehicle sizes are often determined by the responsible authority based on the classifications of the road (i.e. interstate, state, county or local roads). However, most regulations have been formulated on the basis of open roads. Ramifications of applying these regulations to road tunnels should be considered. For example, the use of full width shoulders in the tunnel might result in high cost. Modifications to these regulations through engineering solutions and economic evaluation should be considered in order to meet the intention of the requirements.

The size and type of vehicles to be considered depend upon the class of road. Generally, the tunnel geometrical configuration should accommodate all potential vehicles that use the roads leading to the tunnel including over-height vehicles such as military vehicles if needed. However, the tunnel height should not exceed the height under bridges and overpasses of the road that leads to the tunnel. On the other hand, certain roads such as Parkways permit only passenger vehicles. In such cases, the geometrical configuration of a tunnel should accommodate the lower vehicle height keeping in mind that emergency vehicles such as fire trucks should be able to pass through the tunnel, unless special low height emergency response vehicles are provided. It is necessary to consider the cost because designing a tunnel facility to accommodate only a very few extraordinary oversize vehicles may not be economical if feasible alternative routes are available. Road tunnel A86 in Paris, for instance, is designed to accommodate two levels of passenger vehicles only and special low height emergency vehicles are provided (Figure 1-5).

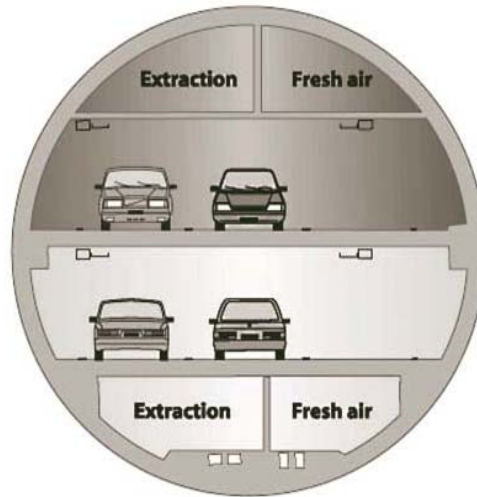

Figure 1-5 A-86 Road Tunnel in Paris, France (FHWA, 2006)

The traveled lane width and height in a tunnel should match that of the approach roads. Often, allowance for repaving is provided in determining the headroom inside the tunnel.

Except for maintenance or unusual conditions, two-way traffic in a single tube should be discouraged for safety reasons except like the A-86 Road Tunnel that has separate decks. In addition, pedestrian and cyclist use of the tunnel should be discouraged unless a special duct (or passage) is designed specifically for such use. An example of such use is the Mount Baker Ridge tunnel in Seattle, Washington.

### 1.1.3 Traffic Capacity

Road tunnels should have at least the same traffic capacity as that of surface roads. Studies suggest that in tunnels where traffic is controlled, throughput is more than that in uncontrolled surface road suggesting that a reduction in the number of lanes inside the tunnel may be warranted. However, traffic will slow down if the lane width is less than standards (too narrow) and will shy away from tunnel walls if insufficient lateral clearance is provided inside the tunnel. Also, very low ceilings give an impression of speed and tend to slow traffic. Therefore, it is important to provide adequate lane width and height comparable to those of the approach road. It is recommended that traffic lanes for new tunnels should meet the required road geometrical requirements (e.g., 12 ft). It is also recommended to have a reasonable edge distance between the lane and the tunnel walls or barriers (See Chapter 2 for further details).

Road tunnels, especially those in urban areas, often have cargo restrictions. These may include hazardous materials, flammable gases and liquids, and over-height or wide vehicles. Provisions should be made in the approaches to the tunnels for detection and removal of such vehicles.

## 1.2 ALTERNATIVE ANALYSES

### 1.2.1 Route Studies

A road tunnel is an alternative vehicular transportation system to a surface road, a bridge or a viaduct. Road tunnels are considered to shorten the travel time and distance or to add extra travel capacity through barriers such as mountains or open waters. They are also considered to avoid surface congestion, improve

air quality, reduce noise, or minimize surface disturbance. Often, a tunnel is proposed as a sustainable alternative to a bridge or a surface road. In a tunnel route study, the following issues should be considered:

- Subsurface, geological, and geo-hydraulic conditions
- Constructability
- Long-term environmental impact
- Seismicity
- Land use restrictions
- Potential air right developments
- Life expectancy
- Economical benefits and life cycle cost
- Operation and maintenance
- Security
- Sustainability

Often sustainability is not considered; however, the opportunities that tunnels provide for environmental improvements and real estate developments over them are hard to ignore and should be reflected in term of financial credits. In certain urban areas where property values are high, air rights developments account for a significant income to public agencies which can be used to partially offset the construction cost of tunnels.

It is important when comparing alternatives, such as a tunnel versus a bridge or a bypass, that the comparative evaluation includes the same purpose and needs and the overall goals of the project, but not necessarily every single criterion. For example, a bridge alignment may not necessarily be the best alignment for a tunnel. Similarly, the life cycle cost of a bridge has a different basis than that of a tunnel.

### **1.2.2 Financial Studies**

The financial viability of a tunnel depends on its life cycle cost analysis. Traditionally, tunnels are designed for a life of 100 to 125 years. However, existing old tunnels (over 100 years old) still operate successfully throughout the world. Recent trends have been to design tunnels for 150 years life. To facilitate comparison with a surface facility or a bridge, all costs should be expressed in terms of life-cycle costs. In evaluating the life cycle cost of a tunnel, costs should include construction, operation and maintenance, and financing (if any) using Net Present Value. In addition, a cost-benefit analysis should be performed with considerations given to intangibles such as environmental benefits, aesthetics, noise and vibration, air quality, right of way, real estate, potential air right developments, etc.

The financial evaluation should also take into account construction and operation risks. These risks are often expressed as financial contingencies or provisional cost items. The level of contingencies would be decreased as the project design level advances. The risks are then better quantified and provisions to reduce or manage them are identified. See Chapter 14 for risk management and control.

### **1.2.3 Types of Road Tunnels**

Selection of the type of tunnel is an iterative process taking into account many factors, including depth of tunnel, number of traffic lanes, type of ground traversed, and available construction methodologies. For example, a two-lane tunnel can fit easily into a circular tunnel that can be constructed by a tunnel boring machine (TBM). However, for four lanes, the mined tunnel would require a larger tunnel, two bores or another method of construction such as cut and cover or SEM methods. The maximum size of a circular



TBM existing today is about 51 ft (15.43 m) for the construction of Chongming Tunnel, a 5.6 mile (9-kilometer) long tunnel under China's Yangtze River, in Shanghai. See Figure 1-6 showing the Chongming Tunnel. Note the scale of the machine relative to the people standing in the invert.



Figure 1-6 Chongming Tunnel under the Yangtze River

When larger and deeper tunnels are needed, either different type of construction methods, or multiple tunnels are usually used. For example, if the ground is suitable, SEM (Chapter 9) in which the tunnel cross section can be made to accommodate multiple lanes can be used. For tunnels below open water, immersed tunnels can be used. For example, the Fort McHenry Tunnel in Baltimore, Maryland accommodated eight traffic lanes of I-95 into two parallel immersed units as shown in Figure 1-7.

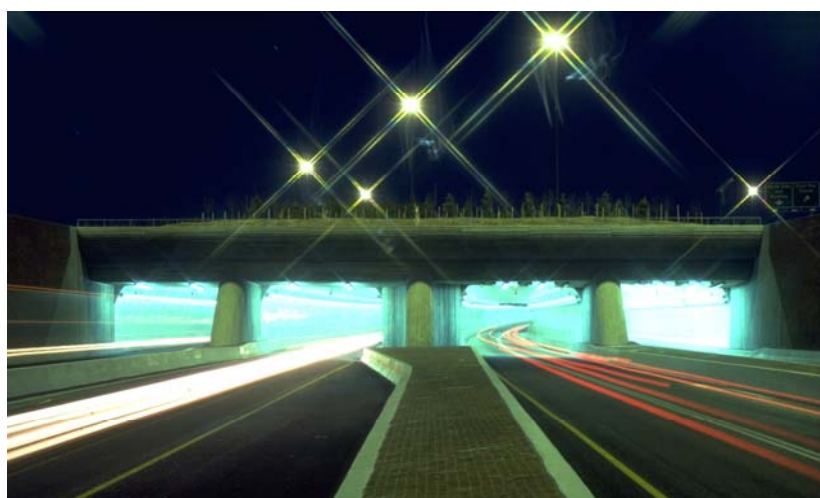

Figure 1-7 Fort McHenry Tunnel in Baltimore, MD

Shallow tunnels would most likely be constructed using cut-and-cover techniques, discussed in Chapter 5. In special circumstances where existing surface traffic cannot be disrupted, jacked precast tunnels are sometimes used. In addition to the variety of tunneling methods discussed in this manual, non-

conventional techniques have been used to construct very large cross section, such as the Mt. Baker Ridge Tunnel, on I-90 in Seattle, Washington. For that project, multiple overlapping drifts were constructed and filled with concrete to form a circular envelop that provides the overall support system of the ground. Then the space within this envelop was excavated and the tunnel structure was constructed within it (Figure 1-8).

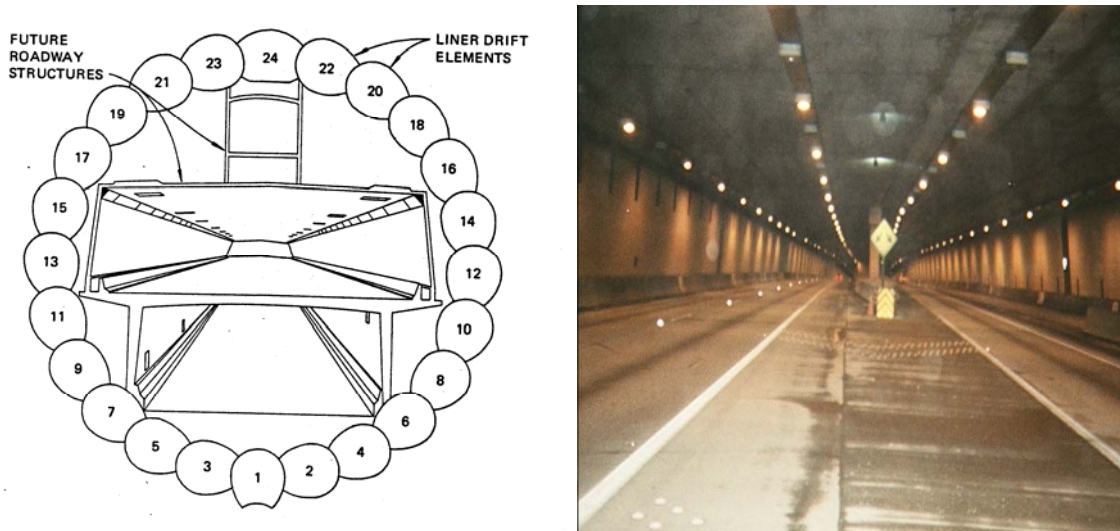

Figure 1-8 Stacked Drift and Final Mt Baker Tunnel, I-90, Seattle, WA

There are times when tunneling is required in a problematic ground such as mixed face (rock and soft ground), squeezing rock or other difficult ground conditions requiring specialized techniques, as discussed in Chapter 8.

#### 1.2.4 Geotechnical Investigations

As discussed in Chapter 3, geotechnical investigations are critical for proper planning of a tunnel. Selection of the alignment, cross section, and construction methods is influenced by the geological and geotechnical conditions, as well as the site constraints. Good knowledge of the expected geological conditions is essential. The type of the ground encountered along the alignment would affect the selection of the tunnel type and its method of construction. For example, in TBM tunnel construction mixed ground conditions, or buried objects add complications to the TBM performance and may result in the inability of the TBM to excavate the tunnel, potential breakdown of the TBM, or potential ground failure and settlements at the surface. The selection of the tunnel profile must therefore take into account potential ground movements and avoid locations where such movements or settlements could cause surface problems to existing utilities or surface facilities and mitigation measures should be provided.

Another example of the effect of the impact of geological features on the tunnel alignment is the presence of active or inactive faults. During the planning phase, it is recommended to avoid crossing a fault zone and preferred to avoid being in a close proximity of an active fault. However, if avoidance of a fault cannot be achieved, then proper measures for crossing it should be implemented. Such measures are discussed in Chapter 13 Seismic Considerations. Special measures may also be required when tunneling in a ground that may contain methane or other hazardous gasses or fluids.

Geotechnical issues such as the soil or rock properties, the ground water regime, the ground cover over the tunnel, the presence of contaminants along the alignment, presence of underground utilities and obstructions such as boulders or buried objects, and the presence of sensitive surface facilities should be taken into consideration when evaluating tunnel alignment. Tunnel alignment is sometimes changed based on the results of the geotechnical to minimize construction cost or to reduce risks. The tunnel profile can also be adjusted to improve constructability or accommodate construction technologies as long as the road geometrical requirements are not compromised. For example, for TBM tunnels the profile would be selected to ensure that sufficient cover is maintained for the TBM to operate satisfactorily over the proposed length of bore. However, this should not compromise the maximum grade required for the road.

If the route selection is limited, then measures to deal with the poor ground in terms of construction method or ground improvement prior to excavation should be considered. It is recommended that the geotechnical investigation start as early as possible during the initial planning phase of the project. The investigation should address not just the soil and rock properties, but also their anticipated behaviors during excavation. For example in sequential excavation or NATM, ground standup time is critical for its success. If the ground does not have sufficient standup time, pre-support or ground improvement such as grouting should be provided. For soft ground TBM tunneling, the presence of boulders for example would affect the selection of TBM type and its excavation tools. Similarly, the selection of a rock TBM would require knowledge of the rock unconfined compressive strength, its abrasivity and its jointing characteristics. The investigation should also address groundwater. For example, in soft ground SEM tunneling, the stability of the excavated face is greatly dependent on control of the groundwater. Dewatering, pre-draining, grouting, or freezing are often used to stabilize the excavation. Ground behavior during tunneling will affect potential settlements on the surface. Measures to minimize settlements by using suitable tunneling methods or by preconditioning the ground to improve its characteristics would be required. Presence of faults or potentially liquefiable materials would be of concern during the planning process. Relocating the tunnel to avoid these concerns or providing measures to deal with them is critical during the planning process.

The selection of a tunnel alignment should take into consideration site specific constraints such as the presence of contaminated materials, special existing buildings and surface facilities, existing utilities, or the presence of sensitive installations such as historical landmarks, educational institutions, cemeteries, or houses of worship. If certain site constraints cannot be avoided, construction methodologies, and special provisions should be provided. For example, if the presence of contaminated materials near the surface cannot be avoided, a deeper alignment and/or the use of mined excavation (TBM or SEM) would be more suitable than cut and cover method. Similarly, if sensitive facilities exist at the surface and cannot be avoided, special provisions to minimize vibration, and potential surface settlement should be provided in the construction methods.

Risk assessment is an important factor in selecting a tunnel alignment. Construction risks include risks related the construction of the tunnel itself, or related to the impact of the tunnel construction on existing facilities. Some methods of tunneling are inherently more risky than others or may cause excessive ground movements. Sensitive existing structures may make use of such construction methods in their vicinity undesirable. Similarly, hard spots (rock, for example) beneath parts of a tunnel can also cause undesirable effects and alignment changes may obviate that. Therefore, it is important to conduct risk analysis as early as possible to identify potential risks due to the tunnel alignment and to identify measures to reduce or manage such risks. An example of risk mitigation related to tunnel alignment being close to sensitive surface facilities is to develop and implement a comprehensive instrumentation and monitoring program, and to apply corrective measures if measured movements reach certain thresholds. Chapter 15 discusses instrumentation and monitoring.

Sometimes, modifications in the tunnel structure or configurations would provide benefits for the overall tunnel construction and cost. For example, locating the tunnel ventilations ducts on the side, rather than at the top would reduce the tunnel height, raise the profile of the tunnel and consequently reduce the overall length of the tunnel.

### **1.2.5 Environmental and Community Issues**

Road tunnels are more environmentally friendly than other surface facilities. Traffic congestion would be reduced from the local streets. Air quality would be improved because traffic generated pollutants are captured and disposed of away from the public. Similarly, noise would be reduced and visual aesthetic and land use would be improved. By placing traffic underground, property values would be improved and communities would be less impacted in the long term. Furthermore, tunnels will provide opportunities for land development along and over the tunnel alignment adding real estate properties and potential economical potential development.

In planning for a tunnel, the construction impact on the community and the environment is important and must be addressed. Issues such as impact on traffic, businesses, institutional facilities, sensitive installations, hospitals, utilities, and residences should be addressed. Construction noise, dust, vibration, water quality, aesthetic, and traffic congestion are important issues to be addressed and any potentially adverse impact should be mitigated. For example, a cut-and-cover tunnel requires surface excavation impacting traffic, utilities, and potentially nearby facilities. When completed, it leaves a swath of disturbed surface-level ground that may need landscaping and restoration. In urban situations or close to properties, cut-and-cover tunnels can be disruptive and may cut off access and utilities temporarily. Alternative access and utilities to existing facilities may need to be provided during construction or, alternatively, staged construction to allow access and to maintain the utilities would be required. Sometimes, top-down construction rather than bottom-up construction can help to ameliorate the disruption and reduce its duration. Rigid excavation support systems and ground improvement techniques may be required to minimize potential settlements and lateral ground deformations, and their impact on adjacent structures. When excavation and dewatering are near contaminated ground, special measures may be required to prevent migration of the groundwater contaminated plume into the excavation or adjacent basements. Dust suppression and wheel washing facilities for vehicles leaving the construction site are often used, especially in urban areas.

Similarly, for immersed tunnels the impact on underwater bed level and the water body should be assessed. Dredging will generate bottom disturbance and create solid turbidity or suspension in the water. Excavation methods are available that can limit suspended solids in the water to acceptable levels. Existing fauna and flora and other ecological issues should be investigated to determine whether environmentally and ecologically adverse consequences are likely to ensue. Assessment of the construction on fish migration and spawning periods should be made and measures to deal with them should be developed. The potential impact of construction wetlands should be investigated and mitigated.

On the other hand, using bored tunneling would reduce the surface impact because generally the excavation takes place at the portal or at a shaft resulting in minimum impact on traffic, air and noise quality, and utility and access disturbance.

Excavation may encounter contaminated soils or ground water. Such soils may need to be processed or disposed in a contained disposal facility, which may also have to be capped to meet the environmental regulations. Provisions would need to address public health and safety and meet regulatory requirements.

## 1.2.6 Operational Issues

In planning a tunnel, provisions should be made to address the operational and maintenance aspects of the tunnel and its facilities. Issues such as traffic control, ventilation, lighting, life safety systems, equipment maintenance, tunnel cleaning, and the like, should be identified and provisions made for them during the initial planning phases. For example, items requiring more frequent maintenance, such as light fixtures, should be arranged to be accessible with minimal interruption to traffic.

## 1.2.7 Sustainability

Tunnels by definition are sustainable features. They typically have longer life expectancy than a surface facility (125 versus 75 years). Tunnels also provide opportunities for land development for residential, commercial, or recreational facilities. They enhance the area and potentially increase property values. An example is the “Park on the Lid” in Mercer Island, Seattle, Washington where a park with recreational facilities was developed over I-90 (Figure 1-9). Tunnels also enhance communities connections and adhesion and protect residents and sensitive receptors from traffic pollutants and noise.



Figure 1-9 “Park on the Lid” Seattle, Washington

## 1.3 TUNNEL TYPE STUDIES

### 1.3.1 General Description of Various Tunnel Types

The principal types and methods of tunnel construction that are in use are:

- Cut-and-cover tunnels (Chapter 5) are built by excavating a trench, constructing the concrete structure in the trench, and covering it with soil. The tunnels may be constructed in place or by using precast sections
- Bored or mined tunnels (Chapters 6 through 11), built without excavating the ground surface. These tunnels are usually labeled according to the type of material being excavated. Sometimes a tunnel

passes through the boundary between different types of material; this often results in a difficult construction known as mixed face (Chapter 8).

- Rock tunnels (Chapter 6) are excavated through the rock by drilled and blasting, by mechanized excavators in softer rock, or by using rock tunnel boring machines (TBM). In certain conditions, Sequential Excavation Method (SEM) is used (Chapter 9).
- Soft ground tunnels (Chapter 7) are excavated in soil using a shield or pressurized face TBM (principally earth pressure balance or slurry types), or by mining methods, known as either the sequential excavation method (SEM) (Chapter 9).
- Immersed tunnels (Chapter 11), are made from very large precast concrete or concrete-filled steel elements that are fabricated in the dry, floated to the site, placed in a prepared trench below water, and connected to the previous elements, and then covered up with backfill.
- Jacked box tunnels (Chapter 12) are prefabricated box structures jacked horizontally through the soil using methods to reduce surface friction; jacked tunnels are often used where they are very shallow but the surface must not be disturbed, for example beneath runways or railroads embankments.

Preliminary road tunnel type selection for conceptual study after the route studies can be dictated by the general ground condition as illustrated in Figure 1-10.

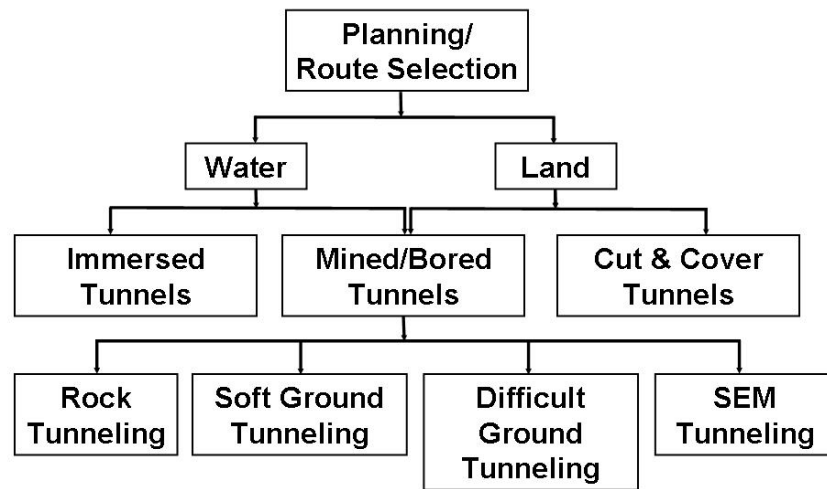

Figure 1-10 Preliminary Road Tunnel Type Selection Process

The selection of a tunnel type depends on the geometrical configurations, the ground conditions, the type of crossing, and environmental requirements. For example, an immersed tunnel may be most suitable for crossing a water body, however, environmental and regulatory requirements might make this method very expensive or infeasible. Therefore, it is important to perform the tunnel type study as early as possible in the planning process and select the most suitable tunnel type for the particular project requirements.

### 1.3.2 Design Process

The basic process used in the design of a road tunnel is:

- Define the functional requirements, including design life and durability requirements;
- Carry out the necessary investigations and analyses of the geologic, geotechnical and geohydrological data
- Conduct environmental, cultural, and institutional studies to assess how they impact the design and construction of the tunnel;
- Perform tunnel type studies to determine the most appropriate method of tunneling.
- Establish design criteria and perform the design of the various tunnel elements. Appropriate initial and final ground support and lining systems are critical for the tunnel design, considering both ground conditions and the proposed method of construction. Perform the design in Preliminary and Final design phases. Interim reviews should be made if indicated by ongoing design issues.
- Establish tunnel alignment, profile and cross-section
- Determine potential modes of failure, including construction events, unsatisfactory long-term performance, and failure to meet environmental requirements. Obtain any necessary data and analyze these modes of failure;
- Perform risk analysis and identify mitigation measures and implement those measures in the design
- Prepare project documents including construction plans, specifications, schedules, estimates, and geotechnical baseline report (GBR).

### 1.3.3 Tunnel Cross-Section

The tunnel cross section geometrical configuration must satisfy the required traffic lanes, shoulders or safety walks, suitable spaces for ventilation, lights, traffic control system, fire/life safety systems, etc. The cross section is also dictated by the method of tunnel construction. For example, bored tunnels using TBM will result in circular configuration, while cut and cover construction will result in rectangular configuration. The structural systems will also vary accordingly. The available spaces in a circular cross section can be used to house tunnel systems, such as the ventilation duct or fans, lighting, traffic control systems and signs, close circuit TV, and the like. For rectangular sections the various systems can be placed overhead, invert or adjacent to the traffic lanes if overhead space is limited. It is essential at early design stages to pay attention to detail in laying out the tunnel cross-section to permit easy inspection and maintenance not only of mechanical and electrical equipment, but also of the tunnel structure itself.

The tunnel structural systems depend on the type of tunnel, the geometrical configuration of the cross section, and method of construction. For example, in cut and cover tunnels of rectangular cross section, cast in place concrete is often the selected structural system, while for SEM/NATM tunnel, the structural system could be lattice girders and shotcrete. For soft ground tunnels using TBM, the structural system is often a precast segmental one pass lining. Sometimes, the excavation support system can be used as the final tunnel structural system such as the case in top down construction.

Chapter 2 provides detailed discussions for the geometrical configurations.

### 1.3.4 Groundwater Control

Building a dry tunnel is a primary concerns of the owner, user, and operator alike. A dry tunnel provides a safer and friendlier environment and significantly reduces operation and maintenance costs. Advancements in tunneling technology in the last few decades in general and in the waterproofing field in

particular have facilitated the implementation of strict water infiltration criteria and the ability to build dry tunnels.

Based on criteria obtained from the International Tunneling Association (ITA), Singapore's Land Transport Authority (LTA), Singapore's Public Utilities Board (PUB), Hong Kong's Mass Transit Rail Corporation (MTRC) and the German Cities Committee, as well as criteria used by various projects in the US and abroad for both highway and transit tunnels (e.g. Washington DC, San Francisco, Atlanta, Boston, Baltimore, Buffalo, Melbourne (Australia), Tyne & Wear (UK) and Antwerp (Belgium), the following ITA ground water infiltration criteria are recommended;

Allowable Infiltration

|                          |   |                      |
|--------------------------|---|----------------------|
| Tunnels                  | ≤ | 0.002 gal/sq. ft/day |
| Underground public space | ≤ | 0.001 gal/sq. ft/day |

In addition no dripping or visible leakage from a single location shall be permitted.

Tunnel waterproofing systems are used to prevent groundwater inflow into an underground opening. They consist of a combination of various materials and elements. The design of a waterproofing system is based on the understanding of the ground and geohydrological conditions, geometry and layout of the structure and construction methods to be used. A waterproofing system should always be an integrated system that takes into account intermediate construction stages, final conditions of structures and their ultimate usage including maintenance and operations.

There are two basic types of waterproofing systems: drained (open) and undrained (closed). Figures 6-40 and 6-41 illustrate drained (open) and undrained system (closed) tunnels, respectively. Various waterproofing materials are available for these systems. Open waterproofing systems allow groundwater inflow into a tunnel drainage system. Typically, the tunnel vault area is equipped with a waterproofing system forming an umbrella-like protection that drains the water seeping towards the cavity around the arch into a drainage system that is located at the bottom of the tunnel sidewalls and in the tunnel invert. The open system is commonly used in rock tunnels where water infiltration rates are low. Groundwater inflow is typically localized to distinct locations such as joints and fractures and the overall permeability is such that a groundwater draw-down in soil layers overlying the rock mass will not be affected. This system is commonly installed between an initial tunnel support (initial lining) and the secondary or final support (permanent lining). The open waterproofing system generally allows for a more economical secondary lining and invert design as the hydrostatic load is greatly reduced or eliminated.

Closed waterproofing systems (closed system), often referred to as tanked systems, extend around the entire tunnel perimeter and aim at excluding the groundwater from flowing into the tunnel drainage system completely. Thus no groundwater drainage is provided. The secondary linings therefore have to be designed for full hydrostatic water pressures. These systems are often applied in permeable soils where groundwater discharge into the tunnels would be significant and would otherwise cause a lowering of the groundwater table and possibly cause surface settlements.

For precast segmental lining, the segments are usually equipped with gaskets to seal the joints between segments and thus provide a watertight tunnel. For cut and cover tunnels under the groundwater table and for immersed tunnels, waterproofing membranes encapsulating the structures are recommended. The waterproofing system should be addressed as early as possible and design criteria for water infiltration should be established during the process. This issue is further discussed in Chapter 10- Tunnel Linings.



### 1.3.5 Tunnel Portals

Portals and ventilation shafts should be located such that they satisfy environmental and air quality requirements as well as the geometrical configuration of the tunnel. At portals, it may be necessary to extend the dividing wall between traffic traveling in opposite directions to reduce recirculation of pollutants from the exit tunnel into the entry tunnel. If possible, Portals should be oriented to avoid drivers being blinded by the rising or setting sun. Special lighting requirements at the portal are needed to address the “black hole” effect (Chapter 2). The portal should be located at a point where the depth of the tunnel is suitably covered. This depends on the type of construction, the crossing configuration, and the geometry of the tunnel. For example, in a cut and cover tunnel, the portal can be as close to the surface as the roof of the tunnel can be placed with sufficient clearance for traffic. On the other hand, in TBM mined tunnels, the portal will be placed at a location where there is sufficient ground cover to start the TBM. In mountain tunnels the portal can be as close to the face of the mountain as practically constructible.

### 1.3.6 Fire-Life Safety Systems

Safety in the event of a fire is of paramount importance in a tunnel. The catastrophic consequences of the tunnel fires (e.g., the Mont Blanc tunnel, 1999 and the Swiss St. Gotthard tunnel, 2001) not only resulted in loss of life, severe property damages, but also great concerns of the lack of fire-life safety protection in road tunnels. During the Gotthard Tunnel October 2001 fire (Figure 1-11) that claimed 11 deaths, the temperature reportedly reached 1,832 °F (1,000 °C) in few minutes, and thick smoke and combustible product propagated over 1.5 mile (2.5km) within 15 minutes.



Figure 1-11 Gotthard Tunnel Fire in October 2001 (FHWA 2006)

For planning purposes, it is important to understand the fire-life safety issues of a road tunnel and consider their impacts on the alignments, tunnel cross section, emergency exits, ventilation provisions, geometrical configuration, right-of-way, and conceptual cost estimates. National Fire Protection Association (NFPA) 502 – Standard for Road Tunnels, Bridges, and Other Limited Access Highways provides the following fire protection and life safety requirements for road tunnels:

- Protection of Structural Elements
- Fire Detection
- Communication Systems
- Traffic Control

- Fire Protection (i.e., standpipe, fire hydrants, water supply, portable fire extinguisher, fixed water-base fire-fighting systems, etc.)
- Tunnel Drainage System
- Emergency Egress
- Electric, and
- Emergency response plan.

In 2005, the FHWA, AASHTO, and the National Cooperative Highway Research Program (NCHRP) sponsored a scanning study of equipment, systems and procedures used in European tunnels. The study concluded with nine (9) recommendations for implementation include conducting research on tunnel emergency management that includes human factors; developing tunnel design criteria that promote optimal driver performance during incidents; developing more effective visual, audible, and tactile signs for escape routes; and using a risk-management approach to tunnel safety inspection and maintenance. Appendix A presents the executive summary of the scan study. The scan study report is available entirely on the FHWA web site at <http://International.fhwa.dot.gov/uts/uts.pdf> (FHWA, 2006).

### 1.3.6.1 Emergency Egress

Emergency egress for persons using the tunnel to a place of refuge should be provided at regular intervals. Throughout the tunnel, functional, clearly-marked escape routes should be provided for use in an emergency. As shown in Figure 1-12, exits should be clearly marked, and the spacing of exits into escape routes should not exceed 1000 feet (300 m) and should comply with the latest NFPA 502 - Standard for Road Tunnels, Bridges, and Other Limited Access Highways. Emergency exits should be provided to safe, secure locations.



Figure 1-12 Emergency Exit (FHWA, 2006)

The emergency egress walkways should be a minimum of 3.6 ft wide and should be protected from oncoming traffic. Signage indicating both direction and distance to the nearest escape door should be mounted above the emergency walkways at reasonable intervals (100 to 150 ft) and be visible in an emergency. The emergency escape routes should be provided with adequate lighting level and connected to the emergency power system.

Where tunnels are provided in twin tubes, cross passages to the adjacent tube can be considered safe haven. The cross passage should be of at least two-hour fire rating construction, should be equipped with self closing fire rated doors that open in both directions or sliding doors, and the cross passages should be located not more than 656 ft (200m) apart. An emergency walkway” at least 3.6 feet (1.12 m) wide should be provided on each side of the cross-passageways.

In long tunnels, sometimes breakdown emergency alcoves (local widening) for vehicles are provided. See Figure 1-13. Some European tunnels also provide at intervals an emergency turn-around for vehicles into the adjacent roadway duct which turn-around would normally be closed by doors.



Figure 1-13 Emergency Alcove

### 1.3.6.2 Emergency Ventilation, Lighting and Communication

An emergency ventilation system should be provided to control smoke and to provide fresh air for the evacuation of passengers and for support to the emergency responders. The emergency ventilation system is often the normal ventilation system operated at higher speeds. Emergency ventilation scenarios should be developed and the operation of the fans would be based on the location of the fire and the direction of the tunnel evacuation. The fans should be connected to an emergency power source in case of failure of the primary power.

Emergency tunnel lighting, fire detection, fire lines, and hydrants should be provided. In certain installations, fire suppression measures such as foam or deluge system have been used. The risk of fire spreading through power cable ducts should be eliminated by dividing cable ducts into fireproof sections, placing cables in cast-in ducts, using fireproof cables where applicable, and other preventative measures. Vital installations should be supplied with fire-resistant cables. Materials used should not release toxic or aggressive gases such as chlorine. Water for fire-fighting should be protected against frost. Fire alarm buttons should be provided adjacent to every cross-passage. Emergency services should be able to approach a tunnel fire in safety.

Emergency telephones should be provided in the tunnels and connected to the emergency power supply. When such a telephone is used, the location of the caller should be identified both at the control center and by a warning light visible to rescuing personnel. Telephones should be provided at cross-passage doors and emergency exits. Communication systems should give the traveling public the possibility of summoning help and receiving instructions, and should ensure coordinated rescue. Systems should raise the alarm quickly and reliably when unusual operating conditions or emergency situations arise.

Radio coverage for police, fire and other emergency services and staff should extend throughout the tunnel. It is necessary for police, fire and emergency services to use their mobile radios within tunnels and cross-passages. Radio systems should not interfere with each other and should be connected to the emergency power supply to communicate with each other. It is also recommended that mobile telephone coverage be provided.

### **1.3.7 Tunnel Drainage**

Good design anticipates drainage needs. Usually sump-pump systems are provided at the portals and at low points. Roadway drainage throughout the tunnel using drain inlets and drainage pipes should be provided. The drainage system should be designed to deal with surface drainage as well as any groundwater infiltration into the tunnel. Other areas of the tunnels, such as ventilation ducts and potential locations for leakage, should have provision for drainage. Accumulation of ice due to inadequate drainage provisions must be avoided for safe passage.

## **1.4 OPERATIONAL AND FINANCIAL PLANNING**

### **1.4.1 Potential Funding Sources and Cash Flow Requirements**

Traditionally State, Federal, and Local funds are the main funding sources for road tunnels. However, recently private enterprises and public-private partnership (PPP) are becoming more attractive potential sources for funding road tunnel projects. For example, the Port of Miami Tunnel has been developed using the PPP approach. Various forms of financing have been applied in various locations in the US and the World. Tolls are often levied on users to help repay construction costs, and to pay operating costs, especially when the roads are financed by private sources. In some cases, bond issues have been used to raise funding for the project.

In developing the funding strategy, it is important to consider and secure the cash flow required to complete the project. In assessing the cash flow analysis, escalation to the year of expenditure should be used. Various indices of escalation rates are available. It is recommended that escalation rates comparable to this type of construction and for the area of the project should be used. Factors such as work load in the area, availability of materials, availability of skilled labor, specialty equipment, and the like, should be taken into consideration. Repayment of loans and the cost of the money should be considered. They may

continue for a substantial number of years while the operation and maintenance costs of the tunnel also have to be covered.

### **1.4.2 Conceptual Level Cost Analysis**

At the conceptual level, cost analyses are often based upon the costs per unit measurement for a typical section of tunnel. The historical cost data updated for inflation and location is also commonly used as a quick check. However, such data should be used with extreme caution since in most cases, the exact content of such data and any special circumstances are not known. In addition, construction of tunnels is a specialty work and involves a significant labor component. Labor experience and productivity are critical for proper estimating of a tunnel construction cost. Furthermore, the tunnel being a linear structure, its cost is highly dependent on the advance rate of construction, which in turn is dependent on the labor force, the geological conditions, the suitability of equipment, the contractor's means and methods, and the experience of the workers. Since tunneling is highly dependent on the labor cost, issues such as advance rates, construction schedule, number of shifts, labor union requirements, local regulations such as permissible time of work, environmental factors such as noise and vibrations, and the like should be taken into considerations when construction cost estimates are made. It is recommended, even at the planning phase, to prepare a bottom up construction cost estimate using estimate materials, labor, and equipment. The use of experience from other similar projects in the area is usually done for predicting labor force and the advance rates. At the conceptual level, substantial contingencies may be required at the early stages of a project. As the design advances and the risks identified and dealt with, contingencies would be reduced gradually as the level of detail and design increases. Soft costs such as engineering, program and construction management, insurance, owner cost, third party cost, right of way costs, and the like should be considered. The cost estimate should progressively become more detailed as the design is advanced. More detailed discussions on this subject are presented in Chapter 14.

### **1.4.3 Project Delivery Methods**

Generally, two categories of delivery methods have been used in the past for underground construction, with various levels of success. They are:

- Design-Bid-Build
- Design-Build

The contractual terms of these two delivery methods vary widely. The most common is the fixed price approach, although for tunneling, the unit prices approach is the most suitable. Other contract terms used include:

- Fixed Price lump sum
- Low bid based on unit prices
- Quality based selection
- Best and Final Offer (BAFO)
- Cost plus fixed fee

The traditional project delivery model is the design-bid-build. In this method, the client finances the project and develops an organization to deal with project definition, legal, commercial, and land access/acquisition issues. It appoints a consulting engineer under a professional services contract to act on its behalf to undertake certain design, procurement, construction supervision, and contract administration activities, in return for which the consulting engineer is paid a fee. The client places construction

contracts following a competitive tendering process for a fixed price, with the selection are often based on low bid. This type of contract is simple, straight forward and familiar to public owners. However, in this process the majority of construction risk is passed to the contractor who often uses higher contingency factors to cover the potential construction risks. The client effectively pays the contractor for taking on the risk, irrespective of whether the risk actually transpires.

Whilst this type of contract has its advantages, its shortfalls particularly on large infrastructure projects could be significant. Adversarial relationships between project participants, potential cost overruns, and delays to project schedules are by no means unusual. With the traditional contract forms, there is significant potential for protracted disputes over responsibility for events, to the detriment of the progress of the physical works. The client, its agents, and the contractors are subject to different commercial risks and potentially conflicting commercial objectives.

In a design-build process, the project is awarded to a design-build entity that design and construct the project. The owner's engineer usually prepares bidding documents based on a preliminary-level design identifying the owner's requirements. Contract terms vary from fixed price to unit prices, to cost plus fee. For tunneling projects, the geotechnical and environmental investigations should be advanced to a higher level of completion to provide better information and understanding of the construction risks. The selected contractor then prepares the final design (usually with consultation with the owner's engineer) and constructs the project. This process is gaining interest among owners of underground facilities in order to reduce the overall time required to complete the project, avoid dealing with disputes over changed conditions, and avoid potential lengthy and costly litigations.

The procurement options of the design-build approach vary based on the project goals and the owners' objectives. Examples of the procurement options include:

- Competitive bid (low price)
- Competitive bid with high responsibility standards (cost and qualifications)
- Competitive bids with alternative proposals
- Price and other factors
- Price after discussion including "Best and Final Offer"
- Quality based selection
- Sole source negotiation

The allocation of risk between the owner and the contractor will have a direct relationship to the contractor contingency as part of the contractor's bid. Therefore, it is important to identify a risk sharing mechanism that is fair and equitable and that will result in a reasonable contingency by the contractor and sufficient reserve fund to be provided by the owner to address unforeseen conditions. For example unforeseen conditions due to changes in the anticipated ground conditions are paid for by the owner if certain tests are met, while the means and methods are generally the contractor's responsibility and his inability to perform under prescribed conditions are risks to be absorbed by the contractor. With proper contracting form and equitable allocation of risks between the owner and the contractor, the contractor contingency, which is part of its bid price, will be reduced. Similarly, the owner's reserve fund will be used only if certain conditions are encountered, resulting in an overall lesser cost to the owner. This is further discussed in Chapter 14 Construction Engineering.

Design-build has the advantage that the design can be tailored to fit the requirements of the contractor's means and methods since both, the designer and the constructor work through one contract. This can be particularly useful when some of the unknown risks are included in the contractor's price without major penalties that could occur if the design is inadequate. Risk sharing is especially useful if anticipated

conditions can be defined within certain limits and the client takes the risk if the limits are exceeded. Examples of conditions that might not be expected include soil behavior, the hardness of rock, flood levels, extreme winds and currents. Considerable use is currently made of Geotechnical Baseline Reports to define anticipated ground conditions in this way.

Most claims in tunnel construction are related to unforeseen ground conditions. Therefore, the underground construction industry in the US tried to provide a viable trigger by means of the Differing Site Condition (DSC) clause, culminating in the use of the Geotechnical Baseline Report (GBR) and Geotechnical Data Report (GDR). It is important from a risk-sharing perspective that the contractual language in the DSC and the GBR are complementary. Chapter 4 discusses Geotechnical Baseline Reports. The contractor qualifications process is further discussed in Chapter 14-Construction Engineering

It is important to establish a selection process by which only qualified contractors can bid on tunneling projects, with fair contracts that would allocate risks equitably between the owner and the contractor, in order to have safe, on time, and high quality underground projects at fair costs.

#### **1.4.4 Operation and Maintenance Cost Planning**

Operations are divided into three main areas, traffic and systems control, toll facility (if any), and emergency services, not all of which may be provided for any particular tunnel. The staff needed in these areas would vary according to the size of the facility, the location, and the needs. For 24-hour operation, staff would be needed for three shifts and weekends; weekend and night shifts would require sufficient staff to deal with traffic and emergency situations.

The day-to-day maintenance of the tunnel generally requires a dedicated operating unit. Tunnel cleaning and roadway maintenance are important and essential for safe operation of the tunnel. Special tunnel cleaning equipment are usually employed. Mechanical, electrical, communication, ventilation, monitoring, and control equipment for the tunnel must be kept operational and in good working order, since faulty equipment could compromise public safety. Regular maintenance and 24-hour monitoring is essential, since failure of equipment such as ventilation, lights and pumps is unacceptable and must be corrected immediately. Furthermore, vehicle breakdowns and fires in the tunnel need immediate response.

Generally most work can be carried out during normal working hours including mechanical and electrical repair, traffic control, and the like. However, when the maintenance work involves traffic lane closure, such as changing lighting fixtures, roadway repairs, and tunnel washing, partial or full closure of the tunnel may be required. This is usually done at night or weekends.

Detailed discussions for the operation and maintenance issues are beyond the scope of this manual.

### **1.5 RISK ANALYSIS AND MANAGEMENT**

Risk analysis and management is essential for any underground project. A risk register should be established as early as possible in the project development. The risk register would identify potential risks, their probability of occurrence and their consequences. A risk management plan should be established to deal with the various risks either by eliminating them or reducing their consequences by planning, design, or by operational provisions. For risks that cannot be mitigated, provisions must be made to reduce their consequences and to manage them. An integrated risk management plan should be regularly updated to identify all risks associated with the design, execution and completion of the tunnel.

The plan should include all reasonable risks associated with design, procurement and construction. It should also include risks related to health and safety, the public and to the environment.

Major risk categories include construction failures, public impact, schedule delay, environmental commitments, failure of the intended operation and maintenance, technological challenges, unforeseen geotechnical conditions, and cost escalation. This subject is discussed in detail in Chapter 14 Construction Engineering.



## CHAPTER 2 GEOMETRICAL CONFIGURATION

Chapter 2 provides general geometrical requirements for planning and design of road tunnels. The topics consist of the following: horizontal and vertical alignments; clearance envelopes; and cross section elements. Geometrical requirements for the tunnel approaches and portals are also provided. In addition to the requirements addressed herein, the geometrical configurations of a road tunnel are also governed by its functionality and locality (see Chapter 1 - Planning), as well as the subsurface conditions (see Chapter 3 – Geotechnical Investigations) and its construction method (i.e. cut-and-cover (Chapter 5), mined and bored (Chapters 6-10), immersed (Chapter 11), etc.). It often takes several iterative processes from planning, environmental study, configuration, and preliminary investigation and design to eventually finalize the optimum alignment and cross section layout.

### 2.1 INTRODUCTION

As defined by the American Association of State Highway and Transportation Officials (AASHTO) Technical Committee for Tunnels (T-20), road tunnels are defined as enclosed roadways with vehicle access that is restricted to portals regardless of type of structure or method of construction. Road tunnels following this definition exclude enclosed roadway created by air-rights structures such as highway bridges, railroad bridges or other bridges. Figure 2-1 illustrates Tetsuo Harano Tunnels through the hillside in Hawaii as a part of the H3 highway system. The tunnels are restricted by portal access and connected to major approach freeway bridges.



Figure 2-1 H3 Tetsuo Harano Tunnels in Hawaii

In addition to the general roadway requirements, road tunnels also require special considerations including lighting, ventilation, fire protection systems, and emergency egress capacity. These considerations often impose additional geometrical requirement as discussed in the following sections.

### **2.1.1 Design Standards**

Road tunnels discussed in this Manual cover all roadways including freeways, arterials, collectors, and local roads and streets in urban and rural locations following the functional classifications from FHWA publication “Highway Functional Classification: Concepts, Criteria, and Procedures”. AASHTO’s “Green Book” - A Policy on Geometric Design of Highways and Streets, which is adopted by Federal agencies, States, and most local highway agencies, provides the general design considerations used for road tunnels from the standpoint of service level, and suggests the requirements for road tunnels which should not differ materially from those used for grade separation structures. The Green Book (AASHTO, 2004) also provides general information and recommendations about cross section elements and other requirements specifically for road tunnels.

In addition to the Green Book (AASHTO, 2004), standards to be used for the design of geometrical configurations of road tunnels should generally comply with the following documents supplemented by recommendations given in this Manual. Additional criteria may include:

- AASHTO A Policy on Design Standards - Interstate System
- Standards issued by the state or states in which the tunnel is situated
- Local authority standards, where these are applicable
- National and local standards of the country where the international crossing tunnel is located

Although the geometrical requirements for roadway alignment, profile and for vertical and horizontal clearances in the above design standards generally apply to road tunnels, amid the high costs of tunneling and restricted right-of-way, minimum requirements are typically applied to planning and design of road tunnels to minimize the overall size of the tunnel yet maintain a safe operation through the tunnel. To ensure roadway safety, the geometrical design must evaluate design speed, lane and shoulder width, tunnel width, horizontal and vertical alignments, grade, stopping sight distance, cross slope, superelevation, and horizontal and vertical clearances, on a case by case basis.

In addition to the above highway design standards, geometrical design for road tunnels must consider tunnel systems such as fire life safety elements, ventilation, lighting, traffic control, fire detection and protection, communication, etc... Therefore, planning and design of the alignment and cross section of a road tunnel must also comply with National Fire Protection Association (NFPA) 502 – Standard for Road Tunnels, Bridges, and Other Limited Access Highways.

The recommendations in this Manual are provided as a guide for the engineer to exercise sound judgment in applying standards to the geometrical design of tunnels and generally base on 5<sup>th</sup> Edition (2004) of the Green Book and 2008 Edition of NFPA 502. The design standards used for a road tunnel project should equal or exceed the minimum given below in this Manual to the maximum extent feasible, taking into account costs, traffic volumes, safety requirements, right of way, socioeconomic and environmental impacts, without compromising safety considerations. The readers should always check with the latest requirements from the above references.

## **2.2 HORIZONTAL AND VERTICAL ALIGNMENTS**

Planning and design of road tunnel alignments must consider the geological, geotechnical and groundwater conditions at the site as well as environmental constraints as discussed in Chapter 1 - Planning. Maximum grade, horizontal and vertical curves, and other requirement/constraints for road tunnel horizontal and vertical alignments are discussed in this Section.

### **2.2.1 Maximum Grades**

Road tunnel grades should be evaluated on the basis of driver comfort while striving to reach a point of economic balance between construction costs and operating and maintenance expenses.

Maximum effective grades in main roadway tunnels preferably should not exceed 4%; although grades up to 6% have been used where necessary. Long or steep uphill grades may result in a need for climbing lanes for heavy vehicles. However, for economic and ventilation reasons, climbing lanes should be avoided within tunnels; the addition of a climbing lane part-way through a tunnel may also complicate construction considerably, particularly in a bored tunnel.

### **2.2.2 Horizontal and Vertical Curves**

Horizontal and vertical curves shall satisfy Green Book's geometrical requirements. The horizontal alignment for a road tunnel should be as short as practical and maintain as much of the tunnel length on tangent as possible, which will limit the numbers of curves, minimize the length and improve operating efficiency. However, slight curves may be required to accommodate ventilation/access shafts location, portal locations, construction staging areas, and other ancillary facilities as discussed in Chapter 1 – Planning. A slight horizontal curve at the exit of the tunnel may be required to allow drivers to adjust gradually to the brightness outside the tunnel.

When horizontal curves are needed, the minimum acceptable horizontal radii should consider traffic speed, sight distances, and the super-elevation provided. In general, for planning purpose, the curve radii should be as large as possible and no less than 850 to 1000-ft radius. A tighter curve may be considered at the detailed design stage based on the selected tunneling method.

Super elevation rate, which is the rise in the roadway surface elevation from the inside to the outside edge of the road, should preferably lie in the range 1% to 6%.

When chorded construction is used for walls where alignments are curved, chord lengths should not exceed 25 feet (7.6 m) for radii below 2,500 feet (762 m), and 50 feet (15 m) elsewhere.

### **2.2.3 Sight and Braking Distance Requirements**

Sight and braking distance requirements cannot be relaxed in tunnels. On horizontal and vertical curves, it may be necessary to widen the tunnel locally to meet these requirements by providing a "sight shelf". When designing a tunnel with extreme curvature, sight distance should be carefully examined, otherwise it may result in limited stopping sight distance.

### **2.2.4 Other Considerations**

Road tunnels with more than one traffic tube should be designed so that in the event that one tube is shut down, traffic can be carried in the other. For reasons of safety, it is not recommended that tunnels be constructed for bi-directional traffic; however, they should be designed to be capable of handling bi-directional traffic during maintenance work, which should be carried out at times of low traffic volume such as at night or weekends. When operating in a bi-directional mode, appropriate signage must be provided. In addition, suitable cross-over areas are required, usually provided outside the tunnel entrances, and the ventilation system and signage must be designed to handle bi-directional traffic.

For bored and mined tunnels, it is probable that separate tunnels are constructed for traffic in each direction. For cut-and-cover, jacked and immersed tunnels, it is preferable for the traffic tubes for the

two directions to be constructed within a single structure so that emergency egress by vehicle occupants into a neighboring traffic tube can be provided easily. Note that NFPA 502-2008 requires that the two tubes be divided by a minimum of 2-hour fire rated construction in order to consider cross-passageways between the tunnels to be utilized in lieu of emergency egress.

In addition to structural requirements, inundation of the tunnel by floods, surges, tides and waves, or combinations thereof resulting from storms must be prevented. The height and shape of walls surrounding tunnel entrances, the elevation of access road surfaces and any entrances, accesses and holes must be designed such that entry of water is prevented. It is recommended that water level with the probability of being exceeded no more than 0.005 times in any one year (the 500-year flood level) be used as the design water level.

### **2.3 TRAVEL CLEARANCE**

Clearance diagram of all potential vehicles traversing the tunnel shall be established using dynamic vehicle envelopes which consider not just the maximum allowable static envelope, but also other dynamic factors such as bouncing, suspension failure, overhang on curves, lateral motion, resurfacing, etc.

The clearance diagram should take into consideration potential future vehicle heights, vehicle mounting on curbs, construction tolerances, and any potential ground and structure settlement. Ventilation equipment, lighting, guide signs, and other equipment should not encroach within the clearance diagram.

Vertical clearance should be selected as economical as possible consistent with the vehicle size (see Chapter 1). The 5<sup>th</sup> Edition of AASHTO Green Book (2004) recommends that the minimum vertical clearance to be 16 feet (4.9 m) for highways and 14 feet (4.3 m) for other roads and streets. Note that the minimum clear height should not be less than the maximum height of load that is legal in a particular state.

Figure 2-2 illustrates the minimum and desirable clearance diagrams for two lane tunnels as recommended by the 5th Edition of the Green Book (AASHTO, 2004).

Figure 2-2(a) illustrates the minimum clearance diagram for a two-lane tunnel which indicates the minimum horizontal curb-to-curb and wall-to-wall clearances to be no less than 24 ft (7.2-m) and 30 ft (9-m), respectively. The curb-to-curb (including shoulders) clearance is also required to be 2 ft (0.6m) greater than the lane widths of the approach traveled way. Therefore, for an approach structure with two standard 12-ft lane widths, the minimum horizontal curb-to-curb clearance for the connecting two-lane tunnel should be no less than 26 ft (7.8 m).

Figure 2-2 (b) illustrates the desirable curb-to-curb and wall-to-wall clearances for a two-lane tunnel to be 39 ft (11.7m) and 44 ft (13.2m), respectively.

The vertical clearance shall also take into consideration for future resurfacing of the roadway. Although it is recommended to resurface roadways in tunnels only after the previous surface has been removed, it is prudent to provide limited allowances for resurfacing once without removal of the old pavement. Consideration should also be given for potential truck mounting on the barrier in the tunnel or on low sidewalk and measures shall be used to prevent such mounting from damaging the tunnel ceiling or tunnel system components mounted on the ceiling or the walls. The designer must follow the latest edition of the Green Book.

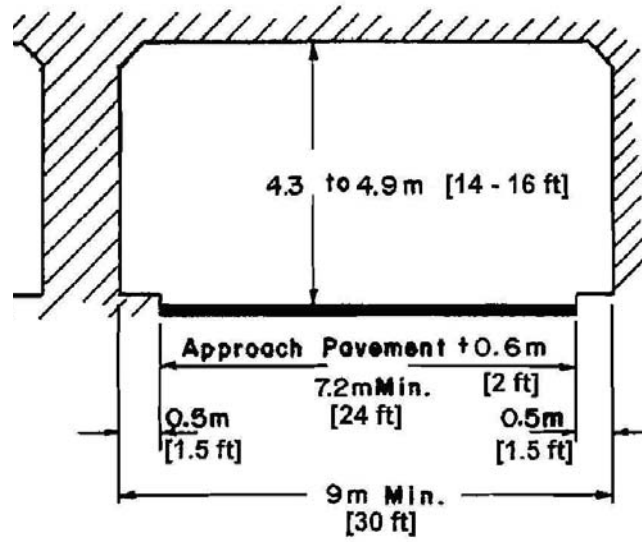

Minimum (a)

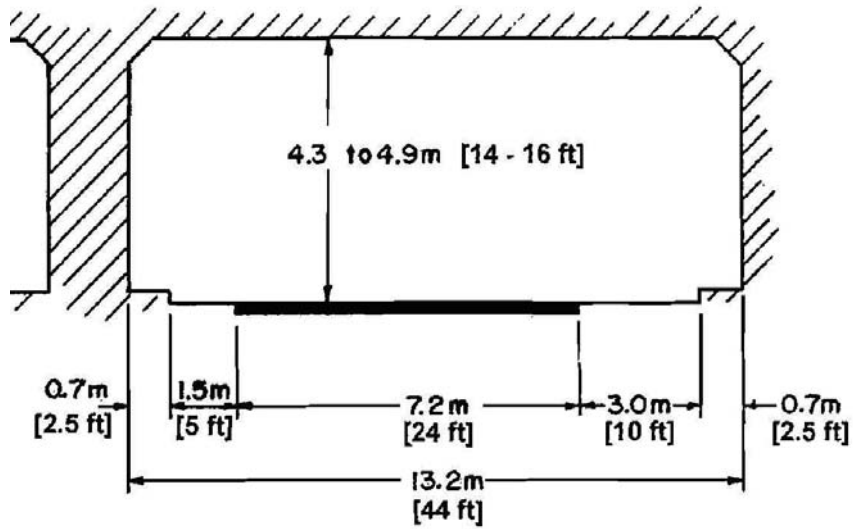

Desirable (b)

Figure 2-2 Typical Two-Lane Tunnel Clearance Requirements - Minimum (a) and Desirable (b) (After AASHTO, 2004)

Tunnel ventilation ducts, if required, can be provided above or below the traffic lanes, or to the sides of them. Where clearances to the outside of the tunnel at a particular location are such that by moving ventilation from overhead to the sides can reduce the tunnel gradients or reduce its length, such an option should be considered.

Over-height warning signals and diverging routes should be provided before traffic can reach the tunnel entrances. The designated traffic clearance should be provided throughout the approaches to the tunnel.

## 2.4 CROSS SECTION ELEMENTS

### 2.4.1 Typical Cross Section Elements

Although many road tunnels appear rectangular from inside bordered by the walls, ceiling and pavement (Figure 2-3), the actual tunnel shapes may not be rectangular. As described in Chapter 1, there are generally three typical shapes of tunnels – circular, rectangular, and horseshoe/ curvilinear. The shape of a tunnel section is mainly decided by the ground condition and construction methods as discussed in Chapter 1.

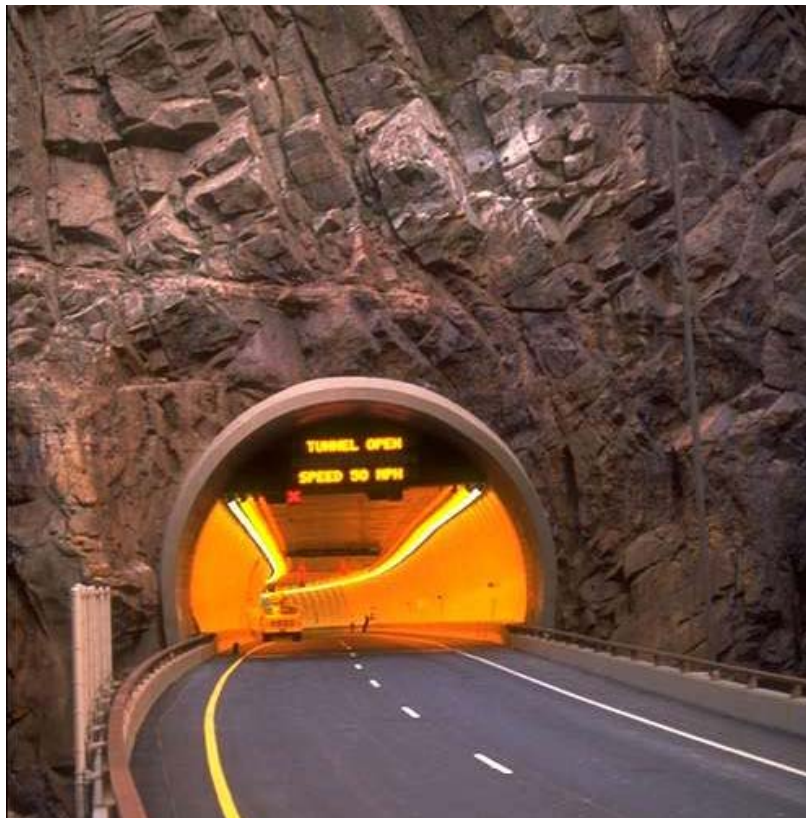

Figure 2-3 A Typical Horseshoe Section for a Two-lane Tunnel (Glenwood Canyon, Colorado)

A road tunnel cross section must be able to accommodate the horizontal and vertical traffic clearances (Section 2.3), as well as the other required elements. The typical cross section elements (Figure 2-4) include:

- Travel lanes
- Shoulders
- Sidewalks/Curbs
- Tunnel drainage
- Tunnel ventilation
- Tunnel lighting
- Tunnel utilities and power
- Water supply pipes for firefighting
- Cabinets for hose reels and fire extinguishers
- Signals and signs above roadway lanes
- CCTV surveillance cameras
- Emergency telephones
- Communication antennae/equipment
- Monitoring equipment of noxious emissions and visibility
- Emergency egress illuminated signs at low level (so that they are visible in case of a fire or smoke condition)

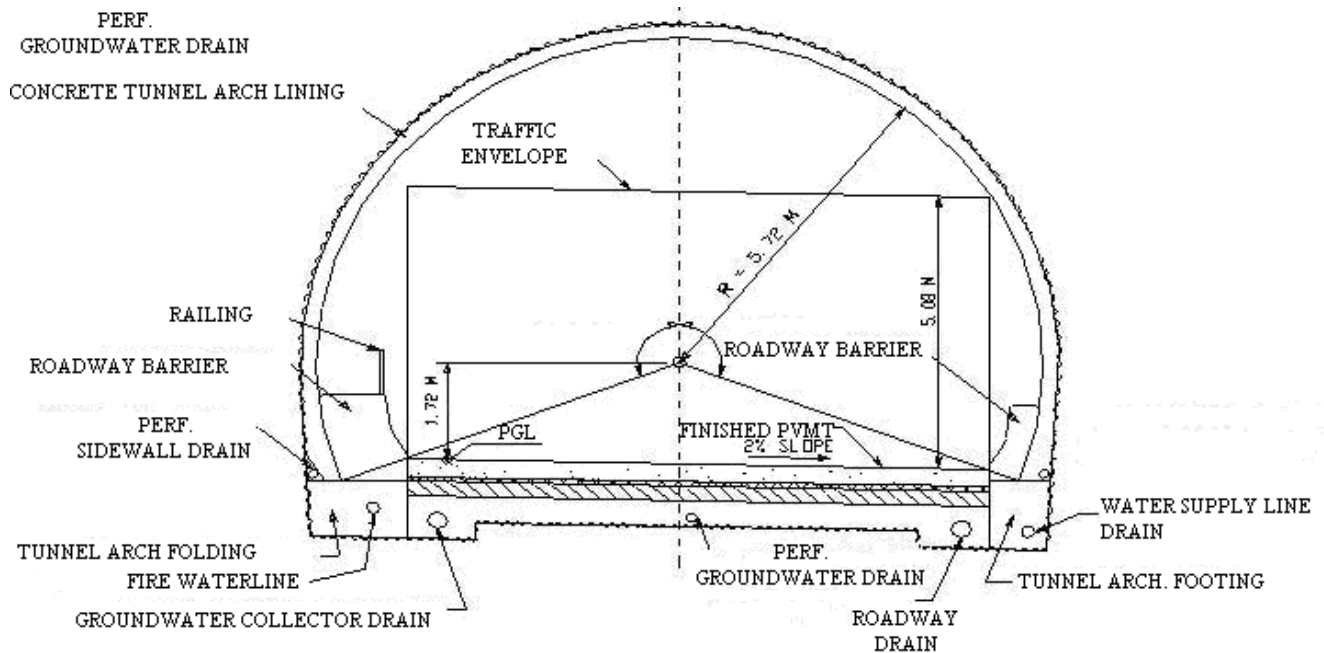

Figure 2-4 Typical Two-Lane Road Tunnel Cross Section and Elements

Additional elements may be needed under certain design requirements and should be taken into consideration when developing the tunnel geometrical configuration. The requirements for travel lane and shoulder width, sidewalks/emergency egress, drainage, ventilation, lighting, and traffic control are discussed in the following sections. Other elements cited above are required for fire and safety protection

for tunnels longer than 1000 ft (300m) or 800 ft (240m) long if the maximum distance from any point within the tunnel to a point of safety exceeds 400 ft (120m) (NFPA, the latest). Fire and safety protection requirements are not within the scope of this manual. Refer to Appendix A, and the latest NFPA 502 Standard for requirement for fire and safety protection elements.

#### **2.4.2 Travel Lane and Shoulder**

As discussed previously, for planning and design purposes, each lane width within a road tunnel should be no less than 12 feet (3.6 m) as recommended in the 5<sup>th</sup> Edition of Green Book (AASHTO, 2004).

Although the Green Book states that it is preferable to carry the full left- and right-shoulder widths of the approach freeway through the tunnel, it also recognizes that the cost of providing full shoulder widths may be prohibitive. Reduction of shoulder width in road tunnels is usual. In certain situations narrow shoulders are provided on one or both sides. Sometimes shoulders are eliminated completely and replaced by barriers. Based on a study conducted by World Road Association (PIARC) and published a report entitled “Cross Section Geometry in Unidirectional Road Tunnels” 2001; shoulder widths vary from country to country and they range from 0 to 2.75 m (9 ft). They are generally in the range of 1 m (3.3 ft). It is suggested for unidirectional road tunnels that the right shoulder be at 4 ft (1-2 m) and left shoulder at least 2 ft (0.6 m).

Figure 2-2(A) does not show a minimum requirement for a shoulder in a tunnel, except it requires that a minimum 2 feet (0.6m) be added to the travel lane width of the approach structure. The Green Book also recommends that the determination of the width of shoulders be established on an in-depth analysis of all aspects involved. Where it is not realistic (for economic or constructability considerations) to provide shoulders at all in a tunnel, travel delays may occur when vehicle(s) become inoperative during periods of heavy traffic. In long tunnels, emergency alcoves are sometimes provided to accommodate disabled vehicles.

To prevent errant vehicles from hitting the walls of the tunnel, a deflecting concrete barrier with a sloping or partially sloping face is commonly used. The height of the barrier should not be so great that it is perceived by drivers of low vehicles to be narrowing the width to the wall nor should it be too low to allow vehicles to mount it. A barrier of 3.3 ft (1 m) is common. A reduced shoulder width from a traveled way to the face of the adjacent barrier ranging between 2 and 4 feet (between 0.6 and 1.2 m) has been found to be acceptable.

Figure 2-5 illustrates an example of a typical tunnel roadway section including and two standard 12 ft lane widths and two reduced shoulder widths. Refer to Section 2.4.3 for the requirements for the barriers when used as the raised sidewalks or emergency egress walkways.

#### **2.4.3 Sidewalks/Emergency Egress Walkway**

Although pedestrians are typically not permitted in road tunnels, sidewalks are required in road tunnels to provide emergency egress and access by maintenance personnel. The 5<sup>th</sup> Edition of Green Book recommends that raised sidewalks or curbs with a width of 2.5 ft (0.7 m) or wider beyond the shoulder area are desirable to be used as an emergency egress, and that a raised barrier to prevent the overhang of vehicles from damaging the wall finish or the tunnel lighting fixtures be provided.

In addition, NFPA 502 requires an emergency egress walkway within the cross-passageways be of a minimum clear width of 3.6 ft (1.12 m).



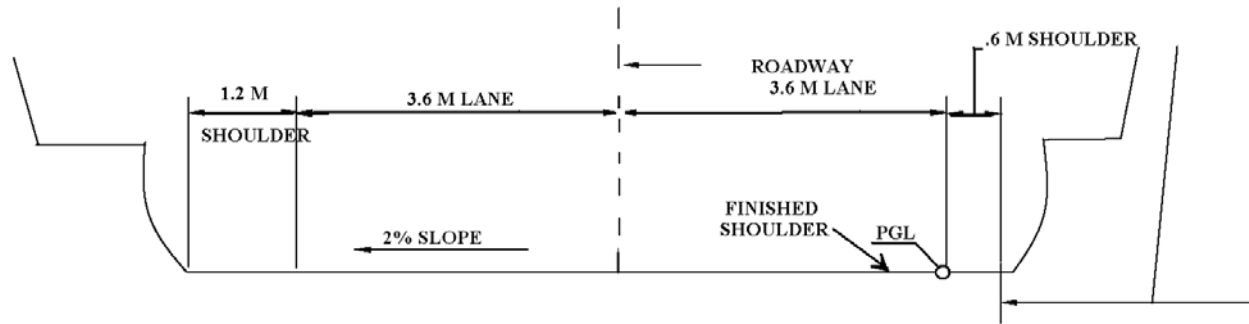

Figure 2-5 Typical Tunnel Roadway with Reduced Shoulder Widths

#### 2.4.4 Tunnel Drainage Requirements

Road tunnels must be equipped with a drainage system consisting of pipes, channels, sump/pump, oil/water separators and control systems for the safe and reliable collection, storage, separation and disposal of liquid/ effluent from the tunnels that might otherwise collect. Drainage must be provided in tunnels to deal with surface water as well as water leakage. However, drainage lines and sump-pumps should be sized to accommodate water intrusion and/or fire fighting requirements. They should be designed so that fire would not spread through the drainage system into adjacent tubes by isolating them. For the safety reason, PVC, fiberglass pipe, or other combustible materials should not be used.

Sumps should be provided with traps to collect and remove solids. Sand traps should be provided, as well as oil and fuel separators. It may be assumed in sizing sumps that fires and storms do not happen simultaneously. Sumps and pumps should be located at low points of a tunnel and at portals to handle water that might otherwise flow into the tunnel. Sumps should be sized to match the duty cycle of the discharge pumps such that inflow does not cause sump capacity to be exceeded. Sumps should be designed to be capable of being cleaned regularly.

#### 2.4.5 Ventilation Requirements

The ventilation system of a tunnel operates to maintain acceptable air quality levels for short-term exposure within the tunnel. The design may be driven either by fire/safety considerations or by air quality; which one governs depends upon many factors including traffic, size and length of the tunnel, and any special features such as underground interchanges.

Ventilation requirements in a highway tunnel are determined using two primary criteria, the handling of noxious emissions from vehicles using the tunnel and the handling of smoke during a fire. Computational fluid dynamics (CFD) analyses are often used to establish an appropriate design for the ventilation under fire conditions. An air quality analysis should also be conducted to determine whether air quality might govern the design. Air quality monitoring points in the tunnel should be provided and the ventilation should be adjusted based on the traffic volume to accommodate the required air quality.

Environmental impacts and air quality may affect the locations of ventilation structures/buildings, shafts and portals. Analyses should take into account current and future development, ground levels, the heights and distances of sensitive receptors near such locations and the locations of operable windows and terraces of adjacent buildings to minimize impacts. Ventilation buildings have also been located below grade and exhaust stacks hidden within other structures.

The two main ventilation system options used for tunnels are longitudinal ventilation and transverse ventilation. A longitudinal ventilation system introduces air into, or removes air from a road tunnel, with the longitudinal flow of traffic, at a limited number of points such as a ventilation shaft or a portal. It can be sub-classified as either using a jet fan system or a central fan system with a high-velocity (Saccardo) nozzle. The use of jet fan based longitudinal system was approved by the FHWA in 1995 based on the results of the Memorial Tunnel Fire Ventilation Test Program (NCHRP, 2006). Generally, it includes a series of axial, high-velocity jet fans mounted at the ceiling level of the road tunnel to induce a longitudinal air-flow through the length of the tunnel as shown in Figure 2-6.



Figure 2-6 Ventilation System with Jet Fans at Cumberland Gap Tunnel

A transverse ventilation system can be either a full or semi-full transverse type. With full transverse ventilation, air supply ducts are located above, below or to the side of the traffic tube and inject fresh air into the tunnel at regular intervals. Exhaust ducts are located above or to the side of the traffic tube and remove air and contaminants. With semi-transverse ventilation, the supply duct is eliminated with its “duties” taken over by the traffic opening. When supply or exhaust ducts are used, the flow is generated by fans grouped together in ventilation buildings. Local noise standards generally would require noise attenuators at the fans or nozzles.

Selection of the appropriate ventilation system obviously has a profound impact on the tunnel alignment, layout, and cross section design. Detailed discussion of tunnel ventilation design is not within the scope of this manual.

## 2.4.6 Lighting Requirements

Lighting in tunnels assists the driver in identifying hazards or disabled vehicles within the tunnel while at a sufficient distance to safely react or stop. High light levels (Portal light zone) are usually required at the beginning of the tunnel during the daytime to compensate for the “Black Hole Effect” that occurs by the tunnel structure shadowing the roadway as shown on Figure 2-7. These high light levels will be used only during daytime. Tunnel light fixtures are usually located in the ceiling, or mounted on the walls near the ceiling. Tunnel lighting methods and guidelines are not within the scope of this manual. However, the location, size, type, and number of light fixtures impact the geometrical requirements of the tunnel and should be taken into consideration.



Figure 2-7 “Black Hole” (Left) and Proper Lighting (Right)

The tunnel lighting documents issued by the IESNA (ANSI/IESNA RP-22 Recommended Practice for Tunnel Lighting) and the CIE (CIE-88 Guide for the Lighting of Road Tunnels and Underpasses) offer comprehensive approaches to tunnel lighting. The AASHTO Roadway Lighting Design Guide provides some recommendations for road tunnels as well.

For improved safety during a fire, it is suggested that strobe lights be placed to identify exit routes. If used they should be placed around exit doors, especially at lower levels which might then be under the smoke level. The strobe lights would be activated only during tunnel fires. Emergency lighting in tunnels including wiring methods and other requirements are included in NFPA 502 “Standard for Road Tunnels, Bridges and Other Limited Access Highways”, PIARC “Fire and Smoke Control in Road Tunnels”, and in the findings of the 2005 FHWA/AASHTO European Scan Tour (Appendix A) .

## 2.4.7 Traffic Control Requirements

The latest NFPA 502 Standard mandates that tunnels 300 ft (90 m) in length should be provided with a means to stop traffic approaching portals (external). In addition, the NFPA 502 also specifies that traffic control means within the tunnel 800 feet (240 m) in length are required. These should include lane control signals, over-height warning signals, changeable message signs (CMS), etc. Traffic control may be required to close and open lanes for maintenance and handling accidents, and for monitoring of vehicles carrying prohibited materials. Incident control systems linked to CCTV cameras should be installed. It is recommended that 100% coverage of the tunnel with CCTV be provided. Refer to the latest NFPA 502 for more detailed requirements. Traffic control requirements should be taken into consideration when developing the cross sectional geometry.

## 2.4.8 Portals and Approach

Tunnel portals may require special design considerations. Portal sites need to be located in stable ground with sufficient space. Orientation of the portals should avoid if possible direct East and West to avoid blinding sunlight. Ameliorating measures should be taken where drivers might otherwise be blinded by the rising or setting sun. Intermittent cross members are sometimes provided across the approach structure above the traffic lanes as an amelioration measure. A central dividing wall sometime is extended some distance out from the portal to prevent recirculation of polluted air, i.e. vented polluted air from one traffic duct is prevented from entering an adjacent duct as “clean” air.

Tunnels with a high traffic volume and long tunnels should be equipped with emergency vehicles at each end with potential access to all traffic tubes. Wrecker trucks should be capable of pushing a disabled vehicle as well as the more traditional method of towing. These vehicles should preferably be equipped with some fire-fighting equipment, the extent of which depending upon the distance to the nearest fire department. At least, they should carry dry chemical fire extinguishers.

If the tunnel is in a remote rural area where responses of nearby fire companies and emergency squads are not available in a timely matter, a larger portal structure as shown in Figure 2-8 may be required to host the operation control center, as well as the fire-fighting and emergency-responding personnel, equipment and vehicles.

In determining portal locations and where to end the approach structure and retaining walls, protection should be provided against flooding resulting from high water levels near bodies of water and tributary watercourses, or from storm runoff. The height of the portal end wall and the approach retaining walls should be set to a level at least 2 ft (0.6m) higher than the design flood level. Alternatively a flood gate can be provided. Adequate provision should be made for immediate and effective removal of water from rainfall, drainage, groundwater seepage, or any other source. Portal cross drain and sump-pump should be provided.



Figure 2-8 Portal Structure for Cumberland Gap Tunnel

## **CHAPTER 3**

### **GEOTECHNICAL INVESTIGATIONS**

#### **3.1 INTRODUCTION**

To successfully plan, design and construct a road tunnel project requires various types of investigative techniques to obtain a broad spectrum of pertinent topographic, geologic, subsurface, geo-hydrological, and structure information and data. Although most of the techniques and procedures are similar to those applied for roadway and bridge projects, the specific scope, objectives and focuses of the investigations are considerably different for tunnel and underground projects, and can vary significantly with subsurface conditions and tunneling methods.

A geotechnical investigation program for a tunnel project must use appropriate means and methods to obtain necessary characteristics and properties as basis for planning, design and construction of the tunnel and related underground facilities, to identify the potential construction risks, and to establish realistic cost estimate and schedule. The extent of the investigation should be consistent with the project scope (i.e., location, size, and budget), the project objectives (i.e., risk tolerance, long-term performance), and the project constraints (i.e., geometry, constructability, third-party impacts, aesthetics, and environmental impact). It is important that the involved parties have a common understanding of the geotechnical basis for design, and that they are aware of the inevitable risk of not being able to completely define existing subsurface conditions or to fully predict ground behavior during construction.

Generally, an investigation program for planning and design of a road tunnel project may include the following components:

- Existing Information Collection and Study
- Surveys and Site Reconnaissance
- Geologic Mapping
- Subsurface Investigations
- Environmental Studies
- Seismicity
- Geospatial Data Management

It is beyond the scope of this manual to discuss each of the above components in details. The readers are encouraged to review the FHWA and AASHTO references provided in this Chapter for more details. Similar investigations and monitoring are often needed during and after the construction to ensure the problems that occurred during construction are rectified or compensated, and short term impacts are reversed. Geotechnical investigations after construction are not discussed specifically in this Chapter.

##### **3.1.1 Phasing of Geotechnical Investigations**

Amid the higher cost of a complete geotechnical investigation program for a road tunnel projects (typically about 3% to 5% of construction cost), it is more efficient to perform geotechnical investigations in phases to focus the effort in the areas and depths that matter. Especially for a road tunnel through mountainous terrain or below water body (Figure 3-1), the high cost, lengthy duration, limited access, and limited coverage of field investigations may demand that investigations be carried out in several phases to obtain the information necessary at each stage of the project in a more cost-efficient manner.



Figure 3-1 Water Boring Investigation from a Barge for the Port of Miami Tunnel, Miami, FL

Furthermore, it is not uncommon to take several decades for a road tunnel project to be conceptualized, developed, designed, and eventually constructed. As discussed in Chapter 1, typical stages of a road tunnel project from conception to completion are:

- Planning
- Feasibility Study
- Corridor and Alignment Alternative Study
- Environmental Impact Studies (EIS) and Conceptual Design
- Preliminary Design
- Final Design
- Construction

Throughout the project development, the final alignment and profile may often deviate from those originally anticipated. Phasing of the geotechnical investigations provides an economical and rational approach for adjusting to these anticipated changes to the project.

The early investigations for planning and feasibility studies can be confined to information studies and preliminary reconnaissance. Geological mapping and minimum subsurface investigations are typically required for EIS, alternative studies and conceptual design. EIS studies may also include limited topographical and environmental investigations to identify potential “fatal flaws” that might stop the project at a later date. A substantial portion of the geotechnical investigation effort should go into the Preliminary Design Phase to refine the tunnel alignment and profile once the general corridor is selected, and to provide the detailed information needed for design. As the final design progresses, additional test borings might be required for fuller coverage of the final alignment and for selected shaft and portal

locations. Lastly, depending on the tunneling method selected, additional investigations may be required to confirm design assumptions, or to provide information for contractor design of temporary works. Figure 3-2 illustrates the flow process of the phases of investigations.

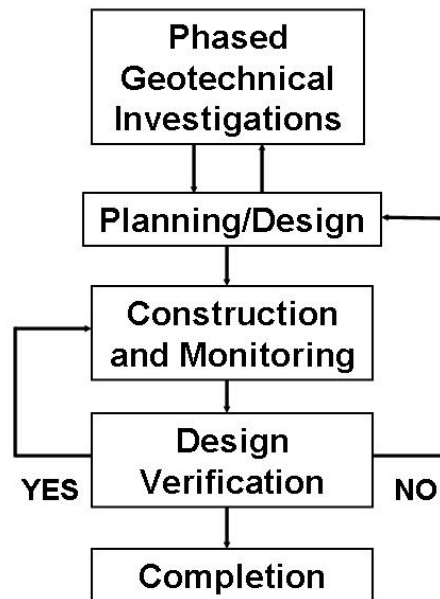

Figure 3-2 Phased Geotechnical Investigations with Project Development Process

This Chapter discusses the subsurface investigation techniques typically used for planning, design and construction of road tunnels. Additional information on this subject is available from FHWA Geotechnical Engineering Circular No. 5 (FHWA, 2002a), FHWA Reference Manual for Subsurface Investigations – Geotechnical Site Characterization (FHWA, 2002b), FHWA Reference Manual for Rock Slopes (FHWA, 1999), and AASHTO Manual on Subsurface Investigations (AASHTO, 1988).

## 3.2 INFORMATION STUDY

### 3.2.1 Collection and Review of Available Information

The first phase of an investigation program for a road tunnel project starts with collection and review of available information to develop an overall understanding of the site conditions and constraints at little cost. Existing data can help identify existing conditions and features that may impact the design and construction of the proposed tunnel, and can guide in planning the scope and details of the subsurface investigation program to address these issues.

Published topographical, hydrological, geological, geotechnical, environmental, zoning, and other information should be collected, organized and evaluated. In areas where seismic condition may govern or influence the project, historical seismic records are used to assess earthquake hazards. Records of landslides caused by earthquakes, documented by the USGS and some State Transportation Departments, can be useful to avoid locating tunnel portals and shafts at these potentially unstable areas.

In addition, case histories of underground works in the region are sometimes available from existing highway, railroad and water tunnels. Other local sources of information may include nearby quarries, mines, or water wells. University publications may also provide useful information.

Table 3-1 presents a summary list of potential information sources and the type of information typically available.

Today, existing data are often available electronically, making them easier to access and manage. Most of the existing information such as aerial photos, topographical maps, etc. can be obtained in GIS format at low or no cost. Several state agencies are developing geotechnical management systems (GMS) to store historical drilling, sampling, and laboratory test data for locations in their states. An integrated project geo-referenced (geospatial) data management system will soon become essential from the initiation of the project through construction to store and manage these extensive data instead of paper records. Such an electronic data management system after the project completion will continue to be beneficial for operation and maintenance purposes. Geospatial data management is discussed in Section 3.9.

### **3.2.2 Topographical Data**

Topographic maps and aerial photographs that today can be easily and economically obtained, are useful in showing terrain and geologic features (i.e., faults, drainage channels, sinkholes, etc.). When overlapped with published geological maps they can often, by interpretation, show geologic structures. Aerial photographs taken on different dates may reveal the site history in terms of earthwork, erosion and scouring, past construction, etc.

U.S. Geological Survey (USGS) topographic maps (1:24,000 series with 10 ft or 20 ft contours) may be used for preliminary route selection. However, when the project corridor has been defined, new aerial photography should be obtained and photogrammetric maps should be prepared to facilitate portal and shaft design, site access, right-of-way, drainage, depth of cover, geologic interpretation and other studies.

## **3.3 SURVEYS AND SITE RECONNAISSANCE**

### **3.3.1 Site Reconnaissance and Preliminary Surveys**

As discussed previously, existing lower-resolution contour maps published by USGS or developed from photogrammetric mapping, are sufficient only for planning purposes. However, a preliminary survey will be needed for concept development and preliminary design to expand existing topographical data and include data from field surveys and an initial site reconnaissance. Initial on-site studies should start with a careful reconnaissance over the tunnel alignment, paying particular attention to the potential portal and shaft locations. Features identified on maps and air photos should be verified. Rock outcrops, often exposed in highway and railroad cuts, provide a source for information about rock mass fracturing and bedding and the location of rock type boundaries, faults, dikes, and other geologic features. Features identified during the site reconnaissance should be photographed, documented and if feasible located by hand-held GPS equipment.



**Table 3-1 Sources of Information Data (After FHWA, 2002a)**

| Source   | Functional Use  | Location  | Examples  |
|--|---|---|---|
| <b>Aerial Photographs</b>                                    | <ul style="list-style-type: none"> <li>Identifies manmade structures</li> <li>Provides geologic and hydrological information which can be used as a basis for site reconnaissance</li> <li>Track site changes over time</li> </ul>  | Local Soil Conservation Office, United States Geological Survey (USGS), Local Library, Local and National aerial survey companies | Evaluating a series of aerial photographs may show an area on site which was filled during the time period reviewed   |
| <b>Topographic Maps</b>                                      | <ul style="list-style-type: none"> <li>Provides good index map of the site</li> <li>Allows for estimation of site topography</li> <li>Identifies physical features and structures</li> <li>Can be used to assess access restrictions</li> <li>Maps from multiple dates indicate changes in land use</li> </ul>                                | USGS and State Geological Survey  | Engineer identifies access areas/restrictions, identifies areas of potential slope instability; and can estimate cut/fill capacity before visiting the site                       |
| <b>Geologic Maps and Reports</b>                             | <ul style="list-style-type: none"> <li>Provides information on local soil/rock type and characteristics; hydrogeological issues, environmental concerns</li> </ul>  | USGS and State Geological Survey  | A twenty year old report on regional geology identifies rock types, fracture and orientation and groundwater flow patterns  |
| <b>Prior Subsurface Investigation Reports</b>                | <ul style="list-style-type: none"> <li>Provides information on local soil/rock type; strength parameters; hydrogeological issues; foundation types previously used; environmental concerns</li> </ul>   | State DOTs, USGS, United States Environmental Protection Agency (US EPA)  | A five year old report for a nearby roadway widening project provides geologic, hydrogeologic, and geotechnical information for the area, reducing the scope of the investigation |
| <b>Prior Underground and Foundation Construction Records</b> | <ul style="list-style-type: none"> <li>Provides information on local soil/rock type; strength parameters; hydrogeological issues; environmental concerns; tunnel construction methods and problems</li> </ul>   | State DOTs, US EPA Utility agencies; Railroads  | Construction records from a nearby railroad tunnel alerted designer to squeezing rock condition at shear zone   |
| <b>Water Well Logs</b>                                       | <ul style="list-style-type: none"> <li>Provide stratigraphy of the site and/or regional areas</li> <li>Yield rate and permeability</li> <li>Groundwater levels</li> </ul>   | State Geological Survey; Municipal Governments; Water Boards  | A boring log of a water supply well two miles from the proposed tunnel shows site stratigraphy facilitating interpretation of local geology                                       |
| <b>Flood Insurance Maps</b>                                  | <ul style="list-style-type: none"> <li>Identifies 100 to 500 yr. Floodplains near water bodies</li> <li>May prevent construction in a floodplain</li> <li>Provide information for evaluation of scour potential</li> </ul>  | Federal Emergency Management Agency (FEMA), USGS, State/Local Agencies  | Prior to investigation, the flood map shows that the site is in a 100 yr floodplain and the proposed structure is moved to a new location   |
| <b>Sanborn Fire Insurance Maps</b>                           | <ul style="list-style-type: none"> <li>Useful in urban areas</li> <li>For many cities provides continuous record for over 100 yrs.</li> <li>Identifies building locations and type</li> <li>Identifies business type at a location (e.g., chemical plant)</li> <li>May highlight potential environmental problems at an urban site</li> </ul> | State Library/Sanborn Company (www.Sanborncompany.com)  | A 1929 Sanborn map of St. Louis shows that a lead smelter was on site for 10 years. This information helps identify a local contaminated area.                                    |

The reconnaissance should cover the immediate project vicinity, as well as a larger regional area so that regional geologic, hydrologic and seismic influences can be accounted for.

A preliminary horizontal and vertical control survey may be required to obtain general site data for route selection and for design. This survey should be expanded from existing records and monuments that are based on the same horizontal and vertical datum that will be used for final design of the structures. Additional temporary monuments and benchmarks can be established, as needed, to support field investigations, mapping, and environmental studies.

### **3.3.2 Topographic Surveys**

As alternatives are eliminated, detailed topographic maps, plans and profiles must be developed to establish primary control for final design and construction based on a high order horizontal and vertical control field survey. On a road tunnel system, centerline of the roadway and centerline of tunnel are normally not identical because of clearance requirements for walkways and emergency passages as discussed in Chapter 2. A tunnel centerline developed during design should be composed of tangent, circular, and transition spiral sections that approximate the complex theoretical tunnel centerline within a specified tolerance (0.25 in.). This centerline should be incorporated into the contract drawings of the tunnel contract, and all tunnel control should be based on this centerline. During construction, survey work is necessary for transfer of line and grade from surface to tunnel monuments, tunnel alignment control, locating and monitoring geotechnical instrumentation (particularly in urban areas), as-built surveys, etc. Accurate topographic mapping is also required to support surface geology mapping and the layout of exploratory borings, whether existing or performed for the project. The principal survey techniques include:

- Conventional Survey
- Global Positioning System (GPS)
- Electronic Distance Measuring (EDM) with Total Stations.
- Remote Sensing
- Laser Scanning

The state-of-art surveying techniques are discussed briefly below. Note that the accuracies and operation procedures of these techniques improve with time so the readers should seek out up-to-date information when applying these techniques for underground projects.

Global Positioning System (GPS) utilizes the signal transit time from ground station to satellites to determine the relative position of monuments in a control network. GPS surveying is able to coordinate widely spaced control monuments for long range surveys, as well as shorter range surveys. The accuracy of GPS measurement is dependent upon the number of satellites observed, configuration of the satellite group observed, elapsed time of observation, quality of transmission, type of GPS receiver, and other factors including network design and techniques used to process data. The drawback for GPS survey is its limitation in areas where the GPS antenna cannot establish contact with the satellites via direct line of sight, such as within tunnels, downtown locations, forested areas, etc.

Electronic Distance Measuring (EDM) utilizes a digital theodolite with electronic microprocessors, called a “total station” instrument, which determines the distance to a remote prism target by measuring the time required for a laser or infrared light to be reflected back from the target. EDM can be used for accurate surveys of distant surfaces that would be difficult or impractical to monitor by conventional survey techniques. EDM can be used for common surveying applications, but is particularly useful for

economically monitoring displacement and settlement with time, such as monitoring the displacement and settlement of an existing structure during tunneling operations.

Remote Sensing can effectively identify terrain conditions, geologic formations, escarpments and surface reflection of faults, buried stream beds, site access conditions and general soil and rock formations. Remote sensing data can be easily obtained from satellites (i.e. LANDSAT images from NASA), and aerial photographs, including infrared and radar imagery, from the USGS or state geologists, U.S. Corps of Engineers, and commercial aerial mapping service organizations. State DOT aerial photographs, used for right-of-way surveys and road and bridge alignments, may also be available.

Laser Scanning utilizes laser technology to create 3D digital images of surfaces. Laser scanning equipment can establish x, y and z coordinates of more than one thousand points per second, at a resolution of about 0.25 inch over a distance of more than 150 feet. Laser scanning can be used to quickly scan and digitally record existing slopes to determine the geometry of visible features, and any changes with time. These data may be useful in interpreting geologic mapping data, for assessing stability of existing slopes, or obtaining as-built geometry for portal excavations. In tunnels, laser scanning can efficiently create cross sections at very close spacing to document conditions within existing tunnels (Figure 3-3), verify geometry and provide as-built sections for newly constructed tunnels, and to monitor tunnel deformations with time.



Figure 3-3 3D Laser Scanning Tunnel Survey Results in Actual Scanned Points

### 3.3.3 Hydrographical Surveys

Hydrographic surveys are required for subaqueous tunnels including immersed tunnel (Chapter 11), shallow bored tunnel, jacked box tunnel, and cofferdam cut-and-cover river crossings to determine bottom topography of the water body, together with water flow direction and velocity, range in water level, and potential scour depth. In planning the hydrographic survey, an investigation should be made to determine the existence and location of submarine pipelines, cables, natural and sunken obstructions, rip rap, etc. that may impact design or construction of the immersed tunnel or cofferdam cut-and-cover

tunnel. Additional surveys such as magnetometer, seismic sub-bottom scanning, electromagnetic survey, side scan sonar, etc., may be required to detect and locate these features. These additional surveys may be done simultaneously or sequentially with the basic hydrographic survey. Data generated from the hydrographic survey should be based on the same horizontal coordinate system as the project control surveys, and should be compatible with the project GIS database. The vertical datum selected for the hydrographic survey should be based on the primary monument elevations, expressed in terms of National Geodetic Vertical Datum of 1929 (NGVD), Mean Lower Low Water Datum, or other established project datum.

### **3.3.4 Utility Surveys**

Utility information is required, especially in the urban areas, to determine the type and extent of utility protection, relocation or reconstruction needed. This information is obtained from surveys commissioned for the project, and from existing utility maps normally available from the owners of the utilities (utility companies, municipalities, utility districts, etc.). Utility surveys are performed to collect new data, corroborate existing data, and composite all data in maps and reports that will be provided to the tunnel designer. The requirement for utility information varies with tunneling methods and site conditions. Cut-and-cover tunnel and shallow soft ground tunnel constructions, particularly in urban areas, extensively impacts overlying and adjacent utilities. Gas, steam, water, sewerage, storm water, electrical, telephone, fiber optic and other utility mains and distribution systems may require excavation, rerouting, strengthening, reconstruction and/or temporary support, and may also require monitoring during construction.

The existing utility maps are mostly for informational purposes, and generally do not contain any warranty that the utility features shown actually exist, that they are in the specific location shown on the map, or that there may be additional features that are not shown. In general, surface features such as manholes and vaults tend to be reasonably well positioned on utility maps, but underground connections (pipes, conduits, cables, etc.) are usually shown as straight lines connecting the surface features. During original construction of such utilities, trenching may have been designed as a series of straight lines, but, in actuality, buried obstructions such as boulders, unstable soil or unmapped existing utilities necessitated deviation from the designed trench alignment. In many instances, as-built surveys were never done after construction, and the design map, without any notation of as-constructed alignment changes, became the only map recording the location of the constructed utilities.

In well-developed areas, it may not be realistic to attempt to locate all utilities during the design phase of a project without a prohibitive amount of investigation, which is beyond the time and cost limitations of the designer's budget. However, the designer must perform a diligent effort to minimize surprises during excavation and construction. Again, the level of due diligence depends on the method of excavation (cut-and-cover, or mined tunnel), the depth of the tunnel, and the number, size and location of proposed shafts.

### **3.3.5 Identification of Underground Structures and Other Obstacles**

Often, particularly in dense urban areas, other underground structures may exist that may impact the alignment and profile of the proposed road tunnel, and will dictate the need for structure protection measures during construction. These existing underground structures may include transit and railroad tunnels, other road tunnels, underground pedestrian passageways, building vaults, existing or abandoned marine structures (bulkheads, piers, etc.), and existing or abandoned structure foundations. Other underground obstructions may include abandoned temporary shoring systems, soil treatment areas, and soil or rock anchors that were used for temporary or permanent support of earth retaining structures. Initial surveys for the project should therefore include a survey of existing and past structures using

documents from city and state agencies, and building owners. In addition, historical maps and records should be reviewed to assess the potential for buried abandoned structures.

### **3.3.6 Structure Preconstruction Survey**

Structures located within the zone of potential influence may experience a certain amount of vertical and lateral movement as a result of soil movement caused by tunnel excavation and construction in close proximity (e.g. cut-and-cover excavation, shallow soft ground tunneling, etc.). If the anticipated movement may induce potential damage to a structure, some protection measures will be required, and a detailed preconstruction survey of the structure should be performed. Preconstruction survey should ascertain all pertinent facts of pre-existing conditions, and identify features and locations for further monitoring. Refer to Chapter 15 for detailed discussions of structural instrumentation and monitoring.

## **3.4 GEOLOGIC MAPPING**

After collecting and reviewing existing geologic maps, aerial photos, references, and the results of a preliminary site reconnaissance, surface geologic mapping of available rock outcrops should be performed by an experienced engineering geologist to obtain detailed, site-specific information on rock quality and structure. Geologic mapping collects local, detailed geologic data systematically, and is used to characterize and document the condition of rock mass or outcrop for rock mass classification (Chapter 6) such as:

- Discontinuity type
- Discontinuity orientation
- Discontinuity infilling
- Discontinuity spacing
- Discontinuity persistence
- Weathering

The International Society of Rock Mechanics (ISRM) ([www.isrm.net](http://www.isrm.net)) has suggested quantitative measures for describing discontinuities (ISRM 1981). It provides standard descriptions for factors such as persistence, roughness, wall strength, aperture, filling, seepage, and block size. Where necessary, it gives suggested methods for measuring these parameters so that the discontinuity can be characterized in a constant manner that allows comparison.

By interpreting and extrapolating all these data, the geologist should have a better understanding of the rock conditions likely to be present along the proposed tunnel and at the proposed portal and shaft excavations. The collected mapping data can be used in stereographic projections for statistical analysis using appropriate computer software (e.g., DIPS), in addition to the data obtained from the subsurface investigations.

In addition, the following surface features should also be observed and documented during the geologic mapping program:

- Slides, new or old, particularly in proposed portal and shaft areas
- Faults
- Rock weathering
- Sinkholes and karstic terrain
- Groundwater springs

- Volcanic activity
- Anhydrite, gypsum, pyrite, or swelling shales
- Stress relief cracks
- Presence of talus or boulders
- Thermal water (heat) and gas

The mapping data will also help in targeting subsurface investigation borings and in situ testing in areas of observed variability and anomalies. Section 4 of AASHTO Subsurface Investigations Manual (1988) provides details of commonly used field geologic mapping techniques and procedures.

Geologic mapping during and after tunnel excavation is briefly discussed in Section 3.8. For details of in-tunnel peripheral geologic mapping refer to US Army Corps of Engineers - Engineering Manual EM-1110-1-1804 for Geotechnical Investigations (USACE, Latest).

### 3.5 SUBSURFACE INVESTIGATIONS

#### 3.5.1 General

Ground conditions including geological, geotechnical, and hydrological conditions, have a major impact on the planning, design, construction and cost of a road tunnel, and often determine its feasibility and final route. Fundamentally, subsurface investigation is the most important type of investigations to obtain ground conditions, as it is the principal means for:

- Defining the subsurface profile (i.e. stratigraphy, structure, and principal soil and rock types)(Figure 3-4)
- Determining soil and rock material properties and mass characteristics;
- Identify geological anomalies, fault zones and other hazards (squeezing soils, methane gas, etc.)
- Defining hydrogeological conditions (groundwater levels, aquifers, hydrostatic pressures, etc.); and
- Identifying potential construction risks (boulders, etc.).

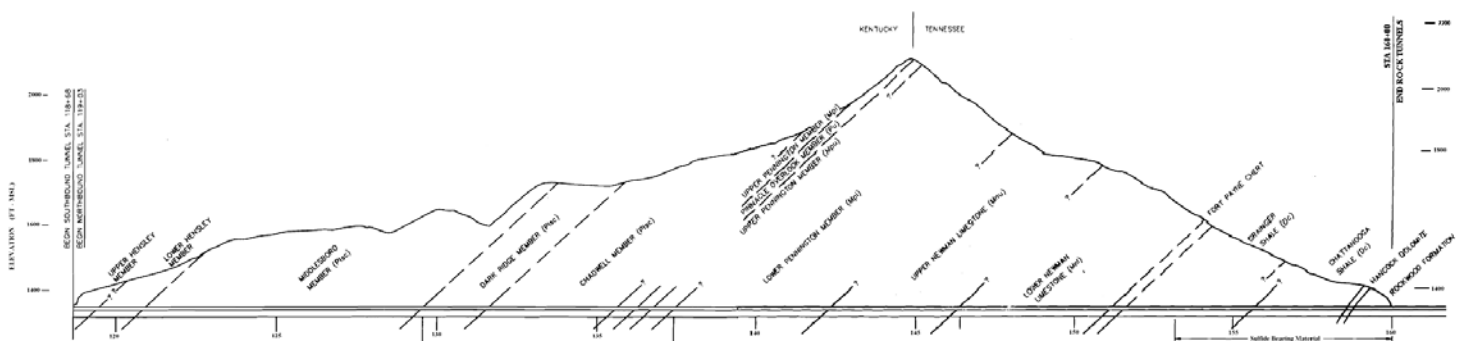

Figure 3-4 Cumberland Gap Tunnel Geological Profile

Subsurface investigations typically consist of borings, sampling, in situ testing, geophysical investigations, and laboratory material testing. The principal purposes of these investigation techniques are summarized below:

- Borings are used to identify the subsurface stratigraphy, and to obtain disturbed and undisturbed samples for visual classification and laboratory testing;
- In situ tests are commonly used to obtain useful engineering and index properties by testing the material in place to avoid the disturbance inevitably caused by sampling, transportation and handling of samples retrieved from boreholes; in situ tests can also aid in defining stratigraphy;
- Geophysical tests quickly and economically obtain subsurface information (stratigraphy and general engineering characteristics) over a large area to help define stratigraphy and to identify appropriate locations for performing borings; and
- Laboratory testing provides a wide variety of engineering properties and index properties from representative soil samples and rock core retrieved from the borings.

Unlike other highway structures, the ground surrounding a tunnel can act as a supporting mechanism, or loading mechanism, or both, depending on the nature of the ground, the tunnel size, and the method and sequence of constructing the tunnel. Thus, for tunnel designers and contractors, the rock or soil surrounding a tunnel is a construction material, just as important as the concrete and steel used on the job. Therefore, although the above subsurface investigative techniques are similar (or identical) to the ones used for foundation design as specified in Section 10 of AASHTO 2006 Interim and in accordance with appropriate ASTM or AASHTO standards, the geological and geotechnical focuses for underground designs and constructions can be vastly different.

In addition to typical geotechnical, geological, and geo-hydrological data, subsurface investigation for a tunnel project must consider the unique needs for different tunneling methods, i.e. cut-and-cover, drill-and-blast, bored, sequential excavation, and immersed. Table 3-2 shows other special considerations for various tunneling methods.

As discussed in Section 3.1.1, subsurface investigations must be performed in phases to better economize the program. Nonetheless, they are primarily performed during the design stage of the project, with much of the work typically concentrated in the preliminary design phase of a project. These investigations provide factual information about the distribution and engineering characteristics of soil, rock and groundwater at a site, allowing an understanding of the existing conditions sufficient for developing an economical design, determining a reliable construction cost estimate, and reducing the risks of construction. The specific scope and extent of the investigation must be appropriate for the size of the project and the complexity of the existing geologic conditions; must consider budgetary constraints; and must be consistent with the level of risk considered acceptable to the client. To ensure the collected data can be analyzed correctly throughout the project, the project coordinate system and vertical datum should be established early on and the boring and testing locations must be surveyed, at least by hand-held GPS equipment. Photographs of the locations should be maintained as well.

Since unanticipated ground conditions are most often the reason for costly delays, claims and disputes during tunnel construction, a project with a more thorough subsurface investigation program would likely have fewer problems and lower final cost. Therefore, ideally, the extent of an exploration program should be based on specific project requirements and complexity, rather than strict budget limits. However, for most road tunnels, especially tunnels in mountainous areas or for water crossings, the cost for a comprehensive subsurface investigation may be prohibitive. The challenge to geotechnical professionals is to develop an adequate and diligent subsurface investigation program that can improve the predictability of ground conditions within a reasonable budget and acceptable level of risk. It is important that the involved parties have a common understanding of the limitations of geotechnical investigations, and be aware of the inevitable risk of not being able to completely define existing geological conditions.

Special considerations for various geological conditions are summarized in Table 3-3 (Bickel, et al., 1996).

**Table 3-2 Special Investigation Needs Related to Tunneling Methods (after Bickel et al, 1996)**

|   |   |
|---|---|
| Cut and Cover (Ch 5)                              | Plan exploration to obtain design parameters for excavation support, and specifically define conditions closely enough to reliably determine best and most cost-effective location to change from cut-and-cover to true tunnel mining construction.   |
| Drill and Blast (Ch 6)                            | Data needed to predict stand-up time for the size and orientation of tunnel.  |
| Rock Tunnel Boring Machine (Ch 6)                 | Data required to determine cutter costs and penetration rate is essential. Need data to predict stand-up time to determine if open-type machine will be ok or if full shield is necessary. Also, water inflow is very important.  |
| Roadheader (Ch 6)                                 | Need data on jointing to evaluate if roadheader will be plucking out small joint blocks or must grind rock away. Data on hardness of rock is essential to predict cutter/pick costs.  |
| Shielded Soft Ground Tunnel Boring Machine (Ch 7) | Stand-up time is important to face stability and the need for breasting at the face as well as to determine the requirements for filling tail void. Need to fully characterize all potential mixed-face conditions.   |
| Pressurized-Face Tunnel Boring Machine (Ch 7)     | Need reliable estimate of groundwater pressures and of strength and permeability of soil to be tunneled. Essential to predict size, distribution and amount of boulders. Mixed-face conditions must be fully characterized.   |
| Compressed Air (Ch 7)                             | Borings must not be drilled right on the alignment and must be well grouted so that compressed air will not be lost up old bore hole in case tunnel encounters old boring   |
| Solution-Mining (Ch 8)                            | Need chemistry to estimate rate of leaching and undisturbed core in order to conduct long-term creep tests for cavern stability analyses.   |
| Sequential Excavation Method/NATM (Ch 9)          | Generally requires more comprehensive geotechnical data and analysis to predict behavior and to classify the ground conditions and ground support systems into four or five categories based on the behavior.   |
| Immersed Tube (Ch 11)                             | Need soil data to reliably design dredged slopes and to predict rebound of the dredged trench and settlement of the completed immersed tube structure. Testing should emphasize rebound modulus (elastic and consolidation) and unloading strength parameters. Usual softness of soil challenges determination of strength of soil for slope and bearing evaluations. Also need exploration to assure that all potential obstructions and/or rock ledges are identified, characterized, and located. Any contaminated ground should be fully characterized. |
| Jacked Box Tunneling (Ch 12)                      | Need data to predict soil skin friction and to determine the method of excavation and support needed at the heading   |
| Portal Construction                               | Need reliable data to determine most cost-effective location of portal and to design temporary and final portal structure. Portals are usually in weathered rock/soil and sometimes in strain-relief zone.  |
| Construction Shafts                               | Should be at least one boring at every proposed shaft location.   |
| Access, Ventilation, or Other Permanent Shafts    | Need data to design the permanent support and groundwater control measures. Each shaft deserves at least one boring.  |



**Table 3-3 Geotechnical Investigation Needs Dictated by (Modified After Bickel et al, 1996)**

|  |   |
|--|---|
| Hard or Abrasive Rock                        | <ul style="list-style-type: none"> <li>• Difficult and expensive for TBM or roadheader. Investigate, obtain samples, and conduct lab tests to provide parameters needed to predict rate of advance and cutter costs.</li> </ul>   |
| Mixed Face                                   | <ul style="list-style-type: none"> <li>• Especially difficult for wheel type TBM</li> <li>• Particularly difficult tunneling condition in soil and in rock. Should be characterized carefully to determine nature and behavior of mixed-face and approximately length of tunnel likely to be affected for each mixed-face condition.</li> </ul>   |
| Karst  | <ul style="list-style-type: none"> <li>• Potentially large cavities along joints, especially at intersection of master joint systems; small but sometimes very large and very long caves capable of undesirably large inflows of groundwater.</li> </ul>  |
| Gypsum                                       | <ul style="list-style-type: none"> <li>• Potential for soluble gypsum to be missing or to be removed because of change of groundwater conditions during and after construction.</li> </ul>  |
| Salt or Potash                               | <ul style="list-style-type: none"> <li>• Creep characteristics and, in some cases, thermal-mechanical characteristics are very important</li> </ul>   |
| Saprolite                                    | <ul style="list-style-type: none"> <li>• Investigate for relict structure that might affect behavior</li> <li>• Depth and degree of weathering; important to characterize especially if tunneling near rock-soil boundary</li> <li>• Different rock types exhibit vastly differing weathering profiles</li> </ul>   |
| High In-Situ Stress                          | <ul style="list-style-type: none"> <li>• Could strongly affect stand-up time and deformation patterns both in soil and rock tunnels. Should evaluate for rock bursts or popping rock in particularly deep tunnels</li> </ul>  |
| Low In-Situ Stress                           | <ul style="list-style-type: none"> <li>• Investigate for open joints that dramatically reduce rock mass strength and modulus and increase permeability. Often potential problem for portals in downcut valleys and particularly in topographic “noses” where considerable relief of strain could occur.</li> <li>• Conduct hydraulic jacking and hydrofracture tests.</li> </ul>  |
| Hard Fissured or Slickensided Soil           | <ul style="list-style-type: none"> <li>• Lab tests often overestimate mass physical strength of soil. Large-scale testing and/or exploratory shafts/adits may be appropriate</li> </ul>   |
| Gassy Ground-always test for hazardous gases | <ul style="list-style-type: none"> <li>• Methane (common)</li> <li>• H<sub>2</sub>S</li> </ul>  |
| Adverse Geological Features                  | <ul style="list-style-type: none"> <li>• Faults <ul style="list-style-type: none"> <li>▪ Known or suspected active faults. Investigate to determine location and estimate likely ground motion</li> <li>▪ Inactive faults but still sources of difficult tunneling condition <ul style="list-style-type: none"> <li>○ Faults sometimes act as dams and other times as drainage paths to groundwater <ul style="list-style-type: none"> <li>- Fault gouge sometimes a problem for strength and modulus</li> </ul> </li> </ul> </li> <li>▪ High temperature groundwater</li> </ul> </li> <li>• Always collect samples for chemistry tests</li> <li>• Sedimentary Formations <ul style="list-style-type: none"> <li>▪ Frequently highly jointed</li> <li>▪ Concretions could be problem for TBM</li> </ul> </li> </ul> |
| Continued on next page                       |   |

**Table 3-3 (Continued) Geotechnical Investigation Needs Dictated by Geology  
(Modified after Bickel et al, 1996)**

|  |  |
|--|--|
| <p>Adverse Geological Features (Continued)</p> | <ul style="list-style-type: none"> <li>▪ Groundwater             <ul style="list-style-type: none"> <li>○ Groundwater is one of the most difficult and costly problems to control. Must investigate to predict groundwater as reliably as possible</li> <li>○ Site characterization should investigate for signs of and nature of:                 <ul style="list-style-type: none"> <li>- Groundwater pressure</li> <li>- Groundwater flow</li> <li>- Artesian pressure</li> <li>- Multiple aquifers</li> <li>- Higher pressure in deeper aquifer</li> <li>- Groundwater perched on top of impermeable layer in mixed face condition</li> <li>- Ananalous or abrupt</li> </ul> </li> <li>○ Aggressive groundwater                 <ul style="list-style-type: none"> <li>- Soluble sulfates that attack concrete and shotcrete</li> <li>- Pyrites</li> <li>- Acidic</li> </ul> </li> </ul> </li> <li>• Lava or Volcanic Formation             <ul style="list-style-type: none"> <li>▪ Flow tops and flow bottoms frequently are very permeable and difficult tunneling ground</li> <li>▪ Lava Tubes</li> <li>▪ Vertical borings do not disclose the nature of columnar jointing. Need inclined borings</li> <li>▪ Potential for significant groundwater flows from columnar jointing</li> </ul> </li> <li>• Boulders (sometimes nests of boulders) frequently rest at base of strata             <ul style="list-style-type: none"> <li>▪ Cobbles and boulders not always encountered in borings which could be misleading.</li> <li>▪ Should predict size, number, and distribution of boulders on basis of outcrops and geology</li> </ul> </li> <li>• Beach and Fine Sugar Sands             <ul style="list-style-type: none"> <li>▪ Very little cohesion. Need to evaluate stand-up time.</li> </ul> </li> <li>• Glacial deposits             <ul style="list-style-type: none"> <li>▪ Boulders frequently associated with glacial deposits. Must actively investigate for size, number, and distribution of boulders.</li> <li>▪ Some glacial deposits are so hard and brittle that they are jointed and ground behavior is affected by the joining as well as properties of the matrix of the deposit</li> </ul> </li> <li>• Permafrost and frozen soils             <ul style="list-style-type: none"> <li>▪ Special soil sampling techniques required</li> <li>▪ Thermal-mechanical properties required</li> </ul> </li> </ul> |
| <p>Manmade Features</p>                        | <ul style="list-style-type: none"> <li>• Contaminated groundwater/soil             <ul style="list-style-type: none"> <li>▪ Check for movement of contaminated plume caused by changes in groundwater regime as a result of construction</li> </ul> </li> <li>• Existing Obstructions             <ul style="list-style-type: none"> <li>▪ Piles</li> <li>▪ Previously constructed tunnels</li> <li>▪ Tiebacks extending out into sheet</li> </ul> </li> <li>• Existing Utilities</li> <li>• Age and condition of overlying or adjacent utilities within zone of influence</li> </ul>  |

A general approach to control the cost of subsurface investigations while obtaining the information necessary for design and construction would include a) phasing the investigation, as discussed in Section 3.1.1, to better match and limit the scope of the investigation to the specific needs for each phase of the project, and b) utilizing existing information and the results of geologic mapping and geophysical testing to more effectively select locations for investigation. Emphasis can be placed first on defining the local geology, and then on increasingly greater detailed characterization of the subsurface conditions and predicted ground behavior. Also, subsurface investigation programs need to be flexible and should include an appropriate level of contingency funds to further assess unexpected conditions and issues that may be exposed during the planned program. Failure to resolve these issues early may lead to costly redesign or delays, claims and disputes during construction.

Unless site constraints dictate a particular alignment, such as within a confined urban setting, few projects are constructed precisely along the alignment established at the time the initial boring program is laid out. This should be taken into account when developing and budgeting for geotechnical investigations, and further illustrates the need for a phased subsurface investigation program.

### **3.5.2 Test Borings and Sampling**

#### **3.5.2.1 Vertical and Inclined Test Borings**

Vertical and slightly inclined test borings (Figure 3-5) and soil/rock sampling are key elements of any subsurface investigations for underground projects. The location, depth, sample types and sampling intervals for each test boring must be selected to match specific project requirements, topographic setting and anticipated geological conditions. Various field testing techniques can be performed in conjunction with the test borings as well. Refer to FHWA Reference Manual for Subsurface Investigations (FHWA, 2002b) and GEC 5 (FHWA, 2002a) for guidance regarding the planning and conduct of subsurface exploration programs.



Figure 3-5 Vertical Test Boring/Rock Coring on a Steep Slope

Table 3-4 presents general guidelines from AASHTO (1988) for determining the spacing of boreholes for tunnel projects:

**Table 3-4 Guidelines for Vertical/Inclined Borehole Spacing (after AASHTO, 1988)**

| <b>Ground Conditions</b>     | <b>Typical Borehole Spacing (feet)</b> |
|------------------------------|--|
| Cut-and-Cover Tunnels (Ch 5) | 100 to 300                             |
| Rock Tunneling (Ch 6)        |  |
| Adverse Conditions           | 50 to 200                              |
| Favorable Conditions         | 500 to 1000                            |
| Soft Ground Tunneling (Ch 7) |  |
| Adverse Conditions           | 50 to 100                              |
| Favorable Conditions         | 300 to 500                             |
| Mixed Face Tunneling (Ch 8)  |  |
| Adverse Conditions           | 25 to 50                               |
| Favorable Conditions         | 50 to 75                               |

The above guideline can be used as a starting point for determining the number and locations of borings. However, especially for a long tunnel through a mountainous area, under a deep water body, or within a populated urban area, it may not be economically feasible or the time sufficient to perform borings accordingly. Therefore, engineering judgment will need to be applied by a licensed and experienced geotechnical professional to adapt the investigation program.

In general, borings should be extended to at least **1.5 tunnel diameters** below the proposed tunnel invert. However, if there is uncertainty regarding the final profile of the tunnel, the borings should extend at least two or three times the tunnel diameter below the preliminary tunnel invert level. Borings at shafts should extend at least **1.5 times the depth of the shaft** for design of the shoring system and shaft foundation, especially in soft soils.

### **3.5.2.2 Horizontal and Directional Boring/Coring**

Horizontal boreholes along tunnel alignments provide a continuous record of ground conditions and information which is directly relevant to the tunnel alignment. Although the horizontal drilling and coring cost per linear feet may be much higher than the conventional vertical/inclined borings, a horizontal borings can be more economical, especially for investigating a deep mountainous alignment, since one horizontal boring can replace many deep vertical conventional boreholes and avoid unnecessary drilling of overburden materials and disruption to the ground surface activities, local community and industries.

A deep horizontal boring will need some distance of inclined drilling through the overburden and upper materials to reach to the depth of the tunnel alignment. Typically the inclined section is stabilized using drilling fluid and casing and no samples are obtained. Once the bore hole reached a horizontal alignment, coring can be obtained using HQ triple tube core barrels.



Figure 3-6 Horizontal Borehole Drilling in Upstate New York

### 3.5.2.3 Sampling - Overburden Soil

Standard split spoon (disturbed) soil samples (ASTM D-1586) are typically obtained at intervals not greater than 5 feet and at changes in strata. Continuous sampling from one diameter above the tunnel crown to one diameter below the tunnel invert is advised to better define the stratification and materials within this zone if within soil or intermediate geomaterial. In addition, undisturbed tube samples should be obtained in each cohesive soil stratum encountered in the borings; where a thick stratum of cohesive soil is present, undisturbed samples should be obtained at intervals not exceeding 15 ft. Large diameter borings or rotasonic type borings (Figure 3-7) can be considered to obtain special samples for classification and testing.



Figure 3-7 Rotosonic Sampling for a CSO Tunnel Project at Portland, Oregon.

#### 3.5.2.4 Sampling – Rock Core

In rock, continuous rock core should be obtained below the surface of rock, with a minimum NX-size core (diameter of 2.16 inch or 54.7 mm). Double and triple tube core barrels should be used to obtain higher quality core more representative of the in situ rock. For deeper holes, coring should be performed with the use of wire-line drilling equipment to further reduce potential degradation of the recovered core samples. Core runs should be limited to a maximum length of 10 ft in moderate to good quality rock, and 5 ft in poor quality rock.

The rock should be logged soon after it was extracted from the core barrel. Definitions and terminologies used in logging rock cores are presented in Appendix B. Primarily, the following information is recommended to be noted for each core run on the rock coring logs:

- Depth of core run
- Core recovery in inches and percent
- Rock Quality Designation (RQD) percent
- Rock type, including color texture, degree of weathering and hardness
- Character of discontinuities, joint spacing, orientation, roughness and alteration
- Nature of joint infilling materials

In addition, drilling parameters, such as type of drilling equipment, core barrel and casing size, drilling rate, and groundwater level logged in the field can be useful in the future. Typical rock coring logs for tunnel design purpose are included in Appendix B.

### **3.5.2.5 Borehole Sealing**

All borings should be properly sealed at the completion of the field exploration, if not intended to be used as monitoring wells. This is typically required for safety considerations and to prevent cross contamination of soil strata and groundwater. However, boring sealing is particularly important for tunnel projects since an open borehole exposed during tunneling may lead to uncontrolled inflow of water or escape of slurry from a slurry shield TBM or air from a compressed air tunnel.

In many parts of the country, methods used for sealing of boreholes are regulated by state agencies. FHWA-NHI-035 “Workbook for Subsurface Investigation Inspection Qualification” (FHWA, 2006a) offers general guidelines for borehole sealing. National Cooperative Highway Research Program Report No. 378 (Lutenegger et al., 1995), titled “Recommended Guidelines for Sealing Geotechnical Holes,” contains extensive information on sealing and grouting boreholes.

Backfilling of boreholes is generally accomplished using a grout mixture by pumping the grout mix through drill rods or other pipes inserted into the borehole. In boreholes where groundwater or drilling fluid is present, grout should be tremied from the bottom of the borehole. Provision should be made to collect and dispose of all drill fluid and waste grout. Holes in pavement and slabs should be patched with concrete or asphaltic concrete, as appropriate.

### **3.5.2.6 Test Pits**

Test pits are often used to investigate the shallow presence, location and depth of existing utilities, structure foundations, top of bedrock and other underground features that may interfere or be impacted by the construction of shafts, portals and cut-and-cover tunnels. The depth and size of test pits will be dictated by the depth and extent of the feature being exposed. Except for very shallow excavations, test pits will typically require sheeting and shoring to provide positive ground support and ensure the safety of individuals entering the excavation in compliance with OSHA and other regulatory requirements.

The conditions exposed in test pits, including the existing soil and rock materials, groundwater observations, and utility and structure elements are documented by written records and photographs, and representative materials are sampled for future visual examination and laboratory testing. The excavation pits are then generally backfilled with excavation spoil, and the backfill is compacted to avoid excessive future settlement. Tampers and rollers may be used to facilitate compaction of the backfill. The ground surface or pavement is then typically restored using materials and thickness dimension matching the adjoining areas.

## **3.5.3 Soil and Rock Identification and Classification**

### **3.5.3.1 Soil Identification and Classification**

It is important to distinguish between visual identification and classification to minimize conflicts between general visual identification of soil samples in the field versus a more precise laboratory evaluation supported by index tests. Visual descriptions in the field are often subjected to outdoor elements, which may influence results. It is important to send the soil samples to a laboratory for accurate visual identification by a geologist or technician experienced in soils work, as this single operation will provide the basis for later testing and soil profile development.

During progression of a boring, the field personnel should describe the sample encountered in accordance with the ASTM D 2488, Practice for Description and Identification of Soils (Visual-Manual Procedure),

which is the modified Unified Soil Classification System (USCS). For detailed field identification procedures for soil samples readers are referred to FHWA-NHI-035 “Workbook for Subsurface Investigation Inspection Qualification”.

For the most part, field classification of soil for a tunnel project is similar to that for other geotechnical applications except that special attention must be given to accurately defining and documenting soil grain size characteristics and stratification features since these properties may have greater influence on the ground and groundwater behavior during tunneling than they may have on other types of construction, such as for foundations, embankments and cuts. Items of particular importance to tunnel projects are listed below:

- Groundwater levels (general and perched levels), evidence of ground permeability (loss of drilling fluid; rise or drop in borehole water level; etc.), and evidence of artesian conditions
- Consistency and strength of cohesive soils
- Composition, gradation and density of cohesionless soils
- Presence of lenses and layers of higher permeability soils
- Presence of gravel, cobbles and boulders, and potential for nested boulders
- Maximum cobble/boulder size from coring and/or large diameter borings (and also based on understanding of local geology), and the unconfined compressive strength of cobbles/boulders (from field index tests and laboratory testing of recovered samples)
- Presence of cemented soils
- Presence of contaminated soil or groundwater

All of the above issues will greatly influence ground behavior and groundwater inflow during construction, and the selection of the tunneling equipment and methods.

### **3.5.3.2 Rock Identification and Classification**

In rock, rock mass characteristics and discontinuities typically have a much greater influence on ground behavior during tunneling and on tunnel loading than the intact rock properties. Therefore, rock classification needs to be focused on rock mass characteristics, as well as its origin and intact properties for typical highway foundation application. Special intact properties are important for tunneling application particularly for selecting rock cutters for tunnel boring machines and other types of rock excavators, and to predict cutter wear.

Typical items included in describing general rock lithology include:

- General rock type
- Color
- Grain size and shape
- Texture (stratification, foliation, etc.)
- Mineral composition
- Hardness
- Abrasivity
- Strength
- Weathering and alteration



Rock discontinuity descriptions typically noted in rock classification include:

- Predominant joint sets (with strike and dip orientations)
- Joint roughness
- Joint persistence
- Joint spacing
- Joint weathering and infilling

Other information typically noted during subsurface rock investigations include:

- Presence of faults or shear zones
- Presence of intrusive material (volcanic dikes and sills)
- Presence of voids (solution cavities, lava tubes, etc.)
- Groundwater levels, and evidence of rock mass permeability (loss of drilling fluid; rise or drop in borehole water level; etc.)

Method of describing discontinuities of rock masses is in accordance with International Society of Rock Mechanics (ISRM)'s "Suggested Method of Quantitative Description of Discontinuities of Rock Masses" (ISRM 1981) as shown in Appendix B. Chapter 6 presents the J values assigned to each condition of rock discontinuities for Q System (Barton 2001).

Index properties obtained from inspection of the recovered rock core include core recovery (i.e., the recovered core length expressed as a percentage of the total core run length), and Rock Quality Designation or RQD (the combined length of all sound and intact core segments equal to or greater than 4 inches in length, expressed as a percentage of the total core run length).

For detailed discussions of rock identification and classification readers are referred to Mayne et al. (2001) and the AASHTO "Manual on Subsurface Investigations" (1988). Another useful reference for rock classification is "Suggested Methods for the Quantitative Description of Discontinuities in Rock Masses" from the International Society of Rock Mechanics (1977). For detailed field identification procedures readers are referred to FHWA-NHI-035 "Workbook for Subsurface Investigation Inspection Qualification" and "Rock and Mineral Identification for Engineer Guide."

Often, materials encountered during subsurface investigations represent a transitional (intermediate) material formed by the in place weathering of rock. Such conditions may sometimes present a complex condition with no clear boundaries between the different materials encountered. Tunneling through the intermediate geomaterial (IGM), in some cases referred as mixed-face condition, can be extremely difficult especially when groundwater is present. In the areas where tunnel alignment must cross this transition zone, the subsurface investigation is conducted much as for rock, and when possible cores are retrieved and classified, and representative intact pieces of rock should be tested. More discussions are included in Chapter 8.

### **3.5.4 Field Testing Techniques (Pre-Construction)**

Field testing for subsurface investigations includes two general categories of tests:

- a) In situ tests
- b) Geophysical testing

In situ tests are used to directly obtain field measurements of useful soil and rock engineering properties. Geophysical tests, the second general category of field tests, are indirect methods of exploration in which changes in certain physical characteristics such as magnetism, density, electrical resistivity, elasticity, or a combination of these are used as an aid in developing subsurface information. There are times that two testing methods can be performed from a same apparatus, such as using seismic CPT

#### **3.5.4.1 In situ Testing**

In situ tests are used to directly obtain field measurements of useful soil and rock engineering properties. In soil, in situ testing include both index type tests, such as the Standard Penetration Test (SPT) and tests that determine the physical properties of the ground, such as shear strength from cone penetration Tests (CPT) and ground deformation properties from pressure meter tests (PMT). In situ test methods in soil commonly used in the U.S. and their applications and limitations are summarized in Table 3-5.

Common in situ tests used in rock for tunnel applications are listed in Table 3-6. One significant property of interest in rock is its in situ stress condition. Horizontal stresses of geological origin are often locked within the rock masses, resulted in a stress ratio ( $K$ ) often higher than the number predicted by elastic theory. Depending on the size and orientation of the tunneling, high horizontal stresses may produce favorable compression in support and confinement, or induce popping or failure during and after excavation. Principally, two different general methods are common to be employed to measure the in situ stress condition: hydraulic fracturing and overcoring. Note that in situ stress can only be measured accurately within a fair or better rock condition. However, since weak rocks are unable to support large deviatoric stress differences, the lateral and vertical stresses tend to equalize over geologic time.

#### **3.5.4.2 Geophysical Testing**

Geophysical tests are indirect methods of exploration in which changes in certain physical characteristics such as magnetism, density, electrical resistivity, elasticity, or a combination of these are used as an aid in developing subsurface information. Geophysical methods provide an expeditious and economical means of supplementing information obtained by direct exploratory methods, such as borings, test pits and in situ testing; identifying local anomalies that might not be identified by other methods of exploration; and defining strata boundaries between widely spaced borings for more realistic prediction of subsurface profiles. Typical uses of geophysical tests include determination of the top of bedrock, the ripability of rock, the depth to groundwater, the limits of organic deposits, the presence of voids, the location and depth of utilities, the location and depth of existing foundations, and the location and depth of other obstruction, to note just a few. In addition, geophysical testing can also obtain stiffness and dynamic properties which are required for numerical analysis.

Geophysical testing can be performed on the surface, in boreholes (down or cross hole), or in front of the TBM during construction. Typical applications for geophysical tests are presented in Table 3-7.

Table 3-8 briefly summarizes the procedures used to perform these geophysical tests, and notes their limitations.

**Table 3-5 In-situ Testing Methods Used in Soil (After FHWA, 2002a)**

| Method                           | Procedure  | Applicable Soil Types   | Applicable Soil Properties   | Limitations / Remarks  |
|----------------------------------|--|---|--|--|
| Electric Cone Penetrometer (CPT) | A cylindrical probe is hydraulically pushed vertically through the soil measuring the resistance at the conical tip of the probe and along the steel shaft; measurements typically recorded at 2 to 5 cm intervals                                       | Silts, sands, clays, and peat                                       | Estimation of soil type and detailed stratigraphy<br>Sand: $\phi'$ , $D_r$ , $\sigma_{ho}'$<br>Clay: $s_u$ , $\sigma_p'$   | No soil sample is obtained; The probe may become damaged if testing in gravelly soils is attempted; Test results not particularly good for estimating deformation characteristics  |
| Piezocoone Penetrometer (CPTu)   | Same as CPT; additionally, penetration porewater pressures are measured using a transducer and porous filter element   | Silts, sands, clays, and peat                                       | Same as CPT, with additionally:<br>Sand: $u_o$ / water table elevation<br>Clay: $\sigma_p'$ , $c_h$ , $k_h$<br>OCR   | If the filter element and ports are not completely saturated, the pore pressure response may be misleading; Compression and wear of a mid-face ( $u_1$ ) element will effect readings; Test results not particularly good for estimating deformation characteristics |
| Seismic CPTu (SCPTu)             | Same as CPTu; additionally, shear waves generated at the surface are recorded by a geophone at 1-m intervals throughout the profile for calculation of shear wave velocity   | Silts, sands, clays, and peat                                       | Same as CPTu, with additionally:<br>$V_s$ , $G_{max}$ , $E_{max}$ ,<br>$\rho_{tot}$ , $e_o$  | First arrival times should be used for calculation of shear wave velocity (if first crossover times are used, the error in shear wave velocity will increase with depth)   |
| Flat Plate Dilatometer (DMT)     | A flat plate is hydraulically pushed or driven through the soil to a desired depth; at approximately 20 to 30 cm intervals, the pressure required to expand a thin membrane is recorded; Two to three measurements are typically recorded at each depth. | Silts, sands, clays, and peat                                       | Estimation of soil type and stratigraphy<br>Total unit weight<br>Sand: $\phi'$ , $E$ , $D_r$ , $m_v$<br>Clays: $\sigma_p'$ , $K_o$ , $s_u$ , $m_v$ , $E$ , $c_h$ , $k_h$ | Membranes may become deformed if over-inflated; Deformed membranes will not provide accurate readings; Leaks in tubing or connections will lead to high readings; Good test for estimating deformation characteristics at small strains                              |
| Pre-bored Pressure meter (PMT)   | A borehole is drilled and the bottom is carefully prepared for insertion of the equipment; The pressure required to expand the cylindrical membrane to a certain volume or radial strain is recorded.  | Clays, silts, and peat; marginal response in some sands and gravels | $E$ , $G$ , $m_v$ , $s_u$  | Preparation of the borehole most important step to obtain good results; Good test for calculation of lateral deformation characteristics   |
| Continued on next page           |  |   |  |  |

**Table 3-5 (Continued) In situ Testing Methods Used in Soil**

| Method                                 | Procedure   | Applicable Soil Types   | Applicable Soil Properties  | Limitations / Remarks   |
|--|---|---|-----------------------------|---|
| Full Displacement Pressure meter (PMT) | A cylindrical probe with a pressure meter attached behind a conical tip is hydraulically pushed through the soil and paused at select intervals for testing; The pressure required to expand the cylindrical membrane to a certain volume or radial strain is recorded  | Clays, silts, and peat  | E, G, $m_v$ , $s_u$         | Disturbance during advancement of the probe will lead to stiffer initial modulus and mask liftoff pressure ( $p_o$ ); Good test for calculation of lateral deformation characteristics  |
| Vane Shear Test (VST)                  | A 4 blade vane is hydraulically pushed below the bottom of a borehole, then slowly rotated while the torque required to rotate the vane is recorded for calculation of peak undrained shear strength; The vane is rapidly rotated for 10 turns, and the torque required to fail the soil is recorded for calculation of remolded undrained shear strength | Clays, Some silts and peats if undrained conditions can be assumed; not for use in granular soils | $s_u$ , $S_t$ , $\sigma_p'$ | Disturbance may occur in soft sensitive clays, reducing measured shear strength; Partial drainage may occur in fissured clays and silty materials, leading to errors in calculated strength; Rod friction needs to be accounted for in calculation of strength; Vane diameter and torque wrench capacity need to be properly sized for adequate measurements in various clay deposits |

Symbols used in Table 3-5:

|                  |   |                |  |
|------------------|---|----------------|--|
| $\phi'$ :        | Effective stress friction angle         | $G_{max}$ :    | Small-strain shear modulus             |
| $D_r$ :          | Relative density                        | G:             | Shear modulus                          |
| $\sigma_{ho}'$ : | In-situ horizontal effective stress     | $E_{max}$ :    | Small-strain Young's modulus           |
| $s_u$ :          | Undrained shear strength                | E:             | Young's modulus                        |
| $\sigma_p'$ :    | Preconsolidation stress                 | $\rho_{tot}$ : | Total density                          |
| $c_h$ :          | Horizontal coefficient of consolidation | $e_o$ :        | In-situ void ratio                     |
| $k_h$ :          | Horizontal hydraulic conductivity       | $m_v$ :        | Volumetric compressibility coefficient |
| OCR:             | Overconsolidation ratio                 | $K_o$ :        | Coefficient of at-rest earth pressure  |
| $V_s$ :          | Shear wave velocity                     | $S_t$ :        | Sensitivity                            |

**Table 3-6 Common in situ Test Methods for Rock (after USACE, 1997)**

| <b>Parameter</b>       | <b>Test Method</b>        | <b>Procedure / Limitations / Remarks</b>   |
|------------------------|---------------------------|--|
| In situ Stress         | Hydraulic Fracturing      | Typically conducted in vertical boreholes. A short segment of the hole is sealed off using a straddle packer. This is followed by the pressurization by pumping in water. The pressure is raised until the rock surrounding the hole fails in tension at a critical pressure. Following breakdown, the shut-in pressure, the lowest test-interval pressure at which the hydrofrac closes completely under the action of the stress acting normal to the hydrofractures. In a vertical test hole the hydrofractures are expected to be formed in vertical and perpendicular to the minimum horizontal stress. |
|                        | Overcoring                | Drills a small diameter borehole and sets into it an instrument to respond to changes in diameter. Rock stresses are determined indirectly from measurements of the dimensional changes of a borehole, occurring when the rock volume surrounding the hole is isolated from the stresses in the host rock  |
|                        | Flat Jack Test            | This method involves the use of flat hydraulic jacks, consisting of two plates of steel welded around their edges and a nipple for introducing oil into the intervening space. Flat jack is inserted into the slot, cemented in place, and pressurized. When the pins have been returned to the initial separation, the pressure in jack approximates the initial stress normal to the jack.   |
| Modulus of Deformation | Plate Bearing Test        | A relatively flat rock surface is sculptured and level with mortar to receive circular bearing plates 20 to 40 inches in diameter. Loading a rock surface and monitoring the resulting displacement. This is easily arranged in the underground gallery. The site may be selected carefully to exclude loose, highly fractured rock.   |
|                        | Borehole Dilatometer Test | A borehole expansion experiment conducted with a rubber sleeve. The expansion of borehole is measured by the oil or gas flow into the sleeve as the pressure raised, or by potentiometers or linear variable differential transformers built inside the sleeve. One problem with borehole deformability test is that it affects a relatively small volume of rock and therefore contains an incomplete sample of the fracture system.  |
|                        | Flat Jack Test            | This method involves the use of flat hydraulic jacks, consisting of two plates of steel welded around their edges and a nipple for introducing oil into the intervening space. Provide measurement points on the face of the rock and deep slot (reference points). Modulus of deformation could be calculated from the measured pin displacements.  |
|                        | Radial jacking test       | Loads are applied to the circumference of a tunnel by a series of jacks reacting against circular steel ring members. This test allows the direction of load to be varied according to the plan for pressuring the jacks.  |
|                        | Pressuremeter             | The pressure required to expand the cylindrical membrane to a certain volume or radial strain is recorded in a borehole. It is applicable for soft rocks.  |

| Parameter                    | Test Method                | Procedure / Limitations / Remarks   |
|------------------------------|----------------------------|---|
|                              | Dynamic Measurement        | The velocity of stress waves is measured in the field. The wave velocity can be measured by swinging a sledgehammer against an outcrop and observing the travel time to a geophone standing on the rock at a distance of up to about 150 ft. The stress loadings sent through the rock by this method are small and transient. Most rock mass departs significantly from the ideal materials, consequently, elastic properties calculated from these equations are often considerably larger than elastic properties calculated from static loading tests, particularly in the case of fractured rocks.   |
| Imaging and Discontinuities  | Acoustic Televiewing       | Acoustic Televiewers (ATV) produce images of the borehole wall based on the amplitude and travel time of acoustic signals reflected from the borehole wall. A portion of the reflected energy is lost in voids or fractures, producing dark bands on the amplitude log. Travel time measurements allow reconstruction of the borehole shape, making it possible to generate a 3-D representation of a borehole.   |
|                              | Borehole Video Televiewing | The Borehole Video System (BVS) is lowered down boreholes to inspect the geology and structural integrity. The camera view of fractures and voids in boreholes provides information.  |
| Permeability (Section 3.5.6) | Slug Test                  | Slug tests are applicable to a wide range of geologic settings as well as small-diameter piezometers or observation wells, and in areas of low permeability where it would be difficult to conduct a pumping test. A slug test is performed by injecting or withdrawing a known volume of water or air from a well and measuring the aquifer's response by the rate at which the water level returns to equilibrium. Permeability values derived relate primarily to the horizontal conductivity. Slug tests have a much smaller zone of infiltration than pumping tests, and thus are only reliable at a much smaller scale.   |
|                              | Packer Test                | It is conducted by pumping water at a constant pressure into a test section of a borehole and measuring the flow rate. Borehole test sections are sealed off by packers, with the use of one or two packers being the most widely used techniques. The test is rapid and simple to conduct, and by performing tests within intervals along the entire length of a borehole, a permeability profile can be obtained. The limitation of the test is to affect a relatively small volume of the surrounding medium, because frictional losses in the immediate vicinity of the test section are normally extremely large.  |
|                              | Pumping Tests              | In a pumping test, water is pumped from a well normally at a constant rate over a certain time period, and the drawdown of the water table or piezometric head is measured in the well and in piezometers or observation wells in the vicinity. Since pumping tests involve large volumes of the rock mass, they have the advantage of averaging the effects of the inherent discontinuities. Most classical solutions for pump test data are based on the assumptions that the aquifers are homogeneous and isotropic, and that the flow is governed by Darcy's law. The major disadvantage is the period of time required to perform a test. Test durations of one week or longer are not unusual when attempting to approach steady-state flow conditions. Additionally, large diameter boreholes or wells are required since the majority of the conditions encountered require the use of a downhole pump. |

**Table 3-7 Applications for Geophysical Testing Methods (after AASHTO, 1988)**

| <b>Geological Conditions to be Investigated</b>                | <b>Useful Geophysical Techniques</b>                                     |                          |
|--|--|--------------------------|
|  | <b>SURFACE</b>   | <b>SUBSURFACE</b>        |
| Stratified rock and soil units (depth and thickness of layers) | Seismic Refraction   | Seismic Wave Propagation |
| Depth to Bedrock   | Seismic Refraction<br>Electrical Resistivity<br>Ground Penetrating Radar | Seismic Wave Propagation |
| Depth to Groundwater Table                                     | Seismic Refraction<br>Electrical Resistivity<br>Ground Penetrating Radar |                          |
| Location of Highly Fractured Rock and/or Fault Zone            | Electrical Resistivity   | Borehole TV Camera       |
| Bedrock Topography (troughs, pinnacles, fault scarp)           | Seismic Refraction<br>Gravity  |                          |
| Location of Planar Igneous Intrusions                          | Gravity, Magnetics<br>Seismic Refraction                                 |                          |
| Solution Cavities  | Electrical Resistivity<br>Ground Penetrating Radar<br>Gravity            | Borehole TV Camera       |
| Isolated Pods of Sand, Gravel, or Organic Material             | Electrical Resistivity   | Seismic Wave Propagation |
| Permeable Rock and Soil Units                                  | Electrical Resistivity   | Seismic Wave Propagation |
| Topography of Lake, Bay or River Bottoms                       | Seismic Reflection (acoustic sounding)                                   |                          |
| Stratigraphy of Lake, Bay or River Bottom Sediments            | Seismic Reflection (acoustic sounding)                                   |                          |
| Lateral Changes in Lithology of Rock and Soil Units            | Seismic Refraction<br>Electrical Resistivity                             |                          |

**Table 3-8 Geophysical Testing Methods**

| <b>Method</b>                        | <b>Procedure</b>   | <b>Limitations / Remarks</b>  |
|--------------------------------------|--|---|
| Seismic Refraction                   | Detectors (geophones) are positioned on the ground surface at increasing distance from a seismic impulse source, also at the ground surface. The time required for the seismic impulse to reach each geophone is recorded.   | Distance between closest and furthest geophone must be 3 to 4 times the depth to be investigated. Reflection from hard layer may prevent identification of deeper layers. Other conditions affecting interpretation: insufficient density contrast between layers; presence of low-density layer; irregular surface topography. |
| Seismic Reflection                   | Performed for offshore applications from a boat using an energy source and receiver at the water surface. The travel time for the seismic wave to reach the receiver is recorded and analyzed.   | The position and direction of the boat must be accurately determined by GPS or other suitable method. Reflection from hard layer may prevent identification of deeper layers.   |
| Electrical Resistivity /Conductivity | Wenner Four Electrode Method is type most commonly used test in the U.S. Four electrodes are placed partially in the soil, in line and equidistant from each other. A low magnitude current is passed between the outer electrodes, and the resulting potential drop is measured at the inner electrodes. A number of traverses are used, and electrode spacing is varied to better define changes in deposits and layering. | Results may be influenced by presence of underground obstructions, such as pipelines, tanks, etc.   |
| <b>Seismic Wave Propagation:</b>     |  |   |
| Cross-Hole                           | At least 2 boreholes are required: a source borehole within which a seismic pulse is generated, and a receiver borehole in which a geophone records generated compression and shear waves. For increased accuracy additional receiver boreholes are used.  | Receivers must be properly oriented and securely in contact with the side of the borehole. Boreholes deeper than about 30 ft should be surveyed using an inclinometer or other device to determine the travel distance between holes.   |
| Up-Hole or Down-Hole                 | Performed in a single borehole. In up-hole method, a sensor is placed at the ground surface and shear waves are generated at various depths in the borehole. In down-hole method, seismic wave is generated at the surface and one or more sensors are placed at different depths within the hole.   | Data limited to area in immediate vicinity of the borehole.   |
| Parallel Seismic                     | Used to determine the depth of existing foundations, an impulse wave is generated at the top of the foundation, and a sensor in an adjacent borehole records arrival of the stress wave at set depth increments.   | Requires access to top of foundation.   |
| Ground Penetrating Radar             | Repetitive electromagnetic impulses are generated at the ground surface and the travel time of the reflected pulses to return to the transmitter are recorded.   | The presence of a clay layer may mask features below that layer.  |
| Continued on Next Page               |  |   |



**Table 3-8 (Continued) Geophysical Testing Methods**

| <b>Method</b> | <b>Procedure</b>  | <b>Limitations / Remarks</b>   |
|---------------|---|--|
| Gravity       | A sensitive gravimeter is used at the ground surface to measure variations in the local gravitational field in the earth caused by changes in material density or cavities.                                     | May not identify small changes in density. May be influenced by nearby surface or subsurface features, such as mountains, solution cavities, buried valleys, etc. not directly in area of interest.  |
| Magnetics     | Magnetic surveys can be performed using either ground-based or airborne magnetometers. With ground equipment, measurements of changes in the earth's magnetic field are taken along an established survey line. | Monitoring locations should not be located near man-made objects that can change the magnitude of the earth's magnetic field (pipelines, buildings, etc.). Corrections need to be made for diurnal variations in the earth's magnetic field. |

It is important to note that the data from geophysical exploration must always be correlated with information from direct methods of exploration that allow visual examination of the subsurface materials, direct measurement of groundwater levels, and testing of physical samples of soil and rock. Direct methods of exploration provide valuable information that can assist not only in the interpretation of the geophysical data, but also for extrapolating the inferred ground conditions to areas not investigated by borings. Conversely, the geophysical data can help determine appropriate locations for borings and test pits to further investigate any anomalies that are found. Readers are also referred to FHWA publication "Application of Geophysical Methods to Highway Related Problems" for more detailed information.

### **3.5.5 Laboratory Testing**

Detailed laboratory testing is required to obtain accurate information for design and modeling purposes.

Soil Testing Detailed soil laboratory testing is required to obtain accurate information including classification, characteristics, stiffness, strength, etc. for design and modeling purposes. Testing are performed on selected representative samples (disturbed and undisturbed) in accordance with ASTM standards. Table 3-9 shows common soil laboratory testing for tunnel design purposes.

Rock Testing Standard rock testing evaluate physical properties of the rock included density and mineralogy (thin-section analysis). The mechanical properties of the intact rock core included uniaxial compressive strength, tensile strength, static and dynamic elastic constants, hardness, and abrasivity indices.

In addition, specialized tests for assessing TBM performance rates are required including three drillability and boreability testing, namely, Drilling Rate Index (DRI), Bit Wear Index (BWI), and Cutter Life Index (CLI). Table 3-9 summarizes common rock laboratory testing for tunnel design purposes.

It is desirable to preserve the rock cores retrieved from the field properly for years until the construction is completed and disputes/claims are settled. Common practice is to photograph the rock cores in core boxes and possibly scan the core samples for review by designers and contractors. Figure 3-8 shows a roc core scanning equipment and result.

**Table 3-9 Common Laboratory Tests for Rock (after USACE 1997)**

| Parameter                  | Test Method   |
|----------------------------|---|
| Index properties           | <ul style="list-style-type: none"> <li>• Density</li> <li>• Porosity</li> <li>• Moisture Content</li> <li>• Slake Durability</li> <li>• Swelling Index</li> <li>• Point Load Index</li> <li>• Hardness</li> <li>• Abrasivity</li> </ul> |
| Strength                   | <ul style="list-style-type: none"> <li>• Uniaxial compressive strength</li> <li>• Triaxial compressive strength</li> <li>• Tensile strength (Brazilian) Shear strength of joints</li> </ul>   |
| Deformability              | <ul style="list-style-type: none"> <li>• Young's modulus Poisson's ratio</li> </ul>   |
| Time dependence            | <ul style="list-style-type: none"> <li>• Creep characteristics</li> </ul>   |
| Permeability               | <ul style="list-style-type: none"> <li>• Coefficient of permeability</li> </ul>   |
| Mineralogy and grain sizes | <ul style="list-style-type: none"> <li>• Thin-sections analysis</li> <li>• Differential thermal analysis</li> <li>• X-ray diffraction</li> </ul>  |

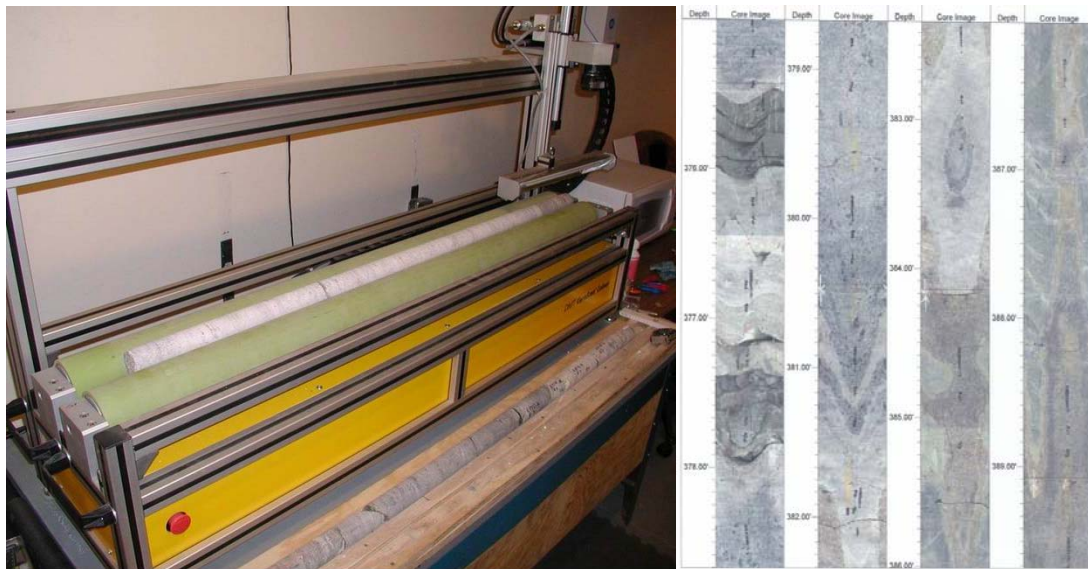

Figure 3-8 Rock Core Scanning Equipment and Result

### 3.5.6 Groundwater Investigation

Groundwater is a major factor for all types of projects, but for tunnels groundwater is a particularly critical issue since it may not only represent a large percentage of the loading on the final tunnel lining, but also it largely determines ground behavior and stability for soft ground tunnels; the inflow into rock tunnels; the method and equipment selected for tunnel construction; and the long-term performance of the completed structure. Accordingly, for tunnel projects, special attention must be given to defining the groundwater regime, aquifers, and sources of water, any perched or artesian conditions, water quality and temperature, depth to groundwater, and the permeability of the various materials that may be encountered during tunneling. Related considerations include the potential impact of groundwater lowering on settlement of overlying and nearby structures, utilities and other facilities; other influences of dewatering on existing structures (e.g., accelerated deterioration of exposed timber piles); pumping volumes during construction; decontamination/treatment measures for water discharged from pumping; migration of existing soil and groundwater contaminants due to dewatering; the potential impact on water supply aquifers; and seepage into the completed tunnel; to note just a few:

Groundwater investigations typically include most or all of the following elements:

- Observation of groundwater levels in boreholes
- Assessment of soil moisture changes in the boreholes
- Groundwater sampling for environmental testing
- Installation of groundwater observation wells and piezometers
- Borehole permeability tests (rising, falling and constant head tests; packer tests, etc.)
- Geophysical testing (see Section 3.5.4)
- Pumping tests

During subsurface investigation drilling and coring, it is particularly important for the inspector to note and document any groundwater related observations made during drilling or during interruptions to the work when the borehole has been left undisturbed. Even seemingly minor observations may have an important influence on tunnel design and ground behavior during construction.

Groundwater observation wells are used to more accurately determine and monitor the static water table. Since observation wells are generally not isolated within an individual zone or stratum they provide only a general indication of the groundwater table, and are therefore more suitable for sites with generally uniform subsurface conditions. In stratified soils with two or more aquifers, water pressures may vary considerably with depth. For such variable conditions, it is generally more appropriate to use piezometers. Piezometers have seals that isolate the screens or sensors within a specific zone or layer within the soil profile, providing a measurement of the water pressure within that zone. Readers are referred to Chapter 15 Geotechnical and Structural Instrumentation for detailed illustrations and descriptions about the wells and piezometers.

Observation wells and piezometers should be monitored periodically over a prolonged period of time to provide information on seasonal variations in groundwater levels. Monitoring during construction provides important information on the influence of tunneling on groundwater levels, forming an essential component of construction control and any protection program for existing structures and facilities. Local and state jurisdictions may impose specific requirements for permanent observation wells and piezometers, for documenting both temporary and permanent installations, and for closure of these installations.

### **3.5.6.1 Borehole Permeability Testing**

Borehole permeability tests provide a low cost means for assessing the permeability of soil and rock. The principal types of tests include falling head, rising head and constant head tests in soil, and packer tests in rock, as described below. Additional information regarding the details and procedures used for performing and interpreting these borehole permeability tests are presented by FHWA (2002b). Borehole tests are particularly beneficial in sands and gravels since samples of such materials would be too disturbed to use for laboratory permeability tests. A major limitation of these tests, however, is that they assess soil conditions only in the immediate vicinity of the borehole, and the results do not reflect the influence of water recharge sources or soil stratification over a larger area.

Borehole permeability tests are performed intermittently as the borehole is advanced. Holes in which permeability tests will be performed should be drilled with water to avoid the formation of a filter cake on the sides of the borehole from drilling slurry. Also, prior to performing the permeability test the hole should be flushed with clear water until all sediments are removed from the hole (but not so much as would be done to establish a water well).

In soil, either rising head or falling head tests would be appropriate if the permeability is low enough to permit accurate determination of water level versus time. In the falling head test, where the flow is from the hole to the surrounding soil, there is risk of clogging of the soil pores by sediments in the test water. In the rising head tests, where water flows from the surrounding soil into the hole, there is a risk of the soil along the test length becoming loosened or quick if the seepage gradient is too large. If a rising head test is used, the hole should be sounded at the end of the test to determine if the hole has collapsed or heaved. Generally, the rising head test is the preferred test method. However, in cases where the permeability is so high as to preclude accurate measurement of the rising or falling water level, the constant head test should be used.

Pressure, or “Packer,” tests are performed in rock by forcing water under pressure into the rock surrounding the borehole. Packer tests determine the apparent permeability of the rock mass, and also provide a qualitative assessment of rock quality. These tests can also be used before and after grouting to assess the effectiveness of grouting on rock permeability and the strength of the rock mass. The test is performed by selecting a length of borehole for testing, then inflating a cylindrical rubber sleeve (“packer”) at the top of the test zone to isolate the section of borehole being tested. Packer testing can thus be performed intermittently as the borehole is advanced. Alternatively, testing can be performed at multiple levels in a completed borehole by using a double packer system in which packers are positioned and inflated at both the top and bottom of the zone being tested, as illustrated in Figure 3-9. Once the packer is inflated to seal off the test section, water is pumped under pressure to the test zone, while the time and volume of water pumped at different pressures are recorded. Guidelines for performing and evaluating packer tests are presented by Mayne et al. (FHWA, 2002b), and by Lowe and Zaccheo (1991).

### **3.5.6.2 Pumping Tests**

Continuous pumping tests are used to determine the water yield of individual wells and the permeability of subsurface materials in situ over an extended area. These data provide useful information for predicting inflows during tunneling; the quantity of water that may need to be pumped to lower groundwater levels; and the radius of influence for pumping operations; among others. The test consists of pumping water from a well or borehole and observing the effect on the water table with distance and time by measuring the water levels in the hole being pumped as well as in an array of observation wells at various distances around the pumping well. The depth of the test well will depend on the depth and thickness of the strata being investigated, and the number, location and depth of the observation wells or

piezometers will depend on the anticipated shape of the groundwater surface after drawdown. Guidelines for performing and evaluating pumping tests are presented by Mayne et al. (FHWA, 2002b).

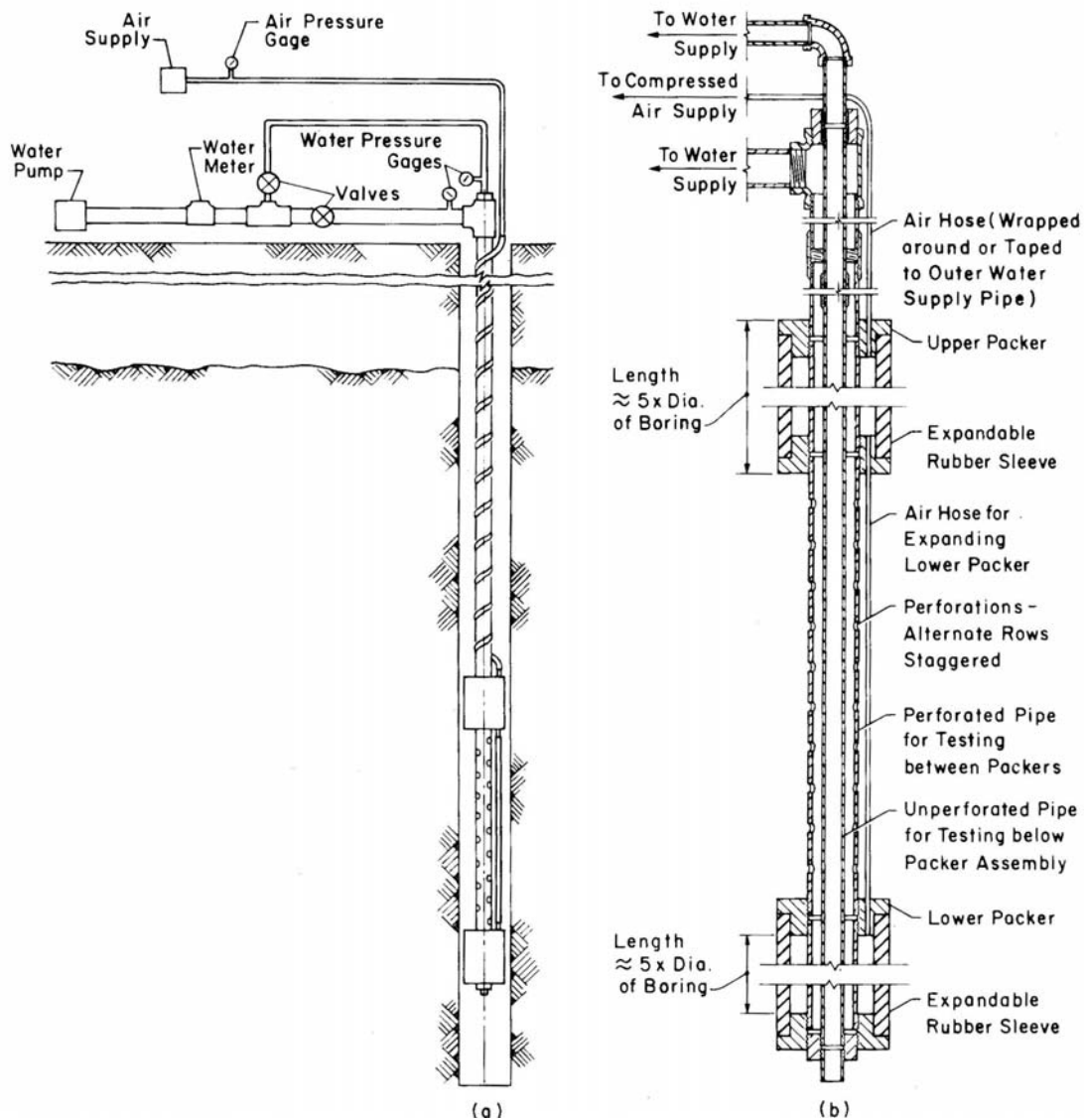

Figure 3-9 Packer Pressure Test Apparatus for Determining the Permeability of Rock (a) Schematic Diagram; (b) Detail of Packer Unit (Lowe and Zaccheo, 1991)

### 3.6 ENVIRONMENTAL ISSUES

Although tunnels are generally considered environmentally-friendly structures, certain short-term environmental impacts during construction are unavoidable. Long-term impacts from the tunnel itself, and from portals, vent shafts and approaches on local communities, historic sites, wetlands, and other aesthetically, environmentally, and ecologically sensitive areas must be identified and investigated thoroughly during the project planning and feasibility stages, and appropriately addressed in environmental studies and design. Early investigation and resolution of environmental issues is an

essential objective for any underground project since unanticipated conditions discovered later during design or construction could potentially jeopardize the project.

The specific environmental data needed for a particular underground project very much depend on the geologic and geographic environment and the functional requirement of the underground facility. Some common issues can be stated, however, and are identified below in the form of a checklist:

- Existing infrastructure, and obstacles underground and above
- Surface structures within area of influence
- Land ownership and uses (public and private)
- Ecosystem habitat impacts
- Contaminated ground or groundwater
- Long-term impacts to groundwater levels, aquifers and water quality
- Control of runoff and erosion during construction
- Naturally gassy ground, or groundwater with deleterious chemistry
- Access constraints for potential work sites and transport routes
- Sites for muck transport and disposal
- Noise and vibrations from construction operations, and from future traffic at approaches to the completed tunnel
- Air quality during construction, and at portals, vent shafts and approaches of the completed tunnel
- Maintenance of vehicular traffic and transit lines during construction
- Maintenance of utilities and other existing facilities during construction
- Access to residential and commercial properties
- Pest control during construction
- Long-term community impacts
- Long-term traffic impacts
- Temporary and permanent easements
- Tunnel fire life safety and security
- Legal and environmental constraints, enumerated in environmental statements or reports, or elsewhere

### **3.7 SEISMICITY**

The release of energy from earthquakes sends seismic acceleration waves traveling through the ground. Such transient dynamic loading instantaneously increases the shear stresses in the ground and decreases the volume of voids within the material which leads to an increase in the pressure of fluids (water) in pores and fractures. Thus, shear forces increase and the frictional forces that resist them decrease. Other factors also can affect the response of the ground during earthquakes.

- Distance of the seismic source from the project site.
- Magnitude of the seismic accelerations.
- Earthquake duration.
- Subsurface profile.
- Dynamic characteristics and strengths of the materials affected.

In addition to the distance of the seismic source to the project site, and the design (anticipated) time history, duration and magnitude of the bedrock earthquake, the subsurface soil profile can have a profound effect on earthquake ground motions including the intensity, frequency content, and duration of

earthquake shaking. Amplification of peak bedrock acceleration by a factor of four or more has been attributed to the response of the local soil profile to the bedrock ground motions (Kavazanjian et.al, 1998).

Chapter 13 discusses the seismic considerations for the design of underground structures and the parameters required.

The ground accelerations associated with seismic events can induce significant inertial forces that may lead to instability and permanent deformations (both vertically and laterally) of tunnels and portal slopes. In addition, during strong earthquake shaking, saturated cohesionless soils may experience a sudden loss of strength and stiffness, sometime resulting in loss of bearing capacity, large permanent lateral displacements, landslides, and/or seismic settlement of the ground. Liquefaction beneath and in the vicinity of a portal slope can have severe consequences since global instability in forms of excessive lateral displacement or lateral spreading failure may occur as a result. Readers are referred to FHWA publication “Geotechnical Earthquake Engineering” by Kavazanjian, et al. (1998) for a detailed discussion of this topic.

### **3.8 ADDITIONAL INVESTIGATIONS DURING CONSTRUCTION**

#### **3.8.1 General**

For tunneling projects it is generally essential to perform additional subsurface investigations and ground characterization during construction. Such construction phase investigations serve a number of important functions, providing information for:

- Contractor design and installation of temporary works
- Further defining anomalies and unanticipated conditions identified after the start of construction
- Documenting existing ground conditions for comparison with established baseline conditions, thereby forming the basis of any cost adjustments due to differing site conditions
- Assessing ground and groundwater conditions in advance of the tunnel heading to reduce risks and improve the efficiency of tunneling operations
- Determining the initial support system to be installed, and the locations where the support system can be changed
- Assessing the response of the ground and existing structures and utilities to tunneling operations
- Assessing the groundwater table response to dewatering and tunneling operations
- Determining the location and depth of existing utilities and other underground facilities

A typical construction phase investigation program would likely include some or all of the following elements:

- Subsurface investigation borings and probings from the ground surface
- Test pits
- Additional groundwater observation wells and/or piezometers
- Additional laboratory testing of soil and rock samples
- Geologic mapping of the exposed tunnel face
- Geotechnical instrumentation
- Probing in advance of the tunnel heading from the face of the tunnel
- Pilot Tunnels

- Environmental testing of soil and groundwater samples suspected to be contaminated or otherwise harmful

Some of the above investigation elements, such as geotechnical instrumentation, may be identified as requirements of the contract documents, while others, such as additional exploratory borings, may be left to the discretion of the contractor for their benefit and convenience. Tunnel face mapping and groundwater monitoring should be required elements for any tunnel project since the information obtained from these records will form the basis for evaluating the merits of potential differing site condition claims.

### **3.8.2 Geologic Face Mapping**

With open-face tunneling methods, including the sequential excavation method (SEM), open-face tunneling shield in soil, and the drill-and-blast method in rock, all or a large portion of the tunnel face will be exposed, allowing a visual assessment of the existing ground and groundwater conditions. In such cases, the exposed face conditions are documented in cross-section sketches (face mapping) drawn at frequent intervals as the tunnel advances. Information typically included in these face maps include the station location for the cross-section; the date and time the face mapping was prepared; the name of the individual who prepared the face map; classification of each type of material observed; the location of interface boundaries between these materials; rock jointing including orientation of principal joints and joint descriptions; shear zones; observed seepage conditions and their approximate locations on the face; observed ground behavior noting particularly the location of any instability or squeezing material at the face; the location of any boulders, piling or other obstructions; the location of any grouted or cemented material; and any other significant observations. In rock tunnels where the perimeter rock is left exposed, sketches presenting similar information can be prepared for the tunnel walls and roof. All mapping should be prepared by a geologist or geological engineer knowledgeable of tunneling and with soil and rock classification.

The face maps can be used to accurately document conditions exposed during tunneling, and to develop a detailed profile of subsurface conditions along the tunnel horizon. However, there are limitations and considerable uncertainty in any extrapolation of the observed conditions beyond the perimeter of the tunnel.

When used in conjunction with nearby subsurface investigation data and geotechnical instrumentation records, the face maps may be used to develop general correlations between ground displacement, geological conditions and other factors (depth of tunnel, groundwater conditions, etc.).

### **3.8.3 Geotechnical Instrumentation**

Geotechnical instrumentation is used during construction to monitor ground and structure displacements, surface settlement above and near the tunnel, deformation of the initial tunnel supports and final lining, groundwater levels, loads in structural elements of the excavation support systems, and ground and structure vibrations, among others. Such instrumentation is a key element of any program for maintenance and protection of existing structures and facilities. In addition, it provides quantitative information for assessing tunneling procedures during the course of construction, and can be used to trigger modifications to tunneling procedures in a timely manner to reduce the impacts of construction. Instrumentation is also used to monitor the deformation and stability of the tunnel opening, to assess the adequacy of the initial tunnel support systems and the methods and sequencing of tunneling, particularly for tunnels constructed by the Sequential Excavation Method (SEM) and tunnels in shear zones or



squeezing ground. Chapter 16 provides a further discussion of geotechnical instrumentation for tunnel projects.

#### **3.8.4 Probing**

If applicable, such as for SEM and hard rock tunneling projects, probing ahead of the tunnel face is used to determine general ground conditions in advance of excavation, and to identify and relieve water pressures in any localized zones of water-bearing soils or rock joints. For tunnels constructed by SEM, probing also provides an early indication of the type of ground supports that may be needed as the excavation progresses. Advantages of probing are a) it reduces the risks and hazards associated with tunneling, b) it provides continuous site investigation data directly along the path of the tunnel, c) it provides information directly ahead of the tunnel excavation, allowing focus on ground conditions of most immediate concern to tunneling operations, and d) it can be performed quickly, at relatively low cost. However, disadvantages include a) the risk of missing important features by drilling only a limited number of probe holes from the face, and b) the interruption to tunneling operations during probing. Probing from within the tunnel must be considered as a supplementary investigation method, to be used in conjunction with subsurface investigation data obtained during other phases of the project.

Probing typically consists of drilling horizontally from the tunnel heading by percussion drilling or rotary drilling methods. Coring can be used for probing in rock, but is uncommon due to the greater time needed for coring. Cuttings from the probe holes are visually examined and classified, and assessed for potential impacts to tunnel excavation and support procedures. In rock, borehole cameras can be used to better assess rock quality, orientation of discontinuities, and the presence of shear zones and other important features..

The length of the probe holes can vary considerably, ranging from just 3 or 4 times the length of each excavation stage (round), to hundreds of feet. Shorter holes can be drilled more quickly, allowing them to be performed as part of the normal excavation cycle. However, longer holes, performed less frequently, may result in fewer interruptions to tunneling operations.

#### **3.8.5 Pilot Tunnels**

Pilot tunnels (and shorter exploratory adits) are small size tunnels (typically at least 6.5 ft by 6.5 ft in size) that are occasionally used for large size rock tunnels in complex geological conditions. Pilot tunnels, when used, are typically performed in a separate contract in advance of the main tunnel contract to provide prospective bidders a clearer understanding of the ground conditions that will be encountered. Although pilot tunnels are a very costly method of exploration, they may result in considerable financial benefits to the client by a) producing bids for the main tunnel work that have much lower contingency fees, and b) reducing the number and magnitude of differing site condition claims during construction.

In addition to providing bidders the opportunity to directly observe and assess existing rock conditions, pilot tunnels also offer other significant advantages, including a) more complete and reliable information for design of both initial tunnel supports and final lining, if any, b) access for performing in situ testing of the rock along the proposed tunnel, c) information for specifying and selecting appropriate methods of construction and tunneling equipment, d) an effective means of pre-draining groundwater, and more confidently determining short-term and long-term groundwater control measures, e) an effective means for identifying and venting gassy ground conditions, e) a means for testing and evaluating potential tunneling methods and equipment, and f) access for installation of some of the initial supports (typically in the crown area of the tunnel) in advance of the main tunnel excavation. Consideration can also be given to locating the pilot tunnel adjacent to the proposed tunnel, using the pilot tunnel for emergency egress, tunnel drainage, tunnel ventilation, or other purposes for the completed project.

### **3.9 GEOSPATIAL DATA MANAGEMENT SYSTEM**

Geographic Information System (GIS) is designed for managing a large quantity of data in a complex environment, and is a capable tool used for decision making, planning, design, construction and program management. It can accept all types of data, such as digital, text, graphic, tabular, imagery, etc., and organize these data in a series of interrelated layers for ready recovery. Information stored in the system can be selectively retrieved, compared, overlain on other data, composite with several other data layers, updated, removed, revised, plotted, transmitted, etc.

GIS can provide a means to enter and quickly retrieve a wide range of utility information, including their location, elevation, type, size, date of construction and repair, ownership, right-of-way, etc. This information is stored in dedicated data layers, and can be readily accessed to display or plot both technical and demographic information.

Typical information that could be input to a GIS database for a tunnel project may include street grids; topographic data; property lines; right-of-way limits; existing building locations, type of construction, heights, basement elevations, building condition, etc.; proposed tunnel alignment and profile information; buried abandoned foundations and other underground obstructions; alignment and elevations for existing tunnels; proposed structures, including portals, shafts, ramps, buildings, etc.; utility line layout and elevations, vault locations and depths; boring logs and other subsurface investigation information; geophysical data; inferred surfaces for various soil and rock layers; estimated groundwater surface; areas of identified soil and groundwater contamination; and any other physical elements of jurisdictional boundaries within the vicinity of the project.

## CHAPTER 4 GEOTECHNICAL REPORTS

### 4.1 INTRODUCTION

Conventionally, for typical roadway and bridge projects, the geotechnical engineer prepares “geotechnical reports” that serve to summarize the subsurface investigations performed, interpret the existing geological conditions, establish the geotechnical design parameters for the various soil and rock strata encountered, provide geotechnical recommendations for design of the proposed foundations and/or geotechnical features, and identify existing conditions that may influence construction. The term geotechnical report is often used generically to include all types of geotechnical reports, e.g. geotechnical investigation report, geotechnical design report, landslide study report, soil report, foundation report, etc. (FHWA, 1988). The concept is the geotechnical report is only used to communicate the site conditions and design and construction recommendations to the roadway design, bridge design and construction personnel. It may or may not be made available to prospective contractors; and when provided, they are generally only included as a reference document and may typically include disclaimers stating that the report is not intended to be used for construction, and that there is no warranty regarding the accuracy of the data or the conclusions and recommendations of the report; contractors must make their own interpretation of the data to determine the means and associated costs for construction.

Although this approach is commonly used, and may still be applicable for cut-and-cover and immersed tunnel projects, it is not appropriate for mined and bored tunnel and other underground construction projects. Underground projects entail great uncertainty and risk in defining typically complex geological and groundwater conditions, and in predicting ground behavior during tunneling operations. Even with extensive subsurface investigations, considerable judgment is required in the interpretation of the subsurface investigation data to establish geotechnical design parameters and to identify the issues of significance for tunnel construction. This situation is further complicated for tunneling projects since the behavior of the ground during construction is typically influenced by the contractor’s selected means and methods for tunnel excavation and type and installation of tunnel supports.

Using conventional geotechnical reports for tunnel projects would essentially assign the full risk of construction to the contractor since the contractor is responsible for interpreting the available subsurface information. Although this approach appears to protect the owner from the uncertainties and risks of construction, experience on underground projects has demonstrated that it results in high contingency costs being included in the contractors’ bids, and does not avoid costly contractor claims for additional compensation when subsurface conditions vary from those that could reasonably be anticipated.

Current practice for tunnel and underground projects in the U.S. seeks to obtain a more equitable sharing of risks between the contractor and the owner. This approach recognizes that owners largely define the location, components and requirements of a project and the extent of the site investigations performed, and therefore should accept some of the financial risk should ground conditions encountered during construction differ significantly from those anticipated during design and preparation of the contract documents, and should they negatively impact the contractor. The overall objectives of this risk sharing approach are to:

- Reduce the contractors’ uncertainty regarding the financial risks of tunneling projects to obtain lower bid prices
- Foster greater cooperation between the contractor and the owner

- Quickly and equitably resolve disputes between the contractor and the owner that may arise when ground conditions encountered during construction differ substantially from those reflected in the contract documents at the time of bidding
- Obtain the lowest final cost for the project.

Contracting practices for underground projects in the U.S. have evolved and currently include a number of measures to help achieve the above objectives. These measures vary somewhat between projects, depending on specific project conditions and owner preferences, but typically consist of the following fundamental elements:

- Thorough geotechnical site investigations
- Full disclosure of available geotechnical information to bidding contractors
- Preparation of a **Geotechnical Data Report (GDR)** to present all the factual data for a project
- Preparation of **Geotechnical Design Memorandum (GDM)** to present an interpretation of the available geotechnical information, document the assumptions and procedures used to develop the design, and facilitate communication within the design team during development of the design. GDMs are not intended to be incorporated into the Contract Documents and are subsequently superseded by the Geotechnical Baseline Report (GBR).
- Preparation of a **Geotechnical Baseline Report (GBR)** to define the baseline conditions on which contractors will base their bids and select their means, methods and equipment, and that will be used as a basis for determining the merits of contractor claims of differing site conditions during construction
- Making the GDR and GBR contractually binding documents by incorporating them within the contract documents for the project; the GBR takes precedence;
- Carefully coordinating the provisions of the contract specifications and drawings with the information presented in the GBR
- Including a Differing Site Condition clause in the specification that allows the contractor to seek compensation when ground conditions vary from those defined in the GBR, and that result in a corresponding increase in construction cost and/or delay in the construction schedule; Establishing a dispute resolution process to quickly and equitably resolve disagreements that may arise during construction without reverting to costly litigation procedures
- Providing escrow of bid documents

This chapter focuses on the three types of geotechnical reports (GDR, GDM, and GBR) noted above for bore/mined tunnel projects, will discuss the specific purposes and typical contents of these reports, and provide guidelines for their preparation. Related topics, including subsurface investigations for tunnel projects and provisions for dispute resolution, are addressed in other chapters of this manual. Additional information on geotechnical reports for underground projects is provided by ASCE (1989, 1991, 1997, and 2007), Brierley (1998), Essex (2002), and Edgerton (2008).

## 4.2 GEOTECHNICAL DATA REPORT

The Geotechnical Data Report (GDR) is a document that presents the factual subsurface data for the project without including an interpretation of these data. The purpose of the GDR is to compile all factual geological, geotechnical, groundwater, and other data obtained from the geotechnical investigations (Chapter 3) for use by the various participants in the project, including the owner, designers, contractors and third parties that may be impacted by the project. It serves as a single and comprehensive source of geotechnical information obtained for the project.

The GDR should avoid making any interpretation of the data since these interpretations may conflict with the data assessment subsequently presented in the Geotechnical Design Memorandum or other geotechnical interpretive or design reports, and the baseline conditions defined in the Geotechnical Baseline Report. Any such discrepancies could be a source of confusion to the contractors and open opportunities for claims of differing site conditions. In practice, it may not be possible to eliminate all data interpretation from the GDR. In such case, the data reduction should be limited to a determination of the properties obtained from that individual test sample, while avoiding any recommendations for the geotechnical properties for the stratum from which the sample was obtained.

The GDR should contain the following information (ASCE, 2007):

- Descriptions of the geologic setting
- Descriptions of the site exploration program(s)
- Logs of all borings, trenches, and other site investigations
- Descriptions/discussions of all field and laboratory test programs
- Results of all field and laboratory testing

Table 4-1 presents a typical outline for a GDR, modified from Brierley (1998).

The GDR would include the logs of all borings performed for the project, but should not present a subsurface profile constructed from the borings since such a profile requires considerable judgment and interpolation of the borehole records to show inferred strata boundaries. As illustrated in the outline, the text of the GDR provides background information and a discussion of the subsurface investigations performed, while the specific data are presented in appendices to the report. The introduction provides a general project description and notes the purpose and scope of the report. The section on background information should identify other sources of geotechnical information that may have been obtained by others at or near the project site, and may include subsurface investigation data and records from previous construction activities. If such additional information is limited in volume, consideration should be given to including these data in an appendix to the report.

Background information should also include a discussion of the regional and local geologic setting, since such information will be invaluable in the assessment of the limited amount of factual data obtained from site investigations. It is recognized that a description of geological conditions requires interpretation of information in the literature and an understanding of the geological processes controlling the formation and properties of soil and rock deposits; however, since an understanding of the geological setting is fundamental to a successful tunneling project, such information is considered an essential component of the GDR.

The report section on field investigations should include a brief description of the type of investigations performed, references to applicable standards for performing the investigations, the method of obtaining and handling samples, and discussion of any special procedures used for the investigations. If specialty work, such as geophysical investigations, is performed by others, the report prepared by the specialty firm can be included as an appendix to the GDR and simply referenced within the text of the GDR.

The section on laboratory testing should document the number of each type of test performed, the name and location of the testing laboratory, the specific standards used to perform each test, and other information pertinent to the testing program.

The attachments and appendices would present the field and laboratory test records, and may also include helpful summary tables and plots that summarize the factual data obtained from the investigations.

**Table 4-1 Sample Outline for Geotechnical Data Reports (After Brierley, 1998)**

|   |
|---|
| <p><b>Introduction</b><br/>General<br/>Purpose and Scope<br/>Survey Control<br/>Report Organization<br/>Report Limitations</p> <p><b>Background Information</b><br/>General<br/>Other Investigations<br/>Regional Geologic Setting<br/>Local Geology</p> <p><b>Field Investigations</b><br/>General<br/>Test Borings<br/>Test Pits<br/>Observation Wells<br/>Geophysical Investigations<br/>In-Situ Testing<br/>Geologic Mapping</p> <p><b>Laboratory Testing Program</b><br/>General<br/>Soil Testing<br/>Rock Testing</p> <p><b>References</b></p> <p><b>Tables</b><br/>Summary of Subsurface Explorations<br/>Summary of Observation Wells<br/>Summary of Laboratory Test Results</p> <p><b>Figures</b><br/>Project Location Map<br/>Subsurface Exploration Plan</p> <p><b>Appendices</b><br/>Glossary of Technical Terminology<br/>Logs of Test Borings<br/>Logs of Observation Wells<br/>Geophysical Investigation Data<br/>In-Situ Test Results<br/>Laboratory Soil Test Results<br/>Laboratory Rock Test Results<br/>Geologic Mapping Data<br/>Existing Information (optional)</p> |
|---|

### 4.3 GEOTECHNICAL DESIGN MEMORANDUM

For tunnel projects, one or more interpretive reports may be prepared to evaluate the available data as presented in the GDR, address a broad range of design issues, and communicate design recommendations for the design team's internal consideration. These interpretive reports are also used to evaluate design alternatives, assess the impact of construction on adjacent structures and facilities, focus on individual elements of the project, and discuss construction issues. The current guidelines recommend referring to such design reports as Geotechnical Design Memoranda (GDM), instead of Geotechnical Interpretive Report (GIR) (ASCE, 2007).

GDM, or GIR may be prepared at different stages of a project, and therefore may not accurately reflect the final design or final contract documents. Hence, preparation of such interpretive reports in the course of the final design is superfluous, and is strongly discouraged to avoid a potential source of confusion and conflict.

Since GDMs are used internally within the design team and with the owner as part of the project development effort, it is not appropriate to include GDMs as part of the contract documents. Thus, GDMs should be clearly differentiated from the Geotechnical Baseline Report (GBR) (Section 4.4). The GBR should be the only interpretive report prepared for use in bidding and constructing the project. The GBR must supersede – take precedence over any other Geotechnical Report(s). However, in the interest of “full disclosure” to prospective bidders, GDMs are often made available “for information only.” In such instances, the GDM must include a disclaimer clearly noting the specific purposes of the report and stating that the information provided in the report is not intended for construction. The GDM must also clearly state that the contract documents, including the GDR and GBR, are the only documents to be considered by contractors when assessing project requirements and determining their bid price for the work. A sample outline for a GDM, similar to the previously recommended outline for GIR, is presented in Table 4-2.

The GDM should include other disclaimers to highlight the interpretive nature of the report. Following are several issues that are commonly addressed by disclaimers:

- The boring logs only represent the conditions at the specific borehole location at the time it was drilled; ground conditions may be different beyond the borehole location, and may change with time as a result of nearby activities as well as natural processes
- Water levels in the boreholes and observation wells are seasonal and may also change as a result of other factors
- The findings and recommendations presented in the report are applicable only to the proposed facilities and should not be used for other purposes

In evaluating the engineering properties of the soil and rock materials, it is appropriate for the GDM to note the likely ranges for these properties and to recommend a value, or range of values, for use in design. The report should document the basis for selecting these parameters and discuss their significance to the design and construction of the proposed facilities. As an interpretive report, it is appropriate and useful to discuss the reasoning and judgment associated with these and other design recommendations presented in the report.

**Table 4-2 Sample Outline for Geotechnical Design Memorandum (After Brierley, 1998)**

|  |
|--|
| <p><b>EXECUTIVE SUMMARY</b></p> <p><b>Introduction</b><br/>General<br/>Purpose and Scope<br/>Report Organization<br/>Report Limitations</p> <p><b>Project Requirements</b><br/>Project Status<br/>Proposed Facilities<br/>Third-Party Facilities</p> <p><b>Site Conditions</b><br/>General<br/>Geologic Setting<br/>Subsurface Profile<br/>Geotechnical Properties for Soil and Rock<br/>Groundwater Conditions</p> <p><b>Design Recommendations</b><br/>Tunnel Design Considerations<br/>Initial Support<br/>Final Tunnel Lining<br/>Shafts and Portals<br/>Tunnel Approaches<br/>Groundwater Control<br/>Third-Party Impacts<br/>Construction Monitoring</p> <p><b>Construction Considerations</b><br/>Tunnel Excavation and Initial Support<br/>Construction Dewatering<br/>Support of Excavations<br/>Third-Party Impacts</p> <p><b>References</b></p> <p><b>Tables</b><br/>Summary of Field Investigations<br/>Summary of Laboratory Investigations</p> <p><b>Figures</b><br/>Project Location Map<br/>Subsurface Exploration Plan<br/>Subsurface Profiles<br/>Project Layout Drawings<br/>Design Details</p> <p><b>Appendices</b><br/>Glossary of Technical Terminology<br/>Design Investigations by Others<br/>Recommended Technical Specifications</p> |
|--|



Presenting a range of parameters, along with a discussion of their consequences on the design, helps the owner and the design team understand and quantify the inherent uncertainty and risk associated with the proposed underground project. Such information allows the owner to determine the level of risk to be accepted, and the share of the risk to be borne by the contractor. An example of this decision process would be a case where a tunnel must be constructed through relatively low strength rock that contains intrusive dikes of very hard igneous rock of unknown frequency and thickness. Based on limited geotechnical investigations, the geotechnical engineer determines that the amount of hard rock may range from 10 to 30 percent of the total length of the tunnel. This range, and possibly a best estimate percentage, would be reported in the GDM. During subsequent preparation of the GBR and other contract documents, a specific baseline value would be determined and referenced for contractual purposes and reflected in the design. If the owner, in an effort to get lower bid prices, is willing to accept the greater risk of cost increases during construction, a value closer to the lower end of the range would be selected as the baseline. However, if the owner wishes to reduce the risk of cost extras during construction, a value closer to the conservative end of the range would be selected. However, in choosing this second option, the owner needs to recognize that it will result in higher bid prices.

In preparing a GDM it is acceptable to use ambiguous terms, such as “may,” “should,” “likely,” etc. in discussing the various technical issues. Such terms reflect the reality of our uncertainty in defining subsurface stratigraphy and the engineering properties of natural materials, and in predicting the behavior of these materials during construction.

The GDM should reference the Geotechnical Data Report (GDR) as the source of information used to develop the conclusions and recommendations of the GDM. The GDM should also identify any other sources of information that may have influenced the findings of the GDM, including technical references, reports, and site reconnaissance observations, among others.

The GDM should include generalized subsurface profiles developed from an assessment of the available geotechnical and geological information. These subsurface profiles greatly facilitate a visualization and understanding of the existing subsurface conditions for design purposes. However, it must be recognized that such definition of subsurface conditions is highly dependent on the quantity and quality of the available geotechnical investigation data, and the judgment of the geotechnical engineer in interpreting these data and the relevant geological information. Accordingly, the report must emphasize that the profiles are based on an interpolation between widely spaced borings, and that actual subsurface conditions between the borings may vary considerably from those indicated on the profiles.

In addition to providing recommendations for design, the GDM should also address construction issues, including the general methods of construction considered appropriate for the existing site conditions and proposed facilities. However, the engineers preparing the report must recognize that the contractor is responsible for selecting the specific equipment, means and methods for performing the work, thus must avoid any detailed recommendations on these issues accordingly. For example, for a proposed subaqueous tunnel through highly permeable sand deposits, it is appropriate to state that a closed face Tunnel Boring Machine (TBM) consisting of either an Earth Pressure Balance (EPB) Shield or Slurry Shield TBM should be used, but it is inappropriate to recommend a specific TBM model, horsepower, etc.

It is also particularly important for the GDM to identify and discuss all potential hazards that may be encountered during construction, and discuss possible measures to mitigate these hazards. A thorough discussion of such issues should help both the design team and the contractor to anticipate and avoid problems that could cause major cost and schedule impacts. For example, for a tunnel to be excavated in mixed face conditions, the GDM should note that typical problems may include: a), large water inflow at the contact between the soil and rock that will be difficult to fully dewater, b), steering problems for the

TBM, and c), ground loss, and corresponding surface settlement due to excavation of the soil in the upper part of the tunnel heading at a faster rate than the rock in the lower part of the heading. For this example, the report should also note mitigating measures, such as grouting the soil to reduce seepage and ground loss, and facilitate steering of the TBM; drilling drainage holes horizontally from the tunnel heading; providing an articulated TBM to facilitate steering corrections; etc.

In summary, the GDM is written by the engineers solely for use by the design team in developing the design for the proposed facilities. It provides an interpretation of the available subsurface information to determine likely subsurface conditions for design purposes. Depending on its specific purpose and the time of its preparation, the GDM may not reflect the final design shown on the contract drawings. An important element of the GDM is a general discussion of the appropriate methods of construction and the potential hazards that may be encountered during construction, as well as the possible measures that can be considered to mitigate these hazards. The GDM is not intended to be a definitive representation of the actual ground conditions, and is not to be used as a baseline for contractual purposes.

## **4.4 GEOTECHNICAL BASELINE REPORT**

### **4.4.1 Purpose and Objective**

As discussed in Section 4.1, a fundamental principal in current U.S. contracting practices for tunnel projects is the equitable sharing of risk between the owner and contractor, with the objectives of reducing contingency fees in contractor bids, achieving lower total cost for the project, and streamlining resolution of contractor claims for changed conditions during construction. Over the years, various forms and names have been given to the interpretive geotechnical report to be incorporated into the Contract Documents for underground projects in order to achieve the aforementioned objectives. Originally, this was called the Geotechnical Design Summary Report (GDSR). However, since 1997 and continuing with the current (2007) “Geotechnical Baseline Reports-Suggested Guidelines” the industry has determined that the incorporated report be called GBR (Geotechnical Baseline Report).

The primary purposes of the GBR are:

- Establish a contractual document that defines the specific subsurface conditions to be considered by contractors as baseline conditions in preparing their bids,
- Establish a contractual procedure for cost adjustments when ground conditions exposed during construction are poorer than the baseline conditions defined in the contract documents.

Although it reflects the findings of the geotechnical investigations and design studies, a GBR is not intended to predict the actual geotechnical and geological conditions at a project site, or to accurately predict the ground behavior during construction. Rather, it establishes the bases for delineating the financial risks between the owner and the contractor.

ASCE (1997) also noted the secondary purposes of the GBR as listed below:

- It presents the geotechnical and construction considerations that formed the basis of design
- It enhances contractor understanding of the key project issues and constraints, and the requirements of the contract plans and specifications
- It identifies important considerations that need to be addressed during bid preparation and construction
- It assists the contractor in evaluating the requirements for tunnel excavation and support; and

- It guides the construction manager in administering the contract and monitoring contractor performance

A common misconception of the GBR is that it represents a warranty of the existing site conditions by the geotechnical engineer and designer. Based on this understanding, the owner of the project may believe they are entitled to compensation by the designer should actual conditions be found less favorable than the conditions defined in the GBR. However, since it principally serves as a contractual instrument for allocating risks, the GBR is not intended to predict or warranty actual site conditions. If the GBR were to become a warranty, it is reasonable to expect that the geotechnical engineer and designer would more conservatively define subsurface conditions and ground behavior, resulting in a higher cost for the project, a consequence clearly contrary to the primary motivation for adopting a risk-sharing approach to tunnel construction contracts.

It is also important to clearly differentiate the GBR from other interpretive reports may be prepared by the design team to addressing a broad range of design issues for the team's internal consideration. As discussed in Section 4.3, such reports should be referred to as Geotechnical Design Memoranda (GDM). The GBR should be the only final report prepared for use in bidding and constructing the project. The GBR should be limited to interpretive discussion and baseline statements, and should make reference to, rather than repeat or paraphrase, information contained in the GDR, drawings, or specifications (ASCE, 2007).

#### **4.4.2 General Considerations**

The various elements of the construction contract documents each serve a different purpose. The GDR provides the factual information used by the designer for designing the various components of the project, and by the contractor for developing appropriate means and methods of construction. The contract plans and specifications detail the specific requirements for the work to be performed, without providing an explanation or background information. The GBR is based on the factual information presented in the GDR as well as input from the owner regarding risk allocation, and provides an explanation for the project requirements as presented in the contract plans and specifications. The baseline information presented in the GBR must be coordinated with the GDR, contract plans and specifications, and contract payment provisions to assure consistency throughout the contract. However, the GBR should not repeat or paraphrase statements made in these other contract documents since even minor rewording of a statement may cause confusion or an unintended interpretation of the statement. Any inconsistency or confusion in the contract documents could lead to a successful contractor claim for additional compensation during construction since these are usually judged against the owner as the originator of the contract.

The contract General Provisions or Special Provisions should clearly define the hierarchy between the various parts of the contract documents to help resolve any conflicts that may inadvertently remain after issuing the documents. The GBR takes precedence over the GDR and any and all other geotechnical report prepared for any reason.

Most often, there is a possible baseline range that can be established for a given set of geologic and construction conditions. As a consequence, where the baseline is set determines the risk allocation for the project. When an adverse baseline is adopted; 1), more risk is assigned to the Contractor who will bid higher, 2), less risk and reduced potential for change orders accrue to the owner, and, 3), higher costs accrue to the owner due to paying for the contingency of encountering the adverse condition(s). Conversely, when a less adverse baseline is adopted: 1) Contractor bids less due to less risk and contingency, 2) higher risk and potential for change orders accrue to the owner, 3) owner pays more if

adverse conditions are encountered but less if they are not encountered. In either case, the cost of site conditions remains with the Owner.

#### **4.4.3 Guidelines for Preparing a GBR**

The GBR translates facts, interpretations and opinions regarding subsurface conditions into clear, unambiguous statements for contractual purposes. Items typically addressed in a GBR include:

- The amounts and distribution of different materials along the selected alignment;
- Description, strength, compressibility, grain size, and permeability of the existing materials;
- Description, strength and permeability of the ground mass as a whole;
- Groundwater levels and expected groundwater conditions, including baseline estimates of inflows and pumping rates;
- Anticipated ground behavior, and the influence of groundwater, with regard to methods of excavation and installation of ground support;
- Construction impacts on adjacent facilities; and
- Potential geotechnical and man-made sources of potential difficulty or hazard that could impact construction, including the presence of faults, gas, boulders, solution cavities, existing foundation piles, and the like.

A general checklist for a GBR is presented in Table 4-3. This checklist assumes that the Geotechnical Data Report contains the information noted in Section 4.2

Following are general guidelines that should be followed for preparation of a Geotechnical Baseline Report:

- The GBR should be brief. The length of a GBR should be limited to not more than 30 pages of text for typical projects, and not more than 50 pages for more complex projects. The length should allow reading the GBR in a single sitting.
- Select baseline parameters following discussions with the owner regarding the levels of risk to be allotted to the owner and contractor
- Use and reference the information presented in the GDR as the basis for selecting baseline parameters
- Avoid using ambiguous terminology, such as “may,” “should,” “can,” etc; rather, use definitive terms, such as “is,” “are,” “will,” etc.
- Whenever possible, refer baselines to properties and parameters that can be objectively observed and measured in the field
- Avoid the use of general adjectives, such as “large,” “significant,” “minor,” etc. unless these terms are defined and quantified
- Carefully select the specific wording used in the GBR to avoid unintended interpretation of the report
- For parameters that are anticipated to vary considerably, the GBR should note the potential range of values, but clearly state a specific baseline value for contractual purposes
- Since ground behavior is largely influenced by construction means and methods, statements of ground behavior in the GBR should also note the corresponding construction equipment, procedures and sequencing on which these statements were based
- Include an independent review of the GBR at different stages of completion to identify possible ambiguity and inconsistencies, and to verify that all relevant issues are appropriately addressed.

Individuals who prepare the GBR must be highly knowledgeable of both the design and construction of underground facilities, with construction experience particularly important for the necessary

understanding of construction methods, equipment capabilities, ground behavior during tunnel excavation, and the potential hazards associated with the different ground conditions and methods of construction. In addition, these individuals must be experienced in the preparation of a GBR and clearly understand its role as a contract document establishing reference baseline conditions. In general, to achieve greater consistency in the contract documents, the individuals preparing the GBR should belong to the same organization that prepares the contract plans and specifications.

**Table 4-3 Checklist for Geotechnical Baseline Reports (After ASCE, 2007)**

|  |
|--|
| <p><b>Introduction</b></p> <ul style="list-style-type: none"> <li>• Project name</li> <li>• Project owner</li> <li>• Design team (and Design Review Board)</li> <li>• Purpose of reports; organization of report</li> <li>• Contractual precedence relative to the GDR and other contract documents (refer to general conditions)</li> <li>• Project constraints and latitude</li> </ul> <p><b>Project Description</b></p> <ul style="list-style-type: none"> <li>• Project location</li> <li>• Project type and purpose</li> <li>• Summary of key project features (dimensions, lengths, cross sections, shapes, orientations, support types, lining types, required construction sequences)</li> <li>• Reference to specific specification sections and drawings to avoid repeating information from other Contract Documents in GBR</li> </ul> <p><b>Sources of Geologic and Geotechnical Information</b></p> <ul style="list-style-type: none"> <li>• Reference to GDR</li> <li>• Designated other available geologic geotechnical reports</li> <li>• Include the historical precedence for earlier sources of information</li> </ul> <p><b>Project Geologic Setting</b></p> <ul style="list-style-type: none"> <li>• Brief overview of geologic and groundwater setting, origin of deposits, with cross reference to GDR text, maps, and figures</li> <li>• Brief overview of site exploration and testing programs – avoid unnecessary repetition of GDR text</li> <li>• Surface development and topographic and environmental conditions affecting project layout</li> <li>• Typical surficial exposures and outcrops</li> <li>• Geologic profile along tunnel alignment(s) showing generalized stratigraphy and rock/soil units, and with stick logs to indicate drill hole locations, depths, and orientations</li> </ul> <p><b>Previous Construction Experience</b> (key points only in GBR if detailed in GDR)</p> <ul style="list-style-type: none"> <li>• Nearby relevant projects</li> <li>• Relevant features of past projects, with focus on excavation methods, ground behavior, groundwater conditions, and ground support methods</li> <li>• Summary of problems during construction and how they were overcome (with qualifiers as appropriate)</li> </ul> |
|--|

Table 4-3 Continued

**Ground Characterization**

- Physical characteristic and occurrences of each distinguishable rock or soil unit, including fill, natural soils, and bedrock; describe degree of weathering / alteration; including near-surface units for foundations/pipelines
- Groundwater conditions; depth to water table; perched water; confined aquifers and hydrostatic pressures; pH; and other key groundwater chemistry details
- Soil/rock and groundwater contamination and disposal requirements
- Laboratory and field test results presented in histogram (or some other suitable) format, grouped according to each pertinent distinguishable rock or soil unit; reference to tabular summaries contained in the GDR
- Ranges and values for baseline purposes; explanations for why the histogram distributions (or other presentations) should be considered representative of the range of properties to be encountered, and if not, why not; rationale for selecting the baseline values and ranges
- Blow count data, including correlation factors used to adjust blow counts to Standard Penetration Test (SPT) values, if applicable
- Presence of boulders and other obstructions; baselines for number, frequency (i.e., random or concentrated along geologic contacts), size and strength
- Bulking/swell factors and soil compaction factors
- Baseline descriptions of the depths/thicknesses or various lengths or percentages of each pertinent distinguishable ground type or stratum to be encountered during excavation; properties of each ground type; cross-references to information contained in the drawings or specifications
- Values of ground mass permeability, including direct and indirect measurements of permeability values, with reference to tabular summaries contained in the GDR; basis for any potential occurrence of large localized inflows not indicated by ground mass permeability values
- For TBM projects, interpretations of rock mass properties that will be relevant to boreability and cutter wear estimates for each of the distinguishable rock types, including test results that might affect their performance (avoid explicit penetration rate estimated or advance rate estimates)

**Design Considerations – Tunnels and Shafts**

- Description of ground classification system(s) utilized for design purposes, including ground behavior nomenclature
- Criteria and methodologies used for the design of ground support and ground stabilization systems, including ground loadings (or reference the drawings/specifications)
- Criteria and bases for design of final linings (or reference to drawings/specifications)
- Environmental performance considerations such as limitations on settlement and lowering of groundwater levels (or in specifications)
- The manner in which different support requirements have been developed for different ground types, and, if required, the protocol to be followed in the field for determination of ground support types for payment; reference to specifications for detailed descriptions of ground support methods/sequences
- The rationale for ground performance instrumentation included in the drawings and specifications

Table 4-3 Continued

**Design Considerations – Other Excavations and Foundations**

- Criteria and methodologies used for the design of excavation support systems, including lateral earth pressure diagrams (or in drawings/specifications) and need to control deflections/deformations
- Feasible excavation support systems
- Minimum pile tip elevations for deep foundations
- Refusal criteria for driven piles
- Allowable skin friction for tiebacks
- Environmental considerations such as limitations on settlement and lowering of groundwater levels (or in specifications)
- Rationale for instrumentation/monitoring shown in the drawings and specifications

**Construction Considerations – Tunnels and Shafts**

- Anticipated ground behavior in response to construction operations within each soil and rock unit
- Required sequences of constructions (or in drawings/specifications)
- Specific anticipated construction difficulties
- Rationale for requirements contained in the specifications that either constrain means and methods considered by the contractor or prescribe specific means and methods, e.g., the required use of an EPB or slurry shield.
- The rationale for baseline estimates of groundwater inflows to be encountered during construction, with baselines for sustained inflows at the heading, flush inflows at the heading, and cumulative sustained groundwater inflows to be pumped at the portal or shaft
- The rationale behind ground improvement techniques and groundwater control methods included in the contract
- Potential sources of delay, such as groundwater inflows, shears and faults, boulders, logs, tiebacks, buried utilities, other manmade obstruction, gases, contaminated soils and groundwater, hot water, and hot rock, etc.

**Construction Considerations – Other Excavations and Foundations**

- Anticipated ground behavior in response to required construction operations within each soil and rock unit
- Rippability of rock, till, caliche, or other hard materials, and other excavation considerations including blasting requirements/limitations
- Need for groundwater control and feasible groundwater control methods
- Casing requirements for drilled shafts
- Specific anticipated construction difficulties
- Rationale for requirements contained in the specifications that either constrain means and methods considered by the Contractor or prescribe specific means and methods
- The rationale for baseline estimates of groundwater inflows to be encountered during construction, with baselines for sustained inflows to be pumped from the excavation
- The rationale behind ground improvement techniques and groundwater control methods included in the Contract
- Potential sources of delay, such as groundwater inflows, shears and faults, boulders, buried utilities, manmade obstruction, gases, or contaminated soils or groundwater

This page is intentionally left blank.



## CHAPTER 5 CUT AND COVER TUNNELS

### 5.1 INTRODUCTION

This chapter presents the construction methodology and excavation support systems for cut-and-cover road tunnels and describes the structural design in accordance with the AASHTO LRFD Bridge Design Specifications (AASHTO, 2008). The intent of this chapter is to provide guidance in the interpretation of the AASHTO LRFD Specifications in order to have a more uniform application of the code and to provide guidance in the design of items not specifically addressed in AASHTO (2008). The designers must follow the latest LRFD Specifications. A design example illustrating the concepts presented in this chapter can be found in Appendix C. Other considerations dealing with support of excavation, maintenance of traffic and utilities, and control of groundwater and how they affect the structural design are discussed.

### 5.2 CONSTRUCTION METHODOLOGY

#### 5.2.1 General

In a cut and cover tunnel, the structure is built inside an excavation and covered over with backfill material when construction of the structure is complete. Cut and cover construction is used when the tunnel profile is shallow and the excavation from the surface is possible, economical, and acceptable. Cut and cover construction is used for underpasses, the approach sections to mined tunnels and for tunnels in flat terrain or where it is advantageous to construct the tunnel at a shallow depth. Two types of construction are employed to build cut and cover tunnels; bottom-up and top-down. These construction types are described in more detail below. The planning process used to determine the appropriate profile and alignment for tunnels is discussed in Chapter 1 of this manual.

Figure 5-1 is an illustration of cut and cover tunnel bottom-up and top-down construction. Figure 5-1(a) illustrates Bottom-Up Construction where the final structure is independent of the support of excavation walls. Figure 5-1(b) illustrates Top-Down Construction where the tunnel roof and ceiling are structural parts of the support of excavation walls.

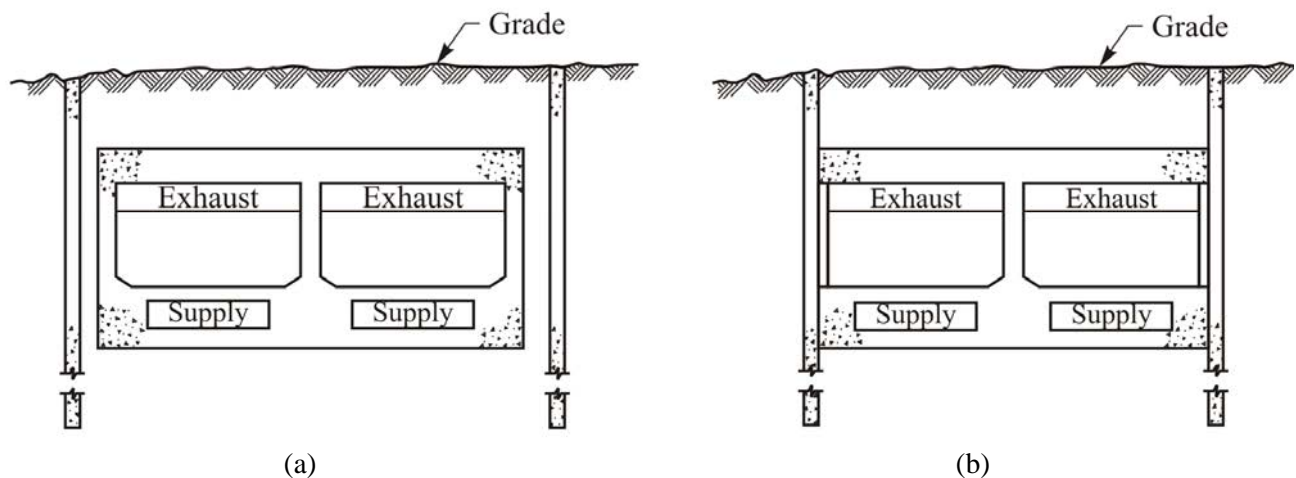

Figure 5-1 Cut and Cover Tunnel Bottom-Up Construction (a); Top-Down Construction (b)

For depths of 30 to 40 feet (about 10 m to 12 m), cut-and-cover is usually more economical and more practical than mined or bored tunneling. The cut-and-cover tunnel is usually designed as a rigid frame box structure. In urban areas, due to the limited available space, the tunnel is usually constructed within a neat excavation line using braced or tied back excavation supporting walls. Wherever construction space permits, in open areas beyond urban development, it may be more economical to employ open cut construction.

Where the tunnel alignment is beneath a city street, the cut-and-cover construction will cause interference with traffic and other urban activities. This disruption can be lessened through the use of decking over the excavation to restore traffic. While most cut-and-cover tunnels have a relatively shallow depth to the invert, depths to 60 feet (18 m) are not uncommon; depths rarely exceed 100 feet (30 m).

Although the support of excavation is an important aspect of cut and cover construction, the design of support of excavation, unless it is part of the permanent structure, is not covered in this chapter.

### 5.2.2 Conventional Bottom-Up Construction

As shown in Figure 5-2, in the conventional “bottom-up” construction, a trench is excavated from the surface within which the tunnel is constructed and then the trench is backfilled and the surface restored afterward. The trench can be formed using open cut (sides sloped back and unsupported), or with vertical faces using an excavation support system. In bottom-up construction, the tunnel is completed before it is covered up and the surface reinstated.

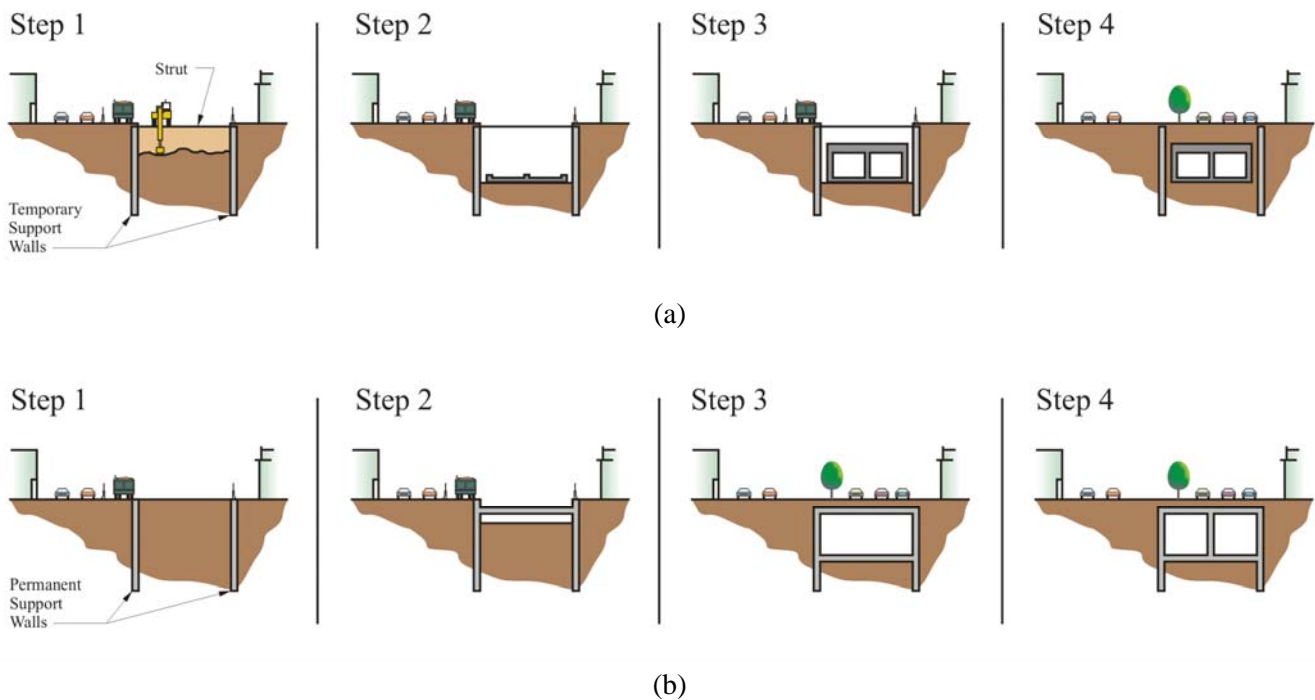

Figure 5-2 Cut-and-Cover Tunnel Bottom-Up (a) and Top-Down (b) Construction Sequence

Conventional bottom-up sequence of construction in Figure 5-2(a) generally consists of the following steps:

- Step 1a: Installation of temporary excavation support walls, such as soldier pile and lagging, sheet piling, slurry walls, tangent or secant pile walls
- Step 1b: Dewatering within the trench if required
- Step 1c: Excavation and installation of temporary wall support elements such as struts or tie backs
- Step 2: Construction of the tunnel structure by constructing the floor;
- Step 3: Complete construction of the walls and then the roof, apply waterproofing as required;
- Step 4: Backfilling to final grade and restoring the ground surface.

Bottom-up construction offers several advantages:

- It is a conventional construction method well understood by contractors.
- Waterproofing can be applied to the outside surface of the structure.
- The inside of the excavation is easily accessible for the construction equipment and the delivery, storage and placement of materials.
- Drainage systems can be installed outside the structure to channel water or divert it away from the structure.

Disadvantages of bottom-up construction include:

- Somewhat larger footprint required for construction than for top-down construction.
- The ground surface can not be restored to its final condition until construction is complete.
- Requires temporary support or relocation of utilities.
- May require dewatering that could have adverse affects on surrounding infrastructure.

### **5.2.3 Top-Down Construction**

With top-down construction in Figure 5-2 (b), the tunnel walls are constructed first, usually using slurry walls, although secant pile walls are also used. In this method the support of excavation is often the final structural tunnel walls. Secondary finishing walls are provided upon completion of the construction. Next the roof is constructed and tied into the support of excavation walls. The surface is then reinstated before the completion of the construction. The remainder of the excavation is completed under the protection of the top slab. Upon the completion of the excavation, the floor is completed and tied into the walls. The tunnel finishes are installed within the completed structure. For wider tunnels, temporary or permanent piles or wall elements are sometimes installed along the center of the proposed tunnel to reduce the span of the roof and floors of the tunnel.

Top-down sequence of construction generally consists of the following steps:

- Step 1a : Installation of excavation support/tunnel structural walls, such as slurry walls or secant pile walls
- Step 1b: Dewatering within the excavation limits if required
- Step 2a: Excavation to the level of the bottom of the tunnel top slab
- Step 2b: Construction and waterproofing of the tunnel top slab tying it to the support of excavation walls
- Step 3a: Backfilling the roof and restoring the ground surface
- Step 3b: Excavation of tunnel interior, bracing of the support of excavation walls is installed as required during excavation

- Step 3c: Construction of the tunnel floor slab and tying it to the support of excavation walls; and  
Step 4 Completing the interior finishes including the secondary walls.

Top-down construction offers several advantages in comparison to bottom-up construction:

- It allows early restoration of the ground surface above the tunnel
- The temporary support of excavation walls are used as the permanent structural walls
- The structural slabs will act as internal bracing for the support of excavation thus reducing the amount of tie backs required
- It requires somewhat less width for the construction area
- Easier construction of roof since it can be cast on prepared grade rather than using bottom forms
- It may result in lower cost for the tunnel by the elimination of the separate, cast-in-place concrete walls within the excavation and reducing the need for tie backs and internal bracing
- It may result in shorter construction duration by overlapping construction activities

Disadvantages of top-down construction include:

- Inability to install external waterproofing outside the tunnel walls.
- More complicated connections for the roof, floor and base slabs.
- Potential water leakage at the joints between the slabs and the walls
- Risks that the exterior walls (or center columns) will exceed specified installation tolerances and extend within the neat line of the interior space.
- Access to the excavation is limited to the portals or through shafts through the roof.
- Limited spaces for excavation and construction of the bottom slab

#### **5.2.4 Selection**

It is difficult to generalize the use of a particular construction method since each project is unique and has any number of constraints and variables that should be evaluated when selecting a construction method. The following summary presents conditions that may make a one construction method more attractive than the other. This summary should be used in conjunction with a careful evaluation of all factors associated with a project to make a final determination of the construction method to be used.

Conditions Favorable to Bottom-Up Construction:

- No right-of way restrictions
- No requirement to limit sidewall deflections
- No requirement for permanent restoration of surface

Conditions Favorable to Top-Down Construction

- Limited width of right-of-way
- Sidewall deflections must be limited to protect adjacent features
- Surface must be restored to permanent usable condition as soon as possible

## 5.3 SUPPORT OF EXCAVATION

### 5.3.1 General

The practical range of depth for cut and cover construction is between 30 and 40 feet (about 10 m to 12 m). Sometimes, it can approach 100 feet. Excavations for building cut and cover tunnels must be designed and constructed to provide a safe working space, provide access for construction activities and protect structures, utilities and other infrastructure adjacent to the excavation. The design of excavation support systems requires consideration of a variety of factors that affect the performance of the support system and that have impacts on the tunnel structure itself. These factors are discussed hereafter.

Excavation support systems fall into three general categories:

- **Open cut slope:** This is used in areas where sufficient room is available to open cut the area of the tunnel and slope the sides back to meet the adjacent existing ground line (Figure 5-3). The slopes are designed similar to any other cut slope taking into account the natural repose angle of the in-situ material and the global stability.
- **Temporary:** This is a structure designed to support vertical or near vertical faces of the excavation in areas where room to open cut does not exist. This structure does not contribute to the final load carrying capacity of the tunnel structure and is either abandoned in place or dismantled as the excavation is being backfilled. Generally it consists of soldier piles and lagging, sheet pile walls, slurry walls, secant piles or tangent piles.
- **Permanent:** This is a structure designed to support vertical or near vertical faces of the excavation in areas where room to open cut does not exist. This structure forms part of the permanent final tunnel structure. Generally it consists of slurry walls, secant pile walls, or tangent pile walls.



Figure 5-3 Cut and Cover Construction using Side Slopes Excavation- Ft McHenry Tunnel, Baltimore, MD

This section discusses temporary and permanent support of excavation systems and provides issues and concerns that must be considered during the development of a support of excavation scheme. The design of open-cut slopes and support of excavation are not in the scope of this manual. Information on the design of soil and rock slopes can be found in FHWA-NHI-05-123 “Soil Slope and Embankment Design” (FHWA, 2005d), and NHI-99-007 “Rock Slopes” (FHWA, 1999), respectively. Supports of Excavation are referred to FHWA-NHI-05-046 “Earth Retaining Structure” (FHWA, 2005e). Many of the issues described below associated with ground and groundwater behavior are applicable to side slopes also.

### 5.3.2 Temporary Support of Excavation

Support of excavation structures can be classified as flexible or rigid. Flexible supports of excavation include sheet piling and soldier pile and lagging walls. A careful site investigation that provides a clear understanding of the subsurface conditions is essential to determining the correct support system. Rigid support of excavation such as slurry walls, secant piles or tangent piles are also used as temporary support of excavation. Descriptions of these systems are provided Section 5.3.3 Permanent Support of Excavation.

A sheet piling wall consists of a series of interlocking sheets that form a corrugated pattern in the plan view of the wall. The sheets are either driven or vibrated into the ground. The sheets extend well below the bottom of the excavation for stability. These sheets are fairly flexible and can support only small heights of earth without bracing. As the excavation progresses, bracings or tie backs are installed at specified intervals. Sheet pile walls can be installed quickly and easily in ideal soil conditions. The presence of rock, boulders, debris, utilities, or obstructions will make the use of sheet piling difficult since these features will either damage the sheet pile or in the case of a utility, be damaged by the sheet pile. Figure 5-4 shows a sheet pile wall with complex multi level internal bracing.



Figure 5-4 Sheet Pile Walls with Multi Level-Bracing

A soldier pile wall consists of structural steel shape columns spaced 4 to 8 feet apart and driven into the ground or placed in predrilled holes. The soldier piles extend well below the level of the bottom of excavation for stability. As the excavation progresses, lagging is placed between the soldier piles to retain the earth behind the wall. The lagging could be timber or concrete planks. The soldier piles are relatively flexible and are capable of supporting only modest heights of earth without bracing. As the excavation progresses, bracing or tie backs are installed at specified intervals. Soldier piles can also be installed in more different ground conditions than can a sheet pile wall. The spacing allows the installation of piles around utilities. The finite dimension of the pile allows drilling of holes through obstructions and into rock, making the soldier pile and lagging wall more versatile than the sheet pile wall. Figure 5-5 shows a braced soldier pile and lagging wall.



Figure 5-5 Braced Soldier Pile and Lagging Wall

Support of excavation bracing can consist of struts across the excavation to the opposite wall, knee braces that brace the wall against the ground, and tie backs consisting of rock anchors or soil anchors that tie the wall back into the earth behind the wall. Struts and braces extend into the working area and create obstacles to the construction of the tunnel. Tie backs do not obstruct the excavation space but sometimes they extend outside of the available right-of-way requiring temporary underground easements. They may also encounter obstacles such as boulders, utilities or building foundations. The suitability of tie backs depends on the soil conditions behind the wall. The site conditions must be studied and understood and taken into account when deciding on the appropriate bracing method. Figure 5-6 shows an excavation braced by tie-backs, leaving the inside of the excavation clear for construction activities.

The design and detailing of the support of excavation must consider the sequence of installation and account for the changing loading conditions that will occur as the system is installed. The design of temporary support of excavation is not in the scope of this manual. The information presented herein is intended to make tunnel designers aware of the impact that the selected support of excavation can have on the design, constructability and serviceability of the tunnel structure. Guidance on the design of support of excavation can be found in FHWA-NHI-05-046 “Earth Retaining Structure” (FHWA, 2005e).



Figure 5-6 Tie-back Excavation Support leaves Clear Access

Use of temporary support of excavation does have the advantage of allowing waterproofing to be applied to the outside face of the tunnel structure. This can be accomplished by setting the face of the support of excavation away from the outside face of the tunnel structure. This space provides room for forming and allows the placement of waterproofing directly onto the finished outside face of the structure. As an alternate, the face of the support of excavation can be placed directly adjacent to the outside face of the structure. Under this scenario, the face of the support of excavation is used as the form for the tunnel structure. Waterproofing is installed against the support of excavation and concrete is poured against the waterproofing. In this case, the temporary support of excavation wall is abandoned in place.

### 5.3.3 Permanent Support of Excavation

Permanent support of excavation typically employs rigid systems. Rigid systems consist of slurry walls, soldier pile tremie concrete (SPTC) walls, tangent pile walls, or secant pile walls. As with temporary support of excavation systems, a careful site investigation that provides a clear understanding of the subsurface conditions is essential to determining the appropriate system.

A slurry wall is constructed by excavating a trench to the thickness required for the external structural wall of the tunnel. Slurry walls are usually 30 to 48 inches thick. The trench is kept open by the placement of bentonite slurry in the trench as it is excavated. The trench will typically extend for some distance below the bottom of the tunnel structure for stability. Reinforcing steel is lowered into the slurry filled trench and concrete is then placed using the tremie method into the trench displacing the slurry. The resulting wall will eventually be incorporated into the final tunnel structure. Excavation proceeds from the original ground surface down to the bottom of the roof of the tunnel structure. The tunnel roof is constructed and tied into the slurry wall. The tunnel roof provides bracing for the slurry wall. Depending on the depth of the tunnel, the roof could be the first level of bracing or an intermediate level. The excavation would then proceed and additional bracing would be provided as needed. At the base of the excavation, the tunnel bottom slab is then constructed and tied into the walls. Figure 5-7 shows a slurry wall supported excavation in an urban area.

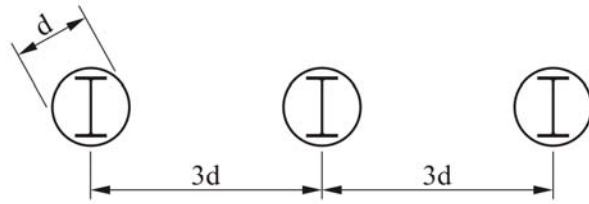



Figure 5-7 Braced Slurry Walls

SPTC walls are constructed in the same sequence as a slurry wall. However, once the trench is excavated, steel beams or girders are lowered into the slurry in addition to reinforcing steel to provide added capacity. The construction of the wall then follows the same sequence as that described above for a slurry wall.

Tangent pile (drilled shaft) walls consist of a series of drilled shafts located such that the adjacent shafts touch each other, hence the name tangent wall. The shafts are usually 24 to 48 inches in diameter and extend below the bottom of the tunnel structure for stability. The typical sequence of construction of tangent piles begins with the excavation of every third drilled shaft. The shafts are held open if required by temporary casing. A steel beam or reinforcing bar cage is placed inside the shaft and the shaft is then filled with concrete. If a casing is used, it is pulled as the tremie concrete placement progresses. Once the concrete backfill cures sufficiently, the next set of every third shaft is constructed in the same sequence as the first set. Finally, after curing of the concrete in the second set, the third and final set of shafts is constructed, completing the walls. Excavation within the walls then proceeds with bracing installed as required to the bottom of the excavation. Roof and floor slabs are constructed and tied into the tangent pile. The roof and floor slabs act as bracing levels. Figure 5-8 is a schematic showing the sequence of construction in plan view. Figure 5-9 shows a completed tangent pile wall.



STEP 1 - INSTALL TANGENT PILES SPACED @ 3d



STEP 2 - INSTALL TANGENT PILES ADJACENT TO PILES INSTALLED IN STEP 1



STEP 3 - COMPLETE WALL BY INSTALLING REMAINING PILES

Figure 5-8 Tangent Pile Wall Construction Schematic



Figure 5-9 Tangent Pile Wall Support

Secant pile walls are similar to tangent pile walls except that the drilled shafts overlap each other rather than touch each other. This occurs because the center to center spacing of secant piles is less than the

diameter of the piles. Secant pile walls are stiffer than tangent piles walls and are more effective in keeping ground water out of the excavation. They are constructed in the same sequence as tangent pile walls. However, the installation of adjacent secant piles requires the removal of a portion of the previously constructed pile, specifically a portion of the concrete backfill. Figure 5-10 is a schematic showing a plan view of a completed secant pile wall.

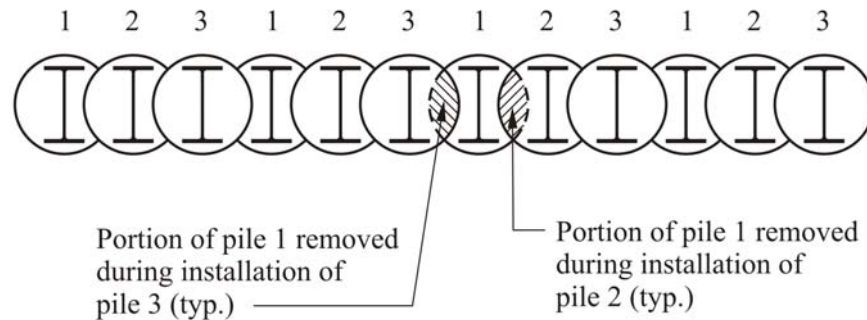

Figure 5-10 Completed Secant Pile Wall Plan View

In general, rigid support systems have more load carrying capacity than flexible systems. This additional load carrying capacity means that they require less bracing. Minimizing the amount of bracing results in fewer obstruction inside the excavation if struts or braces are used, making construction activities easier to execute. Rigid wall systems incorporated into the final structure can also reduce the overall cost of the structure because they combine the support of excavation with the final structure. Waterproofing permanent support walls and detailing the connections between the walls and other structure members are difficult. This difficulty can potentially lead to leakage of groundwater into the tunnel. The design and detailing of the support of excavation must consider the sequence of installation and account for the changing loading conditions that will occur as the excavation proceeds and the system is installed.

### 5.3.4 Ground Movement and Impact on Adjoining Structures

An important issue for cut-and-cover tunnel analysis and design is the evaluation and mitigation of construction impacts on adjacent structures, facilities, and utilities. By the nature of the methods used, cut-and-cover constructions are much more disruptive than bored tunnels. It is important for engineers to be familiar with analytical aspects of evaluating soil movement as a result of the excavation, and the impacts it can have on existing buildings and utilities at the construction site. Soil movement can be due to deflection of the support of excavation walls and ground consolidation:

- Deflection of support of excavation walls: Walls will deflect into the excavation as it proceeds prior to installation of each level of struts or tiebacks supporting the wall. The deflection is greater for flexible support systems than for rigid systems. The deflections are not recoverable and they are cumulative.
- Consolidation due to dewatering: In excavations where the water table is high, it is often necessary to dewater inside the excavation to avoid instability. Dewatering inside the cut may lead to a drop in the hydrostatic pressure outside the cut. Depending on the soil strata, this can lead to consolidation and settlement of the ground.

Existing buildings and facilities must be evaluated for the soil movement estimated to occur due to the support wall movement during excavation. This evaluation depends on the type of existing structure, its

distance and orientation from the excavation, the soil conditions, the type of foundations of the structure, and other parameters. The analysis is site specific, and it can be very complex. Empirical methods and screening tools are available to more generally characterize the potential impacts. The existing buildings and facilities within the zone of influence must be surveyed (Chapter 3) and monitored as discussed in Chapter 15 Geotechnical and Structural Instrumentation.

Measures to deal with this issue include:

- Design of stiffer and more watertight excavation support walls.
- Provide more closely spaced and stiffer excavation support braces and/or tiebacks.
- Use of pre-excavation soil improvement.
- Underpinning of existing structures.
- Provide monitoring and instrumentation program during excavation.
- Establish requirement for mitigation plans if movements approach allowable limits.

### **5.3.5 Base Stability**

Poor soil beneath the excavation bottom may require that the excavation support structure be extended down to a more competent stratum to ensure the base stability of the structure. This may depend upon whether the earth pressures applied to the wall together with its weight can be transferred to the surrounding soil through a combination of adhesion (side friction) and end bearing.

Soft clays below the excavation are particularly susceptible to yielding causing the bottom of the excavation to heave with a potential settlement at the ground surface, or worse to blow up. High groundwater table outside of the excavation can result in base instability as well. Measures to analyze the subsurface condition, and provide sufficient base stability must be addressed by the geotechnical engineer and/or tunnel designer. Readers are referred to FHWA-NHI-05-046 “Earth Retaining Structure” (FHWA, 2005e) for more details.

## **5.4 STRUCTURAL SYSTEMS**

### **5.4.1 General**

A structural system study is often prepared to determine the most suitable structural alternatives for the construction of the cut-and-cover tunnel. This involves a determination of the proposed tunnel section as discussed in Chapter 2, the excavation support system, the tunnel structural system, the construction method (top-down vs. bottom up), and the waterproofing system. Each of these elements is interdependent upon the other. Options for each element are discussed below. The system study should consider all options that are feasible in a holistic approach, taking into account the effect that one option for an element has on another element.

#### **5.4.1.1 Structural Element Sizing**

As described in Chapter 1, the shape of the cut and cover tunnels is generally rectangular. The dimensions of the rectangular box must be sufficient to accommodate the clearance requirements (Chapter 2). Dimensional information required for structural sizing includes wall heights and the span lengths of the roof. The width of the tunnel walls added to the clear space width requirements will determine the final width of the excavation required to construct the tunnel. To minimize the horizontal width of the excavation the support of excavation can be incorporated as part of, the final structure.

However, this might have negative impacts on the watertightness of the structure. Some reasons that would require minimization of the out to out width of the excavation are:

- Limited horizontal right-of-way. In urban areas where tunnels are constructed along built up city streets, additional right-of-way may be impractical to obtain. There may be existing buildings foundations adjacent to the tunnel or utilities that are impractical to move.
- There may be natural features that make a wider excavation undesirable or not feasible such as rock or bodies of water.

The depth of the roof and floor combined with the clearance requirements will define the vertical height of the tunnel structure, the depth of excavation required, and the height of the associated support of excavation. It is recommended in cut-and-cover construction that the tunnel depth be minimized to reduce the overall cost which extends beyond the cost of the tunnel structure. A shallower profile grade can also result in shorter approaches and approach grades that are more favorable to the operational characteristics of the vehicles using the tunnel resulting in lower costs for the users of the tunnel.

#### **5.4.2 Structural Framing**

The framing model for the tunnel will be different according to whether the support of excavation walls is a temporary (non-integral) or a permanent (integral) part of the final structure. With temporary support of excavation walls, the tunnel section would be considered a frame with fixed joints. When support of excavation walls are to form part of the tunnel structure, fixed connections between the support of excavation walls and the rest of the structure may be difficult to achieve in practice; partial fixity is more probable, but to what degree may be difficult to define. A range of fixities may need to be considered in the design analysis.

Corners of rectangular tunnels often incorporate haunches to increase the member's shear capacity near the support, in effect creating more of an arched shape. A true arch shape provides an efficient solution for the tunnel roof but tends to create other issues. Flat arches result in horizontal loads at the spring line that must be resisted by the walls. Semicircular arches eliminate these forces but result in a section larger than required vertically and drive down the tunnel profile which will add cost. When using temporary support of excavation walls, the tunnel section is constructed totally within them, often with a layer of waterproofing completely enveloping the section. In contrast, when the support of excavation walls become part of the final structure, an enveloping membrane is difficult to achieve. Therefore, provisions for overlapping, enveloping and sealing the joints would be needed. Furthermore, physical keying of the structural top and bottom slabs into the support of excavation walls is essential for any transmission of moments and shear.

Some old tunnels employ a structural system consisting of transverse structural steel frames spaced about 5 feet (1.5 m) apart. Typically, these frames are embedded in un-reinforced cast-in-place floors and walls, while for the roof, these frames are exposed and support a cast-in-place roof slab. This type of construction may still be competitive when applied to shallow tunnels, especially when longer roof spans are required for multiple lane cross sections. More details on these issues are provided in the following paragraphs that described specific materials for construction.

#### **5.4.3 Materials**

Cast-in-place concrete is the most common building material used in cut and cover tunnel construction, however other materials such as precast prestressed concrete, post tensioned concrete and structural steel are used. These materials and their application are discussed below.

### 5.4.3.1 Cast-in-Place Concrete

Cast-in-place concrete is commonly used in tunnel construction due to the ease with which large members can be constructed in restricted work spaces. Formwork can be brought in small manageable pieces and assembled into forms for large thick members. Complex geometry can be readily constructed utilizing concrete, although the formwork may be difficult to construct. Concrete is a durable material that performs well in the conditions that exist in underground structures. The low shear capacity of concrete can be offset by thickening the roof and the floor at the corners as shown in Figure 5-11.

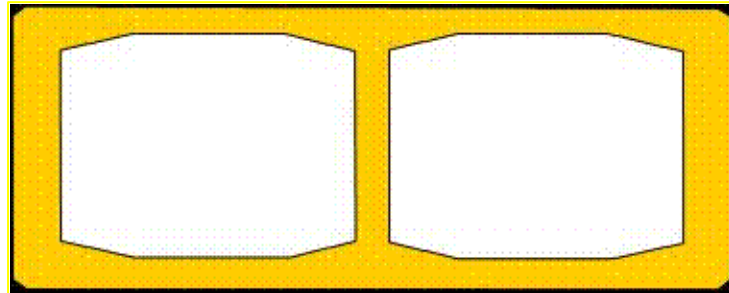

Figure 5-11 Tunnel Structure with Haunches

Connecting the structural concrete members to permanent support of excavation walls can be challenging. A simple end connection can be created quickly by placing the concrete slab in precast seats or pockets in the walls; however this results in a less efficient structure with thicker structural elements. Full moment connections can be created using splicing of reinforcing steel if sufficient wall pockets can be provided. When creating a full moment connection, the walls must be detailed to accept the transferred moment. To minimize the amount of wall pocket required, mechanical splicing or welding can be used. Waterproofing the connection, as well as the remainder of the structure, when using permanent support of excavation walls as part of the structure, is challenging.

Proper detailing of concrete members and application of all AASHTO requirements in terms of reinforcing steel is essential to create a durable concrete structure. The minimum requirements for shrinkage reinforcement should be noted. Using a larger number of smaller bars rather than a small number of large bars helps distribute cracks and consequently reduces their size. Ground water chemistry should be investigated to ensure that proper mix designs compatible with ground water chemistry are used to reduce the potential for chemical attack of the concrete.

### 5.4.3.2 Structural Steel

Structural steel has excellent weight to strength characteristics. Structural steel beams with a composite slab can be used to reduce the thickness of roof slabs. This can reduce the depth to the profile with the accompanying reductions in overall cost of the tunnel associated with a shallower excavation and shorter retained tunnel approaches. Structural steel is easier to connect to permanent support of excavation walls than are concrete slabs. Local removal of the permanent wall in small isolated pockets is all that is required to provide a seat for the steel beam creating a simple end. If simple ends are used, the movement of the beam due to temperature changes inside the tunnel should be accommodated. If the support of excavation used SPTC, tangent or secant pile walls, the embedded steel cores of these walls can be

exposed and a full moment connection can be made. A full moment connection will not allow temperature movements, so the resulting force effects must be evaluated and accommodated by design.

Structural steel beams are best fabricated and delivered in a single piece. However, if the excavation support system has complex internal bracing, it may not be possible to deliver and erect the steel beams inside the excavation which would require splicing of the steel beams. Connections also require careful inspection which adds to the future maintenance cost of the tunnel if the connections are not encased. Waterproofing the connections to the exterior walls can be difficult. Tunnels typically produce a damp environment, if combined with the potential to leak around connections, this results in conditions that can result in aggressive corrosion to steel members. Corrosion protection must be considered as part of the structural steel structural system.

In addition to the roof structure described above, steel frames have also been used in road tunnels and under some circumstances, may still be appropriate. The frame includes columns and the roof beams. In permanent support walls, the columns would be embedded in the walls. The steel columns are erected on a suitable foundation cast on the bottom of the excavation, the beams are then erected and joined with the columns and the entire frames are then encased in concrete, with nominal reinforcement. The roof beams can be completely encased or exposed supporting a thin concrete roof slab. If exposed, inspection and maintenance are required.

#### **5.4.3.3 Prestressed Concrete**

Prestressed concrete, including precast prestressed beams such as AASHTO beams or similar, may be suitable for large roof spans when clearances are tight and the overall depth of section must be limited. Precast prestressed beams have been used for the top slab supported on cast in place walls. Precast concrete beams, in the number and lengths required for cut and cover tunnels are impractical to splice. They must be delivered in a single piece and be able to be erected within the space available inside the excavation. The type and configuration of the excavation must therefore be considered when evaluating the use of precast concrete beams. Making connections with permanent support of excavation walls can be accomplished by creating pockets in the walls to support the beams in a simple support arrangement. Simple supports also require a method for allowing movement of the beams during temperature changes inside the tunnel. Waterproofing this connection is difficult. Making a moment connection requires more elaborate details of the junction between the wall and the beam to be able to install the reinforcing required for the moment connection. A moment connection at the beam also requires that the wall itself be capable of accepting the moment transferred by the beam. Therefore the detailing of the wall must be compatible with the structural system selected. A full moment connection will not allow temperature movements, so the resulting force effects must be evaluated and accommodated by the design.

Although seldom, post tensioning is used in cut and cover tunnels; however in developing the post tensioning strategy, it is important to consider the various loading stages and potentially have multiple stages of post tensioning. For example, the introduction of high post-tensioning forces in tunnel slabs before backfilling causes temporary high tensile stresses in the opposite face of the slabs. These stresses may limit the depth to which post-tensioned members can be used, unless some of the tendons are tensioned from inside the box after backfilling. The elastic shortening of the slab will induce resistance to the post-tensioning via the walls, and should be taken into consideration. The additional moments created will also need to be resisted. Isolating the top slab from the walls by means of a movement joint (such as neoprene or Teflon bearings) would eliminate the above shortcomings but also eliminate the advantages of moment connection; waterproofing of the movement joint will need to be addressed. The design should identify space requirements for operation of the stressing jacks from both sides (if required). In many cases, the tendon would be less than 100 ft (30 m) long, needing only one end for stressing. Usually, in such a case, alternate strands would be stressed from alternate ends, requiring suitable space on each side.

#### 5.4.4 Buoyancy

Buoyancy is a major concern in shallow tunnels that are under or partially within the water table. Buoyancy should be checked during the design. The structural system selected should take into account its ability to resist buoyancy forces with its own weight or by providing measures to deal with negative buoyancy. In cases where the structure and backfill are not heavy enough to resist the buoyancy forces, flotation can occur. Measures to resist the forces of flotation must be provided and accounted for in the design.

The resistance against flotation can be achieved by a variety of methods. Typical methods used to increase the effective weight of the structure include:

- Connecting the structure to the excavation support system and thus mobilizing its weight and/or its friction with the ground
- Thickening structural members beyond what is required for strength in order to provide dead load to counter the flotation forces
- Widening the floor slab of the tunnel beyond the required footprint to key it into adjacent soil and thus to include the weight of soil above these protrusions
- Using steel or concrete tension piles to resist the uplift forces associated with flotation
- Using permanent tie-down anchors; in soils, it may be prudent for the anchors only to carry a nominal tension under normal conditions and for the anchors to be fully mobilized only under extreme conditions. Properly protected anchor heads can be located in formed recesses within the base slab
- Permanent pressure relief system beneath the base of the structure. This is a complicated system to remove the buoyant forces by allowing water to be collected from under the bottom slab and removed from the tunnel. This type of system requires maintenance and redundancy in addition to the life cycle costs associated with operating the system. It can also have the effect of lowering the local groundwater table which may have negative consequences.

Considering the long design life of underground structures, the design of tension piles or tie-down anchors to resist flotation forces must include provisions to address the risk of corrosion of these tension elements and consideration of their connection to the tunnel structure. Similarly, the use of an invert pressure relief system and backup system must include provisions to address the risk of the long-term operation and maintenance requirements. For most projects, generally, buoyancy forces are resisted by increased dead load of the structure and/or weight of fill above the structure.

#### 5.4.5 Expansion and Contraction Joints

Many cut and cover tunnels are constructed without permanent expansion or contraction joints. Although expansion joints may not be required except close to the portals, contraction joints are recommended throughout the tunnel. Significant changes in support stiffness or surcharge can cause differential settlement. If the induced moments and shears resulting from this are greater than the section can handle, relieving joints can be used to accommodate localized problems. Expansion joints are usually provided at the interfacing with ventilation building or portals or other rigid structures to allow for differential settlements and movements associated with temperature changes. It is recommended that contraction joints be placed at intervals of approximately 30 feet (about 9 m).

Seismic loading can cause significant bending moments in cut and cover tunnels. Joints may be used to relieve the moments and shears that would have occurred in continuous rigid structures, particularly as the width (and hence the stiffness) of the structure increases. Joints may also be required to handle relative seismic motion at locations where the cross-sectional properties change significantly, such as at



ventilation buildings and portals. Such motion can be both longitudinal and transverse (horizontal and vertical) to the tunnel.

Joints are potential areas where leaks can occur. As such, they are potential sources of high maintenance costs over the life of the tunnel. The number of joints should be minimized and special care should be taken in the detailing of joints to ensure water tightness. The type and frequency of joints required will be a function of the structural system required and should be evaluated in the overall decision of the type selected.

#### **5.4.6 Waterproofing**

The existence of a high groundwater table or water percolating down from above requires that tunnels be waterproof. Durability is improved when the tunnel is waterproof. Good waterproofing design is also imperative to keep the tunnel dry and reduce future maintenance. Leaking tunnels are unsightly and can give rise to concern by users. In colder climates such as in the North East, leaks can become hazardous ceiling icicles or ice patches on roadways. Tunnel waterproofing is discussed briefly in Chapter 10. The waterproofing system should be selected based on the required performance and its compatibility with the structural system.

### **5.5 LOADS**

#### **5.5.1 General**

The relevant loads to be considered in the design of the cut and cover tunnel structures along with how to combine the loads are given in Section 3 of the AASHTO LRFD specifications. Section 3 of the AASHTO LRFD specification divides loads into two categories: Permanent Loads and Transient Loads. Paragraph 3.3.2 “Load and Load Designation” of the AASHTO LRFD specifications defines following permanent loads that are applicable to the design of cut and cover tunnels:

DC = Dead Load: This load comprises the self weight of the structural components as well as the loads associated with nonstructural attachments. Nonstructural attachments can be signs, lighting fixtures, signals, architectural finishes, waterproofing, etc. Typical unit weights for common building materials are given in Table 3.5.1-1 of the AASHTO LRFD specifications. Actual weights for other items should be calculated based on their composition and configuration.

DW = Dead Load: This load comprises the self weight of wearing surfaces and utilities. Utilities in tunnels can include power lines, drainage pipes, communication lines, water supply lines, etc. Wearing surfaces can be asphalt or concrete. Dead loads, wearing surfaces and utilities should calculate based on the actual size and configuration of these items.

EH = Horizontal Earth Pressure Load. The information required to calculate this load is derived by the geotechnical data developed during the subsurface investigation program. In lieu of actual subsurface data, the information contained in paragraph 3.11 of the AASHTO specifications can be used. *At-rest pressures should be used in the design of cut and cover tunnel structure.*

EL = Accumulated locked-in force effects resulting from the construction process including secondary forces from post tensioning if used.

ES = Earth surcharge load. This is the vertical earth load due to fill over the structure that was placed above the original ground line. *It is recommended that a minimum surcharge load of 400 psf be used in the design of cut and cover tunnels.* If there is a potential for future development over the tunnel structure, the surcharge from the actual development should be used in the design of the structure. In lieu of a well defined loading, it is recommended that *a minimum value of 1000 psf be used when future development is anticipated.*

EV = Vertical pressure from the dead load of the earth fill. This is the vertical earth load due to fill over the structure up to the original ground line. The information required to calculate this load are derived by the geotechnical data developed during the subsurface investigation program. In lieu of actual subsurface data, the information contained in paragraph 3.11 of the AASHTO specifications can be used. Note that AASHTO provides modification factors for this load based on soil structure interaction in paragraph 12.11.2.

Paragraph 3.3.2 “Load and Load Designation” of the LRFD specifications defines following transient loads that are applicable to the design of cut and cover structures:

CR = Creep.

CT = Vehicular Collision Force: This load would be applied to individual components of the tunnel structure that could be damaged by vehicular collision. Typically, tunnel walls are very massive or are protected by redirecting barriers so that this load need be considered only under usual circumstances. It is preferable to detail tunnel structural components so that they are not subject to damage from vehicular impact.

EQ = Earthquake. This load should be applied to the tunnel lining as appropriate for the seismic zone for the tunnel. The scope of this manual does not include the calculation of or design for seismic loads. However, some recommendations are provided in Chapter 13 – Seismic Considerations”. The designer should be aware that seismic loads should be accounted for in the design of the tunnel lining in accordance with LRFD Specifications.

IM = Vehicle dynamic load allowance: This load can apply to the roadway slabs of tunnels and can also be applied to roof slab of tunnels that are constructed under other roadways, rail lines, runways or other facilities that carry moving vehicles. An equation for the calculation of this load is given in paragraph 3.6.2.2 of the AASHTO LRFD specifications.

LL = Vehicular Live Load: This load can apply to the roadway slabs of tunnels and can also be applied to roof slab of tunnels that are constructed under other roadways, rail lines, runways or other facilities that carry moving vehicles. This load would be distributed through the earth fill prior to being applied to the tunnel roof, unless traffic bears directly on the tunnel roof. Guidance for the distribution of live loads to buried structures can be found in paragraphs 3.6.1 and 12.11.2 of the AASHTO LRFD specifications.

SH = Shrinkage. Cut and cover tunnel structural elements usually are relatively massive. As such, shrinkage can be a problem especially if the exterior surfaces are restrained. This load should be accounted for in the design or the structure should be detailed to minimize or eliminate it.

TG = Temperature Gradient. Cut and cover structural elements are typically constructed of concrete which has a large thermal lag. Combined with being surrounded by an insulating soil backfill that maintains a relatively constant temperature, the temperature gradient across the thickness of the members can be measurable. This load should be examined on case by case basis depending

on the local climate and seasonal variations in average temperatures. Paragraph 4.6.6 of the AASHTO LRFD specifications provides guidance on calculating this load. Note that paragraph C3.12.3 allows the use of engineering judgment to determine if this load need be considered in the design of the structure.

TU = Uniform Temperature. This load is used primarily to size expansion joints in the structure. If movement is permitted at the expansion joints, no additional loading need be applied to the structure. Since the structure is rigid in the primary direction of thermal movement, the effects of the friction force resulting from thermal movement can be neglected in the design. Some components may be individually subject to this load. The case where concrete or steel beams support the roof slab is an example. If these beams are framed into the side walls to create a full moment connection, the expansion and contraction of these beams will add force effect to the frames formed by the connection. This effect must be accommodated in the design. This effect is usually not considered in the case of a cast-in-place concrete box structure due to the insulating qualities of the surrounding ground and the large thermal lag of concrete.

WA = Water load. This load represents the hydrostatic pressure expected outside the tunnel structure. Tunnel structures are typically detailed to be watertight without provisions for relieving the hydrostatic pressure. As such, the tunnel is subject to horizontal hydrostatic pressure on the sidewalls, vertical hydrostatic pressure on the roof and a buoyancy force on the floor. Hydrostatic pressure acts normal to the surface of the tunnel. It should be assumed that water will develop full hydrostatic pressure on the tunnel walls, roof and floor. The design should take into account the specific gravity of the groundwater which can be saline near salt water. Both maximum and minimum hydrostatic loads should be used for structural calculations as appropriate to the member being designed. For the purpose of design, the hydrostatic pressures assumed to be applied to underground structures should ignore pore pressure relief obtained by any seepage into the structures unless an appropriately designed pressure relief system is installed and maintained. Two groundwater levels should be considered: normal (observed maximum groundwater level) and extreme, 3 ft (1 m) above the design flood level (100 to 200 year flood).

Some of the loads shown in paragraph 3.3.2 of the LRFD specifications are not shown above because they are not applicable to the design of cut and cover highway tunnels as described below.

DD = Downdrag: This load comprises the vertical force applied to the exterior walls of a top-down structure that can result from the subsidence of the surrounding soil due to the subsidence of the in-situ soil below the bottom of the tunnel. This load would not apply to cut and cover structures since it requires subsidence or settlement of the material below the bottom of the structure to engage the downdrag force of the walls. For the typical highway tunnel, the overall weight of the structure is usually less than the soil it is replacing. As such, unless backfill in excess of the original ground elevation is placed over the tunnel or a structure is constructed over the tunnel, settlement will not be an issue for cut and cover tunnels.

BR = Vehicular Braking Force: This load would be applied only under special conditions where the detailing of the structure requires consideration of this load. Under typical designs, this force is resisted by the mass of the roadway slab and need not be considered in design.

CE = Vehicular centrifugal force: This load would be applied only under special conditions where the detailing of the structure requires consideration of this load. Under typical designs, this force is resisted by the mass of the roadway slab and need not be considered in design.

- CV = Vessel Collision Force is generally not applicable to cut and cover construction unless it is done under a body of water such as in a cofferdam. It is applicable to immersed tube tunnels, which are a specialized form of cut and cover tunnel and are covered separately in Chapter 11 of this manual.
- FR = Friction. As stated above, the structure is usually rigid in the direction of thermal movement. Thermal movement is the source of the friction force. In a typical tunnel, the effects of friction can be neglected.
- IC = Ice load. Since the tunnel is not subjected to stream flow nor exposed to the weather in a manner that could result in an accumulation of ice, this load is not used in cut and cover tunnel design.
- PL = Pedestrian Live load. Pedestrian are typically not allowed in road tunnels, so there is no need to design for a pedestrian loading.
- SE = Settlement. For the typical road tunnel, the overall weight of the structure is usually less than the soil it is replacing. As such, unless backfill in excess of the original ground elevation is placed over the tunnel or a structure is constructed over the tunnel, settlement will not be an issue for cut and cover tunnels. If settlement is anticipated due to poor subsurface conditions or due to the addition of load onto the structure or changing ground conditions along the length of the tunnel, it is recommended that ground improvement measures or deep foundation (piles or drilled shafts) be used to support the structure.
- WL = Wind on live load. The tunnel structure is not exposed to the environment, so it will not be subjected to wind loads.
- WS = Wind load on structure. The tunnel structure is not exposed to the environment, so it will not be subjected to wind loads.

Section 3 of the LRFD specifications provides guidance on the methods to be used in the computations of these loads. The design example in Appendix C shows the calculations involved in computing these loads. The order of construction will impact loading and assumptions. For example, in top down construction, permanent support of excavation walls used as part of the final structure will receive heavier bearing loads, because the roof is placed and loaded before the base slab is constructed. The permanent support of excavation walls are also braced as the excavation progresses by the roof slab resulting a different lateral soil pressure distribution than would be found in the free standing walls of a cast-in-place concrete structure constructed using bottom up construction. The base slab of a top-down construction tunnel acts as a mat for supporting vertical loads, but it is not available until towards the end of construction of the section eliminating its use to resist moments from the walls or to act as bracing for the walls. Typical loading diagrams are illustrated respectively for bottom-up and top-down structures in Figure 5-12, and Figure 5-13, respectively.

### **5.5.2 Load Combinations**

The loads described above should be factored and combined in accordance with the LRFD specification and applied to the structure. Cut and cover structures are considered buried structures and as such the design is governed by Section 12 of the AASHTO LRFD specifications. Paragraph 12.5.1 gives the limit states and load combinations that are applicable for buried structures as Service Limit State Load Combination I and Strength Limit State Load Combinations I and II. These load combinations are given in Table 3.4.1-1 of the AASHTO Specifications. In some cases, the absence of live load can create a governing case. For example, live load can reduce the effects of buoyancy. Therefore, in addition to the

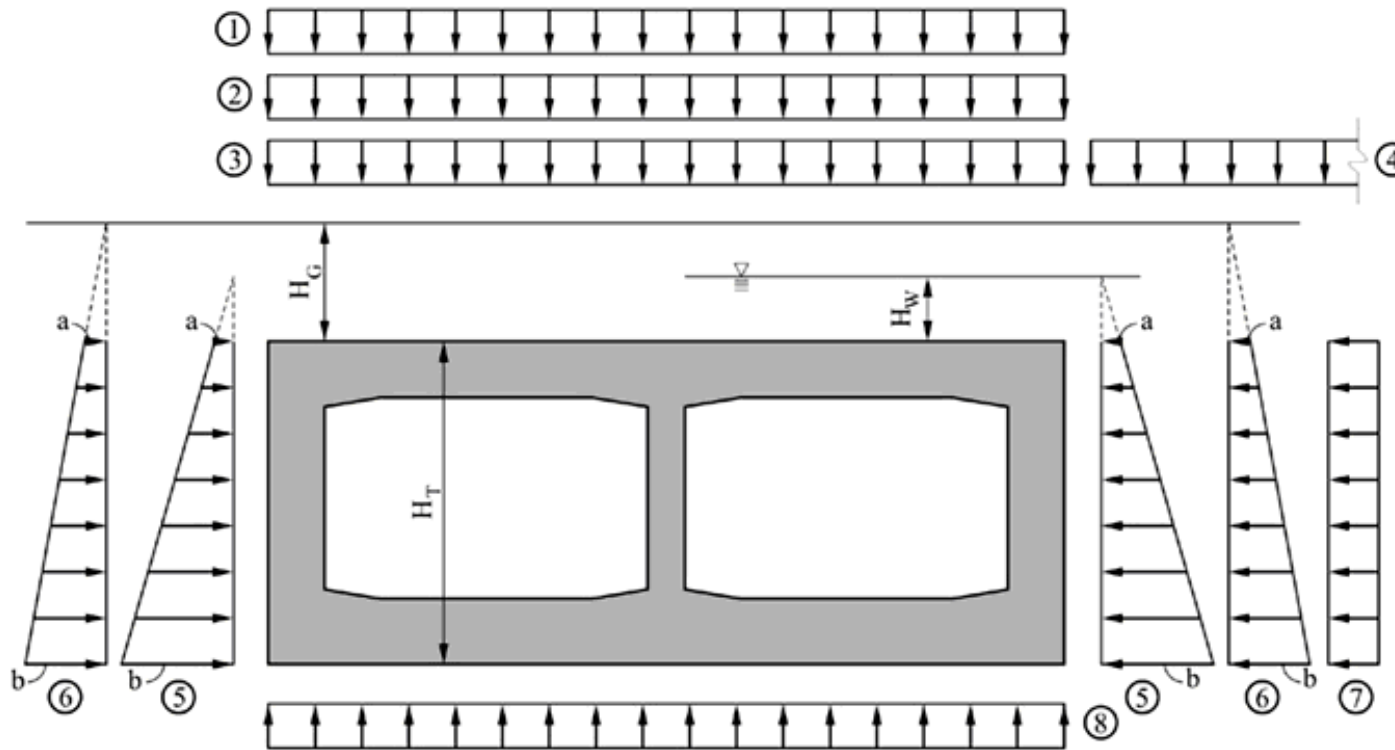

**FIGURE 5-12**  
**CUT AND COVER TUNNEL LOADING DIAGRAM - BOTTOM UP CONSTRUCTION IN SOIL**

- ① - Live load - determined as per site conditions & AASHTO LRFD specifications
- ② - Vertical Earth Load =  $\gamma_S(H_G - H_W) + \gamma_{S_b}(H_W)$
- ③ - Vertical Hydrostatic Pressure =  $\gamma_W H_W$
- ④ - Vertical Surcharge Load - determined as per site conditions ( $F_S$ )
- ⑤ - Horizontal Hydrostatic Load:  $a = \gamma_W H_W$      $b = \gamma_W(H_W + H_T)$
- ⑥ - Horizontal Earth Load:  $a = \gamma_S R_O(H_G - H_W) + \gamma_{S_b} R_O H_W$      $b = a + \gamma_{S_b} R_O H_T$
- ⑦ - Horizontal Surcharge Load =  $F_S R_O$

- ⑧ - Vertical Hydrostatic Load (Buoyancy) =  $\gamma_W(H_W + H_T)$   
 Where:  
 $\gamma_S$  = dry unit weight of soil  
 $\gamma_{S_b}$  = buoyant unit weight of soil  
 $H_G$  = height of backfill over the tunnel  
 $H_W$  = height of water table over the tunnel  
 $H_T$  = height of the tunnel structure  
 $R_O$  = at rest lateral earth pressure coefficient  
 $F_S$  = magnitude of surcharge in units of Force/Area

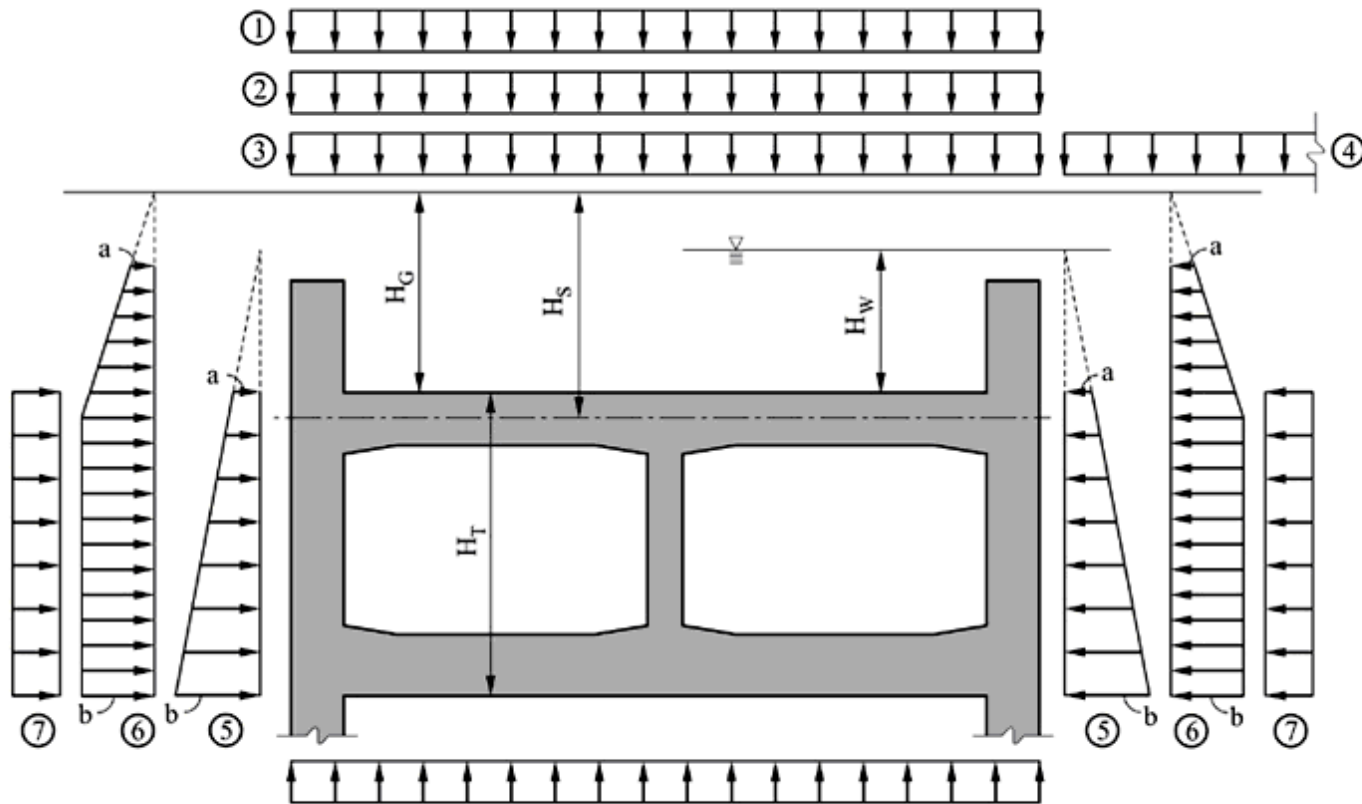

**FIGURE 5-13**  
**CUT AND COVER TUNNEL LOADING DIAGRAM TOP-DOWN CONSTRUCTION IN SOIL**

- |  |   |
|--|---|
| <p>① - Live load - determined as per site conditions &amp; AASHTO LRFD specifications</p> <p>② - Vertical Earth Load = <math>\gamma_S(H_G - H_W) + \gamma_{S_b}(H_W)</math></p> <p>③ - Vertical Hydrostatic Pressure = <math>\gamma_W H_W</math></p> <p>④ - Vertical Surcharge Load - determined as per site conditions (<math>F_S</math>)</p> <p>⑤ - Horizontal Hydrostatic Load: <math>a = \gamma_W H_W</math>    <math>b = \gamma_W(H_W + H_T)</math></p> <p>⑥ - Horizontal Earth Load: <math>a = \gamma_S R_O (H_G - H_W) + \gamma_{S_b} R_O H_W</math>    <math>b = a + \gamma_{S_b} R_O H_S</math></p> <p>⑦ - Horizontal Surcharge Load = <math>F_S R_O</math></p> | <p>⑧ - Vertical Hydrostatic Load (Buoyancy) = <math>\gamma_W(H_W + H_T)</math></p> <p>Where:</p> <p><math>\gamma_S</math> = dry unit weight of soil</p> <p><math>\gamma_{S_b}</math> = buoyant unit weight of soil</p> <p><math>H_G</math> = height of backfill over the tunnel</p> <p><math>H_W</math> = height of water table over the tunnel</p> <p><math>H_T</math> = height of the tunnel structure</p> <p><math>R_O</math> = at rest lateral earth pressure coefficient</p> <p><math>F_S</math> = magnitude of surcharge in units of Force/Area</p> |
|--|---|

load cases specified in Section 12 of the AASHTO LRFD specifications, the strength and service load cases that do not include live load should be used, specifically Strength III and Service IV. Note that load case Strength IV does not include live load. However, when using the loadings applicable to cut and cover tunnels, Strength III and Strength IV are in fact the same load cases. Combining the requirements of Section 12 and Section 3 as described above results in the following possible load combinations for use in the design of cut and cover structures:

**Table 5-1 Cut and Cover Tunnel LRFD Load Combination Table**

| Load Comb. Limit State | DC   |      | DW   |      | EH* EV# |      | ES   |      | EL              | LL, IM | WA   | TU, CR, SH |      | TG   |
|------------------------|------|------|------|------|---------|------|------|------|-----------------|--------|------|------------|------|------|
|                        | Max  | Min  | Max  | Min  | Max     | Min  | Max  | Min  |                 |        |      | Max        | Min  |      |
| Strength I             | 1.25 | 0.90 | 1.50 | 0.65 | 1.35    | 0.90 | 1.50 | 0.75 | 1.00            | 1.75   | 1.00 | 1.20       | 0.50 | 0.00 |
| Strength II            | 1.25 | 0.90 | 1.50 | 0.65 | 1.35    | 0.90 | 1.50 | 0.75 | 1.00            | 1.35   | 1.00 | 1.20       | 0.50 | 0.00 |
| Strength III           | 1.25 | 0.90 | 1.50 | 0.65 | 1.35    | 0.90 | 1.50 | 0.75 | 1.00            | 0.00   | 1.00 | 1.20       | 0.50 | 0.00 |
| Service I              | 1.00 |      | 1.00 |      | 1.00    |      | 1.00 |      | 1.00            | 1.00   | 1.00 | 1.20       | 1.00 | 0.50 |
| Service IV             | 1.00 |      | 1.00 |      | 1.00    |      | 1.00 |      | 1.00            | 0.00   | 1.00 | 1.20       | 1.00 | 1.00 |
| Service IVA**          | 0.00 |      | 0.90 |      | 0.90    |      | 0.90 |      | 0.00            | 0.00   | 1.00 | 0.00       | 0.00 | 0.00 |
| Extreme Event I        | 1.25 | 0.90 | 1.50 | 0.65 | 1.35    | 0.90 | 1.50 | 0.75 | $\gamma_{EQ}^+$ | 1.00   | N/A  | N/A        | N/A  | N/A  |

\* The load factors shown are for at-rest earth pressure. At-rest earth pressure should be used for all conditions of design of cut and cover tunnel structures. Horizontal earth pressure is not used for Load Combination Service IVA.

# The load factors shown are for rigid frames. All cut and cover tunnel structures are considered rigid frames.

+ This load factor is determined on a project specific basis and is not in the scope of this manual.

\*\* This load case used to check buoyancy for tunnel structures below the permanent groundwater table.

Cut and cover tunnels below the water table should be evaluated for the effect of buoyancy. This check is shown as Load Combination Service IVA in the Table 5-1. The buoyancy force should be assessed to ensure that the applied dead load effect is larger than the applied buoyancy effect. Frequently, structural member sizes will have to be increased to ensure that the buoyancy is completely resisted by the dead load or alternatively, the structure should be tied down. Calculations for buoyancy should be based on minimum characteristic material densities and maximum water density. The net effect of water pressure on the tunnel, i.e., the buoyancy, is the difference between hydrostatic loads on the roof and on the underside. The total uplift force is equal to the weight of water displaced. Friction effects (the theoretical force required to dislodge the wedge of material over the tunnel) of overlying natural materials and backfill should not be taken into account.

When developing the loads to be applied to the structure, each possible combination of load factors should be developed. Engineering judgment can then be used to eliminate the combinations that will not govern.

Extreme event loading is not specifically called for in the ASSHTO LRFD specification. Cut and cover tunnels, however can be subjected to extreme event loadings such as earthquakes, fires and explosions. The analysis and design for these loadings are very specialized and as such are not in the scope of this manual. However, it is recommended that during the planning phase of a tunnel, a risk analysis be

performed to identify the probability of these loads occurring, the level at which they may occur and the need for designing the tunnel to resist these loads.

## 5.6 STRUCTURAL DESIGN

### 5.6.1 General

Historically there have been three basic methods used in the design of cut and cover tunnel structures:

- Service load or allowable stress design which treats each load on the structure equally in terms of its probability of occurrence at the stated value. The factor of safety for this method is built into the material's ability to withstand the loading.
- Load factor design accounts for the potential variability of loads by applying varying load factors to each load type. The resistance of the maximum capacity of the structural member is reduced by a strength reduction factor and the calculated resistance of the structural member must exceed the applied load.
- Load and resistance factor design takes into account the statistical variation of both the strength of the structural member and of the magnitude of the applied loads.

The fundamental LRFD equation can be found in paragraph 1.3.2.1 of the AASHTO specification (AASHTO Equation 1.3.2.1-1) as follows:

$$\sum \eta_i \gamma_i Q_i \leq \phi R_n = R_r \quad 5-1$$

In this equation,  $\eta_i$  is a load modifier relating to the ductility, redundancy and operation importance of the feature being designed. The load modifier  $\eta$  is comprised of three components;

- $\eta_D$  = a factor relating to ductility = 1.0 for cut and cover tunnels constructed with conventional details and designed in accordance with the AASHTO LRFD specification.
- $\eta_R$  = a factor relating to redundancy = 1.0 for cut and cover tunnel design. Typical cast in place and prestressed concrete structures are sufficiently redundant to use a value of 1.0 for this factor. Typical detailing using structural steel also provides a high level of redundancy.
- $\eta_I$  = a factor relating to the importance of the structure = 1.05 for cut and cover tunnel design. Tunnels usually are important major links in regional transportation systems. The loss of a tunnel will usually cause major disruption to the flow of traffic, hence the higher importance factor.

$\gamma_i$  is a load factor applied to the force effects ( $Q_i$ ) acting on the member being designed. Values for  $\gamma$  can be found in Table 5-1 above.

$R_r$  is the calculated factored resistance of the member or connection.

$\phi$  is a resistance factor applied to the nominal resistance of the member ( $R_n$ ) being designed. The resistance factors are given in the AASHTO LRFD specifications for each material in the section that covers the specific material. Specifically, Section 5 covers Concrete Structures and in general, the resistance factors to be used in concrete design can be found in Section 5. However, Section 12 of the AASHTO LRFD specifications gives the following values to be used for  $\phi$  in Table 12.5.5-1:



For Reinforced Concrete Cast-in-Place Box Structures:

$$\begin{aligned}\phi &= 0.90 \text{ for flexure} \\ \phi &= 0.85 \text{ for shear}\end{aligned}$$

Since the walls, floors and roofs of cut and cover tunnel sections will experience axial loads, the resistance factor for compression must be defined. The value of  $\phi$  for compression can be found in Section 5.5.4.2.1 of the AASHTO LRFD specifications given as:

$$\phi = 0.75 \text{ for compression}$$

Values for  $\phi$  for precast construction are also given in Table 12.5.5-1 of the AASHTO LRFD specifications, however due to size of the members involved in road tunnels, it is seldom that precast concrete will be used as a building material.

Structural steel is also used in cut and cover tunnel construction. Structural steel is covered in Section 6 of the AASHTO LRFD specifications. Paragraph 6.5.4.2 gives the following values for steel resistance factors:

For Structural Steel Members:

$$\begin{aligned}\phi_f &= 1.00 \text{ for flexure} \\ \phi_v &= 1.00 \text{ for shear} \\ \phi_c &= 0.90 \text{ for axial compression for plain steel and composite members}\end{aligned}$$

## 5.6.2 Structural Analysis

Structural analysis is covered in Section 4 of the AASHTO LRFD specifications. It is recommended that classical force and displacement methods be used in the structural analysis of cut and cover tunnel structures. Other numerical methods may be used, but will rarely yield results that vary significantly from those obtained with the classical methods. The modeling should be based on elastic behavior of the structure as per the AASHTO LRFD specifications paragraph 4.6.2.1.

Since all members of a cut and cover tunnel, with the possible exception of the floor of tunnels built using top-down construction, are subjected to bending and axial load, the secondary affects of deflections on the load affects to the structural members should be accounted for in the analysis. The AASHTO LRFD specifications refer to this type of analysis as “large deflection theory” in paragraph 4.6.3.2. Most general purpose structural analysis software have provisions for including this behavior in the analysis. If this behavior is accounted for in the analysis, no further moment magnification is required.

Paragraph 4.5.1 of the AASHTO LRFD specifications states that the design of the structure should include “...where appropriate, response characteristics of the foundation”. The response of the foundation for a cut and cover tunnel structure can be modeled through the use of a series of non linear springs placed along the length of the bottom slab. These springs are non linear because they should be specified to act in only one direction, the downward vertical direction. This model will provide the proper distribution of loads to the bottom slab of the model and give the designer an indication if buoyancy is a problem. This indication is seen in observing the calculated displacements of the structure. A net upward displacement of the entire structure indicates that there is insufficient resistance to buoyancy.

Structural models for computer analysis are developed using the centroid of the structural members. As such, it is important when calculating the applied loads, that the loads are calculated at the outside surface of the members. The load is then adjusted according to the actual length of the member as input.

Other numerical methods of analysis for cut-and-cover tunnel sections include:

- Frame analysis with a more rigorous soil-structure interaction by modeling the soil properties together with the tunnel. The same frame analysis, but with the addition of a series of unidirectional springs on the underside to model the effect of the soil as a beam on an elastic foundation. Lateral or horizontal springs may be applied in conjunction with assumed soil loads. Care must be taken to ensure that the assumed soil spring acts only when deflection into the soil occurs. This may require multiple iterations of the input parameters for each load combination. Many commercially available programs will automatically adjust the input values and rerun the analysis. This gives a better modeling representation of the structure and takes advantage of more realistic base slab soil support, often resulting in more economical design. Setting up a model is a little more difficult with the springs, and suitable values for the spring modulus are difficult to quantify. It may be appropriate to use a range of values and run the model for each.
- Finite element and finite difference analyses. The material of the tunnel structure and the soil are modeled as a continuum grid of geometric elements. Structural elements are usually treated as linear elastic. A number of different mathematical models for the soil type are available. This method of modeling and analysis can more closely represent actual conditions, especially if better numerical resolution is used where there are conditions of difficult tunnel geometry such as the framing details. The method is usually complex to setup and run, and results require careful interpretation.

As stated above, two-dimensional sectional analysis is sufficient for most tunnel conditions. Three-dimensional modeling may be required where tunnel sections vary along the length of the tunnel or where intersections exist such as at ramps or cross-passages. 3-D modeling is very complex and the accuracy of the loading data, uncertainty about soil behavior, and its inherent lack of homogeneity may not warrant such detailed analysis for highway tunnels except for special locations such as ramps, cross passages, and connections to other structures.

## **5.7 GROUNDWATER CONTROL**

### **5.7.1 Construction Dewatering**

When groundwater levels are higher than the base level of the tunnel, excavations will require a dewatering system. For cut and cover construction, the dewatering systems will depend on the permeability of the various soil layers exposed. Lowering the water table outside the excavation could cause settlement of adjacent structures, impact on vegetations, drying of existing wells, and potential movement of contaminated plumes if present. Precautions should be taken when dewatering the area outside the excavation limits. Within the excavation, dewatering can be accomplished with impermeable excavation support walls that extend down to a firm, reasonably impermeable stratum to reduce or cut-off water flow.

Impervious retaining walls, such as steel interlocking sheeting or concrete slurry walls, could be placed into deeper less pervious layers, such as glacial till or clay, to reduce groundwater inflow during construction and limit draw-down of the existing groundwater table. For most braced excavation sites,

dewatering within the excavation is often done. Sometimes the excavation is done in the wet, then the water is pumped out. Subsequent to the excavation, any water intrusion will be pumped from the trench by providing sumps and pumps within the excavation. In some areas, a pumped pressure relief system may be required to prevent the excavation bottom from heaving due to unbalanced hydrostatic pressure.

Pumped wells can be used to temporarily lower the groundwater table outside the excavation support during construction; however this may have environmental impact or adverse effects on adjacent structures. To minimize any lowering of the water table immediately outside the excavation, water pumped from the excavation can be used to recharge the water bearing strata of the groundwater system by using injection wells. Provision would have to be made for disposal of water in excess of that pumped to recharge wells, probably through settlement basins draining to storm drains.

After construction is completed, if there is a concern that the permanent excavation support walls above the tunnel might be blocking the cross flow of the groundwater or may dam up water between walls above the tunnel, the designer may need to consider to breach the walls above the tunnel at intervals or removed to an elevation to allow movement of groundwater. Granular backfill around tunnels can also help to maintain equal hydrostatic heads across underground structures.

### **5.7.2 Methods of Dewatering and Their Typical Applications**

Groundwater can be controlled during construction either by using impervious retaining walls (such as concrete slurry or tangent pile walls, steel interlocking sheeting, etc.), by well-points drawing down the water table, by chemical or grout injection into the soils, or by pumping from within the excavation. Groundwater may be lowered, as needed, by tiers of well-points. Improper control of groundwater is often a cause for settlement and damage to adjacent structures and utilities; consequently it is important that the method selected is suitable for the proposed excavation.

Where the area of excavations is not too large, an economical method of collecting water is through the use of ditches leading to sump pumps. Provisions to keep fines from escaping into the dewatering system should be made.

In larger excavations in permeable soil, either well points or deep wells are often used to lower the water table in sand or coarse silt deposits, but are not useful in fine silt or clay soils due to their low permeability. It is recommended that test wells be installed to test proposed systems. In certain cases, multiple stages of well points, deep wells with submersible pumps or an eductor system would be needed

### **5.7.3 Uplift Pressures and Mitigation Measures**

After construction is complete and dewatering ceases, hydrostatic uplift (buoyancy) pressures should be considered. Options that have been used to overcome this are included in Section 5.4.42.

### **5.7.4 Piping and Base Stability**

In fine-grained soils, such as silts or clayey silts, differential pressure across the support of excavation may cause sufficient water flow (piping) for it to carry fines. This causes material loss and settlement outside as well as a loss of integrity of soils within, rendering the soils unsuitable as a foundation. In extreme cases, the base of the excavation may become unstable, causing a blow-up and failure of the excavation support. This situation may be mitigated by ensuring that cut-off walls are sufficiently deep, by stabilizing the soil by grouting, or freezing, or by excavating below water without dewatering and making a sufficiently thick tremie slab to overcome uplift before dewatering.

### **5.7.5 Potential Impact of Area Dewatering**

Dewatering an excavation may lower the groundwater outside the excavation and may cause settlements. The lowering of the external groundwater can be reduced by the use of slurry walls, tangent or secant piles, or steel sheet piling. Adjacent structures with a risk of settlement due to groundwater lowering may require underpinning. Furthermore, where lowering of groundwater exposes wooden piles to air, deterioration may occur.

### **5.7.6 Groundwater Discharge and Environmental Issues**

In most cases, the water will require testing and possibly treatment before it can be discharged. Settling basins, oil separators, and chemical treatments may be required prior to disposal. Local regulations and permitting requirements often dictate the method of disposal.

The excavated material itself will require testing before the method of disposal can be determined. Material excavated below water may need to stand in settling ponds to allow excess water to run off before disposal. Contaminated material may need to be placed in confined disposal facilities.

## **5.8 MAINTENANCE AND PROTECTION OF TRAFFIC**

When the excavation crosses existing roads or is being performed under an existing road, decking would be required to maintain the existing road traffic. When decking is required the support of excavation walls must be designed to handle the imposed live loads. The depth of the walls may need to be determined by the necessity of transferring decking loads to a more competent stratum below. This may depend upon whether the load applied to the wall together with its weight can be transferred to the surrounding soil through a combination of adhesion (side friction) and end bearing. Thick types of excavation support walls, such as slurry walls, drilled-in-place soldier piles, and tangent piles, are much more effective than thinner walls, such as sheet piles or driven soldier piles, in carrying the live loads to the bearing stratum.

Decking often consists of deck framing and roadway decking. Figure 5-14 depicts a typical general arrangement for street decking over a cut-and-cover excavation using timber decking. Pre-cast concrete planks have been used also as decking. Structural steel deck beams can be arranged to function also as the uppermost bracing tier of the support of excavation. The deck framing should be designed for AASHTO HL-93 loading, or for loading due to construction equipment that actually will operate on the deck, whichever is greater.

## **5.9 UTILITY RELOCATION AND SUPPORT**

### **5.9.1 Types of Utilities**

Constructing cut and cover tunnels in urban areas often encounters public and private utility lines such as water, sewer, power, communication, etc... Often, utilities are not located where indicated on existing utility information. Therefore, it is important to identify and locate all utilities in the field prior to excavation. Great care must be taken when excavating in the vicinity of utilities, sometimes requiring that the final excavation to expose them be done by hand. Of particular concern are those utilities that are movement-sensitive and those carrying hazardous substances; these include large diameter water pipes, high pressure gas lines, fiber optic lines, petroleum pipes and high voltage cables. Some utilities such as

buried high voltage lines are not only extremely expensive to move but have very long lead times. Utilities such as sewers can present a different problem; if gravity flow is used, diversions around a proposed tunnel may pose a serious challenge. Some older water and sewer lines are extremely fragile, particularly if they are of brick or cast iron construction.

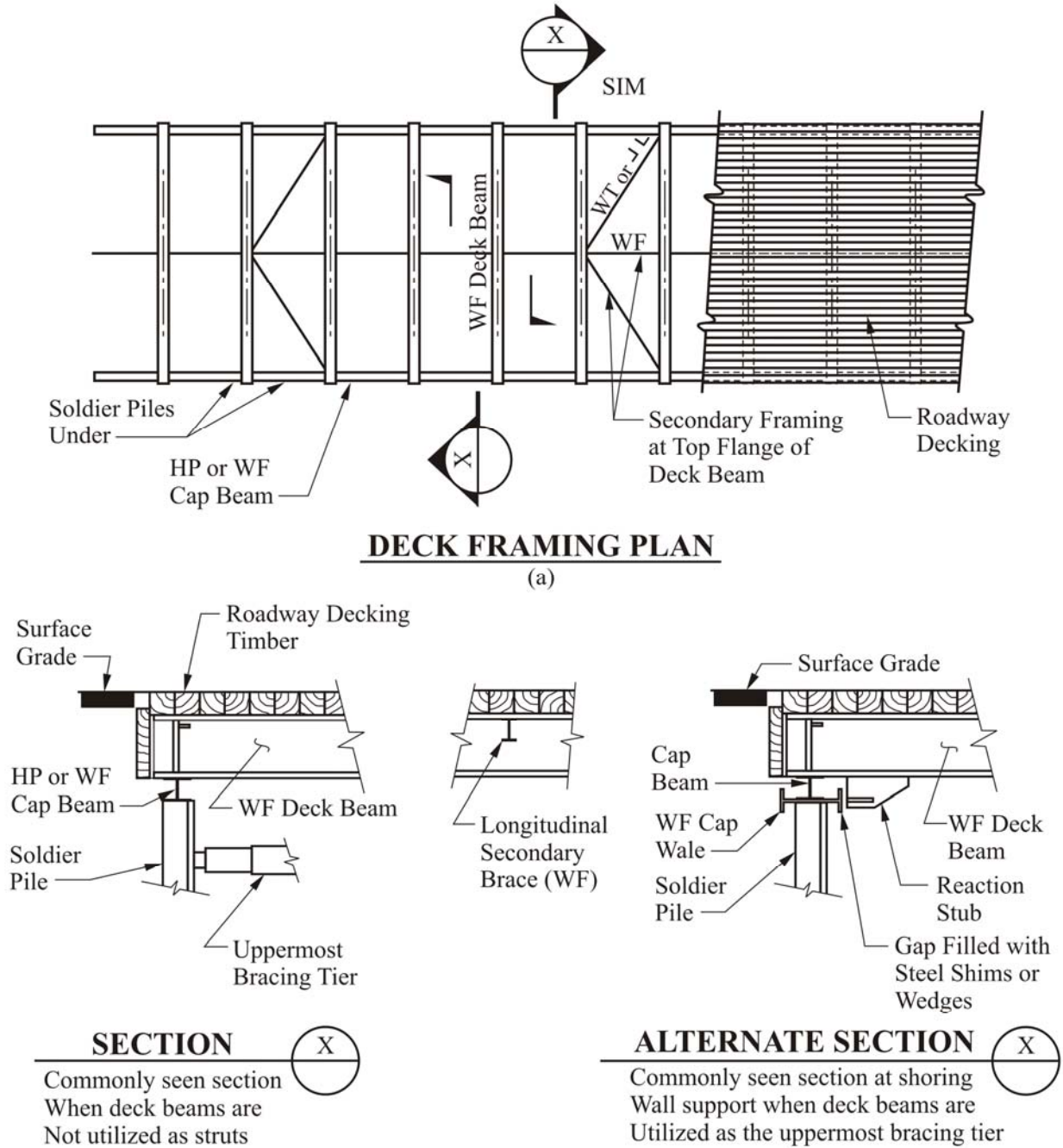

Figure 5-14 Typical Street Decking (After Bickel et al., 1996)

## 5.9.2 General Approach to Utilities during Construction

It is not uncommon to divert utilities away from the proposed construction corridor. However, diversion is not always possible, it may be too expensive, or a utility crossing may be unavoidable; in such cases, it will be necessary to support the utilities in place. It is essential to have a coordinated effort so that no interferences among the various utilities occurs and that the construction can be done while the utilities are in place. Sometimes, utility relocations are done in stages to accommodate the construction requiring relocating the utility more than once.

Before the start of underground construction, a condition survey should be made of all utilities within the zone of potential influence of construction, making detailed reports for those that may incur movements in excess of those allowable for the utility. The nature of any work required for each utility should be identified, i.e., protection, support or relocation, and the date by which action is required. It is essential that all utilities that need action are identified in sufficient time to allow the construction to progress as programmed.

Supports may either be temporary or permanent. Depending upon the sensitivity of the utility being supported, it may be necessary to provide instrumentation to monitor any movement so that remedial action can be taken before damage occurs. Systems providing vertical support should be designed as bridge structures. Lateral support may be considered as retaining walls.

Most utilities require access for repairs; it is therefore required to have provisions for access to utilities passing beneath a tunnel. In some cases, it has been found appropriate to relocate utilities to a trough or utility tunnel in which all utilities can be easily accessed. In some cases, utilities cannot be raised sufficiently to clear the tunnel roof slab; it may be possible to create a narrow trough across the roof in which the utility may be relocated. In certain situations, utilities were passed through the tunnel by providing a special conduit below the tunnel roof. In all cases, all utility work must be carefully coordinated with the utility owner.

## **CHAPTER 6**

### **ROCK TUNNELING**

#### **6.1 INTRODUCTION**

Chapters 6 through 10 present design recommendations and requirements for mined and bored road tunnels in all types of grounds. Chapter 6 addresses analysis, design and construction issues for rock tunneling including rock failure mechanism, rock mass classification, excavation methods, excavation supports, and design considerations for permanent lining, groundwater control, and other ground control measures. Chapter 10 addresses the design of various types of permanent lining applicable for rock tunnels.

Because of the range of behavior of tunnels in rock, i.e., from a coherent continuum to a discontinuum, stabilization measures range from no support to bolts to steel sets to heavily reinforced concrete lining and numerous variations and combinations in between. Certainly these variations are to be expected when going from one tunnel to another but often several are required in a single tunnel because the geology and/or the geometry change. Thus, the engineer must recognize the need for change and prepare the design to allow for adjustments to be made in the field to adjust construction means, methods, and equipment to the challenges presented by the vagaries of nature. This chapter provides the engineer with the basic tools to approach the design, it is not a cookbook that attempts to give instantaneous solutions/designs for the novice designer.

The data needed for analysis and design rock tunnels and the investigative techniques to obtain the data are discussed in Chapter 3. The results of the analysis and design presented hereafter are typically presented in the geotechnical/technical design memorandum (Chapter 4) and form the basis of the Geotechnical Baseline Report (Chapter 4). Readers are referred to Chapter 7 for tunneling issues in soft ground. Problematic ground condition such as running sand and very soft clays are discussed in Chapter 8. Mining sequentially based on the sequential excavation method (SEM) principles is discussed in Chapter 9.

#### **6.2 ROCK FAILURE MECHANISM**

Only in the last half-century has rock mechanics evolved into a discipline of its own rather than being a sub-set of soil mechanics. At the same time there was a “merging of elastic theory, which dominated the English language literature on the subject, with the discontinuum approach of the Europeans” (Hoek, 2000). These two phenomena have also occurred during a time of ever-increasing demand for economical tunnels. Hence, design and construction of rock tunnels have taken on a new impetus and importance in the overall field of heavy construction as it applies to infrastructure.

Understanding the failure mechanism of a rock mass surrounding an underground opening is essential in the design of support systems for the openings. The failure mechanism depends on the in situ stress level and characteristics of the given rock mass. At shallow depths, where the rock mass is blocky and jointed, the stability problems are generally associated with gravity falls of wedges from the roof and sidewalls since the rock confinement is generally low. As the depth below the ground surface increases, the rock stress increases and may reach a level at which the failure of the rock mass is induced. This rock mass failure can include spalling, slabbing, and major rock burst.

Conversely, excavation of an underground opening in an unweathered massive rock mass may be the most ideal condition. When this condition, paired together with relatively low stresses, exists, the

excavation will usually not suffer from serious stability problems, thus support requirement will be minimal.

### 6.2.1 Wedge Failure

Due to the size of tunnel openings (relative to the rock joint spacing) in most infrastructure applications, the rock around the tunnel tends to act more like a discontinuum. Behavior of a tunnel in a continuous material depends on the intrinsic strength and deformation properties of that material whereas behavior of a tunnel in a discontinuous material depends on the character and spacing of the discontinuities. Design of the former lends itself more naturally to analytical modeling (similar to most tunnels in soil) whereas design of the latter requires consideration of possible block or wedge movement or failure wherein the design approach is to hold the rock mass together. By doing so, the rock is forced to form a “ground arch” around the opening and hence to redistribute the forces such that the ground itself carries most of the “load”.

To stabilize blocks or wedges, and hence the opening, the first step is to determine the number, orientations and conditions of the joints. The Q system, described in 6.3.4 gives the basic information required for the joint sets:

- Number of joints
- Joint roughness
- Joint alteration
- Joint water condition
- Joint stress condition

With these parameters defined, analyses can be made of the block or wedge stability and of the support required to increase that stability to a satisfactory level. For small tunnels of ordinary geometry the initial analysis (if not the final) can be estimated from a simple free-body approach.

For larger tunnels with complicated geometry and/or a more complicated joint system, it is recommended that a computer program such as Unwedge be used to analyze the opening. Once the basic parameters of the problem are input to the program, a series of runs can be made to evaluate the impact of such variations on the calculated support required for the opening. A design practice using Unwedge will be introduced in Section 6.6.2.

As indicated earlier, except for a small tunnel in very massive rock, the concept of “solid rock” is usually a misconception. As a result, the behavior of the ground around a rock tunnel is usually the combination of that of a blocky medium and a continuum. Hence, the “loads” on the tunnel support system are usually erratic and nonuniform. This is in contrast to soft ground tunnels where the ground may sometimes be approximated by elastic or elastic-plastic assumptions or where the parameters going into numerical modeling are significantly more amenable to rational approximations.

In its simplest terms the challenge to supporting a tunnel in rock is to prevent the natural tendency of the rock to “unravel”. Most failures in rock tunnels are initiated by a block (called “keyblocks” by Goodman, 1980) that wants to loosen and come out. When that block succeeds, others tend to loosen and follow. This can continue until the tunnel completely collapses or until the geometry and stress conditions come to equilibrium and the unraveling stops. Contrarily, if that first block can be held in place the stresses rearrange themselves into the ground arch around the tunnel and stability is attained. Figure 6-1 illustrates how detrimental blocky behavior propagates while Figure 6-2 shows how holding the key block in place can stabilize the opening (After Deere 1969).



## 6.2.2 Stress Induced Failure

As the depth of a tunnel becomes greater or where adjacent underground structures exist and the ground condition becomes less favorable, the stress within the surrounding rock mass increases and failure occurs when the stress exceeds the strength of the rock mass. This failure can range from minor spalling or slabbing in the rock surface to an explosive rockburst where failure of a significant volume of rock mass occurs.



- Step 1- Block A drops down
- Step 2- Block B rotates counterclockwise and drops out
- Step 3- Block C rotates counterclockwise and drops out
- Step 4- Block D drops out followed by block E
- Step 5- Block E drops out followed by block F
- Step 6- Block F rotates clockwise and drops out

Figure 6-1 Progressive Failure in Unsupported Blocky Rock

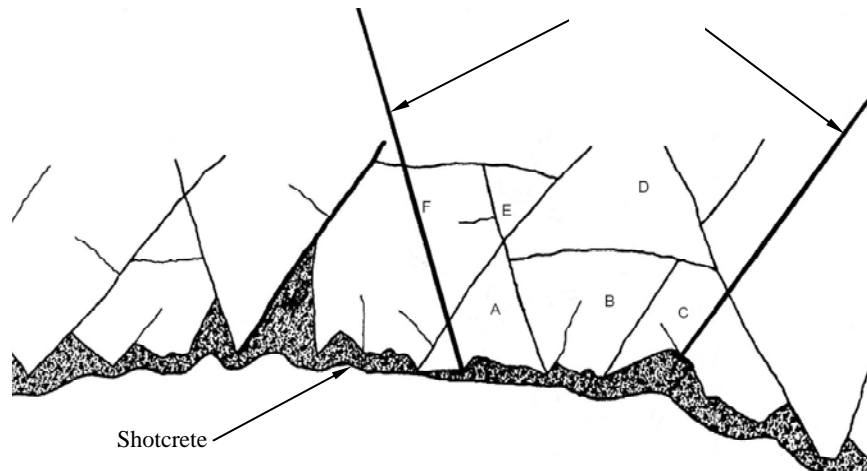

- Step 1- Block A and C are held in place by rock bolts and shotcrete
- Step 2- Block B is held in place by Blocks A and C
- Step 3- Block D is held in place by Blocks A, B, and C
- Step 4- Blocks E and F are held in place by Blocks A, B, and D assisted by rock bolts and shotcrete

Figure 6-2 Prevention of Progressive Failure in Supported Blocky Rock

The stress induced failure potential can be investigated using the strength factor (SF) against shear failure defined as  $(\sigma_{1f} - \sigma_3) / (\sigma_1 - \sigma_3)$ , where  $(\sigma_{1f} - \sigma_3)$  is the strength of the rock mass and  $(\sigma_1 - \sigma_3)$  is the

induced stress,  $\sigma_1$  and  $\sigma_3$  are major and minor principal stresses, and  $\sigma_{1f}$  is major principal stress at failure. A SF greater than 1.0 indicates that the rock mass strength is greater than the induced stress, i.e., there is no overstress in the rock mass. When SF is less than 1.0, the induced stresses are greater than the rock mass strength, and the rock mass is overstressed and likely to behave in the plastic range.

### 6.2.3 Squeezing and Swelling

Squeezing rock is associated with the creation of a plastic region around an opening and severe face instability. From a tunnel design point of view, a rock mass is considered to be weak when its in-situ uniaxial compressive strength is significantly lower than the natural and excavation induced stresses acting upon the rock mass surrounding a tunnel. Hoek et. al. (2000) proposed a chart to predict squeezing problems based on strains with no support system as shown in Figure 6-3. As a very approximate and simple estimation, Figure 6-3 can be directly used to predict squeezing potential by comparing rock mass strength and in-situ stress. If finite element analysis results are available, one can simply predict the squeezing potential based on the calculated strains from the FE analysis. For example, the squeezing problems, if a tunnel is excavated at the proposed depth, are severe when the calculated strains from FE analysis is 2.5% or higher. It should be noted that strains in Figure 6-3 are based on tunnels with no support installed.

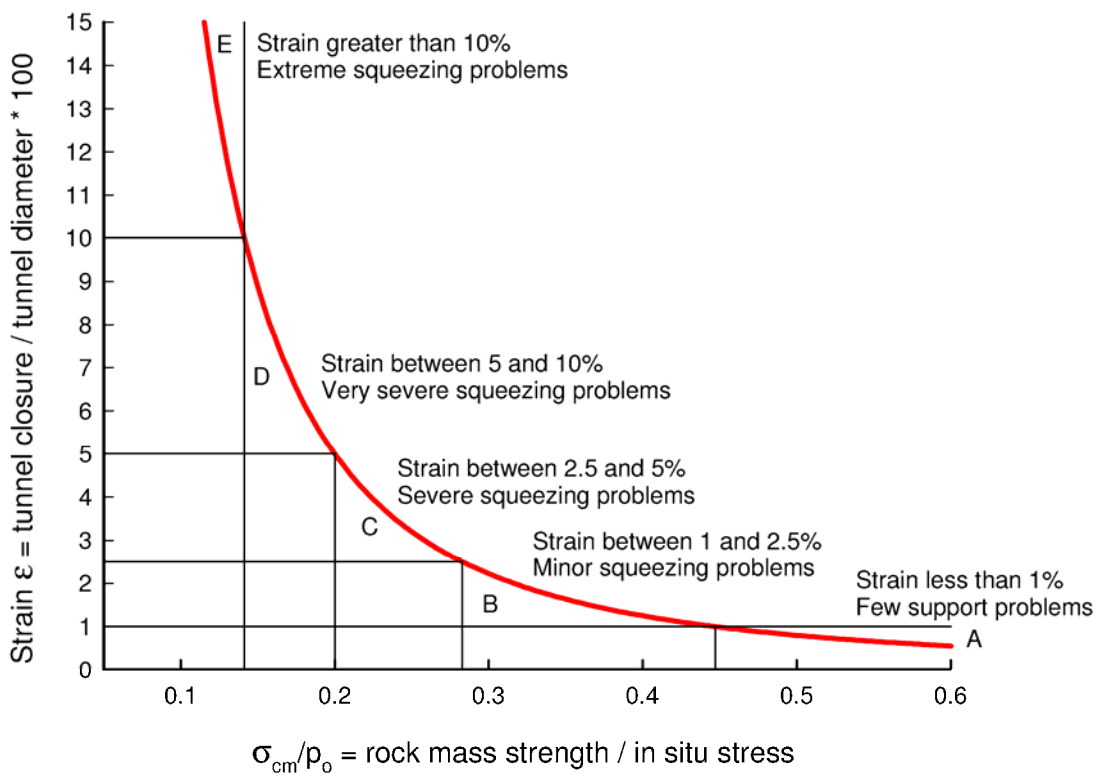

Figure 6-3 A Relationship between Strain and Squeezing Potential of Rock Mass (Hoek, et. al., 2000)

Swelling rock, in comparison, is associated with an increase in moisture content of the rock. Swelling rock can sometimes be associated with squeezing rock, but may occur without formation of a plastic zone. The swelling is usually associated with clay minerals, indurated to shale or slate or not, imbibing water and expanding. A relatively simple swell test in the laboratory will allow prediction of the swell and will

also provide the “swelling pressure”, where the swelling pressure is defined as that pressure that must be applied to the rock to arrest the swelling. Obviously, the support system has to resist at least the full swelling pressure to arrest the swelling movement. Montmorillinitic shales, weathered nontronite basalts, and some salts found in evaporate deposits are typical swelling rocks. Chapter 8 provides more detailed discussions about problematic squeezing and swelling ground.

## 6.3 ROCK MASS CLASSIFICATIONS

### 6.3.1 Introduction

Rock mass classification schemes have been developed to assist in (primarily) the collection of rock into common or similar groups. The first truly organized system was proposed by Dr. Karl Terzaghi (1946) and has been followed by a number of schemes proposed by others. Terzaghi’s system was mainly qualitative and others are more quantitative in nature. The following subsections explain three systems and show how they can be used to begin to develop and apply numerical ratings to the selection of rock tunnel support and lining. This section discusses various rock mass classification systems mainly used for rock tunnel design and construction projects.

### 6.3.2 Terzaghi’s Classification

Today rock tunnels are usually designed considering the interaction between rock and ground, i.e., the redistribution of stresses into the rock by forming the rock arch. However, the concept of loads still exists and may be applied early in a design to “get a handle” on the support requirement. The concept is to provide support for a height of rock (rock load) that tends to drop out of the roof of the tunnel (Terzaghi, 1946). Terzaghi’s qualitative descriptions of rock classes are summarized in Table 6-1.

**Table 6-1 Terzaghi’s Rock Mass Classification**

| <b>Rock Condition</b>   | <b>Descriptions</b>   |
|-------------------------|---|
| Intact rock             | Contains neither joints nor hair cracks. Hence, if it breaks, it breaks across sound rock. On account of the injury to the rock due to blasting, spalls may drop off the roof several hours or days after blasting. This is known as a spalling condition. Hard, intact rock may also be encountered in the popping condition involving the spontaneous and violent detachment of rock slabs from the sides or roof |
| Stratified rock         | Consists of individual strata with little or no resistance against separation along the boundaries between the strata. The strata may or may not be weakened by transverse joints. In such rock the spalling condition is quite common  |
| Moderately jointed rock | Contains joints and hair cracks, but the blocks between joints are locally grown together or so intimately interlocked that vertical walls do not require lateral support. In rocks of this type, both spalling and popping conditions may be encountered   |
| Blocky and seamy rock   | Consists of chemically intact or almost intact rock fragments which are entirely separated from each other and imperfectly interlocked. In such rock, vertical walls may require lateral support  |
| Continued on next page  |   |

**Table 6-1 (Continued) Terzaghi's Rock Mass Classification**

| <b>Rock Condition</b>              | <b>Descriptions</b>   |
|------------------------------------|---|
| Crushed but chemically intact rock | Has the character of crusher run. If most or all of the fragments are as small as fine sand grains and no recementation has taken place, crushed rock below the water table exhibits the properties of a water-bearing sand           |
| Squeezing rock                     | Slowly advances into the tunnel without perceptible volume increase. A prerequisite for squeeze is a high percentage of microscopic and sub-microscopic particles of micaceous minerals or clay minerals with a low swelling capacity |
| Swelling rock                      | Advances into the tunnel chiefly on account of expansion. The capacity to swell seems to be limited to those rocks that contain clay minerals such as montmorillonite, with a high swelling capacity                                  |

### 6.3.3 RQD

In 1966 Deere and Miller developed the Rock Quality Designation index (RQD) to provide a systematic method of describing rock mass quality from the results of drill core logs. Deere described the RQD as the length (as a percentage of total core length) of intact and sound core pieces that are 4 inches (10 cm) or more in length. Several proposed methods of using the RQD for design of rock tunnels have been developed. However, the major use of the RQD in modern tunnel design is as a major factor in the Q or RMR rock mass classification systems described in the following sub-sections. Readers are referred to Subsurface Investigation Manual (FHWA, 2002) for more details.

### 6.3.4 Q System

On the basis of an evaluation of a large number of case histories of underground excavations, Barton et al. (1974) of the Norwegian Geotechnical Institute proposed a Tunneling Quality Index (Q) for the determination of rock mass characteristics and tunnel support requirements. According to its developer: "The traditional application of the six-parameter Q-value in rock engineering is for selecting suitable combinations of shotcrete and rock bolts for rock mass reinforcement, and mainly for civil engineering projects". The numerical value of the index Q varies on a logarithmic scale from 0.001 to a maximum of 1,000 and is estimated from the following expression (Barton, 2002):

$$Q = \left[ \frac{RQD}{J_n} \right] \times \left[ \frac{J_r}{J_a} \right] \times \left[ \frac{J_w}{SRF} \right] \quad 6-1$$

Where *RQD* is Rock Quality Designation, *J<sub>n</sub>* is joint set number, *J<sub>r</sub>* is joint roughness number, *J<sub>a</sub>* is joint alteration number, *J<sub>w</sub>* is joint water reduction factor, and *SRF* is stress reduction factor. It should be noted that *RQD/J<sub>n</sub>* is a measure of block size, *J<sub>r</sub>/J<sub>a</sub>* is a measure of joint frictional strength, and *J<sub>w</sub>/SRF* is a measure of joint stress.

Table 6-2 (6-2.1 through 6-2) gives the classification of individual parameters used to obtain the Tunneling Quality Index Q for a rock mass. It is to be noted that Barton has incorporated evaluation of more than 1,000 tunnels in developing the Q system.

**Table 6-2 Classification of Individual Parameters for Q System (after Barton et al, 1974)**

| DESCRIPTION   | VALUE                   | NOTES   |
|---|-------------------------|---|
| <b>1. ROCK QUALITY DESIGNATION</b>  | <b>RQD</b>              |   |
| A. Very poor  | 0 - 25                  | 1. Where RQD is reported or measured as $\leq 10$ (including 0), a nominal value of 10 is used to evaluate Q.   |
| B. Poor   | 25 - 50                 |   |
| C. Fair   | 50 - 75                 |   |
| D. Good   | 75 - 90                 | 2. RQD intervals of 5, i.e. 100, 95, 90 etc. are sufficiently accurate.   |
| E. Excellent  | 90 - 100                |   |
| <b>2. JOINT SET NUMBER</b>  | <b><math>J_n</math></b> |   |
| A. Massive, no or few joints  | 0.5 - 1.0               |   |
| B. One joint set  | 2                       |   |
| C. One joint set plus random  | 3                       |   |
| D. Two joint sets   | 4                       |   |
| E. Two joint sets plus random   | 6                       |   |
| F. Three joint sets   | 9                       | 1. For intersections use $(3.0 \times J_n)$   |
| G. Three joint sets plus random   | 12                      |   |
| H. Four or more joint sets, random, heavily jointed, 'sugar cube', etc.   | 15                      | 2. For portals use $(2.0 \times J_n)$   |
| J. Crushed rock, earthlike  | 20                      |   |
| <b>3. JOINT ROUGHNESS NUMBER</b>  | <b><math>J_r</math></b> |   |
| <b>a. Rock wall contact</b>   |                         |   |
| <b>b. Rock wall contact before 10 cm shear</b>  |                         |   |
| A. Discontinuous joints   | 4                       |   |
| B. Rough and irregular, undulating  | 3                       |   |
| C. Smooth undulating  | 2                       |   |
| D. Slickensided undulating  | 1.5                     | 1. Add 1.0 if the mean spacing of the relevant joint set is greater than 3 m.   |
| E. Rough or irregular, planar   | 1.5                     |   |
| F. Smooth, planar   | 1.0                     |   |
| G. Slickensided, planar   | 0.5                     | 2. $J_r = 0.5$ can be used for planar, slickensided joints having lineations, provided that the lineations are oriented for minimum strength.                     |
| <b>c. No rock wall contact when sheared</b>   |                         |   |
| H. Zones containing clay minerals thick enough to prevent rock wall contact   | 1.0<br>(nominal)        |   |
| J. Sandy, gravely or crushed zone thick enough to prevent rock wall contact   | 1.0<br>(nominal)        |   |
| <b>4. JOINT ALTERATION NUMBER</b>   | <b><math>J_a</math></b> | $\phi_r$ degrees (approx.)  |
| <b>a. Rock wall contact</b>   |                         |   |
| A. Tightly healed, hard, non-softening, impermeable filling   | 0.75                    | 1. Values of $\phi_r$ , the residual friction angle, are intended as an approximate guide to the mineralogical properties of the alteration products, if present. |
| B. Unaltered joint walls, surface staining only   | 1.0                     | 25 - 35   |
| C. Slightly altered joint walls, non-softening mineral coatings, sandy particles, clay-free disintegrated rock, etc.  | 2.0                     | 25 - 30   |
| D. Silty-, or sandy-clay coatings, small clay-fraction (non-softening)  | 3.0                     | 20 - 25   |
| E. Softening or low-friction clay mineral coatings, i.e. kaolinite, mica. Also chlorite, talc, gypsum and graphite etc., and small quantities of swelling clays. (Discontinuous coatings, 1 - 2 mm or less) | 4.0                     | 8 - 16  |

**Table 6-2 (Continued) Classification of Individual Parameters for Q System**

| <b>4. JOINT ALTERATION NUMBER</b>   | $J_a$       | $\phi$ or degrees (approx.)                   |  |
|---|-------------|---|--|
| <b>b. Rock wall contact before 10 cm shear</b>  |             |   |  |
| F. Sandy particles, clay-free, disintegrating rock etc.   | 4.0         | 25 - 30                                       |  |
| G. Strongly over-consolidated, non-softening clay mineral fillings (continuous < 5 mm thick)  | 6.0         | 16 - 24                                       |  |
| H. Medium or low over-consolidation, softening clay mineral fillings (continuous < 5 mm thick)  | 8.0         | 12 - 16                                       |  |
| J. Swelling clay fillings, i.e. montmorillonite, (continuous < 5 mm thick). Values of $J_a$ depend on percent of swelling clay-size particles, and access to water. | 8.0 - 12.0  | 6 - 12  |  |
| <b>c. No rock wall contact when sheared</b>   |             |   |  |
| K. Zones or bands of disintegrated or crushed   | 6.0         |   |  |
| L. rock and clay (see G, H and J for clay   | 8.0         |   |  |
| M. conditions)  | 8.0 - 12.0  | 6 - 24  |  |
| N. Zones or bands of silty- or sandy-clay, small clay fraction, non-softening   | 5.0         |   |  |
| O. Thick continuous zones or bands of clay  | 10.0 - 13.0 |   |  |
| P. & R. (see G.H and J for clay conditions)   | 6.0 - 24.0  |   |  |
| <b>5. JOINT WATER REDUCTION</b>   | $J_w$       | approx. water pressure (kgf/cm <sup>2</sup> ) |  |
| A. Dry excavation or minor inflow i.e. < 5 l/m locally  | 1.0         | < 1.0   |  |
| B. Medium inflow or pressure, occasional outwash of joint fillings  | 0.66        | 1.0 - 2.5                                     |  |
| C. Large inflow or high pressure in competent rock with unfilled joints   | 0.5         | 2.5 - 10.0                                    | 1. Factors C to F are crude estimates; increase $J_w$ if drainage installed.   |
| D. Large inflow or high pressure  | 0.33        | 2.5 - 10.0                                    |  |
| E. Exceptionally high inflow or pressure at blasting, decaying with time  | 0.2 - 0.1   | > 10  | 2. Special problems caused by ice formation are not considered.  |
| F. Exceptionally high inflow or pressure  | 0.1 - 0.05  | > 10  |  |
| <b>6. STRESS REDUCTION FACTOR</b>   |             | <b>SRF</b>                                    |  |
| <b>a. Weakness zones intersecting excavation, which may cause loosening of rock mass when tunnel is excavated</b>   |             |   |  |
| A. Multiple occurrences of weakness zones containing clay or chemically disintegrated rock, very loose surrounding rock any depth)                                  |             | 10.0  | 1. Reduce these values of SRF by 25 - 50% but only if the relevant shear zones influence do not intersect the excavation |
| B. Single weakness zones containing clay, or chemically disintegrated rock (excavation depth < 50 m)  |             | 5.0   |  |
| C. Single weakness zones containing clay, or chemically disintegrated rock (excavation depth > 50 m)  |             | 2.5   |  |
| D. Multiple shear zones in competent rock (clay free), loose surrounding rock (any depth)   |             | 7.5   |  |
| E. Single shear zone in competent rock (clay free). (depth of excavation < 50 m)  |             | 5.0   |  |
| F. Single shear zone in competent rock (clay free). (depth of excavation > 50 m)  |             | 2.5   |  |
| G. Loose open joints, heavily jointed or 'sugar cube', (any depth)  |             | 5.0   |  |

**Table 6-2 (Continued) Classification of Individual Parameters for Q System**

| DESCRIPTION  | VALUE               |                     | NOTES   |
|--|---------------------|---------------------|---|
| <b>6. STRESS REDUCTION FACTOR</b>  |                     |                     | <b>SRF</b>  |
| <i>b. Competent rock, rock stress problems</i>   |                     |                     |   |
|  | $\sigma_c/\sigma_1$ | $\sigma_t/\sigma_1$ | 2. For strongly anisotropic virgin stress field   |
| H. Low stress, near surface  | > 200               | > 13                | (if measured): when $5 \leq \sigma_1/\sigma_3 \leq 10$ , reduce $\sigma_c$  |
| J. Medium stress   | 200 - 10            | 13 - 0.66           | to $0.8\sigma_c$ and $\sigma_t$ to $0.8\sigma_t$ . When $\sigma_1/\sigma_3 > 10$ ,  |
| K. High stress, very tight structure<br>(usually favourable to stability, may<br>be unfavourable to wall stability)  | 10 - 5              | 0.66 - 0.33         | reduce $\sigma_c$ and $\sigma_t$ to $0.6\sigma_c$ and $0.6\sigma_t$ , where<br>$\sigma_c$ = unconfined compressive strength, and<br>$\sigma_t$ = tensile strength (point load) and $\sigma_1$ and<br>$\sigma_3$ are the major and minor principal stresses. |
| L. Mild rockburst (massive rock)   | 5 - 2.5             | 0.33 - 0.16         | 5 - 10  |
| M. Heavy rockburst (massive rock)  | < 2.5               | < 0.16              | 10 - 20   |
| <i>c. Squeezing rock, plastic flow of incompetent rock<br/>under influence of high rock pressure</i>   |                     |                     |   |
| N. Mild squeezing rock pressure  |                     |                     | 5 - 10  |
| O. Heavy squeezing rock pressure   |                     |                     | 10 - 20   |
| <i>d. Swelling rock, chemical swelling activity depending on presence of water</i>   |                     |                     |   |
| P. Mild swelling rock pressure   |                     |                     | 5 - 10  |
| R. Heavy swelling rock pressure  |                     |                     | 10 - 15   |
| <b>ADDITIONAL NOTES ON THE USE OF THESE TABLES</b>   |                     |                     |   |
| When making estimates of the rock mass Quality (Q), the following guidelines should be followed in addition to the notes listed in the tables:   |                     |                     |   |
| 1. When borehole core is unavailable, RQD can be estimated from the number of joints per unit volume, in which the number of joints per metre for each joint set are added. A simple relationship can be used to convert this number to RQD for the case of clay free rock masses: $RQD = 115 - 3.3 J_v$ (approx.), where $J_v$ = total number of joints per $m^3$ ( $0 < RQD < 100$ for $35 > J_v > 4.5$ ).   |                     |                     |   |
| 2. The parameter $J_r$ representing the number of joint sets will often be affected by foliation, schistosity, slaty cleavage or bedding etc. If strongly developed, these parallel 'joints' should obviously be counted as a complete joint set. However, if there are few 'joints' visible, or if only occasional breaks in the core are due to these features, then it will be more appropriate to count them as 'random' joints when evaluating $J_r$ .  |                     |                     |   |
| 3. The parameters $J_r$ and $J_a$ (representing shear strength) should be relevant to the weakest significant joint set or clay filled discontinuity in the given zone. However, if the joint set or discontinuity with the minimum value of $J_r/J_a$ is favourably oriented for stability, then a second, less favourably oriented joint set or discontinuity may sometimes be more significant, and its higher value of $J_r/J_a$ should be used when evaluating Q. The value of $J_r/J_a$ should in fact relate to the surface most likely to allow failure to initiate. |                     |                     |   |
| 4. When a rock mass contains clay, the factor SRF appropriate to loosening loads should be evaluated. In such cases the strength of the intact rock is of little interest. However, when jointing is minimal and clay is completely absent, the strength of the intact rock may become the weakest link, and the stability will then depend on the ratio rock-stress/rock-strength. A strongly anisotropic stress field is unfavourable for stability and is roughly accounted for as in note 2 in the table for stress reduction factor evaluation.                         |                     |                     |   |
| 5. The compressive and tensile strengths ( $\sigma_c$ and $\sigma_t$ ) of the intact rock should be evaluated in the saturated condition if this is appropriate to the present and future in situ conditions. A very conservative estimate of the strength should be made for those rocks that deteriorate when exposed to moist or saturated conditions.  |                     |                     |   |

Evaluation of these Q-parameters and the use of Table 6-2 can be illustrated considering a reach of tunnel with the following properties:

| Parameter                    | Description   | Value        | Table |
|------------------------------|---|--------------|-------|
| RQD                          | 75 to 90  | $RQD = 80$   | 6-2.1 |
| Joint Sets                   | Two joint sets plus random joints   | $J_n = 6$    | 6-2.2 |
| Joint roughness              | Smooth, undulating  | $J_r = 2$    | 6-2.3 |
| Joint alteration             | Slightly altered joint walls, non-softening mineral coatings, sandy particles, clay-free disintegrated rock, etc. | $J_a = 2$    | 6-2.4 |
| Joint water reduction factor | Medium inflow with occasional outwash of joint fillings   | $J_w = 0.66$ | 6-2.5 |
| Stress reduction factor      | Medium stress, favorable stress condition   | $SRF = 1.0$  | 6-2.6 |

With the parameters established,  $Q$  is calculated:

$$Q = \left[ \frac{RQD}{J_n} \right] \times \left[ \frac{J_r}{J_a} \right] \times \left[ \frac{J_w}{SRF} \right] = \frac{80}{6} \times \frac{2}{2} \times \frac{0.66}{1} = 9$$

Refer to Figure 6-25 for guidance in using  $Q$  to select excavation support. It should be noted, however, that “the  $Q$ -system has its best applications in jointed rock mass where instability is caused by rock falls. For most other types of ground behavior in tunnels, the  $Q$ -system, like most other empirical (classification) methods has limitations. The  $Q$  support chart gives an indication of the support to be applied, and it should be tempered by sound and practical engineering judgment” (Palmstream and Broch, 2006). The  $Q$ -system was developed from over 1000 tunnel projects, most of which are in Scandinavia and all of which were excavated by drill and blast methods. When excavation is by TBM there is considerably less disturbance to the rock than there is with drill and blast. Based upon study of a much smaller data base (Barton, 1991) it is recommended that the  $Q$  for TBM excavation be increased by a factor of 2 for  $Q$ s between 4 and 30.

### 6.3.5 Rock Mass Rating (RMR) System

Z.T. Bieniawski (1989) has developed the Rock Mass Rating (RMR) system somewhat along the same lines as the  $Q$  system. The RMR uses six parameters, as follows:

- Uniaxial compressive strength of rock
- RQD
- Spacing of discontinuities
- Condition of discontinuities
- Groundwater condition
- Orientation of discontinuities

The ratings for each of these parameters are obtained from Table 6-3. The sum of the six parameters becomes the basic RMR value as demonstrated in the following example. Table 6-9 presents how the RMR can be applied to determining support requirements for a tunnel with a 33 ft (10 m) width span.

Determination of the RMR value using Table 6-3 can be demonstrated in the following example:

| Parameter                    | Description                        | Table 6-3 | Value     |
|------------------------------|------------------------------------|-----------|-----------|
| Rock Strength                | 20,000 psi = 138 MPa               | A1        | 12        |
| RQD                          | 75 to 90                           | A2        | 17        |
| Spacing of Discontinuities   | 4 ft -- 1.2M                       | A3        | 15        |
| Condition of Discontinuities | Slightly rough, slightly weathered | A4        | 25        |
| Groundwater                  | Dripping                           | A5        | 4         |
| Discontinuity Orientation    | Fair                               | B         | -5        |
| <i>Total Rating</i>          | <i>Class II, Good Rock</i>         | <i>C</i>  | <i>68</i> |



**Table 6-3 Rock Mass Rating System (After Bieniawski, 1989)**

| A. CLASSIFICATION PARAMETERS AND THEIR RATINGS                        |                                      |   |  |  |  |   |   |         |         |
|---|--------------------------------------|---|--|--|--|---|---|---------|---------|
| Parameter   |                                      | Range of values   |  |  |  |   |   |         |         |
| 1   | Strength of intact rock material     | Point-load strength index   | >10 MPa  | 4-10 MPa   | 2-4 MPa  | 1-2 MPa   | For this low range - uniaxial compressive test is preferred |         |         |
|   |                                      | Uniaxial comp. strength   | >250 MPa   | 100-250 MPa  | 50-100 MPa   | 25-50 MPa   | 5-25 MPa  | 1-5 MPa | < 1 MPa |
|   | Rating                               | 15  | 12   | 7  | 4  | 2   | 1   | 0       |         |
| 2   | Drill core Quality <i>RQD</i>        | 90%-100%  | 75%-90%  | 50%-75%  | 25%-50%  | < 25%   |   |         |         |
|   | Rating                               | 20  | 17   | 13   | 8  | 3   |   |         |         |
| 3   | Spacing of discontinuities           | > 2 m   | 0.6-2 . m  | 200-600 mm   | 60-200 mm  | < 60 mm   |   |         |         |
|   | Rating                               | 20  | 15   | 10   | 8  | 5   |   |         |         |
| 4   | Condition of discontinuities (See E) | Very rough surfaces<br>Not continuous<br>No separation<br>Unweathered wall rock | Slightly rough surfaces<br>Separation < 1 mm<br>Slightly weathered walls | Slightly rough surfaces<br>Separation < 1 mm<br>Highly weathered walls | Slickensided surfaces<br>or<br>Gouge < 5 mm thick<br>or<br>Separation 1-5 mm<br>Continuous | Soft gouge >5 mm thick<br>or<br>Separation > 5 mm<br>Continuous |   |         |         |
|   |                                      | Rating  | 30   | 25   | 20   | 10  | 0   |         |         |
| 5   | Ground water                         | Inflow per 10 m tunnel length (l/m)   | None   | < 10   | 10-25  | 25-125  | > 125   |         |         |
|   |                                      | (Joint water press)/ (Major principal $\sigma$ )                                | 0  | < 0.1  | 0.1,-0.2   | 0.2-0.5   | > 0.5   |         |         |
|   | General conditions                   | Completely dry  | Damp   | Wet  | Dripping   | Flowing   |   |         |         |
|   | Rating                               | 15  | 10   | 7  | 4  | 0   |   |         |         |
| B. RATING ADJUSTMENT FOR DISCONTINUITY ORIENTATIONS (See F)           |                                      |   |  |  |  |   |   |         |         |
| Strike and dip orientations   |                                      | Very favourable   | Favourable   | Fair   | Unfavourable   | Very Unfavourable   |   |         |         |
| Ratings   | Tunnels & mines                      | 0   | -2   | -5   | -10  | -12   |   |         |         |
|   | Foundations                          | 0   | -2   | -7   | -15  | -25   |   |         |         |
|   | Slopes                               | 0   | -5   | -25  | -50  |   |   |         |         |
| C. ROCK MASS CLASSES DETERMINED FROM TOTAL RATINGS                    |                                      |   |  |  |  |   |   |         |         |
| Rating  | 100 ← 81                             | 80 ← 61   | 60 ← 41  | 40 ← 21  | < 21   |   |   |         |         |
| Class number  | I                                    | II  | III  | IV   | V  |   |   |         |         |
| Description   | Very good rock                       | Good rock   | Fair rock  | Poor rock  | Very poor rock   |   |   |         |         |
| D. MEANING OF ROCK CLASSES  |                                      |   |  |  |  |   |   |         |         |
| Class number  | I                                    | II  | III  | IV   | V  |   |   |         |         |
| Average stand-up time   | 20 yrs for 15 m span                 | 1 year for 10 m span  | 1 week for 5 m span  | 10 hrs for 2.5 m span  | 30 min for 1 m span  |   |   |         |         |
| Cohesion of rock mass (kPa)   | > 400                                | 300-400   | 200-300  | 100-200  | < 100  |   |   |         |         |
| Friction angle of rock mass (deg)                                     | > 45                                 | 35-45   | 25-35  | 15-25  | < 15   |   |   |         |         |
| E. GUIDELINES FOR CLASSIFICATION OF DISCONTINUITY conditions          |                                      |   |  |  |  |   |   |         |         |
| Discontinuity length (persistence)                                    | < 1 m                                | 1-3 m   | 3-10 m   | 10-20 m  | > 20 m   |   |   |         |         |
| Rating  | 6                                    | 4   | 2  | 1  | 0  |   |   |         |         |
| Separation (aperture)   | None                                 | < 0.1 mm  | 0.1-1.0 mm   | 1-5 mm   | > 5 mm   |   |   |         |         |
| Rating  | 6                                    | 5   | 4  | 1  | 0  |   |   |         |         |
| Roughness   | Very rough                           | Rough   | Slightly rough   | Smooth   | Slickensided   |   |   |         |         |
| Rating  | 6                                    | 5   | 3  | 1  | 0  |   |   |         |         |
| Infilling (gouge)   | None                                 | Hard filling < 5 mm   | Hard filling > 5 mm  | Soft filling < 5 mm  | Soft filling > 5 mm  |   |   |         |         |
| Rating  | 6                                    | 4   | 2  | 2  | 0  |   |   |         |         |
| Weathering  | Unweathered                          | Slightly weathered  | Moderately weathered   | Highly weathered   | Decomposed   |   |   |         |         |
| Rating  | 6                                    | 5   | 3  | 1  | 0  |   |   |         |         |
| F. EFFECT OF DISCONTINUITY STRIKE AND DIP ORIENTATION IN TUNNELLING** |                                      |   |  |  |  |   |   |         |         |
| Strike perpendicular to tunnel axis                                   |                                      |   |  | Strike parallel to tunnel axis   |  |   |   |         |         |
| Drive with dip-Dip 45-90°   |                                      | Drive with dip-Dip 20-45°   |  | Dip 45-90°   |  | Dip 20-45°  |   |         |         |
| Very favourable   |                                      | Favourable  |  | Very favourable  |  | Fair  |   |         |         |
| Drive against dip-Dip 45-90°  |                                      | Drive against dip-Dip 20-45°  |  | Dip 0-20-Irrespective of strike°                                       |  |   |   |         |         |
| Fair  |                                      | Unfavourable  |  | Fair   |  |   |   |         |         |

\*Some conditions are mutually exclusive. For example, if infilling is present, the roughness of the surface will be overshadowed by the influence of the gouge. In such cases use A.4 directly.

\*\*Modified after Wickham et al. (1972).

Bieniawski, Barton and others have suggested various correlations between RMR and other parameters. For the purpose of this manual, the most applicable correlation between Q and RMR is given in:

$$Q = 10^{\frac{RMR-50}{15}} \quad 6-2$$

### 6.3.6 Estimation of Rock Mass Deformation Modulus Using Rock Mass Classification

The in situ deformation modulus of a rock mass is an essential parameter for design, analysis and interpretation of monitored data in any rock tunnel project. Evaluation of the stress and deformation behavior of a jointed rock mass requires that the modulus and strength of intact rock be reduced to account for the presence of discontinuities such as joints, bedding, and foliation planes within the rock mass. Since the in situ deformation modulus of a rock mass is extremely difficult and expensive to measure, engineers tend to estimate it by indirect methods. Several attempts have been made to develop relationships for estimating rock mass deformation modulus using rock mass classifications.

The modulus reduction method using RQD requires the measurement of the intact rock modulus from laboratory tests on intact rock samples and subsequent reduction of the laboratory value incorporating the in-situ rockmass value. The reduction in modulus values is accomplished through a widely used correlation of RQD (Rock Quality Designation) with a modulus reduction ratio,  $E_M/E_L$ , where  $E_L$  represents the laboratory modulus determined from small intact rock samples and  $E_M$  represents the rock mass modulus, as shown in Figure 6-4. This approach is infrequently used directly in modern tunnel final design projects. However, it is still considered to be a good tool for scoping calculations and to validate the results obtained from direct measurement or other methods.

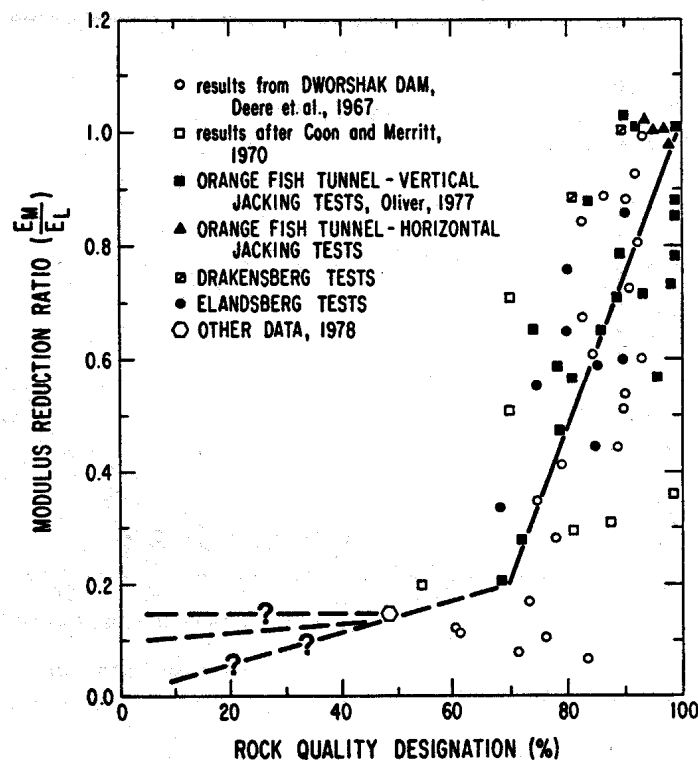

Figure 6-4 Correlation between RQD and Modulus Ratio (Bieniawski, 1984)

Based on the back analyses of a number of case histories, several methods have been propounded to evaluate the in situ rock mass deformation modulus based on rock mass classification. The methods are summarized in Table 6-4.

**Table 6-4 Estimation of Rock Mass Deformation Modulus Using Rock Mass Classification**

| Rock Mass Deformation Modulus (MPa)  | Reference   |
|--|---|
| $E_m = 10^{\frac{(RMR-10)}{40}}$   | Serafim and Pereira (1983)                              |
| $E_m = 25 \text{Log}_{10} Q$   | Barton et. al. (1980, 1992), Grimstad and Barton (1993) |
| $E_m = \sqrt{\frac{\sigma_{ci}}{100}} \cdot 10^{\left(\frac{GSI-10}{40}\right) *}$           | Hoek and Brown (1998)                                   |
| $E_m = 100000 \left[ \frac{1 - D/2}{1 + e^{((75+25D-GSI)/11)}} \right] **$                   | Hoek and Diederichs (2006)                              |
| $E_m = 2RMR - 100$ for $RMR \geq 50$   | Bieniawski (1978)                                       |
| $E_m = E_i / 100 \left[ 0.0028RMR^2 + 0.9 \exp(RMR / 22.82) \right]$ , $E_i = 50 \text{GPa}$ | Nicholson and Bieniawski (1990)                         |
| $E_m = 0.1(RMR/10)^3$  | Read et. al. (1999)                                     |

\* GSI represents Geological Strength Index. The value of GSI ranges from 10, for extremely poor rock mass, to 100 for intact rock. ( $GSI = RMR_{76} = RMR_{89} - 5 = 9 \text{Log}_e Q + 44$ )

\*\* D is a factor which depends upon the degree of disturbance due to blast damage and stress relaxation. It varies from 0 for undisturbed in situ rock masses to 1 for very disturbed rock masses. Guidelines for the selection of D are presented in Table 6-5.





## 6.4 ROCK TUNNELING METHODS

### 6.4.1 Drill and Blast

When mankind first started excavating underground, the choices of tools were extremely limited – bones, antlers, wood and rocks, along with a lot of muscle power. Exactly when and where black powder was first used has been lost in history but it is generally agreed that progress was quite slow until the early 1800's. Then, in the mid 1800's, Alfred Nobel invented dynamite and we began to make significant progress in excavations for mining, civil, and military applications. For the reader who wants to pursue this interesting topic, see Hemphill (1981).

Modern drill and blast excavation for civil projects is still very much related to mining and is a mixture of art and science. The basic approach is to drill a pattern of small holes, load them with explosives, and then detonate those explosives thereby creating an opening in the rock. The blasted and broken rock (muck) is then removed and the rock surface is supported so that the whole process can be repeated as many times as necessary to advance the desired opening in the rock.

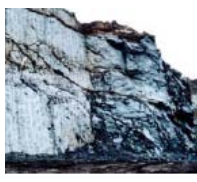
**Table 6-5 Estimation of Disturbance Factor, D**

| Appearance  | Description of Rock Mass  | Suggested Value  |
|---|---|--|
|    | Excellent quality controlled blasting or excavation by Tunnel Boring Machine results in minimal disturbance to the confined rock mass surrounding a tunnel.   | D = 0  |
|    | Mechanical or hand excavation in poor quality rock masses (no blasting results in minimal disturbance to the surrounding rock mass.<br><br>Where squeezing problems result in significant floor heave, disturbance can be severe unless a temporary invert, as shown in the paragraph, is placed. | D = 0<br><br>D = 0.5<br>No invert                                      |
|    | Very poor quality blasting in a hard rock tunnel results in severe local damage, extending 2 or 3m, in the surrounding rock mass.   | D = 0.8  |
|   | Small scale blasting in civil engineering slopes results in modest rock mass damage, particularly if controlled blasting is used as shown on the left hand side of the paragraph. However, stress relief results in some disturbance.   | D = 0.7<br>Good blasting<br><br>D = 1.0<br>Poor blasting               |
|  | Very large open pit mine slopes suffer significant disturbance due to heavy production blasting and also due to stress relief from overburden removal.<br><br>In some softer rocks excavation can be carried out by ripping and dozing and the degree of damage to the slope is less              | D = 1.0<br>Production blasting<br><br>D = 0.7<br>Mechanical excavation |

By its very nature this process leaves a rock surface fractured and disturbed. The disturbance typically extends one to two meters into the rock and can be the initiator of a wedge failure as discussed previously. As a minimum this usually results in an opening larger than needed for its service requirement and in the need to install more supports than would be needed if the opening could be made with fewer disturbances. To reduce the disturbance “Controlled Blasting” technique as discussed in Section 6.4.1.1 can be applied.

#### **6.4.1.1 Controlled Blasting Principles**

Explosives work by a rapid chemical reaction that results in a hot gas with much larger volume than that occupied by the explosive. This is possible because the explosive contains both the fuel and the oxidizer. When the explosive detonates, the rapidly expanding gas performs two functions: applying a sharp impulse to the borehole wall (which fractures the rock) and permeating the new fractures and existing discontinuities (which pries the fragments apart). To deliver this one-two punch effectively, the explosive is distributed through the rock mass, by drilling an array of boreholes that are then loaded with explosives and fired in an orderly sequence.

### 6.4.1.2 Relief

In order to effectively fragment the rock, there must be space for the newly created fragments to move into. If there is not, the rock is fractured but not fragmented, and this unstable mass will remain in place. Therefore the geometry of the array of boreholes must be designed to allow the fragments to move. This is optimum if there is more than one free face available. Creating an artificial “free face” is discussed in Section 6.4.1.5.

### 6.4.1.3 Delay Sequencing

To optimize the relief, internal free faces must be created during the blast sequence. To do this, millisecond delay detonators separate the firing times of the charges by very short lengths of time. Historically, because of scatter in the firing times of pyrotechnic detonators, “long” period delays between holes (on the order of hundreds of milliseconds) have been used in tunnel and underground mining, resulting in blasts that last several seconds. This is changing as more accurate electronic detonators are developed.

### 6.4.1.4 Tunnel Blast Specifics

As mentioned, tunnel blasting (like underground mine blasting) differs from surface blasting in that there is usually only one free face that provides relief. To blast some large tunnels, an upper heading is blasted first, and the rest of the rock is taken with a bench blast. Often, though, the whole face is drilled and blasted in one event. An array of blastholes is drilled out using drilling equipment that can drill several holes at once. The pattern of drill holes is determined before the blast, taking into account the rock type, the existing discontinuities in the rock (joints, fractures, bedding planes), and of course the desired final shape of the tunnel. Figure 6-5 shows a rather simplified example of a full-face tunnel round, with the various types of holes. The sequence of firings is Burn Cut (the holes in the neighborhood of the Open Cut Holes shown in the diagram), Production Holes (the holes in the “Blasthole Slash Area”), and the Smoothwall Holes (at the perimeter of the round).

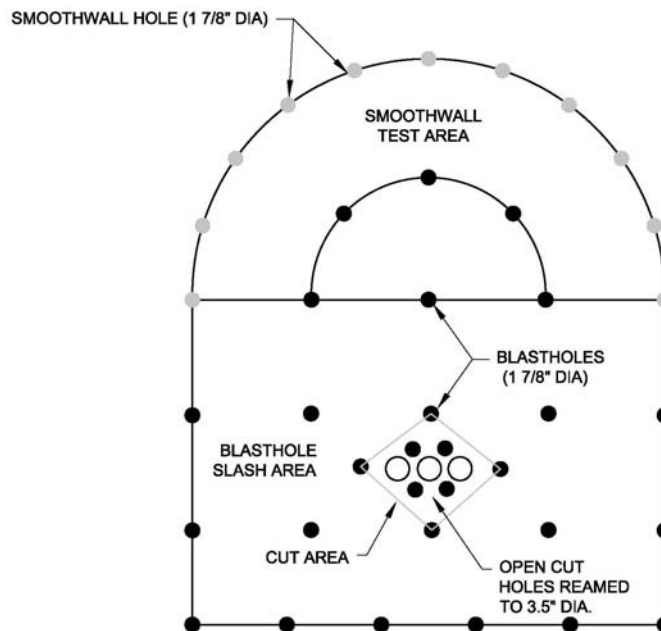

Figure 6-5 Example of a Full-face Tunnel Blast

### 6.4.1.5 Burn Cut

Because the start of each cut with a solid face has no relief, several extra holes are usually drilled and not loaded with explosives in the immediate neighborhood of the initiation point. These burn holes are generally larger than the explosively loaded holes, requiring an additional operation beyond the normal drilling. Many different geometries of burn holes are used to optimize the cut, depending on the rock type and joint patterns in a specific tunnel geology. These holes are fired first, with enough firing time to allow the creation of a free face for the following holes to expand into.

Production Holes The mass of the rock, following the initiation of the burn cut, are fired in a sequence so that the rock moves in a choreographed sequence, moving into the area opened up by the burn cut, and out into the open space in front of the blast.

Wiring up the charges in the right sequence can be a challenging task in the confined environment of a tunnel. Figure 6-6 shows the hook-up of a rather complex blast round, with the surface connectors shown in red, and the period (corresponding to a specific delay time) next to each blast hole.

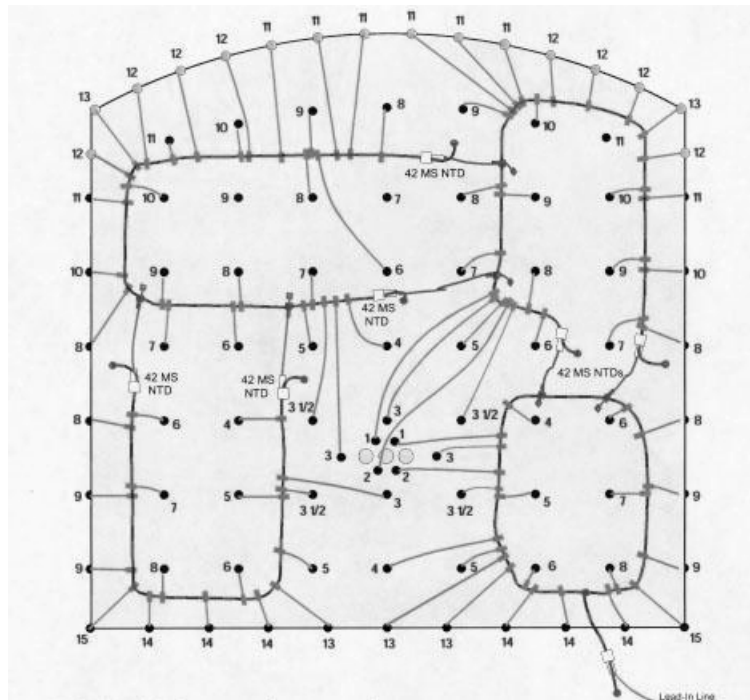

Figure 6-6 Complex Round Hook-up

The desired sequence will fire holes so that there is enough time for rock to move out of the way (create relief) but not so much time that the rock surrounding unfired blast holes will fracture (creating a cutoff).

Perimeter Control It is important to blast so that the final wall is stable and as close to the designed location as possible. The final holes are loaded more lightly, and called “perimeter holes” or “smoothwall holes”, and fired with some extra delay so that there is sufficient time for rock to fracture cleanly and create little damage to the rock outside of the “neat” line (such damage is called overbreak). Typical blast charges for these smoothwall holes are shown in Figure 6-7.

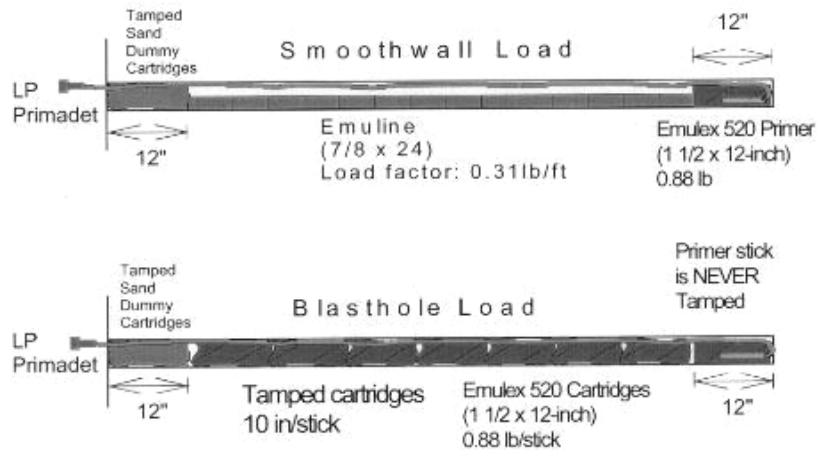

Figure 6-7 Typical Blast Charges

Though fired after the Production Holes have been detonated, the Smoothwall Holes are often fired on the same delay period, creating a “zipper” effect of the holes generating a smooth fracture on the perimeter.

Environmental Effects – Vibration and Airblast Not all of the energy from blasting goes into fragmenting rocks – some of it is unavoidably wasted as vibration that propagates away from the blast area. This vibration can be cause for concern both for the stability of the tunnel itself, as well as neighboring underground and surface structures.

Airblast is an air pressure wave that propagates away from the blast site, due to movement of the rock face and also possible venting of explosive gases from the boreholes. This is not so much a problem in tunneling, where personnel are evacuated from the blast area before a blast, but still must be taken into account.

Both of these issues are covered in more detail in Chapter 15, Instrumentation.

#### 6.4.1.6 Blasting – Art vs. Science

As mentioned earlier, explosives have been used for a long time to excavate rock. With the passage of time, engineers have studied the scientific relationships between the properties of explosives, the controllable variables such as the geometry of a blast and the timing, and uncontrollable variables such as variations in rock type and existing jointing and fracturing. Many relationships can show the most appropriate configuration of the blastholes, timing, and explosive type. However, as can be seen from the Figure 6-8 of actual drilling for a tunnel blast, the ideal is difficult to achieve.

Holes are marked out with spray paint on an irregular surface, and drilled in a dirty, often wet environment. The roof is supported with rock bolts (shown by the red squares in Figure 6-8) and meshes. Lighting is limited. Overall, this makes for a very challenging work environment.

Experience, or the “art” of blasting, comes into play in implementing the desired blast design. Choice of an experienced and capable blasting contractor, as well as a blast consultant to advise the contractor, is important to obtain the desired results.



Figure 6-8 Drilling for a Tunnel Blast

#### 6.4.2 Tunnel Boring Machines (TBM)

While progress and mechanization continued to be applied to drill and blast excavation well into the 1960's, the actual advance rates were still quite low, usually measured in feet per day. Mechanized tunneling machines or tunnel boring machines had been envisioned for over a century but they had never proven successful. That began to change in the 1960's when attempts were made to apply oil field drilling technology. Some progress was made, but it was slow because the physics were wrong – the machines attempted to remove the rock by grinding it rather than by excavating it. All of that changed in the later 1960's with the introduction of the disk cutter, see Figure 6-9. The disk cutter causes the rock to fail in shear, forming slabs (chips) of rock that are measured in tens of cubic inches rather than small fractions of a cubic inch. Much of the credit for this development, which now allows tunnels to advance at 10's or even 100's of feet per day, belongs to The Robbins Co.

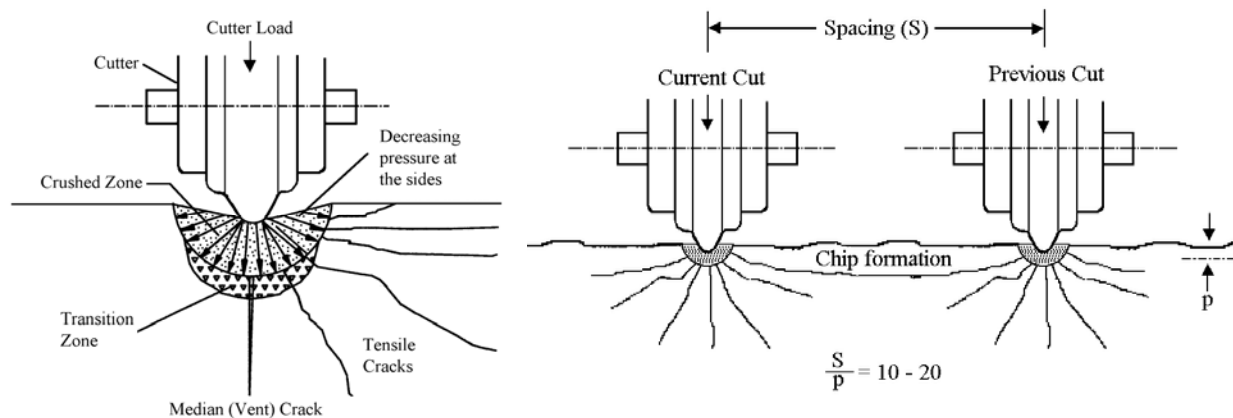

Figure 6-9 Chipping Process between Two Disc Cutters (After Herrenknecht, 2003)



Today, tunnel boring machines (TBM) excavate rock mass in a form of rotating and crushing by applying enormous pressure on the face with large thrust forces while rotating and chipping with a number of disc cutters mounted on the machine face (cutterhead) as shown in Figure 6-10. Design of disc cutters RPM, geometry, spacing, thrust level, etc. are beyond the scope of this manual.



Figure 6-10 Rock Tunnel Boring Machine Face with Disc Cutters for Hard Rock, Australia.

#### 6.4.2.1 Machine Types and Systems

Tunnel Boring Machines (TBMs) nowadays are full-face, rotational (with cutter heads) excavation machines that can be generally classified into two general categories: Gripper and Segment as shown in Figure 6-11. Based on Figure 6-11, there are three general types of TBMs suitable for rock tunneling including Open Gripper/Main Beam, Closed Gripper/Shield, and Closed Segment Shield, as shown within the dashed box on the Figure.

The open gripper/beam type of TBMs are best suited for stable to friable rock with occasional fractured zones and controllable groundwater inflows. As shown in Appendix D, three common types of TBMs belong to this category including Main Beam (Figure 6-12), Kelly Drive, and Open Gripper (without a beam or Kelly).

The closed shield type of TBMs for most rock tunneling applications are suitable for friable to unstable rocks which cannot provide consistent support to the gripper pressure. The closed shield type of TBMs can either be advanced by pushing against segment, or gripper. Note that although these machines are classified as a closed type of machine, they are not pressurized at the face of the machine thus cannot handle high external groundwater pressure or water inflows. Shielded TBMs for rock tunneling include: Single Shield (Figure 6-13), Double Shield (Figure 6-14), and Gripper Shield.

The typical machine elements and backup system for each category are discussed in the following section. Pressurized-face Closed Shield TBMs are predominantly utilized in tunneling in soft ground and are discussed in Chapter 7. Appendix D presents descriptions for various types of TBMs.

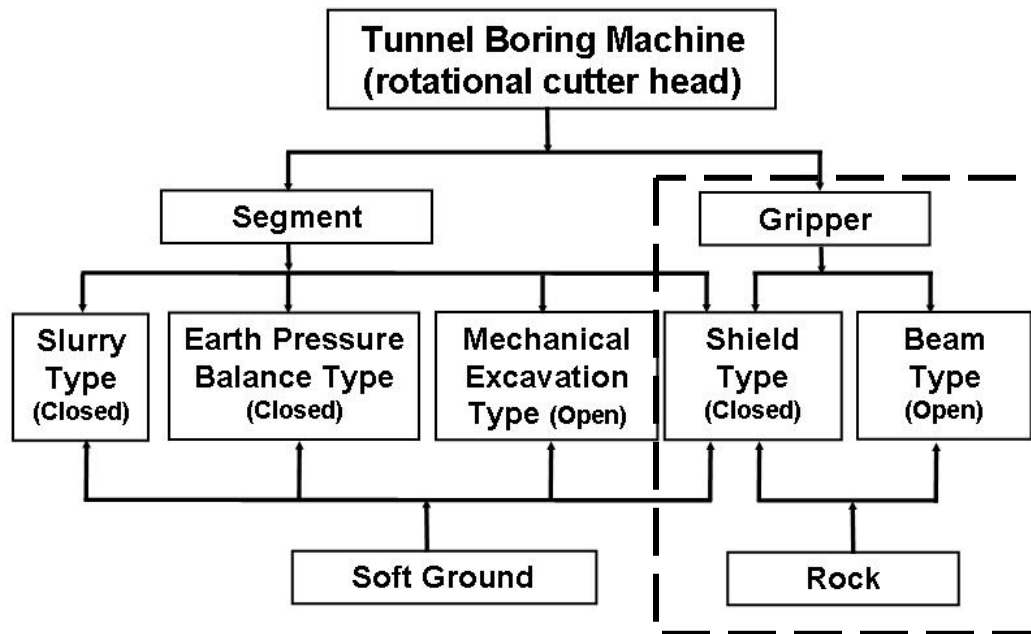

Figure 6-11 Classification of Tunnel Excavation Machines

#### 6.4.2.2 Machine Main and Support Elements

A TBM is a complex system with a main body and other supporting elements to be made up of mechanisms for cutting, shoving, steering, gripping, shielding, exploratory drilling, ground control and support, lining erection, spoil (muck) removal, ventilation and power supply. As shown in Figures 6-12, 6-13 and 6-14, the main body of a typical rock TBM (either open or closed) includes some or all of the following components:

- Cutterhead and Support
- Gripper (Except Single Shield TBM)
- Shield (Except Open TBM)
- Thrust Cylinder
- Conveyor
- Rock Reinforcement Equipment

In addition, the main body of a TBM is supported with a trailing system for muck and material transportation, ventilation, power supply, etc. A fully equipped TBM can occupy over 1000 ft of tunnel.

Appendix D includes detailed descriptions for each of the above TBM types.

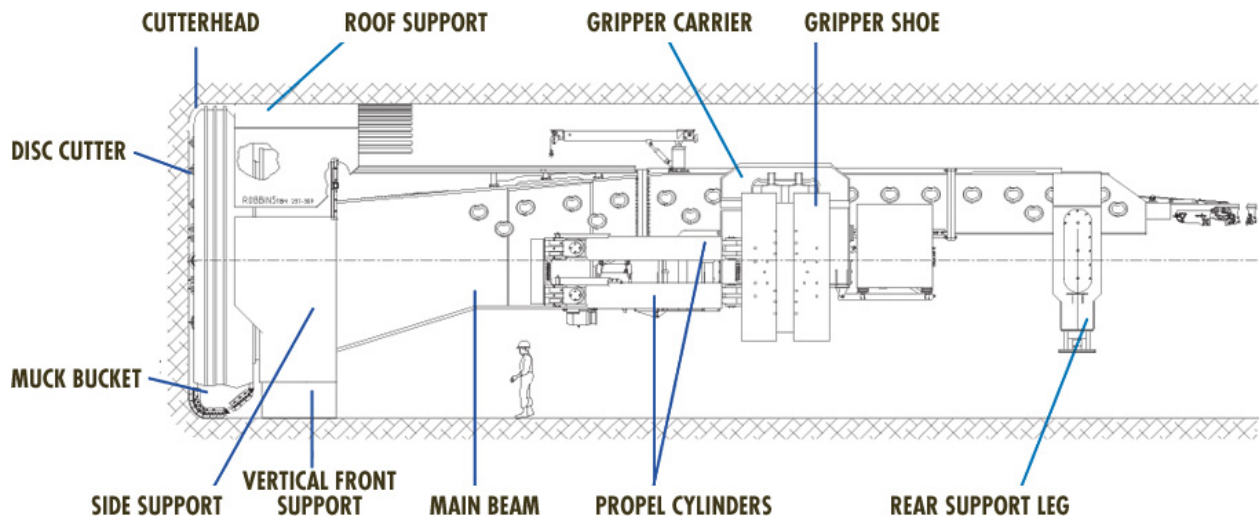

Figure 6-12 Typical Diagram for an Open Gripper Main Beam TBM (Robbins).

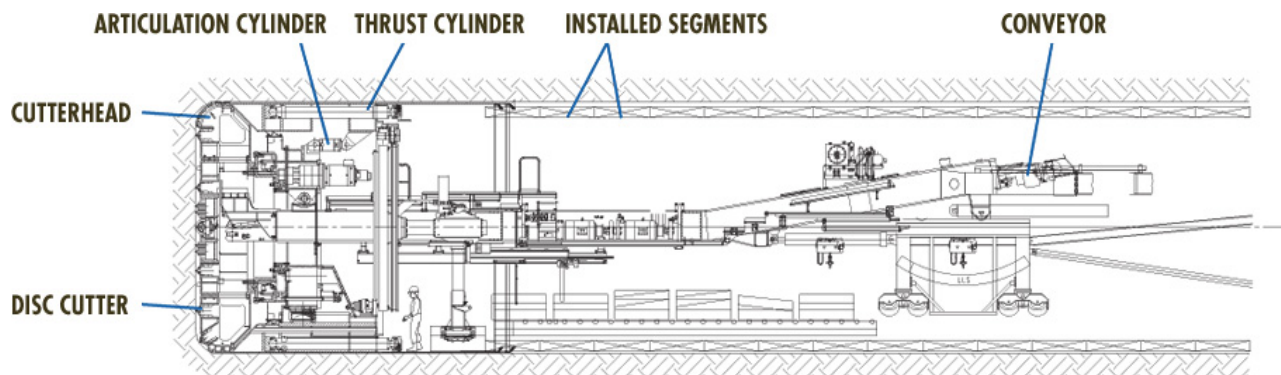

Figure 6-13 Typical Diagram for Single Shield TBM (Robbins)

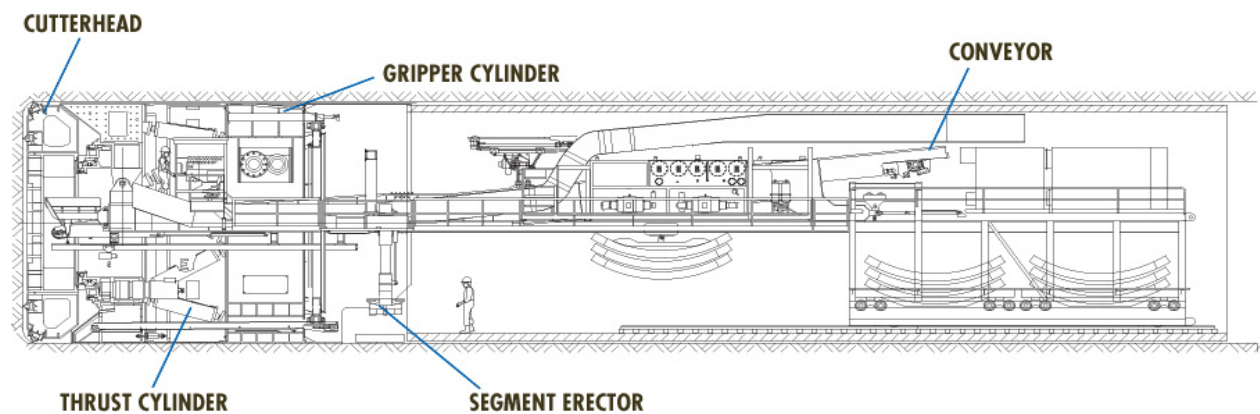

Figure 6-14 Typical Diagram for Double Shield TBM (Robbins)

### 6.4.2.3 Compatible Ground Support Elements

Most ground support elements discussed in Section 6.5 can be specified with the use of hard rock TBMs, especially if the TBMs are manufactured specifically for the project.

- Rock reinforcement by roof bolting
- Spiling/forepoling
- Pre-injection
- Steel ring beams with or without lagging (wire mesh, timber, etc.)
- Invert segment
- Shotcrete
- Precast concrete segmental lining
- Others

Details of the above support measures are discussed in Section 6.5 of this Chapter, and Chapter 10 Tunnel Lining.

### 6.4.2.4 TBM Penetration Rate

With a rock TBM, the penetration rate is affected by the following factors (from Robbins, 1990):

- Total machine thrust
- Cutter spacing
- Cutter diameter and edge geometry
- Cutterhead turning speed (revolutions per minute)
- Cutterhead drive torque
- Diameter of tunnel
- Strength, hardness, and abrasivity of the rock
- Jointing, weathering and other characteristics of the rock.

However, penetration rate (an instantaneous parameter) by itself does not assure a high average advance rate. The latter requires a good combination of penetration rate and actual cutting time. In turn, actual cutting time is affected by the following factors:

- Learning (start-up) curves
- Downtime for changing cutters
- Downtime for other machine repairs/maintenance
- Overly complex designs
- Back-up (trailing) systems
- Tunnel support requirements
- Muck handling
- Water handling
- Probe hole drilling, grouting
- Available time (total and shift)

The bottom line is that actual utilization typically runs in the range of 50% as shown by Figure 6-15.

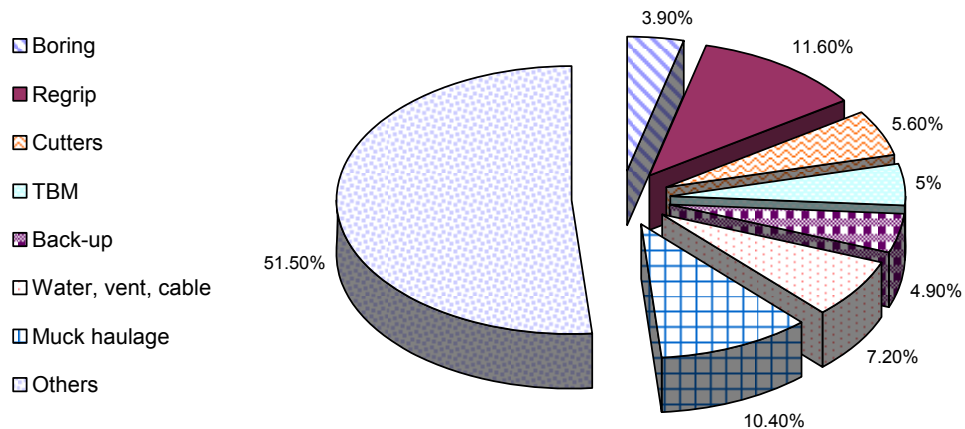

Figure 6-15 TBM Utilization on Two Norwegian Tunnels (After Robbins, 1990)

### 6.4.3 Roadheaders

Typical TBM's cut circular tunnels which are the most practical cross section but not always the cross section that provides the most useable volume as a proportion of the total volume excavated. The Japanese and others have developed specialized machines with multiple heads that cut "slots" or other shapes that can be more efficient in providing useable volume.

Another approach to cutting an opening closer to some actual required section is the roadheader. The basic cutting tool for a roadheader is a very large milling head mounted on a boom, which boom, in turn, is mounted on tracks or within a shield. Figure 6-16 shows a large size roadheader. Corners must be cut to the curvature of the milling head, but the rest of the walls, crown and invert can be cut to almost any desired shape. In addition and in contrast to a TBM, a single roadheader can cut variable or odd shapes that otherwise would require TBM excavation in combination with drill and blast or drill and blast itself. Because of their adaptability, availability (a few months rather than a year or longer), and lower cost, roadheaders also are the method of choice for relatively short tunnels, say less than one mile in length.



Figure 6-16 AM 105 Roadheader, Australia

On the negative side, roadheaders are far less efficient on longer drives and in hard rock. The picks on the roadheader are something like 10% as efficient as TBM disks at removing rock, must be replaced very frequently and simply may not be effective in rock with an unconfined compressive strength greater than 20,000 psi (140MPa). Changes and improvements in roadheader design are on-going, however, and it is expected that this will result in constant improvements in these limitations.

The following is a general list when roadheaders may be considered:

- Rock strength below about 20000 - preferably below 15000.
- Short runs, one of a kind openings
- Odd, non-circular shapes
- Connections, cross passages, etc
- Low to moderate abrasivity
- Preferably self supporting rock
- No or small inclusions - chert etc
- Nominal water pressure

#### **6.4.4 Other Mechanized Excavation Methods**

Other mechanized excavation methods are being developed by specialized equipment manufacturers to address specific issues in mining and civil applications. A good example of such developments is the “Mobile Miner” developed by Robbins as a “non-circular hard rock cutting system to be applied to underground mine development” (Robbins, 1990). The mobile miner is described as follows:

“A boom mounts a large cutter wheel with a transverse axis having rows of cutters arranged only on the periphery of the wheel. As the boom is swung from side to side an excavated shape is generated with a flat roof and floor and curved walls. Although the prototype machines have operated only with this side-swinging action, in order to cut openings which are better suited to vehicular tunnels the cutterhead boom must be elevated up and down and at the same time swung from side to side. In this way a horseshoe-shaped excavation can be generated.

To date such machines have had some success in excavating openings approaching a horseshoe or slot configuration, but they are not commonly used. However, they do illustrate the points that shapes other than circular can be cut and that inventive and special-purpose machines are constantly being developed.

#### **6.4.5 Sequential Excavation Method (SEM)/ New Austrian Tunneling Method (NATM)**

In actual practice, the Sequential Excavation Method (SEM)/New Austrian Tunneling Method (NATM) has been adapted from its original concept, which applied to rock tunnels only, to a more general concept that applies to tunnels in either soil or rock. Readers are referred to Chapter 9 “SEM Tunneling” for more detailed discussion.

### **6.5 TYPES OF ROCK REINFORCEMENT AND EXCAVATION SUPPORT**

#### **6.5.1 Excavation Support Options**

The purpose of an initial support (sometimes called temporary lining, or temporary support of excavation) in rock tunneling is to keep the opening open, stable and safe until the final lining is installed and

construction is complete. As a consequence the initial support system in a rock tunnel can be one or a combination of a number of options:

- Rock reinforcement (i.e., rock dowels, rock bolts, rock anchors, etc.)
- Steel ribs
- Wood or other lagging
- Lattice girders
- Shotcrete
- Spiles or forepoling
- Concrete
- Re-steel mats
- Steel mats
- Cables
- Precast concrete segments
- Others

The first five above are the most common on US projects, and of those, a combination of rock bolts or dowels and shotcrete is the single most common. Especially in good (or better) rock tunnels, modern rock bolting machines provide rapid and adjustable “support” close to the heading by knitting and holding the rock (ground) arch in place, thus taking maximum advantage of the rock’s ability to support itself. Preferably, shotcrete is added (if needed) a diameter or so behind the face where its dust and grit and flying aggregate is not the problem for both workers and equipment that it is at the heading. Where there is a concern with smaller pieces of rock falling, the system can be easily modified by adding shotcrete closer to the face or more usually, by embedding any of a number of types of steel mats in the shotcrete.

Where the rock quality is lower there is currently a movement toward replacing steel ribs by lattice girders – perhaps somewhat more so in Europe than in the US. Like steel ribs, the lattice girders form a template of sorts for the shotcrete and for spiling. However, the lattice girders are lighter and can be erected faster. To provide the same support capacity, the lattice girder system may require nominally more shotcrete (e.g., an additional ½ to 1 inch) but that is more than compensated for by the easier and faster erection. A second new trend is the use of steel fiber reinforced shotcrete. The fiber doesn’t change the compressive strength significantly but does produce a significant increase in the toughness or ductility of the shotcrete. Chapter 9 provides more detailed discussion about shotcrete and lattice girder.

## **6.5.2 Rock Reinforcement**

Rock reinforcement including rock dowels and bolts are used to hold loose (key) blocks in place and/or to knit together the rock (ground) arch that actually provides the support for an opening in rock. Dowels and bolts are very similar but the differences in their behavior can be quite significant.

### **6.5.2.1 Rock Dowel**

Rock dowels as shown in Figure 6-17a, are passive reinforcement elements that require some ground displacement to be activated. Similar to passive concrete reinforcement, the reinforcement effect of dowels is activated by the movement of the surrounding material. In particular, when displacements along discontinuities occur, dowels are subject to both shear and tensile stresses (Figure 6-17b). The level of shear and tensile stress and the ratio between them occurring during a displacement is dependent on the properties of the surrounding ground, the properties of the grout material filling the annular gap between the dowel and the ground and the strength and ductility parameters of the dowel itself. Also, the degree of dilation during shear displacement influences the level of stress acting within the dowel. Table 6-6

describes various types of rock dowels. In addition, Table 9-5 summarizes commonly used rock dowels and application considerations for the installation as part of initial support in SEM tunneling in rock.

For example a #9 dowel 10 ft. long will have to elongate almost 0.2 inch before it develops its full design capacity of 40,000 lb. This may not be a concern in most applications where there is some interlocking between rock blocks due to the natural asperities on discontinuity surface.

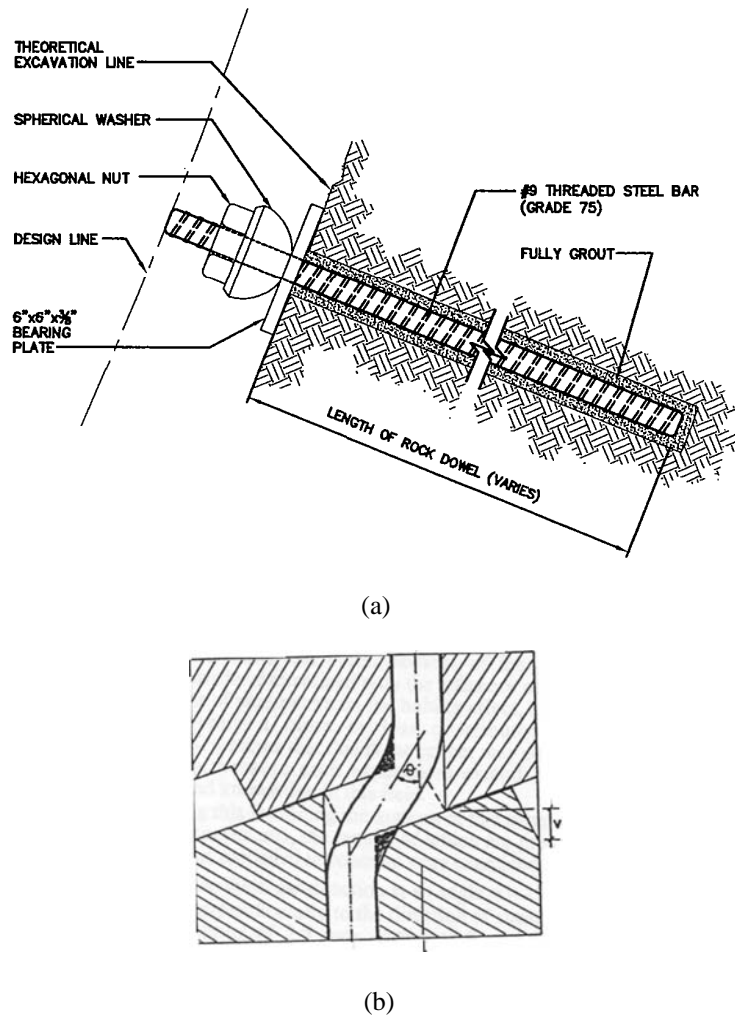

Figure 6-17 (a) Temporary Rock Dowel; (b) Schematic Function of a Rock Dowel under Shear

### 6.5.2.2 Rock Bolts

Rock bolts (Figure 6-18) have a friction or grout anchor in the rock and are tensioned as soon as that anchorage is attained to actively introduce a compressive force into the surrounding ground. This axial force acts upon the rock mass discontinuities thus increasing their shear capacity and is generated by pre-tensioning of the bolt. The system requires a ‘bond length’ to enable the bolt to be tensioned. Rock bolts frequently are fully bonded to the surrounding ground after tensioning, for long-term load transfer considerations. They may or may not be grouted full length. In any case, bolts begin to support or knit the rock as soon as they are tensioned, that is, the rock does not have time to begin to move before the bolt becomes effective. Table 6-6 describes various types of rock bolts. In addition, Table 9-5



summarizes commonly used rock bolts and application considerations for the installation as part of initial support in SEM tunneling in rock.

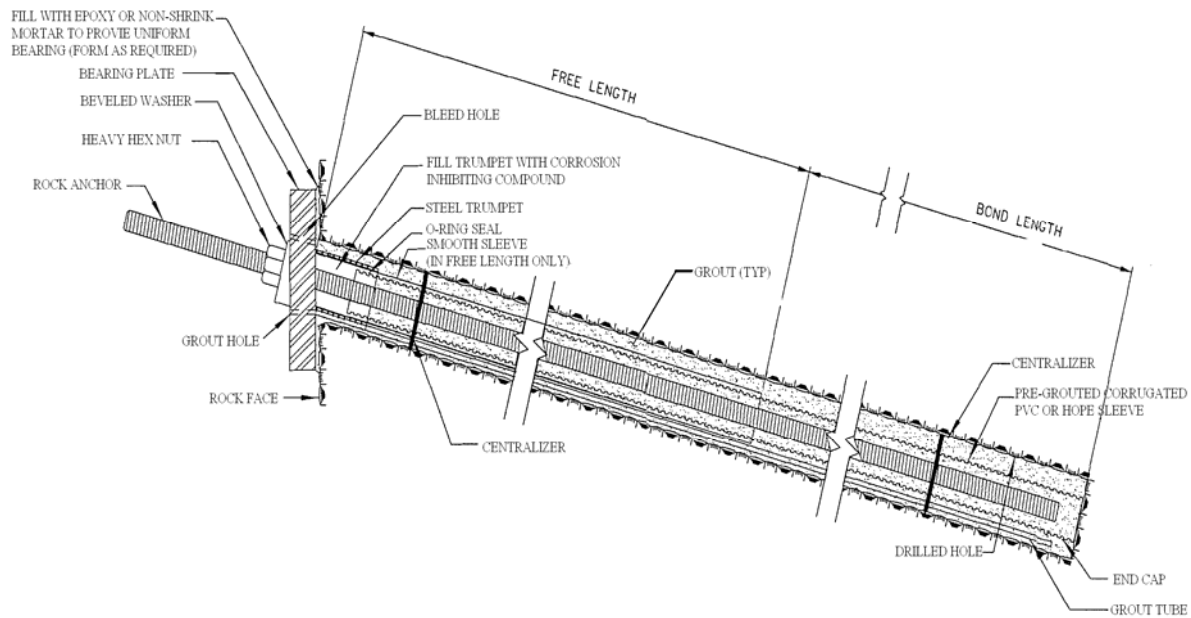

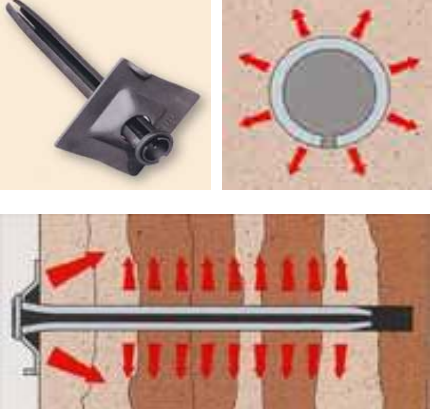

Figure 6-18 Typical Section of Permanent Rock Bolt

Table 6-6 Types of Rock Bolts

| Type                             | Description  | Illustration |
|----------------------------------|--|--------------|
| <b>Resin Grouted Rock Bolt</b>   | <ul style="list-style-type: none"> <li>• Additional capacity due to side friction</li> <li>• develops after setting of the second resin</li> <li>• Good for soft and hard rocks</li> <li>• Withstands blasting vibrations</li> </ul> |              |
| <b>Expansion shell rock bolt</b> | <ul style="list-style-type: none"> <li>• Post grouted expansive bolt</li> <li>• Good for relatively good rocks</li> <li>• Fully grouted</li> <li>• Corrosion protection</li> </ul>   |              |

Continued on next page

**Table 6-6 (continued) Common Types of Rock Bolts**

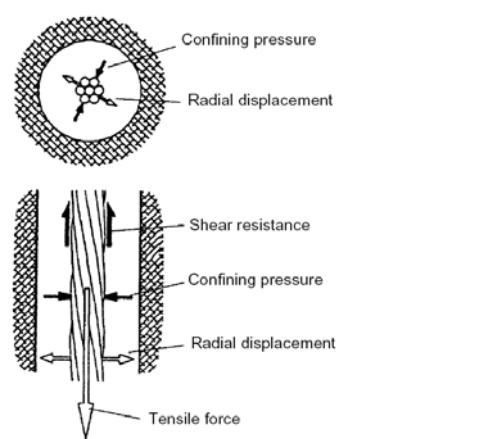
| Type                                  | Description   | Illustrations   |
|---------------------------------------|---|---|
| <p><b>Split set stabilizers</b></p>   | <ul style="list-style-type: none"> <li>• Slotted bolt is inserted into a slightly smaller diameter hole</li> <li>• Induced radial stress, anchors the system in place by friction</li> <li>• Mainly for mining, and under mild rock burst conditions</li> <li>• It slips instead of suddenly failing</li> <li>• Limited load handling</li> </ul>  |   |
| <p><b>Swellex</b></p>                 | <ul style="list-style-type: none"> <li>• Length up to 12 m</li> <li>• Hole diameter =32-52 mm</li> <li>• Tensile load= 100 -240 kN</li> <li>• Inflation pressure ≈ 30 Mpa</li> <li>• Instant full load bearing capacity</li> <li>• Fast application</li> <li>• Not sensitive to blasting</li> <li>• Elongation range: 20-30%</li> </ul>   |    |
| <p><b>Self Drilling Anchor</b></p>    | <ul style="list-style-type: none"> <li>• Drilling, installation, and injection in one single operational step</li> <li>• No pre-drilling of a borehole by using a casing tube and extension rods with subsequent anchor installation necessary</li> <li>• Minor space requirement for anchor installation</li> <li>• Optimized machinery and manpower requirements</li> </ul>   | <p><b>IBO - SELF DRILLING ANCHORS</b></p>  <p>IBO-anchorage plate<br/> IBO-nut with convex seal<br/> IBO-coupling cold rolled with continuous inside thread, screwed inside and stressed middle step. Assembly relief through chamfered ends. IBO-coupling for optimal stroke transmission, rinse medium, transport of rock outtings.<br/> IBO-anchorage cold rolled with continuous outside thread. Optimal stroke transmission through hardened and unburied out areas of the anchor ends, mortar connection through outside profiling.<br/> Drillbit<br/> AT-Anci-Shaped Drillbit<br/> AT-Anci-Butterbit</p> |
| <p><b>Cablebolt reinforcement</b></p> | <ul style="list-style-type: none"> <li>• Primarily used to support large underground structures, i.e mining applications, underground power caverns etc.</li> <li>• Can handle high loads</li> <li>• Tendons are grouted with concrete mix</li> <li>• At very high loads the governing parameter is most often the bond between the tendon and the grout</li> <li>• Cable capacity is confining stress dependent</li> </ul> |  <p>Confining pressure<br/> Radial displacement<br/> Shear resistance<br/> Confining pressure<br/> Radial displacement<br/> Tensile force</p>   |

### 6.5.3 Ribs and Lagging

Ribs and lagging (Figure 6-19) are not used as much now as they were even a couple of decades ago. However, there are still applications where their use is appropriate, such as unusual shapes, intersections, short starter tunnels for TBM, and reaches of tunnel where squeezing or swelling ground may occur.

In 1946, Proctor and White (with major input from Dr. Karl Terzaghi) wrote the definitive volume “Rock Tunneling with Steel Supports”. Their design approach assumes the ribs are acted upon by axial thrust and by bending moments, the latter a function of the spacing of the lagging or blocking behind the ribs. This approach is still valid when wood or other blocking is used with steel ribs and hence will not be repeated here. In today’s applications, steel ribs are often installed with shotcrete being used instead of wood for the blocking (lagging) material. When shotcrete is used, it often does not fill absolutely the entire void between steel and rock. Hence, with properly applied shotcrete it is recommended that the maximum blocking point spacing be taken as 20 in. and the design proceed according to the Proctor and White procedure.

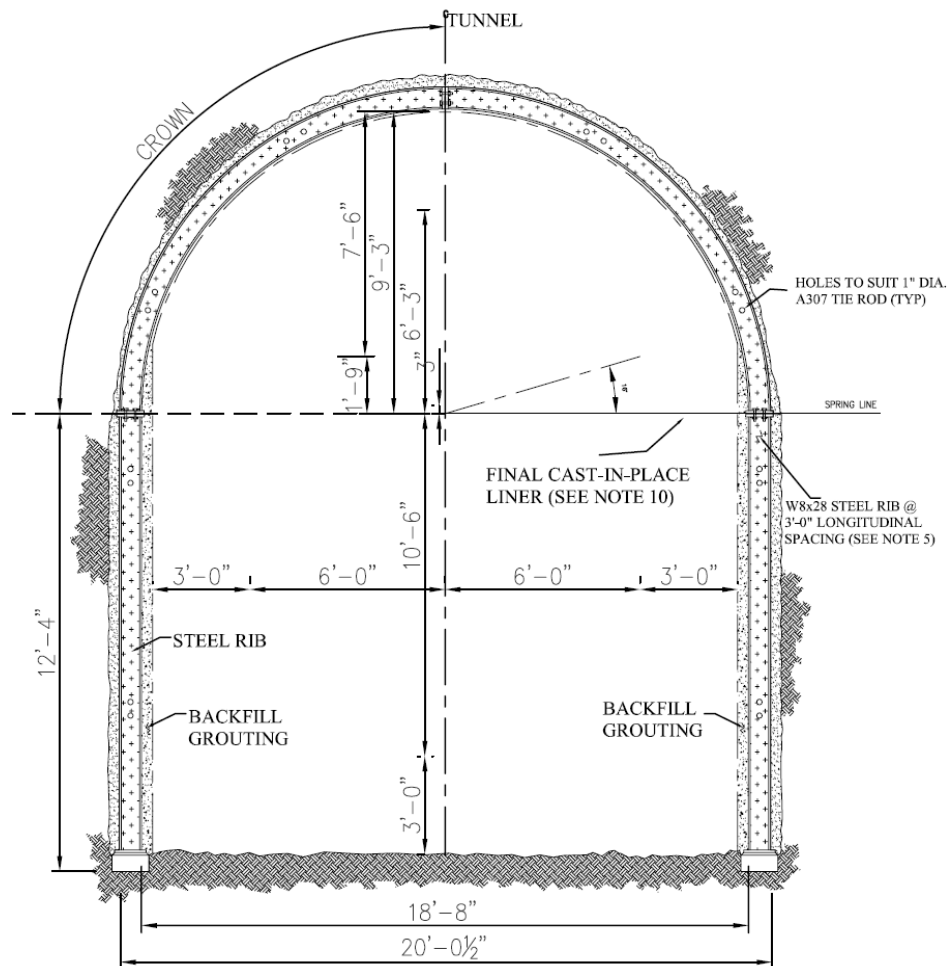

Figure 6-19 Steel Rib Support

## 6.5.4 Shotcrete

Shotcrete is simply concrete sprayed into place through a nozzle. It contains additives to gain strength quicker and to keep it workable until it is sprayed. Shotcrete can be made with or without the addition of reinforcing fibers and can be sprayed around and through reinforcing bars or lattice girders. Both the quality and properties of shotcrete can be equal to those of cast in place concrete but only if proper care and control of the total placement procedure is maintained throughout. The reader is referred to Section 9.5.1 for more details related to the design and use of shotcrete as a support and lining material.

## 6.5.5 Lattice Girder

Lattice girders are support members made up of steel reinforcement bars laced together (usually) in a triangular pattern (see

Figure 6-20) and rolled to match the shape of the opening. Because their area is typically very small compared to the surrounding shotcrete, lattice girders do not, by themselves, add greatly to the total support of an opening. However, they do provide two significant benefits:

1. They are typically spaced similarly to rock bolts, thus they quickly provide temporary support to blocks having an immediate tendency to loosen and fall
2. They provide a ready template for assuring that a sufficient thickness of shotcrete is being applied

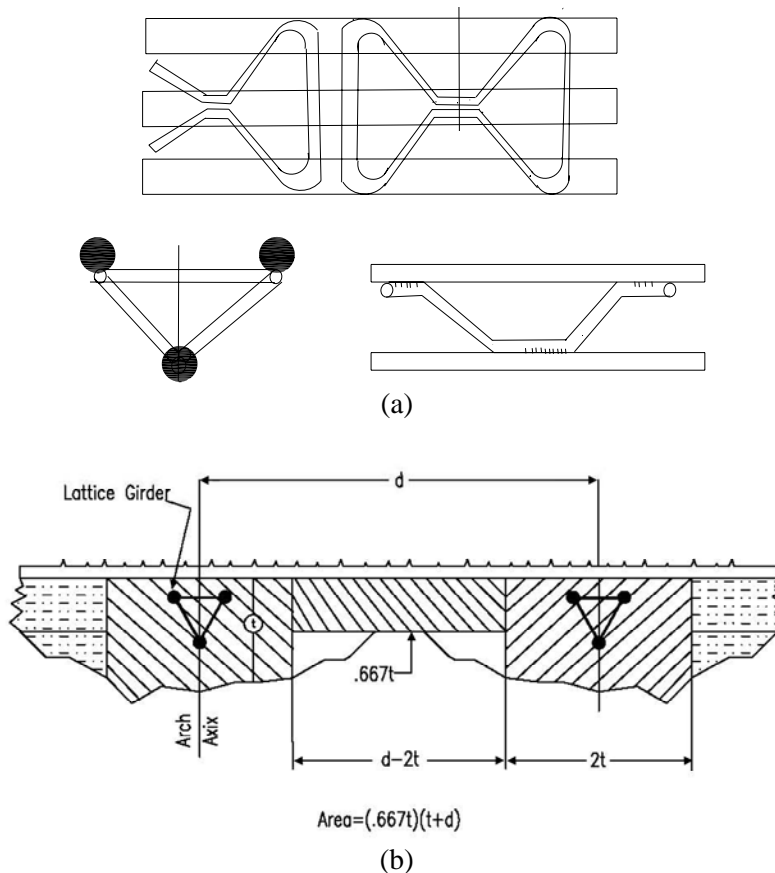

Figure 6-20 (a) Lattice Girder Configuration (Emilio-2-2901-1997); (b) Estimation of Cross Section for Shotcrete-encased Lattice Girders (Emilio-2-2901-1997)

Generally, lattice girders are used much more frequently in tunnels driven by the sequential excavation method. Therefore, the reader is directed to Chapters 9 for further discussion of these supports.

### 6.5.6 Spiles and Forepoles

Spiles and forepoles (Figure 6-21) are used interchangeably to describe support elements consisting of pipes or pointed boards or rods driven ahead of the steel sets or lattice girders. These elements (herein called spiles) provide temporary overhead protection while excavation for and installation of the next set or girder is accomplished. Typically, spiles are driven in an overlapping arrangement as shown in Figure 6-21 so that there is never a gap in coverage. Design of spiles is best described as “intuitive” as it must be kept flexible and constantly adjusted in the field as the ground behavior is observed during the construction. A working first approximation of design load might be a height of rock equal to  $0.1B$  to  $0.25B$ , where  $B$  is the width of the opening. Section 9.5.4.1 provides discussions for pre-support measures involving spiling or grouted pipe arch canopies that bridge over the unsupported excavation round.

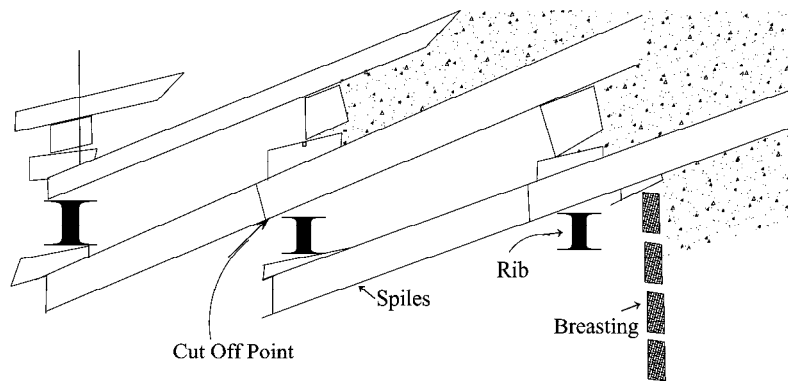

Figure 6-21 Spiling (Forepoling) Method of Supporting Running Ground

### 6.5.7 Precast Segment Lining

Tunnel lining consisting of precast segments may be used in single-pass or double pass lining systems to support rock loadings and water pressures. Generally the concrete segments are reinforced either with reinforcement bar or fiber. The segment ring usually consists of five to seven segments with a key segment. The ring division and the segment dimension have to be optimized according to project specific requirements such as tunnel diameter, maximum size for transport and installation (erector), and number of thrust jacks and their distribution over the range of the ring. Figure 6-22 illustrates a typical seven ring plus one key segment concrete lining. A typical circumferential dowel (Figure 6-22a) and radial bolt (Figure 6-22b) are also presented.

The precast segment concrete lining is mostly used in TBM tunnel construction projects and, at this time, more frequently in soft ground tunnels. The segmental ring is erected in the TBM tail shield and during the advance, the rams act on the ring. The ring never can be independent from the TBM, hence the design of the TBM and the segmental ring must be harmonized. Rams must act on prepared sections of the ring, rolling of the tunnel shield and the ring must be taken into account. The ram axis should be identical with the ring axis. The ring taper should be designed according to the TBM curve drive capabilities and not only according to the designed tunnel axis. Details of design considerations for precast segment lining will be discussed in Chapter 10.

## 6.6 DESIGN AND EVALUATION OF TUNNEL SUPPORTS

There exists a wide range of tunnel support systems as shown in previous sections. In recent years the tunneling community has moved away from support to reinforcement as the basic approach. That is, from providing heavy structures, primarily ribs and lagging, to using rock bolts and dowels, spiling, lattice girders and shotcrete. In all of these latter systems the goal is to keep the rock from moving and blocks from loosening thereby keeping a large dead load of rock from coming onto the support system; that is holding the rock together and causing the ground around the opening to form a natural and self supporting ground arch around the opening.

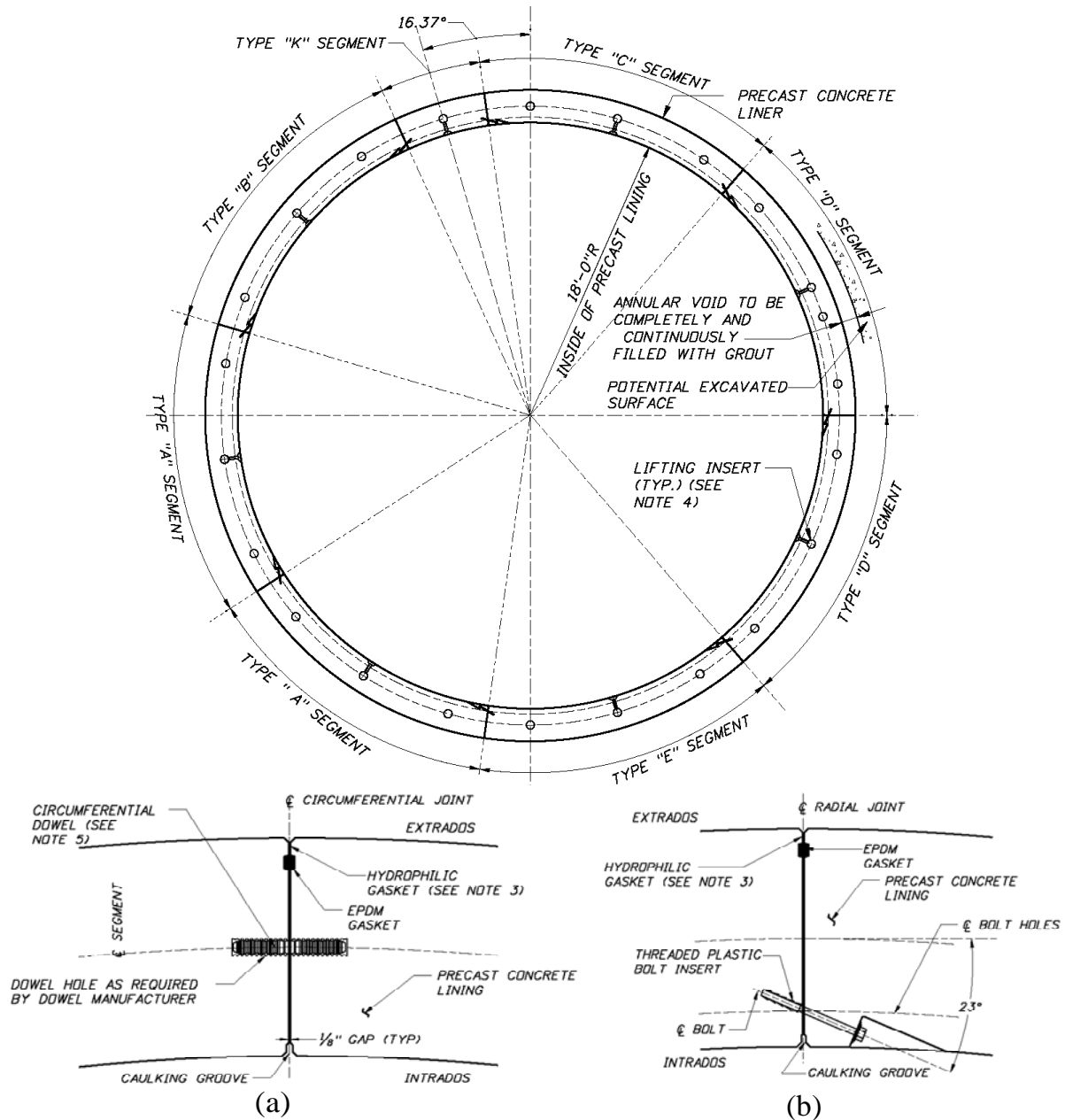

Figure 6-22 A Typical Seven Segment and a Key Segment Precast Segment Lining: (a) Circumferential Dowel; (b) Radial Bolt

This trend was started in the U.S. on the Washington D.C. subway system where on two successive sections the amount of structural steel support was reduced by three quarters. This was accomplished by holding the rock in place with rock bolts until the final lining of shotcrete with light ribs at four foot centers could be installed and become effective in causing the rock to help support itself. In contrast, the previous section relied upon steel ribs to carry the dead (rock) loads and thus required twice the weight of steel members at one-half the spacing.

Tunnel support design is an iterative process including assumptions on support type installed and evaluating the support pressure it provides. Table 6-7 lists typical tunnel support systems used in the current practice for various ground conditions. This table can be used for the initial selection of the support system to initiate the interaction and iteration.

**Table 6-7 Typical Initial Support and Lining Systems Used in the Current Practice (TRB, 2006)**

| Ground      | Rock bolts | Rock bolts with wire mesh | Rock bolts with shotcrete | Steel ribs and lattice girder with shotcrete | Cast-in-place concrete | Concrete segments |
|-------------|------------|---------------------------|---------------------------|--|------------------------|-------------------|
| Strong rock | O          | O                         |                           |  |                        |                   |
| Medium Rock |            | O                         | O                         |  |                        |                   |
|             |            | O                         | O                         | O  |                        |                   |
| Soft Rock   |            |                           | O                         | O  | O                      |                   |
|             |            |                           |                           | O  | O                      | O                 |
| Soil        |            |                           |                           | O  | O                      | O                 |

In making the selection of support measures for a given project, however, the full range of possible support system should be considered simply because each project is unique. Factors to be considered include the following:

1. Local custom: contractors like to use systems with which they are familiar.
2. Relative costs: for example, is it cost effective to design bolts with suitable corrosion resistance to assure their permanence.
3. Availability of materials

This Section introduces design practice and evaluation of initial tunnel supports, including empirical, analytical and numerical methods. Design of underground structures can be based largely on previous experience and construction observations to assess expected performances of specified ground support systems.

### 6.6.1 Empirical Method

Terzaghi's tunnelman's classification (Table 6-1) of rock condition and recommended rock loadings, expressed as a function of tunnel size are presented in Table 6-8. These recommendations sprang from Terzaghi's observations in the field and his trap door experiments in the laboratory.

**Table 6-8 Suggested Rock Loadings from Terzaghi's Rock Mass Classification**

| Rock condition                           | Rock Load, $H_p$ (ft)                                       | Remarks   |
|--|---|---|
| Hard and intact                          | Zero  | Light lining, required only if spalling or popping occurs   |
| Hard stratified or schistose             | 0 to 0.5 B  | Light support. Load may change erratically from point to point  |
| Massive, moderately jointed              | 0 to 0.25 B   |   |
| Moderately blocky and seamy              | 0.25B to 0.35 (B + H <sub>i</sub> )                         | No side pressure  |
| Very blocky and seamy                    | (0.35 to 1.10) (B + H <sub>i</sub> )                        | Little or no side pressure  |
| Completely crushed but chemically intact | 1.10 (B + H <sub>i</sub> )                                  | Considerable side pressure. Softening effect of seepage towards bottom of tunnel requires either continuous support for lower ends of ribs or circular ribs |
| Squeezing rock, moderate depth           | (1.10 to 2.10) (B + H <sub>i</sub> )                        | Heavy side pressure, invert struts required. Circular ribs are recommended  |
| Squeezing rock, great depth              | (2.10 to 4.50) (B + H <sub>i</sub> )                        |   |
| Swelling rock                            | Up to 250ft. irrespective of value of (B + H <sub>i</sub> ) | Circular ribs required. In extreme cases use yielding support   |

As a first approximation to rock bolt or dowel selection, Cording et al. (1971) provides a compilation of case histories for underground rock excavations based on excavation sizes (span width and height), as shown in Figure 6-23 and Figure 6-24, the following are recommended by Cording et al. (1971):

- A crown support pressure equal to a rock load having a height of 0.3B.
- A sidewall support pressure of 0.15H.
- A crown bolt length of 0.33B.
- A sidewall bolt length of 0.33H.

where B is the opening width. In rock with an RQD greater than 75%, it is expected that the sidewall pressure typically will be smaller (often zero) than estimated above and only spot bolts to hold obvious wedges will be required.

Two most widely used rock mass classifications, RMR and Q, incorporate geotechnical, geometrical, and engineering parameters. Using rock mass classifications and equivalent dimension of the tunnel, which is defined as ratio of dimension of tunnel and ESR (Excavation Support Ratio), Barton et al. (1974) proposed a number of support categories and the chart was updated by Grimstad and Barton (1993). The updated chart using the Q system is presented in Figure 6-25. Table 6-9 presents how the RMR is applied to support design of a tunnel with 10 m span.



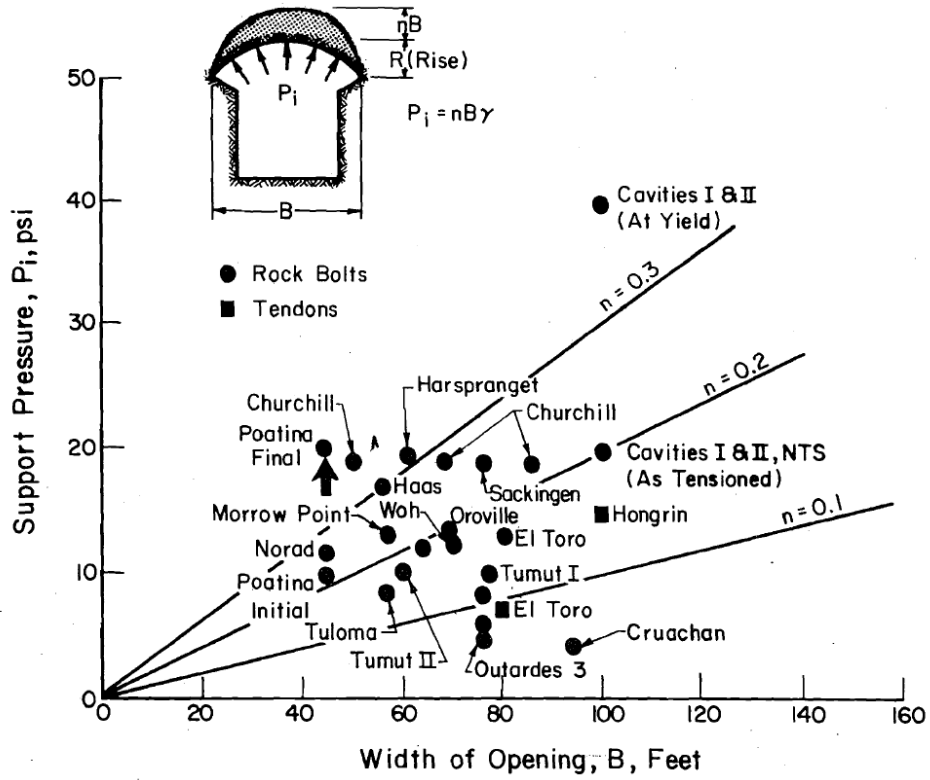

(a)

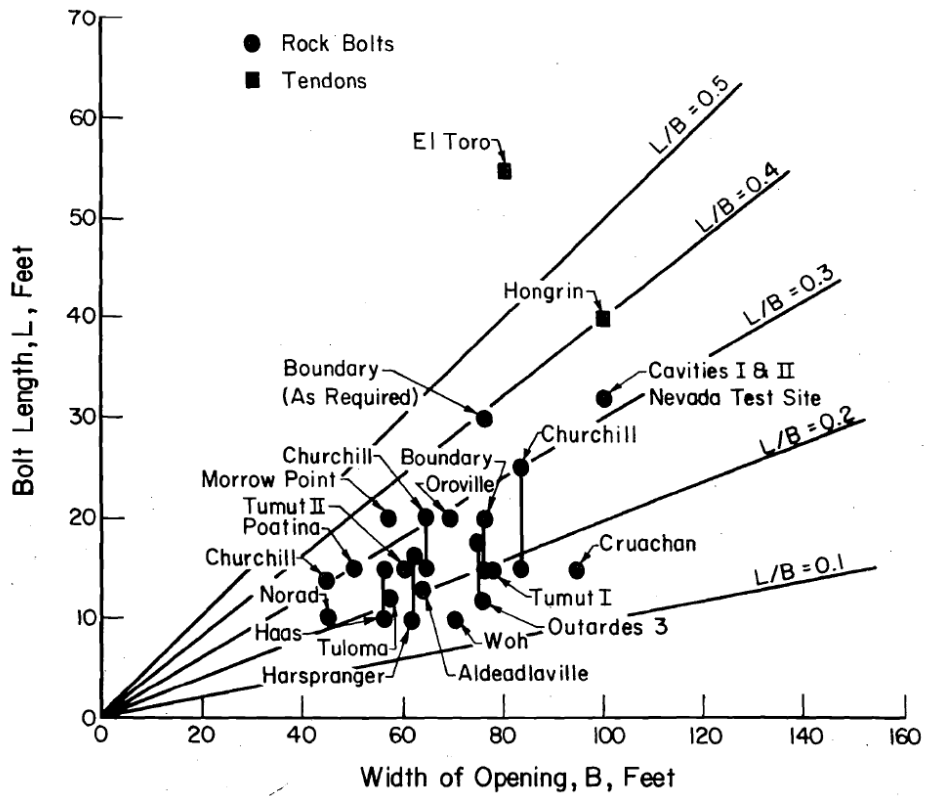

(b)

Figure 6-23 Support Pressures (a) and Bolt Lengths (b) Used in Crown of Caverns (Cording, 1971)

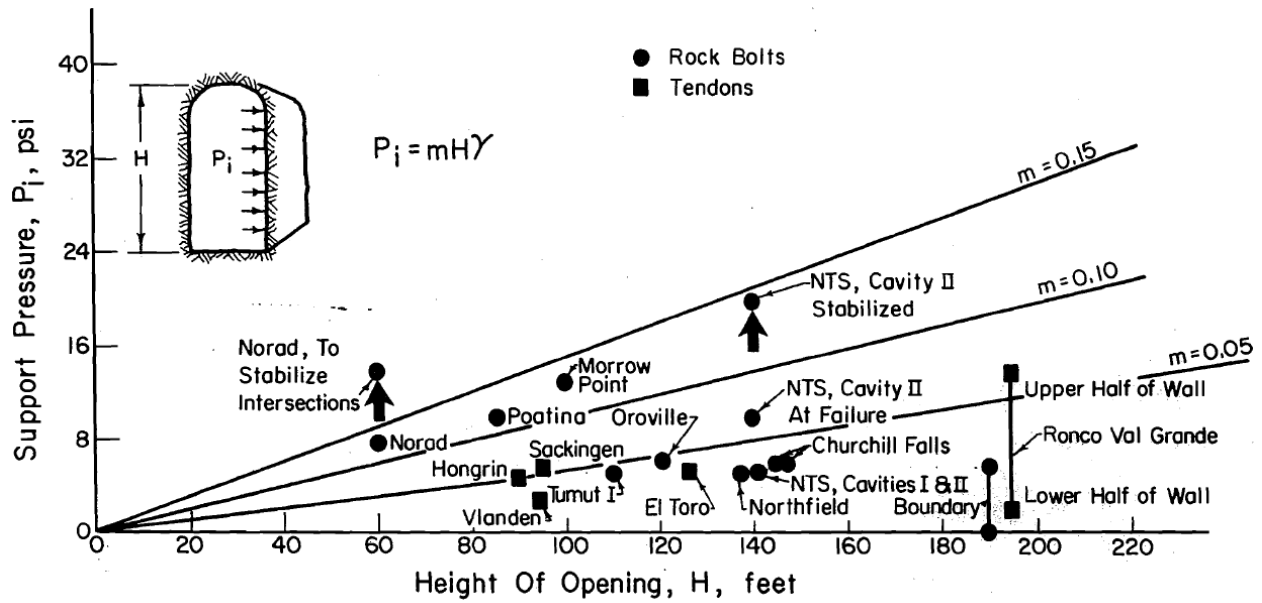

(a)

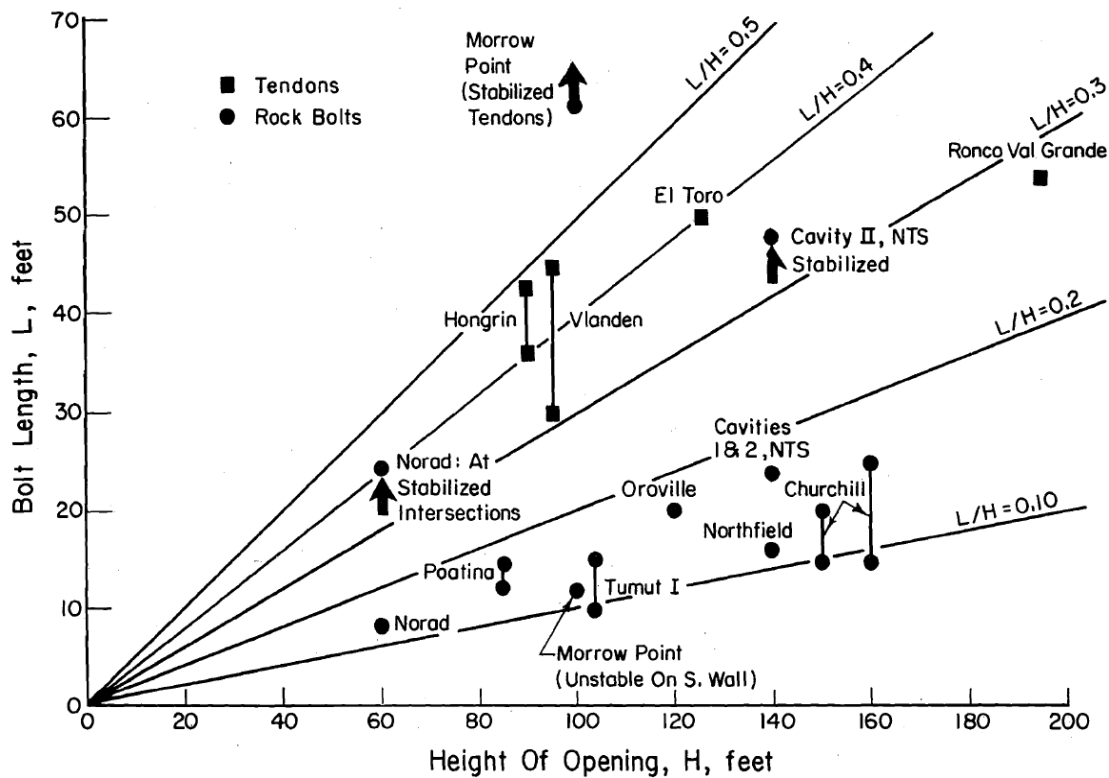

(b)

Figure 6-24 Support Pressures (a) and Bolt Lengths (b) Used on Cavern Walls (Cording, 1971)

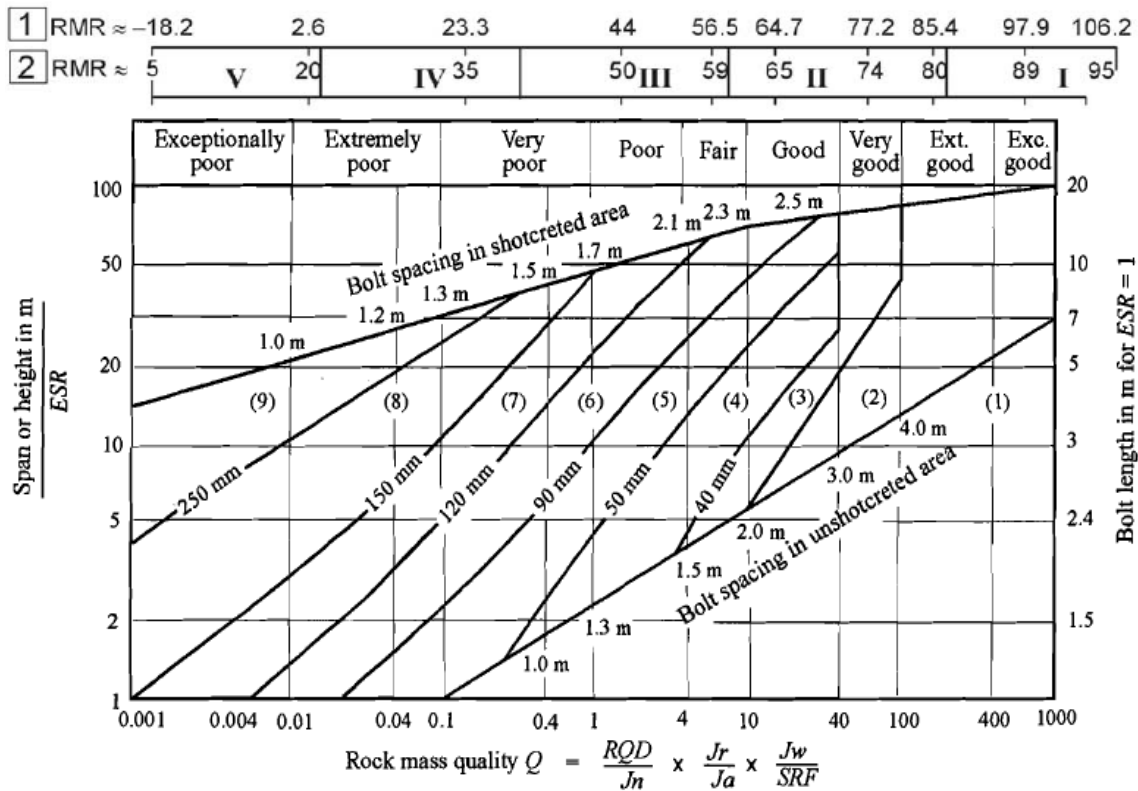

Reinforcing Categories:

- (1) Unsupported
- (2) Spot Bolting
- (3) Systematic Bolting
- (4) Systematic bolting with 40-100 mm unreinforced shotcrete
- (5) Fiber reinforced shotcrete, 50 - 90 mm, and bolting
- (6) Fiber reinforced shotcrete, 90 - 120 mm, and bolting
- (7) Fiber reinforced shotcrete, 120 - 150 mm, and bolting
- (8) Fiber reinforced shotcrete, > 150 mm with reinforced ribs of shotcrete and bolting
- (9) Cast concrete lining

Figure 6-25 Rock Support Requirement using Rock Mass Quality Q System

It should be noted that “the Q-system has its best applications in jointed rock mass where instability is caused by rock falls. For most other types of ground behavior in tunnels the Q-system, like most other empirical (classification) methods has limitations. The Q support chart gives an indication of the support to be applied, and it should be tempered by sound and practical engineering judgment” (Palmstream and Broch, 2006).

Also note that the Q-system was developed from over 1000 tunnel projects, most of which are in Scandinavia and all of which were excavated by drill and blast methods. When excavation is by TBM there is considerably less disturbance to the rock than there is with drill and blast. Based upon study of a much smaller data base, Barton (1991) recommended that the Q for TBM excavation be increased by a factor of 2 for Qs between 4 and 30.

**Table 6-9 Guidelines for Excavation and Support of 10 m Span Rock Tunnels in Accordance with the RMR System (after Bieniawski, 1989)**

| Rock mass class                   | Excavation  | Rock bolts (20 mm diameter, fully grouted)  | Shotcrete   | Steel sets   |
|-----------------------------------|---|---|---|--|
| I – very good rock<br>RMR: 81-100 | Full face<br>3 m advance  | Generally no support required except spot bolting   |   |  |
| II – Good rock<br>RMR: 61-80      | Full face, 1-1.5 m advance.<br>Complete support 20 m from face  | Locally, bolts in crown 3 m long, spaced 2.5 m with occasional wire mesh                    | 50 mm in crown where required                           | None   |
| III – Fair rock<br>RMR: 41-60     | Top heading and bench 1.5-3 m advance in top heading.<br>Commence support after each blast. Complete support 10 m from face                         | Systematic bolts 4 m long spaced 1.5-2 m in crown and walls with wire mesh in crown         | 50-100 mm in crown and 30 mm in sides                   | None   |
| IV – Poor rock<br>RMR: 21-40      | Top heading and bench 1.0-1.5 m advance in top heading.<br>Install support concurrently with excavation, 10 m from face                             | Systematic bolts 4-5 m long, spaced 1-1.5 m in crown and walls with wire mesh               | 100-150 mm in crown and 100 mm in sides                 | Light to medium ribs spaced 1.5 m where required                                       |
| V – Very poor rock<br>RMR: < 20   | Multiple drifts<br>0.5-1.5 m advance in top heading. Install support concurrently with excavation.<br>Shotcrete as soon as possible after blasting. | Systematic bolts 5.6 m long, spaced 1-1.5 m in crown and walls with wire mesh. Bolt invert. | 150-200 mm in crown, 150 mm in sides, and 50 mm on face | Medium to heavy ribs spaced steel lagging and forepoling if required.<br>Close invert. |

Note Table 6-9 above assumes excavation by drill and blast.

Barton et al. (1980) proposed rock bolt length, maximum unsupported spans and roof support pressures to supplement the support recommendations. The length of rock bolts,  $L$  can be estimated from the excavation width,  $B$  and the Excavation Support Ratio ( $ESR$ ) as follow:

$$L = \frac{2 + 0.15B}{ESR}, \text{ in meters} \quad 6-3$$

The maximum unsupported span can be estimated from:

$$\text{Maximum Unsupported Span} = 2 ESR Q^{0.4}, \text{ in meters} \quad 6-4$$

Grimstad and Barton (1993) proposed a relationship between  $Q$  value and the permanent roof support pressure,  $P_{roof}$  as follow:

$$P_{roof} (MPa) = \frac{2\sqrt{J_n} Q^{-1/3}}{3J_r} \quad 6-5$$

The value of Excavation Support Ratio (*ESR*) is related to the degree of security which is demanded of the support system installed to maintain stability of the excavation. Barton et al. (1974) suggested *ESR* values for various types of underground structures as presented in Table 6-10. An *ESR* value of 1.0 is recommended for civil tunnel projects.

**Table 6-10 Excavation Support Ratio (*ESR*) Values for Various Underground Structures (Barton et al., 1974)**

| Excavation Category |   | Suggested <i>ESR</i> Value |
|---------------------|---|----------------------------|
| A                   | Temporary mine openings   | 3 – 5                      |
| B                   | Permanent mine openings, water tunnels for hydro power (excluding high pressure penstocks), pilot tunnels, drifts and headings for large excavations. | 1.6                        |
| C                   | Storage rooms, water treatment plants, minor road and railway tunnels, surge chambers, access tunnels   | 1.3                        |
| D                   | Power stations, major road and railway tunnels, civil defense chambers, portal intersections  | 1.0                        |
| E                   | Underground nuclear power stations, railway stations, sports and public facilities, factories   | 0.8                        |

### 6.6.2 Analytical Methods

The state of stress due to tunnel excavation can be calculated from analytical elastic closed form solutions. Kirsch’s elastic closed form solution is one of the commonly used analytical solutions and is presented in Appendix E. The closed form solution is restricted to simple geometries and material models, and therefore often of limited practical value. However, the solution is considered to be a good tool for a “sanity check” of the results obtained from numerical analyses.

The interaction between rock support and surrounding ground is well described by the ground reaction curve (Figure 6-26), which relates internal support pressure to tunnel wall convergence. General description of ground reaction curve is well described Hoek (1999).

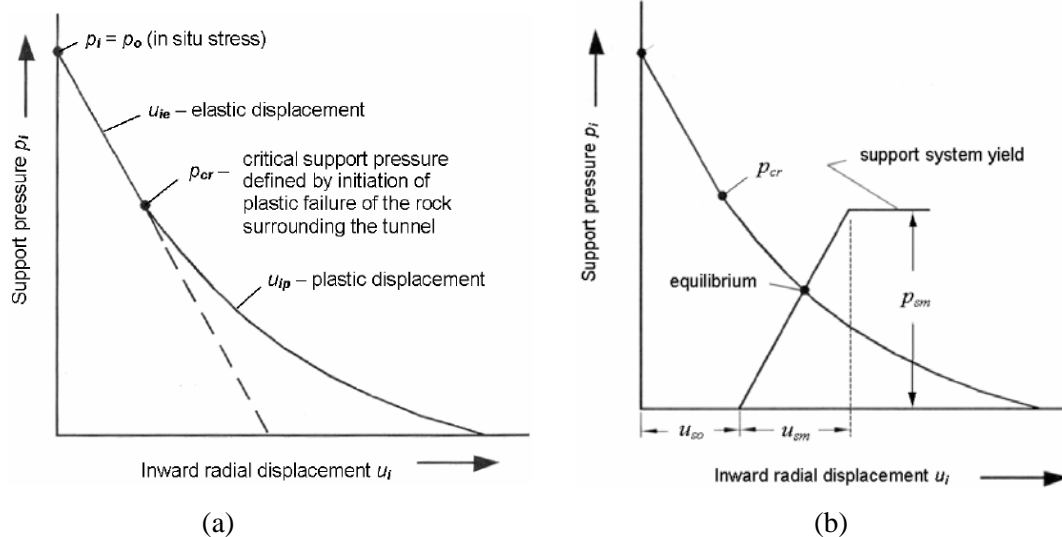

Figure 6-26 Ground Reaction Curves between Support Pressure and Displacement (Hoek et al., 1995)

As shown in Figure 6-26a, zero displacement occurs when the support pressure equals in-situ stress, i.e.,  $P_i = P_o$ . When the support pressure is greater than critical support pressure and less than in-situ stress, i.e.,  $P_o > P_i > P_{cr}$ , elastic displacement occurs. When the support pressure is less than the critical support pressure, i.e.,  $P_i < P_{cr}$ , plastic displacement occurs. Once the support has been installed and is in full and effective contact with the surrounding rock mass, the support starts to deform elastically. Maximum elastic displacement which can be accommodated by the support system is  $u_{sm}$  and the maximum support pressure,  $P_{sm}$  is defined by the yield strength of the support system. As shown in Figure 6-26b, the tunnel wall displacement has occurred before the support is installed and stiffness and capacity of support system controls the wall displacement.

Hoek (1999) proposed a critical support pressure required to prevent failure of rock mass surrounding the tunnel as follow:

$$P_{cr} = \frac{2P_o - \sigma_{cm}}{1+k}, \quad k = \frac{1 + \sin \phi}{1 - \sin \phi} \quad 6-6$$

Where:

- $P_{cr}$  = Critical support pressure
- $P_o$  = Hydrostatic stresses
- $\sigma_{cm}$  = Uniaxial compressive strength of rock mass
- $\phi$  = Angle of friction of the rock mass

If the internal support pressure,  $P_i$  is greater than the critical support pressure  $P_{cr}$ , no failure occurs and the rock mass surrounding the tunnel is elastic and the inward displacement of tunnel is controlled.

A more realistic design, especially for large tunnels and large underground excavations, is based on the true behavior of rock bolts: to act as reinforcement of the rock arch around the opening. This rock reinforcement increases the thrust capacity of the rock arch. The design objective is to make that increase in thrust capacity equivalent to the internal support that would be calculated to be necessary to stabilize the opening.

The increase in unit thrust capacity ( $\Delta T_A$ ) of the reinforced zone (rock arch) shown in Figure 6-27 is given by the equation (see Figure 6-27) developed by Bischoff and Smart (1977):

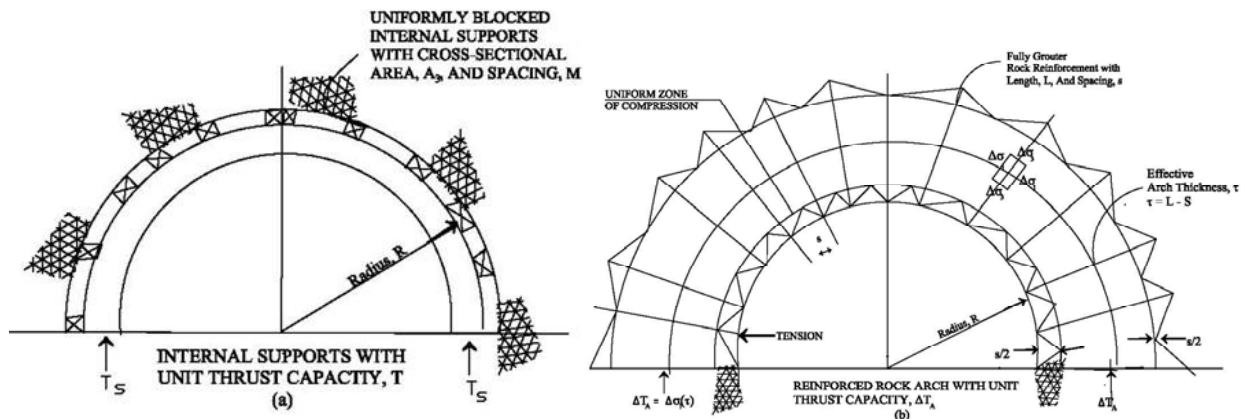

Figure 6-27 A Reinforced Rock Arch (After Bischoff and Smart, 1977)

$$\Delta T_A = \tan^2 \left( 45^\circ + \frac{\phi}{2} \right) \frac{T_b A_b}{S^2} t \quad 6-7$$

where  $\Delta T_A$  is increase in unit thrust capacity of the rock arch,  $\phi$  is effective friction angle of the rock mass,  $T_b$  is stress at yield of the rock reinforcement steel (fully grouted rock bolts),  $A_b$  is cross-sectional area of the reinforcement steel,  $S$  is spacing of the reinforcement steel, in both directions,  $t$  is effective thickness of the rock arch ( $= L - S$ ), and  $L$  is length of the reinforcement steel.

Analytical solutions to calculate support stiffness and maximum support pressure for concrete/shotcrete, steel sets, and ungrouted mechanically or chemically anchored rock bolts/cables are summarized in Table 6-11.

**Table 6-11 Analytical Solutions for Support Stiffness and Maximum Support Pressure for Various Support Systems (Brady & Brown, 1985)**

| Support System   | Support stiffness (K) and maximum support pressure ( $P_{max}$ )  |
|--|---|
| Concrete /Shotcrete lining   | $K = \frac{E_c [r_i^2 - (r_i - t_c)^2]}{(1 + \nu_c) [(1 - 2\nu_c)r_i^2 + (r_i - t_c)^2]}$ $P_{max} = \frac{\sigma_{cc}}{2} \left[ 1 - \frac{(r_i - t_c)^2}{r_i^2} \right]$  |
| Blocked steel sets   | $\frac{1}{K} = \frac{S r_i}{E_s A_s} + \frac{S r_i^3}{E_s I_s} \left[ \frac{\theta(\theta + \sin \theta \cos \theta)}{2 \sin^2 \theta} \right] + \frac{2S \theta t_B}{E_B W^2}$ $P_{max} = \frac{3A_s I_s \sigma_{ys}}{2S r_i \theta \{3I_s + X A_s [r_i - (t_B + 0.5X)](1 - \cos \theta)\}}$ |
| Ungrouted mechanically or chemically anchored rock bolts or cables | $\frac{1}{K} = \frac{s_c s_l}{r_i} \left( \frac{4l}{\pi d_b^2 E_b} + Q \right)$ $P_{max} = \frac{T_{bf}}{s_c s_l}$  |

**NOTATION:**  $K$  = support stiffness;  $P_{max}$  = maximum support pressure;  $E_c$  = Young's modulus of concrete;  $t_c$  = lining thickness (Figure 6-28a);  $r_i$  = internal tunnel radius (Figure 6-28a);  $\sigma_{cc}$  = uniaxial compressive strength of concrete or shotcrete;  $W$  = flange width of steel set and side length of square block;  $X$  = depth of section of steel set;  $A_s$  = cross section area of steel set;  $I_s$  = second moment of area of steel set;  $E_s$  = Young's modulus of steel;  $\sigma_{ys}$  = yield strength of steel;  $S$  = steel set spacing along the tunnel axis;  $\theta$  = half angle between blocking points in radians (Figure 6-28b);  $t_B$  = thickness of block;  $E_B$  = Young's modulus of block material;  $l$  = free bolt or cable length;  $d_b$  = bolt diameter or equivalent cable diameter;  $E_b$  = Young's modulus of bolt or cable;  $T_{bf}$  = ultimate failure load in pull-out test;  $s_c$  = circumferential bolt spacing;  $s_l$  = longitudinal bolt spacing;  $Q$  = load-deformation constant for anchor and head.

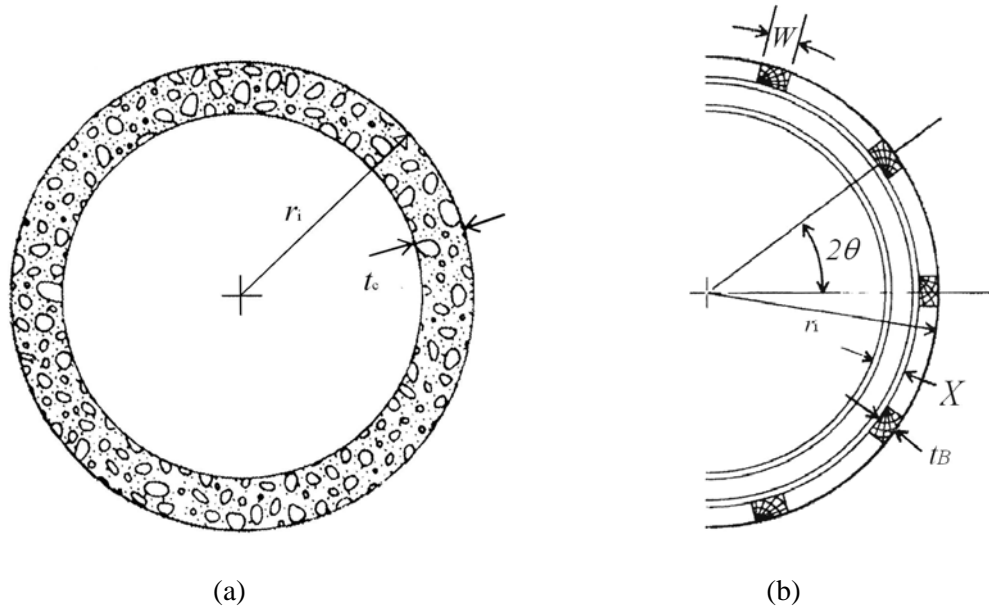

Figure 6-28 Support Systems: (a) Concrete / Shotcrete Lining, (b) Blocked Steel Set

The size and shape of wedges formed in the rock mass surrounding a tunnel excavation depend upon geometry and orientation of the tunnel and also upon the orientation of the joint sets. The three dimensional geometry problems can be solved by computer programs such as UNWEDGE (Rocscience Inc.). UNWEDGE is a three dimensional stability analysis and visualization program for underground excavations in rock containing intersecting structural discontinuities. UNWEDGE provides enhanced support models for bolts, shotcrete and support pressures, the ability to optimize tunnel orientation and an option to look at different combinations of three joint sets based on a list of more than three joint sets. In UNWEDGE, safety factors are calculated for potentially unstable wedges and support requirements can be modeled using various types of pattern and spot bolting and shotcrete. Figure 6-28 presents a wedge formed by UNWEDGE on a horse-shoe shape tunnel.

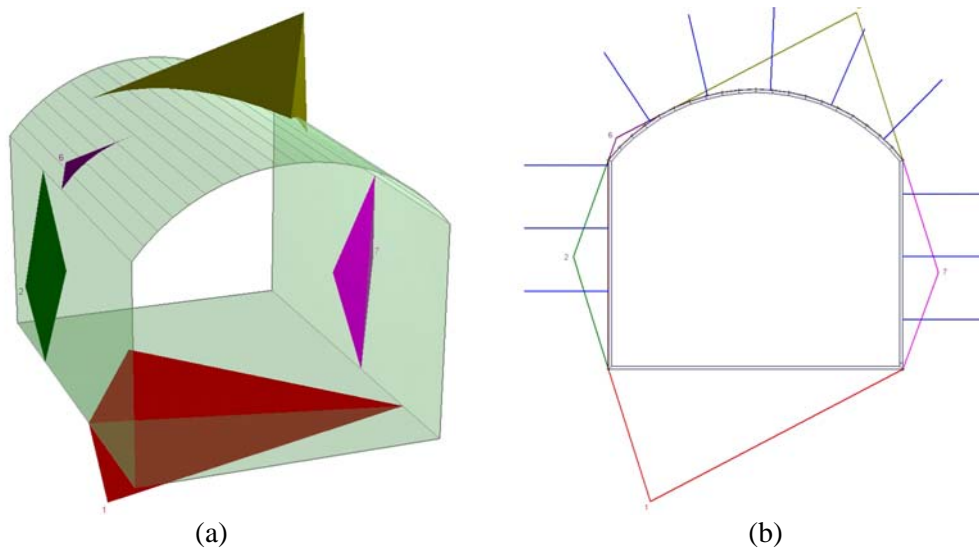

Figure 6-29 UNWEDGE Analysis: (a) Wedges Formed Surrounding a Tunnel; (b) Support Installation



### 6.6.3 Numerical Methods

Another powerful design tool is an elasto-plastic finite element or finite difference stress analysis. Finite element or finite difference analysis has been used for a wide range of engineering projects for the last several decades. Complex, multi-stage models can be easily created and quickly analyzed. The analyses provide complex material modeling options and a wide variety of support types can be modeled. Liner elements, usually modeled as beam elements, can be applied in the modeling of shotcrete, concrete layers, and steel sets. A typical finite element analysis layout to design support system is presented in Figure 6-30.

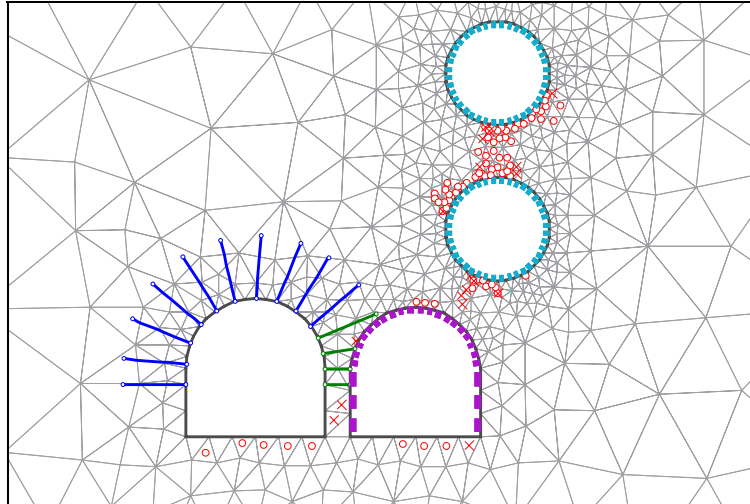

Figure 6-30 Design of Support System in FE Analysis (o: Yield in Tension, x: Yield in Compression)

Almost every project undertaken today requires numerical modeling to predict behavior of structures and the ground, and there is no shortage of numerical analysis programs available to choose from. Perspectives on numerical modeling in tunneling fields have changed dramatically during the last several decades. In the past, numerical modeling was generally thought to be either irrelevant or inadequate. The focus has now shifted to numerical computations as numerical techniques advance. There are a number of commercial computer programs available in the market—the problem is in knowing how to use these programs effectively and in having an understanding of their strengths and weaknesses.

All the programs require the user to have a sound understanding of the underlying numerical models and constitutive laws. The user interface is improving with the most recent Windows programs, although the learning curve for all the programs should not be underestimated. A number of numerical methods have been developed in civil engineering practice. The methods include finite element method (FEM), finite difference method (FDM), boundary element method (BEM), discrete element method (DEM) and hydrocodes. The numerical modeling programs commercially available in tunnel design and analysis are briefly introduced in Table 6-12.

Continuum Analysis FEM, FDM and BEM are so-called continuum analysis methods, where the domain is assumed to be a homogeneous media. These methods are used extensively for analysis of underground excavation design problems. To account for the presence of discontinuities, mechanical and hydraulic properties of rock mass were reduced from those measured from intact samples. (Refer to section 6.3.6)

**Table 6-12 Numerical Modeling Programs used in Tunnel Design and Analysis**

| <b>Programs</b> | <b>Descriptions</b>  | <b>Applications</b>  |
|-----------------|--|--|
| FLAC<br>FDM     | <ul style="list-style-type: none"> <li>• A two-dimensional finite difference code</li> <li>• Widely used in general analysis and as a design tool applied to a broad range of problems</li> <li>• Using user-defined constitute models and FISH functions, it is well suited for modeling of several stages, such as sequential excavation, placement of supports and liners, backfilling and loading.</li> <li>• As an option, this program enables dynamic analysis, thermal analysis, creep analysis, and two-phase flow analysis.</li> <li>• The explicit solution process of finite difference code enables numerical calculations stable, however, requires high running time when complex geometry and/or sequence modeling is involved.</li> </ul> | <ul style="list-style-type: none"> <li>• Mechanical behavior of soils and rock mass</li> <li>• Coupling of hydraulic and mechanical behavior of soils</li> <li>• Well suited for tunneling or excavation in soil</li> <li>• Global overview of engineering solution in rock mass, where equivalent properties of the rock mass should be properly evaluated</li> <li>• Seismic analysis</li> </ul> |
| FLAC 3D<br>FDM  | <ul style="list-style-type: none"> <li>• Three-dimensional version of FLAC</li> <li>• Meshing generation software is recommended for complicated geometry.</li> </ul>  | <ul style="list-style-type: none"> <li>• Complex three-dimensional behavior of geometry</li> <li>• Suitable for interaction study for crossing tunnels</li> </ul>  |
| PLAXIS<br>FEM   | <ul style="list-style-type: none"> <li>• A finite element packages for two-dimensional and three-dimensional analysis</li> <li>• Automatic finite element mesh generator</li> <li>• User Friendly</li> </ul>   | <ul style="list-style-type: none"> <li>• Tunneling and excavations in soil</li> <li>• Coupling of hydraulic and mechanical behavior</li> <li>• Modeling of hydrostatic and non-hydrostatic pore pressures in the soil</li> </ul>   |
| PHASE2<br>FEM   | <ul style="list-style-type: none"> <li>• Two-dimensional elasto-plastic finite element stress analysis</li> <li>• Well suited for rock engineering</li> <li>• Automatic finite element mesh generator</li> <li>• Easy-to-use</li> </ul>  | <ul style="list-style-type: none"> <li>• Tunneling and excavations in rock</li> <li>• Global overview of engineering solution in rock mass</li> </ul>  |
| SEEP/W          | <ul style="list-style-type: none"> <li>• A finite element code for analyzing groundwater seepage and excess pore-water pressure dissipation problems within porous materials</li> <li>• Available from simple, saturated steady-state problems to sophisticated, saturated-unsaturated time-dependent problems</li> <li>• Both saturated and unsaturated flow</li> </ul>   | <ul style="list-style-type: none"> <li>• Steady state and transient groundwater seepage analysis for tunnels and excavations</li> <li>• Equivalent properties of the rock mass should be properly evaluated</li> </ul>   |

**Table 6-12 Continued**

|                               |   |   |
|-------------------------------|---|---|
| <p><b>MODFLOW<br/>FDM</b></p> | <ul style="list-style-type: none"> <li>• A modular finite difference groundwater flow model</li> <li>• Most widely used tool for simulating groundwater flow</li> <li>• To simulate aquifer systems in which (1) saturated flow conditions exist, (2) Darcy’s Law applies, (3) the density of groundwater is constant, and (4) the principal directions of horizontal conductivity or transmissivity do not vary within the system</li> </ul>   | <ul style="list-style-type: none"> <li>• Three-dimensional steady state and transient flow</li> <li>• Modeling of heterogeneous, anisotropic aquifer system</li> <li>• Fate and transport modeling for geoenvironmental problems with available package</li> </ul>  |
| <p><b>UDEC<br/>DEM</b></p>    | <ul style="list-style-type: none"> <li>• A two-dimensional discrete element code</li> <li>• Well suited for problems involving jointed rock systems or assemblages of discrete blocks subjected to quasi-static or dynamic conditions</li> <li>• Modeling of large deformation along the joint systems</li> <li>• The intact rock (blocks) can be rigid or deformable blocks</li> <li>• Full dynamic capability is available with absorbing boundaries and wave inputs</li> <li>• Joints data can be input by statistically-based joint-set generator</li> <li>• Coupling of hydraulic and mechanical modeling</li> </ul> | <ul style="list-style-type: none"> <li>• Tunneling and excavation in jointed rock mass</li> <li>• Well suited if dominating weak planes are well identified with their properties properly quantified</li> <li>• Hydrojacking potential analysis for pressure tunnels, which requires details of joint flow, aperture and disclosure relationships</li> <li>• Seismic analysis</li> </ul> |
| <p><b>3DEC<br/>DEM</b></p>    | <ul style="list-style-type: none"> <li>• Three-dimensional extension of UDEC</li> <li>• Specially designed for simulating the quasi-static or dynamic response to loading of rock mass containing multiple, intersecting joint systems</li> <li>• Full hydromechanical coupling is available</li> </ul>   | <ul style="list-style-type: none"> <li>• Complex three-dimensional behavior of geometry</li> <li>• Suitable for interaction study for crossing tunnels in jointed rock mass</li> <li>• Hydrojacking potential analysis for pressure tunnels</li> </ul>  |
| <p><b>UNWEDGE</b></p>         | <ul style="list-style-type: none"> <li>• Pseudo-three-dimensional wedge generation and stability analysis for tunnels</li> <li>• Simple safety factor analysis</li> <li>• Three joint sets are required to form wedges</li> </ul>   | <ul style="list-style-type: none"> <li>• Conceptual analysis tool for tunnel support design</li> <li>• A parametric study for wedge loading diagrams for tunnel</li> </ul>  |
| <p><b>SWEDGE</b></p>          | <ul style="list-style-type: none"> <li>• Pseudo-three-dimensional surface wedge analysis for slopes and excavations</li> <li>• An easy to use analysis tool for evaluating the geometry and stability of surface wedges</li> <li>• Wedges formed by two intersecting discontinuity planes and a slope surface</li> </ul>  | <ul style="list-style-type: none"> <li>• Conceptual design of slopes</li> <li>• A parametric study for wedge loading diagrams for slopes and excavations</li> </ul>   |

**Table 6-12 Continued**

|         |  |   |
|---------|--|---|
| LSDYNA  | <ul style="list-style-type: none"> <li>• A general purpose transient dynamic finite element program</li> <li>• It is optimized for shared and distributed memory Unix-, Linux-, and Windows-based platforms</li> <li>• Coupling of Euler-Lagrange non-linear dynamic analysis</li> <li>• Widely used in impact and dynamic analysis</li> </ul> | <ul style="list-style-type: none"> <li>• Impact analysis</li> <li>• Blast/explosion analysis</li> <li>• Seismic/vibration analysis</li> <li>• Modeling of computational fluid dynamics</li> </ul> |
| AUTODYN | <ul style="list-style-type: none"> <li>• A finite difference, finite volume and finite element-based Hydrocode</li> <li>• Coupling of Euler-Lagrange non-linear dynamic analysis</li> <li>• Convenient material library</li> <li>• Widely used in dynamic analysis</li> </ul>  | <ul style="list-style-type: none"> <li>• Blast/explosion analysis</li> <li>• Impact analysis</li> <li>• Seismic/vibration analysis</li> <li>• Modeling of computational fluid dynamics</li> </ul> |

The continuum analysis codes are sometimes modified to accommodate discontinuities such as faults and shear zones transgressing the domain. However, inelastic displacements are mostly limited to elastic orders of magnitude by the analytical principles exploited in developing solution procedures. FLAC, PHASES, PLAXIS, SEEP/W, and MODFLOW are widely used programs for continuum analyses. Figure 6-31 presents an example of contour plot on the strength factor (SF) on a circular tunnel in gneiss from Finite Element Analysis (Choi et. al., 2007). Based on SF contour plots presented in Figure 6-31, the minimum SF against shear failure near the tunnel is 40, which means the rock mass strength is 40 times the induced stresses, indicating that the entire domain is not over-stressed and no stress-induced stability problems are anticipated.

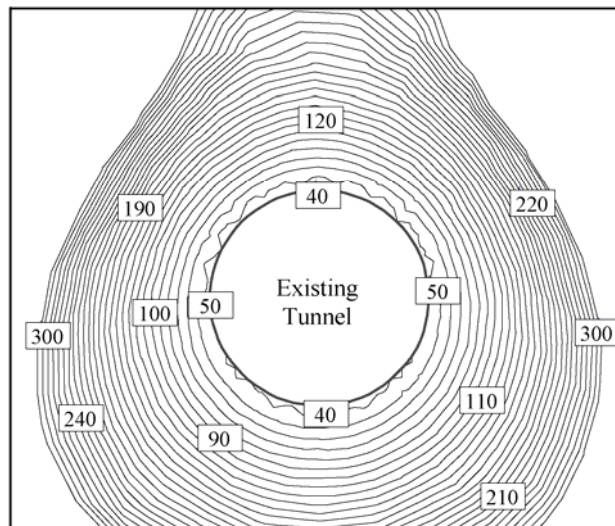

Figure 6-31 Strength Factor Contours from Finite Element Analysis (from Choi et. al., 2007)

**Discrete Element Analysis** If the domain contains predominant weak planes and those are continuous and oriented unfavorably to the excavation, then the analysis should consider incorporating specific characteristics of these weak planes. In this case, mechanical stiffness (force/displacement characteristics) or hydraulic conductivity (pressure/flow rate relationship) of the discontinuities may be much different from those of intact rock. Then, a discrete element method (DEM) can be considered to solve this type of problems. Unlike continuum analysis, the DEM permits a large deformation and finite

strain analysis of an ensemble of deformable (or rigid) bodies (intact rock blocks), which interact through deformable, frictional contacts (rock joints). In hydraulic analysis, the DEM permits flow-networking analysis, which is suitable in ground water flow analysis in jointed rock mass.

The coupled hydromechanical analysis is another powerful strength of DEM analysis because a flow in jointed rock mass is closely related to applied loading. This type of analysis requires details of joint flow, aperture and closure relationships and is suitable only if dominating weak planes are well identified with their properties properly quantified. UDEC and 3DEC are the most predominant programs, while UNWEDGE and SWEDGE are good alternatives for conceptual design purposes. An example of discrete element analysis is presented in Figure 6-32.



Figure 6-32 Graphical Result of Discrete Finite Element Analysis

#### 6.6.4 Pre-Support and Other Ground Improvement Methods

Pre-support is used in both rock and soil tunnels, perhaps somewhat more frequently in soil tunnels. In rock tunnel applications pre-support may be called for when the tunnel encounters zones of badly weathered and/or broken rock. In such rock, the stand up time may be too short to install the usual support system.

Pre-support may include a number of techniques. For example, spiles and forepoling typically are installed through and ahead of the tunnel face. These members are driven or drilled as shown schematically in Figure 6-21 and pass over the support nearest the face and under or through the next support back from the face. Thus, overlapping “cones” of spiles are formed and this results in a sawtooth pattern to the opening profile. These spiles are usually selected based upon experience and judgment as there is no known design method. Therefore, successful application usually rests on the workers in the field because they are at the face and have to make the decisions in real time and in short time as the ground is exposed and its behavior observed.

#### 6.6.5 Sequencing of Excavation and Initial Support Installation

As shown in Section 6.4, the three principal excavation methods for rock tunnels are as follows:

- Drill and blast (including SEM/NATM) for full face or multiple heading advance of any shape in any rock.
- Roadheader for full face or multiple heading advance of a shape in rock up to moderate strength.
- TBM for full face (generally round only) in any rock.

When an excavation is made in intact rock by any method there is an adjustment (or redistribution) in the stresses and strains around that excavation. This adjustment, however, quickly dissipates such that the change is only about six percent at a clear distance of three radii from the wall of the opening. The insitu stresses in the rock are generally low for most highway tunnels because those tunnels are at relatively shallow depth. Thus, in intact rock the (“elastic”) stresses resulting from this redistribution do not exceed the rock strength so stability is not a concern.

However, rock in reality is a jointed (blocky) material and it is the behavior of a blocky mass that nearly always governs the behavior of the tunnel. Evert Hoek describes this behavior as follows (Hoek, 2000): “In tunnels excavated in jointed rock mass at relatively shallow depth, the most common types of failure are those involving wedges falling from the roof or sliding out of the sidewalls of the openings. These wedges are formed by intersecting structural features, such as bedding planes and joints, which separate the rock mass into discrete but interlocked pieces. When a free face is created by the excavation of the opening, the restraint from the surrounding rock is removed. One or more of these wedges can fall or slide from the surface if the bounding planes are continuous or rock bridges along the discontinuities are broken.

Unless steps are taken to support these loose wedges, the stability of the back and walls of the opening may deteriorate rapidly. Each wedge, which is allowed to fall or slide, will cause a reduction in the restraint and the interlocking of the rock mass and this, in turn, will allow other wedges to fall. This failure process will continue until natural arching in the rock mass prevents further unraveling or until the opening is full of fallen material.

The steps which are required to deal with this problem are:

- Step 1: Determination of average dip and dip direction of significant discontinuity sets.
- Step 2: Identification of potential wedges which can slide or fall from the back or walls.
- Step 3: Calculation of the factor of safety of these wedges, depending upon the mode of failure.
- Step 4: Calculation of the amount of reinforcement required to bring the factor of safety of individual wedges up to an acceptable level.”

The concepts for and applications of sequencing of excavation and initial support installation are generally based on drill and blast excavation, but also apply to roadheader excavation. These concepts can be summarized in “one sentence” as follows: do not excavate more than can be quickly removed and quickly supported so that ground control is never compromised.

### **6.6.6 Face Stability**

In general, face stability is not as great a concern in rock tunnels as in soil tunnels because the rock stresses tend to arch to the sides and ahead of the face. However, in low strength rock, in areas where the rock is broken up or where the rock is extremely weathered face stability may be an issue. As discussed in Chapter 7 and in Section 6.6.5 the secret to successful tunneling where face stability may be an issue is to assure that individual headings are never so large that they cannot be quickly excavated and quickly supported. In addition, where groundwater exists it should be drawn down or otherwise controlled because, as noted by Terzaghi, unstable ground is usually associated with or aggravated by groundwater under pressure.

### 6.6.7 Surface Support

Surface support in a rock tunnel may be supplied by ribs and lagging as discussed above, or, more frequently now, by shotcrete in combination with rock bolts or dowels, steel sets, lattice girders, wire mesh or various types of reinforcement mats. For the most part modern rock tunnels are supported by shotcrete and either rock bolts or lattice girders.

Either system provides a flexible support that takes advantage of the inherent rock strength but that can be stiffened simply and quickly by adding bolts, lattice girders and/or shotcrete. In addition, lattice girders provide a simple template by which to judge the thickness of shotcrete. For other situations wire mesh or reinforcement mats have proven to successfully arrest and hold local raveling until sufficient shotcrete can be applied to knot the whole system together and hold it until the shotcrete attains its strength.

### 6.6.8 Ground Displacements

For the most part, ground displacements around a rock tunnel can be estimated from elastic theory or calculated using any of a number of computer programs. Elastic theory allows an approximate calculation of the ground displacements around a round tunnel in rock, as shown in Figure 6-33. The approximate radial displacement at a point directly around a tunnel in elastic rock is given by:

$$u = \frac{P_z(1+\nu)a^2}{E r} \quad 6-8$$

Where:

- $u$  = Radial movement, in.
- $P_z$  = Stress in the ground
- $\nu$  = Poisson's ratio
- $E$  = Rock mass modulus
- $a$  = Radius of opening
- $r$  = Radius to point of interest as presented in Figure 6-33.

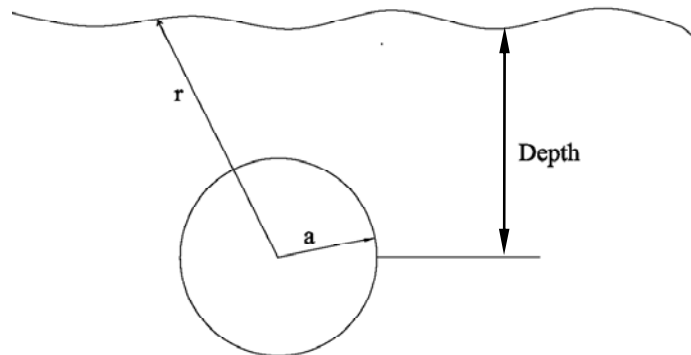

Figure 6-33 Elastic Approximation of Ground Displacements around a Circular Tunnel in Rock

For any shape other than circular, one can usually sketch a circle that most nearly approximates the true opening and use the radius of that circle in the above solution for an approximate displacement. However, in the rare case where the precise value of movement might be a concern, then it should be determined by numerical analysis. Displacement contours induced by two tunnel excavation, calculated by Finite Element Method, are presented in Figure 6-34.

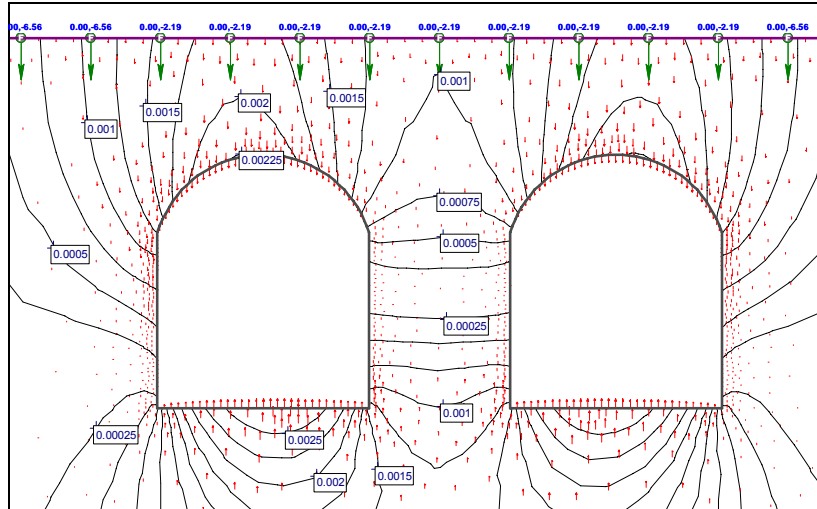

Figure 6-34 Ground Displacement Contours Calculated by Finite Element Method

## 6.7 GROUNDWATER CONTROL DURING EXCAVATION

Groundwater control in rock can take many forms depending on the nature and extent of the problem. In fact, for many cases experience has proven that a combination of control methods may be the best solution. For a given tunnel it may also be found that different solutions apply at different locations along the alignment.

### 6.7.1 Dewatering at the Tunnel Face

Dewatering at the tunnel face is the most common method of groundwater control. This consists simply of allowing the water to drain into the tunnel through the face, collecting the water, and taking it to the rear by channels or by pumping. It then joins the site water disposal system. Note that if there are hydraulic or other leaks or spills at the TBM or other equipment in the tunnel such contaminants are in this water.

### 6.7.2 Drainage Ahead of Face from Probe Holes

Probe holes ahead of the tunnel may be placed to verify the characteristics of the rock and hence to provide information for machine operation and control. These holes will also predrain the rock and provide warning of (and drain) any methane, hydrogen sulfide or any other gas, petroleum, or contaminant that may be present. In areas where there are such known deposits of gas or other contaminants it is common (and recommended) practice to keep one or more probe holes out in front of the machine. When such materials are encountered, the probes alert the workers to the need to increase the frequency of gas readings, to increase the volume of ventilation or to take other steps as required to avoid the problem of unexpected or excessive gas in the tunnel.

### 6.7.3 Drainage from Pilot Bore/Tunnel

Pilot tunnels can provide a number of benefits to a larger tunnel drive, including:

- Groundwater drainage
- Gas or other contaminant drainage



- Exploratory information on the geology
- Grouting or bolting galleries for pre-support of a larger opening
- Rock behavior/loading information for design of the larger opening

The question of location and size of pilot tunnel always leads to a spirited discussion such that no two are ever the same. They are typically six to eight feet in general size and may be located at one or more of several locations. As one example, on the H-3 project in Hawaii there was concern that huge volumes of water might be encountered. This is a 36 ft  $\pm$  highway through the mountain to the opposite side of the island. Borings were limited, but did not indicate huge volumes of water. However it was common knowledge that similar sites contained water-filled cavities large enough for canoe navigation and there was concern that a similarly large volume would be found in the H-3 tunnel. The pilot tunnel, proved that water was not a major concern and at the same time provided a second, unexpected benefit: by being able to see and analyze the rock for the whole tunnel bore, the winning contractor determined that he could perform major parts of the excavation by ripping with state-of-the-art large rippers in lieu of using drill and blast techniques. Because of this evaluation he was able to shave off millions of dollars in his bid and accelerate the construction schedule by several weeks. As an added benefit, the pilot tunnel was enlarged slightly and now is the permanent access (by way of special drifts) for maintenance forces to access the entire length of tunnel with small pickups without using the active traffic lanes.

#### **6.7.4 Grouting**

Groundwater inflow into rock tunnels almost exclusively comes in at joints, bedding planes, shears, fault zones and other fractures. Because these can be identified grouting is the most commonly used method of groundwater control. A number of different grout materials are used depending on the size of the opening and the amount of the inflow.

The design approach is first to detect zones of potentially high groundwater inflow by drilling probe holes out in front of the tunnel face. Second, the zones are characterized and, hopefully, the major water carrying joints tentatively defined. Then, third, a series of grout holes are drilled out to intercept those joints 10 feet to a tunnel diameter beyond the tunnel face or wall. Fourth, using tube-a-machetes, cement and/or water reactive grouts are injected to seal off the water to a level such that succeeding holes are drilled as the fifth step and injected with finer, more penetrating grouts such as micro-fine or ultra-fine cements and/or sodium silicate can be injected to complete the sealing off process. Based on evaluation of the grouting success additional holes and grouting may be required to finally reduce the inflow to an acceptable level. Typically it will be found that steps four and five must be repeated, trial and error, until the required reduction in flow is achieved.

#### **6.7.5 Freezing**

On rare occasions, it may become necessary to try freezing for groundwater control in a tunnel in rock. This might occur, for example, at a shaft where it was necessary to control the groundwater locally for a breakout of a TBM into the surrounding rock. If upon beginning excavation of the TBM launch chamber it were found that the water inflow was too great the alternative control methods would be to grout as discussed above or perhaps to freeze.

The authors are not aware of any examples in the U.S. where freezing has been used in a rock tunnel, probably for a very simple reason that high inflow encountered into a rock tunnel would be concentrated at the joints present in the rock. The concentration would usually result in a relatively high velocity of flow. Such velocity would typically exceed six feet per day, the maximum groundwater velocity for which it is feasible to perform effective freezing. Thus, for the most part freezing would not be used in

rock tunneling except very locally, as discussed above, and even then it might be necessary to use liquid nitrogen to perform the freezing.

### **6.7.6 Closed Face Machine**

A closed face machine could be used for rock tunneling in high groundwater flow conditions over short lengths. In reality such a machine would be more like an earth pressure balance (EPB) machine with sufficient rock cutters installed to excavate the rock. For any extended length (greater than a few hundred feet) this would typically be uneconomical. The machine would have to grind up the rock cuttings and mix, the resulting “fines” with large quantities of conditioners and the existing water to result in a plastic material. This is necessary for the EPB to control the face in front of the bulkhead and to bring the material from its pressurized state at the face down to ambient by means of the EPB screw conveyor (See Chapter 7).

For these reasons, one would not normally plan to build a closed face rock machine but to equip an EPB with rock cutters for driving short stretches in rock within a longer soft ground tunnel. An exception to this general statement would be a rock tunnel in weak or soft rock such as chalk, marl, shale, or sandstone of quite low strength such that it essentially behaved as high strength soft ground.

### **6.7.7 Other Measures of Groundwater Control**

The groundwater control methods discussed above probably account for more than 95% of the cases where such control is required in a tunnel in rock. For the odd tunnel (or shaft) where something else is required the designer may have to rely on experience and or ingenuity to come up with the solution. A few suggestions are given here, but really inventive solutions may have to be developed on a case-by-case basis.

Compressed Air once was a mainstay for control of groundwater or flowing or squeezing ground conditions but it is used very infrequently in modern construction. Where the tunnel (or shaft) can be stabilized by relatively low pressures (say 10 psi or less) it may still be used. However, it requires compressor plants, locks, special medical emergency preparation and decompression times.

Panning may be attractive in some cases where the water inflow is not too excessive and is concentrated at specific points and/or seams. In this case pans are placed over the leaks and shotcreted into place. Water is carried in chases or tubes to the invert and dumped into the tunnel drainage system

Drainage Fabric is now frequently used in rock tunnels. These geotechnical fabrics can be put in over the whole tunnel circumference or, more often, in strips on a set pattern or where the leaks are occurring. Fastened to the surface of the rock with the waterproof membrane portion facing into the tunnel, this fabric is then sandwiched in place by the cast-in-place concrete lining. The fibrous portion of the fabric provides a drainage pathway around and down the tunnel walls and into a collection system at the tunnel invert.

## **6.8 PERMANENT LINING DESIGN ISSUES**

### **6.8.1 Introduction**

For many tunnels the principle purpose of the final lining is to prepare the tunnel for its end use, for example, to improve its aesthetics for people or its flow characteristics for water conveyance. Thus, the final lining may consist of cast-in-place concrete, precast concrete panels, or shotcrete.

On the Washington DC subway for example both cast-in-place concrete and precast concrete panels were used. For downtown stations a variety of initial support schemes were used but a final lining of cast-in-place concrete, with a “waffle” interior finish was used for final support and lining. For outlying stations both initial support and the final structural lining were provided by rock bolts, embedded steel sets and shotcrete all installed as the stations were excavated. The precast concrete segmental inner lining (with waffle finish) that was installed at the outlying stations is architectural only – it carries no rock load. Precast concrete segments are more common in soil than in rock tunnels because in soil they are both initial and (sometimes) final support and they provide the reaction for propelling the machine forward. In rock tunnels the machine typically propels itself by reaction against grippers set against the rock.

## 6.8.2 Rock Load Considerations

As discussed in section 6.6, rock loads can be evaluated empirically or analytically. The calculated rock loads are often times described as roof load, side load, and eccentric load, where roof load and side load are uniformly distributed (Figure 6-35). It is recommended that the permanent lining is designed based on the uniform loads (roof and side loads) and checked by eccentric load case. Detailed load considerations are presented in Chapter 10 “Tunnel Lining”.

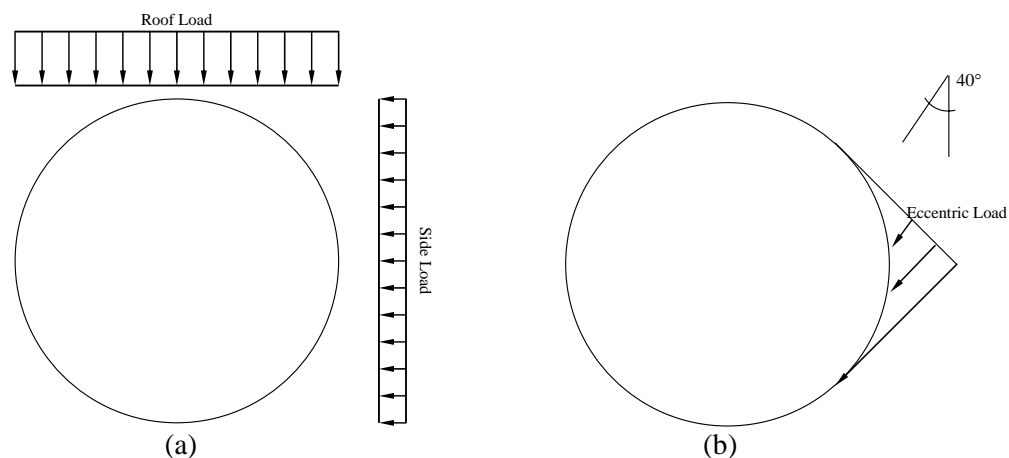

Figure 6-35 Rock Loads for Permanent Lining Design: (a) Uniform Roof and Side Loads; (b) Eccentric Load

The question of what “loads” to use for design of the permanent lining of a tunnel in rock always raises interesting challenges. Fundamentally, three conditions are possible:

1. If initial support(s) are installed early and correctly, it can be shown, that they will not deteriorate within the design life of the structure, and if the opening is stable, then a structural final lining is not required. (Figure 6-36).
2. If initial support(s) are installed early and correctly, the opening is stable (with no continuing loosening), but it cannot be demonstrated that the initial supports will remain completely effective for the design life of the structure, then the load(s) on the final lining may be essentially equal to those of the initial support. An example of this situation is the H-3 tunnel in Hawaii where initial support is provided by 14-ft rock bolts and the load on the final lining was assumed to be 14 feet of rock, analyzed in three ways:

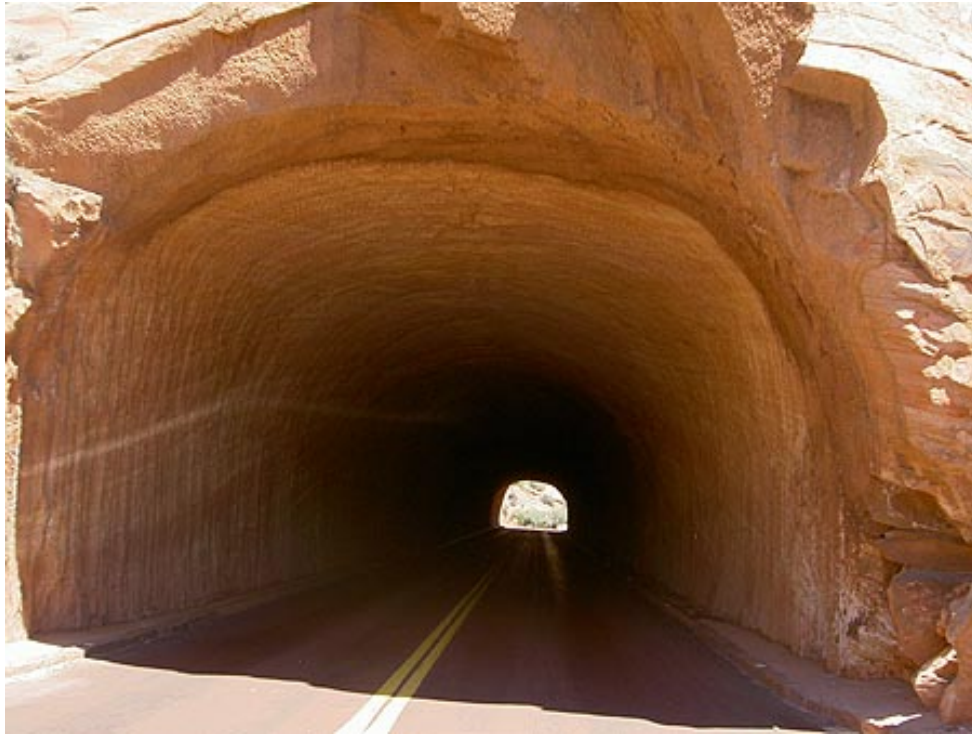

Figure 6-36 Unlined Rock Tunnel in Zion National Park, Utah

- Uniform load across the entire tunnel width
  - Uniform load across half of the tunnel width
  - Triangular load across the entire tunnel width with the maximum at the centerline.
3. If initial support(s) are providing a seemingly stable opening but it is known that additional support is required for long term stability then that support must be provided by the final lining. An example of this situation is the Superconducting Super Collider where tunnels in chalk were initially stabilized by pattern rock bolts in the crown and spot bolts elsewhere. Months later, however, slaking (and perhaps creep) resulted in linear wedges (with dimensions up to approximately by one-third the tunnel diameter) “working” and sometimes falling into tunnels driven and supported months earlier. To be stable long-term, a lining or additional permanent rock bolts capable of supporting these wedges or blocks would have been necessary.

As illustrated by the above, determination of the requirement for and value of “loads” to be used for design of final linings in tunnels cannot be prescribed in the manner that is possible for structural beams and columns. Rather, the vagaries of nature must be understood and applied by all on the design and construction team.

### 6.8.3 Groundwater Load Considerations

For conventional tunnels, the groundwater table is lowered by tunnel excavation, because the tunnels act as a drain. When the undrained system is considered, the groundwater lowering measures are disrupted after the final lining is placed and the groundwater table will reestablish its original position. For a

drained system, the groundwater is lowered and will be lowered so long as rainfall or at the project site seepage is not sufficient to raise the groundwater table. For underwater tunnels, the groundwater table keeps constant due to the water body above the tunnels and full hydrostatic water pressure should be considered with an undrained system unless an intensive grouting program is implemented in the surrounding ground.

This section discusses factors affecting groundwater flow regime and interaction with concrete lining, and methods to estimate groundwater loadings in the lining design including empirical method, analytical solution, and numerical method.

### **6.8.3.1 Factors on the Lining Loads due to Water Flow**

Groundwater loadings on the underwater tunnel linings can be reduced with a drained system while the groundwater table keeps constant. The main factors that affect water loads on the underwater tunnel linings due to water flow are: (1) relative ground-lining permeability; (2) relative ground-lining stiffness; and (3) geometric factors such as depth below the water body.

The water loads on the lining are greatly dependent on the relative permeability between the lining and surrounding ground. For a tunnel where the lining has a relatively low permeability when compared to the surrounding ground, the lining will behave almost as impermeable and almost no head will be lost in the surrounding ground resulting in hydrostatic water pressures applied directly on the lining.

A relatively permeable lining, on the other hand, will behave as a drain and almost no head will be lost when the water flows through the lining and no direct loads will act on the lining. The loads due to the groundwater will only act on the lining indirectly through the loads applied by the seepage force onto the surrounding ground.

The influence of the relative stiffness is well visualized for the tunnels in a stiff rock mass, where the linings are not designed for the full hydrostatic water pressures by using drained systems. For tunnels in soft ground, the linings are normally designed to withstand a full hydrostatic load.

### **6.8.3.2 Empirical Groundwater Loads**

The empirical groundwater loading conditions used for the design of tunnel linings in New York are shown in Figure 6-37 and are based on empirical data. As indicated in Figure 6-37, the groundwater loading diagram follows hydrostatic pressure to a maximum near the tunnel springline (head of  $H_s$ ), is held constant over a sidewall area of  $1/3H_{sw}$ , then decreases to 10 percent of hydrostatic pressure at the invert ( $0.1H_w$ ).

The empirical loads shown in Figure 6-37 are based on the assumptions that the drainage system is to be comprised of a wall drainage layer (filter fabric), invert drainage collector pipes placed behind the wall and below the cavern floor, and a drainage blanket developed by covering the entire invert with a gravel layer. The water load at the invert level is reduced to 10 percent of hydrostatic water pressure at the invert level with a well-sized and designed gravel drainage bed and drain pipe(s) in the invert (including appropriate provisions and follow up actions for long term maintenance). Under other circumstances, 25 percent of hydrostatic water pressure is recommended at the invert level. The empirical loads are probably conservative but address concerns that groundwater percolating through the wall rock over time could possibly clog the drainage layer (fabric) placed outside the concrete wall causing a buildup of groundwater pressure beyond that assumed under the assumption that the thick invert drainage blanket and collector drains should continue to function.

### 6.8.3.3 Analytical Closed-Form Solution

An analysis of the interaction between a liner and the surrounding rock mass needs to be carried out to evaluate the rate of leakage and the hydraulic head drop across the liner. Fernandez (1994) presented a hydraulic model for the analysis of the hydraulic interaction between the lining and the surrounding ground.

When a tunnel is unlined, the hydrostatic water pressure is exerted directly on the tunnel boundary. When a liner is placed, the total head loss across the liner-rock system,  $\Delta h_w$ , is composed of head losses across the liner,  $\Delta h_L$ , head losses across the grout zone if any,  $\Delta h_G$ , and head losses across the medium,  $\Delta h_m$ . The head loss across the liner is systemically presented in Figure 6-38.

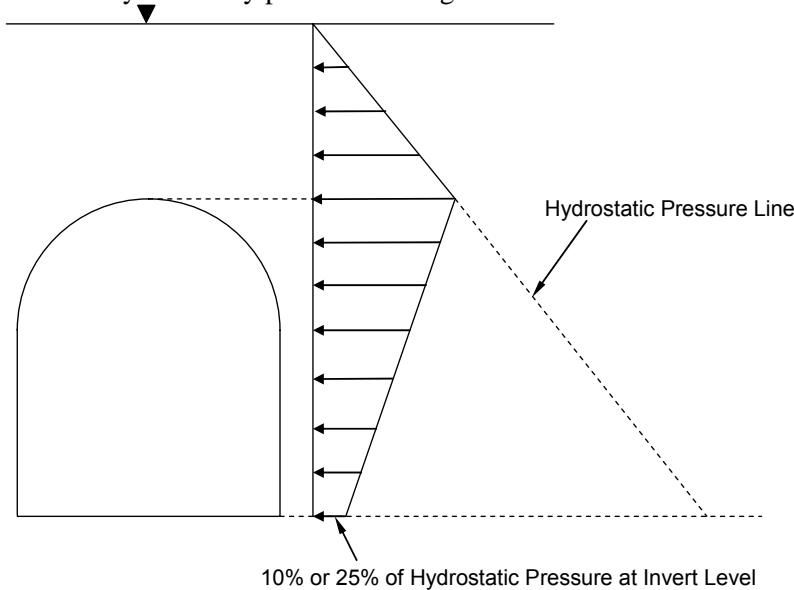

Figure 6-37 Empirical Groundwater Loads on the Underground Structures

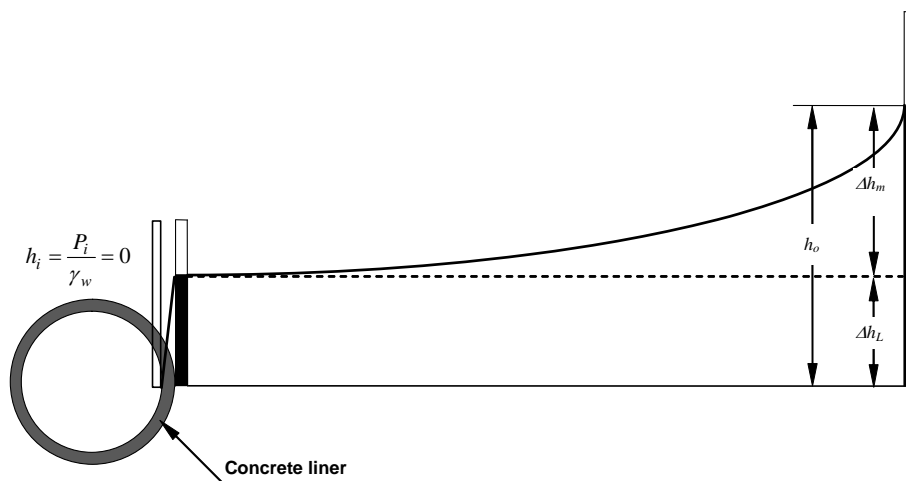

Figure 6-38 Head Loss across the Lining and Surrounding Ground

Fernandez (1994) indicated that the head loss across the liner normalized by the total head loss across the system is expressed by:

$$\frac{\Delta h_L}{\Delta h_w} = \frac{1}{1 + C \frac{k_L}{k_m}} \quad C = \frac{\ln(L/b)}{\ln(b/a_1)} \quad 6-9$$

where  $k_L$  and  $k_m$  are the permeability of the liner and surrounding ground, respectively, and  $b$  and  $a_1$  are outside and inside radii of the lining, respectively.  $L$  can be estimated as twice the depth of the tunnel below the groundwater level unless a drainage gallery is excavated parallel to the tunnel. If a drainage gallery is drilled parallel to the tunnel, the value of  $L$  can be adjusted and set equal to the center to center distance between the pressure tunnel and the gallery. In common engineering practice, the hydraulic head loss across the liner could be 80-90 % of the net hydraulic head for relatively impermeable liners, with  $k_L/k_m$  approximately equal to 1/80 to 1/100.

#### 6.8.3.4 Numerical Methods

A finite element seepage analyses can be used to predict hydraulic response of the ground in the vicinity of the tunnel construction (Figure 6-39). In the finite element analysis, both the tunnel liner and surrounding ground are idealized as isotropic and homogeneous media. The actual flow regime through the jointed rock mass and cracked concrete may be a fluid flow through the fracture networks; therefore, the absolute value of the hydraulic and mechanical response of the rock mass and concrete liner may differ from the prediction based on the assumption of isotropic, homogeneous, porous media.

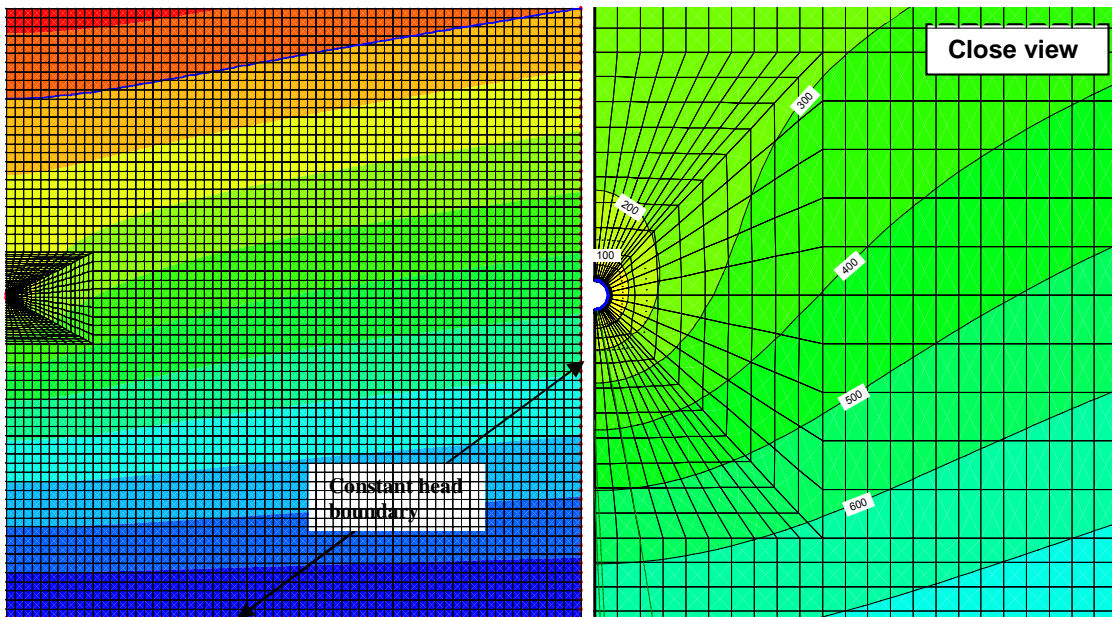

Figure 6-39 Two Dimensional Finite Element Groundwater Flow Model Analysis

It should be noted that this Finite Element Method analysis was focused on the global behavior of the rockmass, treating the rockmass as a porous, continuum, isotropic rather than discrete (i.e., blocky) material. The finite element approach (i.e., rock mass rather than discrete rock blocks) considers the

equivalent rockmass permeability, where the effects of hydraulic characteristics of fluid flow through rock joints are accounted for and approximated by the equivalent rockmass permeability. This approach has been used frequently for groundwater flow problems in the field of tunnel engineering. However, estimating the equivalent rock mass permeability closer than an order of magnitude is a great challenge and certainly requires special attention.

Use of discrete element analysis is sometimes very difficult because it requires detailed input parameters of the rock joints such as joint attitudes, joint spacing, joint connectivity, hydraulic apertures of the joints, normal and shear stiffness. Coupling effect of the mechanical and hydraulic behavior of rock joints also requires understanding of the relationship between mechanical closure and hydraulic aperture of the joints. Without proper input parameters, the results from the discrete element analysis would not be reliable.

#### 6.8.4 Drained Versus Undrained System

Drained Waterproofing System Drained waterproofing systems reduce hydrostatic loads on structures, enabling thinner and more lightly reinforced liners to be designed. In a fractured rock mass, high groundwater inflows often enter drained systems (even after rock mass grouting) resulting in increased pumping costs. High inflows can also increase the deposition of calcium precipitate in pipes. Under these conditions, an undrained system may be more efficient.

In the drained waterproof systems, the pipes and drainage layers are required to remain open and flowing to prevent the build-up of hydrostatic pressures. Regular inspections and maintenance of the drainage system are required to prevent hydrostatic loads rising to a level that could exceed the capacity of the structure. Figure 6-40 presents the cross-sectional layout for typical drained waterproofing system.

Allowable water infiltration rate varies depending upon the purpose of tunnel, tunnel dimension and local environmental law requirements. The rate of allowable infiltration acceptable to the owner shall be as specified in the contract documents. Some owners have used a rate of 1 gallon/minute per 1000 ft of tunnel length. The local infiltration limit is 0.25 gallon per day for 10 square feet of area, and 1 drip per minute at any location.

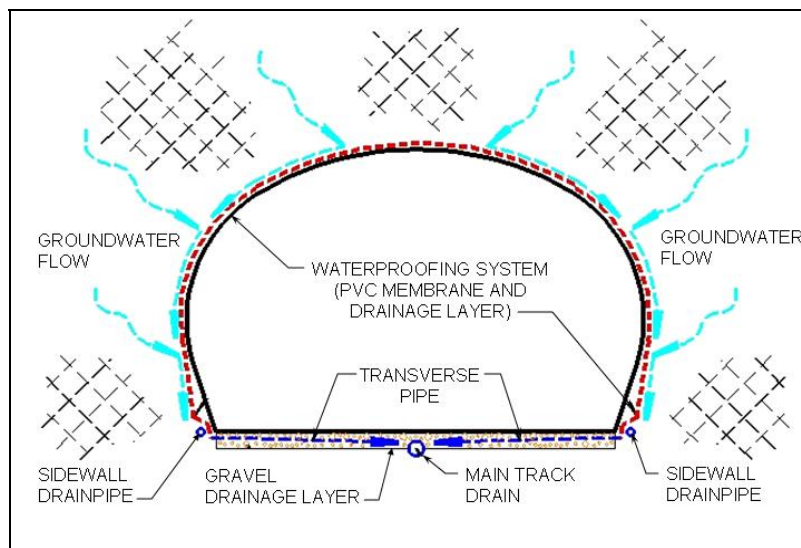

Figure 6-40 Drained Waterproofing System



**Undrained Waterproofing System** Undrained waterproofing systems incorporate a membrane that extends around the entire tunnel perimeter with the aim of excluding groundwater completely. Final linings are designed for full hydrostatic water pressures. Thus, flat-slab walls or inverts are generally thick, whereas curved liners generally require less strength enhancement. The increased volume of excavation to create a curved or thicker invert is offset by reduced excavation for a gravel invert and sidewall pipes. Figure 6-41 presents the cross-sectional layout for typical undrained waterproofing system.

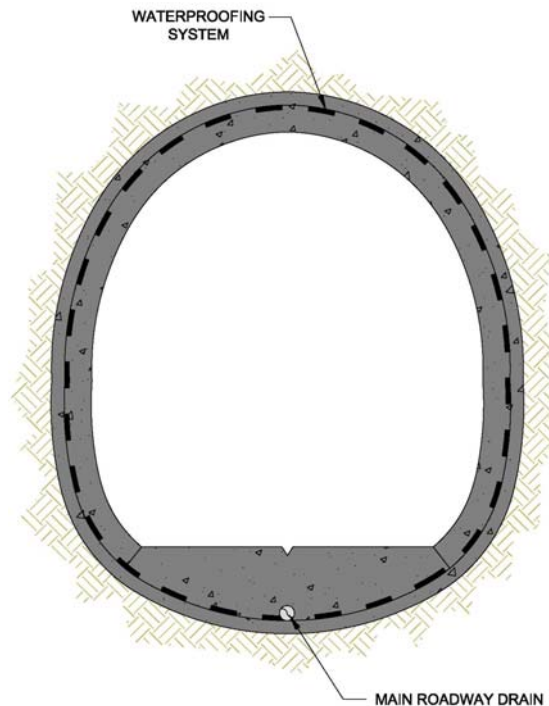

Figure 6-41 Undrained Waterproofing System

No groundwater drainage system is provided in the undrained system, resulting in cost savings from eliminating perforated sidewall pipes, porous concrete, transverse pipes and the gravel layer. If initial construction is of a high quality, operations and maintenance costs are low, because there is reduced pumping and without groundwater entering the tunnel drainage system, calcite deposits accumulate much more slowly. Reducing the inflow and drawdown also minimizes the chance of having to deal with contaminated water.

### 6.8.5 Uplift Condition

The question of uplift forces on the tunnel lining must also be considered for tunnels in rock, especially if the tunnel is to be undrained. When squeezing or swelling conditions are encountered they act upwards on the invert just as they act anywhere else around the perimeter. When the tunnel is first driven, these forces may be at least partially relieved by the act of excavation and also somewhat reduced because gravity works in opposition to these upward forces. As time passes, however, the upward forces from swelling and/or squeezing come into full effect, that is, equal to those occurring anywhere else around the opening. Even if these rock loads should not be developed, the water head on an undrained tunnel will certainly be equal to the in-situ groundwater pressure.

Whether it is swelling, squeezing, water pressure or any combination thereof the invert of the tunnel will be subjected to upward forces. Typically, this means that the invert should be modified to a curved geometry to react to these upward forces – it is far easier to develop a stable curved structure than it is to permanently stabilize a flat invert. Even without squeezing or swelling the uplift water load can be quite expensive to resist with a flat invert as compared to a curved one. Thus, the most economical solution is usually to go directly to a curved configuration wherein the curved shape (when supported by steel ribs) will carry almost twice the load it will carry with a straight invert or straight sides (Proctor, 1968).

### **6.8.6 Waterproofing**

For the most part tunnels in rock are waterproofed by a sandwich consisting of:

- A geotechnical drainage fabric that is put in place directly against the rock either continuously or in strips. This may be held in place by pins or nails driven or shot into the rock.
- Next a continuous waterproof membrane is installed. This membrane may be high density polyethylene (HDPE) or polyvinylchloride (PVC) or other similar material. To be continuous the membrane has to be cut and fit to all strange shapes and corners encountered and welded together (by heat) to make a continuous waterproofing membrane within the tunnel. Successful installation is quite dependent upon workmanship in three areas:
  - Avoiding puncturing, tearing and the like of the membrane.
  - Correctly making and testing all joints.
  - Connecting the waterproof membrane to the wall without introducing leaks.
- Finally a cast in place lining of concrete is placed to hold the sandwich together and to provide the desired inner surface of the tunnel. Of course, the challenge is to get the concrete placed without damaging the membrane(s), this is especially challenging when the cast in place concrete must be reinforced.

Unlined and partial lined tunnels are common in many short mountainous tunnels in competent rock and stabilized with or without patterned rock bolts on the exposed rock (Figure 6-37). Groundwater inflows are tolerated and collected. See Chapter 16 for groundwater control measures.

## CHAPTER 7 SOFT GROUND TUNNELING

### 7.1 INTRODUCTION

Chapters 6 through 10 present design recommendations and requirements for mined and bored road tunnels. Chapter 7 addresses analysis, design and construction issues specifically for tunneling (mostly shield tunneling) in soft ground including cohesive soils, cohesionless soils and silty sands. Chapter 10 addresses the design of various types of permanent lining applicable for soft ground tunnels.

Human kind has been excavating in soft ground for thousands of years. Archeological digs in Europe and elsewhere show that all kinds of tools were used by our ancestors to excavate soil (mostly for “caves” in which to live): bones, antlers, sticks, rocks and the like. However, there are tunnels in Europe that were built by the Romans, are over 2000 years old, and are still in service carrying water. As the population grows and we demand more and more transportation services, there can be no doubt that the requirement for tunnels will also grow. Through it all, the art of tunnel design and construction will also continue to develop, but it is doubtful that this art will ever develop into a science comparable to structural design. The structural engineer can specify both the configuration and the properties in great detail; the tunnel engineer must work with existing materials that cannot be specified and, in addition, are constantly changing, often dramatically.

Problematic soft ground conditions such as running sand and very soft clays are discussed in Chapter 8. Mining sequentially through soft ground based on the sequential excavation method (SEM) principles is discussed in Chapter 9. The data needed for analysis and design is discussed in Chapter 3. The results of the analysis and design presented herein are typically presented in the Geotechnical design memorandum (Chapter 4) and form the basis of the Geotechnical Baseline Report (Chapter 4).

### 7.2 GROUND BEHAVIOR

#### 7.2.1 Soft Ground Classification

Anticipated ground behavior in soft ground tunnels was first defined by Terzaghi (1950) by means of the Tunnelman’s Ground Classification (Table 7-1). It can be also be discussed in terms of soil identification (by particle size) and by considering behavior above and below the water table as summarized in the following.

Cohesive Soils and Silty Sand Above Water Table Cohesive (clayey) soils behave as a ductile plastic material that moves into the tunnel in a theoretically uniform manner. Following Peck’s (1969) lead for cohesive (clay) materials or materials with sufficient cohesion or cementation to sample and test for unconfined compression strength, an estimate of ground behavior in tunneling can be obtained from the equation:

$$N_{crit} = \frac{P_z - P_a}{S_u} \quad 7-1$$

Where  $N_{crit}$  is the stability factor,  $P_z$  is the overburden pressure to the tunnel centerline,  $P_a$  is the equivalent uniform interior pressure applied to the face (as by breasting or compressed air), and  $S_u$  is the undrained shear strength (defined for this purpose as one-half of the unconfined compressive strength).

**Table 7-1 Tunnelman's Ground Classification for Soils**

| Classification |                        | Behavior  | Typical Soil Types   |
|----------------|------------------------|---|--|
| Firm           |                        | Heading can be advanced without initial support, and final lining can be constructed before ground starts to move.  | Loess above water table; hard clay, marl, cemented sand and gravel when not highly overstressed.   |
| Raveling       | Slow raveling          | Chunks or flakes of material begin to drop out of the arch or walls sometime after the ground has been exposed, due to loosening or to over-stress and "brittle" fracture (ground separates or breaks along distinct surfaces, opposed to squeezing ground). In fast raveling ground, the process starts within a few minutes, otherwise the ground is slow raveling. | Residual soils or sand with small amounts of binder may be fast raveling below the water tale, slow raveling above. Stiff fissured clays may be slow or fast raveling depending upon degree of overstress.   |
|                | -----<br>Fast raveling |   |  |
| Squeezing      |                        | Ground squeezes or extrudes plastically into tunnel, without visible fracturing or loss of continuity, and without perceptible increase in water content. Ductile, plastic yield and flow due to overstress.  | Ground with low frictional strength. Rate of squeeze depends on degree of overstress. Occurs at shallow to medium depth in clay of very soft to medium consistency. Stiff to hard clay under high cover may move in combination of raveling at excavation surface and squeezing at depth behind surface. |
| Running        | Cohesive - running     | Granular materials without cohesion are unstable at a slope greater than their angle of repose (approx 30° -35° ). When exposed at steeper slopes they run like granulated sugar or dune sand until the slope flattens to the angle of repose.  | Clean, dry granular materials. Apparent cohesion in moist sand, or weak cementation in any granular soil, may allow the material to stand for a brief period of raveling before it breaks down and runs. Such behavior is cohesive-running.  |
|                | -----<br>Running       |   |  |
| Flowing        |                        | A mixture of soil and water flows into the tunnel like a viscous fluid. The material can enter the tunnel from the invert as well as from the face, crown, and walls, and can flow for great distances, completely filling the tunnel in some cases.  | Below the water table in silt, sand, or gravel without enough clay content to give significant cohesion and plasticity. May also occur in highly sensitive clay when such material is disturbed.   |
| Swelling       |                        | Ground absorbs water, increases in volume, and expands slowly into the tunnel.  | Highly preconsolidated clay with plasticity index in excess of about 30, generally containing significant percentages of montmorillonite.  |

\* Modified by Heuer (1974) from Terzaghi (1950)

Table 7-2 shows the anticipated behavior of tunneling in clayey soils (Modified from Peck 1969 and Phienwaja 1987.) Silty sand above water table may have some (apparent) cohesion but they typically behave in a brittle manner adjacent to the tunnel opening. Predicting their behavior by the above equation is more subjective but may be attempted as shown in Table 7-2.

**Table 7-2 Tunnel Behavior for Clayey Soils and Silty Sand (after Bickel et al., 1996)**

| Stability Factor, $N_{crit}$                                       | Soft Ground Tunnel Behavior   |
|--|---|
| <b>Cohesive Soils</b>  |   |
| 1  | Stable  |
| 2-3  | Small creep   |
| 4-5  | Creeping, usually slow enough to permit tunneling   |
| 6  | May produce general shear failure. Clay likely to invade tail space too quickly to handle |
| <b>Silty Sands Above Water Table (with some apparent cohesion)</b> |   |
| <b>1/4 - 1/3</b>   | <b>Firm</b>   |
| <b>1/3 - 1/2</b>   | <b>Slow Raveling</b>  |
| <b>1/2 - 1</b>   | <b>Raveling</b>   |

Cohesionless Granular Soils including Silty Sand Below the Water Table From the tunneling perspective, dry or partially saturated sand and gravel above the groundwater table may possess some temporary apparent cohesion from negative pore pressure. When the material is below the water table, it lacks sufficient cohesion or cementation and the behavior is more subjective and can easily run or flow into the excavation. The behavior of sands and gravels in tunneling were summarized by Terzaghi (1977) and that summary still applies (Table 7-3). Note that the cleaner the sand, the more liable it is to run or flow when exposed in an unsupported vertical face during tunnel construction. Chapter 8 provides more discussion for running and flowing sands

For silty sands below the groundwater table, they can be problematic and flow if the uniformity coefficient  $C_u$  is not less than 3 and flowing to cohesive running if  $C_u$  is less than 6 (Terzaghi 1977).

### 7.2.2 Changes of Equilibrium during Construction

Excavation of a soft ground tunnel opening and the subsequent construction of supports change the stress conditions for the tunnel and the surrounding medium. These changes may be continuous or in stages. A comprehension of the deformations associated with these changes is necessary for an understanding of the behavior of tunnel supports.

“The state of the medium before the excavation of a tunnel cavity is one of equilibrium in a gravity field. The process of tunneling evokes new equilibrium conditions which will change during the various stages of tunneling and construction of supports until a final equilibrium is reached. In this final equilibrium, all changes in strain and stress around the tunnel opening cease and a new equilibrium condition is established.

**Table 7-3 Tunnel Behavior: Sands and Gravels**

| Designation                            | Degree of Compactness | Tunnel Behavior   |  |
|--|-----------------------|---|--|
|  |                       | Above Water Table   | Below Water Table  |
| Very Fine Clean Sand                   | Loose, $N \leq 10$    | Cohesive Running  | Flowing  |
|  | Dense, $N > 30$       | Fast Raveling   | Flowing  |
| Fine Sand With Clay Binder             | Loose, $N \leq 10$    | Rapid Raveling  | Flowing  |
|  | Dense, $N > 30$       | Firm or Slowly Raveling   | Slowly Raveling  |
| Sand or Sandy Gravel with Clay Binder  | Loose, $N < 10$       | Rapid Raveling  | Rapidly Raveling or Flowing  |
|  | Dense, $N > 30$       | Firm  | Firm or Slow Raveling  |
| Sandy Gravel and Medium to Coarse Sand |                       | Running ground. Uniform ( $C_u < 3$ ) and loose ( $N < 10$ ) materials with round grains run much more freely than well graded ( $C_u > 6$ ) and dense ( $N > 30$ ) ones with angular grains. | Flowing conditions combined with extremely heavy discharge of water. |

A region of changing stresses, characterized by increased vertical pressure, travels ahead of the advancing face of the tunnel. Changes of equilibrium conditions are also felt at a considerable distance behind the face. The distribution of stresses has a three dimensional character at a point near the face, but approaches a two-dimensional state as the face advances. The rate at which the two-dimensional state is approached is influenced by the rate of advance of the face in relation to the time-dependent behavior of the medium.

The continuous or frequent changes in the conditions for stress equilibrium cannot take place without deformations in the medium. If supports are employed, these will deform as well. There is always an immediate deformation response to a change in equilibrium conditions, and commonly there is an additional, time-dependent response. In a waterbearing medium, the excavation of a tunnel changes the pore water pressures around the opening, and flow of water is induced. In fine grained materials with a low permeability, the establishment of hydrostatic or hydrodynamic equilibrium is not immediate. The associated time-dependent changes in effective intergranular pressures in the medium then lead to time-dependent deformations.

Time lags may also be associated with visco-elastic or visco-plastic phenomena such as creep in the medium itself or along joint planes in the medium. Whatever the cause of the time lags, their most important effect is that a final equilibrium for a set of boundary conditions often is not reached before new changes in boundary conditions occur.

Tunnel construction not only changes the equilibrium conditions but in many cases the medium itself. Blasting commonly reduces the strength of the rock around the opening; shoving by a closed or nearly closed shield disturbs and may remold the soil. Indeed, disturbing the material in the immediate vicinity of the opening is hardly avoidable. Where a tunnel is advanced without blasting in a medium which requires little or no immediate support, however, the disturbance may be minimal.

### **7.2.3 The Influence of the Support System on Equilibrium Conditions**

Most tunnel openings are supported at some stage of construction. The behavior of a tunnel opening and a support system is dependent on the time and manner of the placement of the support and its deformational characteristics.

The reasons for providing support are manifold. Sometimes support is required for the immediate stability of the opening. It may be furnished even before excavation, for example by air pressure, forepoling or ground improvements. Under these circumstances the interaction between the medium and the supporting agent commences during or before excavation. When a shield is used for immediate support, a lining is erected inside the shield, and the annular void cleared by the shove of the shield is at least partly filled with pea-gravel and/or grout. The lining may be intended as a permanent support consisting, for example, of precast concrete segments. It may alternatively be a relatively flexible one in which a stiffer permanent lining will later be constructed. In this event, at least three different equilibrium conditions must be considered.

Where there is need for long-term but not immediate support, the support may be constructed at some distance behind the face. A partial relaxation with associated movements may then take place before the support interacts with the medium. Often a liner is erected and expanded into contact with the medium. The expansion induces a prestress in both the liner and the medium and influences subsequent deformations.

Even where instability or collapse of the opening is not imminent, support may still be required for various reasons, usually to control or limit deformations. Large deformations may lead to undesired settlements of the ground surface or to interference with other structures. Such deformation must be restrained at a suitably early stage. Deformations of a soil or rock mass commonly result in an undesirable reduction in strength and coherence of the medium. In a jointed or weak rock the material above the opening tends to loosen and may sooner or later exert considerable loads on the support. These loads are reduced if loosening is prevented by suitable support.

Although the initial stability may be satisfactory, conditions may be such that final equilibrium cannot be reached without support. This may occur in jointed rock mass subject to progressive loosening, in creeping or swelling materials, and in materials whose strength decreases with time. Except in such creeping materials as salts, these long term phenomena are associated with volume changes.

It is impossible and undesirable to avoid deformations in the soft ground altogether. Some movement is necessary to obtain a favorable distribution of loading between the medium and the support system. In each instance, the engineer must determine how much movement is beneficial to the behavior of the tunnel, and at what movements the effects will become detrimental. The engineer's conclusions regarding these matters determine whether and where restraints are to be applied to the tunnel walls. His conclusions also determine the character and magnitude of those restraints. In tunnels in hard rock the beneficial movements take place almost immediately, and subsequent movements are likely to lead to loosening and additional loading. Hence, in this case rapid construction of supports is usually desirable. It is apparent that many factors determine whether and where a support system should be constructed for structural reasons alone. The final choice of whether and where supports are actually employed is

influenced by additional factors such as the psychological well-being of the workers, or the economy that might be achieved by adopting a uniform construction procedure throughout the same tunnel even though the properties of the medium vary.

No matter what the reason for using restraints, the loads to which a support will be subjected depend on the stage of equilibrium prevailing at the time the support is introduced. Thus, if final equilibrium has been reached before support is provided, the support may not receive loads from the medium at all. On the other hand, when support is furnished before final equilibrium has been established, new boundary conditions are superimposed on the conditions existing at the time the support is constructed. The new final conditions depend on the time the support was provided and involve the interaction between the support and the medium. If a stiff support could be installed in the medium before excavation by an imaginary process that did not in any way disturb the remaining material, it would be subjected to stresses resembling those of the in-situ condition existing before the excavation. However, the at least temporary reduction of the radial stresses to atmospheric pressure (or to the air pressure in the tunnel), as well as many other activities, generally introduce such deformations into the medium that the stresses ultimately acting on the tunnel support bear little or no resemblance to the initial stresses in the medium.

Procedures for the analysis and design of tunnel supports are necessarily simplified, but they should be based on the considerations of equilibrium and deformations briefly outlined above. In addition, a number of factors which are not directly related to the interaction between a support system and the medium are significant in the actual design of supports. Such factors, which are dealt with in the following section, sometimes even override considerations of structural interaction.” (After Deere, 1969).

### 7.3 EXCAVATION METHODS

#### 7.3.1 Shield Tunneling

Generally soft ground tunneling did not become viable until the introduction of the tunnel shield (accrued to Sir Marc Brunel), except for small hand-excavated openings in soft ground and somewhat larger ones in soft rock, tunneling. Brunel wrote: “The great desideratum (sic) therefore consists in finding efficacious means of opening the ground in such a manner that no more earth shall be misplaced than is to be filled by the shell or body of the tunnel and that the work shall be effected with certainty” (Copperthwaite, 1906). In other words, never open more than is needed, can be excavated rapidly, and quickly supported. Brunel patented a circular shield (Figure 7-1) in 1818 that was described by Copperthwaite (1906) as covering “every subsequent development in the construction and working of tunnel shields.”

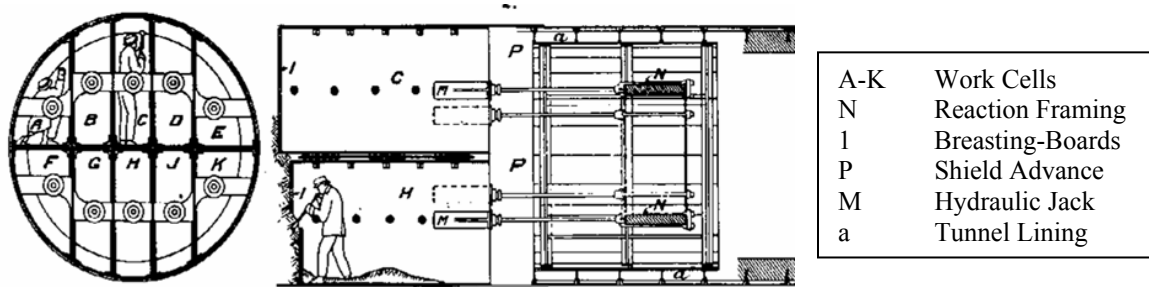

Figure 7-1 Patent Drawing for Brunel’s Shield, 1818 (Cooperthwaite, 1906).



If we fast forward, we find that nearly all soft/ground tunnels driven in North America into the 1960's and the early 1970's were mostly under 10 feet (3 m) diameter and driven using the basic concepts of the Brunel tunnel shield; viz, compartmentalized, face breasting with timber and lots of hand labor.

In ground conditions that required a higher level of support than the basic Brunel shield, compressed air was commonly used (actually from the mid 1800's into the 1980's). When used correctly, compressed air provided the needed support and allowed many tunnels to be completed that would otherwise not have been possible. Because of the decompression required and all the associated equipment and procedures, not to mention the potential hazards to the workers, e.g., the bends or even death, compressed air has largely been eliminated as a tunneling adjunct.

Starting in the late 1960's and early 1970's, mechanization began to be introduced by incorporating excavating machines within the circular shields, hence the term digger shield (Figures 7-2 and 7-3).



Figure 7-2 Digger Shield with Hydraulically Operated Breasting Plates on Periphery of Top Heading of Shield used to Construct Transit Tunnel.

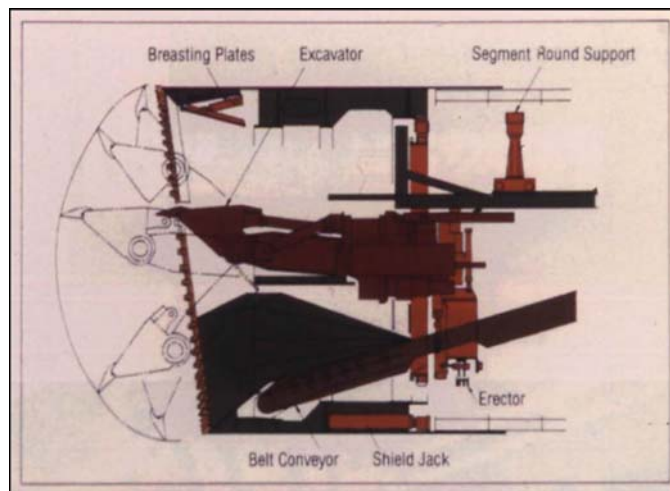

Figure 7-3 Cross-section of Digger Shield

However, digger shield machines too often met with poor results and were usually unsatisfactory for three reasons:

1. Ground loss occurred ahead and above the shield when retracting the doors or poling plates. Typically, the orange-peel doors could not be retracted in tune with the forward progress of the shield. Also when retracting the doors, the miner does not have access to deal with running ground. Thus the machine encouraged unwanted ground movement, rather than controlling it.
2. Maintaining the right soil “plug” in the invert was always a headache.
3. Mounting the digger in the center created a “Catch 22”: if the ground movement in the center became excessive, the only way to stop it was to cram the digger bucket into the face. However, that made it impossible to excavate and move the shield forward because to do so meant the bucket had to be moved, allowing the face to fail.

Shields with open faced wheeled excavators were another, early step in mechanization of soft-ground machines that have some things in common with their cousins the hard rock TBMs. Wheeled excavators were used with success in firm ground conditions, but not so well in running or fast raveling ground conditions. In some ground conditions this arrangement was marginally successful but in general it was not possible always to control the amount of ground allowed through the wheel to be equal to only that described by the cutting edge of the shield.

Figure 6-11 shows the types of tunnel boring machines suitable for soft ground conditions. The various conventional shield tunneling methods are summarized by Zosen (1984) as show in Table 7-4. The following sections focus on the modern Earth Pressure Balance (EPB) and Slurry Face Machines (SFM).

### **7.3.2 Earth Pressure Balance and Slurry Face Shield Tunnel Boring Machines**

As a turning point in global tunneling equipment development, soft ground tunnel shields equipped with wheeled excavators were exported to Japan. Further development of soft-ground tunneling machines was flat in the USA for many years, Japan, however, took a good idea, invested heavily in equipment development and within a decade or so exported vastly improved tunneling methods back to the USA in the form of pressurized-face tunneling machines.

Thus as soft ground tunneling in the USA was affixed with traditional shield tunneling, the Japanese, Europeans (read that Germans), the UK, and Canadians were developing two more “modern” machines – the earth pressure balance machine (EPB) and the slurry face machine (SFM) that are also summarized in Table 7-4 (also Figure 7-4 to Figure 7-7).

At first-hand, these machines are similar in that they both have:

1. A revolving cutter wheel.
2. An internal bulkhead that traps cut soil against the face (hence, they are called closed face), and that maintains the combined effective soil and water pressure and thereby stabilizes the face.
3. No workers are at the face but rely on mechanization and computerization to control all functions, except segment erection (to date).
4. Precast concrete segments erected in the shield tail, with the machine advanced by shoving off those segments.

**Table 7-4 Shield Tunneling Methods in Soft Ground (Modified from Hitachi Zosen, 1984)**

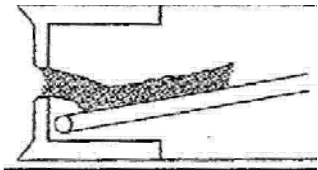
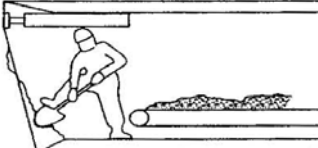
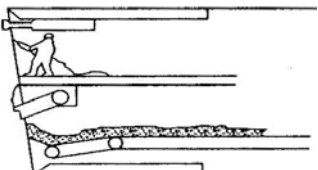
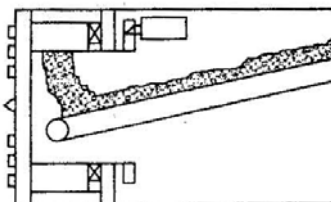
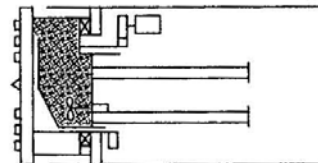
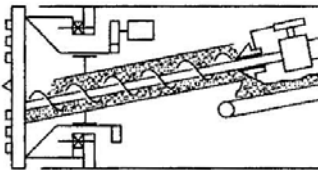
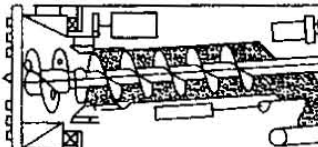
| Type   | Description   | Sketch  |
|--|---|---|
| Blind shield   | <ul style="list-style-type: none"> <li>• A closed face (or blind) shield used in very soft clays and silts</li> <li>• Muck discharge controlled by adjusting the aperture opening and the advance rate</li> <li>• Used in harbor and river crossings in very soft soils. Often results in a wave or mound of soil over the machine</li> </ul>   |    |
| Open face, hand-dug shield                               | <ul style="list-style-type: none"> <li>• Good for short, small tunnels in hard, non-collapsing soils</li> <li>• Usually equipped with face jacks to hold breasting at the face</li> <li>• If soil conditions require it, this machine may have movable hood and/or deck</li> <li>• A direct descendent of the Brunel shield</li> </ul>  |    |
| Semi-mechanized  | <ul style="list-style-type: none"> <li>• The most common shield</li> <li>• Similar to open face, but with a back hoe or boom cutter</li> <li>• Often equipped with "pie plate" breasting and one or more tables</li> <li>• May have trouble in soft, loose, or running ground</li> <li>• Compressed air may be used for face stability in poor ground</li> </ul>  |    |
| Mechanized   | <ul style="list-style-type: none"> <li>• A fully mechanized machine</li> <li>• Excavates with a full face cutter wheel and pick or disc cutters</li> <li>• Manufactured with a wide variety of cutting tools</li> <li>• Face openings (doors, guillotine, and the like) can be adjusted to control the muck taken in versus the advance of the machine</li> <li>• Compressed air may be used for face stability in poor ground</li> </ul>   |   |
| Slurry face Machine                                      | <ul style="list-style-type: none"> <li>• Using pressurized slurry to balance the groundwater and soil pressure at the face</li> <li>• Has a bulkhead to maintain the slurry pressure on the face</li> <li>• Good for water bearing silts and sands with fine gravels.</li> <li>• Best for sandy soils; tends to gum up in clay soils; with coarse soils, face may collapse into the slurry</li> </ul>   |  |
| Earth pressure balance (EPB) machine                     | <ul style="list-style-type: none"> <li>• A closed chamber (bulkhead) face used to balance the groundwater and/or collapsing soil pressure at the face</li> <li>• Uses a screw discharger with a cone valve or other means to form a sand plug to control muck removal from the face and thereby maintain face pressure to "balance" the earth pressure</li> <li>• Good for clay and clayey and silty sand soils, below the water table</li> <li>• Best for sandy soils, with acceptable conditions</li> </ul> |  |
| Earth pressure balance (EPB) high-density slurry machine | <ul style="list-style-type: none"> <li>• A hybrid machine that injects denser slurry (sometimes called slime) into the cutting chamber</li> <li>• Developed for use where soil is complex, lacks fines or water for an EPB machine, or is too coarse for a slurry machine</li> </ul>  |  |

The actual functioning of the machines, however, has some distinct differences: in the EPB the pressure is transmitted to the face mechanically, through the soil grains, and is reduced by means of friction over the length of the screw conveyor. Control is obtained by matching the volume of soil displaced by forward motion of the shield with the volume of soil removed from the pressurized face by that screw conveyor and deposited (at ambient pressure) on the conveyor or muck car. Clearly the range of natural geologic conditions that will result in suitably plastic material to transfer the earth pressure to the face and, at the same time, suitably frictional to form the “sand plug” in the screw conveyor is rather limited – generally only combinations of fine sands and silts.



Figure 7-4 Earth Pressure Balance Tunnel Boring Machine (EPB) (Lovat).

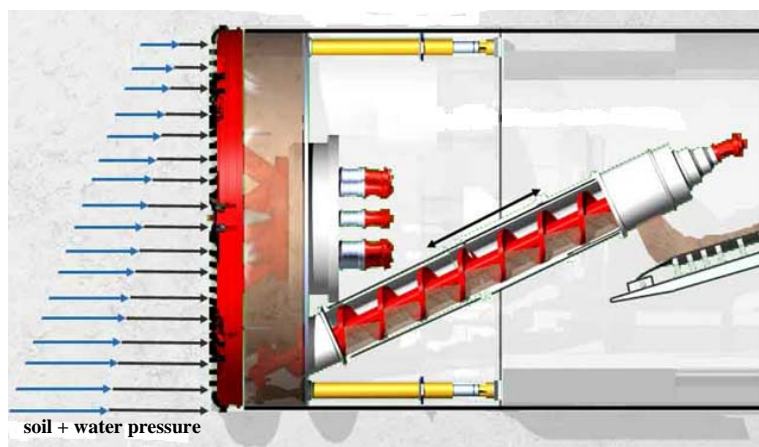

Figure 7-5 Simplified Cross-section of Earth Pressure Balance Tunnel Boring Machine (EPB)

In contrast, the SFM transmits pressure to the face hydraulically through a viscous fluid formed by the material cut and trapped at the face and mixed with slurry (basically bentonite and water). In this case the pressure transmitted can be controlled by means of pressure gages and control valves in a piping system. By this system a much more precise and more consistent pressure control is attained. The undesirable

aspect of this system is the separation plant that has to be built and operated at the surface to separate the slurry from the soil cuttings for disposal and permit re-use of the slurry. Finding a site for the slurry separation that is satisfactory for the process and acceptable to the public can present interesting challenges.



Figure 7-6 Slurry Face Tunnel Boring Machine (SFM) (courtesy of Herrenknecht).

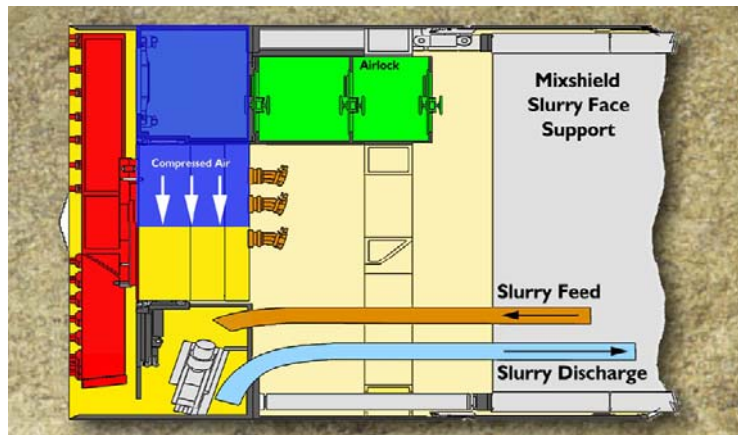

Figure 7-7 Simplified Cross-section of Slurry Face Tunnel Boring Machine (SFM) (from Herrenknecht).

During the last decade or so, great strides have been made in developing new families of conditioning agents that can be used in both types of closed face machines. These additives tend to blur the distinctions portrayed above and widen the range of applicability of both types of machines. Indeed, we predict that in another decade we will not be talking about the two type of machines but rather a new family of machines that will operate interchangeably and with equal efficiency as an open face wheel machine in stable ground or as a closed face machine (with conditioners) that will cut any type of soft ground. Herrenknecht, for one, is already moving ahead with development of this new breed of machine.

Throughout all of this development, the role of the miner at the tunnel face is steadily being diminished. With any closed face machine, the miner is not doing any excavating or breasting of the face. The miner

is operating machines that, unfortunately, can not always do the job as advertised. (After Hansmire and Monsees, 2005)

### **7.3.3 Choosing between Earth Pressure Balance Machines and Slurry Tunneling Machines**

The choice of the type of closed-face tunneling machine and its facilities is a critical decision on a soft-ground tunneling project. This decision will be guided by thorough assessment of the ground types and conditions to be encountered and by numerous other aspects.

Other aspects that will influence the choice include the particular experience of the project's contractor, the logistics and configuration of the works, and requirements of the contract as a means to ensure that the client's minimum specification is met. The initial choice is guided by reference to the grading envelope of the soils to be excavated. Since it is likely that the geology will fall into more than one envelope, the final choice may require a degree of compromise or development of a dual-mode open/closed-faced TBM system or a dual slurry/EPB system.

Review of Ground Types In many tunnel drives the conditions encountered along the route may vary significantly with a resulting need to specify a system capable of handling the full range of expected conditions. Closed-face tunneling machines can be designed and manufactured to cope with a range of ground conditions. Some machines are capable of handling many or all of this range of anticipated conditions with a limited degree or reconfiguration for efficient operation.

There have been several attempts to classify the naturally occurring range of soft-ground characteristics from the tunneler's perspective. This work was summarized most recently by Whittaker and Frith (1990) and the following categorization is based partly on their work. It consists of eight categories of physical ground behavior that may be observed within the soft-ground tunnel excavation range. The characteristics are summarized in Table 7-5. Each of these may be associated with particular types of soils.

Selection Criteria Based on Particle Size Distribution and Plasticity An SFM is ideal in loose waterbearing granular soils that are easily separated at the separation plant. By contrast SFMs have problems dealing with clays and some silts.

If the amount of fines (particles smaller than 60 mm or able to pass through a 200 sieve) is greater than 20% then the use of an SFM becomes questionable although it is not ruled out. In this situation it will be the difficulty in separating excavated spoil from the slurry, rather than the operation of the TBM, that is likely to affect critically the contract program and the operating cost.

An EPBM will perform better where the ground is silty and has a high percentage of fines both of which will assist the formation of a plug in the screw conveyor and will control groundwater inflows. A fines content of below 10% may be unfavourable for application of EPBMs. For an EPBM the costs of dealing with poorly graded or no-fines soil will be in the greater use of conditioners and possibly, in extreme cases, the use of positive displacement devices, such as rotary feeders or piston dischargers, at the screw conveyor discharge point to maintain EPB pressures.

Higher plasticity index (PI) clays ('sticky clays') can lead to 'balling' problems and increased problems at the separation plant for SFMs. Similarly these materials can be problematic for EPBMs where special attention is required in selecting the most appropriate conditioning agents.

**Table 7-5 Soft-ground Characteristics (after British Tunneling Society, BTS, 1990)**

| Ground                    | Description   |
|---------------------------|---|
| Firm ground               | Ground in which the tunnel can be advanced safely without providing direct support to the face during the normal excavation cycle and in which ground support or the lining can be installed before problematic ground movement occurs. Where this short-term stability may be attributable to the development of negative pore pressure in the fine grained soils, significant soil movements and/or ground loading of the tunnel lining may occur later. Examples may include stiff clays and some dewatered sands. A closed-face tunneling machine may not be needed in this ground type.  |
| Raveling ground           | Ground characterized by material that tends to deteriorate with time through a process of individual particles or blocks of ground falling from the excavation surface. Examples may include glacial tills, sands and gravels. In this ground a closed-face tunneling system may be required to provide immediate support to the ground.  |
| Running or flowing ground | Ground characterized by material such as sands, silts and gravels in the presence of water, and some highly sensitive clays that tend to flow into an excavation. Above the water table running ground may occur in granular materials such as dry sands and gravels. Below the water table a fluidized mixture of soil and water may flow as a liquid. This is referred to as running or flowing ground. Such materials can sometimes pass rapidly through small openings and may completely fill a heading in a short period of time. In all running or flowing ground types there will be considerable potential for rapid over-excavation. Hence, a closed-face tunneling system will be required to support such ground safely unless some other method of stabilization is used.  |
| Squeezing ground          | Ground in which the excavation-induced stress relief leads to ductile, plastic yield of ground into the tunnel opening. The phenomenon usually is exhibited in soft clays and stiffer clays over a more extended period of time. A closed-face machine may be required to provide resistance to squeezing ground, although in some conditions there is also a risk of the TBM shield becoming trapped.  |
| Swelling ground           | Soil characterized by a tendency to increase in volume due to absorption of water. This behavior is most likely to occur either in highly over-consolidated clay or in clays containing minerals naturally prone to significant swelling. A closed-face machine may be useful in providing resistance to swelling ground although, as with squeezing ground, there is a risk of the shield becoming trapped.  |
| Weak rock                 | Weak rock may be regarded effectively as a soft-ground environment for tunneling because systems used to excavate soft-ground types may also be applied to weak rock materials such as chalk. Weak rock will often tend to be self-supporting in the short term with the result that closed face tunneling systems may not be needed. However, groundwater may be significant issue. In these instances a closed-face machine is an effective method of protecting the works against high volumes of water ingress that could also be under high hydrostatic pressure.  |
| Hard rock                 | A closed-face TBM may also be deployed in normally self-supporting hard rock conditions. The main reason would be to provide protection against groundwater pressures and prevent inundation of the heading.  |
| Mixed ground conditions   | Potentially, the most difficult of situations for a closed-face tunneling system is that of having to cope with a mixture of different ground types either along the tunnel from zone to zone or sometimes from meter to meter, or within the same tunnel face. Ideally the vertical alignment would be optimized to avoid, as far as possible, a mixed ground situation, however, in urban locations the alignment may be constrained by other considerations.<br><br>For changes in ground types longitudinally, a closed-face machine may have to convert from a closed-face pressurized mode to an open non-pressurized mode when working in harder ground types to avoid over stressing the machine's mechanical functions. Such a change may require some modification of the machine and the reverse once again when the alignment enters a reach of soft, potentially unstable ground. In the case of mixed ground types across the same face, the tunneling machine will almost certainly have to operate in a compromise configuration. In such cases great care will be needed to ensure that this provides effective ground control. A common problem, for example, is a face with a hard material in the bottom and running ground at the top. In this situation the TBM will generally advance slowly while cutting the hard ground but may tend to draw in the less stable material at the top leading to over-excavation of the less stable material and subsequent subsidence or settlement at the surface. Different ground types at levels above the tunnel will also be of significance. For example, in the event that over-excavation occurs, the presence of running or flowing materials at horizons above the tunnel will increase the potential quantity of ground that may be over-excavated and again lead to subsidence or surface settlement. Another potential problem occurs when a more competent layer exists over potentially running ground in which case possible over-excavation would create voids above the tunnel and below the competent material, giving rise to potential longer-term instability problems. |

Permeability As a general guide the point of selection between the two types of machines is a ground permeability of  $1 \times 10^{-5}$  m/s, by using SFMs applicable to ground of higher permeability and EPBMs for ground of lower permeability. However, an EPBM can be used at a permeability of greater than  $1 \times 10^{-5}$  m/s by using an increased percentage of conditioning agent in the plenum. The choice will take into account the content of fines and the ground permeability.

Hydrostatic Head High hydrostatic heads of groundwater pressure along the tunnel alignment add a significant concern to the choice of TBM. In situations where a high hydrostatic head is combined with high permeability or fissures it may be difficult to form an adequate plug in the screw conveyor of an EPBM. Under such conditions an SFM may be the more appropriate choice especially as the bentonite slurry will aid in sealing the face during interventions under compressed air.

Settlement Criteria Both types of machine are effective in controlling ground movement and surface settlement – providing they are operated correctly. While settlement control may not be an overriding factor in the choice of TBM type, the costs associated with minimizing settlement should be considered. For example, large quantities of conditioning agent may be needed to reduce the risk of over-excavation and control settlement if using EPBM in loose granular soils. See Section 7.5.

Final Considerations Other aspects to consider when making the choice between the use of an SFM or an EPBM include the presence of gas, the presence of boulders, the torque and thrust required for each type of TBM and, lastly, the national experience with each method. These factors should be considered but would not necessarily dictate the choice.

The overriding decision must be made on which type of machine is best able to provide stability of the ground during excavation with all the correct operational controls in place and being used.

If both types of machine can provide optimum face stability, as is often the case, other factors, such as the diameter, length and alignment of the tunnel, the increased cutter wear associated with EPBM operation, the work site area and location, and spoil disposal regulations are taken into consideration.

The correct choice of machine operated without the correct management and operating controls is as bad as choosing the wrong type of machine for the project. (After British Tunneling Society, BTS, 2005)

#### **7.3.4 Sequential Excavation Method (SEM)**

In addition to shield tunneling methods discussed above, soft ground tunnels can be excavated sequentially by small drifts and openings following the principles of the Sequential Excavation Method (SEM), aka New Austrian Tunneling Method (NATM) first promulgated by Professor Rabcewicz (1965). The SEM has now been defined as “a method where the surrounding rock or soil formations of a tunnel or underground opening are integrated into an overall ring-like support structure and the following principles must be observed:

- The geotechnical behavior must be taken into account
- Adverse states of stresses and deformations must be avoided by applying the appropriate means of support in due time.
- The completion of the invert gives the above mentioned ring-like structure the static properties of a tube.
- The support means can/should be optimized according to the admissible deformations.



- General control, geotechnical measurements and constant checks on the optimization of the pre-established support means must be performed. (From ILF, 2004)

The underlying principle of SEM is actually the same as that stated by Sir Marc Brunel almost two centuries ago: “The great desideratum therefore consists in finding efficacious means of opening the ground in such a manner that no more earth shall be displaced than is to be filled by the shell or body of the tunnel and that the work shall be effected with certainty”. (Copperthwaite, 1906) In other words, never open more than is needed, can be excavated rapidly, and quickly supported.

As applied to soft ground tunneling, SEM generally cannot compete with tunneling machines for long running tunnels but often is a viable method for:

- Short tunnels
- Large openings such as stations
- Unusual shapes or complex structures such as intersections
- Enlargements

Refer to Chapter 9 for detail discussion regarding SEM/NATM.

## 7.4 GROUND LOADS AND GROUND-SUPPORT INTERACTION

### 7.4.1 Introduction

The main objectives of tunnel support system are to (1) stabilize the tunnel heading, (2) minimize ground movements, and (3) permit the tunnel to operate over the design life. In general, the first two functions are provided by an initial support system, whereas the third function is preserved with a final lining.

The loading on the support system and its required capacity is dependent on when and how it is installed and on the loadings that will occur after it is installed. If the final lining is installed after the tunnel has been stabilized by initial support, the final lining will undergo very little additional loadings such as contact grouting pressures, thermal stresses, groundwater pressure, and/or time dependent loading (creep).

Generally, two types of loading have been considered to generate analytical solutions in tunneling in soil – overpressure loading and excavation loading. If a ground is assumed to be isolated and a pressure is applied to the upper surface, it is considered to be *overpressure loading*, where the support system is placed in the ground when it was unstressed and the lining and the ground is normally handled by applying lateral pressure to the ground.

Practically the support system is never placed in an unstressed ground, instead it is placed in the opening after the initial deformation has occurred, and before any additional deformation occurs and the additional deformation induces loading into the support system. This induced loading is called *excavation loading*.

The load developed on the support system (initial support and final lining) is a function of relative stiffness of the lining with respect to the soil (ground-lining interaction). Both analytical solutions and numerical methods have been commonly used by design engineers to evaluate the effect of the relative lining stiffness on the displacement, thrust, moments in the lining for various loading configurations. The available methods are summarized in this section. The reader should refer Chapter 10 for the final lining design practice.

## 7.4.2 Loads for Initial Tunnel Supports

This section presents a simplified system of determining the load on the initial support for circular and horseshoe tunnels in soft ground. These presented loads are patterned after Terzaghi's original recommendations (1950) but have been simplified. In all cases, it is important that the experience and judgment of the engineer also be applied to the load selection. Table 7-6 shows the loads recommended for design of initial tunnel supports in soft ground.

**Table 7-6 Initial Support Loads for Tunnels in Soft Ground**

| Geology  | Circular Tunnel                                  | Horseshoe Tunnel                                 | Notes  |
|--|--|--|--|
| Running ground   | Lessor of full overburden or 1.0 B               | Lessor of full overburden or 2.0 B               | Floor indicated in horseshoe if compressed air used. Otherwise ignore compressed air |
| Flowing ground in air free   | Lessor of full overburden or 2.0 B               | Lessor of full overburden or 4.0 B               | Stiff floor required in horseshoe  |
| Raveling ground <ul style="list-style-type: none"> <li>• Above water table</li> <li>• Below water table</li> </ul> | Same as running ground<br>Same as flowing ground | Same as running ground<br>Same as flowing ground | Stiff floor required in horseshoe<br>Stiff floor required in horseshoe               |
| Squeezing ground   | Depth to tunnel springline                       | Depth to tunnel springline                       |  |
| Swelling ground  | Same as raveling ground                          | Same as raveling ground                          |  |

The vast majority of tunnels in soft ground are driven with modern tunneling machines and are, therefore, circular. However, some tunnels are still driven by hand and are often horseshoe or modified horseshoe in shape, for example, pump stations or cross passages between transit tunnels. Therefore the table also provides initial support recommendations for horseshoe tunnels.

The term tunnel liner actually should be broken into two concepts that have historically had distinct but related functions. Initial support is that support needed to make the soft ground tunnel opening stable and safe during the complete construction operation. It includes the gamut of support measures from reinforcement to grouting to freezing to shotcrete to ribs and boards to precast concrete segments and everything in between.

Final lining is the concrete or other lining placed to make the tunnel acceptable aesthetically and functionally, e.g., smooth to air or water flow, and to make the tunnel permanently stable and safe for its design life of 100 years or more.

While technically this distinction should still be made, with the advent of tunnel boring machines and high quality precast concrete lining systems (which are needed to propel the machines) this distinction is becoming blurred. For most modern tunnels a single lining of precast concrete segments is typically installed as the tunnel is advanced and used for both functions.

### 7.4.3 Analytical Solutions for Ground-Support Interaction

The state of stress due to tunnel excavation and interaction between rock support system and supporting ground were previously discussed in Chapter 6. The elastic formulations and interaction diagram discussed in Section 6.6.2 are also valid for a tunnel in soft ground.

Analytical solutions for ground-support interaction for a tunnel in soil are available in the literature. The solutions are based on two dimensional, plane strain, linear elasticity assumptions in which the lining is assumed to be placed deep and in contact with the ground (no gap), i.e., the solutions do not allow for a gap to occur between the support system and ground.

Early analytical solutions by Burns and Richard (1964), Dar and Bates (1974), and Hoeg (1968) were derived for the overpressure loading, while solutions by Morgan (1961), Muir Wood (1975), Curtis (1976), Rankin, Ghaboussi and Hendron (1978), and Einstein et. al. (1980) were for excavation loading. Solutions are available for the full slip and no slip conditions at the ground-lining interface. Appendix E present the available published analytical solutions in Table E-2, as well as the background (excerpt from FHWA Tunnel Design Guidelines published in 2004). Appendix E also presents a sample analysis is in Table E-3, for a 22ft diameter circular tunnel with 1.5 ft thick concrete lining. The tunnel is located at 105 ft deep from the ground surface to springline and groundwater table is located 10 ft below the ground surface. Details of input parameters are shown in Table E-3a. The calculated lining loads from various analytical solutions are presented in Table E-3b. The result of finite element analysis is shown in Figure 7-8.

### 7.4.4 Numerical Methods

Application of the analytical solutions is restricted when the variation of stress magnitude is significant with depth from the tunnel crown to the invert, such that assumptions made in the analytical solutions are not valid. Then, numerical method can be used to simulate support-ground interactions.

Numerical modeling has been driven by a perceived need from the tunneling industry in recent times. It has led to large, clumsy and complex numerical models. Properly performed numerical modeling will lead engineers to think about why they are building it - why build one model rather than another - and how the design can be improved and performed effectively.

An outline of the steps recommended for performing a numerical analysis for tunneling is as follow:

- Step 1: Define the objective of the numerical analysis
- Step 2: Select 2D or 3D approach and appropriate numerical software
- Step 3: Create a conceptual drawing of the analysis layout
- Step 4: Create geometry and finite element meshes
- Step 5: Select and apply boundary condition, initial condition and external loading
- Step 6: Select and apply constitutive model and material properties
- Step 7: Perform the simulation for the proposed construction sequence
- Step 8: Check / verify the results
- Step 9: Interpret the results

For the analysis of tunneling in soil, continuum analysis is generally accepted, where the domain can reasonably be assumed to be a homogeneous media. The continuum analysis includes Finite Element Method (FEM), Finite Difference Method (FDM), and Boundary Element Method (BEM). The details of numerical analysis softwares are discussed in Section 6.6.3. Sample loads on the concrete lining

calculated by Finite Element analysis on a tunnel (Appendix E) are shown in Figure 7-8. Figure 7-8 illustrates loads on the concrete liner including axial force, bending moment, and shear force calculated from two-dimensional, plain strain analysis.

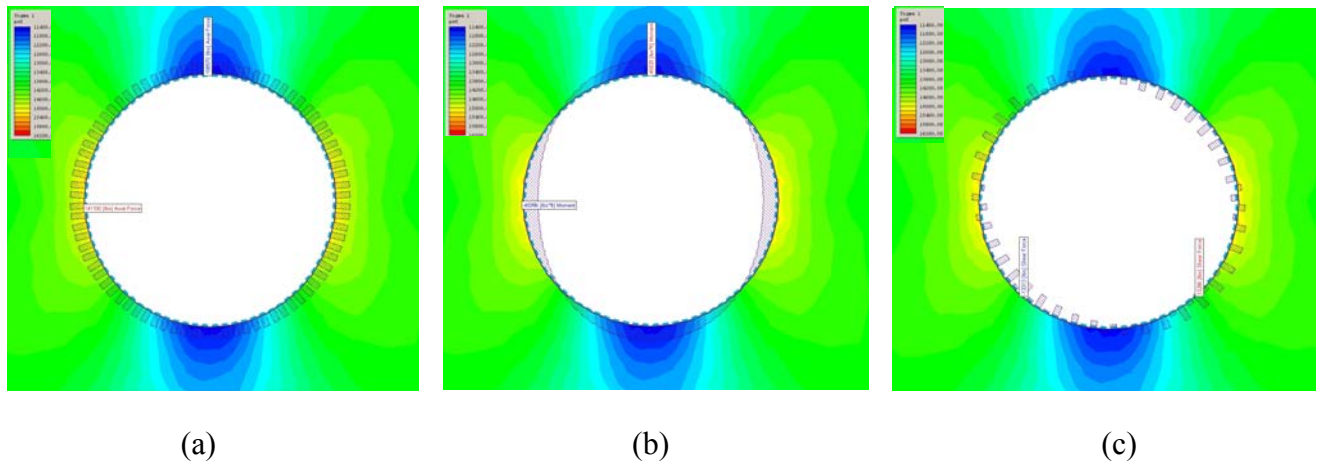

Figure 7-8 Loads on a Concrete Lining Calculated by Finite Element Analysis: (a) Axial Force, (b) Bending Moment, (c) Shear Force

## 7.5 TUNNELING INDUCED SETTLEMENT

### 7.5.1 Introduction

Ground settlement is of greater concern for soft ground tunnels than for rock for two reasons:

- Settlements are nearly always greater for soft ground tunnels.
- Typically more facilities that might be negatively impacted by settlements exist near soft ground tunnels than near rock tunnels.

With modern means and methods, both the designer and the contractor are now better equipped to minimize settlements and, hence, their impact on other facilities.

### 7.5.2 Sources of Settlement

Although there are a large number of sources or causes of settlement, they can be conveniently lumped into two broad categories: those caused by ground water depression and those caused by lost ground.

Groundwater Depression Groundwater depression may be caused by intentional lowering of the water during construction or by the tunnel itself (or other construction) acting as a drain. When either of these occurs the effective stress in the ground increases. Basic soils mechanics can then be applied to estimate the resulting settlement. For tunnels in granular soil the settlement due to this increase in effective stress is usually reflected as an elastic phenomenon requiring knowledge of the low stress modulus of the ground and calculation of the change in effective stress. Unless the soil contains silt or very fine sand, this elastic settlement will typically represent the majority of the total but its absolute value will also be relatively small.

For fine grained soils, the situation is a bit more challenging but certainly manageable using normal soil mechanics approaches. With fine-grained soils, the conditions are reversed. In most instances, the settlement is mostly due to consolidation brought on by the changes in effective stress and hence is analyzed by the usual soil mechanics consolidation theories. In some instances, primarily if lenses of sands are contained in the soil, there may also be a relatively small contribution by elastic compression. In comparison to the settlement of granular soils, consolidation can lead to several inches of settlement when the consolidating soils are thick and the change in effective stress is significant.

Lost Ground Lost ground has a number of root causes (at least nine) and is usually responsible for the settlements that make the headlines. By definition, lost ground refers to the act of taking (or losing) more ground into the tunneling operation than is represented by the volume of the tunnel. Thus it is highly reflective of construction means and methods. As will be discussed, modern machines can be a great help in controlling lost ground but in the end it usually comes down to quality of workmanship.

For the purposes of this manual, the causes of lost ground are lumped into three groups: face losses, shield losses and tail losses.

- Face losses results from movement in front of and into the shield. This includes running, flowing, caving, and/or squeezing behavior of the ground itself or simply mining more ground than displaced by the tunneling machine.
- Shield losses occur between the cutting edge and the tail of the shield. All shields employ some degree of overcut so that they can be maneuvered. In addition, any time a shield is off alignment, the shield yaws, pitches, or plows when brought back to alignment. Mother Nature abhors a vacuum and the surrounding soils begin to fill these planned or produced voids the instant they are produced. Note that a one inch overcut plus one-eighth inch hard facing on a 20 foot shield produces lost ground of nearly two percent if not properly filled [ $1.125/12 (20) 3.1416 / (10)^2 3.1416 = 1.88\%$ ].
- Tail losses are similar to shield losses in that they are caused by the space being vacated by the tail itself as well as the extra space that must be provided between the tail and the support elements so those elements can be erected and so that they don't become "iron bound" and seize the tail shield. However, like the shield losses, these tail voids will rapidly fill with soil if they are not first eliminated by grouting and/or expansion of the tunnel support elements.

### 7.5.3 Settlement Calculations

Estimates of settlement in soft ground tunneling are just that, estimates. The vagaries of nature and of construction are such that settlements cannot be estimated in soft ground tunnels to the same level of confidence as, say, the settlement of a loaded beam. In tunneling we rely heavily on our experience with some assistance from analysis. Thus, there are two related methods to attack the problem: experience and empirical data.

Experience can be used where a history of tunneling and of taking measurements exists. An example of this is Washington, D.C., where soft ground tunnels have been constructed in well-defined geology for over 40 years. During that time the industry has progressed from basic Brunel shields to the most current closed-face tunneling machines. For this case it would be anticipated that an experienced contractor would achieve between 0.5 and 1.0 percent ground loss (see Table 7-7). An inexperienced contractor would attain 1.0 to 2.0 percent loss.

**Table 7-7 Relationship between Volumes Loss and Construction Practice and Ground Conditions**

| Case   | $V_L$ (%)   |
|--|-------------|
| Good practice in firm ground; tight control of face pressure within closed face machine in slowly raveling or squeezing ground | 0.5         |
| Usual practice with closed face machine in slowly raveling or squeezing ground   | 1.0         |
| Poor practice with closed face in raveling ground  | 2           |
| Poor practice with closed face machine in poor (fast raveling) ground  | 3           |
| Poor practice with little face control in running ground   | 4.0 or more |

When there is no record to rely upon, the design would have to be based strictly on empirical data and an engineering assessment of what the contractor could be expected to achieve with no track record to rely upon. In that case the above evaluations might be bumped up one-half percentage point each as an insurance measure

State-of-the-art pressurized-face tunnel boring machines (TBM) such as EPB and SFM as discussed in Section 7.3.2 minimize the magnitude of ground losses. These machines control face stability by applying active pressure to the tunnel face, minimizing the amount of overcut, and utilizing automatic tail void grouting to reduce shield losses. Typically, ground loss during soft ground tunnel excavation using this technology limits ground loss to 1.0 percent or less assuming excellent tunneling practice (adequate pressure applied to the face and effective and timely tail void grouting).

The volume of ground loss experienced during tunneling can be related to the volume of settlement expected at the ground surface (Peck, 1969). For a single tunnel in soft ground conditions, it is typically assumed the volume of surface settlement is equal to the volume of lost ground. However, the relationship between volume of lost ground and volume of surface settlement is complex. Volume change due to bulking or compression is typically not estimated or included in the calculations. Ground loss will produce a settlement trough at the ground surface where it can potentially impact the settlement behavior of any overlying or adjacent bridge foundations, building structures, or buried utilities transverse or parallel to the alignment of the proposed tunnel excavation. Empirical data suggests the shape of the settlement trough typically approximates the shape of an inverse Gaussian curve (Figure 7-9).

The shape and magnitude of the settlement trough is a function of excavation techniques, tunnel depth, tunnel diameter, and soil conditions. In the case of parallel adjacent tunnels, surface settlement is generally assumed to be additive. The shape of the curve can be expressed by the following mathematical relationships (Schmidt, 1974).

$$w = w_{\max} \exp\left(\frac{-x^2}{2i^2}\right) \quad 7-2$$

where:

- $w$  = Settlement,  $x$  is distance from tunnel or pipeline centerline
- $i$  = Distance to point of inflection on the settlement trough

The settlement trough distance,  $i$  is defined as:

$$i = KZ_o \quad 7-3$$

where:

$K$  = Settlement trough parameter (function of soil type)  
 $Z_o$  = The depth from ground surface to tunnel springline

The maximum settlement,  $w_{max}$  is defined as:

$$w_{max} = \frac{V_L \pi \left(\frac{D}{2}\right)^2}{2.5i} \quad 7-4$$

where:

$V_L$  = Volume of ground loss during excavation of tunnel  
 $D$  = A diameter of tunnel.

Table 7-7 summarizes likely volumes of lost ground as a percentage of the excavated volume and a function of combined construction practice and ground conditions.

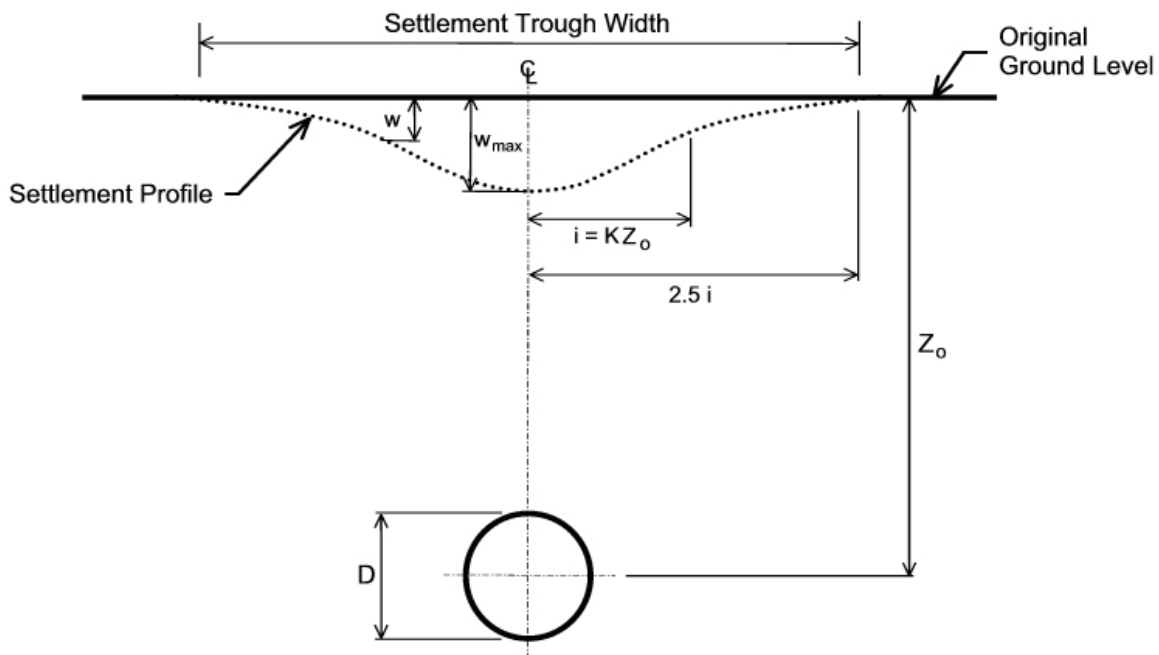

Figure 7-9 Typical Settlement Profile for a Soft Ground Tunneling

For geometrics other than a single tunnel, adjustments of the types given below should be made to obtain settlement estimates:

- For *parallel tunnels* three or more diameters apart (center to center), surface settlements are usually reasonably well predicted by adding the individual bell curves of the two tunnels. In good ground and with good practice, this will often give workable approximations up to the point where the tunnels are two diameters apart. On the other extreme, when the tunnels are less than one and one-half diameters apart, the volume of lost ground assumed for the second tunnel should be increased approximately one level in severity in Table 7-7 before the bell curves are added. Intermediate conditions may be estimated by interpolation.
- For *over-and-under tunnels*, it is usually recommended that the lower tunnel be driven first so that it does not undermine the upper tunnel. However, driving the lower tunnel will disturb the ground conditions for the upper. This effect may be approximated by increasing the lost ground severity of the second (upper) tunnel by approximately one level in Table 7-7 before adding the resulting two settlement estimates to approximate the total at the surface. (Monsees, 1996)

As shown in Figure 7-9 the width of the settlement trough is measured by an  $i$  value, which is theoretically the horizontal distance from the location of maximum settlement to the point of inflection of the settlement curve. The maximum value of the surface settlement is theoretically equal to the volume of surface settlement divided by  $2.5 i$ . Figure 7-10 illustrates assumptions for  $i$  values (over tunnel radius  $R$ ) for calculating settlement trough width in various ground conditions.

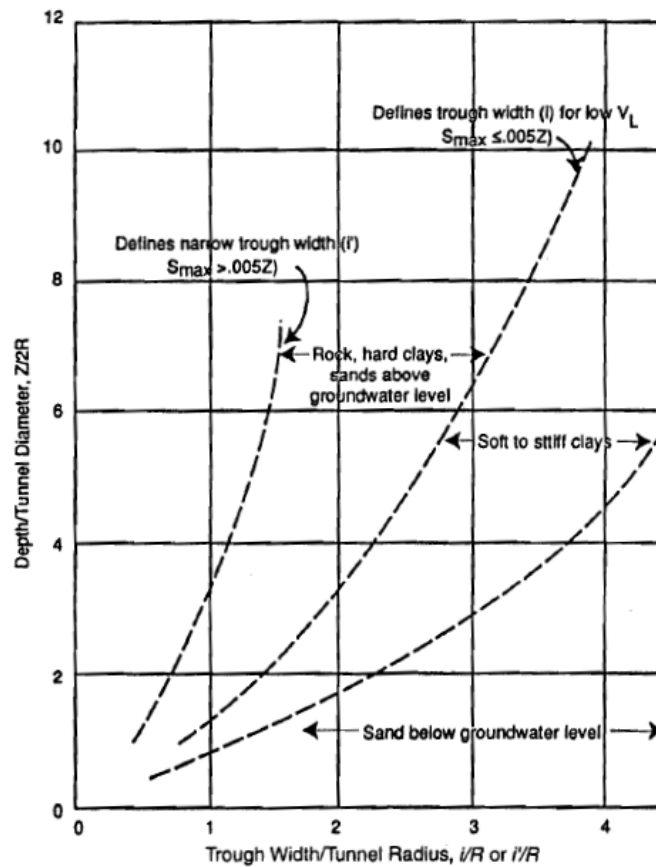

Figure 7-10 Assumptions for width of settlement trough (adapted from Peck, 1969)



The ground settlement also can be predicted by numerical methods. The numerical method is extremely useful when the tunnel geometry is not a circular or horse-shoe shape since analytical/empirical method is not directly applicable. A sample finite element settlement analysis is shown in Figure 7-11.

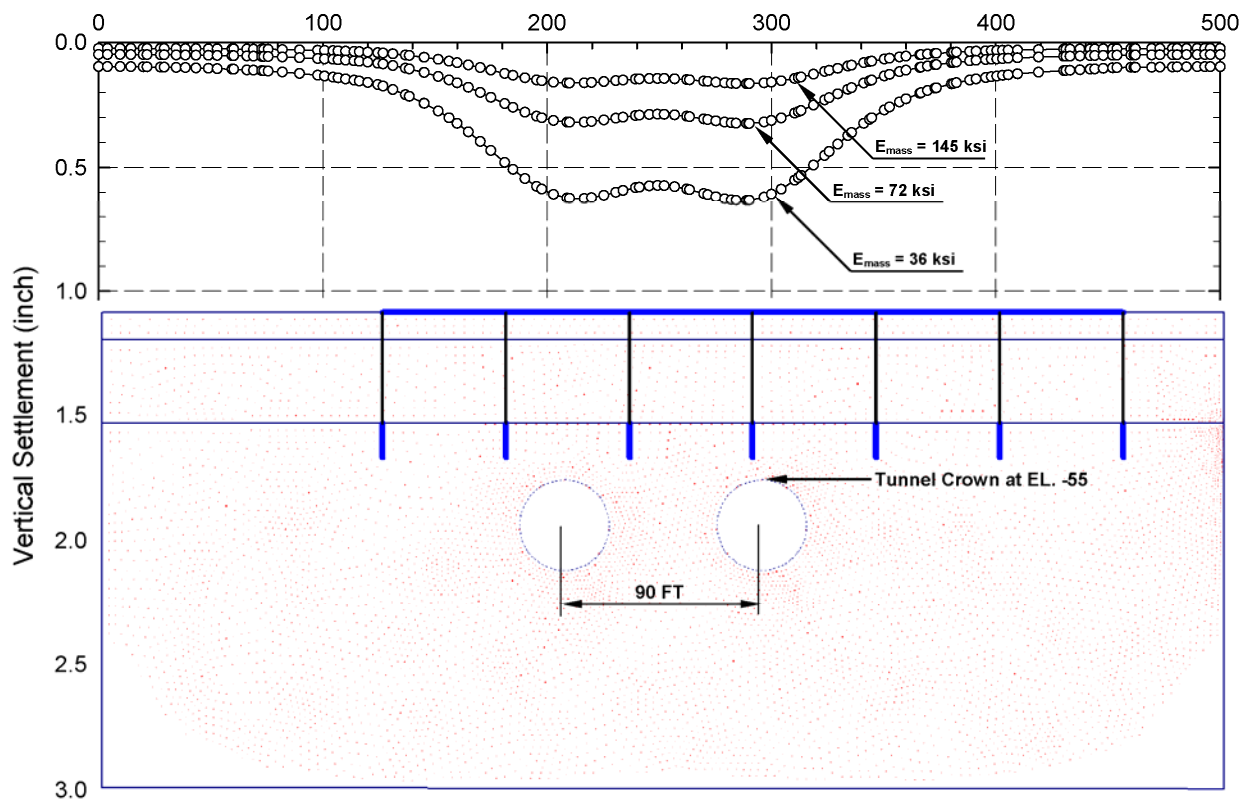

Figure 7-11 Example of Finite Element Settlement Analysis for Twin Circular Tunnels under Pile Foundations

## 7.6 IMPACT ON AND PROTECTION OF SURFACE FACILITIES

### 7.6.1 Evaluation of Structure Tolerance to Settlement

Evaluation of structural tolerance to settlement requires definition of the possible damage that a structure might experience. Boscardin and Cording (1989) introduced three damage definitions for surface structures due to tunneling induced settlement (where settlement is calculated per Section 7.5):

1. **Architectural Damage:** Damage affecting the appearance but not the function of structures, usually related to cracks or separations in panel walls, floors, and finishes. Cracks in plaster walls greater than 1/64-in. wide and cracks in masonry or rough concrete walls greater than 1/32-in. wide are representative of a threshold where damage is noticed and reported by building occupants.
2. **Functional Damage:** Damage affecting the use of the structure, or safety to its occupants, usually related to jammed doors and windows, cracking and falling plaster, tilting of walls and floors, and other damage that would require nonstructural repair to return the building to its full service capacity.

3. **Structural Damage:** Damage affecting the stability of the structure, usually related to cracks or distortions in primary support elements such as beams, columns, and load-bearing walls.

A number of methods for evaluating the impact of settlements on building or other facilities have been proposed and used. In 1981, Wahls collected and studied data from other investigators (e.g., Skimpton and MacDonald, 1956; Grant, Christian, and Vanmarked; Polshin and Tokar) plus his own observations (totaling more than 193 cases). From that study Wahls proposed the correlation of angular distortion (the relative settlement between columns or measurement points) and building damage as shown in Table 7-8.

As an alternative initial screening method, Rankin (1988) proposed a damage risk assessment chart based on maximum building slope and settlement as shown Table 7-9.

**Table 7-8 Limiting Angular Distortion (Wahls, 1981)**

| Category of Potential Damage                    | Angular Distortion |
|---|--------------------|
| Danger to machinery sensitive to settlement     | 1/750              |
| Danger to frames with diagonals                 | 1/600              |
| Safe limit for no cracking of building          | 1/500              |
| First cracking of panel walls                   | 1/300              |
| Difficulties with overhead cranes               | 1/300              |
| Tilting of high rigid building becomes visible  | 1/250              |
| Considerable cracking of panel and brick walls  | 1/150              |
| Danger of structural damage to general building | 1/150              |
| Safe limit for flexible brick walls*            | 1/150              |

<sup>a</sup> Safe limit includes a factor of safety.

**Table 7-9 Damage Risk Assessment Chart (Rankin, 1988)**

| Risk category | Maximum slope of building | Maximum settlement of building (mm) | Description of risk  |
|---------------|---------------------------|-------------------------------------|--|
| 1             | Less than 1/500           | Less than 10                        | Negligible: superficial damage unlikely  |
| 2             | 1/500–1/200               | 10–50                               | Slight: possible superficial damage which is unlikely to have structural significance  |
| 3             | 1/200–1/50                | 50–75                               | Moderate: expected superficial damage and possible structural damage to buildings, possible damage to relatively rigid pipelines |
| 4             | Greater than 1/50         | Greater than 75                     | High: expected structural damage to buildings. Expected damage to rigid pipelines, possible damage to other pipelines            |

### 7.6.2 Mitigating Settlement

Where the settlement is or would be caused by groundwater lowering the first, and usually the simplest, approach is simply to reduce or eliminate the conditions causing or allowing dewatering. This could include, for example:

- Reduce drawdown at critical structures by reinjecting water, using impervious cutoff walls and the like.
- Using closed, pressurized face tunneling machines so that drawdown can not occur. Pressure at the face should be equal to the groundwater head.
- Grouting the ground around the tunnel to eliminate water inflow into the tunnel.

Where the settlement is or could be caused by lost ground in the tunneling operation that settlement can nearly always be mitigated with proper construction means and methods. For example consider:

- Requiring a closed face, pressurized TBM (EPB or SFM) and keep the pressure at least equal to if not greater than the combined soil and groundwater pressure in the ground at tunnel level.
- Immediately and completely grout the annular space between the tunnel lining and the ground at the tail of the machine. Use automated grouting systems that will not permit the machine to advance without this void being simultaneously grouted.
- Control the operation (steering) of the machine so that it is not forced to pitch or yaw to make excessive alignment corrections. Each one percent of correction translates to a potential 1.5 percent of ground loss.
- Use compaction or compensation grouting to “make up” for ground loss before it migrates to the building.
- Treat areas of loose soils by consolidation or jet grouting before tunneling into them.

### 7.6.3 Structure Protection

The concept of and methods for structure protection are already woven into earlier paragraphs. First and foremost are the tunneling procedures of maintaining face pressure (control) and immediately grouting to fill the annular (or any other) void.

The next step is ground improvement either by consolidation or jet grouting and, closely related compensation or compaction grouting.

As a last resort, to be applied when all else appears to be unsuccessful and or unworkable, is underpinning. Like the use of compressed air, this method is now seldom used because modern tunneling techniques make it unnecessary. At times, as with the Pershing Square garage in Los Angeles it is still applicable, but most of the time practitioners believe it to have the possibility to do more damage than to be beneficial. Typical steps of underpinning method are summarized as follow:

- Break out and hand excavate down to (or nearly to) the potentially impacted foundation.
- Install piles or other founding elements to a bearing below and/or outside the impacted foundation and the tunnel.
- Install a needle beam or similar method to transfer the impacted foundation load to the new elements.
- Preload the new elements, i.e., unload the impacted foundation onto those new elements

- Cut or release any load to the impacted foundation. At this point all load is transferred through the new elements to a bearing location/condition that is completely independent of the tunneling operation and the tunnel.
- As required or necessary remove or leave in place the original foundation.

Instrumentation and monitoring for the existing structures are discussed in Chapter 15 Geotechnical and Structural Instrumentation.

## 7.7 SOIL STABILIZATION AND IMPROVEMENT

### 7.7.1 Purpose

Until fairly recently essentially all the design effort for tunnels in soft ground was to provide a support system or systems that would stabilize the existing ground during construction and then, perhaps with some modification, would permanently support the ground and provide an opening suitable for the long term mission of the tunnel. In the last two or three decades, however, the situation has changed such that in some applications a dual approach is taken. First, the characteristics of the ground are modified by stabilization and/or improvement to make that ground contribute more to its own stability. Then, secondly a supplementary but less costly support/lining system is installed to make the tunnel perform for its full lifetime. In this section the various methods of soil stabilization and improvement are summarized. References with more details on these methods are also given.

### 7.7.2 Typical Applications

The decision to use soil stabilization or improvement must be made on each individual case. This decision may sometimes be easy with there being no other way to construct the tunnel. More often, the decision comes down to a trade off among treating the ground, using high-tech machines, and/or a combination of the two. With all of the possibilities it can be said that there are now no unacceptable construction sites. Table 7-10 summarizes the challenging ground sites and corresponding treatment methods.

**Table 7-10 Ground Treatment Methods**

| <b>Challenging Ground Conditions</b> | <b>Treatment Method(s)</b>   |
|--------------------------------------|--|
| Weak Soils                           | <ul style="list-style-type: none"> <li>• Vibro Compaction</li> <li>• Dynamic Compaction</li> <li>• Compaction Grouting</li> <li>• Permeation Grouting</li> <li>• Jet Grouting</li> </ul> |
| Ground Water                         | <ul style="list-style-type: none"> <li>• Dewatering</li> <li>• Freezing</li> <li>• Grouting</li> </ul>   |
| Unstable Face                        | <ul style="list-style-type: none"> <li>• Soil Nails</li> <li>• Spiling</li> <li>• Soil Doweling</li> <li>• Micro Piles</li> </ul>  |
| Soil Movement                        | <ul style="list-style-type: none"> <li>• Compensation Grouting</li> <li>• Compaction Grouting</li> </ul>   |

It is to be noted that the boundaries between both ground conditions and treatment methods are not fixed. Also, the use of vibrocompaction techniques or dynamic compaction is typically applicable at or near the tunnel portals as these techniques are applied to the ground surface and are not effective beyond about 100 ft depth for vibro compaction and 35 ft depth for dynamic compaction. Both are generally effective only in granular soils.

Readers are referred to the Ground Improvement Methods Reference Manual (FHWA, 2004) for more detailed discussion for the soil stabilization and improvement techniques presented below.

### **7.7.3 Reinforcement Methods**

Soil Nails Soil nails may be used to stabilize a tunnel face in soil during construction. Steel or fiberglass rods or nails are installed in the face and the resulting reinforced block(s) are analyzed for stability much as for usual slope stability analyses. Several methods (e.g., Davis, Modified Davis, German, French, Kinematical, Golder, and Caltrans) are used for these analyses. Walkinshaw (1992) has studied these methods and concluded that all had some level of inconsistencies, such as:

- Improper cancellation of interslice forces (Davis method)
- Lateral earth pressures inconsistent with nail force and facing pressure distribution (all)
- No redistribution of nail forces according to construction sequence and observed measurements (all except Golder)
- Complex treatment and impractical emphasis on nail stiffness (Kinematical) (after Walkinshaw, 1992; Xanthakos, 1994)

For more discussion readers are referred to GEC No.7 Soil Nail Walls (FHWA, 2003), which also recommends that the Caltrans SNAIL program be used because it will handle both nails and tiebacks. However, it must be recognized that application of that or any other program must be tempered with appropriate judgment, measurements and case history experience.

Soil Doweling Soil doweling entails the installation of larger reinforcement members than does nailing. These dowels act in tension like soil nails but are large enough in cross section that they also develop some shearing resistance where they pass through the sliding surfaces.

### **7.7.4 Micropiles**

As they are applied to tunneling, micropiles are essentially the same as soil dowels. These are typically drilled piles two to six inches in diameter that contain a large reinforcing bar centered in the hole and the hole backfilled with concrete. As opposed to pin piles that are typically installed at the surface (and that act in compression), the pin piles placed in tunnels typically act in tension and shear across the sliding surfaces.

Soil nails, soil dowels, and pin piles are typically installed at the face of the tunnel to stabilize that face for construction. Thus, they are continually being installed and mined out of the face. For ease in this mining operation, fiberglass bars (rods) are typically used in these applications because they are much easier to mine out and cut. In contrast, spiling tends to look out around the perimeter of the tunnel, thus steel is more likely to be used for spiling bars or plates.

Readers are also referred to “Micropile Design and Construction Reference Manual” (FHWA, 2005f) for more details.

### 7.7.5 Grouting Methods

All grouting involves the drilling of holes into the ground, the insertion of grout pipes in the holes, and the injection of pressurized grout into the ground from those pipes. The details of the operations, however, are distinctly different. Readers are referred to the Ground Improvement Methods Reference Manual (FHWA, 2004) for more detailed discussion for the grouting techniques discussed hereafter.

Permeation Grouting Permeation grouting involves the filling of pore spaces between soil grains (perhaps displacing water). The grout may be one of a number of chemicals (but is usually sodium silicate or polyurethane) or neat cement using regular, micro- or ultra- fine cement, along with chemicals and other additives. Once injected into the pore spaces, the grout sets and converts the soil into a stable, weak sandstone material. Permeation grouting usually involves grout holes at three to four feet centers with enough secondary holes at split spacing to verify that all the ground is grouted. If necessary to get full coverage all of the split spacing holes may have to be grouted and verification performed by the tertiary holes.

Compaction Grouting Compaction grouting uses a stiffer grout than does permeation grouting. In compaction grouting the goal is to form a series of grout bulbs or zones four to six feet above and around the tunnel crown. By pumping the stiff grout in under pressure these bulbs compress (densify) the ground above the tunnel and between the tunnel and overlying facilities.

The pipes for compaction grouting are pre-positioned and drilled into place and all the grouting pumps, hoses, header pipes, instrumentation and the like are in place before the tunnel drive begins. Instrumentation is read as the tunnel approaches and passes a facility and the grouting operation is adjusted real time in response to the movement readings. Actually, in most applications it is possible to either pre-heave the ground or to jack it back up (at least partially) by pumping more grout at higher pressures.

Compensation Grouting Compensation grouting is, in some ways, similar to compaction grouting. The goal is to monitor ground movements, primarily between the tunnel and any overlying facility. When it is apparent that ground is being lost in the tunneling operation, a grout, typically slightly more liquid than the compaction grout mix, is injected to replace (compensate for) the lost ground. As indicated the differences between these two schemes are relatively minor – compaction grouting seeks to recompact the ground by forming grout bulbs, compensation grouting seeks to refill voids created by the tunneling operations.

Jet Grouting Jet grouting is the newest of the grouting methods and is rapidly becoming the most widely used. Jet grouting uses high pressure jets to break up the soils and replace them with a mixture of excavated soils and cement, typically referred to as “soilcrete”. There are a number of variations of jet grouting depending on the details of the application and on the experience and expertise of both the designer and the contractor.

The design of a jet-grouted column is influenced by a number of interdependent variables related to in situ soil conditions, materials used, and operating parameters. Table 7-11 presents a summary of the principal variables of the jet grouting system and their potential impact on the three basic design aspects of the jet-grouted wall: column diameter, strength and permeability. Table 7-11 gives typical ranges of operating parameters and results achieved by the three basic injection systems of jet grouting. It should be noted however, that the grout pressures indicated in this table are based on certain equipment and can vary. This table can be used in feasibility studies and preliminary design of jet-grouted wall systems.

The actual operating parameters used in production are usually determined from initial field trials performed at the beginning of construction.

Jet grouting is frequently used as a ground control measure in conjunction with tunneling in soft ground using Sequential Excavation Method (Chapter 9).

**Table 7-11 Summary of Jet Grouting System Variables and their Impact on Basic Design Elements**

| <b>Principal Variables</b>           | <b>General Effect of the Variable on Basic Design Elements (Strength, Permeability and Column Diameter)</b>  |
|--------------------------------------|--|
| <b>(a) Jet-Grouted Soil Strength</b> |  |
| Degree of mixing of soil and grout   | Strength is higher and less variable for higher degree of mixing   |
| Soil type and gradation              | Sands and gravels tend to produce stronger material while clays and silts tend to produce weaker material.   |
| Cement Factor                        | Strength increases with an increase in cement factor (weight of cement per volume of jet-grouted mass).  |
| Water/cement ratio of grouted mass   | Strength of the jet-grouted soil mass decreases with increase in in situ water/cement ratio.   |
| Jet grouting system                  | The strength of the double fluid system may be reduced due to air entrapment in the soil-grout mix.  |
| Age of grouted mass                  | As the jet-grouted soil mass cures, the strength increases but usually at a slower rate than that of concrete.   |
| <b>(b) Wall Permeability</b>         |  |
| Wall continuity                      | Overall permeability of a jet grout wall is almost entirely contingent on the continuity of the wall between adjacent columns or panels. Plumb, overlapping multiple rows of columns would produce lower overall permeability. In case of obstructions (boulders, utilities, etc.) if complete encapsulations is not achieved then overall permeability may be increased due to possible leakage along the obstruction-grout interfaces. |
| Grout composition                    | Assuming complete wall continuity and complete replacement of in situ soil, the lowest permeability which can be obtained is that of the grout (typically $10^{-6}$ to $10^{-7}$ cm/sec). Lower permeabilities may be possible if bentonite or similar waterproofing additive is used.   |
| Soil composition                     | If complete replacement is obtained (as may be possible with a triple fluid system) then soil composition does not matter. Otherwise, if uniform mixing is achieved then finer grained soils would produce lower permeabilities as compared to granular soils.   |
| <b>(c) Column Diameter</b>           |  |
| Jet grouting system                  | The diameter of the completed column increases in size as the number of fluids is increased from the single to the triple fluid systems.   |
| Soil density and gradation           | As density increases, column diameter reduces. For granular soils, the diameter increases with reducing uniformity coefficient ( $D_{60}/D_{10}$ ).  |
| Degree of mixing of soil and grout   | Larger and more uniform diameters are possible with higher degree of mixing.   |

### 7.7.6 Ground Freezing

As with much of tunneling technology, ground freezing was developed first in the mining industry and was probably first used in sinking mine shafts. For a mine the shaft (and the mine) is located where the ore is. Thus, means of obtaining access in unfavorable ground conditions, of providing emergency support in unstable ground below the water table, and of maintaining stability of working faces below the water table, such as freezing, often had their roots in the mining industry.

In its simplest form, ground freezing involves the extraction of heat from the ground until the groundwater is frozen. Thus converting the groundwater into a cementing agent and the ground into a “frozen sandstone”. The heat is extracted by circulating a cooling liquid, usually brine, in an array of pipes. Each pipe is actually two nested pipes, with the liquid flowing down the center pipe and back out through the annulus between the pipes. When the pipes are close enough and the time long enough, the cylinders of frozen soil formed at each pipe eventually coalesce into one solid frozen mass. This mass may be a ring or donut as needed to support a shaft or a solid block of whatever shape necessary to stabilize the working face or heading.

Because of the dearth of engineering data on the properties of frozen ground (especially clays) it is recommended that two steps be taken early in any design of ground freezing:

1. A qualified consultant be engaged to advise on the design and construction of the project. Advice from such a professional is essential for the work and will pay for itself many times over.
2. Laboratory tests be designed and carried out using soil samples from the actual site. Only in this manner can meaningful properties of frozen soil be obtained for the site involved for purposes of conceptual engineering (“scoping the problem”).

However, a few general guidelines can be stated as follows (after Xanthakos, 1994).

1. Pipes are normally spaced 3 to 4 feet apart.
2. Select a spacing-to-diameter ratio  $\leq 13$  (for pipes 120 mm or less in diameter).
3. Use a brine temperature  $\leq 25^{\circ}$  C.
4. Provide 0.013 to 0.025 tons of refrigeration per foot of freeze pipe.
5. Determine typical frozen ground properties by laboratory testing.

Groundwater flow across the site requires special considerations closer pipe spacing, multiple rows of pipes and the like. Groundwater flow velocities approximately  $\geq 2$  m/day may impede or prevent freezing. A number of special challenges associated with ground freezing should be considered in both the design and construction stage. Those are creep of frozen ground, sensitivity of frozen ground properties to loading condition, ground heave or settlement, and others.

Readers are referred to the discussions and details of ground freezing application in Chapter 12.



## **CHAPTER 8**

### **TUNNELING IN DIFFICULT GROUND**

#### **8.1 INTRODUCTION**

Engineers like to work with materials having defined characteristics that do not change from one location or application to another. Unfortunately, geology seldom if ever cooperates with this natural desire but instead tends to present new and challenging conditions throughout the length of a tunnel. Some of these conditions approach the “ideal” closely enough that they can be approached as presented for rock and soft ground in Chapters 6 and 7. However, in many cases special approaches or arrangements must be made to safely and efficiently drive and stabilize the tunnel as it passes through this “Difficult Ground”.

The factors that make tunneling difficult are generally related to instability, which inhibits timely placement or maintenance of adequate support at or behind the working face; heavy loading from the ground which creates problems of design as well as installation and maintenance of a suitable support system; natural and man-made obstacles or constraints; and physical conditions which make the work place untenable unless they can be modified.

This chapter is an update of the Chapter 8 “Tunneling in Difficult Ground” of the 2<sup>nd</sup> Edition Tunnel Engineering Handbook authored by Terrence G. McCusker (Brickel, et al., 1996) and emphasizes on creating and maintaining stable openings by mining or boring in difficult ground which actively resists such efforts. Chapters 6 through 10 presents design recommendations and requirements for mined and bored road tunnels. Mining sequentially based on the sequential excavation method (SEM) principles is discussed in Chapter 9. Chapter 10 addresses the design of various types of permanent lining applicable for rock tunnels.

##### **8.1.1 Instability**

Instability can arise from: lack of stand-up time, as in non-cohesive sands and gravels (especially below the water table) and weak cohesive soils with high water content or in blocky and seamy rock; adverse orientation of joint and fracture planes; or the effects of water. The major problems with mixed face tunneling can also be ascribed to the potential for instability and this class of tunneling will be discussed under this heading.

##### **8.1.2 Heavy Loading**

When a tunnel is driven at depth in relatively weak rock, a range of effects may be encountered, from squeezing through popping to explosive failure of the rock mass. Heavy loading may also result from the effects of tunneling in swelling clays or chemically active materials such as anhydrite. Adverse orientation of weak zones such as joints and shears can also result in heavy loading, but this is usually dealt with as a problem of instability rather than loading. Combinations of parallel and intersecting tunnels are a special case in which loadings have to be evaluated carefully.

##### **8.1.3 Obstacles and Constraints**

Natural obstacles such as boulder beds in association with running silt and caverns in limestone are just two examples of natural obstacles that demand special consideration when tunneling is contemplated. In urban areas, abandoned foundations and piles present manmade obstructions to straightforward tunneling

while support systems for existing buildings and for future developments present constraints which may limit the tunnel builder's options. In urban settings, interference conflicts, public convenience or the constraints imposed by the need or desire for connection to existing facilities will sometimes result in the need to construct shallow tunnels, which have a range of problems from working in confined spaces, avoiding subsidence and uneven ground loading and support.

#### **8.1.4 Physical Conditions**

In areas affected by relatively recent tectonic activity or by ongoing geothermal activity, both high temperatures and noxious, explosive or deadly gases may be encountered. Noxious gases are also commonly present in rock of organic origin; and elevated temperatures are commonly associated with tunneling at depth. In an urban setting, contaminated ground may be encountered and will be especially troublesome when found in association with other difficult conditions.

Where appropriate, some information is provided as to the reasons why the condition under discussion creates problems for construction. Some examples of each of the conditions referred to above are discussed briefly to yield insight into the problems and to define the range of solutions available.

## **8.2 INSTABILITY**

### **8.2.1 Non-Cohesive Sand and Gravel**

Cohesion in sands is more than a matter of grain size distribution. For instance, beach-derived sands normally contain salt (unless it has been leached out), which aids in making sand somewhat cohesive regardless of grain size. The moisture content then becomes a determining factor.

The age and geologic history of the deposit is also important since compacted dune sands with “frosted” grain surfaces may develop a purely mechanical bond; and leaching and redeposit of minerals from overlying strata may also provide weak to strong chemical bonding.

As discussed in Chapter 7, a very low water content amounting to less than complete saturation will provide temporary apparent cohesion as a fresh surface is exposed in tunnel excavation because of capillary forces or “negative pore pressure.” This disappears as the sand dries and raveling begins. Nevertheless, some unlooked-for stand up time may be available. In this case, it is important not to overrate the stability of the soil. As it dries out, the cohesion will disappear and it cannot be restored by rewetting the ground.

If groundwater is actually flowing through the working face, any amount may be sufficient to permit the start of a run which can develop into total collapse as shown in Figure 8-1.

There is no such thing as a predictably safe rate of flow in clean sands. Uncontrolled water flows affect more than the face of the excavation. If the initial support system of the tunnel is pervious, water flowing behind the working face will carry fines into the tunnel and may create substantial cavities--sometimes large enough to imperil the integrity of the structural supports. This phenomenon occurred in Los Angeles where a ruptured water main caused sufficient flow through a tunnel support system to cause a failure and resulting large sink hole in the street.

While factors such as compaction or chemical bonding may permit some flow without immediate loss of stability, this is not a reliable predictor. Soil deposits are hardly ever of a truly uniform nature. It has been observed in soft ground tunnels in recent deposits that all that is necessary to trigger collapse may be the presence of sufficient water to result in a film on the working face; i.e., there is no negative pore pressure to assist in stabilizing the working face. Of course, there is never a safety factor arising from surface tension (capillary action) in coarse sand or gravel.

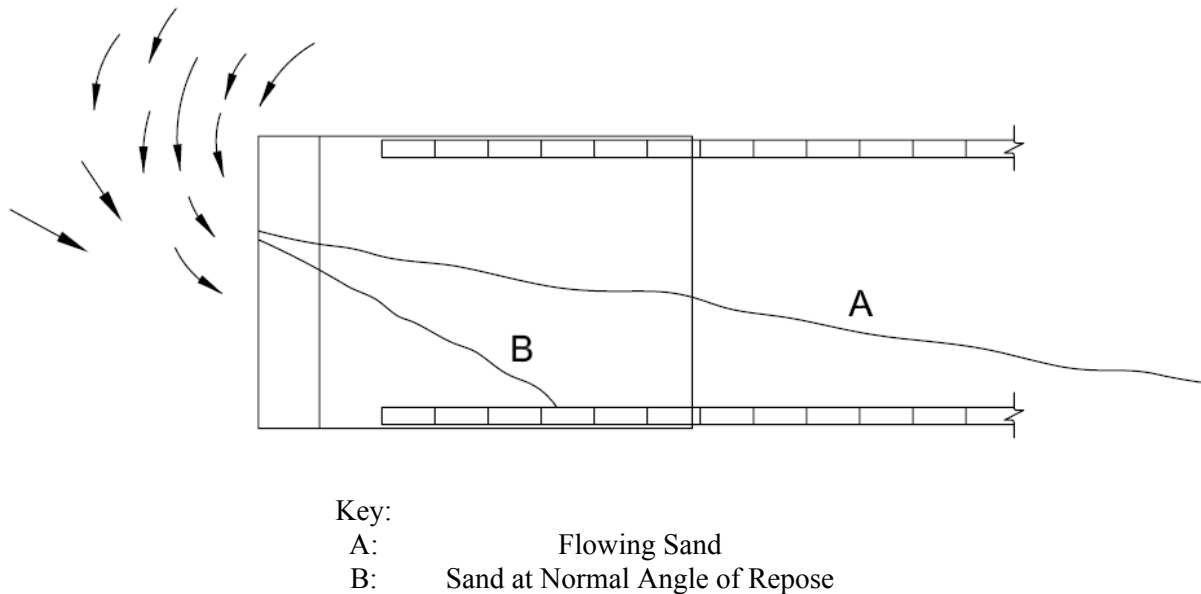

Figure 8-1 Flowing Sand in Tunnel

The cleaner the sand, the more liable it is to run or flow when exposed in an unsupported vertical face during tunnel construction. Single sized fine grained sands (UCS classification SP) are the most troublesome, closely followed by SP-SM sands containing less than about 7% of silt and clay binder. Saturated sands in these classes have been observed to flow freely through sheet piles and to settle into fans having an angle of repose of less than 5°. Unconfined SP sands will run freely, as in an hourglass, whether wet or dry, having some stability only when damp but less than saturated (no piezometric head). The large proportion of the sand particles of the same size allow the sand to move almost as freely over one another as would glass marbles.

Silt, intermediate in grain size between sand and clay, may behave as either a cohesive or non-cohesive material. In some areas it is common to find thin seams of saturated fine sandy silt trapped between clay beds in glacial deposits. In general, unless the seams are thicker than about 9-12 inches, when the silt layer is exposed in the wall of an excavation, the soil slumps out at intervals leaving a series of small shallow caves like entrances to burrows. The water appears to drain fast enough from the increased surface area exposed so that the remainder of the exposed material stabilizes.

The usual problem encountered with running sand is settlement and cratering at the surface with damage to structures or utilities in the area. If the ground is permeable, consolidation grouting of the entire sensitive area can be undertaken to stabilize the soil before tunneling. If dewatering is successful in depressing the water table below the tunnel invert, it may be found that the sand is just as unstable dry as

wet. The alternative of using compressed air is attractive, provided the working pressure is very carefully controlled; but even so, the ground may be too dried out for stability.

If the face is a full face of sand and similarly weak materials, a slurry machine or an earth pressure balance machine, will be required. In general, rotary head tunneling machines for soft ground tunnels require very similar physical properties over the entire working face and the entire job. If these conditions do not prevail, then weaker ground, and running sands in particular, must be prevented from entering the shield more rapidly than is proper for the rate of advance. Slurry shields have the best opportunity of controlling variable conditions where running sands are present; but they will prove difficult to keep on line and grade in mixed face conditions if one of the beds present is even a strong clay. If the sand and clay beds are more or less evenly distributed (e.g., a varved clay), then this problem may not arise. Of the digger type shields, neither extensible poling plates nor orange peel breasting have proved to be generally successful, hence these machines are now rarely used.

A problem with all shield construction is the necessary difference in diameter between the shield and the lining. If the soil has no stand-up capability by the time it is exposed in the upper part of the tunnel before expansion of a primary lining or introduction of pea gravel or more commonly, grout into the annular space for non-expanded linings, then there will be loss of ground. If the unfilled annular space averages one inch in a 20 ft tunnel, the lost ground from this single cause is approximately 1.7% shown in Table 7.2 as “poor” practice. Even if only local raveling takes place, it may choke off the flow of grout before the void can be filled with a continuous supporting fill material. This loss of ground results in a contribution to settlement.

### 8.2.2 Soft Clay

For the purposes of this discussion, soft clay includes any plastic material that will close around a tunnel excavation if free to do so. This will be the case if the overburden pressure at spring line exceeds the shear strength of the clay by a factor of about three or more. However, if the clay is sensitive and loses strength when remolded, the remolded strength will govern some of the clay behavior during tunnel construction. The phenomenon of sensitivity is mediated by several factors that cannot be fully discussed here but, in general, sensitivity may be suspected in clays with a high moisture content. Particularly at risk are marine clays from which the salt has been leached. The loss of strength may lie within a wide range, the ratio of undisturbed to remolded strength sensitivity being from 2 to 1,000. Moderate sensitivity of 2 to 4 is quite common. During remolding, the void ratio in the clay is reduced and free water is released. When this free water has access to a drainage path such as a sand bed or the tunnel itself, there will be a volume change in the soil mass which will result in surface settlement.

As discussed in Chapter 7, Equation 7-1 is used to calculate a Stability Number to estimate ground behavior in tunneling. Table 7-2 summarizes the behavior of cohesive soils during excavation. As shown in Table 7-2, if the cohesive soil is to be stabilized so that closure around the tunnel lining is minimized and stable control of line and grade are maintained, the critical number must be reduced below about 5; this will enable reasonable control of alignment and grade. Equation 7-1 can be written to the following equation:

$$P_a = P_z - (N_{crit} \times S_u) \quad 8-1$$

where  $N_{crit}$  is the critical number,  $P_z$  is the overburden pressure at tunnel spring line,  $P_a$  is the working pressure in a compressed air tunnel or the equivalent average pressure provided by the initial support system, and  $S_u$  is the undrained shear strength of the soil in compatible units. As an example, if  $N$  is to be maintained at a value of 5, the overburden pressure is 40 psi and the unconfined shear strength of the soil

is 1,000 psf = 7 psi, then from Equation 8-1, the required working pressure in the tunnel will be  $(40 - 5 \times 7) = 5$  psi. From this same equation, it can be seen that if the shear strength of the soil is reduced by remolding caused by passage of the shield through the ground to a value of 250 psf, then the required air pressure for stability increases to over 30 psi, transforming the project from a relatively straightforward one to a difficult one.

Attempting to calculate the required volume of grout injection into the annular void between shield excavation and lining in clays often is not a fruitful exercise. It will certainly be possible to inject the requisite volume of grout, but it may be difficult to make it flow around the tunnel perimeter in an even layer. The best results are obtained by establishing multiple simultaneous injection points permanently fixed within the shield tail and passing through the tail seals. Grout is injected throughout the time the shield is in motion. For this system to work, the lining must be a bolted segmented lining with built-in gashets between segments. It must be expected that for simultaneous injection through multiple ports while the shield is in motion there will be a substantial learning curve before all elements of the system are functioning smoothly to achieve the desired result.

It is generally difficult to use any mechanical excavation equipment in this type of ground except for a slurry shield or earth pressure balance shield (EPB). These days, the two types of machine are approaching interchangeability with the continuing development of chemical additives (conditioners). The edge goes to slurry machines in coarse geology and/or where the rock crusher may be needed to reduce rock or boulders to a size that will pass the machine.

The EPB is preferred as being somewhat more flexible in varying conditions and somewhat less expensive than a slurry shield. In order to control pressure in the plenum chamber behind the cutterhead, a screw conveyor is required. The rotational speed of the screw is matched to the advance rate of the EPB and pressure in the plenum is monitored using multiple sensors. If boulders are likely to be encountered, especially if they will be larger than can pass through the screw conveyor, the cutterhead must be fitted with disk cutters in addition to the drag bits normally associated with this type of machine. This topic is covered in more detail below in Section 8.4.1 dealing with boulders.

### **8.2.3 Blocky Rock**

As discussed in Chapter 6, rock is a basically strong material which requires little or no structural support when intact; although it may require protection from exposure to air, water or from fluids conveyed in the tunnel. However, when the rock joints and fractures are open sufficiently that the natural rugosity of the block surfaces will not prevent movement of rock blocks or substantial fragments, the rock is said to be “blocky.” If the joints and fractures contain clay-like material resulting from weathering or light shearing, then the rock is described as “blocky and seamy.” As can be seen from Table 6-7, this may raise the rock load by a factor of approximately three. In zones where the rock has small folds, but is open along the direction of the folds, it may be free to move in only one direction. Such rock is still blocky.

When rock is subjected to the action of explosives, high-pressure gases flow into any fissures in the rock before they have finished their explosive and rock-fracturing expansion. Even in hard granite, a result of blasting is the creation of micro-fissures extending well outside the blasted perimeter. In blocky rock, the effect may well extend more than a tunnel diameter outside the desired finished surface; a good deal of overbreak and potential loosening and movement of blocks is likely to result.

Another problem with this type of rock is that it is highly susceptible to the destabilizing effects of water flowing through the fracture system with sufficient energy to dislodge successively more rock. This action is dealt with more fully in a later section. Finally, it is quite likely when blocky and seamy rock is encountered in a tunnel excavation, especially in heavily folded strata, that there will be zones where the

weathering has proceeded to a conclusion resulting in the presence of weak earth-like material with little capacity to sustain loads or to preserve the tunnel outline.

All of the rock conditions described require early and carefully placed primary support to preserve ground stability and to provide a safe workplace. Even before support installation, it is necessary to minimize surprises by scaling off any loose rock which will present a hazard to the crews installing the support system. Many still prefer to use steel ribs and wood lagging in this type of rock. It provides positive support and is quickly installed in tunnels less than about 5 meters in diameter. Unfortunately, crews still have to work under the unsupported rock to install the ribs and lagging; the material costs are high; the presence of timber results in the possibility of future uneven loading on the permanent tunnel lining as wood rots out and steel corrodes; and it becomes relatively difficult to ensure good contact between the lining concrete and the rock even after contact grouting.

For these reasons the use of shotcrete and rock bolts has become popular. In rock known to be blocky and therefore to need support, an initial layer of shotcrete about 5 cm thick should be applied as soon as possible in the tunnel crown. This is followed by the installation of pattern rock bolts whose length and diameter are governed principally by the tunnel diameter. (See Chapter 6 for more details)

#### **8.2.4 Adverse Combinations of Joints and Shears**

Jointing systems in rock arise from many causes, some of which are noted here. Sedimentary rocks, and particularly limestone, typically have three more or less orthogonal joint sets arising from the modes of deposition and induration which formed them. Not all joints are continuous, but those in any set are parallel. There may be many sets or, in weak, massive sandstone, for instance, only one or two. Joints and fracture systems combine to break up the rock mass into interlocking fragments of varying sizes and degrees of stability.

In the absence of direct evidence to the contrary, it should be assumed that shears and faults are continuous throughout their intersection with the tunnel excavation. In schistose materials, weathering usually follows a foliation plane to great depths, even in temperate climates when a weak zone has been formed by slippage along that plane. Other faulting may cause the development of extensive fracture systems in any direction. A section through the project area perpendicular to the strike of the exposed surfaces in schistose materials will generally reveal a saw-tooth profile with one of the surfaces parallel to the foliation. Continuation of the plane thus defined to tunnel elevation will be a preliminary indicator of the presence of sheared and weathered rock in the excavation.

Continuous joints and shears can define large blocks with little or nothing to hold them in place once the tunnel excavation has been completed. It is important to identify the locations of blocks with the potential for falling out in order to provide support during cautious excavation. For large diameter tunnels in particular, this requires an assessment of the potential before construction begins, mapping during construction, and control of drift size and round length to ensure against complete exposure of an unstable block in a single round. Readers are referred to Chapter 6 for details.

The difficulty of controlling the correct placement of steel sets in multiple drift headings works against the use of this kind of support. Initial rock bolting followed by reinforced shotcrete is a reasonable approach. In all cases where rock bolts have to be located to take direct and reasonably predictable loads, it is better that they be installed ahead of the shotcrete while the joint locations are still visible. If mechanical rock bolt installers cannot be used, then the crews must be protected by overhead cages.

## 8.2.5 Faults and Alteration Zones

Tectonic action, high pressure and high temperatures may metamorphose rock into different structures with unpredictable joint patterns. The uplift and folding of rocks by tectonic action will cause fracturing perpendicular to the fold axis along with faulting where the rock cannot accommodate the displacements involved, so that shears develop parallel to the fold axis. Other types of faults arise as the earth accommodates itself to shifting tectonic forces. Faults or shears may be thin with no more significance than a continuous joint or they may form shear zones over a kilometer wide in which the rock is completely pulverized but with inclusions of native rock, sometimes of large size.

All of the conditions briefly described above may be additionally complicated by the presence of locked-in stress, high overburden loads, or water.

Dealing with the conditions encountered in such fault zones and weathered intrusive zones depends on the excavation method in use, the depth below the ground surface, the strength of the fault gouge, the sheared material or the weathered or altered rock, and the water conditions. Water problems are discussed in general in the next section, including consideration of the difficult water conditions commonly found in association with faults; however, to the extent that they affect the selection of construction methods appropriate to fault crossings, they are referred to here.

Current technology provides other solutions, such as the use of precast concrete lining in the weak ground with supplementary jacking capability to enable the lining to provide the jacking reaction for the thrust of the TBM.

In general, fault crossings offer conditions akin to those of mixed face tunneling and the same methods are available to deal with them. Different circumstances come into play with deeper tunnels, especially if these are of large diameter. Such tunnels are usually long and logistics are important. The comparative lengths of fault zone and normal tunnel dictate that the construction method be efficient for the normal tunnel. Nevertheless, sufficient flexibility is required to permit safe and reasonably expeditious construction through the worst conditions likely to be encountered. Drill and blast excavation is still commonly used in such tunnels. Rock bolts and shotcrete then become the preferred support system, although steel ribs and lagging or steel ribs with shotcrete are also still used. TBM successes in these conditions have been few. There are two principal problems: the loose material in the fault runs into the buckets and around the cutters and stalls the cutterhead; and if the fault contains cohesive material, it squeezes and binds the cutterhead and shield with similar results.

One solution to the problem of loose or loosened raveling and running material is to establish a grout curtain ahead of the TBM and then to maintain it by continuing a grout and excavation cycle throughout the fault-affected portion of the drive. Even if imperfect--as consolidation grouting tends to be, especially when placed from within the tunnel in conditions providing limited access--it is likely that a properly designed and executed program will add sufficient stability to the ground to permit progress. It should be noted that any such program will be expensive and time-consuming. It is therefore unlikely that any contractor will willingly do the necessary work unless it has already been envisaged in the contract as a priced bid item. It is also important to recognize that if water is running into the tunnel through the working face, a bulkhead will be required to stop the flow while the initial grouting is in progress. Grouting into running water is a slow and expensive way to establish a grout seal.

Within limits, the squeezing problem can be dealt with in part in TBM tunneling by tapering the shield and making its diameter adjustable within limits; and by bevelling the cutterhead itself to the extent that this is possible without interfering with the efficiency of the buckets. Expandable gauge cutters are also

used, but this is still a developing technology. One of the problems is that there is a tendency for local shearing of the cutter supports to result in an inability to withdraw the cutter once it has been extended. Also, since such cutters are acting well outside the radius of the buckets, muck which falls to the invert is not collected but provides an obstruction the cutters must pass through repeatedly. This grinds the debris finer and finer and abrades the cutter mounts as well as the cutter disk. This makes it necessary to provide means for eccentric cutterhead rotation so that the invert is properly swept. Unfortunately, squeezing is commonly, if not most often, manifested preferentially in the tunnel invert.

## **8.2.6 Water**

It was Terzaghi's view that the worst problems of tunneling could be traced to the presence of water. Among other things, he considered that (except for circular tunnels) it was prudent to double the design rock load on the tunnel lining when the tunnel was below the water table. This in itself would not be a serious problem, since most tunnel linings are already limited as to their minimum dimensions by problems of placement rather than by design considerations. However, there are many other problems that are associated with the presence of water. Several are discussed below, working in sequence from clay to rock and, within rock, from weak and fractured to strong and intact.

### **8.2.6.1 Clay**

Most clays are at least slightly sensitive. This arises from the microstructure of clay soils which are composed largely of platy minerals. As with a heap of coins, the packing is not perfect, even though the clay is relatively impermeable. Each fragment is held in place by some combination of free body equilibrium forces, ionic interaction and chemical or mechanical bonds at the contact points. The pores of the clay are generally filled with water, which may contain salts in solution. Disturbance of the clay results in disruption of the bonding, migration of water and at least temporary weakening of the clay structure. The free water will be released at any temporary boundaries formed by shearing. As the clay reconsolidates, it is likely to gain strength over the initial condition, but this will be a protracted process. The immediate effect, and the one that affects tunnel construction, is loss of shear strength throughout the disturbed mass. In organic silty clays, the sensitivity is commonly about 4, indicating a fourfold loss of strength upon remolding. This is associated with an initial water content of about 60%. As shown on Page 8-4, a four fold loss of strength can result in more than a sixfold increase in the required support. In any one material, the sensitivity may vary greatly, depending on the water content. Sensitivities as high as 500 to 1,000 may be found in some clays, such as the Leda clay commonly encountered in previously glaciated areas. Marine clays such those found in Boston lose salt by diffusion when situated below the water table. Such clays are typically highly sensitive.

Tunneling is already sufficiently challenging in moderately sensitive clays as the critical number (Section 8.2.2) suffers a local fourfold or more increase. For shielded tunneling, it is very important to avoid excessive efforts to correct line and grade as it is easily possible to create a situation in which control is lost.

A further effect of disturbance of sensitive clays is directly dependent on the loss of pore water expressed from the clay. The volume change results directly in rapid subterranean and surface settlement. In addition, the clay closes rapidly on to the tunnel lining, resulting in even greater settlement unless sufficient compensation and/or contact grout can be injected promptly.



### 8.2.7 Mixed Face Tunneling

Tunneling in mixed face conditions is a perennial problem and fraught with the possibility of serious ground loss and consequent damage to utilities and structures as well as the prospect of hazard to traffic. The term “mixed face” usually refers to a situation in which the lower part of the working face is in rock while the upper part is in soil. The reverse is possible, as in basalt flows overlying alluvium encountered in construction of the Melbourne subway system. Also found are hard rock ledges in a generally soft matrix bed of hard rock alternating with soft, decomposed and weathered rock; and non-cohesive granular soil above hard clay (as in Washington D.C.) or above saprolite (as in Baltimore). The definition can also be extended to include boulders in a soft matrix (discussed elsewhere in this chapter) and hard, nodular inclusions distributed in soft rock (e.g., flints beds in chalk or garnet in schist).

The primary problem situation is the presence of a weak stratum above a hard one as clearly illustrated in Figure 8-2 for the construction of the 2.3 km long C line and the 4 km long S line of the Oporto Metro project as a part of the mass transit public transport system of Porto, Portugal (Babendererde et al., 2004). The highly variable nature of the deeply weathered Oporto granite overlying the sound granite posed significant challenges to two 8.7 m diameter EPB Tunnel Boring Machines.

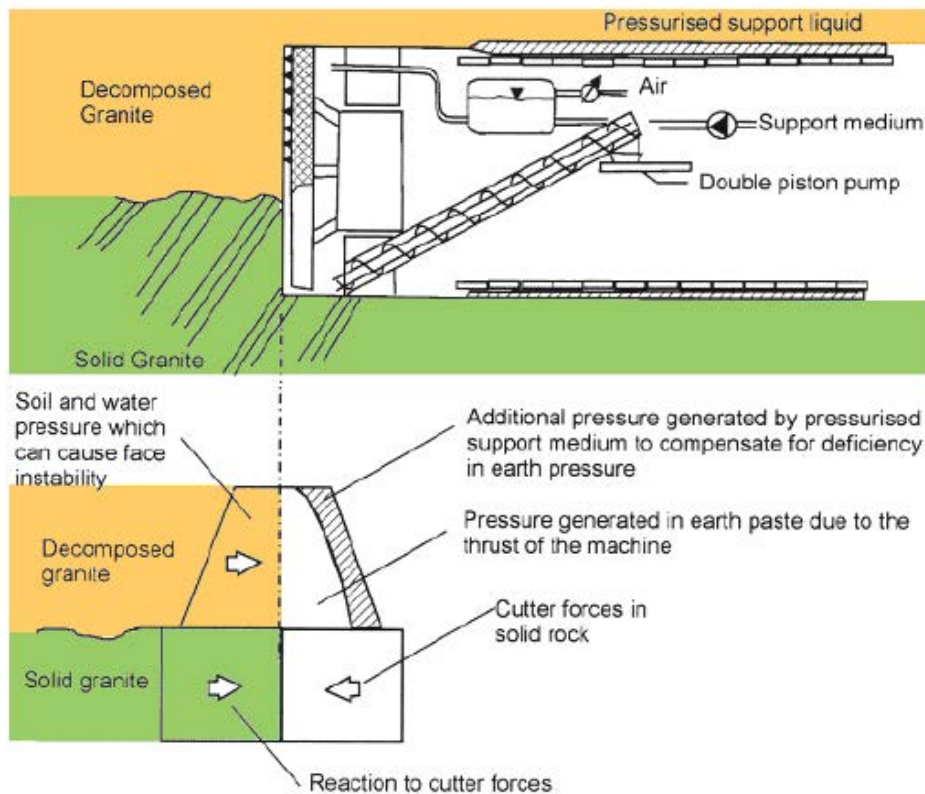

Figure 8-2 Mixed Face Tunneling Example (Babendererde et al., 2004)

There will always be water at the interface which will flow into the tunnel once the mixed face condition is exposed. This increases the hazard because of the destabilization of material already having a short stand-up time. Stabilization therefore calls for groundwater control as well as adequate and continuous

support of the weak material. Moreover, this support must be provided where energetic methods, such as drill-and-blast excavation, are required to remove the harder material.

Dewatering can reduce the head of water, but it cannot remove the groundwater completely; nor can it be realistically expected to offer control on an undulating interface with pockets and channels lower than the general elevations established by borehole exploration. Compressed air working will not deal with water in confined lenticular pockets and it is usually inappropriate when the length of the mixed face and soft ground conditions amount to only a few percent of what is otherwise a rock tunnel. Also, recent experience where extensive beds of clean (SP and SP-SM) sands have been major components of the weak ground shows that compressed air alone will not stabilize the ground which becomes free-flowing as soon as it has dried out. Therefore, on the whole, consolidation grouting is to be preferred in this situation.

It is emphasized that the best time to seal off groundwater is before it has started to flow into the tunnel. Once the water is flowing, it is extremely difficult to stop it from within the tunnel except by establishing a bulkhead.

### **8.3 HEAVING LOADING**

#### **8.3.1 Squeezing Rock**

When a tunnel opening is formed, the local stress regime is changed. The radial stress falls to zero and the tangential stresses increase to three times the in situ overburden load (neglecting the effects of any locked-in stress resulting from past tectonic action that has not been relieved). If the unconfined compressive strength of the rock is less than the increased tangential stress, a mode of failure will be initiated which is described as "squeezing rock". As elastic failure occurs, with consequent reduced load-bearing capacity of the ground, the load is transferred by internal shear to adjacent ground until an equilibrium condition is reached. If the ground develops brittle failure and is shed from the tunnel walls, then there will be no residual strength of the failed ground to share in the load redistribution. If the ground is sufficiently weak or the overburden load too great, the unrestrained tunnel may close completely.

#### **8.3.2 The Squeezing Process**

The detailed mechanism of ground movement is complex and depends on the presence or absence of water and swelling minerals as well as on the physical properties of the ground. For the purposes of this discussion, however, the squeezing process may be described as follows.

##### **8.3.2.1 Initial Elastic Movement**

As the tunnel is excavated, stress relief allows elastic rebound of ground previously in compression to relieve stress. This stress relief occurs beyond the working face as well as around the tunnel excavation. In thinly laminated rocks such as schist and phyllite, the modulus of elasticity parallel to the foliation is likely to be much higher than that in the perpendicular direction. Therefore, the elastic movement immediately distorts the shape of the excavation as the rock moves a greater distance perpendicular to the foliation than parallel to it. Moreover, since the rock can move more easily along regular foliation planes than perpendicular to them, more than one factor is at work determining the actual distortion of the tunnel shape. The elastic rebound takes place in all tunnel excavations and is not properly a part of squeezing, which is associated with changes in the rock structure. However, the associated increase in tangential stress in the rock initiates the next phase of movement (squeezing) as the rock fails. As the rock moves

toward the tunnel opening, the circumference of the tunnel shortens. There is a limit imposed by the modulus and strength of the rock on how far this process can continue before elastic failure is initiated. Consider a rock of compressive strength 35 Mpa and an elastic modulus of 17,500 Mpa. The circumferential strain per unit length at failure will be  $35/17,500$  cm/cm or 2 mm/m. For a tunnel of 2 m radius therefore, a shortening of this radius by about 4 mm implies the initiation of impending elastic failure at the exposed rock surface. This does not mean that the rock suddenly loses all strength (unless it is brittle enough to flake off the wall) but rather that its residual strength is greatly reduced. As the tangential shear stress builds up there will come a time when the differential stress is sufficient to cause internal shear failure. This is manifested by the development of new parting surfaces where the overstressed rock separates from the neighboring rock.

### **8.3.2.2 Strength Reduction**

When the rock remaining is insufficiently strong to carry the increased load passed to it as shearing progresses it will fail in turn. In strong and brittle rocks, this failure can result in explosive release of rock fragments from the surface in a phenomenon known as “rock bursting.” A somewhat gentler expression of the same phenomenon is known as “popping rock,” which is still a dangerous phenomenon. Because these occurrences actually remove rock from the surface there is obviously no residual load-carrying capability of the failed rock. In weaker and less brittle rock the failed material stays in place and enters a plastic or elasto-plastic regime. Its modulus of elasticity and its unconfined compressive strength (which represent its load-carrying capacity) may be reduced by two orders of magnitude, but it can still support some load. In the meantime, the load shed by the failed rock at the perimeter of the opening is transferred deeper into the rock mass where the degree of confinement is higher and the ultimate load-bearing capacity is therefore also higher. The phenomenon may be modelled step-wise, but it is truly a continuous process and will cease only when the total load has been redistributed. Depending on the amount of excess load-carrying capacity available in the partially confined rock around the tunnel perimeter, the stress regime may be affected up to several tunnel diameters away from the opening.

Compounding the stress increase, which leads to failure, is the similar regime in the dome ahead of the working face. The abutment of this dome is the already overstressed rock behind the working face. The problem is therefore three-dimensional in the region affected. The initial movements associated with strength reduction take place quite fast, so that as much as 30% of the final loss of tunnel size may be completed within one to one and a half tunnel diameters behind the working face.

### **8.3.2.3 Creep**

As a consequence of the reduced elastic modulus and the reduced strength of the rock additional radial movement of the tunnel walls occurs. In the zone outside the tunnel, the rock properties are substantially changed. In particular, both the elastic modulus and the unconfined compressive strength decrease continuously (but not in a linear fashion) from their original values still existing in undisturbed rock toward the tunnel wall. The tunnel decreases in diameter as the weakened material creeps toward the tunnel boundary. The rate of movement is roughly proportional to the applied load. The movement is therefore time-dependent (after the initial elastic stress relief, which may be regarded as essentially instantaneous). As the ground is allowed to strain, so the strength of the support required to restrain further movement is reduced. However, depending on the amount of squeezing, shear failures and dilatation accompanying failure may result in unstable conditions in the tunnel walls and crown. Since the timing, location and amount of such failures are not subject to precise definition, support is usually introduced well before the full amount of potential movement has occurred.

#### **8.3.2.4 Modeling Rock Behavior**

Because of the nature of the failure mode, elasto-plastic and visco-elasto-plastic mathematical models have been developed to describe the resulting movements and to evaluate the stress regimes for tunnels in rock. These models are not exact but correspond sufficiently well with experience to be useful. Unfortunately, for any given tunnel they depend on the use of information which can only be derived from experience in the specific tunnel involved. This is the origin of the observational approach to tunnel support exemplified by the Sequential Excavation Method (SEM) discussed in Chapter 9.

It has been noted from experimental work that the net load appearing at the tunnel surface varies with the tunnel diameter as a power function. The loading is also dependent on the rate of tunnel advance. It is therefore clear that when such conditions are encountered, the smallest tunnel diameter adequate for the purpose should be selected. Experience also shows that circular tunnels are easier to support than any other shape.

#### **8.3.2.5 Other Factors**

If the rock contains porewater, negative pore pressures are set up as the rock moves toward the tunnel. This provides limited initial support until the negative pore pressure is dissipated. In addition, the new pressure gradient set up by the release of confining pressure results in seepage pressures toward the tunnel boundary. In regions of high hydrostatic head, significant increases in rock loading can occur. It is also thought that even small proportions of swelling clay minerals in the rock can contribute significantly to rock loads when water is present. This water need not be flowing--only present in the pores. When all factors contributing to rock mass behavior have been identified and quantified, it may be possible to develop more exact predictive models and to devise new means for controlling and improving ground behavior. In the meantime, we must make do with approximations based on experience.

#### **8.3.2.6 Monitoring**

Rate of squeeze and rock loads are somewhat dependent on tunnel size and rate of advance. It is essential in squeezing (or swelling) conditions--or even in blocky and seamy rock where joint closure may create problems--to establish a program of convergence point installations which will be routinely used to monitor the amount and rate of movement of the tunnel walls. This information collected over time and collated with the behavior of the tunnel support system will provide the information needed both to predict and to install the appropriate amount of support as tunneling progresses. This technique lies at the heart of SEM tunneling in rock (Chapter 9). Geotechnical instrumentation is discussed in Chapter 15.

#### **8.3.3 Yielding Supports**

One approach to squeezing rock is to go to a simple and workable system of yielding supports as illustrated in Figure 8-3. The number of yielding joints can be modified to provide the needs of the rock currently being excavated since all components are manufactured on site. Each joint permits up to 22 cm of closure. (See

Figure 8-4) It has been found essential to shotcrete the gaps once the closure nears the limit allowed without the steel sections actually butting together. Failures have been common when this butting has been allowed to happen. It has also been found that allowing the invert to heave freely for twenty to thirty days before making an invert closure allows the total support system to resist all remaining loads with some reserve capacity for long term load increases. Other, more complicated yielding systems have been designed and used.

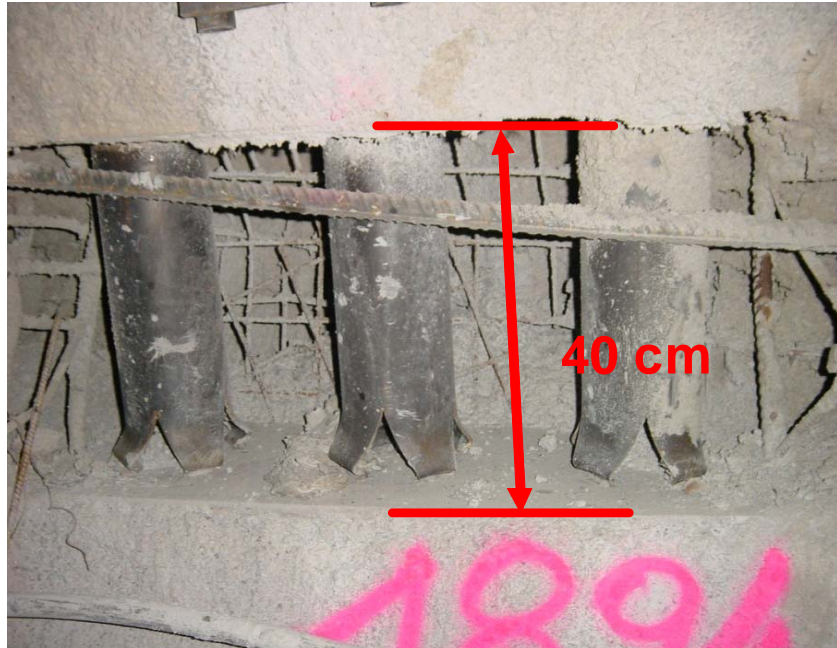

Figure 8-3 Yielding Support in Squeezing Ground



Figure 8-4 Yielding Support Crushed to 20 cm (One-half) (ILF, 2008)

In summary, the support system provides a relatively low initial support pressure and permits almost uniform stress relief for the rock in a controlled manner around the entire circumference of the tunnel while preventing the rock from ravelling. The shotcrete is not damaged by the convergence because of the yielding joints and so maintains its integrity, provided that timely closures are made. After allowing practically all of the stress relief required by the elasto-plastic stage of rock deformation, the support

system is made rigid whence it can support a pressure of 3.8 MPa which is available to deal with long term creep pressure.

#### **8.3.3.1 Timber Wedges and Blocking**

The use of blocking tightened against the ground by pairs of folding wedges introduces a structural element that can be allowed to fail by crushing. Observation of progressive failure coupled with experience provides warning that the behavior of the steel supports should be closely monitored in case a decrease in spacing or an increase in section becomes necessary.

#### **8.3.3.2 Precast Invert**

When squeezing is sufficiently severe to be troublesome, it will be seen that the prime tendency is for the lower sidewalls to move in and for the invert to heave. The loss of strength of the rock in the invert leads to the rapid development of muddy and unstable conditions under the tunnel haulage operations. In this case it may be desirable to use precast concrete invert slabs kept up close to the working face in place of invert struts. In one location where high squeezing occurred, such slabs were heaved up and required maintenance to keep the track on grade. However, they did provide a good and trouble-free surface otherwise.

#### **8.3.4 TBM Tunneling**

Because of the number of large tunnels now under consideration where the use of TBMs is contemplated and where squeezing conditions may become important, the following discussion is extended, even though not based on a great deal of current experience.

The majority of examples of tunnels in squeezing ground are related to the crossing of faults. TBMs have been troubled in this situation by inrushes of water carrying sand and finely divided rock or by blocks of rock jamming between the cutters. The second of these problems has been dealt with in many tunnels in otherwise normal conditions. The primary solution is the use of a machine design which allows only a limited projection of the cutters forward of the cutterhead by means of a face shield ahead of the structural support element. The second development is a design which permits worn cutters to be changed from within the tunnel, so that no access is required in front of the cutterhead. There has, as yet, been no easy solution for the problem of the cutterhead and its buckets being choked with sand and rock fragments while unrelenting water flows are in progress. It becomes a difficult and slow process of cleaning out and gaining progress slowly until the affected area has been cleared. Also in such conditions, the presence of a shield is important to protect the machine and to provide temporary support to material with no stand-up time. In some circumstances, if the condition is known to exist or to be likely to exist, probing ahead to identify the precise location can give an opportunity to stabilize the ground with grout injections, keeping a bulkhead thickness ahead of the excavation at all times. It is sometimes possible to allow most of the water to drain out of the ground, but this is not a reliable approach to prediction of construction methods. Shielded TBMs have been used successfully in such conditions, but unfortunately the use of a long shield militates against successful use in squeezing ground.

The other major problem, whether or not in a fault or shear zone, is the closure of the ground around the cutterhead shield and any protective shield behind the cutterhead. Many TBMs, have been immobilized because the load on the shield system was too high to permit the machine to advance. One way to approach this problem is by the use of a short shrinkable shield on the machine.

It is not anticipated that tunneling in squeezing ground or fault zones will ever become a simple and routine operation because of the erratic and unpredictable variability of conditions. However, the current climate of opinion is that virtually all tunnels can be attacked by TBM methods whenever there is an economic advantage in doing so.

As previously noted, the difficulty of predicting rock behavior in squeezing ground has played a major role in the development of observational methods for determination of rock support requirements. However, if tunneling by TBM is selected, some of the flexibility of the observational method is removed because it is difficult to see the face or to measure movements. Hence, decisions must be made at the time the TBM is designed as to the amount of ground movement to be anticipated or permitted and the design of the support system to accept the loadings implied at different stages of the tunneling operation.

Since squeezing of soft rock does not usually lead to immediate instability, it should be possible and practical to delay major support installation until a high percentage of the total strain has taken place and ground loading has been reduced. Sixty to seventy percent of the potential ground movement has usually taken place within about three diameters of the working face. If the total amount of squeezing is not great, it may not be necessary, or even desirable, to delay support installation so long.

Ideally, final support is not installed until convergence is less than one millimeter per month. The loading associated with a given amount of convergence is dependent on the parameters of the project. It is also important to take into consideration any long-term requirement for the tunnel to carry water. Finally, it must be realized that if groundwater is to be totally excluded from the tunnel, the final lining must be designed to carry the full hydrostatic head unless the aquifer is fully sealed off by consolidation grouting. If groundwater is admitted, whether in a controlled manner or by allowing local cracking of the lining, then only seepage pressures need be accounted for. In the case of weak squeezing ground or faulted rock with an unknown potential for swelling behavior, the latter alternative appears undesirable.

### **8.3.5 Steel Rib Support System**

Steel ribs set close to the tunnel surface and blocked from it are often used as the initial support system for rock tunnels especially those constructed by conventional drill-and-blast methods. Wood, concrete or steel lagging may be placed between the ribs and the rock to secure blocky or ravelling ground or welded wire fabric may also be used. The same system can also be used in TBM tunnels, but it is necessary to allow an initial small distance between rib and ground so that the last rib segment can be positioned conveniently. In normal tunneling, this space is later closed by expanding the rib against the ground. Especially in squeezing ground, the rib must be blocked to the rock all around its perimeter. As the ground movement occurs and continues, it will squeeze past the ribs and stress relief will occur. In this type of installation, it is necessary for the ribs to be as stiff as possible to prevent displacement and buckling. The chief safeguard is to install steel ties and collar braces at intervals around the rib. The collar braces are typically steel pipe sections set between the ribs. The ties then pass through holes in the web of the steel section and through the pipe forming the collar brace. These members are also subject to deformation by the invading ground. If this creates any substantial problem, angle irons welded to the inner face of the ribs can be substituted.

It is significant that in tunnels where the ribs have buckled under squeezing load but have been left in place, they commonly retain enough structural strength to provide support. The problem is that the squeezing usually intrudes on the required final profile of the tunnel.

### **8.3.6 Concrete Segments**

Segmental concrete linings take two quite different forms. The traditional bolted and gasketed lining is meant to be a final lining erected in one pass. Until recently, the more common application has been to use unbolted, ungasketed segments, with light reinforcement to allow handling, as a “sacrificial: primary lining. This latter type of lining is sacrificial only in the sense that it is allowed to sustain fractures resulting from jacking loads or redistribution of stress; it retains most of its initial load-bearing capacity. A final lining is always placed within this type of lining; it sometimes is an unreinforced concrete lining of nominal thickness, say 10 inches. The combination lining may be less expensive than the one-pass system and has the merit of flexibility. Problems arose with the precast concrete tunnel lining when there was insufficient erection space to allow for deviations normal to tunneling.

In electing to use a precast concrete lining decisions are necessary as to the amount of ground movement to be allowed and the backfill material to be used between the lining and the rock. In allowing for a large amount of potential ground movement, certain problems of erection stability arise. The lining will require support clear of the invert and a horizontal tie or blocking to keep it in shape during and after erection until backfill grouting is complete. There is time and skill involved in executing the work, but no significant difficulty.

Current technology is now trending towards the use of a one pass system of concrete segments. These segments are of high quality concrete and are usually bolted and gasketed at all joints. However, specially doweled circumferential joints are being used. It is necessary that such rings be cast and cured in a controlled factory environment and that they be of high strength concrete for high resistance and high elastic modulus. Steel fibers may be used in lieu of reinforcing steel in some applications.

It is important that the moving ground should not come into contact with the completed ring at a point. Distortion would necessarily result with a possible consequence of reducing load-bearing capacity. It is also possible to use compressible backfill in the annular void provided the material offers sufficient resistance to mobilize passive reactions sufficient to withstand distortion of the lining. At the least, careful consideration would be needed in specifying the strength and deformability of any compressible material to be used.

### **8.3.7 TBM Tunneling System**

The principal components of a TBM affected by the difference between tunneling in squeezing and non-squeezing ground are discussed below. Chapter 6 presents major components and back up system for a tunnel boring machine.

#### **8.3.7.1 Cutterhead**

Many different cutterhead designs have been used over the years from the earliest flat heads with multiple disc cutters through domed heads, rounded edge flat heads and conical designs. These days the cutterhead geometry is selected on the basis of the ground it is expected to penetrate. It has been found preferable to arrange that at least the gauge cutters be designed to be changed from behind and it is now common to arrange this system for all cutters. A spoke design allows ready access to the working face and simplifies design in some respects. However, such machines offer little support if weak ground is encountered and it is generally considered prudent to use a closed face machine. Also, to protect the cutters and cutter mounts, a lighter false face is provided so that the cutter disks protrude only a short distance.



In conventional designs, the cutterhead is provided with its own shield as part of the cutterhead bucket system. The conventional design creates a drum about 4 feet (1.2 m) long almost in contact with the ground. In squeezing ground this shield is vulnerable to the pressure exerted by rock movement. It is therefore better that the shield be smaller in diameter than the excavation and that it be tapered toward the rear. The gauge cutters should be arranged to protrude beyond the main body of the cutterhead.

If the cutterhead is not in close contact with the ground, provision must be made to provide stable support in its place. This will be the equivalent of a sole plate as used for overcutter compensation in earth pressure balance machines. However, in order to provide for varying amounts of overcut, the support will need to be hydraulically actuated. Since it will be subjected to substantial shear loading, the design will have to be very stiff.

### **8.3.7.2 Propulsion**

A TBM requires a reaction against which to propel itself forward. This reaction can be obtained by shoving directly against the tunnel support system with jacks spaced around the perimeter of the machine or by developing frictional resistance against the tunnel sidewalls.

The thrust needed to keep the cutterhead moving forward is about 25,000 kg per cutter. When the ground is weak, it is desirable to limit the bearing pressure on the tunnel walls because the weak rock would fail under even light loads, especially perpendicular to the direction of foliation. This would accelerate the rate of squeezing and might increase the total strain. At the same time it would be desirable to limit the length occupied by the grippers so as to minimize the necessary distance between the working face and any support system. This would probably require that there be multiple grippers covering most of the circumference but of limited length to minimize uneven bearing on the squeezing rock surface.

### **8.3.7.3 Shield**

If any shield is felt to be desirable or necessary, it should be short and shrinkable. Many TBMs have been stuck because the ground has moved on to the shield and exerted sufficient load to stall the machine.

### **8.3.7.4 Erector**

It is desirable to have complete flexibility in selecting the point at which ring erection is to take place. Therefore the erector should be free to move along the tunnel, mounted on the conveyor truss. A ring former should also be used to maintain the shape of the last erected ring until it has been grouted if concrete segmental lining is used.

### **8.3.7.5 Spoil Removal**

Conventional conveyor to rail car systems or single conveyor systems designed for the tunnel size selected are appropriate.

### **8.3.7.6 Back-Up System**

In order to keep the area between the grippers and the ring erection area as clear as possible, any ancillary equipment such as transformers, hydraulic pumps etc. should be kept clear of this space at track level.

### **8.3.8 Operational Flexibility**

It is envisaged that the system outlined above would be capable of handling either steel ribs or precast concrete supports. If shoving off the supports were to be selected for TBM propulsion, the degree of flexibility would be less than with the use of a gripper system. It would also be more vulnerable to problems in any circumstance where the convergence rate was markedly higher than expected.

### **8.3.9 Swelling**

Swelling phenomena are generally associated with argillaceous soils or rocks derived from such soils. In the field, it is difficult to distinguish between squeezing and swelling ground, especially since both conditions are often present at the same time. However, except in extreme conditions, squeezing is almost always self-limiting and will not recur vigorously, or at all, once the intruding material has been removed; while swelling may continue as long as free water and swelling minerals are present especially when the intruding material has been removed, thereby exposing fresh, unhydrated rock. Many European rail and highway tunnels are constructed in formations noted for their susceptibility to swelling. Most construction involves a more or less circular wall and roof section with an invert slab having a greater radius of curvature. Some of them are still being periodically repaired a century after construction. It has been noted in this connection that as the invert arches are excavated and replaced to more nearly circular configurations, the greater the time that elapses before the next repair is necessary.

Expansive clays are more common in younger argillaceous rocks, the proportions ranging from 65% in Pliocene and Miocene age material to only 5% in Cambrian and Precambrian. Montmorillonite is found in rocks of all ages as thin partings or thicker beds. Sodium montmorillonite is much more expansive than calcium montmorillonite.

### **8.3.10 Swelling Mechanism**

Most swelling is due to the simultaneous presence of unhydrated swelling clay minerals and free water. Tunnel construction commonly creates these conditions. Minerals such as montmorillonite form layered platy crystals; water may be taken up in the crystal lattice with a resultant increase in volume of up to ten times the volume of the unhydrated crystal. The displacements resulting from this increase in volume give rise to the observed swelling pressures, whether in soil or in rock.

If possible water should be kept away from rock or soil containing swelling clay minerals; however, it must be realized that water from fresh concrete, water vapor from a humid atmosphere or pore water released from confinement within the rock will initiate the swelling process. Since the swelling will not passivate in the same way as squeezing generally will in rock, tunnel support must be designed to resist the swelling pressure (which can be measured in the laboratory), even if it proves possible to let some swelling take place without creating problems.

### **8.3.11 Other Rock Problems**

Schists commonly contain clay minerals such as biotite, mica and chlorite. All of these are platy minerals and are found aligned with the foliation. If present as continuous layers, they have to be considered planes of weakness when assessing questions of rock stability. Similarly, weathered material in shears and mylonite not yet weathered indicate planes of weakness.

Anhydrite converts to gypsum in the presence of water with a volume increase of up to 60% accompanying the conversion. However, beds of anhydrite are not affected in the same way as finely

divided rock since the reaction does not penetrate below the surface. However, if the anhydrite is fractured, the conversion will proceed faster and faster as more fracturing is developed by the expansive reaction. The actual amount of expansion will depend upon the void ratio of the anhydrite. As with other water-sensitive minerals, every effort should be made to keep water away from anhydrite. This may be a particular problem when fluid transport tunnels are being constructed since any leakage will result in major damage to the tunnel.

## **8.4 OBSTACLES AND CONSTRAINTS**

### **8.4.1 Boulders**

Practical experience of the value of cutterhead disks in such a situation was first developed in Warrington, England. A slurry shield was to be used for a tunnel originally expected to be in soils. A late decision to change the alignment because of local constraints forced the tunnel into an area where boulders and sandstone bedrock would be encountered in the invert. Since the equipment was already built, disk cutters were added to the head in the hope that they would solve the unexpected problem. These hopes were fulfilled. More recent investigation in Japan has indicated from experimental models that even very soft clay will provide sufficient support to hold boulders in place so that they are broken up by the action of disk cutters. On the other hand, rotary head excavators of various general designs have failed to deal successfully with boulders when drag picks were relied on.

A particular difficulty sometimes occurs when boulder beds are encountered which have saturated fine silt in the void spaces between the boulders. This problem seems to be most often encountered in regions which have been subjected to glaciation. The loss of ground associated with flow of the saturated fines into the tunnel does not normally result in ground settlement, because the movement of any other material replacing the lost fines will generally be choked off. If this is not the case, or if it is felt undesirable to leave such voids unfilled, various courses of action are available. Compressed air working will drive water out of the silt and thereby stabilize it, provided that the boulder bed is not confined within impervious material. In such a case, compressed air working will not be very effective.

The use of an EPB fitted with disk cutters will be effective provided that the pressure in the plenum chamber is kept at a level high enough to balance the hydrostatic head in the silt. Slurry shield operation with the same restrictions would be even more effective, but at a higher cost. As a last resort, consolidation or replacement grouting may be employed behind the shield. The choice of method will depend on economics, as is often the case when selecting a construction method. If the condition exists in only a small part of a long tunnel, less efficient means may be selected for dealing with the boulder bed--even including local cut-and-cover work, if the tunnel is not too deep or the water table too high. In any case, full breasting of the face is required if the boulders are not in intimate contact with one another. It is conceivable that grout could be injected into the working face at a distance behind it so as to force out the flowing material. For such a program to be effective, it would be necessary to grout multiple points simultaneously so as to avoid development of a preferred path for escaping fines. The grout would also have to extend outside the tunnel perimeter for a sufficient distance to establish a plug which could be excavated without developing problems behind the shield. However, it must be said that in small tunnels, access for implementation of such a program is unlikely to be available.

### **8.4.2 Karstic Limestone**

Karstic limestone is often riddled with solution cavities of various sizes. Depending on the geologic history of the locale in which it is found, cavities ahead of the excavation may be filled with water, mud

or gravel or a combination of these. Flowing water may be present in large quantities. There may be an insufficient thickness of sound rock at tunnel elevation to provide safe support for tunneling equipment. All of these possibilities point out the need for thorough exploration before undertaking tunnel construction in limestone, particularly in an area where there is no prior history of underground construction or mining.

### **8.4.3 Abandoned Foundations**

Abandoned foundations or other facilities, are to be expected in urban tunnels. To illustrate, on one project 898 piles were encountered during construction of rapid transit tunnels in an urban area. This was more than double the highest estimate. These piles were mostly unrecorded relics of earlier construction abandoned after fires which regularly ravaged the area during the late 19th century as well as piles left behind by successive reclamation operations, which moved the waterfront several hundred meters into the bay over a few decades.

All but two of the piles were timber; they were removed by cutting them into short lengths as they were exposed in the face of the shield using a hydraulically powered beaver-tail chain saw purpose-made for the job. The other two posed a different problem. One was concrete and the other steel. Since the tunnel was being constructed in compressed air, both burning the steel and breaking the concrete were non-trivial problems. Removal of these piles took about 10 times as long as removal of the timber piles. With a TBM, similarly, the wood piles can be cut by the disk cutters but a similar increase in time would be expected for the steel and concrete piles. As an additional problem, the lengths of pile left in place above the tunnel eventually crept downward as they sought to carry the weight of soil adhering to them as well as the artificial fill above. In a number of places it was necessary to reinforce the skin of the fabricated steel liner plates which were dimpled by the point loads exerted.

A second illustrative project involved construction of a storm drainage tunnel. For a short distance at the downstream portal, the tunnel was in soil; because of its short length it was driven without a shield. Since the soil was largely, if not entirely, fill, it proved difficult to maintain the tunnel shape until steel ribs were introduced between alternate rings of liner plate. It was known that old mill foundations lay ahead, but their location was uncertain. It was therefore deemed prudent to continue this tunneling method into the sandstone ahead for at least a short distance. During the drive, some of the foundations were found in the soil tunnel. Careful breasting to isolate the concrete was successful in controlling soil movement while the concrete was broken out. With the next advance of normal tunneling, the voids were promptly and completely filled and there was no encroachment on the tunnel profile.

It would be possible to multiply examples endlessly, but the key to all such problems is to gather the maximum available information, project the worst scenario and be prepared to deal with it as an engineering rather than an economic problem.

### **8.4.4 Shallow Tunnels**

The problem with shallow tunnels is that side support is not reliable and loading on the support system is far from the usual comfortable assumption of essentially uniform radial load. It is quite common in urban situations to be restricted by the presence of significant structures--whether on the surface or underground. Consolidation grouting has been used where ground conditions are favorable and compaction grouting has also been used successfully to avoid the need for underpinning. In other cases; jet grouting, pipe canopies or other spiling may be appropriate. It is not practical to define the range of conditions leading to selection of any particular solution, since all such projects tend to have unique

features. Sequential excavation method (Chapter 9), cut and cover method (Chapter 5) and/or jacked box tunneling method (Chapter 12) can be considered as well.

## **8.5 PHYSICAL CONDITIONS**

### **8.5.1 Methane**

Methane is commonly found where organic matter has been trapped below or within sedimentary deposits, whether or not they have yet been lithified. It is particularly common in the shaley limestones around the Great Lakes; in hydrocarbon--whether coal or oil-- deposits in Pennsylvania, West Virginia, Colorado or California and in many other localities. It should be noted here that “methane” is commonly used as a denotation of all of the ethane series that may be present, although methane is distinguished as the major component usually present. It is also the only member substantially lighter than air. Methane forms an explosive mixture when mixed with air and between about 5 and 15% of the total volume is methane. It is readily diluted and flushed from a tunnel by ventilation when encountered in the quantities that are normally expected.

Safety rules require that action be taken when methane is present in concentrations of 20% of the lower explosive limit. For practical purposes, this means a concentration of 1% by volume. It is necessary to use routine testing to determine whether or not explosive gasses are present. This testing is carried out in all tunnels identified as being gassy or potentially gassy. A positive rating of non-gassy is required to relieve the contractor of the duty to test, although in many localities it is deemed prudent to continue testing on a reduced schedule even though no gas has been identified in the tunnel excavation.

### **8.5.2 Hydrogen Sulfide**

Hydrogen sulfide is present in association with methane often enough that its presence should always be suspected in gassy conditions. Its presence is easily identified in low concentrations by its typical rotten egg smell. It is a cumulative poison and deadly in low concentrations; a whiff at 100 percent concentration is generally instantly fatal. It should also be noted that, when hydrogen sulfide is present in low concentrations, the nose becomes desensitized to its presence. Apart from testing and maintenance of high volume ventilation, signs of its presence follow a sequence of headaches, coughing, nausea and unconsciousness. Concentrations should be limited to 10 ppm or less (depending on local regulations) of eight hour exposures.

Meticulous attention to ventilation, especially in work areas, is required when hydrogen sulfide is present or suspected. As with methane, ventilation must be maintained at high volumes for dilution 24 hours a day, 7 days a week, regardless of whether work is in progress or not. Even so, no shaft, pit or tunnel or other opening below grade should be entered without first testing the air. This is especially important if the purpose of entering is to repair a defective fan. Where possible, the gas should be extracted directly and discharged into the ventilation system without ever entering the tunnel atmosphere.

### **8.5.3 High Temperatures**

The geothermal gradient is different in different localities within a range of about 2:1. As a rule of thumb, one degree Celsius per 100 meters of depth will be a reasonable guide. Where the tunnel is comparatively shallow--say less than about 150 m--there will be little effect. In fact, it will be found that the tunnel temperature is the average year-round temperature at that location.

Nevertheless, especially in areas of volcanism or geothermal activity or tropical temperatures, the temperature in deep tunnels can rise to body heat or higher. If hot water flows are present or if the tunnel is very humid (which is more common than not), conditions can be actively dangerous as sweating and evaporation are inhibited; heat stroke can be induced in such conditions. The only factor that can be directly controlled is the tunnel ventilation. By supplying air at a lower temperature, the local conditions can be kept bearable, especially if the incoming air is dry enough to accept evaporating moisture.

#### **8.5.4 Observations**

The significant effects and the construction problems resulting from the various difficult tunneling conditions discussed above make it clear that all of the possibilities associated with the geology and occupational history of the region in which new tunneling is contemplated need to be borne in mind from the construction as well as the design standpoint when the preliminary and final geotechnical exploration and testing programs are designed.

It is important that engineers designing a tunnel project develop a full understanding of the nature of the ground conditions affecting the construction; so that not only the field investigation but also the design development, specifications and geotechnical reports reflect a full understanding of the problems and the variety of potential approaches to their solution. In the end, the project owner's interests will be best served by thoughtful analysis and full disclosure of conditions and of the solutions foreseen, and of the underlying design approach rather than by avoiding the recognition of problems and their potential impact.

## CHAPTER 9

### SEQUENTIAL EXCAVATION METHOD (SEM)

#### 9.1 INTRODUCTION

The Sequential Excavation Method (SEM), also commonly referred to as the New Austrian Tunneling Method (NATM), is a concept that is based on the understanding of the behavior of the ground as it reacts to the creation of an underground opening. In its classic form the SEM/NATM attempts to mobilize the self-supporting capability of the ground to an optimum thus achieving economy in ground support. Building on this idea practical risk management and safety requirements add to and dictate the required tunnel support. Initially formulated for application in rock tunneling in the early 1960's, NATM has found application in soft ground in urban tunneling in the late 60's and has since then enjoyed a broad, international utilization in both rural and urban settings.

A large number of tunnels have been built around the world using a construction approach which was loosely termed NATM. During the years of discussions and the application of NATM a variety of terms have been used for the same construction approach. These terms were primarily aimed at describing the construction approach rather than the region of its reported origin. While in the 70's and early 80's the term "Shotcrete Method" was frequently used in Germany and Switzerland, besides NATM, developments in the UK in the late 90's led to the use of the term "Sprayed Concrete Lining" or SCL. Alternatively, "Conventional Tunneling Method" was used in Austria and Germany. As the NATM is largely based on an observational approach, the term "Observational Method" was introduced and used in many countries. The term "Conventional" as opposed to TBM driven tunnels has recently found its way into publications by the International Tunneling Association's (ITA) Working Group 19. In the German speaking countries in Europe namely in Austria and Germany very recent standards and codes use the term "Cyclic Tunneling Method."

In the US, where NATM was systematically applied for the first time in the late 70's and early 80's for the construction of the Mount Lebanon tunnel in Pittsburgh and the Redline tunnels and Wheaton Station of the Washington, DC metro the term adopted was NATM. Gradually, however, the term has been and is being abandoned in the US and replaced by Sequential Excavation Method or SEM. Today, SEM is becoming increasingly popular in the US for the construction of tunnels, cross passages, stations, shafts and other underground structures (Gildner et. al., 2004).

The SEM offers flexibility in geometry such that it can accommodate almost any size of opening. The regular cross section involves generally an ovoid shape to promote smooth stress redistribution in the ground around the newly created opening. By adjusting the construction sequence expressed mainly in round length, timing of support installation and type of support it allows for tunneling through rock (Chapter 6), soft ground (Chapter 7) and a variety of difficult ground conditions (Chapter 8). Depending on the size of the opening and quality of the ground a tunnel cross section may be subdivided into multiple drifts.

Application of the SEM involves practical experience, earth and engineering sciences and skilled execution. The SEM tunneling process addresses:

- Ground and excavation and support classification based on a thorough ground investigation
- Definition of excavation and support classes by:
  - Round length (maximum unsupported excavation length)
  - Support measures (shotcrete lining and its reinforcement, ground reinforcement by bolts or dowels in rock)
  - Subdivision of the tunnel cross section into multiple drifts or headings as needed (top heading, bench, invert, side wall drifts)
  - Ring closure requirements
  - Timing of support installation (typically every round)
  - Pre-support by spiling, fore poling, and pipe arch canopy
  - Local, additional initial support by dowels, bolts, spiles, face support wedge, and shotcrete
- Instrumentation and monitoring
- Ground improvement measures prior to tunneling

A key support element is shotcrete mainly due to its capability to provide an interlocking, continuous support to the ground. Implementation of ground improvement measures in the form of dewatering, grouting, ground freezing and others and of pre-support measures in the various forms of spiling have further widened the range of SEM applications mainly in urban tunneling. These are specified to enhance the quality of the ground prior to and during the tunneling process. The SEM features typically a dual lining cross section by which a waterproofing membrane is inserted between an initial shotcrete and a final, typically cast-in-place concrete lining as addressed in Chapter 10 Tunnel Lining. An instrumental element of SEM tunneling is the monitoring of deformations of tunnel and surrounding ground (Chapter 15). Evaluation of monitoring allows for the verification of design assumptions or adjustment of the tunneling process.

Lastly, because SEM tunneling allows for an adjustment to ground conditions as encountered in the field it benefits from a unit-price contract form. Geotechnical baseline reports (GBR) as discussed in Chapter 4 and Geotechnical Design Summary Reports (GDSR) facilitate the adjustment process and aid in risk sharing between owner and contractor. Geotechnical investigations are discussed in Chapter 3.

## **9.2 BACKGROUND AND CONCEPTS**

The origins of the NATM lie in the alpine tunnel engineering in the early 1960s. In 1948, Ladislaus von Rabcewicz applied for a patent for the use of a dual lining system with the initial lining being allowed to deform. The NATM is based on the philosophy that the ground surrounding the tunnel is used as an integrated part of the tunnel support system. The deformable shotcrete initial lining allows a controlled ground deflection to mobilize the inherent shear strength in the ground and to initiate load redistribution. The key for the successful use of a relatively thin lining layer applied to the excavation surface lies in the smooth tunnel shape to avoid stress concentrations and the tight contact between the shotcrete lining and the surrounding ground to provide an intense interaction between the support and the ground. In order to augment the support provided by the initial lining, rock reinforcement is used in response to the rock mass conditions. The rock reinforcement avoids the development of wedge failure (keystone), and it generates a rock mass ring with significantly improved strength characteristics around the opening.

Smooth, concavely rounded excavation surfaces initiate confinement forces and limit bending and tension forces in the lining and the ground in the vicinity of the tunnel opening. This is of particular importance for tunneling in ground with limited stand-up time, where fracturing and weathering reduce the ground's natural shear strength.



NATM was the first concept, where the ground and its strength were used as a building material and became an integrated part of the tunnel support system. Rather than implementing stiff support members that attract high loads to fight the ground deformation, the flexible, yet strong shotcrete lining shares with and re-distributes loads into the ground by its deflection.

Rabcewicz summarizes the philosophy of NATM in his patent of 1948 (Rabcewicz, 1948) as follows: “NATM is based on the principle that it is desirable to take utmost advantage of the capacity of the rock to support itself, by carefully and deliberately controlling the forces in the readjustment process which takes place in the surrounding rock after a cavity has been made, and to adapt the chosen support accordingly.” By briefly reviewing the stress conditions around a newly created cavity and the interaction between ground and its support needs the following lays out the principle approach taken in NATM tunnel design (Rabcewicz et al., 1973).

The stress conditions around a cavity after Kastner are schematically provided in Figure 9-1. The primary stress  $\sigma_0$  in the surrounding ground before any cavity is created depends mainly on the overburden, the unit weight and any tectonic stresses  $\sigma_s$ . Following tunnel excavation the tangential stresses will increase next to the tunnel circumference (solid line  $\sigma_t^0$ ). If the induced tangential and radial stresses ( $\sigma_t$  and  $\sigma_r$ ) around the tunnel opening exceed the strength of the surrounding ground yielding will occur. Such yielding will create a plastified zone that reaches to a certain distance R into the ground beyond the tunnel circumference (dashed line R).

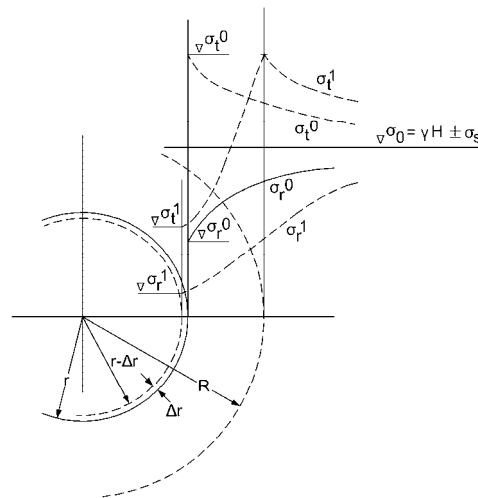

Figure 9-1 Schematic Representation of Stresses Around Tunnel Opening (Rabcewicz et al., 1973)

A schematic illustration of the relationships between the radial stresses  $\sigma_r$ , deformation of the tunnel opening  $\Delta r$ , the required outer and inner supports  $p_i^a$  and  $p_i^i$  respectively, and the time of support application T is provided in Figure 9-2. According to Rabcewicz the outer support or outer arch ( $p_i^a$ ) involves the ground itself, its reinforcement by rock bolts and any support applied to the opening itself ranging from sealing shotcrete (flashcrete) to a structural initial lining involving reinforced shotcrete or concrete and steel ribs. The inner support involves a secondary lining that is applied after the tunnel opening with the help of the outer arch has reached equilibrium. The  $\sigma_r / \Delta r$  curve, often referred to as ground reaction curve schematically describes the relationship between deformation of the tunnel opening and tunnel support provided by the outer arch. At any intersection point between the support  $p_i$  and the  $\sigma_r$ ,

curve equilibrium is reached for the respective support. It is characteristic for the NATM that the intersection between the support and the  $\sigma_r$  curve takes place at the descending side of the curve. Undesirable loosening of the ground starts at point B of the  $\sigma_r$  curve if the minimum support  $p_i$  min is not provided. Within the ascending side of the  $\sigma_r$  curve the ground has lost strength and consequently its supporting capacity and thus requires enhanced tunnel support to passively support the overburden.

Examination of curves Figure 9-1 and Figure 9-2 exemplifies the relationship between timing of support installation, yielding of the ground and the amount of support needed. The minimum support is required at point B to prevent loosening and loss of strength in the surrounding ground. It will result in the largest deformations but the most economical tunnel support. Curve 1 which intersect the  $\sigma_r$  curve in point A will require enhanced support  $p_i^a$  but result in less deformation  $\Delta r$  and a higher factor of safety. Selection of a stiffer outer arch in curve 2 will result in more support loads because the ground has not been allowed to deform and mobilize its strength and consequently led to a decrease of the safety factor.

The capacity of the inner arch is chosen to satisfy a desired safety factor  $s$ . This will depend on specific needs and assuming that the initial tunnel support (outer arch) will deteriorate over time then  $p_i^a$  may be used as guidance to arrive at a desired safety factor. C and C' denote a loaded and unloaded condition of the inner arch respectively.

The  $\sigma_r / \Delta r$  curve may be approximated by means of numerical modeling using the deformation and strength characteristics of the ground along with the specific geometry of the opening and the envisioned excavation sequencing (Rabcewicz, 1973).

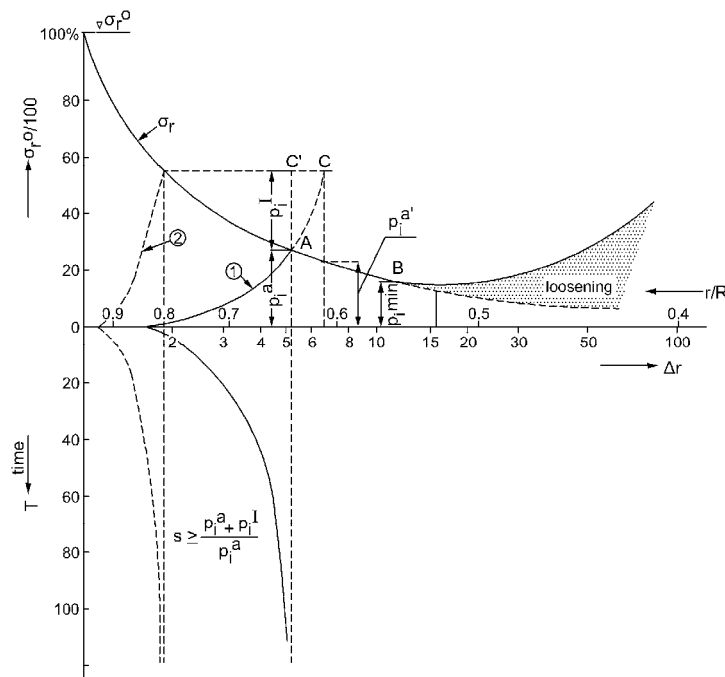

Figure 9-2 Schematic Representation of Relationships Between Radial Stress  $\sigma_r$ , Deformation of the Tunnel Opening  $\Delta r$ , Supports  $p_i$ , and Time of Support Installation  $T$  (Rabcewicz et al., 1973)

While the NATM had its origins in alpine tunneling in fractured or squeezing rock, its field of application expanded dramatically in the 70's and the following decades. The superb flexibility of the construction concept to adapt to a wide range of ground conditions and tunnel shapes in combination with significant developments in construction materials, installation techniques as well as ground treatment methods formed the basis for a radical expansion from the alpine rock tunneling into soft ground tunneling. The use of NATM thus expanded from rural tunneling in rock into urban tunneling in predominantly soft ground and highly built-up environments with sensitive structures above the tunnel alignment.

The major focus in rock tunneling in rural settings is to find equilibrium in the surrounding ground with the best possible economy in the amount of initial support installed. In urban settings however, in particular when tunneling at shallow overburden depths in soft ground the main goal is to minimize the impact on the surface and adjacent structures thus to minimize settlements. As shown in Figure 9-2 less and delayed support installation will be associated with larger deformations of the tunnel  $\Delta r$  and consequently with larger surface settlements when tunneling at shallow depth. Curve No. 1 describes a relatively "soft" support that is applied later than the support represented by curve No. 2, which is applied earlier and is "stiffer." The curves point out that in order to reduce settlements generally an early and stiffer support should be used. Reduction of the round length and subdivision of the tunnel cross section will aid in applying support to the ground early thus reducing deformations. The stiffness of the support can be increased by increasing the initial shotcrete lining thickness and using shotcrete with early and high strength development.

Today's tunnel construction economies require tunneling approaches that are competitive to fully mechanized tunneling methods by TBMs with their high initial capital cost while being adjustable to project specific space demands. The main field of SEM application is, apart from rural railway and highway tunnels, in the construction of tunnel schemes with complex geometries, short tunnels, large size tunnels and caverns in urban areas at shallow depths. Shallow tunnel depths frequently involve the challenge of soft ground tunneling. With the help of modern equipment for rapid excavation, modern high quality construction materials (mainly shotcrete), and modern ground support installation techniques as well as the overarching SEM concept, complex and challenging underground structures can be built in practically all types of ground. A major advantage of the SEM is its flexibility.

## **9.3 SEM REGULAR CROSS SECTION**

### **9.3.1 Geometry**

The shape of the tunnel cross section is designed to comply with SEM principles, which are to (as effectively as possible) activate the self-supporting arch in the surrounding ground. To accommodate this principle cross section geometries shall be curvilinear, consisting of compound curves in both arch and invert (if constructed in soft ground like conditions). Any straight walls and sharp edges in the excavation cross section shall be avoided. Thus the geometry of the excavation cross section will enable a smooth flow of stresses in the ground around the opening, minimizing loads acting on the tunnel linings. While adhering to these principles the excavation cross section shall be optimized in size to achieve economy. The layout of the invert will depend on the ground conditions in which the tunnel is constructed. In competent rock formations the tunnel invert will be flat, whereas in weak rock and soft ground tunnels the invert will be rounded to facilitate ring closure and stability.

### 9.3.2 Dual Lining

The SEM regular cross section is of dual lining character and consists of an initial shotcrete lining and a final, cast-in-place concrete or shotcrete lining. A waterproofing system is sandwiched between the initial and final linings. The waterproofing system consists of a flexible, continuous membrane (typically PVC). A regular cross section is developed for each tunnel geometry: the main tunnel, widenings, niches, cross passages, and other miscellaneous structures. A typical regular SEM cross-section for a two-lane highway tunnel is shown in Figure 9-3 distinguishing between a rounded (right side) and flat (left side) invert. A rounded invert is typically associated with tunneling in soft ground whereas a flat invert is used in competent ground conditions, typically rock. As discussed in Chapter 2, the tunnel cross section is designed around the project clearance envelope including tolerances. Figure 9-4 displays a completed SEM tunnel section for a three-lane road tunnel showing rounded cast-in-place concrete tunnel walls. The alignment of the tunnel is curved to accommodate alignment needs of an urban environment. In the front the SEM tunnel abuts a straight tunnel wall of an adjoining cut-and-cover box tunnel. Figure 9-4 also displays tunnel installations including lighting and jet fans for tunnel ventilation.

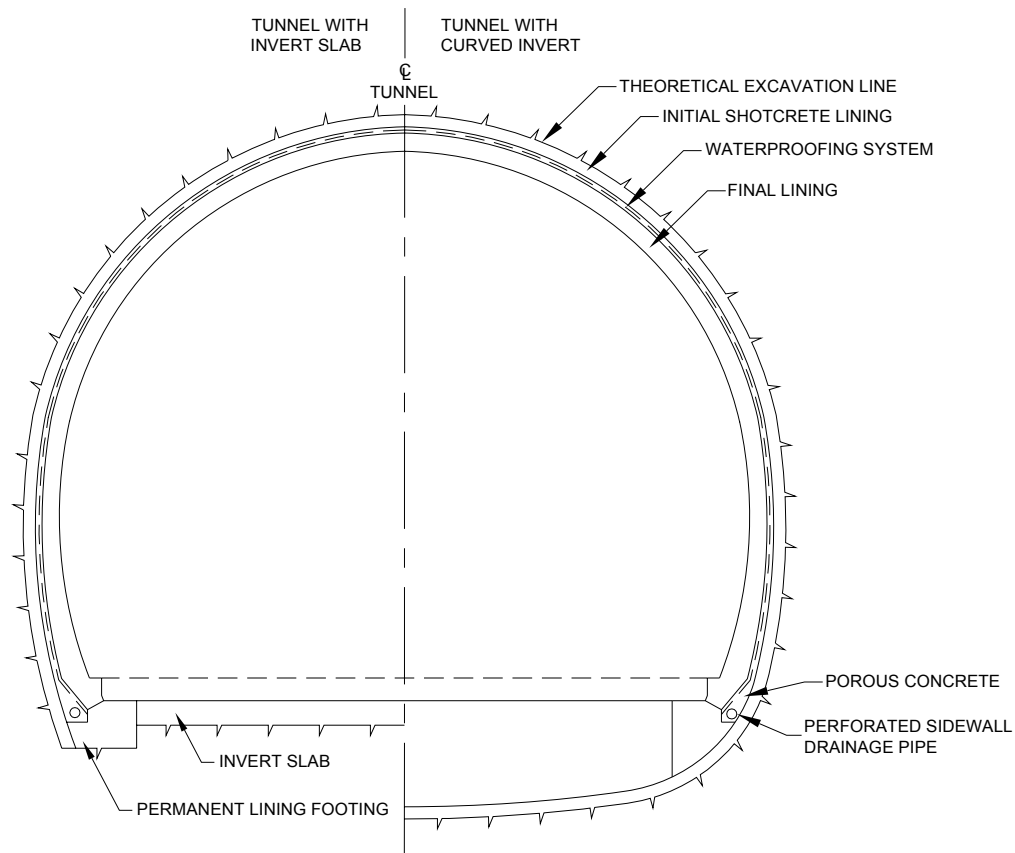

Figure 9-3 Regular SEM Cross Section



Figure 9-4 Three-Lane SEM Road Tunnel Interior Configuration (Fort Canning Tunnel, Singapore)

### 9.3.3 Initial Shotcrete Lining

The initial shotcrete lining is the layer of shotcrete applied to support the ground following excavation. It has a thickness ranging generally from 4 to 16 inches (100 to 400 mm) mainly depending on the ground conditions and size of the tunnel opening. It is reinforced by either welded wire fabric or steel fibers; the latter have generally replaced the traditional welded wire fabric over the last ten to fifteen years.

Occasionally structural plastic fibers are used in lieu of steel fibers. This is the case where the shotcrete lining is expected to undergo high deformations and ductility post cracking is of importance. Where the shotcrete lining is greater than about 6 inches (150 mm) it further includes lattice girders. Depending on loading conditions and purpose rolled steel sets may replace lattice girders or act in combination.

### 9.3.4 Waterproofing

The SEM uses flexible, continuous membranes for tunnel waterproofing. Most frequently PVC membranes are used at thicknesses of 80 to 120 mil (2.0 to 3.0 mm) depending on the size of the tunnel. Only in special circumstances, for example when contaminated ground water is present, special membranes are applied using hydrocarbon resistant polyolefin or very light density polyethylene (VLDPE) membranes.

The impermeable membrane is backed by a geotextile that also acts as a protection layer, and in drained systems as a drainage layer behind the membrane. This waterproofing system is placed against the initial lining and prior to installation of the final lining. Prior to waterproofing system installation all tunnel deformations must have ceased.

In drained system applications water is collected behind the membrane and conducted to perforated sidewall drainage pipes located at tunnel invert elevation on each side of the tunnel. From there collected water is conveyed via transverse, non-perforated pipes to the tunnel's main roadway drain. In undrained systems the membrane and geotextile wrap around the entire tunnel envelope and prevent water seepage into the tunnel thereby subjecting it to hydrostatic pressures. If this is the case the tunnel invert geometry and structural design must be adapted to accommodate for the hydrostatic head. Utilization of drained vs. undrained systems is discussed in Chapter 1.

Over the past decades a so called “compartmentalization system” has been developed and nowadays supplements the installation of flexible membrane based waterproofing systems. The purpose of this compartmentalization is to provide repair capability in case of leakage. In particular, when the tunnel is not drained and the waterproofing has to withstand long-term hydrostatic pressures, installation of such systems provides a cost effective back up and assures a dry tunnel interior. Compartmentalization refers to the concept of subdividing the waterproofing membrane into individual areas of self-contained grids (compartments) by means of base seal water barriers. These water barriers are specifically formulated for the purpose of creating these compartments. They feature ribs of 1.3-inch (30 mm) minimum height to properly key into the final lining, which is cast (or sprayed) against the waterproofing. In case of water leakage the water infiltration is limited to the individual compartment thus preventing uncontrolled water migration over long distances behind the final lining. Within each compartment control and grouting pipes are installed. These pipes penetrate through the final lining and are in contact with the membrane. Figure 9-5 displays an installed PVC waterproofing system with compartments, control and grouting pipes, and hoses prior to final lining installation. Control and grouting pipes serve a twofold purpose; should leakage occur then water would find its path to these pipes and exit there thus signaling a breach within the compartment. Once detected, the same pipes may be used for injection of low viscosity, typically hydro-active grouts into the compartments. The injection of grout is limited to leaking compartment(s) and once cured provides a secondary waterproofing layer in the form of a membrane that acts as a remedial waterproofing layer.



Figure 9-5 Waterproofing System and Compartmentalization (Automated People Mover System at Dulles International Airport, Virginia)

### **9.3.4.1 Smoothness Criteria**

To provide a suitable surface for the installation of the waterproofing system, all shotcrete surfaces to which the membrane is to be applied must meet certain smoothness criteria. These are expressed in the waviness of the shotcrete surface to which the waterproofing system will be applied. The waviness is measured with a straight edge laid on the surface in the longitudinal direction. The maximum depth to wavelength ratio should be generally 1:5 or smoother. The surface has to be inspected prior to installation of the waterproofing system and all projections should be removed or covered by an additional plain shotcrete layer, which meets the smoothness criteria. The SEM design documents will address required smoothness criteria and set those in relation to the waterproofing system to be used.

### **9.3.5 Final Tunnel Lining**

The final permanent lining for a SEM tunnel may consist of cast-in-place concrete or shotcrete. Cast-in-place concrete can be un-reinforced or reinforced. Shotcrete is generally fiber reinforced. Chapter 10 provides general discussions about permanent tunnel lining. The following addresses design and construction considerations specifically for SEM application.

#### **9.3.5.1 Cast-in-Place Concrete Final Lining**

The traditional final lining consists of cast-in-place concrete at a thickness of generally 12 inches for two-lane road tunnels. While the lining may generally remain unreinforced, structural design considerations and project design criteria will dictate the need for and amount of reinforcement. The Lehigh Tunnel (Pennsylvania) and Cumberland Gap Tunnels (Kentucky / Tennessee) are the first road tunnels built in the US in the late 80's and early 90's using SEM construction methods. Both feature unreinforced, 12-inch thick cast-in-place concrete final linings. The flexible membrane based waterproofing is in particular beneficial in unreinforced cast-in-place concrete lining applications in that it acts as a debonding layer between the initial and final linings and therefore reduces shrinkage cracking in the final lining.

To ensure a contact between the initial and final linings, contact grouting is performed as early as the final lining has achieved its 28-day design strength. With this grouting the contact is established between the initial lining and final tunnel support. Any deterioration or weakening of the initial support will lead to an increased loading of the final support by the increment not being supported by the initial lining. The loads can be directly transferred radially due to the direct contact between initial and final linings.

Cast-in-place final concrete linings (concrete arch placed on sidewall footings) are frequently installed in pour lengths not exceeding 30 feet (10 meters). This restriction is important to limit surface cracking in general and becomes mandatory if unreinforced concrete linings are used. A 30 feet (10 meter) long section in a typical two-lane highway tunnel is also practical in terms of formwork installation and sequencing and duration of concrete placement.

Adjacent concrete pours feature construction joints that are true lining separators designed as contraction joints. The inside face at joint location shall be laid out with a trapezoidally shaped joint. A continuous reinforcement is not desired in construction joints to allow their relative movement in particular for thermal deformation effects.

### 9.3.5.2 Water Impermeable Concrete Final Lining

Use of water impermeable cast-in-place concrete linings as an alternative to membranes is generally not considered due to the high demands on construction quality and exposure to freeze thaw conditions in cold climates. Elaborate measures are needed to prevent cracking. Detailed arrangement of construction joints is needed as well as complex concrete mix designs to suppress excessive hydration heat. The curing requires elaborate procedures. These aspects generally do not render water impermeable concrete practical in road tunnels. If selected these construction aspects have to be addressed in detail in specifications and working procedures and they have to be rigidly enforced.

### 9.3.5.3 Shotcrete Final Lining

Shotcrete represents a structurally and qualitatively equal alternative to cast-in-place concrete linings. When shotcrete is utilized as a final lining in dual lining applications it will be applied against a waterproofing membrane. The lining thickness will be generally 12 inches (300 mm) or more and its application must be carried out in layers with a time lag between layer applications to allow for shotcrete setting and hardening. Its surface appearance can be tailored to the desired project goals. It may remain of a rough, sprayer type shotcrete finish, but may have a quality comparable to cast concrete when trowel finish is specified. Shotcrete as a final lining is typically utilized when the following conditions are encountered:

- The tunnels are relatively short in length and the cross section is relatively large and therefore investment in formwork is not warranted, i.e. tunnels of less than 100-250 m (300-800 feet) in length and larger than about 8-12 m (25-40 feet) in springline diameter.
- The access is difficult and staging of formwork installation and concrete delivery is problematic.
- The tunnel geometry is complex and customized formwork would be required. Tunnel intersections, as well as bifurcations qualify in this area. Bifurcations are associated with tunnel widenings and would otherwise be constructed in the form of a stepped lining configuration and increase cost of excavated material.

Figure 9-6 displays a typical shotcrete final lining section with waterproofing system, welded wire fabric (WWF), lattice girder, grouting hoses for contact grouting and a final shotcrete layer with PP fiber addition.

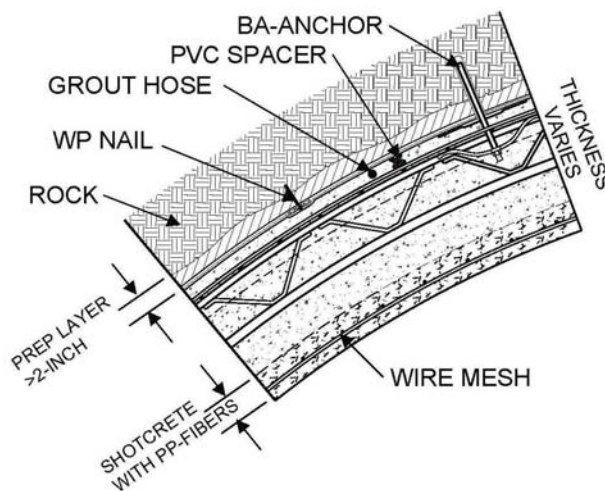

Figure 9-6 Typical Shotcrete Final Lining Detail



Readers are referred to Chapter 10 for detailed discussion about utilizing shotcrete as a final lining.

#### **9.3.5.4 Single Pass Linings**

Under special circumstances the initial shotcrete lining alone or with the addition of an additional shotcrete layer designed to withstand long-term loads may be used as a single support lining for the long term. Although labeled “single pass” this final shotcrete lining may be applied in multiple shotcrete application cycles. Use of a single pass lining will generally be limited to conditions where the ground water inflow is not of concern and deterioration of the shotcrete product over the life time of the tunnel lining can be excluded or partially tolerated. In multiple layer applications the shotcrete surface to which additional layers will be applied must be sufficiently clean and free of any layer that may cause debonding over the long term (Kupfer, et al., 1990 and Hahn, 1999). Specially detailed construction joints and high quality shotcrete must be required to assure water tightness and long-term integrity.

### **9.4 GROUND CLASSIFICATION AND SEM EXCAVATION AND SUPPORT CLASSES**

#### **9.4.1 Rock Mass Classification Systems**

A series of qualitative and quantitative rock mass classification systems have been developed over the years and are implemented on tunneling projects worldwide. Section 6.3 provides an overview of the most commonly used rock mass classification systems including Terzaghi’s qualitative classification (Table 6-1), and quantitative systems such as the Q system and the Rock Mass Rating (RMR) system.

Rock mass classification systems aid in the assessment of the ground behavior and ultimately lead to the definition of the support required to stabilize the tunnel opening. While the above quantitative classification systems lead to a numerical rating system that results in suggestions for tunnel support requirements (Section 6.5), these systems cannot replace a thorough design of the excavation and support system by experienced tunnel engineers.

#### **9.4.2 Ground Support Systems**

In the early years of the use of NATM (SEM) in Austria, Switzerland and Germany, standards and codes used descriptive (qualitative) categories to define ground support classes. Recent standards, codes and guidelines implemented in Austria and Germany utilize a process-oriented approach (OGG, 2007). This approach defines the process of using relevant parameters from ground investigation to derive a ground response classification and subsequently assess tunnel support needs. This forms a more objective basis for all parties involved and promotes the understanding of the rationale in retrospect by persons that have not been involved in the design process. It also provides a common platform for contractors, owners and engineers to negotiate the project specific challenges in the field during actual construction.

All classification systems have in common that they should be based on thorough ground investigation and observation. The process from the ground investigation to the final definition of the ground support system can be summarized in three models:

- Geological Model
- Geotechnical Model
- Tunnel Support Model

### **9.4.2.1 Geological Model**

A desk study of the geological information available for a project area forms the starting point of the ground investigation program. Literature, maps and reports (e.g. from the US Geological Survey) form the basis for a desk study. Subsequently and in coordination with initial field mapping results, a ground investigation program is developed and carried out. The geological information from the ground investigation, field mapping, and the desk study are compiled in the geological model.

### **9.4.2.2 Geotechnical Model**

With the data from the geological model in combination with the test results from the ground investigation program and laboratory testing the ground response to tunneling is assessed. This assessment takes into account the method of excavation, tunnel size and shape as well as other parameters such as overburden height, environmental issues and groundwater conditions. The geotechnical model assists in deriving zones of similar ground response to tunneling along the alignment and Ground Response Classes (GRC) are defined. These GRCs form the baseline for the anticipated ground conditions. Typically, the ground response to an unsupported tunnel excavation is analyzed in order to assess the support requirements for the stabilization of the opening (OGG, 2007).

### **9.4.2.3 Tunnel Support Model**

After assessing the ground support needs, excavation and support sequences, subdivision into multiple drifts, as well as the support measures are defined. These are combined in Excavation and Support Classes (ESCs) that form the basis for the Contractor to develop a financial and schedule bid as well as to execute SEM tunnel work.

## **9.4.3 Excavation and Support Classes (ESC) and Initial Support**

Excavation and Support Classes (ESCs) contain clear specifications for excavation round length, subdivision into multiple drifts, initial support and pre-support measures to be installed and the sequence of excavation and support installation. They also define means of additional initial support or local support or pre-support measures that augment the ESC to deal with local ground conditions that may require additional support.

In SEM tunneling initial support is provided early on. In soft ground and weak rock it directly follows the excavation of a round length and is installed prior to proceeding to the excavation of the next round in sequence. In hard rock tunneling initial support is installed close to the face. The intent is to provide structural support to the newly created opening and ensure safe tunneling conditions. Initial support layout is dictated by engineering principles, economic considerations, and risk management needs.

The amount and design of the initial support was historically motivated mainly by the desire to mobilize a high degree of ground self support and therefore economy. This was possible at the outset of SEM applications in “green field” conditions where deformation control was of a secondary importance and tolerable as long as equilibrium was reached. Nowadays, however, safety considerations, risk management, conservatism and design life, and the need for minimizing settlements in urban settings add construction realities that ultimately decide on the layout of the initial support.

Initial support is provided by application of a layer of shotcrete to achieve an interlocking support with the ground. Shotcrete is typically reinforced by steel fibers or welded wire fabric. Plastic fibers are used for reinforcement only occasionally. With higher support demands of the ground and with shotcrete

thicknesses of generally 6 inches or greater lattice girders are embedded within the shotcrete. Occasionally and if needed by special support needs rolled steel sets are used in lieu of, or in combination with lattice girders. Initial support also includes all measures of rock reinforcement in rock tunneling. Types of rock reinforcement are provided in Section 9.7.1.

Figure 9-7 and Figure 9-8 show a prototypical ESC cross section and longitudinal section respectively. Figure 9-7 displays a cross section without a closed invert on the left side and ring closure on its right side. Invert closure is typically required in weak rock conditions and squeezing ground. Figure 9-7 includes elements of typical initial support including rock bolts/dowels, initial shotcrete lining and tunnel pre-support. The arrangement of rock bolts/dowels is typical and varies depending on the excavation and support. The table in Figure 9-8 provides details of initial support measures for a prototypical ESC Class IV. In that sense, the SEM is a prescriptive method which defines clearly and in detail tunnel excavation and initial support means.

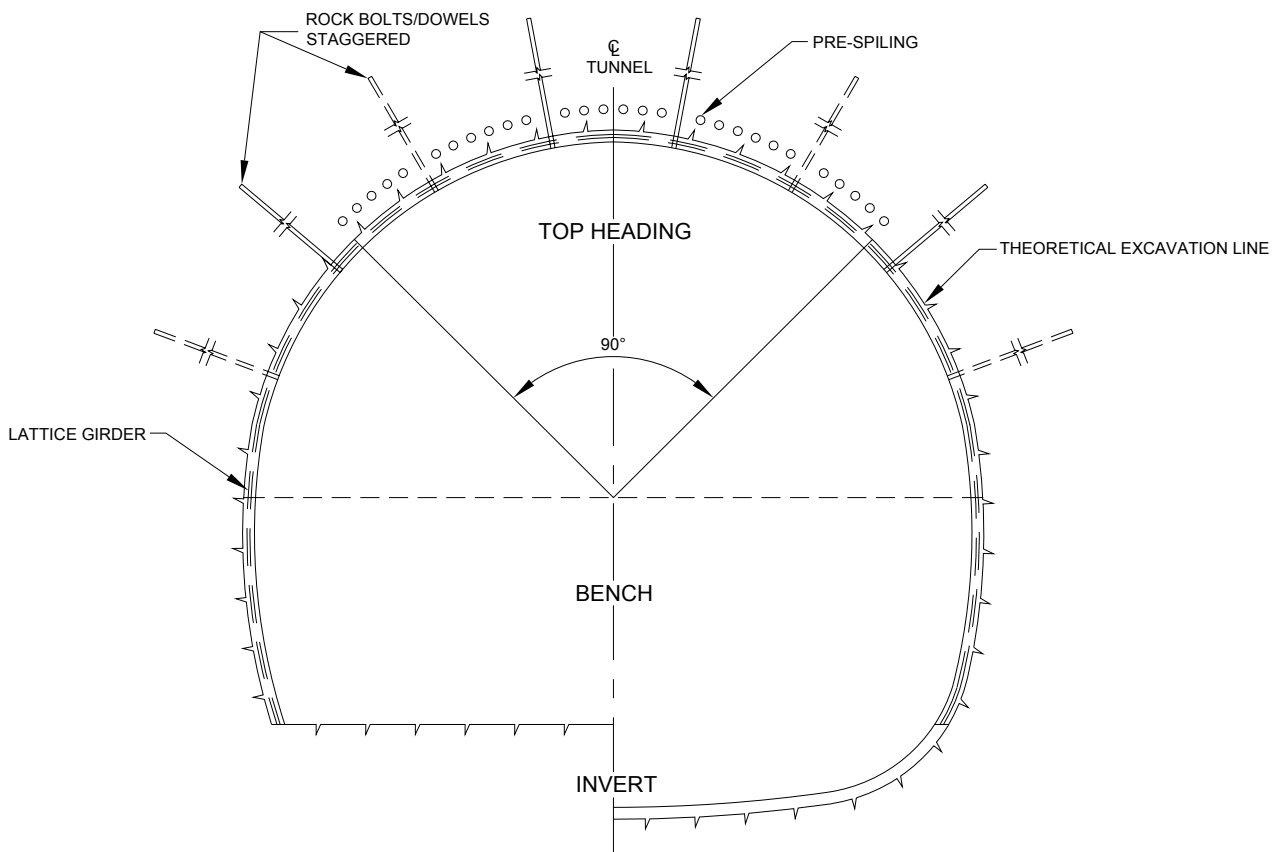

Figure 9-7 Prototypical Excavation Support Class (ESC) Cross Section

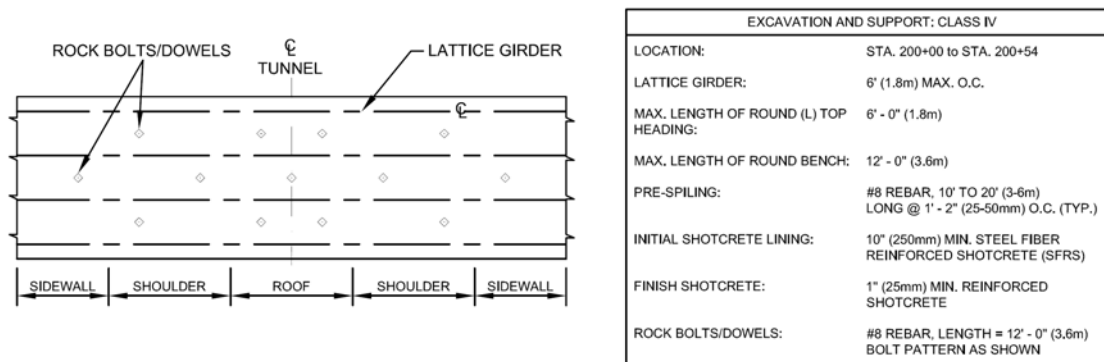
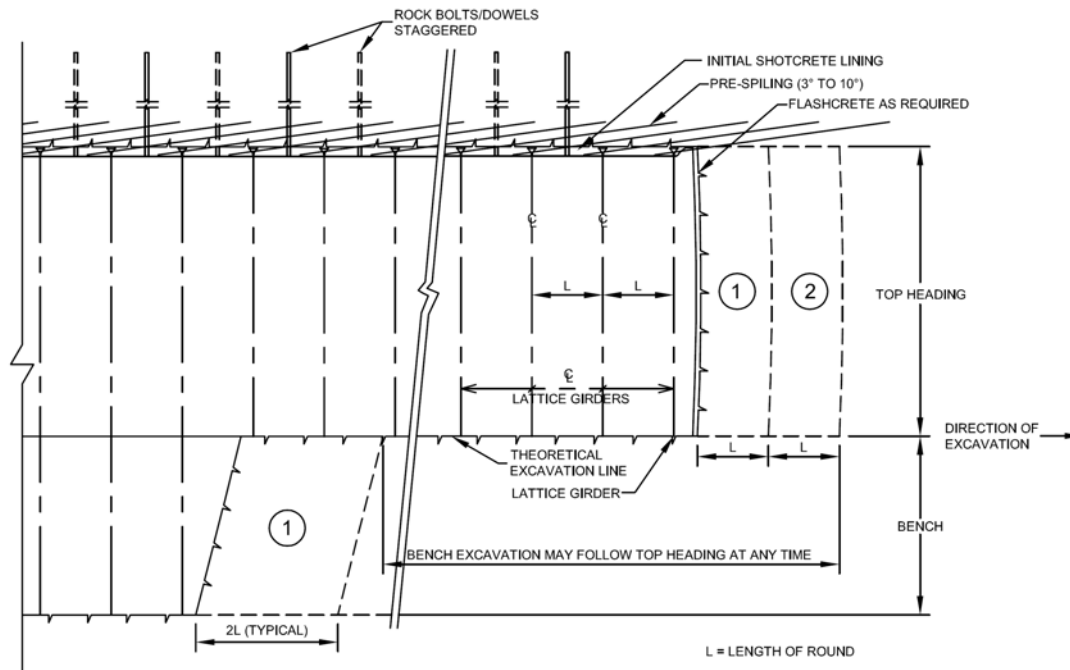

Figure 9-8 Prototypical Longitudinal Excavation and Support Class (ESC)

#### 9.4.4 Longitudinal Tunnel Profile and Distribution of Excavation and Support Classes (ESCs)

SEM contract documents contain all Excavation and Support Classes (ESCs) assigned along the tunnel alignment in accordance with the Ground Response Classes (GRCs) and serve as a basis to estimate quantities. A summary longitudinal section along the tunnel alignment shows the anticipated geological conditions, the GRCs with the relevant description of the anticipated ground response, hydrological conditions and the distribution of the ESCs. Figure 9-9 displays a prototypical longitudinal profile with an overlay of GRCs and corresponding ESCs, which form a baseline for the contract documents.

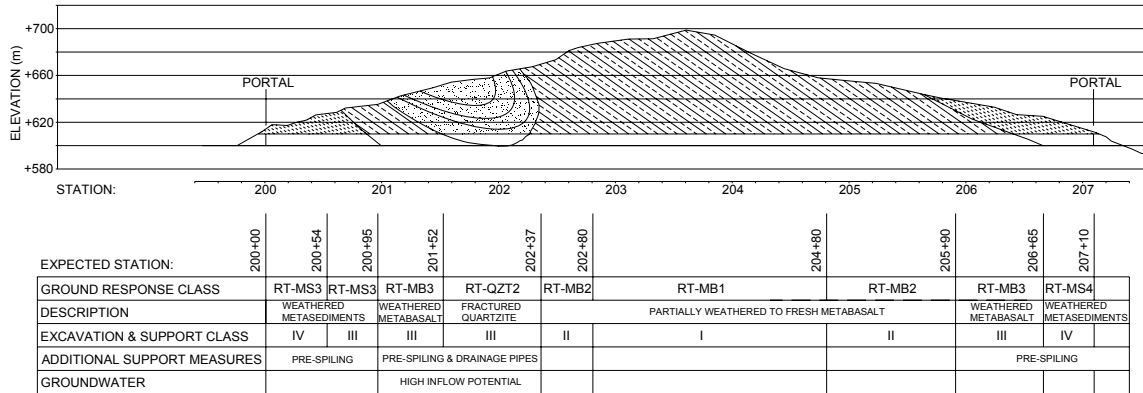

Figure 9-9 Prototypical Longitudinal Profile

Geological data, Ground Response Classes, Excavation and Support Classes, the Longitudinal Tunnel Profile as well as design assumptions and methods shall be described and displayed in reports that become part of the contract documents. When defining the reaches and respective lengths of GRCs and corresponding ESCs it is understood that these are a prognosis and may be different in the field. Therefore contract documents establish the reaches as a basis and call for observation of the ground response in the field and the need for their adjustment as required by actual conditions encountered. Actual conditions must be accurately mapped in the field to allow for a comparison with the baseline assumptions portrayed in the GRCs. For that purpose standard form sheets are developed as portrayed for a typical SEM rock tunnel mapping in Section 9.9.

### 9.4.5 Tunnel Excavation, Support, and Pre-Support Measures

Table 9-1 and Table 9-2 exemplify the use of most common initial support measures, along with excavation and support installation sequencing frequently associated with SEM road tunnels depending on the basic types of ground encountered, i.e. rock and soft ground respectively. These tables indicate basic concepts to derive Excavation and Support Classes (ESCs) for typical ground conditions portrayed. The support and pre-support means addressed in the tables are further detailed in Section 9.7 Ground Support Elements.

Table 9-1 builds on the use of Terzaghi’s Rock Mass Classification. According to this Classification, it can be distinguished between the following rock mass qualities:

- Intact Rock
- Stratified Rock
- Moderately Jointed Rock
- Blocky and Seamy Rock
- Crushed, but Chemically Intact Rock
- Squeezing Rock
- Swelling Rock

The column labeled “Excavation Sequence” in Table 9-1 lists typical heading sequences used for road tunnels in ground conditions portrayed. Further subdivision of the headings into multiple drifts either for the purpose of construction logistics or to handle extraordinary ground conditions is not addressed. Table 9-2 characterizes the typical soils characteristics in column 1 directly.

**Table 9-1 Elements of Commonly Used Excavation and Support Classes (ESC) in Rock**

| Ground Mass Quality - Rock | Excavation Sequence                    | Rock Reinforcement   | Initial Shotcrete Lining   | Installation Location   | Pre-Support                                      | Support Installation influences progress | Remarks |
|----------------------------|--|--|--|---|--|--|---------|
| Intact Rock                | Full face or large top heading & bench | Spot bolting (fully grouted dowels, Swellex®)  | Patches to seal surface in localized fractured areas   | Typically Several rounds behind face or directly near face to secure isolated blocks/slabs/wedges | None   | No                                       |         |
| Stratified Rock            | Top heading & bench                    | Systematic doweling or bolting in crown considering strata orientation (fully grouted dowels, Swellex®, rock bolts)  | Thin shell (fiber reinforced) typically 4 in (100 mm) to bridge between rock reinforcement in top heading; alternatively chain link mesh; installed with the rock reinforcement.                                     | Two to three rounds behind face   | None   | No or eventually                         |         |
| Moderately Jointed Rock    | Top heading & bench                    | Systematic doweling or bolting in top heading considering joint spacing (fully grouted dowels, Swellex®, rock bolts) | Systematic shell with reinforcement (welded wire fabric or fibers) in top heading and potentially bench; dependent on tunnel size thickness of 6 in (150 mm) to 8 in (200mm); installed with the rock reinforcement. | One to two rounds behind face   | Locally to limit over break                      | Yes                                      |         |
| Blocky and Seamy Rock      | Top heading & bench                    | Systematic doweling or bolting in top heading & bench considering joint spacing                                      | Systematic shell with reinforcement (welded wire fabric or fibers) in top heading & bench; depending on tunnel size thickness 8 in (200 mm) to 12 in (300 mm)  | At the face or maximum one round behind face  | Systematic spiling in tunnel roof or parts of it | Yes                                      |         |

| <b>Ground Mass Quality - Rock</b>   | <b>Excavation Sequence</b> | <b>Rock Reinforcement</b>  | <b>Initial Shotcrete Lining</b>  | <b>Installation Location</b> | <b>Pre-Support</b>  | <b>Support Installation influences progress</b> | <b>Remarks</b>   |
|-------------------------------------|----------------------------|--|--|------------------------------|---|---|--|
| Crushed, but Chemically Intact Rock | Top heading, bench, invert | N/A  | Systematic shell with reinforcement (welded wire fabric or fibers) and ring closure in invert; dependent on tunnel size thickness 12 in (300 mm) and more; for initial stabilization and to prevent desiccation, a layer of flashcrete may be required                                   | After each round             | Systematic grouted pipe spiling or pipe arch canopy   | Support installation dictates progress          | If water is present, groundwater draw down or ground improvement is required |
| Squeezing Rock                      | Top heading, bench, invert | Systematic doweling or bolting in top heading & bench considering joint spacing; extended length | Systematic shell with reinforcement (welded wire fabric or fibers) and ring closure in invert; dependent on tunnel size thickness 12 in (300 mm) and more; potential use for yield elements; for initial stabilization and to prevent desiccation, a layer of flashcrete may be required | After each round             | Systematic grouted pipe spiling or pipe arch canopy   | Support installation dictates progress          |  |
| Swelling Rock                       | Top heading, bench, invert | Systematic doweling or bolting in top heading & bench considering joint spacing; extended length | Systematic shell with reinforcement (welded wire fabric or fibers) and ring closure in invert; dependent on tunnel size thickness 12 in (300 mm) and more; potential use for yield elements  | After each round             | Systematic grouted pipe spiling or pipe arch canopy may be required depending on degree of fracturing | Support installation dictates progress          | Deepened invert for additional curvature                                     |

**Table 9-2 Elements of Commonly Used Soft Ground Excavation and Support Classes (ESC) in Soft Ground**

| <b>Ground Mass Quality – Soil</b>                             | <b>Excavation Sequence</b>   | <b>Initial Shotcrete Lining</b>   | <b>Installation Location</b>   | <b>Pre-Support</b>   | <b>Support Installation</b>            | <b>Remarks</b>  |
|---|--|---|--|--|--|---|
| Stiff/hard cohesive soil - above groundwater table            | Top heading, bench & invert; dependent on tunnel size, further sub-divisions into drifts may be required | Systematic reinforced (welded wire fabric or fibers) shell with full ring closure in invert; dependent on tunnel size 6 in (150 mm) to 16 in (400 mm) typical; for initial stabilization and to prevent desiccation, a layer of flashcrete may be required  | Installation of shotcrete support immediately after excavation in each round. Early support ring closure required. Either temporary ring closure (e.g. temporary top heading invert) or final ring closure to be installed within one tunnel diameter behind excavation face.  | Typically none; local spiling to limit over-break  | Support installation dictates progress | Overall sufficient stand-up time to install support without pre-support or ground modification  |
| Stiff/hard cohesive soil - below groundwater table            | Top heading, bench and invert; dependent on ground strength, smaller drifts required than above          | Systematic reinforced (welded wire fabric or fibers) shell with full ring closure in invert; dependent on tunnel size 6 in (150 mm) to 16 in (400 mm) typical; for initial stabilization and to prevent desiccation, a layer of flashcrete may be required; frequently more invert curvature than above | Installation of shotcrete support immediately after excavation in each round. Early support ring closure required. Either temporary ring closure (e.g. temporary top heading invert) or final ring closure to be installed within less than one tunnel diameter behind excavation face; typically earlier ring closure required than above | Typically none; locally pre-spiling to limit over-break  | Support installation dictates progress | Sufficient stand-up time to install support without pre-support or ground improvement; dependent on water saturation, swelling or squeezing can occur |
| Well consolidated non-cohesive soil - above groundwater table | Top heading, bench & invert; dependent on tunnel size, further sub-divisions into drifts may be required | Systematic reinforced (welded wire fabric or fibers) shell with full ring closure in invert; dependent on tunnel size 6 in (150 mm) to 16 in (400 mm) typical; for initial stabilization and to prevent desiccation, a layer of flashcrete is required  | Installation of shotcrete support immediately after excavation in each round. Early support ring closure required. Either temporary ring closure (e.g. temporary top heading invert) or final ring closure to be installed within less than one tunnel diameter behind excavation face   | Frequently systematic pre-support required by grouted pipe spiling or grouted pipe arch canopy; alternatively ground improvement | Support installation dictates progress | Stand-up time insufficient to safely install support without pre-support or ground improvement  |
| Well consolidated   | Top heading, bench &   | Systematic reinforced   | Installation of shotcrete support  | Frequently   | Support                                | Stand-up time   |



| <b>Ground Mass Quality – Soil</b>                 | <b>Excavation Sequence</b>  | <b>Initial Shotcrete Lining</b>   | <b>Installation Location</b>   | <b>Pre-Support</b>   | <b>Support Installation</b>            | <b>Remarks</b>   |
|---|---|---|--|--|--|--|
| non-cohesive soil - below groundwater table       | invert; dependent on tunnel size, further sub-divisions into drifts may be required; Pocket excavation and/or face stabilization wedge may be required                      | (welded wire fabric or fibers) shell with full ring closure in invert; dependent on tunnel size 6 in (150 mm) to 16 in (400 mm) typical for initial stabilization and to prevent desiccation, a layer of flashcrete is required                                 | immediately after excavation in each round. Early support ring closure required. Either temporary ring closure (e.g. temporary top heading invert) or final ring closure to be installed within less than one tunnel diameter behind excavation face                                   | systematic pre-support required by grouted pipe spiling or grouted pipe arch canopy; groundwater draw down or ground improvement | installation dictates progress         | insufficient to safely install support without pre-support or ground improvement; Running ground conditions or boiling may occur               |
| Loose non-cohesive soil - above groundwater table | Top heading, bench & invert; dependent on tunnel size, further sub-divisions into drifts may be required; Pocket excavation and/or face stabilization wedge may be required | Systematic reinforced (welded wire fabric or fibers) shell with full ring closure in invert; dependent on tunnel size thickness 6 in (150 mm) to 16 in (400 mm) typical for initial stabilization and to prevent desiccation, a layer of flashcrete is required | Installation of shotcrete support immediately after excavation in each round. Early support ring closure required. Either temporary ring closure (e.g. temporary top heading invert) or final ring closure to be installed within less than one tunnel diameter behind excavation face | Systematic pre-support required by grouted pipe arch canopy; alternatively ground improvement                                    | Support installation dictates progress | Stand-up time insufficient to safely install support without pre-support and/or ground improvement   |
| Loose non-cohesive soil - below groundwater table | Top heading, bench & invert; dependent on tunnel size, further sub-divisions into drifts may be required; Pocket excavation and/or face stabilization wedge may be required | Systematic reinforced (welded wire fabric or fibers) shell with full ring closure in invert; dependent on tunnel size thickness 6 in (150 mm) to 16 in (400 mm) typical for initial stabilization and to prevent desiccation, a layer of flashcrete is required | Installation of shotcrete support immediately after excavation in each round. Early support ring closure required. Either temporary ring closure (e.g. temporary top heading invert) or final ring closure to be installed within less than one tunnel diameter behind excavation face | Systematic pre-support required by grouted pipe arch canopy frequently in combination with ground improvement                    | Support installation dictates progress | Stand-up time insufficient to safely install support without pre-support or ground improvement; Running ground conditions or boiling may occur |

#### 9.4.6 Example SEM Excavation Sequence and Support Classes

While Section 9.5.3. introduced excavation and support classes in a prototypical context the following tables show examples on how, based on a ground classification, excavation and support classes were realized on selected projects. Grouped into two main types of ground, rock and soft ground, the examples are shown in tables Table 9-3 and Table 9-4 for rock and soft ground respectively.

The three examples in Table 9-3 outline tunnel constructions in three different characteristic rock mass types ranging from intact to fractured rock. The examples have rock mass reinforcement as a common element of initial support while systematic shotcrete support is used in stratified and fractured rock. Tunnel cross sections typically have horse-shoe-like shapes and no structural tunnel invert closure.

For the tunnel construction in intact rock, drill-and-blast excavation with round lengths of up to 12 feet (3.7 m) was utilized at the Bergen Tunnel in New Jersey. The initial tunnel support consisted of spot bolting to support loose rock blocks and slabs. Shotcrete was not systematically used as initial shotcrete lining but for local sealing of the rock face and for smoothening of the rock surface prior to waterproofing installation. Support was generally installed as required by field conditions.

The construction for the Zederhaus tunnel in Austria in stratified rock required systematic rock doweling and initial shotcrete lining installation. Excavation was carried out using drill-and-blast techniques with round lengths of typically 6 feet and 6 inches (2 m). The initial shotcrete lining was installed after each excavation round, whereas the installation of the rock dowels lagged 1 to 2 rounds behind the excavation. The bench excavation followed in a distance to the top heading excavation to suit the tunnel construction logistics.







A dense, systematic rock doweling pattern and an initial shotcrete lining were installed after each excavation round when tunneling through fractured rock at the Devil's Slide tunnel project in California. Drill-and-blast techniques and road headers were employed for excavation depending on ground quality. The maximum length of round in the top heading was limited to 7 feet and 2 inches (2.2 m), while the bench excavation was limited to twice that length. There was no restriction on the distance between the top heading and bench construction.

The three examples in Table 9-4 are taken from typical soft ground tunneling projects where different sizes of tunnels were constructed at different overburden depths.

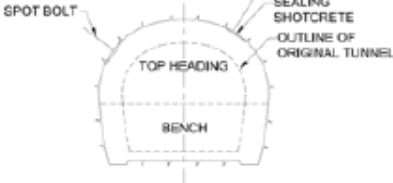
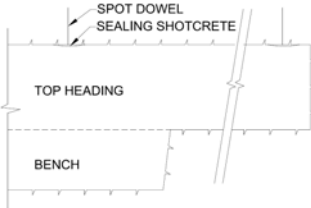

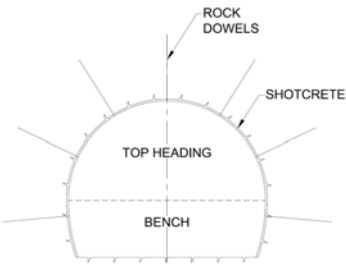
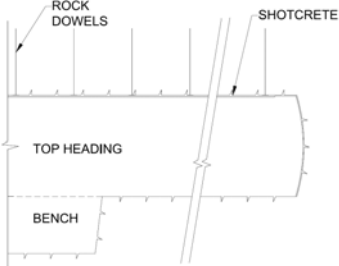

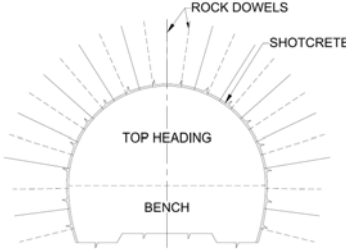
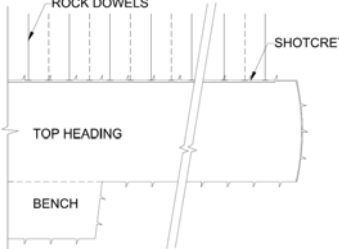
The three examples show the typical, rounded tunnel geometry with a systematic initial shotcrete lining that is closed in the curved invert. The support is installed after each excavation round prior to commencement of the next round in sequence.

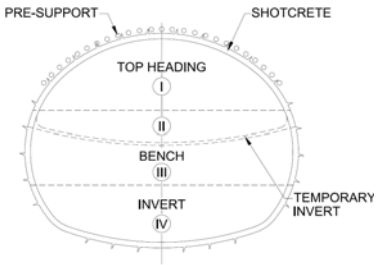
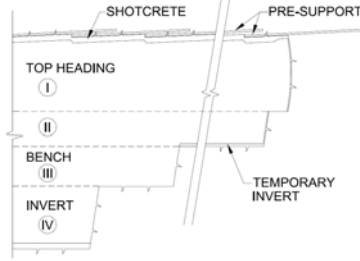

The shallow cover of maximum about 16 feet (5 m) combined with soft ground conditions required the systematic installation of a grouted steel pipe arch pre-support canopy over the entire tunnel length at the Fort Canning Tunnel in Singapore. The tunnel cross section was split into top heading, bench and invert excavation with a shotcrete invert closure. To enable longer advances of the top heading ahead of the final invert closure, a temporary shotcrete invert was provided in the top heading. Excavators were used for the excavation of residual soils with round lengths limited to 3 feet and 4 inches (1 m) in the top heading and 6 feet and 8 inches (2 m) in the bench and invert.

**Table 9-3 Example SEM Excavation and Support Classes in Rock**

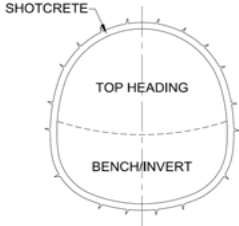
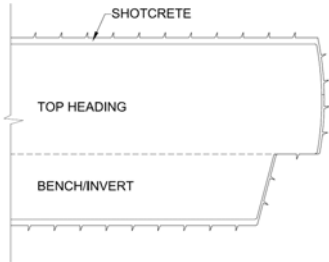
| Description  | Cross Section  | Longitudinal Section  | Photo   |
|--|--|---|---|
| <p><b>Intact Rock:</b></p> <ul style="list-style-type: none"> <li>▪ Spot bolting</li> <li>▪ Occasional sealing shotcrete</li> <li>▪ Full face or top heading/bench excavation</li> <li>▪ Round Length                             <ul style="list-style-type: none"> <li>Top Heading: 8'-12" (2.5-3.7 m)</li> <li>Bench: Up to 16'-0" (4.9 m)</li> </ul> </li> <li>▪ Dimensions                             <ul style="list-style-type: none"> <li>Height: 20'-0" (6 m)</li> <li>Width: 29'-0" (8.8 m)</li> </ul> </li> </ul> <p><b>Example:</b> Bergen Tunnels, NJ</p>  |    |    |    |
| <p><b>Stratified Rock:</b></p> <ul style="list-style-type: none"> <li>▪ Systematic rock doweling</li> <li>▪ Systematic shotcrete initial lining</li> <li>▪ Top heading excavation</li> <li>▪ Bench excavation follows distant</li> <li>▪ Round Length                             <ul style="list-style-type: none"> <li>Top Heading: 6'-6" (2 m)</li> <li>Bench: 6'-6" (2 m)</li> </ul> </li> <li>▪ Dimensions                             <ul style="list-style-type: none"> <li>Height: 29'-6" (9 m)</li> <li>Width: 36'-0" (11 m)</li> </ul> </li> </ul> <p><b>Example:</b> Zederhaus, Austria</p>                 |   |   |   |
| <p><b>Fractured Rock:</b></p> <ul style="list-style-type: none"> <li>▪ Systematic rock doweling</li> <li>▪ Systematic shotcrete initial lining</li> <li>▪ Top heading excavation</li> <li>▪ Bench excavation follows any time</li> <li>▪ Round Length                             <ul style="list-style-type: none"> <li>Top Heading: 7'-2" (2.2 m)</li> <li>Bench: 13'-0" (4.0 m)</li> </ul> </li> <li>▪ Dimensions                             <ul style="list-style-type: none"> <li>Height: 28'-0" (8.5 m)</li> <li>Width: 36'-5" (11.1 m)</li> </ul> </li> </ul> <p><b>Example:</b> Devil's Slide Tunnels, CA</p> |  |  |  |

**Table 9-4 Example SEM Excavation and Support Classes in Soft Ground**

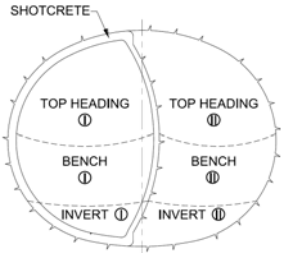
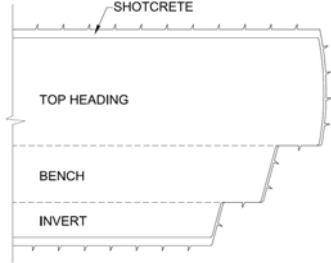
| Description  | Cross Section  | Longitudinal Section   | Photo  |
|--|--|--|--|
| <p><b>Soft Ground – shallow cover:</b></p> <ul style="list-style-type: none"> <li>▪ Systematic pre-support</li> <li>▪ Systematic shotcrete initial lining support with early ring closure</li> <li>▪ Top heading excavation (with temporary invert), bench and invert excavation</li> <li>▪ Round Length                             <ul style="list-style-type: none"> <li>Top Heading: I – 3’-3” (1 m)</li> <li>Top Heading: II – 6’-6” (2 m)</li> <li>Bench III/Invert IV – 6’-6” (2 m)</li> </ul> </li> <li>▪ Dimensions                             <ul style="list-style-type: none"> <li>Height: 38’-0” (11.6 m)</li> <li>Width: 48’-0” (14.7 m)</li> </ul> </li> </ul> <p><b>Example:</b> Fort Canning Tunnel, Singapore</p> |  |   |   |
| <p><b>Soft Ground – deep level:</b></p> <ul style="list-style-type: none"> <li>▪ Systematic shotcrete support with early ring closure</li> <li>▪ Top heading excavation closely followed by bench/invert excavation</li> <li>▪ Round Length                             <ul style="list-style-type: none"> <li>Top Heading: 3’-3” (1 m)</li> <li>Bench: 6’-6” (2 m)</li> </ul> </li> <li>▪ Dimensions                             <ul style="list-style-type: none"> <li>Height: 20’-3” (6.3 m)</li> <li>Width: 20’-3” (6.3 m)</li> </ul> </li> </ul> <p><b>Example:</b> London Bridge Station, London, UK</p>   |  |  |  |

| Description   | Cross Section  | Longitudinal Section  | Photo   |
|---|--|---|---|
| <p><b>Soft Ground – deep level:</b></p> <ul style="list-style-type: none"> <li>▪ Systematic shotcrete support with early ring closure</li> <li>▪ Sub-division into sidewall drifts</li> <li>▪ Top heading excavation closely followed by bench and invert excavation</li> <li>▪ Round Length <ul style="list-style-type: none"> <li>Top Heading: 3'-3" (1 m)</li> <li>Bench: 6'-6" (2 m)</li> <li>Invert: 6'-6" (2 m)</li> </ul> </li> <li>▪ Dimensions <ul style="list-style-type: none"> <li>Height: 30'-2" (9.2 m)</li> <li>Width: 37'-0" (11.3 m)</li> </ul> </li> </ul> <p><b>Example:</b> London Bridge Station, London, UK</p> |  |  |  |

The tunnels built for London Bridge subway station in London, UK, located at approximately 80 feet (25 m) depth below ground surface, were excavated in over-consolidated clays using excavators and road headers with maximum round lengths of 3 feet and 4 inches (1 m) and 6 feet and 8 inches (2 m) in the top heading and bench/invert respectively. While the smaller running tunnels were excavated and supported in a staggered full face sequence in a top heading and bench/invert arrangement, the 37 feet (11.3 m) wide turn-out was constructed using a single-sidewall drift with a top heading, bench and invert excavation in each partial drift. The temporary middle wall provided temporary sidewall support for the first tunnel half during construction. During the enlargement to the full tunnel size the temporary middle wall was removed.

### 9.4.7 Excavation Methods

During the history of application of the SEM/NATM, tunneling methods for a wide variety of ground conditions have been developed. With the further development and refinement of support means, the application field of the SEM has ever been expanded. From its original implementation in alpine, “green field” rock and soft rock tunnels the focus moved into urban areas and soft ground tunneling. SEM tunneling is typically accomplished in hard rock using drill-and-blast excavation techniques (Section 6.4.1), medium hard and soft rock using a road header (6.4.3) and in soft ground using backhoe excavation.

Figure 9-10 through Figure 9-13 display such SEM excavations from hard rock through soft ground. Figure 9-10 displays drilling of a face in a rock tunnel for a drill-and-blast excavation. A close up of the drilling at the face is shown in Figure 9-11 that also displays the shotcrete initial lining installed close to the face. The rock face has been sealed by a layer of flashcrete. Figure 9-12 shows a close up of a road header boom excavating a medium hard, jointed rock mass. Figure 9-13 displays tunnel construction of a soft ground tunnel in a top-heading, bench, and invert excavation using backhoes. The backhoe is in the background at the tunnel face.



Figure 9-10 Face Drilling for Drill-and-Blast SEM Excavation (Andrea Tunnel, Austria)

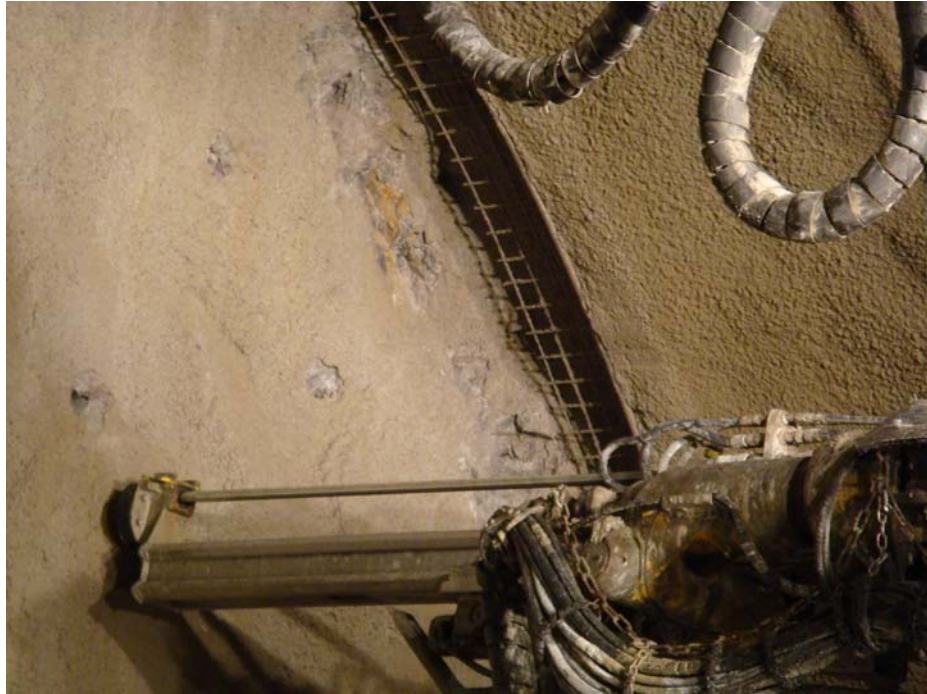

Figure 9-11 Shotcrete Lining Installed at the Face in a SEM Tunnel Excavated by Drill-and-Blast (Andrea Tunnel, Austria)



Figure 9-12 Road Header SEM Excavation in Medium Hard, Jointed Rock (Devil's Slide Tunnels, California)



Figure 9-13 Soft Ground SEM Excavation Tunnel Using Backhoes (Fort Canning Tunnel, Singapore)

## 9.5 GROUND SUPPORT ELEMENTS

This section addresses special ground support and material considerations that have evolved with the application of shotcrete supported SEM excavations. Chapter 6 also provides detailed discussions about rock reinforcement elements.

### 9.5.1 Shotcrete

The original name for shotcrete was "Gunitite" when it was used for the purpose of taxidermy by spraying mortar on wire frames in the US in the early 1900's. In its early applications, sprayed dry mix material has also been used for the improvement of the fire resistance of timber supports in mines. During the course of the early 1930's, the term "Shotcrete" was introduced and has been widely used since. Development of equipment technology for the application of shotcrete progressed rapidly and the use of shotcrete for ground support purposes spread worldwide. In particular, the use of NATM / SEM, and the associated extensive use of shotcrete contributed to development of shotcrete which nowadays can be viewed as sprayed concrete, the major distinction between concrete and shotcrete being merely the method of placement (Vandewalle, 2005).

#### 9.5.1.1 Effect of Shotcrete

When concrete is sprayed on a rough ground surface, it fills small openings, cracks and fissures and as initial support provides immediate support after excavation. It reduces the potential for relative movement of rock bodies or soil particles and, therefore, limits loosening of the exposed ground surrounding the tunnel. The adhesion depends on the condition of the ground surface, the dampness and



presence of water and the composition of the shotcrete. Generally, the rougher the ground surface the better the adhesion. Dry rock surfaces have to be sufficiently dampened prior to application of shotcrete. Dusty or flaky surfaces, water inflow or a water film on the rock surface or other contaminant reduce the adhesion of shotcrete.

Modern admixtures improve the "stickiness" of shotcrete significantly such that rebound is reduced considerably. Fibers increase the adhesion and cohesion of the freshly applied ("green") shotcrete and therefore improve the build-up quality of the shotcrete. In turn, excessive stickiness of the shotcrete mix (as frequently observed when sodium silicate accelerators are used) can have an adverse effect. Too sticky shotcrete tends to accumulate around reinforcement bars, resulting in insufficiently compacted, low quality concrete or even voids or "shadows" behind the reinforcement bars.

In order to stabilize small wedges and slabs, shotcrete is applied locally. This application type does not form a continuous layer of shotcrete over an extended area to form a supporting member in the sense of a lining or structural shell. Rather, edges and corners generated by the intersection of discontinuities are filled with shotcrete bonding the bodies together thus forming local support.

Flashcrete: also referred to as sealing shotcrete, is applied immediately after excavation by spraying a thin layer of shotcrete if required to seal off the exposed ground surface. Flashcrete is often used in poor rock or soft ground (soil) in combination with (steel) fibers for reinforcement. This application limits desiccation, effects of humidity on sensitive ground material, softening due to contact with water, and loosening of the ground due to differential movement of ground particles. Flashcrete may be applied locally (and in areas where required) or over the entire exposed ground surface after excavation. Flashcrete is not considered to be an active support and, therefore is normally followed by a systematically applied initial shotcrete lining.

Shotcrete Face Support: In poor ground conditions a temporary face support may be required to restrict the ground from moving into the excavation. Dependent on the length of period through which the support is required and the ground conditions, the thickness and reinforcement of the face support varies. For tunnel stubs, permanent head walls are constructed with shotcrete. A domed face shape is of great importance in poor ground for successful face stabilization.

Experience gained from tunnel projects in soft ground demonstrates that ground deflections and hence surface settlements continue until a final, fully domed head wall with sufficient connection to the tunnel shotcrete initial lining is established.

Temporary Shotcrete Support: In poor ground conditions or where large tunnel cross sections are constructed, the excavation area must often be split into several drifts. To provide immediate support and, if required, ring closure for each sub-drift, temporary shotcrete support shells or linings are used. The thickness of the temporary lining is designed based on the cross sectional area of the drift to be supported and the period for which the support is required. The temporary shell is removed during subsequent construction steps that complete the excavation to the full tunnel opening. Figure 9-14 shows a typical SEM tunnel excavation with a temporary middle wall.



Figure 9-14 Typical Tunnel Excavation with Temporary Middle Wall (Beacon Hill Station, Washington)

**Initial Shotcrete Lining:** Initial shotcrete lining typically consists of 4 to 16 inch (100 to 400 mm) thick shotcrete layer mainly depending on the ground conditions and size of the tunnel opening, and provides support pressure to the ground. It is also referred to as shotcrete lining. A shotcrete ring can carry significant ground loads although the shotcrete lining forms a rather flexible support system. This is the case where the shotcrete lining is expected to undergo high deformations and hence ductility post cracking is of importance. By deforming, it enables the inherent strength and self-supporting properties of the ground to be mobilized as well to share and re-distribute stresses between the lining and ground. During deformation, stresses acting within the shotcrete lining are transferred into the surrounding ground. This process generates subgrade reaction of the ground that provides support for the lining. From the ground support point of view the design of the shotcrete lining is governed by the support requirements, i.e., the amount of ground deformations allowed and ground loads expected as well as economical aspects. The earlier the sprayed concrete gains strength the more the support restrains ground deformation. However, by increasing stiffness the support system increasingly attracts loads. It depends on the ground conditions and local requirements how stiff or flexible the support system has to be and thus what early strength requirements, thickness and reinforcement should be specified.

In shallow tunnel applications and beneath surface structures that are sensitive to deformations such as buildings, ground deformations and consequently surface settlements have to be kept within acceptable limits. The advantage of the mobilization of the self-supporting capacity of the ground can therefore be

only taken into account to a very limited extent. Here, early strength of the shotcrete is required to gain early stiffness of the support to limit ground deflections. Under these conditions the shotcrete lining takes on significant ground loads at an early stage however in a generally low stress environment due to the shallow overburden. Early strength can be achieved with admixtures and modern cement types.

In contrast for tunnels under high overburden the prevention of ground deformation and surface settlement plays a secondary role. Excessive ground loads in squeezing ground and active tectonic pressures applied on the tunnel perimeter may be the design criteria for deep tunnels. By allowing the ground to deflect (without over-straining it) the ground's self-supporting capability, mainly shear strength, is mobilized. Consequently, the ground loads acting upon the shotcrete lining can be limited significantly because the ground assumes a part of the support function and a portion of the ground loads is dissipated before the initial support is loaded. For rock tunnels under high cover, early strength is not a necessity but final strength of the entire system is of importance. In special cases it may be required to construct "deformation joints" by implementing special yield elements to allow substantial deformation of the ground without generating uncontrolled cracks in the shotcrete lining while maintaining a defined support pressure during the process of deformation. Yield elements are designed such as to allow prescribed maximum deformation under defined lining loads (Section 8.3.3).

Rock reinforcement installed in rock tunnels augments the strength of the surrounding ground, controls deformation and limits the ground loads acting upon the shotcrete initial lining. Shotcrete support and rock reinforcement are designed to form an integrated support system in view of the excavation and support sequence. The design engineer must define the requirements for the support system based on thorough review of the ground response anticipated.

The effect of the shotcrete is heavily dependent on the radial and tangential subgrade reaction generated by the surrounding ground. Therefore, shape, shotcrete thickness and installation time have to be designed in accordance with the ground conditions and the capacities of the surrounding ground and the support system. Site personnel should assess the support requirements and, if necessary, adjust the designed support system based on observations in the field. Notwithstanding the need for reaction to site conditions, the designer should always be party to the decision making process prior to changing any support means on site. The design intent and philosophy must be taken into consideration when adjustments of the support system are made.

Friction between the ground and the sprayed concrete lining (tangential subgrade reaction) is paramount for the support system. This friction reduces differential movement of ground particles at the ground surface and contributes to the ground-structure interaction. Even the shotcrete arch not forming a closed ring provides substantial support to the ground, given that tight contact between the sprayed concrete and the ground is maintained.

The requirement for a ring closure, be it temporary or permanent, is governed by the size of the underground opening and the prevailing ground conditions. In a good quality rock mass, no ring closure is required. In low quality ground (weak rock and soil), it has been proven in numerous case histories that the time of support application after excavation, length of excavation round and time lag between the excavation of the top heading and the invert closure rules the ground and lining deflection. To reduce ground deflection and the potential for ground/lining failure, the excavation and support sequence must be designed such that an early ring closure of the shotcrete support in soft ground is achieved. Also the timely (immediately after excavation) installation of the shotcrete support members is of utmost importance. To achieve an early, temporary ring closure and to reduce excavation face size, partial drifts such as sidewall drifts, middle drifts and top heading, bench, and invert drifts can be used. These partial drifts are supported by temporary shotcrete support, such as temporary middle walls, invert supports, etc.

An important aspect of shotcrete linings is the design and construction of construction joints. These joints are located at the contact between shotcrete applications in longitudinal and circumferential directions between the initial lining shells of the individual excavation rounds and drifts. An appropriate location and shape as well as connection of the reinforcement through the longitudinal joints is of utmost importance to the integrity and capacity of the support system. Longitudinal joints have to be oriented radially, whereas circumferential joints should be kept as rough as possible. Splice bars/clips and sufficient lapping of reinforcement welded wire fabric maintain the continuity of the reinforcement across the joints. Rebound, excess water, dust or other foreign material must be removed from any shotcrete surface against which fresh concrete will be sprayed. The number of construction joints should be kept to a minimum.

In case of ground water ingress, the ground water has to be collected and drained away. Any build-up of groundwater pressure behind the shotcrete lining should be avoided for the following reasons: Increased ground water pressure in joints and pores reduces the shear strength in the ground, undue loads may be shed onto the shotcrete lining (unless it is designed for that, which is unusual for initial shotcrete linings); softening of the ground behind the lining; increased leaching of shotcrete; shotcrete shell will be detached from the ground.

## **9.5.2 Rock Reinforcement**

As discussed in Chapter 6, rock reinforcement and rock mass act as a complex interactive system, where the individual elements always have to be seen in view of their interaction and interdependence. The overall strength of a reinforced rock mass with a joint system is governed by the characteristics of the joints (roughness, fill, rock material, orientation) and the contribution provided by the reinforcement elements. For the design of rock mass reinforcement systems, sufficient appreciation of the expected ground conditions and experience are of fundamental importance. Readers are referred to Section 6.5.2 for more detailed discussion for each type of rock reinforcement. The following focuses on the SEM applications and issues.

### **9.5.2.1 Types of Rock Reinforcement**

Rock Dowels: (Figure 6-17), are passive reinforcement elements that require some ground displacement to be activated. In deep tunnels or under tunneling conditions where ground deflection is permitted or even desired, passive rock reinforcement is frequently installed. This applies for example to tunnel construction sequences where the excavation and support installation is carried out in sequences (e.g. top heading, bench, invert). In order to best use the support effect of the rock dowels, an early installation is required. The majority of ground deflections develop during excavation and closely behind the progressing tunnel face. In sequential rock tunneling using multiple drifts, ground deflection typically ceases after top heading excavation and support but commences again after a period of relative stability during excavation for bench and invert construction. Therefore, rock dowels should be installed right after excavation or close to the progressing excavation face.

Rock Bolts: (Figure 6-18) actively introduce a compressive force into the surrounding ground. This axial force acts upon the rock mass discontinuities thus increasing their shear capacity and is generated by pre-tensioning of the bolt. The system requires a 'bond length' to enable the bolt to be tensioned. Rock bolts frequently are fully bonded to the surrounding ground after tensioning, for long-term load transfer considerations.

Rock bolts are not only installed during construction. Rock bolts may also be used for existing underground openings, where further deformation of the ground and/or the support is to be inhibited or for

additional support of existing structures that will undergo subsequent enlargement or be influenced by adjacent tunnel construction.

For tunnels constructed in an environment where ground deflection and surface settlement has to be limited (e.g. shallow tunnels in urban areas), rock bolt aid in limiting the ground displacement caused by the SEM tunneling. Furthermore, during construction of large openings ground deflection limitation may be desired to avoid loosening (and hence weakening) of the rock mass. In high stress environments, special compressible elements have been developed, that are installed between the ground/support surface and the face plate of the bolt allowing a certain amount of displacement while the tension force at the bolt is kept constant.

Rock Anchors: Rock anchors are used under conditions where high anchor forces have to be accommodated often significantly higher than for example rock bolt forces. For instance in very large span tunnels, where high support forces have to be generated to stabilize the ground, anchors are frequently used.

Generally, it can be stated that pre-tensioning of bolts establishes a stiffer system of the reinforced rock mass after installation and minimizes the magnitude of shear displacement. The design and application of a pre-tensioned rock reinforcement system requires excellent knowledge of the ground conditions and ground behavior to avoid over-tensioning during ground displacement. In comparison, an initially untensioned rock dowel reinforcement may ultimately lead to the same strength and reinforced rock mass capacity, however, only along with larger deformations.

Table 9-5 summarizes commonly used rock reinforcement elements and application considerations for the installation as part of initial support in SEM tunneling in rock.

### **9.5.2.2 Practical Aspects**

Several practical aspects related to rock dowel/bolt installation in the field have been summarized below based on experience in SEM tunneling. Each individual project has its own particularities and, therefore, this list is not exhaustive.

Layout of Rock Mass Reinforcement Pattern: While it also has to observe theoretical considerations, the design must take practical issues of installation into account. As a consequence of a design lacking practical considerations, rock mass reinforcement systems are frequently ‘adjusted’ on site to suit practical aspects without considering the ground conditions and the design intent. Such installed rock reinforcement systems may be of limited benefit or even have an adverse effect.

Grouting: Rock dowel/bolt grouting systems aim for the full embedment of a rock dowel/bolt in grout. Full embedment not only ensures bond over the entire length of the dowel/bolt but also provides corrosion protection. Regardless of the method used, the appropriate consistency of the grout material is the most important factor in achieving the required bond between the ground and the reinforcement element. This particularly applies for cementitious grout materials. While the available diameter of the grouting hose dictates the consistency of the grout material to some extent, too high or too low viscosity can lead to insufficient bond. It can frequently be observed that installation crews adjust grout mixing plants and pumps and do not visually check the consistency of the grout mix produced. Even with the use of the most sophisticated mixing and pumping devices, it is required to visually check the grout mix produced before commencing each installation operation. All foreign material must be removed prior to installation to ensure proper bond.

**Table 9-5 Commonly used Rock Reinforcement Elements and Application Considerations for SEM Tunneling in Rock**

| No. | Name              | Material*                       | Anchorage  | Tensioned | Installation  | Ground **   | Advantages   | Limitations   |
|-----|-------------------|---------------------------------|--|-----------|---|---|--|---|
| 1   | Steel rebar dowel | Deformed (solid) steel rebar    | Fully bonded using cement grout or resin                       | No        | Rebar inserted into pre-drilled and grout filled hole;<br>Rebar inserted in pre-drilled hole together with grouting hose and grouted subsequently | Massive to highly jointed rock mass   | Low cost; Availability; If properly installed, high performance and heavy duty support                               | Requires skilled and experienced installation personnel; collapsing boreholes hamper installation                           |
| 2   | Glass Fiber Dowel | Deformed fiber glass bar        | Fully bonded using cement grout, more frequently with resin    | No        | Rebar inserted into pre-drilled and grout filled hole;<br>Rebar inserted in pre-drilled hole together with grouting hose and grouted subsequently | Massive to highly jointed rock mass; frequently used in areas to be excavated subsequently (e.g. face bolting, break-out areas) | High performance heavy duty support; can be easily removed during subsequent excavations within reinforced rock mass | Requires skilled and experienced installation personnel; limited shear resistance; collapsing boreholes hamper installation |
| 3   | Split Set         | Longitudinally split steel pipe | Friction over entire length generated by spring action of pipe | No        | Forced into pre-drilled borehole of slightly smaller diameter than outer diameter of split set  | Massive to jointed rock mass  | Immediate support action; simple installation; no grouting required  | Very limited shear resistance; Light support only; very corrosion sensitive; cannot be used in collapsing borehole          |
| 4   | Swellex           | Folded, inflatable steel pipe   | Friction over entire length generated by inflation of          | No        | Inserted into pre-drilled borehole and inflated with highly   | Massive to jointed rock mass  | Immediate support action; Can achieve  | Limited shear resistance and durability; cannot be re-tightened; requires special equipment for inflation;                  |

| No. | Name                 | Material*  | Anchorage  | Tensioned | Installation  | Ground **                                       | Advantages  | Limitations  |
|-----|----------------------|--|--|-----------|---|---|---|--|
|     |                      |  | tube   |           | pressurized water   |   | significant support capacity  | higher material cost; collapsing boreholes hamper installation   |
| 5   | Grouted Pipes        | Perforated steel pipe                              | Fully bonded with cement or resin grout                                    | No        | Inserted into pre-drilled borehole (or rammed into soft ground with thick walled pipes) and grouted through pipe and perforation holes      | Jointed to heavily fractured ground (soil like) | Simple installation; Availability; More controllable embedment results                            | Limited shear resistance (depending on wall thickness); collapsing boreholes hamper installation                               |
| 6   | Self-drilling dowels | Thick walled steel pipes with disposable drill bit | Fully bonded with cement or resin grout                                    | No        | Reinforcement element functions as drill rod, drill bit and dowel remains in ground after drilling and is grouted through flushing openings | Jointed to heavily fractured rock mass          | Installation steps limited to two steps (fast installation); High performance heavy duty support; | More expensive than bar reinforcement; May become trapped in collapsing boreholes as it does not have reverse cutting tools;   |
| 7   | Rammed Dowels        | Steel rebar or thick walled steel tube             | Shear resistance generated between ground and element (friction, adhesion) | No        | Rammed into ground  | Decomposed rock, soil                           | Least ground disturbance during installation; Immediate support action                            | Relies on shear resistance generated between ground and element; requires ramming equipment; limited to soft ground conditions |
| 8   | Steel rebar bolt     | Deformed steel rebar                               | a. End anchored: cement grout or resin;                                    | Yes       | a. Grouting behind grout seal through grouting hose (aeration   | Massive to highly jointed rock mass             | Low cost; Availability; if properly installed, high   | Requires skilled and experienced installation personnel; collapsing boreholes hamper   |

| No. | Name                 | Material*                | Anchorage                             | Tensioned | Installation   | Ground **  | Advantages   | Limitations   |
|-----|----------------------|--------------------------|---------------------------------------|-----------|--|--|--|---|
|     |                      |                          |                                       |           | hose);   |  | performance heavy duty support   | installation<br>a. Requires grout seal;   |
|     |                      |                          | b. Fully bonded: two phase resin      |           | b. resin grout with two different setting times                                |  |  | b. Resin is more expensive than grout; Requires different types of resin  |
| 9   | Glass fiber bolt     | Deformed glass fiber bar | a. End anchored: cement grout, resin; | Yes       | a. Grouting behind grout seal through grouting hose (aeration hose);           | Massive to highly jointed rock mass                            | High performance heavy duty support; can be easily removed due to limited shear resistance | Requires skilled and experienced installation personnel; collapsing boreholes hamper installation<br>a. Requires grout seal;    |
|     |                      |                          | b. Fully bonded: two phase resin      |           | b. resin grout with two different setting times                                |  |  | b. Resin is more expensive than grout; Requires different types of resin  |
| 10  | Expansion Shell Bolt | Steel rebar              | Mechanically end anchored             | Yes       | Inserted in pre-drilled borehole, shell at end expanded by tightening the bolt | Massive to jointed rock mass; requires competent rock material | Immediate support effect; can provide high support capacity;                               | Relatively expensive; Slip or rock crushing may occur; tends to lose tension due to vibration (blasting) and ground deformation |

\* Reinforcement material

\*\* Ground conditions described are typical application examples; reinforcement elements may also be used in other ground conditions.



**Contact:** Frequently rock dowels and face plates as well as nuts are installed in time, but the nuts are not tightened or are tightened only after a long period of time and far behind the progressing excavation face. While tensioning of a fully bonded rock dowel does not have any effect on the strength of the integrated rock - reinforcement system (rock mass and reinforcement), it is important to tighten the nuts to ensure a tight fit of the face plate and, if used in combination with a shotcrete support, to aid an appropriate contact between the ground surface and the shotcrete support lining/face plate. If used without a shotcrete lining, tightening of nuts assists in limiting early deformation and loosening of the rock mass close to the opening.

**Testing and monitoring:** Pull-out-tests are an important tool to ensure adequate anchorage of rock bolts. While useful to check the bond strength and therefore, the support capacity of a tendon with a defined bonded anchorage section and a free section, pull-out tests are irrelevant when used for testing fully bonded rock dowels, because they do not provide any information on the overall performance of a fully bonded rock reinforcement. The conventional pull-out test, when used for fully bonded reinforcement, provides information on the shear capacity between the bolt and grout and the ground adjacent to the head of the tested element, but it does not yield any information of the overall bond along the reinforcement element or whether the element is fully embedded in grout.

Similar to above, monitoring the anchor forces between the ground surface and the face plate of a fully bonded rock dowel/bolt does not provide any information on the forces acting within the fully bonded reinforcement element over its length. Therefore, only monitoring devices (e.g. strain gages) mounted directly onto the shank along the reinforcement element can supply information on the performance and stresses acting within the reinforcement during ground deformation.

### **9.5.3 Lattice Girders and Rolled Steel Sets**

As discussed in Chapter 6, lattice girders (Figure 6-20) are lightweight, three-dimensional steel frames typically fabricated of three primary bars connected by stiffening elements. Lattice girders are used in conjunction with shotcrete and once installed locally act as shotcrete lining reinforcement. The girder design is defined in the contract documents by specifying the girder section and size and moment properties of the primary bars. To address stiffness of the overall girder arrangement the stiffening elements must provide a minimum of five percent of the total moments of inertia. This percentage is calculated as an average value along repeatable lengths of the lattice girder. The arrangement of primary bars and stiffening elements is such as to facilitate shotcrete penetration into and behind the girder, thereby minimizing shadows. Lattice girders are installed to provide:

- Immediate support of the ground (in a limited manner due to the low girder capacity)
- Control of tunnel geometry (template function)
- Support of welded wire fabric (as applicable)
- Support for fore poling pre-support measures

In particular cases where, for example, immediate support is necessary for placing heavy spilling for pre-support, the use of rolled steel sets may be appropriate. In such instances steel sets are used for implementation of contingency measures. Steel sets of bell shaped profile (Heintzmann profile) are also used as structural members in temporary shotcrete sidewalls in multiple drift tunneling. Their primary purpose apart from increased capacity over lattice girders is their ease of removal when demolishing temporary shotcrete walls in multiple drift tunneling applications.

## 9.5.4 Pre-support Measures and Ground Improvement

When tunneling in competent ground, the ground surrounding the tunnel opening provides sufficient strength to ensure stand-up time needed for the installation of the initial SEM support elements without any pre-support or improvement of ground strength prior to tunneling.

With the significantly increased use of the SEM in particular in soft ground and urban areas over the past decades, traditional measures to increase stand-up time were adopted and further developed to cope with poor ground conditions and to allow an efficient initial support installation and safe excavation.

These measures are installed ahead of the tunnel face. They include ground modification measures to improve the strength characteristics of the ground matrix including various forms of grouting, soil mixing and ground freezing, the latter for more adverse conditions. Most commonly they include mechanical pre-support measures consisting of spiling methods installed ahead of the tunnel face often with distances of up to 60 to 100 feet (18 to 30 m) referred to as pipe arch canopies or at shorter distances, as short as 12 ft (3.6 m) utilizing traditional spiling measures such as grouted solid bars or grouted, perforated steel pipes. Ground improvement and pre-support measures can be used in a systematic manner over long tunnel stretches or only locally as required by ground conditions.

### 9.5.4.1 Pre-support Measures

Pre-support measures involve spiling or grouted pipe arch canopies that bridge over the unsupported excavation round. These longitudinal ground reinforcement elements are supported by the previously installed initial shotcrete lining behind the active tunnel face and the unexcavated ground ahead of the face. These mechanical pre-support measures are generally used to:

- Increase stand-up time by preventing ground material from raveling into the tunnel opening causing potentially major over-break or tunnel instabilities
- Limit over-break
- Reduce the ground loads acting on the immediate tunnel face
- Reduce ground deflection and, consequently surface settlements.

Mechanical pre-support measures are generally less intrusive than systematic ground modifications. They rely on the ground reinforcing action of passive reinforcement elements such as steel or fiberglass pipes/bars. Similar to passive concrete reinforcement the elements must directly interact with the surrounding ground to be efficient as reinforcement. This interaction can only be established by a tight contact between the reinforcement element and the ground. This interaction can be achieved by either fully grouting the pre-support elements to lock the reinforcement in with the ground or by ramming the reinforcement elements into ground if susceptible to this action in soft ground conditions. Loosely installed elements installed in soft rock or soil do not achieve their intended function and such installations must be avoided. In fractured, but competent rock, steel rebars loosely installed in boreholes may be acceptable but merely to limit over-break. Figure 9-15 displays closely spaced No. 8 rebar spiles bridging across an excavation round and keeping soft, cohesive fine soil materials in place. Spiles rest on the initial shotcrete lining (front) and on the unexcavated ground beyond the tunnel face. The narrow spacing allows even very soft and soils with little cohesion to bridge between individual spiles.



Figure 9-15 Spiling Pre-support by No. 8 Solid Rebars (Berry Street Tunnel, Pennsylvania)

The effect of mechanical pre-support has frequently been misjudged. On one hand, the stiffness of the steel elements used for pre-support is often taken as basis for assessing an increase of the overall stiffness of the ground surrounding the pre-support. This can easily lead to an over-estimation of the pre-support function, as the longitudinal stiffness of the entire system must be taken into account in those considerations. On the other hand, the radial action of a systematic pre-support arch is often underestimated or not considered at all.

The longitudinal effect of a pre-support element is less governed by the stiffness of the reinforcement element than by the improvement of the tensile and shear capacity of its surrounding ground.

When grout is used to establish the bond between the reinforcing element and the ground, grouting pressure used for installation, type of grout and grouted length have a paramount influence on the effect and efficiency of the pre-support in particular in soft ground conditions.

Though it has been proven in countless applications that mechanical pre-support has the effects mentioned above, quantification of the effect by numerical analyses methods proved to be difficult involving efforts that go beyond the usual design efforts. Hence, the effect of pre-support is often assessed using simple approaches that result in very conservative assessments, thus underestimating the actual effect of pre-support. In many cases, the effect of pre-support is even ignored in a design and pre-support is viewed merely as an increase of the safety margin rather than a settlement-limiting element of the tunnel support.

**Pre-Support in Rock Tunneling:** Pre-support installation in fractured, yet competent rock mass types is typically aimed at limiting the over-break during and after excavation. Pre-spiling with steel rebars is a frequent method to keep rock fragments in place (Section 6.5.6). Dependent on the degree of fracturing, the rebars are installed in empty boreholes arranged around the perimeter of the roof, or the boreholes are filled with cement grout prior to insertion of the rebars. Alternatively, perforated steel pipes are used that

are inserted into the boreholes and subsequently grouted. In a severely fractured rock mass where boreholes tend to collapse, self-drilling rock reinforcement pipes are used. With the grouted applications, grout may intrude into cracks and fractures introducing a limited cementing effect of the surrounding material.

In soft rock mass types, where fracturing and limited material strength result in conditions with low overall strength, grouted pipe spiling or grouted pipe arches are used for pre-support. If required, these pre-support measures are combined with groundwater drawdown measures to reduce the joint water pressure and to increase the frictional capacity along the joints.

Permeation grouting of the discontinuities is used to reduce the mass permeability and to increase the overall shear strength by cementing the rock fragments together.

Pre-Support in Soft Ground (Soil) Tunneling: Similar to soft rock, grouted mechanical pre-support measures are used to pre-stabilize soil or soil like ground. Dependent on the susceptibility of the soil to grout, these mechanical pre-support methods are combined with grouting systems that allow penetration of grout into the ground leading to cementation of the ground surrounding the pre-support. Penetrability of the ground and the intended purpose of the pre-support govern the selection of the grouting materials. While grout with standard cements has a limited capability for penetrating ground containing sand or smaller fractions, penetration results can be improved by the use of micro or ultra fine cement products or chemical grouting (resin grouting). The current market offers resin grouting materials with viscosity values close to water.

In many cases, particularly under shallow cover with the groundwater table in the lower part or below the tunnel invert, mechanical pre-support measures are sufficient as long as the support elements are sufficiently locked into the ground over their entire length by an appropriate grouting material. Any additional effect by grout material penetrating voids in vicinity of the installed pre-support is considered an additional benefit.

In very loose, generally non-cohesive ground, ground improvement measures may be required to cement the ground and to decrease the permeability of the soil.

Pre-Support Elements: Most commonly used mechanical pre-support elements include grouted pipe spiling of typically 2-inch (50 mm) diameter perforated steel pipes and rebar spiling using solid No. 8 (25 mm diameter) steel rebars as shown in Figure 9-15. These are primarily installed in the area of the tunnel roof and shoulders, but may also be installed in the sidewall and invert if suitable and required. Grouting of these spiling elements establishes a tight contact between the reinforcement element and the surrounding ground. So-called self-drilling and grouted rebars (type IBO, ISCHEBECK or similar) provide for a very efficient installation of grouted, solid steel bars.

Grouted Pipe Arch Canopy: Pipe arch canopy methods involve a systematic installation of grouted pipes at a spacing of typically 12 inch (300 mm) around the tunnel crown. This installation typically involves one single row of pipes but under critical ground conditions and / or when surface settlements must be restricted may involve a double row of pipes. The pipes are installed at lengths typically not to exceed 15 to 24 meters (50 to 80 feet) using conventional drilling techniques at a shallow lookout angle from the tunnel and ahead of the tunnel excavation. Specialized drill bit and casing systems are utilized that aim at limiting and strictly controlling the over cut, i.e., annular void space between inserted pipe and the surrounding ground. They also provide for direction control and high installation accuracy. Drilling techniques include ODEX<sup>®</sup>, CENTREX<sup>®</sup>, ALWAG and similar methods.

The steel pipes are typically perforated and have a diameter of between 4.5 inch and 6 inch (114 mm to 150 mm). The steel pipes are grouted to facilitate contact between steel pipe and the surrounding ground and to create the desired arching effect around the tunnel opening during excavation. Depending on purpose and susceptibility of the ground to grouting, the perforated steel pipes may be grouted either from the single entry point at pipe end within the tunnel or using packers or double packers. Grouting with double packers will allow for targeted grouting with respect to location, grout mix, injected volumes, and pressures. These pipe arch systems have furthered the use of SEM applications in particular in urban settings under shallow overburdens and also in difficult ground conditions.

Figure 9-16 displays the installation of a steel pipe for an arch application for a 3-lane road tunnel in soft ground. The figure displays the steel pipe on a drill jumbo boom and a 4.5 inch (114 mm) steel pipe being drilled near the circumference of the shotcrete initial lining. Figure 9-17 displays previously installed pipe arch steel pipes exposed in the ground when opening a new excavation round.



Figure 9-16 Steel Pipe Installation for Pipe Arch Canopy (Fort Canning Tunnel, Singapore)

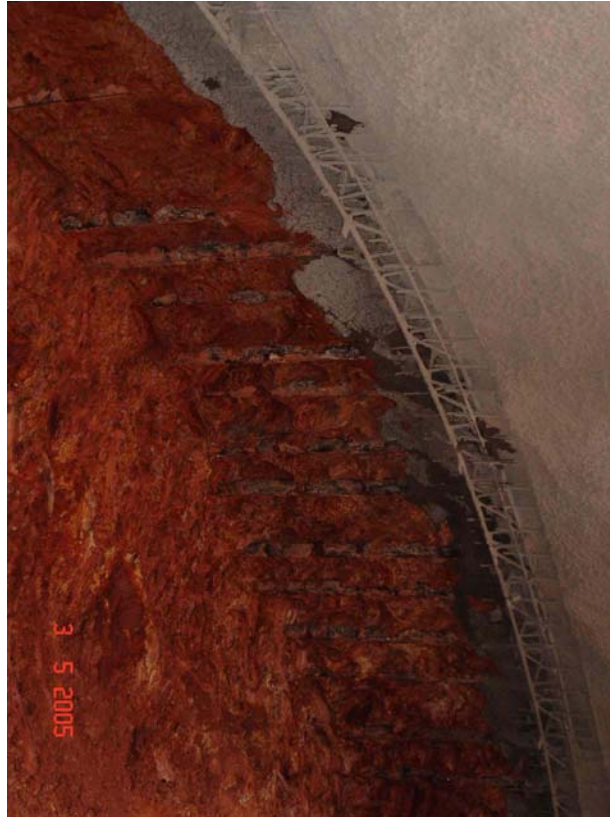

Figure 9-17 Pre-support by Pipe Arch Canopy, Exposed Steel Pipes Upon Excavation of a New Round (Fort Caning Tunnel, Singapore)

Face Doweling: Face doweling forms a specific form of pre-support. Other than the mechanical pre-support installed in the tunnel roof and shoulder area, the face pre-support is installed within the excavation face to stabilize squeezing or raveling ground at the face prior to excavation. Passive elements are installed in the ground and usually grouted in place to increase the tensile and shear strength of the ground material. Since the reinforcement elements have to be excavated during subsequent excavation rounds, fiberglass reinforced resin dowels or pipes are frequently used. Steel elements for face doweling hamper the excavation progress and during excavation their removal transfers tension forces into the ground, promoting ground disturbance ahead of the progressing tunnel face. Face doweling can be combined with application of grouting methods to locally improve the overall strength of the ground within the tunnel cross-section and act with the face dowels.

Face support dowels are usually made of GFRP (glass fiber reinforced polyester resin) and provide significant tensile strength while allowing for easy removal during excavation due to the material composition and low shear resistance.

#### **9.5.4.2 Ground Improvement**

Ground improvement measures are primarily aimed at modifying the ground matrix to increase its shear (cohesion) and compressive strengths. An increase of the stiffness (deformation modulus) is coincidental to this improvement. These measures are frequently installed from the surface and well in advance of the tunnel excavation or are applied from within the tunnel ahead of the face. Ground improvement measures

range from lowering of the groundwater table or reduction of the pore/joint water pressure to intrusive changes of the ground composition such as jet grouting, soil mixing or ground freezing.

Groundwater Draw Down: Draw down of the groundwater table reduces or eliminates the groundwater inflow into tunnels during construction and increases the effective shear strength of the ground. Groundwater flowing into the tunnel opening during construction not only causes unsafe conditions and increases equipment wear and tear; it also can promote ground instabilities. The reduction of the hydrostatic head reduces the water pressure acting within discontinuities and soil pores. Groundwater draw down can be carried out from the surface or from within the tunnel.

In fine-grained soils (fine sands, silts, clays) the reduction of the pore pressure results in a significant increase of the overall strength of the ground. Where gravity drainage is insufficient, vacuum wells or other means such as drainage by osmosis can be applied.

Permeation Grouting: Permeation grouting is frequently used to cement the ground matrix if it is sufficiently coarse and uniform to achieve reliable grout penetration. Microfine cement or chemical (resin) grouts are used for finer grained soils.

Where soils are not sufficiently uniform or groutable, other measures such as jet grouting or soil mixing are used. These methods actively modify the ground's fabric by mixing the ground with a cementing agent such as cement grout or lime. Jet grouting uses a high-pressure water-grout mix jet to cut the ground and mix it with the stabilizing agent generating improved soil columns of significant diameter. Readers are referred to Ground Improvement Methods Reference Manual (FHWA 2004) for more details.

Ground Freezing: Ground freezing is often considered as 'last resource' due to its high cost when compared to other ground improvement measures. However, ground freezing achieves a high degree of reliability of ground modification. This particularly applies for non-uniform soils. The frozen ground provides groundwater cut-off while its mechanical properties are sufficiently increased to allow an efficient and safe tunnel excavation and support installation under the protection of the frozen soil body. Ground freezing has provided solutions for tunneling under very complex conditions in urban settings.

Readers are also referred to Chapter 7 for discussions about the above ground improvement techniques. Chapter 15 presents a ground freezing application for jacked box tunnels.

## **9.5.5 Portals**

### **9.5.5.1 General**

This section describes the layout of temporary tunnel portal structures for highway tunnels that are frequently built with SEM tunneling. These structures provide a protection against rock fall, and stabilize the portal face from which SEM tunneling commences thus provide start-up condition for safe tunnel excavation.

Shotcrete canopies are also frequently used as an extension of the tunnel and are integrated into the final tunnel portal architecture. The tunnel final lining is cast against these shotcrete canopies and therefore the tunnel internal geometry is uniform from the cut-and-cover (shotcrete canopy) section into the mined tunnel. The shotcrete canopies are backfilled for the final condition.

### 9.5.5.2 Pre-Support and Portal Collar

The level of weathering and loosening of rock close to the surface must be addressed when starting tunnel construction. Even in generally good rock mass, surface near weathering and loosening requires pre-support at the portal.

After clearing the surface and installing required rock support at the portal face, a row of horizontal pre-spiling or grouted steel pipes should be installed to provide pre-support for the initial excavation rounds for the tunnel construction. Dependent on the degree and depth of weathering, this pre-support is typically 10 ft (3 m) to 60 ft (18 m) long and the reinforcement elements are grouted in place. The pre-support elements are typically spaced at 12-inch (0.30 m) centers around the future tunnel opening. Such tunnel pre-support at the portal is shown in Figure 9-18.



Figure 9-18 Pre-Support at Portal Wall and Application of Shotcrete for Portal Face Protection (Devil's Slide Tunnels, California)

Following the pre-support installation, a reinforced shotcrete collar should be installed that is tied in with the protruding pre-support elements. The collar shall follow the tunnel perimeter extending from one sidewall to the other. In soft ground, the collar may extend over the entire tunnel perimeter. The collar provides stability to the ground in the immediate vicinity of the future tunnel opening and is structurally connected to the initial shotcrete lining for the first round of tunnel excavation.

### 9.5.5.3 Shotcrete Canopy

The shotcrete canopy comprises reinforced shotcrete and lattice girders. The canopy is founded on a strip foundation that extends over the entire length of the canopy. The length of the canopy is dependent on the rock fall protection required and on local conditions such as wind loads, temporary ventilation requirements, and needs of the final tunnel structure.

Portal canopies have to be designed for rock fall and snow loads, construction loads, dead loads, and any wind loads, as dictated by local site conditions. The canopy also serves as a counter form for final lining



installation in the portal area. Figure 9-19 displays construction of a shotcrete canopy whereas the first three lattice girders and reinforcement have been placed and shotcrete is being sprayed against an expanded metal sheet placed on the outside of the lattice girders.



Figure 9-19 Shotcrete Canopy Construction after Completion of Portal Collar and Pre-support (Schürzeberg Tunnel, Germany)

## 9.6 STRUCTURAL DESIGN ISSUES

### 9.6.1 Ground-Structure Interaction

The SEM realizes excavation and support in distinct stages with limitations imposed on size of excavation and length of round followed by the application of initial support measures. In particular the shotcrete lining has an interlocking function and provides an early, smooth support. To adequately address this sequenced excavation and support approach the structural design shall be based on the use of numerical, i.e. finite element, finite difference, or distinct element methods (see also Chapter 6). These numerical methods are capable of accounting for ground structure interaction. They allow for representation of the ground, the structural elements used for initial and final ground support, and enable an approximation of the construction sequence.

Embedded frame analyses have limitations in adequately describing the ground structure interaction. Due to this and the fact that these methods can not simulate excavation sequencing their use shall be limited to applications where the ground structure interaction phenomenon, in particular development of a ground-supporting arch, is of secondary importance. This is for example the case for shotcrete canopies that are frequently erected at tunnel portals as freestanding or backfilled reinforced shell structures and tunnel final linings.

## 9.6.2 Numerical Modeling

### 9.6.2.1 Two (2)-Dimensional and Three (3)-Dimensional Calculations

In general, use of two-dimensional models is sufficient for line structures. Where three-dimensional stress regimes are expected, such as at intersections between main tunnel and cross passages, or where detailed investigations at the tunnel face are undertaken such as for the behavior of pipe arch pre-supports, three-dimensional models should be used.

### 9.6.2.2 Material Models

In representing the ground, the structural models shall account for the characteristics of the tunneling medium. Material models used to describe the behavior of the ground shall apply suitable constitutive laws to account for the elastic, as well as inelastic ranges of the respective materials. For example when tunneling in rock, intact rock as well as the rock structure, i.e., the presence of discontinuities shall be taken into account. It is customary to apply Mohr-Coulomb or Drucker-Prager failure criteria for the representation of both rock and soil materials. Finite element programs that were developed initially for the simulation of underground excavations in rock such as Phase 2 by Rockscience, Inc. also allow use of rock mass material behavior using Hoek and Brown rock mass parameters (Hoek and Brown, 1980, 2002).

### 9.6.2.3 Ground Loads - Representation of the SEM Construction Sequence

Tunnel excavation causes a disturbance of the initial state of stress in the ground and creates a three-dimensional stress regime in the form of a bulb around the advancing tunnel face. Such a stress regime is indicatively displayed in Figure 9-20.

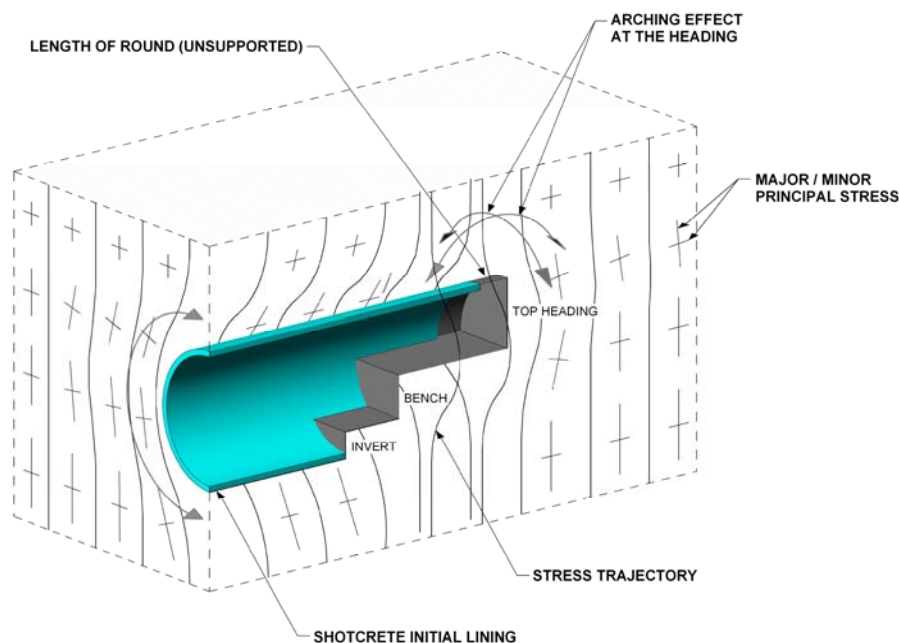

Figure 9-20 Stress Flow Around Tunnel Opening (after Wittke, 1984 and Kuhlmann)

Far ahead of the advancing tunnel face the initial state of stress is represented by vertical and horizontal stress trajectories denoting major and minor principal stresses respectively (assuming that vertical stresses are higher than horizontal stresses in a geostatic stress field). At the tunnel face the stresses flow around the tunnel opening arching ahead of the tunnel excavation and behind it onto the newly constructed initial lining in longitudinal direction and to the sides of the opening perpendicular to the tunneling direction. At a distance where the tunnel is no longer affected by the three-dimensional stress conditions around the active tunnel face two-dimensional arching conditions are established.

The extent of the stress disturbance around an active heading depends mainly on ground conditions, size of the excavation and length of round. This disturbance begins up to two excavation diameters ahead of the active tunnel face as shown indicatively in Figure 9-21. The SEM design dictates limits on excavation size and length of round and prescribes installation of initial support elements often following each individual excavation round directly or shortly thereafter. These requirements are portrayed in the Excavation and Support Class (ESC, see Chapter 9.5.3). Initial support elements are therefore installed within the shelter of a load-carrying arch around the newly created opening in an area where some pre-deformation has occurred. As the excavation of the tunnel advances the shotcrete hardens from an initially “green” shotcrete and becomes fully loaded at a distance of about one to two tunnel diameters from the face. Such sequencing combined with early support installation contributes to the development of the self-supporting capability of the ground. It further aids in minimizing deformations and ground loosening.

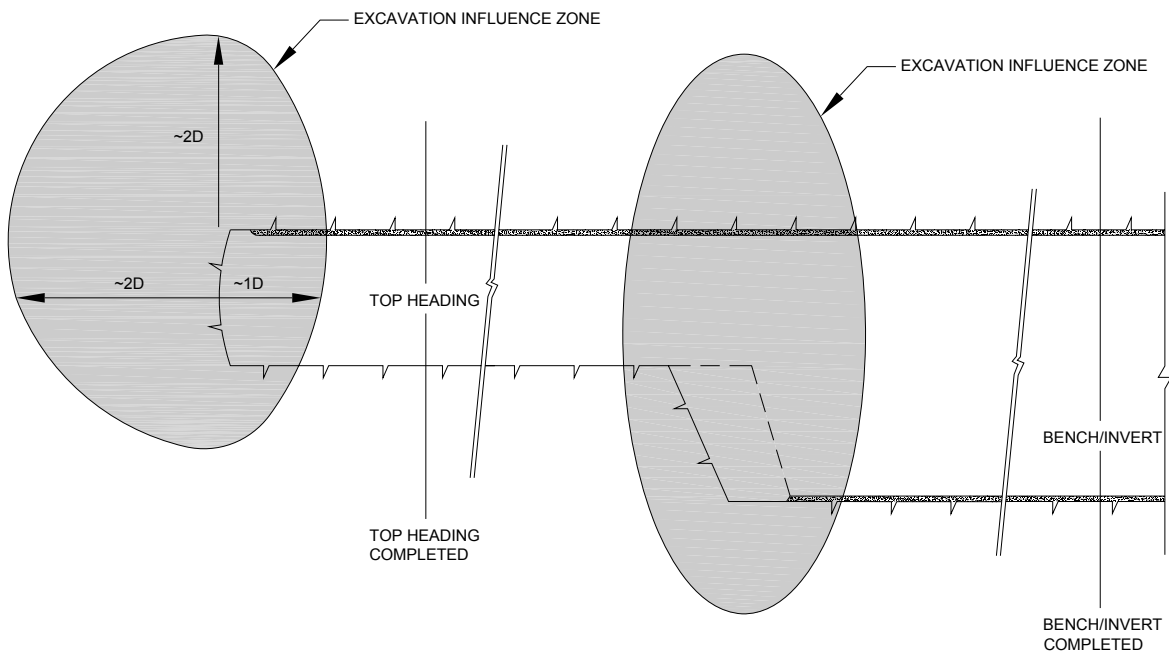

Figure 9-21 SEM Tunneling and Ground Disturbance (after OGG, 2007)

It is therefore important to portray this excavation and support sequencing closely in the numerical analyses. For shotcrete lining structural assessments it is important to distinguish between a “green” shotcrete when installed and when it has hardened to its 28-day design strength. Green shotcrete is typically simulated using a lower modulus of elasticity in the computations. A value of approximately 1/3 of the elastic modulus of cured shotcrete is commonly used to approximate green shotcrete in 2-D applications. In 3-D simulations the shotcrete may be modeled with moduli of elasticity in accordance with the anticipated strength gain in the respective round where it is installed.

Excavation and support installation sequencing can be readily realized in three-dimensional models. In two-dimensional modeling, however, auxiliary techniques must be utilized. A frequently utilized approach relies on the use of ground modulus reduction within the excavation perimeter prior to the insertion of the initial lining elements into the model. Other techniques involve the use of supporting forces applied to the circumference of the tunnel opening. Because of its frequent use the ground modulus reduction approach is used in describing a typical two-dimensional modeling sequence of SEM tunnel excavation and support of a line structure below. A calculation example is provided in Paragraph 9.7.3.7.

- Represent the in-situ stresses including the geostatic stress field and surface loads as applicable.
- Represent the excavation of the respective round by reducing the elastic modulus of the ground located within the geometric boundaries of the round to about 40% - 60% of its original value. The purpose of the modulus reduction is to achieve a pre-deformation of the ground prior to installation of the initial support measures. The extent of modulus reduction is only within the region where excavation takes place, i.e. a drift (top heading, bench, invert). It is an arbitrary measure applied to simulate an otherwise three-dimensional stress distribution at the face (see Figure 9-20) in two-dimensional computations. The value of 40-60% is a frequently used reduction amount and represents a typical range (Mohr and Pierau, 2004 and Coulter and Martin, 2004). A higher reduction will yield larger, a lower reduction will yield smaller deformations of the surrounding ground. A sensitivity analysis related to the actual reduction value is typically part of the computations.
- Activate the initial support elements per design assumptions to represent the installation of initial support. Because the shotcrete will not have developed its design strength at this stage reduced shotcrete elastic properties (modulus) are initially taken into account and amount to about 1/3 of the hardened shotcrete. During subsequent simulation stages the shotcrete modulus is then increased to its 28-day design strength to represent a fully hardened shotcrete lining.
- Remove the ground elements within the respective drift thereby completing excavation and support within the round.
- Repeat this sequence until all drifts of the final tunnel cross section geometry have been excavated and supported.

Once accomplished, this completes modeling of the tunnel excavation and installation of initial support. The installation of the final tunnel lining generally occurs once all deformations of the tunnel opening have ceased. To account for this fact the calculations perform installation of the final lining into a stress-free state. The final lining becomes loaded only in the long-term resulting from a (partial) deterioration of the initial support (shotcrete initial lining and rock bolts if any), rheological long-term effects and ground water if applicable. Although modeling of the final lining is often undertaken by embedded frame analyses (see Chapter 10) its analysis within a ground-structure interaction numerical model will be most appropriate and can follow directly after the initial support is installed as follows:

- Activate the structural elements representing the final tunnel lining.
- If the modeling was carried out with temporary rock reinforcing elements without corrosion protection then all such supporting elements are deactivated.
- If the ground water is generally aggressive and it may be assumed that the shotcrete initial lining will deteriorate long-term then it is assumed that no contributing support function may be derived from it for long-term considerations. This has been traditionally assumed on projects such as the Lehigh Tunnel, Cumberland Gap Tunnels and on NATM tunnels of the Washington, DC Metro. Washington Metropolitan Area Transit Authority (WMATA) has substantial experience with the design and construction of NATM tunnels in both soft ground and rock (Rudolf et al., 2007). To date it is

customary on WMTA projects to assume that the shotcrete initial lining will deteriorate over time. Such computational approach will yield a conservative final lining design. Due to the nowadays high quality shotcrete fabrication however, and in particular in non-aggressive ground and ground water conditions it is admissible to assume that when the shotcrete initial lining is more than approximately 6-inch (150 mm) thick then 50% of its structural capacity may be taken into account in the final lining computations. The combined removal of initial support elements (rock reinforcement and shotcrete initial lining) will result in ground loads imposed onto the final lining in the long-term.

- In addition to the ground loads, the concrete lining will be loaded with hydrostatic loads in un-drained or partially drained waterproofing systems. This load case generally occurs well before the final lining is loaded with any ground loads and shall be considered separately in the calculations.
- Final lining calculations consider the existence of the waterproofing system, which is embedded between the initial shotcrete lining and the final lining. A plastic membrane will act as a de-bonding layer in terms of the transfer of shear stresses. Therefore simulation techniques should be used to simulate this “slip” layer. This is accomplished by only allowing the transfer of radial forces from the initial lining onto the final lining.

#### **9.6.2.4 Ground Stresses and Deformations**

Each step involving the simulation of excavation and installation of initial support allows for analysis of the ground response expressed in deformations, strains, and stresses. Both, elastic and, if yielded, inelastic portions of strains can be obtained and used to evaluate the state of stress in the ground and its capacity reserves. Stresses, strains and section forces are available in ground support elements such as dowels and rock bolts. The computational programs (for a selected list see Chapter 6) often provide such information in a user friendly display using numeric and graphic formats.

#### **9.6.2.5 Lining Forces**

Section forces and stresses are available for beam (2-D) or shell (3-D) elements. Section force and moment combinations are used to evaluate the capacity of the initial shotcrete and final concrete linings using ACI 318 or other accepted concrete design codes. Acceptance of codes is generally an owner driven process. For example, Washington Metropolitan Area Transit Authority (WMATA) allowed the use of the German Industry Standard DIN 1045 for the design of plain (unreinforced) cast-in-place concrete final linings (Rudolf et al., 2007 and Gnisen, 1986).

Based on this evaluation the adequacy of lining thickness and its reinforcement (if any) is assessed. If the selected dimensions are found not to be adequate then the model must be re-run with increased dimensions and/or reinforcement. The process is an iterative approach until the design codes are satisfied.

These calculations do not distinguish between the type of lining application and therefore shotcrete and cast-in-place final linings are treated in the same manner within the program using the material properties and characteristics of concrete.

#### **9.6.2.6 Ground Reinforcing Elements**

Ground reinforcing elements are rock bolts and dowels. These are activated in the computations in accordance with the design of the SEM excavation and support installation. Once implemented and loaded during the simulation of excavation and support, section forces and stresses are available to evaluate their adequacy. Stresses and forces are compared with the capacity of the individual dowel or bolt.

### **9.6.2.7 Calculation Example**

A calculation example (Appendix F) demonstrates the SEM tunneling analysis and lining design of a typical two-lane highway tunnel using the finite element code Phase2 by Rocscience, Inc. The calculation is carried out in stages and follows the approach laid out in 9.6.2.3 above and evaluates ground reaction as indicated in 9.6.2.4 and evaluates support elements as described in 9.6.2.5 and 9.6.2.6.

### **9.6.3 Considerations for Future Loads**

Mainly due to its flexibility and ability to minimize surface settlements often in combination with ground improvement methods the SEM is frequently utilized for the construction of roadway tunnels in urban settings. In particular under such circumstances it is important to consider any future loads that may be imposed onto the tunnel for which the final linings must be designed. Such loads include among others buildings, foundations, and miscellaneous underground structures fulfilling future infrastructure needs. These can be readily implemented in the computation approach presented above in the form of external or internal modeling loads.

## **9.7 INSTRUMENTATION AND MONITORING**

### **9.7.1 General**

An integral part of SEM tunneling is the verification by means of in-situ monitoring of design assumptions made regarding the interaction between the ground and initial support as a response to the excavation process.

For this purpose, a specific instrumentation and monitoring program is laid out in addition to general instrumentation programs connected with the overall tunneling work, i.e. surface and subsurface instrumentation. The SEM tunnel instrumentation aims at a detailed and systematic measurement of deflection of the initial lining. While monitoring of deformation is the main focus of instrumentation historically stresses in the initial shotcrete lining and stresses between the shotcrete lining and the ground were monitored to capture the stress regime within the lining and between lining and ground. Reliability of stress cells, installation complexity and difficulty in obtaining accurate readings have nowadays led to the reliance on deformation monitoring only in standard tunneling applications. Use of stress cells is typically reserved for applications where knowledge of the stress conditions is important, for example where high and unusual in-situ ground stresses exist or high surface loads are present in urban settings.

Monitoring data are collected, processed and interpreted to provide early evaluations of:

- Adequate selection of the type of initial support and the timing of support installation in conjunction with the prescribed excavation sequence
- Stabilization of the surrounding ground by means of the self-supporting ground arch phenomenon,
- Performance of the work in excavation technique and support installation
- Safety measures for the workforce and the public
- Long-term stress/settlement behavior for final safety assessment
- Assumed design parameters, such as strength properties of the ground and in-situ stresses used in the structural design computations (see Chapter 9.7).

Based on this information, immediate decisions can be made in the field concerning proper excavation sequences and initial support in the range of the given ground response classes (GRC) and with respect to the designed excavation and support classes (ESC).

### 9.7.2 Surface and Subsurface Instrumentation

The general instrumentation should include surface settlement markers, cased deep benchmarks, subsurface shallow and deep settlement indicators, inclinometers, multiple point borehole extensometers, and piezometers (see Chapter 15).

The locations, types and number of these instruments should be determined by consultations between the civil, structural, geotechnical and SEM design teams to provide information on surface and subsurface structure settlements and to complement the SEM tunnel instrumentation readings.

### 9.7.3 Tunnel Instrumentation

Deformation Measurements Instruments are installed in the tunnel roof and at selected points along the tunnel walls to monitor vertical, horizontal, and longitudinal (in tunnel direction) deformation components. The number of points and their detailed location depends on the size of the tunnel and the excavation sequencing in multiple drift applications. As a minimum, the wall of each drift (including temporary) should be equipped with a device capable of measuring deformations. It is customary to install optical targets for this purpose. Figure 9-22 shows a series of deformation monitoring cross sections using optical targets in a SEM tunnel. Optical targets are the white reflecting points arranged in the tunnel roof and tunnel sidewalls.



Figure 9-22 Deformation Monitoring Cross Section Points (Light Rail Bochum, Germany)

Stress Measurements If stress information is sought then measurements should be taken with a direct measuring tool that does not rely on any further conversions from say strains to stresses. For example, instruments based on strain gage principles require the knowledge of the elastic modulus of the material

to covert strains to stresses. This introduces an additional parameter that must be estimated thus introducing a secondary uncertainty.

Stress measurements within shotcrete linings are frequently carried out using hydraulic pressure cells filled with mercury whereas ground stress measurements are carried out with cells filled with oil. If stress measurements are to be monitored then ground load cells and concrete pressure cells should be grouped in pairs.

### 9.7.4 SEM Monitoring Cross Sections

Monitoring devices are grouped into monitoring cross sections (MCS). These MCS are depicted with their respective instrument layout indicating location and number of instruments within that MCS. Typical MCSs are shown on the design drawings for each individual tunnel cross-section geometry and excavation sequence. Locations of the respective monitoring cross-sections are shown on dedicated instrumentation drawings by station references. An example deformation MCS is shown in Figure 9-23.

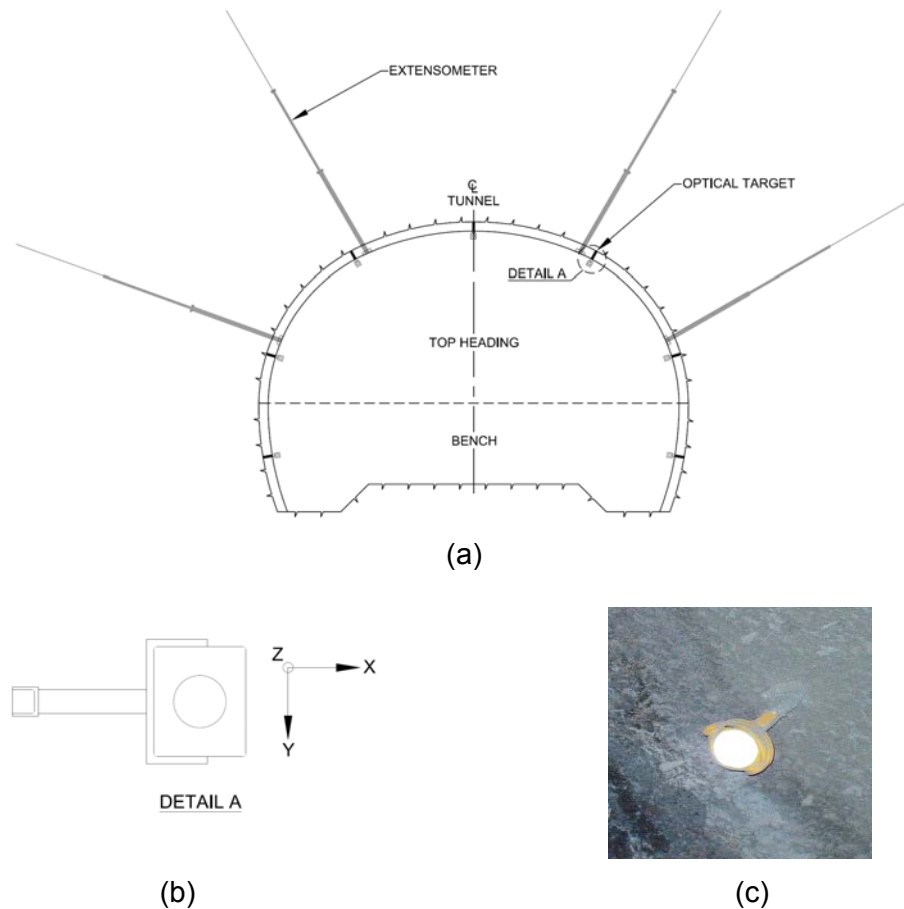

Figure 9-23 Typical SEM Deformation Monitoring Cross Section - a) Typical Tunnel Monitoring Cross Section displaying Extensometers and Optical Targets, b) Detail A, view of Optical target displaying axes of measurement: Y=Vertical Displacement, X=Lateral Displacement, Z=Longitudinal Displacement, c) Image of Optical Target in place.



During execution the installation of all MCSs is documented by a detailed description of the geological and tunneling conditions in the field using sketches showing the exact location of the instruments and the actual thickness of the shotcrete lining.

### 9.7.5 Interpretation of Monitoring Results

All readings must be thoroughly and systematically collected and recorded. An experienced SEM tunnel engineer, often the SEM tunnel designer, must evaluate the data, occasionally complemented by visual observations of the initial shotcrete lining for any distress, for example as indicated by cracking. To establish a direct relationship between the behavior of the tunnel and the ground as these react to tunnel excavation it is recommended to portray the development of monitoring values as a function of the tunnel progress. This involves a combined graph showing the monitoring value (i.e. deformation, stress or other) vs. time and the tunnel progress vs. time. An example is shown in Figure 9-24. In this example a prototypical deformation of a surface settlement point located above the tunnel centerline has been graphed on the ordinate (left vertical axis) vs. time on the horizontal axis. The same time horizontal axis is used to portray the tunnel excavation progress by station location on the right vertical axis. As can be seen from this graph the surface settlement increases as the top heading and later bench/invert faces move towards and then directly under that point and gradually decrease as both faces again move away from the station location of the surface settlement point. The settlement curve shows an asymptotic behavior and becomes near horizontal as the faces are sufficiently far away from the monitoring point indicating that no further deformations associated with tunnel excavation and support occur in the ground indicating equilibrium and therefore ground stability.

The evaluation of monitoring results along with the knowledge of local ground conditions portrayed on systematic face mapping sheets forms the basis for the verification of the selected excavation and support class (ESC) or the need to make any adjustments to it.

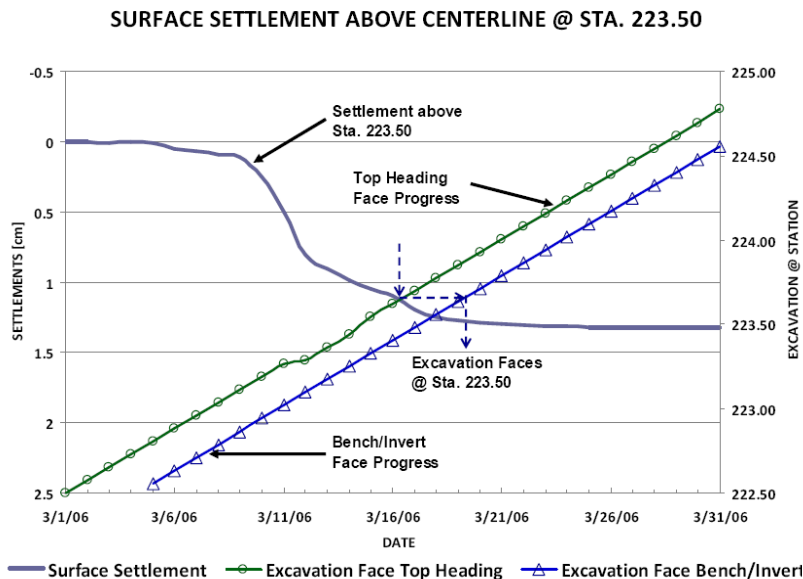

Figure 9-24 Prototypical Monitoring of a Surface Settlement Point Located Above the Tunnel Centerline in a Deformation vs. Time and Tunnel Advance vs. Time Combined Graph

## 9.8 CONTRACTUAL ASPECTS

SEM construction requires solid past experience and personnel skill. This skill relates to the use of construction equipment and handling of materials for installation of the initial support including shotcrete, lattice girders, pre-support measures, and rock reinforcing elements and even more importantly observation and evaluation of the ground as it responds to tunneling. It is therefore important to invoke a bidding process that addresses this need formally by addressing contractor qualifications and skills and payment on a unit price basis described below. For general contractual aspects refer to Chapter 14.

### 9.8.1 Contractor Pre-Qualification

It is recommended that the bidding contractors be pre-qualified to assure a skilled SEM tunnel execution. This pre-qualification can occur very early on during the design development but at a minimum should be performed as a separate step prior to soliciting tunnel bids. On critical SEM projects such as the NATM tunneling at Russia Wharf in Boston in the late 90's the project owner solicited qualifications from contractors at the preliminary design stage. This pre-qualification resulted in a set of pre-qualified contractors that were invited to comment on the design at the preliminary and intermediate design stages. This early process ensured that contractors were aware of the upcoming work and could plan ahead in assembling a qualified work force. Pre-qualification documents shall identify the scope of work and call for a similar experience gained on past projects by the tunneling company and key tunneling staff including project manager, tunnel engineers, and tunnel superintendents. As a minimum the documents lay out description of ground conditions, tunnel size and length, excavation and support cycles, and any special methods intended for ground improvement.

### 9.8.2 Unit Prices

It is recommended that SEM tunneling be procured within a unit price based contract. Unit prices suit the observational character of SEM tunneling and the need to install initial support in accordance with a classification system and amount of any additional initial or local support as required by field conditions actually encountered. The following shall be bid on a unit price basis:

- Excavation and Support on a linear foot basis for all excavation and installation of initial support per Excavation and Support Class (ESC). This shall include any auxiliary measures needed for dewatering and ground water control at the face.
- Local support measures including:
  - Shotcrete per cubic yard installed.
  - Pre-support measures such as spiling, canopy pipes and any other support means such as rock bolts and dowels, lattice girders, and face dowels shall be paid per each (EA) installed.
  - Instrumentation and monitoring shall be paid for either typical instrument section (including all instruments) or per each instrument installed. Payment will be inclusive of submitted monitoring results and their interpretation.
  - Ground improvement measures per unit implemented, for example amount of grout injected including all labor and equipment utilized.

Waterproofing and final lining installed to complete the typical SEM dual lining structure may be procured on either lump sum basis or on a per tunnel foot basis.

The quantity of local support (additional initial support) measures shall be part of the contract to establish a basis for bid.

## **9.9 EXPERIENCED PERSONNEL IN DESIGN, CONSTRUCTION, AND CONSTRUCTION MANAGEMENT**

Because the SEM relies on tunneling experience it is imperative that experienced personnel be assigned from the start of the project, i.e., in its planning and design phase. The SEM design must be executed by an experienced designer. At this level of project development it is incumbent upon the owner to select a team that includes a tunnel designer with previous, proven, and relevant SEM tunneling design and construction experience.

The SEM tunnel contract documents have to identify minimum contractor qualifications. In this case it is secondary whether the project is executed in a design-bid-build, design-build or any other contractual framework. For example, if the project uses the design-build framework then it is imperative that the builder take on an experienced SEM tunnel designer.

The construction contract documents must spell out minimum qualifications for the contractor's personnel that will initially prepare and then execute the SEM tunnel work. This is the case for field engineering, field supervisory roles and the labor force who must be skilled. SEM contract documents call for a minimum experience of key tunneling staff by number of years spent in the field on SEM projects of similar type. Experienced personnel will include Senior SEM Tunnel Engineers, Tunnel Superintendents and Tunnel Foremen. All of such personnel should have a minimum of ten (10) years SEM tunneling experience. These personnel are charged with guiding excavation and support installation meeting the key requirements of SEM tunneling:

- Observation of the ground
- Evaluation of ground behavior as it responds to the excavation process
- Implementation of the "right" initial support.

Knowledgeable face mapping, execution of the instrumentation and monitoring program, and interpretation of the monitoring results aid in the correct application of excavation sequencing and support installation. Figure 9-24 displays a typical face mapping form sheet that is used to document geologic conditions encountered in the field. While this form sheet portrays mapping for rock tunneling, mapping of soft ground conditions is similar and lays out the characteristics of anticipated soil conditions. Face mapping should occur for every excavation round and be formally documented and signed off by both the contractor and the owner's representative.

The Senior SEM Tunnel Engineer is generally the contractor's highest SEM authority and supervises the excavation and installation of the initial support, installation of any local or additional initial support measures and pre-support measures in line with the contract requirements and as adjusted to the ground conditions encountered in the field. As a result the ground encountered is categorized in accordance with the contract documents into ground response classes (GRCs) and the appropriate excavation and support classes (ESC) per contract baseline. Any need for additional initial support and/or pre-support measures is assessed and implemented. This task is carried out on a daily basis directly at the active tunnel face and is discussed with the Owner's representative for each round. The outcome of this process is subsequently documented on form sheets that are then signed by the Contractor's and Owner's representatives for concurrence.

This frequent assessment of ground conditions provides for a continuous awareness of tunneling conditions, for an early evaluation of adequacy of support measures and as needed for implementation of contingency measures that may involve more than additional initial support means. Such contingency



## CHAPTER 10 TUNNEL LINING

### 10.1 INTRODUCTION

This chapter covers considerations for the structural design, detailing and construction of tunnel linings for highway tunnels focusing on mined or bored tunnels. Tunnel linings are structural systems installed after excavation to provide ground support, to maintain the tunnel opening, to limit the inflow of ground water, to support appurtenances and to provide a base for the final finished exposed surface of the tunnel. Tunnel linings can be used for initial stabilization of the excavation, permanent ground support or a combination of both. The materials for tunnel linings covered in this chapter are cast-in-place concrete lining (Figure 10-1), precast segmental concrete lining (Figure 10-2), steel plate linings (Figure 10-3), and shotcrete lining (Figure 10-4). Uses, design procedures, detailing and installation are covered in subsequent sections of this chapter. The final finishes are not specifically addressed.



Figure 10-1 Cumberland Gap Tunnel

Cast-in-place concrete linings are generally installed some time after the initial ground support. Cast-in-place concrete linings are used in both soft ground and hard rock tunnels and can be constructed of either reinforced or plain concrete. Cast-in-place concrete linings can take on any geometric shape, with the shape being determined by the use, mining method and ground conditions.

Precast concrete linings are used as both initial and final ground support (Figure 10-2). Segments in the shape of circular arcs are precast and assembled inside the shield of a tunnel boring machine to form a ring. If necessary they can be used in a two pass system as only the initial ground support. Initial Support Segments for a two pass system are often lightly reinforced and rough cast. The second pass or final lining typically is cast-in-place concrete. Precast concrete linings can also be used in a one pass system where the segments provide both the initial and final ground support. One pass precast segmental

concrete linings are cast to strict tolerances and are provided with gaskets and bolted together to reduce the inflow of water into the tunnel.



Figure 10-2 Precast Segmental Lining

Steel plate linings (liner plates) are a type of segmental construction where steel plates are fabricated into arcs that typically are assembled inside the shield of a tunnel boring machine to form a ring. The steel plate lining may form the initial and final ground support. The segments are provided with gaskets to limit the inflow of ground water into the tunnel. Steel plates are also used in lieu of lagging where steel ribs are used as the initial ground support. With the advent of precast concrete segments, liner plates are not used as much as previously.



Figure 10-3 Baltimore Metro Steel Plate Lining

As discussed in Chapter 9, shotcrete is a pneumatically applied concrete that is used frequently as an initial support but now with the advances in shotcrete technology permanent shotcrete lining is designed and constructed in conjunction with sequential excavation method (SEM) tunneling (Chapter 9). One of the first applications of final shotcrete lining in the United States is at Lehigh Tunnel No. 2 of Pennsylvania Turnpike. Shotcrete can take on a variety of compositions as discussed in Chapters 9 and 16. It can be applied over the exposed ground, reinforcing steel, welded wire fabric or lattice girders. It can be used in conjunction with rock bolts and dowels, it can contain steel or plastic fibers and it can be composed of a variety of mixes. It is applied in layers to achieve the desired thickness. Chapter 16 addresses using shotcrete for concrete lining repairs.



Figure 10-4 New Lehigh Tunnel on Pennsylvania Turnpike Constructed with Final Shotcrete Lining

Cross passages and refuge areas are usually mined by hand after the main tunnel is excavated. These areas, due to their unique shape and small areas are typically lined with cast-in-place concrete. There is insufficient quantity involved in the lining of these features to make prefabricated linings economic.

### 10.1.1 Load and Resistance factor Design (LRFD)

The design of tunnel linings, with the exception of steel tunnel lining plates, is not addressed in standard design codes. This chapter is intended to establish procedures for the design of tunnel linings utilizing the American Association of State Highways and Transportation Officials (AASHTO) LRFD Bridge Design Specifications, current edition.

LRFD is a design philosophy that takes into account the variability in the prediction of loads and the variability in the behavior of structural elements. It is an extension of the load factor design methodology that has been in use for a number of years. This chapter is intended to assist the designer in the application of the LRFD specifications to tunnel lining design and to provide for a uniform interpretation of the AASHTO LRFD specification as it applies to tunnel linings.

## 10.2 DESIGN CONSIDERATIONS

### 10.2.1 Lining Stiffness and Deformation

Tunnel linings are structural systems, but differ from other structural systems in that their interaction with the surrounding ground is an integral aspect of their behavior, stability and overall load carrying capacity. The loss or lack of the support provided by the surrounding ground can lead to failure of the lining. The ability of the lining to deform under load is a function of the relative stiffnesses of the lining and the surrounding ground. Frequently, a tunnel lining is more flexible than the surrounding ground. This flexibility allows the lining to deform as the surrounding ground deforms during and after tunnel excavation. This deformation allows the surrounding ground to mobilize strength and stabilize. The tunnel lining deformation allows the moments in the tunnel lining to redistribute such that the main load inside the lining is thrust or axial load. The most efficient tunnel lining is one that has high flexibility and ductility.

A tunnel lining maintains its stability and load carrying capacity through contact with the surrounding ground. As load is applied to one portion of the lining, the lining begins to deform and in so doing, develops passive pressure along other portions of the lining. This passive pressure prevents the lining from buckling or collapsing. Ductility in the lining allows for the creation of “hinges” at points of high moment that relieve the moments so that the primary load action is axial force. This ductility is provided for in concrete by the formation of cracks in the concrete. Under reinforcing or no reinforcing help promote the initiation of the cracks. The joints in segmental concrete linings also provide ductility. In steel plate linings, the negligible bending stiffness of the steel plates and the inherent ductility of steel allow for the creation of similar hinges.

### 10.2.2 Constructability Issues

Each tunnel is unique. Ground conditions, tunneling means and methods, loading conditions, tunnel dimensions and construction materials all vary from tunnel to tunnel. Each tunnel must be assessed on its own merits to identify issues that should be considered during design such that construction is feasible. Some common elements that should be considered are as follows:

- Materials: Selection of tunnel lining materials should be made to facilitate transportation and handling of the materials in the limited space inside a tunnel. Pieces should be small and easily handled. Piece lengths should be checked to ensure that they can negotiate the horizontal and vertical geometry of the tunnel. Materials should be nontoxic and nonflammable.
- Details: Detailing should be performed to facilitate ease of construction. For example, sloping construction joints in cast-in-place concrete linings can eliminate the difficulty associated with building a bulkhead against an irregular excavated surface.
- Procedures: Construction procedures should be specified that are appropriate for conditions encountered in the tunnel; conditions that are often moist or wet, sometimes even with flowing water. Allow means and methods that do not block off portions of the tunnel for significant periods of time. The entire length of the tunnel should be available as much as practical.



### **10.2.3 Durability**

Tunnels are expensive and are constructed for long term use. Many existing tunnels in the United States have been in use for well over one hundred years with no end in sight to their service lives. Having a tunnel out of service for an extended period of time can result in great economic loss. As such, details and materials should be selected that can withstand the conditions encountered in underground structures. All structures, including tunnels require inspection, periodic maintenance and repair. Chapter 17 discusses tunnel inspection, maintenance, and rehabilitation. Nonetheless, detailing should be such that anticipated maintenance is simplified and long term durability is maximized.

Highway tunnels can also be exposed to extreme events such as fires resulting from incidents inside the tunnel. Tunnel lining design should consider the effects of a fire on the lining. The lining should be able to withstand the heat of the fire for some period of time without loss of structural integrity. The length of time required will be a function of the intensity of the anticipated fire and the response time for emergency personnel capable of fighting the fire. The tunnel lining should also sustain as little damage as possible so that the tunnel can go back into service as soon as possible. Protection from fire can be gained from concrete cover, tunnel finishes and the inclusion of plastic fibers in concrete mixes.

### **10.2.4 High Density Concrete**

High density concrete is produced by using very finely ground cement and/or substituting various materials such as fly ash or blast furnace slag for cement. The cementitious content of high density concrete is very high. The high cement content makes handling difficult under ideal conditions. Complicated mixes with multiple admixtures and careful water monitoring are required to keep the concrete in a plastic state long enough to be placed in forms. High cement content will result in high heat of hydration. Proper curing of these materials is essential to produce a quality end product. Improper or incomplete curing can be the cause of severe cracking due to shrinkage. Shrinkage cracks can reduce the effectiveness of the product, affect its durability and potentially make it unusable.

High density concrete, however, can be beneficial in many tunnel applications. It can limit the inflow of water and provide significant protection against chemical attack. High density concrete has low heat conductivity which is beneficial in a fire. High density concrete should be used in conjunction with careful inspection and strict enforcement of specifications during construction.

### **10.2.5 Corrosion Protection**

Corrosion is associated with steel products embedded in the concrete and otherwise used in tunnel applications. Ground water, ground chemicals, leaks, vehicular exhaust, dissimilar metals, deicing chemicals, wash water, detergents, iron eating bacteria and stray currents are all sources of corrosion in metals. Each of these and any other aspect that is unique to the tunnel under consideration must be evaluated during the design phase. Corrosion protection methods designed to combat the source of corrosion should be incorporated into the design.

Corrosion protection can take the form of coatings such as epoxies, powder coatings, paint or galvanizing. Insulation can be installed between dissimilar metals and sources of stray currents. High density concrete can provide protection for reinforcing steel. Coatings on concrete can minimize the infiltration of water, a component of almost all corrosion processes. Tunnel finishes can also protect the tunnel structural elements from attack by the various sources of corrosion.

Cathodic protection uses sacrificial material to protect the primary material from corrosion. In highly corrosive environments, an electrical current is induced in the materials to force corrosion to occur in the sacrificial material. These systems are highly effective when properly designed, installed and maintained. Sacrificial elements must be replaced and electrical supply equipment serviced regularly. Cathodic protection also requires a reliable long term source of electricity and adds to the maintenance and operation costs of the tunnel.

Increased concrete cover over reinforcing steel is an effective means of protecting reinforcing steel from corrosion. Increasing the concrete cover, however will also increase the thickness of the lining. The increased thickness will result in a larger excavation which will increase the overall cost of the tunnel. The use of increased concrete cover should be evaluated in terms of the overall cost of the tunnel compared to the benefit derived.

### **10.2.6 Lining Joints**

Joints in linings are required to facilitate construction. Cast-in-place concrete requires construction joints. Construction joints can be sloped or formed. Segmental linings constructed from concrete or steel can have either bolted or unbolted joints. Unbolted joints are used in both gasketed and ungasketed concrete segments. Steel liner plates are bolted. More detailed information on the advantages and disadvantages of joints is provided in subsequent sections of this chapter.

Joints in linings also provide relief from stresses induced by movements due to temperature changes. Cast-in-place linings should have contraction joints every 30 feet and expansion joints every 120 feet. Expansion joints should also be used where cut and cover portions of the tunnel transition to the mined portion. Segmental concrete linings do not require contraction joints and require expansion joints only at the cut and cover interface.

## **10.3 STRUCTURAL DESIGN**

Structural design will be governed by the latest AASHTO LRFD Bridge Design Specifications. The AASHTO specifications do not cover structural plain concrete which is frequently used in tunnel lining construction. This chapter will provide design procedures based on the AASHTO specifications for structural plain concrete. These procedures can be found in section 10.4 Cast-in-Place Concrete.

### **10.3.1 Loads**

The loads to be considered in the design of structures along with how to combine the loads are given in Section 3 of the LRFD specifications. Section 3 of the LRFD specification divides loads into two categories: Permanent Loads and Transient Loads. Paragraph 3.3.2 “Load and Load Designation” of the LRFD specifications defines the following permanent loads that are applicable to the design of mined tunnel linings:

DC = Dead Load: This load comprises the self weight of the structural components as well as the loads associated with nonstructural attachments. Nonstructural attachments can be signs, lighting fixtures, signals, architectural finishes, waterproofing, etc. Typical unit weights for common building materials are given in Table 3.5.1-1 of the AASHTO LRFD specifications. Actual weights for other items should be calculated based on their composition and configuration.

DW = Dead Load: This load comprises the self weight of wearing surfaces and utilities. Utilities in tunnels can include power lines, drainage pipes, communication lines, water supply lines, etc.

Wearing surfaces can be asphalt or concrete. Dead loads of wearing surfaces and utilities should be calculated based on the actual size and configuration of these items.

EH = Horizontal Earth Pressure Load. The information required to calculate this load are derived by the geotechnical data developed during the subsurface investigation program. The methods used in determining earth loads on mined tunnel linings are described in Chapters 6 and 7 of this manual.

ES = Earth surcharge load. This is the vertical earth load due to fill over the structure that was placed above the original ground line. It is recommended that a minimum surcharge load of 400 psf be used in the design of tunnels. If there is a potential for future development adjacent to the tunnel structure, the surcharge from the actual development should be used in the design of the structure. In lieu of a well defined loading, it is recommended that a minimum value of 1000 psf be used when future development is a possibility.

EV = Vertical earth pressure. The methods used in determining earth loads on mined tunnel linings are described in Chapters 6 and 7 of this manual.

Paragraph 3.3.2 “Load and Load Designation” of the LRFD specifications defines the following transient loads that are applicable to the design of mined tunnel linings:

CR = Creep.

CT = Vehicular Collision Force: This load would be applied to individual components of the tunnel structure that could be damaged by vehicular collision. Typically, tunnel linings are protected by redirecting barriers so that this load need be considered only under usual circumstances. It is preferable to detail tunnel structural components and appurtenances so that they are not subject to damage from vehicular impact.

EQ = Earthquake. This load should be applied to the tunnel lining as appropriate for the seismic zone for the tunnel. Other extreme event loadings such as explosive blast should be considered. The scope of this manual does not include the calculation of or design for seismic and blast loads, however, the designer must be aware that extreme event loads should be accounted for in the design of the tunnel lining.

IM = Vehicle dynamic load allowance: This load is applied to the roadway slabs of mined tunnels. This load can also be transmitted to a tunnel lining through the ground surface when the tunnel is under a highway, railroad or runway. Usually a mined tunnel is too far below the surface to have this transmitted to the structure. However, this load may be a consideration near the interface between the cut and cover approaches and the mined tunnel section. An equation for the calculation of this load is given in paragraph 3.6.2.2 of the AASHTO LRFD specifications.

LL = Vehicular Live Load: This load is applied to the roadway slabs of mined tunnels. This load can also be transmitted to a tunnel lining through the ground surface when the tunnel is under a highway, railroad or runway. Usually a mined tunnel is too far below the surface to have this loads from the surface transmitted to the structure however, this load may be a consideration near the interface between the cut and cover approaches and the mined tunnel section.. Guidance for the distribution of live loads to buried structures can be found in paragraphs 3.6.1 of the AASHTO LRFD specifications.

- LS = Live Load Surcharge: This load is applied to the lining of tunnels that are constructed under other roadways, rail lines, runways or other facilities that carry moving vehicles. This is a uniformly distributed load that simulates the distribution of wheel loads through the earth fill. Usually a mined tunnel is too far below the surface to have this loads from the surface transmitted to the structure, however, this load may be a consideration near the interface between the cut and cover approaches and the mined tunnel section.
- PL = Pedestrian Live load. Pedestrian are typically not permitted in highway tunnels, however, there are areas where maintenance and inspection personnel will need access. Areas such as ventilation ducts when transverse ventilation is used, plenums above false ceilings, and safety walks. These loads are transmitted to the lining through the supporting members for the described features.
- SH = Shrinkage. Cut and cover tunnel structural elements usually are relatively massive. As such, shrinkage can be a problem. This load should be accounted for in the design or the structure should be detailed to minimize or eliminate it.
- TU = Uniform Temperature. This load is used primarily to size expansion joints in the structure. If movement is permitted at the expansion joints, no additional loading need be applied to the structure. Since the structure is very stiff in the primary direction of thermal movement, the effects of the friction force resulting from thermal movement can be neglected in the design.
- WA = Water load. This load represents the hydrostatic pressure expected outside the tunnel structure. Mined tunnels are usually detailed to be watertight without provisions for relieving the hydrostatic pressure. As such, the tunnel lining is subject to hydrostatic pressure. Hydrostatic pressure acts normal to the surface of the tunnel. It should be assumed that water will develop full hydrostatic pressure on the tunnel when no relief mechanism is used. The calculation of this load should take into account the specific gravity of the groundwater which can be saline near salt water. Both maximum and minimum hydrostatic loads should be used for structural calculations. For the purpose of design, the hydrostatic pressures assumed to be applied to underground structures should ignore pore pressure relief obtained by any seepage into the structures unless an appropriately designed pressure relief system is installed and maintained. Two groundwater levels should be considered: normal (observed maximum groundwater level) and extreme, 3 ft (1 m) above the 200-year flood level. The buoyancy force should be carefully evaluated to ensure that the applied dead load effect is larger than the applied buoyancy effect. Calculations for buoyancy should be based on minimum characteristic material densities and maximum water density. The total uplift force is equal to the weight of water displaced. Friction effects (the theoretical force required to dislodge the wedge of material over the tunnel) of overlying natural materials and backfill should not be taken into account, however the weight of soil and water over the tunnel should be used to calculate the resisting forces. When a relief system is included, the functioning of the relief system is evaluated to determine the hydrostatic pressure to be applied to the tunnel.

Some of the loads shown in paragraph 3.3.2 of the LRFD specifications are not shown above because they are not applicable to the design of mined highway tunnels as described below.

- DD = Downdrag: This load comprises the vertical force applied to the exterior of the lining that can result from the subsidence of the surrounding soil due to the subsidence of the in-situ soil below the bottom of the tunnel. This load would not apply to mined tunnels since it requires subsidence or settlement of the material below the bottom of the structure to engage the downdrag force of the lining. For the typical highway tunnel, the overall weight of the structure is usually less than the soil it is replacing. As such, unless backfill in excess of the original ground elevation is placed

over the tunnel or a structure is constructed over the tunnel, settlement will not be an issue for mined tunnels.

- BR = Vehicular Breaking Force: This load would be applied only under special conditions where the detailing of the structure requires consideration of this load. Under typical designs, this force is resisted by the mass of the roadway slab and need not be considered in design.
- CE = Vehicular centrifugal force: This load would be applied only under special conditions where the detailing of the structure requires consideration of this load. Under typical designs, this force is resisted by the mass of the roadway slab and need not be considered in design.
- CV = Vessel Collision Force is not applicable since it would only be applied to immersed tube tunnels. Immersed tube tunnels are a specialized form of cut and cover tunnel and are covered separately in Chapter 12 of this manual.
- EL = Accumulated locked-in force effects resulting from the construction process including secondary forces from post tensioning.
- FR = Friction. As stated above, the structure is very stiff in the direction of thermal movement. Thermal movement is the source of the friction force. In a typical tunnel, the effects of friction can be neglected.
- IC = Ice load. Since the tunnel is not subjected to stream flow nor exposed to the weather in a manner that could result in an accumulation of ice, this load is not used in cut and cover tunnel design.
- SE = Settlement. For the typical highway tunnel, the overall weight of the structure is usually less than the soil it is replacing. As such, unless backfill in excess of the original ground elevation is placed over the tunnel or a structure is constructed over the tunnel, settlement will not be an issue for cut and cover tunnels. If settlement is anticipated due to poor subsurface conditions or due to the addition of load onto the structure or changing ground conditions along the length of the tunnel, it is recommended that a deep foundation (piles or drilled shafts) be used to support the structure. Ground settlements are difficult to predict and are best eliminated by the use of deep foundations.
- TG = Temperature Gradient. This load should be examined on case by case basis depending on the local climate and seasonal variations in average temperatures. Typically due to the relative thin members used in tunnel linings, this load is not used. Paragraph 4.6.6 of the AASHTO LRFD specifications provides guidance on calculating this load. Note that paragraph C3.12.3 of the AASHTO LRFD Specifications allows the use of engineering judgment to determine if this load need be considered in the design of the structure.
- WL = Wind on live load. The tunnel structure is not exposed to the environment, so it will not be subjected to wind loads.
- WS = Wind load on structure. The tunnel structure is not exposed to the environment, so it will not be subjected to wind loads.

Section 3 of the LRFD specifications provides guidance on the methods to be used in the computations of these loads. The design example (Appendix G) shows the calculations involved in computing these loads.

### 10.3.2 Load Combinations

The AASHTO Specification defines four limit states; service, fatigue and fracture, strength, and extreme event). Each of these limit states contain several load combinations. These limit states and load combinations were developed for loadings that are typically encountered by highway bridges. Many of the loadings that bridges are subjected to are not applicable to tunnel linings. Loads such as wind, stream flow, vessel impact and fatigue do not occur in mined tunnels. The unique conditions under which tunnels operate allow for eliminating many of the loading conditions used for bridges. Tunnels should be designed for the following load combinations.

The loads described above should be factored and combined in accordance with the LRFD specification and applied to the tunnel lining. These load combinations are given in Table 3.4.1-1 of the AASHTO specifications. The recommended load cases for the design of linings for mined highway tunnels are given in Table 10-1.

**Table 10-1 Load Factor ( $\gamma_j$ ) and Load Combination Table**

| Load Comb. Limit State | DC   |      | DW   |      | EH* EV# |      | ES   |      | LL, IM, LS, CT, PL | WA   | TU, CR, SH |      | TG   |
|------------------------|------|------|------|------|---------|------|------|------|--------------------|------|------------|------|------|
|                        | Max  | Min  | Max  | Min  | Max     | Min  | Max  | Min  |                    |      | Max        | Min  |      |
| Strength I             | 1.25 | 0.90 | 1.50 | 0.65 | 1.35    | 0.90 | 1.50 | 0.75 | 1.75               | 1.00 | 1.20       | 0.50 | 0.00 |
| Strength II            | 1.25 | 0.90 | 1.50 | 0.65 | 1.35    | 0.90 | 1.50 | 0.75 | 1.35               | 1.00 | 1.20       | 0.50 | 0.00 |
| Strength III           | 1.25 | 0.90 | 1.50 | 0.65 | 1.35    | 0.90 | 1.50 | 0.75 | 0.00               | 1.00 | 1.20       | 0.50 | 0.00 |
| Service I              | 1.00 |      | 1.00 |      | 1.00    |      | 1.00 |      | 1.00               | 1.00 | 1.20       | 1.00 | 0.50 |
| Service IV             | 1.00 |      | 1.00 |      | 1.00    |      | 1.00 |      | 0.00               | 1.00 | 1.20       | 1.00 | 1.00 |
| Extreme Event I        | 1.25 | 0.90 | 1.50 | 0.65 | 1.35    | 0.90 | 1.50 | 0.75 | $\gamma_iEQ^+$     | 1.00 | N/A        | N/A  | N/A  |

\* The load factors shown are for at-rest earth pressure. At-rest earth pressure should be used for all conditions of design of cut and cover tunnel structures.

# The load factors shown are for rigid frames. All cut and cover tunnel structures are considered rigid frames.

+ This load factor is determined on a project specific basis (refer to Chapter 13 Seismic Considerations).

When developing the loads to be applied to the structure, each possible combination of load factors should be developed.

### 10.3.3 Design Criteria

Historically there have been three basic methods used in the design of structures:

- Service load or allowable stress design which treats each load on the structure equally in terms of its probability of occurrence at the stated value. The factor of safety for this method is built into the material's ability to withstand the loading.

- Load factor design accounts for the potential variability of loads by applying varying load factors to each load type. The resistance of the maximum capacity of the structural member is reduced by a strength reduction factor and the calculated resistance of the structural member must equal or exceed the applied load.
- Load and resistance factor design takes into account the statistical variation of both the strength of the structural member and of the magnitude of the applied loads.

The fundamental LRFD equation can be found in paragraph 1.3.2.1 of the AASHTO specification. This equation is:

$$\Sigma \eta_i \gamma_i Q_i \leq \phi R_n = R_r \qquad \qquad \qquad 10-1$$

(AASHTO Equation 1.3.2.1-1)

In this equation,  $\eta$  is a load modifier relating to the ductility, redundancy and operation importance of the feature being designed. The load modifier  $\eta_i$  is comprised of three components;

- $\eta_D$  = a factor relating to ductility = 1.0 for tunnel linings constructed with conventional details and designed in accordance with the AASHTO LRFD specification.
- $\eta_R$  = a factor relating to redundancy = 1.0 for mined tunnel linings.
- $\eta_I$  = a factor relating to the importance of the structure = 1.05 for tunnel design. Tunnels usually are important major links in regional transportation systems. The loss of a tunnel will usually cause major disruption to the flow of traffic, hence the high importance factor.

$\gamma_i$  is a load factor applied to the force effects ( $Q_i$ ) acting on the member being designed. Values for  $\gamma_i$  can be found in Table 10.1 above.

$R_r$  is the calculated factored resistance of the member or connection.

$\phi$  is a resistance factor applied to the nominal resistance of the member ( $R_n$ ) being designed. The resistance factors are given in the AASHTO LRFD specifications for each material in the section that covers the specific material. Specifically, Section 5 of the AASHTO LRFD specifications covers Concrete Structures and in general, the resistance factors to be used in concrete design can be found there. These values are as follow.

For Reinforced Concrete Linings:

- $\phi = 0.90$  for flexure
- $\phi = 0.90$  for shear
- $\phi = 0.70$  for bearing on concrete

Since tunnel linings will experience axial loads, the resistance factor for compression must be defined. The value of  $\phi$  for compression can be found in Section 5.5.4.2.1 of the AASHTO LRFD specification as:

$$\phi = 0.75 \text{ for axial compression}$$

Structural steel is covered in Section 6 of the AASHTO LRFD specification. Paragraph 6.5.4.2 gives the following values for steel resistance factors:

For Structural Steel Members:

- $\phi_f = 1.00$  for flexure
- $\phi_v = 1.00$  for shear
- $\phi_c = 0.90$  for axial compression for plain steel and composite members

Chapter 12 of the AASHTO specifications addresses the design of tunnel linings constructed from steel lining plate. Table 12.5.5-1 provides the following additional resistance factors to be used in the design of steel lining plate:

- $\phi = 1.00$  for minimum wall area and buckling
- $\phi = 1.00$  for minimum longitudinal seam strength

For Plain Concrete Members: Un-reinforced concrete is also referred to as plain concrete. The AASHTO provisions do not address plain concrete. The following design procedures should be followed for structural plain concrete.

Calculate the moment capacity on the compression face of the lining as follows:

$$\phi M_{nC} = \phi 0.85 f'_c S \quad 10-2$$

Where:

- $M_{nC}$  = The nominal resistance of the compression face of the concrete
- $\phi = 0.55$  for plain concrete
- $f'_c$  = 28 day compressive strength of the concrete
- $S$  = The section modulus of the lining section based on the gross uncracked section

Calculate the moment capacity on the tension face of the lining as follows:

$$\phi M_{nT} = \phi 5(f'_c)^{1/2} S \quad 10-3$$

Where:

- $M_{nT}$  = The nominal resistance of the tension face of the concrete
- $\phi = 0.55$  for plain concrete
- $f'_c$  = 28 day compressive strength of the concrete
- $S$  = The section modulus of the lining section

Calculate the compressive strength of the lining as follows:

$$\phi P_C = \phi 0.6 f'_c A \quad 10-4$$

Where:

- $P_C$  = The nominal resistance of lining in compression
- $\phi = 0.55$  for plain concrete
- $f'_c$  = 28 day compressive strength of the concrete
- $A$  = The cross sectional area of the lining section



Check the compression face as follows:

$$Q_A/\phi P_C + Q_M/\phi M_{nC} \leq 1 \quad 10-5$$

Where:

$Q_A$  = The axial load force effect modified by the appropriate factors

$Q_M$  = The moment force effect modified by the appropriate factors

Calculate the tension strength of the lining as follows:

$$\phi P_T = 5\phi (f'_c)^{1/2} \quad 10-6$$

Where:

$P_T$  = The nominal resistance of lining in tension

$\phi$  = 0.55 for plain concrete

$f'_c$  = 28 day compressive strength of the concrete

Check the tension face as follows:

$$Q_M/S - Q_A/A \leq \phi P_T \quad 10-7$$

Where the values of the variables are described above.

The shear strength of the lining is calculated as follows:

$$\phi V_n = \phi 1.33(f'_c)^{1/2} b_w h \quad 10-8$$

Where:

$V_n$  = The nominal resistance of lining in shear

$\phi$  = 0.55 for plain concrete

$f'_c$  = 28 day compressive strength of the concrete

$b_w$  = the length of tunnel lining under design

$h$  = the design thickness of the tunnel lining

This design method is adapted for LRFD from the provisions for structural plain concrete from the American Concrete Institute's Building Requirements for Structural Concrete (ACI 318).

### 10.3.4 Structural Analysis

Structural analysis of tunnel linings has been a subject of numerous papers and theories. Great disparity of opinion exists on the accuracy and usefulness of these analyses. However, some rational method must be adopted to determine a lining's ability to maintain the excavated opening of a tunnel. Some widely accepted methods are described in this section.

Beam Spring Models A general purpose structural analysis program can be used to model the soil structure interaction. This method is known as the beam spring model. The computer model is constructed by placing a joint or node at points along the centroid of the lining. These nodes are joined by straight beam members that approximate the lining shape by a series of chords. When constructing this type of model, the chord lengths should be approximately the same as the lining thickness for the radii that can be expected in highway tunnels. Chord members that are too long can produce fictitious moments and chord members that are too short can result in computational difficulties because of the very small angles subtended by short members. A subtended angle dimension of approximately  $60/R$ , where  $R$  is the radius of the tunnel in feet, will generally produce acceptable results. Properties such as cross sectional area and moment of inertia should be entered to accurately depict the real behavior of the lining. Since the compressive forces are generally large enough to have compression over the entire thickness of the lining, the area and moment of inertia are calculated using the gross, uncracked dimensions of the lining. In rock tunnels, overbreak will result in a lining thickness larger than the design thickness. The design thickness is used in the analysis. This type of model is useful in analyzing all geometric shapes.

The surrounding ground is modeled by placing a spring support at each joint. Springs can be placed in the radial and tangential directions. The tangential springs offer little value in the analysis and an unnecessary complication to the model. The numerical value of the spring constant at each support is calculated from the modulus of subgrade reaction of the surrounding ground multiplied by the tributary length of lining on each side of the spring. Many ground conditions can be encountered within the length of a single tunnel. Parametric studies that vary the ground conditions and the spring constants should be performed to determine the worst case scenario for the lining.

Loads are applied to the model and the displacement at each joint is checked. For joints that move away from the center of the tunnel into the ground, the spring is left active. When the joint displacement is toward the center of the tunnel, the spring is removed or made inactive. This process is repeated until all displacements match the spring condition (active or inactive) at that joint. Once the model converges, the moments, thrusts and shears are used to design the lining.

If the model reveals that the lining is beyond its capacity, making the lining thicker or stiffer will not alleviate the problem. In fact, stiffening the lining will cause it to attract more moment and it will likely continue to fail. The lining must be made to be more flexible. This can be accomplished by making the lining thinner, which may not work. The primary load action on the lining is axial load or thrust. If the lining is close to its capacity under this load action, then thinning will not work. Modeling lining flexibility such that the moments are relieved may show the lining to be adequate. This is what happens in reality. One way to model this phenomenon is to install full or partial hinges in the lining at points of theoretical high moment. The hinge can be modeled to accept as much moment as the lining can support or it can be modeled as a full hinge with no moment capacity. In reality, the lining is performing somewhere in between these two extremes. Analyzing both conditions will bracket the lining behavior and provide a reasonable assurance that the lining can support the loads.

Three Dimensional Models The model described above is usually a two dimensional model that represents a single foot along the length of the tunnel. More sophisticated models are required when large penetrations of the lining or intersecting tunnels are being analyzed. To model these conditions, a three dimensional finite element model is used. The model is constructed in a similar manner to the two dimensional model, with finite elements used to connect the nodes and create the three dimensional model. The modeling parameters described above hold true for this type of model also. The model should extend a minimum of one tunnel diameter beyond the feature being investigated on each side of the feature.

It has been argued that this model does not account for the nonlinearity of the surrounding ground, particularly in soft ground, nor does it account for the variation of ground movement with time. Careful development of loading diagrams and spring constants for this model can bracket the actual behavior of the surrounding ground. This will provide results that are comparable to more sophisticated analysis methods. It should be noted that this method of analysis typically over estimates the bending moment in the lining.

Empirical Method for Soft Ground For circular tunnels in soft ground, the validity of the beam spring model has been highly criticized. The beam spring model described above assumes the soil to be a homogenous elastic material when in fact it is often non-homogenous and the behavior is plastic rather than elastic. Plastic deformations of the soil take place and the lining “goes along for the ride”, that is, the stiffness of the lining is incapable of resisting the soil deformations. Since the lining is typically more flexible than the surrounding soil, it distorts as the soil displaces and the lining’s flexibility allows it to shed moments to the point where it is acting almost entirely in compression. Since the lining is not completely flexible, some residual moment remains in the lining. This moment is accounted for by assigning an arbitrary change in radius and calculating the theoretical moment resulting from this change in radius. Using this method, the thrust in the tunnel lining is calculated by the formula:

$$T = wR \quad 10-9$$

Where:

- T = the thrust in the tunnel lining
- w = the earth pressure at the spring line of the tunnel due to all load sources
- R = the radius of the tunnel

The percentage of radius change to be used is a function of the type of soil. Values for this percentage estimated by Birger Schmidt are shown in Table 10-2.

**Table 10-2 Percentage of Lining Radius Change in Soil**

| Soil Type                                    | $\Delta R/R$ – Range |
|--|----------------------|
| Stiff to Hard Clays                          | 0.15 – 0.40%         |
| Soft Clays or Silts                          | 0.25 – 0.75%         |
| Dense or Cohesive Soils, Most Residual Soils | 0.05 – 0.25%         |
| Loose Sands                                  | 0.10 – 0.35%         |

Notes:

1. Add 0.1 to 0.3 percent for tunnels in compressed air, depending on air pressure.
2. Add appropriate distortion for effects such as passing neighbor tunnel.
3. Values assume reasonable care in construction, and standard excavation and lining methods.

The resulting bending moment in the lining is calculated using the following formula:

$$M = 3EI/R \times \Delta R/R \quad 10-10$$

Where:

- M = the calculated bending moment
- R = radius to the centroid of the lining
- $\Delta R$  = tunnel radius change

- E = modulus of elasticity of the lining material
- I = effective moment of inertia of the lining section

The effective moment of inertia can be calculated for precast segmental linings using the following formula:

$$I_e = I_j + I(4/n)^2 \quad 10-11$$

Where:

- $I_e$  = The effective moment of inertia
- $I_j$  = The joint moment of inertia (conservative taken as zero)
- I = The moment of inertia of the gross lining section
- n = The number of joints in the lining ring

This formula was developed by Muir Wood

The moment of inertia for the uncracked section should be used for cast-in-place concrete linings. This method should be used in conjunction with any other analysis for round tunnels in soft ground as verification. The method described above can be used for both concrete and steel segmental linings. It is recommended that steel lining plate also be checked using the provisions of Section 12.7 of the AASHTO specifications for wall resistance and resistance to buckling.

Numerical Methods Commercial software is also available to model both the lining and the surrounding ground as a continuum utilizing a three dimensional finite element or finite difference approach. FLAC3D is a finite difference based continuum analysis program, where the domain (ground) is assumed to be a homogeneous media. The structural elements (beam or shell elements) can be used to model the tunnel lining. Using interface elements between the lining elements and the surrounding ground, rock-lining interaction including slip can be simulated.

If the ground contains predominant weak planes and those are continuous and oriented unfavorably to the excavation, then the analysis should consider incorporating specific characteristics of these weak planes. In this case, mechanical stiffness (force/displacement characteristics) of the discontinuities may be much different from those of intact rock. Then, a discrete element method (DEM) can be considered to solve this type of problem. 3DEC is a commercially available program for this type of analysis. Unlike continuum analysis, the DEM permits a large deformation and finite strain analysis of an ensemble of deformable (or rigid) bodies (intact rock blocks) which interact through deformable, frictional contacts (rock joints).

It is greatly task dependent whether a continuum (FLAC3D) or discrete analysis (3DEC) is adequate. If the ground is soil, the FLAC3D is adequate. If the ground is jointed rockmass and the joints are predominant in rock-lining interaction, 3DEC should be utilized. These programs can be used to calibrate and verify beam spring models, and vice versa.

## 10.4 CAST-IN-PLACE CONCRETE

### 10.4.1 Description

Cast-in-place concrete linings are used as final linings in two pass lining systems. Initial ground support is installed in the tunnel as the tunnel is excavated and can take any form from steel ribs and lagging to

precast concrete segments. A water proofing system or drainage blanket is typically placed between the initial ground support and the cast-in-place concrete lining.

Figure 10-5 shows the typical section for the cast-in-place lining used for the Cumberland Gap Tunnel. The Cumberland Gap Tunnel is a highway tunnel excavated in rock by the drill and blast method. Initial ground support is untreated rock, shotcrete and rock bolts. The initial ground support varied along the length of the tunnel due to varying ground conditions.

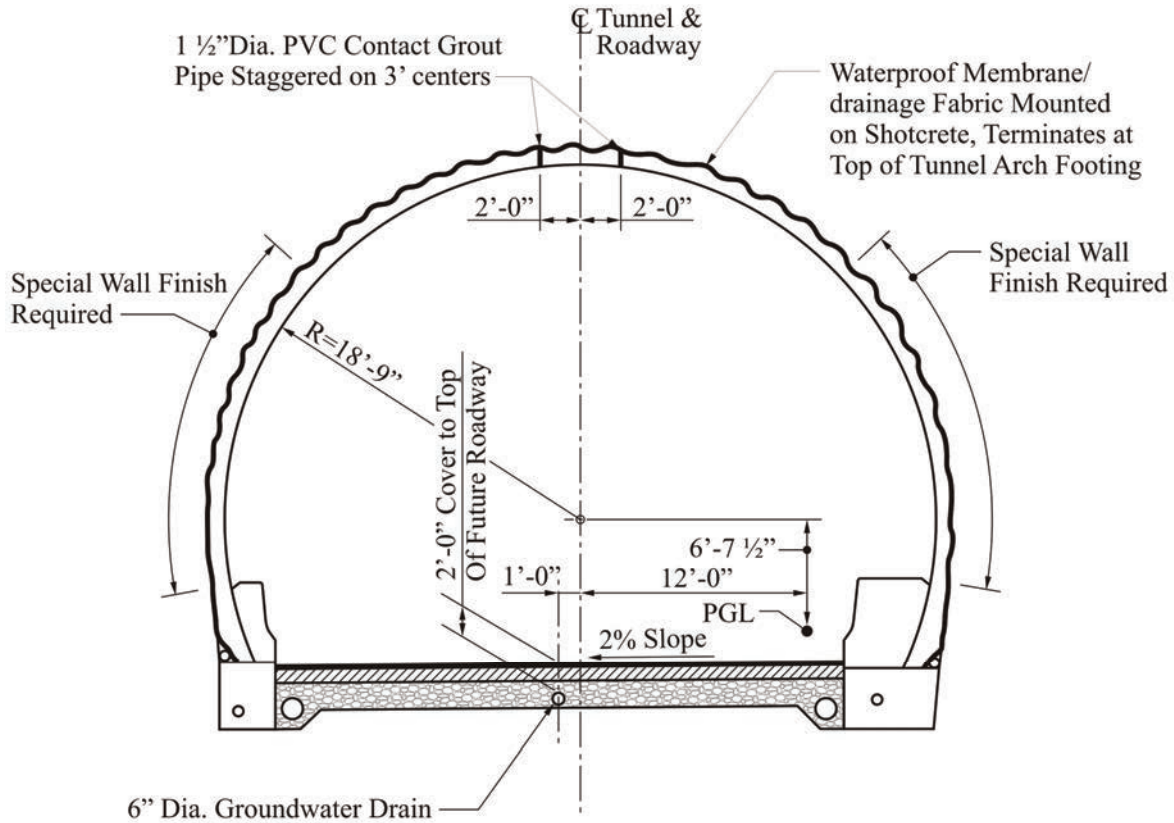

Figure 10-5 Cumberland Gap Tunnel Lining (Unfinished)

Figure 10-6 is a photograph of a heavy rail transit tunnel in Washington, DC. This tunnel was excavated in soft ground by a tunnel boring machine. This tunnel utilized a two pass system consisting of rough cast precast concrete segments as the initial ground support and a final lining of cast-in-place concrete. A high density polyethylene waterproofing membrane was placed between the precast segments and the cast-in-place concrete final lining.

Advantages of a cast-in-place concrete lining are as follows:

- Suitable for use with any excavation and initial ground support method.
- Corrects irregularities in the excavation.
- Can be constructed to any shape.
- Provides a regular sound foundation for tunnel finishes.
- Provides a durable low, maintenance structure.



Figure 10-6 Cast-In-Place Concrete Lining, Washington DC

Disadvantages of a cast-in-place concrete lining are as follows:

- Concrete placement, especially around reinforcement can be difficult. The nature of the construction of the lining restricts the ability to vibrate the concrete. This can result in incomplete consolidation of the concrete around the reinforcing steel.
- Reinforcement when used is subject to corrosion and resulting deterioration of the concrete. This is a problem common to all concrete structures, however underground structures can be also be subject to corrosive chemicals in the groundwater that could potentially accelerate the deterioration of reinforcing steel.
- Cracking that allows water infiltration can reduce the life of the lining.
- Chemical attack in certain soils can reduce lining life.
- Construction requires a second operation after excavation to complete the lining.

#### 10.4.2 Design Considerations

In order to maximize flexibility and ductility, a cast-in-place concrete lining should be as thin as possible. There are, however, practical limits on how thin a section can be placed and still obtain proper consolidation and completely fill the forms. 10 inches (25 cm) is considered the practical minimum thickness for a cast-in-place concrete lining.

Reinforcing steel in a thin section can also be problematic. The reinforcement inhibits the flow of the concrete making it more difficult to consolidate. If two layers of reinforcement are used, then staggering the bars may be required to obtain the required concrete cover over the bars. This can make the forms congested and concrete placement more difficult. Self consolidating concrete has been in development in recent years and has been used in unreinforced concrete linings in Europe with some success. Self consolidating concrete may prove useful in reinforced concrete linings, however it recommended that an

extensive testing program be made part of the construction requirements to ensure that proper results are, in fact, obtained.

Cast-in-place concrete is used as the final lining. In many cases a waterproofing system is placed over the initial ground support prior to placing the final concrete lining. Placing reinforcing steel over the waterproofing system increases the potential for damaging the waterproofing. In all cases that are practical to do so, cast-in-place concrete linings should be designed and constructed as plain concrete, that is with no reinforcing steel. The presence of the waterproofing systems precludes load sharing between the final lining and the initial ground support. A basic design assumption is that the final lining carries long term earth loads with no contribution from the initial ground support.

Ground water chemistry should be investigated to ensure that chemical attack of the concrete lining will not occur should the lining be exposed to ground water. If this is an issue on a project, mitigation measures should be put in place to mitigate the effects of chemical attack. The waterproofing membrane can provide some protection against this problem. Admixtures, sulfate resistant cement and high density concrete may all be potential solutions. This problem should be addressed on a case by case basis and the appropriate solution be implemented based on best industry practice.

Concrete behavior in a fire event must also be considered. When heated to a high enough temperature, concrete will spall explosively. This produces a hazardous condition for motorists attempting to exit the tunnel and for emergency response personnel responding to the incident. This spalling is caused by the vaporization of water trapped in the concrete pores being unable to escape. Spalling is also caused by fracture of aggregate and loss of strength of the concrete matrix at the surface of the concrete after prolonged exposure to high temperatures. Reinforcing steel that is heated will loose strength. Spalling and loss of reinforcing strength can cause changes in the shape of the lining, redistribution of stresses in the lining and possibly structural failure.

The lining should be protected against fire. Both external and internal protection can be provided. External protection in the form of coatings or boarding is available commercially. These are specialty products that can provide a measure of protection against relatively low temperature fires. Manufacturers should be consulted to ascertain the exact level of protection that they can provide. Including polypropylene fibers in the concrete mix can reduce vaporization of entrapped water. The fibers melt during a fire and provide a pathway for water to escape.

### **10.4.3 Materials**

Mixes for cast-in-place concrete should be specified to have a high enough slump to make placement practical. A slump of 5" (12.7 cm) is recommended. Air entrainment should be used. The moist environment in many tunnels combined with exposure to cold weather makes air entrainment important to durable concrete; 3 to 5 percent air entrainment is recommended.

Compressive strength should be kept to a minimum. High strength concretes require complex mixes with multiple admixtures and special placing and curing procedures. Since concrete lining acts primarily in compression, 28 day compressive strengths in the range of 3,500 to 4,500 psi (24 to 31 MPa) are generally adequate.

Reinforcing steel bars should conform to the requirements of ASTM A615 grade 60 and welded wire fabric when used should conform to ASTM A185.

#### **10.4.4 Construction Considerations**

Cast-in-place concrete must attain a minimum strength prior to stripping forms. The concrete must also be cured. Leaving the forms in place can accomplish both these goals, but can inhibit the rate of construction. The concrete should reach some minimum strength prior to stripping the forms. This should be computed by the designer assuming that the tunnel is supported by the initial support and thus the final lining at the time of stripping will be carrying only its own weight. The strength of the concrete in the forms can be verified by breaking field cured cylinders. This will allow the forms to be stripped as soon as possible. Curing can continue after stripping by keeping the concrete moist or by applying a curing compound. Curing compounds should only be used if the concrete is the finished exposed surface. The curing compound will act as a bond breaker if finishes such as ceramic tile are applied to the concrete. Sealants and coating will not adhere to concrete surfaces that have had curing compound applied unless the curing compound is removed via sand blasting or other technique.

The length of pour along the centerline of tunnel should be limited to minimize shrinkage in the concrete. Lining forms are usually designed to be re-used so limiting the length of pour does not impose a hardship on the contractor. Construction joints can be bulkheaded or sloping. Bulkheaded joints provide a uniform appearance, however, depending on how uneven the face of excavation is, construction of the bulkhead may be difficult. Sloped construction joints do not affect the performance of the lining, but can be unattractive and should be rubbed out after the forms are stripped.

Placing concrete in a curved shape overhead will leave a void at the crown. This void is filled after the concrete is cured by pumping grout into the void. Grout pipes are installed in the forms prior to placing the concrete to facilitate this operation. Spacing of the grout pipes along the tunnel should be limited to 10 feet and the pipes should be offset from the crown by 15 degrees on both sides.

When appurtenances are attached to the finished concrete lining, using adhesive type anchors their use and inspection should follow FHWA's Technical Advisory TA5140.26: Use and Inspection of Adhesive Anchors in Federal-aid Projects (see Appendix I).

### **10.5 PRECAST SEGMENTAL LINING**

#### **10.5.1 Description**

Precast segmental linings are used in circular tunnels that are mined using a tunnel boring machine. They can be used in both soft and hard ground. Several curved precast elements or segments are assembled inside the tail of the tunnel boring machine to form a complete circle. The number of segments used to form the ring is a function of the ring diameter and to a certain respect, contractor's preferences. The segments are relatively thin, 8 to 12 inches (20 to 30 cm) and typically 40 to 60 (1 to 1.5 m) inches (cm) wide measured along the length of the tunnel.

Precast segmental linings can be used as initial ground support followed by a cast-in-place concrete lining (the "two-pass" system) or can serve as both the initial ground support and final lining (the "one-pass" system) straight out of the tail of the TBM. Segments used as initial linings are generally lightly reinforced, erected without bolting them together and have no waterproofing. The segments are erected inside the tail of the TBM. The TBM pushes against the segments to advance the tunnel excavation. Once the shield of the TBM is passed the completed ring, the ring is jacked apart (expanded) at the crown or near the springlines. Jacking the segments helps fill the annular space that was occupied by the shield of the TBM. After jacking, contact grouting may be used to finish filling the annular space and to ensure



complete contact between the segments and the surrounding ground. A waterproofing membrane is installed over the initial lining and the final concrete lining is cast in place against the waterproofing membrane. Horizontal and vertical curvature in the tunnel alignment is created by using tapered rings. The curvature is approximated by a series of short chords.

Precast segmental linings used as both initial support and final lining are built to high tolerances and quality. They are typically heavily reinforced, fitted with gaskets on all faces for waterproofing and bolted together to compress the gaskets after the ring is completed but prior to advancing the TBM. As the completed ring leaves the tail of the shield of the TBM, contact grouting is performed to fill the annular space that was occupied by the shield. This provides continuous contact between the ring and the surrounding ground and prevents the ring from dropping into the annular space. Bolting is often performed only in the circumferential direction. The shove of the TBM is usually sufficient to compress the gaskets in the longitudinal direction. Friction between the ground and the segments hold the segment in place, maintaining compression on the gasket. When first introduced into the United States in the mid-1970's, segmental linings were fabricated in a honeycomb shape that allowed for bolting in both the longitudinal and circumferential directions. Figure 10-2 shows the lining used for Section A of the Baltimore Metro. After 30 years of service, this lining is still providing a stable dry opening for over a hundred trains per day. Recent lining designs have eliminated the longitudinal bolting and the complex forming and reinforcing patterns that were required to accommodate the longitudinal bolts. Segments now have a flat inside surface as shown in Figure 10-7 and Figure 10-8. Figure 10-8 shows the segments in the casting bay after being stripped of the forms. Once adequate strength is achieved, the segments are inverted to the position they must be in for erection inside the side the tunnel. Segments are generally stored in a stacked arrangement, with one stack containing the segments required to construct a single ring inside the tunnel. As with segments used for initial lining, horizontal and vertical tunnel alignment is achieved through the use of tapered segments. Figure 10-8 shows the segments stacked in the storage yard awaiting transport into the tunnel.

Advantages of a precast segmental lining are as follows:

- Provides complete stable ground support that is ready for follow-on work.
- Materials are easily transported and handled inside the tunnel.
- No additional work such as forming and curing is required prior to use.
- Provides a regular sound foundation for tunnel finishes.
- Provides a durable low maintenance structure.

Disadvantages of a precast segmental lining are as follows:

- Segments must be fabricated to very tight tolerances
- Reinforcing steel must be fabricated and placed to very tight tolerances.
- Storage space for segments is required at the job site.
- Segments can be damaged if mishandled.
- Spalls, cracked and damaged edges can result from mishandling and over jacking.
- Gasketed segments must be installed to high tolerances to assure that gaskets perform as designed.
- Reinforcement when used is subject to corrosion and resulting deterioration of the concrete.
- Cracking that allows water infiltration can reduce the life of the lining.
- Chemical attack in certain soils can reduce lining life.



Figure 10-7 Precast Segments for One-Pass Lining, Forms Stripped



Figure 10-8 Stacked Precast Segments for One-Pass Lining

### 10.5.2 Design Considerations

Initial Lining Segments Segments used as an initial support lining are frequently designed as structural plain concrete. Reinforcing steel is placed in the segments to assist in resisting the handling and storage loads imposed on the segments. Reinforcement is often welded wire fabric or small reinforcing steel bars. The segments are usually cast by a precaster or in a yard set up specifically for manufacturing the segments.



Figure 10-9 Stacked Precast Segments for Two-Pass Lining



Figure 10-10 Steel Cage for Precast Segments for Two-Pass Lining

Figure 10-9 shows stacked segments for a two-pass liner system. These segments are used as the initial lining and are not required to be waterproof. Therefore no gaskets are used. No keyway for a gasket is cast into the segment. Note however, the keyway cast into the sides of the segments used to help with placement of the segment and maintaining alignment of the segments in the radial direction. Figure 10-10 shows the reinforcing steel cages for the segments.

Structural analysis is performed by one of the methods described in section 10.3.4. When using a structural analysis program for analysis, the structural model should include hinges (points where no bending moment can develop) at the locations of the joints in the ring. Using hinges at the joint locations provides the ring with the flexibility required to adjust to the loads, resulting in the predominant loading being axial load or thrust. This is an approximation of the behavior of the lining since joints will transfer

some moment. The actual behavior of a segmental lining can be bounded by models that have zero fixity at the joints and full fixity at the joints.

Radial joints in between segments can be flat or concave/convex as shown on Figure 10-11. Convex/concave joints facilitate rotation at the joint, allowing the segment to deform and dissipate moments. Flat joints are more efficient at transferring axial load between segments and may result in less end reinforcement. In either case, the ends of the segments that form the joints should be reinforced to facilitate the transfer of load from one segment to another without cracking and spalling. The amount of reinforcement used should consider the type of joint and the resulting load transfer mechanism. Handling and erecting the segments are also sources of damage at the joints. Reinforcing can mitigate this damage.

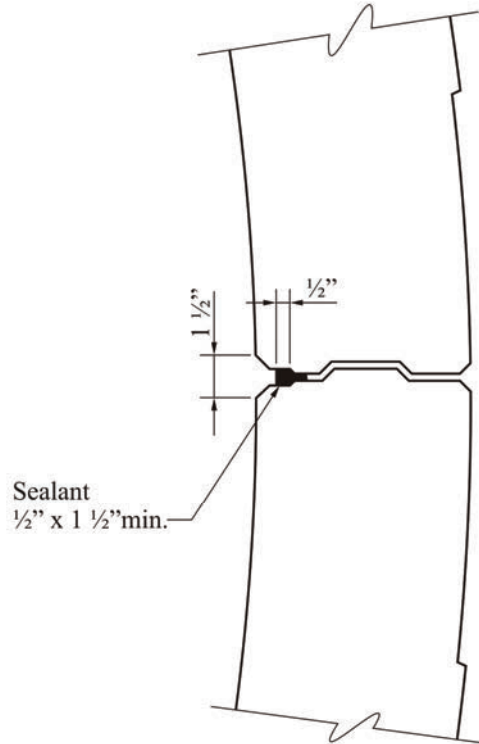

Figure 10-11 Radial Joints, Baltimore, MD

The primary load carried by the precast segments is axial load induced by ground forces acting on the circumference of the ring. However, loads imposed during construction must also be accounted for in the design. Loads from the jacking forces of the TBM are significant and can cause segments to be damaged and require replacement. These forces are unique to each tunnel and are a function of the ground type and the operational characteristics of the TBM. Reinforcement along the jacking edges of the segments is usually required to resist this force. The segments should be checked for bearing, compression and buckling from TBM thrust loads.

Handling, storage, lifting and erecting the segments also impose loads. The segments should be designed and reinforced to resist these loads. The dead weight of the segment with a dynamic factor of 2.0 applied to that dead weight is recommended for design to resist these loads. When designing reinforcement for these loads, the provisions of Chapter 5 of the LRFD specifications should be used. Grouting pressure can also impose loads on the lining. Grouting pressures should be limited to reduce the possibility of damage to the ring by these loads. A value of 10 psi (69 kPa) is recommended as the maximum

permissible grouting pressure. The anticipated grouting pressure should be added to the load effects of the ground loads applied to the lining.

Initial lining segments are considered to be temporary support, therefore long term durability is not considered in the design of the linings or materials used.

Final Lining Segments Segments used as a final lining are designed as reinforced concrete. The reinforcement assists in resisting the loads and limits cracking in the segment. Limiting cracking helps make the segments waterproof. The provisions of chapter 5 of the AASHTO LRFD specifications should be used to design the segments. The segments are manufactured by a precaster or in a yard set up specifically for manufacturing the segments. Since the segments are cast and cured in a controlled environment, higher tolerances can be attained than in cast-in-place concrete construction.

Structural analysis is performed by one of the methods described in section 10.3.4. When using a structural analysis program for analysis, an effective moment of inertia should be used to account for the flexibility induced in the ring at the bolted joints. The effective moment of inertia can be calculated using formula 10-10. When using this effective moment of inertia, no hinges are installed in the beam spring model.

Final lining segments can be fabricated with straight or skewed joints. Figure 10-12 shows a schematic of a lining system with straight joints. The orientation of the joint should be considered in the design of the lining to account for the mechanism of load transfer across the joint between segments. Skewed joints will induce strong axis bending in the ring and this should be accounted for in the design of the ring. Whether using straight or skewed joints, segments are rotated from ring to ring so that the joints do not line up along the longitudinal axis of the tunnel. Figure 10-13 is a picture of a mock-up of a ring of segmental lining.

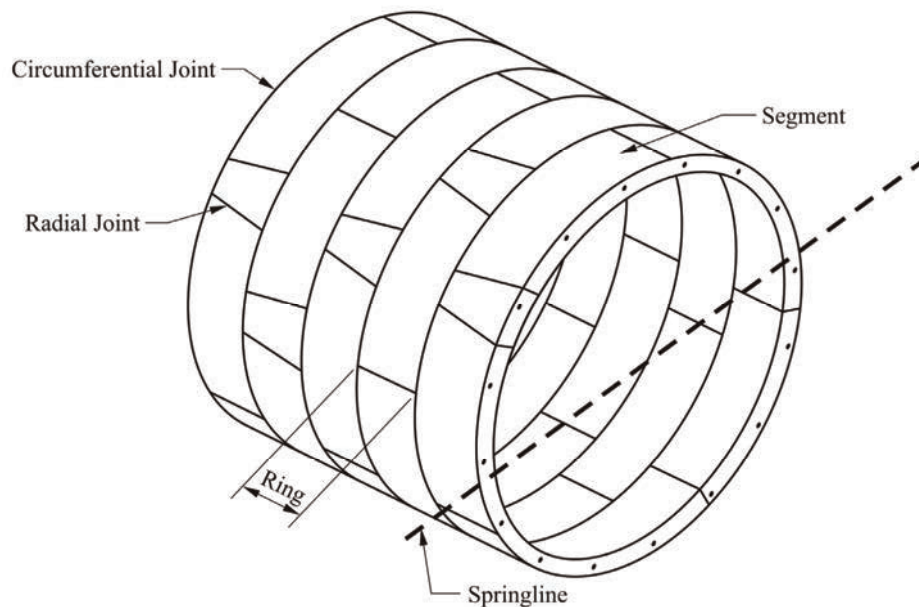

Figure 10-12 Schematic Precast Segment Rings



Figure 10-13 Mock-up of Precast Segment Rings

Joint design should consider the configuration of the gaskets. The gasket can eliminate much of the bearing area for load transfer between joints (See Figure 10-11 for example). Joints should be adequately reinforced to transfer load across the joints without damage.

The primary load carried by the precast segments is axial load induced by ground, hydrostatic and other forces acting on the circumference of the ring. The presence of the waterproofing systems precludes load sharing between the final lining and the initial ground support. A basic design assumption is that the final lining carries long term earth loads with no contribution from the initial ground support. Loads imposed during construction must also be accounted for in the design. Loads from the jacking forces of the TBM are significant and can cause segments to be damaged and require replacement. These forces are unique to each tunnel and are a function of the ground type and the operational characteristics of the TBM. Reinforcement along the jacking edges of the segments may be required to resist this force. The segments should be checked for bearing, compression and buckling from TBM thrust loads.

Lifting and erecting the segments also impose loads. The segments should be designed and reinforced to resist these loads. The dead weight of the segment with a dynamic factor of 2.0 applied to the dead weight is recommended for design to resist these loads. When designing reinforcement for these loads, the provisions of Chapter 5 of the LRFD specifications should be used.

Grouting pressure can also impose loads on the lining. Grouting pressures should be limited to reduce the possibility of damage to the ring by these loads. A value of 10 psi (69 kPa) is recommended as the maximum permissible grouting pressure. The anticipated grouting pressure should be added to the load effects of the earliest ground loads applied to the lining.

Ground water chemistry should be investigated to ensure that chemical attack of the concrete lining will not occur should it be exposed to ground water. If this is an issue on a project, mitigation measures should be put in place to reduce the effects of chemical attack. The waterproofing membrane can provide some protection against this problem. Admixtures, sulfate resistant cement and high density concrete may all be potential solutions. This problem should be addressed on a case by case basis and the appropriate solution implemented based on best industry practice.

Concrete behavior in a fire event must also be considered. When heated to a high enough temperature, concrete will spall explosively. This produces a hazardous condition for motorists attempting to exit the tunnel and to emergency response personnel responding to the incident. This spalling is caused by the vaporization of water trapped in the concrete pores being unable to escape. Spalling is also caused by fracture of aggregate and loss of strength of the concrete matrix at the surface of the concrete after prolonged exposure to high temperatures. Reinforcing steel that is heated will lose strength. Spalling and loss of reinforcing strength can cause changes in the shape of the lining, redistribution of stresses in the lining and possibly structural failure.

The lining should be protected against fire. Both external and internal protection can be provided. External protection in the form of coatings or boarding is available commercially. These items can provide a measure of protection against relatively low temperature fires. These are specialty products and manufacturers should be consulted to ascertain the exact level of protection that they can provide. Including polypropylene fibers in the concrete mix can reduce vaporization of entrapped water. The fibers melt during a fire and provide a pathway for water to escape.

Appendix G presents a calculation example to illustrate the design process for precast segmental lining.

### **10.5.3 Materials**

Concrete mixes for precast segments for initial linings do not require special designs and can generally conform to the structural concrete mixes provided in most state standard construction specifications. Strengths in the range of 4,000 to 5,000 psi (27 to 35 MPa) are generally adequate. These strengths are easily attainable in precast shops and casting yards. Curing is performed in enclosures and is well controlled. Air entrainment is desirable since segments may be stored outdoors for extended periods of time and final lining segments may be exposed to freezing temperatures inside the tunnel.

Steel fiber reinforced concrete has become a topic of discussion and research for precast tunnel linings. Theoretically, steel fibers can be used in lieu of steel reinforcing bars. The fibers can potentially eliminate the need for fabricating the steel bars to very tight tolerances, provide ductility for the concrete and make the segments tougher and less damage prone during construction. Unfortunately, there is no US design code for the design of steel fiber reinforced concrete. Papers have been written that propose design methods and several European countries have developed design methods. The recommended practice until further research is conducted and design codes are developed is to use steel fibers in segments where the design is conducted as detailed in this manual and the lining is found to be adequate without reinforcing. The steel fibers then can be included in the concrete to improve handling characteristics during construction. A testing program is required by the specifications to have the contractor prove via field testing that the fiber reinforced segments can withstand the handling loads imposed during construction. The fibers then can be used in lieu of reinforcement that would be installed to resist the handling loads.

Reinforcing steel bars should conform to the requirements of ASTM A615 grade 60 and welded wire fabric when used should conform to ASTM A185.

Concrete mixes for one pass lining segments have strengths ranging from 5,000 psi to 7,000 psi (34 to 48 MPa). Higher strengths are easily obtainable in precast shops and assist in resisting handling and erection loads.

#### 10.5.4 Construction Considerations

Initial Lining Segments Grout holes are required for contact grouting. Grout holes can also serve as lifting points for the segments. Locate the grout holes symmetrically so that the load to the lifting devices is evenly applied. Grout holes and lifting devices are usually designed by the contractor to loads and criteria specified by the designer. The construction industry is moving toward vacuum erection and handling equipment. This device does not rely on the grout holes to handle the segments. A device of this type can be seen in Figure 10-7. This device relies on vacuum created between the segment face and the device to produce the reaction required to lift and erect the segments.

Segments should be cast and cured in accordance with the requirements of the standard specifications of the owner. In the absence of standard specifications, the requirements of the Precast Concrete Institute should be used to develop construction specifications for the precast segments. Segments should be stored in a manner that will not damage the segments. Support locations should be shown on the drawings and maximum stacking heights should be specified.

Segments should be detailed to facilitate jacking the rings at the crown or near springline after erection. Space for material to temporarily close off the gap to stop earth from coming into the tunnel is required. A means to jack the segments should be devised and the space remaining from the jacking should be backfilled with concrete and/or contact grouting to complete the ring. The ends of the segments that are used for jacking may require additional reinforcing or steel plates to protect them from the forces associated with jacking.

The number of segments for two pass systems is usually kept at a minimum, with the segments being slightly larger than for a one pass system and the joints in the rings will line up with joints in adjacent rings.

Final Lining Segments (One-Pass System) The same considerations as for initial lining segments apply to final lining segments. Final lining segments, however are not jacked at the crown after erection. Final lining segments must also be detailed to accommodate the gaskets required for waterproofing. Often, final lining segments also receive a waterproofing coating applied to the outside of the segment. This waterproofing coating should be a robust material such as coal tar epoxy since the segments slide along the shield as it advances and damage to the coating will occur.

#### 10.6 STEEL PLATE LINING

Steel plate lining is a segmental lining system. It is sometimes used for circular tunnels in soft ground mined by TBM or other methods. Several curved steel elements or segments are assembled inside the tunnel or the TBM to form a complete circle. The segments are constructed from steel plates that are pressed into the required shape. The plates have flanges along all four edges. The flanges are used to bolt the segments together in the longitudinal and circumferential directions. Adjacent rings are rotated so that joints do not line up from ring to ring. The segments are fitted with gaskets along all the flanges that are compressed when the bolts are tightened. These gaskets are intended to provide waterproofing for the tunnel. Lining plate is manufactured in standard sizes and in widths of either 12" (25.4 cm) or 24" (50.8 cm). Only the radius changes to meet the requirements of the project. Figure 10-14 shows typical steel lining plate details.



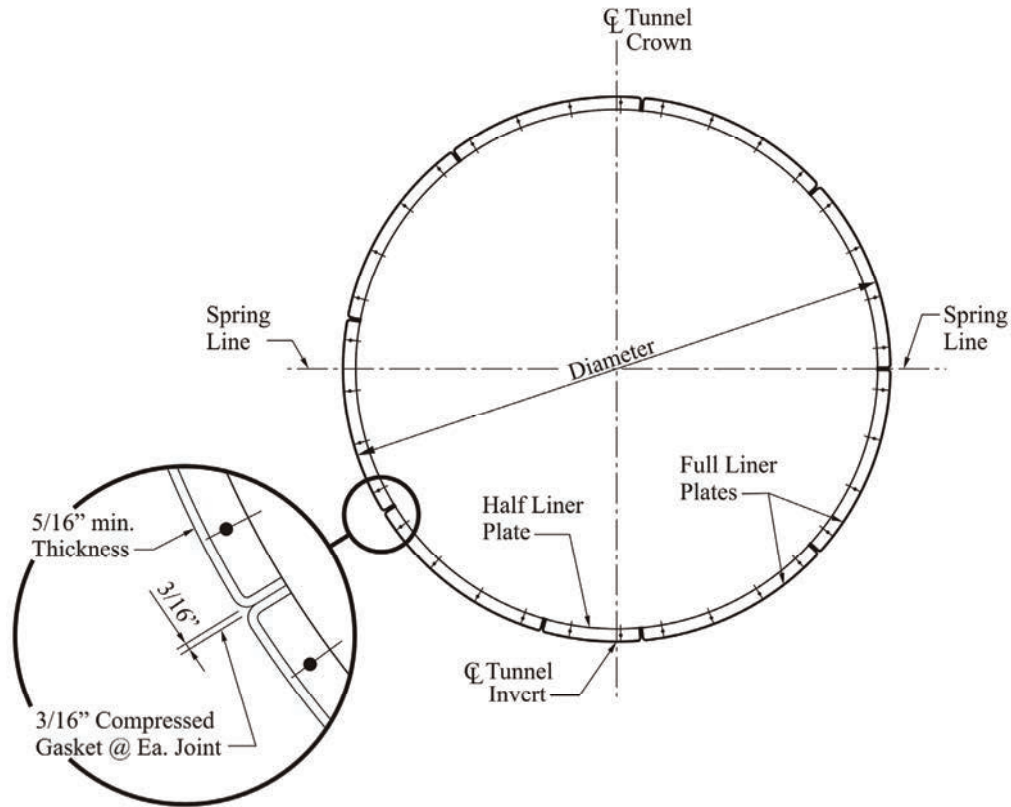

Figure 10-14 Typical Steel Lining Section

Advantages of a steel plate lining are as follows:

- Provides complete stable ground support that is ready for follow-on work.
- Materials are easily transported and handled inside the tunnel.
- No additional work such as forming and curing is required prior to being ready to use.

Disadvantages of a steel lining plate are as follows:

- Thrust applied from TBM must be limited to the capacity of the plate.
- Steel is subject to corrosion in the damp environment usually encountered in a tunnel.
- Fire can cause the lining plate to buckle and/or fail.
- Cast-in-place concrete will be needed for fire protection.

### 10.6.1 Design Considerations

Design of steel plate linings should be in accordance with Chapter 12 of the AASHTO LRFD specifications. The required checks for the service condition are included in that chapter. Typically, the design parameters and minimum dimensional requirements are specified on the drawings. The information on the drawings is developed from the AASHTO LRFD requirements. Lining plate manufacturers have standard products that can be selected for use on a project. The contractor will provide a specific product intended for use on the project and supply computations illustrating that the product meets the minimum requirements shown on the drawings.

The steel plate lining must be designed to resist jacking loads imposed by a TBM. A jacking ring or some other method of distributing these loads to the plates must be utilized to avoid damaging the plates during tunneling. Often, stiffeners are required at the center of the plates to resist the jacking loads. These stiffeners along with the flanges at the edges of the plates resist the bulk of this jacking force. The stiffeners and flanges are designed as columns to resist the anticipated jacking loads. Design of steel lining plate linings must include other loads induced by construction activities. Lifting and erection stresses should be checked by the contractor.

Curvature in horizontal and vertical alignments is accommodated with tapered segments just as with concrete segments.

Steel plate linings should be protected against corrosion. The exterior surface can be protected by a coating such as coal tar epoxy. The interior can be protected with coatings such as paint or galvanizing, but the most effective protection is a layer of unreinforced concrete. This concrete layer provides protection against corrosion and against heat damage due to fires. The protective concrete layer is placed after completion of the mining operation to avoid damage that can be caused by the jacking or the shield.

Gasket requirements for steel plate linings are similar to those for concrete segments. However, steel plate linings have far less surface area for gasket installation than do concrete segments.

## **10.7 SHOTCRETE LINING**

As discussed in Chapter 9, shotcrete represents a structurally and qualitatively equal alternative to cast-in-place concrete linings. Its surface appearance can be tailored to the desired project goals. It may remain a rough, sprayer type shotcrete finish, or may have a quality comparable to cast concrete when trowel finish is specified. Shotcrete as a final lining is typically utilized in combination with the initial shotcrete supports in SEM applications when the following conditions are encountered:

- The tunnels are relatively short in length and the cross section is relatively large and therefore investment in formwork is not warranted, i.e. tunnels of less than 400-600 feet (150-250 m) in length and larger than about 25-35 feet (8-11 m) in springline diameter.
- The access is difficult and staging of formwork installation and concrete delivery is problematic.
- The tunnel geometry is complex and customized formwork would be required. Tunnel intersections, as well as bifurcations qualify in this area. Bifurcations are associated with tunnel widenings and would otherwise be constructed in the form of a stepped lining configuration and increase cost of excavated material.

When shotcrete is utilized as a final lining in dual shotcrete lining applications it will be applied against a waterproofing membrane as presented in Chapter 9. The lining thickness will be generally 10 to 12 inches (200 to 300 mm) or more and its application must be carried out in layers with a time lag between layer applications to allow for shotcrete setting and hardening. To ensure a final lining that behaves close to monolithically from a structural point of view it is important to limit the time lag between layer applications and assure that the shotcrete surface to which the next layer is applied is clean and free of any dust or dirt films that could create a de-bonding feature between the individual layers. It is typical to limit the application between the layers to 24 hours. Shotcrete final linings are applied onto a carrier system that is composed of lattice girders and welded wire fabric mounted to lattice girders toward the waterproofing membrane side. This carrier system also acts fully or partially as structural reinforcement of the finished lining. The remainder of the required structural reinforcing may be accomplished by rebars

or mats or by steel or plastic fibers. The final shotcrete layer allows for the addition of micro poly propylene (PP) fibers that enhance fire resistance of the final lining.

Unlike the hydrostatic pressure of cast-in-place concrete during installation the shotcrete application does not develop pressures against the waterproofing membrane and the initial lining and therefore one must ensure that any gaps between waterproofing system and initial shotcrete lining and final shotcrete lining be filled with contact grout. As in final lining applications contact grout is accomplished with cementitious grouts but the grout takes are much higher. To assure a proper grouting around the entire lining circumference it is customary to use longitudinal grout hoses arranged radially around the perimeter. Figure 10-15 displays a typical shotcrete final lining section with waterproofing system, welded wire fabric (WWF), lattice girder, grouting hoses for contact grouting and a final shotcrete layer with PP fiber addition.

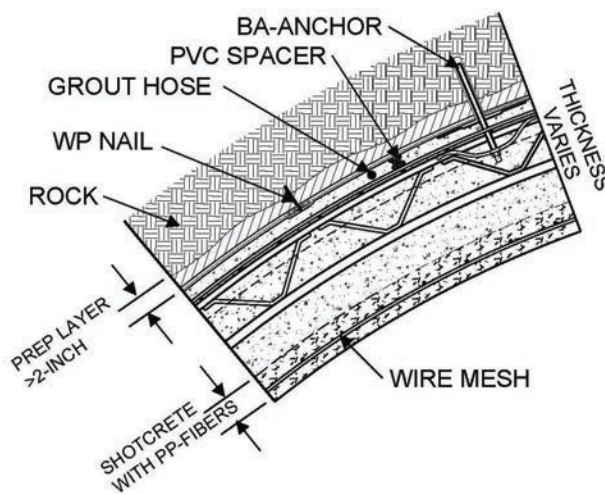

Figure 10-15 Typical Shotcrete Lining Detail

Probably the most important factor that will influence the quality of the shotcrete final lining application is workmanship. While the skill of the shotcrete applying nozzlemen (by hand or robot) is at the core of this workmanship, it is important to address all aspects of the shotcreting process in a method statement. This method statement becomes the basis for the application procedures, and the applicator's and the supervision's Quality Assurance / Quality Control (QA/QC) program. Minimum requirements to be addressed in the method statement are as follows:

- Execution of Work (Installation of Reinforcement, Sequence of Operations, Spray Sections, Time Lag)
- Survey Control and Survey Method
- Mix Design and Specifications
- QA/QC Procedures and Forms ("Pour Cards")
- Testing (Type and Frequency)
- Qualifications of Personnel
- Grouting Procedures

General trends in tunneling indicate that the application of shotcrete for final linings presents a viable alternative to traditional cast-in-place concrete construction. The product shotcrete fulfills cast-in-place

concrete structural requirements. Design and engineering, as well as application procedures, can be planned such as to provide a high quality product. Excellence is needed in the application itself and must go hand-in-hand with quality assurance during application.

Chapter 9 presents detail discussions about shotcrete for initial support. Chapter 16 presents details about applying shotcrete for concrete repairs.

## 10.8 SELECTING A LINING SYSTEM

Each tunnel is a unique project and has its own combinations of ground conditions, opening size, groundwater condition, alignment and applicable construction technique. Given the wide range of combinations of these variables, guidance on the selection of a lining type can only be made using generalizations. The lining system designed for a project is selected based on the best judgment and experience of the designer. Once the project has been bid and awarded, it is not unusual for the contractor to request a change in the lining type, the mining method or both. The following paragraphs give conditions under which certain lining types make sense and offers caveats to be heeded when selecting a lining type for the project.

Cast-in-Place Concrete Cast-in-place concrete can be used in any tunnel with any tunneling method. It requires some form of initial ground support to maintain the excavated opening while the lining is formed, placed and cured. Cast-in-place concrete is usually used in hard ground tunnels mined using drill and blast excavation and soft ground tunnels mined using sequential excavation. Cast-in-place concrete can be formed into any shape so that the lining shape can be optimized to the required opening requirements.

Cast-in-place concrete is also used in both hard and soft ground tunnels excavated using a tunnel boring machine. In these tunnels, the cast-in-place concrete lining is the final lining constructed after initial ground support is installed. Using cast-in-place concrete (two pass system) in a TBM tunnel can result in a larger excavated opening than if a single pass precast lining is used.

Cast-in-place concrete linings are cast against a waterproofing membrane. The membrane can be damaged during placement of reinforcing steel and forms. Forms must remain in place until the lining gains enough strength to support itself and curing must take place after forms are stripped.

Precast Segmental Lining Precast segmental linings are used exclusively in soft and hard ground tunnels excavated using a tunnel boring machine. This single pass system provides the ground support required during excavation and also forms the final lining of the tunnel. This system requires gaskets on each edge of the segments to provide a watertight lining. The segments must be manufactured to tight tolerances. The segments require specialized equipment to handle and erect inside the tunnel. Once erected and in place, the lining system is complete.

Steel Plate Lining Steel plate linings can be used in any ground condition with any mining method. The steel plates form the final lining and ground support once in place. This single pass system provides the ground support required during excavation and also forms the final lining of the tunnel. This system requires gaskets on the each edge of the segments to provide a watertight lining. The segments must be manufactured to tight tolerances. The segments require specialized equipment to handle and erect inside the tunnel. The segments are usually thin and not very stiff in the longitudinal direction. This lack of stiffness limits the amount of thrust that can be used to advance the tunnel boring machine. Difficult ground conditions that require high thrusts to advance the TBM may preclude the use of steel lining plate. Corrosion problems associated with steel linings can severely reduce the life of the lining.

## CHAPTER 11 IMMERSED TUNNELS

### 11.1 INTRODUCTION

This chapter describes the structural design of immersed tunnels in accordance with the AASHTO LRFD Bridge Design Specifications (AASHTO). The intent of this chapter is to provide guidance in the interpretation of the AASHTO specifications in order to have a more uniform application of the code and to provide guidance in the design of items not specifically addressed in AASHTO. The chapter begins with a basic description of immersed tunnel construction methodology.

Immersed tunnels consist of very large pre-cast concrete or concrete-filled steel tunnel elements fabricated in the dry and installed under water. More than a hundred immersed tunnels have been built to provide road or rail connections. They are fabricated in convenient lengths on shipways, in dry docks, or in improvised floodable basins, sealed with bulkheads at each end, and then floated out. Tunnel elements can and have been towed successfully over great distances. They may require outfitting at a pier close to their final destination. They are then towed to their final location, immersed, lowered into a prepared trench, and joined to previously placed tunnel elements. After additional foundation works have been completed, the trench around the immersed tunnel is backfilled and the water bed reinstated. The top of the tunnel should preferably be at least 5 ft (1.5 m) below the original bottom to allow for sufficient protective backfill. However, in a few cases where the hydraulic regime allowed, the tunnel has been placed higher than the original water bed within an underwater protective embankment.

Immersed tunnel elements are usually floated to the site using their buoyant state. However, sometimes additional external buoyancy tanks attached to the elements would be used if necessary. The ends of the tunnel elements are equipped with bulkheads (dam plates) across the ends to keep the inside dry, located to allow only about 6 to 8 ft (2 m to 2.5 m) between the bulkheads of adjacent elements at an immersion joint; this space is emptied once an initial seal is obtained during the joining process. The joints are usually equipped with gaskets to create the seal with the adjacent element. They are also equipped with adjustment devices to allow placement of the elements on line and grade. The tunnel elements will be lowered into their location after adding either temporary water ballast or tremie concrete. Figure 11-1 shows an illustration of the placement of an immersed tunnel.



Figure 11-1 Immersed Tunnel Illustration

### 11.1.1 Typical Applications

Immersed tunnels may have special advantages over bored tunnels for water crossings at some locations since they lie only a short distance below water bed level. Approaches can therefore be relatively short. Compared with high level bridges or bored tunnels, the overall length of crossing will be shorter. Tunnels can be made to suit horizontal and vertical alignments. They can be constructed in soils that would be a real challenge to a long-span bridge structure and under such conditions may be very cost competitive. However, immersed tunnels have potential disadvantages in term of environmental disturbance to the water body bed. They may have impact on fish habitats, ecology, current, and turbidity of the water. Furthermore, impacts on navigation in all navigable waterways should be considered and often extensive permitting would be required. In addition, many of the water bodies such as harbors or causeways have contaminated sediments requiring special handling. The use of immersed tunnel techniques might encounter such contaminated ground and would require its regulated disposal. For very long crossings where navigation is important, bridge-tunnel combinations can provide a most economical solution; long trestle bridges extend out from the shores through relatively shallow water to man-made islands at which the transition between bridge and tunnel is made, with the tunnel extending across the usually deeper navigation channels. The Chesapeake Bay Bridge-Tunnel in Norfolk, Virginia, was completed in 1964, is over 17 miles long and has immersed tunnels at each of the two main shipping channels, one of which is shown in Figure 11-2.



Figure 11-2 Chesapeake Bay Bridge-Tunnel

### 11.1.2 Types of Immersed Tunnel

Two main types of immersed tunnel have emerged, known as steel and concrete tunnels, terminology that relates to the method of fabrication. Both types perform the same function after installation. Steel tunnels

use structural steel, usually in the form of stiffened plate, working compositely with the interior concrete as the structural system. Concrete tunnels rely on steel reinforcing bars or prestressing cables. The steel immersed tunnel elements are usually fabricated in ship yards or dry docks similar to ships, launched into water and then outfitted with concrete while afloat. Concrete immersed elements are usually cast in dry docks, or specially built basins, then the basin is flooded and the elements are floated out. Steel tunnels can have an initial draft of as little as about 8 feet (about 2.5 m), whereas concrete tunnels have a draft of almost the full depth. Tunnel cross-sections may have flat sides or curved sides.

Historically, concrete tunnels have predominantly been rectangular, which is particularly attractive for wide highways and combined road/rail tunnels. In Europe, Southeast Asia and Australia, virtually all immersed tunnels are concrete. In Japan, steel and concrete tunnels are in approximately equal numbers. Although most tunnels in North America are steel tunnels, there are also concrete immersed tunnels .

Steel tunnels have been circular, curved with a flat bottom, and rectangular (particularly in Japan), but the predominant shape in the US has been the double-shell tunnel, which is a circular shell within an octagonal shape. Most or all of the concrete in steel tunnels is placed while the steel shell is afloat, in direct contrast to concrete tunnels that are virtually complete before being floated out. The order in which concrete is placed for a steel tunnel is tightly controlled to minimize deformations and the resulting stresses. Steel immersed tunnels can be categorized into three sub-types: Single shell, double shell and sandwich.

### 11.1.3 Single Shell Steel Tunnel

In this type, the external structural shell plate works compositely with the interior reinforced concrete and no external concrete is provided. The shell plate requires corrosion protection, usually in the form of cathodic protection. The Hong Kong Cross-Harbour tunnel (Figure 11-3 and Figure 11-12) and San Francisco BART trans-bay tunnel are typical of this type .

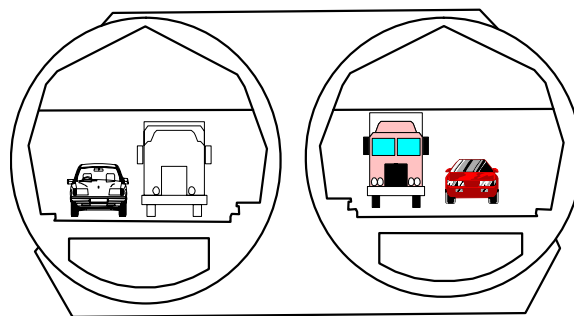

Figure 11-3 Cross Harbour Tunnel Hong Kong

Early examples of the single shell type are The Detroit River tunnel (1910), and the Harlem River tunnel (1914); both are rail tunnels and being the first two immersed transportation tunnels ever built, have similarities to single-shell tunnels. Of the eight existing single-shell immersed tunnels in the world, three are for rail in Tokyo, Japan, and three are for rail in the US. Two road tunnels have been constructed using the single shell method: The Baytown Tunnel in Texas (since removed) and the Cross Harbor Tunnel (Figure 11-12) in Hong Kong. Figure 11-4 shows the BART tunnel in San Francisco, a transit tunnel built in 1969. It is 5800m long and consists of 57 elements, all end launched.

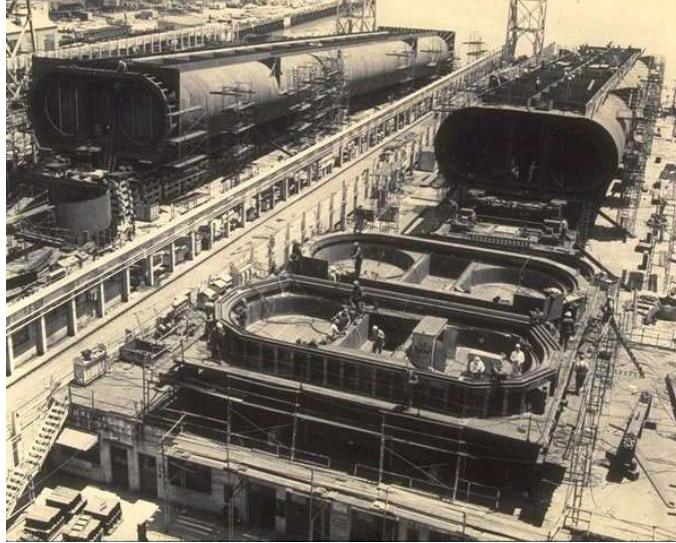

Figure 11-4 BART Tunnel, San Francisco

The initial draft of a single shell tunnel is less than that for other immersed tunnel types because of the elimination of the outer shell. However, leaks in the steel shell may be difficult to identify and seal; subdividing the surface into smaller panels by using ribs will improve the chances of sealing a leak. Great care and considerable testing is required to ensure that the welds are defect free. The risks of permanent leakage can be higher in single shell immersed tunnels than in other types. To avoid this, the external structural steel shell often requires a positive form of corrosion protection.

#### 11.1.4 Double Shell

A double shell tunnel element is comprised of an internal structural shell that acts compositely with concrete placed within the steel shell. The top and invert concrete outside the structural shell plate is also structural. A second steel shell is constructed outside the structural steel shell to act as formwork for ballast concrete at the sides placed by tremie. In this configuration the interior structural shell plate works compositely with internal reinforced concrete while it is protected by external concrete placed within non-structural steel form plates. Figure 11-5 shows the cross section of the Second Hampton Roads Tunnel in Virginia. The steel portion of the double shell tunnel element is often fabricated at a shipyard. Prior to launching, the invert concrete may be placed to make the element more stable during towing and outfitting and to internally brace the steel elements. Due to the double shell configuration, this element is stiffer than the single shell section. However, due to the potential for rough conditions during towing and in particular during launching if not constructed in a dry dock, internal bracing may be required until the tunnel element is in its final position.

Multiple bores are created by linking sections with diaphragms. The diaphragms also serve to stiffen the steel shell. Diaphragms are spaced along the length of the tunnel element. Longitudinal stiffeners in the form of plates or T-sections are used in the longitudinal direction of the element between diaphragms to stiffen the shell. Figure 11-6 is a photograph of double shell tunnel elements constructed for the Fort McHenry Tunnel in Baltimore, Maryland.



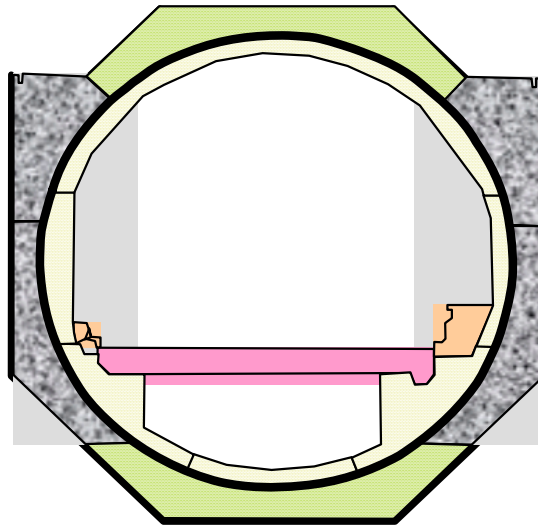

Figure 11-5 Double Shell - Second Hampton Road Tunnel, Virginia

### 11.1.5 Sandwich Construction

This construction type consists of a structural concrete layer sandwiched between two steel shells. Both the inner and outer shells are load carrying and both act compositely with the inner concrete layer. The concrete is un-reinforced and is formulated to be non-shrink and self consolidating. The inner surfaces of the steel shells are stiffened with plates and L-shaped ribs that also provide the connection required for composite action with the internal concrete. The internal concrete, once cured, carries compression loads and also serves to stiffen the steel shells. The steel shells carry the tension loads. Figure 11-7 shows a schematic of this type of construction.



Figure 11-6 Fort McHenry Tunnel, Baltimore

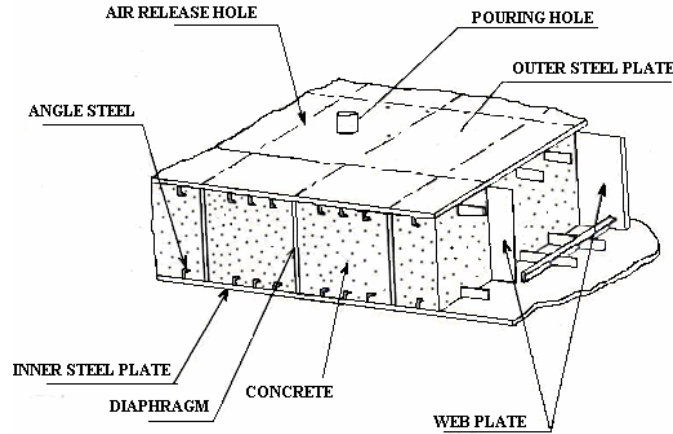

Figure 11-7 Schematic of Sandwich Construction

As with the other types, the steel shells are fabricated at a shipyard, launched and towed to the tunnel site. Internal diaphragms between the two shells stiffen the section sufficiently to resist the loads imposed during transport and outfitting. Once at the outfitting pier, the internal concrete is placed and the element draft increases. The element is towed to its location along the tunnel alignment and the final ballast and structural concrete is placed so that it can be lowered into place.

The steel sandwich construction provides a double layer of protection against leaks. However it is a very complex arrangement that requires carefully defined and executed procedures for fabrication and concreting. Distortion of the section during welding and poor quality welds can be costly mistakes for this type of construction. A recent example of a tunnel using this methodology is the Bosphorus crossing in Istanbul, Turkey where the end sections of each element are made in this way. Figure 11-8 shows two elements afloat while being outfitted. Several tunnels of this type exist in Japan.



Figure 11-8 Bosphorus Tunnel, Istanbul, Turkey

### 11.1.6 Concrete Immersed Tunnels

Cast-in-place concrete is a versatile and durable material. It is easily formed into any shape or configuration to meet the needs of a specific project. Due to the fact that concrete is heavy, immersed tunnel elements constructed from concrete will float usually with very large drafts. In fact the freeboard for concrete elements is often less than a foot resulting in almost the entire element being underwater when being towed into position. This requires careful planning when using a concrete element. The path from the fabrication site to the tunnel alignment must contain water deep enough for the element to pass. Therefore, concrete elements are usually cast in a basin constructed close to the project site. A dredged channel may be required from the basin to the tunnel alignment. Once the concrete elements have been fabricated, the basin is flooded. The elements are towed out of the basin and to the tunnel alignment. Figure 11-9 shows construction of a concrete immersed tunnel crossing the Fort Point Channel in Boston.



Figure 11-9 Fort Point Channel Tunnel, Boston

Considerable development in the design and construction of concrete immersed tunnels has occurred over recent years, particularly in the use of materials and construction methods that reduce the number of construction joints. Water-cement ratio has been substantially reduced, and there have been efforts to reduce the heat of hydration, both of which result in fewer through-cracks during the curing of the concrete. Reducing the through cracks is key to making the sections waterproof. Figure 11-10 shows an above-ground fabrication facility and a transfer basin for the Øresund crossing in Denmark.

The length of concrete cast in a single operation for a full-width segment (bay) of a tunnel element has increased in length from some 30 ft (10 m) to about 60 ft (20 m) over the years, despite the very large volumes of concrete to place, and the expansion and contraction that occur during the first few days due to the heat of hydration.

To prevent cracking due to heat of hydration, mitigation measures have been used including concrete cooling using refrigerated pipes cast into the concrete, mix design, low heat cement such as ground granulated blast furnace cement, shielding from the elements and proper curing. Each of these measures has advantages and disadvantages. All aspects of these measures must be understood in order for them to be implemented. For example, high percentages of blast furnace slag will slow down the set of the

concrete; pressure due to any additional height of liquid concrete needs to be considered in the formwork design.



Figure 11-10 Fabrication Facility and Transfer Basin, Øresund Tunnel, Denmark

Typically, the floor slab is cast first, followed by walls and then roof. Techniques have evolved permitting the outer walls and even the base slab to be cast with the roof slab, thereby reducing the number of construction joints in the exterior. Since construction joints are particularly susceptible to leakage, most often due to thermal restraint, it is most desirable to minimize their numbers.

Prestressing has been used in certain cases to resist bending moments and to reduce cracking. Some tunnels are prestressed transversely, and some have a nominal longitudinal prestressing applied. Careful detailing and good workmanship should be able to eliminate virtually all deleterious cracking in concrete.

## 11.2 CONSTRUCTION METHODOLOGY

### 11.2.1 General

The construction of an immersed tunnel consists of excavating an open trench in the bed of the body of water being crossed. Tunnel elements are fabricated off site, usually at a shipyard or in dry docks. Elements constructed on launching ways are launched similar to ships by sliding them into the water. Elements constructed in dry docks, are floated by flooding the dry dock. The ends of each element are closed by bulkheads to make the element watertight. The bulkheads are set back a nominal distance from the end of the element, resulting in a small space at the ends of the adjoining sections that is filled with water and will require dewatering after the connections with the previous element is made. After fabrication and launching, the elements are towed into position over the excavated trench, once positioned and attached to a lowering device (lay barge, pontoons, crane, etc), ballast is placed in or on the element so that it can be lowered to its final position. Sometimes ballasting of the element is achieved by water ballast in temporary internal tanks or by adding concrete. After placing the element in its position, connection is made between the newly placed element and the end face of the previously placed element or structure to which it is to be joined. Once the element is in its final position butted up against the adjacent element, the water within the joint between two elements is pumped out. After any remaining foundation work has been completed and locking fill is in place, the joint can be completed and the area made watertight. Once locking fill is in position, another element can be placed. The bulkheads can then be removed, making the tunnel opening continuous. For safety reasons, the bulkheads at the joint to the most recently placed tunnel element are left in position. The tunnel is then backfilled and a protective layer of stone is placed over the top of the tunnel if required.

Variations in the construction method deal primarily with materials and location of the fabrication site at which the sections are constructed.

### 11.2.2 Trench Excavation

The most common method of excavation for immersed tunnels is the use of a clamshell dredger (Figure 11-11). Sealed buckets should be used for contaminated materials and/or to reduce turbidity in environmentally sensitive areas. Cutter suction dredgers have also been used and are able to remove most materials other than hard rock. Blasting may be required in certain areas, though it is highly environmentally undesirable.



Figure 11-11 Sealed Clam Shell Dredge

The tunnel trench should be dredged to longitudinal profiles and bottom widths taking potential sloughing of the sides and accuracy of dredging into account so that the necessary bottom width and profile can be maintained during lowering of the elements and placing of the foundation materials. Over-dredged areas should be refilled with materials conforming to design requirements for foundation materials. Dredging should be carried out in at least two stages: removal of bulk material; and trimming. The trimming should involve removal of at least the last 3 feet (1.0 m) above final dredge level. All silt or other material that may accumulate on the bottom of the trench should be cleared immediately before placing the element. Dredging methods and equipment should be designed to limit the dispersal of fine materials in the water. Turbidity or silt curtains or other measures should be used where appropriate. Methods, materials, and mitigation measures should be used to avoid or reduce to acceptable levels the impacts of excavation, filling and other operations on the marine environment.

Trench excavation in any waterway is an environmentally sensitive issue. Once the environmental conditions have been set by the planning and permitting process, extreme care should be taken to meet these conditions. Trench excavation underwater is a difficult and complex process that can be complicated by contaminated materials, tides, storms and construction restrictions in waterways due to

environmental concerns associated with fish migration and mating patterns and with ecology and marine life. Scheduling of construction activities, environmentally friendly construction techniques and equipment and innovative methods of dealing with contaminants must be considered in the design of the excavation and backfill.

Locations, elevations and dimensions of all underwater utility lines and marine structures should be determined in the area of the dredging and protection should be provided if required. Excavations should be evaluated for stability using appropriate limit state methods of analysis. Temporary slopes offshore should be designed for a minimum factor of safety of 1.3. Side slopes of the trench should not be steeper than 2 horizontal to 1 vertical in soil, nor steeper than 1 horizontal to 4 vertical in rock provided the minimum specified factor of safety is achieved. The design should ensure that the bottom of any excavation is stable. The design should take into account excavation base stability against heave in any cohesive soils. Remedial measures such as ground improvement may be required to provide stability of the excavation base against heave.

Special requirements to handle the disposal of dredged materials are usually specified. Contaminated materials must be disposed of in special spoil containment facilities, while uncontaminated materials, if suitable, can be reused for backfill. Materials for reuse must be stored in areas where excess water can drain away. For most immersed tunnel projects where spoil containment facilities are required, the quality and quantity of the wet material are such that existing facilities are too small or unsuitable. A dramatic increase in dredging and disposal costs over the past three decades due primarily to continually tightening environmental restrictions present significant challenges to the disposal of unwanted material. Unique solutions were developed for various projects including: the use of the dredged materials to construct a manmade island such as for the Second Hampton Road Tunnel in Virginia or to reclaim a capped confined disposal facility (CDF) as a modern container terminal such as the case of the Fort McHenry Tunnel in Baltimore.

### **11.2.3 Foundation Preparation**

Once the trench excavation is complete, installation of the foundation should begin. Two types of foundations are used in immersed tunnel construction, continuous bedding (screeded foundation or pumped sand) or individual supports.

Continuous Bedding Continuous bedding should consist of clean, sound, hard durable material with a grading compatible with the job conditions. These include applied bearing pressure, the method with which the bedding is placed and the material onto which the bedding is placed. The foundation thickness should not be less than 20 inches (500) mm and preferably less than 4.5 feet (1.4 m). The gap between the underside of the tunnel and the trench bottom should be filled with suitable foundation material. The foundation can be prepared prior to lowering the elements (screeded), or it can be completed after placing the elements on temporary supports in the trench (pumped sand); foundations formed after placement have included sand jetting, sand flow and grout. For a screeded foundation, the bedding is fine graded with a screed to the line and grade required for section placement, or a stone bed may be placed with a computer-controlled tremie pipe (“scrading”). Settlement analyses for the immersed tunnel should be performed and should consider compression of the foundation course placed beneath the tunnel elements. Analyses should also be performed to estimate the longitudinal and transverse differential settlement within each tunnel element, between adjoining tunnel elements, and at the transitions at the ends of the immersed tunnel. Measures should be taken to prevent sharp transitions from soil to rock foundations. Varying the thickness of the continuous bedding can accomplish this. Alternately the tunnel structure should be designed to resist the load effects from the potential differential settlement of the sub-foundation material.

Individual Supports Individual supports usually consist of driven piles. Pile foundations should be designed in accordance with generally recognized procedures and methods of analysis. The piles should be designed to fully support all applied compression, uplift and lateral loads, and any possible down-drag (negative friction) loads from compressible soil strata. The load-bearing capacity, foundation settlement and lateral displacement should be evaluated for individual piles and for pile groups, as appropriate. The load capacity for bearing piles should be confirmed by static and/or dynamic pile load testing in accordance with recognized standards. The piles and tunnel sections are usually detailed to be adjustable in order to fine tune the horizontal and vertical placement of the tunnel. Once the tunnel sections are in their final positions, the adjustment is locked off and a permanent connection between the tunnel and pile may be made. The space between the bottom of the tunnel section and the bottom of the trench below the tunnel section is then filled with granular material. This process must be carefully controlled so that the bottom of the trench is not disturbed and that the void is completely filled. Since in most cases, the weight of the tunnel section being placed is less than the weight of the soil it is replacing, pile foundations are rarely used.

#### 11.2.4 Tunnel Element Fabrication

For steel tunnels, fabrication is usually done by modules, each module being in the range of 15ft (5m) long, spanning between diaphragms. The modules are then connected and welded together to form the completed shell of the tunnel element. Electro-slag and electro-gas welding are not permitted, and all groove and butt welds are full-penetration welds. Measures need to be taken to eliminate warping and buckling of steel plates resulting from their local overheating during welding. Welds must be tested by non-destructive methods; it is recommended that ultrasonic testing be supplemented by X-ray spot-check testing. In some cases, stress relieving may be necessary. The placing of keel concrete should be done in such a way that it avoids any overstressing or excessive deflections in the bottom shell and its stiffeners. All length and angular measurements for tolerances need to be made while the structure is shielded from direct sunlight to eliminate errors due to warping from differential temperatures. Figure 11-12 shows the completed fabrication of a tunnel element for the Hong Kong Cross Harbor Tunnel, almost ready to be side launched.



Figure 11-12 Hong Kong Cross Harbour Tunnel is Nearly Ready for Side Launching.

Concrete tunnel elements are usually constructed in a number of full-width segments to reduce the effects of shrinkage. The segment joints may be construction joints with reinforcement running through them, or

they may be movement joints. All joints must be watertight. Tight controls on casting and curing must be maintained to minimize cracking. Differential heat of hydration can be controlled by the use of high percentages of blast furnace slag to replace Portland cement or by using internal cooling system. Where concrete segments are cast with movement joints, they are joined together using temporary or permanent post-tensioning to form complete elements at least during transportation and installation. Care must be taken to ensure that long-term movements of short segments free to move are acceptable.

Tunnel elements are generally fabricated to be approximately 300 to 400 feet in length each. The actual length is a function of the capacity of the fabrication facility, restrictions along the waterway used to float the elements to the construction site, restrictions at the tunnel including accommodation of marine traffic during construction, currents, element shape and the availability of space for an outfitting pier, and the capacity of the equipment used to lower the elements into place.

All construction hatches, openings, etc., need to be sealed, by welding or other secure means, upon completion of concreting or other works for which they were required. Before the launching or floating of elements, bulkheads, manholes and doors, etc. should be inspected to ensure that they are secure and watertight. When no longer needed, any temporary access manholes through the permanent structure should be closed and a permanent seal made.

As tunnel elements are installed, the actual installed length of tunnel and position should be monitored so that any changes to the overall length of future tunnel elements and the orientation of the end faces can be adjusted as required to ensure fit with the actual surveyed positions of installed tunnel elements. This is especially important prior to fabrication and placement of the closure (last) element.

### **11.2.5 Transportation and Handling of Tunnel Elements**

The stability of tunnel elements must be ensured at every stage of construction, especially when afloat. In checking tunnel elements for stability while floating, due attention must be paid to effects of variations in structural dimensions, including results of thermal and hydrostatic effects. Items to consider include:

- Sufficient freeboard for marine operations, so that tunnel elements are relatively unaffected even when waves run over the top. A positive buoyancy margin exceeding 1% is recommended to guard against sinking due to variations in dimensions and the densities of both tunnel materials and the surrounding water.
- Lateral stability of the element using cross-curves of stability analysis should have a factor of safety in excess of 1.4 of the area under the righting moment curve against the heeling moment curve. A positive metacentric height (static stability) exceeding 8 inches (200 mm) is also recommended.

When a storm warning is issued, or forecast wave heights are expected to exceed operational limits, all marine operations should be ceased temporarily; marine plant and floating tunnel elements should be sent to their designated storm moorings or shelters. It is recommended that an emergency berth be identified for tunnel elements, preferably within or close to the placement site. Special measures may be required to control tunnel elements in areas with currents or navigation channels. Figure 11-13 shows the transportation of a tunnel element to its final position.

### **11.2.6 Lowering and Placing**

After outfitting at their final destination, immersed tunnel elements are prepared for immersion and lowering onto prepared foundations in a trench in the bed. The equipment used may typically be provided on a purpose-built catamaran straddling the element (Figure 11-14). Other methods include the placement of pontoons on top of elements (Figure 11-13), or cranes have sometimes been used. In Boston, for the



Fort Point Channel tunnel, vertical buoyancy tubes were attached to the top of the elements and immersion by progressively adding water ballast was done.



Figure 11-13 Osaka Port Sakishima Tunnel Element Transported to Site with Two Pontoon Lay Barges



Figure 11-14 Catamaran Lay Barge

To lower an element to its final position, it is usual for either a temporary ballasting system to be used or for the element weight to be such that the element will itself have sufficient negative buoyancy. The method of immersion must:

- Maintain stability, including control over the tunnel element, while it is lowered to its final position.

- Enable the negative buoyancy to be increased as necessary so that a minimum factor of safety against flotation and overturning of 1.025 is obtained immediately after lowering.
- Enable the negative buoyancy to be increased to give a minimum factor of safety against flotation and overturning of 1.04 within a few hours of lowering and placing, ignoring assistance from adjacent elements.
- Maintain a vertical downward load of not less than 112.5 kips (500 kN) on every temporary seabed support, if used, until the element is placed on its final foundation.

The calculation of the factor of safety may include items such as external ballast, for example concrete blocks or internal ballast water tanks.

Lowering equipment should be designed to enable the lowering operation to be effectively controlled from a central control point and to make available at the central control accurate information on the position of the element and the loads on the lowering and the holding lines.

Elements are lowered and butted up to preceding elements. Thereafter, the joint between them is dewatered. A typical joint between elements includes watertight bulkheads (dam plates); watertight access bulkhead doors; joint seal and gaskets, dewatering equipment including any pumps and piping; location devices to guide the element horizontally and vertically into place relative to the preceding element, provision for shear keys (horizontal and vertical) and vertical and horizontal adjustment devices such as wedges, jacks and shims.

Tunnel elements should be installed at an elevation that considers an allowance for settlement such that after completion of the foundation works and all backfilling, they will be expected to be located within a tolerance of 2 inches (50 mm) laterally and vertically from their theoretical location, or any such lower figure on which the design methods are based. The allowance for settlement included in the determination of the installation level should be determined before installation. Notwithstanding the above, the relative location laterally and vertically should not be more than 1 inch (25 mm) across any joint. The relative location vertically across the terminal joints to other structures should not exceed 2 inches (50 mm).

Where foundation pads are used for temporarily supporting tunnel elements, any requirements for preloading and all subsequent behavior of the pads should be determined. The effect of potential hard spots beneath the tunnel element created by the foundation pads should be evaluated. Settlement of the foundation pads should be measured from the time of installation through any period of preloading until the tunnel element no longer requires support by the pads.

Permanent survey markers are needed within and on top of each element so that at any time its position relative to its position at time of casting is known. Survey towers or other markers or systems are needed so that the position of the element during lowering and placing is accurately known.

### **11.2.7 Element Placement**

Element placement is the most delicate of all operations involving immersed tunnel elements. The needed duration of weather windows must be defined as well as “go / no-go” hold points. Some recent tunnels where prevailing currents could affect placing operations have used a weather-forecasting modeling system to forecast the required window; this may require monitoring of the hydrological and meteorological conditions concurrently to develop a forecasting model. Such a model should provide an understanding of the relationship between observed flow and meteorological and hydrological conditions. The last “go / no-go” decision should be based upon the current waves, and other physical conditions staying below the designed upper limits with a statistical probability of more than 90%. In all cases, the

actual current at the element position should be checked immediately before lowering and continuously observed during the lowering and placing operation.

The element should have sufficient negative buoyancy to maintain stability and control of the tunnel element during immersion, so that the element can be lowered safely to its final position. The design should enable the negative buoyancy to be increased, if required, to give the minimum factors of safety given in Clause 11.2.6. Figure 11-15 shows the placement of a tunnel element using a catamaran lay barge.



Figure 11-15 A Tunnel Element is Being Placed.

Valves for dewatering of immersed joints should be operated from inside the previously placed tunnel element. No watertight doors or hatches should be opened until it can be confirmed that there is no water on the other side. Access must be maintained to the inside of the first element that is placed from the time when the element is placed until completion of permanent access through one of the terminal joints. Where hydrostatic pressure exists on a temporary bulkhead, the next two bulkheads should remain in place (one at the remote end of the same element, and the immediately adjacent one in the next tunnel element). Watertight doors in these bulkheads should remain closed at all times when the last tunnel element is unoccupied by personnel. Watertight doors should not be opened until the absence of water on the far side has been confirmed. The stability of the installed immersed tunnel elements during removal of temporary ballast and joint dewatering must be controlled to ensure that necessary factors of safety are maintained for the element as a whole, not only for the ends and for the sides, and so that the bearing pressure on the foundation remains approximately uniform.

After lowering and initial joining of each immersed tunnel element, its position should be precisely surveyed before the next element is placed. Settlement monitoring of tunnel elements should be carried out using the survey markers installed inside the elements. Levels should be recorded weekly until completion of backfilling of the subsequent element to ensure no remedial action is required and monthly thereafter until settlement becomes negligible.

### 11.2.8 Backfilling

The design should take into account the suitability of excavated material for use as backfill. The design should ensure that backfill placed next to the immersed tunnel is placed uniformly on both sides of the structure to avoid imbalanced lateral loads on the structure. The maximum difference in backfill level outside such structures above the locking fill should be 3 ft (1 m) until the lower side has been filled to its final level. Elements with more than 3 ft (1 m) difference in backfill level should be designed to accommodate the resulting transverse loads.

All fill materials subject to waves and currents should be designed to prevent scour and erosion. All underwater filling and rock protection material should be placed in a way that avoids damage to the waterproofing membranes (if present) or to the structure from impact or abrasion. The material should be placed in even layers on either side of the tunnel to avoid unequal horizontal pressures on the structures, and should be placed by means of buckets or tremie.

Prior to and during the placing of fill, the trench should be checked for sediment. Sediment that is detrimental to the performance of the material being placed should be removed.

Backfill should be provided around the tunnel. In seismic areas where there is a risk of liquefaction, the foundation and backfill should be designed as free-draining to prevent the development of excess pore-water pressure during and following a seismic event. Armor protection, if needed, should be provided to prevent long-term loss of backfill at the sides and on top of the tunnel.

The backfill usually consist of the following:

- Selected locking fill to secure the elements laterally
- General backfill to the sides and top of the tunnel structure, also providing an impact-absorbing / load-spreading layer above the tunnel
- A rock protection blanket generally above and adjacent to the tunnel to provide scour protection;
- Rock-fill anchor-release bands at both sides of the tunnel are sometimes provided.

### 11.2.9 Locking Fill

Selected locking fill is placed in the trench to a minimum level of half the height of each element after the joint to the adjacent tunnel has been dewatered. Locking fill should extend at least 6 ft (2 m) horizontally from the tunnel element before being allowed to slope down not steeper than 1:2. Locking backfill is placed in layers of uniform thickness not exceeding 2 ft (600mm), such that lateral and vertical forces on the tunnel element are minimized and no displacement of the element occurs. Placement of locking backfill proceeds from the inboard (jointed) end of tunnel elements and progresses towards the outboard end of tunnel elements in a manner that produces a uniformly dense backfill bearing tightly against the tunnel periphery.

The locking fill must be a granular, clean, sound, hard, durable material that will compact naturally and that will remain stable under both non-seismic and seismic conditions (where required). It may include crushed sound rock or gravel. Well graded sub-angular sand may be included. Sand fill, if used, must be free-draining.

### **11.2.10 General Backfill**

General backfill should be used to fill the remainder of the trench above the selected locking fill up to the underside of any protection layer, or to the pre-existing seabed level if no protection layer is used. General backfill should be placed by a method that avoids segregation or misplacement of the fill.

The properties of general fill must suit the proposed design and method of placing. General fill may comprise soft cohesionless material that will remain stable. General fill must be free from clay balls and be chemically inert. Often the dredged materials for the trench are suitable as general backfill.

### **11.2.11 Protection Blanket**

The elevation of the top of the protection layer should approximate pre-existing seabed levels unless instructed otherwise. However in certain situations, the top of the tunnel can extend above the original seabed in an underwater embankment if permitted. In this situation, the protective blanket shall be provided above the embankment backfill.

Rock protection blanket material should consist of hard inert material, usually sound, dense, newly quarried rock in clean angular pieces, well graded between 1 inch to 10 inches (25 mm and 250 mm). The material should be durable for at least the design life of the tunnel. The method of placing this material must ensure that the large-size stones do not penetrate the general backfill and must cause no damage to waterproofing of the tunnel (if used). The protection layer should not be placed by bottom dumping.

### **11.2.12 Anchor Release Protection**

In navigable waters, anchor release protection should be provided, if required, and if the tunnel cover extends above the bed. Rock armor for anchor release bands should be of sound, dense, newly quarried rock in clean angular pieces and well graded. The intent of the anchor release protection is to bring the anchor to the surface and choke the gape (the space between the hook and the shank). The size of anchor should be for vessels plying those waters. The material needs to be durable for at least the design life of the tunnel.

## **11.3 LOADINGS**

### **11.3.1 General**

For the assessment of loads, the density of materials should be based on actual measurements made on samples from the same source as will be used for construction. For the design of individual sections, the least favorable loading should be used. The design should take into account the fact that the specific gravity of water may vary according to depth, prevailing weather conditions and season. The effect of suspended material should be taken into account in determining the specific gravity of water. The maximum hydrostatic load should be used for structural calculations. To ensure flotation (during launching or floating of the elements), the minimum relevant specific gravity of water should be used, and to prevent flotation (after placement of the element) the maximum should be used. The maximum and minimum values for each material used must be specified. The design must take into account any particular current regimes expected. This must include consideration of current speed, depth, direction, any interface between contra-flowing currents and the turbulence engendered thereby.

### 11.3.2 Loads

The loads to be considered in the design of structures along with how to combine the loads are given in Section 3 of the AASHTO LRFD specifications. It divides loads into two categories: Permanent Loads and Transient Loads. Paragraph 3.3.2 “Load and Load Designation” of the AASHTO LRFD specifications defines following permanent loads that are applicable to the design of immersed tunnels:

- DC = Dead Load: This load comprises the self weight of the structural components as well as the loads associated with nonstructural attachments. Nonstructural attachments can be signs, lighting fixtures, signals, architectural finishes, waterproofing, etc. Typical unit weights for common building materials are given in Table 3.5.1-1 of the AASHTO LRFD specifications. Actual weights for other items should be calculated based on their composition and configuration. [These items have essentially well defined weights.]
- DW = Dead Load: This load comprises the self weight of wearing surfaces and utilities. Utilities in tunnels can include power lines, drainage pipes, communication lines, water supply lines, etc. Wearing surfaces can be asphalt or concrete. Dead loads of wearing surfaces and utilities should be calculated based on the actual size and configuration of these items. [The weights of these items are generally less well defined, may be removed or replaced, and have different load factors.]
- EH = Horizontal Earth Pressure Load. This load is generated by the backfill material and any armoring located above the backfill. The properties of the backfill material should be well defined. The value of the horizontal earth pressure should be calculated based on the properties of the specified backfill material. At-rest pressures should be used in the design of immersed tunnels.
- EL = Accumulated locked-in force effects resulting from the construction process including secondary forces from post tensioning.
- ES = Earth surcharge load. This is the vertical earth load due to fill over the structure that was placed above the original ground line. This load may be generated by armoring that is placed over the backfill.
- EV = Vertical pressure from the dead load of the earth fill. This is the vertical earth load due to fill over the structure up to the original ground line. The properties of the backfill material should be well defined. The value of the vertical earth pressure should be calculated based on the properties of the specified backfill material.

Paragraph 3.3.2 “Load and Load Designation” of the LRFD specifications defines following transient loads that are applicable to the design of immersed tunnels:

- CL = Construction Load: These loads are not explicitly defined in the AASHTO LRFD specifications, but must be considered when designing immersed tunnels. They include loads imposed when the tunnel section is launched, transporting loads such as loads imposed when towing the sections, wave action on the floating section, current loads when the section is being outfitted or placed, the loads imposed when the section is floating and concrete is placed in or on the section, wind on the section when it is being towed or when it is moored and being outfitted.
- CR = Creep: Creep can be a factor in the design of concrete immersed tunnels and should be considered accordingly.

- CT = Vehicular Collision Force: Inside the tunnel, this load would be applied to individual components of the tunnel structure that could be damaged by vehicular collision. Typically, tunnel walls are very massive or are protected by redirecting barriers so that this load need be considered only under very unusual circumstances. It is preferable to detail tunnel structural components so that they are not subject to damage from vehicular impact.
- CV = Vessel Collision Force: This load could is generated by a sinking ship coming to rest over the tunnel. The magnitude of this load is a function of the type and size of vessels using the waterway over the tunnel. A study of the vessel traffic should be performed and the load determined based on the results of that study. Another category of this load is anchor impact. Should a ship drop its anchor in the vicinity of the tunnel, this will impart a significant load on the tunnel. This load should not be applied in combination with the vessel collision force. The following section provides guidelines for computing these loads.
- EQ = Earthquake. This is a load that should be considered in areas where seismic activity is expected. This is discussed in Chapter 13.
- IM = Vehicle dynamic load allowance: This load can apply to the roadway slabs of tunnels. An equation for the calculation of this load is given in paragraph 3.6.2.2 of the AASHTO LRFD specifications.
- LL = Vehicular Live Load: This load can apply to the roadway slabs of tunnels and should be applied in accordance with the provisions of paragraph 3.6.1.2 of the AASHTO LRFD specifications.
- PL = Pedestrian Live load. Pedestrian are typically not permitted in highway tunnels, however, there are areas where maintenance and inspection personnel will need access, areas such as ventilation ducts when transverse ventilation is used, plenums above false ceilings, and safety walks. These loads are transmitted to the lining through the supporting members for the described features.
- SE = Settlement: Allowance should be taken of immediate settlements during the first week or so after placement of the element due to compaction of the foundation material (this could easily be 1 inch or 25 mm), expected long term movements due to placement of backfill and subsequent movements of the underlying materials, and movements resulting from the placement and backfilling of adjacent tunnel elements. Lateral movements can occur in soils that are non-uniform laterally and where the soil surface is sloping. Proper preparation of the foundation and placement of the backfill can minimize these effects. For the typical highway tunnel, the overall weight of the structure is less than the soil it is replacing. As such, unless backfill in excess of the original ground elevation is placed over the tunnel, settlement will not be an issue for immersed tunnels. If settlement is anticipated due to poor subsurface conditions or due to the addition of load onto the structure or changing ground conditions along the length of the tunnel, it is recommended that a pile foundation be used.
- SH = Shrinkage: Shrinkage usually results in cracking. In the case of concrete immersed tunnels, detailing and construction methods should be employed to minimize shrinkage in order to minimize the resulting cracking. Shrinkage can also occur in the concrete placed as part of steel shell tunnel sections. The effect of this force should be accounted for in the design or else the structure detailed to minimize the effect of shrinkage.
- SL = Support Loss: This loading is not defined in AASHTO since it is unique to immersed tunnels. It should include loss of support (subsidence) below the tunnel or to one side, and storms and extreme water levels with a probability of being exceeded not more than once during the design

life (considering appropriate static and dynamic effects for each). A loss of support of not less than 10% of the length of an immersed tunnel element and uneven support from the foundation over the full width of the tunnel element should be considered.

TG = Temperature Gradient. Concrete immersed tunnel elements are typically massive members that have a large thermal lag. Combined with being surrounded by an insulating soil backfill that maintains a relatively constant temperature, the temperature gradient across the thickness of the members can be measurable. This load should be examined on a case by case basis depending on the local climate and seasonal variations in average temperatures. Steel tunnel sections may be thinner and would have a smaller thermal lag, which would help reduce this effect. However, it is recommended that this load be studied for all tunnel types. Paragraph 4.6.6 of the AASHTO LRFD specifications provides guidance on calculating this load. Note that paragraph C3.12.3 allows the use of engineering judgment to determine if this load need be considered in the design of the structure.

TU = Uniform Temperature. This load is used primarily to size expansion joints in the structure. If movement is permitted at the expansion joints, no additional loading need be applied to the structure. Since the structure is very stiff in the primary direction of thermal movement, the effects of the friction force resulting from thermal movement can be neglected in the design.

WA = Water load. This load represents the hydrostatic pressure expected outside the tunnel structure. Immersed tunnel structures are typically detailed to be watertight. Hydrostatic pressure acts normal to the surface of the tunnel. The design should take into account the specific gravity of the water which can be saline. Both maximum and minimum hydrostatic loads should be used for structural calculations as appropriate to the member being designed. The designer should take into account the fact that the specific gravity of water may vary according to depth, prevailing weather conditions and season. The effect of suspended material should be taken into account in determining the specific gravity of water. The maximum hydrostatic load should be used for structural calculations. To ensure flotation (during launching or floating of the elements), the minimum relevant specific gravity of water should be used, and to prevent flotation (after placement of the element) the maximum should be used. Two water levels should be considered: normal (observed maximum water level) and extreme, 3 ft (1 m) above the 200-year flood level. The buoyancy force should be carefully evaluated to ensure that the applied dead load effect is larger than the applied buoyancy effect. Frequently, structural member sizes will have to be increased to ensure that the buoyancy is completely resisted by the dead load or ballast added to the tunnel to counteract the buoyancy effect. The net effect of water pressure on the tunnel, i.e., the buoyancy, is the difference between hydrostatic loads on upward and downward facing surfaces. The total uplift force is equal to the weight of water displaced. Friction effects (the theoretical force required to dislodge the wedge of material over the tunnel) of backfill should not be taken into account, but the weight of material vertically above the structure may be taken into account.

Some of the loads shown in paragraph 3.3.2 of the LRFD specifications are not shown above because they are not applicable to the design of highway immersed tunnels as described below.

BR = Vehicular Breaking Force: This load would be applied only under special conditions where the detailing of the structure requires consideration of this load. Under typical designs, this force is resisted by the mass of the roadway slab and need not be considered in design.



- CE = Vehicular centrifugal force: This load would be applied only under special conditions where the detailing of the structure requires consideration of this load. Under typical designs, this force is resisted by the mass of the roadway slab and need not be considered in design.
- DD = Downdrag: This load comprises the vertical force applied to the exterior of the tunnel that can result from the subsidence of the surrounding soil due to the subsidence of the in-situ soil below the bottom of the tunnel. This load would not apply to immersed tunnels since it requires subsidence or settlement of the material below the bottom of the structure to engage the downdrag force of the tunnel. For a typical immersed tunnel, the overall weight of the structure is usually less than the soil it is replacing. As such, unless backfill significantly in excess of the original ground elevation is placed over the tunnel, settlement will not be an issue.
- FR = Friction. The structure is very stiff in the direction of thermal movement. Thermal movement is the source of the friction force. In a typical tunnel, the effects of friction can be neglected.
- IC = Ice load. Since the tunnel is not subjected to stream flow and unlikely to be exposed to the weather in a manner that could result in an accumulation of ice or icebergs, this load does not apply to immersed tunnel design.
- LS = Live Load Surcharge: This load would be generated by vehicles traveling over or adjacent to the tunnel. Since immersed tunnels are constructed under water, this load does not apply.
- WL = Wind on live load. The tunnel structure is not exposed to the environment, so it will not be subjected to wind loads.
- WS = Wind load on structure. The tunnel structure is not exposed to the environment, so it will not be subjected to wind loads when in service, however, when the tunnel section is being towed to the tunnel site, this is a potential loading. See construction loads (CL) listed above.

Section 3 of the LRFD specifications provides guidance on the methods to be used in the computations of these loads. Loadings unique to immersed tunnels such as anchor and ship impact are calculated as follows.

### **11.3.3 Ship Anchors**

The effect of an anchor impacting the underwater tunnel structure directly or being dragged across the line of the tunnel structure should be considered. Either the tunnel structure should be designed to resist the full loading imposed by the design anchor system, or the backfill / armor system should be designed to mitigate the loading, in which case the tunnel structure should be designed for the demonstrable reduced load. Rupture of the waterproofing membrane should not occur. The design anchor should be selected as appropriate to shipping using or expected to use the waterway, based on the relevant section of Lloyd's Rules.

The penetration depth of a falling anchor through tunnel roof protection material should be estimated. The formulae given in CEB Bulletin d'Information No 187, August 1988, reproduced for reference below provide a good design method to calculate the anchor penetration depth in granular material:

## Penetration Depth of a Falling Anchor through Granular Material:

$$\begin{aligned}x &= 10N_{pen}d_e \\ N_{pen} &= \sqrt{\frac{m_w}{E_r d_e^3}} \cdot v_i \\ d_e &= \sqrt{\frac{4A}{\pi}} \\ A &= 0.6 + 0.2 \frac{m_a}{1000}\end{aligned}\tag{11-1}$$

- where  $x$  penetration depth (m)  
 $N_{pen}$  penetration parameter  
 $d_e$  equivalent diameter of striking area of anchor (m)  
 $m_w$  mass of anchor reduced by the mass of the displaced water (kg)  
 $m_a$  mass of anchor in air (kg)  
 $E_r$  modulus of elasticity in the longitudinal direction of the layer (N/m<sup>2</sup>)  
 $v_i$  impact velocity of anchor (m/s)  
 $A$  cross-sectional striking area of anchor (m<sup>2</sup>)

The calculated maximum penetration depth should not exceed 90% of the total thickness of the protection layer covering the tunnel using the 5% fractile value for  $E_r$ . The dynamic load factor (DLF) ratio of the static equivalent load on the tunnel roof to the triangular dynamic load pulse  $F = m_w v_i / T_d$  may be obtained from Figure 11-16 below using the minimum duration of impact  $T_d = x / v_i$  (where  $x$  is calculated with the 95% fractal value for  $E_r$ ), and the natural period  $T_0$  of the affected element.

### 11.3.4 Ship Sinking

The primary sunken ship design case should be assumed to consist of a ship of the size approximating those using or expected to use the waterway. The imposed loading of a ship on the tunnel should be taken as an appropriate uniform loading over an area not exceeding the full width of the tunnel times a length as measured on the longitudinal axis of the tunnel of 100 feet (30 m). Collision impact loading should not be considered.

If appropriate, a secondary sunken ship design case should be assumed to consist of a smaller vessel, such as a ferry or barge, sinking and impacting the tunnel structure with the stem or sternpost in a manner similar to that of a dropped anchor. A static equivalent concentrated load of 225 kips (1,000 kN) working on an area of 3.3 x 6.6 ft<sup>2</sup> (1x2 m<sup>2</sup>) directly on the tunnel roof should be considered.

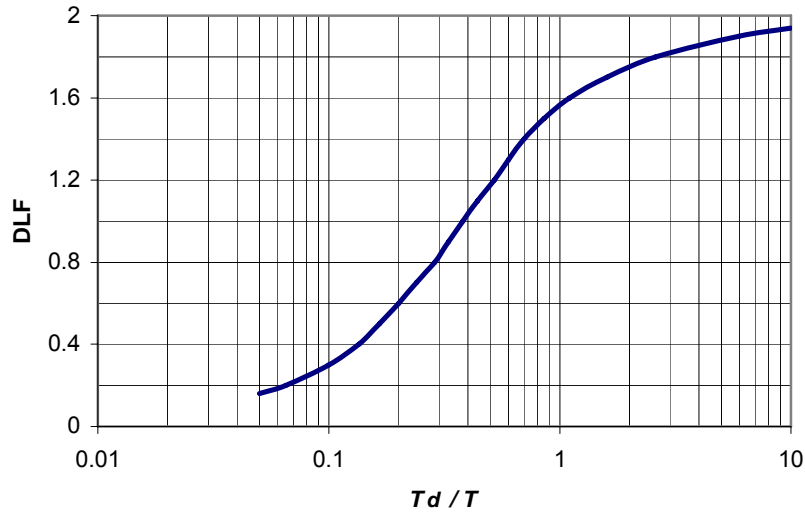

Figure 11-16 Graph of Dynamic Load Factor (DLF) Against  $T_d / T$

The intensity of uniformly distributed loading from a sunken ship should be determined by methods such as that outlined in Chapter 6 of the State-of-the-Art Report, 2nd Edition, International Tunnelling Association Immersed and Floating Tunnels Working Group, Pergamon, 1997. In the absence of data to the contrary, it may be assumed that the ship will exert a pressure of 1 ksf (50 kN/m<sup>2</sup>).

### 11.3.5 Load Combinations

The loads described above should be factored and combined in accordance with the LRFD specification and applied to the structure. Paragraph 12.5.1 gives the limit states and load combinations that are applicable for buried structures as Service Limit State Load Combination I and Strength Limit State Load Combinations I and II. These load combinations are given in Table 3.4.1-1. In some cases, the absence of live load can create a governing case. For example, live load can reduce the effects of buoyancy. Therefore, in addition to the load cases specified in Section 12 of the AASHTO LRFD specifications, the strength and service load cases that do not include live load should be used, specifically Strength III and IV and Service IV. In addition, vessel collision forces and earthquake forces must be considered in the design of immersed tunnels. These loads are contained in the Extreme Event I and II load combinations. Combining the requirements of Section 12 and Section 3 as described above results in the following possible load combinations shown in Table 11-1 for use in the design of immersed tunnels:

When developing the loads to be applied to the structure, each possible combination of load factors should be developed. Assessment can then be used to eliminate the combinations that obviously will not govern.

**Table 11-1 Permanent In-Service Load Combinations**

| Load Comb. Limit State | DC   |      | DW   |      | EH*<br>EV#<br>SL |      | ES   |      | EL   | LL,<br>IM     | WA   | TU, CR,<br>SH, CL |      | TG   | EQ<br>**<br>CT<br>CV | SE***         |
|------------------------|------|------|------|------|------------------|------|------|------|------|---------------|------|-------------------|------|------|----------------------|---------------|
|                        | Max  | Min  | Max  | Min  | Max              | Min  | Max  | Min  |      |               |      |                   | Max  | Min  |                      |               |
| Strength I             | 1.25 | 0.90 | 1.50 | 0.65 | 1.35             | 0.90 | 1.50 | 0.75 | 1.00 | 1.75          | 1.00 | 1.20              | 0.50 | 0.00 | 0.00                 | $\gamma_{SE}$ |
| Strength II            | 1.25 | 0.90 | 1.50 | 0.65 | 1.35             | 0.90 | 1.50 | 0.75 | 1.00 | 1.35          | 1.00 | 1.20              | 0.50 | 0.00 | 0.00                 | $\gamma_{SE}$ |
| Strength III           | 1.25 | 0.90 | 1.50 | 0.65 | 1.35             | 0.90 | 1.50 | 0.75 | 1.00 | 0.00          | 1.00 | 1.20              | 0.50 | 0.00 | 0.00                 | $\gamma_{SE}$ |
| Strength IV            | 1.50 | 0.90 | 1.50 | 0.65 | 1.35             | 0.90 | 1.50 | 0.75 | 1.00 | 0.00          | 1.00 | 1.20              | 0.5  | 0.00 | 0.00                 | 0.00          |
| Extreme Event I        | 1.25 | 0.90 | 1.50 | 0.65 | 1.35             | 0.90 | 1.50 | 0.75 | 1.00 | $\gamma_{EQ}$ | 1.00 | 0.00              | 0.00 | 0.00 | 0.00                 | $\gamma_{SE}$ |
| Extreme Event II       | 1.25 | 0.90 | 1.50 | 0.65 | 1.35             | 0.90 | 1.50 | 0.75 | 1.00 | 0.5           | 1.00 | 0.00              | 0.00 | 0.00 | 0.00                 | $\gamma_{SE}$ |
| Service I              | 1.00 |      | 1.00 |      | 1.00             |      | 1.00 |      | 1.00 | 1.00          | 1.00 | 1.20              | 1.00 | 0.5  | 0.50                 | $\gamma_{SE}$ |
| Service IV             | 1.00 |      | 1.00 |      | 1.00             |      | 1.00 |      | 1.00 | 0.00          | 1.00 | 1.20              | 1.00 | 1.00 | 1.00                 | 1.00          |

\* The load factors shown are for at-rest earth pressure. At-rest earth pressure should be used for all conditions of design of immersed tunnel structures.

# The load factors shown are for rigid frames. All immersed tunnel structures are considered rigid frames.

\*\* EQ is used only in Extreme Event I, CT and CV are used, one at a time in Extreme Event II.

\*\*\*  $\gamma_{SE}$  is computed is considered on project specific basis. It should be determined based on the certainty that anticipated settlements can be accurately predicted.

### 11.3.6 Loads during Fabrication, Transportation and Placement

During fabrication, load effects caused by placement of concrete while the element is afloat or by settlements of the foundation (in case of concrete elements), and other items should be evaluated. Some of these loads may cause locked-in stresses that must be considered together with stresses due to external loads.

Particular care must be taken during the placement of concrete while an element is afloat to ensure not only that stresses stay within limits, but also that the deflected shape due to the weight of the new concrete is within acceptable limits. At all times when the element is afloat, stresses due to waves should be checked to ensure that all limit states are satisfied; the wave height and length used in design must be specified for each stage of construction and for towing so that measures can be taken to move the element to a place of safety when forecasts predict conditions that exceed allowable limits. If the freeboard is such that waves could run over the top of an element, this loading should also be taken into consideration.

During transportation and while moored at the outfitting pier or elsewhere and even while in the fabrication yard, a tunnel element can be subject to wind loads that should be considered.

The tunnel element may be suspended from lifting hooks during immersion and may be placed on temporary supports in the final location pending completion of the foundation. All limits states must be satisfied. Temporary supports if used should be released before backfill is placed. When adjacent tunnel

elements are connected by shear keys, the effects due to relative differential settlements of each tunnel element during progressive backfilling operations must be taken into account.

Paragraph 3.4.2 of the AASHTO LRFD specifications provides guidance for minimum load factors to be used when investigating loads that occur during construction. The following Table 11-2 reflects the load combinations and load factors to be used when evaluating immersed tunnel sections for construction loads.

**Table 11-2 Construction Load Combinations**

|              | DC   | EL   | WS   | CL  | WA   |
|--------------|------|------|------|-----|------|
| Strength I   | 1.25 | 1.00 | 0.00 | 1.5 | 1.00 |
| Strength II  | 1.25 | 1.00 | 0.00 | 1.5 | 1.00 |
| Strength III | 1.25 | 1.00 | 1.25 | 1.5 | 1.00 |
| Strength IV  | 1.25 | 1.00 | 0.00 | 1.5 | 1.00 |
| Service I    | 1.00 | 1.00 | 1.25 | 1.5 | 1.03 |
| Service IV   | 1.00 | 1.00 | 0.00 | 1.5 | 1.05 |

## 11.4 STRUCTURAL DESIGN

### 11.4.1 General

Historically there have been three basic methods used in the design of immersed tunnels:

- Service load or allowable stress design which treats each load on the structure equally in terms of its probability of occurrence at the stated value. The factor of safety for this method is built into the material's ability to withstand the loading.
- Load factor design accounts for the potential variability of loads by applying varying load factors to each load type. The resistance of the maximum capacity of the structural member is reduced by a strength reduction factor and the calculated resistance of the structural member must exceed the applied load.
- Load and resistance factor design takes into account the statistical variation of both the strength of the structural member and of the magnitude of the applied loads.

The fundamental LRFD equation can be found in paragraph 1.3.2.1 of the AASHTO specification. This equation is:

$$\sum \eta_i \gamma_i Q_i \leq \phi R_n = R_r$$

11-2  
(AASHTO Equation 1.3.2.1-1)

In this equation,  $\eta$  is a load modifier relating to the ductility, redundancy and operation importance of the feature being designed. The load modifier  $\eta$  is comprised of three components:

$\eta_D =$  a factor relating to ductility = 1.0 for immersed tunnels constructed with conventional details and designed in accordance with the AASHTO LRFD specification.

$\eta_R =$  a factor relating to redundancy = 1.0 for immersed tunnel design. Typical cast in place and prestressed concrete structures are sufficiently redundant to use a value of 1.0 for this factor. Typical detailing using structural steel also provides a high level of redundancy.

$\eta_I =$  a factor relating to the importance of the structure = 1.05 for immersed tunnel design. Tunnels usually are important major links in regional transportation systems. The loss of a tunnel will usually cause major disruption to the flow of traffic, hence the higher importance factor.

$\gamma$  is a load factor applied to the force effects (Q) acting on the member being designed. Values for  $\gamma$  can be found in Table 11-1 above.

$\phi$  is a resistance factor applied to the nominal resistance of the member (R) being designed. The resistance factors are given in the AASHTO LRFD specifications for each material in the section that covers the specific material. Specifically, Section 5 covers Concrete Structures and in general, the resistance factors to be used in concrete design can be found in Section 5. However, Section 12 of the AASHTO LRFD specifications gives the following values to be used for  $\phi$  in Table 12.5.5-1:

For Reinforced Concrete Box Structures:

$$\phi = 0.90 \text{ for flexure}$$

$$\phi = 0.85 \text{ for shear}$$

Since the walls, floors and roofs of immersed tunnel elements will experience axial loads, the resistance factor for compression must be defined. The value of  $\phi$  for compression can be found in Section 5.5.4.2.1 of the AASHTO LRFD specification given as:

$$\phi = 0.75 \text{ for compression}$$

Values for  $\phi$  for precast construction are also given in Table 12.5.5-1. However, only rarely under unusual circumstances will a casting yard be set up to create the same controlled conditions that exist in a precast plant. Therefore, it is recommended that the  $\phi$  values given for cast-in-place concrete be used for the design of immersed tunnels.

Structural steel is also used in immersed tunnel construction. Structural steel is covered in Section 6 of the AASHTO LRFD specification. Paragraph 6.5.4.2 gives the following values for steel resistance factors:

For Structural Steel Members:

$$\begin{aligned}\phi_f &= 1.00 \text{ for flexure} \\ \phi_v &= 1.00 \text{ for shear} \\ \phi_c &= 0.90 \text{ for axial compression for plain steel and composite members}\end{aligned}$$

$R_r$  is the calculated factored resistance of the member or connection.

## 11.4.2 Structural Analysis

Structural analysis is covered in Section 4 of the AASHTO LRFD specifications. Section 4 describes a number of analysis methods that are permitted. It is recommended that classical force and displacement methods be used in the structural analysis of concrete immersed tunnel elements. Other methods (as described below) may be used, but will rarely yield results that vary significantly from those obtained with the classical methods. The modeling should be based on elastic behavior of the structure as per AASHTO paragraph 4.5.2.1. Steel immersed tunnels can also be analyzed using the same structural model except that the efficiency of any curvature of the steel members will not be fully utilized. Most general purpose structural analysis programs have routines based on these principles for dimensional models.

Since all members of a concrete immersed tunnel element are subjected to bending and axial load, the secondary effects of deflections on the load affects to the structural members should be accounted for in the analysis. AASHTO LRFD specifications refer to this type of analysis as “large deflection theory” in paragraph 4.5.3.2. Most general purpose structural analysis software have provisions for including this behavior in the analysis. If this behavior is accounted for in the analysis, no further moment magnification is required. Alternatively finite element models can be used. These models can identify load sharing, account for secondary effects and identify load paths

Steel immersed tunnel elements, are complex assemblies of plates that might be curved, stiffeners and diaphragms. Simplifying these systems to the point where classical methods of analysis can be used often undermines the efficient use of materials that can result from complex load paths. Steel structures lend themselves well to sophisticated computer modeling such as finite element models. These models can identify load sharing, account for secondary effects and identify load paths. It is recommended that these models be used in the analysis of steel immersed tunnel sections.

Paragraph 4.5.1 of the AASHTO LRFD specifications states that the mathematical model used to analyze the structure should include “...where appropriate, response characteristics of the foundation”. The response foundation for an immersed tunnel element can be modeled through the use of a series of non-linear springs placed along the length of the bottom of the section. These springs are considered non-linear because they should be specified to act in only one direction, the downward vertical direction. This model will provide the proper distribution of loads to the bottom of the model and give the designer an indication if buoyancy is a problem. This indication is seen in observing the calculated displacements of the structure. A net upward displacement of the entire structure indicates that there is insufficient resistance to buoyancy.

Structural models for computer analysis are developed using the centroids of the structural members. Due to the thickness of the walls and the slabs of an immersed tunnel, it is important when calculating the applied loads, that the loads are calculated at the outside surface of the members. The load is then adjusted according to the actual length of the member as input. For example, if the out to out bottom width of a tunnel structure is 90 feet and the bottom of the bottom slab is located 15 feet below the water table, the buoyancy force on the bottom slab is calculated as:

62.4pcf x 15ft x 1ft (along length of tunnel) = 936plf for a total load on the bottom of the tunnel of:

$$936\text{plf} \times 90\text{ft} = 84,240\text{lbs}$$

If the outside walls of the tunnel are 4ft thick, then the length of the structural model is 90ft – 4ft = 86ft

Using 86ft, the applied buoyancy force is 936plf x 86ft = 80,496lbs. This computation underestimates the buoyancy force by 5 percent. Given that the load factor for the buoyancy force is 1.00, this could result in a buoyancy problem with the tunnel. The solution would be to apply the actual calculated load as follows: 84,240lbs / 86ft = 980plf. This results in a slightly conservative estimate of the load for bending and shear, but an accurate estimate of the buoyancy effect including the axial load in the side walls.

This problem is not as prevalent in a finite element model. However, the designer should be careful that sufficient load is being applied to the model to be sure that the actual conditions are being modeled as closely as possible.

## **11.5 WATERTIGHTNESS AND JOINTS BETWEEN ELEMENTS**

### **11.5.1 External Waterproofing of Tunnels**

External waterproofing for tunnel elements should be considered for both steel tunnels and concrete tunnels. The waterproofing should envelop every part of the element exposed to soil or water with materials impervious to the surrounding waters. For steel tunnels the outer steel membrane would act as waterproofing membrane, while for concrete elements either steel or synthetic membrane should be used. For steel waterproofing membranes used on either concrete or steel elements, an appropriate corrosion protection and monitoring system should be used to ensure that the minimum design thickness is maintained during the life of the facility or an added sacrificial thickness should be provided. Non-structural steel membranes should be no less than 1/4 in (6 mm) thick.

The membrane should be watertight. Typical materials used for concrete elements include two coats of a spray-applied elasticized epoxy material; steel plates; and flexible PVC waterproofing sheet. Minimum thickness should be no less than 0.06 inch (1.5 mm), and anchored to the concrete using T-shaped ribs. The materials of the waterproofing system should have a proven resistance to the specific corrosive qualities of the surrounding waters and soils. The materials of the system should be flexible and strong enough to span any cracks that may develop during the life of the structure. Bituminous membranes are not recommended. The waterproofing system should preferably adhere at every point to the surfaces to which it is applied so that, if perforated at any one location, water may not travel under it to another. The areas of free water flow between the membrane and the underlying concrete in case of leakage should be limited to no more than 100sf (10m<sup>2</sup>). For a steel tunnel, the membrane could be the external steel shell, provided that an adequate corrosion protection is provided either by cathodic protection or additional sacrificial thickness. Steel plates should be joined using continuous butt welds. All welds should be inspected and tested for soundness and tested for watertightness. Notwithstanding the provision of a membrane, the underlying structural concrete should be designed to be watertight.

Depending upon the type of waterproofing used, it may require protection on the sides and top of the tunnel elements to ensure that it remains undamaged during all operations up to final placement and during subsequent backfilling operations.



### 11.5.2 Joints

Joints between immersed tunnels elements can be classified as described below.

Immersion Joint (or Typical Joint) The immersion joint is the joint formed when a tunnel section is joined to a section that is already in place on the seabed. After placing the new element, and joining it with the previously placed element, the space between the bulkheads (dam plates) of the two adjoining elements is then dewatered. In order to dewater this space, a watertight seal must be made. A temporary gasket with a soft nose such as the Gina gasket (Figure 11-17) is most often used. In addition an omega seal is also provided after dewatering the joint from inside the joint.



Figure 11-17 Gina-Type Seal

For immersion joints, the primary compression or immersion seal is usually made of natural or neoprene rubber compounds. The most common cross-section used today is the “Gina” type. This consists of a main body with designed load/compression characteristics and an integral nose and seating ridge. The materials used should have a proven resistance to the specific corrosive qualities of the water and soils and an expected life no shorter than the design life of the tunnel unless the gasket is considered temporary. For flexible joints, a secondary seal is usually required in case of failure of the primary seal. It is usually manufactured from chloroprene rubber to an overall cross-section corresponding to that known as an “Omega” type (Figure 11-18), the materials having proven resistance against the specific corrosive qualities of the water and soils, oil, fungi and micro-organisms, oxygen, ozone and heat.



Figure 11-18 Omega Type Seal

Figure 11-19 shows a typical immersion joint. It is essential that immediately after dewatering of the chamber between the two bulkheads, an inspection of the primary seal is made so that any lack of watertightness can be remedied. Similarly, the secondary seal of a flexible joint should be pressure tested up to the expected maximum service pressure via a test pipe and valve to ensure that it too can function as required; after a successful testing, the chamber between the seals should be de-watered.

Closure or Final Joint: Where the last element has to be inserted between previously placed elements rather than appended to the end of the previous element, a marginal gap will exist at the secondary end.

This short length of tunnel sometimes is completed as cast-in-place and is known as the closure or final joint.

The form of the closure or end joint is dependent on the sequence and method of construction. Closure joints may also be immersion joints, although details may need to be different. Potential options for the closure joints include:



Figure 11-19 Gina-type Immersion Gasket at Fort Point Channel, Boston, MA

- Place the last element between two previously placed elements and dewater one joint between the newly placed element and the one of the previously placed elements. Then insert under water closure form plates and place tremie concrete around the closure joint to seal it. The joint can then be dewatered and interior concrete can be completed from within the joint. Other methods such as telescopic extension joints and wedge joints have been developed to make the closure joint similar to the immersion joint.
- Construct both end (terminal) joints first, lay the tunnel elements outwards from these and complete the immersed tunnel with a special closure (final) joint.
- Construct one terminal joint first and lay all the immersed tunnel elements outwards from that side and backfill over the top of the final element, using a soil-cement mixture (or other reasonably watertight material) in the vicinity of the second terminal joint. Construct the structures abutting the second terminal joint after the immersed tunnel is complete.
- Lay and complete the immersed tunnel with or without a special closure joint and backfill at the terminal elements using a soil-cement mixture (or other reasonably watertight material) in the vicinity of both terminal joints. Construct the structures abutting the both terminal joints after the immersed tunnel is complete.

Earthquake Joint This may be an immersion joint of special design to accommodate large differential movements in any direction due to a seismic event. It also applies to a semi-rigid or flexible joint strengthened to carry seismic loads and across which stressed or unstressed prestressing components may be installed.

Segment or Dilatation Joint Moveable segment joints must be able to transmit shear across the joint and well as allowing dilatation and rotation. The joints contain an injectable rubber-metal waterstop as well as neoprene and hydrophilic seals.

### 11.5.3 Design of Joints between Elements

All immersed tunnel joints must be watertight throughout the design life, and must accommodate expected movements caused by differences in temperature, creep, settlement, earthquake motions, method of construction, etc. Displacements in any direction should be limited so that the waterproof limits of a joint are not exceeded. Joint shear capability should take into account the influence of normal forces and bending moments on the shear capacity of the section; the design should take account of shear forces generated where the faces of the joints are not normal to the tunnel axis. Joints must be ductile in addition to accommodating longitudinal movements. Tension ties may be used to limit movement so that joints do not leak or break open, especially during a seismic event.

The axial compression of tunnel elements and bulkheads due to depth of immersion should be taken into account in determining joint dimensions at installation.

The design of primary flexible seals at tunnel joints must be designed to take into account the maximum deviations of the supporting frames relative to their theoretical location, the maximum deviation of the planes of the frames, and any relaxation of the seal. The seal is required to have a minimum compression of 3/8 inch (10 mm) greater than the compression required to maintain a seal. Just in case an initial seal is not obtained after immersion and joining, it may be advisable in some cases for the immersion joint to be designed so that a backup method of obtaining an initial seal is available.

For flexible joints, a secondary seal (omega) capable of carrying the full water pressure should be fitted across the inside of the joint and should be capable of being inspected, maintained and replaced. The seal should be capable of absorbing the long-term movements of the joint. The secondary seals should be provided with a protective barrier against damage from within the tunnel. All joints in the tunnel should be finished to present a smooth surface.

The metal hardware in joints should have a design life adequate to fulfill its purpose throughout the design life of the joint. Nuts and bolts for primary and secondary seals should be stainless steel. Plate connections between elements should be corrosion-protected to ensure that the design life is obtained.

The mounting procedure or the mounting surface for the primary seal of immersion joints must allow for fine adjusting and trimming of the seal alignment in order to compensate for construction tolerances. It is recommended that the gasket be protected from accidental damage until the time of immersion. All embedded parts, fixings, including the bolts and their corrosion protection system, mating faces, clamping bars and other fixings, must have a design life at least equal to that of the tunnel structure. Where clamping bars and other fixings are used for the secondary seal, these need to have a design life at least equal to that of the secondary seal. The gasket assembly should have provision for injection in case of leakage.

This page is intentionally left blank.

## CHAPTER 12 JACKED BOX TUNNELING

### 12.1 INTRODUCTION

Jacked box tunneling is a unique tunneling method for constructing shallow rectangular road tunnels beneath critical facilities such as operating railways, major highways and airport runways without disruption of the services provided by those surface facilities or having to relocate them temporarily to accommodate open excavations for cut and cover construction (Chapter 5). Originally developed from pipe jacking technology, jacked box tunneling is generally used in soft ground at shallow depths and for relatively short lengths of tunnel, where TBM mining would not be economical or cut-and-cover methods would be too disruptive to overlying surface activities.

Jacked box tunneling has mostly been used outside of United States (Taylor et al, 1998) until it was successfully applied to the construction of three short tunnels beneath a network of rail tracks at South Station in downtown Boston. These tunnels were completed and opened in 2003 as a part of the extension of Interstate I-90 for the Central Artery/Tunnel (CA/T) Project. Figure 12-1 shows the opening ceremony for the completed I-90 tunnels. Since CA/T Project represents the most significant application to date of the jacked box tunneling in the US, it will be used to demonstrate the method throughout this Chapter.



Figure 12-1 Completed I-90 Tunnels

## 12.2 BASIC PRINCIPLES

Figure 12-2 illustrates the basic jacking sequence of jacked box tunneling under an existing railway. The box structure is constructed on jacking base in a jacking pit located adjacent to one side of an existing railway. A tunneling shield is provided at the front end of the box and hydraulic jacks are provided at the rear. The box is advanced by excavating ground from within the shield and jacking the box forward into the opening created at the tunnel heading. In similar fashion to pipe jacking, lengths of tunnel that would exceed the capacities of jacks situated at the rear of the box structure can be successfully advanced into place by dividing the box structure into sections and establishing intermediate jacking stations. The box structure shown in Figure 12-2 is divided into two sections with an intermediate jacking station set up in between them.

In order to maintain support to the tunnel face, excavation and jacking normally carried out alternately in small increments, typically in the range of 2 to 4 feet. In most cases, the soft ground must be treated by means of ground improvement techniques such as ground freezing, jet grouting, etc. as discussed in Chapter 7 Soft Ground Tunneling to enhance its stand up time. Refer to Chapter 5 for discussions about temporary excavation support systems.

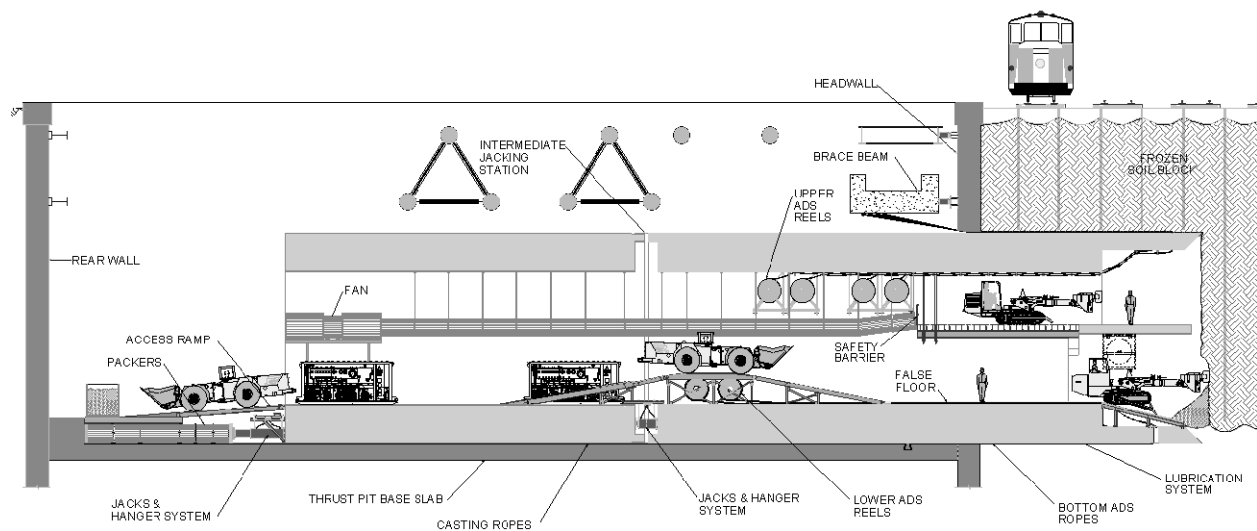

Figure 12-2 Typical Jacked Box Tunneling Sequence under an Existing Rail Track

## 12.3 CENTRAL ARTERY/TUNNEL (CA/T) PROJECT JACKED BOX TUNNELS

The use of the jacked box tunneling method on the CA/T Project in Boston is described by van Dijk et al. (2000) and van Dijk et al., (2001). A major component of the CA/T project was the extension of Interstate I-90 eastward to Boston's Logan International Airport. This extension required three crossings of the network of tracks leading into South Station, a regional transportation hub used by Amtrak and the Massachusetts Bay Transportation Authority (MBTA) for hundreds of train movements daily. The critical surface use of the site, the large spans of the underground openings required to accommodate a multi-lane highway, the relatively shallow cover dictated by the roadway profile, and the poor soils in combination with the high groundwater level at the site led to tunnel jacking being selected as the preferred tunneling method over staged cut-and-cover and conventional tunneling techniques.

The three crossings of the tracks consisted of box structures for the eastbound lanes of I-90, the westbound lanes, and westbound exit ramp that provided access to Interstate I-93. The box structure for the I-90 EB lanes was the longest of the three, at 379 feet. It was constructed in 3 sections, with cross-sectional dimensions of 36 feet high by 79 feet wide, and a total weight of approximately 32,500 tons. The other two box structures were 38 feet high by 78 feet wide and were each constructed in two sections. The I-90 WB tunnel was 258 feet long and weighed approximately 27,000 tons, while the exit ramp tunnel was 167 feet long and weighed 17,000 tons.

Subsurface Condition and Ground Freezing: As shown in Figure 12-3, the geologic conditions through which the three box tunnel structures were jacked included (at the top of the subsurface profile) a layer of miscellaneous fill 20 to 25 feet thick, primarily a medium dense silty sand. This fill layer contained a number of obstructions related to the more than 150 years use of the site for rail road, industrial and waterfront infrastructure, which included granite block seawalls, rock filled timber cribwalls, brick and masonry structure foundations, a buried trackway, and an abandoned brick-lined sewer. Below the historic fill material was a deposit of weak organic sediments 10 to 15 feet thick, consisting of organic silt with some fine sand and peat. Underlying the organic layer were lenses of alluvial sand and inorganic silt deposits, generally less than 5 feet thick. The remaining part of the profile through which the tunnel boxes were jacked consisted of marine clay, consisting of clay and silt that was soft, except for the upper 15 feet, which was somewhat stronger and less compressible. Groundwater at the site was generally 6 to 10 feet below track level, resulting in the tunneling horizon in each case being completely submerged.

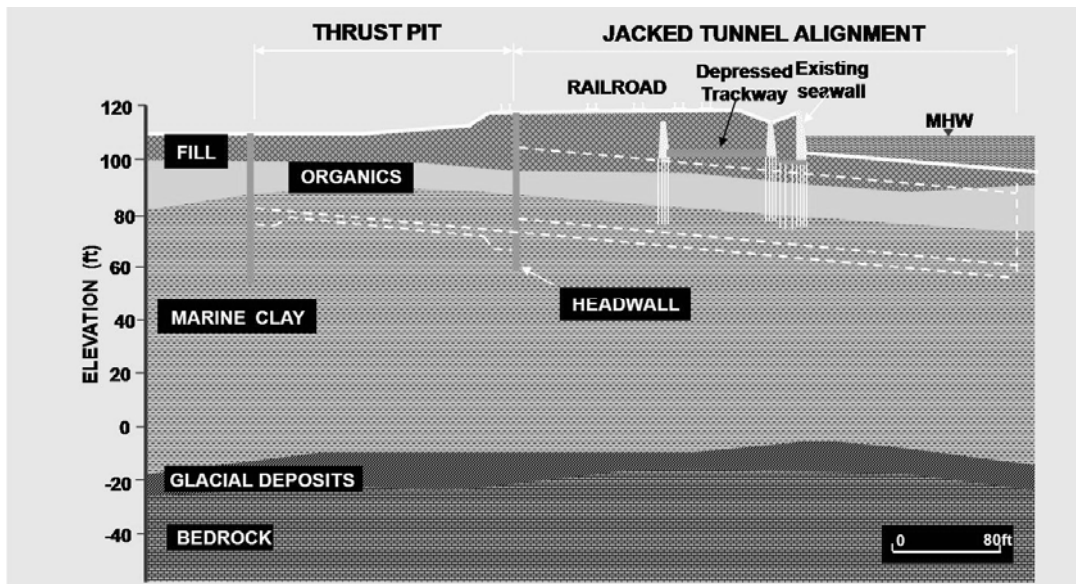

Figure 12-3 Generalized Subsurface Profile for the I-90 Jacked Box Tunnels

The success of the box jacking operation depended critically on maintaining the stability of the soils through which the tunnels passed. For the existing condition of weak soils below the groundwater table, shallow cover over the tunnel boxes, and the large spans required, there were serious concerns about loss of ground at the headings, the potential for significant settlement of the overlying track structures, and loss of alignment control during jacking. Therefore, ground improvement was required to enable the tunneling to be performed effectively and safely. The original design for the tunnels had called for

ground treatment consisting of a combination of dewatering and chemical grouting in the miscellaneous fill materials; horizontal jet grouting in the organic sediments; and soil nailing of the marine clay layer. The Contractor was concerned about the potential risks associated with the implementation of this combination of soil stabilization methods, and consequently made a value engineering proposal to substitute ground freezing for all of the methods. This proposal was accepted, and a large scale freezing operation was performed that encompassed all three tunnel alignments, as further discussed below in Section 12.5.

Box Casting Operation: Each tunnel box structure was constructed in a “jacking pit” immediately adjacent to the west side of the South Station track network (Figure 12-4). The jacking pits were constructed by slurry wall methods, with post-tensioning of the sidewalls and the formation of a low-level improved soil “strut” formed by jet grouting below the base slab to reduce the number of bracing levels required so that the boxes could be constructed without interference from a cross-lot bracing system. The concrete base slab of each jacking pit was placed with a tight tolerance on grade, since it served as the casting surface for the box structures and also established the starting profile to ensure that the tunnel sections were jacked to the required alignment.



Figure 12-4 Tunnel Structure Construction Operation

After the base slab of each jacking pit was completed, a series of steel wire ropes were installed longitudinally on the slab and steel plates covering the entire footprint of the box sections were placed on the wire ropes. Shear studs were welded to the base plates to anchor the plates to the concrete slab, so that when jacking started, the frictional resistance that the jacks needed to overcome to move the box structures would result from steel plates sliding over steel wire ropes, rather than concrete sliding on concrete. Figure 12-4 shows the construction of the I-90 WB tunnel box structures.



The structural design of these tunnel sections had to consider not only the long term loads from the overburden and railroad surcharge loads, but also the construction phase jacking loads. Each tunnel was constructed in sections (2 sections for the I-90 WB exit ramp tunnel and the I-90 WB tunnel itself, and 3 sections for the I-90 EB tunnel) to reduce the jacking forces required to move the tunnels into their final positions by using intermediate jacking stations in addition to the jacks positioned at the rear. To prevent soil from entering into the gap between adjacent box sections, a system of transversely continuous sliding overlapping steel “bridge” plates were used. Once jacking was completed, the jacks were removed and the intermediate jacking station areas were filled with concrete.

The external surfaces of the box structures could not be waterproofed because the waterproofing material would have been torn away during jacking. Water seepage control was achieved by using low permeability concrete mixes to construct the boxes and grouting the interface between the boxes and the surrounding ground through grout ports cast into the walls and roof slab after tunneling and jacking were completed.

A cellular concrete shield was constructed at the front of each lead box section to support the excavation operation by establishing multiple access points to the face that could be closed off if stability problems developed. A beveled steel knife edge was provided at the perimeter of the shield that was flared a small amount to ensure that the opening into which the tunnel box structures would be jacked could be closely controlled, but also excavated large enough to prevent the boxes from getting stuck as they were pushed forward.

Tunnel Excavation: Mining of the frozen soils at the tunnel face, which had estimated uniaxial compressive strengths in the range of 700 to 1400 psi, was done primarily with roadheaders, working at two levels within the shield.



Figure 12-5 Excavation of the Frozen Ground at the Front of the Tunnel Shield by Roadheader

The roadheaders also proved to be effective at removing the numerous timber piles that were encountered. For removing masonry obstructions, which were firmly bound in place in the frozen soil mass, hydraulic hammers were used. The excavated material dropped to the bottom of the shield during the mining operation, where it was collected using a Gradall machine and a loader. A wheel-mounted scoop tram was used to shuttle the material to the rear of the tunnel box structure and dump it into a skip bucket, which was lifted out of the pit by crane and stockpiled for loading onto haul trucks. Figure 12-6 shows the scoop tram loading the skip bucket.



Figure 12-6 Scoop Tram Loading Excavated Material into Skip Bucket for Removal

Based on typical mining production rates, stand-up time for the unsupported frozen ground, the volume of excavated material to be handled, the design of the jacking system, and the shift schedule, the Contractor determined that incremental excavation advance for efficient, consistent progression of the jacking operation was approximately 3 feet. Depending on the amount of obstructions encountered in a particular round, the advance rate achieved was generally one to two rounds per day, or 3 to 6 feet. At the completion of each excavation increment, the Contractor had to check the shield perimeter to ensure that all obstructions, including abandoned freeze pipes, were cut back sufficiently to be clear of the tunnel box.

Anti-Drag System As discussed previously, an anti-drag system was installed above and below the tunnel box structure to reduce the frictional resistance between the box structure and the surrounding ground. The system worked to even out the friction acting over the roof and bottom surface areas of the box, which contributed to alignment control during jacking, and also reduced the potential for surface settlement and lateral movement of the shallow overburden over the tunnel by separating the interface between the box concrete and the soil. This was achieved by installing a series of greased  $\frac{3}{4}$ -inch diameter wire ropes that were anchored to the jacking pit and threaded through slots in the shield into the interior of the tunnel box structure, where they were stored on slings mounted on the soffit of the roof slab and on reels on the base slab located inside the tunnel. The system was configured so that as the tunnel moved forward, the wire ropes were run out from the storage units to cover the portion of the top and

bottom surfaces of the box structure that was embedded in the ground beyond the thrust pit. More discussions of the Anti-Drag System (ADS) are provided in Section 12.4.1.

Tunnel Jacking Operation: At the completion of each excavation round, the tunnels structures were jacked into the space created at the face. This was accomplished by a group of 25 hydraulic jacks positioned at base slab level at the rear of the tunnel box, and additional groups of 26 to 32 jacks situated in the intermediate jacking stations. Each jack had a working capacity of 533 tons at a working pressure of 6100 psi, and could deliver a maximum thrust of 889 tons at a pressure of 10,200 psi. The maximum stroke of the rear jacks was 42 inches, while the stroke of the intermediate station jacks was limited to 16.5 inches. At each jacking station, the individual jacks were connected in nine clusters of 2 to 4 jacks each. This simplified the hydraulic control, and also enabled some horizontal steering capability through variable operation of the clusters. The required thrust reaction for the jacks was transferred to a heavily reinforced concrete block wall at the rear of the jacking pit through a series of steel pipe sections referred to on the project as “packers.” The loads exerted on the reaction block wall were in turn transferred into the surrounding ground through the pit base slab and rear wall. More discussions about the jacking operations are included in Section 12.4.2.

## **12.4 LOAD AND STRUCTURAL CONSIDERATIONS**

In most aspects, the structural loading and design considerations for jacked box tunnels are similar to those for cast-in-place cut and cover tunnels as discussed in Chapter 5. Readers are referred to Sections 5.3 for detailed discussions about structural framing, design, buoyancy, waterproofing, etc., and Sections 5.4 about loads and load combination. Section 5.5 provides discussions about structural design procedures and considerations for a box tunnel.

However, in addition to the typical design loads discussed in Section 5.4, jacked box design can be dominated by two unique loads during construction: jacking thrust loads and interface drag loads.

### **12.4.1 Ground Drag Load and Anti-Drag System (ADS)**

Ground drag, resulted from the contact pressures between soil and box structure is calculated and multiplied by appropriate friction factors, and is used to estimate drag loads at frictional interfaces; an appropriate adhesion value is used at the interface between the box and cohesive ground. Simplifying assumptions are made in developing ADS loads and modeling box/ADS/soil interaction, the validity of which is done by back-analyses of loads and other historical data. To reduce such an enormous drag load, an anti-drag system (ADS) is used to separate the external surface of the box from the adjacent ground during tunnel jacking.

As described in Section 12.3, the CA/T tunnels utilized an ADS consisting of an array of closely-spaced wire ropes which are initially stored within the box with one end of each rope anchored at the jacking pit. As the box advances, the ropes are progressively drawn out through guide holes in the shield and form a stationary separation layer between the moving box and the adjacent ground. The drag forces are absorbed by the ADS and transferred back to the jacking pit. In this manner the ground is isolated from drag forces and remains largely undisturbed. Readers are also referred to Ropkins 1998 for more discussions for other ADS applications.

## 12.4.2 Jacking Load

The ultimate bearing pressures on the face supports and on the shield perimeter are used to calculate the jacking load required to advance the shield. Note that the face pressure must be analyzed using the treated soil properties. In addition, jacking load also includes the ADS loads as discussed above.

Jacking thrust is provided by means of specially built high capacity hydraulic jacking equipment. Jacks of 500 tons (4,448 kN) or more can be utilized on large tunnels. As discussed in Section 12.3, jacks with a capacity of 533 tons at a working pressure of 6100 psi (42 MPa) were used in the I-90 tunnels (Figure 12-7). For jacking a large size road tunnel structure, multiple jacks are required to provide sufficient jacking thrust to counter the face pressure. In addition, using multiple jacks offers some steering control redundant capacity in the event of possible underestimates of the required jacking loads.

Reaction to the jacking thrust developed is provided by either a jacking base or a thrust wall, depending on the site topography and the relative elevation of the tunnel. An example of a heavily reinforced thrust block wall is also shown in Figure 12-7. These temporary structures must in turn transmit the thrust into a stable mass of adjacent ground. A thrust wall is normally stabilized by passive ground pressure. In developing this reaction, the wall may move into the soil and this movement must be taken into account when designing the jacking system. When a thrust wall is used in a vertical sided jacking pit, care is required to ensure that movement of the thrust wall under load does not cause any lack of stability elsewhere in the pit.



Figure 12-7 Close Up of High Capacity Hydraulic Jacks, Reaction Blocks, and Packers

As the tunnel box and the jacks were gradually advanced away from the thrust wall, the Contractor needed to come up with a method to continue to transfer the jacking reaction force back into the thrust block wall. This was done by installing a series of 3-ft diameter structural steel pipe sections (i.e., packers) to bridge the gap between the jack pistons and the thrust block wall. Figure 12-7 also shows Initial short packer sections installed once the tunnel box structure had been jacked away from the rear reaction block a distance exceeding the maximum stroke of the jacks. The packers were connected

together with 1-inch thick diaphragm plates that were anchored to the base slab in the thrust pit. Three views of the packer installations are shown in Figure 12-7, Figure 12-8, and Figure 12-9.

A jacking base is normally stabilized by shear interaction with the ground below and on each side. Where the interface is frictional, the interaction may be enhanced by surcharging the jacking base by means of pre-stressed ground anchors or compacted tunnel spoil. The jacking base is also stabilized by both the top and bottom ADS which are anchored to it.



Figure 12-8 Installation of Packer Sections and Connecting Diaphragm Plates



Figure 12-9 Progressive Installation of Packer Sections and Connecting Diaphragm Plates

## 12.5 GROUND CONTROL

As discussed previously, the soft ground most likely will need to be pre-treated to provide sufficient stand-up time during jack tunneling. In addition, ground may need to be stabilized in advance to control surface settlement must be controlled when tunnel jacking at such a shallow depth.

Techniques for stabilizing ground for jacked box tunneling include: grouting, well point dewatering, and freezing which are presented in Sections 7.6.5 “Grouting Methods”, 7.6.6 “Ground Freezing”, and 7.6.7 “Dewatering”. Ground freezing is discussed hereafter to demonstrate how a ground control measure is used for jacked box tunneling.

### 12.5.1 Ground Freezing for CA/T Project Jacked Tunnels

As discussed in Section 12.3 above the Contractor made a value engineering proposal to replace the various soil stabilization methods indicated in the Contract with ground freezing. This alternative approach offered several advantages, including the ability to completely stabilize the soil mass through which the tunnel box structures were jacked. In contrast, the horizontal jet grouting and soil nailing methods in the original design, would have required tunnel jacking to be interrupted periodically to permit installation of the ground improvement measures from the heading. Ground freezing also offered: 1), the advantages of improved face stability, which made breasting of shield compartments unnecessary, 2), better encapsulation of obstructions which otherwise had the potential to suddenly ravel into the heading when exposed, and 3) the avoidance of windows of untreated ground.

The freezing system was installed entirely from the ground surface overlying each tunnel alignment, within the track network. The Contractor selected a conventional brine freezing system, with an ammonia plant providing the refrigeration. In the freeze plant, ammonia gas was compressed, condensing it to a liquid, then evaporated to chill the brine to an average temperature range of  $-25^{\circ}\text{C}$  to  $-30^{\circ}\text{C}$ . The brine used to cool and eventually freeze the ground was circulated through circuits of vertical freeze pipes as shown schematically in Figure 12-10.

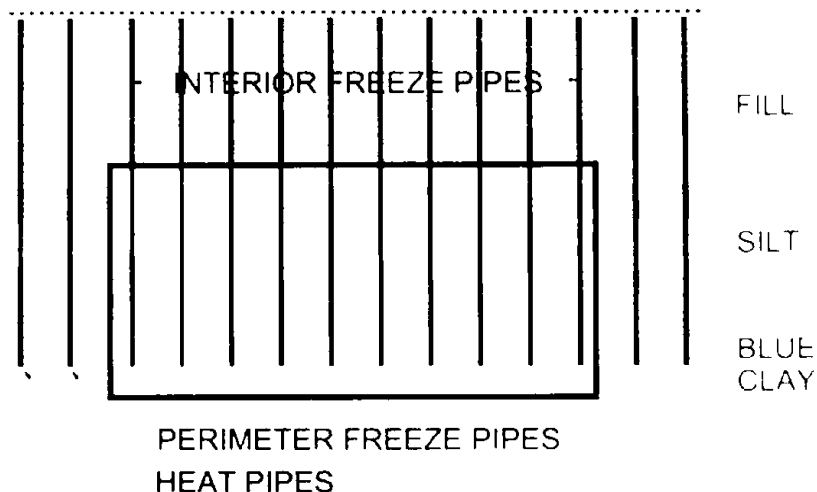

Figure 12-10 Schematic Arrangement of Freeze Pipes to Freeze Ground Mass Prior to Tunnel Jacking

Each individual freeze pipe consisted of a 4.5-inch diameter steel pipe closed at the end, with a 2-inch diameter plastic pipe inserted in it that was open at the bottom. As shown in Figure 12-11, the chilled brine was pumped from a supply header line into the inner pipe, where it exited at the bottom and rose up in the annulus between the inner and outer pipe, cooling the surrounding ground in the process. At the top of the pipe, the brine was sent to the next freeze pipe for cooling circulation, as part of a circuit of 4 to 7 pipes. After passing through all of the pipes in the circuit, the brine was pumped back to the freeze plant for re-chilling through a return header pipe. The brine was circulated continuously in this manner through all of the circuits comprising the freeze zone in what was a closed system. The temperature of the ground mass was gradually lowered over a period of 4 to 5 months until the soil froze and an average target temperature of  $-10^{\circ}\text{C}$  was reached.

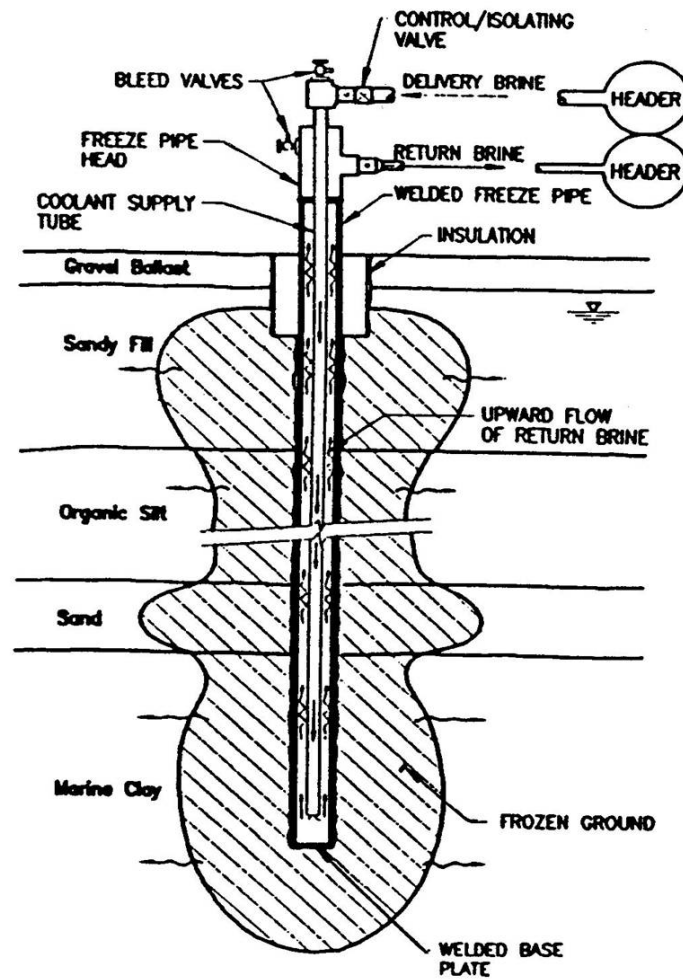

Figure 12-11 Arrangement of an Individual Freeze Pipe showing Brine Circulation

The freeze pipes were installed within the track area using a sonic type drill rig, which used a vibratory coring bit to advance a starter hole through the miscellaneous fill material and any obstructions contained within it, and then vibrated the outer steel freeze pipe into place in a dry drilling process that displaced the underlying organic sediments and marine clay deposits. The drill rig was mounted on a turntable on the back of a high-rail truck vehicle, which provided flexibility for locating the pipes between rails and

outside of the timber ties and switching and signal equipment. Most of the drilling work was done at night by using a series of carefully coordinated track outages with the Railroad, and the sonic drilling method proved to be very effective for installing the freeze pipes quickly with relatively little drilling spoils being generated. Figure 12-12 shows the system in operation while commuter trains continued to run through the freezing area. A total of nearly 1800 freeze pipes were used on the project to freeze over 3.5 million cubic feet of soil.



Figure 12-12 Ground Freezing System in Operation while Commuter Trains Run Through the Area

The ground freezing method was very effective at providing a stable face over the entire tunnel cross-sectional face area, as shown in Figure 12-13. The one significant disadvantage of the method was the expansion of water when it freezes caused the overlying track area to heave. The amount of heave varied considerably over the alignment of each tunnel, depending on the variation in moisture content of the underlying soil profile. Typically the maximum deformation, which was monitored daily by detailed surveys of rail elevations, was in the range of 4 to 7 inches. The heave tapered to the original ground elevation over distances that extended laterally from tunnel centerline to approximate distances of about 50 to 70 feet beyond the edge of the tunnel box structure. The magnitude of this deformation required periodic re-profiling of the tracks by the Railroad to ensure that their rail geometry requirements for safe operation of their trains were maintained.

The temperature of the frozen soil mass was monitored by a series of temperature probes installed at each freeze site. After the target temperature was reached, the freeze system was adjusted to maintain that temperature, which controlled the stability of the soils at the tunnel face. As the excavation progressed for each tunnel, the freeze circuits were shutdown and the brine and inner pipes removed from the outer steel pipes, which were left in place. This progressive shut-down and dismantling of the freeze system was timed to avoid any significant warming of a section of the soil mass prior to it being exposed in the tunnel heading. When the abandoned steel freeze pipes were encountered, they were removed by cutting them out with a torch.

The Tunnel Designer should ensure that ground treatment measures do not in themselves cause an unacceptable degree of ground disturbance and surface movement.





Figure 12-13 Frozen Face Seen from Shield at Front of Jacked Box Structure

### 12.5.2 Face Loss

Design should also include provisions for controlling face loss which occurs when the ground ahead of the shield moves towards the tunnel as a result of reduction in lateral pressure in the ground at the tunnel face. With face loss, as the tunnel advances, a greater volume of ground is excavated than that represented by the theoretical volume displaced by the tunnel advance.

In cohesive ground, face loss is controlled by supporting the face at all times by means of a specifically-designed tunneling shield and by careful control of both face excavation and box advance. The shield is normally divided into cells by internal walls and shelves which are pushed firmly into the face. Typically 0.5 ft (150mm) of soil is trimmed from the face following which the box is jacked forward 0.5 ft (150mm). This sequence is repeated until the tunneling operation is complete, thus maintaining the necessary support to the face.

### 12.5.3 Over Cut

Design should also include provisions for controlling overcut in soft ground, by ensuring that the shield perimeter is kept buried and cuts the ground to the required profile. However, a degree of over-cut at the roof and sides beyond the nominal dimensions of the box is required for three reasons:

1. The hole through which the box travels must be large enough to accommodate irregularities in the external surfaces of the box.
2. It is desirable to reduce contact pressures between the ground and the box, to reduce drag.
3. Overcutting may be required to fully remove obstructions at the perimeter of the shield.

The amount of over-cut required should be minimized if unnecessary ground disturbance and surface settlement is to be avoided. This demands that the external surfaces of the box be formed as accurately as

possible. Typical forming tolerances are:  $\pm 0.4$  in (10mm) at the bottom and  $\pm 0.6$  in (15mm) at the walls and roof.

## **12.6 OTHER CONSIDERATIONS**

### **12.6.1 Monitoring**

The jacked box tunneling operation must be carefully monitored and controlled to ensure proper performance and safety. Throughout the tunneling operation, movements at the ground surface over the area affected by the tunneling operation, jacking forces and vertical and horizontal box alignment are all regularly monitored and compared to predicted or specified values.

Chapter 15 presents a variety of available instrument for monitoring ground surface movement (Section 15.2). Section 15.7 discusses overall instrumentation management considerations. Daugherty (1998) also provides detail discussions about the instrumentation design for the CA/T C09A4 tunnels.

### **12.6.2 Vertical Alignment**

Design should also include provisions for controlling vertical alignment. A long box has directional stability by virtue of its large length to depth ratio. The box is guided during the early stages of installation by its self weight acting on the jacking base. Beyond the jacking base, the bottom ADS 'tracks' maintain the box on a correct vertical alignment. As the pressure on the ground under the 'tracks' is normally less than or similar to the pre-existing pressure in the ground and as localized disturbance of the ground is eliminated, no settlement of the tracks can occur. Any tendency for the box to dive is thereby prevented.

In the case of a short box or series of short boxes, it is necessary to steer each box by varying the elevation of the jacking thrust. This is done by arranging groups of jacks at each jacking station at different elevations within the height of the box and by selectively isolating individual groups. The jacking process is complicated by the need to check, at each stage of the operation, the alignment of all box units and if necessary to employ a suitable steering response at all jacking stations.

### **12.6.3 Horizontal Alignment**

Design should also include provisions for controlling horizontal alignment. As discussed previously under vertical alignment, a long box has a degree of directional stability by virtue of its length to width ratio, and is normally guided during the early stages of installation by fixed guide walls located on the jacking base along both sides of the box. Where appropriate, steerage may also be used and is normally provided by selectively isolating one or more groups of thrust jacks located across the rear of the box. Depending on the ground conditions, some adjustment in horizontal position can also be obtained by controlling the amount of undercut/overcut of the excavation on one side of the heading relative to the other.

In the case of a short box or series of short boxes, fixed side guides are also appropriate but more reliance has to be placed on steerage.

## CHAPTER 13 SEISMIC CONSIDERATIONS

### 13.1 INTRODUCTION

Tunnels, in general, have performed better during earthquakes than have above ground structures such as bridges and buildings. Tunnel structures are constrained by the surrounding ground and, in general, can not be excited independent of the ground or be subject to strong vibratory amplification, such as the inertial response of a bridge structure during earthquakes. Another factor contributing to the reduced tunnel damage is that the amplitude of seismic ground motion tends to reduce with depth below the ground surface. Adequate design and construction of seismic resistant tunnel structures, however, should never be overlooked, as moderate to major damage has been experienced by many tunnels during earthquakes, as summarized by Dowding and Rozen (1978), Owen and Scholl (1981), Sharma and Judd (1991), and Power et al. (1998), among others. The greatest incidence of severe damage has been associated with large ground displacements due to ground failure, i.e., fault rupture through a tunnel, landsliding (especially at tunnel portals), and soil liquefaction. Ground shaking in the absence of ground failure has produced a lower incidence and degree of damage in general, but has resulted in moderate to major damage to some tunnels in recent earthquakes. The most recent reminder of seismic risk to underground structures under the ground shaking effect is the damage and near collapse at the Daikai and Nagata subway stations (Kobe Rapid Transit Railway) during the 1995 Kobe Earthquake in Japan. Near-surface rectangular cut-and-cover tunnels and immersed tube tunnels in soil have also been vulnerable to transient seismic lateral ground displacements, which tend to cause racking of a tunnel over its height and increased lateral pressures on the tunnel walls. Their seismic performance could be vital, particularly when they comprise important components of a critical transportation system (e.g., a transit system) to which little redundancy exists.

The general procedure for seismic design and analysis of tunnel structures should be based primarily on the ground deformation approach (as opposed to the inertial force approach); i.e., the structures should be designed to accommodate the deformations imposed by the ground. The analysis of the structure response can be conducted first by ignoring the stiffness of the structure, leading to a conservative estimate of the ground deformations. This simplified procedure is generally applicable for structures embedded in rock or very stiff/dense soil. In cases where the structure is stiff relative to the surrounding soil, the effect of soil-structure interaction must be taken into consideration. Other critical conditions that warrant special seismic considerations include cases where a tunnel intersects or meets another tunnel (e.g., tunnel junction or tunnel/cross-passage interface) or a different structure (such as a ventilation building). Under these special conditions, the tunnel structure may be restrained from moving at the junction point due to the stiffness of the adjoining structure, thereby inducing stress concentrations at the critical section. Complex numerical methods are generally required for cases such as these where the complex nature of the seismic soil-structure interaction system exists.

### 13.2 DETERMINATION OF SEISMIC ENVIRONMENT

#### 13.2.1 Earthquake Fundamental

General: Earthquakes are produced by abrupt relative movements on fractures or fracture zones in the earth's crust. These fractures or fracture zones are termed *earthquake faults*. The mechanism of fault movement is elastic rebound from the sudden release of built-up strain energy in the crust. The built-up strain energy accumulates in the earth's crust through the relative movement of large, essentially intact

pieces of the earth's crust called *tectonic plates*. This relief of strain energy, commonly called *fault rupture*, takes place along the *rupture zone*. When fault rupture occurs, the strained rock rebounds elastically. This rebound produces vibrations that pass through the earth crust and along the earth's surface, generating the ground motions that are the source of most damage attributable to earthquakes. If the fault along which the rupture occurs propagates upward to the ground surface and the surface is uncovered by sediments, the relative movement may manifest itself as *surface rupture*. Surface ruptures are also a source of earthquake damage to constructed facilities including tunnels.

The major tectonic plates of the earth's crust are shown in Figure 13-1 (modified from Park, 1983). There are also numerous smaller, minor plates not shown on this figure. Earthquakes also occur in the interior of the plates, although with a much lower frequency than at plate boundaries.

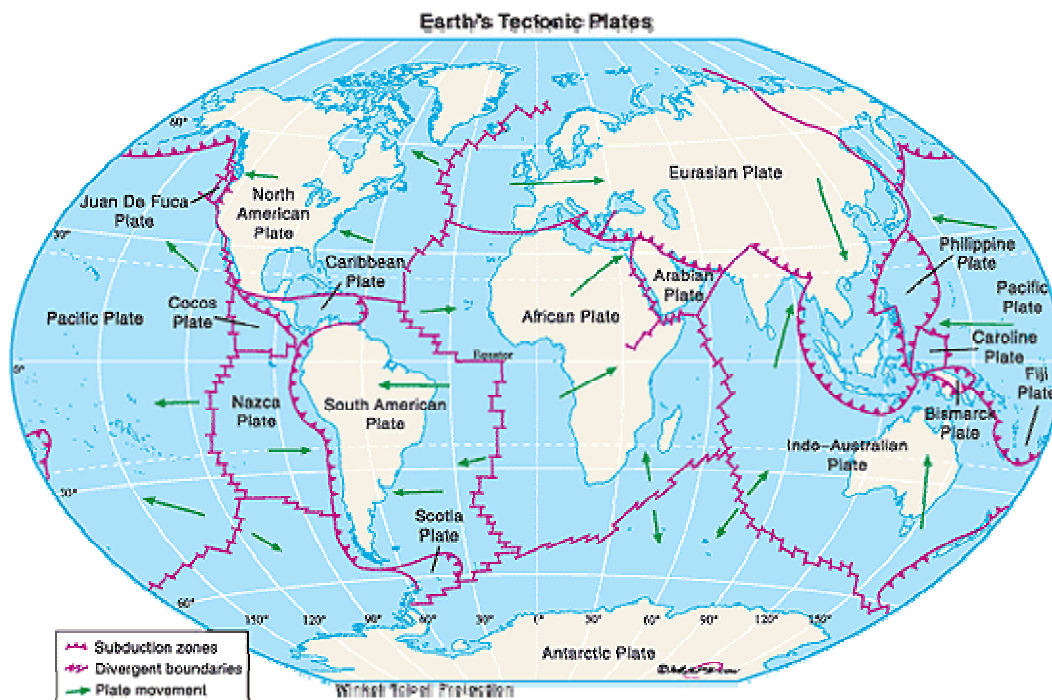

Figure 13-1 Major Tectonic Plates and Their Approximate Direction of Movement.  
(Source: [www.maps.com](http://www.maps.com))

For the continental United States, the principal tectonic plate boundary is along the western coast of the continent, where the North American Plate and the Pacific Plate are in contact. In California, the boundary between these plates is a transform fault wherein the relative movement is generally one of lateral slippage of one plate past the other. Elsewhere along the west coast (e.g., off the coast of Oregon, Washington, and Alaska), the plate boundary is a *subduction zone* wherein one plate dives (subducts) beneath the other plate. In the western interior of the United States, adjacent to the western edge of the American Plate, there may be subplates that have formed as a result of subcrustal flow. Earthquake sources in Utah and Montana may be attributable to such subplate sources. Earthquake source areas in the central and eastern United States and along the Saint Lawrence Valley are within the American Plate and are considered to be intraplate source zones. The mechanisms generating earthquakes in these intraplate zones are poorly understood, but may be related to relief of locked-in stresses from ancient tectonic movements, crustal rebound from the ice ages, re-adjustment of stress in the interior of the plate due to boundary loads, sediment load such as the Mississippi River basin, or other unrecognized

mechanisms. Earthquakes in Hawaii are believed to be associated with an isolated plume of molten rock from the mantle referred to as a hot spot.

The intensity and impact of earthquakes may be as great or greater in the plate interiors as they are at the active plate boundaries. The differences between plate boundary and intraplate earthquakes is in their geographic spread and the frequency of occurrence. Earthquake activity is much greater along the plate boundaries than in the plate interior. However, ground motions from intraplate earthquakes tend to attenuate, or dissipate, much more slowly than those from plate boundary events. Plate boundary faults are relatively longer than those in the plate interior and tend to be associated with a smaller *stress drop* (the stress drop is the sudden reduction of stress across the fault plane during rupture), longer duration of shaking, and a more frequent rate of earthquake occurrence.

Fault Movements: Faults are created when the stresses within geologic materials exceed the ability of those materials to withstand the stresses. Most faults that exist today are the result of tectonic activity that occurred in earlier geological times. These faults are usually non-seismogenic (i.e. incapable of generating earthquakes, or inactive). However, faults related to past tectonism may be reactivated by present-day tectonism in seismically active areas and can also be activated by anthropogenic (man-made) activities such as impoundment of a reservoir by a dam or injection of fluids (e.g. waste liquids) deep into the subsurface. The maximum size of an earthquake on an anthropogenically reactivated fault is a subject of some controversy, but earthquakes as large as moment magnitude 6.5 have been attributed to reservoir impoundment.

Not all faults along which relative movement is occurring are a source of earthquakes. Some faults may be surfaces along which relative movement is occurring at a slow, relatively continuous rate, with an insufficient stress drop to cause an earthquake. Such movement is called *fault creep*. Fault creep may occur along a shallow fault, where the low overburden stress on the fault results in a relatively low threshold stress for initiating displacement along the fault. Alternatively, a creeping fault may be at depth in soft and/or ductile materials that deform plastically. Also, there may be a lack of frictional resistance or asperities (non-uniformities) along the fault plane, allowing steady creep and the associated release of the strain energy along the fault. Fault creep may also prevail where phenomena such as magma intrusion or growing salt domes activate small shallow faults in soft sediments. Faults generated by extraction of fluids (e.g., oil or water in southern California), which causes ground settlement and thus activates faults near the surface may also result in fault creep. Faults activated by other non-tectonic mechanisms, e.g. faults generated by gravity slides that take place in thick, unconsolidated sediments, could also produce fault creep.

Active faults that extend into crystalline bedrock are generally capable of building up the strain energy needed to produce, upon rupture, earthquakes strong enough to affect transportation facilities. Fault ruptures may propagate from the crystalline bedrock to the ground surface and produce ground rupture. Fault ruptures which propagate to the surface in a relatively narrow zone of deformation that can be traced back to the causative fault in crystalline rock are sometimes referred to as primary fault ruptures. Fault ruptures may also propagate to the surface in diffuse, distributed zones of deformation which cannot be traced directly back to the basement rock. In this case, the surface deformation may be referred to as secondary fault rupture.

Whether or not a fault has the potential to produce earthquakes is usually judged by the recency of previous fault movements. If a fault has propagated to the ground surface, evidence of faulting is usually found in geomorphic features associated with fault rupture (e.g., relative displacement of geologically young sediments). For faults that do not propagate to the ground surface, geomorphic evidence of previous earthquakes may be more subdued and more difficult to evaluate (e.g., near surface folding in sediments or evidence of liquefaction or slumping generated by the earthquakes). If a fault has undergone

relative displacement in relatively recent geologic time (within the time frame of the current tectonic setting), it is reasonable to assume that this fault has the potential to move again. If the fault moved in the distant geologic past, during the time of a different tectonic stress regime, and if the fault has not moved in recent (Holocene) time (generally the past 11,000 years), it may be considered inactive. For some very important and critical facilities, such as those whose design is governed by the US Nuclear Regulatory Commission (NRC), a timeframe much longer than the 11,000-yr criterion has been used. In accordance with the US NRC regulations a fault is defined as “capable” (as opposed to “active”) if it has shown activity within the past 35,000 years or longer.

Geomorphic evidence of fault movement cannot always be dated. In practice, if a fault displaces the base of unconsolidated alluvium, glacial deposits, or surficial soils, then the fault is likely to be active. Also, if there is micro-seismic activity associated with the fault, the fault may be judged as active and capable of generating earthquakes. Microearthquakes occurring within basement rocks at depths of 7 to 20 km may be indicative of the potential for large earthquakes. Microearthquakes occurring at depths of 1 to 3 km are not necessarily indicative of the potential for large, damaging earthquake events. In the absence of geomorphic, tectonic, or historical evidence of large damaging earthquakes, shallow microtremors may simply indicate a potential for small or moderate seismic events. Shallow microearthquakes of magnitude 3 or less may also sometimes be associated with mining or other non-seismogenic mechanisms. If there is no geomorphic evidence of recent seismic activity and there is no microseismic activity in the area, then the fault may be inactive and not capable of generating earthquakes.

In some instances, fault rupture may be confined to the subsurface with no relative displacement at the ground surface due to the fault movement. Subsurface faulting without primary fault rupture at the ground surface is characteristic of almost all but the largest magnitude earthquakes in the central and eastern United States. Due to the rarity of large magnitude intraplate events, geological processes may erase surface manifestations of major earthquakes in these areas. Therefore, intraplate seismic source zones often must be evaluated using instrumental seismicity and paleoseismicity studies. This is particularly true if the intraplate sources are covered by a thick mantle of sediments, as in the New Madrid, Tennessee, and Charleston, South Carolina, intraplate seismic zones. Instrumental recording of small magnitude events can be particularly effective in defining seismic source zones.

Essentially all of the active faults with surface fault traces in the United States are shallow crustal faults west of the Rocky Mountains. However, not all shallow crustal faults west of the Rocky Mountains have surface fault traces. Several recent significant earthquakes along the Pacific Coast plate boundary (e.g., the 1987 Whittier Narrows earthquake and the 1994 Northridge earthquake) were due to rupture of thrust (compressional) faults that did not break the ground surface, termed *blind thrust* faults.

A long fault, like the San Andreas Fault in California or the Wasatch Fault in Utah, typically will not move along its entire length at any one time. Such faults typically move in portions, one segment at a time. An immobile (or "locked") segment, a segment which has remained stationary while the adjacent segments of the fault have moved, is a strong candidate for the next episode of movement.

Type of Faults: Faults may be broadly classified according to their mode, or style of relative movement. The principal modes of relative displacement are illustrated in Figure 13-2 and are described subsequently.

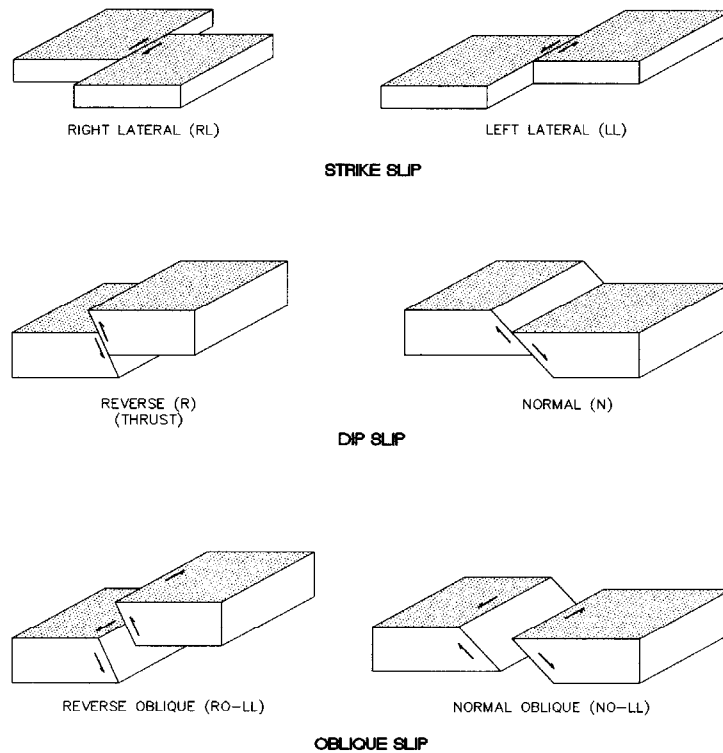

Figure 13-2 Types of Fault Movement

*Strike Slip Faults:* Faults along which relative movement is essentially horizontal (i.e., the opposite sides of the fault slide past each other laterally), are called strike slip faults. Strike slip faults are often essentially linear (or planar) features. Strike slip faults that are not fairly linear may produce complex surface features. The San Andreas fault is a strike slip fault that is essentially a north-south linear feature over most of its length. Strike slip faults may sometimes be aligned in en-echelon fashion wherein individual sub-parallel segments are aligned along a linear trend. En-echelon strike slip faulting is sometimes accompanied by step over zones where fault displacement is transferred from adjacent strike slip faults. Ground rupture patterns within these zones may be particularly complex.

*Dip Slip Faults:* Faults in which the deformation is perpendicular to the fault plane may occur due to either *normal* (extensional) or *reverse* (compressional) motion. These faults are referred to as *dip slip* faults. Reverse faults are also referred to as *thrust faults*. Dip slip faults may produce multiple fractures within rather wide and irregular fault zones.

*Other Special Cases:* Faults that show both strike slip and dip slip displacement may be referred to as *oblique slip faults*.

Earthquake Magnitude: *Earthquake magnitude, M*, is a measure of the energy released by an earthquake. A variety of different earthquake magnitude scales exist. The differences among these scales is attributable to the earthquake characteristic used to quantify the energy content. Characteristics used to quantify earthquake energy content include the local intensity of ground motions, the body waves generated by the earthquake, and the surface waves generated by the earthquake. In the eastern United States, earthquake magnitude is commonly measured as a (short period) *body wave magnitude, m<sub>b</sub>*. However, the (long period) body wave magnitude, *m<sub>B</sub>*, scale is also sometimes used in the central and

eastern United States. In California, earthquake magnitude is often measured as a *local (Richter) magnitude*,  $M_L$ , or *surface wave magnitude*,  $M_s$ . The *Japan Meteorological Agency Magnitude* ( $M_{JMA}$ ) scale is commonly used in Japan.

Due to limitations in the ability of some recording instruments to measure values above a certain amplitude, some of these magnitude scales tend to reach an asymptotic upper limit. To correct this, the *moment magnitude*,  $M_w$ , scale was developed by seismologists (Hanks and Kanamori, 1979). The moment magnitude of an earthquake is a measure of the kinetic energy released by the earthquake.  $M_w$  is proportional to the *seismic moment*, defined as a product of the material rigidity, fault rupture area, and the average dislocation of the rupture surface. Moment magnitude has been proposed as a unifying, consistent magnitude measure of earthquake energy content. Figure 13-3 (Heaton, *et al.*, 1986) provides a comparison of the various other magnitude scales with the moment magnitude scale.

Hypocenter and Epicenter and Site-to-Source Distance: The *hypocenter* (focus) of an earthquake is the point from which the seismic waves first emanate. Conceptually, it may be considered as the point on a fault plane where the slip responsible for an earthquake was initiated. The *epicenter* is a point on the ground surface directly above the hypocenter. Figure 13-4 shows the relationship between the hypocenter, epicenter, fault plane, and rupture zone of an earthquake. Figure 13-4 also shows the definition of the *strike* and *dip angles* of the fault plane.

The horizontal distance between the site of interest to the epicenter is termed *epicentral distance*,  $R_E$ , and is commonly used in the eastern United States. The distance between the site and the hypocenter (more widely used in the western United States) is termed *hypocentral distance*,  $R_H$ .

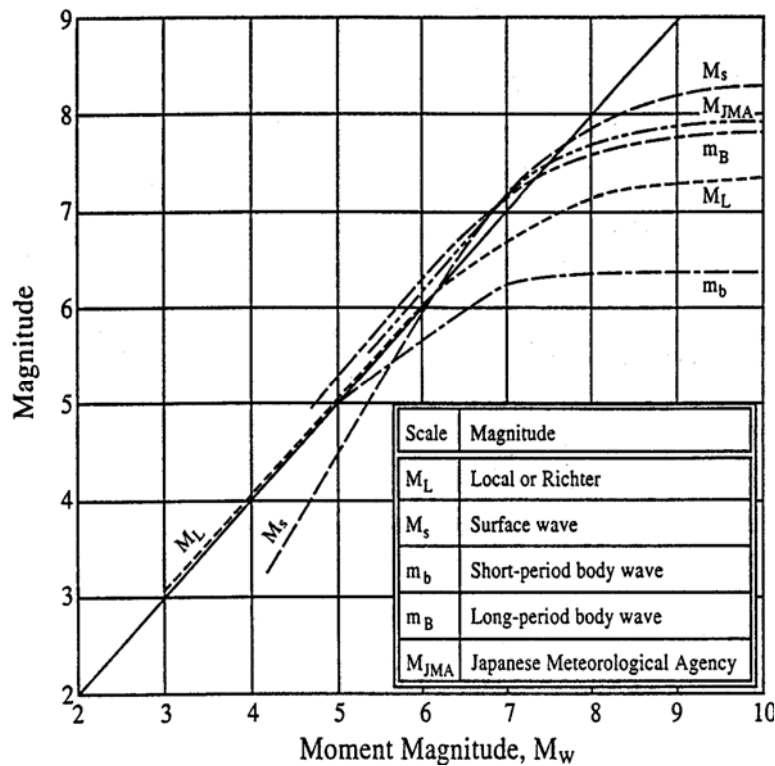

Figure 13-3 Comparison of Earthquake Magnitude Scales (Heaton, *et al.*, 1986)



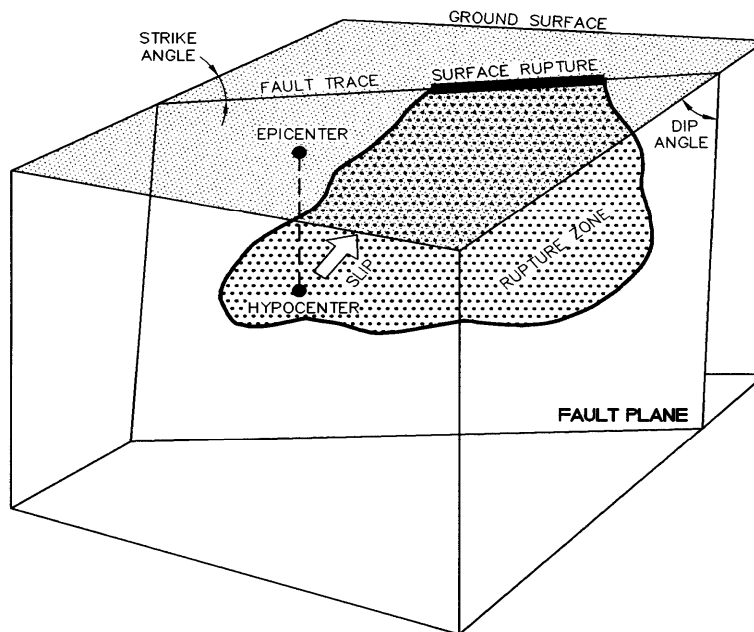

Figure 13-4 Definition of Basic Fault Geometry Including Hypocenter and Epicenter

### 13.2.2 Ground Motion Hazard Analysis

For the seismic design of underground tunnel facilities, one of the main tasks is to define the design earthquake(s) and the corresponding ground motion levels and other associated seismic hazards. The process by which design ground motion parameters are established for a seismic analysis is termed the *seismic hazard analysis*. Seismic hazard analyses generally involve the following steps:

- Identification of the seismic sources capable of strong ground motions at the project site
- Evaluation of the seismic potential for each capable source
- Evaluation of the intensity of the design ground motions at the project site

Identification of seismic sources includes establishing the type of fault and its geographic location, depth, size, and orientation. Seismic source identification may also include specification of a random seismic source to accommodate earthquakes not associated with any known fault. Evaluation of the seismic potential of an identified source involves evaluation of the earthquake magnitude (or range of magnitudes) that the source can generate and, often times, the expected rate of occurrence of events of these magnitudes.

Identification of capable seismic sources together with evaluation of the seismic potential of each capable source may be referred to as *seismic source characterization*. Once the seismic sources are characterized, the intensity of ground motions at the project site from these sources must be characterized. There are three general ways by which the intensity of ground motions at a project site is assessed in practice. They are, in order of complexity: (1) use of existing hazard analysis results published by credible agencies such as US Geological Survey (USGS) and some State agencies; (2) project-specific and site-specific deterministic seismic hazard evaluation; and (3) project-specific and site-specific probabilistic seismic

hazard evaluation. Which particular approach is adopted may depend on the importance and complexity of the project and may be dictated by regulatory agencies.

The choice of the design ground motion level, whether based upon probabilistic or deterministic analysis, cannot be considered separately from the level of performance specified for the design event. Sometimes, facilities may be designed for multiple performance levels, with a different ground motion level assigned to each performance level, a practice referred to as performance based design. Common performance levels used in design of transportation facilities include protection of life safety and maintenance of function after the event. A safety level design earthquake criterion is routinely employed in seismic design. Keeping a facility functional after a large earthquake adds another requirement to that of simply maintaining life safety, and is typically required for critical facilities.

The collapse of a modern transportation tunnel (particularly for mass transit purpose) during or after a major seismic event could have catastrophic effects as well as profound social and economical impacts. It is typical therefore for modern and critical transportation tunnels to be designed to withstand seismic ground motions with a return period of 2,500 years, (corresponding to 2 % probability of exceedance in 50 years, or 3% probability of exceedance in 75 years). In addition, to avoid lengthy down time and to minimize costly repairs, a modern and critical transportation tunnel is often required to withstand a more frequent earthquake (i.e., a lower level earthquake) with minimal damage. The tunnel should be capable of being put immediately back in service after inspection following this lower level design earthquake. In the high seismic areas, this lower level earthquake is generally defined to have a 50% probability of exceedance 75 years, corresponding to a 108-year return period. In the eastern United States, where earthquake occurrence is much less frequent, the lower level design earthquake for modern and critical transportation tunnels is generally defined at a higher return period such as 500 years.

Use Of Existing Hazard Analysis Results: Information used for seismic source characterization can often be obtained from publications of the United States Geological Survey (USGS), or various state agencies. These published results are often used because they provide credibility for the designer and may give the engineer a feeling of security. However, if there is significant lag time between development and publication, the published hazard results may not incorporate recent developments on local or regional seismicity. Furthermore, there are situations where published hazard results may be inadequate and require site-specific seismic hazard evaluation. These situations may include: (1) the design earthquake levels (e.g., in terms of return period) are different than those assumed in the published results, (2) for sites located within 6 miles of an active surface or shallow fault where near-field effect is considered important, and (3) the published hazard results fail to incorporate recent major developments on local or regional seismicity.

Seismic hazard maps that include spectral acceleration values at various spectral periods have been developed by USGS under the National Earthquake Hazard Reduction Program (NEHRP). Map values for peak and spectral accelerations with a probability of being exceeded of 2 percent, 5 percent, and 10 percent in 50 years (corresponding approximately to 2,500-yr, 1,000-yr, and 500-yr return period, respectively) can be recovered in tabular form. Figure 13-5 below shows an example of the national ground motion hazard maps in terms of peak ground acceleration (in Site Class B – Soft Rock Site) for an event of 2% probability of exceedance in 50 Years (i.e., 2,500-yr Return Period). In addition, USGS also provides information (e.g., the de-aggregated hazard) that can be used to estimate the representative “magnitude and distance” for a site in the continental United States.

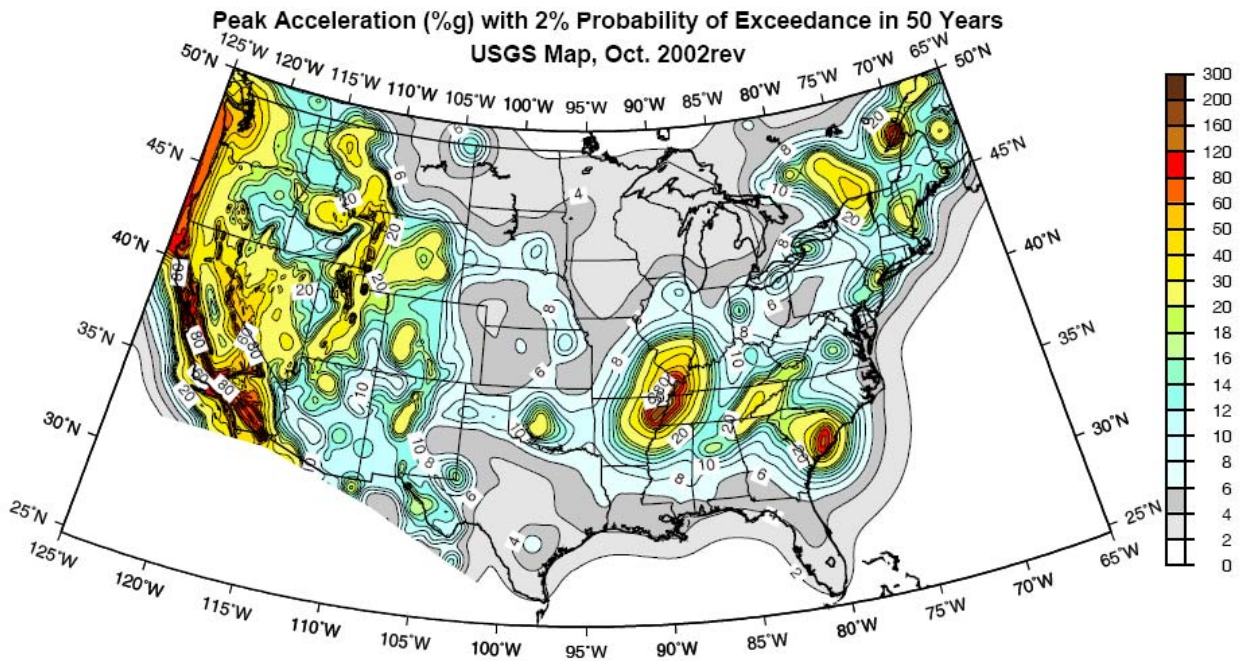

Figure 13-5 National Ground Motion Hazard Map by USGS (2002) - Peak Ground Acceleration with 2% Probability of Exceedance in 50 Years (2,500-yr Return Period) - for Site Class B, Soft Rock

The Deterministic Hazard Analysis Approach: In a deterministic seismic hazard analysis, the seismologist performing the analysis first identifies the capable seismic sources and assigns a maximum magnitude to each source. Then, the intensity of shaking at the site from each capable source is calculated and the design earthquake is identified based on the source capable of causing the greatest damage. The steps in a deterministic seismic hazard analysis are as follows:

1. Establish the location and characteristics (e.g., style of faulting) of all potential earthquake sources that might affect the site. For each source, assign a representative earthquake magnitude.
2. Select an appropriate attenuation relationship and estimate the ground motion parameters at the site from each capable fault as a function of earthquake magnitude, fault mechanism, site-to-source distance, and site conditions. Attenuation relationships discriminate between different styles of faulting and between rock and soil sites.
3. Screen the capable (active) faults on the basis of magnitude and the intensity of the ground motions at the site to determine the governing source.

The deterministic analysis approach provides a framework for the evaluation of worst-case scenarios at a site. It provides little information about the likelihood or frequency of occurrence of the governing earthquake. If such information is required, a probabilistic analysis approach should be used to better define the seismic ground motion hazard.

The Probabilistic Hazard Analysis Approach: A probabilistic seismic hazard analysis incorporates the likelihood of a fault rupturing and the distribution of earthquake magnitudes associated with fault rupture into the assessment of the intensity of the design ground motion at a site. The objective of a probabilistic seismic hazard analysis is to compute, for a given exposure time, the probability of exceedance

corresponding to various levels of a ground motion parameter (e.g., the probability of exceeding a peak ground acceleration of 0.2 g in a 100-year period). The ground motion parameter may be either a peak value (e.g., peak ground acceleration) or a response spectra ordinate associated with the strong ground motion at the site. The probabilistic value of the design parameter incorporates both the uncertainty of the attenuation of strong ground motions and the randomness of earthquake occurrences. A probabilistic seismic hazard analysis usually includes the following steps, as illustrated in Figure 13-6:

1. Identify the seismic sources capable of generating strong ground motion at the project site. In areas where no active faults can be readily identified it may be necessary to rely on a purely statistical analysis of historical earthquakes in the region.
2. Determine the minimum and maximum magnitude of earthquake associated with each source and assign a frequency distribution of earthquake occurrence to the established range of magnitudes. The Gutenberg-Richter magnitude-recurrence relationship (Gutenberg and Richter, 1942) is the relationship used most commonly to describe the frequency distribution of earthquake occurrence. While the maximum magnitude is a physical parameter related to the fault dimensions, the minimum magnitude may be related to both the physical properties of the fault and the constraints of the numerical analysis.
3. For each source, assign an attenuation relationship on the basis of the style of faulting. Uncertainty is usually assigned to the attenuation relationships based upon statistical analysis of attenuation in previous earthquakes.
4. Calculate the probability of exceedance of the specified ground motion parameter for a specified time interval by integrating the attenuation relationship over the magnitude distribution for each source and summing up the results.

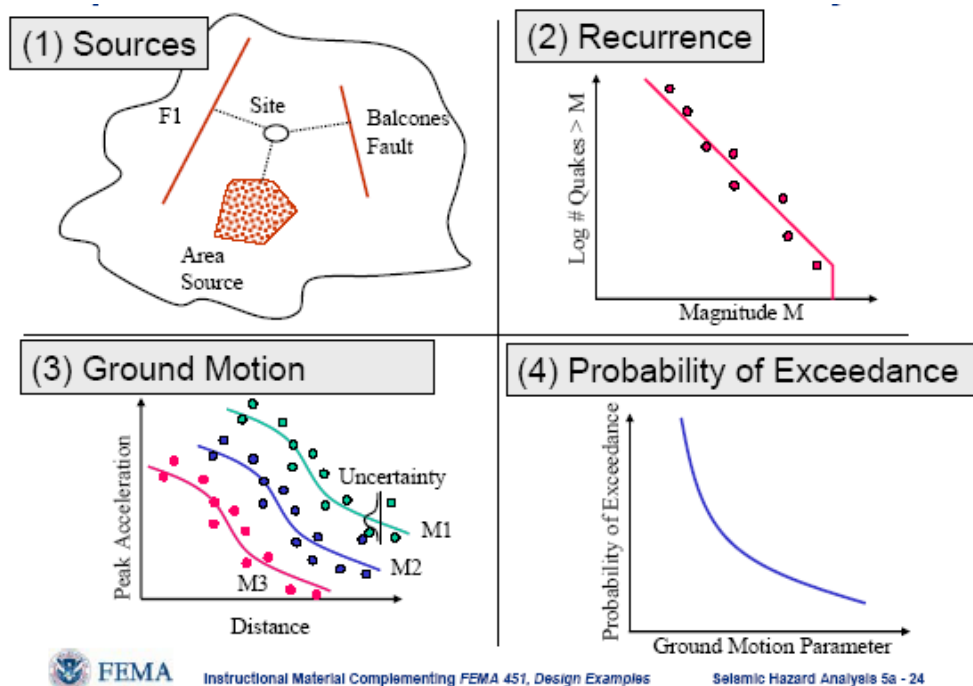

Figure 13-6 General Procedure for Probabilistic Seismic Hazard Analysis

### 13.2.3 Ground Motion Parameters

Once the design earthquake events are defined, design ground motion parameters are required to characterize the design earthquake events. Various types of ground motion parameters may be required depending on the type of analysis method used in the design. In general, ground motions can be characterized by three translational components (e.g., longitudinal, transverse, and vertical with respect to the tunnel axis). The various types of common ground motion parameters are described in the following paragraphs.

Peak Ground Motion Parameters: Peak ground acceleration (PGA), particularly in the horizontal direction, is the most common index of the intensity of strong ground motion at a site. Peak ground velocity (PGV) and peak ground displacement (PGD) are also used in some engineering analyses to characterize the damage potential of ground motions. For seismic design and analysis of underground structures including tunnels, the PGV is as important as the PGA because ground strains (or the differential displacement between two points in the ground) can be estimated using the PGV. PGA values are generally available from published hazard results such as those from the USGS hazard study. Attenuation relations are also generally available for estimating PGA values. However, there has been little information in the past for estimating the PGV values. Previous studies have attempted to correlate the PGV with PGA by establishing PGV-to-PGA ratios (as a function of earthquake magnitudes, site soil conditions, and source-to-site distance in some cases). However, these correlations were derived primarily from ground motion database in the Western United States (WUS) and failed to account for the different ground motion characteristics in the Central and Eastern United States (CEUS). Recent study (NCHRP-12-70, 2008) has found that PGV is strongly correlated with the spectral acceleration at 1.0 second ( $S_1$ ). Using published strong motion data, regression analysis was conducted and the following correlation has been recommended for design purposes.

$$PGV = 0.394 \times 10^{0.434C} \quad 13-1$$

Where:

PGV is in in/sec

$$C = 4.82 + 2.16 \log_{10} S_1 + 0.013 [2.30 \log_{10} S_1 + 2.93]^2 \quad 13-2$$

The development of the PGV- $S_1$  correlation is based on an extensive earthquake database established from recorded accelerograms representative of both rock and soil sites for the WUS and CEUS. The earthquake magnitude was found to play only a small role and is not included in the correlation in developing Equations 13-1 and 13-2. Equation 13-1 is based on the mean plus one standard deviation from the regression analysis (i.e., 1.46 x the median value) for conservatism.

Design Response Spectra: Response spectra represent the response of a damped single degree of freedom system to ground motion. Design response spectra including the consideration of soil site effects can be established using code-specified procedures such as those specified in the NEHRP (National Earthquake Hazards Reduction Program) publications or the new AASHTO LRFD Guide Specifications using the appropriate design earthquake parameters consistent with the desirable design earthquake hazard levels (refer to discussions in Section 13.2.2). Figure 13-7 illustrates schematically the construction of design response spectra using the NEHRP procedure. The terms and parameters used in Figure 13-7 are documented in details in NEHRP 12-70 (2008) and in AASHTO LRFD Bridge Design Specifications (2008 Interim Provisions). Alternatively, project-specific and site-specific hazard analysis can also be performed to derive the design response spectra. Site-specific dynamic soil response analysis can also be performed to study the effects of the local soil/site conditions (site effects).

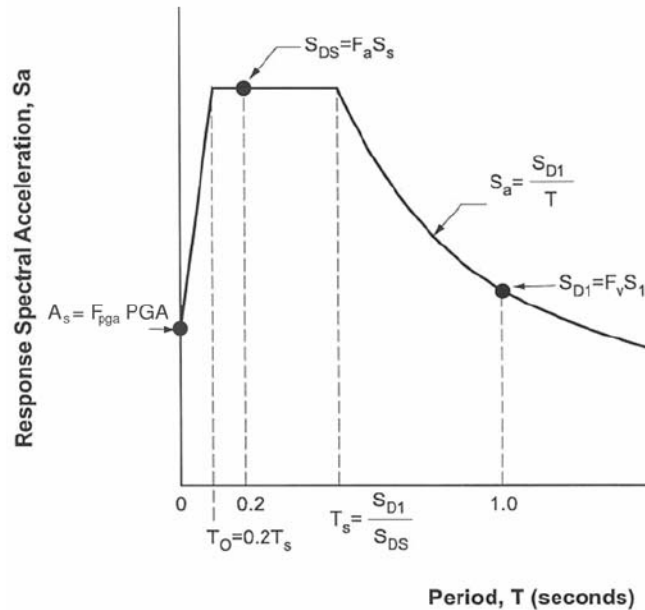

Figure 13-7 Design Response Spectra Constructed Using the NEHRP Procedure

It should be noted that while the design response spectra are commonly used for the seismic design and analysis of above-ground structures such as bridges and buildings, they are not as useful in the seismic evaluation for underground structure. This is because response spectra are more relevant for evaluating the inertial response effect of above-ground structures while for underground structures, ground strains or ground displacements are the governing factor. Nevertheless, design response spectra effectively establish the ground motion shaking intensity level and can be used for deriving other ground motion parameters that are useful and relevant for underground structures. For example, using the design spectral acceleration at 1.0 sec ( $S_{D1}$ ), PGV can be estimated using the empirical correlation discussed above (Equation 13-1). In addition, design response spectra can also be used as the target spectra for generating the design ground motion time histories which in turn can be used in seismic analysis for underground structures if more refined numerical analysis is required.

Ground Motion Time histories and Spatially Varying Ground Motion Effects: The developed time histories should match the target design response spectra and have characteristics that are representative of the seismic environment of the site and the local site conditions. Characteristics of the seismic environment of the site to be considered in selecting time-histories include: tectonic environment (e.g., subduction zone; shallow crustal faults in WUS or similar crustal environment; CEUS or similar crustal environment); earthquake magnitude; type of faulting (e.g., strike-slip; reverse; normal); seismic-source-to-site distance; local site conditions; and design or expected ground-motion characteristics (e.g., design response spectrum; duration of strong shaking; and special ground-motion characteristics such as near-fault characteristics).

It is desirable to select time-histories that have been recorded under conditions similar to the seismic conditions (as described above) at the site, but compromises are usually required because of the multiple attributes of the seismic environment and the limited data bank of recorded time-histories. Selection of time-histories having similar earthquake magnitudes and distances, within reasonable ranges, are especially important parameters because they have a strong influence on response spectral content, response spectral shape, duration of strong shaking, and near-source ground-motion characteristics.

For long structures such as tunnels, different ground motions may be encountered by different parts of the structure. Thus, it is sometime necessary for the tunnel to be evaluated for the spatially varying ground motions effects, particularly when the longitudinal response of the tunnel is of concern (refer to discussions in Section 13.5.2). In this case the differential displacements and force buildup along the length of the tunnel could be induced due to the spatially varying ground motion effects. In deriving the spatially varying ground motion time histories, as a minimum the following factors should be taken into considerations:

- Local soil site effect
- Wave traveling/passage effect
- Extended source effect
- Near-field effect.

Ground Motion Parameters Attenuation with Depth: The ground motions parameters discussed above are typically established at ground surface. Tunnels, however, are generally constructed at some depth below the ground surface. For seismic evaluation of the tunnel structure, the ground motion parameters should be derived at the elevation of the tunnel. Because ground motions generally decrease with depth below the ground surface, these parameters generally have lower values than estimated for ground surface motions (e.g., Chang et al., 1986). The ratios of ground motion values at tunnel depths to those at the ground surface may be taken as the ratios summarized in Table 13-1 unless lower values are justified based on site-specific assessments.

For more accurate assessment of the ground motion parameters at depth, site-specific dynamic site response analysis should be performed to account for detailed subsurface conditions and site geometry. Results from the dynamic site response analysis would provide various aspects of ground motion parameters as a function of depth (in a one-dimensional site response analysis) or as a function of spatial coordinates (in a two- or three-dimensional site response analysis).

**Table 13-1 Ground Motion Attenuation with Depth**

| Tunnel Depth (m) | Ratio Of Ground Motion At Tunnel Depth To Motion At Ground Surface |
|------------------|--|
| ≤ 6              | 1.0  |
| 6 -15            | 0.9  |
| 15 -30           | 0.8  |
| ≥ 30             | 0.7  |

### 13.3 FACTORS THAT INFLUENCE TUNNEL SEISMIC PERFORMANCE

The main factors influencing tunnel seismic performance generally can be summarized as (1) seismic hazard, (2) geologic conditions, and (3) tunnel design, construction, and condition. Each of these factors is briefly described in the following sections.

#### 13.3.1 Seismic Hazard

In a broad sense, earthquake effects on underground tunnel structures can be grouped into two categories: (1) ground shaking, and (2) ground failure. Based on tunnel performance records during past earthquakes, the damaging effects of ground failure on tunnels are significantly greater than the ground shaking effects.

Ground Shaking: Ground shaking refers to the vibration of the ground produced by seismic waves propagating through the earth's crust. The area experiencing this shaking may cover hundreds of square miles in the vicinity of the fault rupture. The intensity of the shaking attenuates with distance from the fault rupture. Ground shaking motions are composed of two different types of seismic waves, each with two sub-types, described as follows:

- Body waves traveling within the earth's material. They may be either longitudinal P waves or transverse shear S waves and they can travel in any direction in the ground.
- Surface waves traveling along the earth's surface. They may be either Rayleigh waves or Love waves.

As the ground is deformed by the traveling waves, any tunnel structure in the ground will also be deformed, since tunnel structures are constrained by the surrounding medium (soil or rock). As long as the ground (i.e., the surrounding medium) is stable, the structures cannot move independently of the ground. Therefore, the design and analysis of underground structures is based on ground deformations/strains rather than ground acceleration values. If the magnitude of ground deformation during earthquakes is small, the seismic effect on tunnels is negligible. For example, there is generally little concern for tunnel sections constructed in reasonably competent rock because the seismically induced deformations/strains in rock are generally very small, except when shear/fault zones are encountered or when there are large loosened rock pieces behind the lining. In loose or soft soil deposits, on the other hand, the soil deformation developed during the design earthquake(s) should be estimated and used for the structure's design and analysis. In general the potential effects of ground shaking range from minor cracking of a concrete liner to collapse of the liner and major caving of geologic materials into the tunnel.

Ground Failure: Ground failure broadly includes various types of ground instability such as fault rupture, tectonic uplift and subsidence, landsliding, and soil liquefaction. Each of these hazards may be potentially catastrophic to tunnel structures, although the damages are usually localized. Design of a tunnel structure against ground instability problems is often possible, although the cost may be high.

If an active fault crosses the tunnel alignment, there is a hazard of direct shearing displacement through the tunnel in the event of a moderate to large magnitude earthquake. Such displacements may range from a few inches to greater than ten feet and, in many cases, may be concentrated in a narrow zone along the fault. Fault rupture can and has had very damaging effects on tunnels. Tectonic uplift and subsidence can have similar damaging effects to fault rupture, if the uplift/subsidence movements cause sufficient differential deformation of the tunnel.

Landsliding through a tunnel, whether statically or seismically induced, can result in large, concentrated shearing displacements and either full or partial collapse of tunnel cross sections. Landslide potential is greatest when a preexisting landslide mass intersects the tunnel. A statically stable landslide mass may be activated by earthquake shaking. The hazard of landsliding is usually greatest in shallower parts of a tunnel alignment and at tunnel portals.

For tunnels located in soils below the groundwater table, there could be a potential for liquefaction if loose to medium-dense cohesionless soils (sands, silts, gravels) are adjacent to the tunnel. Potential effects of liquefaction of soils adjacent to a tunnel include: (a) increased lateral pressures on the lining or walls of the tunnel, which could lead to failure of the lining or walls depending on their design; (b) flotation or sinking of a tunnel embedded in liquefied soil, depending on the relative weight of the tunnel and the soils replaced by the tunnel; and (c) lateral displacements of a tunnel if there is a free face toward which liquefied soil can move and/or if the tunnel is constructed below sloping ground.



### **13.3.2 Geologic Conditions**

Other unfavorable geologic conditions could lead to unsatisfactory seismic tunnel performance unless recognized and adequately accounted for in the tunnel design and construction. Unfavorable geologic conditions include: soft soils; rocks with weak planes intersecting a tunnel, such as shear zones or well developed weak bedding planes and well developed joint sets that are open or filled with weathered and decomposed rock; failures encountered during tunnel construction that may have further weakened the geologic formations adjacent to a tunnel (e.g., cave-ins or running ground leaving incompletely filled voids or loosened rock behind a lining; squeezing ground with relatively low static factor of safety against lining collapse); and adjacent geologic units having major contrasts in stiffness that can lead to stress concentrations or differential displacement.

### **13.3.3 Tunnel Design, Construction, and Condition**

Elements of tunnel design, construction, and condition that may influence tunnel seismic behavior include:

1. Whether seismic loadings and behavior were explicitly considered in tunnel design
2. The nature of the tunnel lining and support system (e.g., type of lining, degree of contact between lining/support systems and geologic material, use of rock bolts and dowels)
3. Junctions of tunnels with other structures
4. History of static tunnel performance in terms of failures and cracking or distortion of lining/support system
5. Current condition of lining/support system, such as degree of cracking of concrete and deterioration of concrete or steel materials over time.

In evaluating an existing tunnel in the screening stage or in a more detailed evaluation, or in designing retrofit measures, it is important to obtain as complete information as possible on the tunnel design, construction, and condition and the geologic conditions along the tunnel alignment. To obtain this information, the design and evaluation team should review the design drawings and design studies, as-built drawings, construction records as contained in the construction engineer daily reports and any special reports, maintenance and inspection records, and geologic and geotechnical reports and maps. Special inspections and investigations may be needed to adequately depict the existing conditions and determine reasons for any distress to the tunnel.

## **13.4 SEISMIC PERFORMANCE AND SCREENING GUIDELINES OF TUNNELS**

### **13.4.1 Screening Guidelines Applicable to All Types of Tunnels**

There are certain conditions that would clearly indicate a potentially significant seismic risk to a bored tunnel, cut-and-cover tunnel, or submerged tube and thus require more detailed evaluations. These conditions include:

- An active fault intersecting the tunnel;
- A landslide intersecting the tunnel, whether or not the landslide is active;
- Liquefiable soils adjacent to the tunnel, and
- History of static distress to the tunnel (e.g., local collapses, large deformations, cracking or spalling of the liner due to earth movements), unless retrofit measures were taken to stabilize the tunnel.

In addition to the above, detailed seismic evaluations should also be conducted for tunnels that are considered lifeline structures (important and critical structures) that must be usable or remain open to traffic immediately after the earthquake. Transit tunnels in metropolitan areas are often considered as critical/lifeline structures and, therefore, warrant detailed seismic evaluations.

#### 13.4.2 Additional Screening Guidelines for Bored Tunnels

If the above conditions do not exist, then the risk to a bored tunnel is a function of the tunnel design and construction, the characteristics of the geologic media, and the level of ground shaking. In this section, additional screening guidelines are presented considering these factors and empirical observations of tunnel performance during earthquakes.

It should be noted that although not as damaging as ground failure effects, ground shaking effect alone (i.e., in the absence of ground failure) has resulted in moderate to major damage to many tunnels in earthquakes. Figure 13-8 shows a highway tunnel experiencing lining falling off from tunnel crown under the ground shaking effect during the 2004 Niigata Earthquake in Japan. In another incident, the 1999 Kocaeli Earthquake in Turkey caused the collapse of two tunnels (the Bolu Tunnels) constructed using NATM method (15 m arch high and 16 m wide). At the time of the earthquake, the collapsed section of the tunnel had been stabilized with steel rib, shotcrete, and anchors.



Figure 13-8 Highway Tunnel Lining Falling from Tunnel Crown – 2004 Niigata Earthquake, Japan

Figure 13-9 presents a summary of empirical observations of the effects of seismic ground shaking on the performance of bored/mined tunnels. The figure is from the study by Power et al. (1998), which updates earlier presentations of tunnel performance data by Dowding and Rozen (1978), Owen and Scholl (1981), and Sharma and Judd (1991). The data are for damage due only to shaking; damage that was definitely or

probably attributed to fault rupture, landsliding, and liquefaction is not included. The data are for bored/mined tunnels only; data for cut-and-cover tunnels and submerged tubes are not included in Figure 13-9.

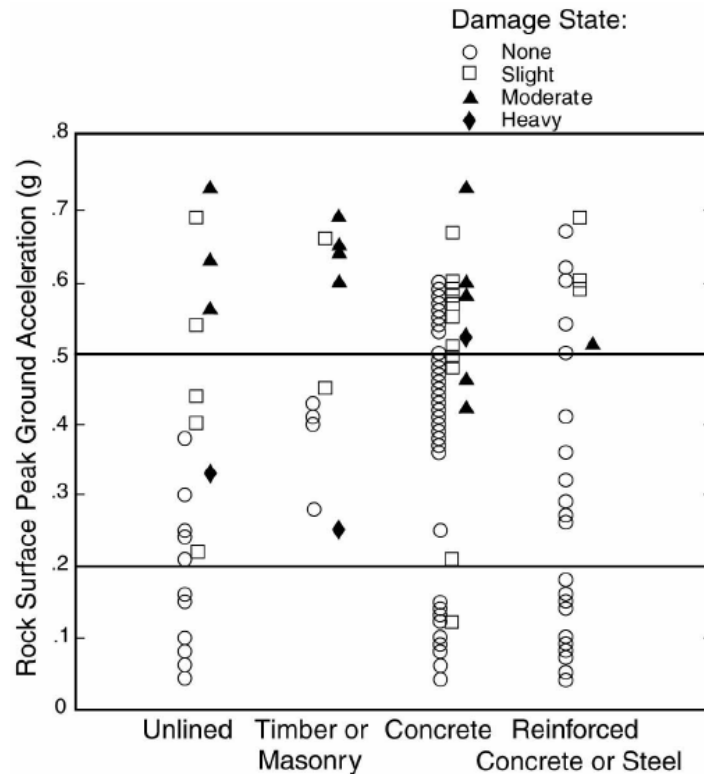

Figure 13-9 Summary of Observed Bored/Mined Tunnel Damage under Ground Shaking Effects (Power et al., 1998)

Figure 13-9 incorporates observations for 192 tunnels from ten moderate to large magnitude earthquakes (moment magnitude  $M_w$  6.6 to 8.4) in California, Japan, and Alaska. Ninety-four of the observations are from the moment magnitude  $M_w$  6.9 1995 Kobe, Japan, earthquake. This earthquake produced by far the most observations for moderate to high levels of shaking (estimated peak ground accelerations, PGA, at ground surface above the tunnels in the range of about 0.4 g to 0.6 g for the Kobe data). Peak ground accelerations in Figure 13-9 are estimated for actual or hypothetical outcropping rock conditions at ground surface above the tunnel. Other observations are from moderate to large ( $M_w$  6.7 to 8.4) earthquakes in California and Japan. Figure 13-9 shows the level of damage induced in tunnels with different types of linings subjected to the indicated levels of ground shaking. Damage was categorized into four states: none for no observable damage; slight for minor cracking and spalling; moderate for major cracking and spalling, falling of pieces of lining and rocks; and heavy for major cave-ins, blockage, and collapse. The figure indicates the following trends:

- For PGA equal to or less than 0.2 g, ground shaking caused essentially no damage in tunnels.
- For PGA in the range of 0.2 g to 0.5 g, there are some instances of damage ranging from slight to heavy. Note that the three instances of heavy damage are all from the 1923 Kanto, Japan, earthquake. For the 1923 Kanto earthquake observation with PGA equal to 0.25 g shown on Figure 13-9, the investigations for this tunnel indicated the damage may have been due to landsliding. For the other two Kanto earthquake observations, collapses occurred in the shallow portions of the tunnels.

- For PGA exceeding about 0.5 g, there are a number of instances of slight to moderate damage (and one instance of heavy damage noted above for the Kanto earthquake).
- Tunnels with stronger linings appear to have performed better, especially those tunnels with reinforced concrete and/or steel linings.

The trends in Figure 13-9 can be used as one guide in assessing the need for further evaluations of the effects of ground shaking on bored/mined tunnels.

### 13.4.3 Additional Screening Guidelines for Cut-and-Cover Tunnels

Reporting on the seismic performance of shallow cut-and-cover box-like tunnels has been relatively poor in comparison to the performance of bored/mined tunnels. This was especially evident during the 1995 Kobe, Japan, earthquake (O'Rourke and Shiba, 1997; Power et al., 1998). Figure 13-10 and Figure 13-11 show the damage to the center columns of the cut-and-cover tunnels running between Daikai and Nagata Stations during the 1995 Kobe Earthquake.



Figure 13-10 Fracture at Base of Columns of Cut-and-Cover Tunnel between Daikai and Nagata Stations - 1995 Kobe Earthquake, Japan



Figure 13-11 Shear Failure at Top of Columns of Cut-and-Cover Tunnel Between Daikai and Nagata Stations - 1995 Kobe Earthquake, Japan

The 1995 Kobe Earthquake also caused a major collapse of the Daikai subway station which was constructed by cut-and-cover method without specific seismic design provisions. The schematic drawing shown in Figure 13-12 (Iida et al., 1996) shows the collapse experienced by the center columns of the station, which was accompanied by the collapse of the ceiling slab and the settlement of the soil cover by more than 2.5 m.

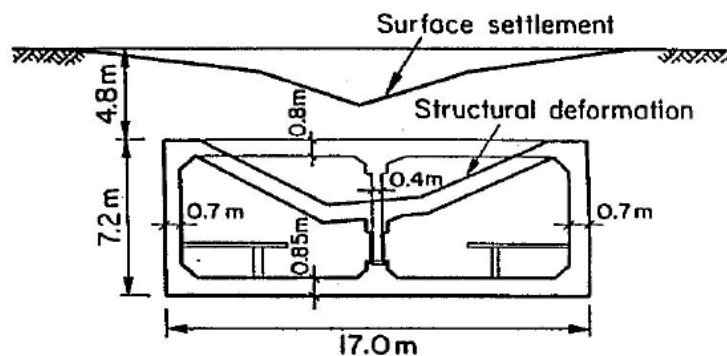

Figure 13-12 Daikai Subway Station Collapse – 1995 Kobe Earthquake, Japan

The relatively poor performance of cut-and-cover tunnels under the ground shaking effect may reflect: (1) relatively softer near-surface geologic materials surrounding these types of structures as compared to the harder materials that often surround bored tunnels at greater depths; (2) higher levels of acceleration at and near the ground surface than at depth (due to tendencies for vibratory ground motions to reduce with depth below the ground surface); and (3) vulnerability of these box-like structures to seismically induced

racking deformations of the box cross section (Refer to Figure 13-13 in Section 13.5), unless specifically designed to accommodate these racking deformations. Cut-and-cover tunnels in soil tend to be more vulnerable than those excavated into rock because of the larger soil shear deformations causing the tunnel racking. Tunnels in soft soil may be especially vulnerable. The most important determinant in assessing whether more detailed seismic evaluations of cut-and-cover tunnels are required is whether the original design considered loadings and deformations consistent with the seismic environment and geologic conditions, and especially, whether racking behavior was taken into account in the seismic analysis, design, and detailing of the structure.

#### 13.4.4 Additional Screening Guidelines for Immersed Tubes

Submerged tubes are particularly susceptible to permanent ground movements during seismic shaking. Tubes are typically located at shallow depths and in soft or loose soils. Liquefaction of loose cohesionless soils may cause settlement, uplift (flotation), or lateral spreading. Earthquake shaking may also cause permanent displacement of soft clay soils on sloping ground. Joints connecting tube segments must accommodate the relative displacement of adjacent segments while maintaining a watertight seal. Generally, submerged tubes can be screened out from more detailed evaluations if the original design appropriately considered and analyzed the potential for ground failure modes and if joints have been carefully designed to achieve water tightness.

### 13.5 SEISMIC EVALUATION PROCEDURES - GROUND SHAKING EFFECTS

Underground tunnel structures undergo three primary modes of deformation during seismic shaking: ovaling/racking, axial and curvature deformations. The ovaling/racking deformation is caused primarily by seismic waves propagating perpendicular to the tunnel longitudinal axis, causing deformations in the plane of the tunnel cross section (Refer to Figure 13-3, Wang, 1993; Owen and Scholl, 1981). Vertically propagating shear waves are generally considered the most critical type of waves for this mode of deformation. The axial and curvature deformations are induced by components of seismic waves that propagate along the longitudinal axis (Refer to Figure 13-14, Wang, 1993; Owen and Scholl, 1981).

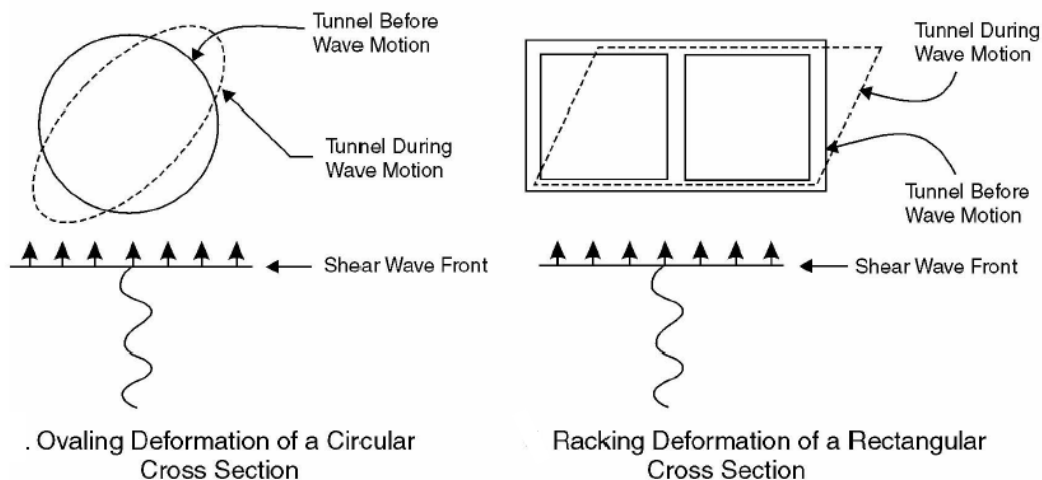

Figure 13-13 Tunnel Transverse Ovaling and Racking Response to Vertically Propagating Shear Waves

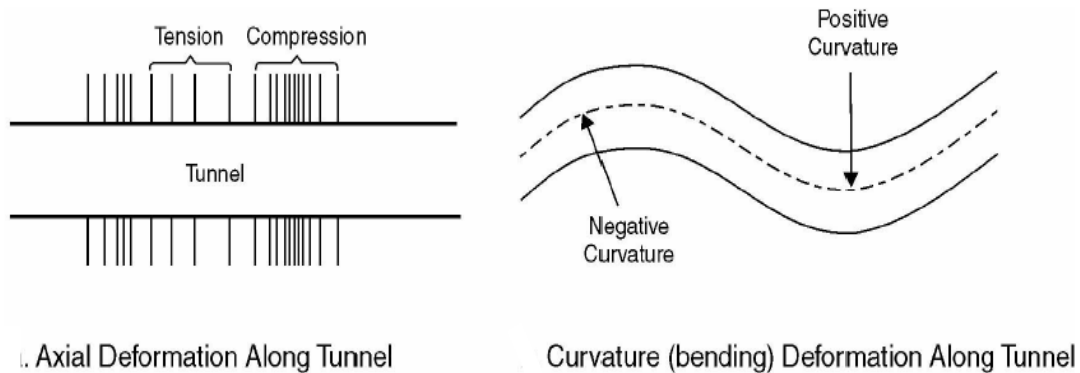

Figure 13-14 Tunnel Longitudinal Axial and Curvature Response to Traveling Waves

### 13.5.1 Evaluation of Transverse Ovaling/Racking Response of Tunnel Structures

The evaluation procedures for transverse response of tunnel structures can be based on either (1) simplified analytical method, or (2) more complex numerical modeling approach, depending on the degree of complexity of the soil-structure system, subsurface conditions, the seismic hazard level, and the importance of the structures. The numerical modeling approach should be considered in cases where simplified analysis methods are less applicable, more uncertain, or inconclusive, or where a very important structure is located in a severe seismic environment or where case history data indicate relatively higher seismic vulnerability for the type of tunnel, such as rectangular cut-and-cover tunnels in seismically active areas. The numerical modeling approach is further discussed in Section 13.5.1.4.

#### 13.5.1.1 Simplified Procedure for Ovaling Response of Circular Tunnels

This section provides methods for quantifying the seismic ovaling effect on circular tunnel linings. The conventionally used simplified free-field deformation method, discussed first, ignores the soil-structure interaction effects. Therefore its use is limited to conditions where the tunnel structures can be reasonably assumed to deform according to the free-field displacements during earthquakes.

A refined method is then presented in Section 13.5.1.2 that is equally simple but capable of eliminating the drawbacks associated with the free-field deformation method. This refined method - built from a theory that is familiar to most mining/underground engineers - considers the soil-structure interaction effects. Based on this method, a series of design charts are developed to facilitate the design process.

**Ovaling Effect:** As mentioned earlier, ovaling of a circular tunnel lining is primarily caused by seismic waves propagating in planes perpendicular to the tunnel axis. The results are cycles of additional stress concentrations with alternating compressive and tensile stresses in the tunnel lining. These dynamic stresses are superimposed on the existing static state of stress in the lining. Several critical modes may result (Owen and Scholl, 1981):

- Compressive dynamic stresses added to the compressive static stresses may exceed the compressive capacity of the lining locally.
- Tensile dynamic stresses subtracted from the compressive static stresses reduce the lining's moment capacity, and sometimes the resulting stresses may be tensile.

**Free-Field Shear Deformations:** As mentioned previously, the shear distortion of ground caused by vertically propagating shear waves is probably the most critical and predominant mode of seismic motions. It causes a circular tunnel to oval and a rectangular underground structure to rack (sideways motion), as shown in Figure 13-13. Analytical procedures by numerical methods are often required to arrive at a reasonable estimate of the free-field shear distortion, particularly for a soil site with variable stratigraphy. Many computer codes with variable degree of sophistication are available (e.g., SHAKE, FLUSH, FLAC, PLAXIS, et al.). The most widely used approach is to simplify the site geology into a horizontally layered system and to derive a solution using one-dimensional wave propagation theory (Schnabel, Lysmer, and Seed, 1972). The resulting free-field shear distortion of the ground from this type of analysis can be expressed as a shear strain distribution or shear deformation profile versus depth.

For a deep tunnel located in relatively homogeneous soil or rock and in the absence of detailed site response analyses, the simplified procedure by Newmark (1968) and Hendron (1985) may provide a reasonable estimate, noting, however, that this method tends to produce more conservative results particularly when the effect of ground motion attenuation with depth (refer to Table 13-1) is ignored. Here, the maximum free-field shear strain,  $\gamma_{\max}$ , can be expressed as

$$\gamma_{\max} = \frac{V_s}{C_{se}} \quad 13-3$$

Where:

- $V_s$  = Peak particle velocity
- $C_{se}$  = Effective shear wave propagation velocity

The effective shear wave velocity of the vertically propagating shear wave,  $C_{se}$ , should be compatible with the level of the shear strain that may develop in the ground at the elevation of the tunnel under the design earthquake shaking. The values of  $C_{se}$  can be estimated by making proper reduction (to account for the strain-level dependent effect) from the small-strain shear wave velocity,  $C_s$ , obtained from in-situ testing (such as using the cross-hole, down-hole, and P-S logging techniques). For rock, the ratio of  $C_{se}/C_s$  can be assumed equal to 1.0. For stiff to very stiff soil,  $C_{se}/C_s$  may range from 0.6 to 0.9. Alternatively, site specific response analyses can be performed for estimating  $C_{se}$ . Site specific response analyses should be performed for estimating  $C_{se}$  for tunnels embedded in soft soils

An equation relating the effective propagation velocity of shear waves to effective shear modulus,  $G_m$ , is expressed as:

$$C_{se} = \sqrt{\frac{G_m}{\rho}} \quad 13-4$$

Where:

- $\rho$  = Mass density of the ground

An alternative simplified method for calculating the free-field ground shear strain,  $\gamma_{\max}$ , is by dividing the earthquake-induced shear stresses ( $\tau_{\max}$ ) by the shear stiffness (i.e., the strain-compatible effective shear modulus,  $G_m$ ). This method is especially suitable for tunnels with shallow burial depths.



In this simplified method the maximum free-field ground shear strain is calculated using the following equation:

$$\gamma_{\max} = \frac{\tau_{\max}}{G_m} \quad 13-5$$

$$\tau_{\max} = (\text{PGA}/g) \sigma_v R_d \quad 13-6$$

$$\sigma_v = \gamma_t (H+D) \quad 13-7$$

Where:

- $G_m$  = Effective strain-compatible shear modulus of ground surrounding tunnel (ksf)
- $\tau_{\max}$  = Maximum earthquake-induced shear stress (ksf)
- $\sigma_v$  = Total vertical soil overburden pressure at invert elevation of tunnel (ksf)
- $\gamma_t$  = Total soil unit weight (kcf)
- $H$  = Soil cover thickness measured from ground surface to tunnel crown (ft)
- $D$  = Height of tunnel (or diameter of circular tunnel) (ft)
- $R_d$  = Depth dependent stress reduction factor; can be estimated using the following relationships:

$$\begin{aligned} R_d &= 1.0 - 0.00233z && \text{for } z < 30 \text{ ft} \\ R_d &= 1.174 - 0.00814z && \text{for } 30 \text{ ft} < z < 75 \text{ ft} \\ R_d &= 0.744 - 0.00244z && \text{for } 75 \text{ ft} < z < 100 \text{ ft} \\ R_d &= 0.5 && \text{for } z > 100 \text{ ft} \end{aligned}$$

Where:

$z$  = the depth (ft) from ground surface to the invert elevation of the tunnel and is represented by  $z = (H+D)$ .

Lining Conforming to Free-Field Shear Deformations: When a circular lining is assumed to oval in accordance with the deformations imposed by the surrounding ground (e.g., shear), the lining's transverse sectional stiffness is completely ignored. This assumption is probably reasonable for most circular tunnels in rock and in stiff soils, because the lining stiffness against distortion is low compared with that of the surrounding medium. Depending on the definition of "ground deformation of surrounding medium," however, a design based on this assumption may be overly conservative in some cases and non-conservative in others. This will be discussed further below.

Shear distortion of the surrounding ground, for this discussion, can be defined in two ways. If the non-perforated ground in the free-field is used to derive the shear distortion surrounding the tunnel lining, the lining is to be designed to conform to the maximum diameter change,  $\Delta D_{\text{free-field}}$ , shown in the top of Figure 13-15.

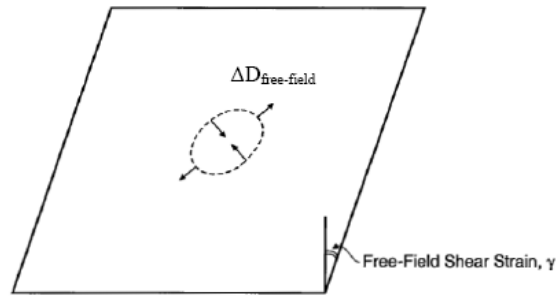

**Free-Field Shear Distortion of Ground  
(Non-Perforated Medium)**

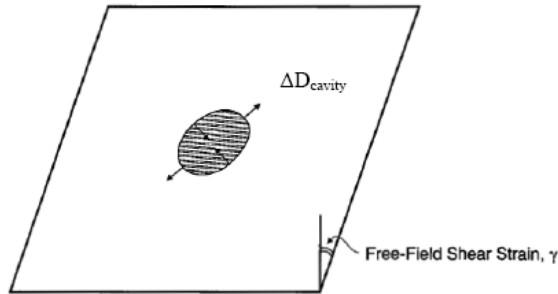

**Shear Distortion of Perforated Ground  
(Cavity in-Place)**

Figure 13-15 Shear Distortion of Ground – Free-Field Condition vs Cavity In-Place Condition

The maximum diametric change of the lining for this case can be derived as:

$$\Delta D_{free - field} = \pm(\gamma_{max} / 2)D \quad 13-8$$

Where:

- D = the diameter of the tunnel
- $\gamma_{max}$  = the maximum free-field shear strain

On the other hand, if the ground deformation is derived by assuming the presence of a cavity due to tunnel excavation (bottom of Figure 13-15, for perforated ground), then the lining is to be designed according to the diametric strain expressed as:

$$\Delta D_{cavity} = \pm 2\gamma_{max} (1 - \nu_m)D \quad 13-9$$

Where:

- $\nu_m$  = the Poisson's Ratio of the medium

Equations 13-8 and 13-9 both assume the absence of the lining. In other words, tunnel-ground interaction is ignored.

Comparison between Equations 13-8 and 13-9 shows that the perforated ground deformation would yield a much greater distortion than the free-field case (non-perforated ground). For a typical ground medium, the difference could be as much as three times. Based on the assumptions made, some preliminary conclusions can be drawn as follows:

- Equation 13-9, for the perforated ground deformation, should provide a reasonable estimate for the deformation of a lining that has little stiffness (against distortion) in comparison to that of the medium.
- Equation 13-8, for the free-field ground deformation, on the other hand, should provide a reasonable result for a lining with a distortion stiffness close or equal to the surrounding medium.

Based on the discussions above, it can be further suggested that a lining with a greater distortion stiffness than the surrounding medium should experience a lining distortion even less than the free-field deformation. This latest case may occur when a tunnel is built in soft to very soft soils. It is therefore clear that the relative stiffness between the tunnel and the surrounding ground (i.e., soil-structure interaction effect) plays an important role in quantifying tunnel response during the seismic loading condition. This effect will be discussed next.

Importance of Lining Stiffness- Compressibility and Flexibility Ratios: To quantify the relative stiffness between a circular lining and the medium, two ratios designated as the compressibility ratio,  $C$ , and the flexibility ratio,  $F$  (Hoeg, 1968, and Peck et al., 1972) are defined by the following equations:

Compressibility Ratio:

$$C = \frac{E_m (1 - \nu_l^2) R_l}{E_l t (1 + \nu_m) (1 - 2\nu_m)} \quad 13-10$$

Flexibility Ratio:

$$F = \frac{E_m (1 - \nu_l^2) R_l^3}{6E_l I_{l,1} (1 + \nu_m)} \quad 13-11$$

Where:

- $E_m$  = Strain-compatible elastic modulus of the surrounding ground
- $\nu_m$  = Poisson's ratio of the surrounding ground
- $R_l$  = Nominal radius of the tunnel lining
- $\nu_l$  = Poisson's ratio of the tunnel Lining
- $I_{l,1}$  = Moment of inertia of lining per unit width of tunnel along the tunnel axis.
- $t_l$  = The thickness of the lining

Of these two ratios, it often has been suggested that the flexibility ratio is the more important because it is related to the ability of the lining to resist distortion imposed by the ground. As will be discussed later, the compressibility ratio also has a significant effect on the lining thrust response.

For most circular tunnels encountered in practice, the flexibility ratio,  $F$ , is likely to be large enough (say,  $F > 20$ ) so that the tunnel-ground interaction effect can be ignored (Peck, 1972). It is to be noted that  $F > 20$  suggests that the ground is about 20 times stiffer than the lining. In these cases, the distortions to be experienced by the lining can be reasonably assumed to be equal to those of the perforated ground (i.e.,  $\Delta D_{\text{cavity}}$ ).

This rule of thumb procedure may present some design problems when a very stiff structure is surrounded by a very soft soil. A typical example would be to construct a very stiff immersed tube in a soft lake or river bed deposit. In this case the flexibility ratio is very low, and the stiff tunnel lining could not be realistically designed to conform to the deformations imposed by the soft ground. The tunnel-ground interaction effect must be considered in this case to achieve a more efficient design.

In the following section a refined procedure taking into account the tunnel-ground interaction effect is presented to provide a more accurate assessment of the seismic ovaling effect on a circular lining.

### 13.5.1.2 Analytical Lining-Ground Interaction Solutions for Ovaling Response of Circular Tunnels

Closed form analytical solutions have been proposed (Wang, 1993) for estimating ground-structure interaction for circular tunnels under the seismic loading conditions. These solutions are generally based on the assumptions that:

- The ground is an infinite, elastic, homogeneous, isotropic medium.
- The circular lining is generally an elastic, thin walled tube under plane strain conditions.
- Full-slip or no-slip conditions exist along the interface between the ground and the lining.

The expressions of these lining responses are functions of flexibility ratio and compressibility ratio as presented previously in Equations 13-10 and 13-11. The expressions for maximum thrust,  $T_{\text{max}}$ , bending moment,  $M_{\text{max}}$ , and diametric strain,  $\Delta D/D$ , can be presented in the following forms:

$$M_{\text{max}} = \pm \frac{1}{6} K_1 \frac{E_m}{(1 + \nu_m)} R_l^2 \gamma_{\text{max}} \quad 13-12$$

$$T_{\text{max}} = \pm K_2 \frac{E_m}{2(1 + \nu_m)} R_l \gamma_{\text{max}} \quad 13-13$$

$$\Delta D_{\text{max}}/D = \pm \frac{1}{3} K_1 F \gamma_{\text{max}} \quad 13-14$$

$$K_1 = \frac{12(1 - \nu_m)}{2F + 5 - 6\nu_m} \quad 13-15$$

$$K_2 = 1 + \frac{F[(1 - 2\nu_m) - (1 - 2\nu_m)C] - \frac{1}{2}(1 - 2\nu_m)^2 C + 2}{F[(3 - 2\nu_m) + (1 - 2\nu_m)C] + C[\frac{5}{2} - 8\nu_m + 6\nu_m^2] + 6 - 8\nu_m} \quad 13-16$$

$K_1$  and  $K_2$  are defined herein as lining response coefficients. The earthquake loading parameter is represented by the maximum shear strain induced in the ground (free-field),  $\gamma_{\max}$ , which may be obtained through a simplified approach (such as Equation 13-15 or 13-16), or by performing a site-response analysis.

The resulting bending moment induced maximum fiber strain,  $\varepsilon_m$ , and the axial force (i.e., thrust) induced strain,  $\varepsilon_T$ , can be derived as follows:

$$\varepsilon_m = \pm \frac{1}{6} K_1 \frac{E_m}{(1 + \nu_m)} R_l^2 \frac{\gamma_{\max} t_l}{2E_l I_l} \quad 13-17$$

$$\varepsilon_T = \pm K_2 \frac{E_m}{2(1 + \nu_m)} R_l \frac{\gamma_{\max}}{E_l t_l} \quad 13-18$$

To ease the design process, Figure 13-16 shows the lining response coefficient,  $K_1$ , as a function of flexibility ratio and Poisson's Ratio of the ground. The design charts showing the lining coefficient  $K_2$ , primarily used for the thrust response evaluation, are presented in Figure 13-17, Figure 13-18, and Figure 13-19 for Poisson's Ratio values of 0.2, 0.35 and 0.5, respectively.

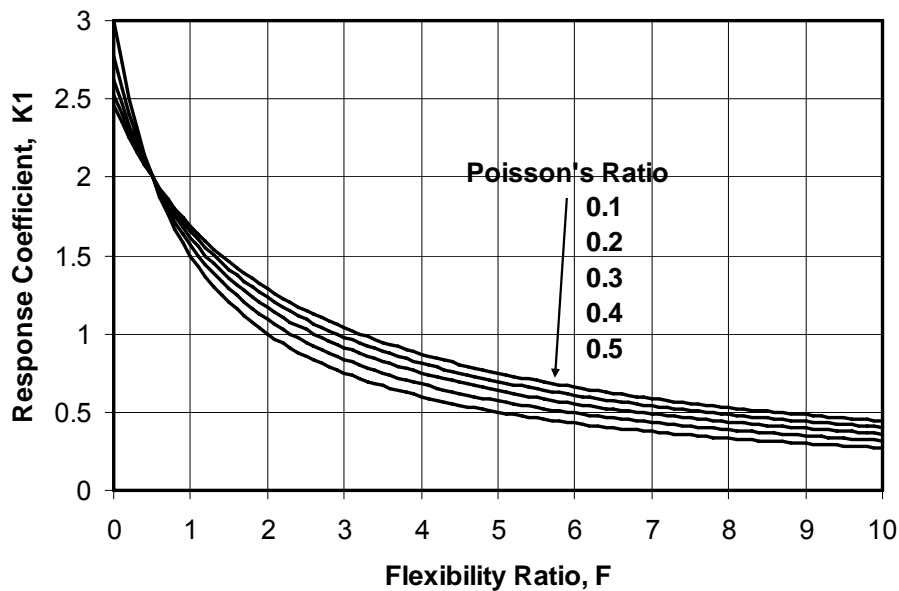

Figure 13-16 Lining Response Coefficient,  $K_1$  (Full-Slip Interface Condition)

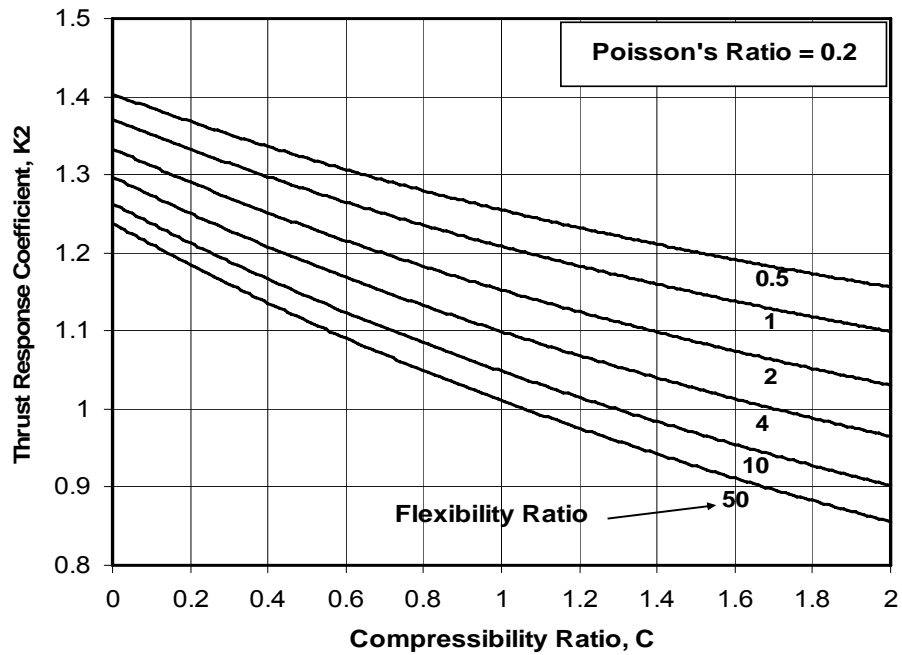

Figure 13-17 Lining Response Coefficient,  $K_2$ , for Poisson's Ratio = 0.2 (No-Slip Interface Condition)

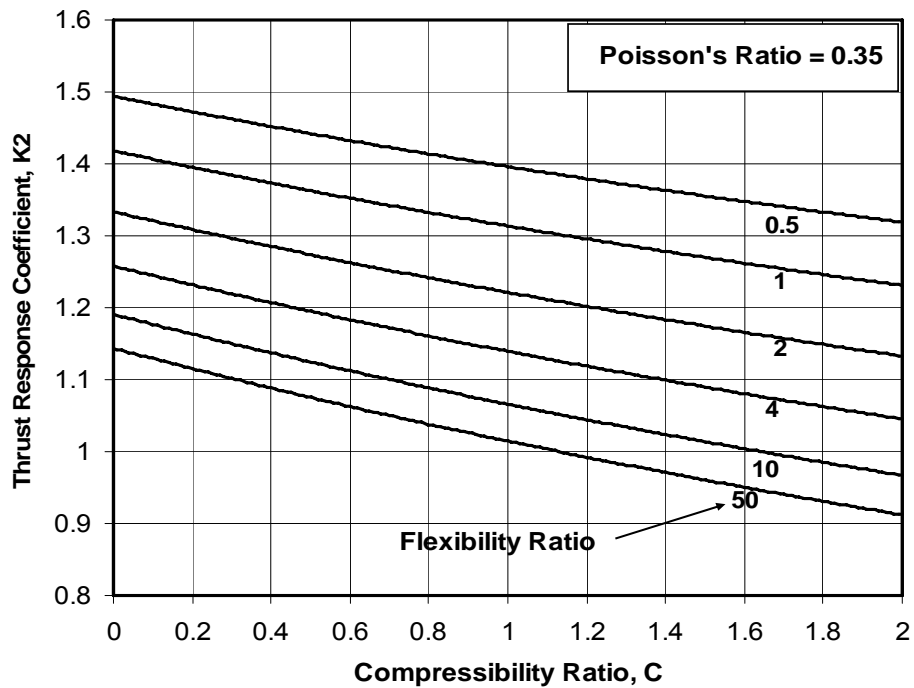

Figure 13-18 Lining Response Coefficient,  $K_2$ , for Poisson's Ratio = 0.35 (No-Slip Interface Condition)

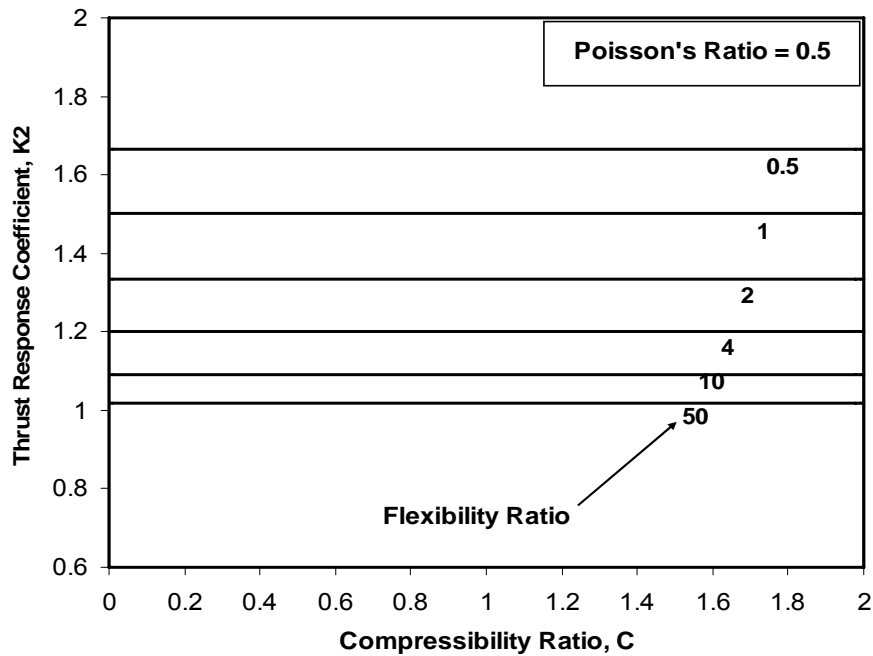

Figure 13-19 Lining Response Coefficient,  $K_2$ , for Poisson's Ratio = 0.5 (No-Slip Interface Condition)

It should be noted that the solutions in terms of  $M_{max}$ ,  $\Delta D_{max}$ , and  $\epsilon_m$  provided herein are based on the full-slip interface assumption. For the maximum thrust response  $T_{max}$  the interface conditions is assumed to be no-slip. These assumptions were adopted because full-slip condition produces more conservative results for  $M_{max}$  and  $\Delta D_{max}$ , while no-slip condition is more conservative for  $T_{max}$ . During an earthquake, in general, slip at interface is a possibility only for tunnels in soft soils, or when seismic loading intensity is severe. For most tunnels, the condition at the interface is between full-slip and no-slip. In computing the forces and deformations in the lining, it is prudent to investigate both cases and the more critical one should be used in design.

The conservatism described above is desirable to offset the potential underestimation of lining forces resulting from the use of equivalent static model in lieu of the dynamic loading condition. Previous studies suggest that a true dynamic solution would yield results that are 10 to 15 percent greater than an equivalent static solution, provided that the seismic wavelength is at least about 8 times greater than the width of the excavation (cavity). Therefore, the full-slip model is recommended in evaluating the moment and deflection response (i.e., Figure 13-16 and Equation 13-15) of a circular tunnel lining.

Using the full-slip condition, however, would significantly underestimate the maximum thrust,  $T_{max}$ , under the seismic simple shear condition. Therefore, it is recommended that the no-slip interface assumption be used in assessing the lining thrust response (Equation 13-16).

**Effective Lining Stiffness:** The results presented above are based on the assumption that the lining is a monolithic and continuous circular ring with intact, elastic properties. Many circular tunnels are constructed with bolted or unbolted segmental lining. Besides, a concrete lining subjected to bending and thrust often cracks and behaves in a nonlinear fashion. Therefore, in applying the results presented herewith, the effective (or, equivalent) stiffness of the lining should be used. Some simple and approximate methods accounting for the effect of joints on lining stiffness can be found in the literature

- Monsees and Hansmire (1992) suggested the use of an effective lining stiffness that is one-half of the stiffness for the full lining section.
- Analytical studies by Paul, et al., (1983) suggested that the effective stiffness be from 30 to 95 percent of the intact, full-section lining.
- Muir Wood (1975) and Lyons (1978) examined the effects of joints in precast concrete segmental linings and showed that for a lining with “n” segments, the effective stiffness of the ring was:

$$I_e = I_j + \left(\frac{4}{n}\right)^2 I \quad 13-19$$

Where:

- $I_e < I$  and  $n > 4$
- $I$  = Lining stiffness of the intact, full-section
- $I_j$  = Effective stiffness of lining at joint
- $I_e$  = Effective stiffness of lining

### 13.5.1.3 Analytical Lining-Ground Interaction Solutions for Racking Response of Rectangular Tunnels

General: Shallow depth transportation tunnels are often of rectangular shape and are often built using the cut-and-cover method. Usually the tunnel is designed as a rigid frame box structure. From the seismic design standpoint, these box structures have some characteristics that are different from those of the bored circular tunnels, besides the geometrical aspects. The implications of three of these characteristics for seismic design are discussed below.

First, cut-and-cover tunnels are generally built at shallow depths in soils where seismic ground deformations and the shaking intensity tend to be greater than at deeper locations, due to the lower stiffness of the soils and the site amplification effect. As discussed earlier, past tunnel performance data suggest that tunnels built with shallow soil overburden cover tend to be more vulnerable to earthquakes than deep ones.

Second, a box frame usually does not transmit the static loads as efficiently as a circular lining, resulting in much thicker walls and slabs for the box frame. As a result, a rectangular tunnel structure is usually stiffer than a circular tunnel lining in the transverse direction and less tolerant to distortion. This characteristic, along with the potential large seismic ground deformations that are typical for shallow soil deposits, makes the soil-structure interaction effect particularly important for the seismic design of cut-and-cover rectangular tunnels, including those built with the sunken/immersed tube method.

Third, typically soil is backfilled above the structure and possibly between the in-situ medium and the structure. Often, the backfill soil may consist of compacted material having different properties than the in-situ soil. The properties of the backfill soil as well as the in-situ medium should be properly accounted for in the design and analysis. The effect of backfill, however, cannot be accounted for using analytical closed-form solutions. Instead, more complex numerical analysis is required for solving this problem if the effect of backfill is considered significant in evaluating seismic response of a cut-and-cover tunnel.



The evaluation procedures presented in this section are based on simplified analytical method. The more refined numerical modeling approach is discussed in Section 13.5.1.4.

Racking Effect: During earthquakes a rectangular box structure in soil or in rock will experience transverse racking deformations (sideways motion) due to the shear distortions of the ground, in a manner similar to the ovaling of a circular tunnel discussed in Section 13.5.1.1. The racking effect on the structure is similar to that of an unbalanced loading condition.

The external forces the structure is subjected to are in the form of shear stresses and normal pressures all around the exterior surfaces of the box. The magnitude and distribution of these external earth forces are complex and difficult to assess. The end results, however, are cycles of additional internal forces and stresses with alternating direction in the structure members. These dynamic forces and stresses are superimposed on the existing static state of stress in the structure members. For rigid frame box structures, the most critical mode of potential damage due to the racking effect is the distress at the top and bottom joints (refer to Figure 13-1, Figure 13-11, Figure 13-12 and Figure 13-13).

Realizing that the overall effect of the seismically induced external earth loading is to cause the structure to rack, it is more reasonable to approach the problem by specifying the loading in terms of deformations. The structure design goal, therefore, is to ensure that the structure can adequately absorb the imposed racking deformation (i.e., the deformation method), rather than using a criterion of resisting a specified dynamic earth pressure (i.e., the force method). The focus of the remaining sections of this chapter, therefore, is on the method based on seismic racking deformations.

Free-Field Racking Deformation Method It has been proposed in the past that a rectangular tunnel structure be designed by assuming that the amount of racking imposed on the structure is equal to the “free-field” shear distortions of the surrounding medium, as illustrated in Figure 13-20 (i.e.,  $\Delta_{\text{free-field}} = \Delta_s$ ). The racking stiffness of the structure is ignored with this assumption.

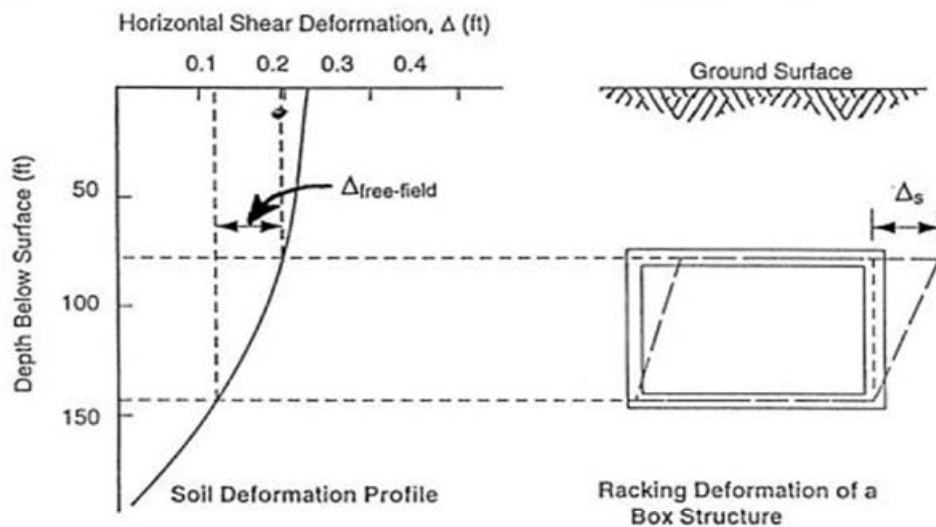

Figure 13-20 Soil Deformation Profile and Racking Deformation of a Box Structure

The free-field deformation method serves as a simple and effective design tool when the seismically induced ground distortion is small, for example when the shaking intensity is low or the ground is very stiff. Given these conditions, most practical structural configurations can easily absorb the ground

distortion without being distressed. The method is also a realistic one when the racking stiffness of the structure is comparable to that of its surrounding medium.

It has been reported (Wang, 1993), however, that this simple procedure could lead to overly conservative design (i.e., when  $\Delta_{\text{free-field}} > \Delta_s$ ) or un-conservative design (i.e., when  $\Delta_{\text{free-field}} < \Delta_s$ ), depending on the relative stiffness between the ground and the structure. The overly conservative cases generally occur in soft soils. Seismically induced free-field ground distortions are generally large in soft soils, particularly when they are subjected to amplification effects. Ironically, rectangular box structures in soft soils are generally designed with stiff configurations to resist the static loads, making them less tolerant to racking distortions. Imposing free-field deformations on a structure in this situation is likely to result in unnecessary conservatism, as the stiff structure may deform less than the soft ground.

On the other hand, the un-conservative cases arise when the shear stiffness of the ground is greater than the racking stiffness of the structures – a behavior similar to that described for the ovaling of circular tunnel (Section 13.5.1.1). To more accurately quantify the racking response of rectangular tunnel structures a rational procedure accounting for the tunnel-ground interaction effect is presented in the following section.

Tunnel-Ground Interaction Analysis: Although closed-form solutions accounting for soil-structure interaction, such as those presented in Section 13.5.1.1, are available for deep circular lined tunnels, they are not readily available for rectangular tunnels due primarily to the highly variable geometrical characteristics typically associated with rectangular tunnels. Complex earthquake induced stress-strain conditions is another reason as most of the rectangular tunnels are built using the cut-and-cover method at shallow depths, where seismically induced ground distortions and stresses change significantly with depth.

To develop a simple and practical design procedure, Wang (1993) performed a series of dynamic soil-structure interaction finite element analyses. In this study, the main factors that may potentially affect the dynamic racking response of rectangular tunnel structures were investigated. These factors include:

- **Relative Stiffness between Soil and Structure.** Based on results derived for circular tunnels (see 13.5.1.1), it was anticipated that the relative stiffness between soil and structure is the dominating factor governing the soil/structure interaction. A series of analyses using ground profiles with varying properties and structures with varying racking stiffness was conducted for parametric study purpose. A special case where a tunnel structure is resting directly on stiff foundation materials (e.g., rock) was also investigated.
- **Structure Geometry.** Five different types of rectangular structure geometry were studied, including one-barrel, one-over-one two-barrel, and one-by-one twin-barrel tunnel structures.
- **Input Earthquake Motions.** Two distinctly different time-history accelerograms were used as input earthquake excitations.
- **Tunnel Embedment Depth.** Most cut-and-cover tunnels are built at shallow depths. Various embedment depths were used to evaluate the effect of the embedment depth effect.

A total number of 36 dynamic finite element analyses were carried out to account for the variables discussed above. Based on the results of the analyses, a simplified procedure incorporating soil-structure interaction for the racking analysis of rectangular tunnels was developed. The step-by-step procedure is outlined below (Wang, 1993).

Step 1: Estimate the free-field ground strains  $\gamma_{\max}$  (at the structure elevation) caused by the vertically propagating shear waves of the design earthquakes, see Section 13.5.1.1 in deriving the free-field ground strain using various methods. Determine  $\Delta_{\text{free-field}}$ , the differential free-field relative displacements corresponding to the top and the bottom elevations of the box structure (see Figure 13-20) by using the following expression:

$$\Delta_{\text{free-field}} = H \cdot \gamma_{\max} \quad 13-20$$

Where:

H = height of the box structure

Alternatively site-specific site response analysis may be performed to provide a more accurate assessment of  $\Delta_{\text{free-field}}$ . Site-specific site response analysis is recommended for tunnels embedded in soft soils.

Step 2: Determine the racking stiffness,  $K_s$ , of the box structure from a structural frame analysis. The racking stiffness should be computed using the displacement of the roof subjected to a unit lateral force applied at the roof level, while the base of the structure is restrained against translation, but with the joints free to rotate. The ratio of the applied force to the resulting lateral displacement yields  $K_s$ . In performing the structural frame analysis, appropriate moment of inertia values, taking into account the potential development of cracked section, should be used.

Step 3: Determine the flexibility ratio,  $F_r$ , of the box structure using the following equation:

$$F_r = (G_m / K_s) \cdot (W/H) \quad 13-21$$

Where:

W = Width of the box structure  
H = Height of the box structure  
 $G_m$  = Average strain-compatible shear modulus of the surrounding ground between the top and bottom elevation of the structure  
 $K_s$  = Racking Stiffness of the box structure

The strain-compatible shear modulus can be derived from the strain-compatible effective shear wave velocity,  $C_{se}$ , see Equation 13-4).

Detailed derivation of the flexibility ratio,  $F_r$ , is given by Wang (1993).

Step 4: Based on the flexibility ratio obtained from Step 3 above, determine the racking coefficient,  $R_r$ , for the proposed structure. The racking coefficient,  $R_r$ , is the ratio of the racking distortion of the structure embedded in the soil,  $\Delta_s$ , to that of the free-field soil,  $\Delta_{\text{free-field}}$ , over the height of the structure (see Figure 13-20):

$$R_r = \Delta_s / \Delta_{\text{free-field}} \quad 13-22$$

From a series of dynamic finite element analyses, Wang (1993) presented results showing the relationship between the structure racking and the flexibility ratio,  $F_r$ . The values of  $R_r$  vs.  $F_r$  obtained from the dynamic finite element analyses are shown in Figure 13-21(a) and Figure 13-21(b). Also shown in these figures are curves from closed-form static solutions for circular tunnels (refer to Section 13.5.1.1). The solutions shown in the figures are from the full-slip solution presented by Wang (1993) and Penzien

(2000) and the no-slip solution presented by Penzien (2000). As can be seen in the figures, the curves from the closed-form solutions provide a good approximation of the finite element analysis results. These curves can therefore be used to provide a good estimate of the racking of a rectangular tunnel as a function of the flexibility ratio defined by Equation 13-21. The analytical expressions for the curves in Figure 13-21 are:

For no-slip interface condition:

$$R_r = \frac{4(1 - \nu_m)F_r}{3 - 4\nu_m + F_r} \quad 13-23$$

For full-slip interface condition:

$$R_r = \frac{4(1 - \nu_m)F_r}{2.5 - 3\nu_m + F_r} \quad 13-24$$

Several observations can be made from Figure 13-21. When  $F_r$  is equal to zero, the structure is perfectly rigid, no racking distortion is induced, and the structure moves as a rigid body during earthquake loading. When  $F_r$  is equal to 1, the racking distortion of the structure is approximately the same as that of the soil (exactly equal to that of the soil for the no-slip interface condition). For a structure that is flexible relative to the surrounding ground, ( $F_r > 1$ ), racking distortion of the structure is greater than that of the free-field. As noted by Penzien (2000), if the structure has no stiffness (i.e.,  $F_r \rightarrow \infty$ ),  $R_r$  is approximately equal to  $4(1 - \nu_m)$ , which is the case of an unlined cavity.

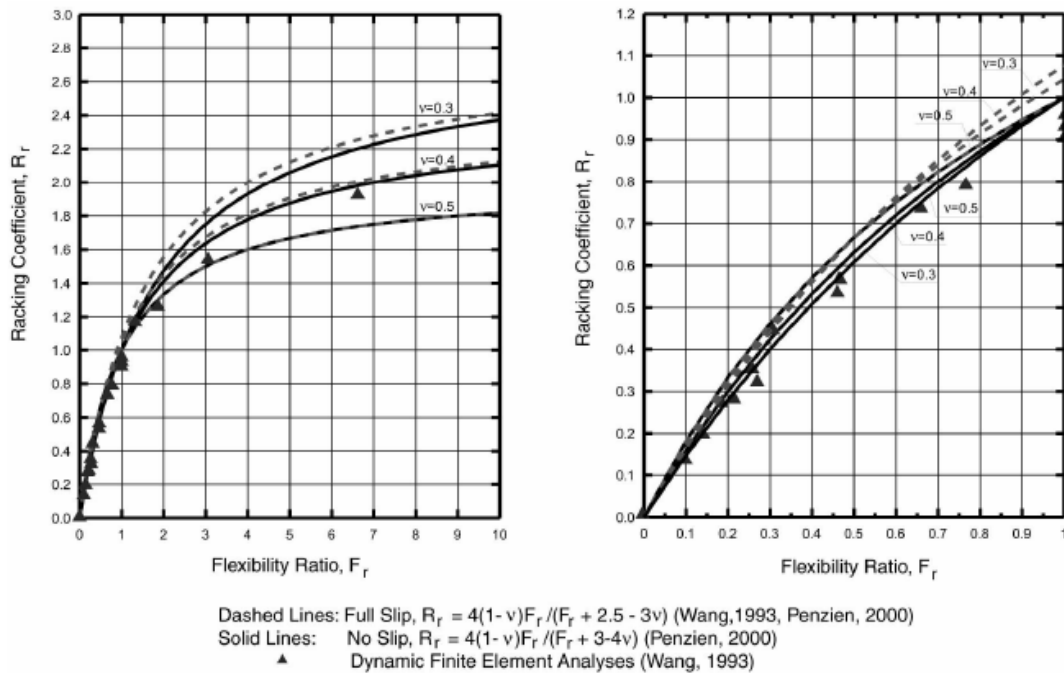

a. Flexibility Ratios Between 0.0 and 10

b. Flexibility Ratios Between 0.0 and 1.0

Figure 13-21 Racking Coefficient  $R_r$  for Rectangular Tunnels (MCEER-06-SP11, Modified from Wang, 1993, and Penzien, 2000)

Step 5: Determine the racking deformation of the structure,  $\Delta_s$ , using the following relationship:

$$\Delta_s = R_r \cdot \Delta_{free-field}$$

Step 6: The seismic demand in terms of internal forces as well as material strains are calculated by imposing  $\Delta_s$  upon the structure in a frame analysis as depicted in Figure 13-22 (MCEER-06-SP11). Results of the analysis can also be used to determine the detailing requirements.

As indicated in Figure 13-22, two pseudo-static lateral force models are recommended. The more critical responses from the two models should be used for design. If the displacements are large enough to cause inelastic deformation of the structure, inelastic soil-structure interaction analyses should be performed to assess structural behavior and ensure adequate strength and displacement capacity of the tunnel structure.

Under the loading from the design earthquake, inelastic deformation in the structure may be allowed depending on the performance criteria and provided that overall stability of the tunnel is maintained. Detailing of the structural members and joints should provide for adequate internal strength, and ductility and energy absorption capability if inelastic deformation is anticipated.

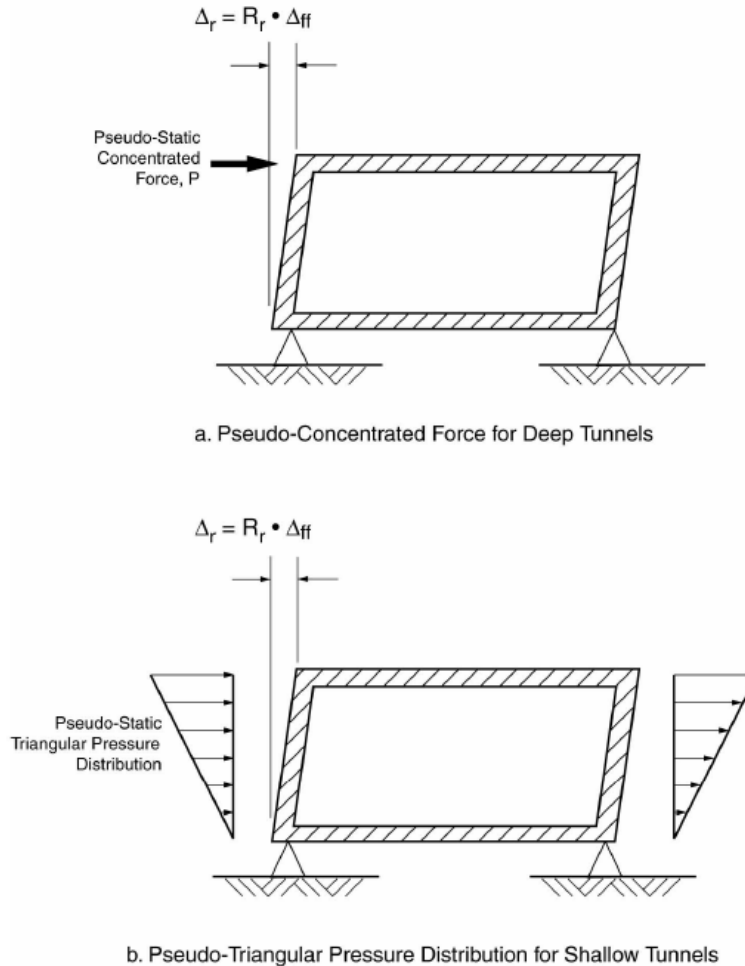

Figure 13-22 Simplified Racking Frame Analysis of a Rectangular Tunnel (MCEER-06-SP11, Modified from Wang, 1993)

Step 7: The effects of vertical seismic motions can be accounted for by applying a vertical pseudo-static loading, equivalent to the product of the vertical seismic coefficient and the combined dead and design overburden loads used in static design. The vertical seismic coefficient can be reasonably assumed to be two-thirds of the design peak horizontal acceleration divided by the gravity. This vertical pseudo-static loading should be applied by considering both up and down direction of motions, whichever results in a more critical load case should govern.

Step 8: Seismic demands due to racking deformations and vertical seismic motions are then combined with non-seismic loads using appropriate load combinations. A load factor of 1.0 is recommended in the load combination criteria.

#### **13.5.1.4 Numerical Modeling Approach**

The analytical solutions presented in Sections 13.5.1.2 and 13.5.1.3 for transverse response of tunnel structures (i.e., ovaling for circular tunnels and racking for rectangular tunnels) have been developed based on ideal conditions and assumptions as follows:

- The tunnel is of completely circular shape for ovaling response or rectangular shape for racking response.
- The material surrounding the tunnel is uniform and isotropic.
- The tunnel is very deep, away from the surface so that no reflection/refraction of seismic wave from the ground surface.
- Only one single tunnel is considered. There is no interaction from other tunnel(s) or structure(s) in proximity.

The actual soil-structure system encountered in the field for underground structures are more complex than the ideal conditions described above and may require the use of numerical methods. This is particularly true in cases where a very important tunnel structure is located in a severe seismic environment.

For transverse ovaling/racking analysis, two-dimensional finite element or finite difference continuum method of analysis is generally considered adequate numerical modeling approach. The model needs to be developed with the capability of capturing SSI effects as well as appropriate depth-variable representations of the earth medium and the associated free-field motions (or ground deformations) obtained from site-response analyses of representative soil profiles.

There are three types of two-dimensional continuum method of analysis that have been used in engineering practice and they are described in the following sections.

Pseudo-Static Seismic Coefficient Deformation Method: In pseudo-static seismic coefficient deformation method, the ground deformations are generated (induced) by seismic coefficients and distributed in the finite element/finite difference domain that is being analyzed. The seismic coefficients can be derived from a separate one-dimensional, free-field site response analysis.

The pseudo-static seismic coefficient deformation method is suitable for underground structures buried at shallow depths. The general procedure in using this method is outlined below:

- Perform one-dimensional free-field site response analysis (e.g., using SHAKE program). From the results of the analysis derive the maximum ground acceleration profile expressed as a function of depth from the ground surface.
- Develop the two-dimensional finite element (or finite difference) continuum model incorporating the entire excavation and soil-structure system, making sure the lateral extent of the domain (i.e., the horizontal distance to the side boundaries) is sufficiently far to avoid boundary effects. The geologic medium (e.g., soil) is modeled as continuum solid elements and the structure can be model either as continuum solid elements or frame elements. The side boundary conditions should be in such a manner that all horizontal displacements at the side boundaries are free to move and vertical displacements are prevented (i.e., fixed boundary condition in the vertical direction and free boundary condition in the horizontal direction). These side boundary conditions are considered adequate for a site with reasonably leveled ground surface subject to lateral shearing displacements due to horizontal excitations.
- The strain-compatible shear moduli of the soil strata computed from the one-dimensional site response analysis should be used in the two-dimensional continuum model.
- The maximum ground acceleration profile (expressed as a function of depth from the ground surface) derived from the one-dimensional site response analysis is applied to the entire soil-structure system in the horizontal direction in a pseudo-static manner.
- The analysis is executed with the tunnel structure in place using the prescribed horizontal maximum acceleration profile and the strain-compatible shear moduli in the soil mass. It should be noted that this pseudo-static seismic coefficient approach is not a dynamic analysis and therefore does not involve displacement, velocity, or acceleration histories. Instead, it imposes ground shearing displacements throughout the entire soil-structure system (i.e., the two-dimensional continuum model) by applying pseudo-static horizontal shearing stresses in the ground. The pseudo-static horizontal shearing stresses increase with depth and are computed by analysis as the product of the total soil overburden pressures (representing the soil mass) and the horizontal seismic coefficients. The seismic coefficients represent the peak horizontal acceleration profile derived from the one-dimensional free-field site response analysis. The lateral extent of the domain in the two-dimension analysis system should be sufficiently far to avoid boundary effects. In this manner, the displacement profiles at the two side boundaries are expected to be very similar to that derived from the one-dimensional free-field site response analysis. However, in the focus area near the tunnel construction the displacement distribution will be different from that of the free field, reflecting the effects of soil-structure interaction (i.e., presence of the tunnel structure) as well as the effect that portion of the earth mass is removed for constructing the tunnel (i.e., a void in the ground).

Pseudo-Dynamic Time-History Analysis The procedure employed in pseudo-dynamic analysis is similar to that for the pseudo-static seismic coefficient deformation method, except that the derivation of the ground displacements and the manner in which the displacements are imposed to the two dimension continuum system are different. The pseudo-dynamic analysis consists of stepping the soil-structure system *statically* through displacement time-history simulations of free-field displacements obtained by a site response analysis performed using vertically propagating shear waves (e.g., SHAKE analyses). Under the pseudo-dynamic loading, the transverse section of a tunnel structure will be subject to these induced ground distortions. Figure 13-23 shows an example of a two-dimensional continuum finite element analysis performed for an immersed tube tunnel structure subject to static stepping of a pseudo-dynamic displacement time history. In this model both the geologic medium (e.g., soil) and the tunnel structure were modeled as continuum solid elements. As indicated in the figure, in addition to the natural in-situ soils, the model can also consider the effect of the backfill material (within the dredged trench) on the ovaling/racking response of the tunnel structure. If warranted, the inelastic behavior of the tunnel structure can also be accounted for and incorporated into the model.

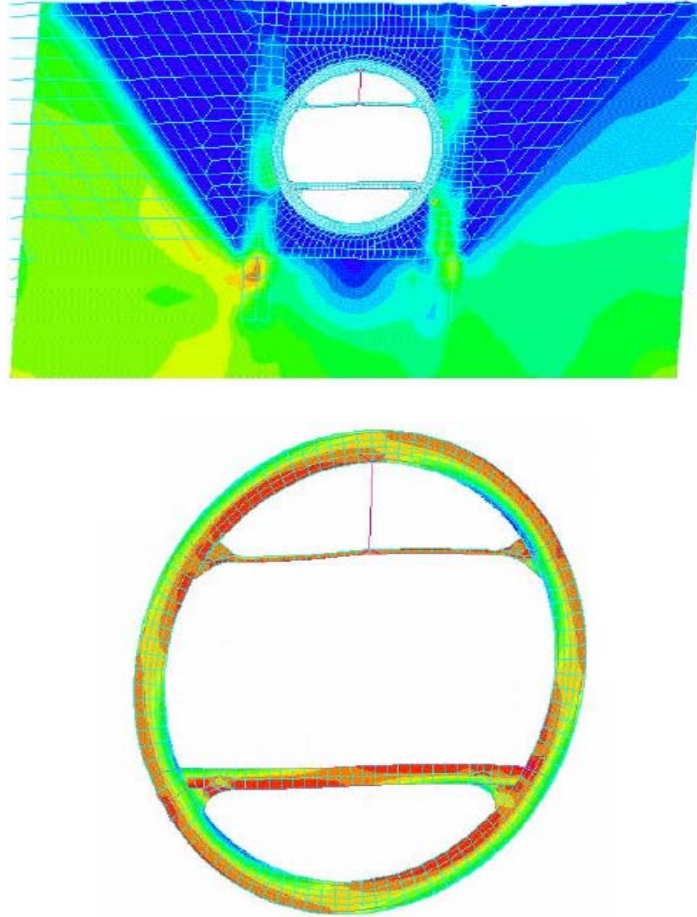

Figure 13-23 Example of Two-dimensional Continuum Finite Element Model in Pseudo-Dynamic Displacement Time-History Analysis

The model shown in Figure 13-23 includes both the geologic medium and the structure in one model. Alternatively, the analysis can also be performed in a *de-coupled* manner, where the tunnel structure is analyzed separately from the surrounding geologic medium. This *de-coupled* analysis involves the following two general steps:

- Computing the *scattered* ground displacements at the perimeter of the tunnel cavity subject to the design earthquake, without the tunnel structure (note that these are the *scattered* motions and not the *free-field* motions, due to the presence of the cavity in the ground). A two-dimensional site response analysis is generally performed using continuum finite element/difference plane-strain model to derive these scattered ground displacements. The soil (continuum) models and the associated properties shall be consistent with the soil strain levels that are expected to develop during the earthquake excitations (i.e., using strain level compatible soil properties).
- Impose the displacements obtained at the perimeter of the tunnel cavity onto the tunnel structure (e.g., a frame model) through interaction soil springs to evaluate the seismic response of the tunnel structure. When appropriate, the interface conditions between the tunnel frame and the surrounding soil should allow for the formation of gaps as well as slippage.



**Dynamic Time History Analysis:** Generally, the inertia of a tunnel is small compared to that of the surrounding geologic medium. Therefore, it is reasonable to perform the tunnel deformation analysis using pseudo-static or pseudo-dynamic analysis in which displacements or displacement time histories are statically applied to the soil-structure system. The dynamic time history analysis can be used to further refine the analysis when necessary, particularly when some portion(s) of the tunnel structure can respond dynamically under earthquake loading, i.e., in the case where the *inertial effect* of the tunnel structure is considered to be significant.

In a dynamic time history analysis, the entire soil-structure system is subject to *dynamic* excitations using ground motion time histories as input at the base of the soil-structure system. The ground motion time histories used for this purpose should be developed to match the target design response spectra and have characteristics that are representative of the seismic environment of the site and the site conditions (refer to Section 13.2.3).

Figure 13-24 shows a sample dynamic time history analysis using a two-dimensional continuum finite difference model for a cut-and-cover box structure. It should be noted in the figure that, the side boundary conditions in a dynamic time history analysis should be in such a manner that out-going seismic waves be allowed to pass through instead of being trapped within the soil-structure system being analyzed. Special *energy absorbing boundaries* should be incorporated into the model to allow radiation of the seismic energy rather than trapping it.

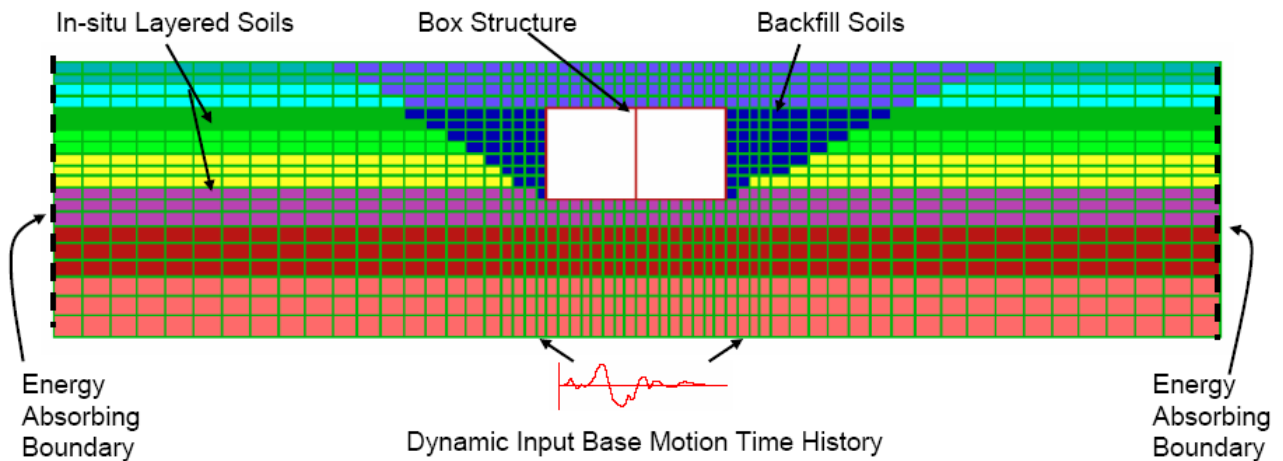

Figure 13-24 Sample Dynamic Time History Analysis Model

### 13.5.2 Evaluation of Longitudinal Response of Tunnel Structures

Similar to the procedures discussed for the evaluation of transverse response of tunnel structures, the evaluation procedures for the longitudinal response of tunnel structures can also be based on either simplified analytical method or more complex numerical modeling approach, depending on the degree of complexity of the soil-structure system, the seismic hazard level, and the importance of the structures. Section 13.5.2.1 discusses the simplified free-field deformation method, which ignores the soil-structure interaction effects. A refined method is then presented in Section 13.5.2.2 that considers the soil-structure

interaction effects based on analytical beam-on-elastic-foundation theory. The more comprehensive and complex method using numerical modeling approach is discussed in Section 13.5.2.3.

### 13.5.2.1 Free-field Deformation Procedure

This procedure assumes that the tunnel lining conforms to the axial and curvature deformations of the ground in the free-field (i.e., without the presence of the tunnel). While conservative, this assumption provides a reasonable evaluation because, in most cases, the tunnel lining stiffness is considered relatively flexible to that of the ground. This procedure requires minimum input, making it useful as an initial design tool and as a method of design verification.

The lining will develop axial and bending strains to accommodate the axial and curvature deformations imposed by the surrounding ground. St. John and Zahran (1987) developed solutions for these strains due to compression P-waves, shear S-waves, and Rayleigh R-waves.

The strains  $\varepsilon$  due to combined axial and curvature deformations can be obtained by combining the longitudinal strains generated by axial and bending strains as follows:

For P-waves:

$$\varepsilon = \frac{V_P}{C_P} \cos^2 \phi + Y \frac{A_P}{C_P^2} \sin \phi \cos^2 \phi \quad 13-26$$

For S-waves:

$$\varepsilon = \frac{V_S}{C_S} \sin \phi \cos \phi + Y \frac{A_S}{C_S^2} \cos^3 \phi \quad 13-27$$

For R-waves:

$$\varepsilon = \frac{V_R}{C_R} \cos^2 \phi + Y \frac{A_R}{C_R^2} \sin \phi \cos^2 \phi \quad 13-28$$

Where:

- $V_P$  = Peak particle velocity of P-waves at the tunnel location
- $V_S$  = Peak particle velocity of S-waves at the tunnel location
- $V_R$  = Peak particle velocity of R-waves at the tunnel location
- $A_P$  = Peak particle acceleration of P-waves at the tunnel location
- $A_S$  = Peak particle acceleration of S-waves at the tunnel location
- $A_R$  = Peak particle acceleration of R-waves at the tunnel location
- $C_P$  = Apparent propagation velocity of P-waves
- $C_S$  = Apparent propagation velocity of S-waves
- $C_R$  = Apparent propagation velocity of R-waves

- $Y$  = Distance from neutral axis of tunnel cross section to the lining extreme fiber
- $\phi$  = Angle at which seismic waves propagate in the horizontal plane with respect to the tunnel axis

It should be noted that:

- S-waves generally cause the largest strains and are the governing wave type
- The angle of wave propagation,  $\phi$ , should be the one that maximizes the combined axial strains.

The horizontal propagation S-wave velocity,  $C_S$ , in general, reflects the seismic shear wave propagation through the deeper rocks rather than that of the shallower soils where the tunnel is located. In general, this velocity value varies from about 2 to 4 km/sec. Similarly, the P-wave propagation velocities,  $C_P$ , generally vary between 4 and 8 km/sec. The designer should consult with experienced geologists/seismologists for determining  $C_S$  and  $C_P$ . In the absence of site-specific data, the horizontal propagation S-wave and P-wave velocities can be assumed to be 2.5 km/sec and 5 km/sec, respectively.

When the tunnel is located at a site underlain by deep deposits of soil sediments, the induced strains may be governed by the R-waves. In such deposits, detailed geological/seismological analyses should be performed to derive a reliable estimate of the apparent R-wave propagation velocity,  $C_R$ .

The combined strains calculated from Equations 13-26, 13-27, and 13-28 represent the seismic loading effect only. To evaluate the adequacy of the structure under the seismic loading condition, the seismic loading component has to be added to the static loading components using appropriated loading combination criteria developed for the structures. The resulting combined strains are then compared against the allowable strain limits, which should be developed based on the performance goal established for the structures (e.g., the required service level and acceptable damage level).

### 13.5.2.2 Procedure Accounting for Soil-Structure Interaction Effects

If a very stiff tunnel is embedded in a soft soil deposit, significant soil-structure interaction effects exist, and the free-field deformation procedure presented above may lead to an overly conservative design. In this case, a simplified beam-on-elastic-foundation procedure should be used to account for the soil-structure interaction effects. According to St. John and Zahran (1987), the effects of soil-structure interaction can be accounted for by applying reduction factors to the free-field axial strains and the free-field curvature strains, as follows:

For axial strains:

$$R = 1 + \frac{E_l A_l}{K_a} \left( \frac{2\pi}{L} \right)^2 \cos^2 \phi \quad 13-29$$

For bending strains:

$$R = 1 + \frac{E_l I_l}{K_h} \left( \frac{2\pi}{L} \right)^4 \cos^4 \phi \quad 13-30$$

Where:

- $E_l$  = Young's modulus of tunnel lining
- $A_l$  = Cross sectional area of the lining
- $K_h$  = Transverse soil spring constant
- $K_a$  = Longitudinal soil spring constant
- $L$  = Wave length of the P-, S-, or R-waves
- $I_l$  = Moment of inertia of the lining cross section.

It should be noted that the axial strain calculated using the procedure presented above should not exceed the value that could be developed using the maximum frictional forces,  $Q_{\max}$ , between the lining and the surrounding soils.  $Q_{\max}$  can be estimated using the following expression:

$$Q_{\max} = \frac{fL}{4} \quad 13-31$$

Where:

- $f$  = Maximum frictional force per unit length of the tunnel

### 13.5.2.3 Numerical Modeling Approach

Numerical modeling approach for the evaluation of longitudinal response of a tunnel structure is desirable for cases where tunnels encounter abrupt changes in structural stiffness or run through highly variable subsurface conditions (where the effect of spatially varying ground motions due to local site effect becomes significant). These conditions include, but are not limited to, the following:

- When a regular tunnel section is connected to a station end wall or a rigid, massive structure such as a ventilation building.
- At the junctions of two tunnels or at the tunnel/cross-passage interface.
- When a tunnel traverses two distinct geological media with sharp contrast in stiffness, for example, a tunnel passing through a soil/rock interface.
- When a tunnel is locally restrained from movements by any means (i.e., "hard spots").

Numerical analysis for the evaluation of longitudinal response of a tunnel structure is typically performed by a three-dimensional pseudo-dynamic time history analysis in order to capture the two primary modes of deformation: axial compression/extension and curvature deformations. As discussed previously, since the inertia of a tunnel is small compared to that of the surrounding geologic medium, the analysis is generally performed by using the pseudo-dynamic approach in which *free-field* displacement time histories are statically applied to soil springs connected to the model of the tunnel (to account for the soil-structure interaction effect). The general procedure for the pseudo-dynamic time history analysis in the longitudinal direction involves the following steps.

- The free-field deformations of the ground at the tunnel elevation are first determined by performing dynamic site-response analyses. For the longitudinal analysis, the three-dimensional effects of ground motions as well as the local site effect including its spatially varying effect along the tunnel alignment should be considered. The effect of wave travelling/phase shift should also be included in the analysis.
- Based on results from the site response analyses, the free-field ground displacement time histories are developed along the tunnel axis. The free-field displacement time histories at each point along the tunnel axis can be defined at the mid-height and mid-width of the tunnel, can be further defined in terms of three time-history displacements representing ground motions in the longitudinal, transverse and vertical directions.
- A three-dimensional finite element/difference structural model is then developed along the tunnel axis. In this model, the tunnel is discretized spatially along the tunnel axis, while the surrounding soil/ground is represented by discrete springs. If inelastic structural behaviour is expected, non-linear inelastic structural elements should be used to represent the tunnel structure in the model. Similar to the ground motions, the soil/ground springs are also developed in the longitudinal, transverse horizontal and transverse vertical directions. The properties of the springs shall be consistent with those used in the site response analysis in described above. If non-linear, the behaviour of the soil/ground should be reflected in the springs. As a minimum, the ultimate frictional (drag) resistance (i.e., the maximum frictional force) between the tunnel and the surrounding soil/ground should be accounted for in deriving the longitudinal springs to allow slippage mechanism, should it occur.
- The computed design displacement time-histories described above are then applied, in a statically stepping manner, at the support ends of the soil/ground springs to represent the soil-tunnel interaction. The resulting sectional forces and displacements in the structural elements (as well as in the tunnel joints if applicable) are the seismic demands under the axial/curvature deformation effect.

### **13.6 SEISMIC EVALUATION PROCEDURES - GROUND FAILURE EFFECTS**

As mentioned earlier, the greatest risk to tunnel structures is the potential for large ground movements as a result of unstable ground conditions (e.g., liquefaction and landslides) or fault displacements. In general, it is not feasible to design a tunnel structure to withstand large ground displacements. The proper design measures in dealing with the unstable ground conditions may consist of:

- Ground stabilization
- Removal and replacement of the problem soils
- Re-route or deep burial to bypass the problem zone

With regard to the fault displacements, the best strategy is to avoid any potential crossing of active faults. If this is not possible, then the general design philosophy is to accept and accommodate the displacements by either employing an oversized excavation, perhaps backfilled with compressible/collapsible material, or using ductile lining to minimize the instability potential of the lining. In cases where the magnitude of the fault displacement is limited or the width of the sheared fault zone is considerable such that the displacement is dissipated gradually over a distance, design of a strong lining to resist the displacement may be technically feasible. The structures, however, may be subject to large axial, shear and bending forces. Many factors need to be considered in the evaluation, including the stiffness of the lining and the ground, the angle of the fault plane intersecting the tunnel, the width of the fault, the magnitude as well as orientation of the fault movement. Analytical procedures are generally used for evaluating the effects of fault displacement on lining response. Some of these procedures were originally developed for buried pipelines (ASCE Committee on Gas and Liquid Fuel Lifelines, 1984). Continuum finite-element or finite-difference methods have also been used effectively for evaluating the tunnel-ground-faulting interaction effects.

The following sections will discuss briefly the general considerations and methodology used in dealing with various types of ground failure effects.

### 13.6.1 Evaluation for Fault Rupture

General: Assessing the behavior of a tunnel that may be subject to the direct shear displacements along a fault includes, first, characterizing the free-field fault displacement (i.e., displacements in the absence of the tunnel) where the fault zone crosses the tunnel and, second, evaluating the effects of the characterized displacements on the tunnel.

Figure 13-25 is an example of such a relationship, which shows that the amount of displacement is strongly dependent on earthquake magnitude and can reach maximum values of several feet or even tens of feet for large-magnitude earthquakes.

Analyzing Tunnels for Fault Displacement: When subjected to fault differential displacements, a buried structure with shear and bending stiffness tends to resist the deformed configuration of the fault offset, which induces axial and shear forces and bending moments in the structure. The axial deformation is resisted by the frictional forces that develop at the soil-tunnel interface in the axial direction, while shear and curvature deformations are caused by the soil resistance normal to the tunnel lining or walls.

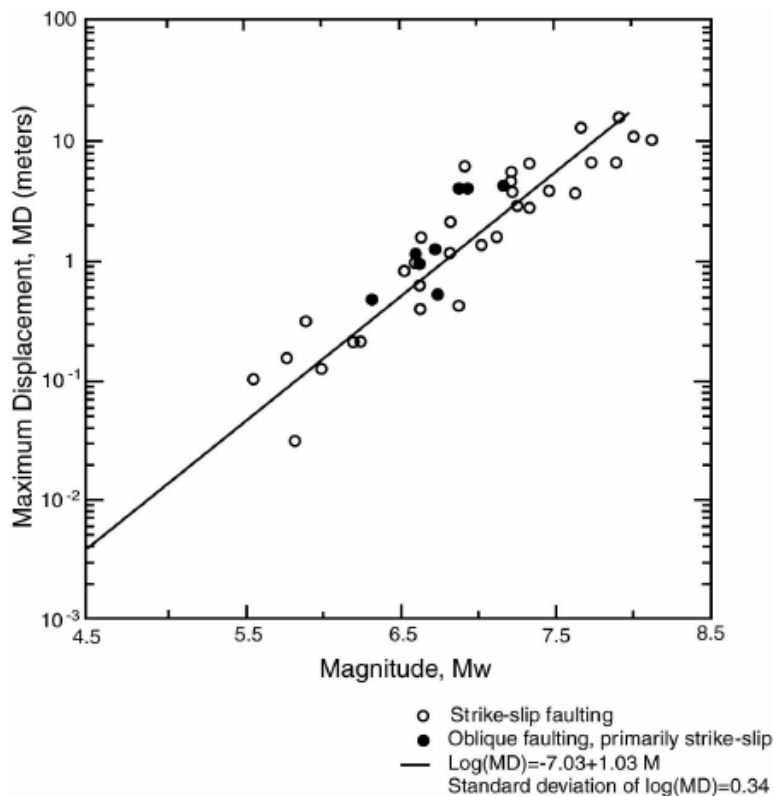

Figure 13-25 Maximum Surface Fault Displacement vs. Earthquake Moment Magnitude,  $M_w$  (Wells and Coppersmith, 1994)

In general, analytical procedures for evaluating tunnels subjected to fault displacements can follow those used for buried pipelines. Three analytical methods have been utilized in the evaluation and design of linear buried structures (ASCE Committee on Gas and Liquid Fuel Lifelines, 1984). They are: (1) Newmark-Hall procedure, (2) Kennedy et al. procedure, and (3) Finite element approach. For detailed evaluation of transportation tunnels at fault crossing, however, it is generally believed that finite element method is more appropriate than other methods. The finite element method is preferred because it can incorporate realistic models of the tunnel and surrounding geologic media. The tunnel is modeled using finite elements, which may incorporate nonlinear behavior (Figure 13-26).

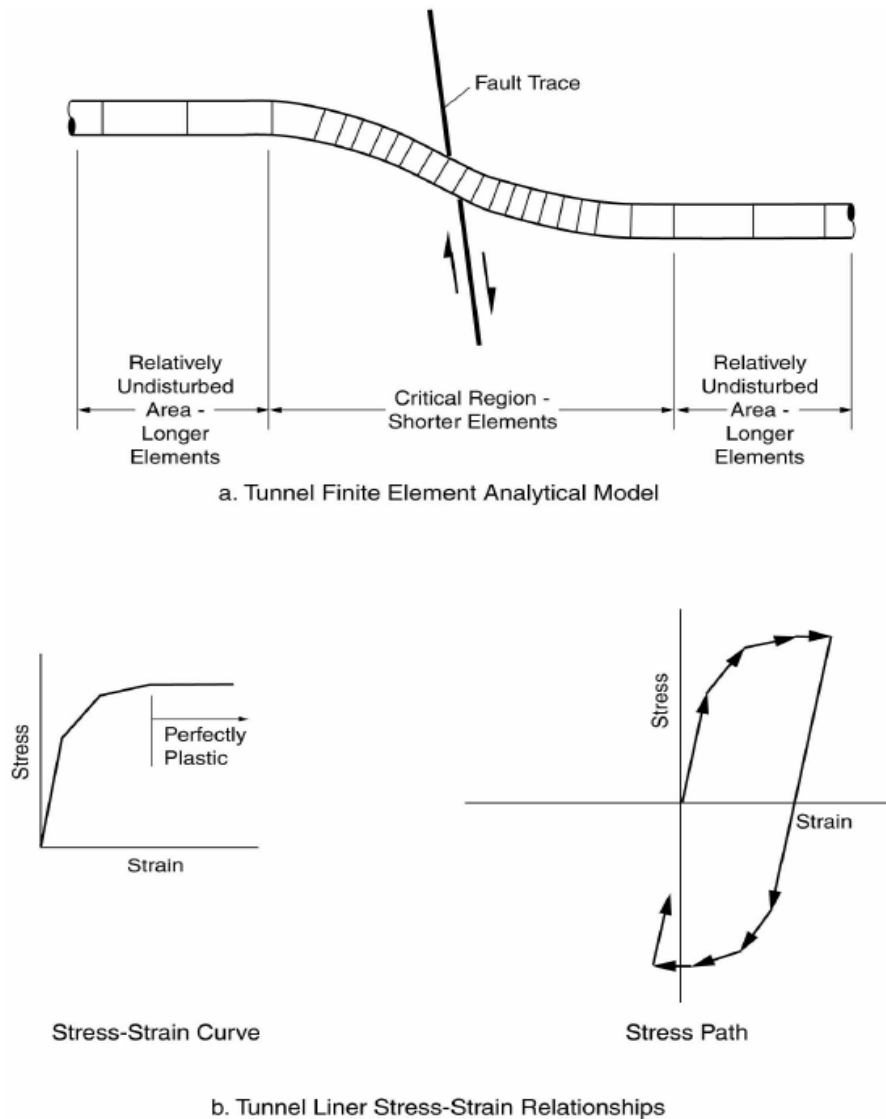

Figure 13-26 Analytical Model of Tunnel at Fault Crossing (ASCE, 1984)

Transverse and axial springs connected to the tunnel model soil normal pressures on the tunnel lining or walls and axial frictional resistance (Figure 13-27); these springs may also incorporate nonlinear behavior if applicable (Figure 13-28). Many commercially available finite element codes may be considered for analyzing the response of tunnels to fault displacement.

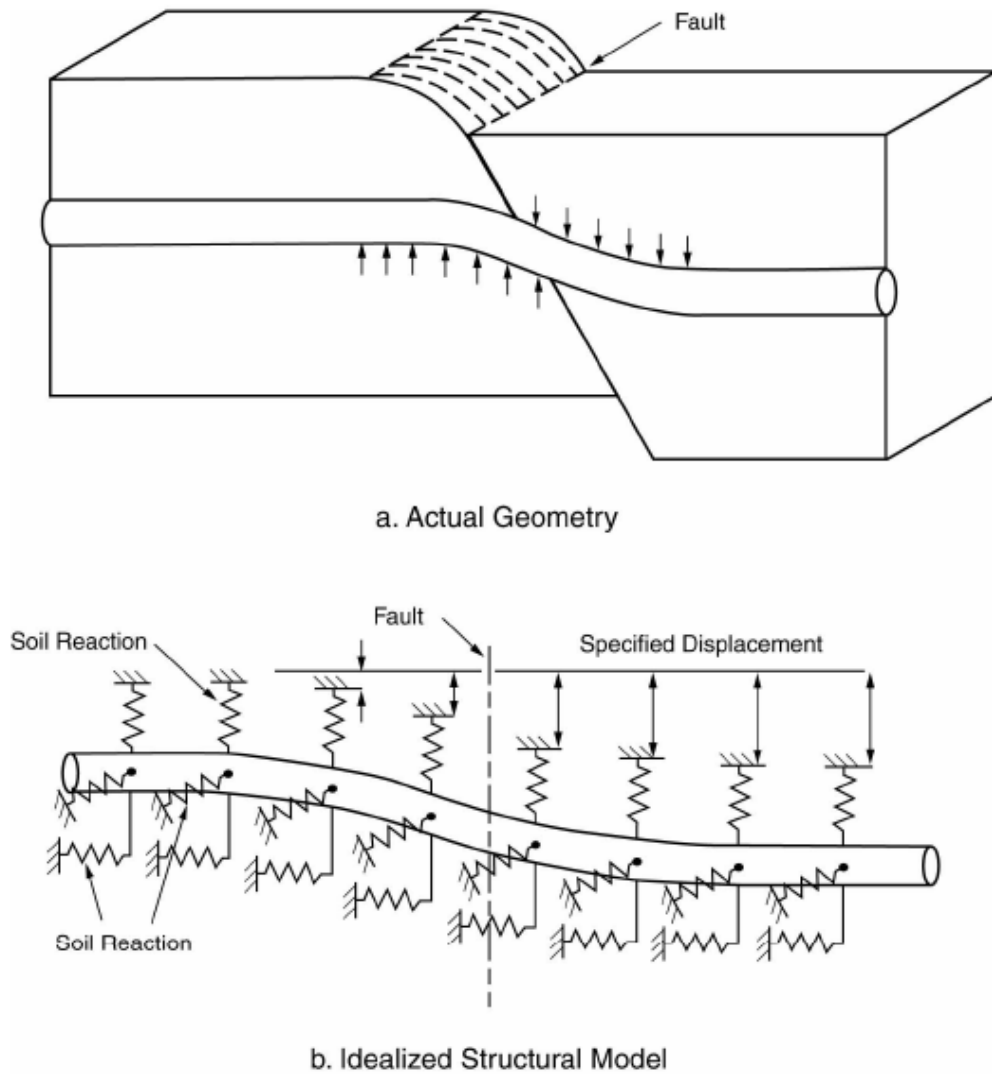

Figure 13-27 Tunnel-Ground Interaction Model at Fault Crossing (ASCE Committee on Gas and Liquid Fuel Lifelines, 1984)



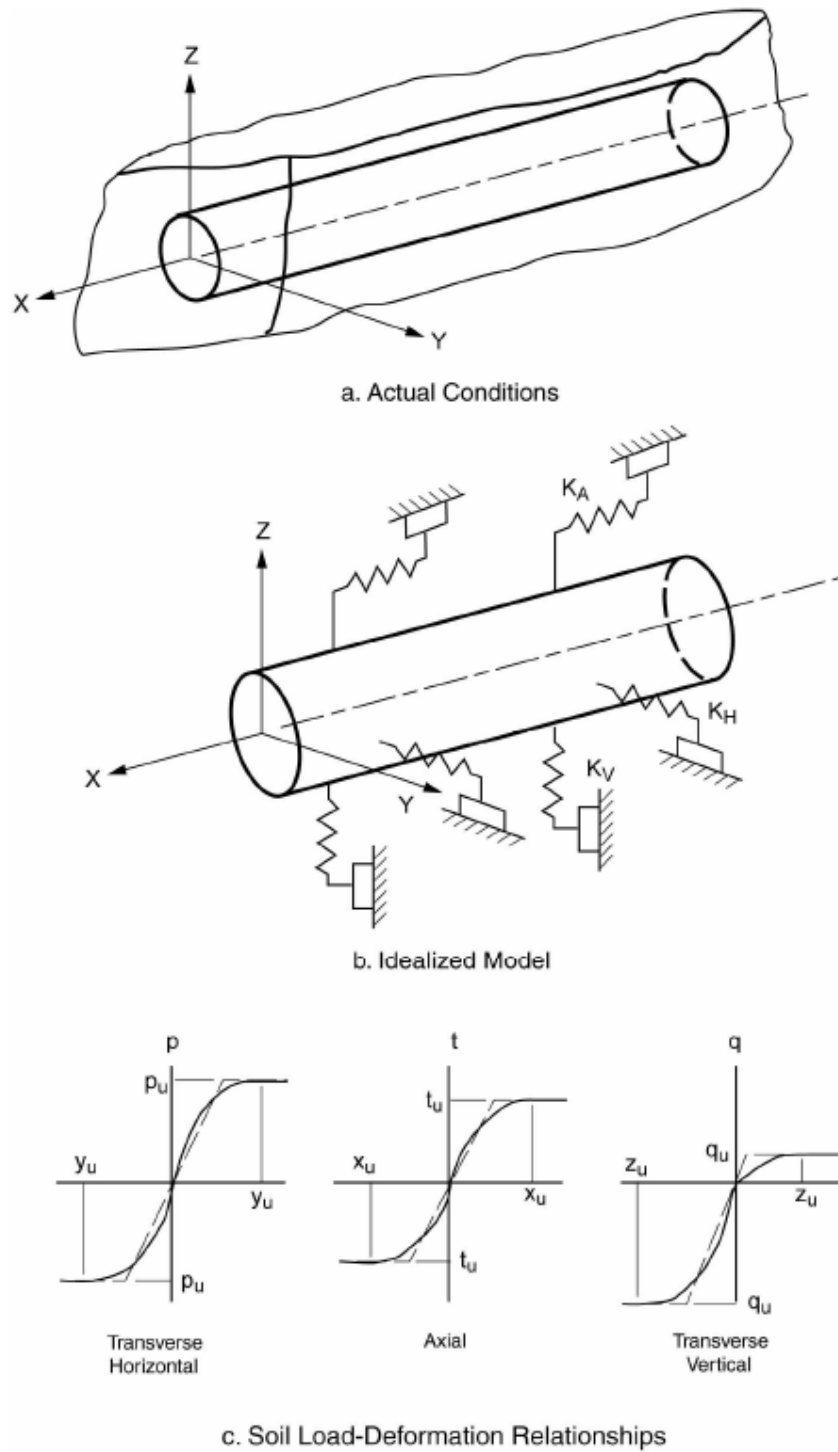

Figure 13-28 Analytical Model of Ground Restraint for Tunnel at Fault Crossing (ASCE Committee on Gas and Liquid Fuel Lifelines, 1984)

### **13.6.2 Evaluation for Landsliding or Liquefaction**

If liquefiable soil deposits or unstable soil masses susceptible to landsliding are identified along the tunnel alignment, then more detailed evaluations may be required to assess whether liquefaction or landsliding would be expected to occur during the design earthquake and to assess impacts on the tunnel.

If slope movements due to landsliding or lateral spreading movements due to liquefaction intersect a tunnel, the potential effects of these movements on the tunnel are similar to those of fault displacement. As is the case for fault displacements, tunnels generally would not be able to resist landsliding or lateral spreading concentrated displacements larger than a few inches without experiencing locally severe damage.

If liquefaction were predicted to occur adjacent to a tunnel lining or wall, a potential consequence could be yielding of the lining or wall due to the increased lateral earth pressure in the liquefied zone. The pressure exerted by a liquefied soil may be as large as the total overburden pressure. The potential for liquefaction to cause uplift of a tunnel embedded in liquefied soil, or for the tunnel to settle into the soil, should also be checked.

## CHAPTER 14

### TUNNEL CONSTRUCTION ENGINEERING

#### 14.1 INTRODUCTION

This chapter focuses mostly on mined/bored tunnel construction engineering; the engineering that must go into a road tunnel project to make it constructible. Each decision made during the planning (Chapter 1) and design of a road tunnel project has impacts on the constructability, cost and schedule of the Work. This chapter will look at these cost drivers and how they influence the project's final cost. Planning, design and finally construction operations should be guided by people experienced in the actual construction of these underground works so that the projects are constructible. The schedules must be realistic and reflect all the restrictions that are imposed on the project whether they are physical, political or third party. Cost estimates must reflect the actual schedule time needed to complete the work and account for all the restrictions imposed on the project.

Tunneling is unique when compared to other types of civil construction. In non tunnel projects like a large building or treatment plant there are usually many places to work at the same time, so the work can continue even if there is a problem holding up work at one location. Tunnels are long linear undertakings with few opportunities to perform the work at more than one location. Tunnels are also a series of repetitive operations each of which usually must be finished before the next can be started.

This uniqueness and the linear, repetitive nature of the work must be understood by the planners and builders of tunnel projects to control and manage the project to a successful conclusion.

Perhaps the most significant factor impacting tunnel cost and schedule is the type of geologic material that the tunnel will be mined through and the amount of ground and surface water that will be encountered or crossed. Tunnels are mined through rock, soil or a combination of both. The geology encountered determines the tunneling methods that will be used, the speed that the tunnel can be constructed and the types of specialized equipment that are required.

The geologic material can also present some unique health and safety concerns that must be accounted for in the planning and construction of underground projects. Gas, petroleum, contamination, voids in the ground, hot water or large quantities of groundwater all pose safety concerns that must be addressed so that the workers building the tunnels are provided an environment free of hazards.

Of similar importance to the tunneling methods and hours of operation are the communities that the tunnel will pass under, the locations of the major work shafts or portals from which the work will be serviced and the streets through which the equipment, personnel and material will get to and from the worksite as well as how the muck removed from the tunnel is disposed of.

All of these factors will have impacts on the cost and schedule of underground projects and in fact represent risks to the project. These risks must be acknowledged, allocated and mitigated. Dealing with these risks can be accomplished through the contractual language between the parties to a tunnel project, or if not dealt with or if dealt with inappropriately, contractor claims or lawsuits.

## 14.2 CONSTRUCTABILITY

The design for an underground project must be constructible. Too often road tunnels are designed by competent engineers who have never actually built anything. Their designs minimize the volume of excavation and concrete but are difficult to build. Underground construction is expensive due to the large proportion of labor used during the construction, the high wages paid to these workers and the linear nature of the work. In order for our tunnels to be less expensive to build, designers must also be schooled in how tunnels are built so they can recognize that their decisions on size, shape, location and esthetics all have cost impacts.

A brief discussion of the labor portion of the cost of underground construction is in order so that designers can start to understand how their decisions impact these costs. Most underground civil construction is performed in a union environment. The union provides skilled labor that performs specific job functions. Typically there is a crew actually performing the work. This crew will consist of miners, miner foremen, operators to run and maintain the equipment, electricians to maintain the power that runs the equipment and provides the necessary lighting levels as well as supervisory people. These folks actually performing the repetitive operations are called the heading or direct labor crews. These crews are supported by an entire separate group of people that supply the project with needed power, material, transportation, maintenance and overall project management. These are called the service crews. The service crew can be as big as the direct labor crews. If you have 25+/- direct labor doing the work you also have 25+/- people supporting the work. These two or more crews are being paid whether the work is going forward or not.

One typical example of where the design of a tunnel project can impact the cost is in a location where a tunnel must be widened out to accommodate an exit or entrance or even an emergency pull-off. In most designs you will see a constantly changing cross section going from the road tunnel and widening out to accommodate the exit, entrance or emergency parking area. This looks nice, is visually pleasing and minimizes both the excavated volume and the amount of concrete that is required in the lining, but is it easy to build and what does it add to the cost?

Most contractors will come back to the project's owner and propose to accommodate the same structure in a stepped fashion instead of a smooth transition. Why? It is relatively easy to excavate the transition cross sections in a rock tunnel (more difficult in a soft ground tunnel operation) and certainly a smoothly transitioning excavation does minimize the volume of material that is taken out. However the lining operation becomes real tricky and costly.

The smooth transition requires different custom built forms for each foot of the structure. There is no, or limited, reuse of forms and most importantly each of these custom forms must be built in place, used and removed thus slowing down the lining operation. Each use of a custom form requires both the direct crew and the service crew to be used for a longer duration driving up the cost and increasing the schedule for the whole project.

Now look at what the use a larger cross section or a stepped transition can do for the cost and schedule. If we simply go from the typical tunnel size to the full size required for the exit, entrance or parking lane we pay for some extra excavation and concrete but we only now have two forms (one extra) to build use and remove. If using just two different cross sections is not possible, then a multi-stepped transition can help to minimize the time and money spent building, using and removing all the specialized forms. An evaluation must be made whether it is faster and less costly to remove extra material and place extra concrete or to install, use and remove all the specialized forms.

So how do we make our designs more constructible? One way is to include a construction expert on the design team. This construction expert would then sit with the designers reviewing what approach they want to utilize, make suggestions on how the design could be more easily built, make sure that all the site constraints have been addressed and providing insight into how a contractor would price the designs so that modifications of the design can be made to control cost and schedule.

### 14.3 CONSTRUCTION STAGING AND SEQUENCING

#### 14.3.1 Construction Staging

Each underground project is unique; however, there are certain requirements and functions common to most or all tunnels. Each project requires one or several places from which the work can be prosecuted. All projects require large quantities of labor, material and equipment be brought underground to excavate and support the tunnel and large quantities of muck and ground water must be removed from the tunnel. All projects therefore require land area to set up the contractor's offices, shops storage yards, muck storage piles, electrical substations and many other space needs. It therefore is logical that the more space that can be made available to the contractor to locate needed structures, store needed materials and allow for the movement of materials and equipment into and out of the worksite, the more efficient and less costly the operation will be. On the other hand the smaller the available worksite the more expensive and less efficient the operation will be (Figure 14-1).

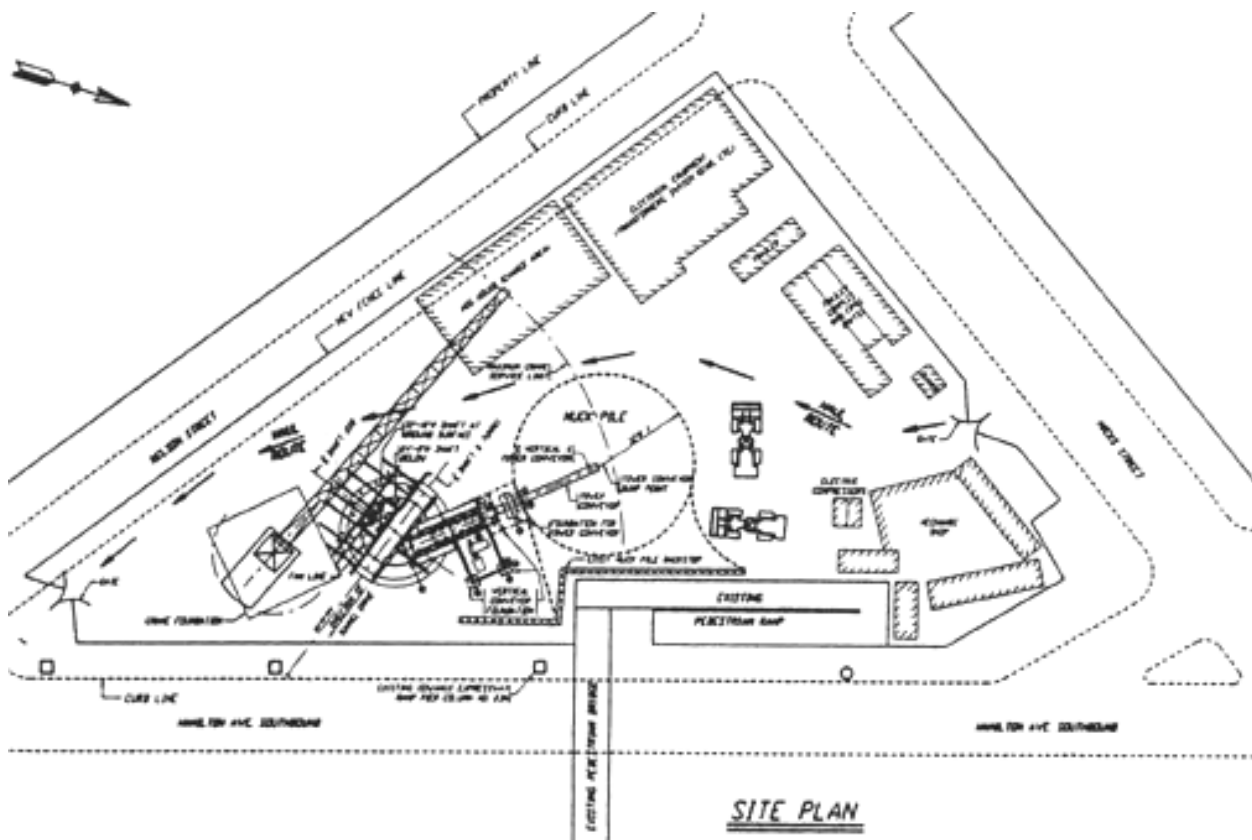

Figure 14-1 Confined Worksite and Staging Area

Underground projects serviced by shaft(s) require room to excavate the shaft. There should be room all around the shaft to allow equipment access and easy flow of the work around the shaft location. Typically owners, who must acquire property to locate the shaft will minimize the size of the property and thereby minimize their expenditure for property acquisition. This can be shortsighted. Paying more for more room can actually provide for a more efficient operation, lowering the overall cost for the work and providing the owner the opportunity to sell off the extra property after the project is completed at a higher price thereby further lowering the total cost of the construction.

Portal projects benefit from not having the expense and schedule impact of excavating and supporting the shaft(s) but also require property on one or both sides of the project to enable the contractor to efficiently prosecute the work (Figure 14-2). Portal areas for a road tunnel may be limited by existing geotechnical hazards.



Figure 14-2 Tunnel Portal

### 14.3.2 Construction Sequencing

Underground construction is a series of individual activities that must be completed before the subsequent activities can start. This series of unique activities is then repeated and repeated until the operation is complete. For tunnels that employ drilling and blasting to create the tunnel opening the series is, “drill, load, shoot, muck and support.” Each round is drilled a certain length or depth using a pre-engineered drill pattern. Once the drilling is done the explosives are loaded into the drill holes and “wired up”. The equipment and crews are then pulled back a safe distance from the loaded face and the blast is “shot”. Exhaust gasses produced by the explosives are removed from the face and fresh air is sent to the heading area. After around 30 minutes the crew is brought back into the area to scale or knock down any loose rock and remove the excavated material or “muck”. Once the muck is removed, the initial tunnel support is installed to make the excavated opening stable and safe for the crew to work under. The cycle is

complete and the tunnel has been advanced some distance. The next round can be started when all of these activities have been completed.

In TBM excavated tunnels there is also a defined sequence of activities needed to advance the heading. The TBM usually completes this series much faster than in drill & blast tunnels but the elements remain similar. The TBM cuts into the rock or earth a certain distance at the same time the muck is removed by conveyor to either waiting muck cars or to a continuous horizontal conveyor, so the TBM is able to combine these two operations thereby saving time and speeding up the tunnel progress. After the end of the TBM's stroke (the hydraulic pistons used to push the TBM cutting head into the rock have a defined length) the excavation is stopped and the TBM readied to start the next excavation cycle. While this is happening the length of tunnel that has just been exposed must be supported to provide a stable and safe opening. The TBM can sometimes be configured to perform this support function concurrently with the excavation sequence depending on the size of the tunnel opening, the type of ground being excavated and the design of the machine. This can be another advantage of using a TBM but does not change the fact that this operation must be done before the next excavation cycle can begin.

Tunnels are usually stabilized for long term use by placing an internal final concrete liner. The concrete lining operation also contains a series of individual steps that must be completed in sequence before the next length of tunnel can be lined.

#### **14.4 MUCKING AND DISPOSAL**

“Muck” is the industry term for excavated material produced during the advancement of the tunnel. All tunnel mining produces muck. This excavated material must be removed from the working face of the tunnel so that the next advance can be made. Tunneling is a series of individual steps, each of which must be completed before the next can start. Once the muck is produced it must be removed from the tunnel and finally disposed of in a legal manner or used as fill for some portion of the tunnel project or other project where it could have a beneficial use.

Muck is actually a broken down state of the insitu material through which the tunnel is driven. Because the natural material is disturbed by either blasting, cutting with a TBM, roadheader or cut out with a bucket excavator the volume of muck removed actually is larger than the natural bank material. This swell is usually approximated as 70% to 100% more in rock and 25% to 40% for soil.

The material that is excavated must be removed from the tunnel. The method chosen to remove this material depends on many factors such as the diameter or size of the excavation, the length of the tunnel excavated from any given heading, the material being moved, the grade of the tunnel being driven and whether the material is going to a shaft for removal or a portal. Horizontal conveyor belts are commonly used for large excavated tunnels that are longer than a few thousand feet and are excavated by a TBM (Figure 14-3). Conveyors can move a large quantity of material quickly. Conveyors require that the excavated material be of relatively uniform small size so that it will sit in the belt during the transfer to the shaft or portal. Conveyors can sometimes be used with a drill and blast excavation method if the contractor employs a crusher to make the drill and blast rock a more even and smaller consistency. This crushing is necessary to ensure that the material sits nicely on the belt, is small enough that when it is loaded onto the belt it does not damage or rip the belt material. Conveyors are usually limited to a grade (or slope) less than 18 degrees to successfully transport muck, but this is never an issue in road tunnels. Conveyors can transport rock or soil. The soil must not be too wet or it will not transport well. Conveyors can also be used in tunnels where there are curves in the alignment but this requires some special care and equipment.



Figure 14-3 Horizontal Muck Conveyor

Material that is too wet to carry on a conveyor belt can sometimes be pumped out of the tunnel through a pipeline from the TBM to the shaft or portal. This method is successfully used on soft ground tunnels where the material is clay like or where sufficient water (and often, conditioners) is mixed with the excavated material to make it slurry like.

For smaller tunnels excavated by a TBM, contractors often choose to load the excavated muck into rail cars and haul it out of the tunnel using locomotives. Rail haulage also has some limitations such as the grades are usually limited to less than 4%, a great amount of rolling stock is required and great care must be paid to maintaining the track.

Once the muck arrives at the shaft or portal it must be off loaded and then disposed of. Figure 14-4 shows a muck train dumping at a tunnel portal. A shaft is a vertical hole through which all excavated material must be lifted and removed and through which all material required for the tunneling operations must be lowered to the tunnel level. In addition all personnel working on or inspecting the tunnel must come in and out of this shaft. In other words it is a busy place. There are many ways to transport the muck up the shaft. Muck cars can be lifted one by one up the shaft, dumped in a pile on the surface and lowered back down to the tunnel. Muck cars can be dumped into a hopper at the bottom of the shaft and then loaded into a bucket that is hoisted to the top and dumped or the muck from the hopper could be loaded onto a vertical conveyor and conveyed to the top of the shaft and dumped onto a pile or hopper. Similarly the muck can be pumped to the surface and deposited on a horizontal conveyor, a stockpile or run through a processing plant to remove the water and the residual dumped on a pile or into hoppers.





Figure 14-4 Muck Train Dumping at Portal

Portals provide easier access to a tunnel since they eliminate the bottleneck that the shaft imposes. Muck is easier to remove at a portal since track can be paced on the ground or on an elevated trestle so that muck cars can be pulled outside to dump their loads onto a muck pile.

The really important thing to remember is that tunneling is a series of steps that must be done and complete before the cycle can start again. This means that any disruption in the muck removal operation will delay the start of the next round or the next advance. If you cannot get rid of the muck you can not produce more! This is also true once the muck reaches the surface. There should be a place to store the muck that is brought out of the tunnel until it can be loaded into trucks or rail cars and hauled away. Without this storage capability on the surface (Figure 14-5), all muck brought out of the tunnel must immediately be loaded into surface trucks or rail cars for disposal. If there is a holdup in the surface trucking or rail cars then no more muck can be brought out and the tunnel advance must stop. This situation is called being “muck bound” and must be avoided at all costs. The more muck storage that is available the more unlikely it will be for a project to become muck bound. Work sites must be large enough to provide this storage cushion, the larger a worksite the bigger the cushion. It is increasingly more difficult to find available land in and around cities to provide a suitably large worksite. Typically urban sites are small and therefore special care must be taken to ensure a steady stream of vehicles to remove the muck as it is produced, and to deliver workers and materials as needed. Thought must also be given to the hours of operation allowed in urban tunnel projects. If the hours of operation for surface work are restricted, i.e., surface work is not allowed after 10 PM at night, then in order to operate the tunnel 24 hours per day, there must be some place to store muck underground that is produced on the shift where no surface work is allowed, and construction noises must be kept below a threshold based on local ordinances and/or certain realistic decibel levels.



Figure 14-5 Surface Muck Storage Area

## 14.5 HEALTH & SAFETY

Construction Engineering and safety go hand in hand. Underground construction is inherently a dangerous undertaking. Work goes on in a noisy environment, in close quarters often with moving heavy machinery. Careful attention must be paid to the layout of the worksites; workers must be protected at all times. The overriding philosophy must be that, “everyone goes home safely at the end of their shift”.

Every step of the operation should be planned with safety in mind. The normal surface safety concerns are also appropriate for underground construction. Workers must be safeguarded from falling off of the work platforms used in the mining process. Workers must be protected from being struck by the moving equipment used throughout the mining process. Workers must be protected from being electrocuted. However there are also many additional hazards that workers must be protected from and guarded against.

Work underground involves mining through rock or soil or a combination of both. In order to excavate the opening required for the tunnel the natural properties of the ground are disturbed. The ground is usually not a homogeneous mass but has been subjected to massive forces of nature and has been altered. Once the opening has been excavated it must be supported in order for the workers to be protected from falling material, collapse or other deterioration of the tunnel roof or crown. So it is the job of the Construction Engineer to plan on making the tunnel opening stable to allow workers to move freely and without concern of falling material.

Because tunnels are by definition below the surface, lighting of the workspace is an important part of underground safety. OSHA has regulations governing all elements of working underground and the Construction Engineer must be familiar with them all. There are required levels of lighting for the actual work locations as well as the previously excavated openings. It is important to remember that the tunnels are long linear work places. As the tunnels are advanced more and more safety plant must be added along with the productive support elements.

One of the more challenging aspects of tunnel safety is the fact that workers must be constantly supplied with high quality breathable air. Again OSHA is very specific in its requirements. Each person

underground must be supplied with 200 cubic feet per minute (cfm) of air. In addition much of the equipment underground is powered by internal combustion engines. Diesel fuel is the only fuel allowed underground. OSHA again has specific requirements for the equipment and for the amount of air that must be delivered to the underground for each and every piece of diesel equipment working underground. This diesel air requirement is in addition to the requirement for each and every person underground. The quality of the tunnel atmosphere must be tested on a regular schedule to ensure that sufficient quantities of oxygen are present and that concentrations of undesirable gasses and byproducts of the internal combustion engines are controlled to acceptable levels.

Also tests must be performed on a regular basis to ensure that the air movement across the excavated cross section is no less than 30 feet per minute.

If this were not enough, as discussed in Chapter 8, Mother Nature can often provide challenges to the safety of workers underground. There can be gasses underground that can seep into the tunnel opening after the excavation operation. These gasses can be poisonous like hydrogen sulfide or explosive like methane. Whenever these gasses are present or suspected to be present the Construction Engineer has additional OSHA requirements to be aware of and to follow. Extra ventilation will be required, in addition to the air needed for both people and diesel equipment and the required quantity can be substantial. Whenever these gasses are suspected there are extra requirements for continuous monitoring of the atmosphere with automatic shutdown of equipment should the gasses be detected in concentrations higher than allowed.

Water entering the tunnel opening is also a safety issue in tunnels. Most tunnels are excavated below the water table. The tunnel opening acts like a big drain and any water running through the rock or contained in the soil tends to collect in the tunnel. Water running through the tunnel bottom or invert can cause several potential safety issues. Tunnels can be accessed by one or more shafts, by a combination of shafts and portal or from a portal alone. It is desirable to drive tunnels up hill so that any water that seeps into the excavated opening flows away from the working face by gravity. This water is usually allowed to run in a ditch located at the side of the tunnel invert. Care must be taken that workers do not step into or fall into this ditch. The higher the inflow of water into the tunnel the greater the problem of safely conveying it back along the tunnel and finally out the shaft or portal.

Tunnels that are driven down hill have the problem that water flows to and accumulates at the working face. This collected water must be removed from the work area by pumping. The water is pumped through a pipe at the side of the excavation. This pipe must extend all the way to the shaft or portal where it can be removed from the tunnel. Water can also enter the tunnel in sudden large flows. These can be very dangerous occurrences and any tunnel where this is a possibility extra care must be taken in the planning for worker safety. Tunnels under bodies of water are of particular concern for this risk of sudden large inflows of water.

Fires in tunnels are especially dangerous and can lead to extensive damage and risk to worker's safety and life. The Tunnel Construction Engineer must be aware of this potential danger and plan to mitigate the risk at every stage of the project. Most tunnels are driven from one point to another from a single point of entry. This single point of entry is what makes tunnel fires so dangerous and concerning as shown in (Figure 14-6). The tunnel environment contains numerous potential sources of fire. Equipment can malfunction and catch fire. Workers using welding or burning torches can set off a fire. Leaking hydraulic fluid or fuel from equipment can be ignited by a stray spark or discarded cigarette. Conveyor belts used to transport muck can build up heat from rubbing on or over something and ignite. All these possible fire risks, and more must be addressed by the Construction Engineer to minimize the possibility of a fire or to minimize the potential damage and injuries resulting from a fire. Only retardant material and hydraulic fluid should be allowed on any underground equipment or material. Fire suppression systems should be

required for all underground equipment, conveyor belt motors and storage magazines. Vertical muck removal belts should be equipped with deluge water systems to dump large quantities of water on any belt fire event. Fire and life safety issues during operation and maintenance of road tunnels are not included in the scope of this Manual.



Figure 14-6 Fire in Work Shaft

Of equal importance in dealing with tunnel fires is how to best provide for the safety of the workers underground. This can be accomplished in several ways. Rescue chambers, where workers can take refuge in a fire, are fully equipped and supplied with independent air supplies and insulation can be deployed along the tunnel as the tunnel is advanced. Equally important the tunnel can be planned with intermediate access points that can be fully equipped to be able to remove workers from the tunnel when the tunnel has been excavated past these locations.

The Tunnel Construction Engineer must also be certain to make sure that the job specifications require strict compliance with all safety measures and regulations local, state and national. The Engineer must stress to the designer and the owner that money spent on worker and job site safety is money well spent since the cost of accidents and replacing structures damaged or destroyed by a fire event is so high.

## **14.6 COST DRIVERS AND ELEMENTS**

There are numerous cost drivers associated with underground construction. These can be grouped into physical, economic and political.

### **14.6.1 Physical Costs**

The single most important driver of project cost is the ground through which the tunnel will be driven. The ground controls the methods and equipment used to drive the tunnel, the support elements that will be needed to ensure that the excavated cross section remains stable and safe for the personnel constructing the tunnel and the final lining needed for long term stability of the structure. In addition the ground through which the tunnel is driven will contain varying amounts of ground water that will dictate the pumping requirements, waterproofing needs and lining quality that will ensure a dry tunnel environment.

The use that the tunnel will serve also has a significant impact on the costs. Tunnels for roads and rail must be dry to safeguard the traveling public so a watertight structure is imperative. Road and rail tunnels are also grade restrictive and curvature restricted which also impact project cost. Tunnels that will service as road and rail infrastructure must be able to deliver large quantities of fresh air throughout the length of the tunnel and be able to remove smoke and heat developed during a fire incident anywhere in the tunnel. Large ventilation structures or in line fan systems are needed to supply this air and remove the smoke.

In rail or road tunnels refuge areas or rest areas are often needed along with on and off ramps or connections to outside rail or road systems.

### **14.6.2 Economic Costs**

All tunnels require personnel, equipment, materials incorporated into the physical structure, materials that are consumed during the construction of the tunnel along with insurances, bonds, offices, shops and other indirect elements. These all impact the cost of the project. The largest portion of these costs is the actual cost of labor. Labor is broken down into the labor actually driving the tunnel or the direct or heading crews; the support crews that provide all the needed supplies of the tunnel, maintain the equipment used during the tunnel driving operations and provide access to and from the tunneling operation and the supervision needed to ensure that all the components work together in the required sequence.

Material is another major cost component of tunnel operations, Materials like cement, steel, copper wiring are all very price volatile now due to strong worldwide demand. Currently the price escalation of key materials is a significant cost driver and one that is often not addresses in the contract specifications as a separate cost. Tunnels require large quantities of both permanent and consumable materials in a constant stream.

We have also the continual cost of disposing of the muck or excavated material that is produced during the tunnel operations. Muck can sometimes be sold off by the contractor or owner to help reduce the cost of tunnel construction. However the market for this material is not guaranteed and often the contractor must pay to haul this muck away and also pay to dispose of it at approved dump locations. More and more regulations governing the disposition of materials are driving up the cost of tunnel construction.

Bonds and Insurance are smaller components of tunnel costs that are becoming cost drivers due to the increased scrutiny being imposed by the insurance and surety industry. Since most owners require both bonds and insurance on their projects by law and as risk management tools any contractor that cannot

qualify for bonds and insurance cannot bid the project. After the terrorists attacks of September 11 and some high profile corporate failures, the marketplace for both bonds and insurance has tightened up and many providers have actually stopped writing bonds and certain types of insurances.

### **14.6.3 Political Costs**

Significant costs are placed on projects by either the communities through which the tunnels will be mined or by the owner agencies by the requirements and restrictions incorporated into the specifications. Tunnels are expensive undertakings even without these restrictions but when concessions to various groups are added to the requirements the costs can skyrocket. Tunnels built in rural areas experience few of these political costs but those driven through urban settings can experience significant costs due to these restrictions. Typical restrictions are, mandating certain types of construction to minimize community disruptions, i.e., mining an underground cavern instead of digging down from the surface or not having a work shaft at a certain location because it is too close to neighbors. Restrictions on the hours worked is commonly employed when the tunnel is in a urban location. Tunnels are a cyclical series of operations where one cannot start till the predecessor is complete. With restrictions on the hours of operation fewer steps can be completed in the reduced time so the job takes longer. In one case an owner agency allowed 24 hour tunneling (recognizing that this is a typical mode of operation) but limited the hours that could be worked at the surface where the muck is brought out to be trucked away. In order to compensate for this reduced time the underground opening had to be made larger, so that the muck that was produced during the time where no surface work could be done, could be stored underground awaiting that time of day when it could be brought to the surface and trucked away, the political cost of being a good neighbor.

Owners might drive up the cost of doing underground work by restricting what costs are recoverable by the contractor in a change order or claim situation and by preventing the contractor from recovering delay costs if the delay is caused by the acts or inaction by the owner. These “No damage for delay” clauses might suggest to the contractors to incorporate into their bids these potential costs and the owner pays for them whether they occur or not.

## **14.7 SCHEDULE**

The importance of the development and use of a realistic schedule and cost estimate for all phases of a project cannot be overemphasized. It is critical to understand the relationships among all the activities and costs that go into a project as well as the needs and interests of all those who are affected by the planning, design, construction, testing and commissioning of the work. With this understanding, projects can go forth in an orderly, predictable manner, which in the end benefits everyone.

The schedule is the road map of how the project progresses through all the necessary steps. It is advised that a comprehensive schedule be developed during the early stages of the conception of a project. During this early stage the project may be too immature to support realistic time durations but some time must be assigned to each and every component; such as planning, siting, environmental process, permitting, right of way acquisition, preliminary and final design, bidding, contract award, construction, testing, commissioning start up and any activity or phase that is important to or has a cost for the project Owner. As the project develops and more of the actual scope and restrictions are known the schedule must be reevaluated and updated to reflect this new knowledge. The schedule development should be a living process that is used and revised constantly to be of maximum benefit to the project.

The realistic time needed to accomplish all aspects of the project must finally be reflected in the schedule. It makes no sense to handicap the tool (schedule) or the process by introducing artificial or incorrect restrictions or by putting unrealistic expectations into the schedule. In fact, these restrictions and incorrect assumptions always create problems later on in the project, usually in the form of delays, claims and higher costs. There can be a positive case made for an Owner to actually build some float time into the schedule, if possible, so that there is some way to cushion the effects of unknown occurrences that could impact the project schedule.

Unrealistic schedules sometime might result from external forces such as the desire to have a project completed in time for an upcoming event or election. These external forces always need to be acknowledged and addressed on a case-by-case basis. They can wreak havoc on a schedule, but they must be taken seriously. It should be noted that throughout a project's life, its schedule will be at the mercy of these external forces. Having said this, the best (and only) way to begin a project is with a realistic, well-thought out schedule and cost estimate. This will reduce the risk that the Owner Agency will be called on to defend a low-ball cost assumption and an inaccurate timeline necessary to complete the project. It is important to remember that the cost and schedule numbers that are initially released to the public are the ones that you will have to live with and defend throughout the project's life. It is much easier if these costs and schedules are reasonable and defensible, backed by professional experience and industry standards.

Numerous examples can be found where projects suffered from low cost and schedule pronouncements that were never achieved. In contrast, where realistic cost and schedules were developed, the Owner Agency managed the projects and was not constantly defending the numbers or the timeline. Having realistic schedules and budgets produces a "win-win" situation for both the Owner agency as well as the contractors by eliminating or at least minimizing the conflicts and finger pointing that can occur on a project that is squeezed for time and/or cash!

As the schedule of how the project is planned and built is developed, a timetable for the work also emerges. The schedule divides the work into discrete activities each with an amount of time needed for completion. Each activity is quantified with the important items of work such as linear feet of tunnel or cubic yards of concrete. Production rates are then applied to these activities and quantities. These discrete activities can then be combined in sequences that depict the way the designer anticipates the work to be constructed. These sequences can be linear or overlapping; but in the end, we have a roadmap of all the elements of the project, how they fit together and how long the project is expected to take.

Each of these discrete activities and the project as a whole are used to calculate the cost of doing the work. In the early stages of a project, these costs can be based on historical costs for similar size projects, in similar geologic conditions and in similar locations. These approximations of costs are useful for developing a potential cost for the work but, and these initial costs must not be used to develop an actual estimate.

The schedule is now the **roadmap** for developing the actual cost for the work. The Design Engineer should follow the procedures used by Contractors when they prepare their estimate for the bidding of the project. Typically, a contractor develops a crew of workers for each activity on the schedule. This crew is based on the work practices in the area, such as health and safety rules, where the project is located. The staffing is determined by the actual work to be accomplished, based on the local labor staffing requirements. After the crews are established the contractor will determine the productivity of the crew to accomplish the quantity of work associated with the activity. This will determine the time required to do the work; or if the time is fixed, a determination is made as to how many workers are needed to perform the required quantity of work in the required time. To this labor, the contractor will add the equipment

needed, the materials incorporated into the work and the materials consumed during the performance of the work.

This method is called a “bottom-up” estimate where all the components are established for each activity of work; then all these activities are combined into the total direct cost for the work. To this direct cost is added the indirect or costs not associated with any specific activity but needed for the overall construction of the project such as insurance, bonds, non union labor and costs of running the project and home offices.

By using a bottom-up estimate prepared by an estimator with some construction or contractor background, the Engineer’s Estimate will be more accurate and will better reflect the true costs for the work. This is the goal.

So why is a realistic schedule important? There are several reasons. The schedule gives the Owner an expectation of when the project is to be completed and ready for use. The schedule is used to coordinate the interfaces with other construction contracts within the project or external to the project, equipment procurement contracts and other interfaces. The schedule is also used to determine the cash flow and financing requirements, such as bond sales.

A schedule is used as the basis to determine the cost of the work. Labor makes up close to 30% of the cost of a tunnel estimate, so an accurate picture of the length of time that labor will be used on the project is important to the total cost the Owner, Contractor and Public will eventually have to pay.

There is an additional benefit that comes from using a realistic schedule as the basis of the engineer’s cost estimate. Once this is done then the schedule and estimate can be used to determine the magnitude of any claim proposed by the contractor (based on the contractor’s schedule and compared to the costs and schedule impacts claimed by the contractor) for delays or the impacts to the budget of Owner initiated extra work.

There are different levels of cost estimates. In early stages of a tunnel project, often a decision is made that for budget level or order of magnitude estimates, a bottoms up estimate is not necessary or appropriate since the project definition is not far enough along. Instead, a quick estimate can rely on unit price methods such as \$-inch foot of tunnels in similar ground conditions. However, once an unrealistic number is estimated, it often stays with the project and establishes unrealistic expectation through out the life of the project as discussed previously. The sooner an experienced construction based scheduler and estimator gets involved the better the schedule and cost numbers will be, even if the estimator needs to make assumptions on typical design details.

## **14.8 CLAIMS AVOIDANCE AND DISPUTES RESOLUTION**

Uncertainty and change in site condition on underground projects often leads to disputes, change orders and claims. Owners usually have years to plan a project, perform geotechnical investigations needed to understand the ground through which the tunnel will be built, and deal with all the regulatory agencies and third party abutters. Contractors are in business to make money. They usually have no input to the project plans, specifications, schedule or contracts but must accept these as given and in the space of a few months come up with a cost to perform the work and beat out all other contractors bidding the work. Underground projects are expensive, linear, and sequential, so any delay to the project leads to extra expense that the contractor will look to recover from the owner.



Recognizing the uncertain nature of underground construction and the need to make the contracts fairer, the federal government has mandated the use of a differing site condition clause in underground projects. This clause says in effect, that if the ground conditions differ from what was predicted or from what reasonably could have been anticipated in similar work then the owner would recognize this as additional costs and the contractor would be issued a change order to cover a portion of this extra cost and schedule. The alternative would be for the contractor to include into its bid a contingency to cover the potential costs if an unknown or unusual event occurred. If the contractor does this and the event does not occur then the owner is stuck paying for this uncertainty. The other option the contractor has is to not include any costs for these potential occurrences but to sue the owner to recover any additional cost should a risk event occur.

How can claims be avoided? One way is to incorporate a change condition clause into the contract. This is one indication that the owner is willing to share the risk on the project. Risk should be given to the party to the contract that is in the best position to control the risk. More and more owners are recognizing that they own the risk of the underground.

Another indication of the owner's stance on risk sharing to a contractor bidding the work is how the contract is worded in areas like, time related impacts of delays caused by the owner or outside agencies or third parties. Contracts that indicate that there will be "No Damage for Delay" make too plain to the contractor that the owner is not willing to share risk but is actively looking to transfer to the contractor all risks that they are not legally required to retain.

#### **14.8.1 Disputes Resolution**

Since disputes are inevitable in underground construction: how should they be dealt with? Suffering with these same issues the practitioners of underground construction got together and in 1974 produced a manual dealing with, "Better Contracting Practices for Underground Construction". This publication contained 14 recommendations to improve the way underground projects were managed. One of these recommendations was the use of a Disputes Review Board (DRB) and the use of Escrow Bid Documents.

A Dispute Review Board is usually a trio of underground experts experienced in the design and construction of underground projects that are brought together by both the owner and contractor to, on a regular basis, become familiar with the project, its progress and problems and to offer their opinion about who is right and wrong in any disputes that arise on the project that cannot be settled by the contracted parties. These "three wise men" as they are sometime referred to, must be impartial and have such standing in the underground in industry that their decisions are accepted.

In any dispute that the DRB is asked to weigh in on, both sides are allowed to lay out their positions and refute the positions of the other side. The DRB is allowed to ask questions and evaluate the "evidence" supplied by both sides. Usually the DRB issues a written decision that then is used as the basis of settling the dispute. One of the side benefits of using a DRB is that often contractors will work hard to reach a settlement with the owner instead of going to the DRB and in fact the presence of a DRB will prevent a contractor presenting frivolous or questionable issues to the DRB so as not to look bad to their peers.

Escrow Bid Documents was another recommendation in the Better Contracting Practices publication. An owner will require that all bidders submit with their bids or the low 3 bidders submit within several days of submitting their bids, all the documents, quotes and other information that the bidders used to produce their bids. These documents usually must conform to minimum formats and are sealed. The owner and the low bidder then open the sealed documents to ensure that all the required information is present and if not the additional info is then added. The complete documents are then sealed and stored with an independent agent. The documents are then available if there is a dispute and can be opened in the presence of both

owner and contractor, to determine what was and was not included by the bidder in the cost at the time of the bid. After the project is complete the Escrow Bid Documents are returned to the contractor.

There are other methods of dispute resolution used to help settle issues that arise on underground projects, arbitration and mediation to mention a few.

## 14.9 RISK MANAGEMENT

By its nature, risk sometimes defies definition, and the most onerous risks are those that were not anticipated by designer, contractor, owner or by anyone else. A well structured risk management process will anticipate, to the extent possible, the potential risks, weigh their probability and effects, and plan for handling the risk to the degree necessary to de-risk the project through every phase from conception to completion. The project owner who does not use risk management often fails to control the cost, schedule, quality and safety of the work.

The origins of risk in tunneling and underground construction often stem from unanticipated obstructions, natural or manmade, soil and groundwater conditions differing from those anticipated; ground behavior differing from that ordinarily expected; and misinterpretation of ground conditions leading to the choice of inappropriate construction methods or equipment. Analysis of historical records, photos and maps, as well as a comprehensive geotechnical investigation plan and other exploratory work, help determine the ground conditions along the tunnel horizon and location of existing or abandoned structures along a tunnel alignment, thereby reducing risk. Administrative risks (e.g., site unavailability for external reasons) are as important to eliminate. Interface risks between adjacent contracts, including items such as potential for late delivery of site or facility by one contractor for use by another, are another type of risk that can derail a construction schedule. Underlying mitigation for risks on tunneling projects include design of features that reduce or eliminate the identified risk; selection of tunnel alignments that, where possible, avoid adverse ground conditions or avoid above ground sensitive structures; specification of minimum requirements for methods of tunneling and shaft construction coupled with monitoring and controls to be implemented during construction that identify adverse trends and warn against impending risks.

Risk assessment, risk analysis and risk management are required to assure the project is kept on schedule and within budget, and to provide greater accuracy in the application of project contingency. A comprehensive risk management process includes the use of risk workshops, development of an “actionable” risk register, risk analysis and the development of risk management and action plans. What’s important is early identification and communication of potential risk factors that might create delays and bottlenecks, followed by proactive management of threats to cost and schedule adherence and to identify opportunities for improvement (as shown in Figure 14-7).

Typically risk management starts by an owner and design engineer conduct a risk workshop in which all participants are encouraged to write down any and all events that could happen on and to the project and that could have impacts on the cost, schedule, quality, viability and/or safety of the project. In addition the participants need to try to determine the owner’s risk tolerance. What is insignificant, tolerable and intolerable to the owner for each of the major drivers of the Project? The Owner’s risk tolerances must be categorized on some scale so that they can be compared and weighed against cost drivers. On the schedule is 1 day delay acceptable? Is a week or a month tolerable? Is several months intolerable? The same for costs, depending on the size of the project, is \$5M tolerable? Is \$50 M intolerable? A scale or matrix (Figure 14-8) must be developed that rates risks consequences from inconsequential all the way to unacceptable so that choices can be made as to which to ignore, which to watch, and which to deal with or eliminate. These matrixes can be a 3x3, 5x5 or even 10x10. The more categories contained in the matrix the more effort is needed to manage this technical phase of the risk management process.

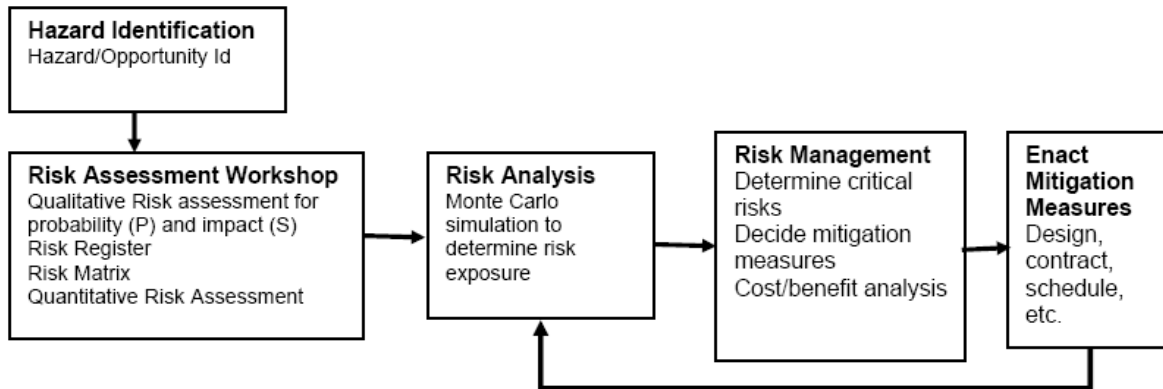

Figure 14-7 Risk Management Process

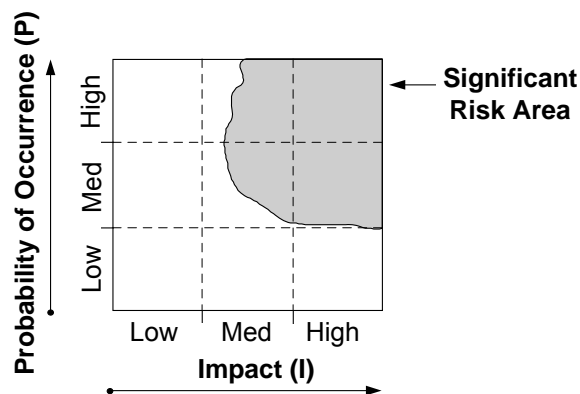

Figure 14-8 Typical Project Risk Matrix

A risk register is used as a way to catalogue the events that might happen on the project, and the probability and consequences if they occur. In addition it is also a tool to compare the risks, catalogue and mitigation measures chosen by the project team to either lessen the probability that the events occur or to lessen the consequences should they occur. The register also allows the project to keep track of all the mitigation efforts and the residual risks that remain. Knowing these residual risks allows an owner to then decide what to do with these residual risks. Residual risks can be accepted by the owner, passed on to the contractor, given to the insurance or bonding companies or can be candidates for additional mitigation. Once these events are catalogued then the workshop participants are asked to identify the probability that these events actually happening and if they happen, what would be the consequences or impacts on the project's cost, schedule, quality, viability and safety. Risk is actually the possibility of an event happening times the consequences that occur should the event happen.

The risk management process forms the basis of design development, accurate cost estimates and development of confident construction schedules. Risk Management and Action plans are developed

based on the residual exposure after the anticipated reduction of the risks have been achieved. Costs can then be attributed to the mitigation of these risks. However, the process does not stop there. Through each phase of the project identified risks should be further evaluated in terms of ultimate risk exposure in schedule uncertainty, monetary value, probability and mitigation costs. Figure 14-9 illustrates the risk management process throughout phases of a project cycle.

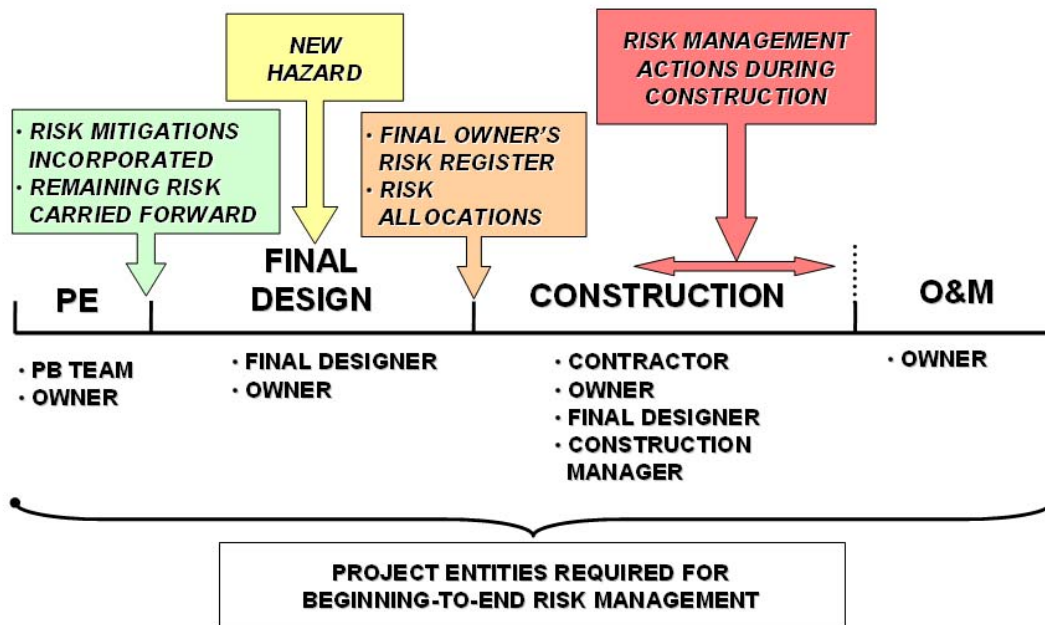

Figure 14-9 Risk Management throughout the Project Cycle

On complex projects design support technologies such as virtual design and construction (VDC) combined with risk management and risk analysis software provides added value in managing risk in the design phase and during construction. Using virtual design and construction and risk analysis models project managers are able to visualize the impacts of unmitigated risk on the project, perform interference checking and clash detection to mitigate risk and control schedule overruns. Project managers can see or experience the project in a highly visual, consistent and interactive manner, and individual teams can drill deeper into the modeling database to evaluate specific project elements, options, layers, disciplines and construction phases of any contract package or combination of packages, that will support critical decision making and mitigate risk. By combining the attributes of VDC and risk analysis projects can avoid costly design and construction errors before they happen and improve communication and coordination during construction. A collaborative risk analysis and VDC approach to risk management takes the guess work out of the project.

Once the underground facilities are in place, some might suggest that most of the risks have been overcome, and the facility will operate for its scheduled life as planned. This is only true only if certain operational risks are mitigated. In fact, the long-term consideration of the operational risk for a tunnel sets a number of design criteria for the works.

## CHAPTER 15

### GEOTECHNICAL AND STRUCTURAL INSTRUMENTATION

#### 15.1 INTRODUCTION

In the context of this manual, the primary purpose of geotechnical and structural instrumentation is to monitor the performance of the underground construction process in order to avoid or mitigate problems. If such monitoring also serves a scientific function, or leads to advancement in design procedures, that is a bonus rather than a primary reason for its implementation. A few decades ago monitoring was not a particularly easy task because the tools were few and some not so well developed. Monitoring was generally performed manually, and the refining of data to a state of usability from the raw readings often required long hours of “number crunching” with relatively crude calculators and more long hours of plotting charts and graphs by hand.

The world of the early 21<sup>st</sup> century is very different for those who pursue the art of determining what ongoing construction is doing to its surroundings, or even to itself. Advanced and refined types of instrumentation abound, and electronics coupled with computers has made remote monitoring, even from half a world away, practically an everyday affair. It is common for even medium sized projects to run a computerized database that reduces raw readings to usable data and can report on any combination of instruments and data plots within minutes. It can also inform interested parties any time of the day or night if movements or stresses have reached pre-set trigger levels that demand some kind of mitigative action. The possibilities have not gone unnoticed by project Owners, and comprehensive instrumentation and monitoring programs are becoming the norm rather than the exception. This is perhaps especially true in the world of tunneling where even small mis-steps can result in damage that may lead to lawsuits or the shutting down of operations.

Readers should be aware that much of the instrumentation described herein may not lend itself particularly well to rural highway tunnels, especially those located in hilly or mountainous terrain that may limit the need for instrumentation if great tunnel depth minimizes ground settlement at the surface, and if lack of surface development minimizes the number of third-party abutters who could be affected by construction. Also, even if a tunnel does require monitoring for whatever reason, great depth may minimize possibilities for damage to surface installations and push designers and constructors toward more in-tunnel installations.

The amazingly large number of instrument types available to tunnelers means that this chapter can do little more than “broad brush” the subject. The most common and/or most promising types of instrument will be covered, but readers will have to turn to the references to see what else is available. A few types will be covered to some degree in other chapters; for example, earth pressure cells that are commonly used by those who specialize in Sequential Excavation Method (SEM) tunneling (Chapter 9), but are not so much used by those who work in other types of underground construction. Although vibration monitoring will be covered herein, the monitoring of noise will not be covered because it is normally considered an environmental rather than a structural or geotechnical concern. Some instruments, such as those used to determine in-situ ground stresses prior to tunneling, will not be covered because they more rightly belong in the category of site investigation instrumentation. And finally, there will not be space to delve deeply into the theory of operation of the various instruments discussed, so readers will again have to turn to the referenced publications for more details.

The first few sections of this chapter will discuss the types of measurements typically made:

- Ground Movement away from the tunnel
- Building Movement for structures within the zone of influence
- Tunnel movement of the tunnel being constructed or adjacent tubes
- Dynamic Ground Movement from Drill & Blast
- Groundwater Movement and Pressure due to changes in the water percolation pattern

The first three items comprise quasi-static changes in position, and the last is also concerned with long-term effects. In contrast, Dynamic Ground Movement covers response due to vibration caused by the shock waves generated by explosive charges used to excavate rock.

All of the monitoring needs to be coordinated to fit with the tunnel construction schedule, and to establish the actions that must be taken in response to the instrumentation findings. These topics are discussed in the final section of this chapter.

## **15.2 GROUND MOVEMENTS – VERTICAL & LATERAL DEFORMATIONS**

### **15.2.1 Purpose of Monitoring**

The primary purpose for monitoring ground movements is to detect them while they are still small and to modify construction procedures before the movements grow large enough to constitute a real problem by affecting either the advancing excavation or some contiguous existing facility. For the advancing excavation, ground support has to be based on conditions encountered; monitoring either confirms the adequacy of the support or indicates whether more or different support may be required. Existing facilities may be at the ground surface – roads, railroads, buildings and the like – or they may be below ground in the form of utilities or other transportation tunnels such as subways. The first line of defense against potentially damaging movements is to detect them at depth in the ground immediately surrounding the advancing tunnel and take mitigative action before those movements can “percolate” upward toward the surface. This kind of monitoring can provide an indication of whether ground treatment such as grouting is effectively limiting movements that might otherwise result in troublesome settlements. Ground can, of course, move upward as well as downward, in the form of heave from unloading that can destabilize the invert of the tunnel under construction, and as a side effect lead to lateral, possibly damaging deformations as the ground moves toward the excavation to take up the slack. In addition to helping control the ground, the data developed can be used (and this may be said of all monitoring discussed in succeeding paragraphs) to verify design assumptions and to evaluate claims by construction contractors and third-party abutters.

### **15.2.2 Equipment, Applications, Limitations**

Several types of instrumentation are used to monitor ground movement:

- Deep Benchmarks
- Survey Points
- Borros Points
- Probe Extensometers
- Fixed Borehole Extensometers, either measured from the surface or during advance of the tunnel
- Telltales or Roof Monitors
- Heave Gages

- Conventional Inclinometers
- In-place Inclinometers
- Convergence Gages

### 15.2.2.1 Deep Benchmarks

Deep Benchmarks (Figure 15-1) are steel pipes/casings drilled into stable strata – preferably sound bedrock – outside the advancing tunnel’s zone of influence. They are used when existing benchmarks, such as those installed by the USGS, are not available and it is important to know actual elevation changes of other instruments meant to detect movements. If installed close to the construction, deep benchmarks need to be carried below invert. They must be absolutely stable in spite of any ground movements that are occurring because it is the surface level collars of these devices that become the unmoving points from which locations and elevations of other instruments can be determined by surveying. A major complication in the installation of benchmarks can be the difficulty of installing them in a location and/or to a depth that absolutely guarantees no movement as tunneling proceeds. In this regard the lowering of groundwater in a soft ground environment can contribute to ground settlements well outside the immediate projected footprint of the advancing tunnel, so the instrument has to be well placed to guard against this eventuality. In cases of very large projects or overlapping projects that cause the water table to be drawn down across a large area, benchmarks have been known to settle even when founded in bedrock because some rock types can be dependent to a degree on pore water pressure for their ability to carry load.

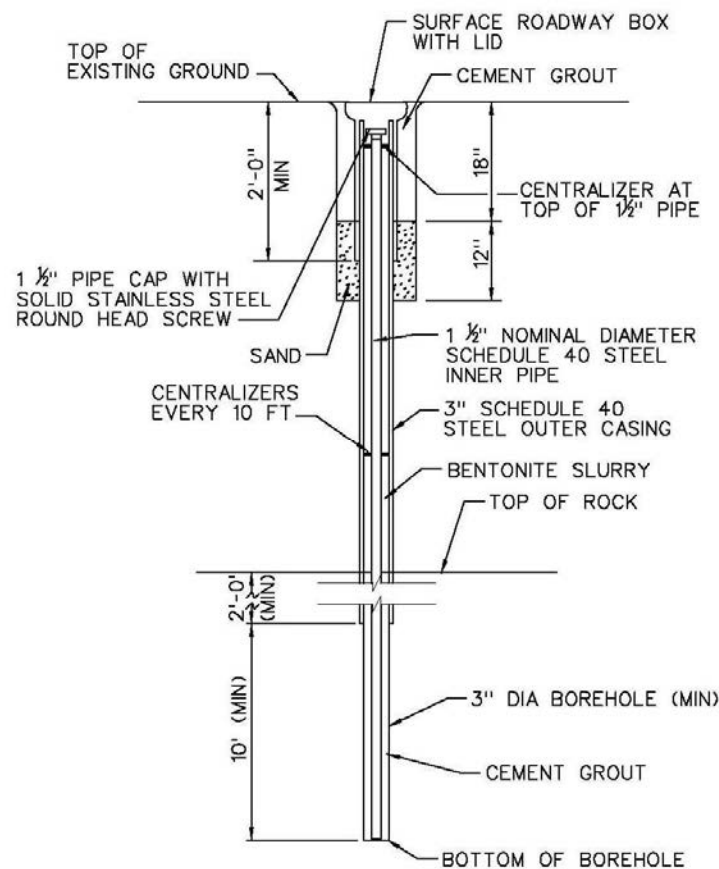

Figure 15-1 Deep Benchmark

### 15.2.2.2 Survey Points

Survey Points are used to detect ground movements at the surface or a few feet below the surface. They may be as simple as wooden stakes driven into the ground and their elevations surveyed through backsighting to a deep benchmark (Figure 15-2). Penetration needs to be at least a foot or so to guard against dislodgment, and the tops should not extend high enough to interfere with mowing machines if they are in a grassy area that requires routine maintenance. A survey point may also be somewhat more sophisticated and take the form of a steel rod with a rounded reference head driven several feet into the ground for better avoidance of possible dislodgment and surface effects such as frost heave (See Figure 15-3). This type of point needs to be protected at the surface by a small utility type roadbox with a secured cover so there is no disturbance to the rounded head. A rounded head is considered best because a surveyor can then always find the high point that has been surveyed in the past for good continuity in the readings. Because there is no hard connection between the rod and the roadbox – the one sort of “floats” inside the other – the survey point is also protected from being pushed down in case of the passage of a heavy vehicle. The major concerns with any type of survey point is the need to keep it out of the way of other users of the area and also protected against damage that may require replacement and lead to loss of continuity between the latest reading and the string of readings taken in the past.

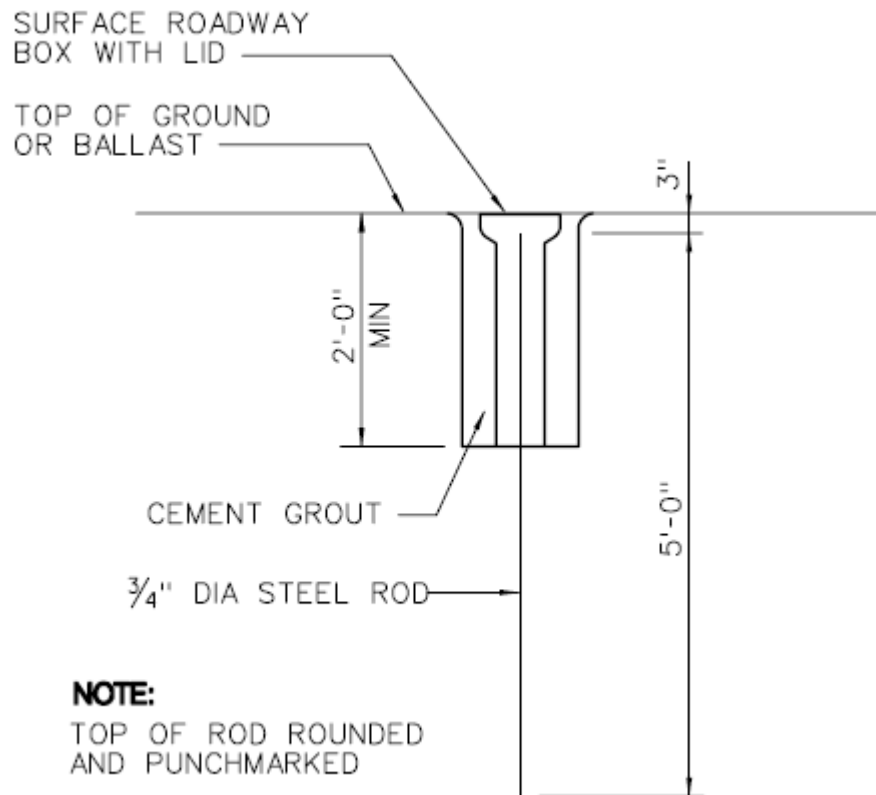

Figure 15-2 Survey Point



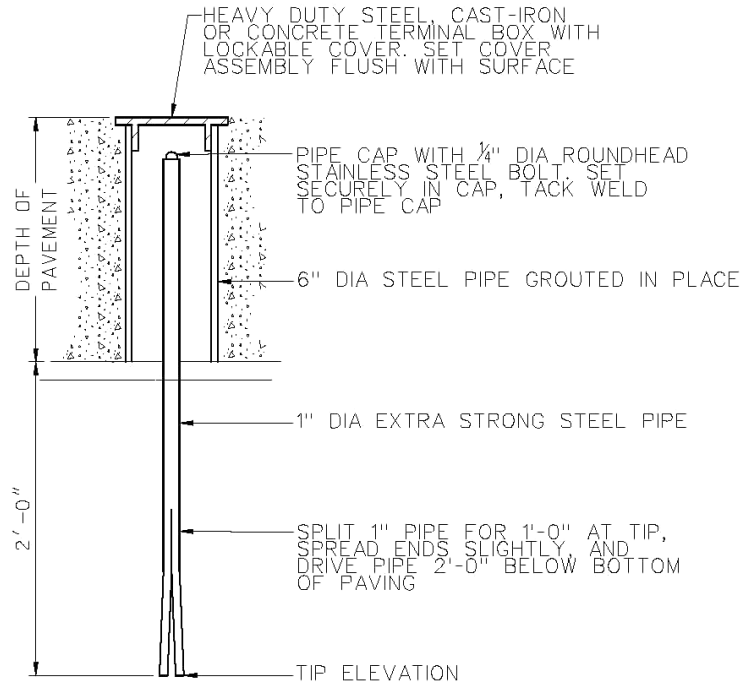

Figure 15-3 Survey Point in Rigid Pavement Surface

### 15.2.2.3 Borros Points

A Borros Point is basically an anchor at the lower end of a driven pipe (See Figure 15-4). The anchor consists of three steel prongs housed within a short length of steel pipe with points emerging from slots in a conical drive point. Installation is achieved by advancing a borehole in soft ground to a few feet above the planned anchor depth and the anchor inserted by attaching extension lengths of riser pipe and outer pipe. When the point reaches the bottom of the hole, it is driven deeper by driving on the top of the outer pipe. The prongs are then ejected by driving on the riser while the prongs are released and the outer pipe bumped back a short distance to achieve a positive anchorage. Such installations are useful for determining the amount of settlement at one precise depth with more certainty than the simple driven steel rod described above, and they are relatively simple and economical. The amount of anchor movement is determined by surveying or otherwise measuring the movement of the inner riser pipe at the ground surface. One disadvantage with such movement detection (and this can be said of most instruments whose data depends on movements measured in a surface mounted reference head) is that, if settlement is great enough to have affected the surface at reading time, then the whole instrument may be moving downward by a certain amount while the anchor is moving downward by a greater amount. Absolute anchor movement may then be difficult to judge unless ground elevation surveys are undertaken at that time and the changes added to the apparent anchor movement.

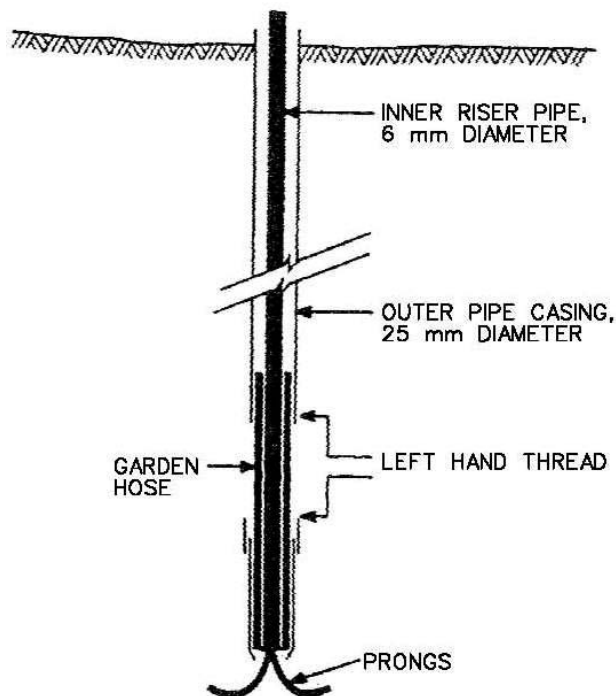

Figure 15-4 Schematic of Borros Point (After Dunnicliff, 1988, 1993)

#### 15.2.2.4 Probe Extensometers

Probe Extensometers are used to measure the change in distance between two or more points within a drilled hole in soft ground, through use of a portable probe containing an electrical transducer. As shown in Figure 15-5, the probe, which contains a reed switch, is inserted into a casing in the drill hole in which the reference points, each of which contains an array of bar magnets, have been fixed in a way to surround the casing on the outside. In the most common type of installation, the reference points are held in place by spring loaded anchors – leaf springs – that “bite” into the ground. The points are free to move with the ground because the outer support casing will have been removed and replaced by grout. The probe detects the depth of the reference points for an indication of whether the soil at those depths is settling due to disturbance from construction. A probe extensometer can thus measure the settlements at a much larger number of depths than can a Borros Point. Probe extensometers are generally drilled to a depth below any potential zone of influence near a cut-and-cover or mined tunnel. The bottom reference point then becomes the unmoving reference from which the movements of the shallower points are judged. In a typical situation near a mined tunnel, it is likely that the lowest moving point will exhibit the most settlement, and that settlements will prove to be less as the probe moves up the casing to where the settlement trough is widening. One problem with probe extensometers is that collection of data can be operator sensitive as the instrument reader strains to detect the exact location of the probe at each reference point depth by listening for the electronic “beep” to ensure readings at precisely the same spot time after time. Another concern may be the time required for monitoring, especially if a large number of reference points have been installed, because the probe does have to be lowered to the bottom of the casing and then readings collected as it is slowly winched back to the surface.

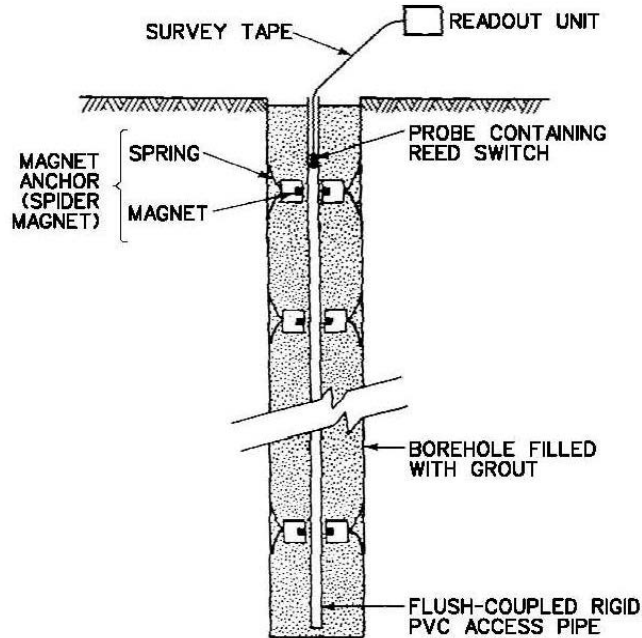
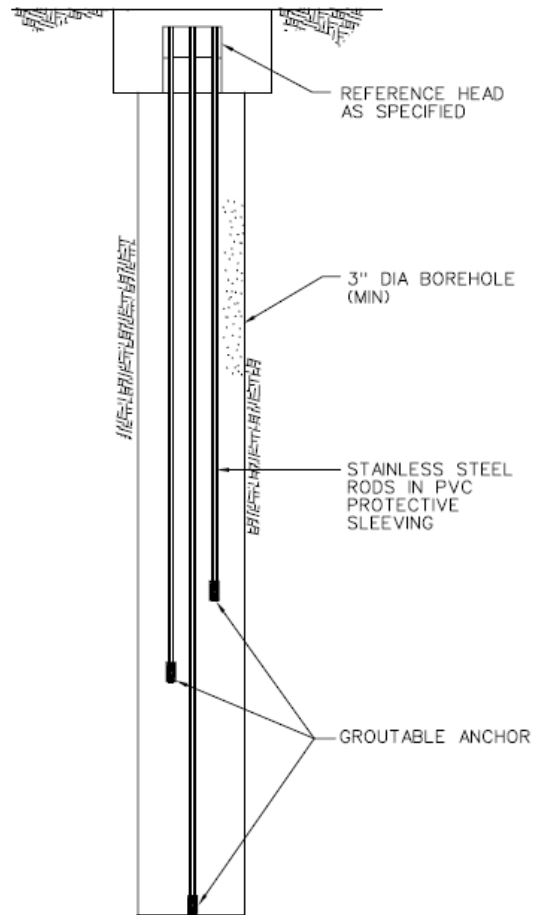

Figure 15-5 Schematic of Probe Extensometer with Magnet/Reed Switch Transducer, Installed in a Borehole (After Dunicliff, 1988, 1993)

#### 15.2.2.5 Fixed Borehole Extensometers Installed from Ground Surface

Fixed Borehole Extensometers installed from ground surface may be used in soft ground or rock and may be Single Position (SPBX) for settlement measurements at one specific elevation or Multiple Position (MPBX) for measurements at several elevations. Figure 15-6 illustrates a schematic of an MPBX. The anchors of a borehole extensometer are grouted into the ground, commonly at various distances above the crown of an advancing tunnel, and connected to surface mounted reference heads by small diameter rods of steel or fiberglass. By detecting movement of the tops of the rods at the surface, one can tell how much each anchor – and hence its increment of soil or rock – is moving in response to excavation and so take steps to mitigate developing problems. Manual readings can be taken in a matter of minutes, assuming there is no problem with access to the instrument collar. However, automatic readings with an electrical transducer and datalogger – which can be salvaged/moved for use on other instruments – are relatively inexpensive and can provide real time data that feeds directly and quickly into a computer for fast analysis and databasing. Although extensometers oriented vertically over mined tunnel crowns are the most common installations, two others may prove useful in particular situations: (a) instruments angled in toward tunnel crowns or haunches from sidewalks where vertical installations are precluded by heavily travelled roads; and (b) instruments installed along the sidewalls of mined tunnels or cut-and-cover excavations where a knowledge of the vertical component of overall ground movement may be advantageous. A common problem with manually read instruments is the one of operator sensitivity, and if more than one reader is employed, they need to practice together to make certain they can monitor with good consistency. Remote monitoring leads to the concern that data collectors and analyzers may, without themselves personally having an eye on the construction operation, be unaware of the type and scheduling of activities that are affecting the data. Hence it may be necessary to make arrangements for construction progress reports to be delivered on a tighter schedule than otherwise might be necessary.



**NOTE:**  
1. TYPICAL ARRANGEMENT SHOWN.

Figure 15-6 Multiple Position Borehole Extensometer Installed from Ground Surface

### 15.2.2.6 Fixed Borehole Extensometers Installed from Advancing Excavations

Fixed Borehole Extensometers installed from advancing excavations are a fairly obvious need if sidewall movements are required for a cut-and-cover excavation. Such horizontal installations are common and the drilling/installing operation has to mesh with the construction so that the larger operation is not overly impacted by what may appear to be a peripheral activity. (Note: “Horizontal” installations are seldom truly horizontal because angling downward by 10 or 15 degrees makes it much easier to manage the grouting of the anchors.) The installation of extensometers oriented from the vertical to the horizontal – including all angles in between – from inside advancing mined rock tunnels may be mandated by the lack of access from the ground surface (Figure 15-7). If possible, they are normally installed just behind a tunnel working face or the tail shield of a TBM. In this position they can provide data on incipient fallouts or more subtle rock movements toward the opening. If installed where a small tunnel is to be enlarged to greater size at a later time, the instrument heads can be recessed beyond the initial excavation outline and saved for use in monitoring the larger excavation. In this way they provide an almost

complete history of rock movements from the earliest to the latest point in time. Another way to use these instruments is to install them from a first driven tunnel toward the location of a following twin tunnel. Readings then indicate whether the pillar between the two tunnels is loosening so that steps can be taken to mitigate the problem.

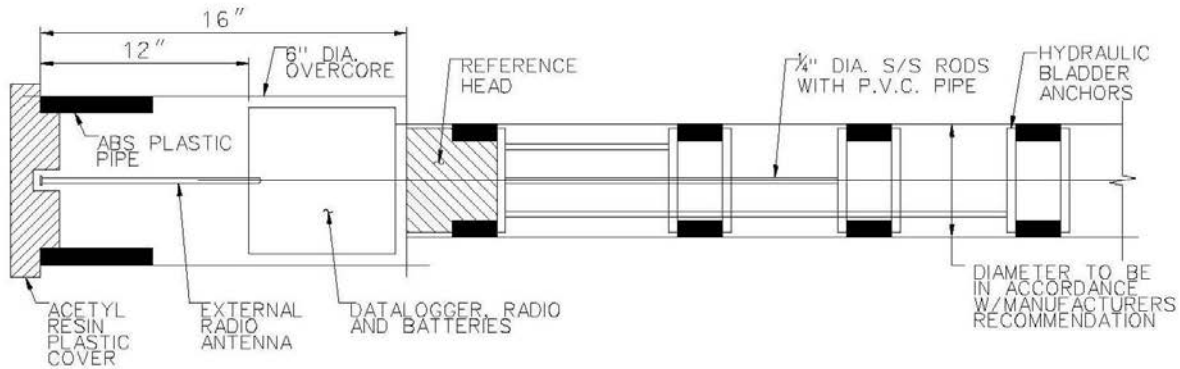

Figure 15-7 Horizontal Borehole Extensometer Installed from Advancing Excavation

Complications for these in-tunnel instruments are more numerous than for those installed from somewhere outside the excavation. As noted, the installation has to be meshed with the construction operation, a particularly tricky proposition in the confines of a small mined tunnel, where constructor complaints of interference are extremely common. Even the collection of data, if it is performed manually, may be obtrusive, especially if cessation of tunneling, use of ladders, or help from constructor personnel are involved. Remote monitoring is also possible, but then there is electrical wiring to be run and the need to find a place for the datalogger(s) to be out of the way. By whatever method the in-tunnel instruments are monitored, the reference heads need to be protected, often by countersinking them in the tunnel wall and perhaps through installation of protective covers. This is especially true where there is going to be more blasting in the vicinity, but also true even where blasting is not involved. Miners tend to have little reverence for objects whose importance is not obvious to them, so vandalism and theft of instrument accoutrements has to be guarded against. Finally, there is the fact that an in-tunnel instrument is almost always installed after the tunneled ground has started to relax, so the initial readings are seldom true zero points from which to compute follow-on movements. The instrumentation specialist's only recourse is to continually press the constructor for access to install instruments at the earliest possible opportunity.

### 15.2.2.7 Telltales or Roof Monitors

Telltales or Roof Monitors (Figure 15-8) are other devices that can be installed from inside an advancing rock tunnel. They are designed to be installed with anchors in stable rock beyond the tips of rock bolts in tunnel roofs to provide fast feedback on stability. The immediate safety of the miners/tunnelers is the primary reason for the instrument's use. The devices were pioneered in French coal mines in the 1970s and further refined by the British and others in succeeding years. The first ones were steel rods with a single anchor and visual movement indicators in the tunnel roof that could be seen by miners as they worked. Simple and installable by rock bolting crews, they proved vulnerable to shearing due to movement of rock blocks and were eventually replaced by more flexible steel wires that are less prone to failure. Modern versions have as many as three anchors and can be wired for remote reading by a trained person watching the data on a laptop computer. Roof monitors are widely used around much of the world and are gaining acceptance in the U.S., where they deserve to join the ranks of commonly used

instruments. They are now used in civil as well as mine construction and also in rock other than flat lying sedimentaries commonly associated with coal seams. As of this writing, the primary factor in considering use of roof monitors in the U.S. may be the need to educate tunnel designers and constructors in their efficacy and ease of use.

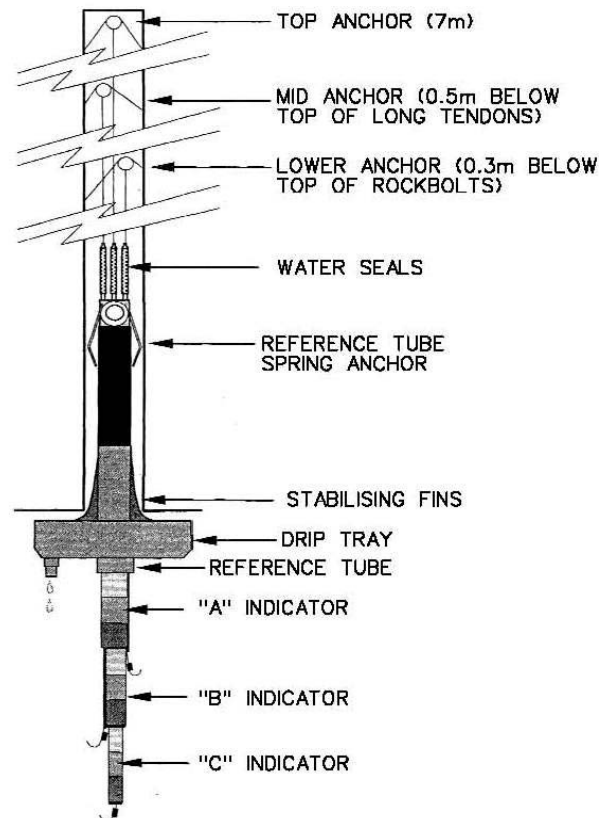

Figure 15-8 Triple Height Telltale or Roof Monitor

### 15.2.2.8 Heave Gages

Heave Gages are most commonly used when excavating for open cut or cut-and-cover in soft clay where there is potential for the bottom to fail by heaving as overburden load is removed. There are several instruments with which heave can be detected and measured, but almost all either suffer from lack of accuracy or are prone to damage or malfunction. Interestingly, the magnet/reed switch gage packaged as for a probe extensometer is probably the best alternative (Figure 15-9). In this type of installation the user measures increasing rather than decreasing distances between spider magnets and a fixed bottom anchor. With care taken to make certain the bottom anchor is well below any expected zone of movement, the installation is made inside the cofferdam prior to start of excavation. After initial readings are taken the access pipe is sealed 5 to 10 feet below the ground surface through use of an expanding plug set with an insertion tool, and the pipe is cut with an internal cutting tool just above the plug. A good fix is made on the plan location of the instrument and, just before the excavation reaches the plug, the pipe is located, a reading made, and the pipe again sealed and cut. The procedure is repeated until excavation is complete. The concern with such installations – a concern not overcome with alternative installation types – is that any large excavation is made by means of heavy equipment, and operators are not prone to watching and caring for things as small as a heave gage pipe. It is common for the gages to be damaged beyond use,

and their protection can be assured only through some forceful construction management and sometimes the levying of penalties for instruments damaged as a result of contractor carelessness.

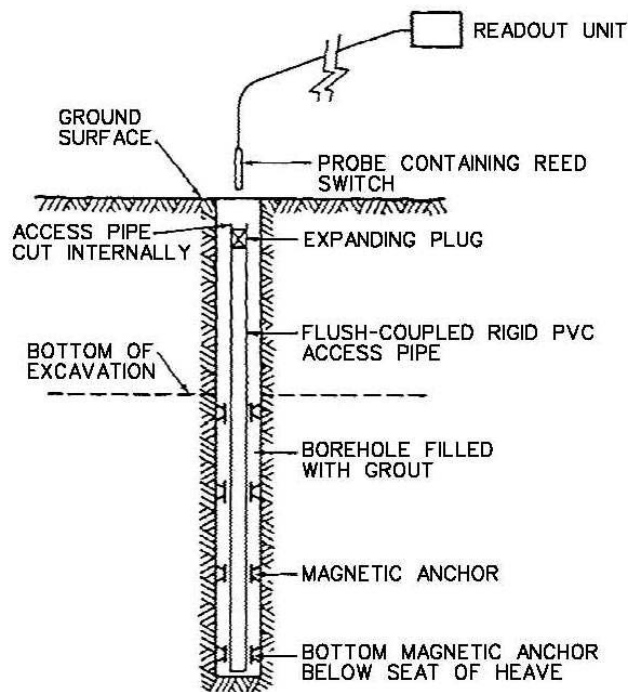

Figure 15-9 Heave Cage

### 15.2.2.9 Conventional Inclinometers

As shown in Figure 15-10, conventional Inclinometers are aluminum or plastic casings drilled vertically to below the level of construction into a stable stratum and used to determine whether the surrounding ground, either rock or unconsolidated material, is moving laterally toward the excavation. Each casing has tracking grooves to guide the sensing probe for orientation both parallel to and at right angles to the axis of the excavation. The probe, which contains tilt sensors, is lowered on a graduated cable to the bottom of the hole and winched upward, with stops at 2-foot intervals for collection of inclination data by means of a readout unit at the ground surface. An iterative process of tilt calculations from the unmoving bottom of the casing permits plotting of a profile that fixes each measured increment of casing in space in relation to the excavation. An initial set of inclination readings is taken before excavation begins and each set of readings thereafter during construction provides data on how the ground is moving when the user plots the newer movement curves against the initial pre-construction curves. The inclinometers are normally situated a few feet from the excavation periphery of open cut or cut-and-cover excavations, but may also be installed just outside a mined tunnel where lateral movement data may be combined with vertical movement data from the extensometers discussed above. The term “conventional inclinometer” is used herein to distinguish the manually read instrument from the “in-place” instruments described below. The major concern with a conventional inclinometer is the time consumed in the monitoring process. Readings are performed twice in each monitoring visit, once with the probe inserted in the “A” direction tracking grooves, then again with the probe in the “B” direction. A “check sum” procedure is carried out by examining the sum of the two readings at the same depth, 180 degrees apart, in order to remove any long term drift of the transducers from the calculations. It commonly requires 45 or so minutes for a reader to collect data from a 100-foot deep instrument, and that is assuming no indication of

excessive movements, which, if discovered, may require another set of readings for confirmation that the movements are real and not due to a reading error or instrument malfunction.

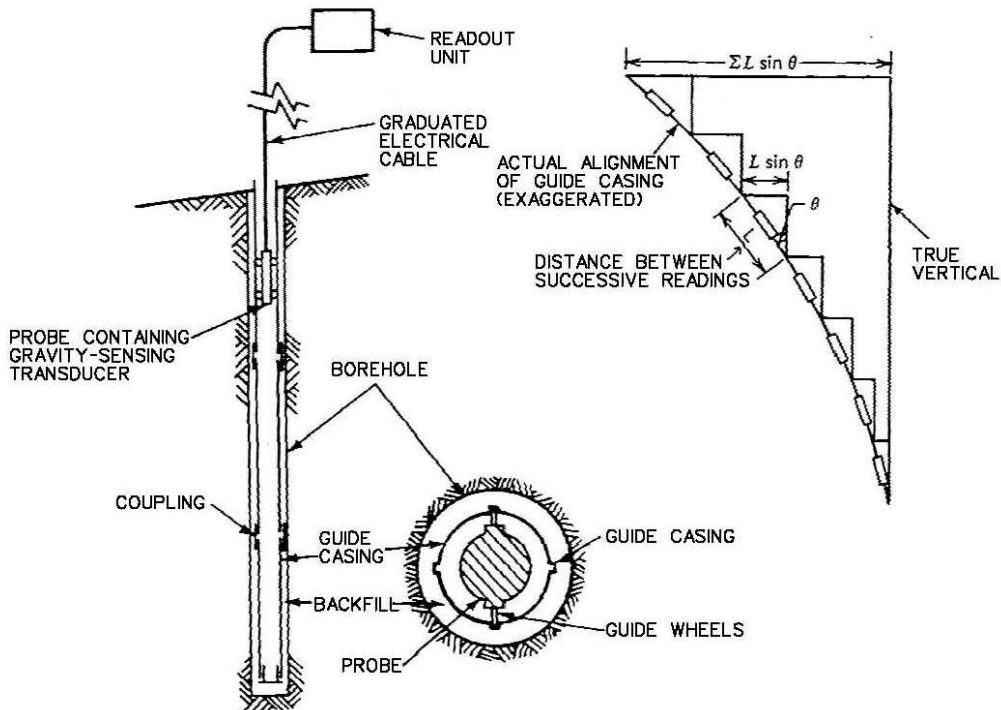

Figure 15-10 Principal of Conventional Inclinometer Operation (After Dunnicliff, 1988, 1993)

### 15.2.2.10 In-Place Inclinometers

In-Place Inclinometers are typically used for monitoring subsurface deformations around excavations when rapid monitoring is required or when instrumented locations are difficult to access for continued manual readings. The sensors are computer driven, gravity-sensing transducers joined in a string by articulated rods, and they can be installed equidistantly in the casing or concentrated in zones of expected movement (Figure 15-11). With the in-place instrument, as many as ten or twelve sensors are mounted in the casing and left semi-permanently in place. A larger number of sensors would be difficult to install in a standard size drill hole because each sensor has its own set of signal wires that take up space, and a very large number of sensors could result in the need for an uneconomically large diameter drill hole. Signals are fed to a datalogger at the surface and can be collected as often as required, or even fed by telephone line to the database computer for something close to real time monitoring. Compared with conventional instruments, the in-place inclinometer hardware is expensive and complex. This can sometimes be compensated to a degree by removing sensors from a bypassed instrument and installing them in a new location as the excavation progresses. A not-so-easily-overcome disadvantage of the in-place instrument lies in the fact that, if there is any long term drift in any of the sensors, it cannot be overcome through the check sums procedure described above. It is also true that the somewhat limited number of sensors in a standard in-place installation leads to a less smooth plot of movements compared with what can be achieved with the conventional inclinometer.



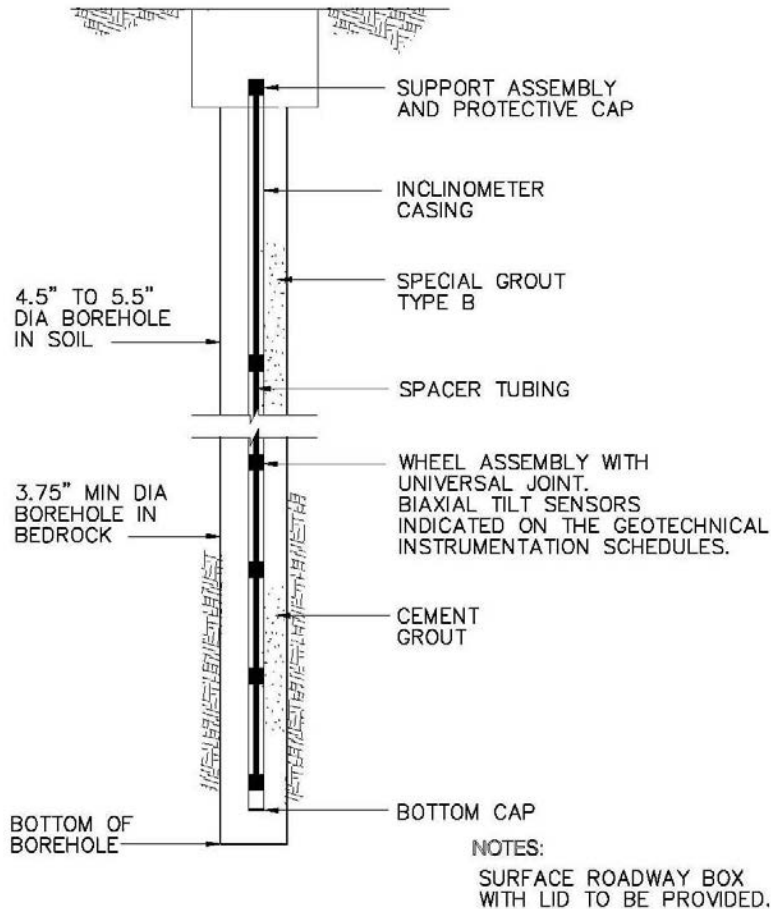

Figure 15-11 In-Place Inclinometer

### 15.2.2.11 Convergence Gages

Convergence Gages may be used for monitoring closure of the ground across either open excavations or mined tunnels. In the first instance they perform a function similar to an inclinometer, although with many fewer data points to give a full picture of movements. In the second function, they detect the load redistribution during and after excavation and the extent to which resulting structure/ground interaction affects the tunnel shape and the lining. Until now the typical gage has been a Tape Extensometer, which includes a steel tape with holes punched at 50 mm intervals (see Figure 15-12). Anchors that define monitoring points consist of eyelets on the ends of grouted rebar sections that extend into the ground for a foot or so (Figure 15-13). The tension in the tape is controlled by a compression spring, and standardization of tension is achieved by rotating the collar until scribed lines are in alignment. After attachment of the extensometer to the anchors and standardization of the tension, readings of distances are made by adding the dial indicator reading to the tape reading. In a typical mined tunnel the pattern of anchors includes one in each sidewall at springline level and one as close as possible to the center of tunnel crown. Three readings are taken in a tent shaped pattern and the results indicate whether the tunnel support is behaving in a predictable way. For very large tunnels, the patterns may be more like trapezoids or overlapping triangles, which requires the installation of additional anchors. Such readings are only relative readings, and if absolute elevation changes are needed, this is usually accomplished by surveying the anchor that is in the crown. (Installation directly in the high point of the crown is seldom possible because of the presence of the ventilation and other lines.)

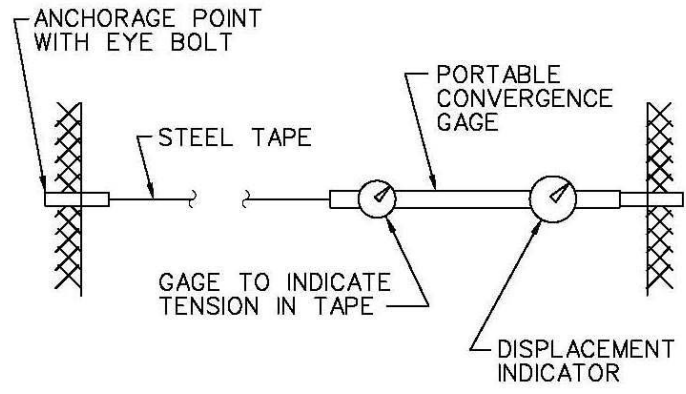

Figure 15-12 Tape Extensometer Typical Detail

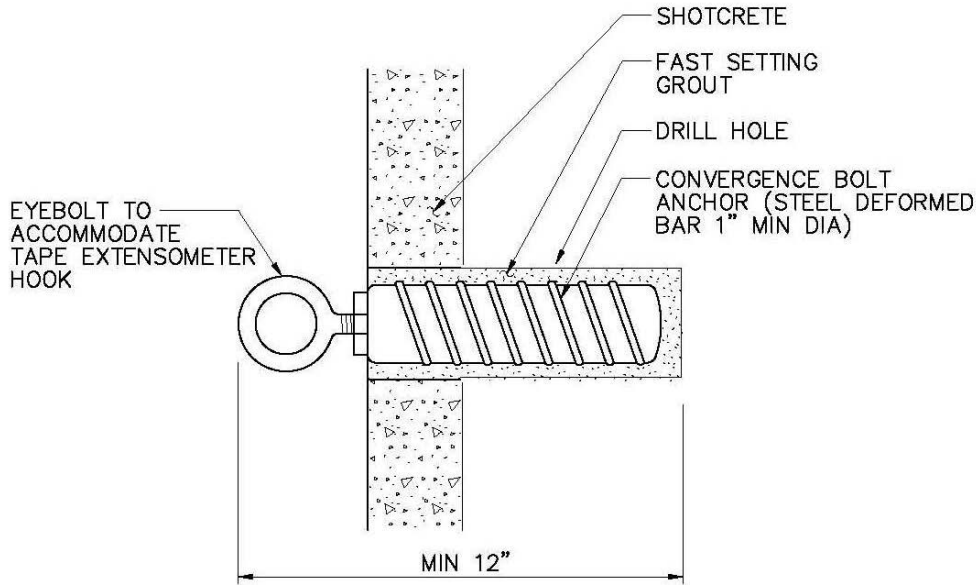

Figure 15-13 Typical Convergence Bolt Installation Arrangement

Whether the tunnel is conventionally mined or excavated by TBM, it is important to install anchors and begin readings at the earliest practicable time before the ground has begun to “work.” Unfortunately, this cannot always be accomplished, especially in a TBM tunnel because, even if the anchors can be installed in a timely manner, there are scores or even hundreds of feet of trailing gear that make the stretching of a tape extensometer essentially impossible. This means that measurements may not begin until the machine is a long way past the monitoring point and knowledge of total from-the-beginning movements cannot be obtained. For this reason it seems likely that an alternative to the tape extensometer is going to be the best choice for future monitoring of tunnel convergence, and it will be in the form of a distometer. The device is small, hand held, and can be used to very accurately determine distances to a target by emitting a laser or infrared beam that is reflected from the target and detected by the same device. By installing brackets or bolts that also include targets at the places where tape extensometer eyelets would normally be placed, monitoring personnel can detect the changing shape of a tunnel without having to stretch a physical connection between points. There remains the problem that a physical object – such as TBM trailing gear – between targets will interfere with the distometer lines of sight and still not permit

measurements in the standard tent shape. By judicious placement of additional brackets and targets at monitoring sections, it should be possible to gather data by working around the trailing gear in a TBM tunnel with patterns of measurements more like the afore mentioned trapezoids or overlapping triangles.

## **15.3 MONITORING OF EXISTING STRUCTURES**

### **15.3.1 Purpose of Monitoring**

If the different parts of a structure should move uniformly by even large amounts, damage could be minimal, maybe non-existent, except perhaps for penetrating utilities such as water pipes that might not be able to accommodate themselves to such movements. However, most structures affected by construction react by exhibiting more movement of the parts closest to the excavation than of the parts that are further away. This differential movement is the principal cause of construction related damages because the affected structure may be subjected to forces it was not designed for. A building, for example, whose footings are settling on one side while the other side settles less or not at all will suffer tilting of some walls, and the racking that ensues may cause cracking or spalling of some architectural features, freezing of doors and windows, or, in the worst case, failure of one or more of the structural members. A bridge whose footings are subjected to differential movements may undergo extensions that literally tear it apart. In general, the detection of settlements is the first line of defense in the protection of existing facilities, whether they be surface (roadways, buildings, bridges) or subsurface (utilities, transit tunnels, other highway tunnels). The detection of tilting can also be useful and has become more common as the development of monitoring devices has proceeded in the direction of increased automation. The simplest kind of monitoring involves the detection and the tracking of joint separations and crack propagation in structural concrete or architectural finishes. The ideal is to detect and mitigate some or all of these movements before they have become severe enough to cause serious damage or perhaps constitute a hazard.

### **15.3.2 Equipment, Applications, Limitations**

As with ground movement instrumentation, there are a number of choices of instrumentation:

- Deformation Monitoring Points
- Structural Monitoring Points
- Robotic Total Stations
- Tiltmeters
- Utility Monitoring Points
- Horizontal Inclinometers
- Liquid Level Gages
- Tilt Sensors on Beams
- Crack Gages

#### **15.3.2.1 Deformation Monitoring Points**

Deformation monitoring points on roads, streets or sidewalks can be as simple as paint marks that get surveyed on a routine basis. However, paint has the disadvantage that it can be visually obtrusive, may wear off with time, and may not display a single spot that surveyors can return to time after time for good

data continuity. A better alternative is a small bolt-like device set in an expansion sleeve that can be installed in a small hole drilled in concrete or asphalt as shown in Figure 5-14. The point should have a *slightly* protruding rounded head with a consistent high point that is always findable by a surveyor as he or she searches for the same unchanging spot on which to set the stadia rod. It is important that the point not protrude too much because it might then become a tripping hazard or be vulnerable to damage from equipment such as snow plows. Although they are inexpensive to purchase and install, the ultimate cost of deformation monitoring points can grow to become relatively high if data collection becomes intensive because it depends upon the mobilization of survey crews. Also, such monitoring is not always foolproof because surveyors are not necessarily attuned to the need for that high degree of accuracy that is sought by instrumentation specialists. It is very common for data thus generated to exhibit a fair amount of “flutter,” i.e., apparent up-down movements that are not real, but are only the result of inconsistencies in the survey process. Such inconsistencies may result from the too-often changing of personnel in survey crews, changes that happen commonly due to the nature of the business. Luckily, extreme accuracy is not required in much of this paved surface monitoring, so if the surveyors can reliably detect changes of one-quarter inch or so, that is often good enough.

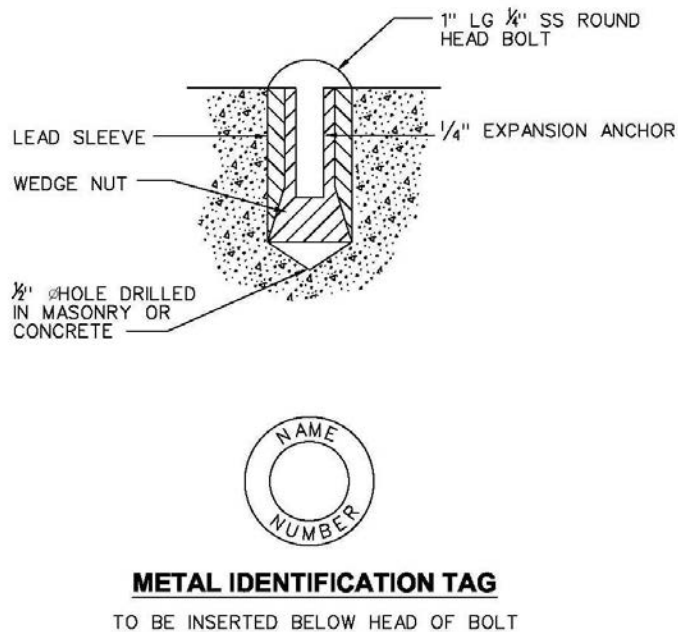

Figure 15-14 Deformation Monitoring Point in Masonry or Concrete Slab

### 15.3.2.2 Structural Monitoring Points

Structural Monitoring Points are survey points that are placed directly on the structures of concern, most often being installed on a vertical wall of a building or a structural element of a bridge (See Figure 15-15). Except for buildings, most structures can accommodate the monitoring point likely to do the best job and the “points” may take several forms. The simplest is a tiny scratch mark that can be easily found on each monitoring visit by a survey crew. A similar point is a stick-on decal target, which is a bit more obtrusive, but easily removable once it is no longer needed. A problem with such surface treatments is that, for buildings particularly, the monitoring point may be only on a facade that moves independently of the underlying structural elements whose movements it is important to detect. This may be overcome by the installation of a bolt-like device that penetrates to the underlying structure for a truer indication of the

movements taking place. The choice of monitoring points will often depend on the wishes of owners or managers of buildings who may object to the visual obtrusiveness or potential for damage from whatever may be installed. Possible damage can extend to the post-construction period when the monitoring point may have to be removed and patched, something that is often insisted on by the party who permitted its installation. Thus, it may be necessary to repair the scars left by the removal, which may entail the use of solvents, infilling, spackling, polishing, painting or replacement for satisfactory restoration.

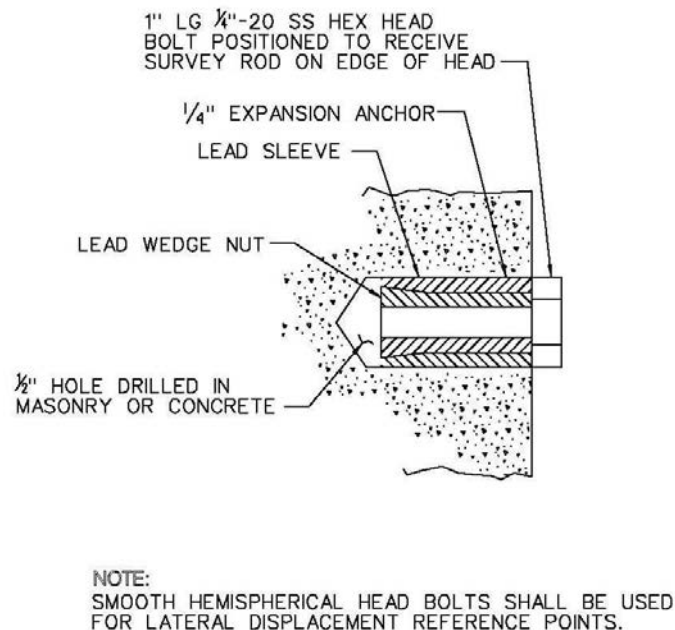

Figure 15-15 Structure Monitoring Point in Vertical Masonry or Concrete Surface

A large consideration in the use of structural monitoring points is the need to depend upon surveyors for the collection of data. Compared with roads and sidewalks, most structures have tight specifications on permissible movements (a lower mitigation-triggering level of 1/4 inch being not unusual), so surveying generally needs to be of a somewhat higher order, not necessarily as stringent as Class I, but at least done with additional care. One way to achieve this is to hold briefings in which the importance of great accuracy is instilled in the surveyors who will do the work. Another (if it is possible in the economic climate of the day) is to write and enforce the survey contract so that each group of structures is always monitored by the same crew using exactly the same equipment. In this way, the “flutter” may be reduced so as to minimize the need for instrumentation interpreters to average the peaks and valleys in determining if settlements are real or only apparent.

### 15.3.2.3 Robotic Total Stations

Robotic Total Stations are used for obtaining almost real time data on movements in three dimensions when it is not feasible to continually mobilize survey crews to collect data. The operation of a Total Station instrument (theodolite) is based on an electronic distance meter (EDM), which uses electromagnetic energy to determine distances and angles with a small computer built directly into the

instrument. Accuracy is generally much greater than that achievable with the use of classical optical surveying. Moreover, the equipment based on EDMs is capable of detecting target movements along all three possible plotting axes, the x, the y and the z. Total stations used in geotechnical and structural monitoring are electro-optical and use either lasers or infrared light as the signal generator.

Robotic (also called automated motorized) total stations are configured to sit atop small electric motors and to rotate about their axes. As shown in Figure 15-16, they are mounted semi-permanently and, at pre-determined intervals, automatically “wake up” to aim themselves at arrays of special glass target prisms (Figure 15-17) that can provide good return signals from a variety of angles. The target prisms, which are 2 to 3 inches in diameter, are installed on structures of concern and the total station instruments installed on other structures as much as 300 feet away. It is best to have the total stations installed outside the expected zone of influence for absolute certainty of measuring target movements with accuracy. However, it is standard practice to install some of the prisms definitely outside the influence zone so that they become reference points from which the total station can determine its own position and calculate the positions of the other prisms that may be subject to movement. Clear lines of sight from total station to target prisms are a requirement so that careful planning is required for proper placement. Data is recorded by means of the total station’s own computer and may be fed to a centralized database computer by means of telephone lines or radio signal.

A major aspect of robotic total station use is the front end expense incurred. Depending upon the number purchased, the cost of top quality target prisms can range from \$80 to \$200 each in 2009 dollars. The total stations can cost from 30 to \$40 thousand each, and they generally require the services of a specialist for the installation and maintenance. Nevertheless, for many projects where almost real time data on structural movements is necessary, this may be the only monitoring system capable of meeting all requirements.

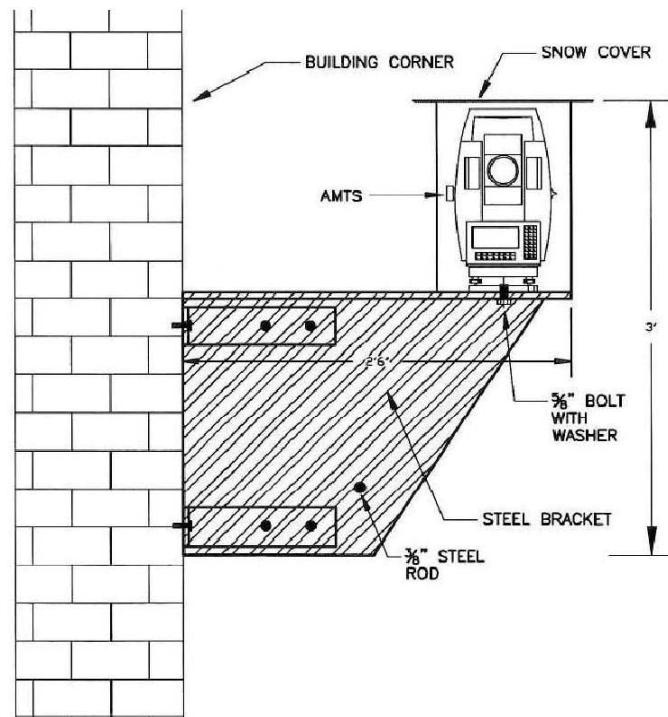

Figure 15-16 Robotic Total Station Instrument

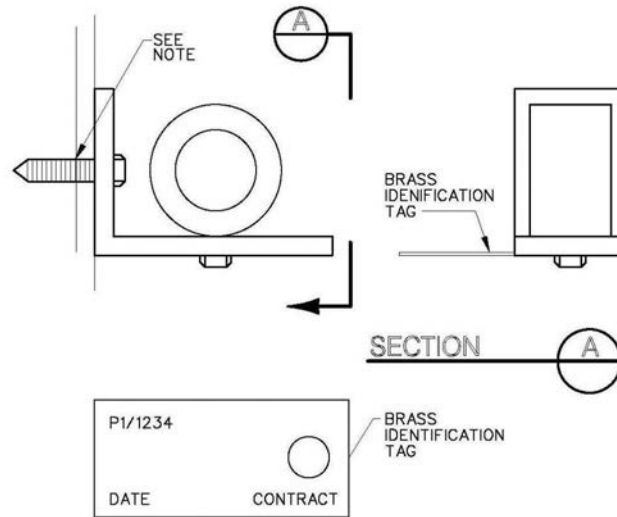

Figure 15-17 Target Prism for Robotic Total Station

#### 15.3.2.4 Tiltmeters

Tiltmeters are used to measure the change in inclination of structural members such as floors, walls, support columns, abutments, and the like, which may tilt when the ground beneath is being lost into an advancing excavation. Manual tiltmeters generally consist of reference points on plates attached to the surface of interest and monitored by means of a portable readout unit, the functioning of which is based on an accelerometer transducer. Because such an arrangement can be operator sensitive and reading is somewhat labor intensive, especially where continued access is not easy, it is becoming more common to collect data remotely by means of electrically powered tiltmeters whose sensing elements may consist of accelerometer or electrolytic level transducers placed in housings that can be attached to the element to be monitored. If only one direction of movement is expected, the chosen instrument may be uni-axial, but if there is a possibility of combinations of movement, the bi-axial instrument would need to be used. Figure 15-18 illustrates a biaxial tiltmeter. Because tiltmeters can inform users only about rotational components of movement, data must be combined with that from other instruments to determine levels of settlement that may be affecting the structure. The most difficult tiltmeter installations are those required for structural elements somewhere inside a building that is occupied. Even the manually read instrument, with a flat 6 to 8-inch diameter plate being the part attached, is somewhat visually obtrusive and may be objected to by a building manager. Remotely read tiltmeters are even more obtrusive because they need to be wired for electric power and connected to a powered datalogger that will probably need to have telephone connections if true real time data is needed. There is some controversy within the monitoring community about the best installation height for these instruments, with some opting for lower floors and some for higher floors where absolute wall movement – though perhaps not *tilt* per se – will be greater. The argument is often laid to rest by a building manager who will permit such installations only in basement levels to better keep them out of the way.

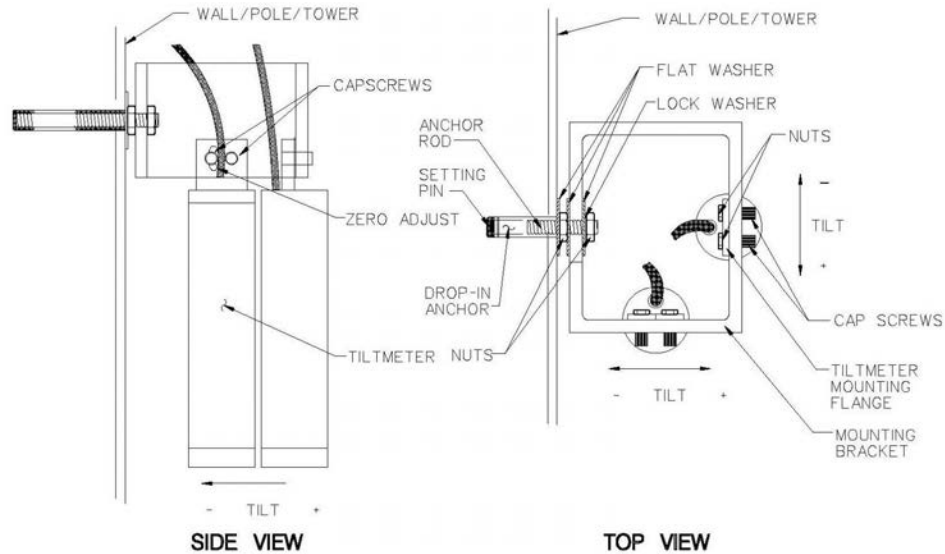

Figure 15-18 Biaxial Tiltmeter

### 15.3.2.5 Utility Monitoring Points

Utility Monitoring Points are very simple instruments used to determine whether an existing utility such as a water line is settling in response to an excavation proceeding nearby or underneath. The device consists of a small pipe with a rounded survey point or arrangement for use of a feeler gage at the upper end. This pipe is situated inside a larger piece of casing attached to a road box for surface protection. The lower end of the small pipe is attached to the top of the utility to be monitored and data collected by determining whether the top seems to be moving downward.

Unfortunately, such an instrument works well only if the monitored utility is exposed in a trench, and the inner pipe of the instrument attached before the utility is re-covered with backfill. When such an installation is attempted with a utility that is not exposed, one of two things may happen: (a) because the location of utilities is seldom known with absolute certainty, there is danger that the installing drillers may penetrate the utility, leading to a larger problem than the new tunnel under construction would have created; and (b) in the confines of a small drill hole it is extremely difficult to actually attach the monitoring pipe to the top of the utility, so it is possible for the utility to settle without there being an indication from the instrument of the movement's true severity.

In a case such as this, the best fallback position is to install a Borros Point (Figure 15-4) or an SPBX beside and to invert depth of the utility. If ground movement is observed at that location, it may be an indication that excavation procedures need to be modified to contain a problem. Depending upon its size and stiffness, a utility may be able to bridge over a zone of disturbance and so be in no immediate danger, but ground settlement of a certain magnitude can be an indication that the movement needs to be arrested before it does become serious.

### 15.3.2.6 Horizontal Inclometers

Horizontal Inclometers are simply inclinometers turned on their sides and the transducers in the probe (conventional instrument) or sensors (in-place instrument) mounted such that the sensitive axes are



perpendicular to the length of the pipe (Figure 15-19). In this way, an inclinometer is measuring the vertical rather than the lateral movements of the instrumented structure. One use for a horizontal inclinometer is in the determination of settlement of a utility along a reach that requires continuous data not producible by the utility monitoring points or extensometers described above. Due to difficulty of continuous access for monitoring, such an inclinometer installation is more likely to entail an in-place instrument that can be remotely read, but even here access may pose at least a minor challenge. If the utility is large and the flow of contained liquids can be controlled, then inclinometer casing may be strung and attached to the roof inside the instrumented structure. If the utility is too small for entry or the liquids cannot be controlled, then it would need to be exposed in a trench for instrument attachment to the outside and then backfilled. In either case, arrangements would be made for wiring to be run to a datalogger for essentially real time monitoring. Difficulty of access for installation is an obvious drawback, but when the need for monitoring is over, it should always be possible to salvage the expensive sensors for re-use.

If entry into the utility were possible for installation, then it should also be possible for recovery efforts. If the instrument were installed and then covered over by backfill, a small manhole will have been provided for access to the reference head and the wiring, and it is from here that the sensors and their attached wires can be removed.

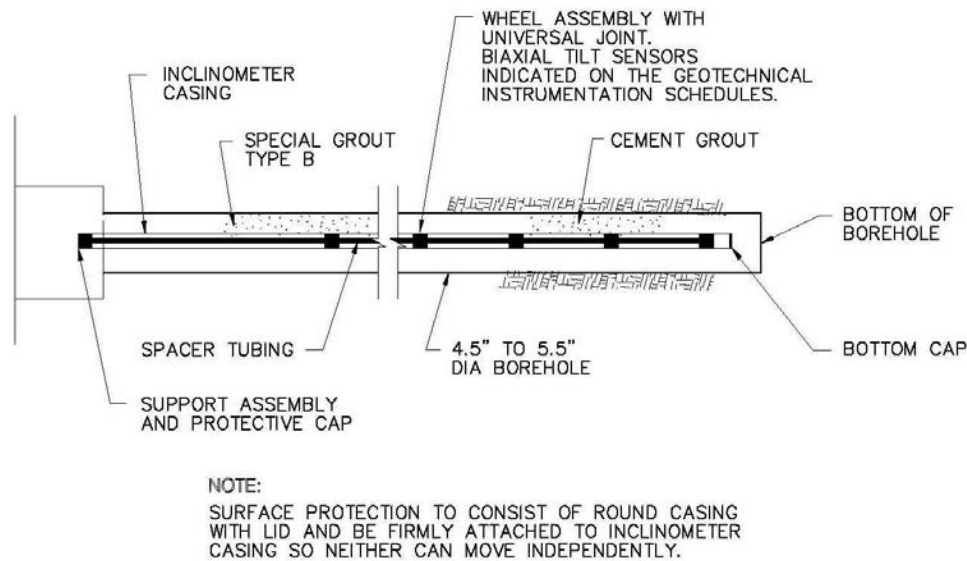

Figure 15-19 Horizontal In-Place Inclinometer

### 15.3.2.7 Liquid Level Gages

Liquid Level Gages are systems of sensors installed in an array that measures the height of a column of water within each gage as shown in Figure 15-20. Sensor gages are connected by small 1/4 to 1-inch diameter tubes or pipes to a reference gage outside the zone of influence. The reference gage is actually a reservoir, with its contained liquid generally kept under pressure to avoid the undesirable effects of barometric changes. The liquid completely fills all of the tubes throughout the array of components, none of the liquid is exposed to outside atmosphere, and so it is referred to as a closed pressurized system. With the liquid always at the same elevation, settlements of the instrumented locations are indicated as the heights of the columns of water within the gages change in relation to the gage housings, which are moving. Signal outputs are most commonly driven by LVDTs (see description under electrical crack gages below) or vibrating wire (see surface mounted strain gages under 15.4.2) force transducers. The

closed systems are small and flexible and can be configured to fit into the convoluted layouts of many instrumented structures. Readings are collected remotely through wiring of the system to a datalogger. Such systems are commonly installed in or on a structure where continuous settlement measurement to an accuracy of several millimeters is needed and where continued access for maintenance is not a large problem.

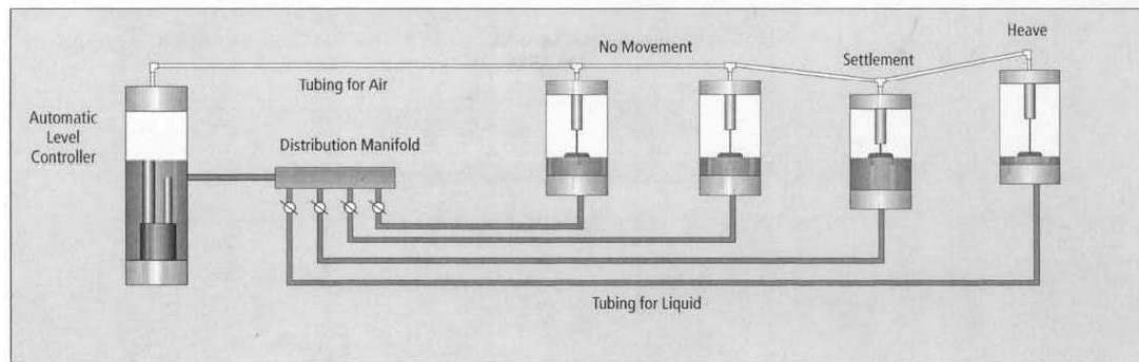
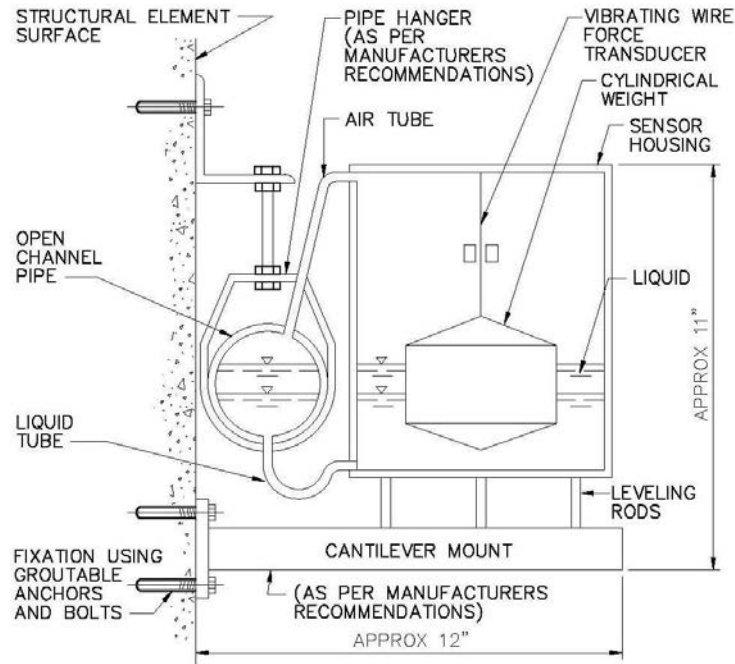

Figure 15-20 Multipoint Closed Liquid Level System

Maintenance visits are a must with these systems, and so the issue of access has to be taken seriously. During installation, which must be performed with great care, the system has to be charged with de-aired water and then purged to make certain no air bubbles have intruded to remain within it. This is one reason most installations utilize some kind of semi transparent plastic tubing; it permits visual detection of bubbles and makes purging them easier. This is critical because air bubbles will migrate to high points in the tubing or to the sensors themselves and can cause readings to be very inaccurate or can even shut down the system altogether. Then, during operation, it is very common for bubbles to appear in spite of careful installation. This may occur due to leakage from the outside, tiny amounts of air coming out of solution and accumulating, etc. Interestingly, the pressurization of the system can inhibit the emergence of bubbles, but never stop it entirely. No closed system is immune to this problem and maintenance visits may be required for purging and de-airing as often as every 6 to 8 weeks. This is why continued access can be so important to the closed pressurized system's functionality.

The maintenance problem can be largely overcome through the use of an open channel system which consists of sensors connected by pipes that are only half filled with water as shown in Figure 15-21. Open to the atmosphere, neither the liquid nor the sensors are affected by the problem of air bubbles. They can be installed to lengths of several thousand feet, operate for many months with hardly any maintenance, and still detect movements to sub-millimeter accuracy. However, such systems are large, heavy (due to the piping), sometimes difficult to install in structures with complicated layouts, and are much higher in front end costs than the smaller closed systems. At present, only a few open channel systems have been installed in the U.S. and only one or two corporate entities have expertise in their manufacture and installation. It seems likely that they will have a much larger presence in the future if downsizing of the components can lower purchase prices and make installations faster and easier.



NOTE:  
 AS AN ALTERNATIVE TO THE ABOVE DETAIL, A CONFIGURATION WITH THE OPEN CHANNEL PIPE IN-LINE WITH THE SENSORS IS ACCEPTABLE, SUCH THAT THE HORIZONTAL DIMENSION IS REDUCED FROM 12" TO 8".

Figure 15-21 Open Channel Liquid Level System

### 15.3.2.8 Tilt Sensors on Beams

Tilt Sensors on Beams, when packaged to monitor elevation changes rather than tilt per se, consist of sensors attached to metallic rods or beams, with the beams linked together with pivots (Figure 15-22). By monitoring changing tilt of each sensor and knowing the length of each +/- 5-foot long beam, users can calculate elevation changes of each pivot with respect to the datum. The relative tilt of each sensor and beam is set in the field and elevation change data determined by making an initial scan of readings, called the reference set, and mathematically subtracting readings in that scan from each subsequent scan. All elevation change data is referenced to one end of the system defined as the datum. Ideally, the datum is in a stable area not likely to move, and its absolute elevation is generally determined by an initial optical survey. Integrating the data is an iterative process as settlements are computed from sensor to sensor. Readings are collected by having the system connected with a datalogger for almost real time monitoring.

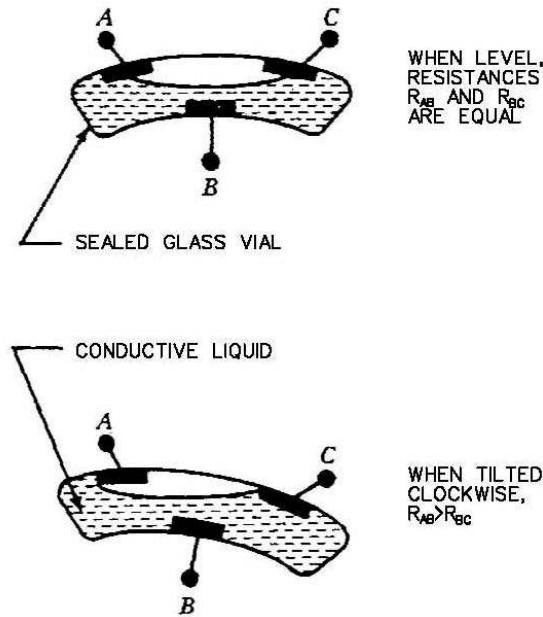

Figure 15-22 Schematic of Electrolytic Level Tilt Sensor (After Dunnicliff, 1988, 1993)

Such installations can work on bridges, the balustrades of buildings, the walls or safety walks of existing tunnels, or even railroad tracks. However, they do depend upon sensing of the mechanical movements of a string of components, and the components need to be as free from interference as possible. If installed where workers or moving equipment may be present, they have to be protected by installation of metallic housings or half rounds of heavy plastic casing. Another potential problem stems from changing temperatures, especially in the outdoors where there may be exposure to severe or very changeable weather. Although the sensors may fare as well as they would in any other type of installation, such as in a tiltmeter housing, the beams and the pivots are metal and subject to thermal effects with the potential to skew the data in unexpected ways. Users need to be aware that, if even one sensor or sensor/beam combination fails for any reason and requires replacement, the whole string of sensors and beams will need to be reinitialized.

### 15.3.2.9 Crack Gages

Crack Gages (also sometimes called Jointmeters) as installed on structures are typically used for monitoring cracks in concrete or plaster, or for determining whether movement across joints is exceeding a structure's design limits. The first appearance of cracks can be an indication of structural distress, and their growth, either in width or length, can be an indication that stress is increasing, as can the continued widening of an expansion joint. There are several ways of measuring these movements; only the two most common can be covered herein.

As shown in Figure 15-23, a Grid Crack Gage consists of two overlapping transparent plastic plates, one installed on each side of the discontinuity and held in place with epoxy or mounting screws. Crossed cursor lines on the upper plate overlay a graduated grid on the lower plate. Movement is determined by observing the position of the cross on the upper plate with respect to the grid. Data is kept in notebooks and has to be keypunched into a computer if needed for an electronic database. Such gages are inexpensive to purchase and install, but readings may vary with changes in monitoring personnel and this has to be guarded against. There are three circumstances in which such simple devices may prove inadequate: (a) where cracks are too narrow or are widening too slowly for the human eye to detect their

growth; (b) where continued physical access is very difficult and remote monitoring is required; and (c) where something close to real time monitoring is required. Such difficulties may be overcome through the selection and installation of Electrical Crack Gages as shown in Figure 15-24.

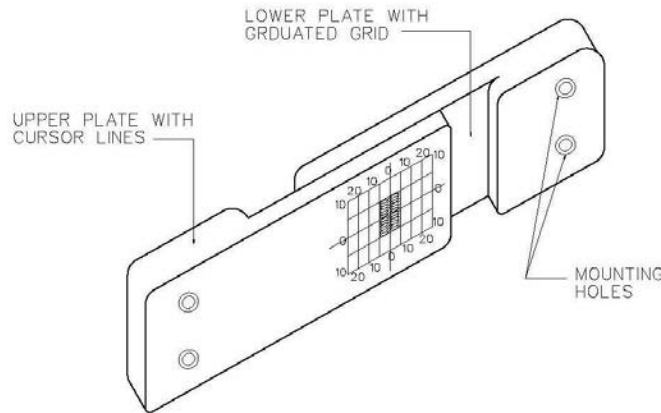

Figure 15-23 Grid Crack Gauge

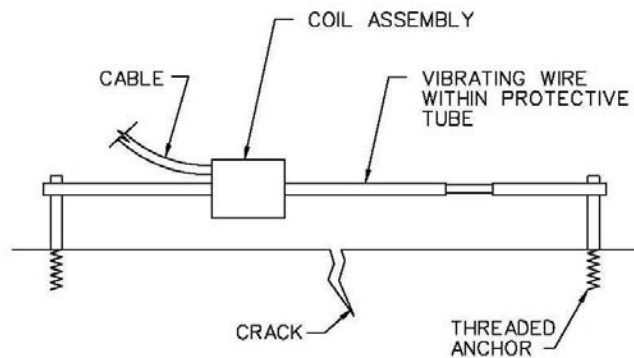

Figure 15-24 Electrical Crack Gauge

There are a number of electrical gage types, but most are based on an arrangement of pins attached on opposite sides of a joint or crack, with the pins connected by sliding extension rods whose differential movements are detected by a built-in transducer. The most common transducer is the linear variable displacement transformer (LVDT) that consists of a movable magnetic core passing through one primary and two secondary coils. Data readouts depend upon detection and measurement of differences between voltages generated in the secondary coils, magnitudes of which depend on the proximity of the moving magnetic core to the secondary coils. Users may prefer to pick up the gage signals by using a small low power radio transmitter installed at the instrument location to avoid the transmission of alternating currents through long lead wires that can introduce output-degrading cable effects.

## 15.4 TUNNEL DEFORMATION

### 15.4.1 Purpose of Monitoring

When the temporary or permanent structural support for a tunnel is being designed, calculations are performed to predict the kinds of movements and stresses the support can safely be subjected to before

there is danger of failure. It is the job of instrumentation specialists to track those movements and stresses and provide guidance on whether the support or the construction process needs to be modified to ensure short term safety and long term stability of the completed tunnel. For braced excavations it is standard practice to measure the loads on some of the support members, and often to combine these with measurements of the support member deflections if the measurement of ground movements outside the support system are not sufficient to present a complete picture of support performance. It is possible to thus monitor the significant performance related behavior of soldier piles, slurry walls, struts, tiebacks and other elements of open cut or cut-and-cover excavations. In mined tunnels it is generally more common to use deflection measurements as a first line of defense against adverse developments because the eccentricities in the movements of many support members, such as steel ribs, make stress and load measurements much more complicated and prone to varying interpretation than they are for braced excavations.

#### **15.4.2 Equipment, Applications, Limitations**

Monitoring of the tunnel itself is similar to ground movement monitoring, using the following instrumentation:

- Deformation Monitoring Points
- Inclometers in Slurry Walls
- Surface Mounted Strain Gages
- Load Cells
- Convergence Gages
- Robotic Total Stations

##### **15.4.2.1 Deformation Monitoring Points**

Deformation Monitoring Points (DMP) on support elements take several forms, but all have one thing in common: they are semi-permanent points to which a surveyor can return again and again and be certain of monitoring exactly the same point. A DMP may consist of a short bolt inside an expandable sleeve if mounted in a small drilled hole in concrete, such as a slurry wall (Figure 15-25), or may be the head of a bolt that is tack welded to a steel surface such as the top of a soldier pile. A DMP can be surveyed for both lateral and vertical movements to help determine whether the upper reaches of support may be “kicking in” or perhaps settling downward as the ground moves. If mounted in or on a vertical surface, the bolt head must have enough stick-out to permit a stadia rod to be rested on it. If mounted in or on a horizontal surface, the bolt head must be rounded, especially if it is to be used for determining vertical movements, for the same reason that a round head DMP is important in the monitoring of roads and streets. If the DMP were simply a flat plate, it would be too easy for the rod person to set up on a slightly different spot with each survey, especially if the monitored support element were bending inward, and this could result in cumulative errors in the elevation data plots. For support elements it is desirable that elevation surveys be carried out to an accuracy of as little as 1/4 or even 1/16 inch, and every effort should be expended to make this as easy for the surveyors as possible. The largest problem for this type of monitoring is the same as was previously discussed in ensuring survey accuracy, except that the difficulties may be greater in this instance because the surveyors are more likely to be working in the middle of heavy construction activity, hence more rushed and/or more distracted.

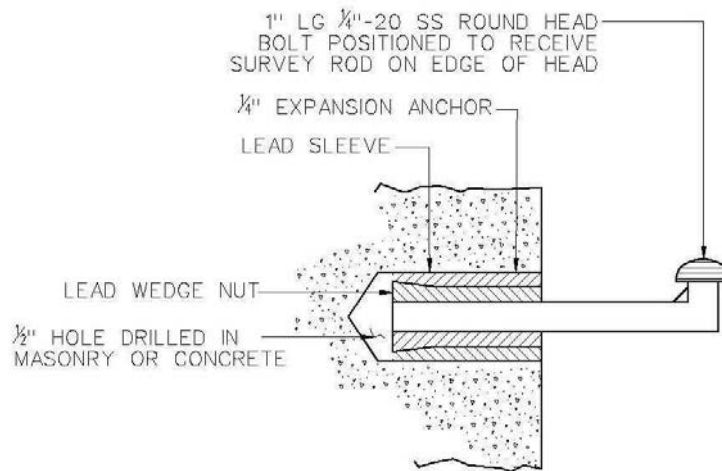

Figure 15-25 Deformation Monitoring Point in Vertical Masonry or Concrete Surface

#### 15.4.2.2 Inclinometers in Slurry Walls

Inclinometers in slurry walls are very similar to those previously described for ground installations, except that drilling is not generally required (Figure 15-26). Installation is accomplished by fastening the instrument casing inside the wall panel's rebar cage as that element is being fabricated. As the cage is lowered into the slurry trench, the inclinometer casing goes with it and remains in place as the slurry is displaced during the introduction of concrete. Because the slurry wall will have been designed to penetrate below any zone of expected movement, the bottom of the inclinometer casing is the presumed unmoving reference from which tilting of shallower points along the casing are calculated. Monitoring is accomplished by the instrumentation specialist lowering a probe to the bottom of the casing and collecting readings as it is winched back to the surface. The biggest problem with an inclinometer in such an installation is the essential impossibility of repair if anything has gone seriously wrong. Also, one cannot replace the instrument by simply drilling a new casing into reinforced concrete a foot or two away. If the instrument is considered absolutely essential, it might be feasible to drill a new one into the ground just in back of the wall, but long drill holes tend to wander away from the vertical – perhaps in a direction away from the slurry wall – and chances are not good that the replacement instrument would truly indicate what the slurry wall itself is doing. This possibility of damage is one argument against the installation of in-place inclinometers in this type of support. Depending on the seriousness and the depth of any damage to the casing, some or most of the expensive sensors could be stuck and impossible to recover.

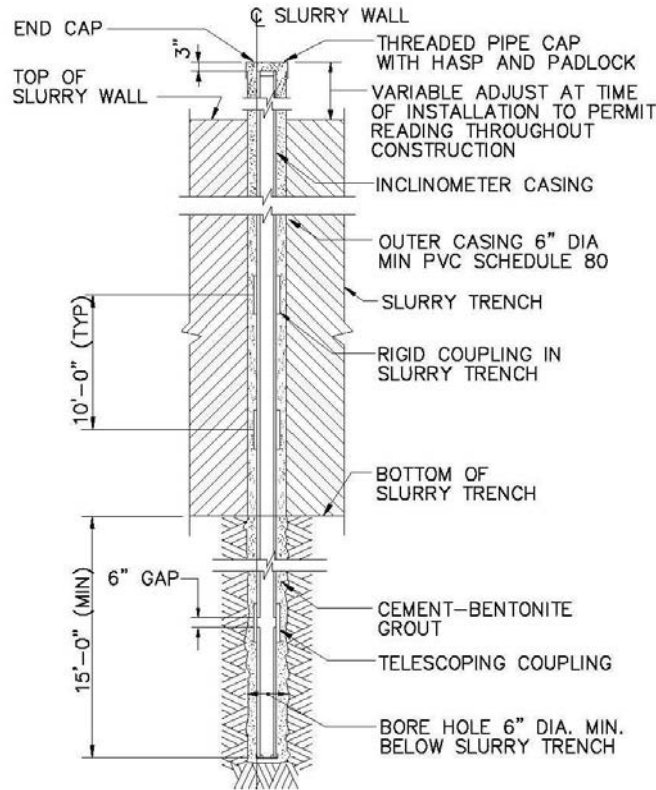

Figure 15-26 Inclinometer Casing in Slurry Wall

### 15.4.2.3 Surface Mounted Strain Gages

Surface Mounted Strain Gages are most commonly used to determine stresses and loads in struts across braced excavations. Although many kinds are available, the vibrating wire type finds the widest application because of a stable output that is in the form of signal frequency rather than magnitude. Figure 15-27 shows a schematic of the vibrating wire type strain gage. In this instrument's packaging, a length of steel wire is clamped at its ends inside a small housing and tensioned so that it is free to vibrate at its natural frequency. The frequency varies with the tension, which depends upon the amount of compression or extension of the instrumented strut to which the gage has been attached by spot welding or bolting. The wire is magnetically plucked by a readout device, and the frequency changes measured and translated into strain, which can in turn be translated into stresses and loads on the instrumented member from a knowledge of the material's modulus. The point of the measurements is that designers will have calculated the permissible loads in the struts and the instrumentation specialist is collecting data to determine if the struts may be approaching their design limits. Gages are typically mounted 2 to 3 strut widths/diameters from the ends in order to avoid the "end effects" that degrade accuracy. Because a strut will bend downward from forces of gravity even when not under load, creating compression at the top and extension at the bottom, it is necessary to install several gages arranged in patterns around the neutral axis and average the readings for the closest possible approximation of maximum stress.



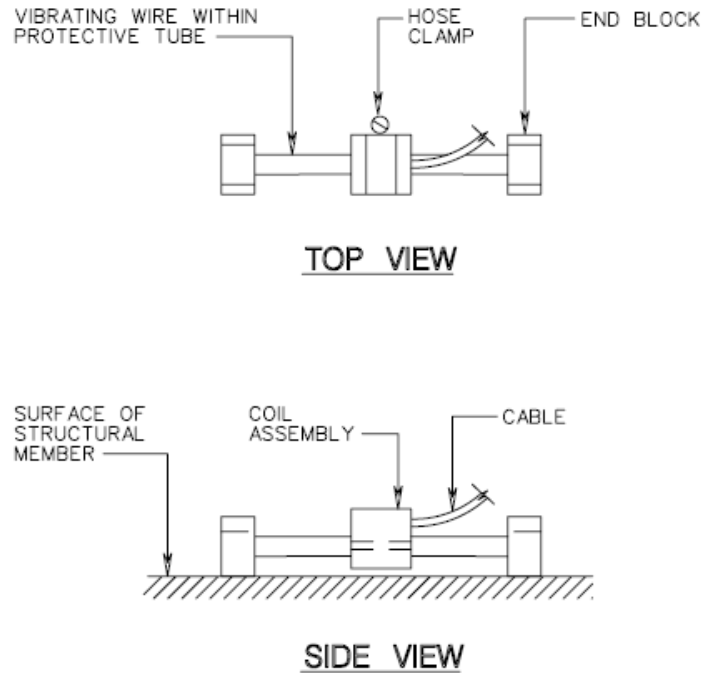

Figure 15-27 Surface Mounted Vibrating Wire Strain Gauge

Many things can go wrong with such installations, and they need to be undertaken with the greatest of care by experts with good experience. However, as noted in the introduction, the greatest problem with these types of measurements can reside in the agendas of the various parties who may need to understand the data and perhaps take action to mitigate apparent problems. Measurements of ground and structure *movements* are in general understood by most people associated with tunneling. However, stresses and strains require a certain amount of sophistication to comprehend, and even among those with the sophistication, interpretations of what the data mean can vary wildly. It is very common for constructors and their consultants to believe instruments are faulty, that data has not been properly collected, or data has not been properly reduced to good engineering values if taking mitigative action is going to interfere with the field operations. Also as previously noted, this is why use of strain gages can be fraught with complications if used on the steel ribs in mined tunnels. Compared with struts in braced excavations, ribs under load can bend and twist in many unanticipated ways, and placing strain gages in the best configurations just where they need to be placed can be difficult.

#### 15.4.2.4 Load Cells

Load Cells are, in general, arrays of strain gages embedded in housings which are placed in instrumented tunnels under construction in such a way that loading forces pass through the cells. For the reasons stated in the strain gage description above, very stable vibrating wire transducers are the data collecting elements on which most load cell configurations are based. As shown in Figure 15-28, the load cell is a “donut” of steel or aluminum with several transducers mounted inside in a way to be read separately and averaged in the readout device. Transducers are oriented so that half of them measure tangential strains and half of them measure axial strains. Integration of the individual strain outputs helps reduce errors that might result from load misalignment or off center loading. Although load cells may be installed on

tensioned rockbolts in mined tunnels, their more common use is in non-braced open excavations. Here the cell is installed on a tieback near the rock face and locked down with thick bearing plates, washers and a large steel nut. In most cases the instrument will be wired for electrical remote reading because it will be left in place for a considerable amount of time, and direct access for data collection will often not be available once the excavation has passed below the tieback's level. If a load cell seems to be producing questionable data, the most likely cause is misalignment of the instrument on the shaft of the tieback. For the most part, tiebacks are angled downward rather than being installed horizontally, and careful placement of bearing plates and washers of the correct thickness is essential.

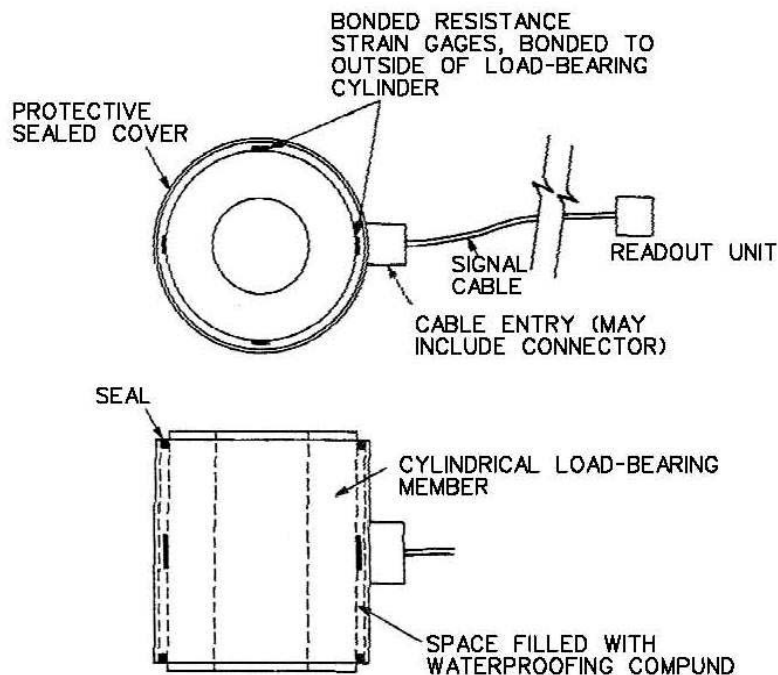

Figure 15-28 Schematic of Electrical Resistance Load Cell (After Dunnycliff, 1988, 1993)

#### 15.4.2.5 Convergence Gages

Convergence Gages may be used on tunnel supports just as they are in monitoring of tunneled ground as described in 15.2.2. above. For the most part it is best to monitor the ground itself because that gives the best from-the-beginning measurements that constitute good initial movement readings. However, if it is necessary for whatever reason, similar anchors, eyelets, cradles and survey targets can also be installed on steel supports, shotcrete linings, and final concrete linings. As in the earlier discussion, it appears that distometers should be the chosen replacement for the older tape extensometers when measuring the distortions.

In modern mining there are situations which do not lend themselves to easy measurement of ground movements from the tunnel itself because of the chosen method of ground support. The most common of these situations results from the use of a TBM where pre-cast concrete segments are erected after each push to form another 4 or 5 feet of completed tunnel ring directly behind the shield. These theoretically perfect circles can distort as ground loads or other pressures – as from a contiguous tunnel also under construction – begin to exert themselves. The tunnel lining may “oval” with long axis vertical from high side pressures, or oval with long axis horizontal from high vertical pressures or low side pressures (the

contiguous tunnel again.) Most instrumentation specifications call for deformation measurements to begin as soon as possible and for them to be taken as often as once or twice per day at first, with monitoring schedules tapering off as the TBM recedes from individual measurement sections. As with monitoring of ground movements, the most common problem with these measurements of lining distortion is the difficulty of getting good lines of sight directly behind the machine in order to achieve a true zero movement initial reading.

#### **15.4.2.6 Robotic Total Stations**

Robotic Total Stations as described for existing structures in 15.3.2. above can also be used to monitor the opening that is under construction. However, there are possibly more limitations on underground installations than on installations associated with inhabited buildings above. A total station instrument sitting atop its motorized support platform has a footprint of at least one square foot, its height is a bit greater, and the platform may protrude from the tunnel wall as much as 18 inches. The package would hardly fit well into a small tunnel, and would be constantly on the move as the tunnel advanced. Hence, the most logical place for such monitoring of active construction would be within a large mined chamber or perhaps a large open excavation. Even here, however, the uses might be more restricted than is at first obvious. The average construction site is a hostile environment, and the decision to install such an expensive piece of equipment cannot be taken lightly. The dust alone on some construction sites might be enough to force heavy maintenance procedures on the part of users. Even in the outdoors, target prisms have to undergo regular maintenance because signals can be so degraded by the accumulating dust from the atmosphere. The interior of a construction site is much worse; maintenance of the expensive instrument itself would be more onerous than usual, and many target prisms would likely be at a height that requires use of a manlift for access. It seems probable that the best use for robotic total stations would be found in an advanced stage of large construction where most of the final concreting has been accomplished and the structure needs to be monitored in something close to real time as the finish stage of construction proceeds.

### **15.5 DYNAMIC GROUND MOVEMENT – VIBRATIONS**

#### **15.5.1 Purpose of Monitoring**

As opposed to the measurements discussed earlier, which concerned long-term effects of the construction of a tunnel on the gross movement of either the ground or buildings adjacent to the tunnel, these measurements are taken to establish the potential impact of drill and blast excavation on structures. Use of explosives often causes concern on the part of stakeholders in the neighborhood of a tunnel excavation. Aside from the images generated by blasting, there is real concern due to the sudden (and sometimes perceptible) motion generated by the explosive energy that is not used in fragmenting rock, but that propagates away from the blast site.

The usual method of monitoring these motions is based upon research studies that correlate the potential for damage from blast vibrations with the motion of the ground

#### **15.5.2 Equipment, Applications, Limitations**

There are two general types of equipment used for monitoring the Dynamic Ground Movement induced by blasting:

- Blast Seismographs

- Dynamic Strain Gages

Blast seismographs are used to monitor ground motion at structures within the zone of influence. Dynamic strain gages are used to monitor the actual strain (or relative displacement) of structural elements of such structures. Both of these instruments monitor data during the actual blast event, though for convenience they may be set to monitor before the actual blasting.

#### 15.5.2.1 Blast Seismographs

The standard blast monitoring equipment has been blast seismographs. These instruments measure the vibration waves generated by blasting then propagate through ground, soil, and structures. This is the dynamic measurement of a wave that is extended in time and space; therefore, there is no single value that totally describes a blast wave. Through many years of research, it has been determined that the single most descriptive value that can be associated with the potential for structural damage is “Peak Particle Velocity,” or PPV. As a blast vibration wave travels, it is analogous to waves on water. If one imagines a bobber on the water, the velocity of the bobber moving as the wave passes is the particle velocity. The peak particle velocity is the highest value of velocity during that wave passage. This value is expressed (in the US) in inches per second.

Blast seismographs measure three components of ground motion: vertical, longitudinal (horizontal along the direction from the blast) and transverse (perpendicular to that direction). The highest of these three values is used as a vibration criterion. There is typically a fourth channel used for above-ground blasting that monitors air overpressure or airblast, but this channel is generally not used when blasting in tunnels, since there is no direct exposure to surface structures.

As mentioned, criteria for blasting have been developed based upon occurrences of damage. Most of the studies done have concentrated on typical residential wood frame structures. Because structures respond in many ways to vibrations that are imposed at the base of the structure, in most cases the vibration is monitored on the ground outside of the structures. The potential for damage is then inferred from the association of the PPV with the potential for damage of a particular structure type. Sometimes the frequency of the vibration is also incorporated in the criteria, but this is not always the case. Criteria are usually adjusted upwards when the structure type is more substantial or engineered, relative to the criteria used for residential structures.

#### 15.5.2.2 Dynamic Strain Gages

Because there is so little accumulated damage data for some structures, an alternative method for monitoring, using dynamic strain gages, has been adopted recently. For engineered structures and infrastructure elements, actual failure criteria can be developed that are independent of the mode of excitation. In this case, a level of strain, which is a dimensionless measure of relative motion, is used as a criterion for avoidance of damage. Strain  $\epsilon$  is defined as  $\epsilon = \Delta l / l$ , where  $\Delta l$  is the change in length of an element, and this is divided by the length of the element. Measurement on a small length of a structural element may then represent the deformation of the entire element when the total structural configuration is known.

Dynamic strain gages are traditionally thin foil resistance gages, which are connected to other gages in what is called a Wheatstone bridge. The gages change resistance when they are deformed. This arrangement of gages will then produce a voltage output that is monitored during the blasting process. The foil gages have been in use for over a half a century, initially in static strain environments, such as those described in 15.4.2.3 above. Though it is a mature technology, there are sometimes problems when

the gages are in electrically noisy environments, or where there are temperature fluctuations. Although they have only been used recently, piezoelectric and fiber optic strain gages are not susceptible to as many problems as are the foil gages.

Dynamic strain gages, since they measure strain on a particular element that is of concern, must be carefully located to obtain the values that can be associated with potential failure of the element. Strain gage mounting must be carefully chosen on a representative location, and a measurement on the ground surface (as is done with blast seismographs) is NOT appropriate.

There is not as much background documentation in associating damage with strain from blasting; however the fundamentals of strain-based failure criteria have been used for many years. The use of strain gages is limited to where there is a sound understanding of the actual limiting strain values that can be accepted as safe, based upon engineering documentation.

## **15.6 GROUNDWATER BEHAVIOR**

### **15.6.1 Purpose of Monitoring**

In a landmark 1984 study titled *Geotechnical Site Investigations for Underground Projects*, the National Academy of Sciences catalogued problems associated with the construction of 84 mined tunnels in the U.S. and Canada, and stated bluntly in its conclusion, “The presence of water accounts, either directly or indirectly, for the majority of construction problems.” Thus, even if groundwater does not flow into an advancing excavation in huge quantities to become a primary problem, it may still alter the ground in a way to make its behavior worse than it would otherwise be, and so become a serious secondary problem. For example, seemingly solid rock may be destabilized by the presence of water if the liquid carries binding particles out of otherwise closed joints or lubricates the joint faces to decrease frictional forces that hold rock blocks in place. Soft ground fares even worse in the presence of water as seepage forces may carry materials into the excavation, thus exacerbating the loss of ground, or perhaps causing subsidence above simply due to the pumping of water if the overlying soils are compressible. Most tunneling experts know that somewhat controllable “running ground” may become much-harder-to-control “flowing ground” if water is present and its effects are not checked. It is a given that, in most soft ground mined or cut-and-cover excavations where the water table is high, some kind of dewatering will need to be carried out to keep the headings safe. It is also a given that, even if formal pre-construction dewatering is not carried out, the excavation will probably cause a decrease in the level of the groundwater as intruding water is pumped out to create dry, workable conditions. Interestingly, even the drying up of the ground to make tunneling easier can have its own unwanted side effects if there are abutting facilities that depend upon the water table staying close to its original elevation for them to maintain their functionality.

### **15.6.2 Equipment, Applications, Limitations**

Three standard types of instrumentation are used to determine the effect of tunnel construction on groundwater movements and pressures:

- Observation Wells
- Open Standpipe Piezometers
- Diaphragm Piezometers

### 15.6.2.1 Observation Wells

Observation Wells are the simplest and least expensive instruments in the list of devices used to determine groundwater pressures. A well consists of a perforated section of pipe attached to a riser pipe installed in a borehole filled with filter material, generally sand or pea gravel (Figure 15-29). The filter prevents fines from migrating in with the water and clogging the well. The filter may extend to only a few feet above the perforated section or may go almost to the ground surface, but the well must have a mortar seal near the top of the riser pipe to prevent surface runoff from entering the hole. Also, a vent is required in the top cap so that water is free to rise and fall in the pipe. The height of the groundwater table is generally measured by lowering an electrical probe at the end of a graduated cable until it touches the top of the water. A circuit is then completed and so indicated by the flicker of an indicator light or sound of a buzzer at the upper end of the cable. Such wells are installed in tunneled ground where it is assumed that the ground is continuously permeable and groundwater pressures will increase uniformly with depth. Tunnel designers try to gain an understanding of the groundwater regime as design proceeds and often will specify the level to which the water must be pulled down by a dewatering program before construction is permitted to proceed too far. It is common to require dewatering to a level a few feet below final invert for either a soft ground mined tunnel or braced excavation. An observation well would then be installed to two or three feet below that drawdown level to be certain of detecting the new during-construction top of water table. The most common problem with observation wells is that they may not be the instrument appropriate for the situation because the complexity of geologic stratification is actually greater than anticipated. If readings seem inexplicable, it may be because the water level corresponds to the head in the most permeable zone rather than to a straight line correlation with depth from the ground surface. It is possible that the wells may need to be supplemented with other instruments such as piezometers.

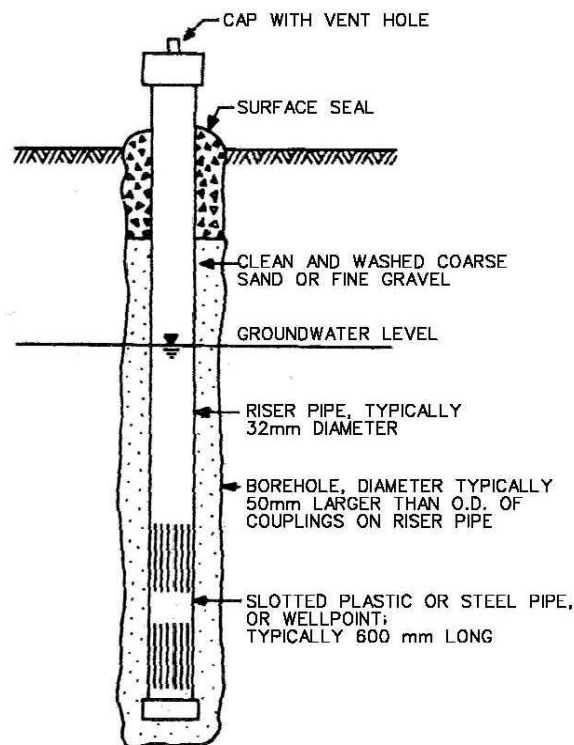

Figure 15-29 Schematic of Observation Well (After Dunicliff, 1988, 1993)

### 15.6.2.2 Open Standpipe Piezometers

Open Standpipe Piezometers are very similar in construction to observation wells, with one major difference: as defined by Dunnycliff, the porous filter element is sealed with bentonitic grout into a particular permeable stratum so the instrument responds to groundwater pressure only at that level and not to pressures at other elevations (Figure 15-30). Such a piezometer may be installed in soil strata or in bedrock and will function as long as the porous intake and filter are sealed in a zone that permits water to flow. In soil the instrument will be measuring pore water pressure; in rock, it will generally be measuring joint water pressure. The instrument creates little or no vertical hydraulic connection between strata and, in contrast to simple observation wells, readings will be more accurate. If stratification is somewhat complex, several piezometers installed at different depths in the same small area would probably reveal more than one level of pressures, as in the case of a perched water table above a clay stratum exhibiting pressures different from those in a permeable stratum below the layer of clay. In construction monitoring it is usual to install the porous intakes at the critical levels only, as in just below the inverts to where the water table needs to be lowered. Another common depth for the intakes would be at the boundary between an upper layer of sand and a lower layer of impervious clay in which the excavation bottoms out. In the latter situation, the dewatering subcontractor would probably be able to pull the water table down only to a few feet above the clay, and that is the elevation that would need to be monitored. Lack of expected response from an open standpipe piezometer is sometimes caused by clogging of the filter due to repeated water inflow and outflow. This may be remedied by high pressure flushing, something readily accomplished if the drill rig used during installation is still in the area. A more serious problem would result from the porous intake having been installed in a relatively impermeable silt or clay stratum because the borehole was not properly logged prior to installation. The only solution would probably be to install another instrument – perhaps another type of instrument – at the same plan location, with more attention being paid to good geologic logging and placement of the porous intake.

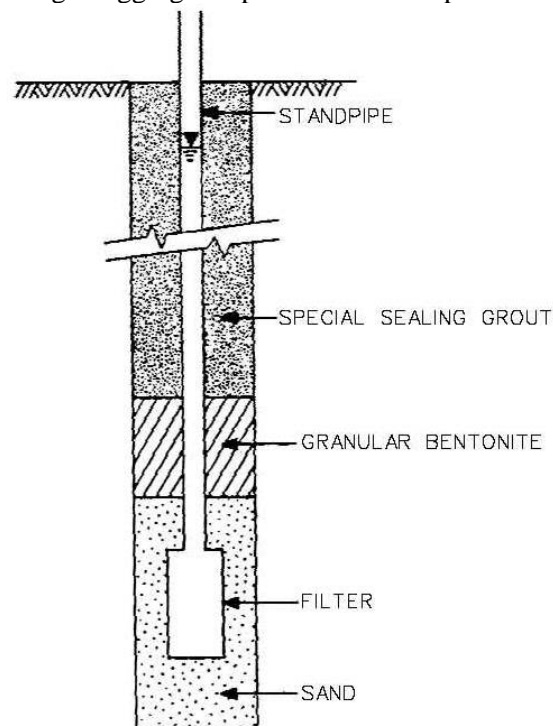

Figure 15-30 Schematic of Open Standpipe Piezometer Installed in Borehole  
(After Dunnycliff, 1988, 1993)

### 15.6.2.3 Diaphragm Piezometers – Fully Grouted Type

As noted earlier, a *piezometer* is a device that is sealed within the ground so that it responds only to groundwater pressure around itself and not to groundwater pressures at other elevations. There are several situations that point to the need for a device that is more sophisticated than the simple open standpipe instrument:

1. Need to measure pore water or joint water pressure in a stratum of very low permeability. The hydrodynamic time lag for an open standpipe instrument is large, meaning that it responds slowly to changes in piezometric head because a significant volume of water must flow to register a change. This cannot happen in materials of low permeability such as clay or massive bedrock with few joints.
2. Some situations make it undesirable to have a rigid standpipe connecting with the surface, especially in the midst of heavy construction.
3. Repeated water flow reversals can cause the sand or pea gravel filter to clog.
4. In very cold climates there is a chance of freeze-up and resultant loss of opportunity to collect data.
5. A large number of readings and/or something close to real time monitoring may be required, but the open standpipe instrument does not lend itself readily to this type of data collection.

Thus there are times when monitoring personnel are forced to choose a type of piezometer consisting of a unit that is pre-manufactured to interpose a diaphragm between the transducer and the pressure source. Pneumatic, electrical resistance and vibrating wire are the three most common type of such instrument. The vibrating wire type is usually chosen because it operates with a short time lag, offers little interference to construction, and the lead wires can easily be connected to a surface readout unit or to a datalogger for real time monitoring.

Even these instruments, however, have always suffered from a major shortcoming: the assumed need to place filters around the sensing units and granular bentonite/cement grout seals and backfilling in the boreholes around and above the monitored elevation. Bridging and material stickiness can make proper emplacement difficult and may lead to degradation of data accuracy or outright instrument malfunction. This emplacement difficulty particularly complicates the installation of multiple piezometers in one borehole, so if readings from various elevations are required, it may mandate the drilling of a separate hole for each elevation that requires measurement.

An obvious way around these difficulties would seemingly have been to forgo the filters and encase diaphragm piezometers and their accoutrements in a cement-bentonite mix seal all the way to the surface in *fully-grouted* installations. However, prevailing opinion for many years was that the grout around the sensing unit might have extremes of permeability that would prevent an instrument from responding accurately to changes in pressures. But from work that began in 1990, it has now been shown that this does not have to be the case. A diaphragm piezometer generally requires only a small flow to respond to water pressure changes, and the grout is able to transmit this small volume over the short distance that separates the sensing unit from the ground in a standard size borehole. The response can be enhanced if the installer minimizes this distance, which can be accomplished through the use of an expandable assembly that lessens the distance between sensor and borehole wall, thus reducing the thickness of the grout between sensor and ground. Studies have shown that accuracy of pressure measurements will be good not only when the permeability of the grout is lower than that of the surrounding ground (which had been assumed all along), but also when the permeability of the mix is up to three orders of magnitude greater than that of the surrounding ground. Obviously, every situation requires that some work be done to formulate a grout mix of an appropriate permeability to be effective at the site being monitored.

Fully-grouted piezometers can be emplaced by loose attachment then detachment from a sacrificial plastic pipe that is withdrawn (along with any support casing) as the grout is tremied in from the bottom up. It is



relatively easy to install more than one instrument in the same hole for water pressure measurements at several elevations. As many as ten in holes penetrating to 500 ft depths have been successfully installed.

Good experience in a greater than 15-year time frame prior to 2009 has shown that most diaphragm piezometers need to be installed as fully-grouted types for the sake of increased simplicity and the collection of much more data at lower cost than had been the case with older methods.

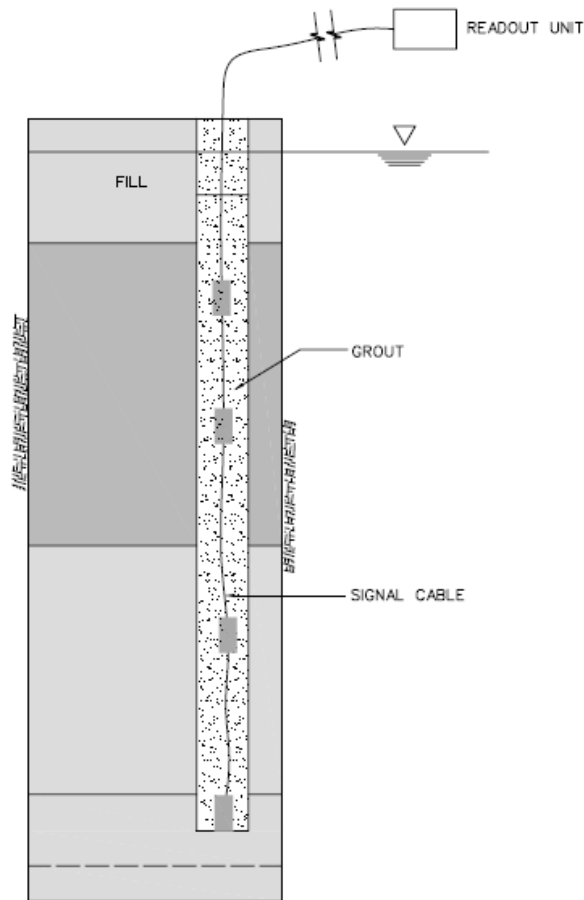

Figure 15-31 Schematic of Multiple Fully-Grouted Diaphragm Piezometer

A continuing use for piezometers and observation wells depends upon their being left in place after construction is complete because of the effects the permanent structure may have on the groundwater regime. For example, if the water table remains depressed due to leakage into the new tunnels, a continuation in monitoring may indicate whether attention needs to be paid to protection of wood support piles that remain exposed to air, or perhaps to wells or ponds that have been wholly or partially dried up. An opposite problem may stem from the mounding up of groundwater because it's normal gradient is interrupted by the presence of the new tunnel, which may result in situations such as once dry basements that are now prone to flooding. Although leaving the instruments in place may result in increased maintenance costs, they can prove to be valuable sources of data when certain long term problems are being investigated.

## 15.7 INSTRUMENTATION MANAGEMENT

### 15.7.1 Objectives

As noted in the introduction to this chapter, the primary function of most instrumentation programs is to monitor performance of the construction process in order to avoid or mitigate problems. There are, of course, other related purposes, and proper management of the program will include decisions on which of the following deserve primary consideration and which may be considered of lesser importance:

1. To prevent or minimize damage to existing structures and the structure under construction by providing data to determine the source and magnitude of ground movements.
2. To assess the safety of all works by comparing the observed response of ground and structures with the predicted response and allowable deformations of disturbance levels.
3. To develop protective and preventive measures for existing and new structures.
4. To select appropriate remedial measures where required.
5. To evaluate critical design assumptions where significant uncertainty exists.
6. To determine adequacy of the Contractor's methods, procedures and equipment.
7. To monitor the effectiveness of protective, remedial and mitigative measures.
8. To assess the Contractor's performance, Contractor-initiated design changes, change orders, changed conditions and disputes.
9. To provide feedback to the Contractor on its performance.
10. To provide documentation for assessing damages sustained to adjacent structures allegedly resulting from ground deformations and other construction related activities.
11. To advance the state of the art by providing performance data to help improve future designs.

An overriding factor in considering what is important about instrumentation may spring from new demands being made by insurance and bonding companies. In many parts of Europe they already have the power to require that every tunneling project, prior to construction, undergo a process of *Risk Analysis* or *Risk Assessment*. Then, during construction, periodic audits are conducted to determine whether a project is successfully practicing *Risk Management*. A low score on this point could result in the cancellation of insurance and the possible termination of the project. Although not yet to such an advanced stage, the tunneling industry in the U.S. is becoming very attuned to the necessity of Risk Analysis and Management, and a good instrumentation program can help to reduce the possibility of major problems. It can be shown to the satisfaction of most observers that a good monitoring program has the potential to pay for itself many times over through the monies saved from incidents that were prevented from happening. In other words, Risk Management backed up by good instrumentation and monitoring can be very cost effective.

### 15.7.2 Planning of the Program

Much of the following material is predicated on the assumption that any particular project will follow the standard U.S. Design-Bid-Build method of services procurement. Where an alternative method such as Design-Build may be a possibility, we will try to point out how this could affect the instrumentation program under consideration.

As noted by Dunnicliff (1988, 1993), the steps in planning an instrumentation program should proceed in the following order:

1. Predict mechanisms that control behavior of the tunneling medium
2. Define the geotechnical questions that need to be answered

3. Define the purpose of the instrumentation
4. Select the parameters to be monitored
5. Predict magnitudes of change
6. Devise remedial action
7. Assign tasks for design, construction, and operation phases
8. Select Instruments
9. Select instrument locations
10. Plan recording of factors that may influence measured data
11. Establish procedures for ensuring reading correctness
12. List the specific purpose of each instrument
13. Prepare a budget
14. Write instrument procurement specifications
15. Plan installation
16. Plan regular calibration and maintenance
17. Plan data collection, processing, presentation, interpretation, reporting, and implementation
18. Write contractual arrangements for field instrumentation services
19. Update budget

Many of these points will be covered in more detail in the following pages, but no. 2 deserves special emphasis here; Dunicliff stated it in the following terms:

***Every instrument on a project should be selected and placed to assist in answering a specific question: if there is no question, there should be no instrumentation.***

The basic point can also be stated as, “Do not do something just because it is possible or because it might result in something that would be nice to know.” Movement in that direction can result in wasted monies and the proliferation of excess – perhaps even conflicting – data that leads to confusion.

Serious work on planning an instrumentation program will probably not begin until some time after the 30-percent design level has been completed because only then will such aspects of the project as geology, tunnel alignment, structural design and probable methods of construction be coming into good focus. Program design should be carried out by geotechnical engineers and geologists who have a good knowledge of instrumentation, assisted as necessary by the structural engineers with the most knowledge of how the new and existing structures are likely to react to the changing forces to which they will be subjected.

### **15.7.3 Guidelines for Selection of Instrument Types, Numbers, Locations**

Due to the large number of permutations and combinations of highway tunnel types, sizes, depths and geographic/geologic locales, it would be very difficult to list truly useful guidelines in the space allotted herein. A few of the authors’ thoughts on the subject can be found in preceding sections 15.3 through 15.6, but even those 20 or so pages can only begin to suggest what can or should be done. But in addition to space limitations, there is also a danger in the listing of specific guidelines in a manual such as this because it can lead to a user’s thinking of the materials as a “cookbook” in which the solutions to most problems are contained and for which no further thought needs to be given. Instrumentation and monitoring is too large a subject for this kind of treatment, and readers are urged to absorb the contents of as many of the listed references as possible in order to knowledgably compile their own project-specific guidelines for the undertaking at hand. That suggested task is summarized in nos. 8 and 9 in section 15.7.2. above.

#### 15.7.4 Remote (Automated) versus Manual Monitoring

As noted in the introduction, the automation of many, perhaps most, types of instrumentation is now possible and in some cases even relatively easy. This does not mean that it should always be done because increasing sophistication may also mean an increase in front end costs, maintenance costs, and in the number of things that can go wrong. Some of these considerations were covered briefly in preceding paragraphs, but without any large generalizations or guidelines having been promulgated.

It is easy to lose sight of one of the advantages of hands-on, manual monitoring, namely that it puts the data collecting technician or engineer on the job site where he or she can observe the construction operations that are influencing the readings. This can be a huge advantage because the interpretation of instrumentation data requires the comparison of one instrument type with another for mutual confirmation of correctness, and then seeing if the data plots match up with known construction activities, such as the removal of a strut or the increased depth of an excavation. Without such information being provided by the geotech field personnel, the instrumentation interpreter has to spend time digging out construction inspectors' reports or talking with various other people who may have knowledge of daily occurrences at the site. Valuable time can thus be lost, a serious consideration if adverse circumstances are developing fast. However, if data interpreters are depending upon their field personnel to provide feedback, those personnel need to have at least some minimal training in construction terminology and methods. For example, it is not helpful if monitoring personnel do not have the vocabulary to note whether they are observing the installation of a strut or a whaler.

Following are some of the most important reasons for choosing automation over manual monitoring of instruments:

1. When there is a requirement for data to be available in real time or something close to real time.
2. When easy and/or continued access to a monitored location is not assured.
3. When there is uncertainty about the continued availability of monitoring personnel.
4. When manual readings are subject to "operator sensitivity" and the same person or crew cannot always be available to monitor an instrument time after time.
5. When manual monitoring would unduly interfere with construction operations.
6. When manual monitoring would be too time consuming; e.g., the several-times-per-day reading of conventional inclinometers.
7. When data needs to be turned around quickly and distributed to multiple parties located in different offices.

#### 15.7.5 Establishment of Warning/Action Levels

At one time it was common for instrumentation program designers to write specifications on equipment types and installation procedures, but then leave up to construction contractors and field instrumentation specialists the decisions on whether allowable movements (or other parameters) were about to be exceeded. This can lead to endless arguments on whether mitigative action needs to be taken and whether the Contractor deserves extra payment for directed actions he may not have foreseen when submitting a bid price. Such problems can be alleviated to a degree by specifying the instrument reading levels which call for some action to be taken. Depending on a project Owner's preferred wording, the action triggering levels may be called instrument *Response Levels*, comprised of *Review* and *Alert Levels*, or *Response Values*, comprised of *Threshold* and *Limiting Values*.

The actions are generally specified in the following manner:

- A. If a Review Level/Threshold Value is reached, the Contractor is to meet with the Construction Manager to discuss response actions. If the CM so decides, the Contractor is to submit a plan of action and follow up within a given time frame so that the Alert Level/Limiting Value is not reached. The CM may also call for the installation of additional instruments.
- B. If, in spite of all efforts, the Alert Level/Limiting Value is reached, the Contractor is to stop work and again meet with the CM. If the CM so decides, the Contractor is to submit another plan of action and follow up within a given time frame so that the Alert Level/Limiting Value is not exceeded. Again, the CM may also call for the installation of additional instruments.

Such wordsmithing is easy compared with the effort involved in actually deciding what kind of levels/values to specify, because it may entail much time spent in structural and geotechnical analysis. It is not uncommon for specifications to stipulate only the actions required when settlements of any existing structure have reached a certain magnitude, or when the vibrations from blasting have exceeded a certain peak particle velocity. However, there are many other parameters that may deserve attention. Following is a partial list of what may be appropriate to consider for inclusion in specifications:

- Depth to which groundwater level must be lowered or depth to which it may be permitted to rise.
- Allowable vertical movements of anchors or sensors located at various depths in the ground.
- Allowable lateral deflections from the vertical as stated in relation to the depth of any sensing point in an inclinometer.
- Allowable deformations of ground or linings in the tunnel under construction.
- Allowable settlements for individual existing structures (as opposed to one set of figures applying to all structures equally).
- Allowable tilting of the walls in individual existing structures.
- Allowable differential settlements and angular distortions for existing structures.
- Allowable increases in widths of structural cracks or expansion joints.
- Allowable load increases in braced excavation struts or tiebacks in non-braced excavations.
- Rate of change of any of the above, in addition to the absolute magnitude.

In the interest of good risk management, it is recommended that designers of instrumentation and monitoring programs include what they consider the most important of the parameters in the specified action-triggering levels.

As these levels are being set, designers should guard against one pitfall: the assignment of readings that are beyond the sensing capabilities of the instrument. For instance, if a lower action-triggering level of  $\frac{1}{4}$  inch has been specified for a settlement point, one must be assured that the survey procedures used to collect data can reliably detect settlements down to  $\frac{1}{16}$  inch, for otherwise construction managers may be constantly responding to apparent emergencies that are not real but are only a result of survey “flutter.” Likewise, the higher action-triggering levels must be set a realistic distance above the lower ones to avoid similar problems. In the noted example, a lower level of  $\frac{1}{4}$  inch perhaps should not be matched with an upper level of  $\frac{3}{8}$  inch because that is an increase of only  $\frac{1}{16}$  inch, still pushing the level of probable surveying accuracy. Again one might end up responding to apparent emergencies that are not real.

### 15.7.5.1 Criteria

It is not within the scope of this document to establish criteria for tunneling projects; however, any monitoring program that is developed to protect adjacent properties must be consistent with both the types of measurements as well as the actual limiting values that are consistent with standard industry practice.

Criteria may be set either by regulations (Federal, State, and/or Local), or by specifications.

| Measurement Category    | Instrumentation   | Type of Reading        | Units         |
|-------------------------|-------------------|------------------------|---------------|
| Ground Movement         | Survey Point      | Displacement           | Inches        |
| Dynamic Ground Movement | Blast Seismograph | Peak Particle Velocity | Inches/second |
| Dynamic Ground Movement | Strain Gage       | Strain                 | Microstrain   |

### 15.7.6 Division of Responsibility

#### 15.7.6.1 Tasks or Actions

Tasks or Actions required for an instrumentation and monitoring program can be summarized as follows:

1. Lay out, design, specify.
2. Procure/furnish.
3. Interface with abutters for permission to install.
4. Install.
5. Maintain.
6. Monitor.
7. Reduce data.
8. Maintain database.
9. Distribute reduced data.
10. Interpret/analyze data.
11. Take mitigative action as required.
12. Remove instruments when need for them is ended.

Potential Performing Entities include the following four, any of whom may be assisted by a specialist consultant or subcontractor:

- The Owner
- The Design Engineer (not a separate entity in cases where the state – the Owner – is also the designer)
- The Construction Manager
- The Construction Contractor

In the case of Design-Build contracting, it is essentially a given that the Construction Contractor will be responsible for all of the listed tasks. This entity will probably be assisted by a consulting engineering firm to carry out the general design, and by an instrumentation specialist to attend to the matters related to instrument procurement, installation and monitoring, but it is the Contractor who takes the overall responsibility for the project.

In the more general (for the U.S.) case of Design-Bid-Build contracting, decisions have to be made by the Owner on how to assign the various responsibilities. Ideally, the Owner or the Owner's designer or

Construction Manager should be responsible for all of the 12 listed tasks except for nos. 3 and 11. Since the Contractor is not even aboard at the time of instrumentation program development, the tasks related to no.1 have to be undertaken by the designers of the project. The Contractor could perform no. 3 and must be the one to perform no. 11. (More will be said shortly about task no. 10.)

In the real world, it is a fact that most owners prefer to relegate to contractors the responsibility for furnishing, installing, maintaining and removing instrumentation, often because it, as a result of being included in a competitive low bid process, seems to provide equipment and services at the lowest possible cost. However, monies that seem to be saved by this decision may be less than they at first appear because low-bidding contractors will seldom opt for the highest quality instruments and will probably be constantly pushing for alternative instrument types for their own convenience rather than for the good of the project. Such contractor responsibilities can be considered acceptable only if the following rules are adhered to: (a) specifications must require the services of properly qualified instrumentation specialists; (b) specifications must be very detailed in the requirements for instrumentation hardware and installation methods, especially if the project is broken up into multiple contracts, where consistency from contract to contract has to be assured; and (c) the CM's staff must make every effort to diligently review contractor submittals and to inspect the field work as installations proceed.

If these rules are followed, it may be acceptable to turn over tasks 2, 4, 5 and 12 to a construction contractor, but one thing must be borne in mind: the Contractor's primary job is to *construct*. Instrumentation related activities are peripheral to that job; they will probably be viewed by the Contractor as a nuisance at best, and possibly as deleterious to progress. The CM needs to be cognizant of this attitude and thus to exercise the oversight necessary to ensure that unacceptable shortcuts are not taken.

One other aspect of low bid construction work can make relegation of these tasks to the constructor at least acceptable if not exactly desirable. When instrument installation is carried out by forces directly responsible to the Owner, there are many instances where the Contractor will have to provide assistance, perhaps even going so far as to shut down operations for a time. This can lead to endless friction with the CM and very likely to many claims for extras as the Contractor perceives too much interference in the construction process. Some of this conflict can be avoided if the actions of the instrument installation personnel are more under the control of the party responsible for progressing the primary job of excavation and support, i.e., the Contractor.

It can never be good policy, however, to turn the instrumentation monitoring, databasing, and data distribution over to the party whose actions are being "policed" through use of that data. Data collection and related tasks must be the responsibility of someone answering directly to the Owner, and that would normally be the Construction Manager. However, along with the responsibility for monitoring must go the responsibility, not just for distributing the reduced data, but also distributing it within a useful time frame. This normally means the morning after the day on which the data is collected, but in the modern world it may be much faster. With many instruments being monitored electronically in real time, and the data fed directly to the Project's main computer, much data can be delivered around the clock and alerts can be issued to users of cellphones and laptops when there is indication that action trigger levels have been reached or exceeded.

Regarding the interpretation of instrumentation data (task no. 10 above) the CM's forces will have to do it as a matter of course to ensure that construction operations are proceeding according to specification. However, it is not incumbent on the CM to immediately deliver interpretations to the Contractor along with the data. The Contractor is still the party with primary responsibility for safety of the job, and therefore, he must also have responsibility for performing an independent interpretation of what the

monitoring data means and stand ready to pursue whatever mitigating actions seem indicated. Otherwise, the Owner will have bought into a part of the responsibility for safety that by right belongs elsewhere.

### **15.7.7 Instrumentation and Monitoring for SEM Tunneling**

As discussed in Chapter 9, instrumentation and monitoring is an integral part of the SEM tunneling for the verification of design assumptions made regarding the interaction between the ground and initial support as a response to the excavation process by means of in-situ monitoring. It aims at a detailed and systematic measurement of deflection and stress of the initial lining. Monitoring data are collected thoroughly and systematically.

Readers are referred to Chapter 9 “SEM Tunneling” for discussions about monitoring management for SEM application.



## CHAPTER 16 TUNNEL REHABILITATION

### 16.1 INTRODUCTION

This chapter focuses on the identification, characterization and repair of typical structural defects in a road tunnel system. The most significant problem in constructed tunnels is groundwater intrusion. The presence of water in a tunnel, especially if uncontrolled and excessive, accelerates corrosion and deterioration of the tunnel liner. This chapter identifies the methods for measuring the flow of water from a leak; describes proper methods for identifying the types of remedial action to be taken including sealing of the liner with either chemical or cementations grout; and describes the procedures to install the various types of grout. A comparison of types of grout available at the time of writing and a chart indicating which type of grout is best suited for each condition is provided. Typical details are included to illustrate the proper methods for grouting.

This chapter presents various structural repair methods to reinstate the structural capacity of a deteriorated tunnel liner including methods for demolition of unsound concrete, brick or steel and methods for the restoration of the tunnel liner to its original condition and function. Details for the repair of concrete, steel reinforcement, and embedded elements of the tunnel liner system are provided. Most of the repair methods presented are designed to be used in active tunnels which permit minimum daily shutdowns. Repairs can be performed in a limited time frame allowing the tunnel to be returned to service on a daily basis.

This Chapter also addresses the structural bonding of cracked concrete. Details are presented to illustrate methods for demolition, surface preparation and placement of concrete to complete repairs. Current state-of-the-art materials available for repair of cast-in-place and precast concrete, steel and cast iron linings are discussed. Special procedures required for the repair of each lining material are presented.

This Chapter also addresses the various methods for the repair of components of segmental liners, including gaskets, attachments and fasteners. Guidelines for the repair of each type of segmental lining are presented. Design details of tunnel segmental lining are discussed in Chapter 10. The repair of hangers for suspended ceilings is discussed.

Repairs of steel/cast iron components addressed hereafter include roof beams columns, knee braces etc. which are often subject to severe corrosion and often need to be upgraded, replaced or rehabilitated. This Chapter covers typical details required for the restoration of riveted sections, rolled steel beams and other specially fabricated steel and cast iron elements of a tunnel system, and includes details on surface preparation, coatings for corrosion protection and proper methods for fire protection of the steel /cast iron elements of a tunnel.

This Chapter also address repairs of brick, dimension (Ashlar) stone and concrete masonry elements that exist in many tunnel systems. Methods of evaluating the condition of the masonry elements and methods for the restoration of masonry elements include removal and replacement, repair of mortar joints and methods for repointing joints. Procedures for the support of masonry structures during rehabilitation are discussed.

Lastly, structural repairs of unlined rock tunnels are briefly discussed in this Chapter.

## **16.2 TUNNEL INSPECTION AND IDENTIFICATION**

Tunnel inspection requires multi-disciplinary personnel familiar with various functional aspects of a tunnel including civil/structural, mechanical, electrical, drainage, and ventilation components, as well as some operational aspects such as signals, communication, fire-life safety and security components.

Recognizing that tunnel owners are not mandated to routinely inspect tunnels and that inspection methods vary among entities that inspect tunnels, the FHWA and the Federal Transit Administration developed guidelines for the inspection of tunnels in 2003 and updated them in 2005 known as “Highway and Rail Transit Tunnel Inspection Manual” available at [www.fhwa.dot.gov/bridge/tunnel/inspectman00.cfm](http://www.fhwa.dot.gov/bridge/tunnel/inspectman00.cfm) (FHWA, 2005a). Note that at the time of preparing this manual, the FHWA is proposing to create a regulation establishing National Tunnel Inspection Standards (NTIS) which would set minimum tunnel inspection standards that apply to all Federal-aid highway tunnels on public roads.

This Manual and Chapter focus on the civil/structural aspect and assumes tunnel inspection to be performed by experienced personnel who are familiar with the types of materials found in tunnels, have a basic understanding of the behavior of tunnel structural systems, have had experience in the inspection of transportation structures and are familiar with the FHWA Bridge Inspection Training Manual (FHWA-FD-91-015), and Highway Rail and Transit Tunnel Maintenance Rehabilitation Manual (FHWA-IF-05-017) (FHWA, 2005b). In addition to the information identified in the Bridge Inspection Training Manual, protocols are described herein that are applicable to the inspection of road tunnels. The following subsections discuss the standard parameters for inspection and documentation.

### **16.2.1 Inspection Parameter Selection**

Inspection parameters are chosen based upon the preliminary inspection of the tunnel and the scope of work. Particular emphasis should be placed on determining the presence of special or unique structures that require the addition of special inspection parameters for inclusion in the project database.

### **16.2.2 Inspection Parameters**

Standardized inspection parameters are necessary to speed the processing and evaluation of the observed data. The use of standardized coding of information, necessary for consistency of reporting, also helps to assure quality control by providing guidelines for inspection personnel and standardizing visual observations. The Deficiency and References Legends in Appendix H provides a recommended standard coding for cataloguing tunnel defects.

### **16.2.3 General Notes in Field Books**

All general field inspection/repair notes, consisting of a chronology of events, must be kept in a bound field book. Each member of the field team must carry a bound field book at all times when on site. The information contained in the field book should include notes on safety issues and on discussions with contractors, operations personnel and other interested parties. Entries into the field book must be chronological by date and time, and consist of clear, concise and factual notification of events and appropriate sketches. Field records, notes and the inspection database shall be maintained in one location. Field books should be copied on a weekly basis to prevent loss of data.

Nowadays electronic notebooks and/or special laptop computers are often used to record field data and sketches digitally which can also include digital photographs and/or videos with date, time, and GPS location information embedded.

#### **16.2.4 Field Notes**

The three types of field notes required for effective inspection of roadway tunnels are:

- General notes in field books
- Documentation of defects on field data forms
- Documentation of defects by photographs/video.

#### **16.2.5 Field Data Forms**

Field data forms document the information required for a particular project. In general, these forms are developed for the project and are project specific. The forms provide a project standard for the tabulation of the data obtained from the inspection. This information is transmitted to the data management personnel for input into the project database.

#### **16.2.6 Photographic Documentation**

The documentation of tunnel defects is best supplemented by the use of a digital camera. Photographs should be taken of typical and atypical conditions. Additionally, the photographs should also be used as documentation for special or unique conditions.

Photographs must:

- Exhibit the project number, date, time, location, photographer and a general description of the item
- Be catalogued and stored in a systematic manner for future recall. Note: It is helpful to name all photo logs in a consistent manner that is outlined in a directory; i.e., using the structure number as a pre-fix to each individual photo file name.

It is essential to follow the photographic method of documentation referenced above. Instituting this method at the beginning of the project will prevent mislabeled or unlabeled data from being distributed or misinterpreted.

#### **16.2.7 Survey Control**

All condition surveys require a definitive baseline for location (survey) purposes. Generally most highway systems have an established survey baseline. The post construction baseline survey of the highway system is usually performed for the maintenance of the roadway and tunnel structure. Such stationing systems are usually well defined with permanent markers located on the tunnel walls. Some tunnels may already have a baseline condition established by laser scanning techniques (Chapter 3).

The tunnel inspection documentation must be linked to the existing baseline stationing system for the following reasons:

- Allow inspection data to be used for long-term monitoring of the tunnel structure by the owner's engineering/maintenance staff
- Allow defects to be readily located for future inspection or repairs
- Facilitate rapid start-up of inspection teams
- Reduce project costs and confusion

In addition to locating the tunnel defects along the alignment, it is necessary to locate them in relation to their position within the structure. To locate defects within the tunnel, the limits of the walls, roof, and invert must be delineated for conformity (Figure 16-1). Circular tunnels are divided up into 30-degree segments clockwise from the highpoint of the tunnel crown as shown in Figure 16-2. This delineation is always performed looking upstation on the established baseline survey.

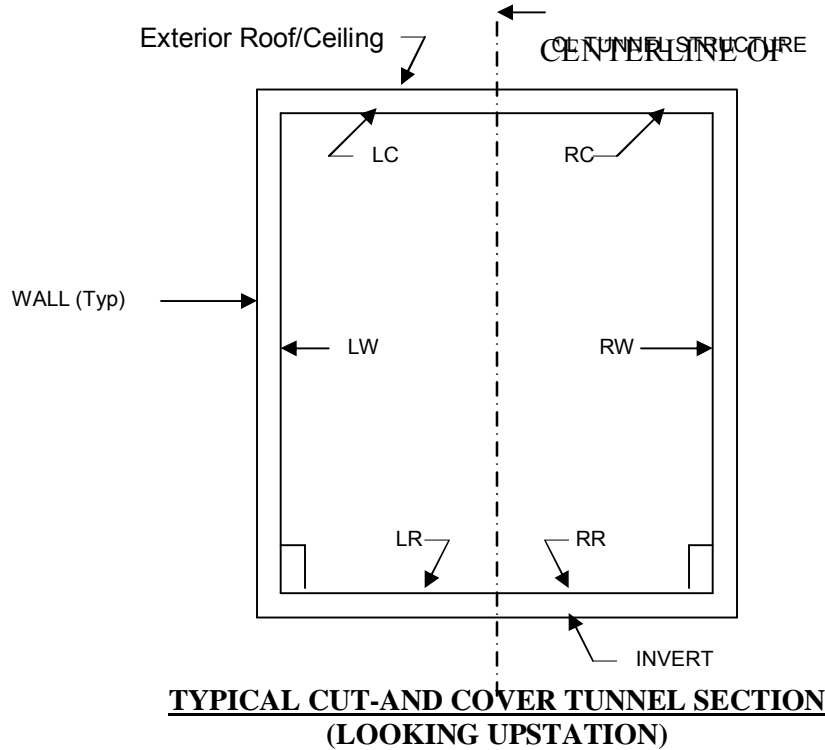

Legend

LC&RC: Left & Right Ceiling ; LW&RW: Left & Right Wall; and LR&RR: Left & Right Roadway Wearing Course

Figure 16-1 Typical Cut and Cover Inspection Surfaces and Limits (Russell, 1992)

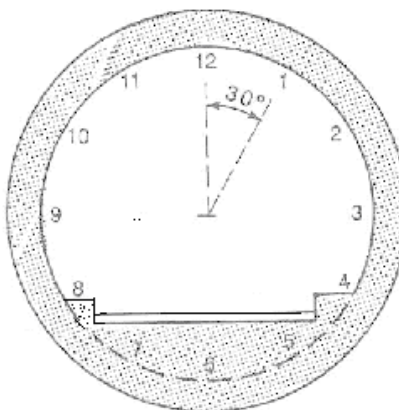

*Typical Circular Cell Tunnel*  
LOOKING UPSTATION

Figure 16-2 Delineation of Typical Circular Tunnel

The development of standard inspection parameters and the associated calibration of inspection crews, prevent many of the errors and omissions that can occur when the work is performed by numerous separate teams. In addition, timely reviews by the project advisory committee allow for program modifications and speedy implementation of supplemental procedures as required.

The documentation for each tunnel, boat section, ventilation building, cross passage, utility room, low point sump, pump station, air duct or other element is made looking up-station. The element being inspected is divided about the centerline. Each component of the element having deficiencies/ observations to the left of the centerline will have a prefix of (L), whereas those to the right of the centerline will have a prefix of (R).

Standardized codes are developed for deficiencies that correspond to each component of the tunnel structure. These deficiencies can be tracked easily in the field and conformed to by the inspection crew. Existing codes for deficiencies are depicted by symbols and identification for both concrete: spalls, delaminations, cracks and joints and steel: reinforcing and framing. Also identified are bolt connections, and tunnel moisture.

Spalls and delaminations may occur in concert and are almost always found in association with structural cracks. There are documented instances where spalls are the result of impact (cars, etc.), insufficient concrete cover over the reinforcing steel or poor quality control of workmanship or materials. Standardized symbols for concrete spalls can be referenced in Deficiency and References Legends, Appendix H and in Table 16-1.

An example of typical structural defects documented using standard inspection parameters is shown below. In this example, a concrete spall located at a construction joint on the right wall panel at station 250+55 is 2-square feet in surface area, 4-inches deep, with exposed reinforcing steel (rebar) ( R) which has a section loss of approximately 20% and has a glistening surface of water (GS) is documented as follows:

| <b>Station</b> | <b>Location</b> | <b>Type</b> | <b>Area (depth)</b> | <b>Re-Rod</b> | <b>Moisture</b> | <b>Comments</b>       |
|----------------|-----------------|-------------|---------------------|---------------|-----------------|-----------------------|
| 250+55         | RW              | S-2         | 2 S.F. (4")         | R-2, 20%      | GS              | At construction joint |

Note: Typical Spall Classifications: S-1 Concrete spall less than 2", S-2 Concrete spall to reinforcing steel ,S-3 Concrete spall behind reinforcing steel, S-4 Special concrete spall

Lists of standardized identification codes for deficiencies are included in Appendix H.

## 16.3 GROUNDWATER INTRUSION

### 16.3.1 General

Groundwater intrusion can be mitigated either by treating the ground outside the tunnel or by sealing the inside of the tunnel. This section will deal with the sealing of an existing lining rather than formation grouting outside of the tunnel.

The selection of the proper repair product for the conditions found on the project is key to the success of a leak containment program. Each site has its own particular environmental and physical properties. The pH, hardness, chemical composition, turbidity of the groundwater entering the tunnel all contribute to the ability of the chemical or particle grouts to effectively seal the leaking defect. The physical conditions that created the defect, movement of the crack or joint, the potential for freezing and the amount of water inflow all are site specific constraints for the selection of the repair material and all of these parameters must be assessed. Ideally, if any movement of the crack or joint is suspected it is best to monitor the defect for a period of time sufficient to allow for an estimation of actual movement.

The selection of the proper grout to seal a tunnel liner is dependent on the degree of leakage into the tunnel from the defect. Typically the tunnel defects that cause leakage are construction joints liner gaskets, and cracks that are the full depth of the liner. Standardized terms have been developed to describe the inflow of water. Standardized terms are useful in the selection of the grout because they allow all personnel including individuals who have not visited the tunnel to be familiar with the degree of water inflow. This familiarity of all personnel including the grout manufacturer facilitates the selection of the proper product and procedure for sealing the leak lists common terms used for the identification of leakage in the United States.

**Table 16-1 Common U.S. Descriptions of Tunnel Leakage (Russell, 1992)**

| <b>Item</b>        | <b>Symbol</b> | <b>Description</b>  |
|--------------------|---------------|---|
| Moist              | M             | Discoloration of the surface of the lining, moist to touch          |
| Past Moisture      | PM            | Area showing indications of previous wetness, calcification etc     |
| Glistening Surface | GS            | Visible movement of a film of water across a surface                |
| Flowing            | F             | Continuous flow of water from a defect; requires volume measurement |
| Dry                | D             | Structural defect illustrates no signs of moisture                  |

### 16.3.2 Repair Materials

The selection of the proper repair product for the site-specific condition is key to the successful repair of a tunnel or underground structure leak. The most common way to seal a tunnel liner is to inject a chemical or cementitious grout. The grout can be applied to the outside of the tunnel to create a “blister” type repair that seals off the leak by covering the affected area with grout. The selection of the grout is dependent on the groundwater inflow and chemical properties from the soil and water.

The most common method of sealing cracks and joints that are leaking is to inject a chemical or particle grout directly into the crack or joint. This is accomplished by drilling holes at a 45 degree angle through the defect. The holes are spaced alternately on either side of the defect at a distance equal to ½ the thickness of the structural element. The drill holes intersect the defect and become the path for the

injection of the grout into the defect. All holes must be flushed with water to clean any debris from the hole and to clean the sides of the crack or joint prior to injection to ensure proper bonding of the grout to the concrete. Typical injection ports are shown in Figure 16-3. Figure 16-4 shows field injection of grout. Figure 16-5 illustrates the typical location of injection ports and leaking crack repair detail (FHWA, 2005b).

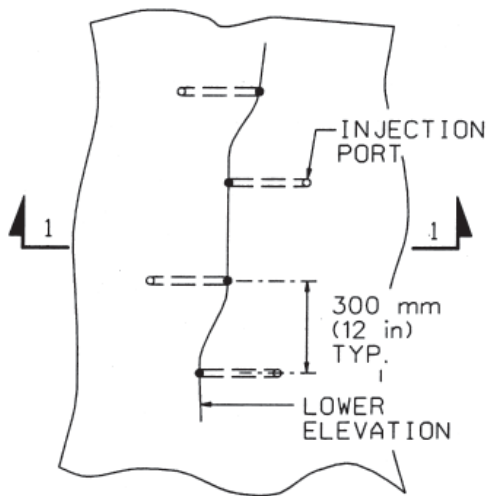

Figure 16-3 Typical Injection Ports for Chemical Grout



Figure 16-4 Leak Injection, Tuscarora Tunnel PA Turnpike

The selection of the grout is dependent on the width, moisture content, and potential for movement within the crack or joint. For joints that move, only chemical grout is appropriate. The movement of the joint or crack will fracture any particle grout and will cause the leak to reappear. Single component water reactive polyurethane chemical grout is the most effective grout for the full depth sealing of cracks and joints that have moisture present within the defect. If the defect is subject to seasonal wetness and is dry at the time of repair a hydrophilic grout should be used. When utilizing a hydrophilic grout, water must be introduced into the defect to catalyze the grout. Hydrophobic grouts have a catalyzing agent injected with the chemical grout or premixed into the grout prior to injection. In both cases water or a catalyst is used to gel the grout. Alternatively, hydrophobic chemical grout may be utilized. Hydrophobic chemical grouts rely upon a chemical reaction to cure whereas hydrophilic chemical grout require water to catalyze. Common hydrophobic grouts are acrylates and closed cell polyurethane. The installation of both types of grout is similar to that described here.



NOTES

1. REMOVE LOOSE MATERIAL FROM CRACK.
2. DRILL 15 MM (5/8 IN) DIA. INJECTION PORTS AT 45 DEG. ANGLE TO CRACK, ALTERNATING SIDES.
3. INSTALL MECHANICAL PACKER IN INJECTION PORT.
4. SEAL SURFACE OF CRACK WITH LOW-MODULUS GEL IF CRACK IS ACTIVELY LEAKING.
5. FLUSH CRACK WITH CLEAN WATER.
6. INJECT LIQUID URETHANE OR ACRYLATE ESTER RESIN INTO LOWEST MECHANICAL PACKER WITH HAND OPERATED HYDRAULIC PUMP UNTIL GROUT CAN BE SEEN AT THE NEXT INJECTION PORT UP.
7. REPEAT PROCESS UNTIL ENTIRE CRACK IS INJECTED.
8. REGROUTING MAY BE PERFORMED FOR UP TO A WEEK AFTER INITIAL GROUTING.

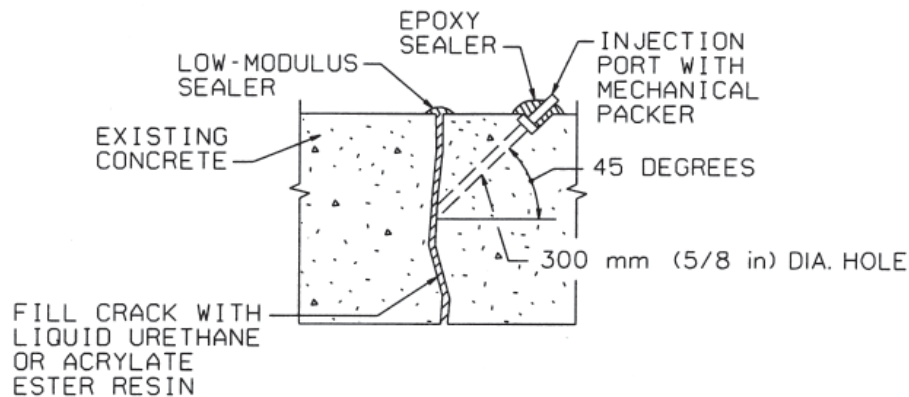

SECTION 1 - 1

Figure 16-5 Typical Location of Injection Ports and Leaking Crack Repair Detail (FHWA, 2005b)

In situations where the defect is not subject to movement and is dry at the time of repair an epoxy grout can be injected into the defect in the same manner that concrete is structurally rebonded. The grouts shown in Table 16-2 are typical grouts for the injection cracks and joints in a tunnel liner. The particle grouts are often used for formation grouting outside of the tunnel liner or in very large dry cracks and joints. The most commonly used grouts for the sealing of cracks in tunnel liners are the polyurethanes and acrylates.



**Table 16-2 Typical Grouts for Leak Sealing (Russell, 1992)**

| Description           | Viscosity         | Toxicity | Strength | Remarks  |
|-----------------------|-------------------|----------|----------|--|
| <b>Particle Grout</b> |                   |          |          |  |
| Flyash Type F;C       | Med (50cps-2:1)   | Low      | High     | Non flexible                                     |
| Type I Cement         | Med(50Cps-2-1)    | Low      | High     | Non flexible                                     |
| Type III Cement       | Med (15cps-2:1)   | Low      | High     | Non flexible                                     |
| Microfine Cement      | Low ( 8cps-2:1)   | Low      | High     | Non flexible                                     |
| Bentonite             | Med ( 50 cps 2:1) | Low      | Low      | Semi flexible                                    |
| <b>Chemical Grout</b> |                   |          |          |  |
| Acrylamides           | Low (10 cps 2:1)  | High     | Low      | Flexible   |
| Acrylates             | Low (10 cps)      | Low      | High     | Semi flexible -No shrinkage: Good success record |
| Silicates             | Low ( 6cps)       | Low      | High     | Non flexible- High Shrinkage                     |
| Lignosulfates         | Low (8 cps)       | High     | Low      | Flexible not widely used                         |
| Polyurethane (MDI)    | High (400 cps)    | Med.     | Low      | Flexible: Good success record (Hydrophilic)      |
| Polyurethane (TDI)    | High (400 cps)    | Med.     | Low      | Flexible : Good success Record(Hydrophobic)      |

Porous concrete can be sealed from the interior (negative side) of the tunnel to provide for a waterproof seal within the tunnel. Crystalline cementitious grouts that are applied to the interior of the tunnel and kept moist for 72 hours after application form a chemical bond with the free lime in the concrete and reduce the pore size of the concrete such that the free water vapor in the concrete cannot pass through. The success of these materials is varied and is to be used when no other alternative is available.

Interior side waterproofing is also performed by covering the interior surface of the wall with a cementitious coating consisting of two 1/8-inch thick coats applied to a moist concrete surface. Figure 16-6 illustrates the success of this type of coating in a tunnel in Pennsylvania with an external hydrostatic pressure of approximately 400 feet of water.

## **16.4 STRUCTURAL REPAIR – CONCRETE**

### **16.4.1 Introduction**

The repair of concrete delaminations and spalls in tunnels has traditionally been performed by the form-and-pour method for the placement of concrete, or by the hand application of cementitious mortars that have been modified by the addition of polymers. Both of these methods are not well suited for highway tunnels that are in continuous daily operation. This daily operation usually permits the tunnel to be out of service for very short periods of time. Therefore, the repair process must be rapid, not infringe on the operating envelope of the daily traffic and be a durable long-term monolithic repair.



Figure 16-6 Negative Side Cementitious Coating, Tuscarora Tunnel PA Turnpike

Today, the repair of concrete structural elements is performed typically by two methods: the use of hand applied mortars for small repairs and the use of shotcrete for larger structural repairs. In either case the preparation of the substrate is the same, only the type of material differs.

Shotcrete (also discussed in Chapters 9 and 10), is the pneumatic application of cementitious products which can be applied to restore concrete structures. This process has been in use for over decades in the US for the construction and repair of concrete structures both above and below ground. Shotcrete is defined by the American Concrete Institute as a “Mortar or concrete pneumatically projected at a high velocity onto a surface.” Since the 1970’s the use of low-pressure application of cementitious mortar has been commonplace in Europe and is known as Plastering. Over the years, developments in materials and methods of application have made the use of polymer cementitious shotcrete products for the repair of defects in tunnel liners in active highway tunnels cost effective. The selection of the process type, and the material to be applied is dependent on the specific conditions for tunnel access and available time for the installation of the repair. Shotcrete is preferred to other repair methods since the repair is monolithic and becomes part of the structure. The use of shotcrete is a process that allows for rapid setup, application and ease of transport into and out of the tunnel on a daily basis.

This section only provides the procedures utilized to delineate the extent of the repairs to the liner, and the work required to implement the shotcrete repairs. Refer to Chapter 10 for a more general discussion regarding shotcrete. Table 16-3 lists the most commonly used materials for the repair of tunnel liners.

**Table 16-3 Comparison of Repair Materials (Russell, 2007)**

| <b>Application</b>                             | <b>Two-Component Self Leveling Mortar</b> | <b>Polymer Shotcrete Wet Process</b> | <b>Two Component Mortar</b> | <b>Polymer Shotcrete Dry Process</b> | <b>Polymer Masonry Mortar</b> |
|--|---|--------------------------------------|-----------------------------|--------------------------------------|-------------------------------|
| On Grade; above, below                         | yes                                       | yes                                  | yes                         | yes                                  | yes                           |
| On horizontal                                  | yes                                       | yes                                  | yes                         | yes                                  | yes                           |
| On vertical                                    | no  | yes                                  | yes                         | yes                                  | yes                           |
| Overlay system                                 | yes                                       | No                                   | yes                         | no                                   | yes                           |
| Structural repair                              | yes                                       | yes                                  | yes                         | yes                                  | yes                           |
| Leveling material                              | yes                                       | yes                                  | no                          | yes                                  | yes                           |
| Filler: voids                                  | no  | yes                                  | yes                         | yes                                  | yes                           |
| Maximum depth                                  | 3 inches                                  | unlimited                            | 1 inch/lift                 | unlimited                            | 1 inch/lift                   |
| Minimum depth                                  | ½ inch                                    | ¼ inch                               | 1/4 inch                    | ¼ inch                               | 1/8 inch                      |
| Extended w/ aggregate                          | yes                                       | No                                   | yes                         | no                                   | yes                           |
| High abrasion                                  | yes                                       | yes                                  | yes                         | yes                                  | yes                           |
| Good bond Strength                             | yes                                       | yes                                  | yes                         | yes                                  | yes                           |
| Compatible coefficient of expansion w/concrete | yes                                       | yes                                  | yes                         | yes                                  | yes                           |
| Resistant to salts                             | yes                                       | yes                                  | yes                         | yes                                  | yes                           |
| High early strength                            | yes                                       | yes                                  | yes                         | yes                                  | yes                           |
| High Flexural                                  | yes                                       | yes                                  | Yes                         | yes                                  | yes                           |
| Good freeze- thaw                              | yes                                       | yes                                  | yes                         | yes                                  | yes                           |
| Vapor Barrier                                  | yes                                       | No                                   | no                          | no                                   | no                            |
| Flammable                                      | no  | No                                   | no                          | no                                   | no                            |
| Ok Potable water                               | yes                                       | yes                                  | yes                         | yes                                  | yes                           |
| Open to traffic 1-2 hours                      | yes                                       | yes                                  | yes                         | yes                                  | yes                           |
| Low rebound dust                               | yes                                       | yes                                  | yes                         | no                                   | yes                           |
| Prepackaged                                    | yes                                       | yes                                  | yes                         | yes                                  | yes                           |

### 16.4.2 Surface Preparation

The surface preparation for concrete repair requires removal of all unsound concrete by either the use of chipping hammers or the use of hydro-demolition. Unsound concrete is removed to the full depth of the unsound concrete. In cases where chipping hammers are used it has been found that limiting the size of the hammers by weight is the best way to control over excavation. Limiting the weight of the chipping hammers with bit, to less than 30 lbs. (13.6Kg) reduces the risk of over excavation of concrete. These hammers are too weak to excavate concrete in excess of 4,000 psi. (27,580 Kpa). The use of Hydro-demolition requires testing on site, at the beginning of the project to determine what pressures are required to excavate the unsound concrete without removing the sound substrate (Figure 16-7).

Hydro-demolition should not be used in areas that house electrical equipment, cables, or other mechanical equipment that may be effected by the excavation process. The area to be repaired must not have feather edges, and must have a vertical edge of at least 1/8 inch in height. This vertical shoulder is necessary to prevent spalling at the edge of the new repair.



Figure 16-7 Substrate after Hydro-demolition, Shawmut Jct. Boston

After the unsound concrete is removed, any leaking cracks or construction joints must be sealed prior to the application of the reinforcing steel coatings and the shotcrete. This sealing should be performed using a chemical grout suitable for the type and magnitude of the leakage. In general single component polyurethane grouts are the most successful in effectively sealing most tunnel leaks. Refer to Section 16.3.2 for more information on sealing leaks.

### 16.4.3 Reinforcing Steel

Once the unsound concrete has been removed, reinforcing steel must be cleaned and if a loss of section is evident the damaged reinforcing steel must be removed and replaced. All rust and scale must be removed from the reinforcing steel and any exposed steel liner sections or other structural steel elements. The cleaning is generally to a white metal commercial grade cleaning. Once cleaned the reinforcing steel is to be evaluated for loss of section and if the loss of section is greater than 30% an analysis must be performed. If the results of the analysis indicate that the lining does not have adequate strength with the remaining reinforcing steel, then the damaged steel must be replaced. Mechanical couplers are used when splicing new reinforcing steel to existing. Mechanical couplers eliminate the need for lap splices in the reinforcing steel and thereby reduce the amount of lining removal required to replace the reinforcing steel. (Figure 16-8)

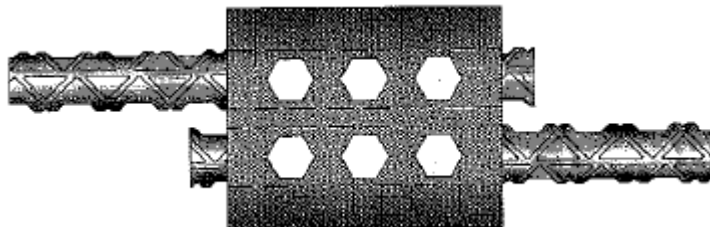

Figure 16-8 Typical Mechanical Coupler for Reinforcing Steel

After the steel has been cleaned a coating must be placed on the steel to protect the steel from accelerated corrosion due to the formation of an electrolytic cell. Numerous products exist for this purpose, including epoxy and zinc rich coatings. Zinc rich coatings are better suited for this application due to the fact that they do not form a bond-breaker as do many epoxies. This is important since these materials are applied by the use of a paint brush and it is difficult to prevent the concrete surface from being accidentally coated. The application of the zinc rich coating is to be performed within 48 hours of the cleaning and not more than 30 days prior the application of the shotcrete.

#### **16.4.4 Repairs**

Small shallow spalls are repaired by the use of a polymer modified hand patch mortar as shown in Figure 16-9. Hand patch mortar is a prepackaged polymer modified mortar that is applied in lifts of 1 to 2 inches. The patch areas are generally less than 2 square feet in area and require keying into the substrate by the use of “j” hooks and welded wire mesh or rebar. Unsound concrete is removed by either a hydro-demolition hand wand or by a chipping hammer with a weight of less than 30 lbs, including bit. The limiting of the hammer size provides for the removal of concrete of less than 4,000 psi compressive strength and limits over excavation since the hammer energy is not sufficiently strong to remove higher strength concrete.

Other than small repairs which utilize the repair mortars, the most commonly used material is shotcrete (or specifically prepackaged polymer modified fibrous shotcrete). Figure 16-10 illustrates the details of typical concrete repairs for deeper spalls. Discussions of the deeper spall repairs are included in Section 16.4.5 Shotcrete Repair.

#### **16.4.5 Shotcrete Repairs**

As discussed in Chapter 10, there are two processes for the application of shotcrete; Dry Process and Wet Process. Both processes have been in use for many years and are equally applicable for use in tunnel rehabilitations. The wet process creates little dust and is applicable for use in tunnels when partial tunnel closures allow traffic inside the tunnel during the repair work. The dry process creates extensive dust and is not suitable for partial tunnel closures due to limited visibility created by the dust.

The successful application of shotcrete regardless of the process chosen relies on the skill of the nozzleman (Figure 16-11) (In the case of the wet process both the nozzleman and the laborer mixing the mortar). A successful repair program requires the nozzleman and the other members of the shotcrete crew to be skilled and tested on site using mock-ups of the types of areas to be repaired. These mock-ups should closely duplicate the shape and surfaces to be repaired. This testing program is often used to certify the skill of the shotcreting crew and provides for better quality control during the progress of the work. The testing program develops an understanding between the Engineer, Owner and Contractor that defines an acceptable product for the work.

Once the reinforcing and structural steel elements have been cleaned and coated, welded wire mesh is to be placed over the area to be shotcreted (Figure 16-12). The mesh is placed to within 2 inches of the edge of the repair. The wire mesh is attached to the existing reinforcing and to the substrate by the use of “J” hooks.

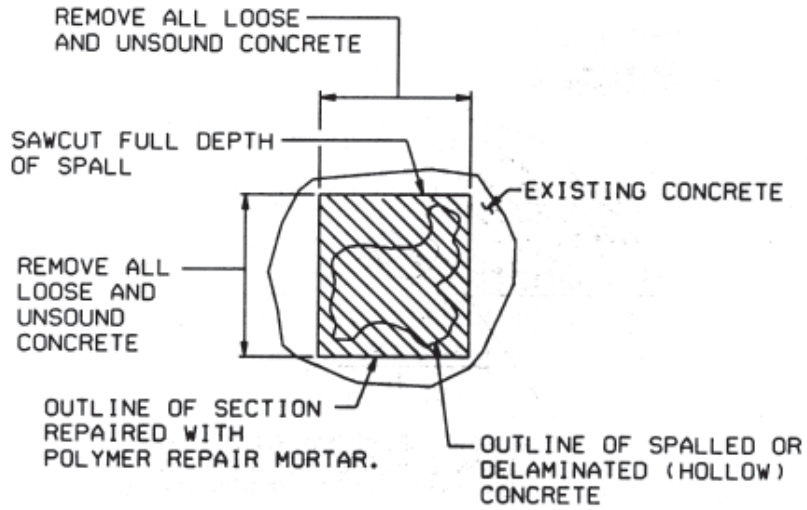

PLAN VIEW

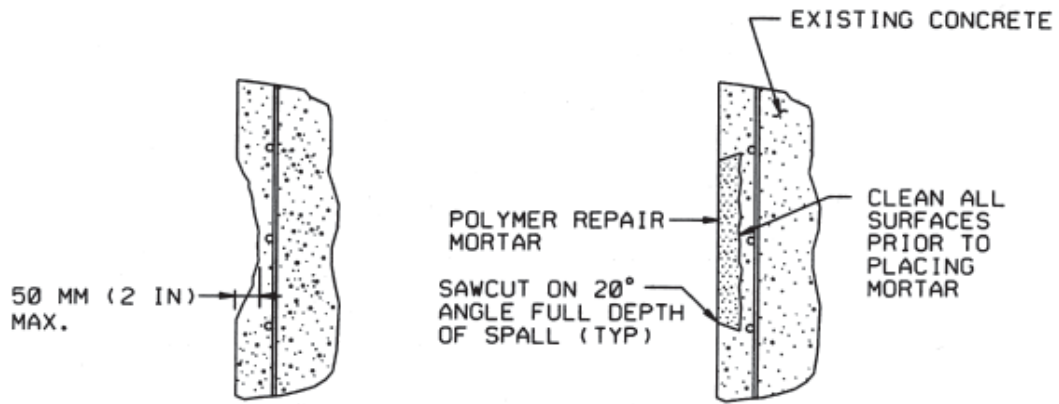

EXISTING SPALL

REPAIR

SECTIONS

Figure 16-9 Shallow Spall Repair (FHWA, 2005b)

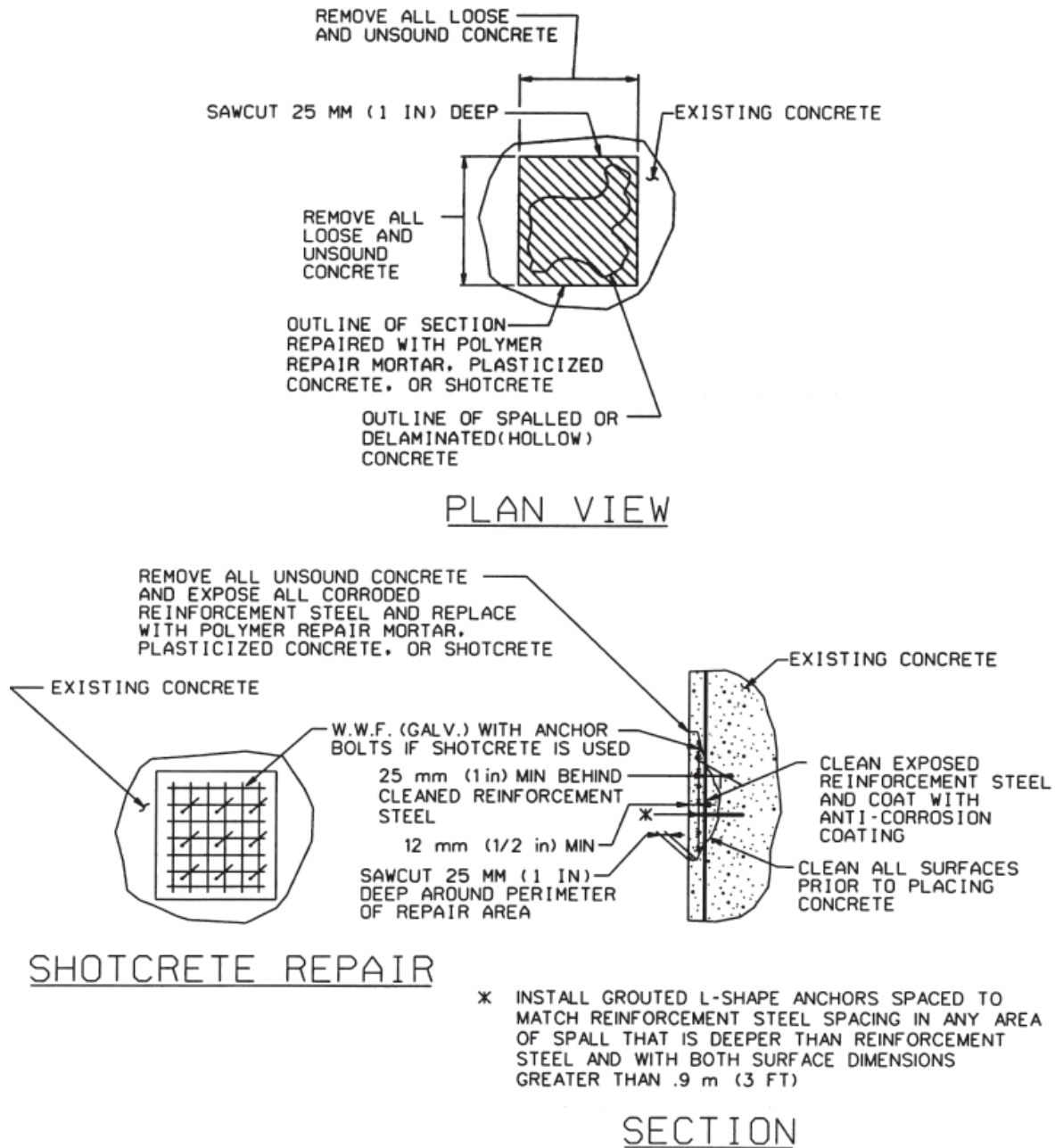

Figure 16-10 Typical Sections at Concrete Repair (FHWA, 2005b)

The purpose of the wire mesh is to assist in the buildup of the shotcrete and to provide for a monolithic repair that becomes part of the host structure. The wire mesh should be hot dipped galvanized after fabrication and is best if delivered to the site in sheets rather than on a roll. If epoxy coated mesh is used it must be in sheets in order to eliminate field touch-up of the cut ends of the mesh. The mesh size for dry process is a 2 X 2 inch mesh and for wet process 4 X 4 inch mesh. The larger mesh is required for the wet process to prevent clogging of the mesh by the shotcrete and therefore creating voids behind the mesh surface.



Figure 16-11 Nozzleman Applying Wet Process Shotcrete, USPS Tunnel Chicago



Figure 16-12 Reinforcing Steel for Repair, Sumner Tunnel Boston

After the entire area to be patched is filled with shotcrete the material is allowed to cure for 20-30 minutes, at which time the mix is screeded and troweled to the desired finish (Figure 16-13). Trying to work the shotcrete prior to this time will result in tearing of the surface and make finishing very difficult. Caution must be exercised to monitor the drying rate of the shotcrete since the times stated here will vary depending on wind conditions and relative humidity. After the repair has been troweled to the desired finish a curing compound must be sprayed on the surface of the new shotcrete to prevent rapid drying. The manufacturer of the premixed shotcrete will recommend a curing compound best suited for the job site conditions.





Figure 16-13 Shotcrete Finishing, Shawmut Jct. Boston

## 16.5 STRUCTURAL INJECTION OF CRACKS

Cracking is the most common defect found in concrete tunnel liners. While most of the cracks are a result of thermal activity, there are cracks that are a result of structural stresses that were not accounted for in the design. It is important to note that cracks also occur as a result of shrinkage and thermal stresses in the tunnel structure. Cracks that exhibit thermal stresses should not be structurally rebonded since they will only move and re-crack. However, structural cracks that occur as a result of structural movement, such as settlement and are no longer moving should be structurally rebonded. Any crack being considered for structural rebonding must be monitored to assess if any movement is occurring. A structural analysis of the tunnel lining should be performed to ascertain if the subject crack requires rebonding.

There are three types of resin typically available for injection of structural cracks in tunnels. They are:

- Vinyl Ester Resin
- Amine Resin
- Polyester Resin

Vinyl ester resin is the common type of resin used for bridge repair work and is usually not suited for tunnel work since most cracks in tunnels are damp or wet. The vinyl ester resin will not bond to surface saturated concrete and will not structurally rebond a damp or moist crack. However, if the crack is totally dry during the injection process this epoxy will provide a suitable rebonding of the concrete.

Amine and polyester resins are best suited for the structural rebonding of cracks in tunnels. Both resins are unaffected by moisture during installation and will bond surface saturated concrete. Cracks with flowing water must be carefully injected and the manufacturer's advise must be obtained to ensure proper installation of the resin.

In all cases the manufacturer's recommendations must be followed for the injection of epoxy resins, particularly in the case of overhead installation. Figure 16-14 illustrates a typical installation of epoxy

resin for the structural rebonding of cracks in concrete. The procedure for rebonding masonry and precast concrete elements is similar.

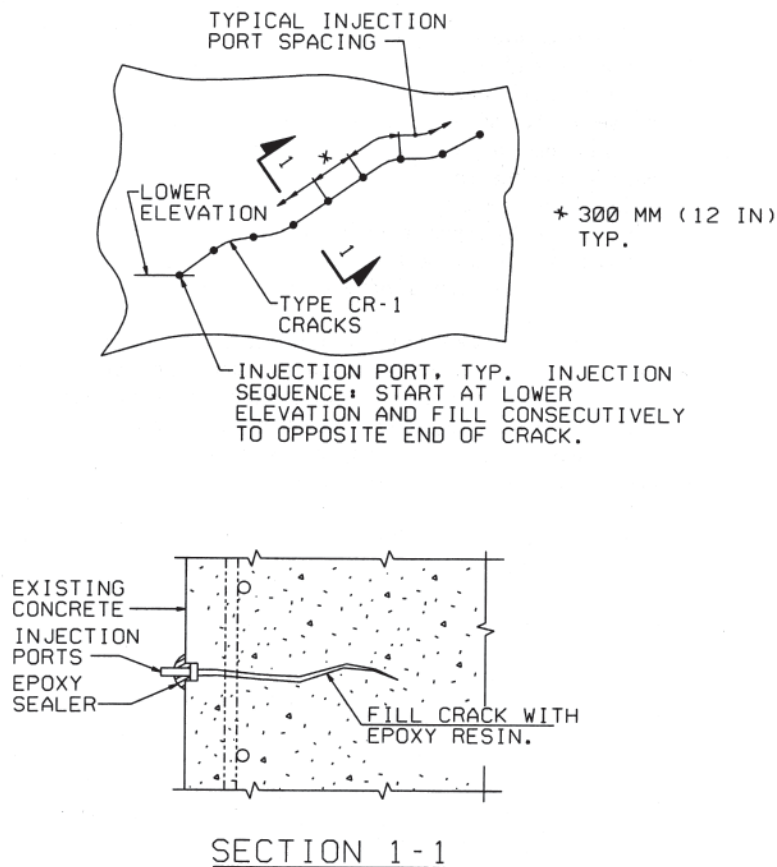

Figure 16-14 Typical Structural Crack Injection (FHWA, 2005b)

## 16.6 SEGMENTAL LININGS REPAIR

As discussed in Chapter 10, segmental lining can be made up of either, precast concrete, steel or cast iron. A segmental liner is usually the primary liner of a tunnel. The segments are either bolted together or keyed. The only segmental liners that are keyed are the precast liners. The most common problems with segmental liners is deformation of the flanges in the case of steel and cast iron liners and corner spalling of precast concrete segments. The spalling of precast segments and deformation of the flanges of steel/cast iron segments usually occurs at installation or as a result of impact damage from vehicles. In addition the rusting through of the liner plate of steel/cast iron segments occasionally occurs.

### 16.6.1 Precast Concrete Segmental Liner

The repair of spalls in precast concrete liner segments is performed by the use of a high performance polymer modified repair mortar which is formed to recreate the original lines of the segment. In the event the segment gasket is damaged the gasket's waterproofing function is restored by the injection of a polyurethane chemical grout as described above. Damaged bolt connections in precast concrete liner segments are repaired by carefully removing the bolt and installing a new bolt, washer, waterproof gasket and nut. The bolts are to be torqued to the original specification and checked with a torque wrench.

## 16.6.2 Steel/Cast Iron Liner

The repair of steel/cast iron liners varies according to the type of liner material. Steel, if made after 1923, is weldable while cast iron is not. Common defects in these types of liners are deformed flanges and penetration of the liner segment due to rusting. Deformed flanges can be repaired by reshaping the flanges with hammers or heat. Holes in steel liner segments can be repaired by welding on a new plate. Bolted connections often have galvanic corrosion which is caused by dissimilar metal contact and often require the entire bolted connection to be replaced. When the bolted connection is replaced a nylon isolation gasket is used to prevent contact between the high strength bolt and the liner plate. Figure 16-15 shows the repair of a rusted through steel segment and a repaired bolted connection.

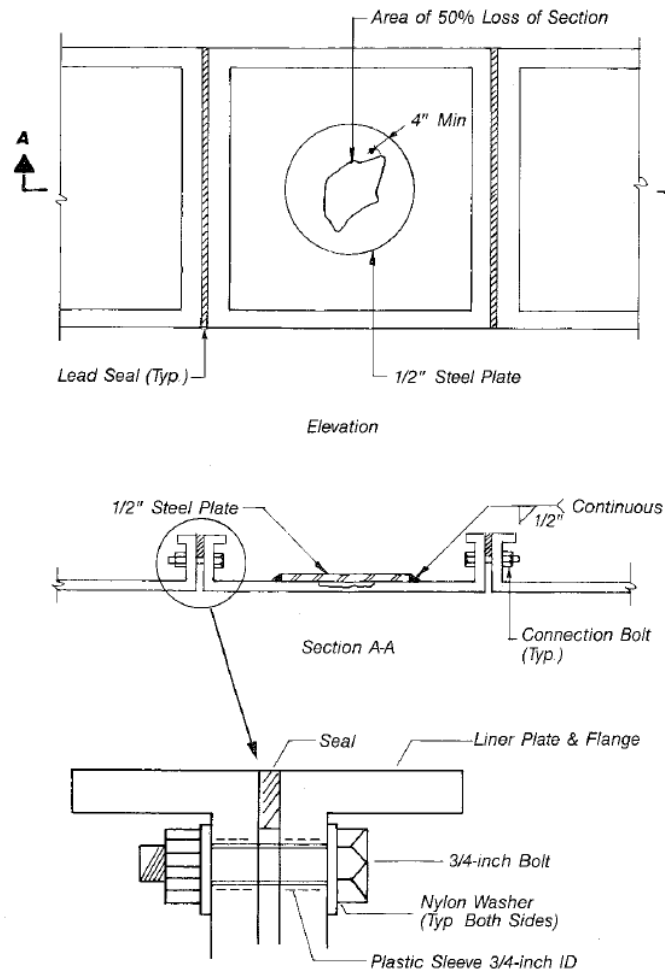

Figure 16-15 Steel Segmental Liner Repair (Russell, 2000)

Repairs to cast iron liner segments is similar to those for steel. However, since cast iron cannot be welded the repair plate for the segment is installed by brazing the repair plate to the cast iron or drilling and tapping the liner segment and bolting the repair plate to the original liner segment. In some instances it is easier to fill the area between the flanges with shotcrete. Figure 16-16 illustrates a test panel for filling a liner plate with shotcrete.



Figure 16-16 Cast Iron Segmental Segment Mock-up of Filling with Shotcrete, MBTA Boston

## 16.7 STEEL REPAIRS

### 16.7.1 GENERAL

Structural steel is commonly used at the portals of tunnels, support of internal ceilings, columns, segmental liners and as standoffs for tunnel finishes. The repairs to steel elements is to be site specific and to be performed in accordance with the appropriate standard (Figure 16-7). The American Welding Society's Standard Structural Steel Welding Code *AWS D1.1/D1.1 Structural Welding Guide* most recent version should be utilized for the construction of all welded steel connections. Repairs to Rivets and bolting must comply with AASHTO Specification.

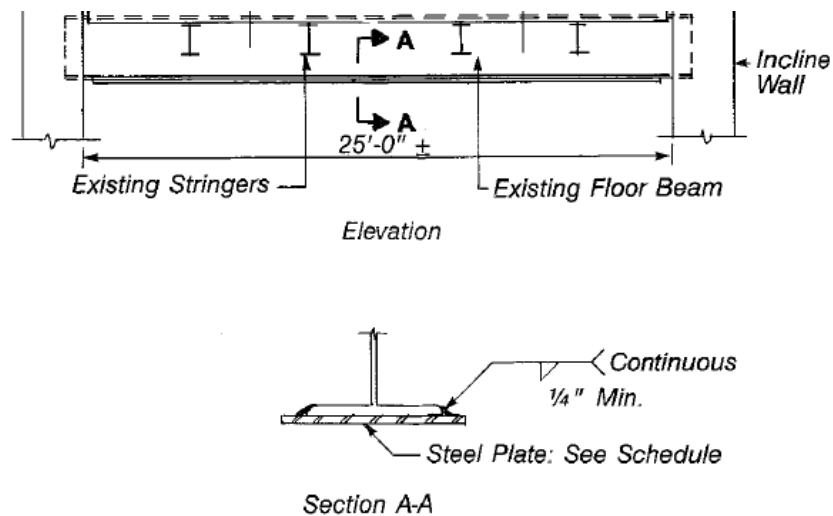

Figure 16-17 Typical Framing Steel Repair at Temporary Incline

## 16.8 MASONRY REPAIR

The restoration of masonry linings composed of clay brick or Ashlar (dimension) stone consists of the repointing of deficient mortar. As shown in Figure 16-18, the repointing of masonry joints consists of raking out the joint to a depth of approximately one inch (2.54cm). Once the joint has been raked clean and all old mortar removed, the joints are repointed with a cementitious mortar, or a cementitious mortar that has been fortified with an acrylic bonding agent.

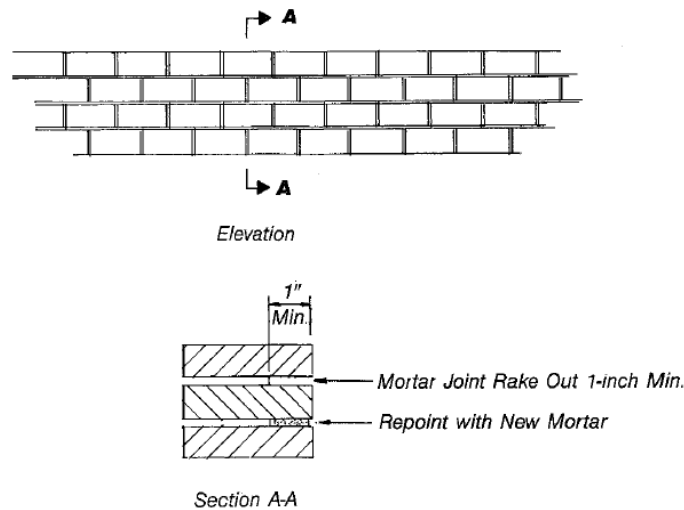

Figure 16-18 Typical Masonry Repair

Replacement of broken, slaked or crushed clay brick requires a detailed analysis to determine the causes and extent of the problem. Once the problem is properly identified a repair technique can be designed for the particular structure. Caution must be exercised in the removal of broken or damaged brick. The removal of numerous bricks from any one section may cause the wall or arch to fail. Therefore it is imperative that any repair work on masonry be performed by competent personnel having experience in the restoration of brick and stone masonry.

## 16.9 UNLINED ROCK TUNNELS

Unlined rock lined tunnels do not required a permanent concrete, brick or steel lining since the rock was competent and illustrated sufficient strength with minimal reinforcement to remain standing. These roadway tunnels are also usually very short in length. Most have support consisting of various types of rock reinforcement; including rock dowels, rock bolts, cable bolts and other reinforcement which were placed at various angles to cross discontinuities in the rock mass. These rock reinforcement elements typically range in length for 5 to 20 feet in length and are installed and grouted with resin or cementitious grout. Please refer to Chapter 6 for more detailed discussions about various types of rock reinforcement elements.

Rock reinforcement elements, may deteriorate and loose strength due to the corrosive environment and exposure typical in tunnels, and require replacement and installation of new rock reinforcement elements. Replacement of rock reinforcement elements requires a detailed investigation of the structural geology of

the tunnel which is performed by an engineering geologist or geotechnical engineer having experience in geologic mapping and the rock stability analysis as discussed in Chapter 6.

Another more frequent cause for the need to repair unlined rock tunnels is the falling of rock fragments which over time become loose and drop onto the roadway. There are many ways to prevent this from occurring, the most common of which is to scale (remove) all loose rock on a periodic basis from the tunnel roof and walls by the use of a backhoe or hoe ram. Other methods include the placement of steel liner roof as a shelter, additional rock bolts and wire mesh to contain the falling rock fragments, and shotcrete on the areas of concern as shown in Figure 16-19 and Figure 16-20.



Figure 16-19 Rock Tunnel with Shotcrete Wall Repair and Arch Liner (I-75 Lima Ohio)



Figure 16-20 Rock Bolts (Dowels) Supporting Liner, I-75 Lima Ohio Underpass

## 16.10 SPECIAL CONSIDERATIONS FOR SUPPORTED CEILINGS/ HANGERS

Numerous highway tunnels in the United States have suspended ceilings for ventilation purposes and in some cases aesthetics. These ceilings are generally supported by keyways in the tunnel walls and by hanger rods that are attached to the tunnel liner either by means of cast-in-place inserts or post-installed mechanical or adhesive (chemical) anchors. FHWA issued a Technical Advisory in 2008 strongly discouraging the use of adhesive anchors for permanent sustained tension or overhead applications (see Appendix I). Any use of adhesive anchors in road tunnels must conform to current FHWA directives and other applicable codes and regulations.

The inspection of these hangers is important to tunnel safety and a rigorous and regular inspection program that considers importance and redundancy is strongly recommended to maintain an appropriate level of confidence in their long-term performance.

During inspection one method used to verify hangers are in tension is by “ringing” each hanger. Ringing a hanger is done by striking it with a masons hammer. A hanger in tension will vibrate or ring like a bell after being struck while a hanger that is not in tension because of a connection or other defect will not ring. Hangers that exhibit a defect or lack of tension should be closely inspected and checked for structural suitability. Examples of typical hangers and their components are shown in Figure 16-21.

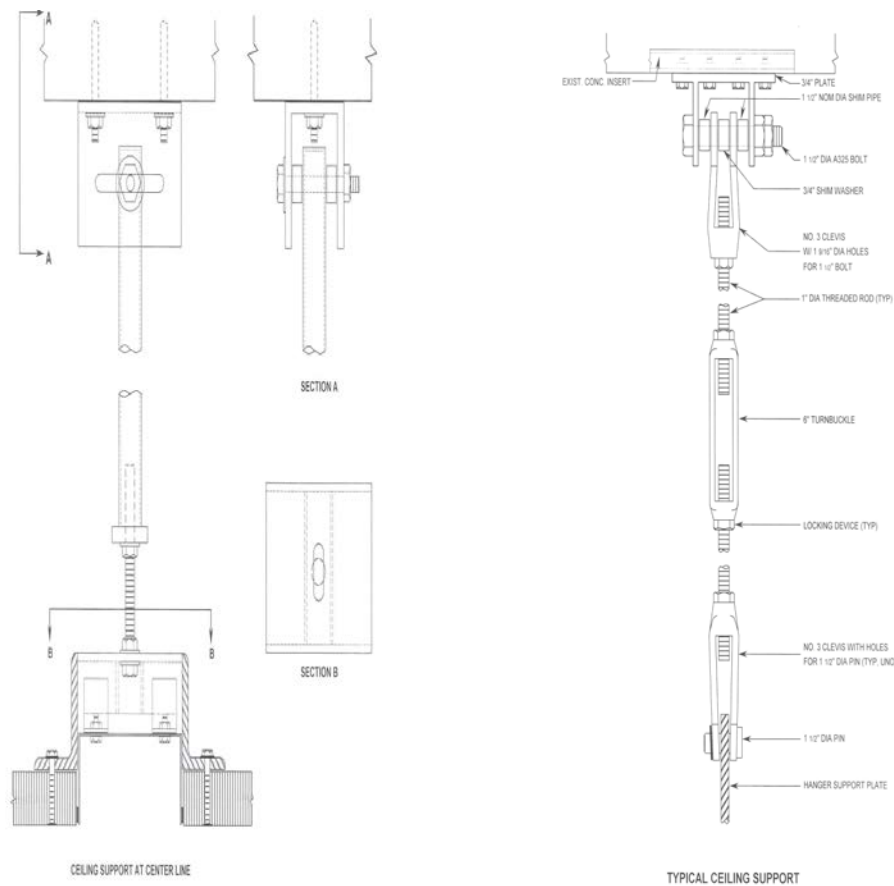

Figure 16-21 Typical Hanger Supports for Suspended Ceiling

The repair of ceiling hangers depends on the particular type of defect. If the hanger rod, clevis, turnbuckle or connection pins are broken or damaged they can be simply replaced with similar components which are readily available from many sources, including most large hardware supply retailers (Figure 16-22).



Figure 16-22 Typical Replacement Hanger Hardware

The repair of loose connections at the tunnel arch is of primary concern. The recommended repair for failed adhesive anchors is to replace them with undercut mechanical anchors typical examples of which are shown in Figure 16-23.



Figure 16-23 Typical Undercut Mechanical Anchors



## GLOSSARY

|                    |   |
|--------------------|---|
| AASHTO             | American Association of State Highway and Transportation Officials  |
| ANFO               | Ammonium nitrate mixed with fuel oil used as an explosive in rock excavation.   |
| ASCE               | American Society of Civil Engineer  |
| Accelerator        | Admixture to accelerate the process of hardening.   |
| Admixtures         | Materials in liquid or powder form, added to the shotcrete mix influencing the chemical process and consistency of sprayed concrete.  |
| Aggregates         | Graded mixture of mineral components being added to a concrete mix.   |
| Alluvium           | A general term for recent deposits resulting from streams.  |
| Aquiclude          | <ol style="list-style-type: none"><li>1. Rock formation that, although porous and capable of absorbing water slowly, does not transmit water fast enough to furnish an appreciable supply for a well or spring.</li><li>2. An impermeable rock formation that may contain water but is incapable of transmitting significant water quantities. Usually functions as an upper or lower boundary of an aquifer.</li></ol> |
| Aquifer            | <ol style="list-style-type: none"><li>1. A water-bearing layer of permeable rock or soil.</li><li>2. A formation, a group of formations, or a part of a formation that contains sufficient saturated permeable material to yield significant quantities of water to wells and springs.</li></ol>  |
| Aquitard           | A formation that retards but does not prevent water moving to or from an adjacent aquifer. It does not yield water readily to wells or springs, but may store groundwater.  |
| Artesian condition | Groundwater confined under hydrostatic pressure. The water level in an artesian well stands above the top of the artesian water body it taps. If the water level in an artesian well stands above the land surface, the well is a flowing artesian well.  |
| Bench              | A berm or block of rock within the final outline of a tunnel that is left after a top heading has been excavated.   |
| Bit                | A star or chisel-pointed tip forged or screwed (detachable) to the end of a drill steel.  |
| Blocking           | Wood or metal blocks placed between the excavated surface of a tunnel and the bracing system, e.g., steel sets. Continuous blocking can also be provided by shotcrete.  |

|                     |  |
|---------------------|--|
| Bootleg or Socket   | That portion or remainder of a shot hole found in a face after a blast has been fired.   |
| Breast boarding     | Partial or complete braced supports across the tunnel face that hold soft ground during tunnel driving.  |
| Bulkhead            | A partition built in an underground structure or structural lining to prevent the passage of air, water, or mud.   |
| Burn cut            | Cut holes for tunnel blasting that are heavily charged, close together, and parallel. About four cut holes are used that produce a central, cylindrical hole of completely shattered rock. The central or bum cut provides a free face for breaking rock with succeeding blasts. |
| CCTV                | Closed-circuit television  |
| CFD                 | Computational fluid dynamics   |
| Chemical grout      | A combination of chemicals that gel into a semisolid after they are injected into the ground to solidify water-bearing soil and rocks.   |
| Cherry picker       | A gantry crane used in large tunnels to pick up muck cars and shift a filled car from a position next to the working face over other cars to the rear of the train.  |
| Cohesion            | A measure of the shear strength of a material along a surface with no perpendicular stress applied to that surface.  |
| Conglomerate        | A sedimentary rock mass made up of rounded to subangular coarse fragments in a matrix of finer grained material.   |
| Controlled blasting | Use of patterned drilling and optimum amounts of explosives and detonating devices to control blasting damage.   |
| Cover               | Perpendicular distance to nearest ground surface from the tunnel.  |
| Crown               | The highest part of a tunnel.  |
| Cut-and-cover       | A sequence of construction in which a trench is excavated, the tunnel or conduit section is constructed, and then covered with backfill.   |
| Cutterhead          | The front end of a mechanical excavator, usually a wheel on a tunnel boring machine, that cuts through rock or soft ground.  |
| Delays              | Detonators that explode at a suitable fraction of a second after passage of the fling current from the exploder. Delays are used to ensure that each charge will fire into a cavity created by earlier shots in the round.   |
| Disk cutter         | A disc-shaped cutter mounted on a cutterhead.  |
| Drag bit            | A spade-shaped cutter mounted on a cutterhead.   |

|                                  |  |
|----------------------------------|--|
| Drift                            | An approximately horizontal passageway or portion of a tunnel. In the latter sense, depending on its location in the final tunnel cross section, it may be classified as a "crown drift," "side drift" "bottom drift", etc. A small tunnel driven ahead of the main tunnel.                    |
| Drill-and-blast                  | A method of mining in which small-diameter holes are drilled into the rock and then loaded with explosives. The blast from the explosives fragments and breaks the rock from the face so that the rock can be removed. The underground opening is advanced by repeated drilling and blasting.  |
| Dry Mix                          | Mixture being supplied to the nozzle where the required amount of water and, if required, liquid accelerator is added.   |
| FHWA                             | Federal Highway Administration   |
| Face                             | The advance end or wall of a tunnel, drift, or other excavation at which work is progressing.  |
| Face stabilization wedge         | Unexcavated portion of the heading temporarily left in place to enhance face stability.  |
| Fibers                           | Steel fibers or synthetic fibers added to mixes to improve flexural strength and post failure characteristics of the shotcrete or concrete.  |
| Final Lining                     | Cast-in-place concrete, shotcrete, precast concrete segment, or steel lining placed after installation of the initial support and waterproofing (if applicable).   |
| Fiber Reinforced Shotcrete (FRS) | Shotcrete reinforced with either steel (SFRS) or synthetic fibers.   |
| Finishing Shotcrete              | Unreinforced sprayed concrete to smoothen rough or undulating surfaces or to cover steel fiber reinforced shotcrete. Typically applied on initial shotcrete lining in preparation for the waterproofing installation or as finishing layer for the final surface of permanent support linings. |
| Finite difference method         |  |
| Finite element method            | The representation of a structure as a finite number of two-dimensional and/or three-dimensional components called finite elements.  |
| Firm ground                      | Stiff sediments or soft sedimentary rock in which the tunnel heading can be advanced without any, or with only minimal, roof support, the permanent lining can be constructed before the ground begins to move or ravel.   |

|                                |  |
|--------------------------------|--|
| Flashcrete (Sealing Shotcrete) | Typically unreinforced or steel fiber reinforced sprayed concrete layer to seal off exposed ground surface, typically 30 to 50 mm (1.2 to 2 in) thick.   |
| Forepole                       | A pointed board or steel rod driven ahead of timber or steel sets for temporary excavation support.  |
| Forepoling                     | Driving forepoles ahead of the excavation, usually supported on the last steel set or lattice girder erected, and in an array that furnishes temporary overhead protection while installing the next set.  |
| Full-face Heading              | Excavation of the whole tunnel face in one operation.  |
| Gouge zone                     | A layer of fine, wet, clayey material occurring near, in, or at either side of a fault or fault zone.  |
| Grade                          | Vertical alignment of the underground opening or slope of the vertical alignment.  |
| Ground control                 | Any technique used to stabilize a disturbed or unstable rock mass.   |
| Ground stabilization           | Combined application of ground reinforcement and ground support to prevent failure of the rock mass.   |
| Ground support                 | Installation of any type of engineering structure around or inside the excavation, such as steel sets, wooden cribs, timbers, concrete blocks, or lining, which will increase its stability. This type of support is external to the rock/soil mass.   |
| Ground Support Class           | Prescribed excavation sequence, support and local support based on the type of host material expected in excavation cross section as well as by the anticipated response and behavior of the host material during excavation.  |
| Ground Support System          | System of interacting support elements such as shotcrete lining, steel support, rock reinforcement (dowels, bolts, spiling, etc.) in combination with an excavation and support sequence. If required, ground support systems can be supplemented by ground improvement measures (e.g. grouting, ground freezing, dewatering). |
| Grout                          | Neat cement slurry or a mix of equal volumes of cement and sand that is poured into joints in masonry or injected into rocks. Also used to designate the process of injecting joint-filling material into rocks. See grouting.   |
| Grouted Pipe Spiling           | Perforated steel pipes installed at the tunnel heading ahead of excavation and grouted as a means to pre-support the ground.   |
| Heading and bench              | A method of tunneling in which a top heading is excavated first, followed by excavation of the horizontal bench.   |

|                          |   |
|--------------------------|---|
| Ho-ram                   | A hydraulically operated hammer, typically attached to an articulating boom, used to break hard rock or concrete.   |
| Hydraulic jacking        | Phenomenon that develops when hydraulic pressure within a jacking surface, such as a joint or bedding plane, exceeds the total normal stress acting across the jacking surface. This results in an increase of the aperture of the jacking surface and consequent increased leakage rates, and spreading of the hydraulic pressures. Sometimes referred to as hydraulic fracturing.   |
| ITA                      | International Tunnel Association  |
| Initial Shotcrete Lining | Shotcrete layer of a minimum thickness as defined in the ground support class typically reinforced with lattice girders, splice bars and either fibers (steel or synthetic) or welded wire fabric.  |
| Initial Support          | Support required to provide stability of the tunnel opening and to maintain the inherent strength of the ground surrounding the tunnel openings while preventing unnecessary loosening and enhancing the stress redistribution process. This function of support may be enhanced by installation of systematic Tunnel Pre-support and local support where required by ground conditions. It typically consists of reinforced shotcrete, rock reinforcement, pre-support, steel rib or lattice girder sets, or combinations thereof. |
| Invert                   | On a circular tunnel, the invert is approximately the bottom 90 deg of the arc of the tunnel; on a square-bottom tunnel, it is the bottom of the tunnel.  |
| Invert strut             | The member of a set that is located in the invert.  |
| Joint                    | A fracture in a rock along which no discernible movement has occurred.  |
| Jumbo                    | A movable machine containing working platforms and drills, used for drilling and loading blast holes, scaling the face, or performing other work related to excavation.   |
| Jump set                 | Steel set or timber support installed between overstressed sets.  |
| Lagging                  | Wood planking, steel channels, or other structural materials spanning the area between sets.  |
| Length of Round          | Length of the unsupported span of exposed ground opened up during one round of excavation, followed by the installation of the initial support to advance the tunnel.   |
| Local Support            | Non-systematic application of initial support measures in addition to the standard support and systematic pre-support as specified by the ground support class for local stabilization and safety during tunneling. Also referred to as additional initial support.   |

|                       |   |
|-----------------------|---|
| Liner Plates          | Pressed steel plates installed between the webs of the ribs to make a tight lagging, or bolted together outside the ribs to make a continuous skin.   |
| Lithology             | The character of a rock described in terms of its structure, color, mineral composition, grain size, and arrangement of its component parts.  |
| Mine straps           | Steel bands on the order of 12 in. wide and several feet long designed to span between rock bolts and provide additional rock mass support.   |
| Mining                | The process of digging below the surface of the ground to extract ore or to produce a passageway such as a tunnel.  |
| Mix                   | Mixture of cement, aggregates and, if required, chemical admixtures being processed in a batching plant.  |
| Mixed face            | The situation when the tunnel passes through two (or more) materials of markedly different characteristics and both are exposed simultaneously at the face (e.g., rock and soil, or clay and sand). |
| Mohr's hardness scale | A scale of mineral hardness, ranging from 1 (softest) to 10 (hardest).  |
| Muck                  | Broken rock or earth excavated from a tunnel or shaft.  |
| NCHRP                 | National Cooperative Highway Research Program   |
| NFPA                  | National Fire Protection Association  |
| NHI                   | National Highway Institute  |
| Nozzle                | Specially manufactured hose through which sprayed concrete is applied. Designed to add water (plus accelerator) through jets to the dry mix or add other admixtures to the wet mix.                 |
| Nozzleman             | Person who applies the shotcrete by operating the nozzle.   |
| Open cut              | Any excavation made from the ground surface downward.   |
| Overbreak             | The quantity of rock that is actually excavated beyond the perimeter established as the desired tunnel outline.   |
| Overburden            | The mantle of earth overlying a designated unit; in this report, refers to soil load overlying the tunnel.  |
| PIARC                 | World Road Association (previously the Permanent International Association of Roadways Congress)  |

|  |  |
|--|--|
| Partial Drifts                           | To achieve an early, temporary ring closure and to reduce excavation face size, partial drifts such as sidewall drifts, middle drifts and top heading, bench, and invert drifts can be used. These partial drifts are supported by temporary shotcrete support, such as temporary middle walls, invert supports, etc.  |
| Pocket Excavation                        | Partial excavation of the tunnel face in unstable ground conditions by which small areas (pockets) of ground are excavated immediately followed by shotcrete installation. A series of pockets are excavated following the drift shape allowing the installation of the shotcrete lining. Typically, a central face stabilization wedge remains in the face that is excavated either during the next excavation round in sequence or after completion of the full shotcrete lining installation. |
| Passive reinforcement                    | Reinforcing element that is not prestressed or tensioned artificially in the rock, when installed, i.e. rock dowel.  |
| Pattern Reinforcement or Pattern Bolting | The installation of reinforcement elements in a regular pattern over the excavation surface.   |
| Phreatic surface                         | That surface of a body of unconfined ground water at which the pressure is equal to that of the atmosphere.  |
| Pillar                                   | A column or area of coal or ore left to support the overlaying strata or hanging wall in mines.  |
| Pilot drift or pilot tunnel              | A drift or tunnel driven to a small part of the dimensions of a large drift or tunnel. It is used to investigate the rock conditions in advance of the main tunnel excavation, or to permit installation of ground support before the principal mass of rock is removed.   |
| Pneumatically applied mortar or concrete | See shotcrete.   |
| Portal                                   | The entrance from the ground surface to a tunnel.  |
| Pre-reinforcement                        | Installation of reinforcement in a rock mass before excavation commences.  |
| Principal stress                         | A stress that is perpendicular to one of three mutually perpendicular planes that intersect at a point on which the shear stress is zero; a stress that is normal to a principal plane of stress. The three principal stresses are identified as least or minimum, intermediate, and greatest or maximum.  |

|                           |   |
|---------------------------|---|
| Raise                     | A shaft excavated upwards (vertical or sloping). It is usually cheaper to raise a shaft than to sink it since the cost of mucking is negligible when the slope of the raise exceeds 40° from the horizontal.  |
| Ravining Ground           | Poorly consolidated or cemented materials that can stand up for several minutes to several hours at a fresh cut, but then start to slough, slake, or scale off  |
| Rebar Spiling             | Reinforcement rebars installed at the tunnel heading ahead of excavation and grouted as a means to pre-support the ground. They can be installed in pre-drilled and grout filled holes or rammed into the soft ground   |
| Recessed rock anchor      | A rock anchor placed to reinforce the rock behind the final excavation line after a portion of the tunnel cross section is excavated but prior to excavating to the final line.   |
| Reinforcement             | Structural steel reinforcement improving the moment capacity of a concrete section.   |
| Relievers or relief holes | The holes fired after the cut holes and before the lifter holes or rib (crown, perimeter) holes.  |
| Retarder                  | Admixture for hydration control to delay setting of wet shotcrete.  |
| Rib                       | <ol style="list-style-type: none"> <li>1. An arched individual frame, usually of steel, used in tunnels to support the excavation. Also used to designate the side of a tunnel.</li> <li>2. An H- or I-beam steel support for a tunnel excavation (see Set).</li> </ol> |
| Rib holes                 | Holes drilled at the side of the tunnel of shaft and fired last or next to last, i.e., before or after lifter holes.  |
| Road header               | A mechanical excavator consisting of a rotating cutterhead mounted on a boom; boom may be mounted on wheels or tracks or in a tunnel boring machine.  |
| Rock Anchor               | Rock anchors are tensioned tendons anchored to the ground over a defined length.  |
| Rock bolt                 | A tensioned reinforcement element consisting of a rod, a mechanical or grouted anchorage, and a plate and nut for tensioning by torquing the nut or for retaining tension applied by direct pull.   |
| Rock dowel                | An untensioned reinforcement element consisting of a rod embedded in a grout-filled hole and bonded to the surrounding ground along their entire length (fully bonded) either by friction or grout.   |
| Rock mass                 | Ground mass built up by in situ pieces of rock material of which are limited by discontinuities. Properties controlled by grade of weathering, discontinuities, fillings, and orientation of discontinuities.   |



|                        |   |
|------------------------|---|
| Rock reinforcement     | Elements reinforcing a jointed rock mass to enhance the rock mass strength and reinforce the rock's natural tendency to support itself.. Passive (dowels, spiles) or active (bolts, anchors) elements are used. Rock mass reinforcement can be installed either in spot applications or systematically. The reinforcement elements used in SEM tunneling are typically steel or fiberglass bars or pipes in conjunction with shotcrete on the rock surface. |
| Rock support           | The placement of supports such as wood sets, steel sets, or reinforced concrete linings to provide resistance to inward movement of rock toward the excavation.   |
| Round                  | A group of holes fired at nearly the same time. The term is also used to denote a cycle of excavation consisting of drilling blast holes, loading, firing, and then mucking.  |
| SINTEF                 | Foundation for Scientific and Industrial Research at the Norwegian Institute of Technology  |
| Scaling                | The removal of loose rock adhering to the solid face after a shot has been fired. A long scaling bar is used for this purpose.  |
| Segments               | Sections that make up a ring of support or lining; commonly steel or precast concrete.  |
| Set                    | The temporary support, usually of Steel or timber, inserted at intervals in a tunnel to support. The ground as a heading is excavated (see Rib).  |
| Shaft                  | An elongated linear excavation, usually vertical, But may be excavated at angles greater than 30 deg from the horizontal.   |
| Shear                  | A deformation that forms from stresses that displace one part of the rock past the adjacent part along a fracture surface.  |
| Shield                 | A steel tube shaped to fit the excavation line of a tunnel (usually cylindrical) and used to provide support for the tunnel; provides space within its tail for erecting supports; protects the men excavating and erecting supports; and if breast boards are required, provides supports for them. The outer surface of the shield is called the shield skin.   |
| Shield tail (or skirt) | An extension to the rear of the shield skin that supports soft ground and enables the tunnel primary lining to be erected within its protection.  |
| Shotcrete              | Concrete applied through a nozzle by compressed air and, if necessary, containing admixtures to provide quick set, high early strength and satisfactory adhesion.   |
| Shove                  | The act of advancing a TBM or shield with hydraulic jacks.  |
| Skip                   | A metal box for carrying reek, moved vertically or along an incline.  |

|   |  |
|---|--|
| Soft Ground                                     | Deteriorated rock or residual soil with limited compressive strength and stand-up time.  |
| Spall   | A chip or splinter of rock. Also, to break rock into smaller pieces.   |
| Spiles  | Pointed boards or steel rods driven ahead of the excavation, (similar to forepoles).   |
| Spoil   | See muck.  |
| Spot reinforcement or spot dowelling or bolting | Localized reinforcement to secure individual rock blocks and wedges in place. Spot reinforcement may be in addition to pattern reinforcement or internal support systems.                                  |
| Spray Shadow                                    | In shotcrete applications a shadow generated by objects (e.g. reinforcement, fixing devices). The shotcrete within this shadow area is less compacted and of low quality.                                  |
| Spring line                                     | The point where the curved portion of the roof meets the top of the wall. In a circular tunnel, the spring lines are at opposite ends of the horizontal center line.                                       |
| Squeezing ground                                | Material that exerts heavy pressure on the circumference of the tunnel after excavation has passed through that area.  |
| Stand-up-time                                   | The time that elapses between the exposure of rock or soil in a tunnel excavation and the beginning of noticeable movements of the ground.   |
| Starter tunnel                                  | A relatively short tunnel excavated at a portal in which a tunnel boring machine is assembled and mobilized.   |
| Struts  | Compression supports placed between tunnel sets.   |
| Systematic Rock Dowelling/Bolting               | Rock reinforcement applied in a systematic pattern designed to suit the ground conditions expected.  |
| TBM   | Tunnel boring machine.   |
| Tail void                                       | The annular space between the outside diameter of the shield and the outside of the segmental lining.  |
| Tie rods  | Tension members between sets to maintain spacing. These pull the sets against the struts.  |
| Tight   | Rock remaining within the minimum excavation lines after completion of a round-that is, material that would make a template fit tight. "Shooting tights" requires closely placed and lightly loaded holes. |
| Timber sets                                     | The complete frames of temporary timbering inserted at intervals to support the ground as heading is excavated.  |

|                             |   |
|-----------------------------|---|
| Top heading                 | <ol style="list-style-type: none"> <li>1. The upper section of the tunnel.</li> <li>2. A tunnel excavation method where the complete top half of the tunnel is excavated before the bottom section is started.</li> </ol>   |
| Tunnel Boring Machine (TBM) | A machine that excavates a tunnel by drilling out the heading to full size in one operation; sometimes called a mole. The tunnel boring machine is typically propelled forward by jacking off the excavation supports emplaced behind it or by gripping the side of the excavation. |
| Tunnel Pre-support          | Systematic measures including pre-spiling with bars or pipes, grouted pipe arch canopy or steel sheets installed from within the tunnel or prior to tunnel construction.  |
| Water table                 | The upper limit of the ground saturated with water.   |
| Waterproofing System        | A layered system consisting of a drainage material (i.e. Geotextile) and a flexible, continuous synthetic membrane (typically PVC).   |
| Weathering                  | Destructive processes, such as the discoloration, softening, crumbling, or pitting of rock surfaces brought about by exposure to the atmosphere and its agents.   |
| Wet Mix                     | Mixture being supplied to the nozzle readily batched with water and admixtures.   |
| Yield Element               | Structural element of high deformation capability applied within the Initial Shotcrete Lining to facilitate controlled deformation.   |

This page is intentionally left blank.

## REFERENCES

- American Association of State Highway and Transportation Officials (AASHTO) (2008) "AASHTO LRFD Bridge Design Specifications 4<sup>th</sup> Edition", Washington, D.C.
- American Association of State Highway and Transportation Officials (AASHTO) (2004) "A Policy on Geometric Design of Highways and Streets", Washington, D.C.
- American Association of State Highway and Transportation Officials (AASHTO) (1988) "Manual on Subsurface Investigations", Washington, D.C.
- American Association of State Highway and Transportation Officials (AASHTO) (1984) "Guide for Roadway Lighting", Washington, D.C.
- American Society of Civil Engineers (ASCE) (2007). "Geotechnical Baseline Reports for Construction – Suggested Guidelines", NY.
- American Society of Civil Engineers. (ASCE) (1997). "Geotechnical Baseline Reports for Underground Construction –Guidelines and Practices", NY.
- American Society of Civil Engineers (ASCE) (1994). "Avoiding and Resolving Disputes during Construction," ASCE Technical Committee on Contracting Practices of the Underground Technology Research Council, ASCE, NY.
- American Society of Civil Engineers.(ASCE) (1991). "Avoiding and Resolving Disputes during Construction.", Technical Committee on Contracting Practices of the Underground Technology Research Council.
- American Society of Civil Engineers.(ASCE) (1989). "Avoiding and Resolving Disputes in Underground Construction.", Technical Committee on Contracting Practices of the Underground Technology Research Council.
- American Society of Civil Engineers (ASCE) "Guidelines for the Seismic Design of Oil and Gas Pipeline Systems", Technical Council on Lifeline Earthquake Engineering", Committee on Gas and Liquid Fuel Lifelines, (1984), ASCE, New York.
- Association Francaise des Travaux en Souterrain. (1991). "Recommendations on Grouting for Underground Works," Tunneling and Underground Space Technology, Vol. 6, No. 4: 383-462.
- Babendererdel, S., Hoek, E., Marinos, P., and Cardoso, A.S. (2004) "Geological risk in the use of TBMs in heterogeneous rock masses - The case of "Metro do Porto" and the measures adopted", Paper for Conference in Aveiro, Portugal in April 2004
- Barton, N., (2002), "Some new Q-value correlations to assist in Site Characterization and Tunnel Design", ISRM, 39, p185-216, Pergamon.
- Barton N. (2001), "Letter to the Editor" News Journal ISRM, No. 2001
- Barton N. (1991), "Geotechnical Design", World tunneling, November 1991, p410-416.

- Barton, N. (1988). "Rock Mass Classification and Tunnel Reinforcement Selection Using the Q-System," ASTM STP 984, Rock Classification Systems for Engineering Purposes.
- Barton N, Buen B, Roald S. (2001) "Strengthening the case for grouting", Tunnels and Tunnelling International, December 2001, January 2002.
- Barton N, Lien R, Lunde J. (1980) Application of the Q-system in design decisions concerning dimensions and appropriate support for underground installations". Int Conf Subsurface Space, Rockstore, Stockholm, Sub-surface Space ; 2:553–61.
- Barton, N., Lien, R., and Lunde, J. (1974). "Engineering Classification of Rock Masses for the Design of Tunnel Support" Rock Mechanics, Vol. 6, No. 4.
- Bickel, Kuesel and King, 2nd ed. (1996) "Tunnel Engineering Handbook"; Chapman & Hall, N.Y.
- Bickel, Kuesel and King, 1st ed. (1984) "Tunnel Engineering Handbook"; Van Nostrand Reinhold, N.Y
- Bieniawski, Z. T. (1992). "Design Methodology in Rock Engineering. 198 pp. Rotterdam: A.A.
- Bieniawski, Z. T. (1989). "Engineering rock mass classifications: a complete manual for engineers and geologists in mining, civil and petroleum engineering. 251p., Wiley, New York:
- Bieniawski, Z. T. (1984). "Rock Mechanics Design in Mining and Tunneling. A.A. Balkema, Rotterdam, 272 p.
- Bieniawski, Z. T. (1979). "The Geomechanics Classification in Rock Engineering Applications," Proceedings, 4<sup>th</sup> International Congress on Rock Mechanics, ISRM, Montreux. A. A. Balkema, Rotterdam, Vol. 2: 41-48.
- Bieniawski, Z.T. (1978). Determining rock mass deformability - experiences from case histories. Int. J. Rock Mech. Min. Sci. & Geomech. Abstr. 15, 237-247.
- Bieniawski, Z.T., (1973). "Engineering classification of jointed rock masses. Trans. S. African Instn.Civ. Engrs., Vol. 15, No 12, Dec. 1973, pp 335 - 344.
- Boscardin, M.D. and Cording, E.J. (1989). "Building Response to Excavation-Induced Settlement," J. of Geotech Eng., 1989, ASCE, 115(1), 1-21.
- Brekke, T. L., and Ripley, B. D. (1993). "Design of Pressure Tunnels and Shafts," Chapter 14 of Comprehensive Rock Engineering - Vol. 2, J. A. Hudson, ed.: 349-369.
- Brierley, G.S. and Hatem, D.J. (2002), "Design Build – Subsurface Projects", Zeni House Books,
- Brierley, G.S. (1998), "Subsurface Investigations and Geotechnical Report Preparation", Chapter 3, Subsurface Conditions Risk Management for Design and Construction Management Professionals, Hatem, D.J., ed., John Wiley & Sons, Inc.
- Brierley, G.S.(1998a), "Going Under? How about Urban Design/Build!", World Tunneling, November 1998.
- British Highway Agency. (1999). "Design of Road Tunnels" Design Manual for Roads and Bridges.

- British Tunnelling Society (BTS) and Institution of Civil Engineers (ICE) (2005). "Closed-Face Tunnelling Machines and Ground Stability - A guideline for best practice". Thomas Telford Ltd., March.
- British Tunnelling Society (BTS) and Institution of Civil Engineers (ICE) (2004). "Tunnel Lining Design Guide", Thomas Telford Ltd., March.
- Brown, E. T. (1981). "Rock Characterization Testing and Monitoring: ISRM Suggested Methods, published for the Commission on Testing Methods, International Society for Rock Mechanics by Pergammon Press.
- Brown, E. T., Bray, J. W., Ladanyi, B., and Hoek, E. (1983). "Ground Response Curves for Rock Tunnels, Journal of Geotechnical Engineering," Vol. 109, No. 1, American Society of Civil Engineering.
- Burns, J. Q., and Richard, R. M., (1964) "Attenuation of Stresses for Buried Cylinders," Proceedings of the Symposium on Soil-Structure Interaction, Tempe, Univ. of Arizona, 1964.
- Chen and Lui (2005) " Handbook of Structural Engineering", Chapter 28 "Tunnel Structures", CRC, NY.
- Choi, S., Ott, K.R., Fareth, A., Kinneen, J., and Barboe, E.S. (2007) "Tunnel Interaction: Hydraulic, Mechanical, and Hydromechanical Approach." Proceeding RETC, Toronto, CN, SME, pp 137-146.
- Chryssanthakis P, Barton N. (1992) "Predicting performance of the 62m span ice hockey cavern in Gjøvik, Norway. Proceedings of the International Conference Fractured and Jointed Rock Masses. Lake Tahoe, CA, 1992.
- Cording, E. J., and W. H. Hansmire. (1975). Displacements around soft ground tunnels. Proceedings, Fifth Panamerican Congress on Soil Mechanics and Foundation Engineering, Buenos Aires.
- Cording, E.J., and Deere, D.U. (1972) "Rock Tunnel Supports and Field Measurement," Proceedings of First North American Rapid Excavation and Tunneling Conference, AIME, Chicago, Illinois, June 5-7.
- Cording, E.J., Hendron A.J., and Deere, D.U. (1971) "Rock Engineering for Underground Caverns" Proceedings of Symposium on Underground Rock Chamber, ASCE, NY, 1971, p567-600.
- Coulter, S. and Martin, D.C., (2004), "Ground Deformations Above Large Shallow Tunnel Excavated Using Jet Grouting," EUROCK 2004 & 53<sup>rd</sup> Geomechanics Colloquium, Schubert (Ed.), VGE.
- Critchfield, J. W. (1985). Tunneling in Gassy Ground," Proceedings, RETC, New York, AIME: 441-461.
- Cundall, P. A. (1976). "Explicit Finite Difference Methods in Geomechanics, Numerical Methods in Engineering," Proceedings of the EF Conference on Numerical Methods in Geomechanics, Blacksburg, Virginia. Vol. 1: 132-150.
- Cundall, P. A., and Hart, R. D. (1993). "Numerical Modeling of Discontinuities" Comprehensive Rock Engineering, Vol. 2, J. A. Hudson, ML, Pergammon Press: 231-243.

- Curtis D.J. (1976), "Discussion of :Muri Wood, A.M., The Circular Tunnel in Elastic Ground," *Geotechnique*, Vol.26, No.2, June, 1976, pp.231-237.
- Dar, S.M. and Bates, R.C., (1974). "Stress Analysis of Hollow Cylindrical Inclusions", *J.Geotechnical Engineering Division, ASCE*, Vol. 100, No. GT2, Feb, 1974, pp. 123-138.
- Daugherty, C.W., (1998), "Monitoring of Movements Above Large Shallow Jacked Tunnels", *Proc. GeoCongress 98, Boston, ASCE Jacked Tunnel Design & Construction*, pp 39-60.
- Deangeli, C et al (1995): "Shear strength evaluation of reinforced rock discontinuities". In: *An-chors in Theory and Practice*, p. 101 - 108, *Proc. Int. Symp. On Anchors in Theory and Practice*, ed. Widmann, R., Salzburg 9-10 October 1995, Rotterdam/Brookfield, 1995.
- Deere, D. U., and Deere, D. W. (1988). "The Rock Quality Designation (RQD) Index in Practice, in *Rock Classification Systems for Engineering Purposes*," L. Kirkaldie, ed., ASTM 1984.
- Deere, D. U., Peck, R. B., Monsees, J. E., and Schmidt, B. (1969). "Design of Tunnel Liners and Support Systems," Report to UMTA, DOT, available through NTIS.
- Deere, D. U., Peck, R. B., Parker, H. W., Monsees, J. E., and Schmidt, B. (1970). "Design of Tunnel Support Systems": *Highway Res. Rec. No. 339:26-33*.
- Dowding, C. H. (1985). *Blast Vibration Monitoring and Control*, Prentice Hall.
- Dowding, C. H., and Rozen, A., *Damage to Rock Tunnels from Earthquake Shaking*, *Journal of the Geotechnical Engineering Division, ASCE*, Vol. 104, No. GT2, 1978.
- Dunnicliff, J. (1998, 1993) "Geotechnical Instrumentation for Monitoring Field Performance, John Wiley & Sons, New York, 577.
- Edgerton, W.W. (2008). "Recommended Contract Practices for Underground Construction", *Society of Mining Engineers*.
- Einstein H.H., (1991). "Observation, Quantification and Judgement: Terzaghi and Engineering Geology." *J. Geotech. Engn., ASCE*, Vol. 117, No. 11, pp. 1772-1778.
- Einstein, H.H. (1989). Design and analysis of underground structures in swelling and squeezing rocks (Chapter 6). In *Underground Structures-Design and Instrumentation*, R.S. Sinha, ed. New York:
- Einstein H.H., Steiner W. and Baecher G.B., (1979). "Assessment of Empirical Design Methods for Tunnels in Rock." *RETC 1979*, pp. 683-705.
- Einstein H.H. and Schwartz, C.W., (1979). "Simplified Analysis for Tunnel Supports", *J. Geotech. Engn. ASCE*, Vol. 105, No. GT4, April 1979, pp.499-518.
- Electric Power Research Institute (EPRI). (1987). "Design Guidelines for Pressure Tunnels and Shafts," Palo Alto, California.
- Federal Highway Administration (FHWA) (2006) "Underground Transportation Systems in Europe: Safety, Operations, and Emergency Response", FHWA-PL-06-012, Washington, D.C.



- Federal Highway Administration (FHWA) (2006a) “Workbook for Subsurface Investigation Inspection Qualification”, FHWA-NHI-05-035, Washington, D.C.
- Federal Highway Administration (FHWA) (2005a) “Highway, Rail and Transit Tunnel Inspection Manual”, FHWA-IF-05-002, Washington, D.C.
- Federal Highway Administration (FHWA) (2005b) “Highway, Rail and Transit Tunnel Maintenance and Rehabilitation Manual”, FHWA-IF-05-017, Washington, D.C.
- Federal Highway Administration (FHWA) (2005c) “Road Tunnel Design Guidelines”, FHWA-IF-05-023, Washington, D.C.
- Federal Highway Administration (FHWA) (2005d) “Soil Slope and Embankment Design”, FHWA-NHI-05-023, Washington, D.C.
- Federal Highway Administration (FHWA) (2005e) “Earth Retaining Structures”, FHWA-NHI-05-046, Washington, D.C.
- Federal Highway Administration (FHWA) (2005f) “Micropile Design and Construction”, FHWA-NHI-05-039, Washington, D.C.
- Federal Highway Administration (FHWA) (2004) “Ground Improvement Methods”, FHWA-NHI-04-001, Washington, D.C.
- Federal Highway Administration (FHWA) (2003) “Geotechnical Engineering Circular No. 7 – Soil Nail Walls”, FHWA-IF-03-017, Washington, D.C.
- Federal Highway Administration (FHWA) (2002a) “Geotechnical Engineering Circular No. 5 - Evaluation of Soil and Rock Properties”, FHWA-IF-02-034, Washington, D.C.
- Federal Highway Administration (FHWA) (2002b) “Subsurface Investigations – Geotechnical Site Characterization – Reference Manual”, FHWA-NHI-01-031, Washington, D.C.
- Federal Highway Administration (FHWA) (1999) “Training Course in Geotechnical and Foundation Engineering: Rock Slopes - Participants Manual” FHWA-HI-99-007, Washington, D.C.
- Federal Highway Administration (FHWA) (1998) “Training Course in Geotechnical and Foundation Engineering: Geotechnical Instrumentation - Participants Manual” FHWA-HI-98-034, Washington, D.C.
- Federal Highway Administration (FHWA) (1989) “Highway Functional Classification: Concepts, Criteria, and Procedures”, <http://www.fhwa.dot.gov/planning/fctoc.htm>, Washington D.C.
- Federal Highway Administration (FHWA) (1988) “Checklist and Guidelines for Review of Geotechnical Reports and Preliminary Plans and Specifications”, FHWA-ED-88-053, Washington, D.C.
- Federal Highway Administration (FHWA) (1983) “Prevention and Control of Highway Tunnel Fires”, FHWA-RD-83-032, Washington, D.C.
- Federal Highway Administration (FHWA) (1976) “Cut-and-Cover Tunneling – Vol. 1. Construction Methods, Design and Activity Variations”, FHWA-RD-76-28, Washington, D.C.

- Fernandez, G., (1994) "Behavio of Pressure Tunnels and Guidelines for Liner Design." J. Geotechnical Engrg. ASCE, Vol. 120, No.10, pp. 1768-1791.
- Gall, V., (2000). "Three Pillars for an Effective Waterproofing System," Proceedings, North American Tunneling 2000, Boston, Massachusetts, June 6 - 11, 2000.
- Gall, V., Munfah, N. and Cerulli, D Zeidler, K., (2004). "Shotcrete for Tunnel Final Linings – Design and Construction Considerations," Seminar Proceedings, NAT 2004 Proceedings, North American Tunneling Conference, Atlanta, Georgia, April 17 – 22, 2004.
- Gall, V., Urschitz, G. and Zeidler, K., (2000). "Frozen Ground for Building Support – Implementation of Innovative Engineering Concepts for Tunneling at Russia Wharf," Proceedings, North American Tunneling, Boston, Massachusetts, June 6 - 11, 2000.
- Garshol, K. (1983). Excavation support and pre-grouting of TBM-driven sewer tunnel, Norwegian Tunneling Technology Publication No.2, Tapir.
- Gildner, J. and Urschitz, G.J., (2004). "SEM/NATM Design and Contracting Strategies", North American Tunneling 2004, Ozdemir ed., Taylor & Francis Group, London
- Goldberg, D.T., W.E. Jaworsky, and M.P. Gordon (1976). Lateral Support Systems and Underpinning, U.S. Department of Transportation, Report No. FHWA-RD-75-128, Vo. I, April, 1976.
- Goodman, R. E., and Shi, G. H. (1985). Block Theory and its Application to Rock Engineering, Prentice-Hall, New Jersey.
- Goodman, R.E. (1995). Block theory and its applications-the 1995 Rankine Lecture. Geotechnique. In press.
- Gnilsen, R., 1986: "Unreinforced Concrete Tunnel Lining – Design Concepts". Technical Bulletin, Volume 1.
- Grant, R., J. T. Christian, and E. H. Vanmarke (1981). Differential settlement of buildings, Journal of Geotechnical Engineering, 107, American Society of Civil Engineers.
- Grimstad, E. & Barton, N. (1993)."Updating of the Q-System for NMT. In Kompen, Opsahl & Berg (eds), Proc. Of the International Symposium on Sprayed Concrete – Modern Use of Wet Mix Sprayed Concrete for Underground Support, Fagernes.
- Hansmire, W. and Monsees, J.E. (2006), "Evolving Practices for Tunnel Contracts in the United States," Proceedings of the 31st ITA-AITES World Tunnel Congress, 2006, Seoul, Korea, Elsevier, London. • “
- Hansmire, W. and Monsees, J.E. (2005), "Engineers, Contractors, and Soft-Ground Tunneling Equipment," Proceedings of NAT 2004, Atlanta, GA, Taylor and Francis Group, London.
- Hemphill, G. B. (1990). "Mechanical Excavation System: Selection, Design, and Performance in Weak Reek; Ph.D. dissertation, University of Idaho, Moscow: 361.???
- Hemphill, G. B. (1981)., "Blasting Operation".

- Heuer, R.E. (2005) "Estimating Rock Tunnel Water Inflow-II," Proceedings of RECT, 2005, Seattle, SME, pp.41-60.
- Heuer, R.E. (1995) "Estimating Rock Tunnel Water Inflow," Proceedings of RECT, 1995, pp.41-60.
- Heuer, R.E. (1974). Important ground parameters in soft ground tunneling. Proceedings of Specialty Conference on Subsurface Exploration for Underground Excavation and Heavy Construction, New York: ASCE
- Heuer, R.E., and D. L. Virgens. (1987). Anticipated behavior of silty sands in tunneling. Proceedings, Rapid Excavation and Tunneling Conference, Littleton, CO: Society of Mining Engineers, Inc.
- Hoeg, K., (1968). "Stresses Against Underground Structural Cylinders," Journal of the Soil Mechanics and Foundation Division, ASCE, Vol. 94, SM4, April 1968.
- Hoehn, K., (1999). The Single-Shell Shotcrete Method Applied at Two Tunneling Sites – Concrete Technology and Economic Viability. Proceedings, Spritzbetontechnologie '99, BMI 1/99, 255-270.
- Hoek, E. (2007), "Practical Rock Engineering"
- Hoek, E (2000), "Big Tunnels in Bad Rock", The Terzaghi Lecture 2000, ASCE Journal of Geotechnical and Geoenvironmental Engineering Vol. 127, No. 9. September 2001, pages 726-740.
- Hoek, E. (1983). "Strength of jointed rock masses." The Rankine Lecture 1983, Geotechnique 33, no 3, pp. 187-223.
- Hoek, E., and Brown, E. T. (1988). "The Hoek-Brown Failure Criterion - A 1988 Update: Proceedings, 15<sup>th</sup> Canadian Rock Mech. Symposium, Toronto: 3-38.
- Hoek, E., and Brown, E. T. (1980). "Underground Excavations in Rock," Institution of Mining and Metallurgy, London, England: 527.
- Hoek, E., Carranza-Torres, C. & Corkum, B. (2002). Hoek-Brown Failure Criterion – 2002 Edition.
- Hoek, E and Diederichs, M. 2006. Empirical estimates of rock mass modulus. Int. J Rock Mech. Min. Sci., 43, 203–215
- Hoek, E., Kaiser, P.K., Bawden, W.F., (2000). "Support of Underground Excavations in Hard Rock".
- Hoek, E., Kaiser, P.K. and Bawden. W.F. (1995). "Support of underground excavations in hard rock", Rotterdam: Balkema.
- Hoeking, G. (1978). "Stresses around Tunnel Intersections," in Computer Methods in Tunnel Design, Institution of Civil Engineers: 41-59.

- Idriss, I. M. and Sun, J. I. (1992), SHAKE91 - A computer Program for Conducting equivalent Linear Seismic Response Analyses of Horizontally Layered Soil Deposits, Center for Geotechnical Modeling, Department of Civil and Environmental Engineering, University of California at Davis.
- International Tunneling Association (ITA) (1997). Immersed and Floating Tunnels State of the Art Report, Working Group No. 11., Tunneling and Underground Space Technology, Pergamon Press, Vol. 12, No.2 (April).
- Institution of Civil Engineers, (1996), "Sprayed Concrete Linings (NATM) for Tunnels in Soft Ground," Thomas Telford Publishing, Thomas Telford Services Ltd., 1 heron Quay, London, E14 4JD.
- International Tunneling Association (ITA) (1988). "Guidelines for the Design of Tunnels", Tunneling and Underground Space Technology, Pergamon Press, Vol. 3, No.3, pp. 237-249 (April).
- ISRM. (1982). International Society for Rock Mechanics, ISRM Suggested Methods: Rock Characterization, Testing and Monitoring (E. T. Brown, ed.), Pergamon Press, Oxford.
- ISRM. (1977). International Society for Rock Mechanics, ISRM Suggested Methods: The Quantitative Description of Discontinuities in Rock Masses, Pergamon Press, Oxford.
- Japanese Society of Civil Engineers (JSCE) (2000). "Japanese Standard for Mountain Tunneling" Working Group for Shield Tunneling; Subcommittee on English Edition of the Japanese Standard for Tunneling.
- Japanese Society of Civil Engineers (JSCE) (1996). "Japanese Standard for Shield Tunneling" Working Group for Shield Tunneling; Subcommittee on English Edition of the Japanese Standard for Tunneling.
- Keifer, O. (1966) Multiple Layer Shotcrete Lining. ACI Publications, SP-14.
- Kessler, P.N and Moore, C.J. (1999); "Tunneling by Tunnel Boring Machine (TBM)".
- Kirsch, G., (1898). „Die theorie der elastizitat und die bedurfnisse der festigkeitslehre.“*Veit. Deit. Ing.* 42 (28), 797-807.
- Korbin, G. E. (1979). "Factors Influencing the Performance of Full-Face Hard Rock Tunnel Boring Machines," Report to USDOT, UMTA-CA-06-0122-79-1.
- Kuesel, T. (1986). "Immersed Tube Tunnels: Concept Design and Construction," Civil Engineering Practice, Boston Society of Civil Engineers, Spring.
- Kuesel, T. R. (1969). Earthquake design criteria for subways. *Journal of the Structural Division*, 95, ST6.
- Kuhlmann, D.: "Tunnelbau". In: *Wayss & Freitag am Donnerstag, Gespraechе mit Wissenschaft und Praxis*, Frankfurt, a.M., Germany.
- Kupfer, H. and Kupfer, H., (1990). Statical Behavior and Bond Performance of the Layers of a Single Permanent Tunnel Lining, *Proceedings, Spritzbetontechnologie '90*, 11ff.

- Lauffer, H. (1995): "Die Bedeutung der Verbundanker für den Untertagebau (The importance of compound anchors for underground excavations)." Proceeding International Symposium on Anchors in Theory and Practice, Widmann, R. (Ed.), Salzburg 9-10 October 1995, Rotterdam/Brookfield, 1995.
- Lawrence, DLJ. (1982) "Shotcrete Lining for a Tunnel Requiring Ground Freezing for Initial Support," Shotcrete I c pp. 155-170.
- Leonards, G. (1962). Foundation Engineering. McGraw-Hill, New York.
- Lowe, J. III and Zaccheo, P.F. (1991) "Subsurface Explorations and Sampling," Chapter 1, Foundation Engineering Handbook, Fang, H. ed., Van Nostrand Reinhold, NY.
- Lutenecker, A. et al. (1995) "Recommended Guidelines for Sealing Geotechnical Holes", National Cooperative Highway Research Program Report No. 378
- Maidl, B., and Handke, D. (1993). "Overcoming a Collapse in the Karawanken Tunnel," Tunnels and Tunnelling: 30-32.
- Mitchell, J. K. (1981). State-of-the-art report on soil improvement, Tenth International Conference on Soil Mechanics and Foundation Engineering, Stockholm.
- Mitchell, J.K, and CB. Villet (1987). Reinforcement of Earth Slopes and Embankments, Transportation Research Board, NCHRP Report 290.
- Monsees, J. E., (1996) "Soft Ground Tunneling," Chapter 6 of the Tunnel Engineering Handbook, Bickel, Kuesel, and King, editors, Chapman and Hall, New York City, 1996.
- Monsees, J. E., and J. L. Merritt (1991). Earthquake considerations in design of the Los Angeles Metro, in Lifeline Earthquake Engineering, M.A. Cassuro, ed., New York: ASCE. •
- Morgan, D. R. (1991). "Steel Fiber Reinforced Shotcrete for Support of Underground Openings in Canada," Concrete International, Nov: 56-64.
- Morgan, H. D. (1961). "A Contribution to the Analysis of Stress in a Circular Tunnel", Geotechnique, Vol.11, No.1, March, 1961, pp. 37-46.
- Muir Wood, A M. (1975). "The circular tunnel in elastic ground. Geotechnique, 1, 1975, 115-127
- Nakamura, S., Yoshida, N., and Iwatate, Y. (1996), Damage to Daikai Subway Station during the 1995 Hyogoken-Nambu Earthquake and Its Investigation, Japan Society of Civil Engineers, Committee of Earthquake Engineering.
- National Fire Protection Association (NFPA) (2008). Standard NFPA 502 "Standard for Road Tunnels, Bridges and Other Limited Access Highways".
- National Fire Protection Association (NFPA) (1990). Standard NFPA 130 "Fixed Guideway Transit Systems".
- National Cooperative Highway Research Program (NCHRP) (2006) "Making Transportation Tunnels Safe and Secure", NCHRP Report 525, Vol. 12

- NAVFAC (1974). Design Manual-Soil Mechanics, Foundations, and Earth Structures, NAVFAC DM-7, U.S. Naval Publications and Forms Center, March, Change 2.
- Nicholson, G.A. and Bieniawski, Z.T. (1990). A nonlinear deformation modulus based on rock mass classification,” *Int. J. Min. & Geological Engng* 8, 181–202.
- O’Carroll, J.B. (2005), “A Guide to Planning, Constructing and Supervising Earth Pressure Balance TBM Tunneling”, Parsons Brinckerhoff Monograph No. 18.
- Occupational Safety and Health Administration, Safety and Health Standards, Washington, DC.
- OGG Austrian Society for Geomechanics, 2007. “Richtlinie fuer die Geomechanische Planung von Untertagbauten mit Zyklischem Vortrieb,” (in print) OGG, December 2007.
- O’Rourke, T. D., and Shiba, Y. (1997), *Seismic Performance and Design of Tunnels*, Annual Report, NCEER Highway Project, sponsored by U.S. Department of Transportation and Federal Highway Administration.
- O’Rourke, T.D. (1984). "Guidelines for Tunnel Lining Design" ASCE 1984.
- Owen, G. N., and Scholl, R. E., *Earthquake Engineering of Large Underground Structures*, prepared for the Feral Highway Administration, FHWA/RD-80/195, 1981.
- Ozdemir, L., and Wang, F. (1979). "Mechanical Tunnel Boring, Prediction, and Machine Design," Final Report NSFIRA-790161: 204.
- Palmstrom, A. and Broch, E. (2006). Use and misuse of rock mass classification systems with particular reference to the Q-system. *Tunnels and Underground Space Technology*, 21, 575-593.
- Pariseau, W. G. (2006), “Design Analysis in Rock Mechanics”, CRC Press, 2006
- Peck, R. B. (1988). Foreword to *Geotechnical [instrumentation for Monitoring Field Performance*, by John Dunicliff, Wiley, New York: vii-ix.
- Peck, R. B. (1973). "Influence of Non-technical Factors on the Quality of Embankment Dams, Embankment Dam Engineering", *Casagrande Vol.*, Wiley, New York: 201-208. Reprinted in *Judgment in Geotechnical Engineering: The Professional Legacy of Ralph B. Peck, J. Dunicliff and D. U. Deere, ed.*, 1984. Wiley, New York: 137-144.
- Peck, R. B. (1972). "Observation and Instrumentation, Some Elementary Considerations," Postscript, in *Judgment in Geotechnical Engineering: The Professional Legacy of Ralph B. Peck, J. Dunicliff and D. U. Deere, ed.*, 1984. Wiley, New York: 128-130.
- Peck, R. B. (1969). “Deep Excavation and Tunneling in soft Ground.” *Proceedings of the 7<sup>th</sup> International Conference of Soil Mechanics, Mexico, State-of-art Volume*, 1969, 225-290.
- Peck, R B, A J Hendron and B Mohraz. (1969). State of the art of soft ground tunneling. 1<sup>st</sup> North A M. Rapid Excavation and Tunnelling Conference, 1969, 259- 285.

- Pellet, F. & Egger, P. (1995). "Analytical model for the behaviour of bolted rock joints and practical applications". Proceeding International Symposium on Anchors in Theory and Practice, Widmann, R. (Ed.), Salzburg 9-10 October 1995, Rotterdam/Brookfield, 1995.
- Pellet, F. et al (1995): "Contribution of fully bonded rock bolts to the shear strength of joints; Analytical and experimental evaluation." Mechanics of Jointed and Faulted Rock, p. 873 – 878, ed. Rossmanith H., Rotterdam/Brookfield, 1995.
- Penzien, J. (2000), "Seismically Induced Racking of Tunnel Linings", Earthquake Engineering and Structural Dynamics, Vol. 29, pp. 683-691.
- Penzien, J. and Wu, C.L. (1998), "Stress in Lining of Bored Tunnels", Earthquake Engineering and Structural Dynamics, Vol. 27, pp. 238-300.
- Permanent International Association of Road Congress (PIARC) (1987). PIARC report.
- Peterson, DL, C.R. Nelson, B.K. Nelson, and B.D. Wagener. (1991). Design and construction of the Lafayette Bluff Tunnel, Proceedings RETC, Seattle.
- Phienwaja, N. (1987). Ground response and support performance in a sheared shale, Stillwater Tunnel, Utah, Ph.D. Thesis, University of Illinois at Urbana-Champaign.
- Phien-Wej, N., and EJ. Cording. (1991). Sheared Shale Response to Deep TBM Excavation. New York: Elsevier.
- Poisel, R. et al (1995). "Das Arbeitsvermögen geankerten Gebirges bei grossen Konvergenzen (The strain energy capacity of bolted rock at large tunnel deformations)". Proceeding International Symposium on Anchors in Theory and Practice, Widmann, R. (Ed.), Salzburg 9-10 October 1995, Rotterdam/Brookfield, 1995.
- Polshin, D.E., and Tokar, R.A. (1957). Maximum allowable non-uniform settlement of structures. Proceedings 4<sup>th</sup> International Conference on Soil Mechanics and Foundation Engineering, Vol. I, London.
- Powers, J. P. (1992). Construction Dewatering-New Methods and Applications, Second Edition, New York: John Wiley and Sons.
- Powers, J. P., (1981). Construction Dewatering-A Guide to Theory and Practice, John Wiley and Sons, New York.
- Powers, J.P. (1972). "Groundwater Control in Tunnel Construction," Proceedings of North American Rapid Excavation and Tunneling Conference, ASCE-AIME, New York.
- Power, M., et al. (2006), "Seismic Retrofit Manual for Highway Structures: Part II – Retaining Structures, Slopes, Tunnels, Culverts and Roadways", MCEER Report: MCEER-06-SP11
- Power, M. S., and Rosidi, D. (1998), Seismic Vulnerability of Tunnels and Underground Structures Revisited, North American Tunneling.
- Proctor, R.Y. and T. L. White (1977). Earth Tunneling with Steel Supports, Commercial Shearing, Inc., Youngstown, OH.

- Procter, R. V., and White, T. L. (1946). "Rock Tunneling with Steel Supports", The Commercial Shearing and Stamping Company, Ohio 1946, revised 1968, copyright 1946 by The Commercial Shearing and Stamping Company.
- Rabcewicz, L. V.(1948) "Patentschrift, Oesterreichisches Patent Nr. 165573" (Patent Entry, Austrian Patent Nr. 165573, 1948).
- Rabcewicz, L.V. (1964). "The New Austrian Tunneling Method," Water Power.
- Rabcewicz, L. V. and Golser, J., (1973). "Principles of Dimensioning the Supporting System for the New Austrian Tunneling Method," Water Power, March 1973 Issue.
- Ranken, R.E., Ghaboussi, J., and Hendron, A.J., (1978). "Analysis of Ground-Liner Interaction for Tunnels." Report No. UMTA-IL-06-0043-78-3, U.S. Department of Transportation, Washington, D.C.
- Rankin, W. J. (1988). "Ground Movements Resulting from Urban Tunnelling: Predictions and Effects." Engineering Geology of Underground Movements Geological Society, 76-88.
- Ricketts, Loftin, and Merritt (2003) "Standard Handbook for Civil Engineers", Chapter 20 "Tunnel Engineering," fifth edition, McGraw-Hill, NY.
- Ropkins J.W.T. (1998). "Jacked Box Tunnel Design" Proc Geo-Congress 98, Boston, ASCE Jacked Tunnel Design & Construction " pp 21-38.
- Roark, R.J., and Yomg,W.C. (1975). Formulas for Stvess and Strain, Fifth Edition, McGraw-Hill, New York.
- Rudolf, J. and Gall, V, 2007: "The Dulles Corridor Metrorail Project – Extension to Dulles International Airport and its Tunneling Aspects", 2007 RETC Conference Proceeding, June 10-13.
- Russell, H.A. (2002). The Inspection of Highway Tunnels, Unpublished paper.
- Russell, H. A. (1992). The Inspection and Rehabilitation of Transit Tunnels, Third Edition, Parsons Brinckerhoff Quade & Douglas Inc. New York, NY.
- Schmidt, B. (1979). Settlements and ground movements associated with tunneling in soil. Ph.D. Thesis, University of Illinois.
- Schmidt, B. (1974). Prediction of Settlement due to Tunneling in Soil: Three case Histories. Rapid Excavation and Tunneling Conference, San Francisco, California, June, 1974-1999.
- Schmidt, B., and Grantz, W. (1979). "Settlement of immersed tunnels," Journal of the Geotechnical Division, ASCE, September.
- Schwartz, C. W., Azzouz, A. S., and Einstein, H. H. (1980). "Improved Design of Tunnel Supports," U.S. Department of Transportation, Report No. UMTA-MA-06-0100-8 0-5.
- Senthive1, A. (1994). Report to the Board of Consultants for the Yacambu-Quibor Transfer Tunnel, November.



- Serafin, J. L., and Pereira, J. P. (1983). "Consideration of the Geomechanics Classification of Bieniawski," Proceedings, Int. Symp. on Exploration for Rock Engineering.
- Sharma, S., and Judd, W. R. (1991), Underground Opening Damage from Earthquakes, Engineering Geology, Vol. 30, 1991.
- Sharp, W., and L. Ozdemir. (1991). "Computer Modeling for TBM Performance Prediction and Optimization," Proceedings, Int. Symp. on Mine Mechanization and Automation, CSMIUSBM, Vol. 1:4-57 to 4-66.
- Shotcrete for Ground Support (1976). Proceedings of the Engineering Foundation Conference, Easton, Maryland (October), ACI Publication SP-54. American Society of Civil Engineers and American Concrete Institute.
- Shotcrete for Rock Support (1992). Guidelines and Recommendations- A Compilation, Draft Document (B. Malmberg), February, for the ITA WG Shotcrete Use.
- Shotcrete for Underground Support I11 (1978). Papers presented at the 1978 Engineering Foundation Conference, St. Anton am Arlberg, Austria (April). Engineering Foundation, New York.
- Shotcrete for Underground Support IV (1982). Selected papers presented at the 1982 Engineering Foundation Conference, Paipa, Boyaca, Colombia (September). Engineering Foundation, New York.
- Shotcrete for Underground Support V (1990). Proceedings of the Engineering Foundation Conference, Uppsala, Sweden (June). American Society of Civil Engineers, New York.
- Shotcrete for Underground Support VI (1993). Proceedings of the Engineering Foundation Conference, Niagara-on-the-Lake, Canada (May). American Society of Civil Engineers, New York.
- Shotcrete for Underground Support VII (1995). Proceedings of the Engineering Foundation Conference, Seefeld, Austria (June).
- Shuster, J.A. (1985). "Ground Freezing for Soft Ground Shaft Sinking," Proceedings of Rapid Excavation and Tunneling Conference, June 16-20, New York.
- Siskind, D. E., Stagg, M. S., Kopp, J. W., and Dowding, C. H. (1980). "Structure Response and Damage Produced by Ground Vibration from Surface Mine Blasting," U.S. Bureau of Mines, Report of Investigation 8507.
- Skempton, A.W ., and D. H. MacDonald. (1956). The allowable settlements of buildings. Proceedings, Institute of Civil Engineers, Part III, London.
- Skinner, E. H. (1988). "A Ground Support Prediction Concept: The Rock Structure Rating (RSR) Model," ASTM STP 984, L. Kirkaldie, ed.
- SME Mining Engineering Handbook. (1992). Second Edition. H. L. Hartman, Senior Editor, Society of Mining Engineers.
- St. John, C. M., and Zahrah, T. F. (1987), Aseismic Design of Underground Structures, Tunneling and Underground Space Technology, Vol. 2, No. 2.

- Stack, B. (1982). Handbook of Mining and Tunneling Machinery, New York: Wiley.
- Stillborg, B. (1986). Professional Users Handbook for Rock Bolting. TransTech Publications, Atlas Copco.
- Stoss and Braun, B. (1985). "Sinking a Freeze Shaft with Installation of a Water-Tight, Flexible Lining," Proceedings of Rapid Excavation and Tunneling Conference, June 12-16, 1983, New York.
- Structural Anchoring Systems. (2002). Undercut Anchor Mockup, J.M. Associates Worcester, MA.
- Szechy, K. (1966). The Art of Tunneling. Akademiai Kiado, Budapest. Use of shotcrete for Underground Structural Support 1974 ACI/ASCE, Detroit.
- Taylor, S. and Winsor, (1998). "Developments in Tunnel Jacking" Proc Geo-Congress 98, Boston, ASCE Jacked Tunnel Design & Construction " pp 1-20.
- Technique fits tunnel to a tee. 1991. Civil Engineering, July 1991.
- Teng, W.C (1962). Foundation Design, Prentice-Hall, Inc., Englewood, NJ.
- Terzaghi, K. (1977). Earth tunneling with steel supports. Commercial Shearing and Stamping Co., Youngstown, OH.
- Terzaghi, K (1954). "Anchored Bulkheads," Transactions, ASCE, Vol. 119.
- Terzaghi, K. (1950). Geologic aspects of soft ground tunneling. Chapter 1 1 in Applied Sedimentation, R. Task and D. Parker, eds. New York: John Wiley & Sons.
- Terzaghi, K. (1946). "Rock Defects and Loads on Tunnel Supports" Rock Tunneling with Steel Support, R. V. Proctor and T. White, Commercial Shearing Co., Youngstown, OH: 15-99.
- Terzaghi, K, and R.B. Peck (1967). Soil Mechanics in Engineering Practice, Second Edition, John Wiley and Sons, New York.
- Terzaghi, K., and Richart, F. E. (1952). "Stresses in Reek About Cavities, Geotechnique, Vol. 3.
- Timoshenko, S. (1936). "Theory of Elastic Stability", McGraw-Hill Book Co., New York.
- Timoshenko, S. (1940). Theory of Plates and Shells, McGraw- Hill, New York, Article 3, p. 15, Figure 9.
- Transportation Research Board (2006). "Making Transportation Tunnels Safe and Secure", NCHRP Report 525, Vol. 12
- Tschebotarioff, G.P. (1962). "Retaining Structures," Foundation Engineering, edited by G.A. Leonards, McGraw-Hill, New York.
- U.S. Army Corps of Engineers (USACE) (1997). "Engineering and Design, Tunnels and Shafts in Rock" EM 1 1 10-2-2901, May.

- U.S. Army Corps of Engineers (USACE) (1982). "Proceedings of the Third International Symposium on Ground Freezing", U.S. Army Corps of Engineers, Cold Regions Research and Engineering Laboratory, Hanover, NH.
- USNCTT (U.S. National Committee on Tunneling Technology). (1984). "Geotechnical Investigations for Underground Projects", National Academy Press, Washington, DC (2 volumes).
- USS (1975). Steel Sheet Piling Design Manual, United States Steel, Pittsburgh, PA.
- Vandewalle, M., 2005: "Tunneling is an Art". NV Bekaert SA.
- Van Dijk, P.A., Taylor, S., and Rice P.M., "Box Jacking in Boston", Proc. North American Tunneling 00, Boston, June 2000.
- Van Dijk, P., Almeraris, G. and Rice, P., "Construction of I-90 Highway Tunnels Under Boston's South Station Rail Yard by Box Jacking, Proc., RETC, San Diego, June 2000, pp. 221-239.
- Wahls, H. E. (1981). Tolerable settlement of buildings. Journal of Geotechnical Engineering, 107, ASCE.
- Walkinshaw, J., (1992). "Landslide Correction Costs on U.S. State Highway System". Transportation Research Record 1343, National Research Council, Washington D.C., pp.36-41.
- Wang, J (1993), *Seismic Design of Tunnels – A Simple State-of-the-Art Design Approach*, Parsons Brinckerhoff Monograph No. 7.
- Whittakar N.B. and Frith, R.C., (1990)"Tunneling, Design, Stability and Construction".
- Wickham, G. E., Tiedemann, H. R., and Skinner, E. H. (1972). "Support Determinations Based on Geologic Predictions," Proceedings, First Rapid Excavation and Tunneling Conference, Chicago, VOII.
- Wickham, G. E., Tiedemann, H. R., and Skinner, E. H. (1974). "Ground Support Prediction Model - RSR Concept," Proceedings, RETC, AWE, New York 691-707.
- Wittke, W., (1984), "Felsmechanik," Springer, Berlin.
- Wood, A.M., (2000). "Tunneling, Management by Design "; E & FN Spon, London.
- Xanthakos, P. P., L.W. Abramson, and D.A. Bruce (1994). Ground Control and Improvement, New York: John Wiley and Sons, Inc.
- Xanthakos, P.P. (1979). Slurry Walls. McGraw-Hill, New York.
- Zosen, H.(1984). Hitachi Zosen's Shield Tunneling Machines, Company Brochure, Tokyo.
- Zosen, Hitachi (1981). "Shield Tunneling Machines", Company Brochure, Tokyo.

This page is intentionally left blank.

# Appendices

This page is intentionally left blank.

# **Appendix A**

## **Executive Summary 2005 Scan Study for the Underground Transportation Systems in Europe**

This page is intentionally left blank.



**Appendix A – Executive Summary – The International Scan Study for Underground  
Transportation Systems in Europe: Safety, Operation, and Emergency Responses**  
**Entire Report available on the FHWA web site at**  
<http://International.fhwa.dot.gov/uts/uts.pdf>

## **A.1 Introduction**

Increasing traffic congestion in urban areas and growing land values in the United States make underground structures increasingly attractive for highways and transit compared to other options. A tunnel can preserve the land above for parks, buildings, homes, and other uses while providing an efficient, cost-effective underground corridor to move people and goods. Unfortunately, only limited national guidelines, standards, or specifications are available for tunnel design, construction, safety inspection, traffic and incident management, maintenance, security, and protection against natural or manmade disasters.

An 11-member team was formed to study European practices on the aforementioned topics. This team consisted of three representatives from the Federal Highway Administration (FHWA), four representatives from State departments of transportation (DOTs), one representative from the Bay Area Rapid Transit District (BART), one representative from the Massachusetts Turnpike Authority who also represented the International Bridge, Tunnel, and Turnpike Association (IBTTA), one tunnel engineering design consultant, and the report facilitator. The scan was sponsored by FHWA, the American Association of State Highway and Transportation Officials (AASHTO), and the National Cooperative Highway Research Program (NCHRP). During late September and early October 2005, the team visited Denmark, France, Norway, Sweden, and Switzerland. In addition, the team had meetings with representatives from Austria, Germany, Italy, and the Netherlands. These countries were selected on the basis of desk scan findings that showed they are innovators in underground transportation systems.

The objectives of the scan were to learn what is being done internationally for underground transportation systems in the areas of safety, operations, and emergency response. The focus of the scan was on equipment, systems, and procedures incorporated into modern underground and underwater tunnels by leading international engineers and designers. The study considered the following:

- Tunnel systems and designs that provide fire protection, blast protection, and areas of refuge or evacuation passages for users.
- Arrangements of the various components to maximize their effectiveness, assure inspectability and maintainability, and promote cost savings.
- Tunnel operations, including incident detection and deterrent technology, and incident response and recovery planning.
- Specialized technologies and standards used in monitoring or inspecting structural elements and operating equipment to ensure optimal performance and minimize downtime during maintenance or rehabilitation.

Regarding the safety and security aspects, the team was interested in learning about planning approaches, standards, manpower roles and responsibilities, communication techniques, and state-of-the-art products and equipment used to deter, detect, deny, defend, respond to, and recover from both natural and manmade disasters and other incidents.

Team members were interested in not only tunnel practices and innovations for highways, but also those for passenger and freight rail.

## **A.2 Findings and Recommendations**

Team members identified a number of underground transportation system initiatives and practices that varied from those in the United States in some respect. The team recommended that nine of these initiatives or practices, briefly described below, be further considered for possible implementation in the United States. Little was discovered related to the threat from terrorism to underground structures, perhaps because of the confidential nature of this information or the lack of perceived need for such measures. The scan team learned that the Europeans consider response and safety measures already in place for crashes and other incidents to also be applicable for many terrorist actions.

The Europeans are doing extensive research resulting in innovative design and emergency management plans that consider how people react in tunnel emergencies. Because motorist behavior is unpredictable in tunnel incidents, Europeans make instructions for drivers, passengers, and tunnel operators as straightforward as possible to reduce required decision making during an incident such as a tunnel fire. The nine initiatives and practices listed below relate to human factors, planning, design, and incident and asset management.

### **1. Develop Universal, Consistent, and More Effective Visual, Audible, and Tactile Signs for Escape Routes**

The scan team noted that the signs Europeans use to indicate emergency escape routes are consistent and uniform from country to country. Emergency escape routes are indicated by a sign showing a white-colored running figure on a green background. Other signs that indicate the direction (and in tunnels, the distance in meters) to the nearest emergency exit also have the white figure on a green background, as used in European buildings and airports. All SOS stations in the tunnels were identified by the color orange. This widespread uniformity promotes understanding by all people, and helps assure that in the event of an emergency, any confusion related to the location of the emergency exit will be minimized. In addition, the team learned that combining the use of sound that emanates from the sign, such as a sound alternating with a simple verbal message (e.g., “Exit Here”) with visual (and, where possible, tactile) cues makes the sign much more effective.

The U.S tunnel engineering community relies on National Fire Protection Association (NFPA) 130, Standard for Fixed Guideway Transit and Passenger Rail Systems, and NFPA 502, Standard for Road Tunnels, Bridges, and Other Limited Access Highways, for fire protection and fire life safety design standards. These standards should be reviewed and revised as necessary to incorporate the most current technology and results of recent human response studies on identification and design of escape portals, escape routes, and cross passages.

### **2. Develop AASHTO Guidelines for Existing and New Tunnels**

Single-source guidelines for planning, design, construction, maintenance, and inspection of roads and bridges have been in place for many years. NFPA has developed standards for safety in highway tunnels and passenger rail tunnels. The American Public Transportation Association (APTA) has general safety standards and guidelines for passenger rail operations and maintenance that incorporate some of the NFPA standards by reference. However, AASHTO does not have standards or guidelines specifically for highway or passenger and freight rail tunnels. Recently, the AASHTO Subcommittee on Bridges and Structures created a new committee, the Technical Committee on Tunnels (T-20), to help address this problem. T-20 should take the lead in developing AASHTO standards and guidelines for existing and new tunnels, working with NFPA, APTA, FHWA, and the appropriate TRB committees on standards and guidelines for highway and passenger and freight rail tunnels. T-20 should consider tunnel safety

measures such as the Mont Blanc Tunnel emergency pullout area and variable message sign showing maximum speed limit and required vehicle spacing, as well as refuge room requirements.

### **3. Conduct Research and Develop Guidelines on Tunnel Emergency Management that Includes Human Factors**

Tunnel design solutions may not anticipate human behavior, and consistently predicting the way people will behave in an incident is not easy. During emergency situations, human behavior is even harder to predict as the stress of the situation replaces intellect with curiosity, fear, or even panic. During a tunnel emergency, people often must be their own first rescuers and must react correctly within a few minutes to survive. Tunnel emergency management scenarios and procedures must take human behavior into account to be fully effective in saving lives. The European experience in human factor design provides a good basis for the United States to discover and include more effective measures for tunnel planning, design, and emergency response.

### **4. Develop Education for Motorist Response to Tunnel Incidents**

During an emergency situation, most people do not immediately know what to do to save themselves and others. Motorists are their own first rescuers, and European studies indicate that self-rescue may be the best first response for a tunnel incident. For this to be an effective strategy, it is important to educate the public about the importance of reacting quickly and correctly to a tunnel incident, such as a fire.

### **5. Evaluate Effectiveness of Automatic Incident Detection Systems and Intelligent Video for Tunnels**

The scan team learned of sophisticated software that—using a computer system interfacing with ordinary video surveillance cameras—automatically detects, tracks, and records incidents. As it does so, it signals the operator to observe the event in question and allows the operator the opportunity to take the appropriate action. This concept can also be applied to detect other activities and incidents in areas besides tunnels, including terrorist activities, crashes, vandalism and other crimes, fires, and vehicle breakdowns.

### **6. Develop Tunnel Facility Design Criteria to Promote Optimal Driver Performance and Response to Incidents**

The Europeans found that innovative tunnel design that includes improved geometry or more pleasing visual appearance will enhance driver safety, performance, and traffic operation. For example, the full-size model of one section of the twin roadway tube for the A-86 motorway in Paris demonstrates the effectiveness of good lighting and painting to improve motorist safety. It is a particularly important consideration for a tunnel roadway section designed with limited headroom. Tunnel designers should evaluate the materials and design details that are incorporated to reduce risks to ensure that they do not pose other unacceptable hazards. For example, paint used to enhance the visual experience should not produce toxic fumes or accelerate fire.

## **7. Investigate One-Button Systems to Initiate Emergency Response and Automated Sensor Systems to Determine Response**

The European scan revealed that one of the most important considerations in responding to an incident is to take action immediately. For this to be effective, the operator must initiate several actions simultaneously. An example of how this immediate action is accomplished is the “press one button” solution that initiates several critical actions without giving the operator the chance to omit an important step or perform an action out of order. On the Mont Blanc Tunnel operations center control panel, operators can initiate several actions by moving a yellow line over the area where a fire incident is indicated on a computer screen. This “one-button” action reduces the need for time-consuming emergency decisions about ventilation control and operational procedures.

The Europeans observed that tunnel operations personnel have difficulty keeping up with events like tunnel fires, and they believe that an automatic system using devices like opacity sensors can help determine the correct response. A closed-loop data collection and analysis system that takes atmospheric conditions, tunnel air speed, and smoke density into account may best control fans and vents.

## **8. Use Risk-Management Approach to Tunnel Safety Inspection and Maintenance**

The scan team learned that some organizations use a risk-based schedule for safety inspection and maintenance. Through knowledge of the systems and the structure gained from intelligent monitoring and analysis of the collected data, the owner can use a risk-based approach to schedule the time and frequency of inspections and establish priorities. It makes more sense to inspect less critical or more durable portions of the system on a less frequent basis, and concentrate inspection efforts on the more critical or more fragile components. A risk-based assessment of the condition of facilities also can be used to make optimal decisions on the scope and timing of facility maintenance or rehabilitation. This method offers a statistical process to manage the tunnel assets.

## **9. Implement Light-Emitting Diode Lighting for Safe Vehicle Distance and Edge Delineation in Tunnels**

The scan team noted that in several European tunnels, light-emitting diode (LED) lights were installed along the edge of the tunnel at regular intervals of approximately 10 to 20 meters (m) (33 to 66 feet (ft)) to clearly identify the edge of the roadway. These lights were either white or a highly visible yellow color. In some tunnels, spaced among these edge-delineation lights were blue lights at 150-m (490-ft) intervals. Motorists are instructed through formal (for truck and bus drivers) and informal driver education to keep a safe distance between them and the vehicle in front, and that distance is indicated by the spacing of the blue lights. This visual cue is more reliable than asking motorists to establish distance between vehicles using speed-based guidelines, such as maintaining one car length spacing for every 16 kilometers per hour (10 miles per hour) of speed. The LED markers are also less susceptible to loss of visibility because of road grime and smoke during a tunnel fire.

### **A.3 IMPLEMENTATION ACTIVITIES**

The scan team has developed a detailed implementation plan for the nine recommended initiatives and practices. Included in the plan are a number of technical presentations and written papers at national meetings and conferences sponsored by FHWA, AASHTO, and other organizations to disseminate information from the scan. Also included in the plan is coordination with AASHTO, FHWA, NFPA, and

APTA to advance these initiatives and practices, including assisting with the development of AASHTO standards and guidelines for highway tunnels and passenger and freight rail tunnels. Considerations for outreach to the public include the development of brochures and radio and television announcements. These and other planned activities are discussed in Chapter 3 of the Scan Report a. available on the FHWA web site at <http://International.fhwa.dot.gov/uts/uts.pdf>.

This page is intentionally left blank.

# **Appendix B**

## **Descriptions for Rock Core Samples**

This page is intentionally left blank.



## Appendix B –Glossary of Terms Used in Rock Core Boring Logs

**Arenaceous:** A sedimentary rock descriptive term that signifies the rock consists in part of sand-size particles.

**Argillaceous:** A sedimentary rock descriptive term that signifies the rock is comprised of a large percentage (but less than 50%) of clay.

**Bedding:** A surface, generally planar or nearly planar, that visibly separates each successive layer of stratified rock from the preceding or following layer.

**Swirly bedding:** Tightly curved, wavy pattern throughout texture of rock.

**Color-banding:** Shades of alternating color in very thin bands parallel to the bedding. Differing lithology or grain size in the various bands is possible.

**Discontinuity:** A collective term for most types of joints, bedding planes, schistosity planes, shear and fault zones.

**Fault:** A fracture or fracture zone along which there has been recognizable displacement.

**Fissile:** Exhibiting the property of easily splitting into very thin layers parallel to the bedding.

**Friable:** Easily crumbled, as would be the case with rock that is poorly cemented.

**Grain size:**

**Fine-grained (rock):** Grain size not visible to just barely visible with naked eye.

**Medium-grained (rock):** Grain size barely to easily visible with the naked eye; up to 1/8 in. (3 mm).

**Coarse-grained (rock):** Grain size 1/8 in. (3 mm) or greater.

**Joints:** A break of geological origin in the continuity of a rock mass along which there has been no visible displacement.

**Horizontal:** Natural breaks inclined to a horizontal plane from 0° to 5°.

**Low angle:** Natural breaks inclined to a horizontal plane from 5° to 35°.

**Moderately dipping:** Natural breaks inclined to a horizontal plane from 35° to 55°.

**High angle:** Natural breaks inclined to a horizontal plane from 55° to 85°.

**Vertical:** Natural breaks inclined to a horizontal plane from 85° to 90°.

**Mottling:** Irregular color patches of limited extent.

**Oolitic:** Composed of smooth, rounded granules.

Parting: Natural break in the rock caused by change in lithology or grain size, parallel to the bedding.

Unlike joints, which can be limited in extent or trend by the thickness of the formation, partings are usually persistent in every direction parallel to the bedding. Often marked by a very thin bed or seam of soft rock or mineral. Stylolitic partings are rough, irregular, and faced with argillaceous materials (see Stylolite).

Pit: Cavity up to 1/4 in. (6mm) size.

Shear: A localized expression of strain resulting from stresses that cause or tend to cause slippage along a plane at the contact of two contiguous parts of a body.

Slickensides: Smooth, highly polished argillaceous facing on a shear. Trace slickensides are not highly polished, but marked by some sign of small movement, such as very small polished areas and/or parallel grooves and striations on a joint face.

Stylolite: A surface, usually in homogeneous carbonate rocks, marked by an irregular and interlocking penetration of the two sides; in cross section it resembles a suture; the seam is characterized by a concentration of clay, carbon, or iron oxides.

Surface Planarity:

Planar - A flat surface.

Stepped - A surface with asperities or steps. The height of the asperity should be estimated or measured.

Wavy - A moderate undulating surface; curved, smoothly uneven.

Surface Roughness:

Very Rough - Near vertical steps and ridges occur on the discontinuity surface.

Rough - Some ridges and side-angle steps are evident; asperities are clearly visible; and discontinuity surface feels very abrasive.

Slightly Rough - Asperities on the discontinuity surface are distinguishable and can be felt.

Smooth - Surface appears smooth and feels so to the touch.

Slickensided - Visual evidence of polishing exists.

Trace: Amount less than 10%; not common.

Vug: Cavity larger than a pit; from 1/4 (6 mm) to 2 in. (50 mm) in size.

Many of the terms above were defined in the following two references:

1. Bates, R.L. and Jackson, J.A., EDS., Glossary of Geology, American Geological Institute, Falls Church, Va, 1980.
2. I.S.R.M., Suggested Methods for the Quantitative Description of Discontinuities in Rock Masses.

## Summary of Terms for Describing Rock Cores

### GRAIN SIZE

| TERM           | GRAIN SIZE   |
|----------------|--|
| Fine-grained   | Not visible to barely visible with naked eye               |
| Medium-grained | Barely to easily visible with naked eye; up to 1/8" (3 mm) |
| Coarse-grained | > 1/8" (3 mm)  |

### CONTINUITY

| TERM                 | LENGTH OF DRILL CORE STEM PIECES |
|----------------------|----------------------------------|
| Sound                | >8" (200 mm)                     |
| Slightly Fractured   | 4"-8" (100-200 mm)               |
| Moderately Fractured | 1"-4" (25-100 mm)                |
| Extremely Fractured  | <1" (25 mm)                      |

### DISCONTINUITY DESCRIPTION

| FRACTURE SPACING (JOINTS, FAULTS, OTHER FRACTURES) |                   |                  | BEDDING SPACING (MAY INCLUDE FOLIATION OR BANDING) |               |                |
|--|-------------------|------------------|--|---------------|----------------|
| DESCRIPTION  | SPACING           |                  | DESCRIPTION  | SPACING       |                |
| Extremely close                                    | < 3/4 in          | (<19 mm)         | Laminated  | < 1/2 in      | (12 mm)        |
| Very close   | 3/4 in - 2-1/2 in | (19 - 60 mm)     | Very thin  | 1/2 in - 2 in | (12 - 50 mm)   |
| Close  | 2-1/2 in - 8 in   | (60 - 200 mm)    | Thin   | 2 in - 1 ft   | (50 - 300 mm)  |
| Moderate   | 8 in - 2 ft       | (200 - 600 mm)   | Medium   | 1 ft - 3 ft   | 300 - 900 mm)  |
| Wide   | 2 ft - 6 ft       | (600 mm - 2.0 m) | Thick  | 3 ft - 10 ft  | (900 mm - 3 m) |
| Very wide  | 6 ft - 20 ft      | (2.0 - 6 m)      | Massive  | > 10 ft       | (3 m)          |

**Discontinuity Orientation (Angle):** Measure the angle of discontinuity relative to a plane perpendicular to the longitudinal axis of the core. (For most cases, the core axis is vertical; therefore, the plane perpendicular to the core axis is horizontal.) Record orientation (angle) on log. For example, a horizontal bedding plane would have a 0 degree angle.

### WEATHERING

| TERM                 | DESCRIPTION  | Grade |
|----------------------|--|-------|
| Unweathered          | No visible sign of rock material weathering, perhaps slight discoloration on major discontinuity surfaces  | I     |
| Slightly weathered   | Discoloration indicates weathering of rock material and discontinuity surfaces. All the rock material may be discolored by weathering and may be somewhat weaker externally than in its fresh condition. | II    |
| Moderately weathered | Less than half of the rock material is decomposed and/or disintegrated to a soil. Fresh or discolored rock is present either as a continuous framework or as corestones.                                 | III   |
| Highly weathered     | More than half of the rock material is decomposed and/or disintegrated to a soil. Fresh or discolored rock is present either as a discontinuous framework or as corestones.                              | IV    |
| Completely weathered | All rock material is decomposed and/or disintegrated to soil. The original mass structure is still largely intact.   | V     |
| Residual soil        | All rock material is converted to soil. The mass structure and material fabric are destroyed. There is a large change in volume, but the soil has not been significantly transported                     | VI    |

The terms and description below help to define some of the descriptions used in the above table.

|               |  |
|---------------|--|
| Fresh         | No visible sign of weathering of the rock material.  |
| Discolored    | The color of the original fresh rock material is changed. The degree of change from the original color should be indicated. If the color change is confined to particular mineral constituents, this should be mentioned |
| Decomposed    | The rock is weathered to the condition of a soil in which the original material fabric is still intact, but some or all of the mineral grains are decomposed.  |
| Disintegrated | The rock is weathered to the condition of a soil in which the original fabric is still intact. The rock is friable, but the mineral grains are not decomposed.   |

## Summary of Terms for Describing Rock Cores (Continued)

### STRENGTH OR HARDNESS

| GRADE  | DESCRIPTION      | FIELD IDENTIFICATION  | UNIAXIAL COMPRESSIVE STRENGTH, PSI (MPa) |
|--|------------------|---|--|
| R0   | Extremely weak   | Indented by thumbnail   | 40-150 (0.3-1)                           |
| R1   | Very weak        | Crumbles under firm blows with point of geological hammer, can be peeled by a pocket knife                              | 150-700 (1-5)                            |
| R2   | Weak rock        | Can be peeled by a pocket knife with difficulty, shallow indentations made by firm blow with point of geological hammer | 700-4000 (5-30)                          |
| R3   | Medium strong    | Cannot be scraped or peeled with a pocket knife, specimen can be fractured with single firm blow of geological hammer   | 4000-7000 (30-50)                        |
| R4   | Strong rock      | Specimen requires more than one blow of geological hammer to fracture it  | 7000-15,000 (50-100)                     |
| R5   | Very strong      | Specimen requires many blows of geological hammer to fracture it  | 15,000-36,000 (100-250)                  |
| R6   | Extremely strong | Specimen can only be chipped with geological hammer   | >36,000 (>250)                           |
| Assess the strength of any filling materials along discontinuity surfaces in accordance with the following descriptions and grades.  |                  |   |  |
| GRADE  | DESCRIPTION      | FIELD IDENTIFICATION  | UNIAXIAL COMPRESSIVE STRENGTH, KSF (KPa) |
| S1   | Very soft clay   | Easily penetrated several inches (cm) by fist   | 0.5 (25)                                 |
| S2   | Soft clay        | Easily penetrated several inches (cm) by thumb  | 0.5-1.0 (25-50)                          |
| S3   | Firm clay        | Can be penetrated several inches (cm) by thumb with moderate effort   | 1.0-2.0 (50-100)                         |
| S4   | Stiff clay       | Readily indented by thumb but penetrated only with great effort   | 2.0-5.0 (100-250)                        |
| S5   | Very stiff clay  | Readily indented by thumbnail   | 5.0-10.0 (250-500)                       |
| S6   | Hard clay        | Indented with difficulty by thumbnail   | >10.0 (>500)                             |
| <ul style="list-style-type: none"> <li>Grades S1 to S6 apply to cohesive soils for example clays, silty clays, and combinations of silts and clays with sand, generally slow draining. If non-cohesive fillings are identified, qualitatively identify, e.g., fine sand.</li> <li>Discontinuity wall strength will generally be characterized by grades R0-R6 (rock) while S1-S6 (clay) will generally apply to filled discontinuities.</li> </ul> |                  |   |  |

### JOINT ROUGHNESS (J<sub>r</sub>) NUMBER

|   | J <sub>r</sub> |
|---|----------------|
| <b>ROCK WALL CONTACT ALONG DISCONTINUITY SURFACE</b>                          |                |
| A. Discontinuous joints   | 4              |
| B. Rough or irregular, undulating   | 3              |
| C. Smooth, undulating   | 2              |
| D. Slickensided, undulating   | 1.5            |
| E. Rough or irregular, planar   | 1.5            |
| F. Smooth, planar   | 1.0            |
| G. Slickensided, planar   | 0.5            |
| <b>NO ROCK WALL CONTACT ALONG DISCONTINUITY SURFACE</b>                       |                |
| H. Zone containing clay minerals thick enough to prevent rock wall contact    | 1.0 (nominal)  |
| I. Sandy, gravelly, or crushed zone thick enough to prevent rock wall contact | 1.0 (nominal)  |

### JOINT ALTERNATION (J<sub>a</sub>) NUMBER

|   | J <sub>a</sub>          |
|---|-------------------------|
| <b>ROCK WALL CONTACT, OR COATING &lt;1/8 IN. (3 MM) THICK</b>   |                         |
| A. Tightly healed, hard, non-softening, impermeable filling. i.e., quartz or epidote  | 0.75                    |
| B. Unaltered joint walls, surface staining only   | 1.0                     |
| C. Slightly altered joint walls. Non-softening mineral coatings, sandy particles, clay-free disintegrated rock etc.   | 2.0                     |
| D. Silty- or sandy-clay coatings, small clay-fraction (non-softening)   | 3.0                     |
| E. Softening or low friction clay mineral coatings, i.e., kaolinite, mica. Also chlorite, talc, gypsum, graphite, etc., and small quantities of swelling clays.                         | 4.0                     |
| <b>NO ROCK WALL CONTACT, CONTINUOUS COATINGS &lt;1/4 IN (5 MM) THICK</b>  |                         |
| F. Sandy particles, clay-free disintegrated rock etc.   | 4.0                     |
| G. Strongly over-consolidation, softening, clay mineral fillings. (Continuous, <5 mm in thickness)  | 6.0                     |
| H. Medium or low over-consolidation, softening, clay mineral fillings. (Continuous, <5 mm in thickness)   | 8.0                     |
| J. Swelling clay fillings, i.e., montmorillonite (Continuous, <5 mm in thickness). Value of J <sub>a</sub> depends on percent of swelling clay-size particles and access to water, etc. | 8.0-12.0                |
| <b>NO ROCK WALL CONTACT, CONTINUOUS COATINGS &gt;1/4 IN (5 MM) THICK</b>  |                         |
| K.,L.,M. Crushed rock and clay (see G., H., J., for description of clay condition)  | 6.0, 8.0 or 8.0-12.0    |
| N. Zones or bands of silty- or sandy clay, small clay fraction (nonsoftening)   | 5.0                     |
| O.,P.,R. Thick continuous zones or bands or clay (see G., H., J. for description of clay condition)   | 10.0, 13.0 or 13.0-20.0 |



Project:  
Project Location:  
Project Number:

## Key to Rock Core Log

Sheet 1 of 2

| Depth,<br>meters | Elevation,<br>meters | ROCK CORE |         |             |             |          |                                |           |    | MATERIAL DESCRIPTION | Packer<br>Tests | Laboratory<br>Tests | Drill Rate,<br>meters/hour | FIELD<br>NOTES |    |
|------------------|----------------------|-----------|---------|-------------|-------------|----------|--------------------------------|-----------|----|----------------------|-----------------|---------------------|----------------------------|----------------|----|
|                  |                      | Run No.   | Box No. | Recovery, % | Frac. Freq. | R Q D, % | Fracture<br>Drawing/<br>Number | Lithology |    |                      |                 |                     |                            |                |    |
| 0                |                      |           |         |             |             |          |                                |           |    |                      |                 |                     |                            |                |    |
| 1                | 2                    | 3         | 4       | 5           | 6           | 7        | 8                              | 9         | 10 | 11                   |                 | 13                  | 14                         | 15             | 16 |
| 2                |                      | 1         | 1       | 100         |             | 80       |                                |           |    |                      |                 |                     |                            |                |    |
| 4                |                      |           |         |             | 1           |          |                                |           |    |                      |                 |                     |                            |                |    |
|                  |                      |           |         |             | 0           |          |                                |           |    |                      |                 |                     |                            |                |    |
|                  |                      |           |         |             |             |          |                                | 1         | M  |                      |                 |                     |                            |                |    |

11 META-ARKOSE, light gray, moderately weathered, moderately strong.

12

|   |   |   |   |   |   |   |   |
|---|---|---|---|---|---|---|---|
| a | b | c | d | e | f | g | h |
|---|---|---|---|---|---|---|---|

1: 75, J, VN, Fe, Su, Pl, S, VC  
M: Mechanical Breakage

Slow drilling

- 1 **Depth:** Distance (in meters) from the collar of the borehole.
- 2 **Elevation:** Elevation (in meters) from the collar of the borehole.
- 3 **Run No.:** Number of the individual coring interval, starting at the top of bedrock.
- 4 **Box No.:** Number of the core box which contains core from the corresponding run.
- 5 **Recovery:** Amount (in percent) of core recovered from the coring interval; calculated as the length of core recovered divided by the length of the run.
- 6 **Frac. Freq.:** (Fracture Frequency) The number of naturally occurring fractures in each foot of core; does not include mechanical breaks, which are considered to be induced by drilling.
- 7 **R Q D:** (Rock Quality Designation) Amount (in percent) of intact core (pieces of sound core greater than 100 mm in length) in each coring interval; calculated as the sum of the lengths of intact core divided by the length of the core run.
- 8 **Fracture Drawing:** Sketch of the naturally occurring fractures and mechanical breaks, showing the angle of the fractures relative to the cross-sectional axis of the core. "NR" indicates no recovery.
- 9 **Fracture Number:** Location of each naturally occurring fracture (numbered) and mechanical break (labeled "M"). Naturally occurring fractures are described in Column 11 (keyed by number) using descriptive terms defined on the following page (Items a - h).
- 10 **Lithology:** A graphic log presentation using symbols to represent differing rock types.
- 11 **Description:** Lithologic description in this order: rock type, color, texture, grain size, foliation, weathering, strength, and other features; descriptive terms are defined on the following page. A detailed descriptive log of overburden materials is not necessarily provided.
- 12 **Discontinuity Description:** Abbreviated description of fracture corresponding to number of naturally occurring fracture in Column 9 using terms defined on the following page (Items a - h).
- 13 **Packer Tests:** A vertical line depicts the interval over which a packer test is performed.
- 14 **Laboratory Tests:** A vertical line depicts the interval over which core has been removed for laboratory testing. Laboratory tests performed are indicated in Column 16.
- 15 **Drill Rate:** Rate (in meters per hour) of penetration of drilling. "N/O" indicates rate not observed.
- 16 **Field Notes:** Comments on drilling, including water loss, reasons for core loss, and use of drilling mud; also, laboratory tests performed on core.

Project:  
Project Location:  
Project Number:

# Key to Rock Core Log

Sheet 2 of 2

| Depth, meters | Elevation, meters | ROCK CORE |         |             |             |          |                         |           | MATERIAL DESCRIPTION | Packer Tests | Laboratory Tests | Drill Rate, meters/hour | FIELD NOTES |
|---------------|-------------------|-----------|---------|-------------|-------------|----------|-------------------------|-----------|----------------------|--------------|------------------|-------------------------|-------------|
|               |                   | Run No.   | Box No. | Recovery, % | Frac. Freq. | R Q D, % | Fracture Drawing/Number | Lithology |                      |              |                  |                         |             |

## KEY TO DESCRIPTIVE TERMS USED ON CORE LOGS

### DISCONTINUITY DESCRIPTORS

- a** Dip of fracture surface measured relative to horizontal
- b** Discontinuity Type:
  - F - Fault
  - J - Joint
  - Sh - Shear
  - Fo - Foliation
  - V - Vein
  - B - Bedding
- c** Discontinuity Width (millimeters):
  - W - Wide (12.5-50)
  - MW - Moderately Wide (2.5-12.5)
  - N - Narrow (1.25-2.5)
  - VN - Very Narrow (<1.25)
  - T - Tight (0)
- d** Type of Infilling:
  - Cl - Clay
  - Ca - Calcite
  - Ch - Chlorite
  - Fe - Iron Oxide
  - Gy - Gypsum/Talc
  - H - Healed
  - No - None
  - Py - Pyrite
  - Qz - Quartz
  - Sd - Sand
- e** Amount of Infilling:
  - Su - Surface Stain
  - Sp - Spotty
  - Pa - Partially Filled
  - Fi - Filled
  - No - None
- f** Surface Shape of Joint:
  - Wa - Wavy
  - Pl - Planar
  - St - Stepped
  - Ir - Irregular
- g** Roughness of Surface:
  - Slk - Slickensided [surface has smooth, glassy finish with visual evidence of striations]
  - S - Smooth [surface appears smooth and feels so to the touch]
  - SR - Slightly Rough [asperities on the discontinuity surfaces are distinguishable and can be felt]
  - R - Rough [some ridges and side-angle steps are evident; asperities are clearly visible, and discontinuity surface feels very abrasive]
  - VR - Very Rough [near-vertical steps and ridges occur on the discontinuity surface]
- h** Discontinuity Spacing (meters):
  - EW - Extremely Wide (>20)
  - W - Wide (7-20)
  - M - Moderate (2.5-7)
  - C - Close (0.7-2.5)
  - VC - Very Close (<0.7)

### ROCK WEATHERING / ALTERATION

| Description                  | Recognition  |
|------------------------------|--|
| Residual Soil                | Original minerals of rock have been entirely decomposed to secondary minerals, and original rock fabric is not apparent; material can be easily broken by hand             |
| Completely Weathered/Altered | Original minerals of rock have been almost entirely decomposed to secondary minerals, minerals, although original fabric may be intact; material can be granulated by hand |
| Highly Weathered/Altered     | More than half of the rock is decomposed; rock is weakened so that a minimum 50-mm-diameter sample can be broken readily by hand across rock fabric                        |
| Moderately Weathered/Altered | Rock is discolored and noticeably weakened, but less than half is decomposed; a minimum 50-mm-diameter sample cannot be broken readily by hand across rock fabric          |
| Slightly Weathered/Altered   | Rock is slightly discolored, but not noticeably lower in strength than fresh rock  |
| Fresh                        | Rock shows no discoloration, loss of strength, or other effect of weathering/alteration  |

### ROCK STRENGTH

| Description           | Recognition                                   | Approximate Uniaxial Compressive Strength (kPa) |
|-----------------------|---|---|
| Extremely Weak Rock   | Can be indented by thumbnail                  | 250 - 1,000                                     |
| Very Weak Rock        | Can be peeled by pocket knife                 | 1,000 - 5,000                                   |
| Weak Rock             | Can be peeled with difficulty by pocket knife | 5,000 - 25,000                                  |
| Medium Strong Rock    | Can be indented 5 mm with sharp end of pick   | 25,000 - 50,000                                 |
| Strong Rock           | Requires one hammer blow to fracture          | 50,000 - 100,000                                |
| Very Strong Rock      | Requires many hammer blows to fracture        | 100,000 - 250,000                               |
| Extremely Strong Rock | Can only be chipped with hammer blows         | > 250,000                                       |

This page is intentionally left blank.



# **Appendix C**

## **Cut-and-Cover Tunnel Design Example**

This page is intentionally left blank.

## **APPENDIX C - EXAMPLE CUT AND COVER BOX TUNNEL**

The purpose of this design example is to provide guidance to the application of the AASHTO LRFD Bridge Design Specifications when designing concrete cut and cover box tunnel structures.

Reference is made to the AASHTO LRFD specifications throughout the design example. Specific references to sections are denoted by the letter "S" preceding the specification article.

# 1. Tunnel Section Geometry and Materials

The tunnel is a reinforced concrete double-chamber box structure. It is located entirely below grade and is built using cut and cover construction. Because the water table is located above the tunnel, hydrostatic soil pressures surround the structure. Figure 1 shows the internal dimensions for one of the openings. These dimensions serve as the starting point for the structural dimensions shown in Figure 2.

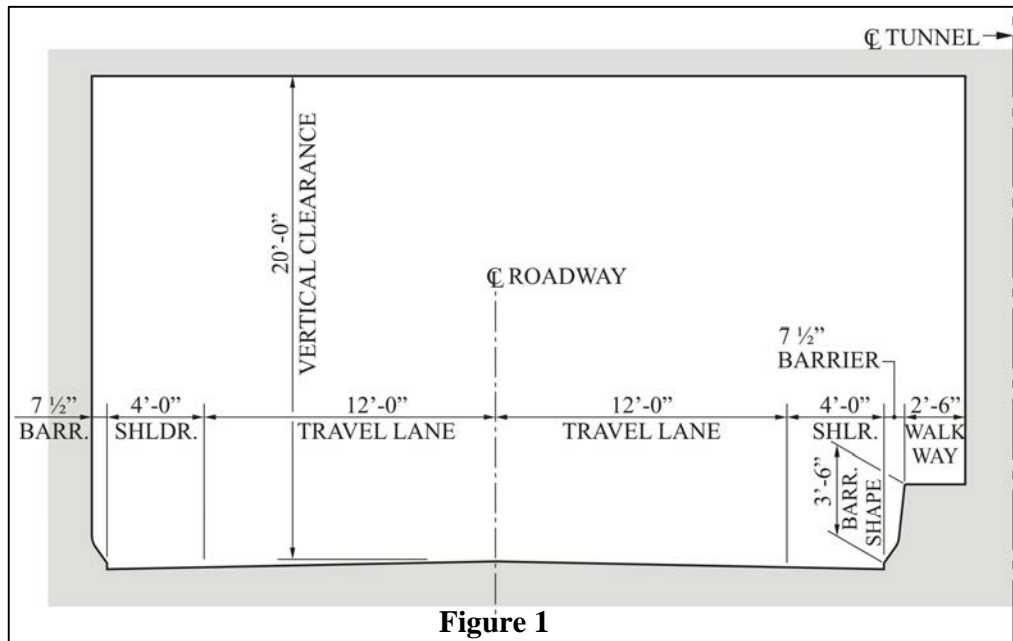

## 1.1 Tunnel Section Dimensions

|  |          |
|--|----------|
| Box interior width, $x =$                          | 35.75 ft |
| Box interior height, $y =$                         | 20.00 ft |
| Interior wall thickness =                          | 1.00 ft  |
| Exterior wall thickness =                          | 2.00 ft  |
| Bottom slab thickness =                            | 1.75 ft  |
| Top slab thickness =                               | 2.50 ft  |
| Soil depth, $Z_1 =$                                | 10.00 ft |
| Water depth, $Z_2 =$                               | 5.00 ft  |
| Total depth, $D =$                                 | 34.25 ft |
| Box total width, $B =$                             | 76.50 ft |
| Width between centroids of exterior walls, $B_1 =$ | 74.50 ft |
| Box total height, $H =$                            | 24.25 ft |
| Height between centroids of slabs, $H_1 =$         | 22.13 ft |

Figure 2 shows the geometry of the underground cut and cover box cross-section.

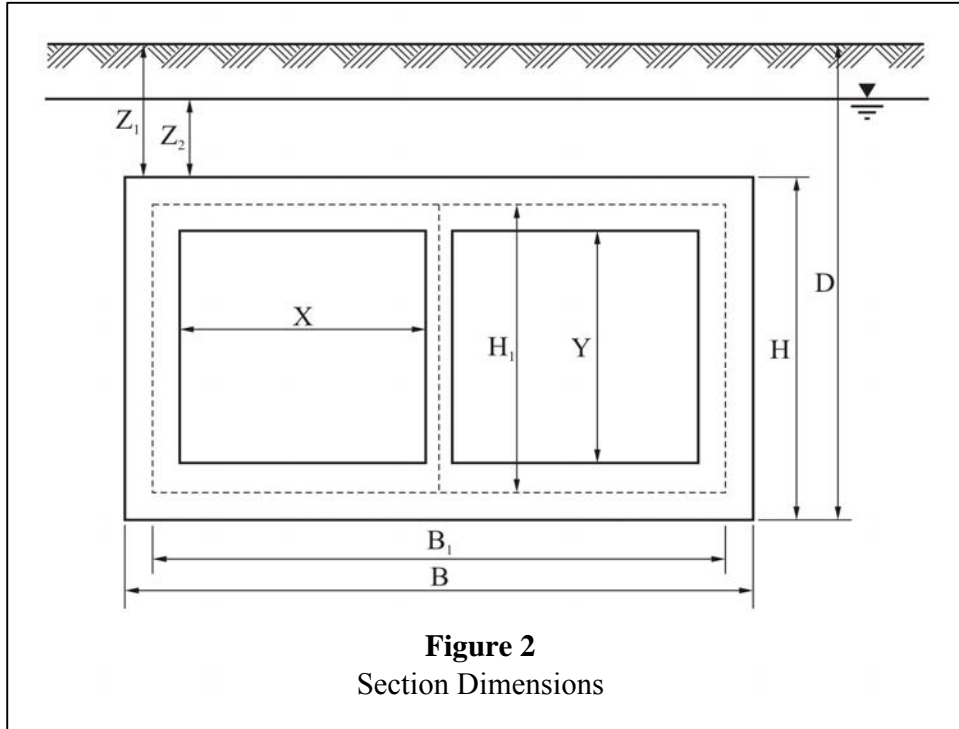

## 1.2 Material Properties

|   |          |
|---|----------|
| Unit weight of concrete, $\gamma_c =$           | 150 pcf  |
| Unit weight of soil, $\gamma_s =$               | 130 pcf  |
| Unit weight of water, $\gamma_w =$              | 62.4 pcf |
| Unit weight of saturated soil, $\gamma_{sat} =$ | 67.6 pcf |
| Coeff. of earth pressure at rest, $k_o =$       | 0.5      |
| Coeff. of water for earth pressure, $k_w =$     | 1        |

## 2. Computer Model of Tunnel

The analysis of the tunnel subjected to applied loads and the design of the structural components are performed using a model generated by general purpose structural analysis computer software. Concrete walls and slabs are modeled as a rigid frame, composed of groups of members that are interconnected by a series of joints (see Section 4.0 Analysis Model Input and Section 5.0 Analysis Model Diagram). All joints are located along the centroids of the structural components. Members are modeled as one foot wide segments in the longitudinal direction of the tunnel to represent a one-foot-wide "slice" of the structure. AASHTO LRFD factored loads and load combinations are applied to the members and joints as required. The structure is analyzed to determine member forces and reactions, which will be used to design individual structural components of the tunnel.

### 2.1 Model Supports

Universal restraints are applied in the Y-translation and X-rotation degrees of freedom to all members. Spring supports located at joints spaced at 1'-0" on center are used to model soil conditions below the bottom slab of the tunnel. Springs with a K constant equal to 2600 k/ft are used, applied only in the downward Z direction. The spring support reaction will account for the earth reaction load.

## 3. Load Determination

The tunnel is located completely below grade and is subjected to loading on all sides. The self weight load of the concrete structure is applied vertically downward as component dead load. Vehicular live loads and vertical earth pressure are applied in the vertical downward direction to the top slab. Buoyancy forces are applied vertically upward to the bottom slab. Lateral forces from live load, soil overburden, horizontal earth pressure, and hydrostatic pressure are applied to the exterior walls. Load designations are referenced from LRFD Section 3.3.2 (see Figure 3).

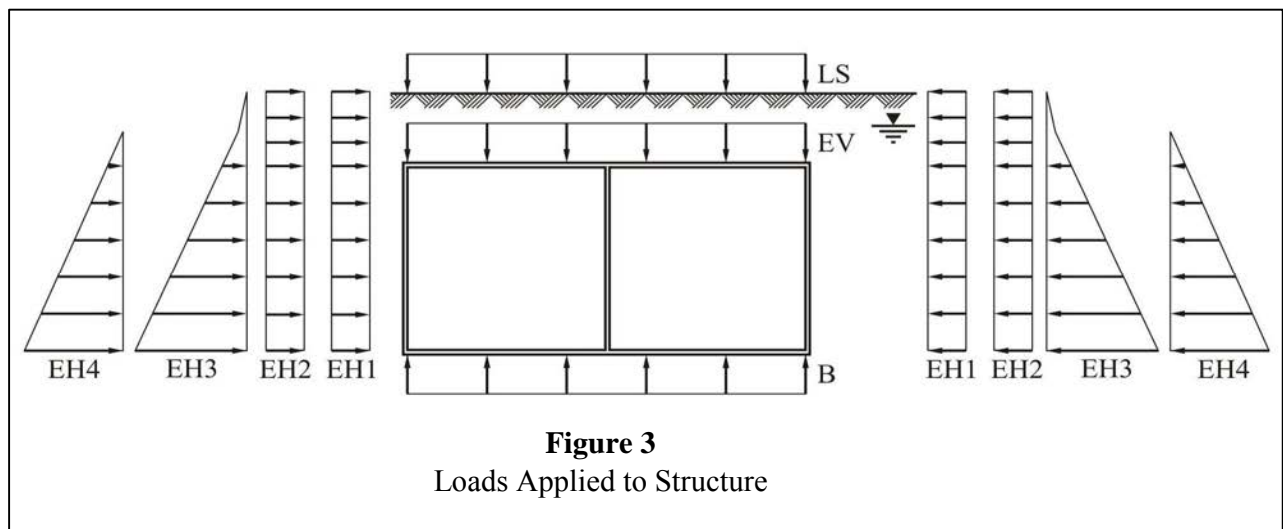

**Figure 3**  
Loads Applied to Structure

### 3.1 Total Dead Loads

Dead loads are represented by the weight of all components of the tunnel structure and the vertical earth pressure due to the dead load of earth fill.

#### Concrete dead load (per foot length) (DC)

|                      |  |   |           |
|----------------------|--|---|-----------|
| Top slab =           | $0.15 \text{ ksf} \times (76.5 \times 2.5)$      | = | 28.69 kip |
| Bottom slab =        | $0.15 \text{ ksf} \times (76.5 \times 1.75)$     | = | 20.08 kip |
| Interior wall =      | $0.15 \text{ ksf} \times (1 \times 20)$          | = | 3.00 kip  |
| Exterior walls (2) = | $0.15 \text{ ksf} \times 2 \times (2 \times 20)$ | = | 12.00 kip |

#### Vertical earth pressure (EV)

|           |                                 |   |           |
|-----------|---------------------------------|---|-----------|
| EV=       | 1.30 ksf                        |   |           |
| Soil wt = | $1.30 \text{ ksf} \times 76.50$ | = | 99.45 kip |

### 3.2 Live Load

Live load represents wheel loading from an HS-20 design vehicle. It is assumed that the wheels act as point loads at the surface and are distributed downward in both directions through the soil to the top slab of the tunnel. The load distribution is referenced from LRFD Section 3.6.1.2.6. Figure 4 shows the distribution of the wheel loads to the top slab.

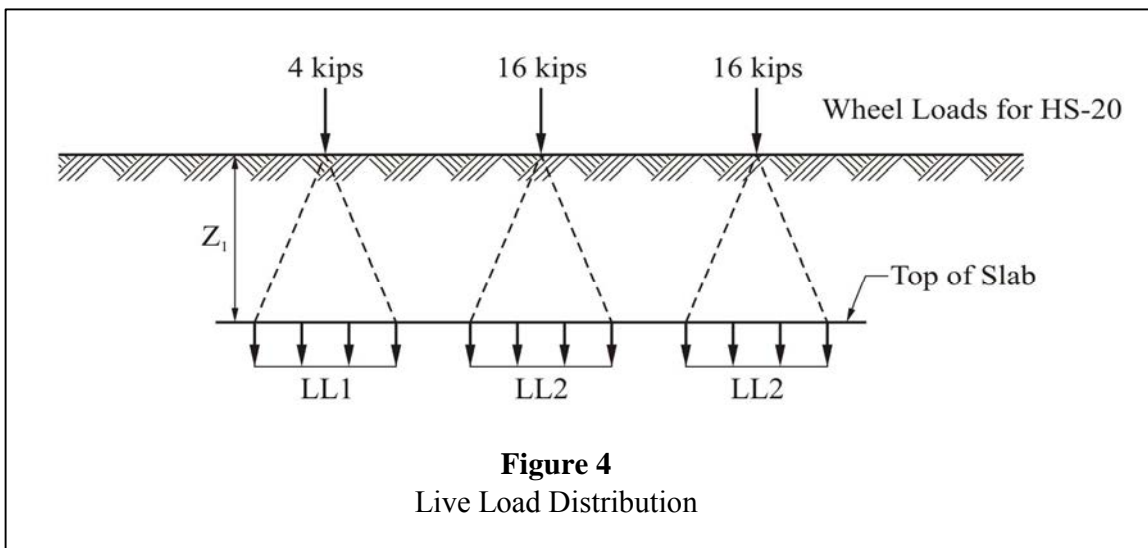

#### Wheel Loads (LL)

$$LL1 = \frac{4k}{(z_1)^2} = 0.04 \text{ ksf} \quad (\text{S3.6.1.2.6})$$

$$LL2 = \frac{16k}{(z_1)^2} = 0.16 \text{ ksf} \quad \text{controls}$$

Live Load Surcharge (LS)

$$LS = 0.16 \times 76.50 = 12.240 \text{ kip}$$

$$\text{Surch. Ht} = \frac{\text{Max}(qw_1, qw_2)}{\gamma_s} = 1.231 \text{ ft}$$

**3.3 Lateral Earth Pressure EH<sub>1</sub>, EH<sub>2</sub>, EH<sub>3</sub>, EH<sub>4</sub>**

Lateral earth pressure is typically represented by the equation:

$$\sigma = k_0 \gamma n$$

The following lateral pressures are applied to the exterior walls of the tunnel (see Figure 5):

EH<sub>1</sub> = LL surcharge

EH<sub>2</sub> = Lateral earth pressure due to soil overburden

EH<sub>3</sub> = Horizontal earth pressure

EH<sub>4</sub> = Hydrostatic pressure

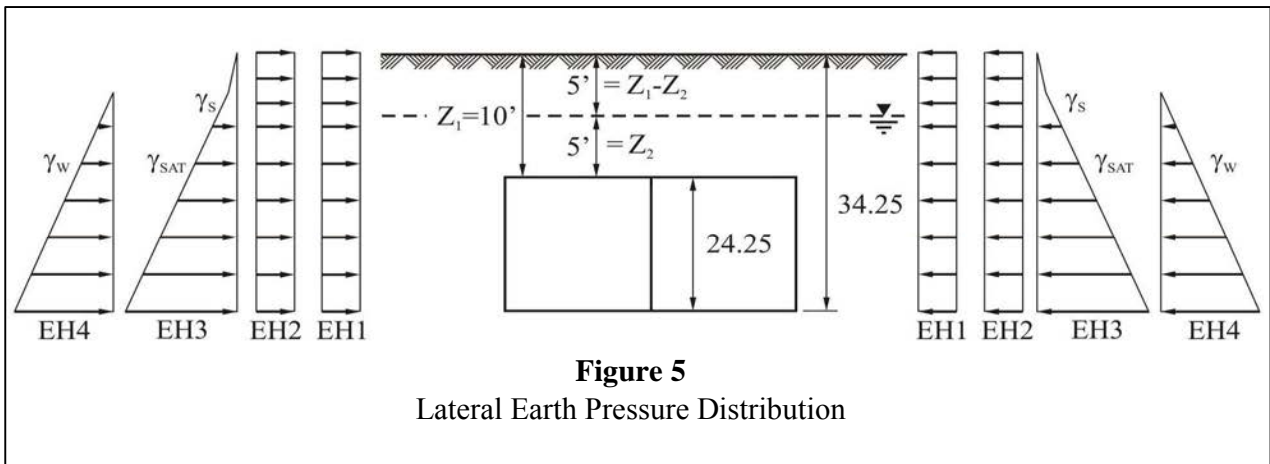



Calculate the lateral earth pressures:

$$EH_1 = k_o(\gamma_s \times n_{\text{surch}}) = 0.080 \text{ ksf}$$

$$EH_2 = k_o(\gamma_s \times n_s + \gamma_{\text{sat}} \times n_{\text{sat}}) = 0.494 \text{ ksf}$$

$$n_s = 5.00 \text{ ft}$$

$$n_{\text{sat}} = 5.00 \text{ ft}$$

$$EH_3 = k_o(\gamma_s \times n_s + \gamma_{\text{sat}} \times n_{\text{sat}}) = 1.314 \text{ ksf}$$

$$n_s = 5.00 \text{ ft}$$

$$n_{\text{sat}} = 29.25 \text{ ft}$$

$$EH_4 = k_w(\gamma_w \times n_w) = 1.825 \text{ ksf}$$

$$n_w = 29.25 \text{ ft}$$

### 3.4 Buoyancy Load WA

Area of water displaced, A

$$A = B \times H = 1855.125 \text{ sq. ft.}$$

$$\text{Buoyancy} = A \times \gamma_w = 115.76 \text{ klf (along tunnel) OK}$$

$$WA = \frac{\text{Buoyancy}}{B} = 1.513 \text{ klf}$$

### 3.5 Load Factors and Combinations

Loads are applied to a model using AASHTO LRFD load combinations, referenced from LRFD Table 3.4.1-1. The loads, factors, and combinations for the applicable design limit states are given in Table 1.

Table 1: Load Factors and Load Combinations

EV - Vertical pressure from dead load of earth fill

DC - Dead load of structural components and nonstructural attachments

LS - Live load surcharge

EH - Horizontal earth pressure load

WA - Water load and stream pressure

| Load Combination |   | LOAD FACTORS |      |      |      |    |
|------------------|---|--------------|------|------|------|----|
|                  |   | EV           | DC   | LS   | EH   | WA |
| Limit State      |   | EV           | DC   | LS   | EH   | WA |
| Strength 1       | A | 1.3          | 1.25 | 1.75 | 1.35 | 1  |
|                  | B | 1.3          | 1.25 | 1.75 | 0.9  | 1  |
|                  | C | 0.9          | 1.25 | 1.75 | 1.35 | 1  |
|                  | D | 0.9          | 1.25 | 1.75 | 0.9  | 1  |
|                  | E | 1.3          | 0.9  | 1.75 | 1.35 | 1  |
|                  | F | 1.3          | 0.9  | 1.75 | 0.9  | 1  |
|                  | G | 0.9          | 0.9  | 1.75 | 0.9  | 1  |
|                  | H | 0.9          | 0.9  | 1.75 | 1.35 | 1  |
| Strength 2       | A | 1.3          | 1.25 | 1.35 | 1.35 | 1  |
|                  | B | 1.3          | 1.25 | 1.35 | 0.9  | 1  |
|                  | C | 0.9          | 1.25 | 1.35 | 1.35 | 1  |
|                  | D | 0.9          | 1.25 | 1.35 | 0.9  | 1  |
|                  | E | 1.3          | 0.9  | 1.35 | 1.35 | 1  |
|                  | F | 1.3          | 0.9  | 1.35 | 0.9  | 1  |
|                  | G | 0.9          | 0.9  | 1.35 | 0.9  | 1  |
|                  | H | 0.9          | 0.9  | 1.35 | 1.35 | 1  |
| Strength 3       | A | 1.3          | 1.25 | n    | 1.35 | 1  |
|                  | B | 1.3          | 1.25 | n    | 0.9  | 1  |
|                  | C | 0.9          | 1.25 | n    | 1.35 | 1  |
|                  | D | 0.9          | 1.25 | n    | 0.9  | 1  |
|                  | E | 1.3          | 0.9  | n    | 1.35 | 1  |
|                  | F | 1.3          | 0.9  | n    | 0.9  | 1  |
|                  | G | 0.9          | 0.9  | n    | 0.9  | 1  |
|                  | H | 0.9          | 0.9  | n    | 1.35 | 1  |
| Service 1        |   | 1.0          | 1    | 1    | 1    | 1  |
| Service 4        |   | 1.0          | 1    | n    | 1    | 1  |

## 4. Analysis Model Input

### 4.1 Joint Coordinates

The cross section of the tunnel model lies in the X-Z global plane. Each joint is assigned X and Z coordinates to locate its position in the model. See Section 5.0 and Figure 6 for a diagram of the model.

### 4.2 Member Definition

Members are defined by a beginning joint and an end joint,  $J_i$  and  $J_j$ , respectively, where  $i$  and  $j$  represent joint numbers.

All members are composed of concrete and represent a one foot wide "slice" of the tunnel section.

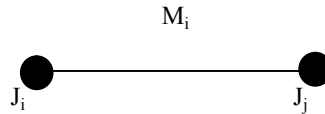

## 5. Analysis Model Diagram

The computer model represents a one foot wide slice of the cross-section of the tunnel. Members are connected by series of joints at their endpoints to form a frame, and are located along the centroids of the walls and roof and floor slabs. Joints in the 100 series and 200 series represent the floor and roof slabs respectively. Joints in the 300 and 500 series represent the exterior walls, while the 400 series represents the interior wall. The bottom diagram of Figure 5 shows all joints in the structure, while the top diagram shows only the joints at the intersections of slabs and walls.

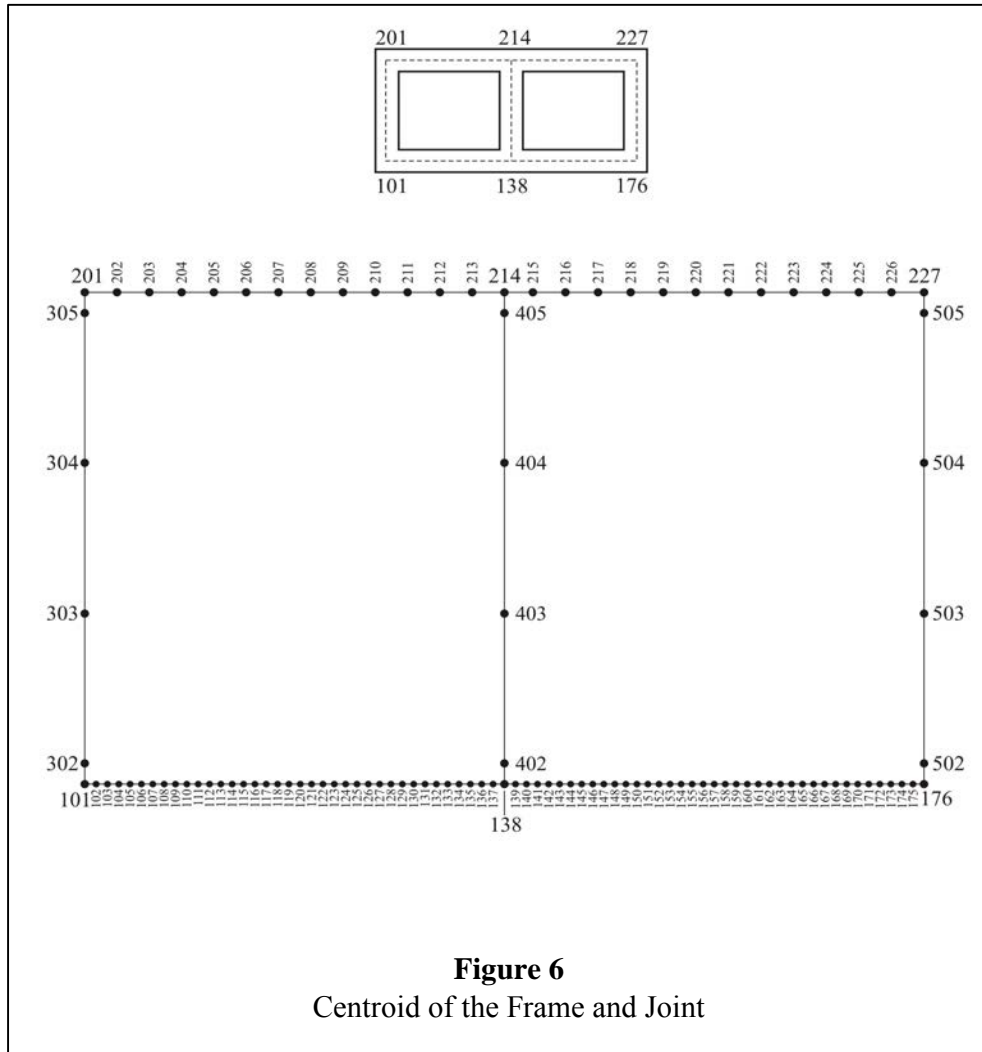

Joints 302, 402, and 502 at the base of the exterior walls and joints 305, 405, and 505 at the top of the exterior walls are included to determine shear at the face of the top and bottom slabs.

## 6. Application of Lateral Loads (EH)

Lateral pressures EH<sub>1</sub> through EH<sub>4</sub> from Section 3.3 are applied to the members of the model as shown below. See Figure 7 for the horizontal earth pressure and hydrostatic pressure load distributions.

### 6.1 Exterior Wall Loads Due to Horizontal Earth Pressure EH<sub>3</sub>

Calculate pressure at top of wall:

$$k_o(\gamma_s \times n_s + \gamma_{sat} \times n_{sat}) = 0.5 \left( \frac{130}{1000} \cdot 5 + \frac{67.6}{1000} \cdot 5 \right) = 0.494 \text{ ksf}$$

Pressure at base of wall = 1.314 ksf (see calculation in Sec. 3.3)

Calculate interval increment for loading all exterior wall members:

$$\Delta = \frac{(1.31 - 0.49)}{5} = 0.164 \text{ ksf}$$

The two tables below show the lateral earth pressure values (ksf) at the beginning and end of each member of the exterior walls:

| Member | start | end  |
|--------|-------|------|
| 301    | 1.31  | 1.15 |
| 302    | 1.15  | 0.99 |
| 303    | 0.99  | 0.82 |
| 304    | 0.82  | 0.66 |
| 305    | 0.66  | 0.49 |

| Member | start | end   |
|--------|-------|-------|
| 501    | -1.31 | -1.15 |
| 502    | -1.15 | -0.99 |
| 503    | -0.99 | -0.82 |
| 504    | -0.82 | -0.66 |
| 505    | -0.66 | -0.49 |

## 6.2 Exterior Wall Loads Due to Hydrostatic Pressure EH<sub>4</sub>

Calculate pressure at top of wall:

$$k_w(\gamma_w \times n_w) = 1 \left( \frac{62.4}{1000} \cdot 5 \right) = 0.312 \text{ ksf}$$

Pressure at base of wall = 1.825 ksf (see calcs. in Sec. 3.3)

Calculate interval increment for loading all exterior wall members:

$$\Delta = \frac{(1.83 - 0.31)}{5} = 0.303 \text{ ksf}$$

The two tables below show the lateral hydrostatic pressure values (ksf) at the beginning and end of each member of the exterior walls:

| Member | start | end  |
|--------|-------|------|
| 301    | 1.83  | 1.52 |
| 302    | 1.52  | 1.22 |
| 303    | 1.22  | 0.92 |
| 304    | 0.92  | 0.61 |
| 305    | 0.61  | 0.31 |

| Member | start | end   |
|--------|-------|-------|
| 501    | -1.83 | -1.52 |
| 502    | -1.52 | -1.22 |
| 503    | -1.22 | -0.92 |
| 504    | -0.92 | -0.61 |
| 505    | -0.61 | -0.31 |

Figure 7 shows the load distribution along the exterior walls (members 301 to 305 and 501 to 505) for horizontal earth pressure (EH<sub>3</sub>) and hydrostatic pressure (EH<sub>4</sub>).

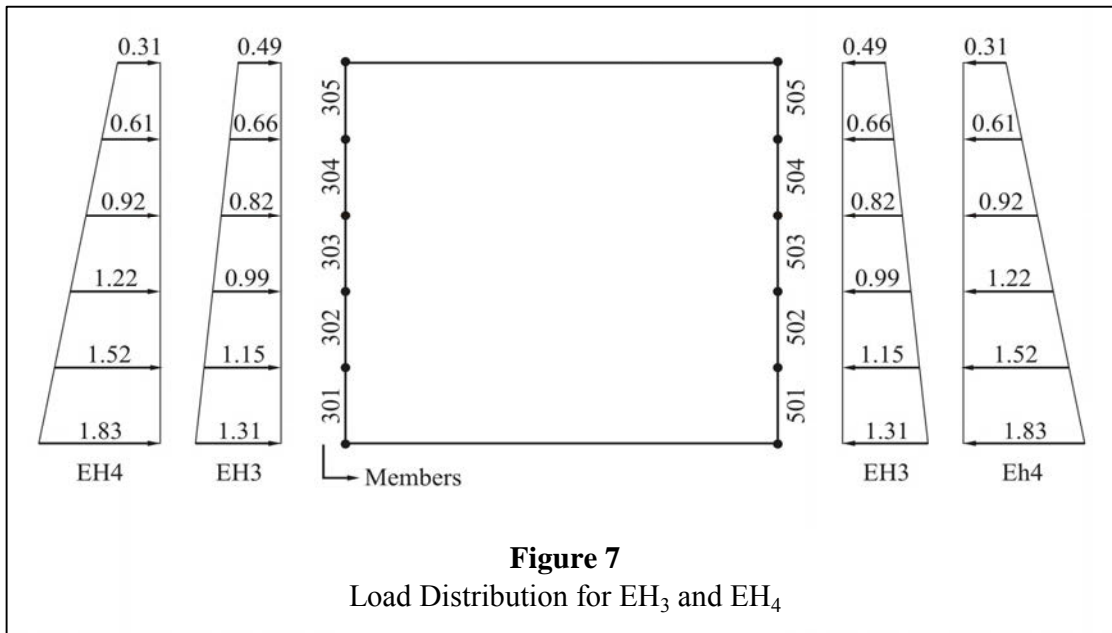

## 7. Structural Design Calculations - General Information

### 7.1 Concrete Design Properties

|  |           |
|--|-----------|
| Modulus of elasticity of steel, $E_s =$        | 29000 ksi |
| Yield strength of steel reinforcement, $f_y =$ | 60 ksi    |
| Compressive strength of concrete, $f'_c =$     | 4 ksi     |

### 7.2 Resistance Factors

Resistance factors for the strength limit state using conventional concrete construction are referenced from AASHTO LRFD Section 5.5.4.2.

|                      |      |   |
|----------------------|------|---|
| Flexure $\Phi =$     | 0.90 | ( $\Phi$ ) varies from 0.75 to 0.9 (0.75 is conservative) |
| Shear $\Phi =$       | 0.90 |   |
| Compression $\Phi =$ | 0.7  | since no spirals or ties                                  |

## 8. Interior Wall Design

### 8.1 Factored Axial Resistance (S5.7.4.4)

For members with tie reinforcement using LRFD eq. (5.7.4.4-3):

$$P_n = 0.80 [0.85 \times f'_c \times (A_g - A_{st}) + f_y \times A_{st}]$$

Where:

$$A_{st} = 1.76 \text{ in}^2 \quad (\#6 \text{ at } 6", \text{ ea. face})$$

$$A_g = 144.00 \text{ in}^2$$

Where  $A_g = 12 \cdot 12 \text{ in}^2$  (assuming wall thickness = 1 foot)

$$P_n = 471.37 \text{ kip}$$

Factored axial resistance of reinforced concrete using LRFD eq. (5.7.4.4-1):

$$P_r = \Phi P_n \quad \Phi = 0.9 \quad \text{for flexure}$$

Where:

$P_r$  = factored axial resistance

$P_n$  = nominal axial resistance

$P_u$  = factored applied axial force

$$P_r = 424.24 \text{ kip}$$

Check  $P_u < P_r$

$$P_u = \text{from computer model output} = 78.00 \text{ kip} < P_r \quad \mathbf{OK}$$

## 9. Top Slab Design

### 9.1 Slenderness Check (S5.7.4.3)

$$\begin{array}{llll}
 K = & 0.65 & & \beta_1 = 0.85 \\
 l_u = & 37.25 \text{ ft} & = & 447 \text{ in} & & d_s = 27.75 \text{ in} \\
 d = & 2.50 \text{ ft} & = & 30.0 \text{ in} & & d'_s = 3.25 \text{ in} \\
 I = & (12 \times 30^3) / 12 & = & 27000 \text{ in}^4 & \#9 \text{ bar dia.} = & 1.13 \text{ in} \\
 r = & \sqrt{\frac{I}{12} \cdot d} & = & 8.66 \text{ in} & & 
 \end{array}$$

$$k \times (l_u / r) = 33.55$$

$$34 - 12 \left( \frac{M_1}{M_2} \right) = 30.38$$

Where  $M_1$  and  $M_2$  are smaller and larger end moments

From analysis output

$$\text{where } M_1 = 77 \text{ kip-ft} \quad P_1 = 28.4 \text{ kip}$$

$$M_2 = 255 \text{ kip-ft} \quad P_2 = 28.4 \text{ kip}$$

Consider slenderness since  $k \times (l_u / r)$  is greater than  $34 - 12 \left( \frac{M_1}{M_2} \right)$



Calculate EI using LRFD eq. (5.7.4.3-1 and 5.7.4.3-2):

$$E_c = 33000 \times \gamma_c^{1.5} \times f_c'^{0.5}$$

$$E_c = 3834.25 \text{ ksi}$$

$$I_g = 27000 \text{ in}^4$$

$$c = 12.5 \text{ in}$$

$$I_s = 2 \left( \pi \cdot \frac{\text{dia}^4}{64} + A_s \cdot c^2 \right)$$

$$I_s = 625.16 \text{ in}^4$$

$$EI = \frac{(E_c \cdot \frac{I_g}{5} + E_s \cdot I_s)}{(1 + \beta_d)}$$

$$EI = 21069824.4 \text{ kip-in}^2$$

$$EI = \frac{\left( E_c \cdot \frac{I_g}{2.5} \right)}{(1 + \beta_d)}$$

$$EI = 22467094 \text{ kip-in}^2$$

$$M_{no} = 215.00 \text{ kip-ft}$$

$$M_2 = 255.00 \text{ kip-ft}$$

Note:  $M_{no}$  does not include effects of vertical live load surcharge

$$\beta_d = \frac{M_{no}}{M_2} = 0.84$$

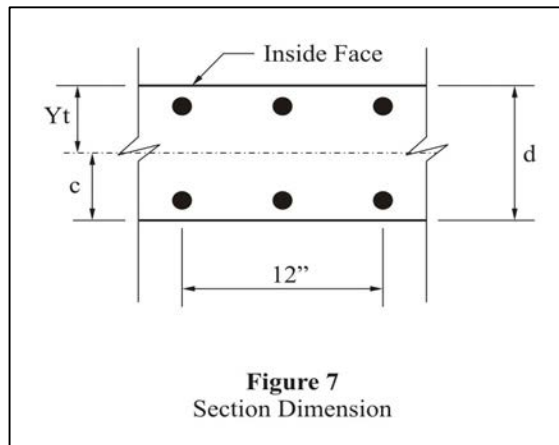

Approximate Method (LRFD 4.5.3.2.2)

The effects of deflection on force effects on beam-columns and arches which meet the provisions of the LRFD specifications may be approximated by the Moment Magnification method described below.

For steel/concrete composite columns, the Euler buckling load,  $P_e$ , shall be determined as specified in article 6.9.5.1 of LRFD. For all other cases,  $P_e$  shall be taken as:

$$P_e = \frac{\pi^2 \cdot EI}{(k \cdot l_u)^2} \quad (\text{LRFD eq. 4.5.3.2.2b-5})$$

Where:

E = modulus of elasticity (ksi)

I = moment of inertia about axis under consideration ( $\text{in}^4$ )

k = effective length factor as specified in LRFD 4.6.2.5

$l_u$  = unsupported length of a compression member (in)

$$P_e = \quad 2626.67 \quad \text{kips}$$

Moment Magnification (LRFD 4.5.3.2.2b)

(The components for sidesway will be neglected. Bracing moment will not include lateral force influence. Live load surcharge is excluded also.)

The factored moments may be increased to reflect effects of deformations as follows:

LRFD eq. (4.5.3.2.2b-1):

$$M_c = \delta_b \times M_{2b} + \delta_s \times M_{2s} \qquad M_u = 215.00 \text{ kip-ft}$$
$$M_{uLAT} = -35.08 \text{ kip-ft}$$

Where:

$$\delta_b = \frac{C_m}{\left(1 - \frac{P_u}{\phi P_e}\right)} \geq 1 \qquad \text{LRFD eq. (4.5.3.2.2b-3)}$$

Where:

For members braced against sidesway and without transverse loads between supports,  $C_m$ :

$$C_m = 0.6 + 0.4 \left( \frac{M_1}{M_2} \right) \qquad \text{LRFD eq. (4.5.3.2.2b-6)}$$
$$C_m = 0.72$$

Where:

$M_1$  = smaller end moment

$M_2$  = larger end moment

$P_u$  = factored axial load (kip) = 28.4 kips

$\phi$  = resistance factor for axial compression

$P_e$  = Euler buckling load (kip)

$$\delta_b = 1$$

$M_{2b}$  = moment on compression member due to factored gravity loads that result in no appreciable sidesway calculated by conventional first-order elastic frame analysis; always positive (kip-ft)

$$M_{2b} = 179.92 \text{ kip-ft}$$

$$M_c = 179.92 \text{ kip-ft}$$

Factored flexural resistance (LRFD 5.7.3.2.1)

The factored resistance  $M_r$  shall be taken as:

$$M_r = \Phi M_n$$

Where:

$\Phi$  = resistance factor = 0.9

$M_n$  = nominal resistance (kip-in)

The nominal flexural resistance may be taken as:

$$M_n = A_s \cdot f_y \cdot \left( d_s - \frac{a}{2} \right) - A'_s \cdot f'_y \cdot \left( d'_s - \frac{a}{2} \right) \quad (\text{LRFD eq. 5.7.3.2.2-1})$$

Do not consider compression steel for calculating  $M_n$ .

Where:

$A_s$  = area of nonprestressed tension reinforcement ( $\text{in}^2$ )

$f_y$  = specified yield strength of reinforcing bars (ksi)

$d_s$  = distance from extreme compression fiber to centroid of nonprestressed tensile reinforcement ( $\text{in}^2$ )

$a$  = depth of equivalent stress block ( $\text{in}$ ) =  $\beta_1 \times c$

Where:

$\beta_1$  = stress block factor specified in Section 5.7.2.2 of LRFD

$c$  = distance from the extreme compression fiber to the neutral axis

$$c = \frac{(A_s \cdot f_y)}{0.85 \cdot f'_c \cdot \beta_1 \cdot b} \quad \text{LRFD eq. (5.7.3.1.2-4)}$$

Where:

$$A_s = 2.0 \text{ in}^2$$

$$f_y = 60.0 \text{ ksi}$$

$$f'_c = 4.0 \text{ ksi}$$

$$\beta_1 = 0.85$$

$$b = 12.0 \text{ in}$$

$$c = 3.46 \text{ in}$$

$$a = 2.94 \text{ in}$$

$$M_n = 3153.53 \text{ kip-in} = 262.79 \text{ kip-ft}$$

$$\Phi M_n = 236.51 \text{ kip-ft} \quad \text{OK } (\geq M_c)$$

$$M_r = 236.51 \text{ kip-ft} \quad M_r > M_u$$

Create interaction diagram

$$\begin{aligned} \text{Assume } \rho_{\min} &= 1.0\% \\ A_{s\min} &= 3.6 \text{ in}^2 \\ \\ A_{s\text{prov}} (\text{total}) &= 4.00 \text{ in}^2 && \text{choose \#9 at 6"} \\ E_s &= 29000 \text{ ksi} \\ \beta_1 &= 0.85 \\ Y_t &= 15 \text{ in} \\ 0.85 \times f'_c &= 3.4 \text{ ksi} \\ A_g \text{ in}^2 &= 360 \text{ in}^2 \\ A_s = A'_s &= 2.0 \text{ in}^2 \end{aligned}$$

At zero moment point using LRFD eq. (5.7.4.5-2)

$$\begin{aligned} \Phi &= 0.7 \\ P_o &= 0.85 \times f'_c \times (A_g - A_{st}) + A_{st} \times f_y = 1450 \text{ kip} \\ \Phi P_o &= 1015 \text{ kip} \end{aligned}$$

At balance point calculate  $P_{rb}$  and  $M_{rb}$

$$\begin{aligned} c_b &= 16.65 \text{ in} \\ a_b &= \beta_1 \times c_b = 14.15 \text{ in} \\ f'_s &= E_s \left[ \left( \frac{0.003}{c} \right) \cdot (c - d') \right] = 70 \text{ ksi} \\ & f'_s > f_y; \text{ set } f'_s = f_y \\ \\ A_{\text{comp}} &= c \times b = 199.8 \text{ in}^2 \\ y' &= a / 2 = 7.07625 \text{ in} \\ \Phi P_b &= \Phi [0.85 \times f'_c \times b \times a_b + A'_s \times f'_s - A_s \times f_y] = 485 \text{ kip} \\ \Phi M_b &= 7442 \text{ kip-in} = 620 \text{ kip-ft} \end{aligned}$$

At zero 'axial load' point (conservatively ignore compressive reinforcing)

$$\begin{aligned} a &= \frac{A_s \cdot f_y}{(0.85 \cdot f'_c \cdot b)} = 2.9 \text{ in} \\ \Phi M_o &= 2838.2 \text{ kip-in} = 237 \text{ kip-ft} \end{aligned}$$

At intermediate points

| a, in | c = a/b <sub>1</sub> | A <sub>comp</sub> , in <sup>2</sup> | f' <sub>s</sub> , ksi | f <sub>s</sub> , ksi | f <sub>y</sub> , ksi | ΦM <sub>n</sub> , k-ft | ΦP <sub>n</sub> , kips |
|-------|----------------------|-------------------------------------|-----------------------|----------------------|----------------------|------------------------|------------------------|
|       |                      |                                     |                       |                      |                      | 237                    | 0                      |
| 2.9   | 3.4                  | 34.8                                | 36                    | 657                  | 60                   | 292                    | 30                     |
| 3     | 3.5                  | 36                                  | 38                    | 635                  | 60                   | 298                    | 36                     |
| 4     | 4.7                  | 48                                  | 50                    | 476                  | 60                   | 355                    | 90                     |
| 5     | 5.9                  | 60                                  | 57                    | 381                  | 60                   | 401                    | 133                    |
| 6     | 7.1                  | 72                                  | 62                    | 317                  | 60                   | 435                    | 167                    |
| 7     | 8.2                  | 84                                  | 66                    | 272                  | 60                   | 461                    | 195                    |
| 8     | 9.4                  | 96                                  | 69                    | 238                  | 60                   | 484                    | 224                    |
| 10    | 11.8                 | 120                                 | 72                    | 190                  | 60                   | 521                    | 281                    |
| 12    | 14.1                 | 144                                 | 75                    | 159                  | 60                   | 546                    | 338                    |
| 15    | 17.6                 | 180                                 | 77                    | 127                  | 60                   | 561                    | 424                    |
| 18    | 21.2                 | 216                                 | 79                    | 106                  | 60                   | 548                    | 509                    |
| 19    | 22.4                 | 228                                 | 79                    | 100                  | 60                   | 537                    | 538                    |
| 21    | 24.7                 | 252                                 | 80                    | 91                   | 60                   | 507                    | 595                    |
| 23    | 27.1                 | 276                                 | 81                    | 83                   | 60                   | 465                    | 652                    |
| 25    | 29.4                 | 300                                 | 81                    | 76                   | 60                   | 410                    | 709                    |
|       |                      |                                     |                       |                      |                      | 0                      | 1015                   |
|       |                      |                                     |                       |                      | End 1                | 77                     | 28                     |
|       |                      |                                     |                       |                      | End 2                | 255                    | 28                     |

Note Φ may decrease from 0.90 to 0.75 as a increases from 0.0 to ab. Use 0.75 to be conservative.

Where:

$$A_{comp} = a \times 12 \quad \text{in}^2$$

$$f'_s = E_s \cdot \left( \frac{0.003}{c} \right) \cdot (c - A'_s) \quad \text{ksi}$$

$$f_s = E_s \cdot \left( \frac{0.003}{c} \right) \cdot (c - A_s) \quad \text{ksi}$$

$$\Phi M_n = \frac{\phi \left[ (A_{comp} - A'_s) \cdot \left( y_t - \frac{a}{2} \right) \cdot 0.85 \cdot f'_c + A_s \cdot f_y (d - y_t) + A'_s \cdot f'_s (y_t - d') \right]}{12} \quad \text{k-ft}$$

$$\Phi P_n = \Phi (A_{comp} - A'_s) \times 0.85 \times f'_c + A'_s \times f'_s - A_s \times f_y \quad \text{kips}$$

### Interaction Diagram

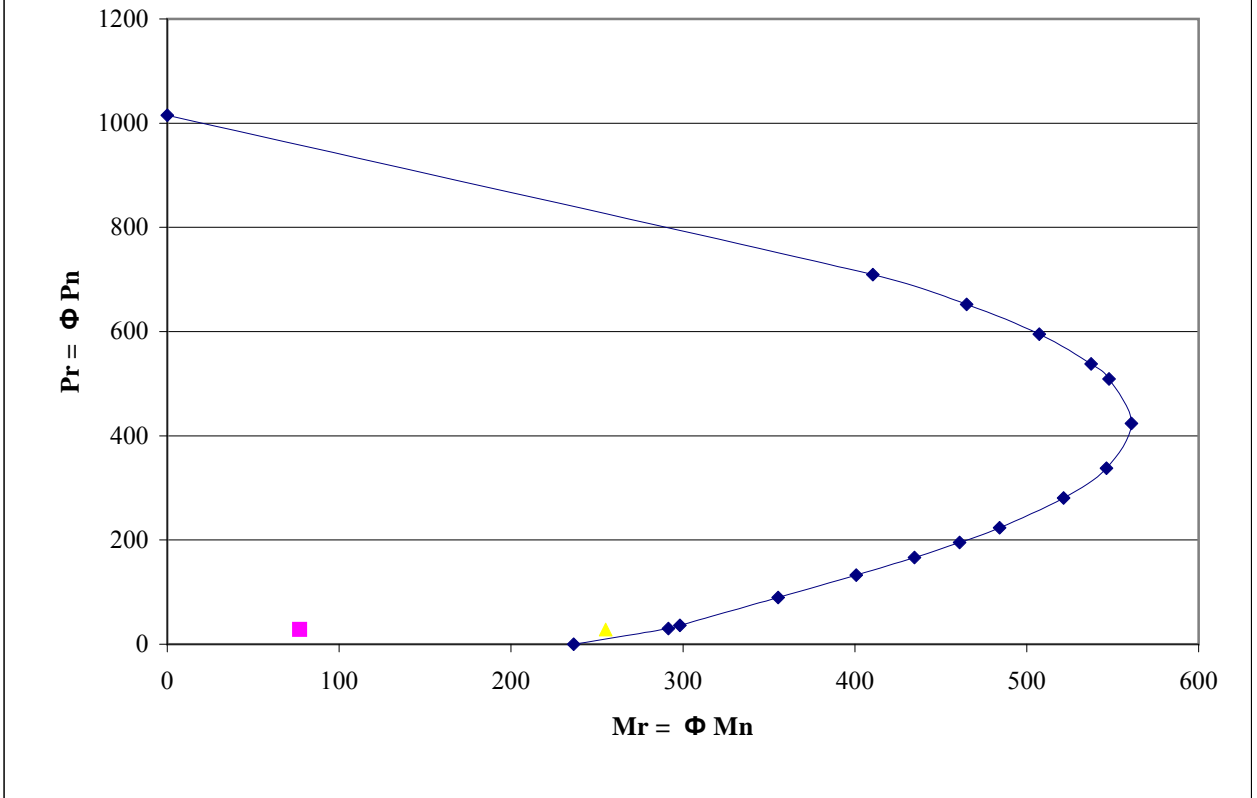

## 9.2 Shear Design (S5.8.3.3)

The nominal shear resistance,  $V_n$  shall be determined as the lesser of

LRFD eq. 5.8.3.3-1:

$$V_n = V_c + V_s$$

or

LRFD eq. 5.8.3.3-2:

$$V_n = 0.25 \times f'_c \times b_v \times d_v$$

Note  $V_p$  is not considered

Where:

$$V_c = \left( 0.0676\sqrt{f'_c} + 4.6 \frac{A_s}{bd_e} \frac{V_u d_e}{M_u} \right) bd_e \leq 0.126 \cdot \sqrt{f'_c} bd_e \quad \text{LRFD eq. (5.14.5.3-1)}$$

$$\text{Where } \frac{V_u \cdot d_e}{M_u} \leq 1.0$$

For slab concrete shear ( $V_c$ ), refer to LRFD Section 5.14.5.

$$V_s = \frac{A_v f_y d_v (\cot \theta + \cot \alpha) \cdot \sin \alpha}{s} \quad \text{LRFD eq. (5.8.3.3-4)}$$

$$\text{Where for } \alpha = 90^\circ \text{ and } \theta = 45^\circ \quad V_s = \frac{A_v \cdot f_y \cdot d_v}{s}$$

Where:

$A_s$  = area of reinforcing steel in the design width (in<sup>2</sup>)

$b$  = design width (in)

$d_e$  = effective depth from extreme compression fiber to centroid of tensile force in tensile reinforcement (in)

$$d_e = 27.75$$

$V_u$  = shear from factored loads (kip)

$M_u$  = moment from factored loads (kip-in)

$A_v$  = area of shear reinforcement within a distance  $s$  (in<sup>2</sup>) = 0 in<sup>2</sup>

$s$  = spacing of stirrups (in) = 12 in

$b_v$  = effective web width taken as the minimum web width within the depth  $d_v$  (in)

$d_v$  = effective shear depth taken as the perpendicular distance to the neutral axis (in)

$$d_v = 0.9 \times d_e \text{ or } 0.72 \times h \quad (\text{LRFD section 5.8.2.9})$$

$$d_v = 24.98 \text{ in}$$

$$\frac{V_u \cdot d_e}{M_u} = 12.33 \quad \text{Use } \frac{V_u \cdot d_e}{M_u} = 1.00$$



Maximum shear and associated moment from analysis output:

$$\begin{aligned}V_u &= 28 \text{ kip} & M_u &= 63.0 \text{ kip-ft} \\V_c &= 63.42 \text{ kip} & & \text{value controls} \\ \text{or } V_c &= 83.92 \text{ kip} \\V_s &= 0.00 \text{ kip} \\V_n &= 63.42 \text{ kip} \\V_n &= 299.70 \text{ kip} & \text{therefore } V_n &= 63.42 \text{ kip} \\ \Phi &= 0.90 \\ \Phi V_n &= 57.08 \text{ kip} & & > V_u \text{ OK}\end{aligned}$$

## 10. Bottom Slab Design

### 10.1 Slenderness Check (S5.7.4.3)

|                  |                      |         |                   |          |
|------------------|----------------------|---------|-------------------|----------|
| K =              | 0.65                 |         | β <sub>1</sub> =  | 0.85     |
| l <sub>u</sub> = | 37.25 ft =           | 447 in  | d <sub>s</sub> =  | 18.75 in |
| d =              | 1.75 ft =            | 21.0 in | d' <sub>s</sub> = | 3.25 in  |
| I =              | 9261 in <sup>4</sup> |         | #8 bar dia. =     | 1.00 in  |
| r =              | 6.06 in              |         |                   |          |

$$k \times (l_u / r) = 47.93$$

From analysis output

|                        |             |                  |          |
|------------------------|-------------|------------------|----------|
| where M <sub>1</sub> = | 13 kip-ft   | P <sub>1</sub> = | 23.6 kip |
| M <sub>2</sub> =       | 57.1 kip-ft | P <sub>2</sub> = | 23.6 kip |

$$34 - 12 \left( \frac{M_1}{M_2} \right) = 31.27$$

Consider slenderness since  $k \times (l_u / r)$  is greater than  $34 - 12 \left( \frac{M_1}{M_2} \right)$

Calculate EI:

|                   |                        |      |                                |
|-------------------|------------------------|------|--------------------------------|
| E <sub>c</sub> =  | 3834.25 ksi            |      |                                |
| I <sub>g</sub> =  | 9261 in <sup>4</sup>   |      |                                |
| c =               | 8 in                   | EI = | 3427836.25 kip-in <sup>2</sup> |
| I <sub>s</sub> =  | 202.34 in <sup>4</sup> | EI = | 6855672.51 kip-in <sup>2</sup> |
| M <sub>no</sub> = | 61.20 kip-ft           |      |                                |
| M <sub>2</sub> =  | 57.10 kip-ft           |      |                                |

Note: M<sub>no</sub> does not include effects of vertical live load surcharge

$$\beta_d = \frac{M_{no}}{M_2} = 1.07$$

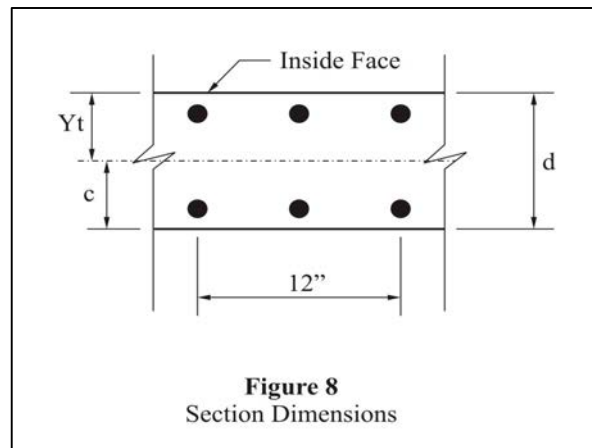

Approximate Method (LRFD 4.5.3.2.2)

$$P_e = \frac{\pi^2 \cdot EI}{(k \cdot l_u)^2}$$
$$P_e = 801.51 \text{ kip}$$

Moment Magnification

(The components for sidesway will be neglected. Bracing moment will not include lateral force influence. Live load surcharge is excluded also.)

$$C_m = 0.6 + 0.4 \left( \frac{M_1}{M_2} \right) = 0.69$$

$$P_u = 23.6 \text{ kip}$$

$$\delta_b = 1.00$$

$$M_c = \delta_b \times M_{2b} + \delta_s \times M_{2s}$$

$$M_u = 61.20 \text{ kip-ft}$$

$$M_{uLAT} = -32.88 \text{ kip-ft}$$

$$M_c = 28.32 \text{ kip-ft}$$

$$\text{where } M_{2b} = 28.32 \text{ kip-ft}$$

Factored flexural resistance

Do not consider compression steel for calculating  $M_n$ .

$$c = 2.73 \text{ in}$$

$$a = 2.32 \text{ in}$$

$$M_n = 1667.36 \text{ kip-in} = 138.95 \text{ kip-ft}$$

$$M_r = \Phi M_n = 125.05 \text{ kip-ft} \quad \text{OK } (\geq M_c) \quad M_r > M_u$$

Create interaction diagram

$$\begin{aligned} \text{Assume } \rho_{\min} &= 1.0\% \\ A_{s\min} &= 2.52 \text{ in}^2 \end{aligned}$$

$$\begin{aligned} A_{s\text{prov}} (\text{total}) &= 3.16 \text{ in}^2 && \text{choose \#8 at 6"} \\ E_s &= 29000 \text{ ksi} \\ \beta_1 &= 0.85 \\ Y_t &= 10.5 \text{ in} \\ 0.85 \times f'_c &= 3.4 \text{ ksi} \\ A_{g'} \text{ in}^2 &= 252 \text{ in}^2 \\ A_s = A'_s &= 1.6 \text{ in}^2 \end{aligned}$$

At zero moment point

$$\begin{aligned} P_o &= 1036 \text{ kip} \\ \Phi P_o &= 725 \text{ kip} \end{aligned}$$

At balance point calculate  $P_{rb}$  and  $M_{rb}$

$$\begin{aligned} c_b &= 11.25 \text{ in} \\ a_b &= 9.56 \text{ in} \\ f'_s &= 62 \text{ ksi} \\ f'_s &> f_y; \text{ set } f'_s = f_y \end{aligned}$$

$$\begin{aligned} A_{\text{comp}} &= 114.75 \text{ in}^2 \\ y' &= 4.78125 \text{ in} \\ \Phi P_b &= 271 \text{ kip} \\ \Phi M_b &= 3303 \text{ kip-in} = 275 \text{ kip-ft} \end{aligned}$$

At zero 'axial load' point (conservatively ignore compressive reinforcing)

$$\begin{aligned} a &= 2.3 \text{ in} \\ \Phi M_o &= 1500.6 \text{ kip-in} = 125 \text{ kip-ft} \end{aligned}$$

At intermediate points

| a, in | c = a/b <sub>1</sub> | A <sub>comp</sub> , in <sup>2</sup> | f' <sub>s</sub> ,ksi | f <sub>s</sub> ,ksi | f <sub>y</sub> , ksi | ΦM <sub>n</sub> , k-ft | ΦP <sub>n</sub> , kips |
|-------|----------------------|-------------------------------------|----------------------|---------------------|----------------------|------------------------|------------------------|
|       |                      |                                     |                      |                     |                      | 125                    | 0                      |
| 2.3   | 2.7                  | 27.6                                | 36                   | 552                 | 60                   | 118                    | 24                     |
| 3     | 3.5                  | 36                                  | 48                   | 423                 | 60                   | 139                    | 63                     |
| 4     | 4.7                  | 48                                  | 58                   | 317                 | 60                   | 162                    | 107                    |
| 5     | 5.9                  | 60                                  | 64                   | 254                 | 60                   | 178                    | 139                    |
| 6     | 7.1                  | 72                                  | 68                   | 212                 | 60                   | 190                    | 168                    |
| 7     | 8.2                  | 84                                  | 70                   | 181                 | 60                   | 200                    | 196                    |
| 8     | 9.4                  | 96                                  | 72                   | 159                 | 60                   | 207                    | 225                    |
| 9     | 10.6                 | 108                                 | 74                   | 141                 | 60                   | 212                    | 253                    |
| 10    | 11.8                 | 120                                 | 75                   | 127                 | 60                   | 215                    | 282                    |
| 11    | 12.9                 | 132                                 | 76                   | 115                 | 60                   | 215                    | 310                    |
| 12    | 14.1                 | 144                                 | 77                   | 106                 | 60                   | 213                    | 339                    |
| 13    | 15.3                 | 156                                 | 78                   | 98                  | 60                   | 208                    | 368                    |
| 14    | 16.5                 | 168                                 | 79                   | 91                  | 60                   | 201                    | 396                    |
| 15    | 17.6                 | 180                                 | 79                   | 85                  | 60                   | 192                    | 425                    |
| 16    | 18.8                 | 192                                 | 80                   | 79                  | 60                   | 180                    | 453                    |
|       |                      |                                     |                      |                     |                      | 0                      | 725                    |
|       |                      |                                     |                      |                     | End 1                | 13                     | 24                     |
|       |                      |                                     |                      |                     | End 2                | 57                     | 24                     |

Note Φ may decrease from 0.90 to 0.75 as a increases from 0.0 to ab. Use 0.75 to be conservative.

**Interaction Diagram**

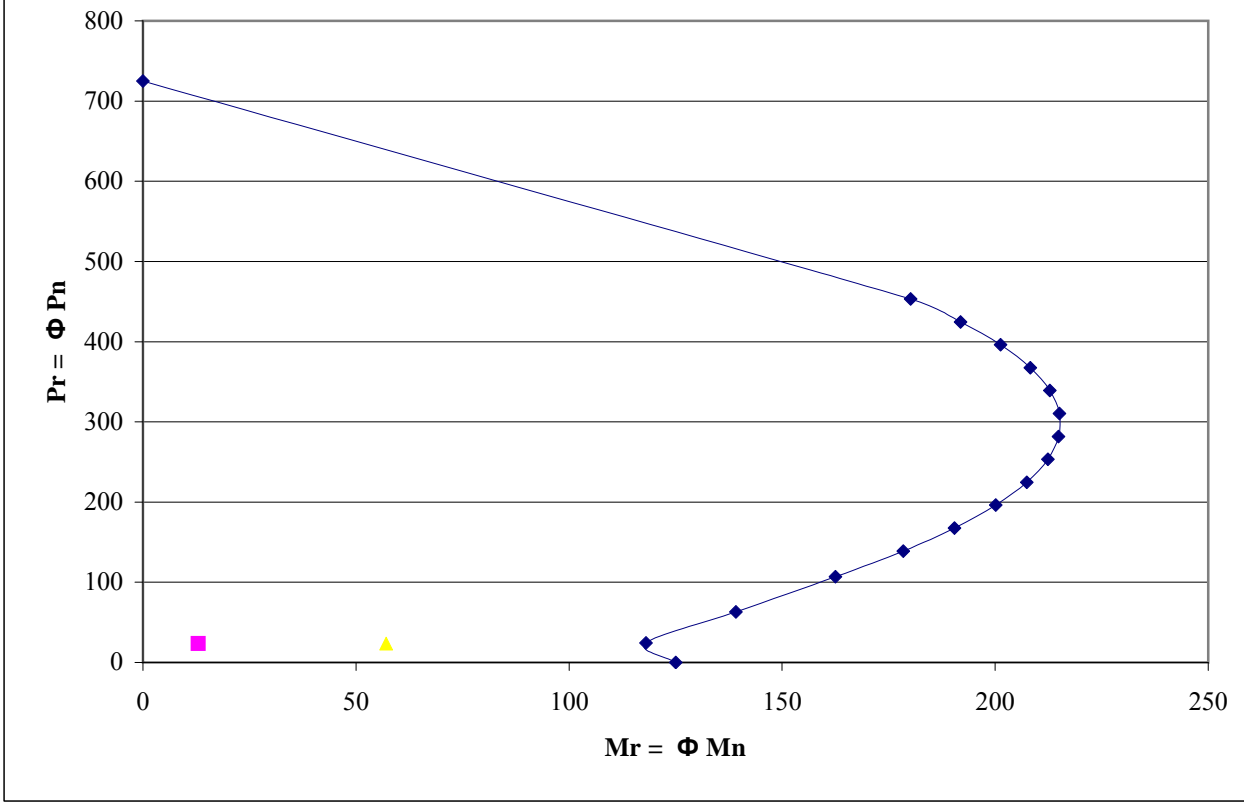

### 10.2 Shear Design (S5.8.3.3)

$$V_n = V_c + V_s \quad \text{or} \quad V_n = 0.25 \times f'_c \times b_v \times d_v$$

$$d_v = 16.88 \quad \text{in}$$

For slab concrete shear ( $V_c$ ), see LRFD Section 5.14.5

$$\frac{V_u \cdot d_e}{M_u} = 12.00 \quad \text{Use} \quad \frac{V_u \cdot d_e}{M_u} = 1.00$$

Maximum shear and associated moment from analysis output:

$$V_u = 19.4 \text{ kip} \quad M_u = 30.3 \text{ kip-ft}$$

$$V_c = 44.96 \text{ kip} \quad \text{value controls}$$

$$\text{or } V_c = 56.70 \text{ kip}$$

$$\text{Where } A_v = 0 \text{ in}^2 \text{ and } s = 12 \text{ in}$$

$$V_s = 0.00 \text{ kip}$$

$$V_n = 44.96 \text{ kip}$$

$$V_n = 202.50 \text{ kip} \quad \text{therefore } V_n = 44.96 \text{ kip}$$

$$\Phi V_n = 40.46 \text{ kip} > V_u \text{ OK}$$

# 11. Exterior Wall Design

## 11.1 Slenderness Check (LRFD 5.7.4.3)

|                  |                       |   |               |                   |          |
|------------------|-----------------------|---|---------------|-------------------|----------|
| K =              | 0.65                  |   | $\beta_1 =$   | 0.85              |          |
| l <sub>u</sub> = | 22.13 ft              | = | 265.5 in      | d <sub>s</sub> =  | 21.75 in |
| d =              | 2.00 ft               | = | 24.0 in       | d' <sub>s</sub> = | 3.25 in  |
| I =              | 13824 in <sup>4</sup> |   | #8 bar dia. = | 1.00 in           |          |
| r =              | 6.93 in               |   |               |                   |          |

$k \times (l_u / r) = 24.91$

From analysis output

|                        |              |                  |          |
|------------------------|--------------|------------------|----------|
| where M <sub>1</sub> = | 171.4 kip-ft | P <sub>1</sub> = | 34.4 kip |
| M <sub>2</sub> =       | 137.2 kip-ft | P <sub>2</sub> = | 34.4 kip |

$34 - 12 \left( \frac{M_1}{M_2} \right) = 19.01$

Consider slenderness since  $k \times (l_u / r)$  is greater than  $34 - 12 \left( \frac{M_1}{M_2} \right)$

Calculate EI:

|                   |                        |      |                                |
|-------------------|------------------------|------|--------------------------------|
| E <sub>c</sub> =  | 3834.25 ksi            |      |                                |
| I <sub>g</sub> =  | 13824 in <sup>4</sup>  |      |                                |
| c =               | 9.5 in                 | EI = | 7330894.82 kip-in <sup>2</sup> |
| I <sub>s</sub> =  | 285.29 in <sup>4</sup> | EI = | 14661789.6 kip-in <sup>2</sup> |
| M <sub>no</sub> = | 61.20 kip-ft           |      |                                |
| M <sub>2</sub> =  | 137.20 kip-ft          |      |                                |

Note: M<sub>no</sub> does not include effects of vertical live load surcharge

$\beta_d = \frac{M_{no}}{M_2} = 0.45$

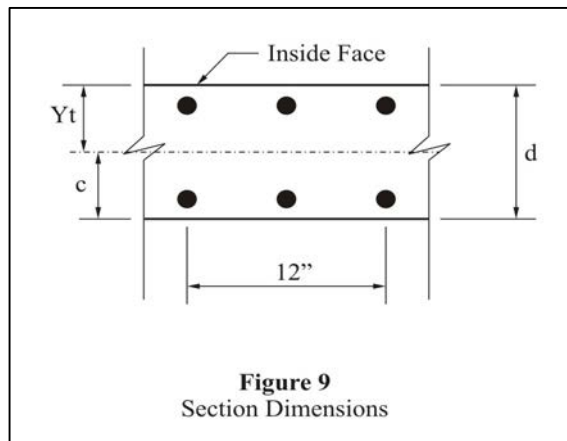

**Figure 9**  
Section Dimensions



Approximate Method (LRFD 4.5.3.2.2)

$$P_e = \frac{\pi^2 \cdot EI}{(k \cdot l_u)^2}$$

$$P_e = 4858.82 \text{ kip}$$

Moment Magnification

(The components for sidesway will be neglected. Bracing moment will not include lateral force influence. Live load surcharge is excluded also.)

$$C_m = 0.6 + 0.4 \left( \frac{M_1}{M_2} \right) = 1.10$$

$$P_u = 34.4 \text{ kip}$$

$$\delta_b = 1.11$$

$$M_c = \delta_b \times M_{2b} + \delta_s \times M_{2s}$$

$$M_u = 61.20 \text{ kip-ft}$$

$$M_{uLAT} = -26.50 \text{ kip-ft}$$

$$M_c = 38.46 \text{ kip-ft}$$

$$\text{where } M_{2b} = 34.70 \text{ kip-ft}$$

Factored flexural resistance

Do not consider compression steel for calculating  $M_n$ .

$$c = 2.73 \text{ in}$$

$$a = 2.32 \text{ in}$$

$$M_n = 1951.76 \text{ kip-in} = 162.65 \text{ kip-ft}$$

$$M_r = \Phi M_n = 146.38 \text{ kip-ft} \quad \text{OK } (\geq M_c) \quad M_r > M_u$$

Create interaction diagram

$$\begin{aligned} \text{Assume } \rho_{\min} &= 1.0\% \\ A_{s\min} &= 2.88 \text{ in}^2 \end{aligned}$$

$$\begin{aligned} A_{s\text{prov}} (\text{total}) &= 3.16 \text{ in}^2 && \text{choose \#8 at 6"} \\ E_s &= 29000 \text{ ksi} \\ \beta_1 &= 0.85 \\ Y_t &= 12 \text{ in} \\ 0.85 \times f'_c &= 3.4 \text{ ksi} \\ A_{g'} \text{ in}^2 &= 288 \text{ in}^2 \\ A_s = A'_s &= 1.6 \text{ in}^2 \end{aligned}$$

At zero moment point

$$\begin{aligned} P_o &= 1158 \text{ kip} \\ \Phi P_o &= 811 \text{ kip} \end{aligned}$$

At balance point calculate  $P_{rb}$  and  $M_{rb}$

$$\begin{aligned} c_b &= 13.05 \text{ in} \\ a_b &= 11.09 \text{ in} \\ f'_s &= 65 \text{ ksi} \\ f'_s &> f_y; \text{ set } f'_s = f_y \end{aligned}$$

$$\begin{aligned} A_{\text{comp}} &= 133.11 \text{ in}^2 \\ y' &= 5.54625 \text{ in} \\ \Phi P_b &= 313 \text{ kip} \\ \Phi M_b &= 4176 \text{ kip-in} = 348 \text{ kip-ft} \end{aligned}$$

At zero 'axial load' point (conservatively ignore compressive reinforcing)

$$\begin{aligned} a &= 2.3 \text{ in} \\ \Phi M_o &= 1756.6 \text{ kip-in} = 146 \text{ kip-ft} \end{aligned}$$

At intermediate points

| a, in | c = a/b <sub>1</sub> | A <sub>comp</sub> , in <sup>2</sup> | f <sub>s</sub> ,ksi | f <sub>s</sub> ,ksi | f <sub>y</sub> , ksi | ΦM <sub>n</sub> , k-ft | ΦP <sub>n</sub> , kips |    |
|-------|----------------------|-------------------------------------|---------------------|---------------------|----------------------|------------------------|------------------------|----|
|       |                      |                                     |                     |                     |                      | 146                    | 0                      |    |
| 2.3   | 2.7                  | 27.6                                | 36                  | 612                 | 60                   | 179                    | 24                     |    |
| 3     | 3.5                  | 36                                  | 48                  | 449                 | 60                   | 211                    | 63                     |    |
| 4     | 4.7                  | 48                                  | 58                  | 315                 | 60                   | 248                    | 107                    |    |
| 5     | 5.9                  | 60                                  | 64                  | 235                 | 60                   | 273                    | 139                    |    |
| 6     | 7.1                  | 72                                  | 68                  | 181                 | 60                   | 293                    | 168                    |    |
| 7     | 8.2                  | 84                                  | 70                  | 143                 | 60                   | 310                    | 196                    |    |
| 8     | 9.4                  | 96                                  | 72                  | 114                 | 60                   | 324                    | 225                    |    |
| 9     | 10.6                 | 108                                 | 74                  | 92                  | 60                   | 335                    | 253                    |    |
| 10    | 11.8                 | 120                                 | 75                  | 74                  | 60                   | 343                    | 282                    |    |
| 11    | 12.9                 | 132                                 | 76                  | 59                  | 60                   | 348                    | 310                    |    |
| 13    | 15.3                 | 156                                 | 78                  | 37                  | 60                   | 348                    | 368                    |    |
| 15    | 17.6                 | 180                                 | 79                  | 20                  | 60                   | 336                    | 425                    |    |
| 17    | 20.0                 | 204                                 | 80                  | 8                   | 60                   | 312                    | 482                    |    |
| 19    | 22.4                 | 228                                 | 81                  | -2                  | 60                   | 276                    | 539                    |    |
| 21    | 24.7                 | 252                                 | 81                  | -10                 | 60                   | 227                    | 596                    |    |
|       |                      |                                     |                     |                     |                      | 0                      | 811                    |    |
|       |                      |                                     |                     |                     |                      | Top of wall            | 171                    | 34 |
|       |                      |                                     |                     |                     |                      | Bot. of wall           | 137                    | 34 |

Note Φ may decrease from 0.90 to 0.75 as a increases from 0.0 to ab. Use 0.75 to be conservative.

Interaction Diagram

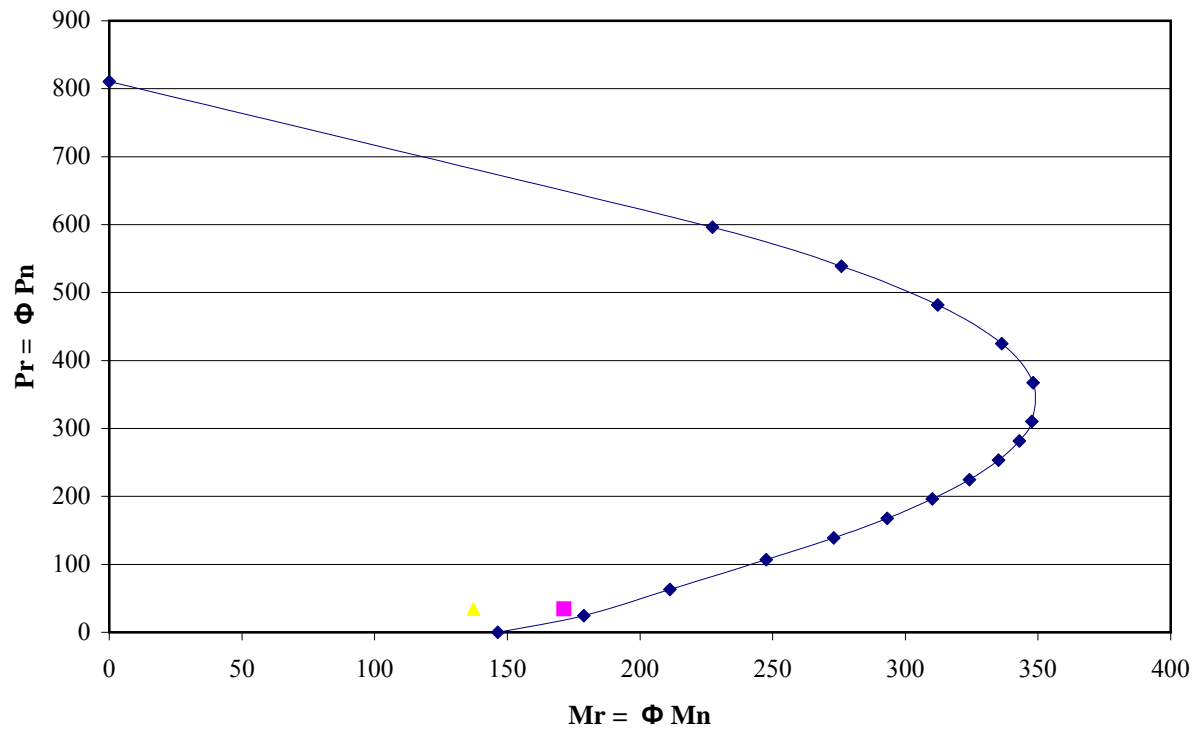

## 11.2 Shear Design (S5.8.3.3)

Maximum shear from analysis output:

$$V_u = 20.76 \text{ kip}$$

Where  $\beta = 2$

$$b_v = 12 \text{ in}$$

$$d_v = 19.58 \text{ in}$$

$$V_c = 0.0316 \times \beta \times f_c^{0.5} \times b_v \times d_v \quad \text{LRFD eq. (5.8.3.3-3)}$$

$$V_c = 29.69 \text{ kip}$$

Where  $A_v = 0 \text{ in}^2$  and  $s = 12 \text{ in}$

$$V_s = 0.00 \text{ kip}$$

$$V_n = 29.69 \text{ kip}$$

$$V_n = 234.90 \text{ kip} \quad \text{therefore } V_n = 29.69 \text{ kip}$$

$$\Phi V_n = 26.72 \text{ kip} > V_u \text{ OK}$$

This page is intentionally left blank.

# **Appendix D**

## **Tunnel Boring Machines**

This page is intentionally left blank.



## Appendix D – TUNNEL BORING MACHINES (TBM)

### D.1 Introduction

A Tunnel Boring Machine (TBM) is a complex system with a main body and other supporting elements to be made up of mechanisms for cutting, shoving, steering, gripping, shielding, exploratory drilling, ground control and support, lining erection, spoil (muck) removal, ventilation and power supply. Figure 6-11 shows a general classification of various types of tunnel boring machines for hard rock and soft ground.

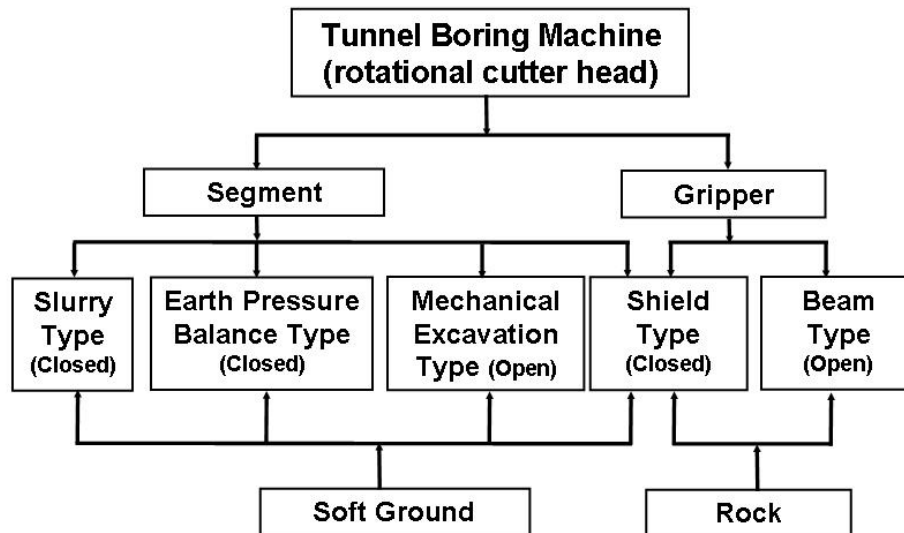

Figure D-1 Classification of Tunnel Boring Machines (Figure 6-11)

This Appendix is intended to demonstrate the components and excavation sequences of common types of tunnel boring machines (TBM) applicable for hard rock and soft ground conditions. The Principal Investigators appreciate Karin Bäßler and Michael Haßler of Herrenknecht AG (Herrenknecht), and Lok Home of The Robbins Company (Robbins) for generously providing excellent illustrations, and photographs and information for large-diameter TBM applications.

### D.2 Hard Rock TBM

As shown in Figure 6-11 above, tunnel boring machines (TBM) suitable for rock tunneling nowadays are full-face, rotational (types of cutter head) excavation machines and can be generally classified into two general categories: Gripper and Segment based on the machine reaction force. Three common types of hard rock TBMs are described hereafter:

- Open Gripper Main Beam TBM (Open Gripper Type)
- Single Shield TBM (Closed Segment-Shield Type)
- Double Shield TBM (Closed Gripper/Segment-Shield Type)

## D.2.1 Open Gripper Main Beam TBM

The open gripper-beam category of TBMs is suited for stable to friable rock with occasional fractured zones and controllable groundwater inflows. Figure D-2 (Robbins) illustrates a typical diagram of a modern open gripper main beam TBM and highlights the major components including:

- Cutterhead (with disc cutters) and Front Support
- Main Beam
- Thrust (propel) Cylinder
- Gripper
- Rear Support
- Conveyor
- Trailing backup system for muck and material transportation, ventilation, power supply, etc.

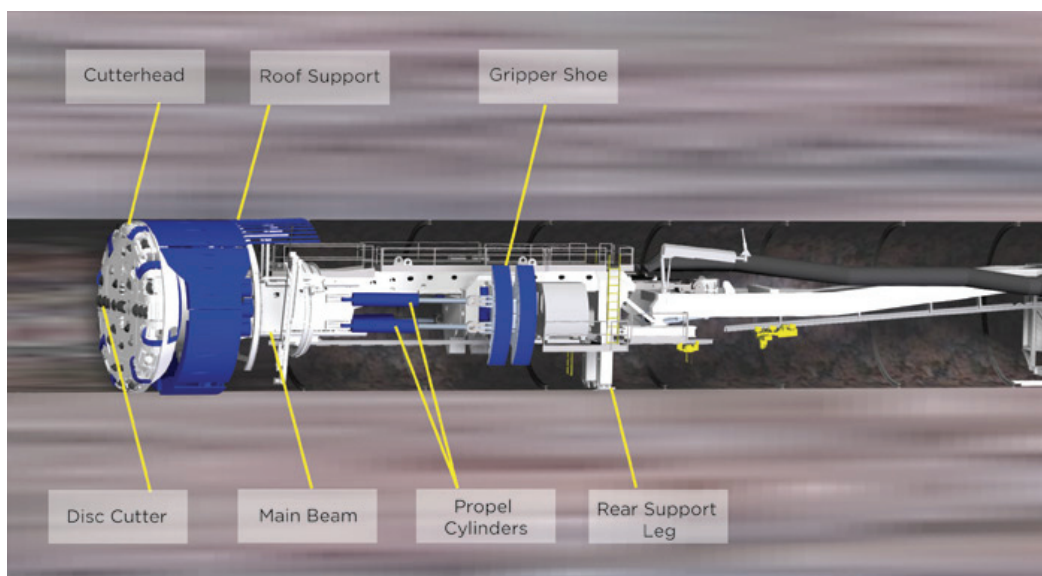

(a)

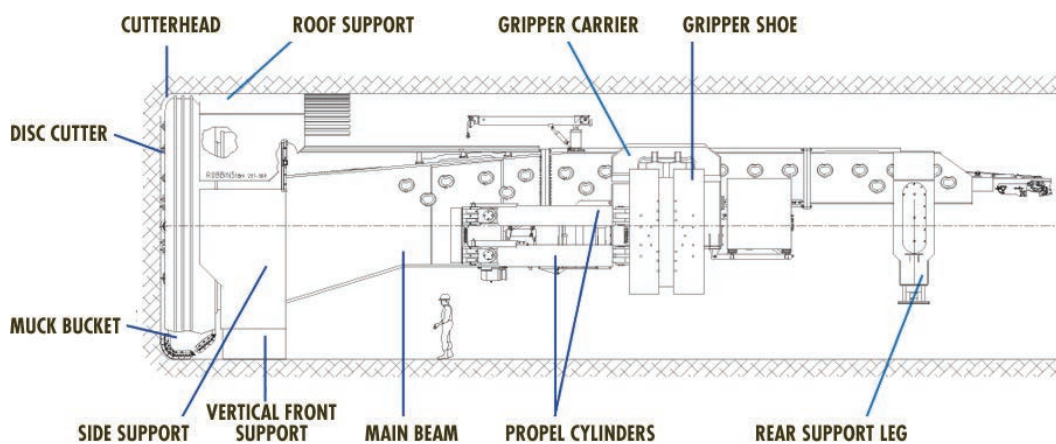

(b)

Figure D-2 Typical Diagram for an Open Gripper Main Beam TBM (Robbins).

The front of the gripper TBM is a rotating cutterhead that matches the diameter of the tunnel (Figure D-3). The cutterhead holds disc cutters. As the cutterhead turns, hydraulic propel cylinders push the cutters into the rock. The transfer of this high thrust through the rolling disc cutters creates fractures in the rock causing chips to break away from the tunnel face (Figure 6-9). A floating gripper system pushes on the sidewalls and is locked in place while the propel cylinders extend, allowing the main beam to advance the TBM. The machine can be continuously steered while gripper shoes push on the sidewalls to react the machine's forward thrust. Buckets in the rotating cutterhead scoop up and deposit the muck on to a belt conveyor inside the main beam. The muck is then transferred to the rear of the machine for removal from the tunnel. At the end of a stroke the rear legs of the machine are lowered, the grippers and propel cylinders are retracted. The retraction of the propel cylinders repositions the gripper assembly for the next boring cycle. The grippers are extended, the rear legs lifted, and boring begins again.



Figure D-3 Herrenknecht S-210 Gripper TBM (Herrenknecht)

Figure D-3 shows the front of the Herrenknecht S-210 Gripper TBM used in the construction for the Gotthard Base Tunnel, Switzerland. See Table D-1 for more data about the machine (Herrenknecht). Although uncommon, hard rock gripper TBMs with a diameter over 46' (145m) have been made, and this limit is constantly being challenged and extended for new mega projects.

## D.2.2 Single Shield TBM

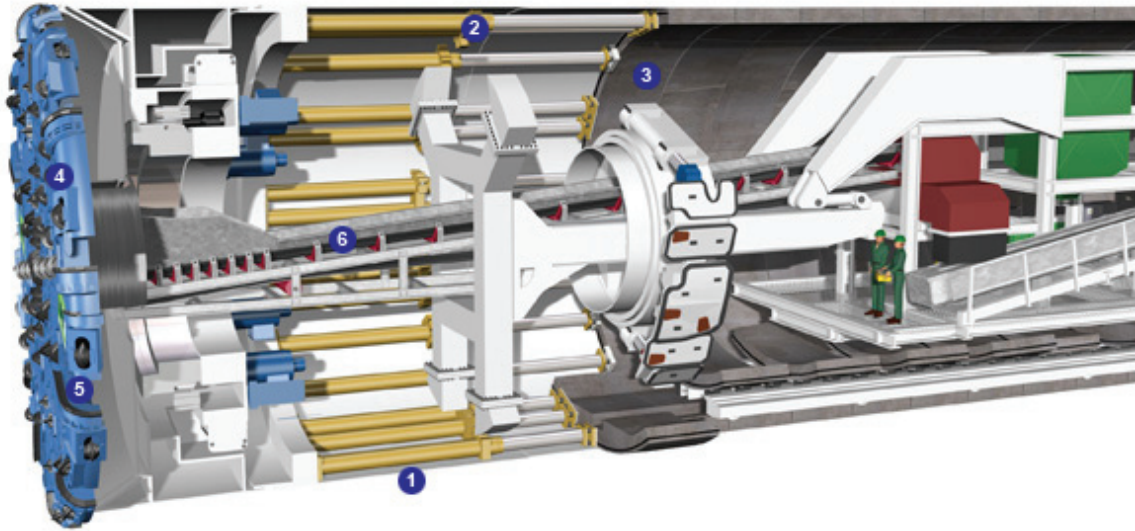

Notes:

(1) Shield; (2) thrust cylinders; (3) segmental lining; (4) cutterhead; (5) muck bucket; and (6) conveyers

Figure D-4 Typical Diagram of Single Shield TBM (Herrenknecht)

As shown in Figure D-4, the Single Shield TBMs are fitted with an open shield (unpressurized face) to cope with more brittle rock formations or soft rock. The TBM is protected by the shield (1), and extended and driven forward by means of hydraulic thrust cylinders (2) on the last completed segment ring (3). The rotating cutterhead (4) is fitted with hard rock disk cutters, which roll across the tunnel face, cutting notches in it, and subsequently dislodging large chips of rock (Figure 6-9). Muck bucket (5), which are positioned at some distance behind the disks, carry the dislodged rock pieces behind the cutterhead. The excavated material is brought to the surface by conveyers (6).

Figure D-5 illustrates a simplified cross section of Single Shield TBM.

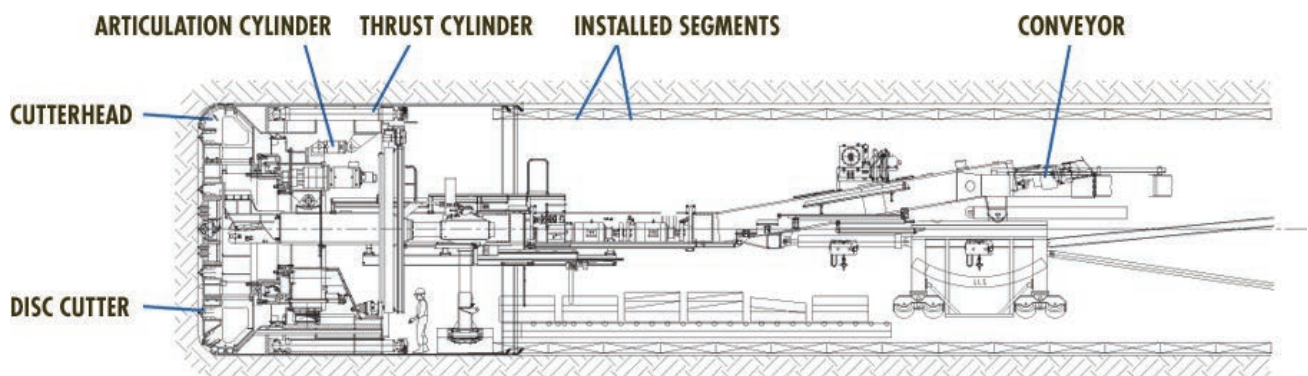

Figure D-5 Typical Diagram for Single Shield TBM (Robbins)

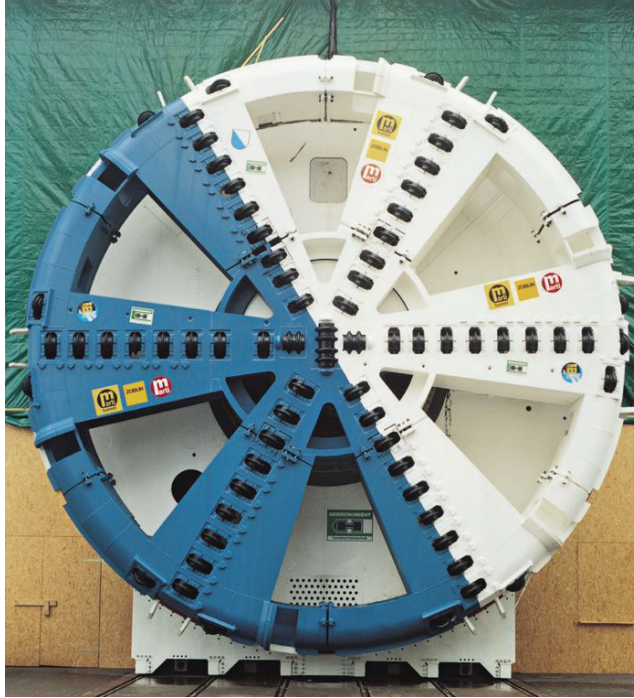

Figure D-6 above shows the cutterhead of the Herrenknecht S-256 Single Shield TBM used in the construction of the Isisberg tunnel, Switzerland, which on completion will be the longest underground section of the western Zurich bypass, will be directing transit traffic to central Switzerland around the city. The diameter of the cutterhead is about 38' (11.8 m). See Table D-1 for more data about the machine (Herrenknecht).

### D.2.3 Double Shield TBM

A Double Shield TBM (Figure D-7) consists of a rotating cutterhead mounted to the cutterhead support, followed by three shields: a telescopic shield (a smaller diameter inner shield which slides within the larger outer shield), a gripper shield and a tail shield.

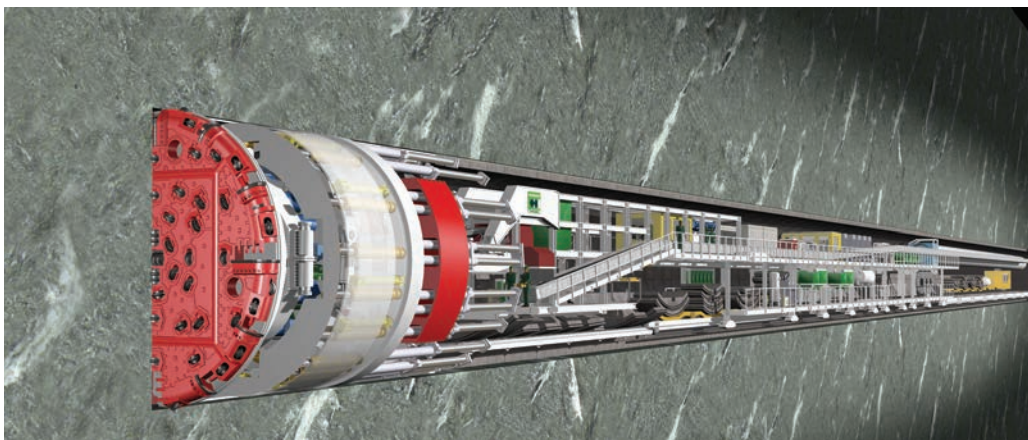

Figure D-7 Overview of a Double Shield TBM (Herrenknecht)

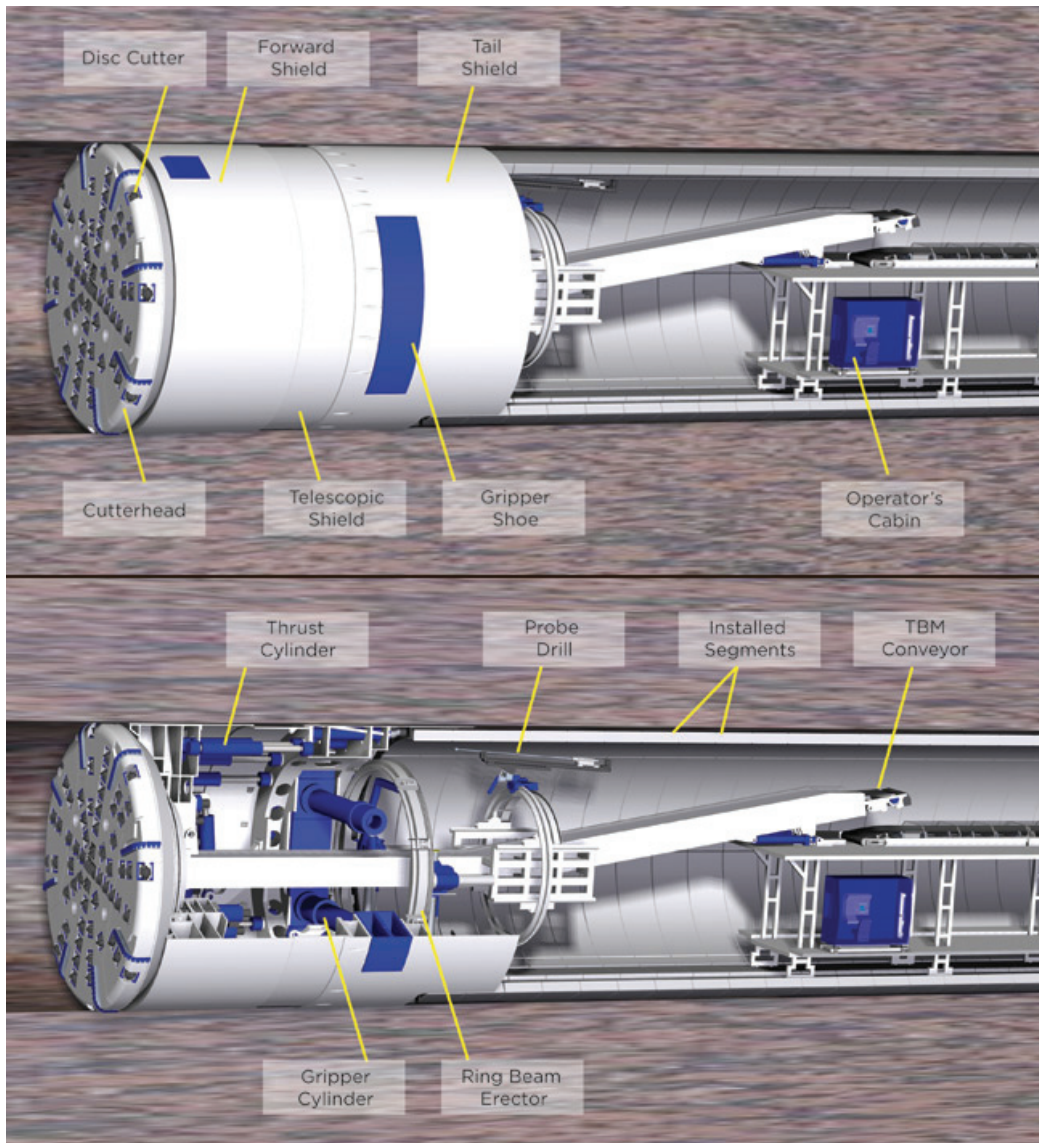

Figure D-8 Typical Diagram of a Double Shield TBM (Robbins).

In double shield mode, the gripper shoes are energized, pushing against the tunnel walls to react the boring forces just like the open gripper TBM. The main propel cylinders are then extended to push the cutterhead support and cutterhead forward. The rotating cutterhead cuts the rock. The telescopic shield extends as the machine advances keeping everything in the machine under cover and protected from the ground surrounding it.

The gripper shield remains stationary during boring. A segment erector is fixed to the gripper shield allowing pre-cast concrete tunnel lining segments to be erected while the machine is boring. The segments are erected within the safety of the tail shield. It is the Double Shield's ability to erect the tunnel lining simultaneously with boring that allows it to achieve such high performance rates. The completely enclosed shielded design provides the safe working environment.

If the ground becomes too weak to support the gripper shoe pressure, the machine thrust must be reacted another way. In this situation, the machine can be operated in "single shield mode". Auxiliary thrust cylinders are located in the gripper shield. In single shield mode they transfer the thrust from the gripper shield to the tunnel lining. Since the thrust is transferred to the tunnel lining, it is not possible to erect the lining simultaneously with boring. In the single shield mode, tunnel boring and tunnel lining erection are sequential operations.



Figure D-9 above shows the cutterhead (about 40' diameter) of the Herrenknecht S-376 Double Shield TBM which is being used for the construction of Brisbane North-South Bypass Tunnel. See Table D-1 for more data about the machine (Herrenknecht).

### D.3 Pressurized Face Soft Ground TBM

As shown in Figure 6-11 above, various types of tunnel boring machines (TBM) are suitable for soft ground tunneling in different conditions. Chapter 7 presents briefly the history and development of shield tunneling machines. Table 7-4 (reproduced below) lists various types of shield tunneling methods in soft ground.

Nowadays modern pressurized-face closed shield TBMs are predominantly utilized in large diameter soft ground tunneling. Section 7.3 describes the principles of the two common types: earth pressure balance (EPB) machines and slurry face machines (SFM), and offers guidelines for selecting between EPB and SFM. This appendix presents the components of each type of TBM and describes the construction sequences.

Table 7-4 Shield Tunneling Methods in Soft Ground (Modified from Hitachi Zosen, 1984)

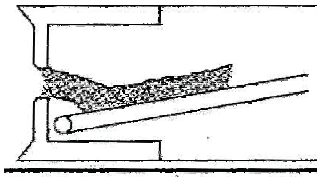
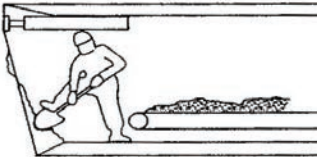
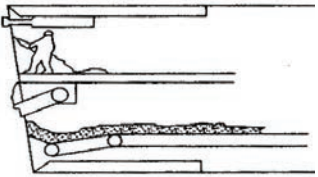
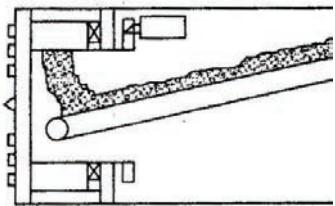
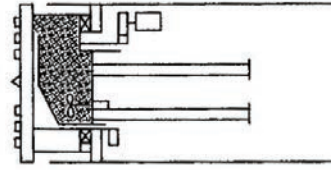
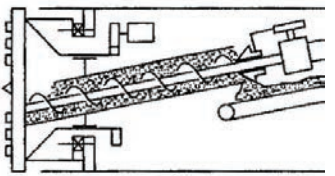
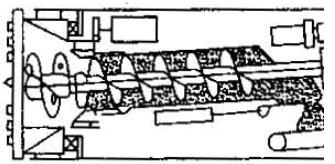
| Type   | Description   | Sketch  |
|--|---|---|
| Blind shield   | <ul style="list-style-type: none"> <li>• A closed face (or blind) shield used in very soft clays and silts</li> <li>• Muck discharge controlled by adjusting the aperture opening and the advance rate</li> <li>• Used in harbor and river crossings in very soft soils. Often results in a wave or mound of soil over the machine</li> </ul>   |    |
| Open face, hand-dug shield                               | <ul style="list-style-type: none"> <li>• Good for short, small tunnels in hard, non-collapsing soils</li> <li>• Usually equipped with face jacks to hold breasting at the face</li> <li>• If soil conditions require it, this machine may have movable hood and/or deck</li> <li>• A direct descendent of the Brunel shield</li> </ul>  |    |
| Semi-mechanized  | <ul style="list-style-type: none"> <li>• The most common shield</li> <li>• Similar to open face, but with a back hoe or boom cutter</li> <li>• Often equipped with “pie plate” breasting and one or more tables</li> <li>• May have trouble in soft, loose, or running ground</li> <li>• Compressed air may be used for face stability in poor ground</li> </ul>  |    |
| Mechanized   | <ul style="list-style-type: none"> <li>• A fully mechanized machine</li> <li>• Excavates with a full face cutter wheel and pick or disc cutters</li> <li>• Manufactured with a wide variety of cutting tools</li> <li>• Face openings (doors, guillotine, and the like) can be adjusted to control the muck taken in versus the advance of the machine</li> <li>• Compressed air may be used for face stability in poor ground</li> </ul>   |   |
| Slurry face Machine                                      | <ul style="list-style-type: none"> <li>• Using pressurized slurry to balance the groundwater and soil pressure at the face</li> <li>• Has a bulkhead to maintain the slurry pressure on the face</li> <li>• Good for water bearing silts and sands with fine gravels.</li> <li>• Best for sandy soils; tends to gum up in clay soils; with coarse soils, face may collapse into the slurry</li> </ul>   |  |
| Earth pressure balance (EPB) machine                     | <ul style="list-style-type: none"> <li>• A closed chamber (bulkhead) face used to balance the groundwater and/or collapsing soil pressure at the face</li> <li>• Uses a screw discharger with a cone valve or other means to form a sand plug to control muck removal from the face and thereby maintain face pressure to “balance” the earth pressure</li> <li>• Good for clay and clayey and silty sand soils, below the water table</li> <li>• Best for sandy soils, with acceptable conditions</li> </ul> |  |
| Earth pressure balance (EPB) high-density slurry machine | <ul style="list-style-type: none"> <li>• A hybrid machine that injects denser slurry (sometimes called slime) into the cutting chamber</li> <li>• Developed for use where soil is complex, lacks fines or water for an EPB machine, or is too coarse for a slurry machine</li> </ul>  |  |



### D.3.1 Earth Pressure Balance Machine

As discussed in Section 7.3, earth pressure balance machines (EPB) (Figure D-10) are pressurized face shield machines specially designed for operation in soft ground especially where the ground is silty and has a high percentage of fines both of which will assist the formation of a plug in the screw conveyor and will control groundwater inflows.

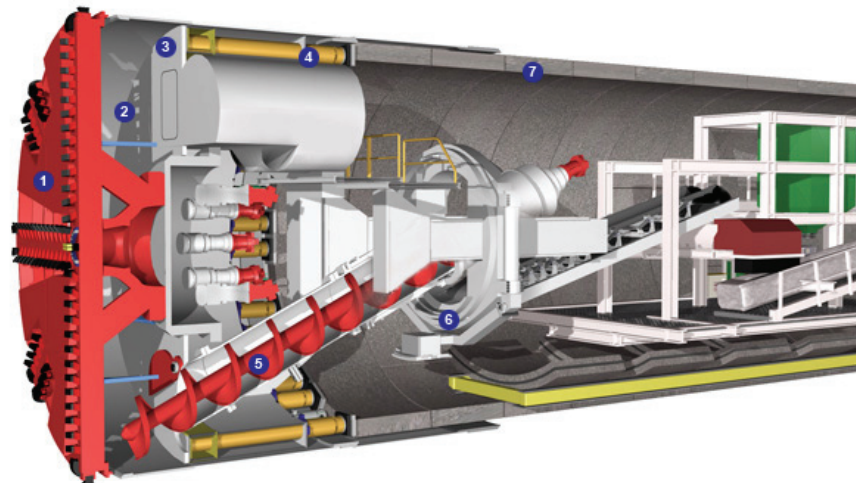
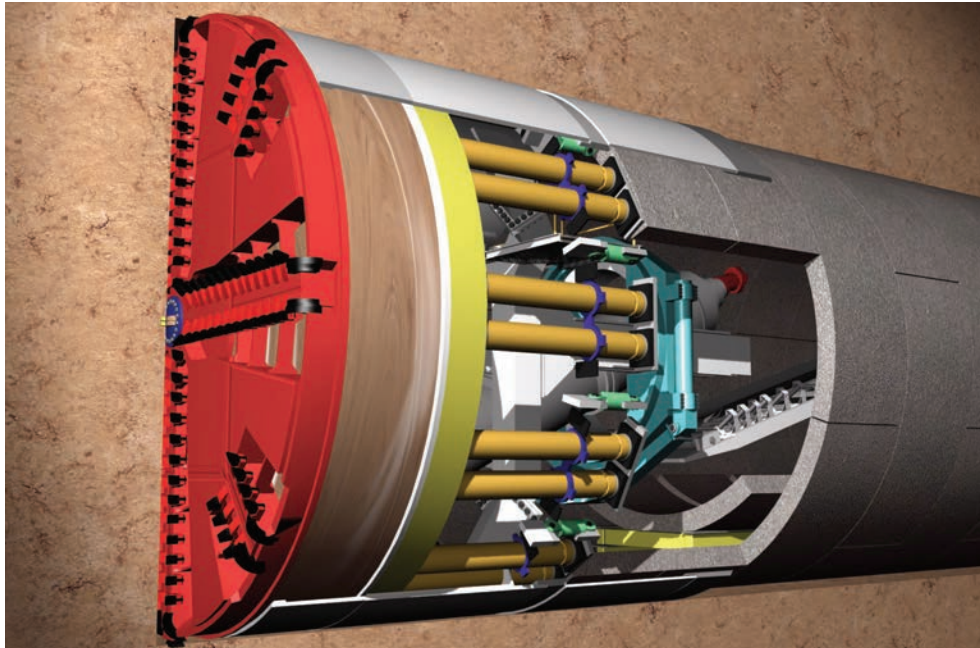

Notes:

(1) Cutterhead; (2) excavation chamber; (3) bulkhead; (4) thrust cylinders; (5) screw conveyor; (6) segment erector; and (7) Segmental Lining

Figure D-10 Overview of Earth Pressure Balance Machine (EPB)

The EPB machine continuously supports to the tunnel face by balancing the inside earth and water pressure against the thrust pressure of the machine. The working area inside the EPB machine is completely sealed against the fluid pressure of the ground outside the machine.

As shown in Figure D-10, the soil is excavated (loosened) by the cutterhead (1) serves to support the tunnel face. The area of the shield in which the cutterhead rotates is known as an excavation chamber (2) and is separated from the section of the shield under atmospheric pressure by the pressure bulkhead (3). The excavated soil falls through the openings of the cutterhead into the excavation chamber and mixes with the plastic soil already there. Uncontrolled penetration of the soil from the tunnel face into the excavation chamber is prevented because the force of the thrust cylinders (4) is transmitted from the pressure bulkhead onto the soil. A state of equilibrium is reached when the soil in the excavation chamber cannot be compacted any further by the native earth and water pressure.

The excavated material is removed from the excavation chamber by a screw conveyor (5). The amount of material removed is controlled by the speed of the screw and the cross-section of the opening of the upper screw conveyor driver. The pressure in the excavation chamber is controlled by balancing the rate of advance of the machine and the rate of extraction of the excavated material by the screw conveyor. The screw conveyor conveys the excavated material to the first of a series of conveyor belts. The excavated material is conveyed on these belts to the so-called reversible conveyor from which the transportation gantries in the backup areas are loaded when the conveyor belt is put into reverse.

The tunnels are normally lined with reinforced precast lining segments (7), which are positioned under atmospheric pressure conditions by means of erectors (6) in the area of the shield behind the pressure bulkhead and then temporarily bolted in place. Grout is continuously injected into the remaining gap between the segments' outer side and the surrounding medium injection openings in the tailskin or openings directly in the segments.

Manual or automatic operation of the EPB system is possible through the integrated PLC and computer-control systems.

As discussed above, the EPB machines support the tunnel face with pressure from the excavated (and remolded) soil within the excavation chamber and crew conveyor. Therefore, EPB machines perform more effectively when the soil immediately ahead of the cutterhead and in the excavation chamber forms a plastic plug, which prevents water inflow and ensures face support. This is accomplished by conditioning the soils ahead of the cutterhead with foams and/or polymers. O'Carroll 2005 lists the benefits of soil conditioning for the EPB machine operation including:

- Improved ground control
- Torque and power requirement reduction
- Abrasion reduction
- Adhesion (stickiness) reduction, and
- Permeability reduction.

Figure D-11 shows the front of the Herrenknecht S-300 EPB TBM used in the construction of the M30-By-Pass Sur Tunel Norte project in Madrid, Spain. The diameter of the cutterhead is almost 50' (15.2 m). See Table D-1 for more data about the machine (Herrenknecht).



Figure D-11 The EPB Machine for the M30-By-Pass Sur Tunnel Norte project in Madrid.

### D.3.2 Slurry Face Machine

As discussed in Section 7.3, slurry face machine (SFM) are pressurized face shield machines specially designed for tunneling in soft ground especially where the ground is loose waterbearing granular soils that are easily separated from the slurry at the separation plant. The SFM provides stability at the face hydraulically by bentonite slurry kept under pressure to counteract the native earth and groundwater pressure, and to prevent an uncontrolled penetration of soil or a loss of stability at the tunnel face.

Figure D-12 shows typical diagrams of Herrenknecht's mixshield machine which employs the slurry face support principle. At the mixshield machine face the soil is loosened by the cutterhead (1) rotating in the bentonite suspension. The soil then mixes with the bentonite suspension. The area of the shield in which the cutterhead rotates is known as the excavation chamber (2) and is separated by the pressure bulkhead (3) from the section of the shield under atmospheric pressure.

The bentonite suspension supplied by the feed line (4) is applied in the excavation chamber via an air cushion (5) at a pressure equaling the native soil and water pressure, thus preventing an uncontrolled penetration of the soil or a loss of stability at the tunnel face. For this reason the excavation chamber behind the cutting wheel is separated from the pressure bulkhead by a so-called submerged wall (6). The area of the submerged wall and pressure bulkhead is known as the pressure/working chamber. Note that unlike the typical slurry shield machines, in the mixshield machines, the support pressure in the excavation chamber is not directly controlled by suspension pressure but by a compressible air cushion between the pressure bulkhead and the submerged wall.

The loosened soil mixed with the suspension is pumped through the feeding circuit to the separation plant outside the tunnel. In order to prevent blockages to the feeding circuit and to ensure trouble-free operation of the discharge pumps, a sieve of largish stones and clumps of soil is placed in front of the suction pipe to block the access to the suction channel.

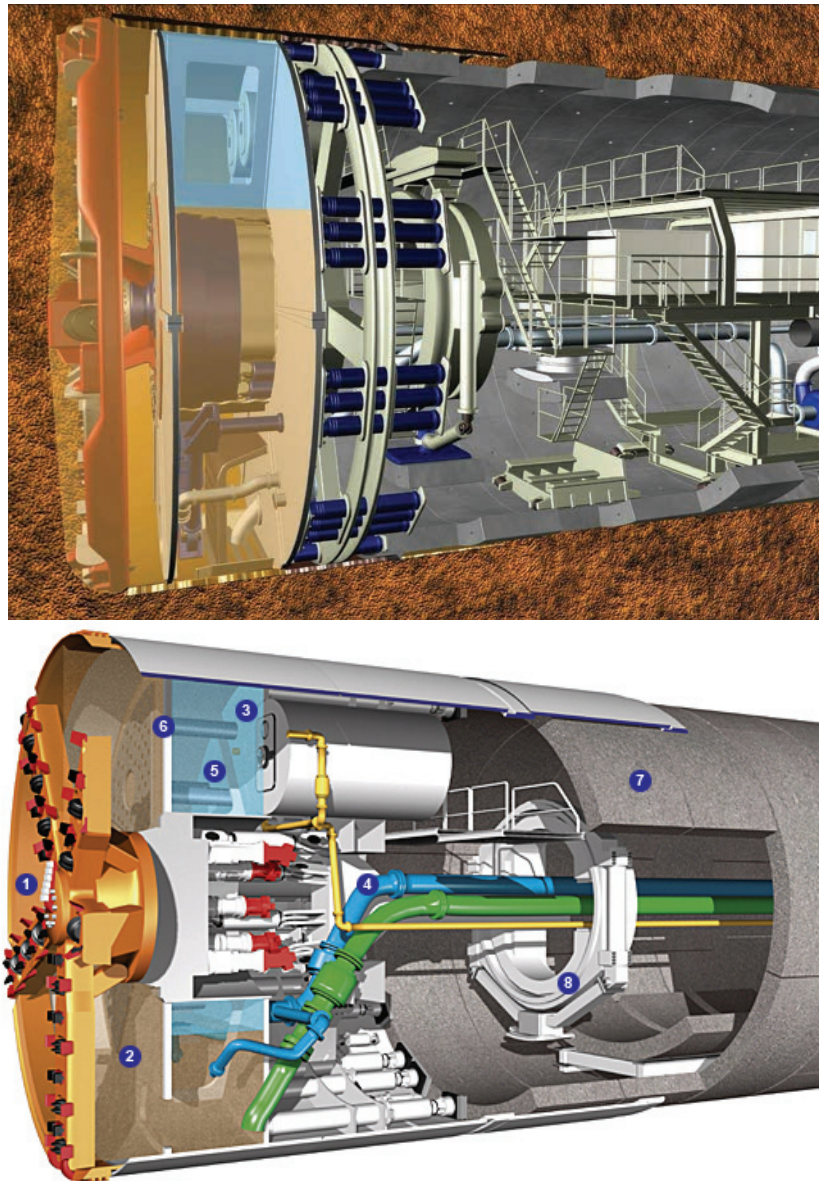

Notes:

(1) Cutterhead; (2) excavation chamber; (3) bulkhead; (4) slurry feed line; (5) air cushion; (6) wall; (7) Segmental Lining; and (8) segment erector

Figure D-12 Overview of Slurry Face Machine (SFM) (Herrenknecht's Mixshield Machines)

Figure D-13 shows the Herrenknecht S-317 Mixshield TBM used in the construction of the Shanghai Changjiang Under River Tunnel Project in China. The diameter of the cutterhead is over 50' (15.4 m). See Table D-1 for more data about the machine (Herrenknecht).



Figure D-13 Photograph of Herrenknecht S-317 Mixshield TBM

**Table D-1  
Project Summary  
(Herrenknecht)**

**Gripper TBM**

Project

| No.   | Project name                                  | Location | Machine description   | Shield diameter [mm] | Tunnel length [m] | Geology                    | Cutterhead power [kW] | Total thrust [kN] | Cutterhead torque [kNm] | Employment |
|-------|---|----------|-----------------------|----------------------|-------------------|----------------------------|-----------------------|-------------------|-------------------------|------------|
| S-210 | Alptransit Gotthard Bodio / Faido East Tunnel | CH       | Hard Rock Gripper TBM | 8,830                | 13,460            | Gneiss<br>Granite<br>Slate | 3,500                 | 27,488            | 5,290                   | Railway    |

**Single Shield TBM**

Project

| No.   | Project name  | Location | Machine description         | Shield diameter [mm] | Tunnel length [m]      | Geology   | Cutterhead power [kW] | Total thrust [kN] | Cutterhead torque [kNm] | Employment  |
|-------|---------------|----------|-----------------------------|----------------------|------------------------|---|-----------------------|-------------------|-------------------------|-------------|
| S-287 | Pajares Los 1 | ES       | Single Shield Hard Rock TBM | 9,900                | 7.650 + 2750           | Sand stones<br>Slate  | 4,900                 | 180,000           | 19,960                  | Railway     |
| S-256 | Islisberg     | CH       | Single Shield Hard Rock TBM | 11,805               | 1 x 4.680<br>1 x 4.645 | Upper fresh water molasse (calcareous silt stones, fine layers of sand) | 1,760                 | 51,700            | 6,012                   | Road Tunnel |

**Double Shield TBM**

Project

| No.   | Project name                       | Location | Machine description         | Shield diameter [mm] | Tunnel length [m] | Geology   | Cutterhead power [kW] | Total thrust [kN]           | Cutterhead torque [kNm] | Employment  |
|-------|------------------------------------|----------|-----------------------------|----------------------|-------------------|---|-----------------------|-----------------------------|-------------------------|-------------|
| S-375 | Brisbane North South Bypass Tunnel | AU       | Double Shield Hard Rock TBM | 12,340               | 4,348             | Brisbane tuff, Neranleigh-Fernvale beds, Rhyolitic Ignimbrite | 4,200                 | pri. 81.430<br>sec. 100.000 | 17,974                  | Road Tunnel |
| S-376 | Brisbane North South Bypass Tunnel | AU       | Double Shield Hard Rock TBM | 12,340               | 4,067             | Brisbane tuff, Neranleigh-Fernvale beds, Rhyolitic Ignimbrite | 4,200                 | pri. 81.430<br>sec. 100.000 | 17,974                  | Road Tunnel |

**Table D-1  
Project Summary  
(Herrenknecht)**

**Earth Pressure Balance Shield TBM**

Project

| No.   | Project name                         | Location | Machine description | Shield diameter [mm]         | Tunnel length [m] | Geology                                       | Cutterhead power [kW] | Total thrust [kN]                        | Cutterhead torque [kNm]              | Employment  |
|-------|--------------------------------------|----------|---------------------|------------------------------|-------------------|---|-----------------------|--|--------------------------------------|-------------|
| S-185 | Heathrow Airside Road Tunnel Project | UK       | EPB-Shield          | 9,160                        | 2 x 1,240         | London clay                                   | 2,800                 | 69,272                                   | 17,195                               | Road Tunnel |
| S-300 | M-30 By-Pass Sur Túnel Norte Madrid  | ES       | EPB-Shield          | 15,095 (Bore diameter 15.20) | 3,650             | Peñuela<br>Peñuela + Gypsum<br>Massive Gypsum | 12,000 + 2,000        | 276,390 at 350 bar<br>315,880 at 400 bar | 96,000 at 0,81rpm<br>8,450 at 1,5rpm | Road Tunnel |

**Mixshield**

Project

| No.   | Project name                                   | Location | Machine description | Shield diameter [mm] | Tunnel length [m] | Geology   | Cutterhead power [kW] | Total thrust [kN] | Cutterhead torque [kNm] | Employment  |
|-------|--|----------|---------------------|----------------------|-------------------|---|-----------------------|-------------------|-------------------------|-------------|
| S-108 | Arge 4. Röhre Elbtunnel Hamburg                | DE       | Mixshield           | 14,200               | 2,560             | Sand<br>Glacial drift<br>Silt<br>Gravel<br>Boulders | 3200 + 200            | 250,000           | 25,780                  | Road Tunnel |
| S-317 | Shanghai Changjiang Under River Tunnel Project | CN       | Mixshield           | 15,430               | 7,170             | Sand<br>Clay<br>Rubble                              | 3,500                 | 203,066           | 39,945                  | Road tunnel |
| S-318 | Shanghai Changjiang Under River Tunnel Project | CN       | Mixshield           | 15,430               | 7,170             | Sand<br>Clay<br>Rubble                              | 3,500                 | 203,066           | 39,945                  | Road tunnel |

This page is intentionally left blank.



# **Appendix E**

## **Analytical Closed Form Solutions**

This page is intentionally left blank.

## Appendix E – Analytical Closed Form Solutions

### E.1 Analytical Elastic Closed Form Solutions for Rock Tunnels

As discussed in Section 6.6.2, the state of stress due to tunnel excavation can be calculated from analytical solutions or using numerical analysis. Kirsch’s elastic closed form solution is one of the commonly used analytical solutions and is presented in Figure E-1. The closed form solution is restricted to simple geometries and material models, and therefore often of limited practical value. However, the solution is considered to be a good tool for a “sanity check” of the results obtained from numerical analyses.

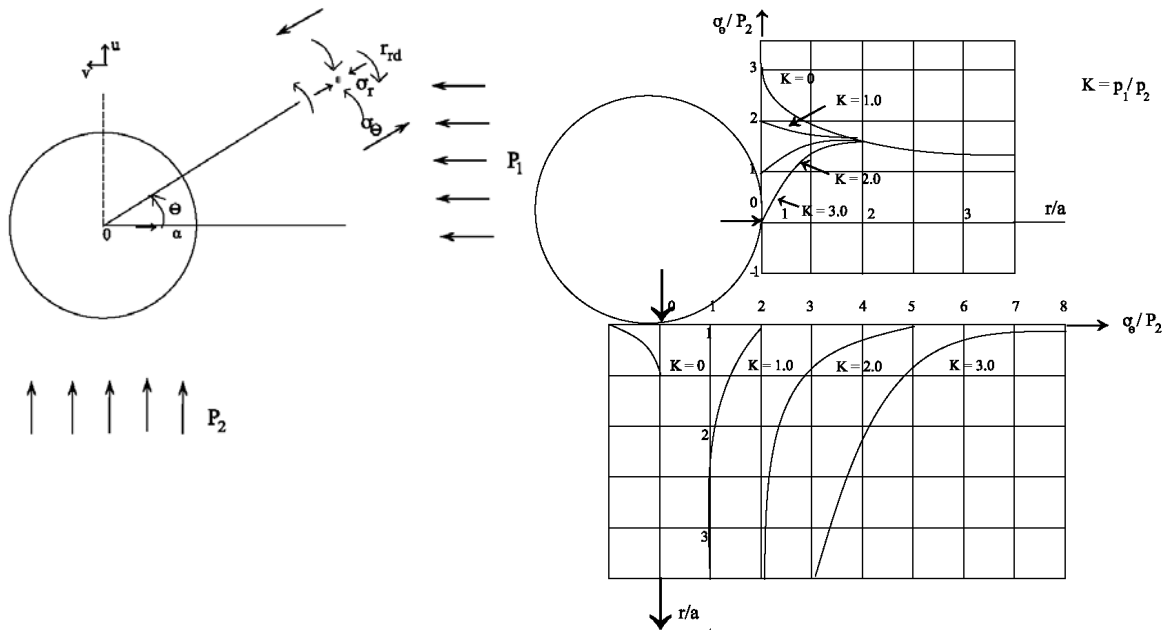

$$\sigma_r = \frac{P_1 + P_2}{2} \left( 1 - \frac{a^2}{r^2} \right) + \frac{P_1 - P_2}{2} \left( 1 - \frac{4a^2}{r^2} + \frac{3a^4}{r^4} \right) \cos 2\theta$$

$$\sigma_\theta = \frac{P_1 + P_2}{2} \left( 1 + \frac{a^2}{r^2} \right) - \frac{P_1 - P_2}{2} \left( 1 + \frac{3a^4}{r^4} \right) \cos 2\theta$$

$$\tau_{r\theta} = -\frac{P_1 - P_2}{2} \left( 1 + \frac{2a^2}{r^2} - \frac{3a^4}{r^4} \right) \sin 2\theta$$

Figure E-1 Kirsch’s Elastic Solution (Kirsch, 1898)

Section 6.6.2 also describes other common analytical solutions proposed by Hoek et al. (1995), Bischoff and Smart (1977), and Brady & Brown (1985).

Analytical solutions to calculate support stiffness and maximum support pressure for concrete/shotcrete, steel sets, and ungrouted mechanically or chemically anchored rock bolts/cables are summarized in Table E-1.

**Table E-1 Analytical Solutions for Support Stiffness and Maximum Support Pressure for Various Support Systems (Brady & Brown, 1985)**

| Support System   | Support stiffness (K) and maximum support pressure ( $P_{max}$ )  |
|--|---|
| Concrete /Shotcrete lining   | $K = \frac{E_c [r_i^2 - (r_i - t_c)^2]}{(1 + \nu_c) [(1 - 2\nu_c)r_i^2 + (r_i - t_c)^2]}$ $P_{max} = \frac{\sigma_{cc}}{2} \left[ 1 - \frac{(r_i - t_c)^2}{r_i^2} \right]$  |
| Blocked steel sets   | $\frac{1}{K} = \frac{S r_i}{E_s A_s} + \frac{S r_i^3}{E_s I_s} \left[ \frac{\theta(\theta + \sin \theta \cos \theta)}{2 \sin^2 \theta} \right] + \frac{2 S \theta t_B}{E_B W^2}$ $P_{max} = \frac{3 A_s I_s \sigma_{ys}}{2 S r_i \theta \{ 3 I_s + X A_s [r_i - (t_B + 0.5 X)] (1 - \cos \theta) \}}$ |
| UngROUTED mechanically or chemically anchored rock bolts or cables | $\frac{1}{K} = \frac{s_c s_l}{r_i} \left( \frac{4l}{\pi d_b^2 E_b} + Q \right)$ $P_{max} = \frac{T_{bf}}{s_c s_l}$  |

**NOTATION:**  $K$  = support stiffness;  $P_{max}$  = maximum support pressure;  $E_c$  = Young's modulus of concrete;  $t_c$  = lining thickness;  $r_i$  = internal tunnel radius;  $\sigma_{cc}$  = uniaxial compressive strength of concrete or shotcrete;  $W$  = flange width of steel set and side length of square block;  $X$  = depth of section of steel set;  $A_s$  = cross section area of steel set;  $I_s$  = second moment of area of steel set;  $E_s$  = Young's modulus of steel;  $\sigma_{ys}$  = yield strength of steel;  $S$  = steel set spacing along the tunnel axis;  $\theta$  = half angle between blocking points in radians;  $t_B$  = thickness of block;  $E_B$  = Young's modulus of block material;  $l$  = free bolt or cable length;  $d_b$  = bolt diameter or equivalent cable diameter;  $E_b$  = Young's modulus of bolt or cable;  $T_{bf}$  = ultimate failure load in pull-out test;  $s_c$  = circumferential bolt spacing;  $s_l$  = longitudinal bolt spacing;  $Q$  = load-deformation constant for anchor and head.

## E.2 Analytical Elastic Closed Form Solutions for Ground Support Interaction

Analytical solutions for ground-support interaction for a tunnel in soil are available in the literatures. The solutions are based on two dimensional, plane strain, linear elasticity assumptions in which the lining is assumed to be placed deep and in contact with the ground (no gap), i.e., the solutions do not allow for a gap to occur between the support system and ground. The background information for the common closed form models are presented in Appendix B of the FHWA Tunnel Design Guidelines (2004) which is reproduced here in Section E.3 for convenience.

Early analytical solutions by Burns and Richard (1964), Dar and Bates (1974), and Hoeg (1968) were derived for the overpressure loading, while solutions by Morgan (1961), Muir Wood (1975), Curtis (1976), Rankin, Ghaboussi and Hendron (1978), and Einstein et al. (1980) were for excavation loading. Solutions are available for the full slip and no slip conditions at the ground-lining interface. Appendix E present the available published analytical solutions in Table E-2. A sample analysis is presented in Table E-3 to illustrate the applications of various closed-form solutions for a 22ft diameter circular tunnel with 1.5 ft thick concrete lining. The tunnel is located at 105 ft deep from the ground surface to springline and groundwater table is located 10 ft below the ground surface. Details of input parameters are shown in Table E-3a. The calculated lining loads from various analytical solutions are presented in Table E-3b.

Table E-2 Analytical Solutions for Soil – Liner Interaction

| Analytical Solutions           |                      | Thrust  | Moment  |
|--------------------------------|----------------------|---|---|
| Wu & Penzien (1997)            | Relaxation           | crown = $P_d + P_s + P_w$<br>Springline = $P_d + P_w - P_s$<br>$P_d = -0.5 \cdot (1 + k_0) \cdot (1 / (1 + C)) \cdot (h \cdot \gamma_m - h_w \cdot \gamma_w) \cdot (d / 2)$<br>$P_s = 0.5 \cdot (1 - k_0) \cdot (1 / (1 + F)) \cdot (h \cdot \gamma_m - h_w \cdot \gamma_w) \cdot (d / 2)$<br>$P_w = -(1 / (1 + C)) \cdot h_w \cdot \gamma_w \cdot (d / 2)$                                   | $= (-1/4) \cdot (1 - k_0) \cdot (1 / (1 + F)) \cdot (h \cdot \gamma_s - h_w \cdot \gamma_w) \cdot (d / 2)^2$  |
|                                | Overburden           | Crown = $P_d + P_s + P_w$<br>Springline = $P_d + P_w - P_s$<br>$P_d = -(1 + k_0) \cdot (1 - \nu_m) / (1 + C) \cdot (h \cdot \gamma_s - h_w \cdot \gamma_w) \cdot (d / 2)$<br>$P_w = -(1 / (1 + C)) \cdot h_w \cdot \gamma_w \cdot (d / 2)$<br>$P_s = (2 \cdot (1 - k_0) \cdot (1 - \nu_m)) / ((3 - 4 \cdot \nu_m) \cdot (1 + F)) \cdot (h \cdot \gamma_m - h_w \cdot \gamma_w) \cdot (d / 2)$ | $= -(1 - k_0) \cdot (1 - \nu_m) / ((3 - 4 \cdot \nu_m) \cdot (1 + F)) \cdot (h \cdot \gamma_m - h_w \cdot \gamma_w) \cdot (d / 2)^2$  |
| Einstein & Schwartz (1979)     | Excavation full slip | Crown = $[0.5 \cdot (1 + k_0) \cdot (1 - a_0) - (0.5 \cdot (1 + k_0) \cdot (1 - 2 \cdot a_2))] \cdot (\gamma_m \cdot h \cdot d / 2)$<br>springline = $[0.5 \cdot (1 + k_0) \cdot (1 - a_0) + (0.5 \cdot (1 + k_0) \cdot (1 - 2 \cdot a_2))] \cdot (\gamma_m \cdot h \cdot d / 2)$   | $= -0.5 \cdot (1 - k_0) \cdot (1 - 2 \cdot a_2) \cdot (\gamma \cdot h \cdot (d / 2)^2)$   |
|                                | Excavation no slip   | Thrust at Crown = $[0.5 \cdot (1 + k_0) \cdot (1 - a_0) - (0.5 \cdot (1 - k_0) \cdot (1 + 2 \cdot a_4))] \cdot (\gamma_m \cdot h \cdot d / 2)$<br>Thrust at Springline = $[0.5 \cdot (1 + k_0) \cdot (1 - a_0) + (0.5 \cdot (1 - k_0) \cdot (1 + 2 \cdot a_4))] \cdot (\gamma_m \cdot h \cdot D / 2)$   | $= -[0.25 \cdot (1 - k_0) \cdot (1 - 2 \cdot h + 2 \cdot b_2)] \cdot (\gamma \cdot h \cdot (D / 2)^2)$  |
|                                |                      | $a_0 = C \cdot F \cdot (1 - \nu_m) / (F + C + (C \cdot F \cdot (1 - \nu_m)))$<br>$a_2 = (F + 6) \cdot (1 - \nu_m) / (2 \cdot F \cdot (1 - \nu_m) + (6 \cdot (5 - 6 \cdot \nu_m)))$<br>$a_4 = \beta \cdot b_2$<br>$\beta = ((F + 6) \cdot (1 - \nu_m) + (2 \cdot F \cdot C)) / (3 \cdot F + 3 \cdot C + 2 \cdot C \cdot F \cdot (1 - \nu_m))$  | $b_2 = [C \cdot (1 - \nu_m)] / [2 \cdot (C \cdot (1 - \nu_m) + 4 \cdot \nu_m - 6 \cdot \beta - 3 \cdot \beta \cdot C \cdot (1 - \nu_m))]$<br>$C = [(d / 2) \cdot E_m \cdot (1 - \nu_L^2)] / [E_L \cdot (A_L / w_L) \cdot (1 - \nu_m^2)]$<br>$F = (d / 2)^3 \cdot E_m \cdot (1 - \nu_L^2) / (E_L \cdot I \cdot (1 - \nu_m^2))$ |
| Peck, Hendron & Moharaz (1972) |                      | Thrust at Crown = $0.5 \cdot [(1 + k_0) \cdot b_1 - 0.3333 \cdot (1 - k_0) \cdot b_2] \cdot \gamma_s \cdot h \cdot (d / 2)$<br>Thrust at Springline = $0.5 \cdot [(1 + k_0) \cdot b_1 + 0.3333 \cdot (1 - k_0) \cdot b_2] \cdot \gamma_s \cdot h \cdot (d / 2)$   | $= (1 - k_0) \cdot b_2 \cdot \gamma_s \cdot h \cdot (d / 2)^2 / 6$  |
|                                | overburden           | $b_1 = 1 - a_1$<br>$a_1 = (1 - 2 \cdot \nu_m) \cdot (C - 1) / ((1 - 2 \cdot \nu_m) \cdot C + 1)$<br>$b_2 = (1 + 3 \cdot a_2 - 4 \cdot a_3)$<br>$a_2 = ((2 \cdot F) + 1 - 2 \cdot \nu_m) / (2 \cdot F + 5 - 6 \cdot \nu_m)$<br>$a_3 = (2 \cdot F) / (2 \cdot F + 5 - 6 \cdot \nu_m)$   |   |

|   |  |  |  |
|---|--|--|--|
| <b>Ranken, Ghahoussi and Hendron (1978)</b> | Overpressure<br>(no slip)  | Thrust at Crown<br>$= (\gamma \cdot h \cdot (d/2)) \cdot \left( (1+k_0) \cdot (1-L_n) - (1-k_0) \cdot (1+J_n) \right)$<br>Thrust at Springline<br>$= (\gamma \cdot h \cdot (d/2)) \cdot \left( (1+k_0) \cdot (1-L_n) + (1-k_0) \cdot (1+J_n) \right)$  | Moment at Crown<br>$= (\gamma \cdot h \cdot (d/2)^2 / 2) \cdot \left[ (1+k_0) \cdot (1-2 \cdot v_m) \cdot (C/(6 \cdot F)) \cdot (1-L_n) - ((1-k)/2) \cdot (1-J_n - 2 \cdot N) \right]$<br>Moment at Springline<br>$= (\gamma \cdot h \cdot (d/2)^2 / 2) \cdot \left[ (1+k_0) \cdot (1-2 \cdot v_m) \cdot (C/(6 \cdot F)) \cdot (1-L_n) + ((1-k)/2) \cdot (1-J_n - 2 \cdot N) \right]$  |
|   | Overpressure<br>(full slip)  | Thrust at Crown<br>$= \left( (1+k_0) \cdot (1-L_f) - (1-k_0) \cdot (1-J_f) \right) \cdot \gamma \cdot h \cdot (d/4)$<br>Thrust at Springline<br>$= \left( (1+k_0) \cdot (1-L_f) + (1-k_0) \cdot (1-J_f) \right) \cdot \gamma \cdot h \cdot (d/4)$  | Moment at Crown<br>$= (\gamma \cdot h \cdot (d/2)^2 / 2) \cdot \left[ (1+k_0) \cdot (1-2 \cdot v_m) \cdot (C/(6 \cdot F)) \cdot (1-L_f) - (1-k) \cdot (1-J) \right]$<br>Moment at Springline<br>$= (\gamma \cdot h \cdot (d/2)^2 / 2) \cdot \left[ (1+k_0) \cdot (1-2 \cdot v_m) \cdot (C/(6 \cdot F)) \cdot (1-L_n) + (1-k) \cdot (1-J) \right]$  |
|   | Excavation<br>(No Slip)  | Thrust at Crown<br>$= \left( (1+k_0) \cdot (1-L_n^*) - (1-k_0) \cdot (1-J_n^*) \right) \cdot \gamma \cdot h \cdot (d/4)$<br>Thrust at Springline<br>$= \left( (1+k_0) \cdot (1-L_n^*) + (1-k_0) \cdot (1-J_n^*) \right) \cdot \gamma \cdot h \cdot (d/4)$  | Moment at Crown<br>$= (\gamma \cdot h \cdot (d/2)^2 / 2) \cdot \left[ (1+k_0) \cdot (L_n^* / (6 \cdot F)) - (0.5 \cdot (1-k_0) \cdot (1+J - N)) \right]$<br>Moment at Springline<br>$= (\gamma \cdot h \cdot (d/2)^2 / 2) \cdot \left[ (1+k_0) \cdot (L_n^* / (6 \cdot F)) + (0.5 \cdot (1-k_0) \cdot (1+J - N)) \right]$  |
|   | Excavation<br>(Full Slip)  | Thrust at Crown<br>$= \left( (1+k_0) \cdot (1-L_f^*) - (1-k_0) \cdot (1-2 \cdot J_f^*) \right) \cdot \gamma \cdot h \cdot (d/4)$<br>Thrust at Springline<br>$= \left( (1+k_0) \cdot (1-L_f^*) + (1-k_0) \cdot (1-2 \cdot J_f^*) \right) \cdot \gamma \cdot h \cdot (d/4)$  | Moment at Crown<br>$= (\gamma \cdot h \cdot (d/2)^2 / 2) \cdot \left[ (1+k_0) \cdot (L_f^* / (6 \cdot F)) - (1-k_0) \cdot (1-2 \cdot J) \right]$<br>Moment at Springline<br>$= (\gamma \cdot h \cdot (d/2)^2 / 2) \cdot \left[ (1+k_0) \cdot (L_f^* / (6 \cdot F)) + (1-k_0) \cdot (1-2 \cdot J) \right]$  |
|   |  | $L_n = (1-2 \cdot v_m) \cdot (C-1) / (1+(1-2 \cdot v_m) \cdot C)$<br>$J_n = (1-2 \cdot v_m) \cdot (1-C) \cdot F - (0.5 \cdot (1-2 \cdot v_m) \cdot C + 2)$<br>$/ [((3-2 \cdot v_m) + (1-2 \cdot v_m) \cdot C) \cdot F + (0.5 \cdot (5-6 \cdot v_m)) \cdot (1-2 \cdot v_m) \cdot C + (6-8 \cdot v_m)]$<br>$N_n = ((1+(1-2 \cdot v_m) \cdot C) \cdot F - (0.5 \cdot (1-2 \cdot v_m) \cdot C) - 2)$<br>$/ [((3-2 \cdot v_m) + (1-2 \cdot v_m) \cdot C) \cdot F + (0.5 \cdot (5-6 \cdot v_m)) \cdot (1-2 \cdot v_m) \cdot C + (6-8 \cdot v_m)]$<br>$L_f = (1-2 \cdot v_m) \cdot (C-1) / (1+(1-2 \cdot v_m) \cdot C)$<br>$J_f = (2 \cdot F + (1-2 \cdot v_m)) / (2 \cdot F + (5-6 \cdot v_m))$<br>$N_f = (2 \cdot F - 1) / (2 \cdot F + (5-6 \cdot v_m))$ | $L_n^* = (1-2 \cdot v_m) \cdot C / (1+(1-2 \cdot v_m) \cdot C)$<br>$J_n^* = [(2 \cdot v_m + (1-2 \cdot v_m) \cdot C) \cdot F + (1-v_m) \cdot (1-2 \cdot v_m) \cdot C$<br>$/ [((3-2 \cdot v_m) + (1-2 \cdot v_m) \cdot C) \cdot F + (0.5 \cdot (5-6 \cdot v_m)) \cdot (1-2 \cdot v_m) \cdot C + (6-8 \cdot v_m)]$<br>$N_n^* = [(3+2 \cdot (1-2 \cdot v_m) \cdot C) \cdot F + (0.5 \cdot (1-2 \cdot v_m) \cdot C)$<br>$/ [((3-2 \cdot v_m) + (1-2 \cdot v_m) \cdot C) \cdot F + (0.5 \cdot (5-6 \cdot v_m)) \cdot (1-2 \cdot v_m) \cdot C + (6-8 \cdot v_m)]$<br>$L_f^* = (1-2 \cdot v_m) \cdot C / (1+(1-2 \cdot v_m) \cdot C)$<br>$J_f^* = (F + (1-v_m)) / (2 \cdot F + (5-6 \cdot v_m))$<br>$N_f^* = (4 \cdot F + 1) / (2 \cdot F + (5-6 \cdot v_m))$ |
| <b>Muir &amp; Wood (1975)</b><br>Excavation | Thrust at Crown<br>$= 1/3 \cdot (\sigma_v - \sigma_H) \cdot (d/2) + (4/3) \cdot \lambda \cdot (\text{deflection}) / (d/2) + (\sigma_v - \sigma_H) \cdot (d/2)$<br>Thrust at Springline<br>$= 2/3 \cdot k_0 \cdot (\sigma_v - \sigma_H) \cdot (d/2) + (2/3) \cdot \lambda \cdot (\text{deflection}) \cdot (d/2) + (\sigma_H) \cdot (d/2)$ | $= (\sigma_v - \sigma_H) / 6^2 \cdot (d/2)^2 \cdot \eta^2 \cdot R_s / (1+R_s)$<br>$\eta = (\phi_{D0} + d) / (2 \cdot d)$   |  |

|               |                      |  |  |  |
|---------------|----------------------|--|--|--|
| Full Slip     |                      | $k = (1 - \nu_m) / ((1 - 2 \cdot \nu_m) \cdot (1 + \nu_m))$<br>$\beta = (E_m / E_L) \cdot (d / 2 \cdot \eta) / (A_L / w_L)$<br>$\eta = (\phi_{ID} + d) / (d / 2)$<br>$\phi_{ID} = (d / 2 - t_L) \cdot 2$   | $\lambda = (3 \cdot E_m) / ((1 + \nu_m) \cdot (5 - 6 \cdot \nu_m) \cdot d / 2)$<br>$Q_1 = (E_m / E_L) \cdot (1 / (1 + \nu_m)) \cdot (\eta \cdot (d / 2)^3 / (12 \cdot I))$<br>$Q_2 = (E_m / E_L) \cdot (1 / (1 + \nu_m)) \cdot ((d / 2)^3 / (12 \cdot I))$<br>$I = (w_L \cdot t_L^3) / 12 / w_L$ | $R_s = (9 \cdot EI) / (\lambda \cdot \eta^3 \cdot (d / 2)^4)$<br>$\sigma_H = \sigma_v \cdot k_0 + H_w \cdot \gamma_w \cdot (1 - k_0)$<br>$\sigma_v = \gamma_m \cdot h + S$ |
| Curtis (1976) | Excavation Full Slip | Thrust at Crown<br>$= N_{\text{constant}} - N_{\text{max}}$<br>Thrust at Springline<br>$= N_{\text{constant}} + N_{\text{max}}$<br>$N_{\text{constant}} = [(\sigma_v + \sigma_H) \cdot d / 2] / [2 + (1 - k_0) \cdot 2 \cdot k \cdot \beta]$<br>$N_{\text{max}} = ((\sigma_v - \sigma_H) \cdot d / 4) \cdot (3 - 4 \cdot \nu_m) / (5 - 6 \cdot \nu_m + 4 \cdot Q_1)$                     |  | $= -[1/2 \cdot (\sigma_v - \sigma_H) \cdot \eta^2 \cdot (d / 2)^2] \cdot (3 - 4 \cdot \nu_m) / (5 - 6 \cdot \nu_m + 4 \cdot Q_1)$  |
|               | Excavation No Slip   | Thrust at Crown<br>$= N_{\text{constant}} - N_{\text{max}}$<br>Thrust at Springline<br>$= N_{\text{constant}} + N_{\text{max}}$<br>$N_{\text{constant}} = [(\sigma_v + \sigma_H) \cdot d / 2] / [2 + (1 - k_0) \cdot 2 \cdot k \cdot \beta]$<br>$N_{\text{max}} = ((\sigma_v - \sigma_H) \cdot d / 2) \cdot [(1 + (2 \cdot \nu_m \cdot Q_1)) \cdot (3 - 4 \cdot \nu_m) \cdot (1 + Q_1)]$ |  | $= -[1/4 \cdot (\sigma_v - \sigma_H) \cdot \eta^2 \cdot (d / 2)^2] / [1 + Q_2 \cdot (3 - 2 \cdot \nu_m)]$  |
|               |                      | $k = (1 - \nu_m) / ((1 - 2 \cdot \nu_m) \cdot (1 + \nu_m))$<br>$\beta = (E_m / E_L) \cdot (d / 2 \cdot \eta) / (A_L / w_L)$<br>$\eta = (\phi_{ID} + d) / (d / 2)$<br>$\phi_{ID} = (d / 2 - t_L) \cdot 2$   | $\lambda = (3 \cdot E_m) / ((1 + \nu_m) \cdot (5 - 6 \cdot \nu_m) \cdot d / 2)$<br>$Q_1 = (E_m / E_L) \cdot (1 / (1 + \nu_m)) \cdot (\eta \cdot (d / 2)^3 / (12 \cdot I))$<br>$Q_2 = (E_m / E_L) \cdot (1 / (1 + \nu_m)) \cdot ((d / 2)^3 / (12 \cdot I))$<br>$I = (w_L \cdot t_L^3) / 12 / w_L$ |  |

NOTATION:

|                                       |                                       |  |
|---------------------------------------|---------------------------------------|--|
| $\nu_m$ : Poisson's ration for ground | $A_L$ : Cross-Sectional Area of Liner | $F$ : Flexibility                          |
| $\nu_L$ : Poisson's ration for Liner  | $\gamma_m$ : Ground Unit Weight       | $k_0$ : Coefficient of Lat. Earth Pressure |
| $E_m$ : Young's Modulus for ground    | $\gamma_w$ : Water Unit Weight        | $h$ : Depth to Springline                  |
| $E_L$ : Young's Modulus for Liner     | $d$ : Diameter of Tunnel              | $h_w$ : Depth from Water Table             |
| $t_L$ : Thickness of Liner            | $I$ : Moment Inertia per Unit Length  | $R_s$ : Stiffness Factor                   |
| $w_L$ : Width of Liner                | $C$ : Compressibility                 | $S$ : Surcharge                            |

Table E-3 Sample Concrete Lining Load Calculation for a 22-ft Diameter Circular Tunnel in Soil

(a) Input Data

| Lining Properties:                        |                             | Ground Properties          |                             |
|---|-----------------------------|----------------------------|-----------------------------|
| Width =                                   | 5 ft                        | Elastic Modulus, $E_m =$   | 2.03E+06 lb/ft <sup>2</sup> |
| Thickness, $t =$                          | 1.500 ft                    | Poisson's Ratio, $n_m =$   | 0.41                        |
| Compressive Strength Concrete, $f_c =$    | 5000 psi                    | Soil Unit Weight, $g =$    | 130 lb/ft <sup>3</sup>      |
| Elastic Modulus, $E_l =$                  | 5.80E+08 lb/ft <sup>2</sup> | Water Unit Weight, $g_w =$ | 62.4 lb/ft <sup>3</sup>     |
| External Diameter (OD) =                  | 22 ft                       |                            |                             |
| Poisson's Ratio, $n_l =$                  | 0.25                        |                            |                             |
| Number of Joints =                        | 0                           |                            |                             |
| <b>Determine Thrusts and Moments for:</b> |                             |                            |                             |
| Depth to Springline =                     | 105 ft                      |                            |                             |
| Depth from water table =                  | 95 ft                       |                            |                             |
| Coeff. Lateral Pressure, $K_0 =$          | 0.7                         |                            |                             |

(b) Concrete Lining Loads Calculated from Various Analytical Solutions

| Analytical Solutions                    | Thrust at Crown/ft | Thrust at Springline/ft | Moment/ft |            |
|---|--------------------|-------------------------|-----------|------------|
| <b>Wu &amp; Penzien</b>                 |                    |                         |           |            |
| Relaxation                              | -129698            | -132731                 | -15165    |            |
| Overburden                              | -131020            | -136283                 | -26316    |            |
| <b>Einstein &amp; Schwartz</b>          |                    |                         |           |            |
| Excavation Full Slip                    | 97536              | 153444                  | -54264    |            |
| Excavation No Slip                      | 108108             | 142872                  | -50176    |            |
| <b>Peck, Hendron, &amp; Moharaz</b>     |                    |                         |           |            |
| Overburden                              | 139515             | 156634                  | -94164    |            |
| <b>Ranken, Ghaboussi, &amp; Hendron</b> |                    |                         | Crown     | Springline |
| Overpressure Case 1 (no slip)           | 117912             | 178237                  | -84545    | 89593      |
| Case 2 (full slip)                      | 139514             | 156635                  | -91640    | 96688      |
| Excavation Case 3 (no slip)             | 108105             | 142869                  | -48037    | 52315      |
| Case 4 (full slip)                      | 120554             | 130420                  | -52125    | 56403      |
| <b>Muir-Wood</b>                        |                    |                         |           |            |
| Excavation Full Slip                    | 124377             | 137264                  | -18055    |            |
| <b>Curtis</b>                           |                    |                         |           |            |
| Excavation Full Slip                    | 132119             | 138192                  | -25644    |            |
| Excavation No Slip                      | 125095             | 145216                  | -23690    |            |



## APPENDIX B.1 – ELASTIC CLOSED FORM MODELS FOR GROUND-LINING INTERACTION

The source document for Appendices B.1 and B.2 is: *Guidelines for Tunnel Lining Design* by the Technical Committee on Tunnel Lining Design of the Underground Technology Research Council, edited by T.D. O'Rourke (1984), and reproduced here, for convenience.

Several closed form models for ground-lining interaction have been developed on the basis of elastic ground and lining properties. Although the models are limited by assumptions of elasticity and specific conditions of loading, they nonetheless possess several attractive features, including their relative simplicity, sensitivity to significant ground and support characteristics, and ability to represent the mechanics of ground-lining interaction. The models are useful for evaluating the variation in lining response to changes in soil, rock, and structural material properties, in-situ stresses, and lining dimensions. However, considerable judgment must be exercised by the tunnel designer in applying these models. Their chief value lies in their ability to place bounding conditions on performance and thereby supplement the many practical considerations of tunnel operation, construction influence, and variation in ground conditions discussed in the main body of this work.

Some special characteristics of elastic closed form models are discussed by Schmidt (1984).

### A.1 Background

Most elastic closed form models are based on the assumption that the ground is an infinite, elastic, homogeneous, isotropic medium. The interaction between the ground and a circular elastic, thin walled lining is assumed to occur under plane strain conditions. The models involve either full slip or no slip conditions along the ground-lining interface.

In some models (Muir Wood, 1975; Curtis, 1976), equations have been developed for interface conditions that involve a shear strength between that of full and no slip conditions. The magnitude of the vertical stress is assumed equal to the product of the soil unit weight,  $\gamma$ , and the depth to the longitudinal centerline of the tunnel,  $H$ . The increased stress from crown to invert is not considered so that the solutions are appropriate for deep tunnels. Finite element analyses by Ranken, Ghaboussi, and Hendron (1978) and a review of analytical work by Einstein and Schwartz (1979) indicate that tunnels are sufficiently deep for application of the elastic solutions when  $H/D$  is greater than about 1.5, where  $D$  is the outside diameter of the tunnel.

The elastic models can be divided into two categories according to the conditions of in-situ stress that prevail

when the lining is installed and loaded. Work by Morgan (1961), Muir Wood (1975), Curtis' (1976), Ranken, Ghaboussi, and Hendron (1978), and Einstein and Schwartz (1979) has been based on lining response within a stressed ground mass.

This condition is commonly referred to as excavation loading. Work by Burns and Richard (1964), Hoeg (1968), Peck, Hendron, and Mohraz (1972), Dar and Bates (1974), and Mohraz, et al. (1975) has been based on lining response in a ground mass subjected to an externally applied pressure.

This condition is commonly referred to as overpressure loading.

Overpressure loading implies that the lining is installed before external loads are applied. This assumption is suitable for simulating the effects of external blasting and the placement of fill above a previously constructed tunnel. Models developed on the basis of overpressure loading do not simulate the most frequently encountered situation in which the lining is constructed in soil or rock subjected to in-situ stresses. In general, models based on overpressure loading result in higher values of thrust and moment compared to those based on excavation loading.

### A.2 Analytical Results

The analytical results derived from the work of Ranken, Ghaboussi, and Hendron (1978) for excavation loading are used in this appendix to show how moments and thrusts vary as a function of the relative stiffness between the ground and lining. The conditions of in-situ stress assumed in the model are illustrated in Figure A.1, where the vertical stress is defined as previously mentioned and the horizontal stress is defined as the product of the coefficient of earth pressure at rest,  $K_0$ , and the vertical stress. It is not possible to install a lining without some relief of in-situ stresses. The amount of stress relief will depend on the characteristics of the excavation and support process and is particularly sensitive to the distance support is installed behind the excavated face. The model therefore represents a limiting condition of restraint against inward ground movement.

It is convenient to summarize the analytical results in dimensionless form. Accordingly, the dimensionless moment, or moment coefficient is given by  $M/(\gamma HR^2)$  where  $M$  is the moment per unit length of tunnel,  $\gamma$  is the ground unit weight,  $H$  is the depth to the tunnel center line, and  $R$  is the external lining radius. Similarly, the thrust coefficient is given by  $T/(\gamma HR)$ , where  $T$  is the thrust per unit length of tunnel. The dimensionless parameters that reflect the relative stiffness between the

ground and lining are referred to as the flexibility ratio,  $F$ , and the compressibility ratio,  $C$ .

The flexibility ratio is a measure of the flexural stiffness of the ground to that of the lining. Assuming a rectangular cross-section of the lining, the flexibility ratio is defined as

$$F = (E_m / E_l) (R/t)^3 [(2(1 - \nu_l^2))/(1 + \nu_m)] \quad (\text{A.1})$$

in which  $E_m$  is the modulus of the surrounding medium, or ground,  $E_l$  is the modulus of the lining,  $t$  is the lining thickness, and  $\nu_l$  and  $\nu_m$  are the Poisson ratios of the lining and ground, respectively.

The compressibility ratio is a measure of the extensional stiffness of the ground to that of the lining. Assuming a rectangular cross-section of the tunnel lining, the compressibility ratio is defined as

$$C = (E_m / E_l) (R/t) [(1 - \nu_l^2)/((1 + \nu_m)(1 - 2\nu_m))] \quad (\text{Equation A.2})$$

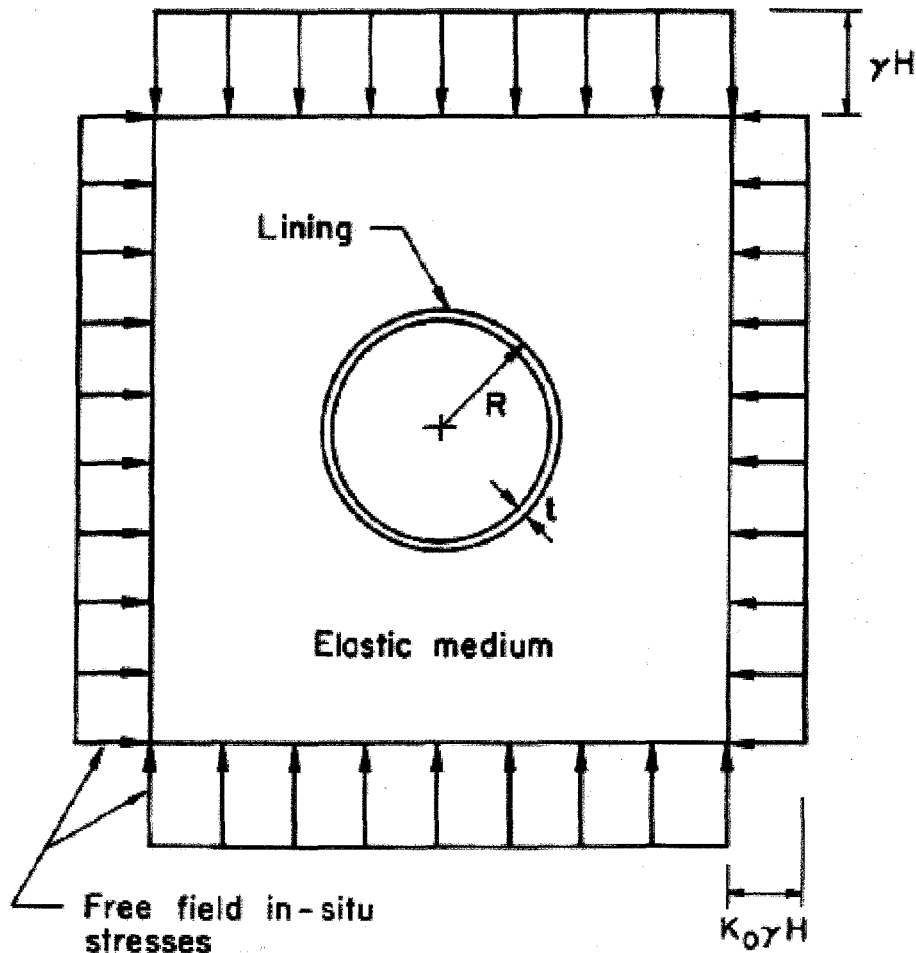

Figure A.1 Stresses and Lining Geometry for Elastic Closed Form Models of Ground-Lining Interaction

It should be pointed out that slightly different expressions for the flexibility and compressibility ratios have been used by others (e.g. Muir Wood, 1975; Einstein and Schwartz, 1979). As  $\nu_m$  approaches 0.5 in Eq. A.2, as would be the case for a fully saturated clay, the value of  $C$  approaches infinity. Einstein and Schwartz (1979) point out that this trend can be conceptually misleading, and have derived an alternative expression on the basis of slightly different assumptions.

Figure A.2 shows the maximum moment coefficient plotted as a function of  $F$  pertaining to  $K_0 = 0.5$  and  $2.0$  for full and no slip conditions. The plots represent absolute values of the moment, which achieves a maximum at the crown, springline, and invert of the tunnel. The moment coefficient diminishes rapidly as  $F$  increases to about 20. Thereafter, there is little variation in moment as the relative stiffness between ground and lining increases. The plots pertain to  $C = 0.4$  and  $\nu_m = 0.4$ .

Because neither of these parameters has a significant influence on moment, the figure may be used as a good approximation of the relationship for other values of  $C$  and  $v_m$  generally encountered in practice.

The thrust coefficient does not vary significantly as a function of  $F$  for values of  $F$  greater than about 3.

However, the thrust decreases substantially with increased  $C$  as shown in Figure A.3. This figure was developed for  $K_o = 0.5$  and  $2.0$ ,  $F = 10$ , and  $v_m = 0.4$  under full and no-slip conditions. The highest thrust occurs generally in the crown and invert, with thrusts being more pronounced for no slip as opposed to full-slip conditions. The thrust can be affected significantly by  $v_m$ . Although not shown, the curves in Figure A 2 would be displaced upward for  $v_m >$

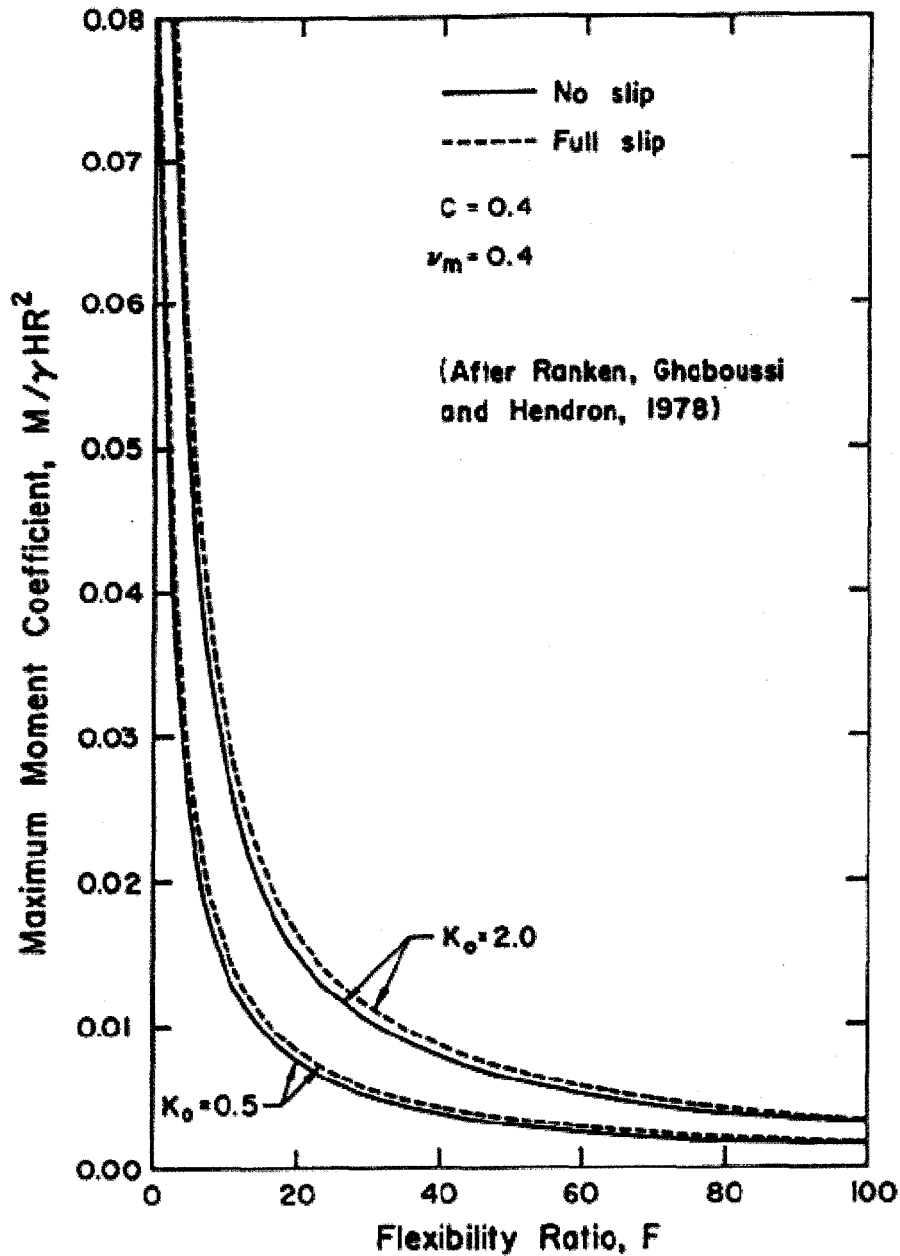

Figure A.2 – Maximum Moment Coefficient as a Function of the Flexibility Ratio

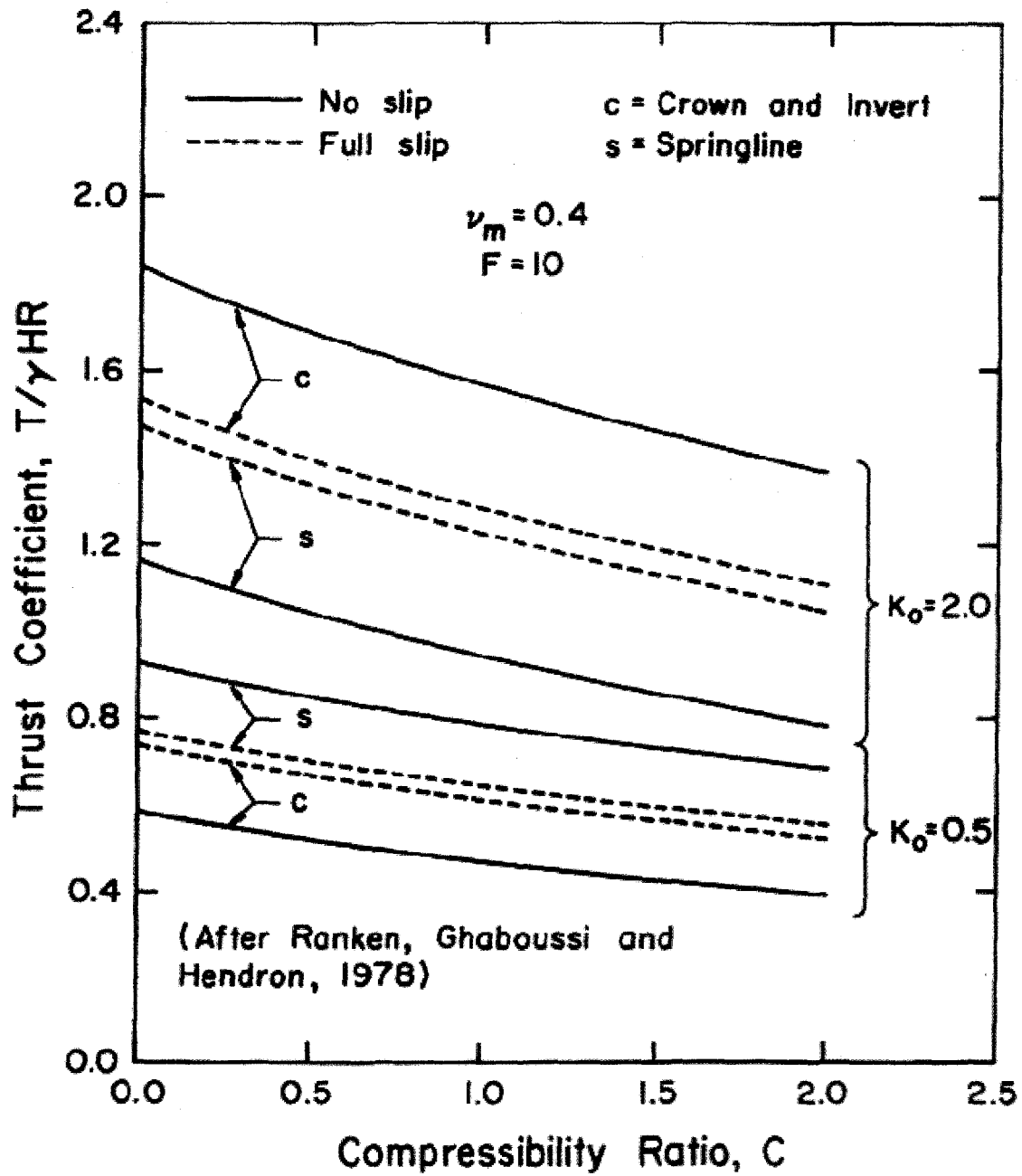

Figure A.3 – Thrust Coefficient as a Function of the Compressibility Ratio

Figures A.2 and A.3 are instructive as indicators of the qualitative behavior of flexible tunnel linings. It should, however, be recognized that quantitative values for analysis of specific cases depend considerably on the value assigned to the at-rest earth pressure coefficient,  $K_0$ , which must generally be estimated on the basis of relatively crude characterizations of actual site conditions. In sandy soils of geologically recent origin with relatively high internal friction,  $K_0$  may approximate 0.5. In overconsolidated clays,  $K_0$  will often exceed 1.0. In rocks that have been subject to complex geological processes,  $K_0$  may be extremely variable. Additional complications arise because the excavation process tends to relieve in-situ stresses adjacent to the tunnel lining. As a consequence, the lining may be subjected to a stress state significantly less than that based on the assumption of at-rest horizontal stresses and full overburden pressure.

### A.3 Applications

The equations, on which Figures A.2 and A.3 are based, were developed for linear elastic linings. Concrete linings, however, are characterized by significant nonlinear stress-strain behavior. Structural failure of a concrete lining results from crushing on the compressive face, and the load bearing capacity of the lining may significantly exceed the structural bending capacity of the section.

Linear elastic models may be biased to a relatively low assessment of the lining capacity because they tend to emphasize the bending capacity of the section.

The lining designer should recognize this bias. In Appendix B.2, the nonlinear response of a concrete lining is considered and compared with the response modeled by the linear elastic solutions.

There are many factors in addition to the effects of nonlinearity that the designer must consider. Concrete creep and the use of segmental linings may lead to an increase in the relative stiffness between the ground and lining. The relief of in-situ stresses during excavation may cause substantial reductions in pressure relative to those inferred by excavation loading. The actual ground loads may not be distributed continuously along the lining, but may be concentrated at specific locations as would be the case for gravity loads in jointed rock and soil where significant loosening is permitted. Moreover, loads from shove jacks and contact grouting as well as those associated with future construction may be more critical than the loads from ground-lining interaction.

Careful evaluation of the many factors affecting lining response requires judgment. Linear elastic models supplement judgment. As discussed previously, the models are appropriately used when they bracket the limiting conditions of performance and point out trends in lining response as a result of variations of important parameters.

## APPENDIX B.2 – LINEAR RESPONSE OF CONCRETE LININGS

As discussed in Appendix B.1, concrete linings are characterized by nonlinear stress-strain behavior so that linear elastic models may lead to results that are not consistent with actual performance. It is useful, therefore, to understand how linings are influenced by nonlinear characteristics. The moment-thrust diagram provides a means of comparing linear and nonlinear responses under similar conditions of loading and relative stiffness between the ground and concrete lining. This appendix provides a brief discussion of moment-thrust diagrams and summarizes analytical results showing the differences between lining performance modeled with linear and nonlinear concrete properties.

### B.1 Moment-Thrust Interaction Diagrams

When the thrust and moment around the lining have been calculated, it is necessary to evaluate these quantities in comparison with allowable values. Normally, it is only necessary to make this comparison at locations where one of the quantities is maximum or where there is an abrupt change in the lining section. Moment and thrust interact strongly, so it is customary to check these quantities together by using the moment thrust (M-T) interaction diagram to represent the allowable combination. The M-T interaction diagram can be drawn for each section of the lining and depends only on the section dimensions and material properties.

One way to obtain a M-T interaction diagram is to use the procedure of the ACI Code (ACI Committee 318, 1983) in which the combinations of moment and thrust, which cause failure of the section under unconfined conditions, are computed and shown on a diagram in which thrust and moment are the axes. A typical M-T diagram for one section of a tunnel lining is shown in Figure B.1. This diagram may represent all the lining sections if they have constant dimensions and composition, or several such diagrams may be used to represent different lining sections.

To determine whether the section for which the M-T diagram in Figure B.1 is adequate, the moment and thrust combination obtained in the analysis should be plotted on the diagram as shown. The ACI Code procedure for constructing the diagram provides for capacity reduction factors as a safety measure to cover uncertainties in material properties, determination of section resistance, and the difference between concrete strength from cylinder tests and the structure. If the moment and thrust combination lies inside the diagram, the section is adequate. If it lies outside the diagram, the section is not adequate. The loads on the lining may be multiplied by a load factor to give the moment and thrust combination an additional margin of safety.

### B.2 Linear and Nonlinear Response

Figure B.1 shows the difference that would be obtained between linear and nonlinear analyses for a lining section composed of reinforced concrete. In the figure, the moment-thrust paths are plotted for two different conditions of relative stiffness between the ground and lining. The nonlinear and linear paths, which intersect the interaction diagram below the balance point, pertain to a flexibility ratio less than that for the paths that intersect above the balance point. Each path is the locus of moment and thrust combinations corresponding to a given type of loading. As discussed in Chapter 3 and Appendix A, the loading and attendant ground-lining interaction may be modeled by means of excavation, overpressure, or gravity loading.

When linear analyses are performed, the material stress-strain response must follow a linear relationship even though the actual stresses carried by the lining may be well above the analytical values. Linear analyses are usually used to design above ground structures, with the understanding that linear assumptions are conservative. The error resulting from using linear analysis for a tunnel lining will be more pronounced than for an above ground structure because the confinement and greater indeterminacy of the underground structure provide more opportunity for moment redistribution.

As the nonlinear moment-thrust path in Figure B.1 intersects the interaction diagram below the balance point, the concrete cracks and the eccentricity decreases resulting in a higher value of thrust (point 2) than would be obtained in the linear analysis (point 1). The section has additional capacity even after the moment-thrust path has reached the envelope, and the thrust continues to increase even though the moment capacity drops off (point 3). Above the balance point, the thrust capacity calculated by nonlinear analysis will be closer to that calculated by linear analysis, as evidenced by comparing the percentage difference between points 4 and 5 with that of points 1 and 3.

A key aspect of the lining response, which is shown by nonlinear analysis, is that the concrete tunnel lining does not fail by excessive moment. It fails by thrust which is affected indirectly by moment.

Figure B.2 helps illustrate the general conditions summarized in Figure B.1 by means of a specific example. The figure shows the moment thrust interaction diagram for a 9-in. (230 mm)-thick concrete lining section. A one-foot length (305 mm) of a continuous lining with no reinforcing steel is considered. Also shown on the graph are moment thrust paths for the crown

obtained from analyses of an 18-ft (5.5 m)-diameter circular lining with the same cross-section as that used to draw the interaction diagram. A uniform gravity load was applied across the tunnel diameter as shown in the figure. Nonlinear geometric and material properties of the lining were modeled, as described by Paul, et al. (1983). The analyses were performed using a beam-spring simulation in which the ratio of the tangential to radial spring stiffness was one fourth. Analyses were performed with spring stiffness corresponding to moduli of the surrounding medium of 111,000 and 1,850,000 psi (770 and 12,800 MN/m<sup>2</sup>), representing soft and medium hard rock. The increased capacity associated with increased stiffness of the media illustrated by the nearly two-fold difference in maximum thrust for the two cases. When the moment and thrust are below the balance point, the thrust capacity from nonlinear analysis exceeds that from

linear analysis by four times. When the moment-thrust paths intersect the M-T diagram above the balance point, the difference in maximum thrust between the linear and nonlinear analyses is only about 10 percent.

It should be emphasized that nonlinear analysis is subject to virtually all constraints that apply for linear models. As discussed in Appendix A, there are many additional factors the designer must consider, covering variations in material properties, ground loading, and construction methods. Nevertheless, nonlinear analysis provides insight regarding the manner in which the concrete lining deforms and shares load with the surrounding ground. The results of nonlinear modeling may be especially useful for moment and thrust combinations below the balance point, where linear evaluations tend to underestimate the load carrying capacity by a significant margin.

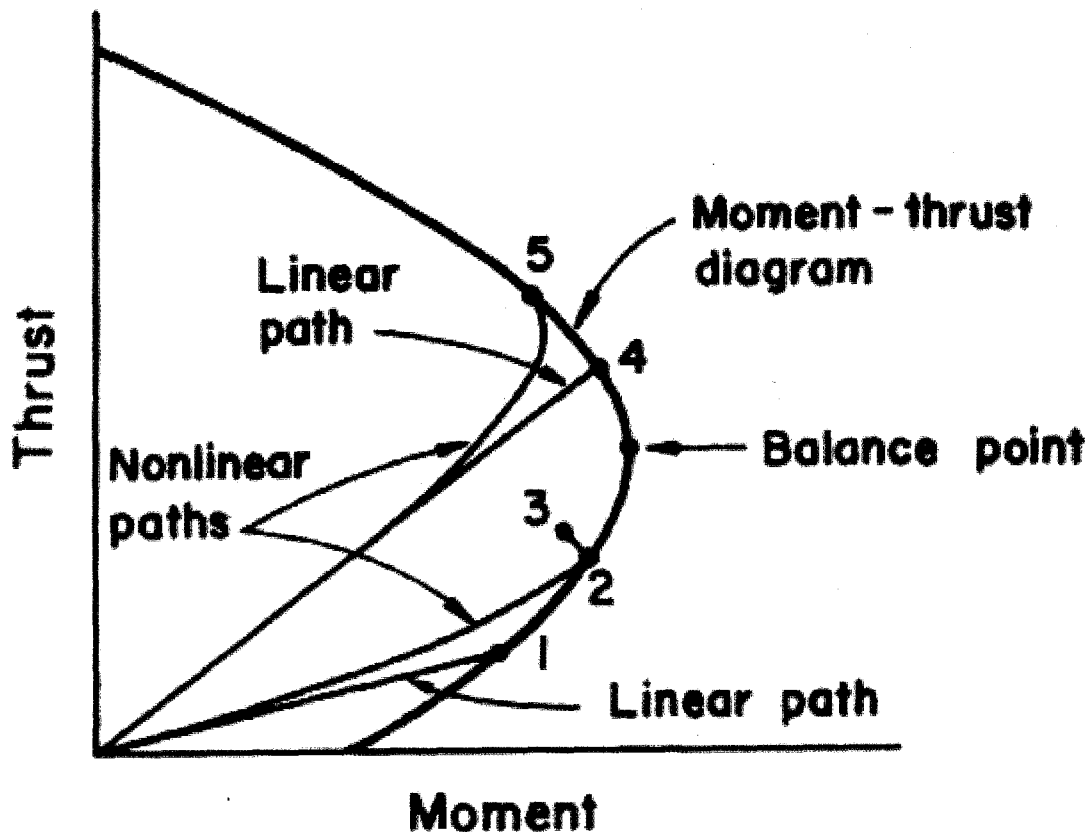

Figure B.1 -- General Moment-Thrust Diagram for a Reinforced Concrete Lining with Linear and Nonlinear Moment-Thrust Paths.

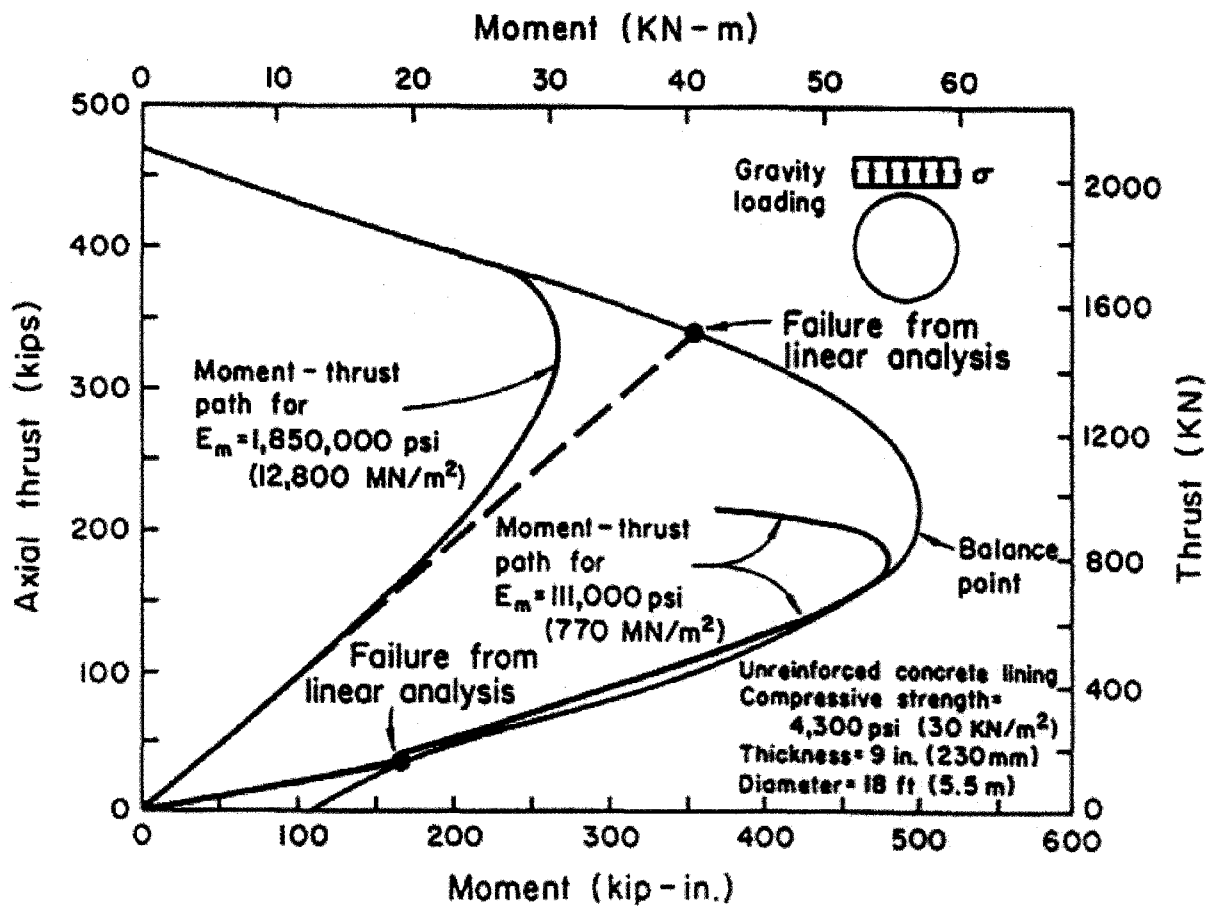

Figure B.2 - Moment-Thrust Paths for an Unreinforced Concrete Lining in Rock.



# **Appendix F**

## **Sequential Excavation Method Example**

This page is intentionally left blank.

## Appendix F – Sequential Excavation Method Example

The calculation example involves the tunneling analysis and lining design of a typical two-lane highway tunnel using the finite element code Phase2 by Rocscience, Inc. The calculation is carried out in stages and follows the approach laid out in 9.7.2.3 above and evaluates ground reaction as indicated in 9.7.2.4 and evaluates support elements as described in 9.7.2.5 and 9.7.2.6.

In this example, homogeneous, isotropic ground conditions are assumed. The constitutive model is based on the Mohr-Coulomb failure criterion. Table 9-6 displays each calculation stage in a left column, typical output graphics in the middle column and further explanations and comments in the right column. The calculation is for a SEM tunnel that uses a top heading and bench excavation sequence. After each excavation step (top heading and bench) the initial support elements are installed and consist of rock dowels and an initial shotcrete lining.



After establishing the initial, geostatic stress conditions in Stage 1, the excavation and installation of initial support is carried out in stages 2 through 5. The tunnel final lining installation occurs in stage 6. For simplicity, it is assumed that the initial lining will deteriorate completely and all ground loads will be imposed onto the final lining in stage 6. No other loading conditions such as ground water loads or seismic loading are included in this example.

The structural capacity of the initial and final linings is evaluated using so called Capacity Limit Curves or “CLCs.” The calculated section force combinations N-M, i.e., initial or final lining normal forces N and lining bending moments M are graphed onto charts where the CLCs denote the capacity of the structural lining section in accordance with ACI 318.

Section force combinations N-M are obtained from each finite element included in the representation of the lining (beam or shell) in the numerical modeling. The capacity of the lining is displayed in accordance with ACI 318 considering lining thickness, concrete (shotcrete) design strength, and structural reinforcement of the lining section. Steel fibers are used for the structural reinforcement of the shotcrete initial lining and conventional, deformed bars are used for the reinforcement of the concrete linings.

The example is presented in a tabulated format (Table F-1) as follows. Note the last row of Table F-1 represents the capacity limit curves for both the initial shotcrete and final concrete linings. All N-M (normal force-bending moment) combinations represented by dots fall well within the enveloping CLCs indicating that in this example the linings as designed will provide sufficient capacity for the anticipated ground conditions and associated ground loads.

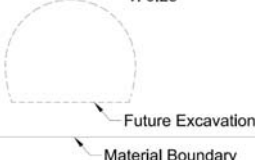
TABLE F-1 SEM Calculation Example for a Two-Lane Highway Tunnel in Rock

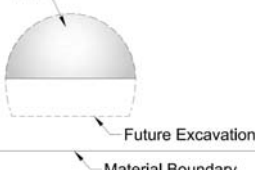
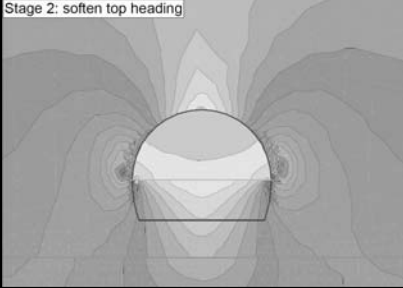
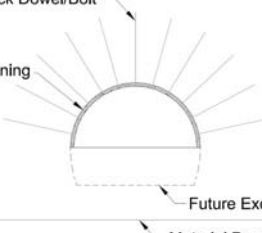
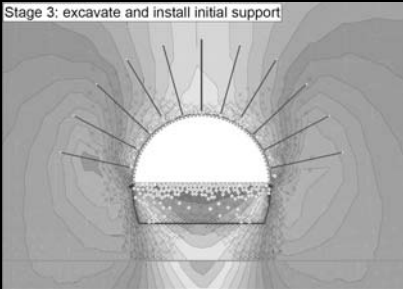

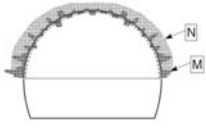
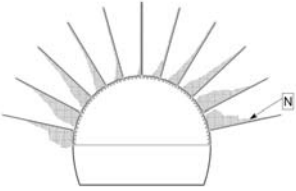
|   |   |  |
|---|---|--|
| <p><b>Stage 1:</b> This stage assesses the in-situ, geostatic stress conditions prior to the tunnel construction. It considers the unit weight of the ground material, lateral loads dictated by the lateral earth pressure coefficient, any tectonic stresses and overburden loads. Main input parameters involve unit weight (<math>\gamma</math>), modulus of elasticity (E), friction angle (<math>\phi</math>), cohesion (c) and Poisson's Ratio (<math>\nu</math>). This stage is considered to be the 'initial stage' of the model prior to any tunnel excavation.</p>   |   |  |
| <p>Stage 1: in-situ stresses</p> <p>Material Properties<br/> <math>\gamma</math>: 0.024 MN/m<sup>3</sup><br/> E: 3000 MPa<br/> <math>\Phi</math>: 27.5°<br/> c: 0.0096 MPa<br/> <math>\nu</math>: 0.25</p>  <p>Future Excavation<br/>Material Boundary</p>   | <p>Stage 1: in-situ stresses</p>                        | <p>Stage 1: Geostatic Stress Conditions</p> <p>Output Options: Ground Stresses and Deformations</p> <p>Output Shown: Major Principal Ground Stress Sigma 1</p>   |
| <p><b>Stage 2:</b> The tunnel excavation causes ground relaxation and ground deflection related to it occurs ahead of the advancing tunnel construction face and around the tunnel. While this relaxation causes ground deflection and surface settlements near excavations, the ground movement also mobilizes shear resistance in the ground. This ground relaxation due to the excavation process before support installation associated with the excavated round length is approximated by "softening" the material within the top heading; the ground material within the top heading is softened by reducing the stiffness of the material by 0.4 – 0.6 times the actual ground modulus (<math>E_{actual}</math>).</p>  |   |  |
| <p>Stage 2: soften top heading</p> <p><math>E_{softened} = 0.4-0.6 \times E_{actual}</math></p>  <p>Future Excavation<br/>Material Boundary</p>  | <p>Stage 2: soften top heading</p>                     | <p>Stage 2: Excavation of the Top Heading</p> <p>Output Options: Ground Stresses and Deformations</p> <p>Output Shown: Major Principal Ground Stress Sigma 1 (Note stress relaxation above the tunnel and stress concentration around top heading sidewalls and temporary invert)</p>  |
| <p><b>Stage 3:</b> In this step the ground elements in the top heading are removed and the initial support elements including shotcrete and rock dowels/bolts are inserted. This leads to a new equilibrium where the initial support elements support the tunnel opening. The shotcrete is modeled using beam elements and the dowels/bolts are modeled using elements that may be loaded in axial loading only. To simulate the early age of the shotcrete its elastic modulus is reduced to one third (1/3) of its final, 28-day design strength. The shotcrete reaches its full strength in the next stage. The initial shotcrete lining capacity is verified in accordance with ACI 318 using Capacity Limit Curves.</p> |   |  |
| <p>Stage 3: excavate and install initial support</p> <p>Rock Dowel/Bolt<br/>Initial Lining</p>  <p>Future Excavation<br/>Material Boundary</p>   | <p>Stage 3: excavate and install initial support</p>  | <p>Stage 3: Installation and Loading of Initial Support in the Top Heading (Shotcrete and dowels/bolts)</p> <p>Output Options: Ground Stresses, Deformations of Ground and Linings, Section Forces (N, M) in Shotcrete Lining, Loads in Rock Dowels/Bolts</p> <p>Output Shown:</p> <ul style="list-style-type: none"> <li>- Major Principal Ground Stress Sigma 1</li> <li>- Shotcrete Lining Force Diagram: <ul style="list-style-type: none"> <li>- N – Axial Force</li> <li>- M – Bending Moment</li> </ul> </li> <li>- Dowel/Bolt Forces:</li> </ul> |

|  |   |                          |
|--|---|--------------------------|
|  | <p>N and M - top heading excavation</p>  | <p>- N – Axial Force</p> |
|  | <p>N - top heading excavation</p>        |                          |

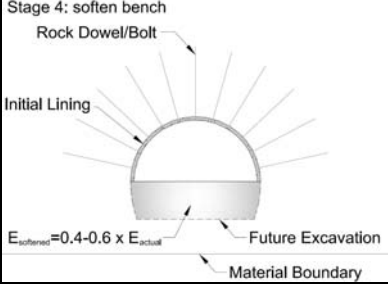
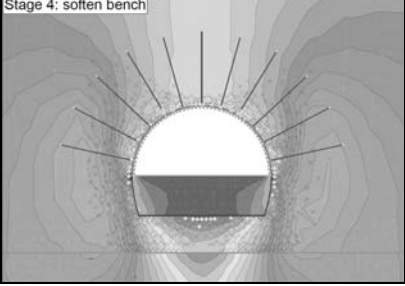
**Stage 4:** Similar to Stage 2 the tunnel excavation in the bench will cause ground relaxation and ground deflection. This ground relaxation due to the excavation process before support installation is approximated by “softening” the material within the bench; the ground material within the bench is softened by reducing the stiffness of the material by 0.4 – 0.6 times the actual ground modulus ( $E_{actual}$ ).

|   |  |  |
|---|--|--|
| <p>Stage 4: soften bench</p>  | <p>Stage 4: soften bench</p>  | <p>Stage 4: Excavation of the Top Heading</p> <p>Output Options: Ground Stresses, Deformations of Ground and Linings, Section Forces (N, M) in Shotcrete Lining (Top Heading), Loads in Rock Dowels/Bolts (Top Heading)</p> <p>Output Shown: Major Principal Ground Stress <math>\sigma_1</math></p> |
|---|--|--|

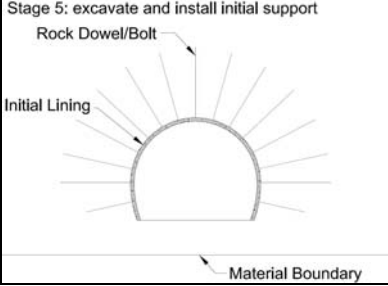
**Stage 5:** Similar to Stage 3 the ground elements in the bench are removed and the initial support elements including shotcrete and rock dowels/bolts are inserted in the bench.

|  |   |   |
|--|---|---|
| <p>Stage 5: excavate and install initial support</p>  | <p>Stage 5: excavate and install initial support</p>  | <p>Stage 5: Installation and Loading of Initial Support in the Bench (Shotcrete and dowels/bolts)</p> <p>Output Options: Ground Stresses, Deformations of Ground and Linings, Section Forces (N, M) in Shotcrete Lining, Loads in Rock Dowels/Bolts</p> <p>Output Shown:</p> <ul style="list-style-type: none"> <li>- Major Principal Ground Stress <math>\sigma_1</math></li> <li>- Shotcrete Lining Force Diagram: <ul style="list-style-type: none"> <li>- N – Axial Force</li> <li>- M – Bending Moment</li> </ul> </li> <li>- Dowel/Bolt Forces: <ul style="list-style-type: none"> <li>- N – Axial Force</li> </ul> </li> </ul> |
|--|---|---|

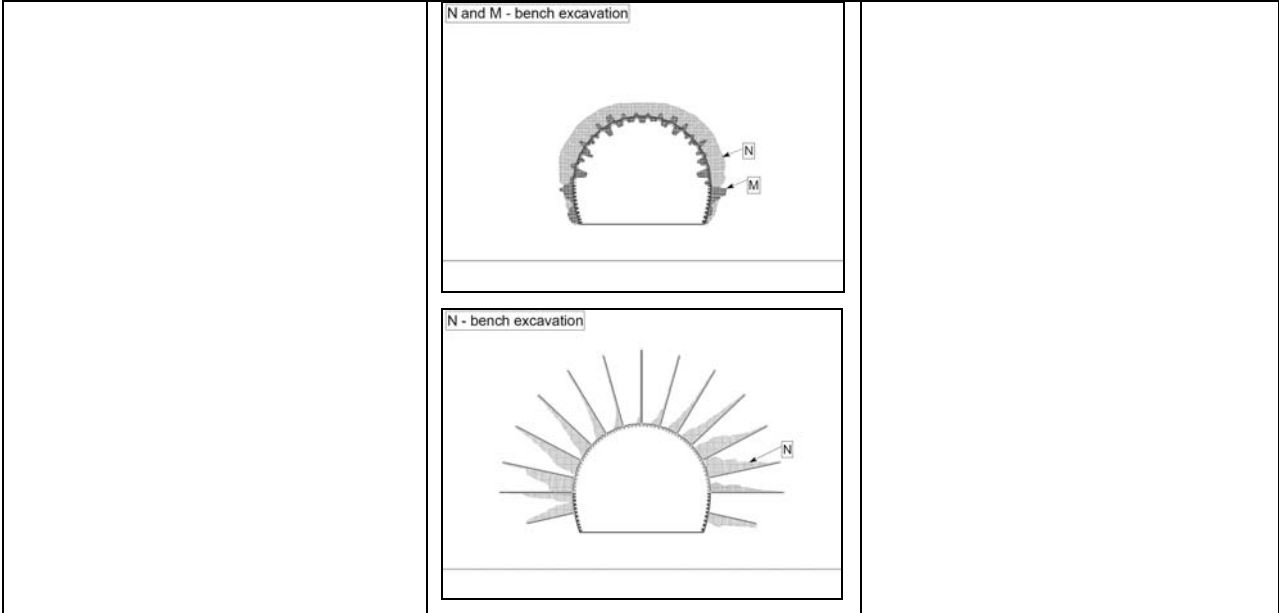

**Stage 6:** This stage involves installation of the concrete final lining beam elements. These are inserted into a stress free state as all ground loads are supported by the initial support elements. A “slip” layer is simulated between the shotcrete and concrete lining beam elements. This layer will allow transfer of radially acting forces only thus representing the waterproofing membrane layer between the linings that is incapable of transferring shear forces. In this example it is assumed that over time, the initial shotcrete lining and rock dowels/bolts deteriorate and all loads need to be supported by the final lining. To simulate this phenomenon, the initial lining elements (i.e. shotcrete and rock dowels/bolts) are removed from the model thus loading the final lining. The final concrete lining capacity is verified in accordance with ACI 318 using Capacity Limit Curves.

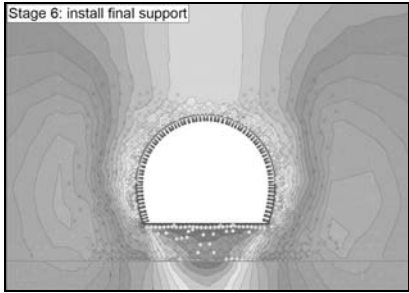
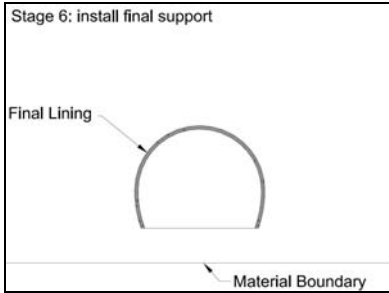

Stage 6: Installation and Loading of Final Concrete Lining by Removing all Initial Support elements in the Top Heading and Bench (Shotcrete and dowels/bolts)

Output Options: Ground Stresses, Deformations of Ground and Linings, Section Forces (N, M) in Shotcrete Lining

Output Shown:

- Major Principal Ground Stress  $\sigma_1$
- Concrete Lining Force Diagram:
  - N – Axial Force
  - M – Bending Moment
- Dowel/Bolt Forces:
  - N – Axial Force

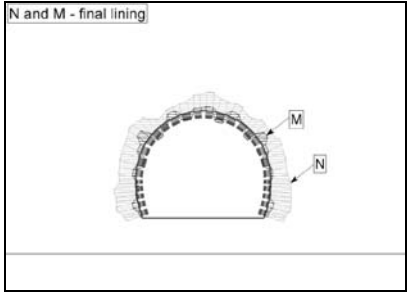

**Stage 3:** Initial Lining Limit Capacity Curve as per ACI 318-99.

**Stage 6:** Final Lining Limit Capacity Curve as per ACI 318-99.

Concrete Tunnel Lining Design to ACI318-99: M-N Interaction Chart

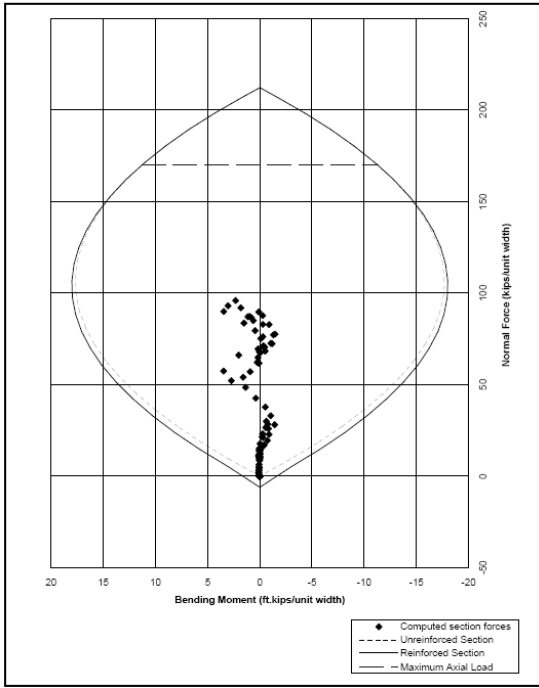

Concrete Tunnel Lining Design to ACI318-99: M-N Interaction Chart

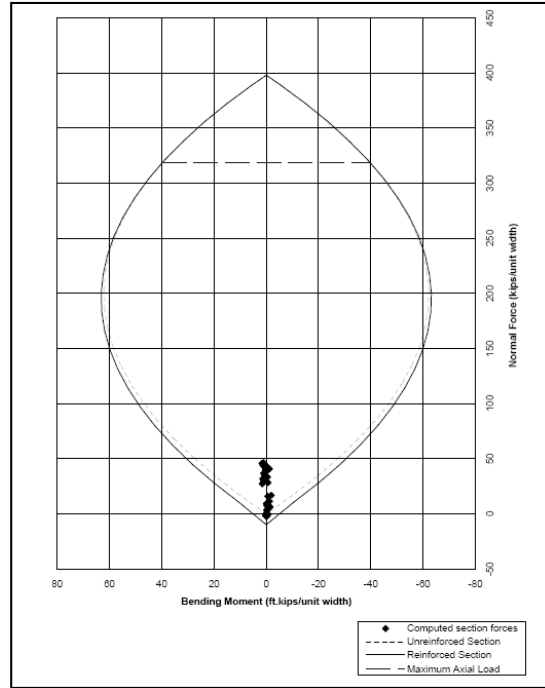

This page is intentionally left blank.



# **Appendix G**

## **Precast Segmental Lining Example**

This page is intentionally left blank.

**APPENDIX G**  
**PRECAST SEGMENTAL LINING DESIGN EXAMPLE**

**INTRODUCTION**

The following design example is intended to illustrate the application of the AASHTO LRFD Specifications to the design of a precast segmental concrete tunnel lining. The design scenario involves a tunnel constructed in soft ground using a tunnel boring machine. The roadway typical section approaching the tunnel is a 4-lane highway with full shoulders and a median. The four lanes will be accommodated in two openings, each carrying two lanes of traffic. The tunnel section therefore will be sized to carry two 12'-0" traffic lanes with reduced shoulders on both sides. A 3'-3" wide walkway for maintenance will be included in the typical section. Emergency egress will be accommodated either at the roadway level using the shoulders provided or through the adjacent bore. Access to the adjacent bore will be gained through cross passages located every 500' along the tunnel alignment. The tunnel will utilize jet fans in a longitudinal ventilation system. The jet fans will be suspended from the tunnel liner.

The analysis of the liner structure will be performed using the beam-spring model described in paragraph 10.???.??.

Figure 10E-1 provides the details of the typical section used in the example.

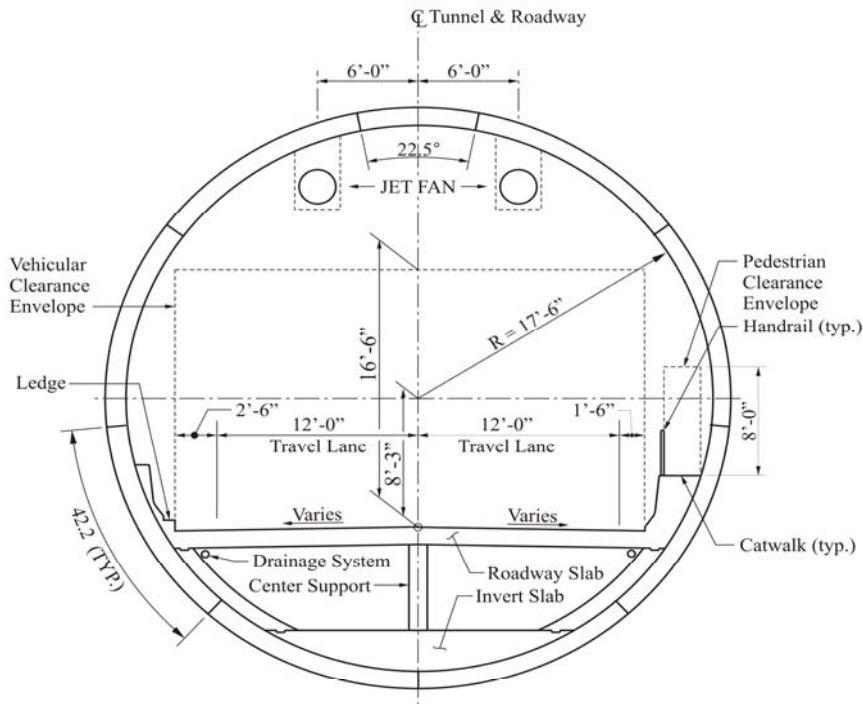

**Figure 10E-1**  
Design Example Typical Section

A typical dimension along the longitudinal axis of the tunnel for the segments is 5'-0". The structural analysis and modeling shown in the following sections of this design example will be based on a five foot length of tunnel. As applied loads and spring constants will be multiplied by 5 to account for the fact that the design section is five feet long.



**APPENDIX G**  
**PRECAST SEGMENTAL LINING DESIGN EXAMPLE**

---

---

**DETERMINE MODEL INPUT DATA**

This section illustrates the development of the data required by most general purpose structural analysis programs. This type of program is required for the beam spring analysis used in this design example. Note that paragraph 4.4 of the AASHTO LRFD specifications describes the acceptable methods of structural analysis. The computer model used in this example for the analysis utilizes a matrix method of analysis which falls into the classical force and displacement category listed in paragraph 4.4. Paragraph 4.5 of the AASHTO LRFD specification describes the mathematical model requirements for analysis. This paragraph states that the model shall include loads, geometry and material behavior of the structure. The input required for these elements will be described below and include the calculation of loads, joint coordinates, the magnitude of the load at each joint, the modulus of elasticity of the concrete and the cross sectional area and moment of inertia of the liner segments.

Paragraph 4.5.1 of the AASHTO LRFD specifications also says that the model shall include the response characteristics of the foundation where appropriate. Since the surrounding ground is an integral part of the structural lining, the response characteristic of the ground is modeled by the springs installed in the model.

**CALCULATE JOINT COORDINATES:**

Joint coordinates are calculated along the centroid of the lining segments. In order to calculate the joint coordinates for the initial analysis runs, a lining thickness must be assumed. If the lining thickness changes as a result of the design process, the analysis should be re-run using the parameters associated with the revised lining thickness. This process continues until the lining thickness will support the loads effects from the analysis.

Assume a lining thickness = 16 "                      Radius to centroid of the lining ( $r_0$ ) = 18.17 ft

Joint coordinates are calculated as:

Y coordinate =  $r_0 \times \sin\alpha$                       X coordinate =  $r_0 \times \cos\alpha$                       See Figure 2

In order to keep the model mathematically stable, use a chord length between joint coordinates approximately equal to 1.5 times the thickness of the liner. See paragraph 10.7 of the manual.

For a radius  $r_0$  = 18.17 ft    the angle subtended by chord length of  $c$  =  $2\sin^{-1}(c/2r_0)$

For chord length = 2.00 ft    subtended angle = 6.31 degrees

Number of joints =  $360 / 6.31 = 57$  say 72 joints at 5 degrees between joints.

72 joints was selected to provide analysis results at the invert, crown and springlines.

Tabulation of Joint Coordinates at the centroid of the lining:

**APPENDIX G**  
**PRECAST SEGMENTAL LINING DESIGN EXAMPLE**

| Joint | $\alpha$<br>(deg) | x<br>(ft) | y<br>(ft) | Joint | $\alpha$<br>(deg) | x<br>(ft) | y<br>(ft) |
|-------|-------------------|-----------|-----------|-------|-------------------|-----------|-----------|
| 1     | 0                 | 18.17     | 0.00      | 37    | 180               | -18.17    | 0.00      |
| 2     | 5                 | 18.10     | 1.58      | 38    | 185               | -18.10    | -1.58     |
| 3     | 10                | 17.89     | 3.15      | 39    | 190               | -17.89    | -3.15     |
| 4     | 15                | 17.55     | 4.70      | 40    | 195               | -17.55    | -4.70     |
| 5     | 20                | 17.07     | 6.21      | 41    | 200               | -17.07    | -6.21     |
| 6     | 25                | 16.46     | 7.68      | 42    | 205               | -16.46    | -7.68     |
| 7     | 30                | 15.73     | 9.08      | 43    | 210               | -15.73    | -9.08     |
| 8     | 35                | 14.88     | 10.42     | 44    | 215               | -14.88    | -10.42    |
| 9     | 40                | 13.92     | 11.68     | 45    | 220               | -13.92    | -11.68    |
| 10    | 45                | 12.85     | 12.85     | 46    | 225               | -12.85    | -12.85    |
| 11    | 50                | 11.68     | 13.92     | 47    | 230               | -11.68    | -13.92    |
| 12    | 55                | 10.42     | 14.88     | 48    | 235               | -10.42    | -14.88    |
| 13    | 60                | 9.08      | 15.73     | 49    | 240               | -9.08     | -15.73    |
| 14    | 65                | 7.68      | 16.46     | 50    | 245               | -7.68     | -16.46    |
| 15    | 70                | 6.21      | 17.07     | 51    | 250               | -6.21     | -17.07    |
| 16    | 75                | 4.70      | 17.55     | 52    | 255               | -4.70     | -17.55    |
| 17    | 80                | 3.15      | 17.89     | 53    | 260               | -3.15     | -17.89    |
| 18    | 85                | 1.58      | 18.10     | 54    | 265               | -1.58     | -18.10    |
| 19    | 90                | 0.00      | 18.17     | 55    | 270               | 0.00      | -18.17    |
| 20    | 95                | -1.58     | 18.10     | 56    | 275               | 1.58      | -18.10    |
| 21    | 100               | -3.15     | 17.89     | 57    | 280               | 3.15      | -17.89    |
| 22    | 105               | -4.70     | 17.55     | 58    | 285               | 4.70      | -17.55    |
| 23    | 110               | -6.21     | 17.07     | 59    | 290               | 6.21      | -17.07    |
| 24    | 115               | -7.68     | 16.46     | 60    | 295               | 7.68      | -16.46    |
| 25    | 120               | -9.08     | 15.73     | 61    | 300               | 9.08      | -15.73    |
| 26    | 125               | -10.42    | 14.88     | 62    | 305               | 10.42     | -14.88    |
| 27    | 130               | -11.68    | 13.92     | 63    | 310               | 11.68     | -13.92    |
| 28    | 135               | -12.85    | 12.85     | 64    | 315               | 12.85     | -12.85    |
| 29    | 140               | -13.92    | 11.68     | 65    | 320               | 13.92     | -11.68    |
| 30    | 145               | -14.88    | 10.42     | 66    | 325               | 14.88     | -10.42    |
| 31    | 150               | -15.73    | 9.08      | 67    | 330               | 15.73     | -9.08     |
| 32    | 155               | -16.46    | 7.68      | 68    | 335               | 16.46     | -7.68     |
| 33    | 160               | -17.07    | 6.21      | 69    | 340               | 17.07     | -6.21     |
| 34    | 165               | -17.55    | 4.70      | 70    | 345               | 17.55     | -4.70     |
| 35    | 170               | -17.89    | 3.15      | 71    | 350               | 17.89     | -3.15     |
| 36    | 175               | -18.10    | 1.58      | 72    | 355               | 18.10     | -1.58     |

**APPENDIX G**  
**PRECAST SEGMENTAL LINING DESIGN EXAMPLE**

Figure 10E-2 shows the arrangement of joints and members for the computer model.

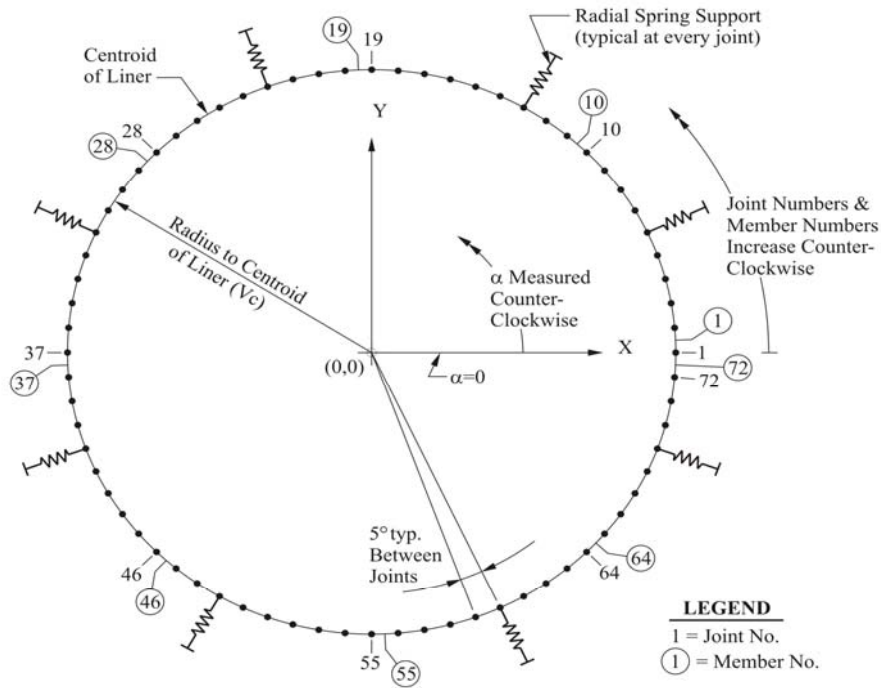

**Figure 10E-2**  
 Joints & Members - Computer Model

APPENDIX G  
PRECAST SEGMENTAL LINING DESIGN EXAMPLE

---

---

CALCULATE SPRING CONSTANTS

The subsurface investigation revealed that the tunnel alignment traverses a very stiff clay.

The modulus of subgrade reaction of the clay supplied by the subsurface investigation program is **22 kcf**.

Spring constants can be determined based on tributary projections on the x and y axis of each joint or alternately, if the analysis software being used supports the use of radial springs, then all spring constants will be the same. The following formulas can be used to determine spring constants.

For orthogonal springs:

Spring constant in the Y direction =  $K_s(X_n + X_{n+1})/2$

Spring constant in the X direction =  $K_s(Y_n + Y_{n+1})/2$

Where:

Where:

$$X_n = |(x_n - x_{n+1})|$$

$$Y_n = |(y_n - y_{n+1})|$$

$$X_{n+1} = |(x_{n+1} - x_{n+2})|$$

$$Y_{n+1} = |(y_{n+1} - y_{n+2})|$$

In the above equations:

The coordinates for joint N =  $(x_n, y_n)$

The coordinates for joint N+1 =  $(x_{n+1}, y_{n+1})$

The coordinates for joint N+2 =  $(x_{n+2}, y_{n+2})$



**APPENDIX G**  
**PRECAST SEGMENTAL LINING DESIGN EXAMPLE**

Figure E10-3 is a graphic representation of the above calculations of orthogonal spring constants.

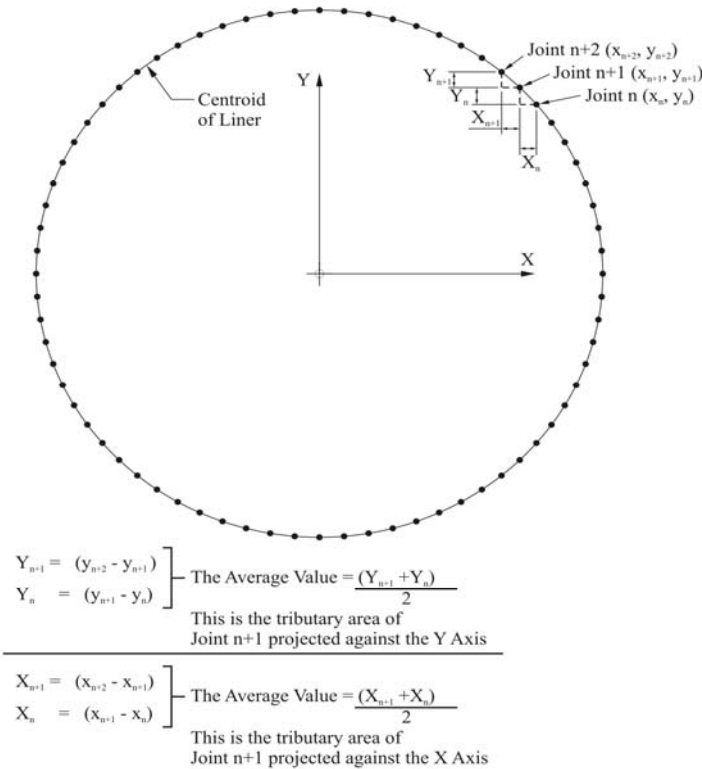

**Figure E10-3**  
Spring Constant Computation

The above computation for orthogonal spring constants uses the coordinates of the joints calculated as input for the model. Since these joints lie along the centroid of the lining and not the outside face where the contact with the surrounding ground occurs, the spring constants calculated using this method should be modified to more closely approximate the resistance provided by the surrounding ground. The modification factor would be the ratio of the outside radius to the radius at the centroid. For this example, the modification factor would be calculated as follows:

|                                     |                      |
|-------------------------------------|----------------------|
| Radius at centroid = $r_c$ =        | 18.17 ft             |
| Radius at outside face = $r_o$ =    | 18.83 ft             |
| Modification factor = $r_o / r_c$ = | 18.83 / 18.17 = 1.04 |

For radial springs, since a one foot length of tunnel is being modeled, the computation of the tributary area for each joint is the same and is the length of the arc between joints.

This tributary area can be calculated as  $\pi r_o \alpha / 180$

Where:

|            |  |   |          |
|------------|--|---|----------|
| $r_o$ =    | Radius to the outside face of the lining | = | 18.83 ft |
| $\alpha$ = | Angle subtended between joints           |   |          |

**APPENDIX G**  
**PRECAST SEGMENTAL LINING DESIGN EXAMPLE**

---

---

It is important to use the outside radius of the tunnel when calculating spring constants since this is the face that is in contact with the surrounding ground.

For this example, the tributary area =  $3.14159 \times 18.83 \times 4 / 180 = 1.31481 \text{ ft}^2$

| Clay   | $E_s$<br>(kcf) | Radial Spring Constant<br>(k/ft) |   |
|--------|----------------|----------------------------------|---|
| Gneiss | 4000           | 5259.3                           | Run analysis using the values shown for |
| Marble | 2500           | 3287                             | Gneiss and Marble to bracket the actual |
| Schist | 750            | 986.11                           | ground conditions.                      |

When running the computer model, only springs that are in compression are considered active. A spring is in compression if the joint displacements at the location of that spring indicate movement away from the center of the tunnel. Joint displacements toward the center of tunnel indicate movement away from the ground and the spring at that location should not be active in the model. The analysis is performed with an initial assumption of active and non active springs. The results of the analysis, specifically the joint displacements are examined to determine if the spring assumptions correspond with the output values. If the correspondence does not match, then the assumptions for the springs is adjusted and the analysis re-run. This procedure continues until a solution is obtained where the input values for the springs matches the output values for the joint displacements.

Many computer programs will perform this iterative process automatically. For programs that do not support an automatic adjustment, it is useful to model the springs as orthogonal springs. Modeling the springs this way makes it easier to determine if a joint is moving toward or away from the center of the tunnel since each component of the movement (x and y) can be examined separately and the direction of the movement ascertained by inspection. When using orthogonal springs, each spring component is adjusted separately.

APPENDIX G  
PRECAST SEGMENTAL LINING DESIGN EXAMPLE

---

---

CALCULATE LINER SECTION PROPERTIES

Segment Thickness = 16 in                      Segment Length = 5 ft = 60 in

As described in section 10.?? the joints in the liner segments will act to reduce the stiffness of the ring.

Formula for reducing stiffness is as follows:  $I_c = I_j + I*(4/n)^2$  (Formula 10 - ??)

where  $I_c$  is modified I  
n is number of joints (more than 4)  
 $I_j$  is joint stiffness - conservatively taken as zero

Unmodified Moment of Inertia =  $60 \times 16^3 / 12 = 20480 \text{ in}^4$

Number of Joints = 9

Reduced Moment of Inertia =  $20480 \times (4/9)^2 = 4045.4 \text{ in}^4$

Segment Area =  $(16.0 / 12) \times 5 = 6.67 \text{ ft}^2$

Assume concrete strength = **5000** psi

AASHTO LRFD specification paragraph 5.4.2.4 provides the method for the calculation of the modulus of elasticity.

$$E_c = 33,000K_1w_c^{1.5}\sqrt{f'_c}$$

Where:

$K_1 = 1.0$   
 $w_c = 145 \text{ pcf}$  (AASHTO LRFD specification Table 3.5.1-1)  
 $f'_c = 5000 \text{ psi}$   
 $E_c = 4074281 \text{ psi}$

Poisson's Ratio is given in AASHTO LRFD specification paragraph 5.4.2.5 as 0.2.

**APPENDIX G**  
**PRECAST SEGMENTAL LINING DESIGN EXAMPLE**

---

---

**CALCULATE LOADS:**

The soil load and the hydrostatic pressure are applied to the outside face of the tunnel lining. The structural model is built at the centroid of the lining. Therefore, the surface area to which the rock and hydrostatic loads are applied is larger than the surface area along the centroid the model. The surface area at the location of the centroid is directly proportional to the surface area at the outside face in the ratio of the radius of the outside face to the radius at the centroid. To account for this difference between the modeled area and the actual area and to include the full magnitude of the applied loads, multiply the rock and hydrostatic loads by the ratio of outside radius to centroidal radius.

$$\begin{aligned} \text{Radius to Centroid } (r_c) &= 18.17 \text{ ft} \\ \text{Radius to Outside face } (r_o) &= 18.83 \text{ ft} \end{aligned}$$

$$\text{Multiply Loads Applied to Outside of Tunnel by } r_o/r_c: \quad 18.83 / 18.17 = 1.037$$

**Calculate Hydrostatic Loads:**

$$\text{Hydrostatic head at the tunnel invert} = \quad \quad \quad \mathbf{40} \text{ ft} = \quad 2.50 \text{ ksf}$$

Hydrostatic Load from ground water is applied to the outside of the tunnel.

$$\text{Value at the invert} = \quad 2.50 \quad \text{ksf}$$

$$\text{Applied amount} = \quad 2.50 \quad \times \quad 1.037 \quad \times \quad 5 \quad = \quad 12.94 \text{ ksf} \quad \text{Where 5' is the length of the segment}$$

The water pressure magnitude at each joint is calculated based on the distance of the joint from the invert:

$$\text{Magnitude of the hydrostatic pressure at joint } j = [\text{Value at invert} - (y_{\text{invert}} - y_j)] \times 62.4] \times r_o/r_c \times \text{segment length}$$

Where:

$y_{\text{invert}}$  = the y coordinate of the joint at the tunnel invert

$y_j$  = the y coordinate of the joint at which the hydrostatic pressure is being calculated

Since the hydrostatic pressure is applied perpendicular to the face of the tunnel, it may be necessary or convenient, depending on the software being used, to calculate the horizontal and vertical components of the hydrostatic pressure at each joint. This value can be calculated at joint j as follows.

$$\text{X component of Hydrostatic Pressure at joint } j = \quad \text{Magnitude at joint } j \text{ times } \cos(\alpha_j)$$

$$\text{Y component of Hydrostatic Pressure at joint } j = \quad \text{Magnitude at joint } j \text{ times } \sin(\alpha_j)$$

Figure 10E-4 is the hydrostatic pressure loading diagram and also includes a depiction of j and  $\alpha$ .

**APPENDIX G**  
**PRECAST SEGMENTAL LINING DESIGN EXAMPLE**

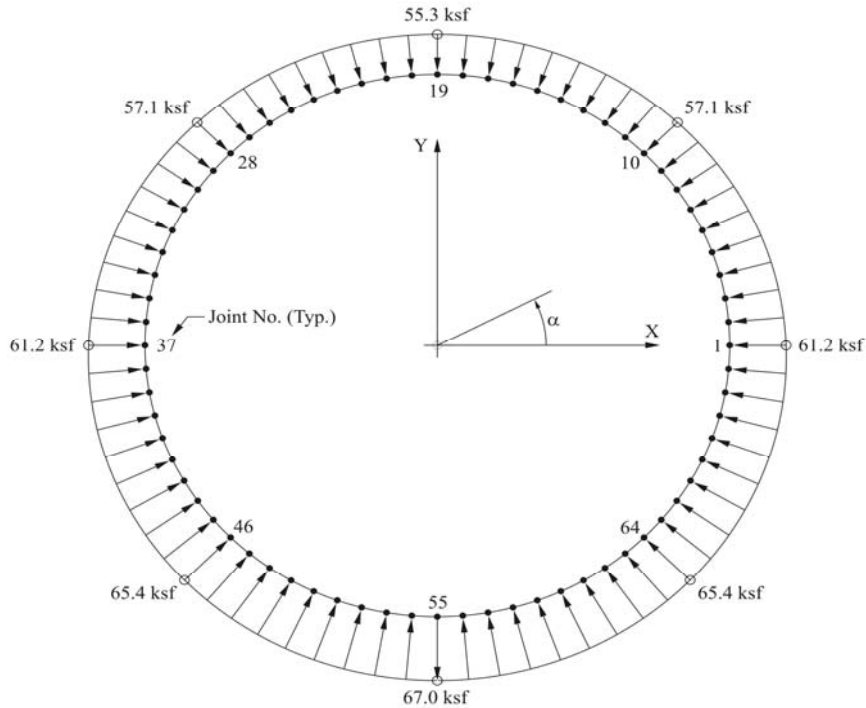

**Figure 10E-4**  
Hydrostatic Pressure Loading Diagram

**Tabulation of Hydrostatic Pressure Input Loads**

| Joint | $\alpha$<br>(deg) | Joint Coordinates |           | Magnitude<br>(ksf) | X<br>Component<br>(ksf) | Y<br>Component<br>(ksf) |
|-------|-------------------|-------------------|-----------|--------------------|-------------------------|-------------------------|
|       |                   | x<br>(ft)         | y<br>(ft) |                    |                         |                         |
| 1     | 0                 | 18.167            | 0.000     | 61.21              | -61.21                  | 0.00                    |
| 2     | 5                 | 18.098            | 1.583     | 60.70              | -60.47                  | -5.29                   |
| 3     | 10                | 17.891            | 3.155     | 60.19              | -59.28                  | -10.45                  |
| 4     | 15                | 17.548            | 4.702     | 59.69              | -57.66                  | -15.45                  |
| 5     | 20                | 17.071            | 6.213     | 59.20              | -55.63                  | -20.25                  |
| 6     | 25                | 16.465            | 7.678     | 58.73              | -53.22                  | -24.82                  |
| 7     | 30                | 15.733            | 9.083     | 58.27              | -50.47                  | -29.14                  |
| 8     | 35                | 14.881            | 10.420    | 57.84              | -47.38                  | -33.18                  |
| 9     | 40                | 13.916            | 11.677    | 57.43              | -44.00                  | -36.92                  |
| 10    | 45                | 12.846            | 12.846    | 57.06              | -40.34                  | -40.34                  |
| 11    | 50                | 11.677            | 13.916    | 56.71              | -36.45                  | -43.44                  |
| 12    | 55                | 10.420            | 14.881    | 56.40              | -32.35                  | -46.20                  |
| 13    | 60                | 9.083             | 15.733    | 56.12              | -28.06                  | -48.60                  |
| 14    | 65                | 7.678             | 16.465    | 55.88              | -23.62                  | -50.65                  |
| 15    | 70                | 6.213             | 17.071    | 55.69              | -19.05                  | -52.33                  |
| 16    | 75                | 4.702             | 17.548    | 55.53              | -14.37                  | -53.64                  |
| 17    | 80                | 3.155             | 17.891    | 55.42              | -9.62                   | -54.58                  |
| 18    | 85                | 1.583             | 18.098    | 55.36              | -4.82                   | -55.15                  |
| 19    | 90                | 0.000             | 18.167    | 55.33              | 0.00                    | -55.33                  |
| 20    | 95                | -1.583            | 18.098    | 55.36              | 4.82                    | -55.15                  |
| 21    | 100               | -3.155            | 17.891    | 55.42              | 9.62                    | -54.58                  |
| 22    | 105               | -4.702            | 17.548    | 55.53              | 14.37                   | -53.64                  |
| 23    | 110               | -6.213            | 17.071    | 55.69              | 19.05                   | -52.33                  |

**APPENDIX G**  
**PRECAST SEGMENTAL LINING DESIGN EXAMPLE**

|    |     |         |         |       |        |        |
|----|-----|---------|---------|-------|--------|--------|
| 24 | 115 | -7.678  | 16.465  | 55.88 | 23.62  | -50.65 |
| 25 | 120 | -9.083  | 15.733  | 56.12 | 28.06  | -48.60 |
| 26 | 125 | -10.420 | 14.881  | 56.40 | 32.35  | -46.20 |
| 27 | 130 | -11.677 | 13.916  | 56.71 | 36.45  | -43.44 |
| 28 | 135 | -12.846 | 12.846  | 57.06 | 40.34  | -40.34 |
| 29 | 140 | -13.916 | 11.677  | 57.43 | 44.00  | -36.92 |
| 30 | 145 | -14.881 | 10.420  | 57.84 | 47.38  | -33.18 |
| 31 | 150 | -15.733 | 9.083   | 58.27 | 50.47  | -29.14 |
| 32 | 155 | -16.465 | 7.678   | 58.73 | 53.22  | -24.82 |
| 33 | 160 | -17.071 | 6.213   | 59.20 | 55.63  | -20.25 |
| 34 | 165 | -17.548 | 4.702   | 59.69 | 57.66  | -15.45 |
| 35 | 170 | -17.891 | 3.155   | 60.19 | 59.28  | -10.45 |
| 36 | 175 | -18.098 | 1.583   | 60.70 | 60.47  | -5.29  |
| 37 | 180 | -18.167 | 0.000   | 61.21 | 61.21  | 0.00   |
| 38 | 185 | -18.098 | -1.583  | 61.72 | 61.49  | 5.38   |
| 39 | 190 | -17.891 | -3.155  | 62.23 | 61.29  | 10.81  |
| 40 | 195 | -17.548 | -4.702  | 62.73 | 60.59  | 16.24  |
| 41 | 200 | -17.071 | -6.213  | 63.22 | 59.41  | 21.62  |
| 42 | 205 | -16.465 | -7.678  | 63.69 | 57.73  | 26.92  |
| 43 | 210 | -15.733 | -9.083  | 64.15 | 55.55  | 32.07  |
| 44 | 215 | -14.881 | -10.420 | 64.58 | 52.90  | 37.04  |
| 45 | 220 | -13.916 | -11.677 | 64.99 | 49.78  | 41.77  |
| 46 | 225 | -12.846 | -12.846 | 65.37 | 46.22  | 46.22  |
| 47 | 230 | -11.677 | -13.916 | 65.71 | 42.24  | 50.34  |
| 48 | 235 | -10.420 | -14.881 | 66.02 | 37.87  | 54.08  |
| 49 | 240 | -9.083  | -15.733 | 66.30 | 33.15  | 57.42  |
| 50 | 245 | -7.678  | -16.465 | 66.54 | 28.12  | 60.30  |
| 51 | 250 | -6.213  | -17.071 | 66.73 | 22.82  | 62.71  |
| 52 | 255 | -4.702  | -17.548 | 66.89 | 17.31  | 64.61  |
| 53 | 260 | -3.155  | -17.891 | 67.00 | 11.63  | 65.98  |
| 54 | 265 | -1.583  | -18.098 | 67.06 | 5.84   | 66.81  |
| 55 | 270 | 0.000   | -18.167 | 67.04 | 0.00   | 67.04  |
| 56 | 275 | 1.583   | -18.098 | 67.06 | -5.84  | 66.81  |
| 57 | 280 | 3.155   | -17.891 | 67.00 | -11.63 | 65.98  |
| 58 | 285 | 4.702   | -17.548 | 66.89 | -17.31 | 64.61  |
| 59 | 290 | 6.213   | -17.071 | 66.73 | -22.82 | 62.71  |
| 60 | 295 | 7.678   | -16.465 | 66.54 | -28.12 | 60.30  |
| 61 | 300 | 9.083   | -15.733 | 66.30 | -33.15 | 57.42  |
| 62 | 305 | 10.420  | -14.881 | 66.02 | -37.87 | 54.08  |
| 63 | 310 | 11.677  | -13.916 | 65.71 | -42.24 | 50.34  |
| 64 | 315 | 12.846  | -12.846 | 65.37 | -46.22 | 46.22  |
| 65 | 320 | 13.916  | -11.677 | 64.99 | -49.78 | 41.77  |
| 66 | 325 | 14.881  | -10.420 | 64.58 | -52.90 | 37.04  |
| 67 | 330 | 15.733  | -9.083  | 64.15 | -55.55 | 32.07  |
| 68 | 335 | 16.465  | -7.678  | 63.69 | -57.73 | 26.92  |
| 69 | 340 | 17.071  | -6.213  | 63.22 | -59.41 | 21.62  |
| 70 | 345 | 17.548  | -4.702  | 62.73 | -60.59 | 16.24  |
| 71 | 350 | 17.891  | -3.155  | 62.23 | -61.29 | 10.81  |
| 72 | 355 | 18.098  | -1.583  | 61.72 | -61.49 | 5.38   |

**CALCULATE EARTH LOADS**

Roof Load = **4.55** ksf

Applied Load = 4.55 x 5 x 1.04 = 23.58 ksf

The horizontal load is given as 1.0 times the vertical load = 23.58 ksf

**APPENDIX G**  
**PRECAST SEGMENTAL LINING DESIGN EXAMPLE**

---

This load is applied vertically to the lining members. Care should be taken in the input of this load to be sure that it is modeled correctly. The total applied load should be equal to the *Roof Load* times the *Outside Diameter of the Tunnel* times the *Length of the Segment*. Figure 10E-5 shows the loading diagram for this load.

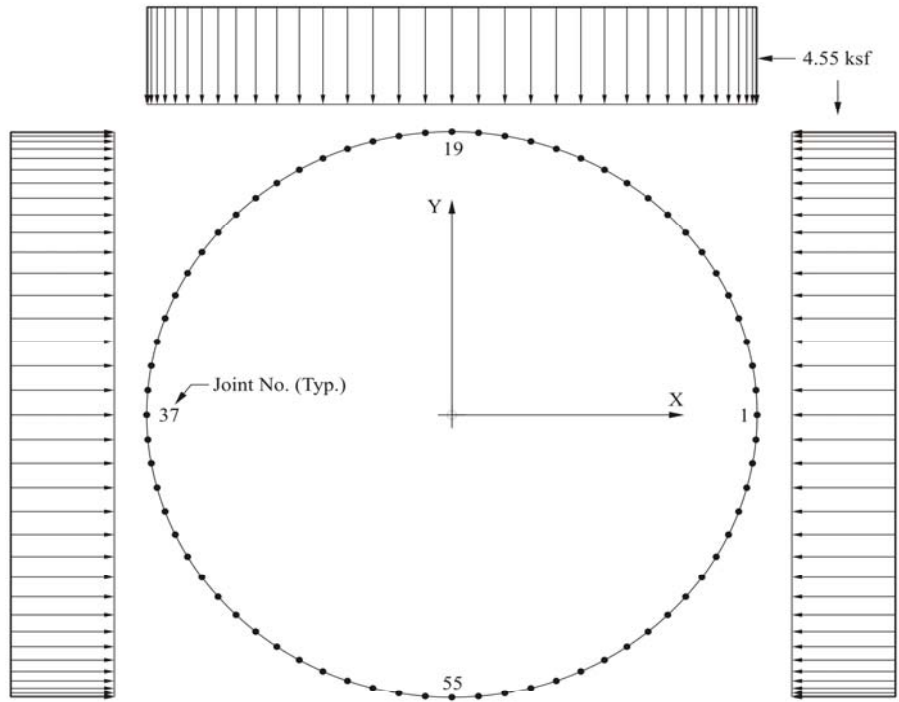

**Figure 10E-5**  
Rock Loading Diagram

**APPENDIX G**  
**PRECAST SEGMENTAL LINING DESIGN EXAMPLE**

---

---

**APPURTENANCE DEAD LOAD**

For this example, the appertenances consist of the jet fans, the drainage system and the roadway slab. The jet fans and the roadway slab are considered as DC loads or the drainage syatem is considered a DW load as given in paragraph 3.3.2 of the AASHTO LRFD specifications.

Jet Fans:

Jet fan load consists of dead load and a dynamic allowance for when the fan starts operation. The dynamic allowance does not need to be treated separately from the dead load. The total anticipated load from the jet fans is 2,000 pounds applied vertically.

Using figure 1, the jet fan load is applied at a location that is 6'-0" on either side of the center line of tunnel. Assume that the supports for the jet fan lie 1'-0" on either side of the centerline of the jet fan. Apply the load as a joint load to the joints that x coordinates are closest to  $\pm 2.00$  and  $\pm 4.00$ . The load applied at each of these joints will be one half of the jet fan load shown above. For this example, the loads will be applied at joints 15, 16, 22 & 23.

Drainage System:

The drainage system consists of a 6" diameter standard weight steel pipe. Conservatively assume that the pipe is full of water to calculate the dead load.

$$\begin{aligned} \text{Pipe weight} &= 18.97 \text{ plf} \\ \text{Inside Diameter} &= 6.065 \text{ in} \\ \text{Inside Area} &= 6.065 \times 3.14159 / 2.00 = 9.53 \text{ in}^2 \\ \text{Weight of water in pipe} &= 9.53 / 144 \times 62.4 = 4.13 \text{ plf} \\ \\ \text{Load Applied to Liner} &= (18.97 + 4.13) \times 5 = 115.49 \text{ pounds} \end{aligned}$$

The pipe weight will be applied at the end of the roadway slab. Referring to Figure 1 shows that the intersection of the center of roadway slab and the tunnel wall is located approximately at approximately 9.2 feet below the center of the tunnel. (Assuming a 15" thickness for the roadway slab.) Therefore, in this model the drainage system load can be applied at joints 42 and 68 to approximatel the effect of this load.

Roadway Slab:

The roadway slab consists of three components, the slab, the vertical center support and the barrier/walkway shapes.

$$\text{Slab: Assume thickness of roadway slab and center support} = 15 \text{ in}$$

The intersection of the center roadway slab and the tunnel wall is located approximately 9.2 feet below the center of the tunnel. Therefore in this model, the slab load should be applied at joints 42 and 68 to approximate the effect of this load.

$$\text{The approximate length of the roadway slab would be the distance between joints 42 and 68} = 32.93 \text{ ft}$$

$$\text{Weight of roadway slab} = 1.25 \times 150 \times 32.93 \times 5 = 30871 \text{ lbs}$$

Since the roadway slab is continuous and supported in the center, assume that 40% of this load is applied at the side walls and 60% is applied at the center support.



**APPENDIX G**  
**PRECAST SEGMENTAL LINING DESIGN EXAMPLE**

---

---

$$\text{Load applied to the side walls} = 30871.1 \times 0.20 = 6174 \text{ lbs}$$

$$\text{Load applied to center support} = 30871.1 \times 0.60 = 18523 \text{ lbs}$$

$$\text{Weight of center support} = 1.25 \times 150 \times 7.50 \times 5 = 7031 \text{ lbs}$$

$$\text{Total load from center support} = 18523 + 7031 = 25554 \text{ lbs}$$

Because of the invert slab, the load from the center support will be distributed over several joints. Apply this load to joints 51 to 59.

### **LIVE LOAD**

Live load from the roadway slab will be the result of the application of the design truck or design tandem coincident with the lane load as per paragraph 3.6.1.2 of the AASHTO LRFD specifications. The minimum spacing of the truck load axles is 14'. The maximum truck axle load is 14'. This means with a 5' long segment, only one truck axial can be on a ring at any time. The maximum truck axle load is 32 kips. The tandem axles are spaced at 4'-0" and weigh 25 kips each. Using the 4-foot spacing, both tandem axles for a total of 50 kips can be on a single ring at a time. Therefore, use the tandem axle arrangement for this example.

The dynamic load allowance (IM) for the limit states used in the tunnel of tunnel linings (i.e., all limit states except fatigue and fracture) is given in AASHTO LRFD specifications in Table 3.6.2.-1 as 33%. The dynamic load allowance is applied only to the design tandem and not to the lane load. The computation of the live load effect then is as follows:

Live Load Case 1 - One Traffic Lane:

$$\begin{array}{rcllcl} 50.000 \text{ kips} & \times & 1.33 & \times & 1.20 & = & 79.8 \text{ kip} \\ 0.640 \text{ klf} & \times & 5.00 & \times & 1.20 & = & \underline{3.84} \text{ kip} \\ \text{Total:} & & & & & & 83.64 \text{ kip} \end{array}$$

Where the value of 1.20 is the Multiple Presence Factor (m) given in the AASHTO LRFD specifications in Table 3.6.1.1.2-1

Where the value of 5.00 is the length of a single ring.

Assign 40% of this value to joint 42 and 60% of this value to joints 51 to 59.

$$\begin{array}{rcl} \text{Load applied at joint 42} = & & 33.5 \text{ kip} \\ \text{Load applied to each of joints 51 to 59} = & & 5.6 \text{ kip} \end{array}$$

Live Load Case 2 - Two Traffic Lanes:

$$\begin{array}{rcllcl} 50.000 \text{ kips} & \times & 1.33 & \times & 1.00 & = & 66.5 \text{ kip} \\ 0.640 \text{ klf} & \times & 5.00 & \times & 1.00 & = & \underline{3.2} \text{ kip} \\ \text{Total:} & & & & & & 69.7 \text{ kip} \end{array}$$

Where the value of 1.00 is the Multiple Presence Factor (m) given in the AASHTO LRFD specifications in Table 3.6.1.1.2-1

Where the value of 5.00 is the length of a single ring.

**APPENDIX G**  
**PRECAST SEGMENTAL LINING DESIGN EXAMPLE**

Assign 40% of this value to joint 42 and 68 and 60% of this value to joints 51 to 59.

Load applied at joints 42 and 68 = 27.9 kip

Load applied to each of joints 51 to 59 = 4.6 kip

**LOAD COMBINATIONS**

The following table represents the load combinations associated with the limit states to be investigated and the associated load factors. These load cases were entered into the structural analysis software to obtain the results that are presented below.

|               | Limit State   | DC   | DW   | EV  | LL  | WA |
|---------------|---------------|------|------|-----|-----|----|
| Strength I    | Strength Ia1  | 1.3  | 1.5  | 1.4 | 1.8 | 1  |
|               | Strength Ib1  | 0.9  | 1.5  | 1.4 | 1.8 | 1  |
|               | Strength Ic1  | 1.3  | 0.65 | 1.4 | 1.8 | 1  |
|               | Strength Id1  | 0.9  | 0.65 | 1.4 | 1.8 | 1  |
|               | Strength Ie1  | 1.3  | 1.5  | 0.9 | 1.8 | 1  |
|               | Strength If1  | 0.9  | 1.5  | 0.9 | 1.8 | 1  |
|               | Strength Ig1  | 1.3  | 0.65 | 0.9 | 1.8 | 1  |
|               | Strength Ih1  | 0.9  | 0.65 | 0.9 | 1.8 | 1  |
|               | Strength Ia2  | 1.3  | 1.5  | 1.4 | 1.8 | 1  |
|               | Strength Ib2  | 0.9  | 1.5  | 1.4 | 1.8 | 1  |
|               | Strength Ic2  | 1.3  | 0.65 | 1.4 | 1.8 | 1  |
|               | Strength Id2  | 0.9  | 0.65 | 1.4 | 1.8 | 1  |
|               | Strength Ie2  | 1.3  | 1.5  | 0.9 | 1.8 | 1  |
|               | Strength If2  | 0.9  | 1.5  | 0.9 | 1.8 | 1  |
|               | Strength Ig2  | 1.3  | 0.65 | 0.9 | 1.8 | 1  |
| Strength II   | Strength Ih2  | 0.9  | 0.65 | 0.9 | 1.8 | 1  |
|               | Strength IIa1 | 1.3  | 1.5  | 1.4 | 1.4 | 1  |
|               | Strength IIb1 | 0.9  | 1.5  | 1.4 | 1.4 | 1  |
|               | Strength IIc1 | 1.3  | 0.65 | 1.4 | 1.4 | 1  |
|               | Strength IId1 | 0.9  | 0.65 | 1.4 | 1.4 | 1  |
|               | Strength IIE1 | 1.3  | 1.5  | 0.9 | 1.4 | 1  |
|               | Strength IIf1 | 0.9  | 1.5  | 0.9 | 1.4 | 1  |
|               | Strength IIg1 | 1.3  | 0.65 | 0.9 | 1.4 | 1  |
|               | Strength IIh1 | 0.9  | 0.65 | 0.9 | 1.4 | 1  |
|               | Strength IIa2 | 1.3  | 1.5  | 1.4 | 1.4 | 1  |
|               | Strength IIb2 | 0.9  | 1.5  | 1.4 | 1.4 | 1  |
|               | Strength IIc2 | 1.3  | 0.65 | 1.4 | 1.4 | 1  |
|               | Strength IId2 | 0.9  | 0.65 | 1.4 | 1.4 | 1  |
|               | Strength IIE2 | 1.3  | 1.5  | 0.9 | 1.4 | 1  |
|               | Strength IIf2 | 0.9  | 1.5  | 0.9 | 1.4 | 1  |
| Strength IIg2 | 1.3           | 0.65 | 0.9  | 1.4 | 1   |    |
| Strength IIh2 | 0.9           | 0.65 | 0.9  | 1.4 | 1   |    |
| SERVICE       | Service I1    | 1    | 1    | 1   | 1   | 1  |
|               | Service I2    | 1    | 1    | 1   | 1   | 1  |
|               | Service II    | 1    | 1    | 1   | N/A | 1  |

The designation 1 & 2 in the above table indicates the number of live load lanes.

**APPENDIX G**  
**PRECAST SEGMENTAL LINING DESIGN EXAMPLE**

---

---

Design will be performed for the following load cases:

1. Maximum moment ( $M_{max}$ ) and associate axial load (P).
2. Maximum axial load ( $P_{max}$ ) and associated moment (M).
3. Maximum shear ( $V_{max}$ ).

The following are the results:

|         |             |        |        |       |       |        |                        |
|---------|-------------|--------|--------|-------|-------|--------|------------------------|
| Schist: | $M_{max} =$ | 367.1  | ft-kip | $P =$ | 524.1 | kip    | Strength IIa1 Joint 19 |
|         | $P_{max} =$ | 1496.1 | kip    | $M =$ | 173.2 | ft-kip | Strength IIa1 Joint 38 |
|         | $V_{max} =$ | 93.5   | kip    |       |       |        | Strength IIa1 Joint 15 |

---

# Appendix G Segmental Concrete Design Example

## DESIGN PROCESS CALCULATIONS

**References:** AASHTO LRFD Bridge Design Specifications, 3rd Ed., 2004

**Data: Segmental lining dimensions:**

Segment Length = 5.00 ft  
Lining Thickness = 1.33 ft

### 1. Structure Design Calculations

#### 1.1 Concrete Design Properties:

AASHTO LRFD Reference

|              |           |               |
|--------------|-----------|---------------|
| $E_s =$      | 29000 ksi | 5.4.3.2       |
| $f_y =$      | 60 ksi    |               |
| $f'_c =$     | 5 ksi     |               |
| $\gamma_c =$ | 145 pcf   | Table 3.5.1-1 |
| $\beta_1 =$  | 0.80      | 5.7.2.2       |

#### 1.2 Resistance Factors

AASHTO LRFD Reference 5.5.4.2

|           |                               |
|-----------|-------------------------------|
| Flexure = | 0.75 ( $\phi$ ) varies to 0.9 |
| Shear =   | 0.90                          |
| Compr. =  | 0.75                          |

### 1.3 Limits for Reinforcement

AASHTO LRFD Reference 5.7.4.2

For non-prestressed compression members, the maximum area of reinforcement is given by AASHTO LRFD Specification Equation 5.7.4.2-1 as:

$$\frac{A_s}{A_g} \leq 0.08 \Rightarrow A_s \leq 76.8 \text{ in}^2$$

For non-prestressed compression members, the minimum area of reinforcement is given by AASHTO LRFD Specification Equation 5.7.4.2-3 as:

$$\frac{A_s f_y}{A_g f'_c} \geq 0.135 \Rightarrow A_s \geq 10.8 \text{ in}^2$$

Where:

$A_s$  = Area of nonprestressed tension steel (in<sup>2</sup>)

$A_g$  = Gross area of the concrete section (in<sup>2</sup>)

$f_y$  = Specified yield strength of the reinforcing bars (ksi)

$f'_c$  = Specified compressive strength of the concrete (ksi)

## 2. Check for One Lining Segment

2.1 Following a Design calculation check will be performed for one lining segment:

### 2.2 Slenderness Check (LRFD 5.7.4.3):

|         |                      |   |         |               |          |
|---------|----------------------|---|---------|---------------|----------|
| $k =$   | 0.65                 |   |         | $\beta_1 =$   | 0.85     |
| $l_u =$ | 5.00 ft              | = | 60 in   | $ds =$        | 13.75 in |
| $d =$   | 1.33 ft              | = | 16.0 in | $d's =$       | 2.25 in  |
| $I =$   | 4096 in <sup>4</sup> |   |         | #8 bar dia. = | 1.00 in  |
| $r =$   | 4.62 in              |   |         |               |          |

$$I = \frac{12 \cdot 30^3}{12}$$

$$r = \sqrt{\frac{I}{12} \cdot d}$$

From analysis output:

$$k \cdot \frac{l_u}{r} = 8.44$$

$$34 - 12 \left( \frac{M_1}{M_2} \right) = 23.55$$

where  $M_1 = 58.8$  kip-ft                       $P_1 = 2864.9$  kip

$M_2 = 67.5$  kip-ft                       $P_2 = 2864.9$  kip

Where  $M_1$  and  $M_2$  are smaller and larger end moments

**Neglect Slenderness**

$$k \cdot \frac{l_u}{r} \text{ is bigger than } 34 - 12 \left( \frac{M_1}{M_2} \right)$$

### 2.3 Calculate EI (LRFD 5.7.4.3):

$$E_c = 33000 \cdot (\gamma_c)^{1.5} \cdot (f'_c)^{0.5}$$

$$E_c = 4074.28 \text{ ksi}$$

$$I_g = 4096 \text{ in}^4$$

$$c = 5.5 \text{ in}$$

$$I_s = 2 \left( \pi \cdot \frac{\text{dia}^4}{64} + A_s \cdot c^2 \right)$$

$$I_s = 363.10 \text{ in}^4$$

$$M_{no} = 67.50 \text{ kip-ft}$$

$$M_2 = 67.50 \text{ kip-ft}$$

$$\beta_d = \frac{M_{no}}{M_2} = 1.00$$

$$EI = \frac{(E_c \cdot \frac{I_g}{5} + E_s \cdot I_s)}{(1 + \beta_d)}$$

$$EI = 6933748.9 \text{ kip-in}^2$$

$$EI = \frac{\left( E_c \cdot \frac{I_g}{2.5} \right)}{(1 + \beta_d)}$$

$$EI = 3337650.74 \text{ kip-in}^2$$

## 2.4 Approximate Method (LRFD 4.5.3.2.2)

The effects of deflection on force effects on beam-columns and arches which meet the provisions of the LRFD specifications and may be approximated by the Moment Magnification method described below.

For steel/concrete composite columns, the Euler buckling load  $P_e$  shall be determined as specified in Article 6.9.5.1 of LRFD. For all other cases,  $P_e$  shall be taken as:

$$P_e = \frac{\pi^2 \cdot EI}{(k \cdot l_u)^2} \quad (\text{LRFD eq. 4.5.3.2.2b-5})$$

Where:

$l_u$  = unsupported length of a compression member (in)

$k$  = effective length factor as specified in LRFD Article 4.6.2.5

$E$  = modulus of elasticity (ksi)

$I$  = moment of inertia about axis under consideration ( $\text{in}^4$ )

$$P_e = 44992.35 \text{ kip}$$

From LRFD section 4.5.3.2.2b:



### Moment Magnification:

(The components for sidesway will be neglected. Bracing moment will not include lateral force influence)

The factored moments may be increased to reflect effects of deformations as follows:

LRFD eq. (4.5.3.2.2b-1):

$$M_c = \delta_b * M_{2b} + \delta_s * M_{2s} \quad M_u = 67.50 \text{ kip-ft}$$

$$M_c = \mathbf{68.89 \text{ kip-ft}}$$

$$\text{where } M_{2b} = 67.50 \text{ kip-ft}$$

in which:

$$\delta_b = \frac{C_m}{\left(1 - \frac{P_u}{\phi P_e}\right)} \geq 1 \quad \text{LRFD eq. (4.5.3.2.2b-3)}$$

$$\delta_b = 1.020656$$

Where:

$P_u$  = factored axial load (kip)

$P_e$  = Euler buckling load (kip)

$M_{2b}$  = moment on compression member due to factored gravity loads that result in no appreciable sidesway calculated by conventional first-order elastic frame analysis; always positive (kip-ft)

$\Phi$  = resistance factor for axial compression

$$P_u = \mathbf{2864.9 \text{ kips}}$$

For members braced against sidesway and without transverse loads between supports,  $C_m$ :

$$C_m = 0.6 + 0.4 \left( \frac{M_1}{M_2} \right) \quad \text{LRFD eq. (4.5.3.2.2b-6)}$$
$$C_m = 0.95$$

Where:

$M_1$  = smaller end moment

$M_2$  = larger end moment

### Factored flexural resistance:

(From LRFD section 5.7.3.2.1)

The factored resistance  $M_r$  shall be taken as:

$$M_r = \Phi M_n$$

Where:

$M_n$  = nominal resistance (kip-in)

$\Phi$  = resistance factor

The nominal flexural resistance may be taken as:

$$M_n = A_s \cdot f_y \cdot \left( d_s - \frac{a}{2} \right) - A'_s \cdot f'_y \cdot \left( d'_s - \frac{a}{2} \right) \quad (\text{LRFD eq. 5.7.3.2.2-1})$$

Do not consider compression steel for calculating  $M_n$

$$M_n = 3754.15 \text{ kip-in}$$

$$M_n = 312.85 \text{ kip-ft}$$

$$\Phi = 0.9$$

$$\Phi M_n = 281.56 \text{ kip-ft} \quad \Rightarrow \text{OK}$$

$$M_r = 281.56 \text{ kip-ft} \quad M_r > M_c$$

Where:

$A_s$  = area of nonprestressed tension reinforcement ( $\text{in}^2$ )

$f_y$  = specified yield strength of reinforcing bars (ksi)

$d_s$  = distance from extreme compression fiber to the centroid of nonprestressed tensile reinforcement (in)

$a = c\beta_1$ ; depth of equivalent stress block (in)

$\beta_1$  = stress block factor specified in Article 5.7.2.2 of LRFD

$c$  = distance from the extreme compression fiber to the neutral axis

$$c = \frac{(A_s \cdot f_y)}{0.85 \cdot f'_c \cdot \beta_1 \cdot b} \quad \text{LRFD eq. (5.7.3.1.2-4)}$$

from which:

$$A_s = 6.0 \text{ in}^2$$

$$f_y = 60.0 \text{ ksi}$$

$$f'_c = 5.0 \text{ ksi}$$

$$\beta_1 = 0.80 \quad \text{LRFD 5.7.2.2}$$

$$b = 12.0 \text{ in}$$

$$c = 8.30 \text{ in}$$

$$a = \beta_1 \cdot c$$

$$a = 6.64 \text{ in}$$

**Create interaction diagram**

$$A_{s_{\min}} = 10.8 \text{ in}^2$$

$$A_{s_{\text{prov}}} (\text{total}) = 12.00 \text{ in}^2$$

**Choose #7 at 6 both faces**

$$E_s = 29000 \text{ ksi}$$

$$\beta_1 = 0.85$$

$$Y_t = 8 \text{ in}$$

$$0.85 \cdot f'_c = 4.25 \text{ ksi}$$

$$A_g, \text{ in}^2 = 960 \text{ in}^2$$

$$A_s = A'_s = 6.0 \text{ in}^2$$

At zero moment point

From LRFD eq. (5.7.4.5-2):

$$P_o = 0.85 \cdot f'_c \cdot (A_g - A_{st}) + A_{st} \cdot f_y$$

$$P_o = 4415 \text{ kip}$$

$$\Phi P_o = \mathbf{3311 \text{ kip}}$$

Where:

$$\Phi = 0.75$$

At balance point calculate  $P_{rb}$  and  $M_{rb}$

$$c_b = 8.25 \text{ in}$$

$$a_b = 7.01 \text{ in}$$

$$a_b = \beta_1 \cdot c_b$$

$$f'_s = 63 \text{ ksi}$$

$f'_s > f_y$ ; set at  $f_y$

$$f'_s = E_s \left[ \left( \frac{0.003}{c} \right) \cdot (c - d') \right]$$

$$A_{\text{comp}} = 420.75 \text{ in}^2$$

$$A_{\text{comp}} = c \cdot b$$

$$y' = \frac{a}{2} = 3.50625 \text{ in}$$

$$\phi P_b = \phi \left[ 0.85 \cdot f'_c \cdot b \cdot a_b + A'_{s'} \cdot f'_s - A_s \cdot f_y \right]$$

$$\Phi P_b = \mathbf{1341 \text{ kip}}$$

$$\Phi M_b = 9046 \text{ kip-in}$$

$$\Phi M_b = \mathbf{754 \text{ kip-ft}}$$

At zero 'axial load' point (conservatively ignore compressive reinforcing)

$$a = 0.3 \text{ in} \quad a = \frac{A_s \cdot f_y}{(0.85 \cdot f'_c \cdot b)}$$

$$\Phi M_o = 3674.4 \text{ kip-in}$$

$$\Phi M_o = \mathbf{306 \text{ kip-ft}}$$

At intermediate points

| a, in | c = a/β <sub>1</sub> | A <sub>comp</sub> , in <sup>2</sup> | f' <sub>s</sub> , ksi | f <sub>s</sub> , ksi | f <sub>y</sub> , ksi | ΦM <sub>n</sub> , k-ft | ΦP <sub>n</sub> , kips |
|-------|----------------------|-------------------------------------|-----------------------|----------------------|----------------------|------------------------|------------------------|
|       |                      |                                     |                       |                      |                      | <b>306</b>             | <b>0</b>               |
| 2     | 2.5                  | 120                                 | 45                    | 270                  | 60                   | <b>439</b>             | <b>363</b>             |
| 3     | 3.8                  | 180                                 | 59                    | 180                  | 60                   | <b>557</b>             | <b>555</b>             |
| 4     | 5.0                  | 240                                 | 66                    | 135                  | 60                   | <b>632</b>             | <b>746</b>             |
| 5     | 6.3                  | 300                                 | 70                    | 108                  | 60                   | <b>688</b>             | <b>937</b>             |
| 6     | 7.5                  | 360                                 | 73                    | 90                   | 60                   | <b>729</b>             | <b>1128</b>            |
| 7     | 8.8                  | 420                                 | 75                    | 77                   | 60                   | <b>754</b>             | <b>1320</b>            |
| 8     | 10.0                 | 480                                 | 77                    | 67                   | 60                   | <b>762</b>             | <b>1511</b>            |
| 10    | 12.5                 | 600                                 | 79                    | 54                   | 60                   | <b>732</b>             | <b>2005</b>            |
| 11    | 13.8                 | 660                                 | 79                    | 49                   | 60                   | <b>693</b>             | <b>2201</b>            |
|       |                      |                                     |                       |                      |                      | <b>0</b>               | <b>3311</b>            |
|       |                      |                                     |                       |                      | End 1                | <b>367</b>             | <b>524</b>             |
|       |                      |                                     |                       |                      | End 2                | <b>173</b>             | <b>1496</b>            |

Φ may decrease from 0.90 to 0.75 as "a" increases

Note: from 0.0 to ab. Use 0.75 to be conservative.

Where:

$$A_{\text{comp}} = a \cdot 60 \text{ in}^2$$

$$f'_s = E_s \cdot \left( \frac{0.003}{c} \right) \cdot (c - A'_s) \text{ ksi}$$

$$f_s = E_s \cdot \left( \frac{0.003}{c} \right) \cdot (c - A_s) \text{ ksi}$$

$$\Phi M_n = \frac{\phi \left[ (A_{\text{comp}} - A'_s) \cdot \left( y_t - \frac{a}{2} \right) \cdot 0.85 \cdot f'_c + A_s \cdot f_y (d - y_t) + A'_s \cdot f'_s (y_t - d') \right]}{12}$$

$$\Phi P_n = \phi (A_{\text{comp}} - A'_s) \cdot 0.85 \cdot f'_c + A'_s \cdot f'_s - A_s f_y \text{ kips}$$

68 3000

**Interaction Diagram**

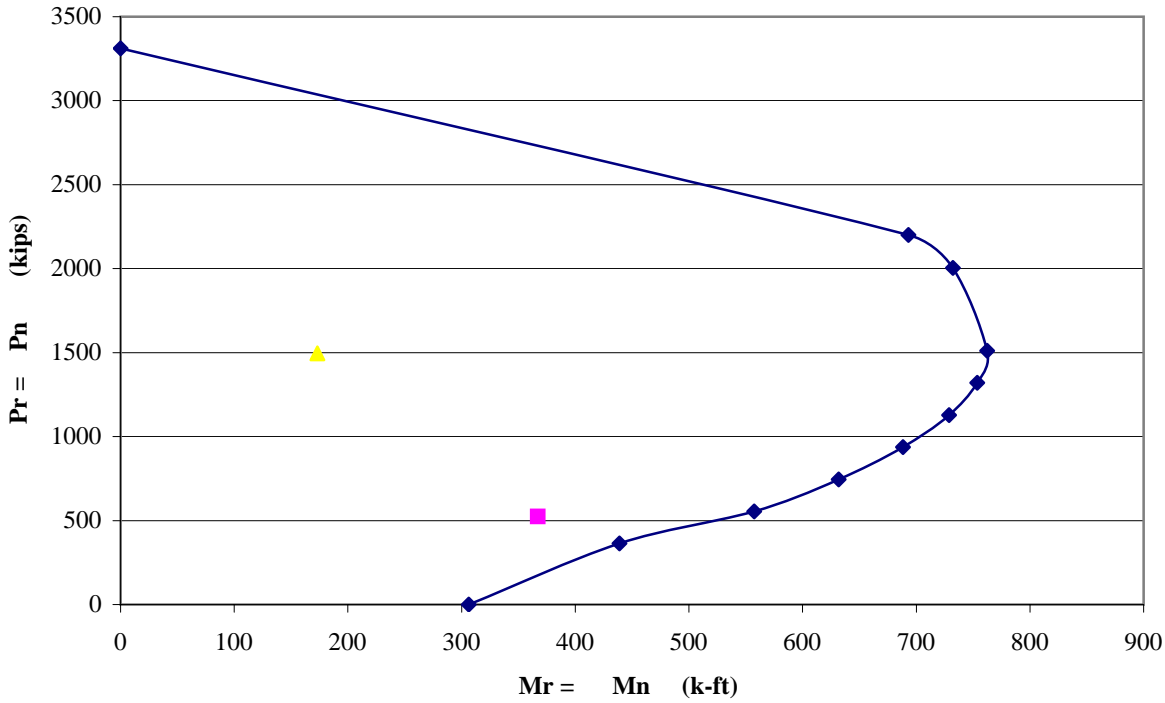

### 3. Shear Design (LRFD section 5.8.3.3)

The nominal shear resistance,  $V_n$  shall be determined as the lesser of:

LRFD eq. 5.8.3.3-1:

$$V_n = V_c + V_s$$

LRFD eq. 5.8.3.3-2:

$$\text{or } V_n = 0.25 \cdot f_c \cdot b_v \cdot d_v$$

NOTE:  $V_p$  is not considered

in which:

For slab concrete shear ( $V_c$ ), refer to LRFD Section 5.14.5:

$$V_c = \left( 0.0676\sqrt{f_c} + 4.6 \frac{A_s}{bd_e} \frac{V_u d_e}{M_u} \right) bd_e \leq 0.126 \cdot \sqrt{f_c} bd_e \quad \text{LRFD eq. (5.14.5.3-1)}$$

$$\text{where } \frac{V_u \cdot d_e}{M_u} \leq 1.0$$

$$V_s = \frac{A_v f_y d_v (\cot \theta + \cot \alpha) \cdot \sin \alpha}{s} \quad \text{LRFD eq. (5.8.3.3-4)}$$

$$\alpha = 90^\circ; \theta = 45^\circ \quad V_s = \frac{A_v \cdot f_y \cdot d_v}{s}$$

Where:

$A_s$ = area of reinforcing steel in the design width ( $\text{in}^2$ )

$d_e$ = effective depth from extreme compression fiber to the centroid of the tensile force in the tensile reinforcement (in)

$V_u$ = shear from factored loads (kip)

$M_u$ = moment from factored loads (kip-in)

$b$ = design width (in)

$b_v$ = effective web width taken as the minimum web width within the depth  $d_v$  (in)

$d_v$ =effective shear depth taken as the distance, measured perpendicular to the neutral axis (in)

$A_v$ = area of shear reinforcement within a distance  $s$  ( $\text{in}^2$ )

$s$ = spacing of stirrups (in)

$$d_v = 0.9 \cdot d_e \text{ or } 0.72 \cdot h \quad (\text{LRFD section 5.8.2.9})$$

$$d_v = 12.38 \text{ in}$$

$$d_e = 27.75$$

$$A_v = 0 \text{ in}^2$$

$$\frac{V_u \cdot d_e}{M_u} = 6.68$$

$$s = 12 \text{ in}$$

$$\text{Use } \frac{V_u \cdot d_e}{M_u} = 1.00$$

Max. shear and associated moment from analysis output:

$$V_u = 32.8 \text{ kip}$$

$$M_u = 67.5 \text{ kip-ft}$$

$$V_c = 80.14 \text{ kip}$$

$$\text{or } V_c = 46.49 \text{ kip}$$

**Controls**

$$V_s = 0.00 \text{ kip}$$

$$V_n = 46.49 \text{ kip} \quad V_n = 185.63 \text{ kip}$$

$$\text{therefore } V_n = 46.49 \text{ kip}$$

$$\Phi = 0.9$$

$$\Phi V_n = 41.84 \text{ kip} \quad > V_u \text{ OK}$$

This page is intentionally left blank.



# **Appendix H**

## **Deficiency and Reference Legends for Tunnel Inspection**

This page is intentionally left blank.

## Appendix H Deficiency and Reference Legends for Tunnel Inspection

### H.1 Deficiency Legends

#### Exhaust Duct Hangers- Vertical & Diagonal

|      |                             |
|------|-----------------------------|
| EDH1 | Hanger is in good condition |
| EDH2 | Hanger needs to be repaired |
| EDH3 | Hanger needs to be replaced |

#### Concrete Masonry Blocks

|      |                        |
|------|------------------------|
| CMU1 | Block - Loss Of Mortar |
| CMU2 | Block - Cracked        |
| CMU3 | Block - Missing        |
| CMU4 | Block - Section Loss   |
| CMU5 | Block - Special        |

#### Concrete Cracks

|    |                           |
|----|---------------------------|
| C1 | Concrete Crack < 1/8"     |
| C2 | Concrete Crack 1/8 - 1/4" |
| C3 | Concrete Crack 1/4 - 1/2" |
| C4 | Concrete Crack > 1/2"     |

#### Concrete Ceiling Panels

|      |             |
|------|-------------|
| CCP1 | Misaligned  |
| CCP2 | Bent        |
| CCP3 | Broken      |
| CCP4 | Buckled     |
| CCP5 | Joints Leak |

#### Concrete Wall Panels

|      |                                     |
|------|-------------------------------------|
| CWP1 | Misaligned                          |
| CWP2 | Tiles Cracked                       |
| CWP3 | Tiles Broken                        |
| CWP4 | Eye Bolts                           |
| CWP5 | Tie down Bolts                      |
| CWP6 | Longit. Stainless Steel Mount. Brkt |

#### Other Codes

|     |                  |
|-----|------------------|
| CD  | Collision Damage |
| CLG | Clogged          |
| COR | Corrosion        |
| CR  | Crack            |

#### Bolt Connections

|    |                       |
|----|-----------------------|
| B1 | Surface Rust          |
| B2 | Loss Of Section %     |
| B3 | Out Of Plane          |
| B4 | Broken                |
| B5 | Buckled               |
| B6 | Other                 |
| B7 | Missing               |
| B8 | Anchorage loose/creep |

#### Other Codes

|     |                |
|-----|----------------|
| BAD | Bad            |
| BAR | Bare           |
| BEN | Bent           |
| BKG | Blockage       |
| BLN | Blown          |
| BRK | Broken         |
| BUC | Buckled Column |

#### Other Concrete Cracking

|        |                                 |
|--------|---------------------------------|
| H1     | Hairline Cracking -<br>Light    |
| H2     | Hairline Cracking -<br>Medium   |
| HORZ   | Horizontal Crack                |
| DFW    | Diagonal Crack From<br>Wall     |
| LONGIT | Longitudinal Crack              |
| MC1    | Map Cracking -<br>Nonrepairable |
| MC2    | Map Cracking -<br>Repairable    |
| MJC    | Mortar Joint Crack              |
| PMCR   | Previous Map Cracking           |
| RC     | Reflective Cracking             |
| TFW    | Transverse Crack From<br>Wall   |
| TRANS  | Transverse Crack                |

#### Concrete Delaminations

|   |              |
|---|--------------|
| D | Delamination |
|---|--------------|

#### Other Codes

|      |                               |
|------|-------------------------------|
| D    | Dry (In "Moisture"<br>column) |
| DAM  | Damaged                       |
| DCOL | Discoloration                 |
| DEF  | Deflection                    |
| DEI  | Defective                     |
| DET  | Deteriorated                  |
| DIR  | Dirty                         |
| DIS  | Disintegrated                 |
| DISC | Disconnected                  |
| DIST | Distorted                     |
| DS   | Differential Settlement       |

#### Exhaust Duct Hangers – Vert/ Diag

|     |                       |
|-----|-----------------------|
| DH1 | Surface Rust          |
| DH2 | Loss Of Section %     |
| DH3 | Loss Of Tension       |
| DH4 | Out Of Plane          |
| DH5 | Broken                |
| DH6 | Buckled               |
| DH7 | Anchorage loose/creep |

#### Other Codes

|     |                     |
|-----|---------------------|
| EFF | Efflorescence       |
| EN  | Excessive Noise     |
| ER  | Eroded              |
| EV  | Excessive Vibration |
| EXP | Exposed             |

#### Framing Steel

|    |                   |
|----|-------------------|
| F1 | Surface Rust      |
| F2 | Loss of Section % |
| F3 | Out of Plane      |

|           |                       |
|-----------|-----------------------|
| <b>F4</b> | Broken                |
| <b>F5</b> | Buckled               |
| <b>F6</b> | Other                 |
| <b>F7</b> | Anchorage loose/creep |

**Steel Liner Plate Flanges**

|            |                   |
|------------|-------------------|
| <b>FL1</b> | Surface Rust      |
| <b>FL2</b> | Loss Of Section % |
| <b>FL3</b> | Out Of Plane      |

**Glass Block Units**

|            |                                   |
|------------|-----------------------------------|
| <b>GB1</b> | Joint Material Cracked or Missing |
| <b>GB2</b> | Cracked Block                     |
| <b>GB3</b> | Broken Block                      |
| <b>GB4</b> | Missing Block                     |

**Other Codes**

|            |         |
|------------|---------|
| <b>GEN</b> | General |
|------------|---------|

|             |                     |
|-------------|---------------------|
| <b>HAZM</b> | Hazardous Materials |
| <b>HC</b>   | Honeycombing        |
| <b>HO</b>   | Hole                |

**Encrustation**

|           |                    |
|-----------|--------------------|
| <b>I1</b> | Encrustation Light |
| <b>I2</b> | Encrustation Heavy |

**Other Codes**

|             |                          |
|-------------|--------------------------|
| <b>INCO</b> | Inadequate Coverage      |
| <b>IV</b>   | Insufficient Ventilation |

**Concrete Joints**

|           |                   |
|-----------|-------------------|
| <b>J1</b> | Joint < 1/8"      |
| <b>J2</b> | Joint 1/8" - 1/4" |
| <b>J3</b> | Joint 1/4 - 1/2"  |
| <b>J4</b> | Joint > 1/2"      |
| <b>J5</b> | Special Joint     |

**Tunnel Lighting**

|            |                                    |
|------------|------------------------------------|
| <b>LF1</b> | Light Fixture Not Working          |
| <b>LF2</b> | Light Fixture Casing Crcked or Brk |
| <b>LF3</b> | Light Fixture Mounting Bracket     |
| <b>LF4</b> | Light Fixture Anchorage            |

|            |                          |
|------------|--------------------------|
| <b>LH</b>  | Loose Handle             |
| <b>LOC</b> | Location (No Deficiency) |
| <b>LOO</b> | Loose                    |

**Tunnel Moisture**

|           |                 |
|-----------|-----------------|
| <b>M1</b> | Damp Patch      |
| <b>M2</b> | Standing Drop   |
| <b>M3</b> | Dripping        |
| <b>M4</b> | Continuous Leak |
| <b>PM</b> | Past Moisture   |

**Metal Ceiling Module Panels- Pre-fabricated**

|             |            |
|-------------|------------|
| <b>MCP1</b> | Misaligned |
|-------------|------------|

|             |             |
|-------------|-------------|
| <b>MCP2</b> | Bent        |
| <b>MCP3</b> | Broken      |
| <b>MCP4</b> | Buckled     |
| <b>MCP5</b> | Joints Leak |

**Miscellaneous Metals**

|            |                          |
|------------|--------------------------|
|            | Framing Steel Suspended  |
|            | Ceiling Support Assembly |
| <b>MF1</b> | Surface Rust             |
| <b>MF2</b> | Loss of Section %        |
| <b>MF3</b> | Out of Plane             |
| <b>MF4</b> | Broken                   |

**Miscellaneous Metals ( continued)**

|            |                          |
|------------|--------------------------|
|            | Framing Steel Suspended  |
|            | Ceiling Support Assembly |
| <b>MF5</b> | Buckled                  |
| <b>MF6</b> | Other                    |
| <b>MF6</b> | Anchorage loose/creep    |

**Miscellaneous Metals**

|            |                          |
|------------|--------------------------|
|            | Conduit Support Assembly |
| <b>MS1</b> | Surface Rust             |
| <b>MS2</b> | Loss of Section %        |
| <b>MS3</b> | Out of Plane             |
| <b>MS4</b> | Broken                   |
| <b>MS5</b> | Buckled                  |
| <b>MS6</b> | Other                    |

**Other Codes**

|              |                 |
|--------------|-----------------|
| <b>MI</b>    | Missing         |
| <b>MISAL</b> | Misaligned      |
| <b>P</b>     | Ponding         |
| <b>PLG</b>   | Plugged         |
| <b>PR</b>    | Previous Repair |

**Paint**

|           |                 |
|-----------|-----------------|
| <b>P1</b> | Paint - Blister |
| <b>P2</b> | Paint - Peeling |

**Rebar**

|           |                       |
|-----------|-----------------------|
| <b>R1</b> | Rebar-Surface Rust    |
| <b>R2</b> | Rebar-Loss Of Section |
| <b>R3</b> | Rebar - Bent          |
| <b>R4</b> | Rebar - Broken        |
| <b>R5</b> | Rebar - Buckled       |
| <b>R6</b> | Rebar - Special       |

**Other Codes**

|             |                      |
|-------------|----------------------|
| <b>RCJ</b>  | Recaulk Joint        |
| <b>RPJ</b>  | Repoint Joint        |
| <b>RPMJ</b> | Repoint Mortar Joint |
| <b>RUS</b>  | Rust                 |

**Concrete Spalls**

|           |                        |
|-----------|------------------------|
| <b>S1</b> | Spall < 2"             |
| <b>S2</b> | Spall to rebar         |
| <b>S3</b> | Spall behind rebar     |
| <b>S4</b> | Special concrete spall |

**Steel Liner Plate Segments**

|     |                   |
|-----|-------------------|
| SP1 | Surface Rust      |
| SP2 | Loss Of Section % |
| SP3 | Out Of Plane      |
| SP4 | Broken            |
| SP5 | Buckled           |
| SP6 | Other             |

**Other Codes**

|     |                   |
|-----|-------------------|
| SAG | Wire Mesh Sagging |
|-----|-------------------|

**Concrete Scaling**

|     |                        |
|-----|------------------------|
| SC1 | <1/4" Light Conc Scale |
| SC2 | >1/4" Deep Conc Scale  |

**Steel Rust**

|     |                           |
|-----|---------------------------|
| SR1 | Steel Rust -Surface       |
| SR2 | Steel Rust - Pitting      |
| SR3 | Steel Rust - Section Loss |
| SR4 | Steel Rust – Severe       |

**Glazed Brick Or Block**

|      |                                |
|------|--------------------------------|
| FSP1 | Minor Surface Spall, No Repair |
| FSP2 | Major Surface Spall, Replace   |

**Other Codes**

|     |                       |
|-----|-----------------------|
| SAG | Wire Mesh Sagging     |
| ST  | Stalactite/Stalagmite |

|      |                                |
|------|--------------------------------|
| VBC  | Violation Of Code              |
| VEC  | Violation Of Electrical Code   |
| VOSH | Violation Of OSHA              |
| VPC  | Violation Of Plumbing Code     |
| VSHC | Violation Of State Health Code |

|     |                   |
|-----|-------------------|
| WA  | Warped            |
| WD  | Water Damage      |
| WHO | Wires Hanging Out |
| WO  | Worn              |

Sign Supports

|      |                             |
|------|-----------------------------|
| SSP1 | Minor rust                  |
| SS2  | Loose components (elec/mech |
| SS3  | Anchorage Loose/creep       |

## H.2 Reference Legends

| <u>Code</u> | <u>Description</u>           | <u>Code</u> | <u>Description</u>         |
|-------------|------------------------------|-------------|----------------------------|
| ABD         | Automatic Ball Drip          | DG          | Diesel Generator (Emerg.)  |
| ACP         | Air Compressor               | DH          | Duct Hanger                |
| ACU         | Air Conditioning Unit        | DIF         | Diffuser                   |
| AF          | Anchors & Fasteners          | DMTR        | Damper Motor               |
| AH          | Access Hatch                 | DPN         | Distribution Panel         |
| AHU         | Air Handling Unit            | DR          | Door                       |
| AL          | Alarm                        | DA          | Damper                     |
| ALC         | Air Lock Concrete            | DRN         | Drain                      |
| AP          | Access Panel                 | DS          | Disconnect Switch          |
| AV          | Air Vent                     | DSB         | Distribution Switchboard   |
| B           | Beam Reinforced Conc.        | DT          | Drain trough - Safety walk |
| BAT         | Battery                      | DW          | Duct Work                  |
| BC          | Battery Charger              | ECP         | Equipment Control Panel    |
| BFP         | Backflow Preventer           | EJR         | Ejector                    |
| BCR         | Bituminous Concrete - Rwy    | EL          | Emergency Light            |
| BL          | Block – CMU and Glazed       | EUH         | Electric Unit Heater       |
| BOI         | Boiler                       | EW          | Eye Wash                   |
| BRE         | Breeching                    | EWC         | Electric Water Cooler      |
| BR          | Brick– Includes Glazed       | EX          | Exit Light                 |
| BS          | Beam - Steel (Not encased)   | EXV         | Exhaust Ventilator         |
| C           | Ceiling – Concrete           | F           | Floor - Concrete           |
| CA          | Cables                       | FA          | Fire Alarm                 |
| CAH         | Cabinet Heater               | FAI         | Fresh Air Intake           |
| CAN         | Canopy                       | FAN         | Fan                        |
| CAP         | Capacitor                    | FCT         | Faucet                     |
| CB          | Catch Basin                  | FDP         | Fire Damper                |
| CBC         | Ceiling - Beam Conc Surface  | FE          | Fire Extinguisher          |
| CBK         | Circuit Breaker              | FH          | Fire Hose                  |
| CBR         | Cross Bracing                | FHC         | Fire Hose Cabinet          |
| CC          | Cable Chase                  | FHV         | Fire Hose Valve            |
| CTSS        | Cable Tray Support Steel     | FIL         | Filter                     |
| CCO         | Column - Concrete            | FL          | Flue                       |
| CCP         | Concrete Ceiling Panels      | FLP         | Flue Plate                 |
| CCPF        | Concrete Ceiling Panel Flues | FLA         | Flashing                   |
| CCTV        | Closed Circuit Television    | FLC         | Flexible Connector         |
| CD          | Conduit – Embedded           | FLCP        | Fan Local Control Panel    |
| CDE         | Conduit – Exposed            | FM          | Force Main                 |
| CESB        | Concrete Encased Steel Beam  | FP          | Fire Proofing – Spray On   |
| CF          | Cabinet Fan                  | FT          | FUCO Tube                  |
| CFO         | Column Foundation            | GAU         | Gauge                      |
| CMU         | Concrete Masonry Unit        | GB          | Glass Block                |
| CO          | Concrete                     | GI          | Girder - Concrete Encased  |
| COM         | CO - Monitor                 | GIS         | Girder - Steel             |
| CPL         | Control Panel                | GND         | Ground                     |
| CST         | Column - Steel               | GR          | Grout                      |
| CURB        | Curb                         | GRA         | Grating                    |
| CWP         | Concrete Wall Panel          | GRL         | Grille                     |
| CWPB        | Concrete Wall Panel Brac     | GU          | Gunite                     |
|             |                              | GUT         | Gutter                     |

| <u>Code</u> | <u>Description</u>           | <u>Code</u> | <u>Description</u>                             |
|-------------|------------------------------|-------------|--|
| HB          | Hose Bib                     | SIS         | Sign Supports                                  |
| HC          | Heating Coil                 | SK          | Sink   |
| HE          | Heat Exchanger.              | SL          | Sleeve   |
| HR          | Handrail                     | SM          | Stone Masonry                                  |
| HSG         | Housing                      | SMW         | Light Gage Sheet Metal Walls –<br>Exhaust Duct |
| HTC         | High Tension Splicing Chmbr  | SNR         | Sensor   |
| HTR         | Heater                       | SO          | Soil Pipe                                      |
| HUM         | Humidistat                   | SPC         | Standpipe Cabinet                              |
| IC          | Island Concrete – Toll Booth | ST          | Stair  |
| IS          | Inlet Screen                 | STK         | Stack  |
| JB          | Junction Box                 | STP         | Steam Trap                                     |
| JT          | Joint - Construction/Expan   | STR         | Strainer                                       |
| L           | Leader                       | STRC        | Strip Recorder                                 |
| LA          | Ladders                      | SWC         | Safety walk - Concrete                         |
| LAV         | Lavatory                     | TB          | Toll Booth                                     |
| LF          | Light Fixture                | TBT         | Toll Booth Tunnel                              |
| LFS         | Light Fixture Support        | TEL         | Telephone System                               |
| LI          | Lintel                       | TH          | Thermostat                                     |
| LL          | Light Level                  | TOI         | Toilet Area                                    |
| LS          | Light Switch                 | TS          | Traffic Signal                                 |
| M           | Miscellaneous Metal          | TSW         | Transfer Switch                                |
| ME          | Meter                        | TV          | Turning Vane                                   |
| MF          | Motor Foundation             | UH          | Unit Heater                                    |
| MH          | Manhole                      | V           | Valve  |
| MM          | Motor Mount                  | VB          | Vacuum Breaker                                 |
| PA          | Public Address               | VI          | Video System                                   |
| PB          | Pull Box (Electrical)        | VNT         | Vent   |
| PBS         | Push Button Station          | VS          | Ventilation Shaft                              |
| PI          | Piping                       | W           | Wall - Concrete                                |
| PLS         | Steel Plates                 | WAM         | Water Meter                                    |
| PNL         | Panel Board                  | WB          | Wall - Block (CMU)                             |
| POP         | Polymer Panels               | WBM         | Wall Beam                                      |
| PP          | Parapet                      | WBR         | Wall - Brick                                   |
| PT          | Partition                    | WC          | Water Closet                                   |
| PV          | Pavement                     | WCB         | Wall - Cinder Block                            |
| RAS         | Radio System                 | WH          | Wall Hydrant                                   |
| RCP         | Receptacle                   | WHA         | Water Hammer Arrestor                          |
| RLY         | Relay                        | WHL         | Wheel  |
| RM          | Roof - Membrane              | WI          | Window   |
| RMP         | Remote Monitoring Panel      | WIR         | Wire (Elect)                                   |
| S           | Structural Steel             | WL          | Window Louvers                                 |
| SF          | Shaft (Mech)                 | WP          | Waterproofing                                  |
| SH          | Shaft (Misc.)                | WR          | Retaining Wall                                 |
| SHE         | Sheave                       | WST         | Waste  |
| SHFT        | Elevator Shaft               | WT          | Wall - Tile                                    |
| SHW         | Shower                       | XFR         | Transformer (Dry Type)                         |
| SI          | Sign                         |             |  |

This page is intentionally left blank.



# **Appendix I**

## **FHWA Technical Advisory T 5140.30**

### **Use and Inspection of Adhesive Anchors in Federal-Aid Projects**

This page is intentionally left blank.



U.S. DEPARTMENT OF  
TRANSPORTATION

**Federal Highway  
Administration**

# Technical Advisory

---

## Subject

**Use and Inspection of Adhesive Anchors in  
Federal-Aid Projects**

---

| Classification Code | Date           | OPI     |
|---------------------|----------------|---------|
| T 5140.30           | March 21, 2008 | HIBT-10 |

---

Par.

1. What is the purpose of this Technical Advisory?
2. Does this Technical Advisory supersede another Technical Advisory?
3. What is the definition of "Fast Set epoxy"?
4. What is the background of this Technical Advisory?
5. What are the recommendations for new Federal-aid projects and existing projects?

1. **What is the purpose of this Technical Advisory?** The purpose of this Technical Advisory is to provide guidance and recommendations regarding the use and in-service inspection of adhesive anchors, including those utilizing "Fast Set epoxy" (see definition in paragraph 3), in sustained tension applications on all Federal-aid highway projects.

2. **Does this Technical Advisory supersede another Technical Advisory?** Yes. This Technical Advisory supersedes Technical Advisory T 5140.26, dated October 17, 2007, by updating the list of "Fast Set epoxies" identified in paragraph 3. Technical Advisory T 5140.26 is herein cancelled.

3. **What is the definition of "Fast Set epoxy"?** "Fast Set epoxy" refers to an epoxy produced by the Sika Corporation called Sikadur AnchorFix-3. This epoxy is also repackaged and distributed by the names/companies presented in a list of adhesives available from the Federal Highway Administration (FHWA) Web site at the following Web link: <http://www.fhwa.dot.gov/Bridge/adhesives.cfm>. FHWA will update this list as new information becomes available and encourages visitation to this Web site for the latest updates.

4. **What is the background of this Technical Advisory?**

- a. On July 10, 2006, a portion of the suspended ceiling system of the I-90 connector tunnel in Boston, Massachusetts, collapsed onto a passing car, killing the passenger and injuring the driver. The suspended ceiling in the

collapsed section was comprised of concrete panels connected to steel hangers suspended from the tunnel concrete ceiling by an adhesive anchor system consisting of stainless steel anchor rods embedded in epoxy. Immediately after the accident, the FHWA launched an independent study and testing plan to determine the probable cause of failure of the suspended ceiling system.

- b. The testing plan consisted of short-term strength and long-term performance testing of the adhesive anchor system installed in the I-90 connector tunnel, as well as an experimental parametric study and a limited sustained load characterization study on the adhesive anchor system supplied for use in the I-90 connector tunnel conducted at the FHWA's Turner-Fairbank Highway Research Center (TFHRC). The testing program identified several installation factors that affect the short-term strength of adhesive anchors. However, while these factors may have contributed to the timing of the failure, the results clearly show that the primary cause of the collapse was the use of "Fast Set epoxy" which is incapable of resisting sustained tension loads without excessive creep.
- c. In addition to the testing conducted on the adhesive used in the I-90 tunnel, data produced at TFHRC show that some anchor systems utilizing adhesives other than "Fast Set epoxy" that have passed the International Code Council (ICC) creep certification process are still vulnerable to creep under typical bridge and tunnel exposure conditions. The results indicate that the current American Society for Testing and Materials (ASTM) and the ICC creep prediction methodology do not appear to guarantee safe performance of adhesive anchors over the entire expected service life (75 to 100 years) of transportation structures. In addition, the ICC does not address issues related to overhead installation of anchors nor the effect that vibration could have on their long-term performance and integrity.
- d. Therefore, as a result of the investigation of the collapsed suspended ceiling support system, and in concurrence with the National Transportation Safety Board's findings, the FHWA is now implementing these safety recommendations to ensure that similar incidents will not occur in the future.
- e. At the time T 5140.26 was issued, the FHWA was aware of the four products originally listed in paragraph 3 as being inadequate. Since that time, the investigation has continued to identify adhesives that are repackaged Sika products that include the fast set hardener (part B of the epoxy). These repackaged adhesives have been added to the original list so that structure's owners are aware of the potential for creep issues associated with these products.

5. **What are the recommendations for new Federal-aid projects and existing projects?**

a. **New Federal-aid projects**

- (1) This Technical Advisory strongly discourages the use of "Fast Set epoxy" for adhesive anchor applications.
- (2) This Technical Advisory also strongly discourages the applications of anchor systems utilizing adhesives other than "Fast Set epoxy" for permanent sustained tension applications or overhead applications until the FHWA is satisfied with an improved certification process that is developed to ensure long-term creep performance and that recognizes the effect of overhead installation.

b. **Existing projects**

- (1) Where applications are those specific to the use of "Fast Set epoxy" adhesive in sustained tension, it is strongly recommended the anchors be retrofitted and/or replaced with a reliable and appropriate mechanical anchor system and that rigorous and regular inspections are performed in the interim.
- (2) Where applications of anchor systems in sustained tension using adhesives other than "Fast Set epoxy" or from an unknown source have been identified, instituting a rigorous and regular inspection program that considers importance and redundancy is strongly recommended to maintain an appropriate level of confidence in their long-term performance. This may require developing a testing protocol and program to determine the site specific ultimate capacities and creep characteristics of the adhesive over the expected life of the structure.

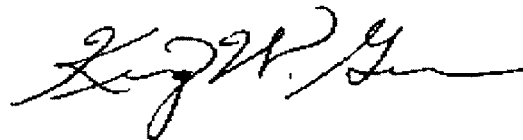

King W. Gee  
Associate Administrator  
for Infrastructure

This page is intentionally left blank.