

8. SUMMARY AND CONCLUSIONS

The classification accuracies resulting from this test ranged from 63.5% to 79.1%. The most common errors occurred between Class 2 (passenger vehicles) and Class 3 (other 2-axle, 4-tire vehicles). A small pickup truck (class 3) is very difficult to distinguish from a large car (class 2) based on length and axle spacing. If class 2 and 3 are combined, then the classification accuracies ranged from 78.8% to 96.2%.

Temperature of the air and pavement was found to have little effect on the performance of the classifiers. However, the range of temperatures was somewhat limited for this test. The percentage of trucks (vehicles with more than 2 axles) tended to have some effect on the classifier accuracies. The classification of class 9 vehicles (a majority of the trucks) was very good on most classifiers, and hence the classification accuracy tended to improve as the percentage of trucks increased. The longer vehicle lengths and axles spacings did result in greater measurement errors as the percentage of trucks increased.

Precipitation, although expected during the second 48-hour test and the 7-day test, did not occur during any of the tests. Therefore, no results concerning the performance of these devices in rain was obtained.

The sensor configuration used by the classifiers did not appear to have a significant effect on the accuracy. Classification accuracy, axle spacing measurement errors, and overall length measurement errors appeared to be independent on the sensor configurations. The primary factor observed in this test to affect the classification accuracy was the performance of the axle sensors. The ability of the equipment to accurately classify vehicles was linearly dependent on the ability of the sensor and classifier to accurately count the number of axles. Therefore, performance of the piezoelectric axle sensor and the interface electronics in the classification equipment are the primary factors effecting the accuracy of the equipment.

A further opportunity has arisen to collect more data concerning the performance of these classification equipments. Road construction is under way at the test site and will result in the sensors in the roadway being overlaid as part of a widening of the road. This presents an opportunity to test the performance of the devices after a pavement overlay. This issue is important to the maintainability of a traffic monitoring site. The results of the overlay tests will be reported in an addendum to this report.

The augmented tube test performed in parallel with the second 48-hour test was essentially unsuccessful. The Peek TrafiCOMP III was incorrectly programmed resulting in the data from the two lanes monitored being summed into one record and no individual lanes being recorded. While there is some possibility that limited results can be obtained from the single data file, there will be much greater potential for analysis if the test is repeated. Therefore, a repeat of the augmented tube test is planned in conjunction with the overlay tests. These tests should be conducted in time for the results to be included in the final report.

APPENDIX A
PARTICIPATING VENDORS AND CONTACT PERSONS

LIST OF PARTICIPATING VENDORS AND CONTACT PERSONS

DIAMOND TRAFFIC PRODUCTS
 P.O. Box 975
 Port Richey, FL 34673-0975

Jerry Schiff (813) 843-0270
 FAX (813) 843-0270
 TT-2001 Classifier

DOCAL ASSOCIATES, INC.
 Suite 211, 264 Amity Road
 Woodbridge, CT 06525

Tony Docal (203) 387-3218
 FAX (203) 387-4957
 Autologger Sensors

ELECTRONIC CONTROL MEASURE
 P.O. Box 888
 Manor, TX 78653

Ron White (512) 272-4346
 FAX (512) 272-5161
 HESTIA Classifier

GOLDEN RIVER TRAFFIC LIMITED
 c/o B B K ELECTRONICS, INC.
 9470 Sacramento Drive
 New Port Richey, FL 34655-1619

Bob Klaush (813) 376-5661
 FAX (813) 372-6918
 Marksman 660 Classifier

INTERNATIONAL ROAD DYNAMICS, INC.
 702 43rd Street
 Saskatoon, Saskatchewan
 Canada S7K 3T9

Rod Klashinsky (306) 934-6777
 FAX (306) 242-5599
 TC/C 530 Classifier

MIKROS SYSTEMS
 P.O. Box/POSBUS 20309
 ALKATRANT 0005
 SOUTH AFRICA

Johan Steyn +27 12 73 1010
 FAX +27 12 73 4646
 TEL-2CM Classifier

MITRON SYSTEMS CORPORATION
 2000 Century Plaza
 Columbia, MD 21044

Donald Dixon (410) 992-7700
 FAX (301) 596-5119
 MSC-3000 DCP Classifier

PAT EQUIPMENT CORPORATION, INC.
 1665 Orchard Drive
 Chambersburg, PA 17201-9206

Siegfried Gassner (717) 263-7655
 FAX (717) 263-7845
 AVC-100 Classifier

PEEK TRAFFIC, INC.
1500 North Washington Blvd.
Sarasota, FL 34236

TIMEMARK, INC.
P.O. Box 12947
Salem, OR 97309

Jim Stemitz (813) 366-8770
FAX (813) 365-0837
TrafiCOMP III and GK-6000
Classifiers

Dan Gossack (503) 363-2012
FAX (503) 363-1716
Delta II Classifier

APPENDIX B
EQUIPMENT BRIEFING FORMS

DIAMOND TRAFFIC PRODUCTS

P.O. Box 975
Port Richey, FL 34673-0975

SALES REPRESENTATIVE

Jerry Schiff

(813) 843-0270

FAX (813) 843-0270

MODEL NAME

Traffic Tally 2001

GENERAL DESCRIPTION OF EQUIPMENT

Multi-lane vehicle classifier. Operates in raw data or binning mode, up to four lanes classification or eight lanes of count. Available with inductive loops, piezoelectric sensors, or road tubes. Equipment also operates with remote center line air switch.

METHOD OF OPERATION

Unattended, capability to access data via telemetry is standard.

METHOD OF DATA STORAGE

Battery-backed static RAM.

DATA STORAGE CAPACITY

68K Standard. Memory can be expanded up to 960K in 128K increments to allow collection of more raw vehicle data.

VEHICLE CLASSIFICATION SCHEME

Raw data and up to 20 bins, but FHWA Scheme F is default setting.

POWER SOURCE

12 Volt 6-1/2 amp-hr Lead Gel/Solar/110 Volt rechargeable internal battery (new equipment uses 6V 12 amp-hr batteries)

OPERATING TEMPERATURE RANGE

-40°F to 158°F (Electronics)

OPERATING VEHICLE SPEED RANGE

5 to 105 mph

DIMENSIONS AND WEIGHT OF EACH MAJOR COMPONENT

12" x 12" x 7.5", 1/8" T-5052 welded alum. construction - 18 lbs

MAXIMUM LENGTH OF LEAD CABLE

Loops - 800 feet; Piezo - 800 feet

PURCHASE COST OF EQUIPMENT

\$1450 to \$3100

INSTALLATION COST

Varies with users desire for enclosures and type of sensors

NOMINAL INSTALLATION TIME

10 - 20 minutes

INSTALLATION PROCEDURE

Attach loops or piezoelectric sensors/solar power (if used).

SOME STATES CURRENTLY USING THIS EQUIPMENT

Idaho, Washington, Florida, North Carolina, Michigan, Wyoming, Alabama, California, Nevada, New York, Tennessee, Oklahoma

OTHER COMMENTS

Other equipment available from Diamond Traffic Products:

TT-501 - Whereas the TT-2001 will classify up to 4 lanes and count as many as 8, the TT-501 is a less expensive, basic version that will classify only one lane and count vehicles in two.

GTRI COMMENTS

Piezo-Loop-Piezo

ELECTRONIC CONTROL MEASURE

P.O. Box 888
Manor, TX 78653

SALES REPRESENTATIVE

Ron White

(512) 272-4346
FAX (512) 272-5161

MODEL NAME

HESTIA Classifier

GENERAL DESCRIPTION OF EQUIPMENT

Card/rack mounted portable or permanent classification and counting system. CMOS component-based electronics for low power consumption at 12 Volts DC. Collects classification and count data in up to 8 lanes of traffic. Collects both individual vehicle data and/or binned data. Available with piezoelectric sensors and/or inductive loops.

METHOD OF OPERATION

Unattended operation with data access via telemetry. Piezo detector is fully automated to allow reliable operation with variable sensor sensitivity.

METHOD OF DATA STORAGE

Binned and/or individual vehicle storage

DATA STORAGE CAPACITY

8M

VEHICLE CLASSIFICATION SCHEME

User programmable (default FHWA scheme F) with up to 56 vehicle configurations.

POWER SOURCE

12V DC

OPERATING TEMPERATURE RANGE

-40°F to 176°F

OPERATING VEHICLE SPEED RANGE

10 to 120 mph

DIMENSIONS AND WEIGHT OF EACH MAJOR COMPONENT

6" x 8" x 12"; 15 lbs

MAXIMUM LENGTH OF LEAD CABLE

Loop: 900 feet
Piezo: 600 feet

PURCHASE COST OF EQUIPMENT
\$3000 to \$6000

INSTALLATION COST
Variable depending on permanent or portable installation

NOMINAL INSTALLATION TIME
Permanent: 3 hours/lane; portable: 5 - 20 minutes

INSTALLATION PROCEDURE
Attach sensors, use computer to set up study

SOME STATES CURRENTLY USING THIS EQUIPMENT
Information not available

GOLDEN RIVER TRAFFIC LIMITED

c/o B B K ELECTRONICS INC.

9470 Sacramento Drive

New Port Richey, FL 34655-1619

SALES REPRESENTATIVE

Bob Klaus

(813) 376-5661

FAX (813) 372-6918

MODEL NAME

Marksman 660 Classifier

GENERAL DESCRIPTION OF EQUIPMENT

Self-contained multi-lane traffic counter classifier and weighing in motion.
Available for use with loops, tubes, piezo, wim strip and switch inputs.

METHOD OF OPERATION

Stand-alone unit that can be addressed with a computer or via telemetry.

METHOD OF DATA STORAGE

Information not supplied

DATA STORAGE CAPACITY

64K standard, 128K or 1024K can be added.

VEHICLE CLASSIFICATION SCHEME

FHWA 13, 12 speed bins, 6 axle bins, 5 length bins, 4 time bins.

POWER SOURCE

6V 10 APR battery, can be continuously connected to a 12 to 18 Volt AC or DC power source.

OPERATING TEMPERATURE RANGE

-40°C to 80°C (-40°F to 176°F)

OPERATING VEHICLE SPEED RANGE

5 to 80 mph

DIMENSIONS AND WEIGHT OF EACH MAJOR COMPONENT

Outer case: 340 mm x 300 mm x 160 mm deep

Inner case: 250 mm x 145 mm x 190 mm deep

Weight: 8.9 kg and 4.9 kg

MAXIMUM LENGTH OF LEAD CABLE

Not specified

PURCHASE COST OF EQUIPMENT

\$2200 to \$3500, depending upon options.

INSTALLATION COST

Varies with users, type of road, and amount of sensors being installed.

NOMINAL INSTALLATION TIME

Depends upon experience of operator and type of sensors being installed.

INSTALLATION PROCEDURE

Attach sensors, use computer to set up study.

SOME STATES CURRENTLY USING THIS EQUIPMENT

Idaho, Maryland, Texas

OTHER COMMENTS

This unit can be purchased as a dual tube counter through 4 lanes of weighing in motion.

INTERNATIONAL ROAD DYNAMICS, INC.

702 43rd Street
Saskatoon, Saskatchewan
Canada S7K 3T9

SALES REPRESENTATIVE

Rod Klashinsky

(306) 934-6777

FAX (306) 242-5599

MODEL NAME

Traffic Counting/Classifying System - 500 Series

GENERAL DESCRIPTION OF EQUIPMENT

Multi-lane vehicle counter/classifier. Operates in raw data or binning mode, up to four lanes classification or eight lanes of count. Available with inductive loops, Dynox axle sensors, piezoelectric sensors, or road tubes.

METHOD OF OPERATION

Unattended, remote access is available with user-supplied modem.

METHOD OF DATA STORAGE

Battery-backed CMOS RAM.

DATA STORAGE CAPACITY

68K standard. Memory can be expanded up to 960K in 128K increments to allow collection of more raw vehicle data.

VEHICLE CLASSIFICATION SCHEME

Raw data and up to 20 bins.

POWER SOURCE

12 Volt 9-1/2 amp-hr rechargeable battery or optional solar power cell

OPERATING TEMPERATURE RANGE

-40°F to 158°F (Electronics)

OPERATING VEHICLE SPEED RANGE

Dependent upon the sensor being used

DIMENSIONS AND WEIGHT OF EACH MAJOR COMPONENT

12.5" x 9" x 8.25" alum. construction - 25 lbs

MAXIMUM LENGTH OF LEAD CABLE

200 feet

PURCHASE COST OF EQUIPMENT

\$1200 to \$2500, depending on the model

INSTALLATION COST

Varies with type of sensors

NOMINAL INSTALLATION TIME

10 minutes with portable sensors; 1/2 day per lane with permanent sensors

INSTALLATION PROCEDURE

Tape or clamp for portable sensors; saw-cut and epoxy for permanent sensors

SOME STATES CURRENTLY USING THIS EQUIPMENT

Louisiana, New Mexico, Tennessee

OTHER COMMENTS

Other equipment from IRD includes Weigh-in-Motion axle and vehicle sensors, Automatic Vehicle Identification (AVI) toll plaza equipment

GTRI COMMENTS

Testing three configurations:

530-4B/BR/4L

Bi'Piezo-Loop-Bi'Piezo

530-4D/4P/4L

Dynax-Loop-Dynax

Piezo-Loop-Piezo

MIKROS SYSTEMS
P.O. Box/POSBUS 20309
ALCATRANT 0005
SOUTH AFRICA

SALES REPRESENTATIVE

Johan Steyn

+27 12 73 1010

FAX +27 12 73 4646

MODEL NAME

TEL-2CM Traffic Event Logger

GENERAL DESCRIPTION OF EQUIPMENT

Multi-lane vehicle classifier. Operates in raw data or binning mode. Available with inductive loops, piezoelectric sensors, or road tubes. Also available with capacitance weigh mats.

METHOD OF OPERATION

Unattended, capability to access data via telemetry is standard.

METHOD OF DATA STORAGE

Non-volatile memory.

DATA STORAGE CAPACITY

32K, expandable to 8M.

VEHICLE CLASSIFICATION SCHEME

Raw data and up to 15 bins. FHWA scheme F selectable.

POWER SOURCE

12 V sealed lead-acid battery (will operate 12 days from a fully charged, 24 A-h battery). Optional solar panel.

OPERATING TEMPERATURE RANGE

Sensors: -20°F to 140°F
Electronics: 0°F to 140°F

OPERATING VEHICLE SPEED RANGE

3 to 100 mph

DIMENSIONS AND WEIGHT OF EACH MAJOR COMPONENT

13.8" x 10.0" x 10.2" alum. casing - 26.5 lbs

MAXIMUM LENGTH OF LEAD CABLE

400 feet

PURCHASE COST OF EQUIPMENT

\$2500 to \$3500

INSTALLATION COST

Varies with users desire for enclosures and type of sensors

NOMINAL INSTALLATION TIME

5 to 15 minutes

INSTALLATION PROCEDURE

Attach sensors to termination box and select a typical small vehicle. The system will perform automatic calibration.

SOME STATES CURRENTLY USING THIS EQUIPMENT

West Virginia

OTHER COMMENTS

The TEL-2CM can be fitted with a weigh interface to collect axle and total weight data with either piezo or capacitance weight sensors. The PC-based software TELCOM allows the user to either directly or remotely via a modem, view live traffic information, extract data, detect violations and monitor the diagnostic features of the system.

Local USA agent: I.D.C.
P.O. Box 5397
Long Beach, CA 90805
Fax: (813) 789-0568

GTRI COMMENTS

Loop-Piezo-Loop

MITRON SYSTEMS CORPORATION

2000 Century Plaza
Columbia, MD 21044

SALES REPRESENTATIVE

Donald A. Dixon

(410) 992-7700

FAX (301) 596-5119

MODEL NAME

MSC 3000 Traffic Counter

GENERAL DESCRIPTION OF EQUIPMENT

Multi-lane vehicle classifier. Operates in binning mode. Operates with inductive loops, piezoelectric sensors, and road tubes.

METHOD OF OPERATION

Unattended, data is retrieved with a separate unit, or via modem/PC (cellular available).

METHOD OF DATA STORAGE

Battery-backed CMOS RAM portable Memory Pack

DATA STORAGE CAPACITY

8K standard, 10K optional; 32K for telemetry unit

VEHICLE CLASSIFICATION SCHEME

FHWA Scheme F capability; custom schemes available

POWER SOURCE

1 each 6 Volt, 12 amp-hr rechargeable and 4 ea. 1.5 V, C-size alkaline batteries (solar or AC available)

OPERATING TEMPERATURE RANGE

-40°F to 176°F (Electronics)

OPERATING VEHICLE SPEED RANGE

0 to 99 mph

DIMENSIONS AND WEIGHT OF EACH MAJOR COMPONENT

12" x 10" x 6.5" painted stainless steel housing - 26 lbs

MAXIMUM LENGTH OF LEAD CABLE

Loop - 800'; Piezo - depends upon the type; Road Tube - 15' to 200', depending on the traffic

PURCHASE COST OF EQUIPMENT

\$739 to \$1600

INSTALLATION COST

Varies with users desire for enclosures and type of sensors

NOMINAL INSTALLATION TIME

5 to 10 minutes

INSTALLATION PROCEDURE

Attach sensors, program study to be conducted

SOME STATES CURRENTLY USING THIS EQUIPMENT

Arizona, Illinois, Florida, North Carolina, South Carolina

OTHER COMMENTS

Piezo unit has multiple threshold adjustments for use with any sensor. New model performs 16 lanes of volume, 8 lanes speed/classification.

GTRI COMMENTS

Piezo-Piezo.

PAT EQUIPMENT CORPORATION, INC.

1665 Orchard Drive
Chambersburg, PA 17201-9206

SALES REPRESENTATIVE

Siegfried Gassner

(717) 263-7655
FAX (717) 263-7845

MODEL NAME

AVC 100 Vehicle Classifier

GENERAL DESCRIPTION OF EQUIPMENT

Multi-lane vehicle classifier. Operates in binning mode, up to four lanes classification or raw vehicle data collection. Available with inductive loops, piezoelectric sensors, or road tubes. Uses a loop-axle detector-loop or axle detector-loop-axle detector configuration.

METHOD OF OPERATION

Unattended, capability to access data via telemetry is standard.

METHOD OF DATA STORAGE

Battery-backed CMOS RAM.

DATA STORAGE CAPACITY

256K Standard. Memory can be expanded up to 4M.

VEHICLE CLASSIFICATION SCHEME

FHWA Scheme F is default setting and other types can be added up to a total of 48 bins

POWER SOURCE

12V, 30 VA solar power panel
12V, 6 VA line - DC supply
(internal battery for backup of parameter, clock, and data memory)

OPERATING TEMPERATURE RANGE

-50°F to 175°F (Electronics)

OPERATING VEHICLE SPEED RANGE

> 2 mph

DIMENSIONS AND WEIGHT OF EACH MAJOR COMPONENT

16" x 15" x 8.5" steel housing - 15 lbs

MAXIMUM LENGTH OF LEAD CABLE

The axle sensors are supplied with a 65' standard length cable. This cable can be extended up to an additional 300' by using a splice kit and coax cable. Should several sensors be installed at a road section, the cables can be concentrated in a bundled multi-conductor coax cable with a maximum length

of 300'. This cable should have an outer shield for additional lightning protection. The loop wires are extended with 2 #16 shielded cables and a splice kit.

PURCHASE COST OF EQUIPMENT

Depending on quantity and memory capacity, \$2200 to \$4300

INSTALLATION COST

Depending on location, lane closure requirements, weather, number of lanes and systems, installation costs can vary from \$1500 to \$8000 per lane

NOMINAL INSTALLATION TIME

Installation of 2 sensors in one lane takes approximately 4 hours for the permanent sensors.

INSTALLATION PROCEDURE

Install permanent induction loops and permanent piezo axle detectors, lay conduits, cabinet base concrete and pullboxes as required, power and phone line connection.

SOME STATES CURRENTLY USING THIS EQUIPMENT

Alaska, Florida, North Carolina

OTHER COMMENTS

System upgradable to WIM; other electronics for WIM available:

- DAW 100 Bending Plate, permanent
- DAW 190P Portable for Piezo, capacitance mat and bending plate.

GTRI COMMENTS

Pat will be testing two sensor configurations, one with a Piezo-Loop-Piezo and the other with a Loop-Piezo-Loop.

PEEK TRAFFIC, INC.
1500 North Washington Blvd.
Sarasota, FL 34236

SALES REPRESENTATIVE

Jim Stemitz

(813) 366-8770

FAX (813) 365-0837

MODEL NAME

TrafiCOMP III Model 241

GENERAL DESCRIPTION OF EQUIPMENT

Multi-lane vehicle classifier. Operates in binning mode, up to four lanes classification or eight lanes of volume. Available with inductive loops, piezoelectric sensors, or road tubes. Equipment also operates with other sensors which provide a contact closure.

METHOD OF OPERATION

Unattended, capability to access data via telemetry is standard.

METHOD OF DATA STORAGE

Battery-backed RAM.

DATA STORAGE CAPACITY

64K Standard.

VEHICLE CLASSIFICATION SCHEME

Up to 15 bins.

POWER SOURCE

6 Volt 10 amp-hr battery, can be powered by AC source or solar power depending on the options selected.

OPERATING TEMPERATURE RANGE

-40°F to 158°F (Electronics)

OPERATING VEHICLE SPEED RANGE

5 to 80 mph

DIMENSIONS AND WEIGHT OF EACH MAJOR COMPONENT

6.5" x 9.5" x 10" cast aluminum housing - 15 lbs

MAXIMUM LENGTH OF LEAD CABLE

Approximately 800 feet

PURCHASE COST OF EQUIPMENT

\$1,475 to \$3,000

INSTALLATION COST

Varies with users desire for type of sensors.

NOMINAL INSTALLATION TIME

10 to 20 minutes

INSTALLATION PROCEDURE

Attach loops, tubes, or piezoelectric sensors and AC or solar power (if used).

SOME STATES CURRENTLY USING THIS EQUIPMENT

Florida, Georgia, Illinois, Maryland, New York

OTHER COMMENTS

Configuration varies with number and type of sensors connectors desired.

GTRI COMMENTS

Piezo-Loop-Piezo

PEEK TRAFFIC, INC.
1500 North Washington Blvd.
Sarasota, FL 34236

SALES REPRESENTATIVE

Jim Stemitz

(813) 366-8770

FAX (813) 365-0837

MODEL NAME

GK 6000 Series Counter/Classifier

GENERAL DESCRIPTION OF EQUIPMENT

Two or four-lane vehicle classifier. Operates in binning mode. Can operate with loops, piezoelectric cable, or road tubes.

METHOD OF OPERATION

Unattended.

METHOD OF DATA STORAGE

Battery-backed RAM. Can be expanded with the optional Data Module.

DATA STORAGE CAPACITY

40k (104k with 64k optional Data Module)

VEHICLE CLASSIFICATION SCHEME

Up to 14 bins

POWER SOURCE

Rechargeable 6 Volt 16 amp-hr sealed lead acid gel battery

OPERATING TEMPERATURE RANGE

-40°F to 158°F (Electronics)

OPERATING VEHICLE SPEED RANGE

5 to 128 mph

DIMENSIONS AND WEIGHT OF EACH MAJOR COMPONENT

8.25" x 8.5" x 5.75" - 6.31 lbs

MAXIMUM LENGTH OF LEAD CABLE

Up to 1000 feet. (varies with set up)

PURCHASE COST OF EQUIPMENT

\$1,500 to \$4,000

INSTALLATION COST

Varies with users desire for type of sensors.

NOMINAL INSTALLATION TIME

Approximately 4 hours for permanent sensors and 15 minutes to set up configuration.

INSTALLATION PROCEDURE

Attach loops, tubes, or piezoelectric sensors.

SOME STATES CURRENTLY USING THIS EQUIPMENT

Arkansas, Georgia, Illinois, New York

GTRI COMMENTS

Piezo-Loop-Piezo

TIMEMARK, INC.

P.O. Box 12947
Salem, OR 97309

SALES REPRESENTATIVE

Dan Gossack

(503) 363-2012

FAX (503) 363-1716

MODEL NAME

Delta II Classifier (Lambda)

GENERAL DESCRIPTION OF EQUIPMENT

The Lambda is a multi-sensor vehicle classifier for portable or permanent installation. It will operate up to twelve sensors simultaneously including road tube, inductive loop, and piezo. The unit will count, provide binned speeds, axle or length classifications, gaps, or provide per vehicle or time-tagged event data.

METHOD OF OPERATION

The Lambda can be set up in the field with a built-in display and keyboard or via local or remote link with a computer.

METHOD OF DATA STORAGE

The Lambda has battery-backed static RAM or can use PCMCIA Series 1 Flash memory cards.

DATA STORAGE CAPACITY

The Lambda comes standard with 256K of onboard memory. The memory card allows expansion of the memory up to the size of card available, currently 20M with a 64M maximum.

VEHICLE CLASSIFICATION SCHEME

The Lambda has a 34 bin axle classification scheme based on Scheme F which can be combined to the thirteen bin standard. Also will allow user defined schemes to be loaded or processed from time-tagged events.

POWER SOURCE

The Lambda comes with a 6V - 10 amp-hour rechargeable battery which can be connected to solar or other charging unit. The unit will run for 10 days from full charge with eight loop capability.

OPERATING TEMPERATURE RANGE

The electronics except for the display will operate down to -20°C and up to 70°C (-4°F to 158°F)

OPERATING VEHICLE SPEED RANGE

The sensors will activate down to 5 mph and up to 120 mph but speeds greater than 80 mph are recorded only as such.

DIMENSIONS AND WEIGHT OF EACH MAJOR COMPONENT

The Lambda unit is 14.5" long, 8" wide, 5" high, and weighs about 18 pounds fully configured.

MAXIMUM LENGTH OF LEAD CABLE

The loop detector can handle inductance of up to 500 micro Henries and the piezo detector can handle down to a 5 milliamp signal.

PURCHASE COST OF EQUIPMENT

The Lambda ranges from \$1500 for a two road tube model to \$2850 for four road tube, eight loop, and eight piezo capability.

INSTALLATION COST

Installation cost will depend on the on-site enclosure, power capabilities, communication options, and sensors.

NOMINAL INSTALLATION TIME

Once all the permanent items are in place it takes less than 10 minutes to attach sensors and configure recorder for data collection.

INSTALLATION PROCEDURE

Connect sensors, power, and communications cables then go through menu to set up for data collection.

SOME STATES CURRENTLY USING THIS EQUIPMENT

Information not available

OTHER COMMENTS

The Lambda is in final testing phase and will be available by January 1994. The loop detector has low current draw without sacrificing speed accuracy. The piezo detector can be adjusted to amplify the signal as well as adjust the sensitivity.

APPENDIX C

**FLOW CHART FOR THE VEHICLE MATCHING ALGORITHM
OF THE ANALYZE PROGRAM**

The matching algorithm used in the ANALYZE program looks at a set of three vehicles from the ground truth and three vehicles from the vendor classifier at a time. It performs a search based on time and the number of axles. The result of the algorithm is one of the following five options:

1. Match - Clear vehicle match found in time and number of axles. Comparison data entered into the classification matrix, and the length and axle spacing statistics. Ground truth (tape data) and vendor (classifier) files are both advanced one vehicle.
2. Sensor Error - Clear vehicle match in time, but not in number of axles. Classification data stored, but not vehicle length and axle spacings. Ground truth (tape data) and vendor (classifier) files are both advanced one vehicle.
3. Missing Vehicle - No vehicle match was found for a vehicle in the ground truth data. The vehicle is stored in a separate file and the ground truth (tape data) file is advanced one vehicle.
4. Extra Vendor Vehicle - No vehicle match was found for a vehicle in the vendor data file. The vehicle is stored in a separate file and the vendor data file is advanced one vehicle.
5. Split - A vehicle in the ground truth (tape data) file is found to match two smaller vehicles in the vendor data file. These are stored in a separate file, the ground truth file is advanced one vehicle, and the vendor data file is advanced two vehicles.
6. Combination - Two vehicle in the ground truth file are found to match to one larger vehicle in the vendor data file. These are stored in a separate file, the ground truth file is advanced two vehicles, and the vendor data file is advanced one vehicle.

The algorithm looks only at the time and number of axles of three vehicles from both the ground truth and vendor data files. In the flow charts on the following pages, the following acronyms are used:

Vtime[#] - Time of vehicle # from the vendor (classifier) data file.

Rtime[#] - Time of vehicle # from the ground truth (tape) data file.

Vaxles[#] - Number of axles on vehicle # from the vendor data file.

Raxles[#] - Number of axles on vehicle # from the ground truth data file.

<delta>t - Maximum time difference allowed to form match.

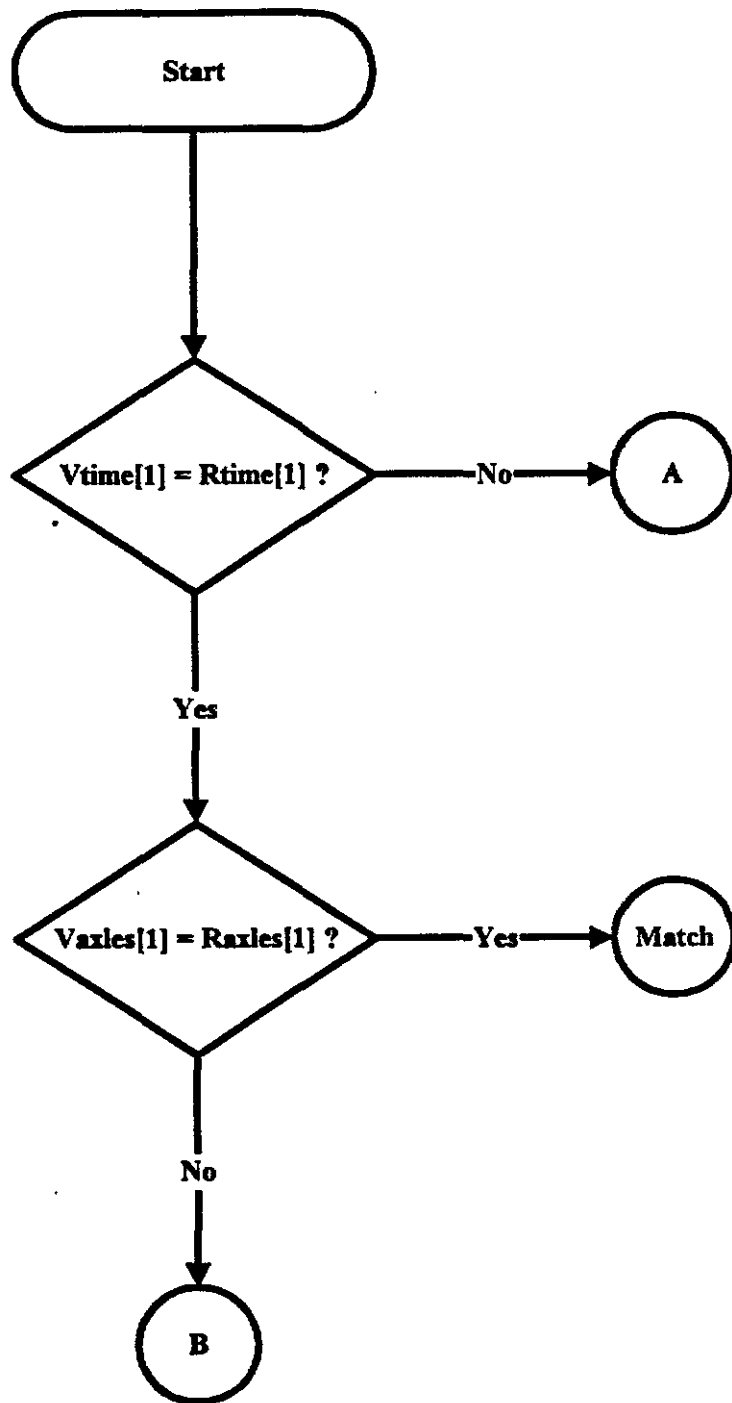

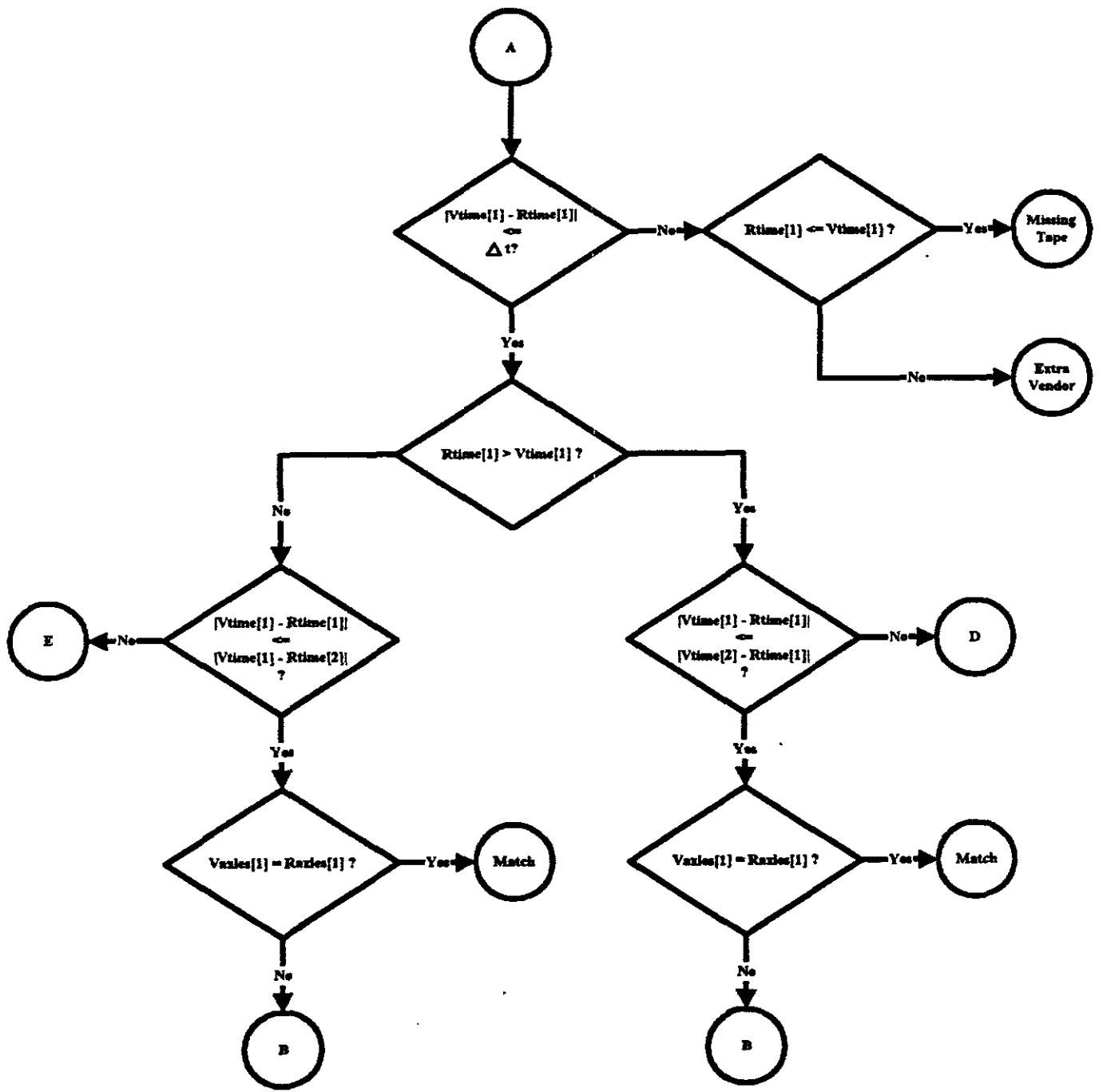

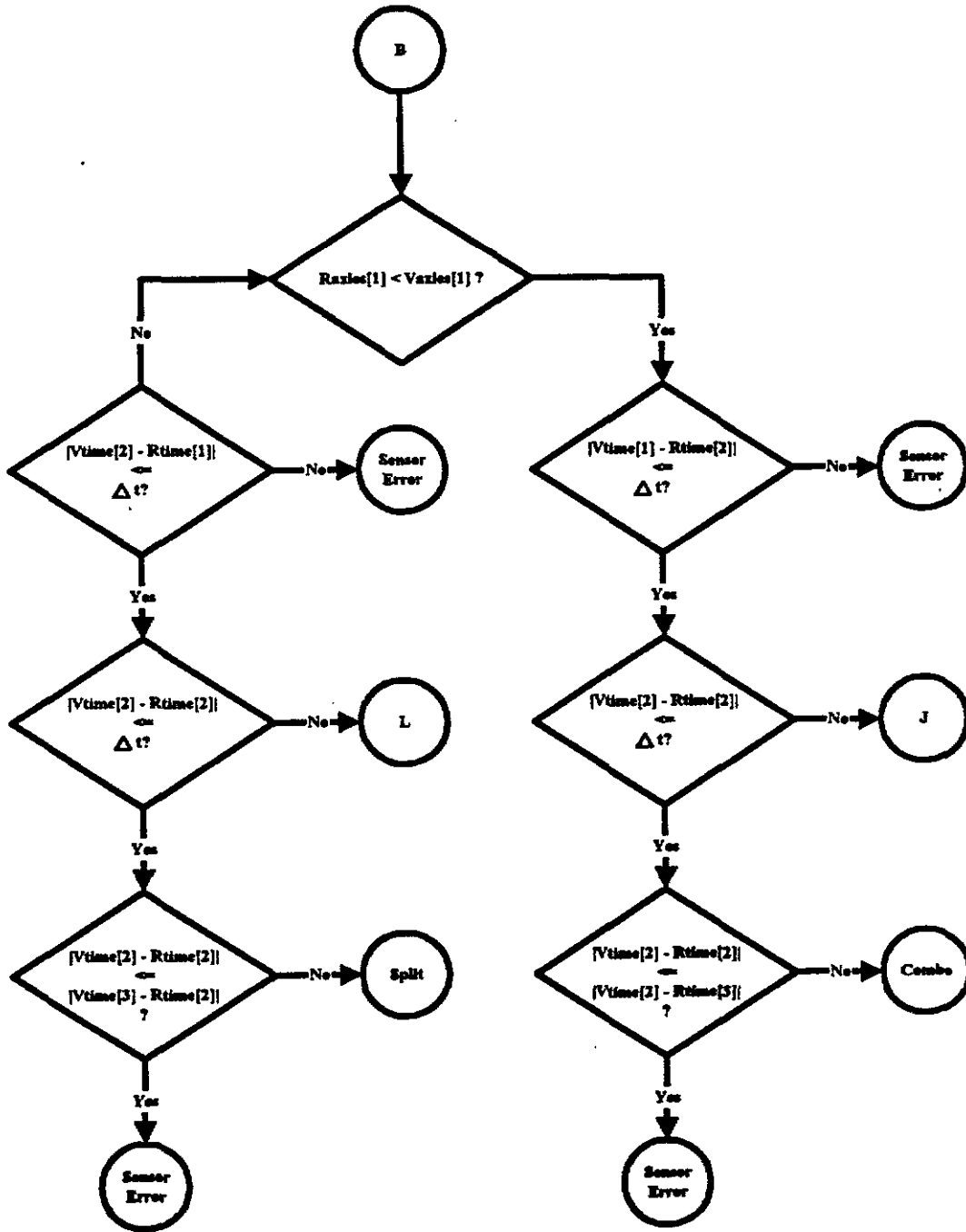

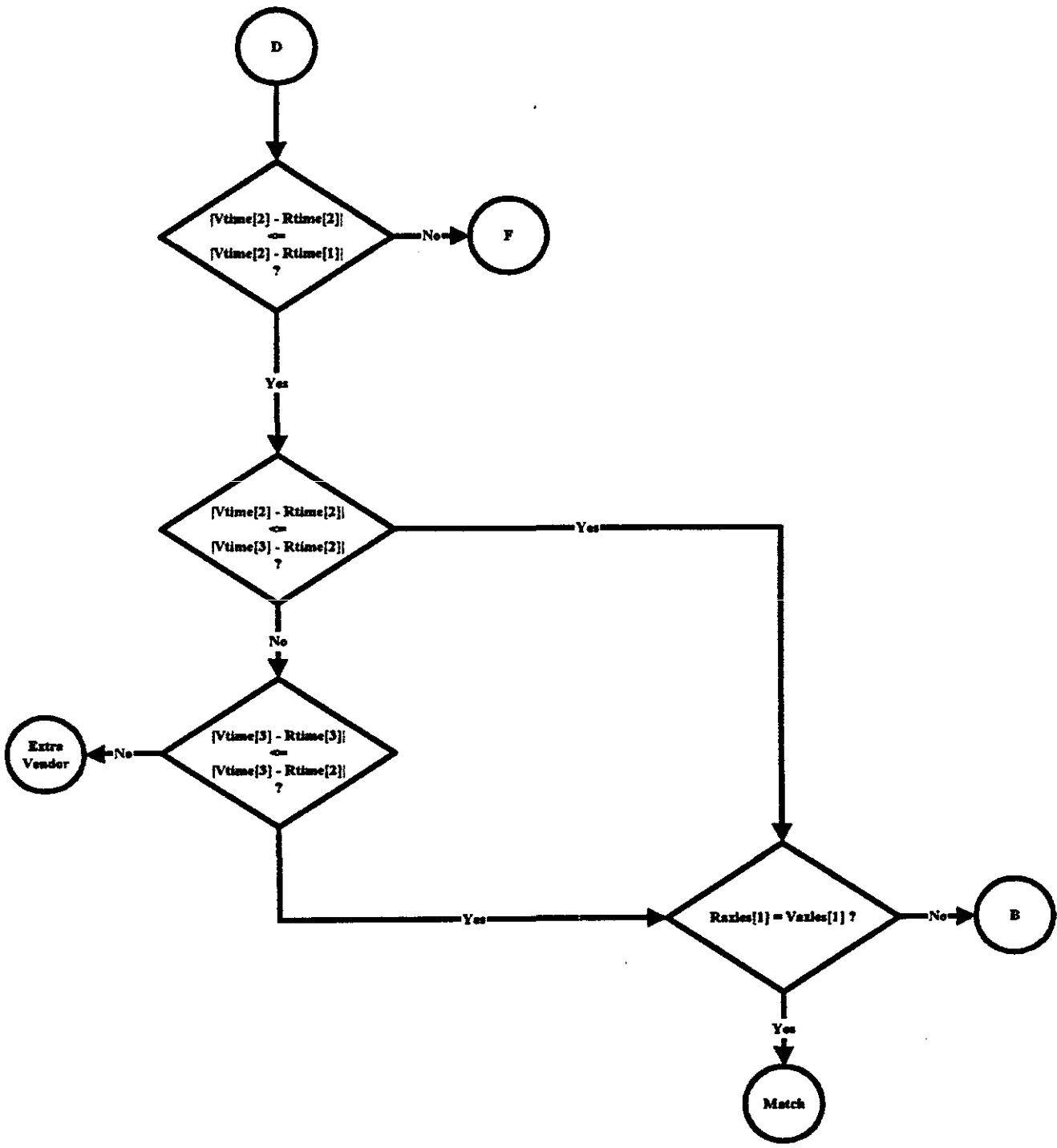

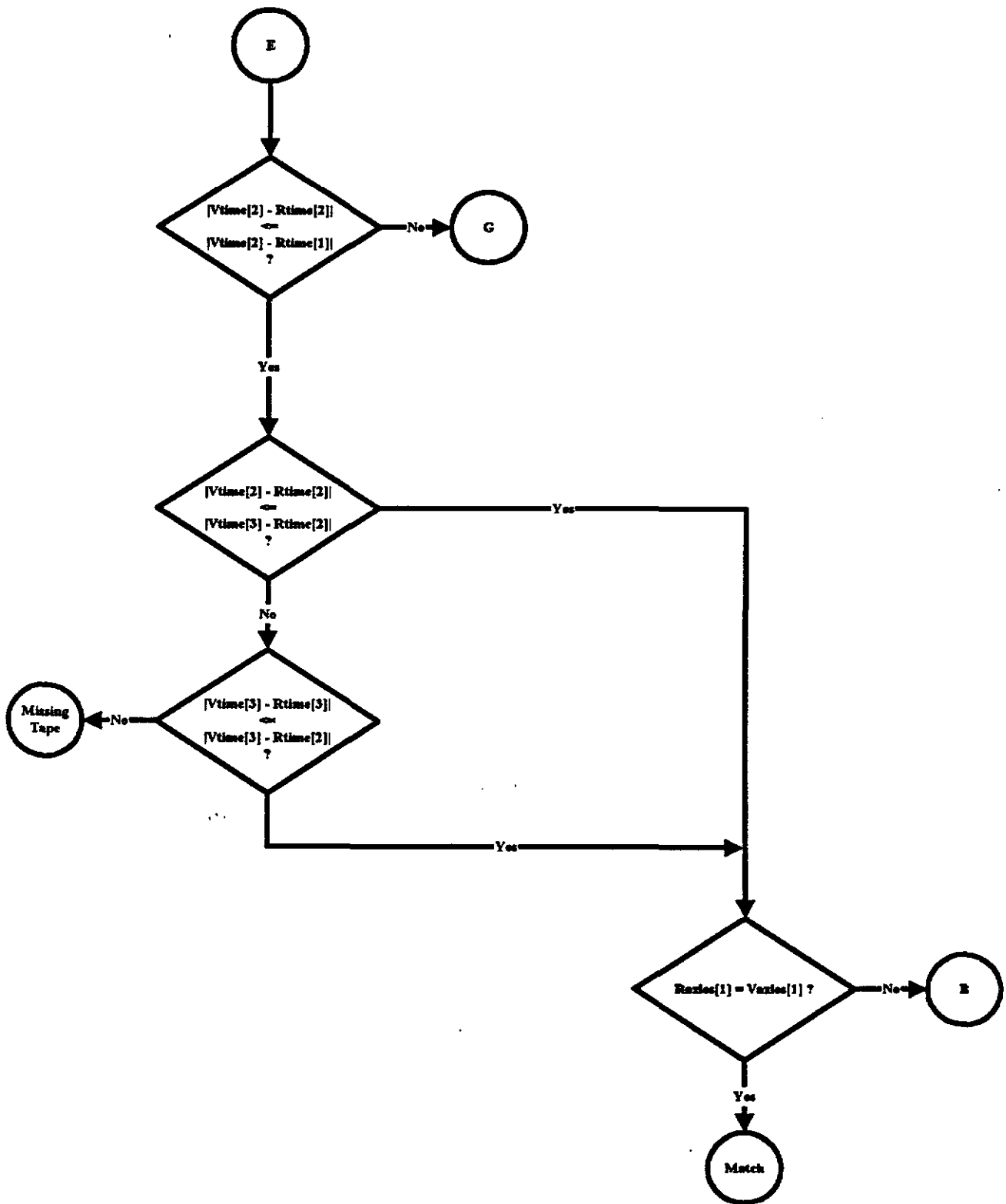

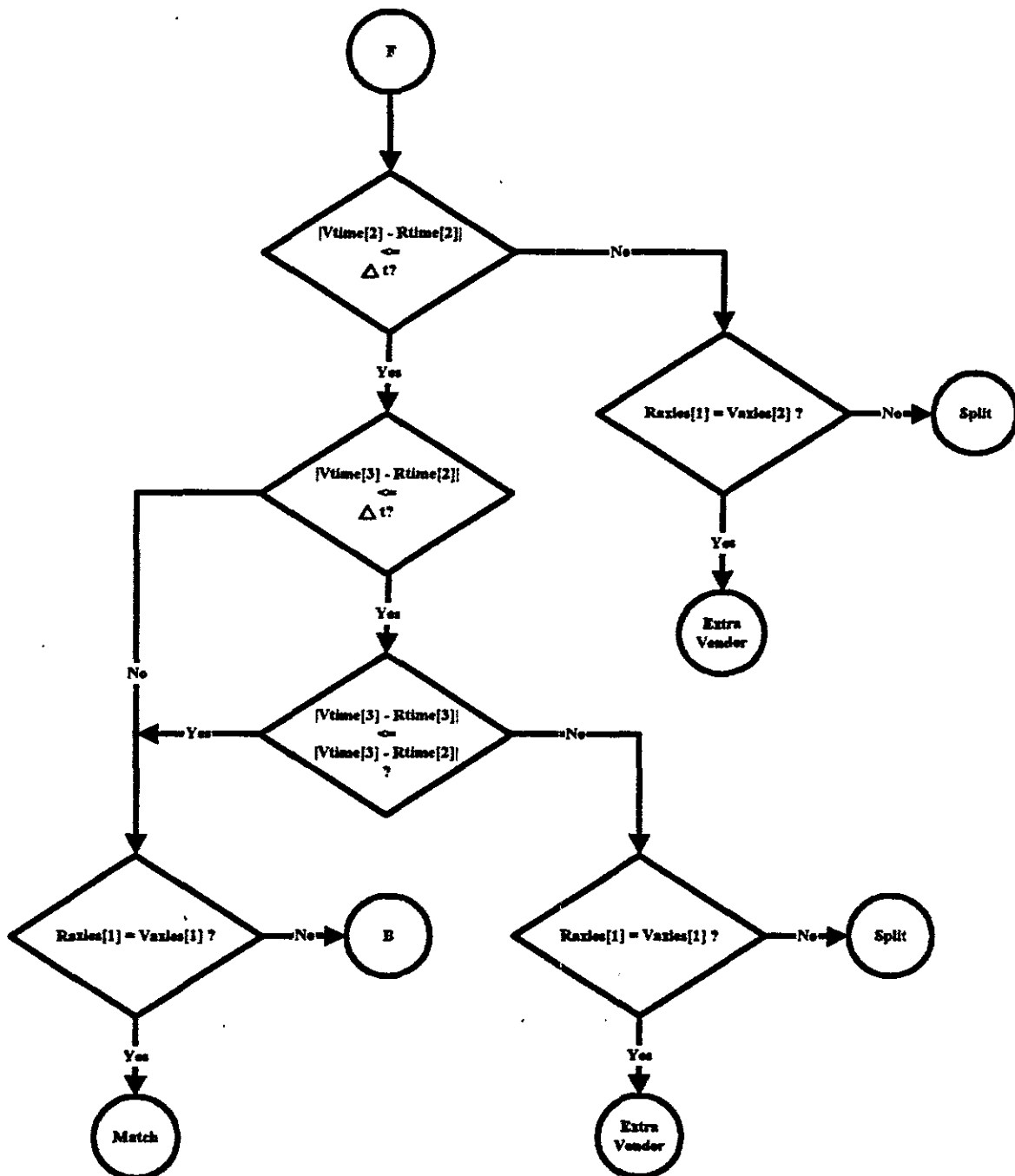

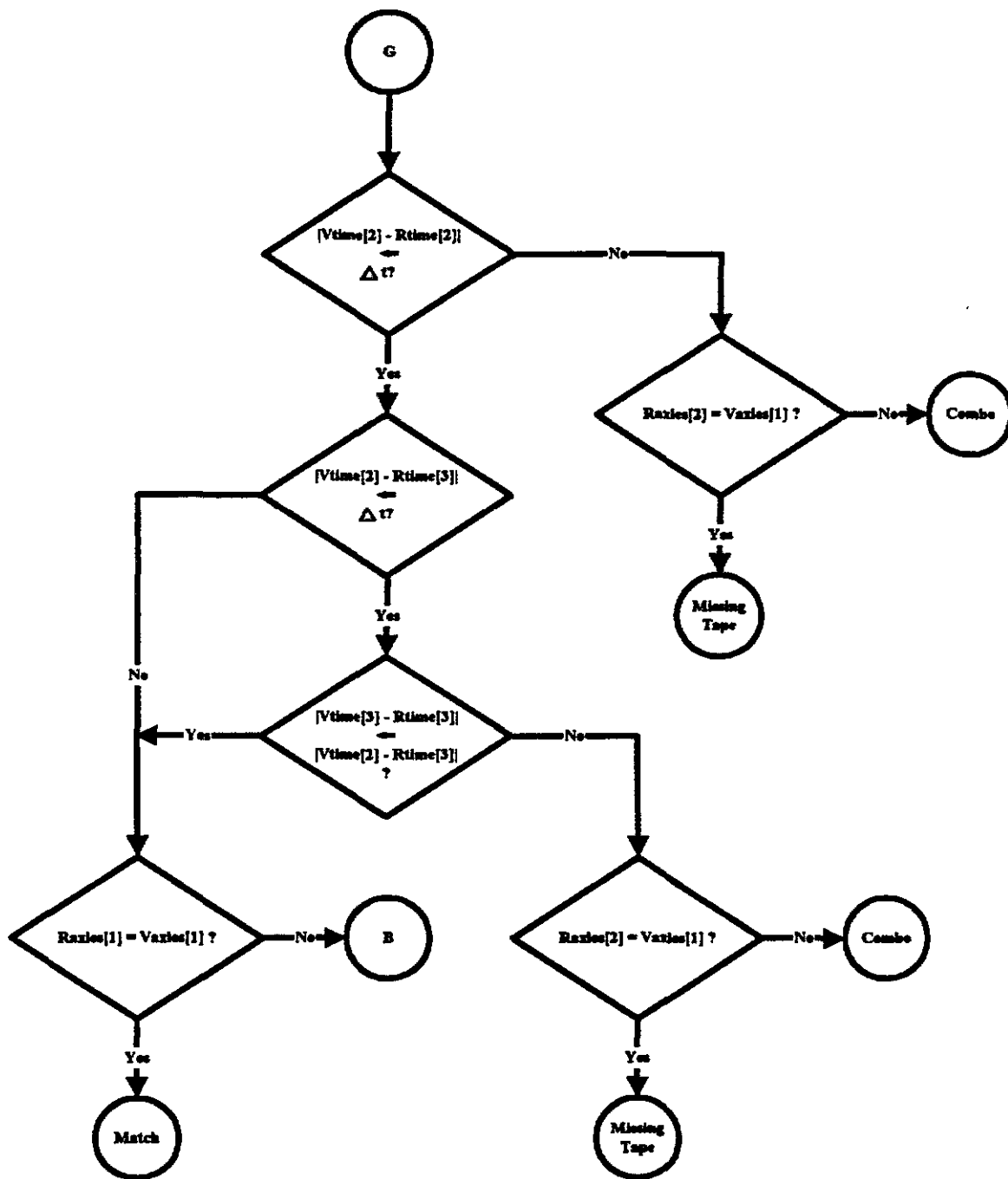

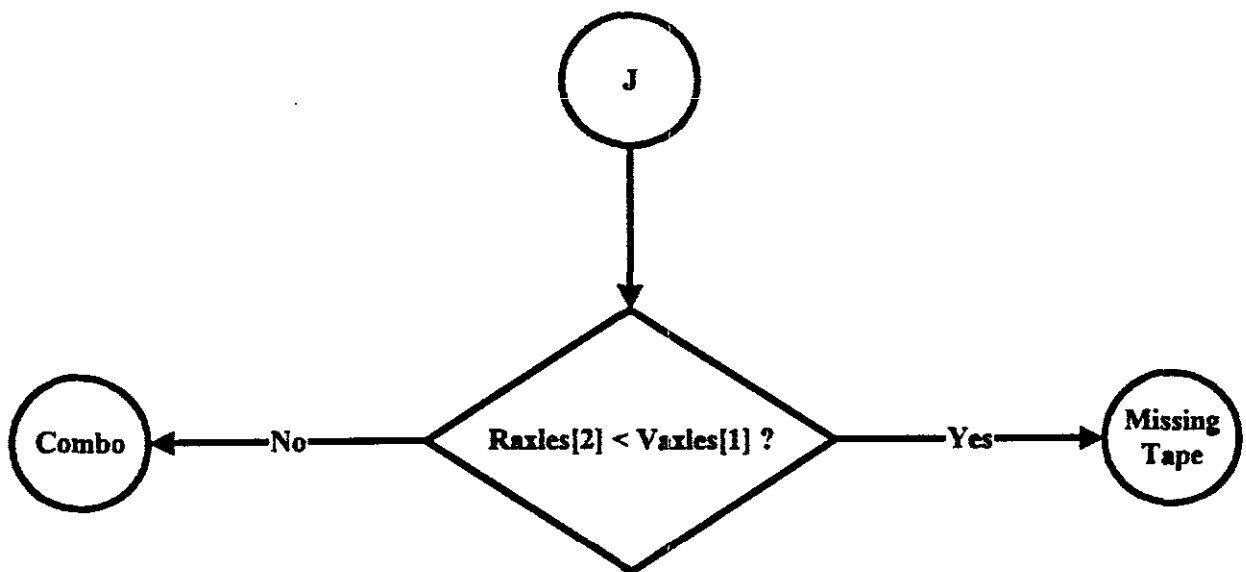
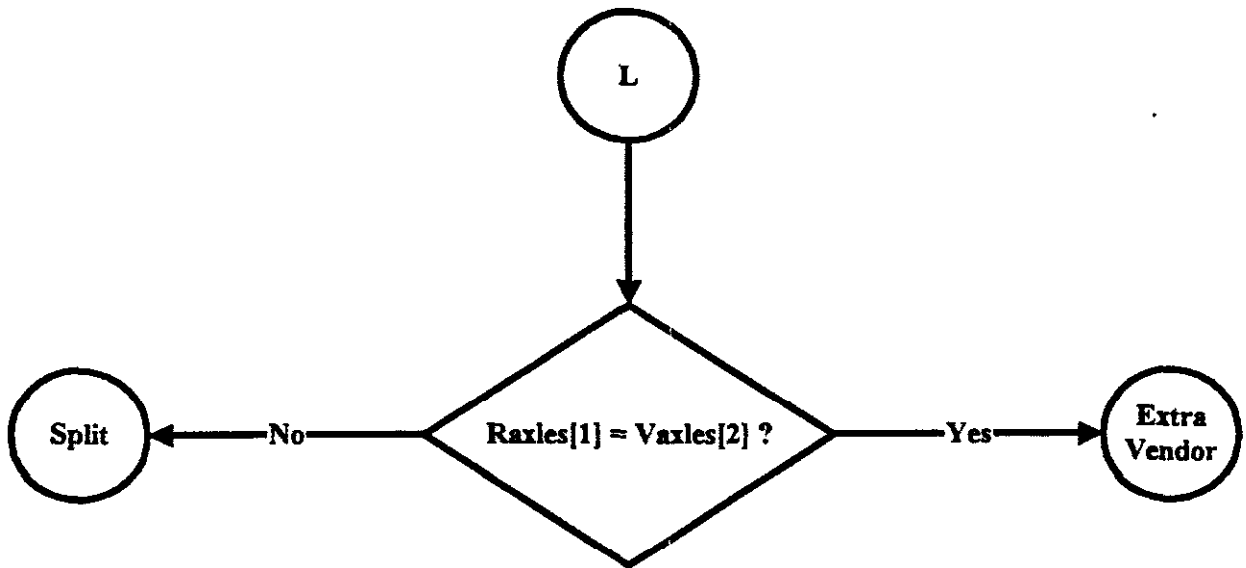

APPENDIX D

MATERIAL SPECIFICATION/INSTRUCTION SHEETS

THERMOCOAX NORCROSS		NO: VB 901 D 003
PHILIPS ELECTRONIC INSTRUMENTS COMPANY INDUSTRIAL AUTOMATION DIVISION 2975 COURTYARDS DRIVE NORCROSS, GEORGIA 30071, USA		PAGE: 1/5 DATE: 06/18/92
VIBRACOAX PIEZOELECTRIC SENSORS INSTALLATION GUIDE		DISTRIBUTION: C
		APPENDIX: -E-BOND DATA SHEET -CONCRETSIVE PASTE
		THERMOCOAX REF:
		CUSTOMER REF:

REV	DATE	AUTHOR	DESIGN	MANUFACTURING	QUALITY
0	06/18/92	GB <i>J. Bailey</i>	T. LLOYD <i>T. Lloyd</i>	A. WHARTON <i>Alan Wharton</i>	GB <i>J. Bailey</i>

This document is the property of Philips/Thermocoax, Norcross, GA and cannot be reproduced without written authorization.

I. Tools - Equipment

This is a non exhaustive list of tools and equipment needed for the Vibracoax sensors installation in road pavements (either asphalt or concrete):

- Traffic Control Signs
- Paint to mark pavement, rulers, strings
- Diamond blade saw
- Chisel and hammer
- Compressed air, hose
- Hot air generator or gas burner
- Temperature probe
- Duck tape
- Generator
- Electric drill with mixer paddles
- Latex rubber or leather gloves, safety glasses

II. Vibracoax Sensors

The appended figures describe the standard Vibracoax Piezoelectric Sensors:

- Class 1, for Weigh In Motion, 11.5 ft long
- Class 2, for classification, 6 ft long

The sensitive piezoelectric sensors are encapsulated inside a protective aluminum channel 1" high 1 1/2" wide, 4" longer than the sensor. The aluminum channel has lips on the bottom to ensure a perfect anchoring inside the pavement.

The encapsulation compound is either a sand epoxy or a hard polyurethane F80. This assembly can survive exposure to temperature up to 200F for half an hour without damage. The sensor is connected to a 50 ohms coaxial cable. The outer sleeve is made of PVC, the inner insulation being polyethylene. The maximum temperature the coaxial cable can survive is 170F. To protect the coaxial cable while transportation and installation, the first 3" of the cable outside the sensor are surrounded by a plastic tubing. Sensors must be electrically checked prior to and after the installation (see procedure VB 901 D 002) procedure.

	AUTHOR: GB	PAGE: 2/5
	CODE: VB 901 D 003	REV: 0
THERMOCOAX NORCROSS		

III. Site Selection

The selection of the site is a critical factor for both the life of the sensor and the accuracy of the measurement. The sensor installed in the pavement is surviving not only the traffic but also of the road deformations and movements.

- * It is obvious that sensors must not be installed in pavement that is uneven, deeply rutted, cracked. They must be installed in a homogeneous material (concrete or asphalt) and not in 2 adjacent layers.

The signal delivered by the Vibracoax sensors is proportional to the dynamic weight of the vehicle axles. To get a signal as close as possible to the static weigh, all vehicle vertical acceleration must be prohibited. This means:

- the pavement must be reasonably flat for 100 yards ahead of the sensor,
- avoid curves, inclines or declines,
- avoid crossings, traffic lights, railroads...,
- avoid areas of speeds less than 20mph.

IV. Sensor Installations

The installation process is to remove part of the pavement to install the sensor in it and to secure it via a grout. Best results are achieved when the sensor is flush to the top surface of the pavement. To allow a fast reopening of the highway lane, the pavement and the grout are usually heated between 90° to 100°F. The sensors are designed to easily survive this temperature but care must be taken to avoid overheating of the grout which can damage the extension cable. While curing the grout, temperature will rise by another 20° to 30°F depending on the size of the groove (the larger the groove, the larger the rise). A careful control of the grout temperature is a must.

The 50 ohms extension cable can also be damaged by bad handling. Avoid: twists, kinks, knots....

For a proper installation follow these steps:

- Step 1: Protection of the site with the required signs and cones for safe operation.
- Step 2: Mark the pavement with paint for loops and sensors. The slot size for Vibracoax sensors is 2" wide, 2" deep and 3" longer than the sensor. For Class 2 sensors, as they are only 6 ft long, be sure that they are always hit by one wheel per axle. Class 1 sensors must be hit by both wheels.

	AUTHOR: GB	PAGE: 3/5
	CODE: VB 901 D 003	REV: 0
THERMOCOAX NORCROSS		

For installation with one Vibracoax sensor and two (2) loops, the sensor must be approximately 1 ft ahead of the second loop.

For installation with one loop and two (2) Vibracoax sensors, the sensors can be placed very close outside the loop. For optimum placement of the sensors, consult the electronic instrument manufacturer.

- Step 3: Cutting of the grooves with a diamond blade saw (see drawings). The depth of the groove is 2". It is critical that the grooves are as straight as possible, parallel each other and perpendicular to the axis of the lane. The groove for the extension cable must be in the center of the sensor's grooves and at the same depth.
- Step 4: Remove the pavement material between the grooves with a chisel and hammer. Particularly in asphalt pavement be careful that the slot width is not larger at the top than at the bottom. Clean and dry the slot with compressed air. Check with a sensor that the slot is large enough to accommodate the sensor with at least 1/8" clearance in all directions.
- Step 5: Without a sensor inside the slot, finish to dry the pavement with hot air or a gas burner. In cold weather it is recommended to reheat the pavement, on approximately 6 inches on each side of the slot, up to 90°F (the human body temperature is 99°F, the pavement will feel warm but not burning). With asphalt pavement be careful not to overheat and burn the asphalt to keep a good adherence with the grout.
- Step 6: Apply a layer of duck tape around the slot to keep the pavement surface clean after the installation is finished. Clean the sensor aluminum channel with an organic solvent or alcohol to achieve a good adherence with the grout. Hang the sensor from holding devices (3 to 4 per sensor) via copper wires.
- Step 7: Grout preparation - Whichever brand is selected carefully read the product data sheet and instructions. Most popular brands are: E-bond G-100, Concrevice Paste epoxies and IRD methyl metacrylate. All grouts contain sand and must be thoroughly mixed and homogenized. Quantity is approximately 1.5 gallon (26lbs) for 6 ft. sensor and 3 gallon (52 lbs) for 11.5 ft sensors. It depends on the exact slot size. Temperature is an extremely critical factor for epoxy resin. If too cold, it requires a long time to cure. If too hot it starts to cure in the container or can exhibit cracks when cured. For E-bond, resin components must be at least 80°F before mixing.

	AUTHOR: GB	PAGE: 4/5
	CODE: VB 901 D 003	REV: 0
THERMOCOAX NORCROSS		

While mixing with an electric drill, the temperature rises - check that temperature stays below 100°F. The optimum temperature is 90°F. The temperature can be checked with a handhold thermometer (e.g., Model HH-21 from Omega Engineering, Inc.)

While curing, the inner epoxy grout rises due to the exothermic chemical reaction. If the mixed grout is left too long in the container the temperature can rise too much leading to possible damage on the extension cable or the impossibility to pour the grout in the slot.

- Step 8: Pour the grout to fill the slot up to half its depth. Install the sensor flush to the top surface of the road, none of the aluminum channel protruding, (e.g., the channel a little bit below the top surface of the duck tape, in the middle of the slot). Be sure that all the sensor's bottom is resting in the epoxy grout and that there is no air pocket underneath the sensor. Lay the extension cable in its slot.
- Step 9: Completely fill the slot with the grout avoiding air bubbles. Level the top surface of the grout with a tongue depressor trial or equivalent. After the grout is mixed (Step 7) the grout must be poured inside the slot (Steps 8 & 9) as fast as possible to avoid the sand to settle down to the bottom of the container and the slot.
- Step 10: Allow the grout to cure. In cold weather it is possible to shorten the curing time by gently heating the pavement and the grout with hot air. Be careful not to overheat and damage the extension cable. The surface temperature of the grout must remain below 110°F. Route the extension cable in its slot and seal it with a conventional magnetic loop sealant.
- Step 11: When the grout is cured (hard enough not to move when a strong pressure is applied to it) cut the hanging wires and remove the holding fixture and duck tapes. The top surface of the grout can be smoothed with a grinder.
- Step 12: After routing and connection of the extension cable, check the integrity of the sensors. Remove traffic signs and allow traffic on the lane. Check the voltage generated by vehicles over the sensors. The actual reading will depend on the voltmeter model. For a truck, the reading should be around 100 mV.

	AUTHOR: GB	PAGE: 5/5
	CODE: VB 901 D 003	REV: 0
THERMOCOAX NORCROSS		

Aluminum Channel

RG58 Cu
(65 Feet)

Encapsulating Compound

Connector

VIBRACOAX

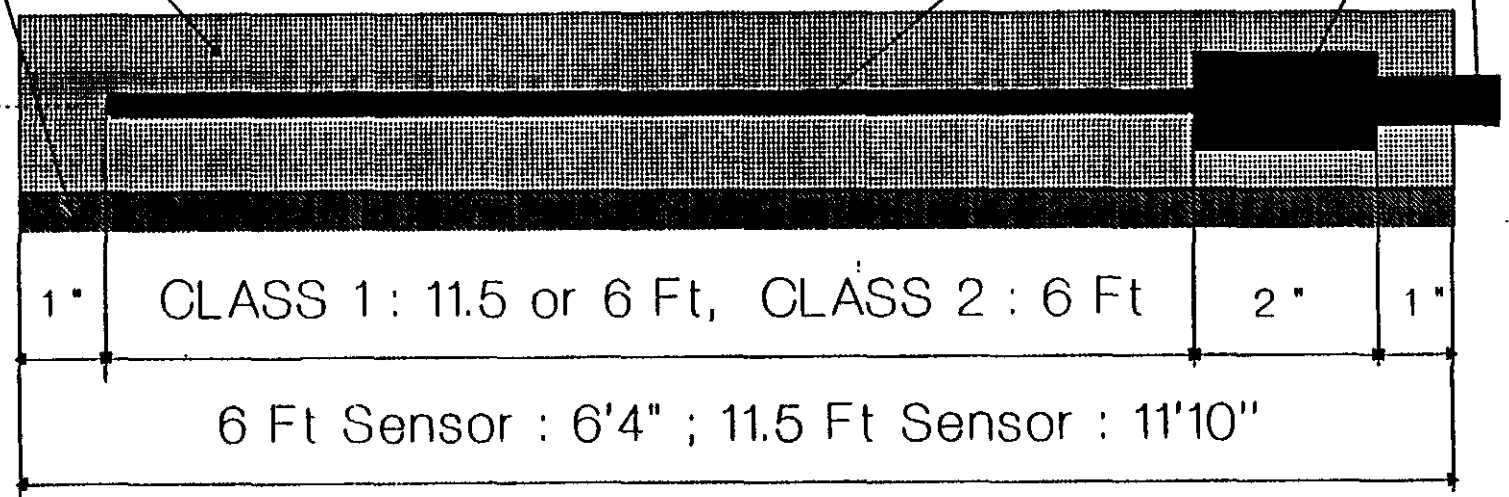

PHILIPS VIBRACOAX SENSORS

ENCAPSULATION COMPOUND

SAND EPOXY

FLEXANE 80

VIBRACOAX

ALUMINUM
CHANNEL

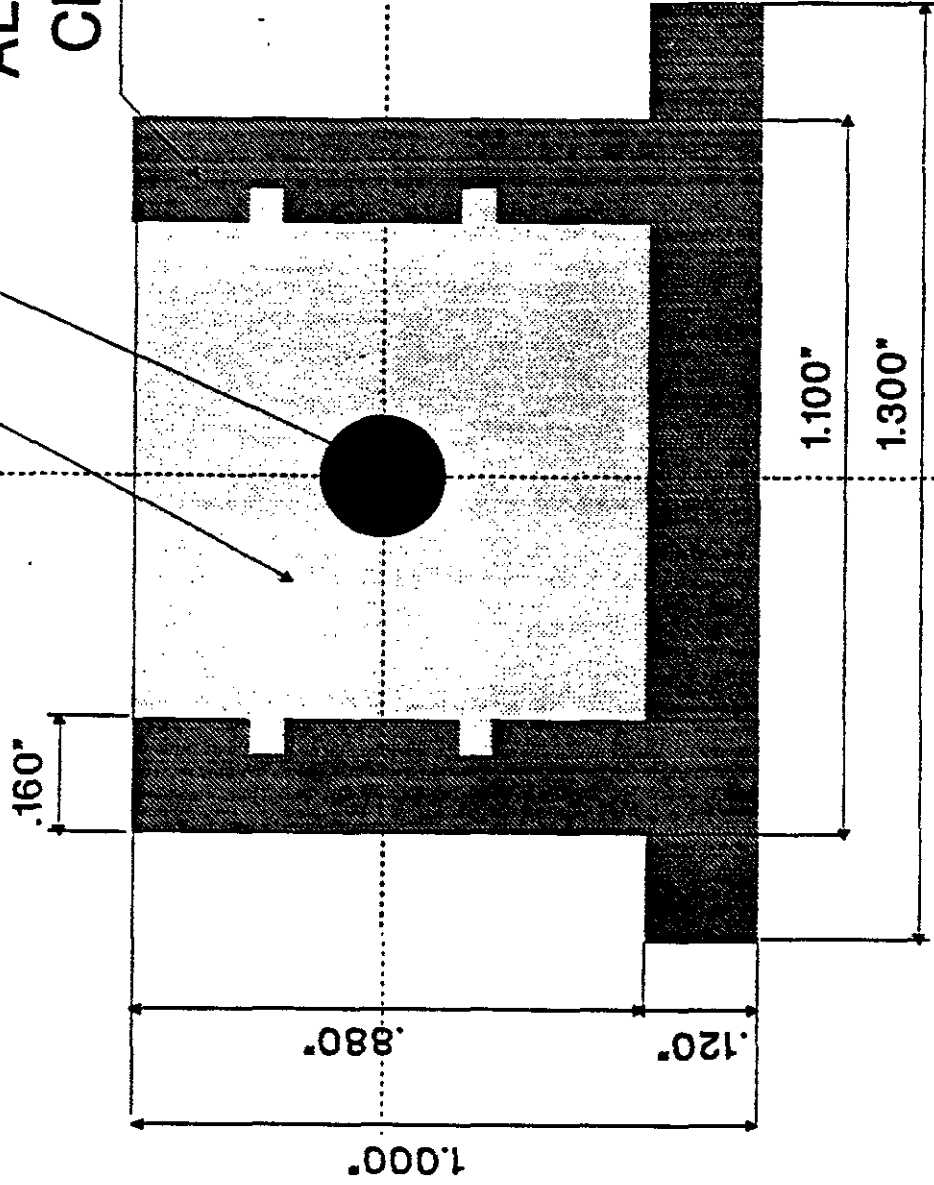

PHILIPS PIEZO SENSOR

SLOT CUTTING (DIAMOND SAW)

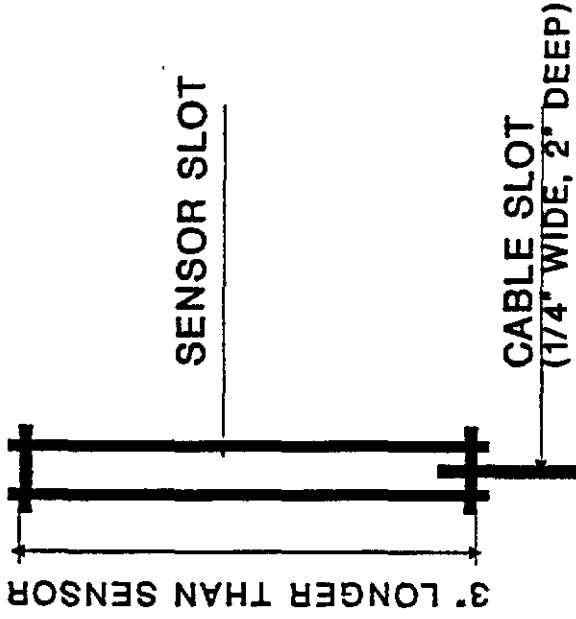
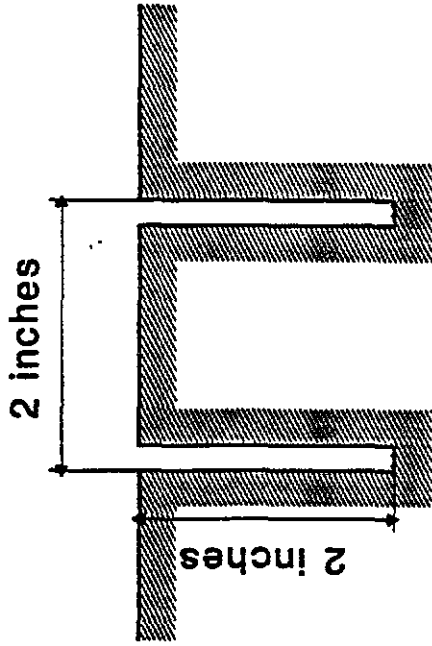

SLOT PREPARATION

- CHISEL & HAMMER
- COMPRESSED AIR
- HOT AIR (PAVEMENT TEMP. 90 F)
- DUCK TAPE

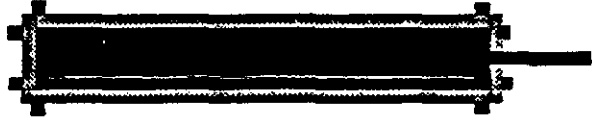
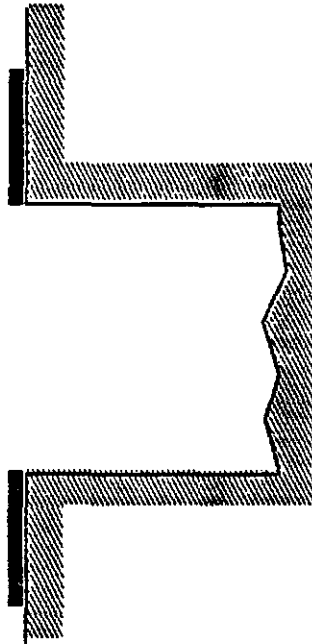

SLOT PREFILLING

EPOXY GROUT (TEMP. < 100 F)

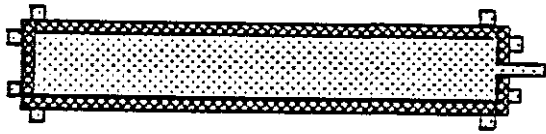
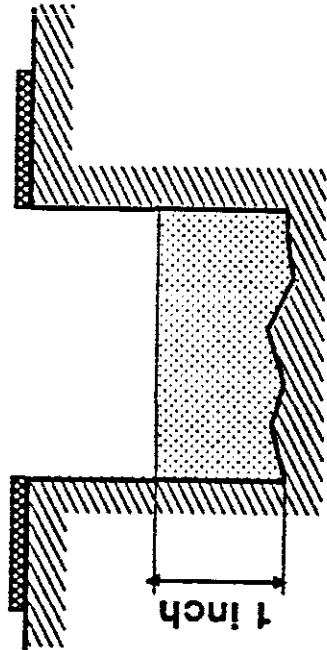

SENSOR INSTALLATION

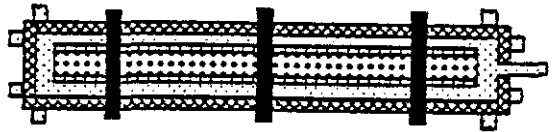
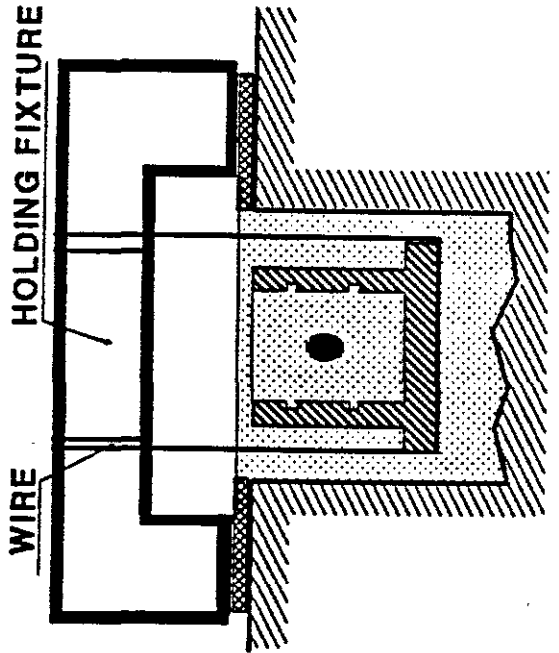

THERMOCOAX

NORCROSS

NO: VB 901 D 002

PHILIPS ELECTRONIC INSTRUMENTS COMPANY
INDUSTRIAL AUTOMATION DIVISION
2975 COURTYARDS DRIVE
NORCROSS, GEORGIA 30071, USA

PAGE: 1/3

DATE: 06/09/92

VIBRACOAX SENSORS
FIELD TEST PROCEDURE

DISTRIBUTION:

APPENDIX:

THERMOCOAX REF:

CUSTOMER REF:

REV	DATE	AUTHOR	DESIGN	MANUFACTURING	QUALITY
0	06/09/92	<i>GB Bailler</i>	<i>AW Bailler</i>		<i>GB Bailler</i>

This document is the property of Philips/Thermocoax, Norcross, GA and cannot be reproduced without written authorization.

Vibracoax sensors are rugged sensors and if installed properly in a pavement they can last for several years delivering good signals.

Nevertheless construction work on highway is not always easy and particularly the use of excessive heating with powerful gas burner can damage the coaxial extension cable.

Then we recommend that immediately after the installation the electrical characteristics of the Vibracoax sensors are thoroughly checked: insulation resistance, capacitance, generated voltage (in this order).

I. INSTRUMENTS

- o Insulation Resistance: ohmmeter capable of reading at least 20 Megohm.
- o Capacitance: Capacitance meter capable of reading at least 30 nanofarad.
- o Voltage: voltmeter capable of reading millivolts D.C.

II. TESTS

All the electrical tests are done between the core and the screen of the extension cable.

II.1 Insulation Resistance (IR)

The insulation resistance must be found higher than 1,000,000,000 ohms (1,000 Megohm) on new sensors.

Practically many multimeter read up to 20 Megohm. If the IR is higher than 20 Megohm the sensor passes the test.

If the IR is lower than 1,000 ohms this means the extension cable was burnt by a severe heating. (the internal insulation material melts and the cable core moves toward the screen resulting in a short-circuit). Locate the defect and repair the cable if possible or the sensor has to be replaced.

	AUTHOR: GB	PAGE: 2/3
	CODE: VB 901 D 002	REV: 0
THERMOCOAX NORCROSS		

II.2 Capacitance (C)

Sensors are made of 2 components:

- o Vibracoax piezoelectric cable: 2,600 pF/ft. (8500 pF/m) typical.
- o RG58 extension cable: 33 pF/ft. (110 pF/m) typical.

Standard sensors with 65 feet of extension cable will exhibit:

CL2 (6 ft): about 18nF

CL1 (11.5 ft): about 32nF

A reading lower than 2nF will tell a rupture in the extension cable continuity (core or screen).

Capacitance measurements are valid only on well insulated sensors

III.3 Voltage Generation Test

The Vibracoax piezoelectric sensors are generating a voltage when submitted to a pressure variation.

When installed in the highway pavement, a pressure variation on a sensor (vehicle passing over, hammer shock, jumping on it) will create a peak voltage of 30 to 100 mv for less than a second but easily visible on a DC Voltmeter connected at the end of the extension cable.

	AUTHOR: GB	PAGE: 3/3
	CODE: VB 901 D 002	REV: 0
THERMOCOAX NORCROSS		



TECHNICAL BULLETIN

READY-SET PAVEMENT GROUT

DESCRIPTION: READY-SET Pavement Grout is an epoxy compound designed for use in sealing sensors into roadway surfaces. It can be traffic ready in 1/2 hour if all of the recommendations in this report are followed. It is supplied in a kit which contains:

- A) 5-gallon pail of graded aggregate.
- B) 1-gallon pail of epoxy (Part A).
- C) 1-quart can of hardener (Part B).

When cured, the epoxy product produces an environment for the sensor which protects it against snow, ice, rain, salts, chemicals, abrasion and temperature extremes.

APPLICATION: READY-SET Pavement Grout is supplied in a kit which measures 1.625 gallons or 375 cubic inches. This amount of material is sufficient to set one 6'4" sensor. Two kits are required to set an 11'10" sensor.

USING THE KIT: As mentioned in the description, the kit contains one 5-gallon pail, one 1-gallon pail and one 1-quart can. Open the 1/2 full gallon of epoxy. Remove the lid from the quart can of hardener and pour the hardener (Part B) into the epoxy (Part A) contained in the gallon pail. Stir them together for 2-3 minutes, either with a stirring stick or with power stirring. Take care to scrape the sides and bottom of the 1-gallon pail during the 2-3 minutes of mixing. Use the stick which is provided for this purpose. After thoroughly blending the epoxy with the har-

dener, transfer this blend immediately into the 5-gallon pail of graded aggregate and begin power agitation. Continue blending the aggregate with the blended epoxy for 2-3 minutes. Once again, scrape the walls and bottom of the aggregate mix to insure a full wetting of all of the aggregate.

Know the air temperature. A thermometer is a handy tool for this purpose AND it should be used. Consult the following graph to determine the waiting period necessary before potting the sensors in their prepared groove. The graph shows the approximate waiting time and could vary upward in time if the wind velocity is over 5 MPH. For example: If the air temperature is 60°F., the graph states that you should wait 25 minutes before potting the sensors. Adding the time that it takes to do the potting, the epoxy will be ready for traffic in 1/2 hour.

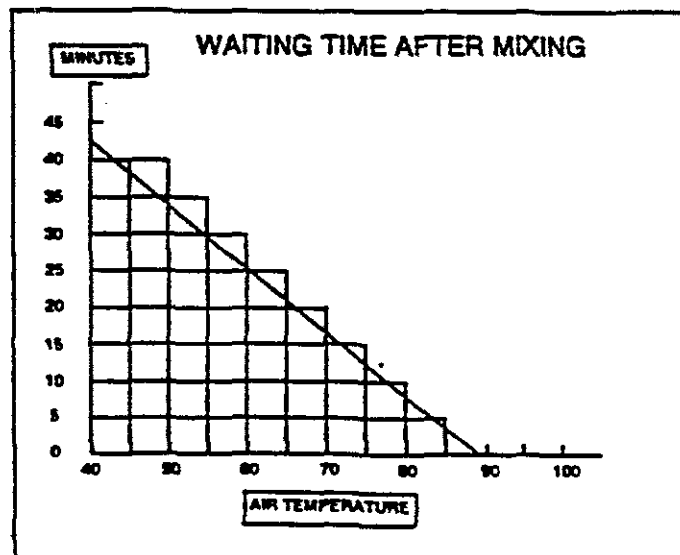

TRICKS OF THE TRADE: The reason for allowing the epoxy, hardener and aggregate mix to wait for some period of time is to allow the exothermic heat of reaction to develop to a temperature of 90°-100°F. The colder the air temperature; the longer it takes to do this. Keeping the full reaction mix in the pail, allows the reaction to proceed as indicated.

A glance at the graph will show that at air temperatures above 90°F., there is no waiting period. Ideally, READY-SET Pavement Grout should be stored at 80°F at all times prior to use. The 80°F. temperature (use the thermometer) is high enough to safely mix, then use the system without further waiting since the actual mixing develops frictional heat and

could bring the temperature to 90°F. rapidly.

Finally, heat applied to the cut groove from a propane torch will both dry and heat the groove. Carefully lay your hand upon the pavement next to the groove. If the pavement feels slightly hotter than your hand, the temperature will be slightly above body temperature. At this point, stop heating and begin potting. Simply pour, spread and finish the grout with appropriate tools (trowel, etc.) to a smooth finish that is flush with the surface of the highway.

NOTE: Always follow the sensor manufacturers recommendations for positioning the sensor and any other techniques of importance which may be suggested in their presentation.

PROPERTIES @ 77°F.

	Typical Values	ASTM Method
Shelf Life	2 years	N/A
Mix Ratio	4.6 : 2 : 20 (A : B : Aggregate)	N/A
Viscosity	Pourable	N/A
Pot Life (Full Mix)	28 minutes	N/A
Hardness (Shore)	87-D to 90-D	D-2240
Tack-Free (10 min. wait) 77°F.	1/2 hour	N/A
Tack-Free (30 min. wait) 55°F.	1/2 hour	N/A
Compressive Strength	8,000-10,000 psi	D-695
Bond Strength	500 psi	C-321
Water Absorption	0.30%	D-570

The values reported are believed to be a true representation of this system. Your evaluation, of course, will be necessary in order to determine the suitability of this system for your specific application.

CAUTION: Can cause skin irritation. Wear protective clothing. Wash contaminated skin with soap and water - NEVER SOLVENT. In case of eye contact, flush with water for 15 minutes; contact a physician immediately.

FOR PROFESSIONAL USE ONLY



INTERNATIONAL ROAD DYNAMICS INC.

CORPORATE OFFICE: 702 43rd Street East, Saskatoon, Saskatchewan, CANADA S7K 3T9
Telephone: (306) 653-6600 Facsimile: (306) 242-5599

**AS-475 AXLE SENSOR GROUT
- DIRECTIONS FOR USE -**

GENERAL

IRD's AS-475 Sensor Grout is a resin based grout. Specifically designed to embed permanent axle sensors in asphalt or portland concrete pavements.

The grout serves two purposes:

- a) Adhesive bond between the sensor and road pavement material
- b) Isolation medium between the sensor and road pavement.

AS-475 grout comes pre-mixed in convenient sized pails and is packaged in kit form to correspond with the sensor type to be installed: **AS-475-1 (20kg)**, **AS-475-2 (15kg)**, **AS-475-3 (5kg)**. The grout consists of a resin material mixed with fine mineral aggregate. The aggregate provides strength, consistency, and acts as a heat sink during the curing reaction (*The curing of the resin liberates heat. The sand absorbs excess heat to prevent the resin from cracking.*)

Curing of the grout begins once the catalyst (*the white BPO-Benzoyl Peroxide Organic*) powder has been added. The reaction time for curing is dependent on external temperature conditions. However the curing time can be controlled by adjusting the amount of BPO catalyst added to the grout for various temperature conditions.

DIRECTIONS FOR USE

AS-475 grout comes with pre-packaged vials of BPO as follows:

Grout Kit	BPO Supplied
AS-475-1 20kg (12 US quarts)	6 Vials, 33g each
AS-475-2 15kg (9 US quarts)	3 Vials, 33g each + 3 Vials, 17g each
AS-475-3 5kg (3 US quarts)	3 Vials, 17g each

Depending on the installation temperature, you use either 1, 2, or 3 of the vials per pail of grout. Working time (*pot life*) will be between 10 and 50 minutes.



INTERNATIONAL ROAD DYNAMICS INC.

CORPORATE OFFICE: 702 43rd Street East, Saskatoon, Saskatchewan, CANADA S7K 3T9
Telephone: (306) 653-6600 Facsimile: (306) 242-5599

TEMPERATURE:

°F	°C	Viols/Pail of Grout
<55	<13	3 x 33g - 10 kg (6 qu) Pail 3 x 17g - 5 kg (3 qu) Pail
56-75	14-24	2 x 33g - 10 kg (6 qu) Pail 2 x 17g - 5 kg (3 qu) Pail
>75	>25	1 x 33g - 10 kg (6 qu) Pail 1 x 17g - 5 kg (3 qu) Pail

MIXING DIRECTIONS

Equipment Required:

- Electric drill
- Mixing paddle for drill
- Grout and BPO
- Well ventilated space

Procedure:

- a) Open pail and start mixing using the drill and mixing paddle.
Mix until all fine aggregate at the bottom of the pail is thoroughly mixed in and the grout takes on a smooth texture (no lumps).
- b) Add appropriate BPO as indicated in "Directions For Use".
- c) Mix thoroughly for an additional 2 minutes.
- d) Apply grout - (10-50 minutes working time). Ensure no voids or air bubbles become trapped in the grout - (45-60 minutes cure).
- e) Traffic may be allowed to pass after surface is tack free.



INTERNATIONAL ROAD DYNAMICS INC.

CORPORATE OFFICE: 702 43rd Street East, Saskatoon, Saskatchewan, CANADA S7K 3T9
Telephone: (306) 653-6600 Facsimile: (306) 242-5599

Precautions:

Read Material Safety Data Sheets (MSDS) as provided

- a) Avoid breathing grout vapors.
- b) Do not use in enclosed areas. Always ensure adequate ventilation.
- c) Do not use BPO powder near heat or open flame. BPO is a very powerful oxidizer
(it supplies its own oxygen when burning).
- d) Use dust mask if required to prevent inhalation of BPO.
Wash skin if contacted by powder.
- e) Always wear appropriate protective clothing, boots, coveralls, gloves
and safety glasses.

CLEAN-UP

Wash any uncured grout from tools and equipment with water.
After curing, grout can only be removed by mechanical means.



To:
Glenn Champion

P. 1/5
DOCAL
ASSOCIATES INC.
Suite 211, 264 Amity Road
Woodbridge, CT 06526
Tel: 203-387-3218
Fax: 203-387-4957

January 15, 1993

Mr. Jerry Schiff
Diamond Traffic
FAX 813-843-0270

Dear Jerry:

Please find attached copies of the installation instructions from the product brochure for the Autologger range of piezo axle sensors. Towards the back of the packet are two sections titled "Maxi Replaceable Sensor" and "Maxi Replaceable Housing" where you would find these installation instructions for the housings and the sensors. These installation instructions are written for someone who is generally familiar with the installation procedures for different types of piezo axle sensors. It is important that the instructions be carefully read and understood prior to the actual installation. Please be sure that if there are any questions or concerns that we are contacted well in advance of the installation date.

There are several points that you should keep in mind regarding the installation of the specific sensors that we have shipped to Glenn Champion, at GA Tech for installation in the Accuracy of Traffic Monitoring Equipment Project.

1. We recommend the use of E-Bond G-100 Epoxy or of Traffic Coll Adhesives Epoxy.
2. The installation instructions discuss the need to drill through the floor of the housing and install rawl plugs into the road surface below. It has been found that the use of rawl plugs is not necessary and in fact that they can reduce sensor life as they loosen up and begin to come up from the sensor floor.
3. It is very important that the epoxy used to install the housing be allowed to set very hard before installing the sensor element into the housing. This will prevent the housing walls from splaying outward resulting in a loose sensor fit. In this manner, when the sensor is installed into the housing it will be a tight fit and may require the use of a rubber hammer or mallet.
4. Please note that the installation instructions indicate that the height of the fitted sensor above the housing surface should be 3 mm. This is not the case with the sensors that were shipped for this project which are designed to be flush fitting, i.e. there is no protrusion of the sensor over the housing. This is a design improvement to reduce the possibility of something like a snow plow or muffler dragging the sensor element out of the housing.

INSTALLATION NOTES

Maxi Replaceable Housing:

The highway surface should be flat and free from excessive irregularity. Dishing or bowing should be limited to 1cm over the length of the housing.

Mark out two straight parallel lines 60mm apart, with a tolerance of better than ± 5 mm across the full width of the lane. Offer up the sensor housing to the desired position and mark out its length plus 50mm across the parallel lines, ensuring that they are perpendicular to the traffic flow.

Aerosol paint and the use of a straight edge as a masking device will be found to be a good method.

Mark out a further two parallel lines, 25mm apart, using the centre line of the previous lines, running from the nearside of the housing to verge of the road or kerbside. Cut clean vertical slots on these four marks to a depth of 50mm, $-0 +5$ mm, using a roadsaw.

Chisel out the gaps between the slots to this depth, ensuring that the base of the rectangular cavity thus created is reasonably smooth, and never less than 50mm. If a double cutter is available, chiselling of the narrower slot may not be necessary to create the conduit channel.

Dam off the conduit slot/sensor slot interface to prevent adhesive loss into this gap. Plasticine or card is adequate.

Remove the spoil from the channels. Blow out all loose debris with compressed air. If a water lubricated cutter has been used, the slot should be dried with a hot air blower. The slots must be clean and dry to ensure that adequate adhesion is obtained.

Ensure that the conduit edges are free from burrs which could damage cable. Install the conduit with one end level with the commencement of the wider channel. The remaining conduit is buried under verge-side soil or kerbing, with its other end passing into the weatherproof box containing signal processing equipment via a weather-proof gland. Conduit radii of less than 200mm should be avoided otherwise it may be found that cable passage will present difficulties.

Conduit materials may vary, but a smooth internal diameter of not less than 10mm is necessary. 12mm copper piping or 'microbore' can provide signal screening, durability and easy cable passage.

Screw metal plates of approx 100mm length and 50mm width at right angles across the housings at intervals of approx 750mm. Small self tapping screws are adequate. The plates suspend the top surface of the housing flush with the highway surface when the housing is set into adhesive.

Observing all Health & Safety and Manufacturers instructions, wipe the outside of the housing with a cloth wetted with hydrocarbon solvent to remove dirt and grease.

Thoroughly mix the two components of the mounting adhesive, observing the maker's safety and handling instructions. An air driven stirrer will be found useful. A two component 4KG pack is adequate for installation on one housing of up to 3.5 metres.

Starting at one end, and gradually working across the lane, pour adhesive into the slot to a depth of 15mm. Place the housing into the channel with the nearside end up to the dam into the conduit slot. Place weights on the mounting plates to hold the housing down against the floating action of the adhesive, and pour adhesive further into the gap between housing and slot. This should be done slowly and with care to avoid cavitation. There should be sufficient spew or excess to ensure the gap is totally full, but this should not be allowed to flow into the housing channel. It should be noted that the retaining screws must be downstream of the traffic flow, i.e. sloping away from the direction of traffic and not sloping into it.

INSTALLATION NOTES

Maxi Replaceable Axle Sensor: Piezo Electric

These sensors should only be installed in Gates Maxi Housings.

Insert the sensor and tap into its seated position. If this is done from the centre out, in each direction, any possibility of kinking the sensor can be avoided. The sensor should be a tight fit, but excessive force should be unnecessary.

Check the height of the fitted sensor above the housing surface. This is specified at 3mm. A vernier calliper gauge will be found useful. Higher protrusion indicates imperfect seating and should be rectified before proceeding further; check for foreign matter between the sensor and housing. Ensure that flexing at cable exit is zero as this will flex break the feeder cable.

Tighten down the retaining screws. A battery powered electric screwdriver makes this quicker. Fill in the screw holes with plasticine.

Fill the space at each end of the sensor, after dam removal, with further plasticine. If particular care is taken at the cable exit end, and the plasticine pushed into the conduit opening, further sealing of the cable can be achieved to help prevent ultimate moisture ingress.

Replacement is straight forward. Remembering to attach a leader cord to the old signal cable can save a lot of frustration! Plasticine sealer should again be used to re-seal both screw heads and the ends of the channel. With experience, replacement can be readily achieved in 5-10 minutes.

The securing bolts in the base of the housing should be checked for protrusion and security whenever sensors are replaced. These bolts must be installed flush or slightly below the base, failure to do this will result in reduced sensor life.

It will be necessary to allow the installed sensor to "bed-in". This is achieved by allowing traffic to flow freely over the installation for a period of time depending on flow rates.

This will achieve a much cleaner signal for tuning purposes.



Golden River Instruments, Inc.
7352 Dartford Drive, #. 7,
McLean, Virginia 22102
Tel 703 847 6645 ;ax 703 847 5648

Single Piezo-electric Cable Sensor

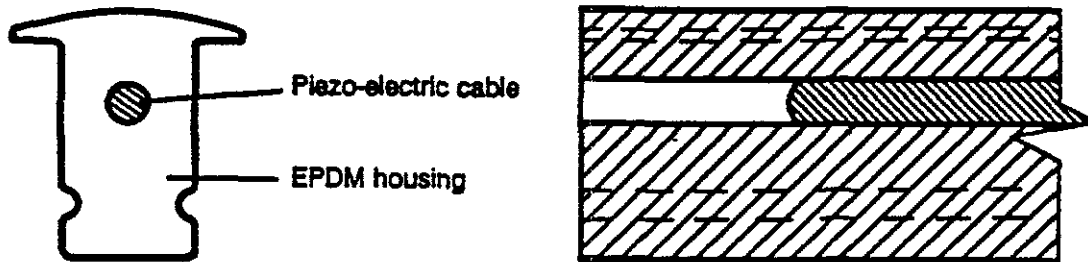

Construction

The sensor comprises a rubber extrusion developed by TRAFFIC 2000 for direct bonding into a road surface. Made from high-performance EPDM, it is impervious to attack from acids, alkalis, salts and ultraviolet. This extrusion houses a pressure-sensitive co-axial cable which produces a voltage when compressed or deformed by impact. The output is used to operate a wide variety of measurement and analysis equipment.

Applications

- A single sensor is used directly for axle counting, enabling simple traffic flow data to be obtained. It also acts as a vehicle detector for car park barrier actuation or security control. It is sensitive to all classes of vehicles, and the output can be used to give an indication of axle weight.
- In conjunction with an inductive-loop presence detector, a single piezo-electric sensor will allow further information to be deduced, such as the number of axles per vehicle.
- Two sensors placed in the road at a known distance apart give a very accurate means of speed measurement. This information is of value in traffic flow surveys, and is also used for speed limit enforcement purposes. Red light violation is detectable, the sensors being used to trigger a camera and to add a speed reading to the photograph.
- If an inductive-loop detector is used with a pair of sensors, complete vehicle classification is possible. This arrangement enables the wheelbase or axle spacing of each vehicle to be calculated, in addition to its speed and approximate weight.
- For some speed law enforcement purposes, two or even three speed measurements are required. In these cases three sensors in parallel are sufficient, allowing a simple and cost-effective installation.
- Other groupings of two or three sensors in various arrays are used to obtain data on, for example, the position of vehicles across the carriageway, width of vehicle, and transverse weight distribution.

Specification

Sensor dimensions

Section widths: 12*, 14*, 16, 18*, 20 mm (* available ex stock)
Depth: to suit 25 mm minimum slot depth
(Other sections can be supplied to customer specifications.)
Lengths: 2, 2.5, 3, 3.5, 4, 5, 6, 7, 8, 9 m. (Other lengths to order.)

Piezo-electric cable

Piezo-electric polymer: polyvinylidene fluoride (PVDF or PVF2)
Piezo-electric coefficient: 3pC/N at 23°C
Capacitance: 850 pF/m
Temperature range: - 40 to + 70°C

Features: A robust and close-tolerance transducer which provides reliable and repeatable signals over a wide temperature range. It is self-screening, and has a proven performance in many environments.

Signal cable

4mm diameter co-axial cable - see Data Sheet No. 15 for full specifications.

Its joint to the piezo-electric cable is carried within the rubber casing for maximum protection from mechanical damage, and specially matched splicing components are used to ensure the most reliable connections. Ten metres of signal cable are provided with the sensor assembly; other lengths on request.

Typical sensor output characteristic:

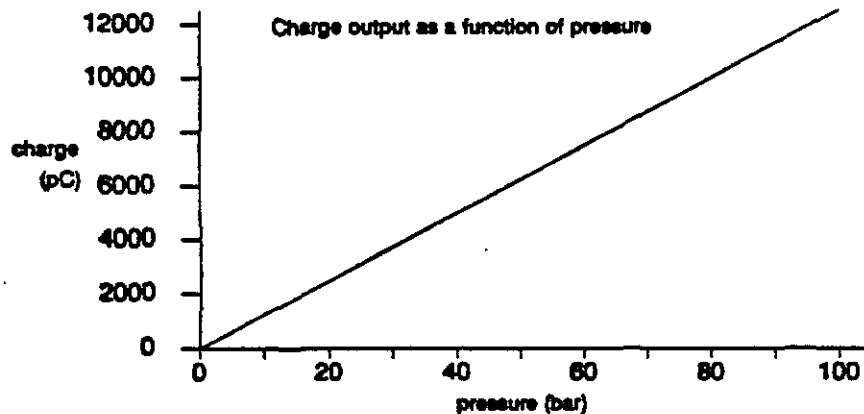

The information in this Data Sheet is believed to be correct. Intending users should carry out their own tests to establish suitability for their application. TRAFFIC 2000 LIMITED will not be liable for consequential damage arising from the use of these products. In line with our policy of continuous product development TRAFFIC 2000 LIMITED reserves the right to amend specifications and prices without prior notice.



Piezo-Electric Data Sheet No. 2

Golden River Instruments, Inc.
7352 Dartford Drive, #7,
McLean, Virginia 22102
Tel 703 847 6025 Fax 703 847 5648

Piezo-electric Sensors - Performance Data

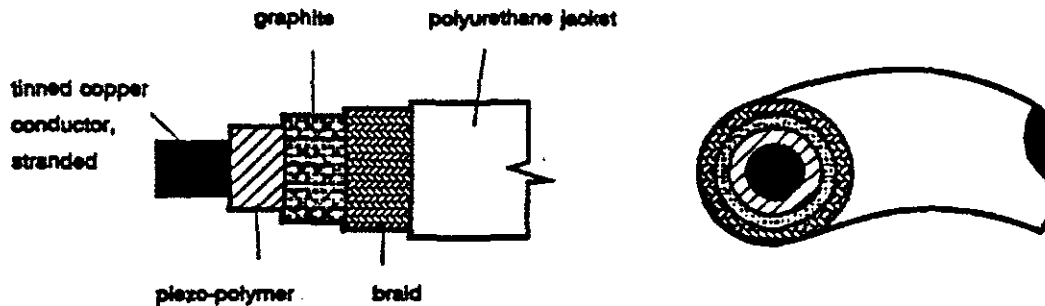

Description

The heart of the sensor cable is a layer of piezo-electric polymer which generates a charge when subjected to changing stress. Thus the cable produces an electrical signal in response to vibration, impact or pressure. Amplitude of the output depends on the intensity of the impact, and frequency is determined by the speed.

TRAFFIC 2000 cable is a very tough and durable transducer with tightly-controlled mechanical and electrical properties. It is supplied embedded in a variety of high-performance rubber profiles, each carefully designed to match the cable characteristics to the particular duty required. Please refer to other Data Sheets in this series for design and application information.

Typical piezo-electric cable characteristic

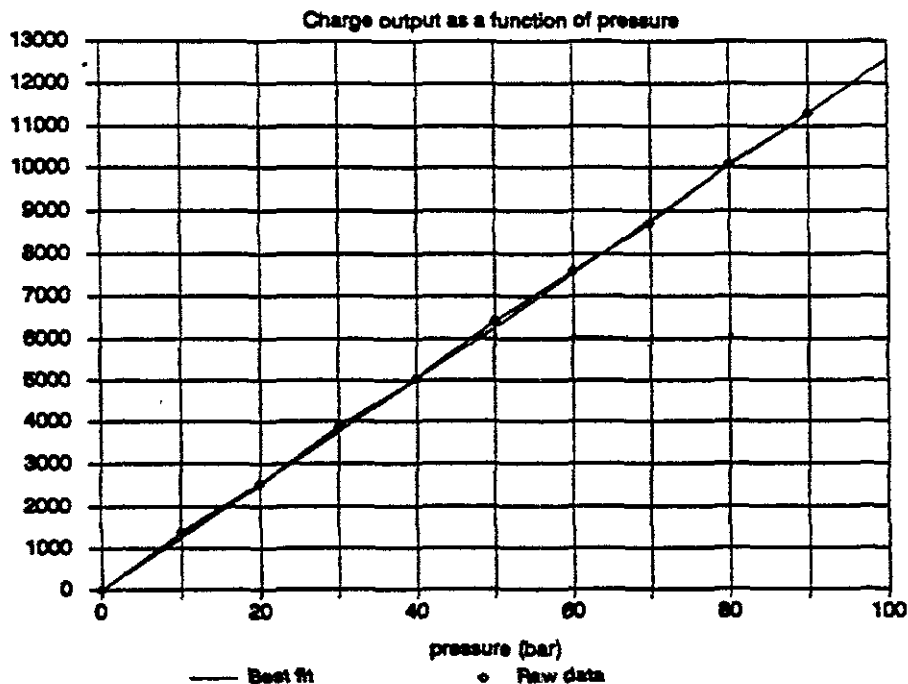

TRAFFIC 2000 LIMITED
3 Church Terrace, Richmond, Surrey TW10 6SE
Tel: 081 948 6736 Fax: 081 332 0813

Piezo-Electric Data Sheet No. 2

Cable Data

Outer diameter: 2.7mm
Piezo-electric polymer: polyvinylidene fluoride (PVDF or PVF2)
Piezo-electric coefficient: 3pC/N at 23°C
Capacitance: 850pF/m
Temperature range: -40°C to +60°C

Sensor output signals

These graphs show actual responses obtained from a TRAFFIC 2000 piezo-electric sensor bonded into a road surface, during the passage of various vehicles. Note that the signal level is dependent upon the rubber profile selected, and upon the signal conditioning equipment used.

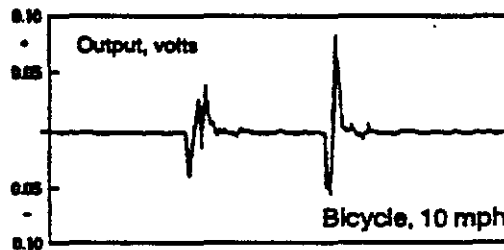
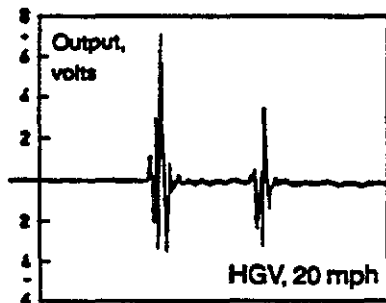
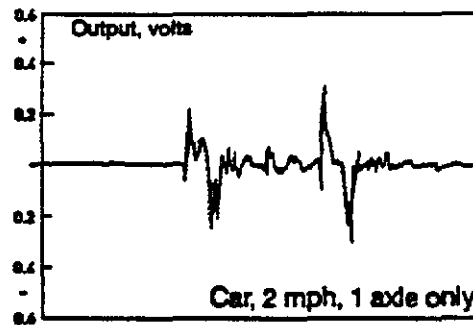
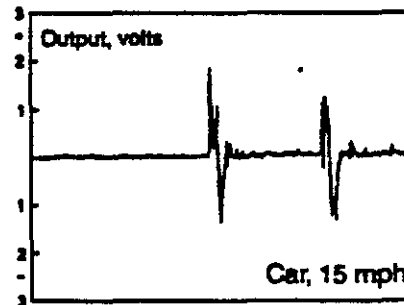
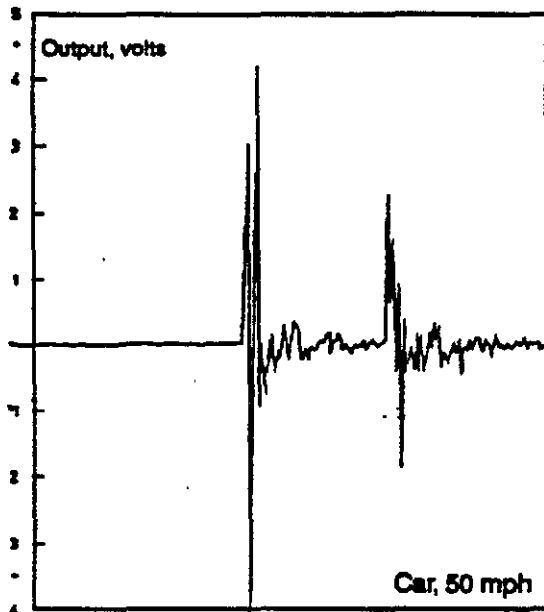

The information in this Data Sheet is believed to be correct. Intending users should carry out their own tests to establish suitability for their application. TRAFFIC 2000 LIMITED will not be liable for consequential damage arising from the use of these products. In line with our policy of continuous product development TRAFFIC 2000 LIMITED reserves the right to amend specifications and prices without prior notice.



Installation Instructions

For TRAFFIC 2000 Slot-Mounted Domed-Profile Traffic Sensors

Handling Precautions

The sensors are supplied in a heavy-duty plastic bag which is sealed when the sensor leaves our premises. The contents have been cleaned with solvent and are therefore free from any grease or other agent which might affect its adhesion in the road. You are advised not to open the bag until ready to install the sensor, and then to keep it clean during handling.

The sensor case is extruded in Ethylene Propylene Diene Monomer, which is not affected by weathering and is particularly durable and hardwearing. However, reasonable precautions should be taken during installation not to cut, crush or kink the sensor, as its performance could be affected.

Adhesives and cleaning solvents must be handled with care, and the instructions and precautions given with those products must be followed.

Installation

1. If this is a new installation then all the required ducting for electrical connections should be installed first.
2. The sensor may be supplied in various cross-section widths, from 10mm to 20mm. The width of the slot to be cut in the road must be 2mm wider than the section to be installed, and a minimum of 25mm deep.
3. The end of the slot farthest away from the side of the road should be cut 3mm deeper and 25mm wide for a length of 50mm. This is to allow the free end of the sensor to be pushed down below the road surface when it is installed. A similar cut-out should be made towards the other end of the slot, to accommodate the cable end of the sensor. This action is necessary to avoid having the ends standing proud, where they would be vulnerable to damage or vandalism.
4. The slot must be blown clean of all loose material and dust, and the surrounding road surface swept clean.
5. The T2000 Slotmastic adhesive or other suitable adhesive should be mixed according to instructions, and poured into the slot such that when the sensor is pushed into the slot the adhesive extrudes along the entire length of the installation, but not excessively.
6. When the sensor is placed into the slot, the extreme end should be pushed down into the enlarged hole and held in place with a piece of timber or similar until the adhesive has gone off.
7. Similarly push the 'rat's tail' end of the sensor down, and hold it down as above.

8. Scrape excess adhesive off the road surface, using it to cover the ends of the sensor and the cable. Leave sufficient adhesive to just cover the feathered edges of the sensor. This is to avoid any edges being visible, and to prevent damage from vehicles braking over the sensor, and from snow ploughs.

Note: In warm weather the adhesive goes off very rapidly.

9. Whilst steps 6 - 8 are being carried out, the whole length of the sensor should be covered with a piece of timber 50mm wide, this being weighted down sufficiently to hold the sensor in position in the road surface. (Small oil drums filled with water and placed 500mm apart would be suitable). The sensor is correctly positioned when the extremities of the domed section are almost in contact with the road surface, apart from a thin layer of adhesive.
10. When the adhesive has gone off sufficiently to hold the sensor in position, wipe along its length with solvent and a cloth to remove adhesive from the domed surface.

The information in this Data Sheet is believed to be correct. Intending users should carry out their own tests to establish suitability for their application. TRAFFIC 2000 LIMITED will not be liable for consequential damage arising from the use of these products. In line with our policy of continuous product development TRAFFIC 2000 LIMITED reserves the right to amend specifications and prices without prior notice.

Piezo Film Components

Application Note

Number 27 (7/92)

INSTALLATION INSTRUCTIONS ROADTRAX SERIES 'P' PIEZOELECTRIC TRAFFIC SENSORS

The Elf Atochem Sensors Inc Roadtrax® Series P Traffic Sensor is a Permanent, In-The-Road, Class II traffic sensor for vehicle classification and counting. The sensor consists of an outer aluminum channel to define the area of the sensor, a molded polyurethane elastomer to protect the sensor, and finally a sensor element. The sensor material is a space age polymer - Polyvinylidene Fluoride or PVDF. PVDF, when it is specially processed during manufacturing via a mechanical orientation and electrical polarization process, is piezo electric, and converts mechanical energy into electrical charge when a stress is imparted on it. Although the actual voltage output will vary based on many parameters, it is typically measured in the range of a few 100 millivolts to volts.

INSTALLATION PREPARATION: The installation site should be carefully chosen. Excessive pavement rutting may result in sensor damage or improper sensor operation. Sites where rutting exceeds ¼" under a 3' straight edge should be avoided. The pavement should be checked for adequate depth and structure, as well as having acceptable feeder cable routes and junction box location. It may also be beneficial to observe the traffic flow patterns of a proposed site over a period of time to ensure proper sensor placement. The best results in terms of uniformity of signals will result from sensors which are placed on straight and level roads.

Sensor installation must be carefully coordinated with proper road management, ensuring that all local regulations are complied with for road closure and hazard marking. Although traffic data is very important, it is not worth the life of a installation crew member. So please, ensure that adequate traffic control is in place, and that safety is taken very seriously.

INSTALLATION: First, it is necessary to mark the road for the location of the sensor. The sensor must be laid perpendicular to the flow of traffic. To assist in doing this accurately, use a lumber crayon and mark an 'x' on the road at position 'A' (Figure 1). Next,

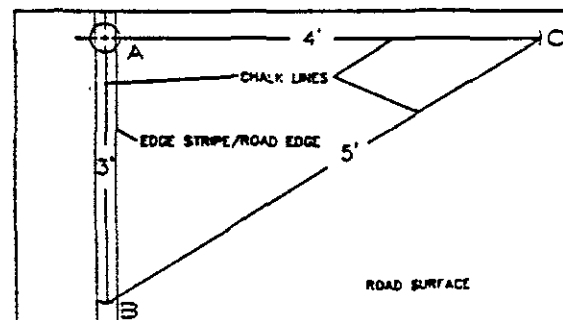

Figure 1: Ensure that the sensor is perpendicular to the flow of traffic.

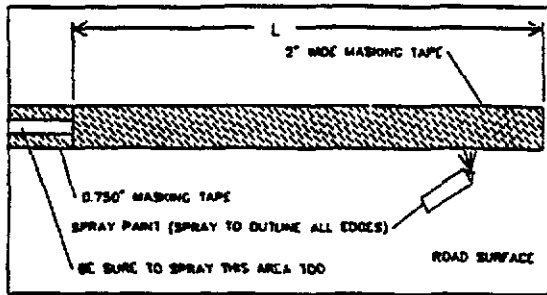

Figure 2: Use tape and a waterproof traffic paint to define the area to be cut.

holding a tape measure at position 'A', measure out 3 feet along the line or road edge and place a mark, called position 'B'. Keeping the same pivot point (position 'A'), rotate the tape straight out onto the roadway, placing the crayon at the 4 foot mark, and marking an arc about 1 foot long. Now move the end or pivot point of the tape measure to position 'B' (on the road edge) and, repeating the above procedure, measure out 5 feet and draw another 1 foot arc so that it intersects with the arc already drawn. Where these two arcs intersect is position 'C'. Using a

straight edge or chalk line mark a line on the roadway using positions 'A' and 'C' as guidelines. The line should be a little longer than the sensor shipping box, or about 7 feet. This line will be perpendicular to the traffic flow.

Now mark the cutting location. Measure the sensor (end of sensor to beginning of lead attachment area), then add a couple inches to this. This measurement will be length L on Figure 2. Decide where the sensor should be placed (typically the end of the sensor at the lead attach end will originate from the edge of the edge stripe closest to the shoulder. Place the masking tape as shown in Figure 2, and using waterproof, quick drying traffic paint, spray over the tape. When the paint is dry, remove the tape exposing a pattern on the roadway which will be used as a cutting guide, as shown in Figure 3.

Carefully move the sensor completely out of the work area. Be careful with the sensor so as not to damage it. Although the passive signal cable has a tough outer jacket, it should be handled carefully. Be especially careful not to step on it or nick it - the jacket can crack if it is nicked and then sharply bent at the nick point. Also remove any other equipment which could be damaged by dust and grit, since the cutting process generates a significant amount of debris

A diamond tipped blade is recommended for slot cutting, although abrasive blades may be used by experienced personnel. The blade width ideally should be between 1/4" - 1/2" wide, but thinner blades may be used. If using abrasive blades which are 1/8" wide, 'bank' two blades together to give the 1/4" recommended width. Wet cutting blades are generally preferred by most contractors, though dry cutting blades are available and may be preferable during cold weather or when water supplies are not available. Always use dust masks when dry cutting!

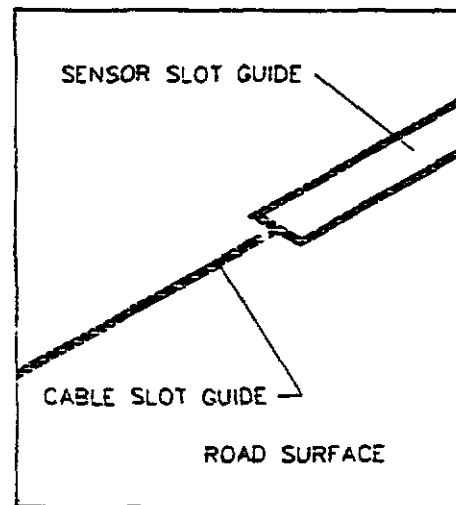

Figure 3: Cut the slot in the sensor slot guide area.

Using the guide marks on the road (Figure 3) begin the cutting. Cut the sensor slot first, cutting out the un-painted area (Figure 4) and leaving the painted marks. Two passes should be made,

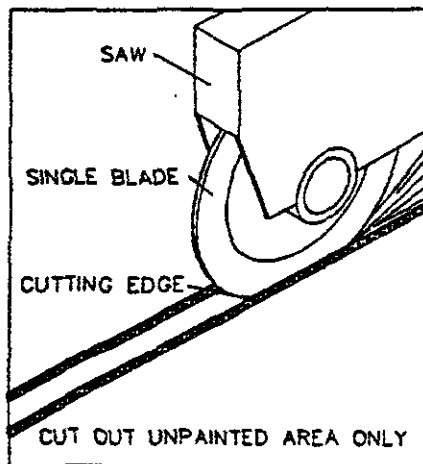

Figure 4 : Carefully cut at an even depth between the lines.

and toil will a channel cut in the road, as shown in Figure 6. Blow out or sweep out large debris from the channel. Get the sensor and place it in the slot to ensure proper fit - re-work if necessary. Now with a wire brush, rough up the sides and bottom of the sensor slot ensure good adhesion of the epoxy compound.

There are two recommended ways to mount the sensor. The first is to use cement anchors and large head flat head screws in the bottom of the channel.

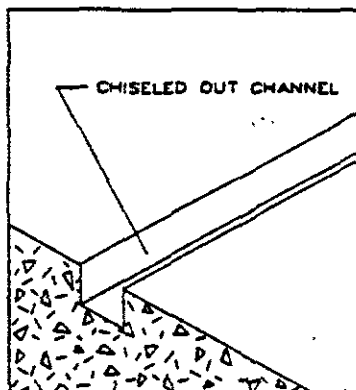

Figure 6: This is the end result of all the hard work

The sensor will rest on these screws, as shown in Figure 7. Using the cement anchors and screws, drill the holes in the bottom of the channel to accommodate the cement anchors, at about 1½' from each end of the slot. Following the manufacturers instructions for the anchors, insert the anchors in the holes, and screw them down sufficiently to ensure that they are correctly installed. Now clean out the channel using compressed air or a portable blower. If these are unavailable, use a broom, but really sweep hard to ensure the channel is clean.

The second option for mounting the sensor is to use the supplied brackets to hold the sensor in place from the top. This is the recommended option, and will be discussed in more detail later.

The slot is now ready for mounting the sensor. If the temperature is below 60° F, it may be

one along each edge - maintaining a depth of 1¼" to 2". Extra care must be taken with regards to cut depth when using abrasive blades, since they wear rather quickly. The recommended depth must be maintained in the guide area. It may be necessary to extend the end by a few inches so that this depth is maintained. Next cut the cable slot for the lead wire. In this case, the painted area should be cut out. Ensure that the cable slot is centered on the sensor slot and should be at least 3 inches deep.

Once the cutting is done, chisel out the center (remaining) section of the road, as shown in Figure 5. If wider blades are used (approximately ½" wide) some contractors prefer cutting out the center section with the saw. This is certainly acceptable, though care should be used to ensure the cut depth remains the same. The end result of all of this hard work, dust

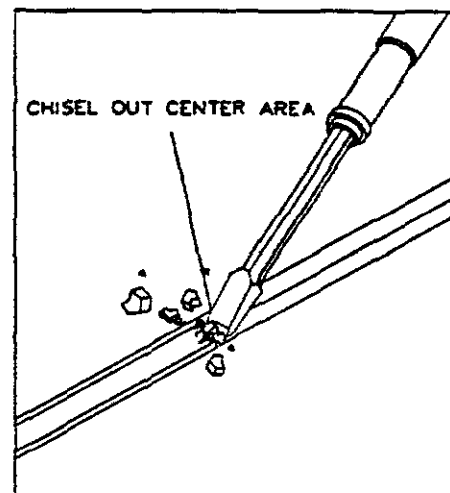

Figure 5: Chisel out the center area to an even depth

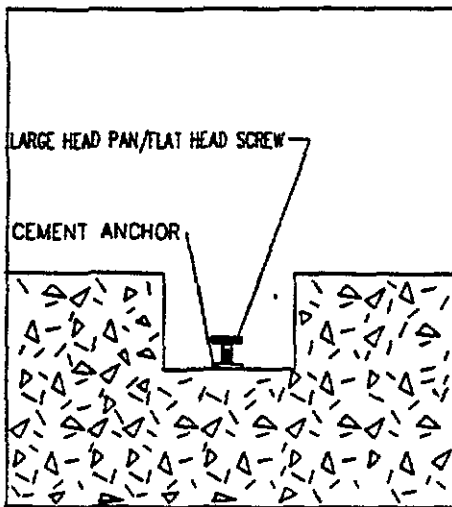

Figure 7: The sensor rests on top of the screw heads

beneficial to place a kerosene ('torpedo') type heater by the slot to gently warm the road surface. If multiple sensors are being installed at the same time, now is a good time to start heating up the channels, to give more time to heat each individual channel. Clean the sensor with a non-petroleum based solvent such as isopropyl alcohol and place the sensor next to the cut channel. The heater may be kept in place, but do not allow it to get too close to the sensor and lead wire; just a gentle warming is suggested. If using screws, insert the sensor into the slot so it rests on the screw heads. Adjust the screws so that the sensor top is resting just above the road surface. The mounting bracket, side 'A' (Figure 8) should be used as a guide. For areas with snowfall and snowplows, side 'B' of the mounting bracket should be used as a guide.

If using the mounting brackets, mount the brackets onto the sensor (see Figure 9) using the cable ties. In areas without snowfall, use side 'A' of the bracket. This will allow for the sensor to be mounted slightly proud of the road surface, giving the sensor that maximum impact from vehicles. In areas of snowfall, it is recommended that the sensor be mounted flush with the surface of the road. In this case, use the flat side (side 'B') of the mounting bracket in contact with the top of the sensor.

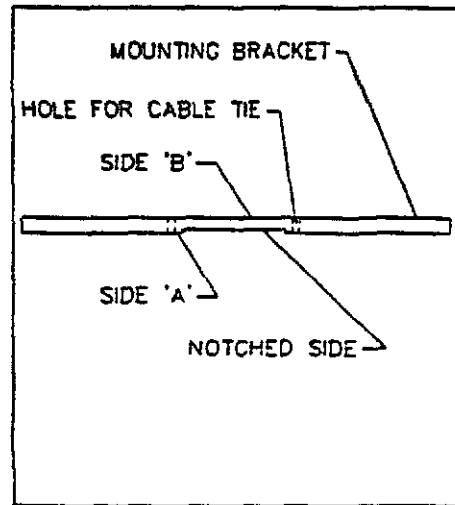

Figure 8: Side 'A' is against the sensor for normal installation; Side 'B' is used in snow areas.

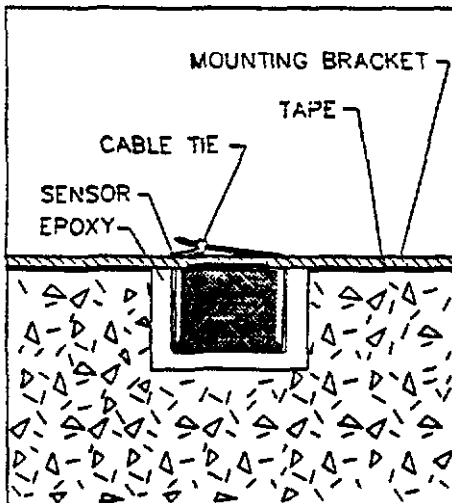

Figure 9: Cable ties are used to hold the sensor to the mounting bracket

Three brackets should be used for each sensor; one about 6" from each end, and one in the middle of the sensor. Note - it is preferable to mount the sensor just above the road surface for higher output, if mounted level, the outputs will be lower.

If there is some minor curvature of the road, the sensor may be GENTLY bent (see Figure 10) to conform to the curvature. **WARNING:** This should normally be left to experienced personnel as too much bending may cause

some damage.

Once the sensor is set to the proper height, place it alongside the channel. Place some tape around the cut slots - see Figure 11 - to keep excess epoxy off the road surface. The tape should be around the entire perimeter of the cut slot. Insert the lead wire into the cable slot, and build a small dam around it using clay or an equivalent, so that the epoxy does not leak past the sensor slot into the cable slot.

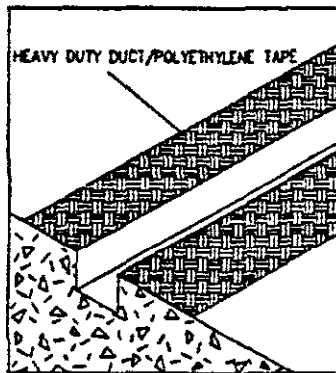

Figure 11: Heavy polyethylene tape is used to keep the epoxy off the road

remains in place. Be sure the sensor is properly seated. Any voids should be filled. Carefully removed any excessive amounts of epoxy from the installation. There must be a smooth transition between the sensor and the road surface.

Weights (bricks do well) may be placed on top of the brackets/sensor but it is recommended to put a layer of polyethylene over the sensor to avoid sticking. Allow the epoxy to cure as per manufacturer's instructions. A 'heat tunnel' can be constructed from cardboard boxes or the sensor shipping box if curing time is critical (Figure 13), but, be careful not to get the heat source too close to the cardboard; it may burn!

Route the lead wires to the electronics, keeping the length of the lead wire and the number of turns should be kept to a minimum. If unable to hook up to the electronics immediately, be sure that the exposed end of the lead wire is protected from water penetration and the cable is protected from damage. Conduit is recommended for wire routing but plenum cable may be buried in the ground without conduit. Use caution while burying the cable with conduit being careful not to damage the cable with tools or sharp objects in the ground.

Once the epoxy has gelled to a semi-hard state, cut the cable ties and remove brackets if these have been used. Trim off any exposed part of the cable tie and remove the tape from around

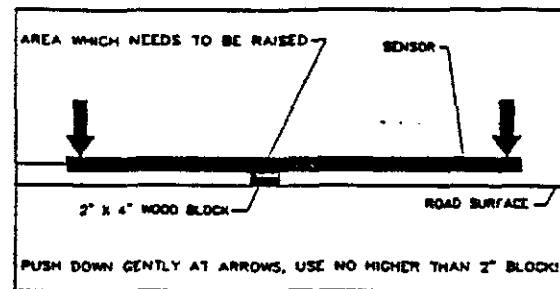

Figure 10: VERY CAREFULLY bend the sensor to conform to the road

Mix the epoxy/grout according to manufacturer's instructions (See appendix 1, epoxy notes). Using a plastic bucket or trowel (depending on consistency of epoxy), carefully pour the epoxy/grout into the cut slot until the channel is a little less than 2/3 full. (Figure 12) Be as neat as possible. Once the epoxy is poured into the slot, the sensor should be placed into the slot as before - see Figure 9. Once the sensor is put into the channel, pull any extra lead wire to remove the slack being sure the dam

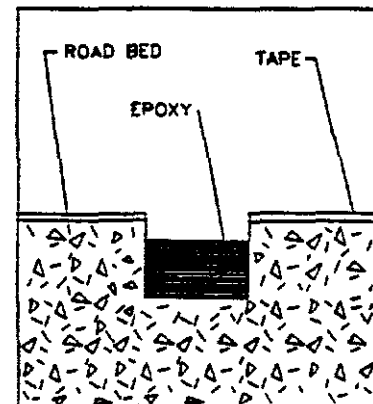

Figure 12: The slot is filled 2/3 full with epoxy

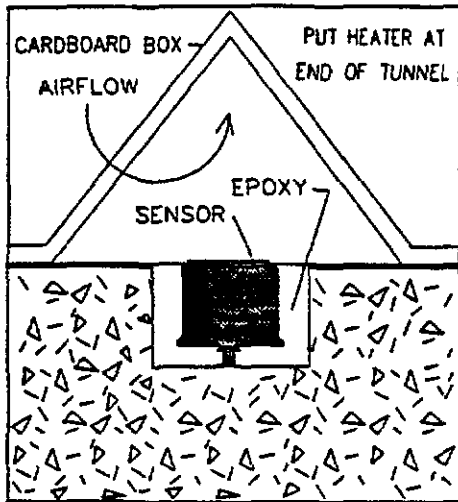

Figure 13: A cardboard 'tent' can be used to speed up the curing times if heaters are used

the slot.

Clean up the area once the epoxy has hardened. The hardening time for the epoxy will vary based on temperature, humidity and type of epoxy used. **NO TRAFFIC SHOULD BE ALLOWED TO PASS OVER THE SENSORS UNTIL THE EPOXY IS FULLY HARDENED!**

If the sensor was mounted flush with the road and higher signals are desired, a piece of asphaltic adhesive tape know as bituthane or polyguard may be placed over the sensor (Figure 14) to increase the signal level. This tape will give you increased signal levels, additional sensor protection, and, if a snowplow tears off the tape, it can be replaced.

The disadvantages of using the tape is that it can only be applied under certain conditions, and that the signal may have to be monitored to ensure uniform levels as the tape wears. Contact Elf Atochem Sensors, Inc. if you have any questions.

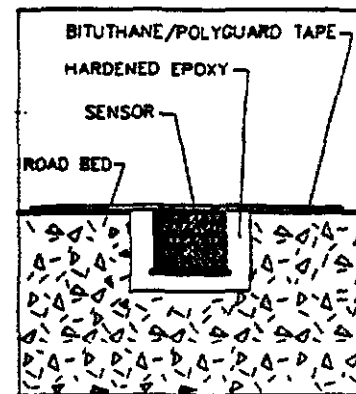

Figure 14: Polyguard tape placed on top of the flush mounted sensor will increase the output level

You are now complete. Once the epoxy has fully hardened, the lane of traffic can be again opened. The electronics needs to be connected, and you are ready to start classifying vehicles. The majority of sensor failures are caused by damage to the lead wire causing water penetration, and improper mounting of the sensor - especially in the use of improper epoxy and allowing traffic to pass over before the epoxy has fully hardened. Please follow all the above procedures and if you have any questions, please call - ELF ATOCHEM SENSORS, Inc. is committed to total customer satisfaction.

Appendix I Notes On Epoxy

The following epoxies are recommend for installation of Roadtrax Series P piezoelectric traffic sensors:

1. **DURAL 331LV:**

Dural 331LV epoxy is manufactured by Tamms Industries, Route 72 West, Kirkland, Illinois 60146. Tel: 800 582 6670

2. **E-Bond G-100:**

E-Bond G-100 epoxy is manufactured by E-Bond Epoxies Inc, Post Office Box 23069, 501 N.E. 33rd Street, Fort Lauderdale, Florida 33307. Tel: 305 566 6555

3. **CONCRESSIVE PASTE (SPL):**

Concressive Paste (SPL) is manufactured by Master Builders Inc, 23700 Chagrin Blvd, Cleveland, Ohio 44122. Tel: 800 227 3350.

CURE TIMES @ TEMP†	Epoxy Type		
	DURAL 331	E-Bond G-110	CONCRESSIVE
Usable Temp. (°F)	25 to 90 °F	50 to 100 °F	25 to 70 °F
Cure Time @ 100 °F	N/A	2 Hours	N/A
Cure Time @ 80 °F	20 Minutes	2.5 hours	N/A
Cure Time @ 70 °F	40 Minutes	3 Hours	1 Hour
Cure Time @ 60 °F	1.25 Hours	6 Hours	2 Hours
Cure Time @ 50 °F	1.75 hours	14 Hours	3.5 Hours

† These times are intended to comparison purposes only. They are only approximate, and dependent on many other factors. They represent an approximate time at which to check the epoxy prior to allowing traffic to pass over the sensor.

In colder temperatures, store and mix the epoxy in a warm area. At warmer temperatures (above 70°F), the Dural and the Concressive should be stored in a cool area such as an ice chest. If these thicken too much from the cold, allow them to sit out for a period of time to gently warm them prior to use. There are many factors which can influence the curing time, especially the use of 'torpedo' heater. Plan to have the required equipment on hand to get the job done in the allotted time. If traffic is allowed to pass over the sensor prior to the epoxy being fully cured, the sensor will be forced too deep into the road, and unacceptably low signal levels could result. Typically, Traffic Management does not allow for extra time for road closure than that authorized. Plan ahead to avoid problems.