

REHABILITATION OF THE HAMMOND BRIDGE IN MARION COUNTY, IOWA



Undated historic image of the Hammond Bridge by photographer Don Berry.
Collection of the State Historical Society of Iowa (Iowa City).

**REPORT COMPILED BY JAN OLIVE NASH
TALLGRASS HISTORIANS L.C., IOWA CITY, IOWA**

**PHOTOGRAPHS BY JAY DAVIS, MARION COUNTY ENGINEERS OFFICE,
AND JAN OLIVE NASH**

2004

*This project was funded in part by the National Historic Covered Bridge Preservation Program of the U.S.
Department of Transportation Federal Highway Administration.*

TABLE OF CONTENTS

HISTORY OF THE HAMMOND BRIDGE IN MARION COUNTY	page 3
DESCRIPTION OF THE HAMMOND BRIDGE	page 6
REHABILITATION OF THE HAMMOND BRIDGE, 2003	page 8
Construction techniques	
Cost information	
SELECTED REFERENCES AND SOURCES OF INFORMATION	page 12
LOCATION OF HAMMOND BRIDGE	page 13
ADDITIONAL PHOTO DOCUMENTATION OF THE WORK IN PROGRESS	pages 14-25
Steel portal frame installation	
Caisson area repairs	
Siding repair/replacement and re-roofing the bridge	
Celebrating the rehabilitated Hammond Bridge	

HISTORY OF THE HAMMOND BRIDGE IN MARION COUNTY



The Des Moines River bisects Marion County in south central Iowa. Navigable by raft, boat, and eventually steamboat, the wide shallow river enabled some of the earliest white settlement to push well into the state's interior. By the 1840s, settlers were staking claims in Marion County, some 120 miles upstream from the Mississippi River and the river port

Figure 1 The rehabilitated Hammond Bridge, 2003. (Jay Davis, Marion County Engineers Office, photo)

town of Keokuk. A well-developed system of small rivers, creeks, and streams drained water into the Des Moines River from throughout the county. Wide, flat upland ridges sported a luxurious tallgrass prairie of forbs and flowers, while thick stands of timber occupied the steeper slopes and bottomlands. Though covered by deep prairie sod in places, the county's rivers and streams had channeled through to expose seams of coal in many areas. In other places, bluffs of clay stood ready and inviting for the brick maker and the potter. This coal and clay played an important role in the county's early industry, but in Indiana township, location of the Hammond Bridge, the streams created a topography too rugged for railroad construction and often too difficult for the even the ubiquitous Midwestern section-line roads. Without a good transportation network, agriculture would be the pursuit of most Indiana township residents.

Pioneers from Indiana first settled the township and named it after their home state. Many of them had earlier roots in Ohio and Pennsylvania. One of the early names in the county was S.M. Hammond, who operated a newspaper in 1859 and 1860 during "the campaign" (Andreas 1875: 476).

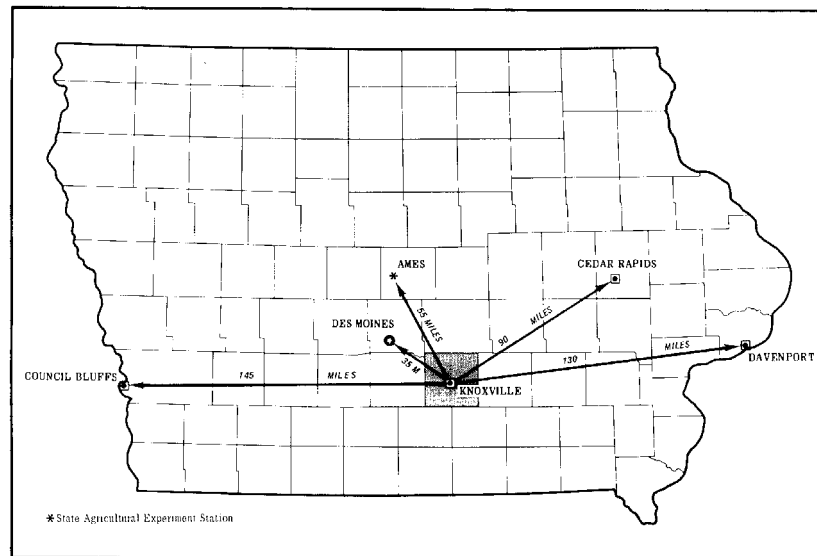

Figure 2 Map of Iowa with Marion County noted. Distances between the county seat of Knoxville and major Iowa cities are also marked.

Marion County was only about 50 miles from the Missouri border and the 1860 presidential campaign rang with heated debate over the slavery issue in the new territories to the west. Using a newspaper for partisan politics was common, as were start-up newspapers in recently settled areas. Thirty-odd years later, another Hammond would have a more lasting impact when he requested the construction of a new bridge over North Cedar Creek, near his growing landholdings in southern Indiana township.

The bridge Samuel B. Hammond got in 1894 was not necessarily the first on this road through land section 26. An earlier landowner, A.C. Allen, and others had prompted the county's construction of the road in 1870. North Cedar Creek was and remains fordable during much of the year, but is impassable during spring melts or other rainy periods (Fig. 3).

With all of section 26 in private hands by the 1870s, and this road the main route between the towns of Attica to the north and Eldorado to the south in Monroe County, the pressure to construct an all-weather crossing for North Cedar Creek was probably strong from the



Figure 3 A lightly used gravel road curves through low floodplain towards Hammond Bridge. (Jan Olive Nash, Tallgrass Historians L.C., photo)

beginning. Attica had a thriving pottery industry in the 1870s; Eldorado was a small coal town populated by optimistic residents but is now long abandoned.



The Attica-Eldorado road descends from the north, rounds a curve, and lowers gently into the North Cedar's broad valley (Fig. 4). The creek's meanderings have left old channels now filled and under cultivation by area farmers. Early maps suggest the

Figure 4 Looking south. (Nash photo)

lowlands had trees at one time but now there are only flat, fertile fields.

On the south side of the creek, after crossing the covered bridge, the road as built headed due south. Today, however, it takes a jog to the east before straightening out and heading up to the opposite wooded ridge. When the covered bridge was constructed by S.F. Collins in 1894, these wooded ridges on either side of the creek were held by both large landowners like S.B. Hammond (who had acquired J.C. Allen's acreage) and numerous individuals holding small woodlots for the lumber and firewood ranging in size from 8 to 40 acres. This continued a pattern existing from the 1870s when the road was constructed.

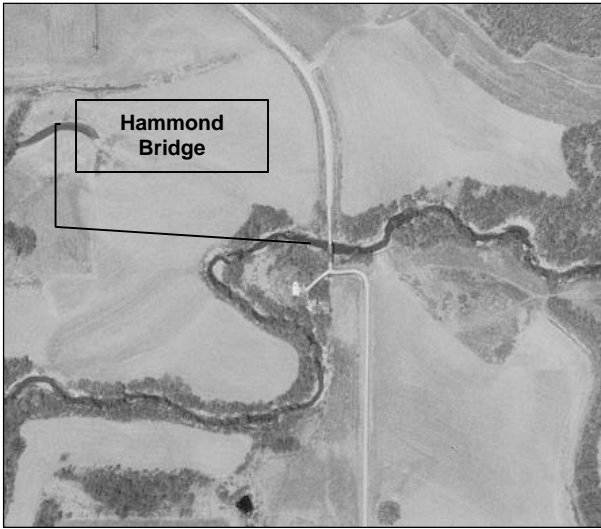

Figures 5 and 6 To the left is recent aerial image of the project location. The photograph on the right is looking north towards the jog in the road and the Hammond Bridge. The tree line on the left marks the approximate location of the old road. *(Right photo by Nash)*

Samuel Hammond and his neighbors filed their request for the construction of a bridge with the Marion County Board of Supervisors in January, 1894, a time of year when the creek and the dirt road were probably frozen solid. The supervisors delayed until April and then inspected the site in wetter spring conditions before approving the new bridge. By June, the

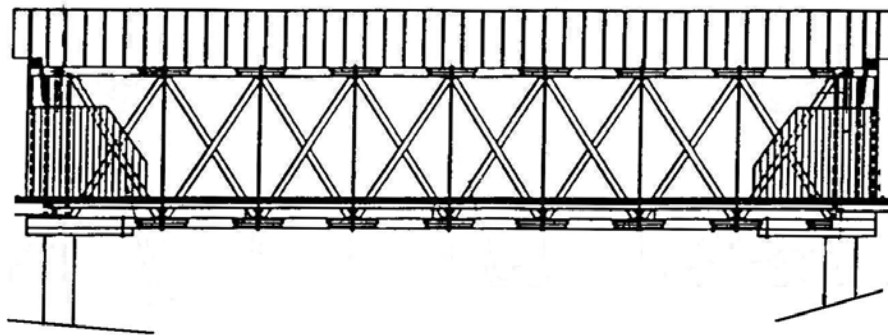

Figure 7 Side view of Hammond Bridge truss system (exterior siding not shown), floor, and rafters. *(Adapted from Shuck-Britson Inc. rehabilitation plans dated January 2003)*

county had builder S.F. Collins under contract to “erect a ‘high lattice bridge’ at the site on iron tubes, based on a design on file” (Iowa Historic Bridge Inventory/HAER Inventory, 1).



Figure 8 Hammond Bridge just prior to its rehabilitation in April 2003. (Nash photo)

DESCRIPTION OF THE HAMMOND BRIDGE

The historic Hammond covered bridge was listed in the National Register of Historic Places in 1998. It is a timber and iron, 8-panel Howe through truss structure with a single, 78-foot long span (Fig. 9). Two more modern approach spans bring the total bridge length to 178 feet. The roadway deck width is 13.3 feet. Supporting this superstructure are concrete-filled metal cylinder piers, though the North Cedar Creek channel no longer flows directly between them. Instead, the stream is rechanneled slightly to the north under the longer of the two approach spans (Fig. 9). The double-span, 80-foot long north approach to the bridge was added in 1952, though as late as 1956 the creek bed carrying water was still directly under the covered span. The timber deck of Hammond Bridge lays on steel stringers. When the bridge was inspected for the Historic American Engineering Record program in 1992, the following additional physical dimensions and construction techniques were noted: “end post: two 4x8 timber posts; upper chord: three 12x8 timber posts; lower chord: three 12x8 timber posts; vertical: two round rods with threaded ends; diagonal: two 6x8, or 8x8, or one 4x8 timber posts; floor beam: I-beam; gabled wood-frame sheathing, with wood roof shingles and vertical wall planks” (Iowa Historic Bridge Inventory/HAER, 1). Physical inspection in 2003 revealed the walls were covered primarily with barn-plank siding applied vertically. Some of the 10- to 12”- wide plank siding was probably original but the lower ends were badly weathered and deteriorated. Underneath the sheathing, joinery of the truss wood members was both by notching and bolts.

According to one bridge historian, the Howe truss wagon road bridge was once much more common in Iowa, with counties erecting them long after railroads abandoned the wood-based truss for stronger metal structures. William Howe patented his truss design in 1840, using timbers for the compression members combined with iron rods in tension. In Iowa, the Hammond Bridge is the last Howe truss road bridge, covered or uncovered, remaining (Iowa Historic Bridge Inventory/HAER, 2).

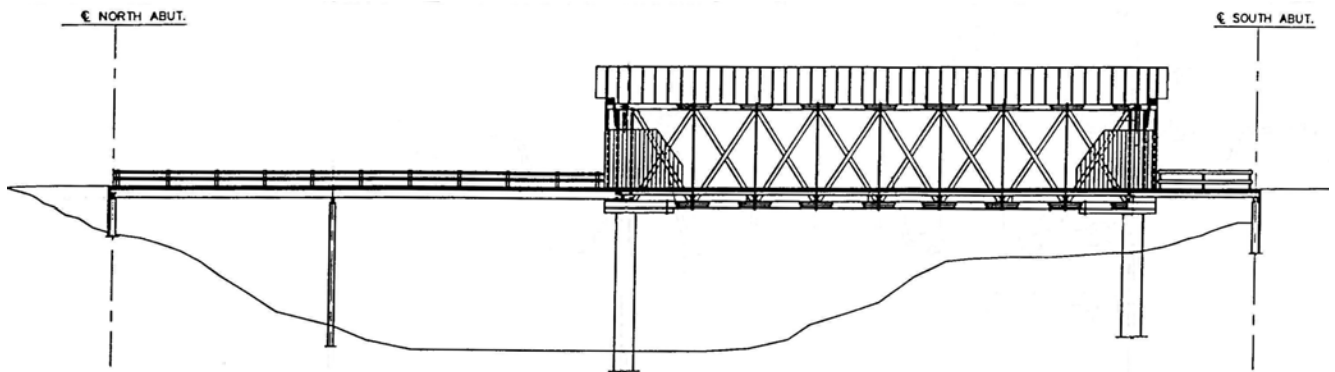
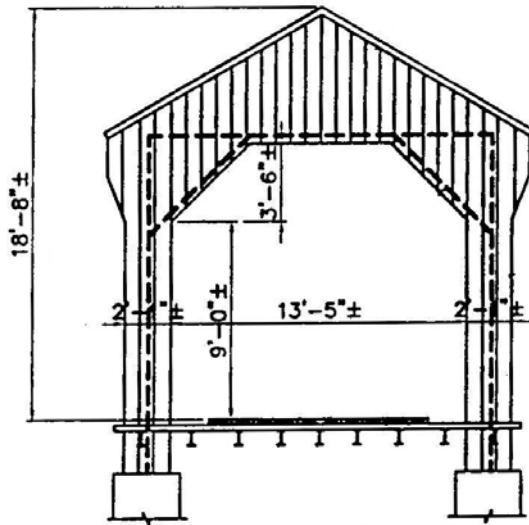

Figure 9 Current side view of Hammond Bridge and its two approach spans. Note the northern movement of the creek channel away from the covered bridge. (Adapted from Shuck-Brinson Inc. rehabilitation plans dated January 2003)



Figure 10 Pre-rehabilitation interior view of “lattice” panels or Howe truss panels, looking north from south end of the bridge. (Nash photo)



Figures 11 and 12 South portal plan (left) and pre-rehabilitation photo (right), facing north. The north portal is similar. (Drawing adapted from Shuck-Britson Inc. rehabilitation plans dated January 2003; Nash photo on right)

Eighty years after it was constructed, a truck that was too tall for the portal attempted to cross the bridge. The resulting accident closed the bridge between 1977 and 1979 for “minor repairs” (Iowa Historic Bridge Inventory/HAER, 1). The bridge is now closed to motor traffic with the road diverted to a concrete ford just downstream (Fig. 19).

REHABILITATION OF THE HAMMOND BRIDGE, 2003

Awarded federal funds under the National Historic Covered Bridge Preservation Program, Marion County undertook the renovation of Hammond Bridge in 2003. Plans drawn up in January, 2003 identified 14 tasks to be accomplished, including the following: replacement of damaged and rotted siding, repair of the steel caissons at N.W. corner, restoration of the horizontal bracing in the floor system, replacement of worn or decayed deck planking, restoration of the canopy at north and south ends to original construction, removal and replacement of the cedar shingles, replacement of any rotted roof sheathing, installation of new portal frames at both ends, removal and replacement of any unsound sections of the southeast truss bearing, and replacement of any unsound bridge railing members while repainting of the rest. Additionally, the historic trusses were to be straightened and made plumb and the south end wood header beam was to be repaired. Trees overhanging and in

contact with the roof would be trimmed back. The Iowa State Historic Preservation Officer's staff was to be given copies of the plans to review in order to assure compliance with the Secretary of the Interior's Standards and Guidelines.

Contractors wishing to work on the project were required to visit and become familiar with the bridge in its setting (Fig. 13) before bidding and were forewarned of the bridge's National Register status. General Notes to the plans called for all "construction work to be done in accordance with the recommended practices as stated in the 1990 edition of the 'Secretary of the Interior's Standards for Rehabilitation and Guidelines for Rehabilitating Historic Buildings' (Revised 1990)." Further, the Notes required "all wood construction to be performed by workers knowledgeable and skilled in carpentry. Quality and attention to detail shall be executed in all aspects of work." The construction company eventually chosen had prior experience with a covered bridge in Madison County, Iowa, and is about to start the reconstruction of another Madison County bridge that was destroyed by an arson's fire in 2002.

Work progressed throughout the summer and fall of 2003 and on October 4th the bridge was ceremonially re-opened with a ribbon-cutting event. The following conceptual diagrams are taken from the January, 2003 rehabilitation plans and illustrate two of the rehabilitation tasks. Photographs were taken by the Marion County Engineer's office as the work progressed and are included here as well. Refer to the end of this report for additional work-in-progress photos.

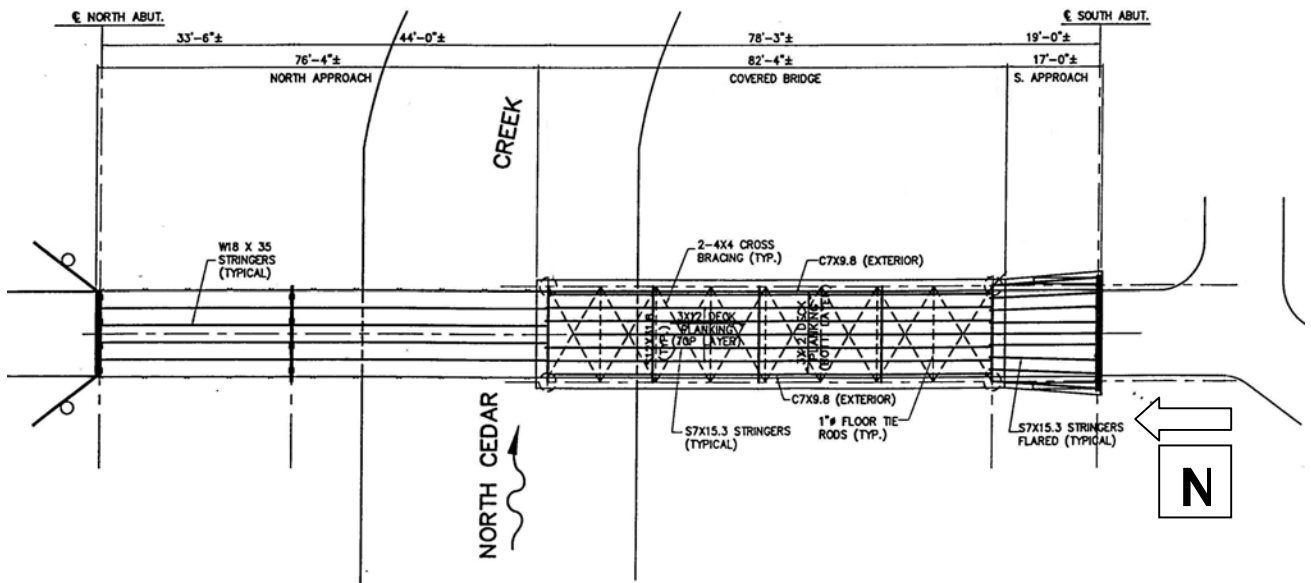
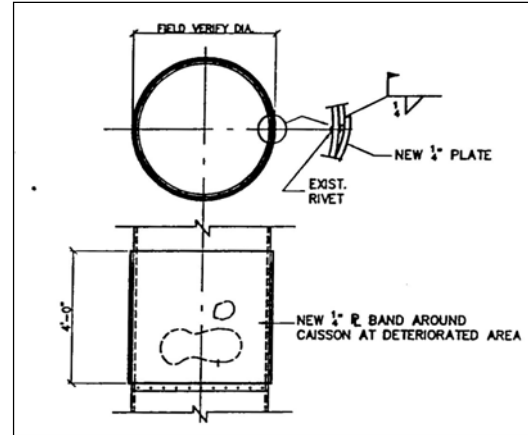
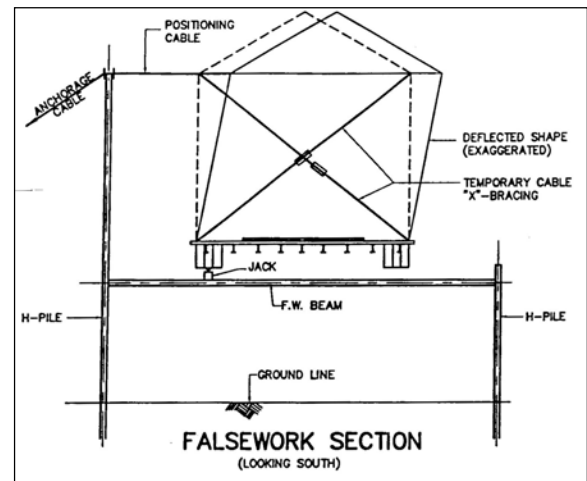

Figure 13 Hammond Bridge site plan. Note the 90-degree left turn upon exiting the south (right) end of the bridge. The drive to a nearby turn-of-the-20th-century farmstead angles to the southwest off the south end of the bridge. (Drawing adapted from Shuck-Britson Inc. rehabilitation plans dated January 2003)



Figures 14 and 15 Northwest cylinder pier and its repair plan.
(Drawing adapted from Shuck-Britson Inc. rehabilitation plans dated January 2003; Nash photo on left)



Figures 16 and 17 Straightening the trusses, looking south.
(Drawing adapted from Shuck-Britson Inc. rehabilitation plans dated January 2003; Jay Davis photo on left)

Construction techniques

Repair methods throughout the project were performed in such a way as to maintain the original appearance of the bridge. The installation of a “portal frame” was one of the more notable examples. A new steel frame was added between existing wood members to strengthen the structure and keep it from leaning after it was straightened (Figs. 21-29). To do this, a steel framework was welded together and then bolted to the wood structure. The steel was then covered with cedar lumber. Cost for this procedure was \$28,000 (refer also to the table of costs below). Also, the timber member at the northwest caisson or cylinder pier was badly decayed. This decayed section was removed and a similar timber was cut to match the size and shape. Bolts and epoxy were used to secure the repaired timber. The cost for this procedure was \$695. Finally, since the roof rafters were not the standard dimension of today’s lumber, the contractor’s crew cut replacements for the rotten rafters out of timbers, matching the dimensions of the historic lumber (not a separate cost item).

Cost information

The following table summarizes project costs by task:

ITEM NO.	ITEMS/DESCRIPTION	DOLLAR AMOUNTS	
		CONTRACT	ACTUAL
1	Safety closure	700	700
2	Traffic control	1,500	1,500
3	Mobilization	15,000	15,000
4	Deck restoration	1,200	1,200
5	Horizontal bracing system	1,400	1,400
6	Paint	7,500	7,500
7	Portal frame installation	28,000	28,000
8	Rail repair (item deleted)		
9	Roof restoration	25,000	25,000
10	Siding, fascia, & canopy restoration	35,000	35,000
11	Steel caisson restoration	3,500	3,500
12	Truss bearing restoration	4,500	4,500
13	Truss realignment	42,000	42,000
14	Change order 1: Bearing restoration	695	695
15	Change order 2: Rail	12,000	12,000
	Total	\$178,195	\$178,195

SELECTED REFERENCES AND SOURCES OF INFORMATION

Andreas, A.T. *Illustrated Historical Atlas of the State of Iowa*. Chicago: Andreas Atlas Co., 1875 (1970 reprint used).

Cheever, L.O. "Covered Bridges in Iowa." *The Palimpsest* 51(November 1970)11:449-496.

Brown, Curt, Herberger Construction Co., Inc., telephone conversation with Jan Olive Nash, 15 March 2004. Mr. Brown was the project manager, while Bentley Huebner was the superintendent on the job site.

Davis, Jay, Marion County Engineers Office, multiple telephone, email, and in-person conversations with Jan Olive Nash, October 2002-March 2003.

Donnel, Wm. M. *Pioneers of Marion County*. Des Moines: Republican Steam Printing House, 1872.

Field inspection by Jan Olive Nash, Tallgrass Historians L.C., 3 April 2003.

Fraser, Clayton B., "HAER Inventory/Iowa Historic Bridge Inventory Form," 28 Feb. 1992.

Marion County Board of Supervisor minutes, 12 Jan. 1894 (Book 9/Page 34); 3 April 1894 (B9/P39); 26 June 1894 (B9/P81). Located at Marion County Courthouse, Knoxville, IA.

Marion County Engineers Office, Hammond Bridge file and *Road Book 2*, Page 586.

Miller, B.L. "Geology of Marion County." *Iowa Geological Survey Administrative Reports*, 11(1901): 130-197.

N.A. "Covered Bridge Seriously Damaged," *Knoxville Journal*, 18 October 1977.

N.A. *History of Marion County, Iowa*. Des Moines: Union Historical Company, 1881.

Photograph Collection. Marion County Historical Society, Knoxville, Iowa (copies of bridge photographs and clippings contained in Marion County Engineers bridge files).

Russell, Robert C., and L. Dale Lockridge. *Soil Survey of Marion County, Iowa*. U.S. Washington, D.C.: Department of Agriculture, 1980.

Staniz, Joe, Shuck-Britson Inc. Consulting Engineers, telephone conversation with Jan Olive Nash, 15 March 2004. Mr. Staniz and Bob Britson both worked on the project.

Wright, John W., and W.A. Young. *History of Marion County, Iowa and its People*. Chicago: S.J. Clarke Publishing Company, 1915.

LOCATION OF HAMMOND BRIDGE

Hammond Bridge is located in T-74N, R-19W, in the southeast quarter of the southwest quarter of Section 26 (civil township Indiana), in Marion County, Iowa. The road's name is 170th Place.

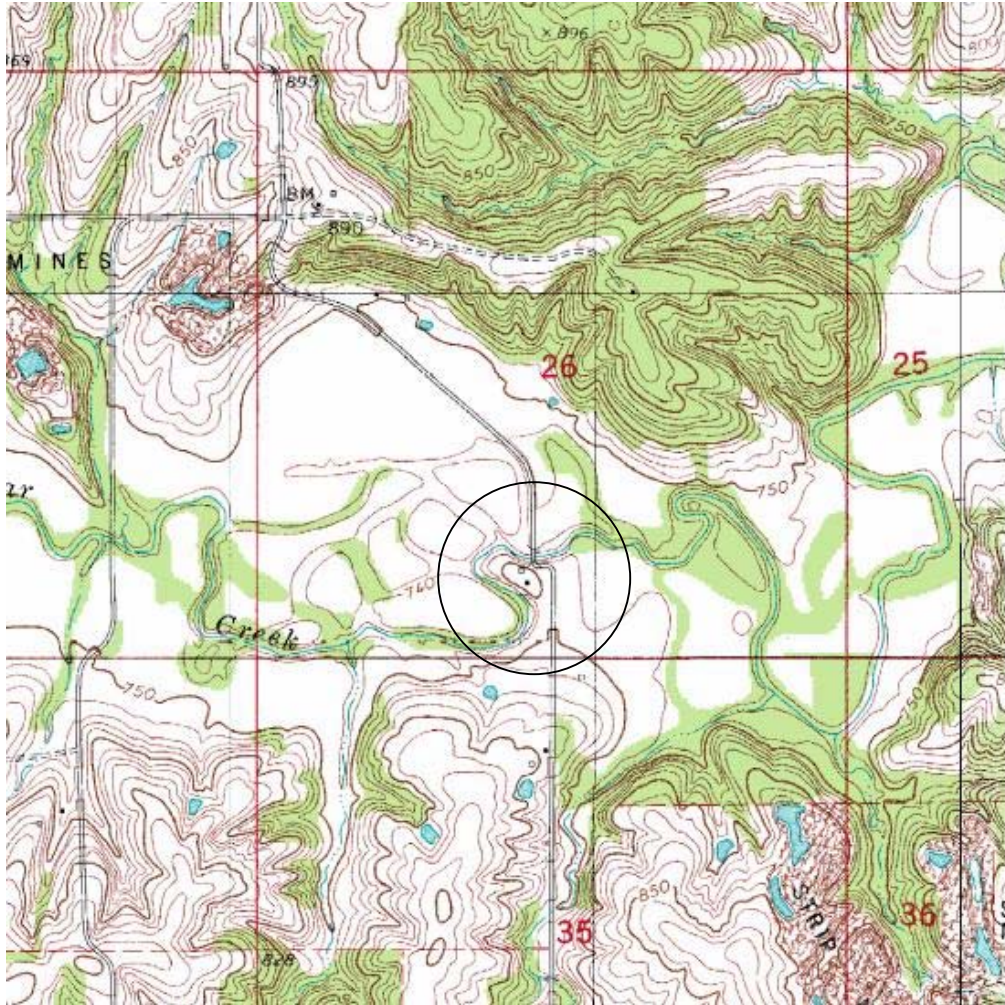

Figure 18 Topographic map of Section 26 with the location of Hammond Bridge circled. (From U.S.G.S. 7.5' series, Attica, Iowa, 1982)

ADDITIONAL PHOTO DOCUMENTATION OF THE WORK IN PROGRESS



Figure 19 A new concrete ford just downstream from Hammond Bridge now carries the road's vehicular traffic and a small pull-out at the north end of the approach (to the right) provides graveled parking for several cars. *(Nash photo)*



Figure 20 Hammond Bridge, rehabilitation finished, looking southeast.

Steel portal frame installation: the following several views show the installation process of this feature, which is intended to strengthen the structure and make it wind resistant. All photos are by Jay Davis.



Figure 21 Representative location of the new steel portal frame.



Figure 22 The steel was installed in the space between timber uprights.

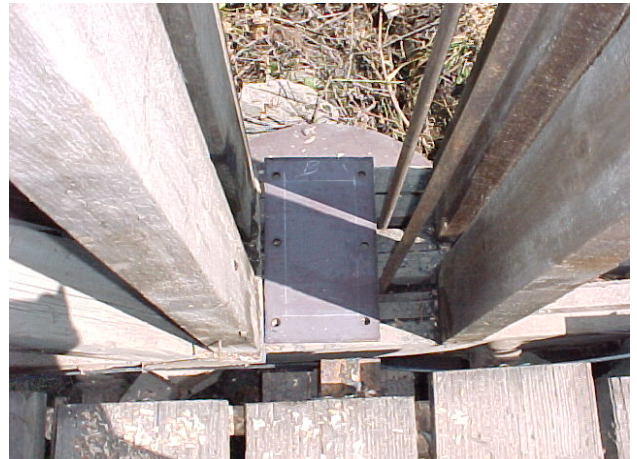

Figures 23 & 24 Setting the foot plate for the steel.



Figure 25 Bringing steel for the new portal beam.



Figure 26 Juncture of the steel portal upright and beam, as bolted to the wooden bridge.



Figure 27 Steel bolted to the historic timber.



Figure 28 Cedar lumber hides the steel.



Figure 29 The reinforced southern portal, clad in new cedar.

Caisson area repairs: The following images document the repair work on the cylinder piers or caissons. All photos are by Jay Davis.



Figures 30 & 31 Floor beam and pier trouble spots.



Figure 32 Repairing the rotten wood at the northwest caisson area.



Figure 33 Priming a caisson/cylinder pier.



Figure 34 Repainting complete.

Siding repair/replacement and re-roofing the bridge: All photos by Jay Davis.



**Figures 35 & 36
Removing and storing siding.**



Figure 37 The timber and metal Howe truss system is easy to see with the siding removed. Note the rafters have no ridge board.



Figure 38 Replacing the siding.



Figure 39 The roofing in process.



Figure 40 Re-roofing with cedar shingles.



Figure 41 Nearly finished and nearly harvest time.

Celebrating the rehabilitated Hammond Bridge: Following a hot summer of work on the bridge, the finished structure was re-opened in early October, 2003 with a public ceremony. All photos by Jay Davis.



Figure 42 A ribbon cutting ceremony officially opens the bridge to pedestrian traffic.



Figure 43 Refreshments encouraged people to linger and enjoy the bridge.



Figure 44 A display informed the public of the rehabilitation process.