



U.S. Department
of Transportation
**Federal Highway
Administration**

SOIL NAILING

FIELD INSPECTORS MANUAL

SOIL NAIL WALLS—DEMONSTRATION PROJECT 103

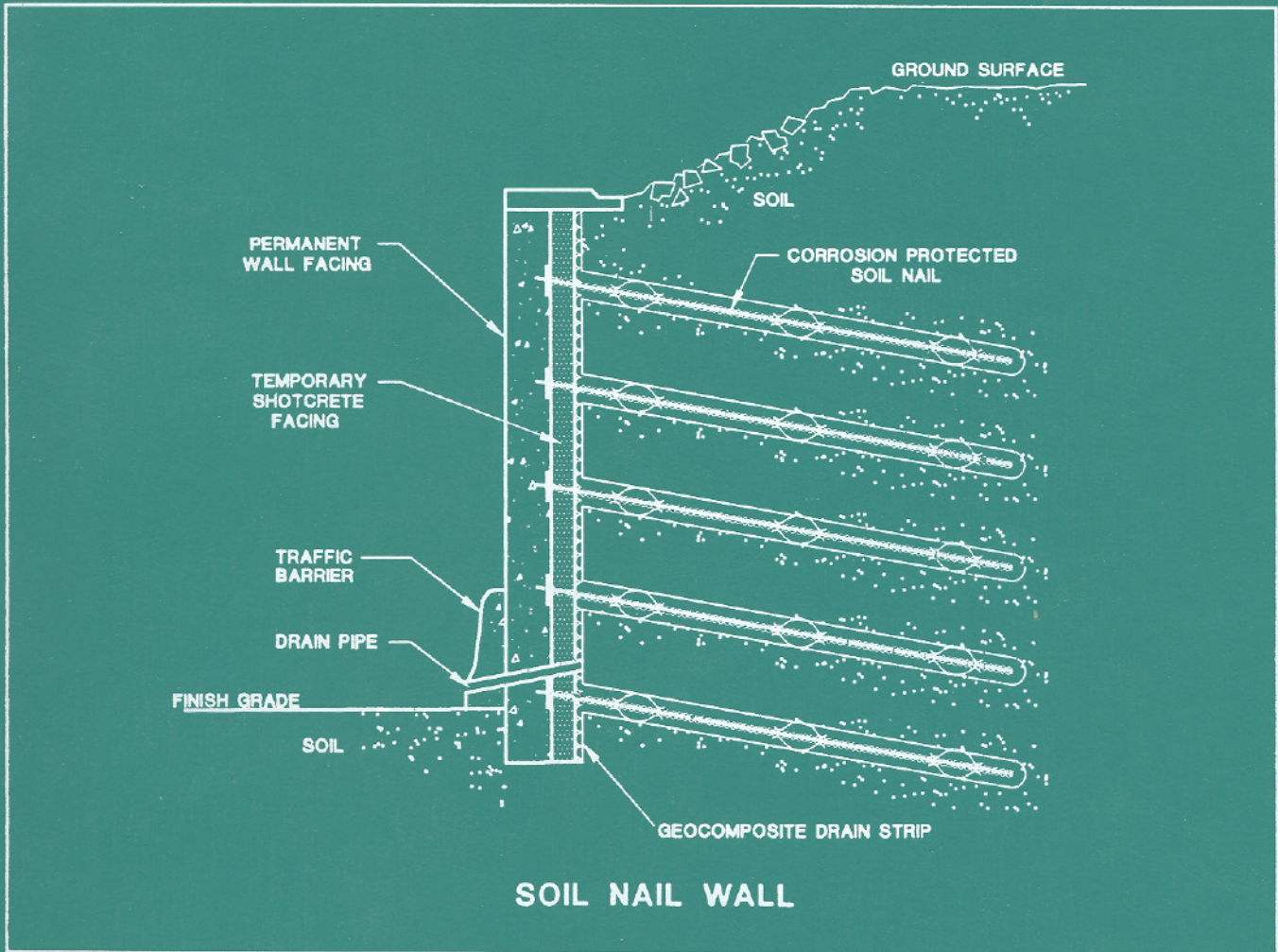

Office of Technology Applications
Federal Highway Administration
400 Seventh Street, SW.
Washington, D.C. 20590

Publication No. FHWA-SA-93-068

April 1994



Innovation Through
Partnership

FOREWORD

The purpose of this manual is to provide field inspectors with the knowledge necessary to effectively monitor and document the construction of soil nail retaining walls. **The manual provides information useful to both the experienced and inexperienced soil nail inspector.**

Soil nailing is a specialized type of construction. It requires the use of methods and techniques not ordinarily employed in conventional highway construction. Therefore, it is advantageous for inspectors to be knowledgeable about special aspects of soil nailing construction. A knowledgeable inspector will greatly enhance the advantages of this technology. **Whenever feasible, it is recommended that inexperienced inspectors be trained under the guidance of an experienced inspector prior to construction.**

The manual is organized into two main parts: **PRECONSTRUCTION PREPARATION** and **CONSTRUCTION INSPECTION**. Checklists which summarize key items discussed in the text are provided throughout the **CONSTRUCTION INSPECTION** section of the manual. **The inspector is encouraged to copy the checklists for use during construction.** For easy reference, representative figures and photographs have been incorporated into the body of the text where appropriate. Chapter 6 — Problem Solving on Construction — contains guidance for solving the more common problems encountered during construction. Chapter 7 — Handling Difficult Ground — contains a discussion of methods and techniques that can be employed when difficult ground is encountered during construction (an estimated 10 to 20 percent of projects). Appendix A contains blank forms that can be used for proper documentation and testing during soil nail wall construction. Appendix B contains examples of completed forms.

The discussions in the manual are brief, and are intended to highlight fundamental procedures. More comprehensive knowledge of particular areas of interest can be gained from specialty contractors, government agencies, consultants, the references listed in this manual, and careful review of part II, chapters 6 and 7, Problem Solving on Construction and Handling Difficult Ground.

This manual is intended to serve as both a field and an office reference for field inspectors. A condensed pocket size field version is planned, and will be distributed by FHWA as soon as it becomes available.

NOTICE

This document is disseminated under the sponsorship of the Department of Transportation in the interest of information exchange. The United States Government assumes no liability for its contents or use thereof. The contents of this report reflect the views of the authors, who are responsible for the accuracy of the data presented herein. The contents do not necessarily reflect the official policy of the Department of Transportation. This report does not constitute a standard, specification, or regulation.

The United States Government does not endorse products or manufacturers. Trade or manufacturers' names appear herein only because they are considered essential to the objective of this document.

Technical Report Documentation Page

1. Report No. FHWA-SA-93-068		2. Government Accession No.		3. Recipient's Catalog No.	
4. Title and Subtitle SOIL NAILING FIELD INSPECTORS MANUAL—SOIL NAIL WALLS				5. Report Date April 1994	
				6. Performing Organization Code	
7. Author(s) James A. Porterfield; David M. Cotton, P.E.; R. John Byrne, P.E.				8. Performing Organization Report No.	
9. Performing Organization Name and Address Golden Associates, Inc. 4104 148th Avenue, NE. Redmond, Washington 98052				10. Work Unit No. (TRAVIS)	
				11. Contract or Grant No.	
12. Sponsoring Agency Name and Address Office of Technology Applications Federal Highway Administration 400 Seventh Street, SW. Washington, D.C. 20590				13. Type of Report and Period Covered Inspectors manual	
				14. Sponsoring Agency Code	
15. Supplementary Notes FHWA COTR: Ronald G. Chassie, P.E.; Geotechnical Engineer, FHWA Region 10 Technical Editors: Ronald G. Chassie, P.E.; and Robert E. Kimmerling, P.E.					
16. Abstract <p>The purpose of this manual is to provide field inspectors with the knowledge necessary to effectively monitor and document the construction of soil nail retaining walls. The manual provides information useful to both the experienced and inexperienced soil nail inspector.</p> <p>The manual is organized into two main parts: <i>Preconstruction Preparation</i> and <i>Construction Inspection</i>. Checklists are provided throughout the Construction Inspection sections of the manual which summarize key items discussed in the text. The inspector is encouraged to copy the checklists for use during construction.</p> <p>Appendix A contains blank forms that can be used for proper documentation and testing during soil nail wall construction. Appendix B contains examples of completed forms.</p> <p>Construction inspectors and engineers from California, Oregon, Texas, and Washington State departments of transportation contributed to this manual. The International Association of Foundation Drilling also provided input from the industry perspective.</p>					
17. Key Words Soil nailing, retaining walls, soil nail walls, nail testing, geocomposite drain, centralizers, groundwater, grouting, excavation, performance specifications			18. Distribution Statement No restrictions. This document is available to the public from the National Technical Information Service, Springfield, Virginia 22161		
19. Security Classification (of this report) Unclassified	20. Security Classification (of this page) Unclassified	21. No. of Pages	22. Price		

ENGLISH TO METRIC (SI) CONVERSION FACTORS

The primary metric (SI) units used in civil and structural engineering are:

- meter (m)
- kilogram (kg)
- second (s)
- newton (N)
- pascal (Pa = N/m²)

The following are the conversion factors for units presented in this manual:

Quantity	From English Units	To Metric (SI) Units	Multiply by	For aid to Quick Mental Calculations
Mass	lb	kg	0.453 592	1 lb(mass) = 0.5kg
Force	lb	N	4.448 22	1 lb(force) = 4.5N
	kip	kN	4.448 22	1 kip(force) = 4.5kN
Force/unit length	plf	N/m	14.593 9	1 plf = 14.5N/m
	klf	kN/m	14.593 9	1 klf = 14.5kN/m
Pressure, stress, modulus of elasticity	psf	Pa	47.880 3	1 psf = 48 Pa
	ksf	kPa	47.880 3	1 ksf = 48 kPa
	psi	kPa	6.894 76	1 psi = 6.9 kPa
	ksi	MPa	6.894 76	1 ksi = 6.9 MPa
Length	inch	mm	25.4	1 in = 25 mm
	foot	m	0.3048	1 ft = 0.3 m
		mm	304.8	1 ft = 300 mm
Area	square inch	mm ²	645.16	1 sq in = 650 mm ²
	square foot	m ²	0.09290304	1 sq ft = 0.09m ²
	square yard	m ²	0.83612736	1 sq yd = 0.84 m ²
Volume	cubic inch	mm ³	16386.064	1 cu in = 16,400 mm ³
	cubic foot	m ³	0.0283168	1 cu ft = 0.03 m ³
	cubic yard	m ³	0.764555	1 cu yd = 0.76 m ³

A few points to remember:

1. In a "**soft**" conversion, an English measurement is mathematically converted to its **exact** metric equivalent.
2. In a "**hard**" conversion, a new **rounded**, metric number is created that is convenient to work with and remember.
3. Use only the meter and millimeter for length (avoid centimeter).
4. The pascal (Pa) is the unit for pressure and stress (Pa = N/m²).
5. Structural calculations should be shown in MPa or kPa.
6. A few basic comparisons worth remembering to help visualize metric dimensions are:
 - One mm is about 1/25 inch or slightly less than the thickness of a dime.
 - One m is the length of a yardstick plus about 3 inches.
 - One inch is just a fraction (1/64 inch) longer than 25 mm (1 inch = 25.4 mm).
 - Four inches are about 1/16 inch longer than 100 mm (4 inches = 101.6 mm).
 - One foot is about 3/16 inch longer than 300 mm (12 inches = 304.8 mm).

TABLE OF CONTENTS

PART I. PRECONSTRUCTION PREPARATION

<u>Chapter</u>	<u>Page</u>
1. Summary of Soil Nail Wall Elements	1
Introduction	1
Basic Components of Soil Nail Walls	7
Soil Nail	7
Drainage Elements	10
Structural Wall Facings	11
Temporary Shotcrete Facing	11
Permanent Wall Facings	11
Architectural Fascias and Face Treatments	11
Applications of Soil Nailing	15
2. Contract Documents	21
Introduction	21
Performance Specifications	21
Contractor Design/Build Specifications	22
Procedural (Method) Specifications	23
3. Know Your Design	24
Introduction	24
Geometry of The Soil Nail and Soil Nail Wall System	24
Soil/Rock and Groundwater Conditions	25
Construction Sequencing	26
4. Corrosion Protection Considerations	27
Introduction	27
Encapsulated Corrosion Protection	27
Epoxy Corrosion Protection	27
Grout Corrosion Protection	27

PART II. CONSTRUCTION INSPECTION

<u>Chapter</u>	
1. Field Quality Control of Materials	29
Introduction	29
Materials Control on the Project	29
Field Handling and Storage of Soil Nail Tendons	29
Inspection of Corrosion Protection	30
Storage of Cement	30
Storage of Reinforcing Steel	30
Storage of Drainage Materials	30
Field Quality Control of Materials Checklist	31

PART II. CONSTRUCTION INSPECTION (cont.)

<u>Chapter</u>		<u>Page</u>
2.	Construction Monitoring	32
	Introduction	32
	Excavation	33
	Soil Nail Hole Drilling	34
	Drill Rigs	34
	Drill Methods	34
	Tendon Installation	35
	Grouting	36
	Structural Wall Facing and Drainage	37
	Construction Monitoring Inspection Checklist	44
3.	Nail Testing	46
	Introduction	46
	Equipment for Testing	47
	Types of Tests	49
	Ultimate Test	49
	Verification Test	50
	Proof Test	50
	Creep Test	50
	Test Acceptance Criteria and What They Mean	50
	Verification/Ultimate Tests	50
	Proof Tests	51
	Meaning of Test Acceptance Criteria	51
	Nail Testing Inspection Checklist	53
4.	Contract Documentation	54
	Introduction	54
	Contract Documentation Checklist	55
5.	Contractor Relationships	56
	Introduction	56
	Personal Safety on Site	57
6.	Problem Solving on Construction	58
	Introduction	58
	Excavation	58
	Soil Nail Installation	59
	Grouting	63
	Shotcrete Facing and Drainage	64
	Soil Nail Testing	65

PART II. CONSTRUCTION INSPECTION (cont.)

<u>Chapter</u>	<u>Page</u>
7. Handling Difficult Ground	68
Introduction	68
Excavation and Drainage	68
Soil Nail Installation	76
Grouting	77
Shotcrete Facing	79

GLOSSARY OF TERMS	82
REFERENCES	86

APPENDIX

A. Blank Forms	A-1
Individual Soil Nail Installation Form	
Soil Nail Installation Summary Form	
Jack Calibration Chart	
Jack Calibration Graph	
Soil Nail Test Data Sheet	
Test Nail Elastic Movement Graph	
Test Nail Creep Movement Graph	
B. Examples of Completed Forms	B-1
Individual Soil Nail Installation Form	
Soil Nail Installation Summary Form	
Jack Calibration Chart	
Jack Calibration Graph	
Soil Nail Test Data Sheet	
Test Nail Elastic Movement Graph	
Test Nail Creep Movement Graph	

LIST OF TABLES

Table

1. Deformed Reinforcing Bars: Sizes and Dimensions	10
2. Causes of Local Instability at the Cut Face of Soil Nail Wall Excavations	75
3. Methods of Controlling Local Instability at the Cut Face of Soil Nail Wall Excavations	75

LIST OF FIGURES

Figure

1.	Typical Nail Wall Construction Sequence	2
2.	Typical Section Through Vertical Wall	3
3.	Typical Section Through Battered Wall	4
4.	Typical Section Through Stepped Wall	5
5.	Typical Production Nail Detail	8
6.	Typical Test Nail Detail	9
7A.	Typical Temporary Shotcrete Facing Detail	12
7B.	Typical Permanent Shotcrete Facing Detail	12
8.	Typical Structural Cast-in-Place Reinforced Concrete Facing Over Temporary Shotcrete	13
9.	Typical Architectural Precast Concrete Panel Finish Face	14
10.	Soil Nail Wall Applications	16
11.	Soil Nail Wall Applications	17
12.	Examples of Wall Drain Details	39
13.	Typical Nail Test Setup	48
14.	Local Cut Face Instability Due to Drilling Action	61
15.	Local Cut Face Stabilized During Drilling with Stabilizing Berm	62
16.	Shotcrete Flashcoat to Control Limited Sloughing of Cut Face After Nail Installation	69
17.	Shotcrete Flashcoat or Full Facing to Control Sloughing of Cut Face Prior to Nail Installation	70
18.	Nail Installation Through Stabilizing Berm	71
19.	Typical Detail of Segmental Slot Excavations	73

LIST OF PHOTOGRAPHS

Photograph

Examples of Permanent Soil Nail Walls — Highway Widening

P1.	Route 85, San Jose, California	18
P2.	Route 37, Vallejo, California	18
P3.	Tonawanda Drive, San Diego, California	18
P4.	I-405, Renton, Washington	18
P5.	Route 89, Tahoe Pines, California	18
P6.	I-78, Allentown, Pennsylvania	18

Examples of Permanent Soil Nail Walls — Widening Under Existing Bridges

P7.	I-5, Tacoma, Washington	19
P8.	I-35, Laredo, Texas	19
P9.	I-495 at G-W Parkway, Fairfax, Virginia	19
P10.	I-495 at G-W Parkway, Fairfax, Virginia	19
P11.	I-5, Swift-Delta Interchange, Portland, Oregon	19
P12.	I-5, Swift-Delta Interchange, Portland, Oregon	19

Examples of Soil Nail Walls — Wall Replacement and Temporary Shoring

P13.	Removal and Replacement of Failing Older Gravity Wall, Seattle, WA	20
P14.	Removal and Replacement of Failing Older Gravity Wall, Seattle, WA	20
P15.	Removal and Replacement of Failing Older Gravity Wall, Seattle, WA	20
P16.	Temporary Nail Shoring Wall, I-10/280, San Bernadino, California	20

Nail Corrosion Protection

P17.	Encapsulated Corrosion Protection	28
P18.	Epoxy Corrosion Protection and PVC Centralizers	28
P19.	Epoxy Corrosion Protection with Encapsulation at Nail Head (Caltrans Detail)	28
P20.	Improperly Centered Tendon Inside Field Fabricated Encapsulation	28
P21.	Improper Fastening of Centralizer	28

Soil Nail Wall Construction

P22.	Excavation to Finish Wall Line	40
P23.	Drill Rig	40
P24.	Drilling Nail Hole	40
P25.	Completed Drillhole	40
P26.	Drillhole Cleaning Tool and High Intensity Light	40
P27.	Cleaning and Inspecting Drillholes	41
P28.	PVC Measuring Rod	41
P29.	Installing Soil Nail Tendon	41
P30.	Tremie Pipe Grout Placement	41
P31.	Installing Drain Strips and Welded Wire Mesh	41
P32.	Roll of Prefab Drain Strip	41
P33.	Securing Mesh and Drain Strips to Excavation Face	42
P34.	Applying Shotcrete	42
P35.	Shotcreting Upper Part of Drillhole	42
P36.	Steel Bearing Plate with Nut, Beveled Washer, and Shear Studs	42
P37.	Form for CIP Facing and Weephole Drain Outlet Pipes	42
P38.	Drainage Gutter Behind Top of Wall	42

Shotcreting a Permanent Structural Shotcrete Wall

P39.	Nozzleman Gunning Prequalification Test Panels	43
P40.	Nozzleman Applying Shotcrete and Blow Pipe Removing Rebound	43
P41.	Rough Screeding Shotcrete Face	43
P42.	Final Hand Texturing with Rubber Float	43
P43.	Completed Permanent Structural Shotcrete Wall Prior to Painting, I-5, Tacoma, WA	43
P44.	Completed Permanent Structural Shotcrete Wall After Painting, I-5, Tacoma, WA	43

Nail Testing

P45.	Typical Nail Testing Setup	49
------	--------------------------------------	----

Problem Solving on Construction

P46.	Mass Excavation and Stabilizing Berm	60
P47.	Drilling Through Stabilizing Berm	60
P48.	Excavating Stabilizing Berm After Nails Installed	60
P49.	Exhuming A Failed Sacrificial Test Nail	67
P50.	Exhumed Test Nail with Inadequate Grouting	67

Handling Difficult Ground

P51.	Drilling Through Shotcrete Facing Due to Caving Ground	80
P52.	False Form to Repair Excavation Face Slough	80
P53.	Backfilling Void Behind False Form	80
P54.	Use of Segmental Slot Excavation to Prevent Face Sloughing	80
P55.	Shotcrete and Excavation to Finish Face in Segmental Slot Excavations	80
P56.	Completed Shotcrete Face Closure in Segmental Slot Excavations	80
P57.	Use of PVC Pipe Weepholes Through Shotcrete Face in Heavy Seepage Areas	81
P58.	Drain Strips over Weepholes on Shotcrete Face	81
P59.	Close-up of Drain Strip on Shotcrete Face	81
P60.	One Example of Dispute Resolution	81

Photo Credits — Photographs in this manual were compiled by the FHWA Region 10 Office of Structures. Photos illustrating construction problems are intentionally not credited. Other photos were provided courtesy of:

P1, 18, 19, 24, 25, 28, 31-37, 46-48 (CALTRANS);
 P2, 3, 5, 16, 23, 27 (CALTRANS/FHWA);
 P4, 7, 17, 35, 41, 43, 44 (WASHINGTON DOT/FHWA);
 P6, 57, 58, 59 (SCHNABEL FOUNDATION CO.);
 P13, 14, 15, 26 (GOLDER ASSOCIATES);
 P9, 10, 29, 38 (VIRGINIA DOT/FHWA);
 P11, 30, 40, 42 (OREGON DOT);
 P12, 39, 45 (OREGON DOT/FHWA);
 P8 (TEXAS DOT);
 P22 (KULCHIN-CONDON & ASSOCIATES).

ACKNOWLEDGEMENTS

Special thanks are given to the many construction inspectors and engineers from the California, Oregon, Texas, and Washington State Departments of Transportation and the FHWA, who provided the constructive review comments and other feedback needed to ensure that this manual contains the practical information required to help field inspectors do their job. Special recognition is due Mr. Gary Garofalo of Caltrans and Mr. Jim Cuthbertson and Mr. Al Kilian of the Washington State DOT for their many helpful and constructive comments.

Thanks also to the International Association of Foundation Drilling (previously ADSC) Earth Retention Committee, particularly Committee Chairman Mr. Ronald Chapman, and Mr. David Weatherby, both with Schnabel Foundation Company, for providing industry input and helping to produce a manual that will benefit **both** public transportation agencies and soil nailing specialty contractors.

Special thanks are due the FHWA Office of Technology Applications, particularly Mr. John Hooks and Mr. Theodore Ferragut, for providing the assistance, encouragement and funding support that made this manual possible.

Lastly, and most importantly, heartfelt thanks are given to the "unsung heroes" i.e. the members of Golder Associates' Wordprocessing and CAD groups and Ms. Marty Moyer of FHWA, Region 10, who typed the original and final edited versions of the manuscript and prepared the graphics.

The FHWA Contracting Officer's Technical Representative (COTR) for this effort was Mr. Ronald G. Chassie. FHWA technical review, direction and editing were provided by Mr. Chassie and Mr. Robert E. Kimmerling, geotechnical engineers in the FHWA Region 10 Office of Structures, Portland, Oregon (USA).

PART I. PRECONSTRUCTION PREPARATION

Chapter 1. Summary of Soil Nail Wall Elements

Introduction

The purpose of this chapter is to familiarize the inspector with the soil nailing technique, the basic elements and types of soil nail walls, their general applications, and major construction concerns. Specific definitions are provided in the Glossary of Terms at the end of this manual.

Soil nailing is a technique used to **reinforce and strengthen** existing ground. Soil is a poor structural material because it is weak in tension. Steel is strong in tension. The fundamental concept of soil nailing is that soil can be effectively reinforced by installing closely spaced grouted steel bars, called "**nails**," into a slope or excavation as construction proceeds from the **top down**. Nails are commonly referred to as "passive" inclusions. The term "passive" means that the nails are not pre-tensioned (as are tiebacks) when they are installed. The nail bars are forced into tension as the ground deforms laterally in response to the loss of support caused by continued excavation. The grouted nails increase the shear strength of the overall soil mass and limit displacement during and after excavation. A structural facing connected to the nails is used when the slope angle exceeds a predetermined critical value or when environmental conditions would cause deterioration of the exposed soil face over its design life.

Soil nail retaining wall construction typically involves the following six steps, as shown in figure 1:

- Step 1. Excavate a small height cut.
- Step 2. Drill hole for nail.
- Step 3. Install and grout soil nail tendon.
- Step 4. Place geocomposite drain strips, initial shotcrete layer, and install bearing plates and nuts.
- Step 5. Repeat process to final grade, and
- Step 6. Place final facing (on permanent walls).

Note: Steps 3 and 4, order of nail and shotcrete installation, may be reversed.

Soil nailing is used to retain vertical, battered, or stepped excavations. Typical details of these wall types are shown in figures 2, 3, and 4. Soil nails are bonded along their full length and are not constructed with a permanent unbonded length as are tieback anchors. Test nails are constructed with a temporary unbonded length that is backfilled with grout after testing is completed.

Soil nail wall construction is sensitive to ground conditions, construction methods, equipment, and excavation sequencing. **Soil nailing cannot be used in all types of ground.** For soil nail walls to be most economical, they should be constructed in ground that can stand unsupported on a vertical or steeply sloped cut of 1 to 2 m (3 to 6 feet) for at least one to two days, and that can maintain an open drill hole for at least several hours.

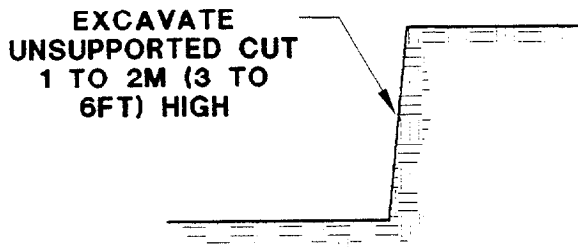

STEP 1. EXCAVATE SMALL CUT

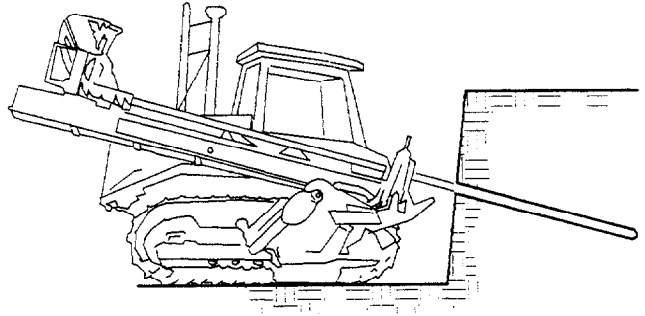

STEP 2. DRILL HOLE FOR NAIL

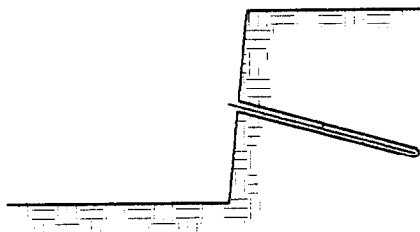

STEP 3. INSTALL AND GROUT NAIL

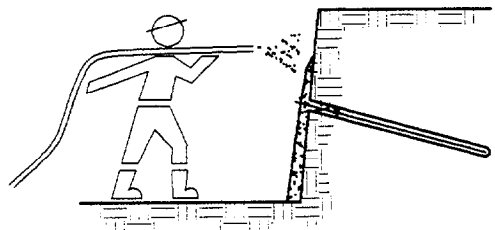

STEP 4. PLACE DRAINAGE STRIPS, INITIAL SHOTCRETE LAYER & INSTALL BEARING PLATES/NUTS

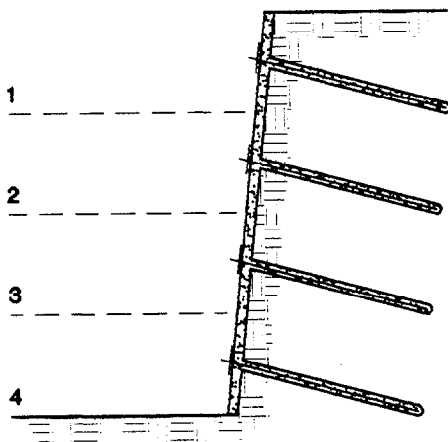

STEP 5. REPEAT PROCESS TO FINAL GRADE

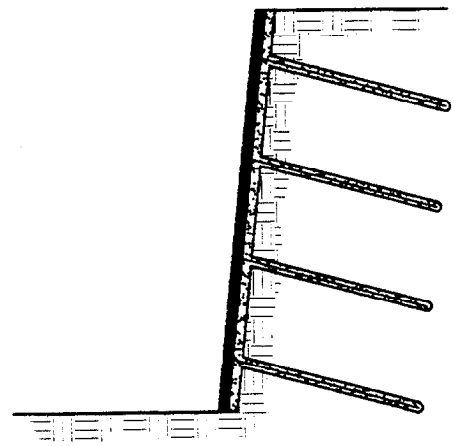

STEP 6. PLACE FINAL FACING (ON PERMANENT WALLS)

Figure 1. Typical Nail Wall Construction Sequence.

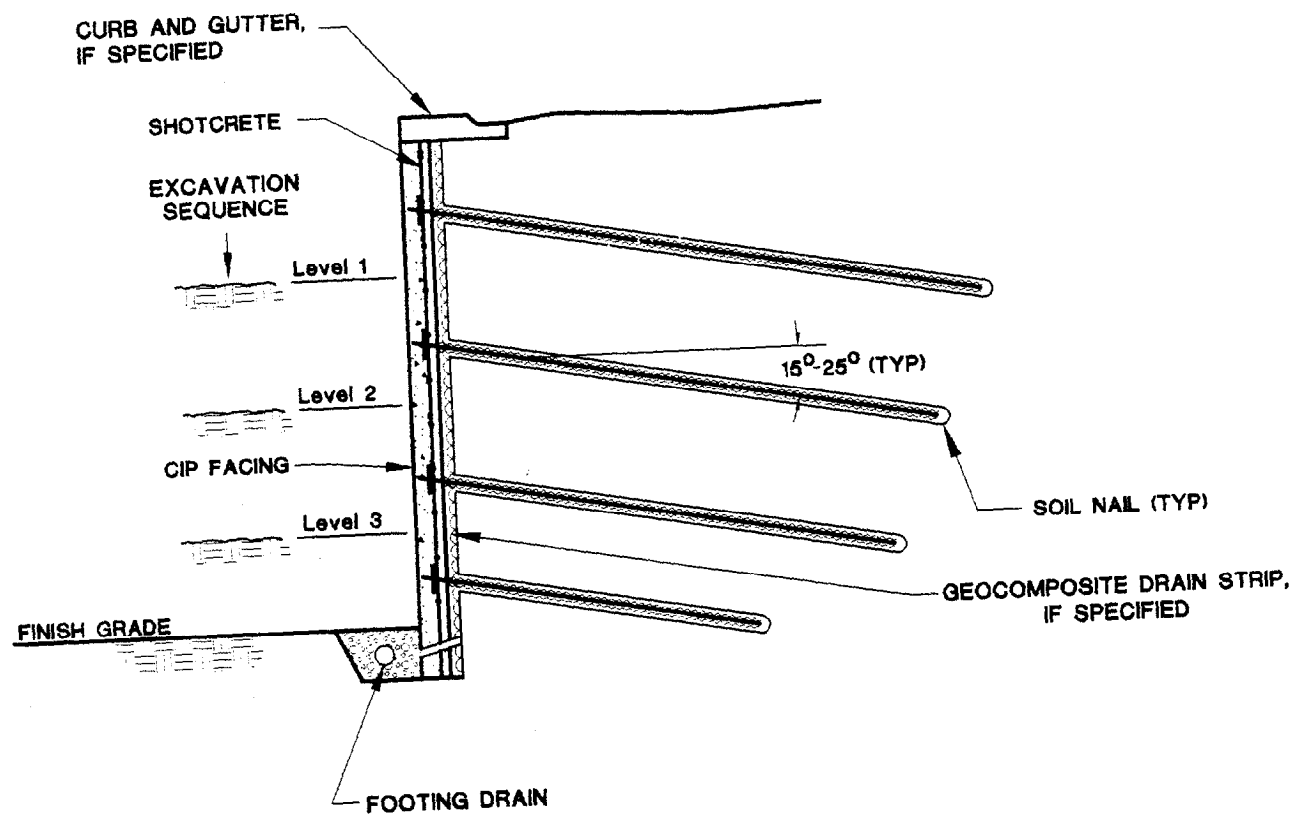

Figure 2. Typical Section Through Vertical Wall.

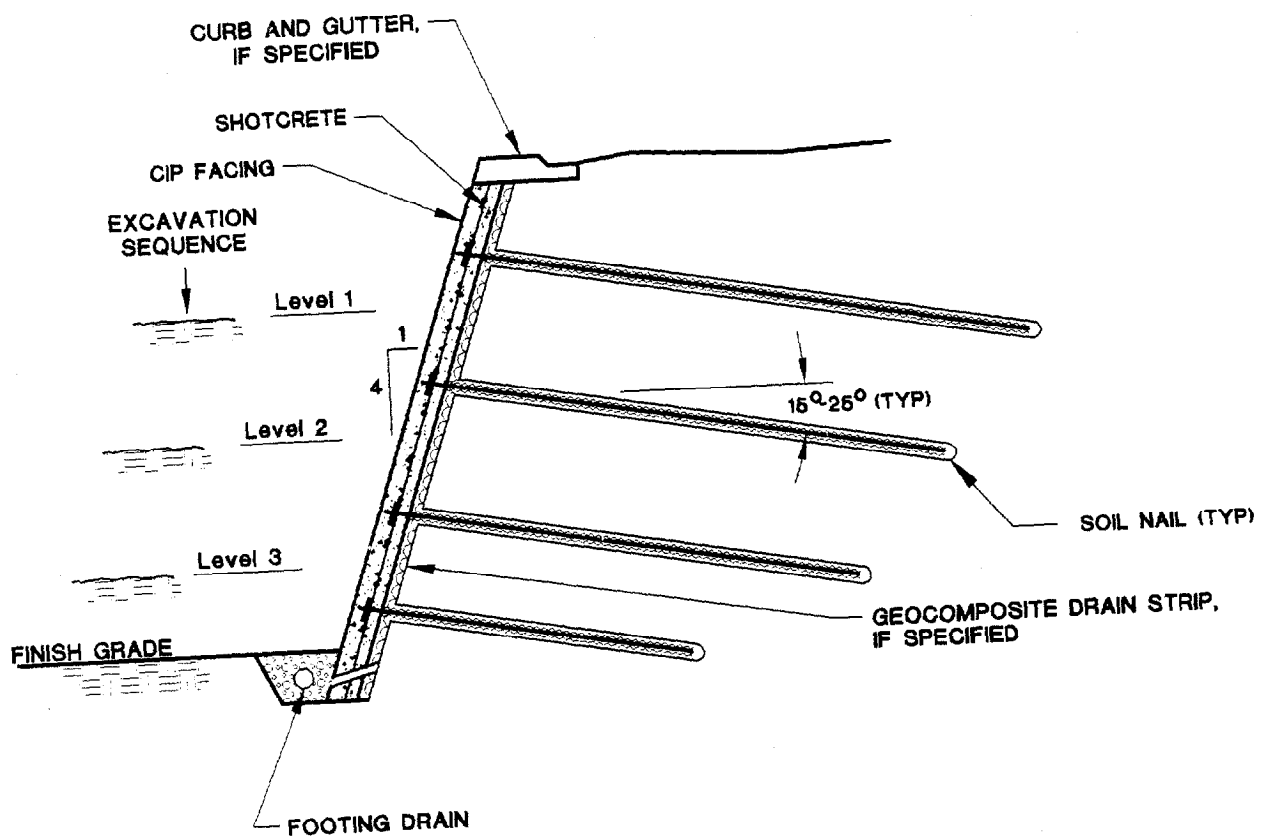

Figure 3. Typical Section Through Battered Wall.

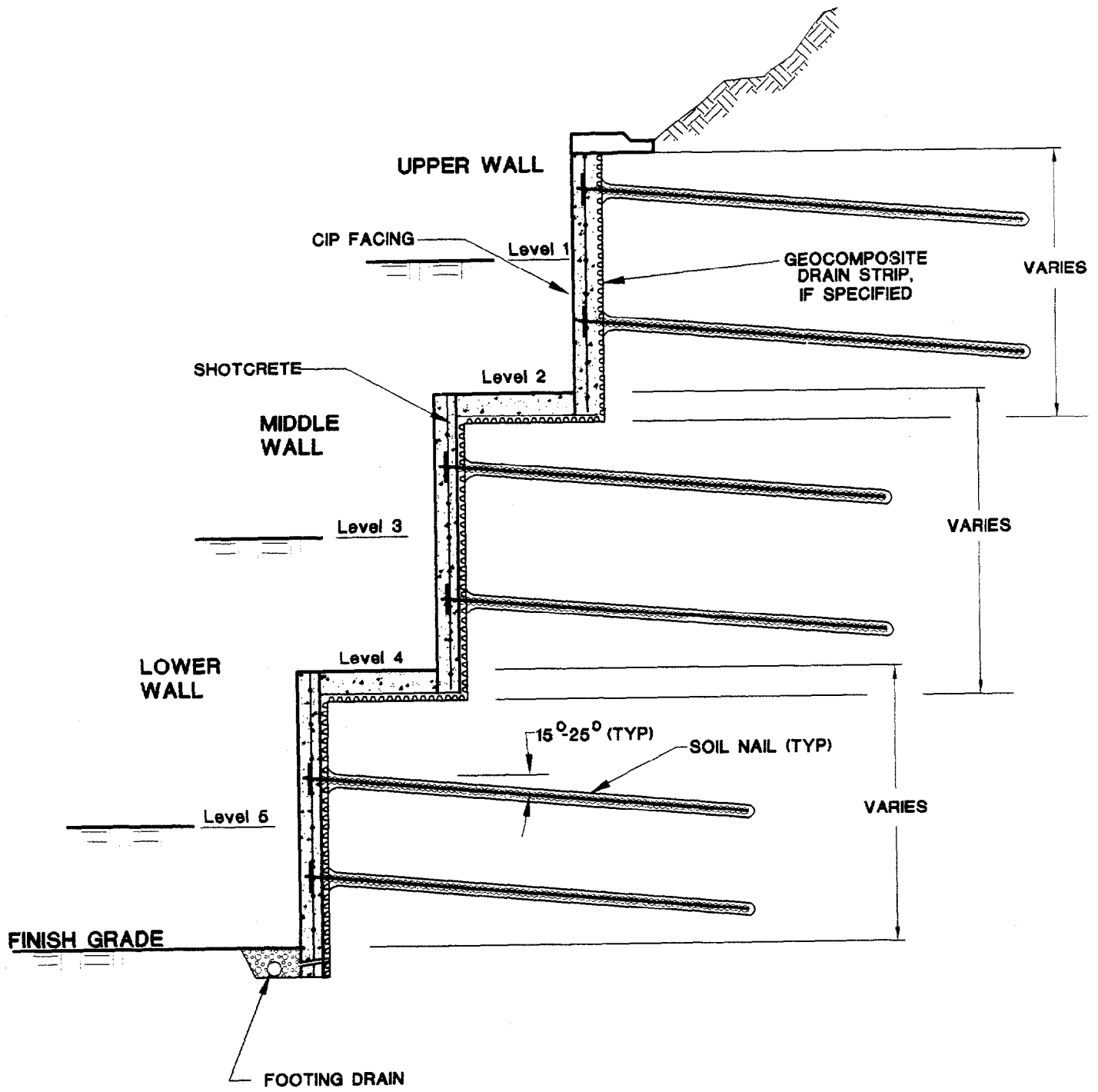

Figure 4. Typical Section Through Stepped Wall.

The following types of ground are considered favorable to soil nailing: naturally cohesive materials (silts and low plasticity clays that are not prone to creep); naturally cemented or dense sands and gravels with some real cohesion (due to fines) or apparent cohesion (due to natural moisture); and weathered rock. From a construction viewpoint, soil nailing is very adaptable and is therefore appropriate for mixed face conditions, such as competent soil over bedrock.

Benefits of soil nailing include the following: ability to easily follow the building outline (i.e., ability to zigzag as required); suitability of small construction equipment compared to alternative methods of construction; suitability for special applications and remedial work; ability to mobilize to a site quickly; elimination of need for soldier piles required with tieback walls; flexibility to allow for modifications during construction (e.g., nail locations can be moved to miss obstructions); and, compatibility with the usual constraints of operating in urban environments (e.g., need for minimum noise, small overhead clearance, etc.). Structural elements (soil nails and facing) and installation methods can easily be adapted, even during construction, to provide the most appropriate solution for specific site and ground conditions.

The limitations of soil nailing include the following: inability to excavate where groundwater is a problem; difficulties associated with soil raveling in cohesionless sands and gravels without use of special, expensive measures; problems associated with heavy concentrations of utilities, vaults or other underground obstructions behind the wall; and potential performance problems if used in expansive or highly frost susceptible soils. In addition, because wall performance is sensitive to the method of construction, optimal results typically can be achieved by experienced specialty contractors.

The more common construction problems encountered on nail wall projects typically have involved encountering loose fill, granular soil with no apparent cohesion (e.g., "caving sands"), residual soils with remnant rock structure dipping adversely into the excavation, water, and man-made obstructions such as utility trenches. Other problems have involved contractor failure to construct the wall in accordance with the plans and specifications (e.g., excessive over-excavation of lifts, elimination of nails, or use of poor grouting procedures) or mis-application of the method in ground conditions not suited to nailing. In a few cases, where significant excavation face sloughing has occurred without prompt remedial action, face collapses have occurred. Chapter 7 — Handling Difficult Ground — addresses the problems of those fewer soil nailing projects that happen to be built in poorer ground (whether by design or as a result of encountering unexpected site conditions).

Note: Since their introduction in Europe approximately 20 years ago, "soil nails" have been installed in a wide variety of ground types, ranging from various types of soil to soils including cobbles and boulders to weathered and unweathered rock. While the term "ground" nail might technically be a more suitable "generic" term (like the term "ground anchor" that has been adopted for tiebacks), the term "soil nail," or "soil nailing," has become established as the commonly accepted "generic" term in use over the last 20 years, both in the U.S. and worldwide. **Therefore, to be consistent with previously established practice, the term "soil nail" is used in this manual as a "generic" term that applies to nails installed in all types of ground.**

Basic Components of Soil Nail Walls

Soil nail walls consist of three basic components: (1) the soil nails, (2) the drainage elements, and (3) the structural wall facing.

Soil Nail

A typical soil nail consists of a deformed steel reinforcing bar (generally Grade 60), also called a tendon, which is inserted into a predrilled, straight shafted, drillhole generally ranging from 100 to 300 mm (4 to 12 inches) in diameter. After the nail tendon is inserted, the drillhole is completely filled with structural grout pumped under low-pressure via a tremie pipe ("**open hole**" installation). The grout "bonds" the nail tendon to the surrounding ground.

Soil nails are typically installed by "open hole" methods using a variety of drilling equipment, usually augers. The open-hole method is used to install 80 to 90 percent of drilled and grouted soil nails. "Cased" or "auger cast" installation methods can be used when caving soil conditions are encountered. The installation method selected by the contractor will depend on soil/rock type, specified design adhesion values, groundwater conditions, site restrictions, structural requirements such as total nail length and nail diameter, and equipment availability. Soil nail drilling and installation procedures are discussed in more detail in chapter 2 of part II. Chapter 7 — Handling Difficult Ground — also contains more detailed information on auger-cast and cased methods.

The basic elements of a typical fully grouted **production** soil nail are shown in figure 5. The drilled length is the length of the nail drillhole; the soil nail length is the grouted tendon length, and the tendon length is the total length of the soil nail tendon.

Test nails are constructed as shown in figure 6 and incorporate an unbonded length to allow for testing. The unbonded length is that length of the tendon located in the upper portion of the drillhole that initially is not filled with grout. The unbonded length isolates the bonded portion of the test nail from the jacking system during testing. The tendon bonded length is the length of tendon that is bonded to the soil nail grout. For test nails, the test nail length is comprised of the unbonded length and the bonded length. The unbonded length of the test soil nail drillhole should be filled with grout promptly after the test is completed.

The grouted hole diameter is commonly assumed to be equal to the nominal diameter of the drillhole. The actual final grout diameter may be larger than the diameter of the predrilled hole, due to oversizing of the hole by drilling action and/or by grout infiltration into surrounding permeable, granular soils. Grout infiltration is not likely in less permeable, fine grained soils.

Centralizers are secured to the nail tendon at regular intervals to centralize the tendon in the drillhole and/or to provide a minimum specified grout cover. Centralizers consist of expanded PVC, steel, or other approved material that is not detrimental to the tendon steel.

The bearing plate is attached to the nail head and transfers wall facing pressures to the nail. The bearing plate is attached to the nail with either a hex nut and beveled washer (most commonly) or a steel spherical seat nut, with the nut typically turned wrench tight.

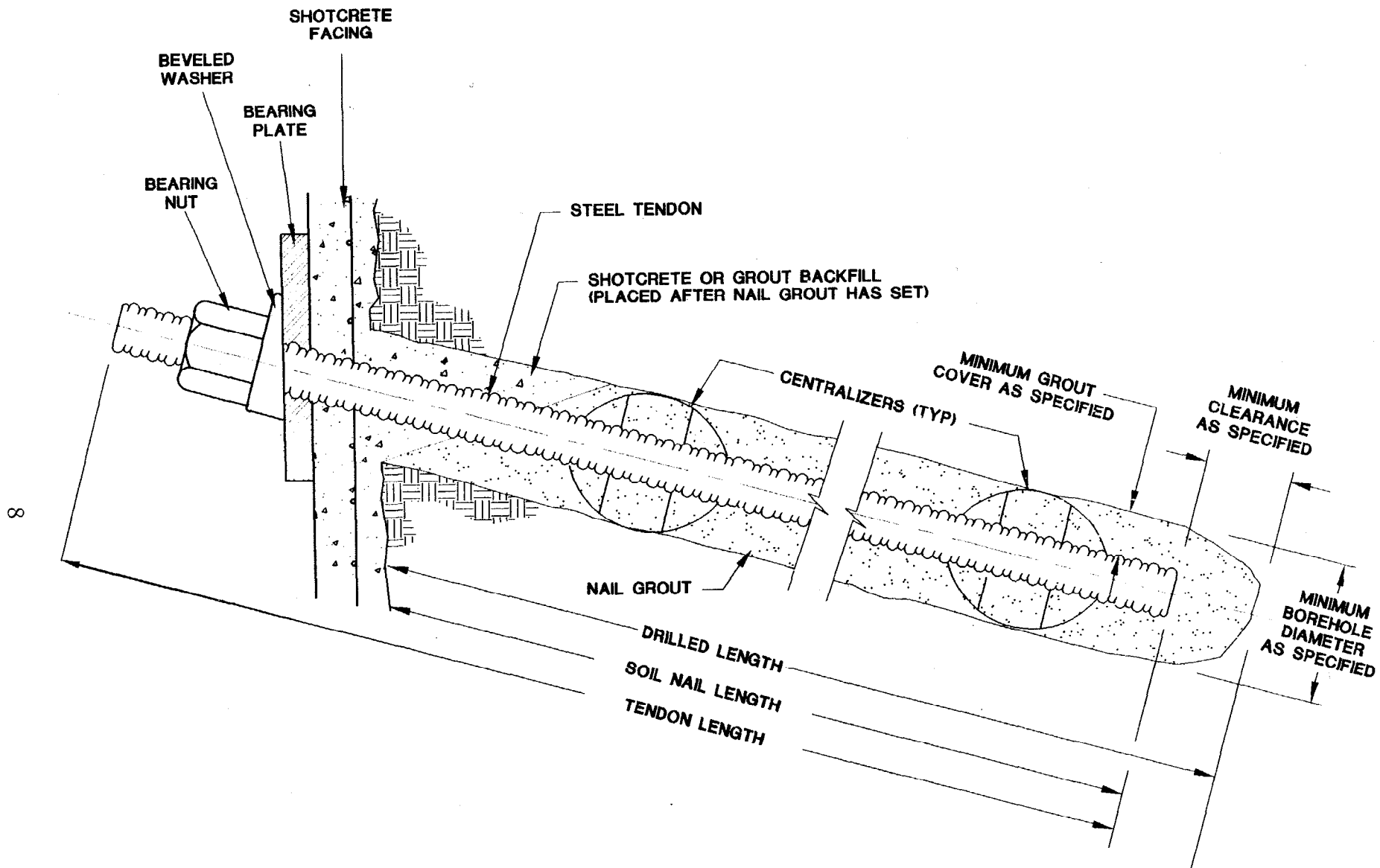

Figure 5. Typical Production Nail Detail.

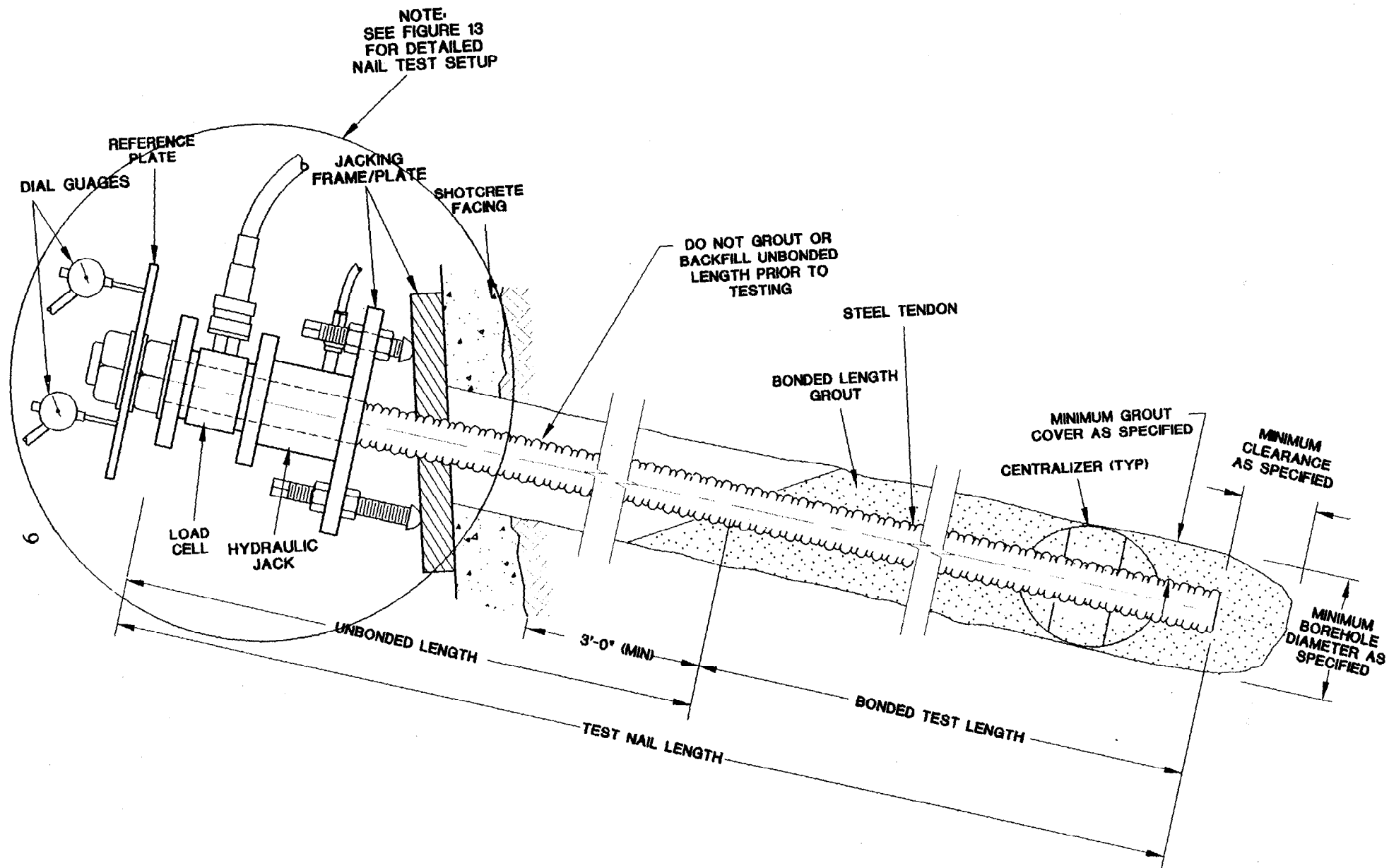

Figure 6. Typical Test Nail Detail.

The nail tendon consists of a deformed steel bar, available in various diameters (see table 1). Nail tendons should be installed as single units without couplers (unless couplers are allowed by the project specifications). Couplers are typically allowed for temporary extension of the nail tendon during testing. Welding is not permissible.

Permanent soil nail systems require corrosion protection of the tendon. Corrosion protection requirements are discussed in chapter 4.

TABLE 1. DEFORMED REINFORCING BARS
Metric (SI) - AASHTO M31M/ASTM A615M (Grade 400)
English - AASHTO M31/ASTM A615 (Grade 60)
Sizes and Dimensions

Bar Size Designation No.		Nominal Dimensions				Diameter	
		Area		Weight			
SI	English	mm ²	in. ²	kg/m	lb/ft	mm	in.
10m	3	100	0.11	0.785	0.376	11.3	0.375
15m	4	200	0.20	1.570	0.668	16.0	0.500
20m	5	300	0.31	2.355	1.043	19.5	0.625
25m	6	500	0.44	3.925	1.502	25.2	0.750
30m	7	700	0.60	5.495	2.044	29.9	0.875
35m	8	1000	0.79	7.850	2.670	35.7	1.000
45m	9	1500	1.00	11.775	3.400	43.7	1.128
55m	10	2500	1.27	19.625	4.303	56.4	1.270
N/A	11	N/A	1.56	N/A	5.313	N/A	1.410
N/A	14	N/A	2.25	N/A	7.650	N/A	1.693
N/A	18	N/A	4.00	N/A	13.600	N/A	2.257

N/A = Not available in metric size in U.S.

Drainage Elements

Drainage is considered a critical element, and is incorporated into all permanent walls and many temporary walls.

Face drainage is the type most commonly used and usually consists of prefabricated vertical geocomposite drainage strips installed from the top to the bottom as the excavation proceeds downward. The drainage strips are typically 300 to 450 mm (12 to 18 inches) wide, and are centered between the vertical nail columns. The strips are connected to weep hole outlet pipes and to a footing drain at the wall base. Drainage strips are used where small quantities of water are present or anticipated. They may not be suitable where large quantities of groundwater are encountered. With the use of vertical drainage strips, water must be captured and carried to the bottom of wall as construction progresses. This may cause a significant construction problem if large quantities of water are encountered. More detailed guidance on handling larger quantities of groundwater is presented in part II, chapter 7 — Handling Difficult Ground.

A surface water collector ditch is usually placed behind the top of the wall to prevent surface runoff from either recharging the ground behind the wall or flowing over the top of wall.

Structural Wall Facings

Structural wall facings are required for face confinement, protection of the retained soil against weathering and erosion, and resisting lateral earth pressures.

Soil nail retaining walls used on transportation projects are typically being constructed using a temporary shotcrete facing followed by a permanent wall facing consisting of cast-in-place (CIP) concrete, additional shotcrete, or precast concrete panels.

Temporary Shotcrete Facing. A temporary shotcrete facing is placed to temporarily restrain and protect the exposed soil in the cut face. Typically, it consists of 75 to 100 mm (3 to 4 inches) of shotcrete reinforced with a single layer of welded wire mesh (figure 7a). The temporary shotcrete facing is placed concurrently with each excavation lift.

Permanent Wall Facings. Permanent wall facings may consist of full-thickness shotcrete (figure 7b), CIP concrete over temporary shotcrete (figure 8), or precast concrete panels over shotcrete (figure 9). Although precast concrete panels are more typically used as architectural facings, some permanent precast structural facings have been used in Europe. Permanent facings consisting of CIP concrete (figure 8) are placed over the shotcrete following completion of the excavation to full height. The soil nail head/bearing plate must be structurally connected to the permanent wall, and the temporary shotcrete wall is sometimes considered sacrificial in the structural facing design. Both cast-in-place and precast concrete can provide a suitable architectural wall finish.

Permanent shotcrete walls are constructed with either (1) the full-thickness shotcrete placed concurrently with each excavation lift (figure 7b), or, (2) a second full-height shotcrete layer placed over the initial shotcrete layer following the excavation to full depth (figure 7a). This type of wall generally has a total thickness of 150 to 300 mm (6 to 12 inches), and is reinforced with reinforcing bars or welded wire mesh.

Architectural Fascias and Face Treatments. In many instances, architectural aesthetic requirements will call for a non-structural fascia to cover a permanent shotcrete or CIP facing. Such architectural fascias may consist of precast concrete panels, masonry stone, or masonry block.

Architectural face treatments are commonly applied to CIP facings through the use of commercially available form liners, boards, or other materials placed inside the face forms. Face treatment can be applied to permanent shotcrete facings by hand finishing and texturing, and coloring can be done by painting, staining or adding coloring agent to the shotcrete mix.

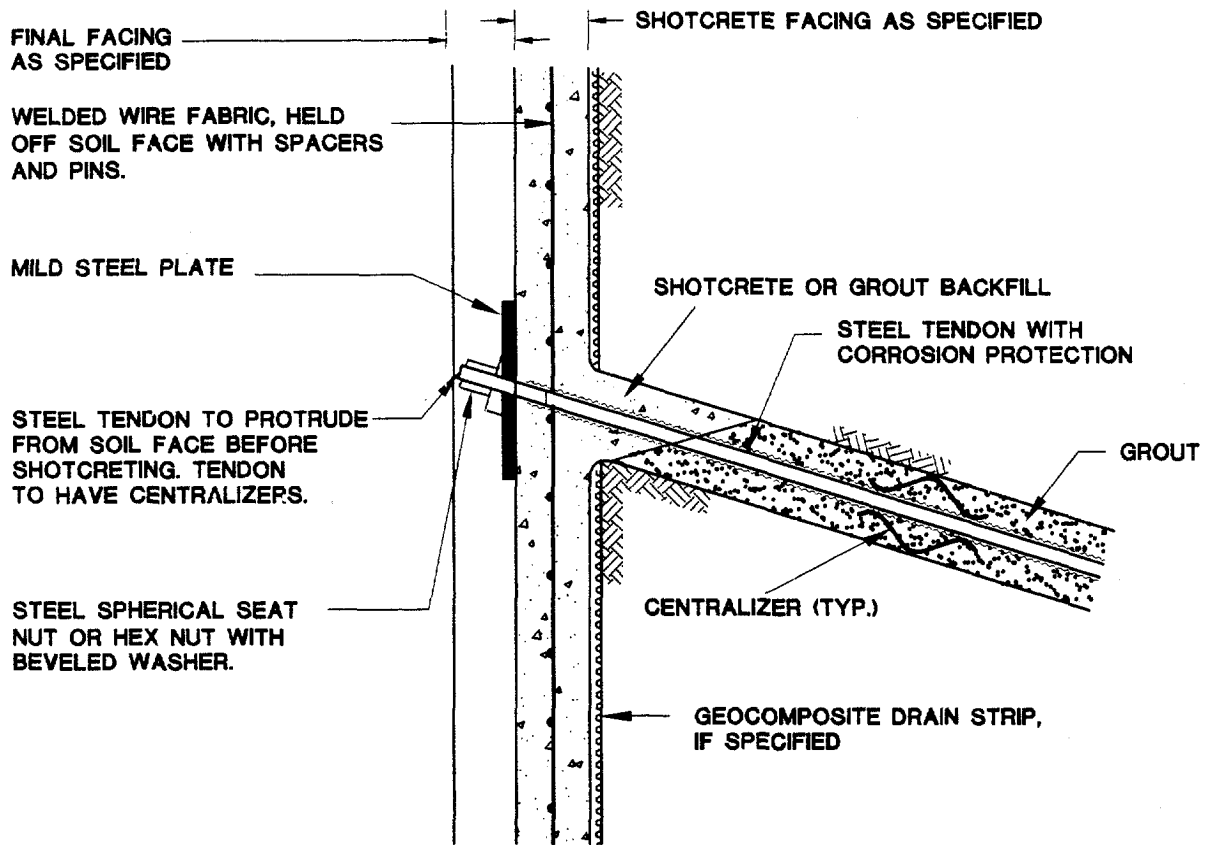

Figure 7A. Typical Temporary Shotcrete Facing Detail.

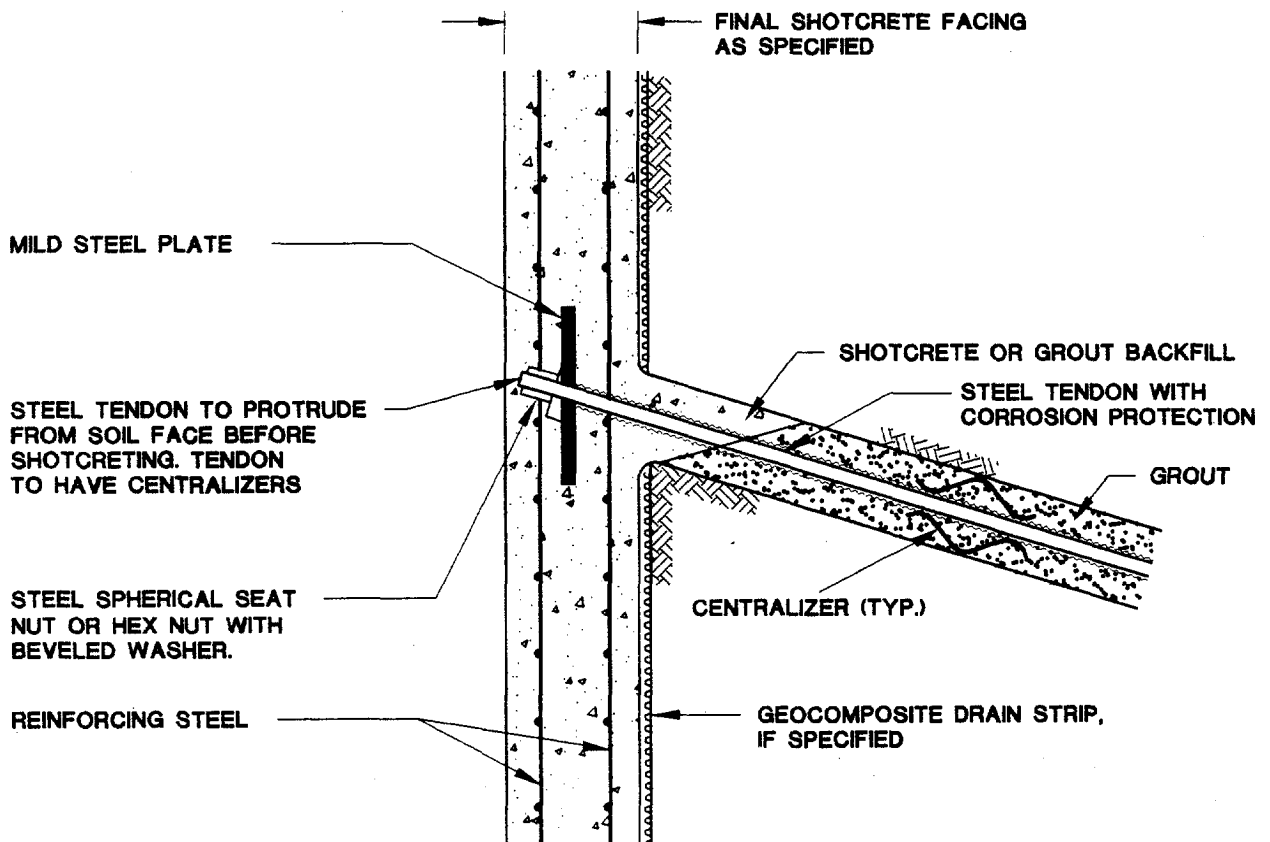

Figure 7B. Typical Permanent Shotcrete Facing Detail.

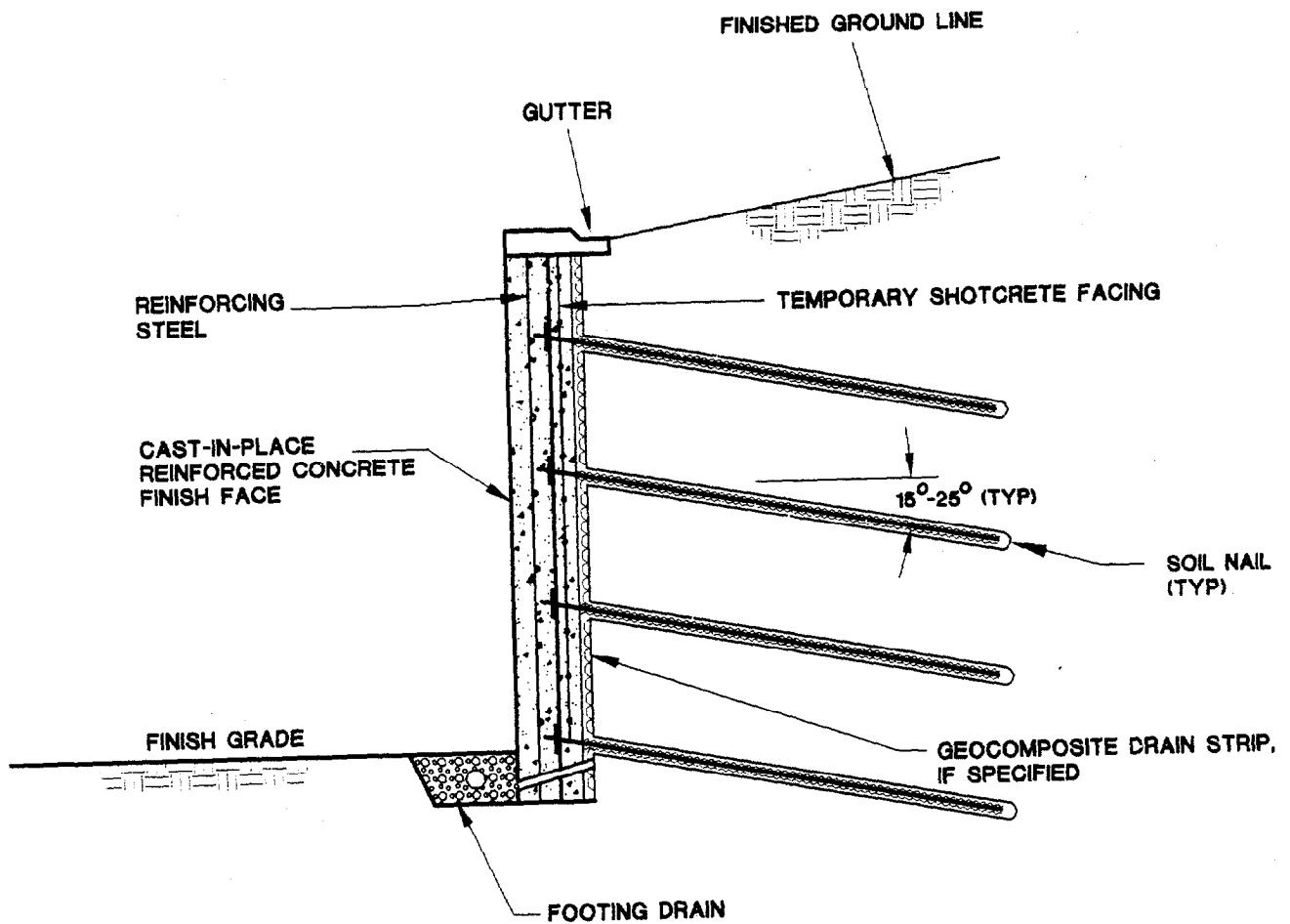

Figure 8. Typical Structural Cast-in-place Reinforced Concrete Facing Over Temporary Shotcrete.

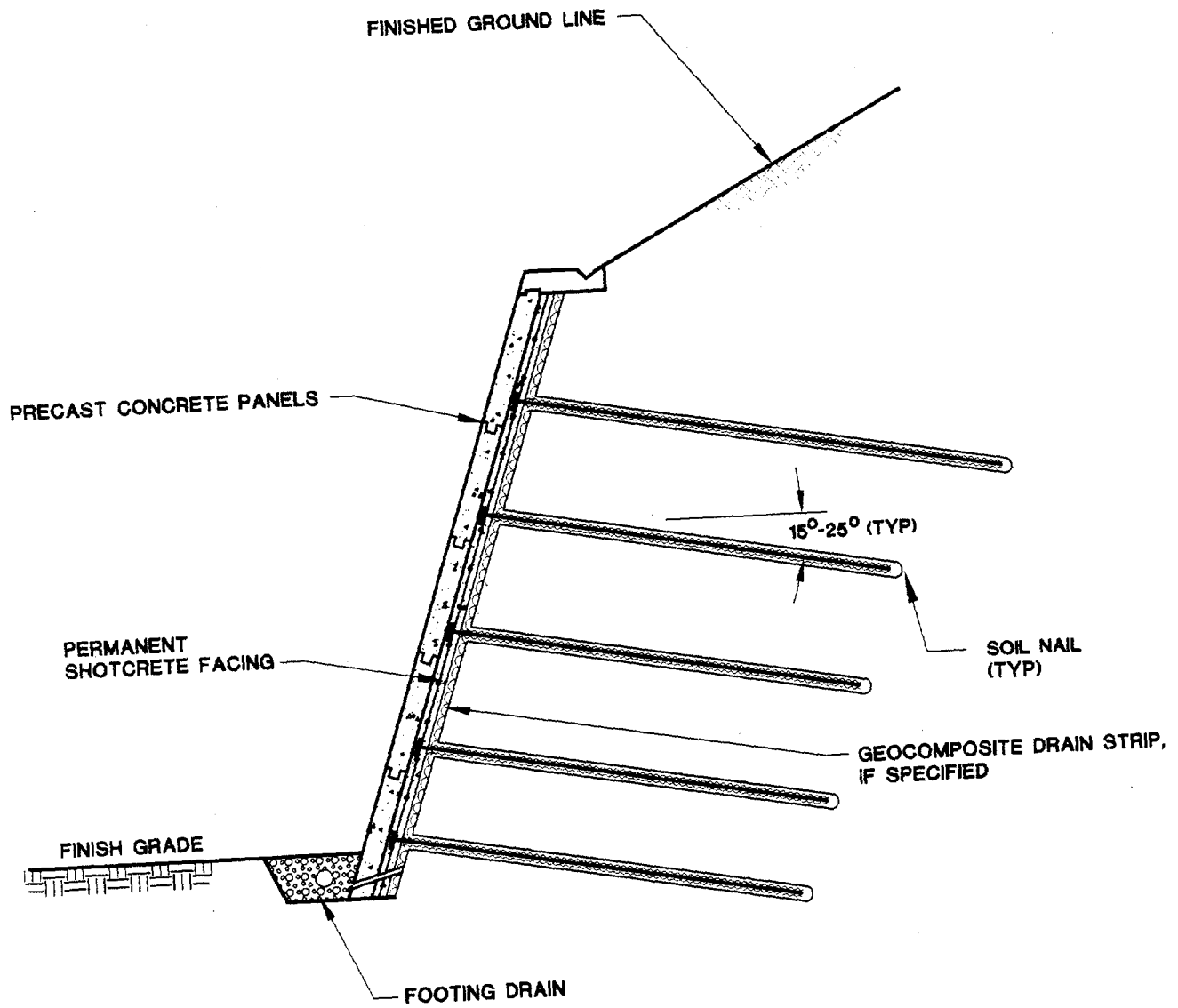

Figure 9. Typical Architectural Precast Concrete Panel Finish Face.

Applications of Soil Nailing

Soil nailing is a cost effective alternative to conventional retaining wall structures when used in **cut** situations in ground suitable for nailing.

Common nail wall applications include the following:

- Temporary and permanent walls for building excavations.
- Cut slope retention for roadway widening and depressed roadways.
- Bridge abutments—addition of traffic lanes by removing end slopes from in front of existing bridge abutments.
- Slope stabilization.
- Repair or reconstruction of existing structures.

Some examples of the above applications are shown in figures 10 and 11 and in photographs P1 to P16.

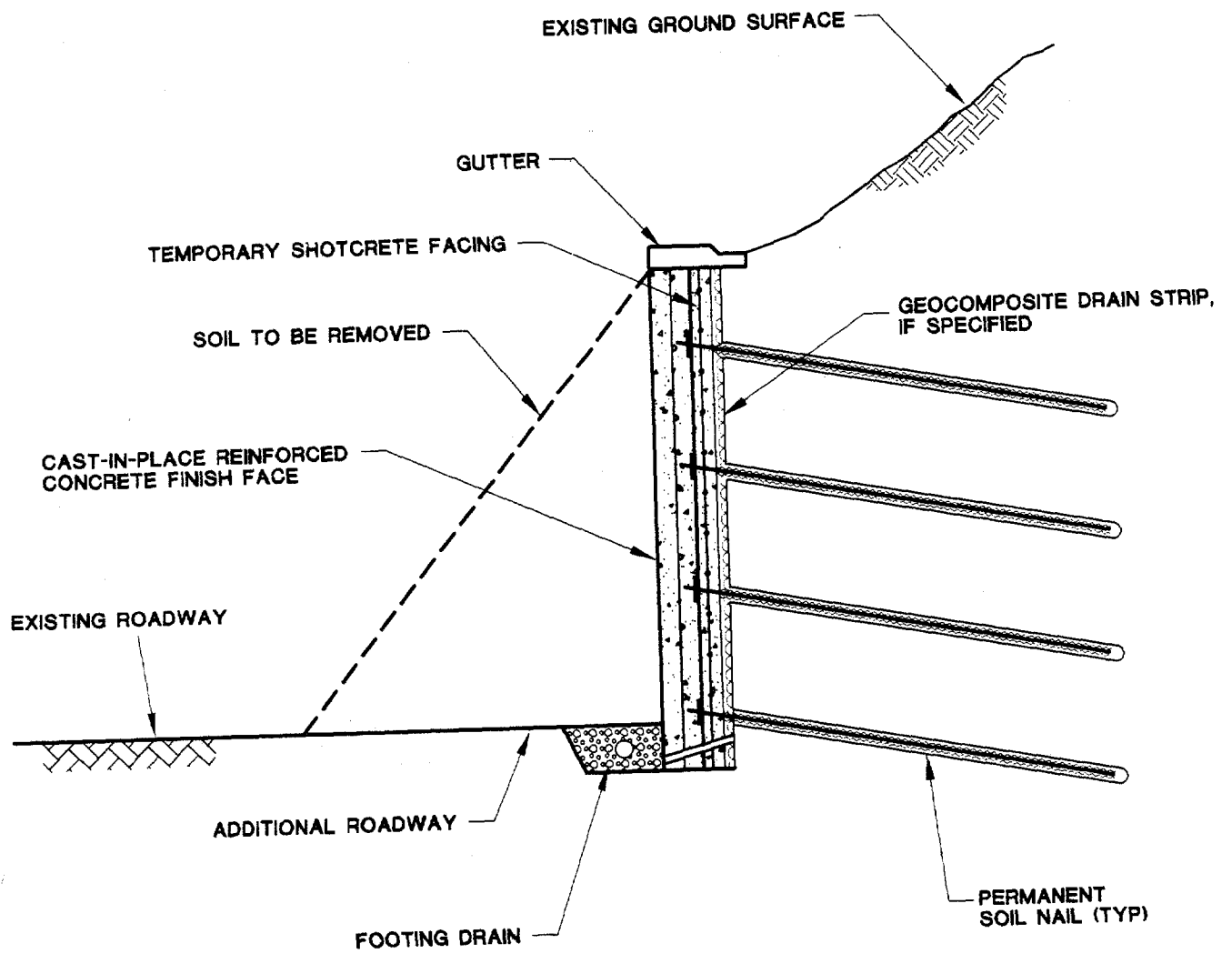

HIGHWAY WIDENING AND TRAFFIC LANE ADDITIONS

Figure 10. Soil Nail Wall Applications.

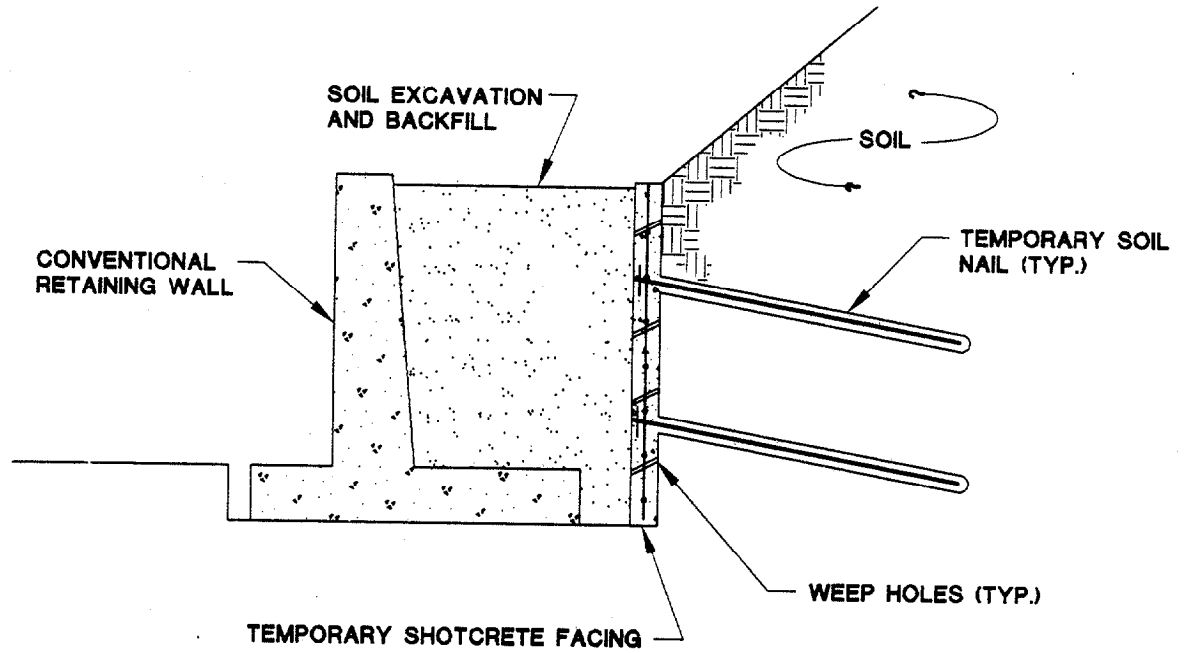

TEMPORARY SHORING

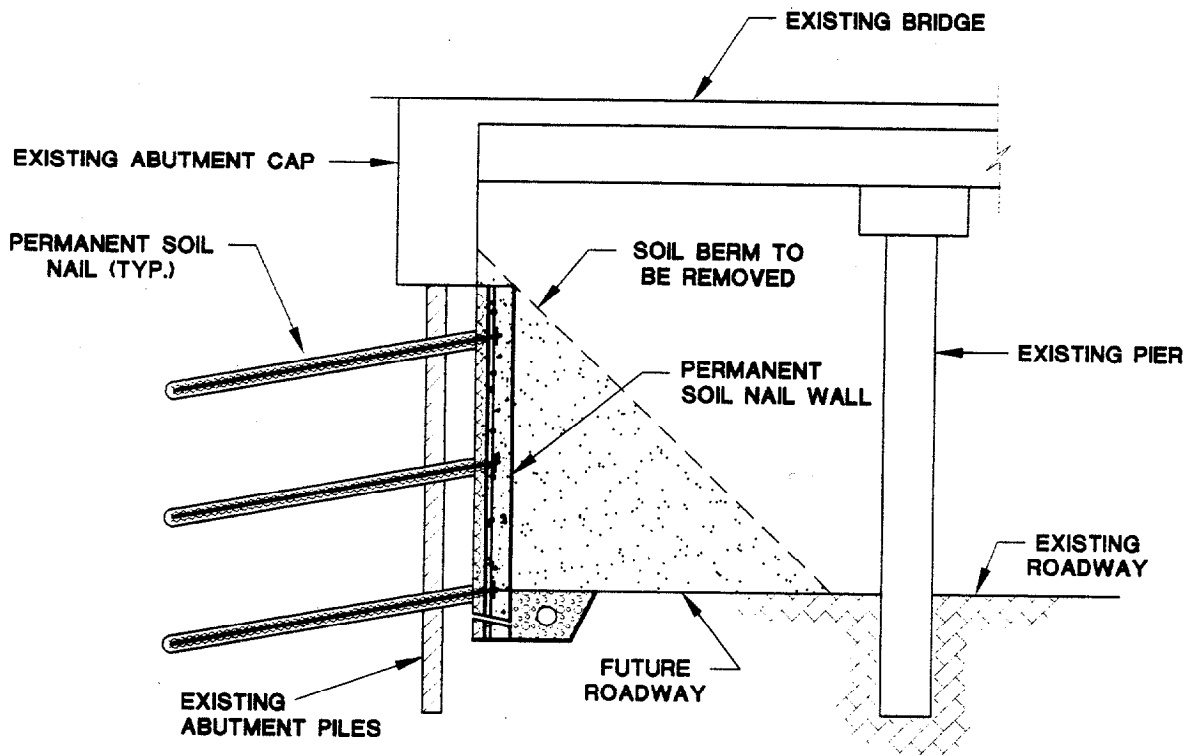

WIDENING UNDER EXISTING BRIDGE

Figure 11. Soil Nail Wall Applications.

P1

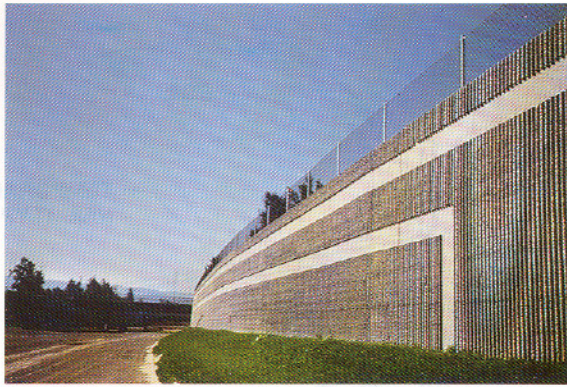

P4



P2

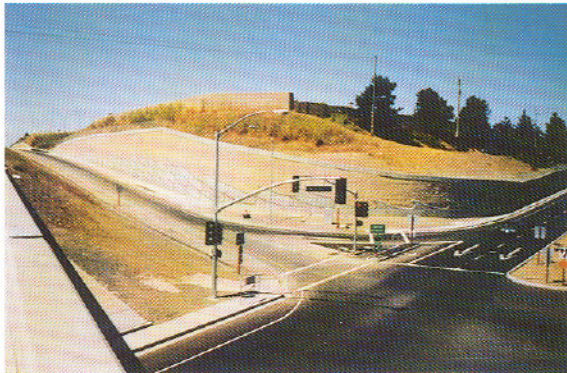

P5



P3

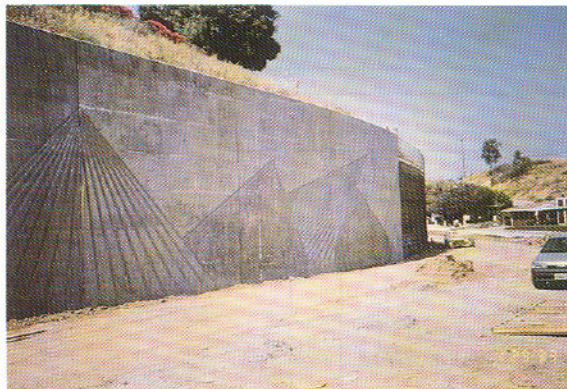

P6

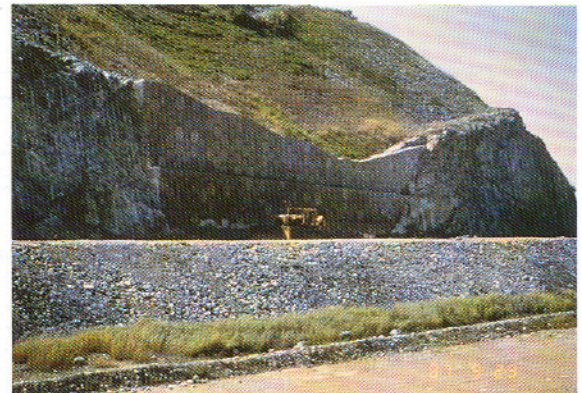

- P1.** Wall with CIP facing and "fractured fin" face treatment placed over temporary shotcrete. New depressed freeway — Route 85, San Jose, CA.
- P2.** Wall with precast panels and masonry block architectural fascia over CIP facing and shotcrete, located next to Aquatic Park. New interchange ramps — Route 37, Vallejo, CA.
- P3.** Wall with CIP facing and "Rope band" face treatment over temporary shotcrete — Tonawanda Drive, San Diego, CA.
- P4.** Lower nail wall with CIP facing supporting upper cantilever wall — I-405, Renton, WA.
- P5.** Two-tier stepped wall with simulated stone masonry CIP facing — Route 89, vicinity of Lake Tahoe, CA.
- P6.** Wall with proprietary modular precast face panels — I-78, Allentown, PA.

Examples of Permanent Soil Nail Walls — Highway Widening.

P7

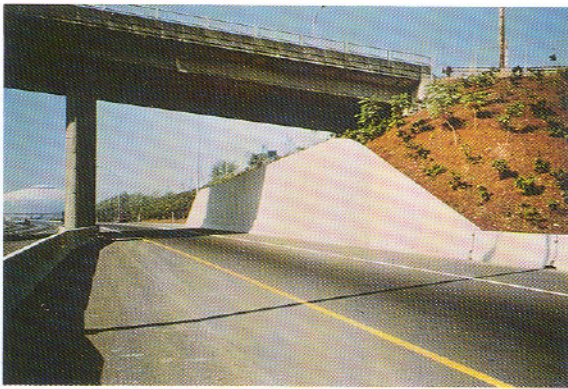

P8

P9

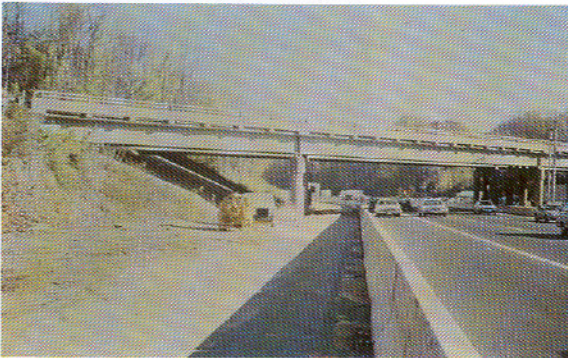

P10

P11



P12

- P7. Permanent shotcrete wall — painted with pigmented sealer. Shotcrete 225 mm (9 inches) thick. Bridge abutment on spread footing — I-5, Tacoma, WA.
- P8. Permanent wall with CIP facing for new "turnaround" lanes. Bridge abutment is on drilled shafts — I-35, Laredo, TX.
- P9, 10. Before and after permanent nail wall — GW Parkway over I-495, Fairfax, VA. Bridge abutments are on spread footings on weathered rock.
- P11, 12. Before and after permanent shotcrete wall painted with pigmented sealer. Shotcrete 200 mm (8 inches) thick. Bridge abutment is on a single row of steel pipe piles — I-5, Swift Delta Interchange, Portland, OR.

Examples of Permanent Soil Nail Walls — Widening Under Existing Bridges.

P13



P14



P15



P16



- P13, 14 & 15.** Replacement of failing old retaining wall. Residential city street—Seattle, WA.
- P13.** Permanent soil nails installed through old wall.
 - P14.** Old wall demolished as new nail wall construction proceeds top-down. Nails plus initial shotcrete support the slope as old wall is removed.
 - P15.** Final hand-finished permanent shotcrete nail wall. Soil nailing allowed installation of new wall without disturbance to homes at top of slope.
 - P16.** Temporary nail shoring wall retains existing bridge end slope to allow excavation for enlarging existing bridge footing for seismic upgrade — I-10/280 Interchange, San Bernadino, CA.

Examples of Soil Nail Walls — Wall Replacement and Temporary Shoring.

PART I. PRECONSTRUCTION PREPARATION

Chapter 2. Contract Documents

Introduction

Three general types of specifications are currently being used for soil nail wall construction: **Performance Specifications, Contractor Design/Build Specifications, and Procedural Specifications.** Each of these specifications assigns different requirements and responsibilities to the owner's inspector and the contractor. The inspector should understand the type of specification being used on the project.

Performance Specifications

When Performance Specifications are used, the responsibilities for the work and the risk are **shared** between the engineer (owner) and the contractor.

The engineer determines the scope of the work, the nail design loads, nail spacings and locations, nail testing procedures, corrosion protection requirements (if any), facing design, and instrumentation and monitoring requirements. The contractor is responsible for the soil nail installation method, soil nail performance, excavation method, and excavation facing construction methods. This contracting method often pre-qualifies the soil nail specialty contractor, based on experience. This is desirable, because the experienced soil nail specialty contractor can best respond to localized changes in ground conditions and to other construction problems. The Performance Specification allows use of both the individual specialty contractor's expertise and his proprietary equipment. Performance Specifications typically result in a better and more economical end product than do strict procedural (prescriptive or method) specifications. **Permanent nail walls are often specified in this manner.**

When a **Performance Specification** is used, on a project **designed by the owner**, the **contract documents** will typically include the following:

1. Provide, or make available, the results of the geotechnical investigation.
2. Specify submittals that the contractor must provide.
3. Specify construction tolerances and minimum soil nail dimensions.
4. Specify required soil nail design loads and design adhesion values.
5. Specify excavation tolerances and sequencing, including the maximum allowable height of excavation lifts.
6. Specify material properties and requirements.
7. Specify the type of corrosion protection required.
8. Specify the type of finish facing required, including dimensions and reinforcing steel requirements.
9. Specify the maximum time duration of finish cut face exposure prior to nail installation and closure with structural shotcrete.
10. Specify the nail testing procedure(s) and acceptance criteria.
11. Establish wall construction monitoring responsibilities and requirements, and
12. Specify the methods of measurement and payment.

The **contractor's** main responsibilities are to:

1. Fulfill the contract submittal requirements.
2. Select the soil nail installation method.
3. Comply with material specifications, construction tolerances, and minimum/maximum dimensions.
4. Obtain and verify the soil nail load carrying capacity and adhesion values used in design.
5. Complete construction excavations in accordance with the specifications.
6. Install wall finish facings in accordance with the contract documents, and
7. Perform the specified tests.

The **inspector's** responsibilities are to:

1. Verify that construction tolerances, construction sequencing, and minimum soil nail requirements have been satisfied.
2. Verify that drilling procedures are not causing excessive ground loss or subsidence.
3. Verify compliance with the specified material properties and requirements.
4. Verify that corrosion protection requirements have been satisfied.
5. Verify that construction excavations are staged in accordance with the specifications.
6. Verify that finish facings are constructed in accordance with the contract documents, and
7. Observe, verify, and record the results of all construction testing.

Contractor Design/Build Specifications

A Contractor Design/Build Specification is very similar to a Performance Specification, except that it makes the Contractor responsible for **both** the design and construction of the soil nail wall. A Contractor Design/Build Specification details the soil nail wall system "end product" and makes the Contractor responsible for the soil nail design and installation method, the soil nail performance, the excavation method, and the excavation facing construction methods. This contracting method establishes the quality level of the work by **requiring prequalification** of the soil nail specialty contractor, based on experience in design and construction. This type of specification allows the use of both the contractor's expertise in design and construction and his proprietary equipment.

When a Contractor Design/Build Specification is used, the contract documents will typically include the following:

1. Provide or make available the results of the geotechnical investigation.
2. Specify submittals which the contractor must provide.
3. Specify safety factors, material properties and requirements.
4. Specify the level of corrosion protection required.
5. Specify the finished face requirements.
6. Specify wall alignment tolerances.
7. Specify the percentage of nails to be tested, testing procedures and acceptance criteria.
8. Establish wall construction monitoring requirements.
9. Specify the methods of measurement and payment.

The **Contractor's** responsibilities are to:

1. Design the wall.
2. Comply with material specifications and wall tolerances.
3. Obtain and verify the soil nail load carrying capacity and adhesion values used in design.
4. Install the soil nails and facing in accordance with the finished face requirements and wall tolerances.

The **Inspector's** responsibilities are to:

1. Verify compliance with the specified material properties and requirements.
2. Verify that corrosion protection requirements have been satisfied.
3. Verify that the wall finish face requirements are met.
4. Verify that wall construction tolerance requirements have been satisfied.
5. Observe, verify, and record the results of all soil nail tests.

Procedural (Method) Specifications

A procedural specification specifies **all** details of design and construction, including the soil nail drilling method, soil nail type and dimensions, corrosion protection system, soil nail installation method, excavation procedures, and finish wall construction methods. Procedural specifications are also referred to as "prescriptive" or "closed" specifications. The responsibility of the contractor is to submit material certifications and build the soil nail system in strict accordance with the plans and specifications.

When a procedural specification is used, the **owner** (and therefore the inspector), is **fully responsible** for the design and performance of the soil nail system, as long as the contractor has installed the nails in accordance with the specification requirements. Furthermore, the inspector and other personnel involved in the administration of the contract are responsible for **directing** the contractor's work if changes are required. The owner assumes all the risk. Procedural specifications do not usually ensure a better job. Rather, they allow bidding by contractors not experienced with nail shoring wall work. Use of procedural specifications means that the potential for costly change orders is great.

The procedural specification method is not generally recommended for contracting soil nail systems.

PART I. PRECONSTRUCTION PREPARATION

Chapter 3. Know Your Design

Introduction

The inspector should have a basic understanding of the soil nail wall design prior to construction. This understanding should include a working knowledge of:

- The contract type (i.e., performance specification, contractor design/build, or procedural specification). (See chapter 2)
- The intended application of the soil nailing system (i.e., permanent versus temporary construction). (See chapter 1)
- The geometry of the soil nails and wall facing. (See this chapter.)
- The subsurface conditions for which the soil nails were designed (i.e., what soil/rock and groundwater conditions are anticipated). (See this chapter.)
- The planned construction sequence and its expected effects on the soil nail wall system. (See this chapter.)
- The anticipated "stand-up" time for excavation faces. (See this chapter.)

Understanding the soil nail wall design will aid the inspector in performing his/her duties, and in recognizing and dealing with changes in subsurface conditions and with any contractual problems that may develop during construction. **A pre-construction meeting of the wall designer, the site inspector, and the contractor's superintendent is strongly encouraged.**

Geometry of the Soil Nail and Soil Nail Wall System

The inspector should be familiar with the construction dimensions, geometry, and specified tolerances of the soil nail system.

Usually, some sort of system for identifying each soil nail will be included in the plans. If such a system is lacking, the inspector should develop one. In the event the inspector has to develop his/her own identification system, this should be done on the nail layout **on the plans** and **not** on a separate worksheet. It is particularly important that the descriptions of the locations of the test nails relate directly to the information on the contract plans. This is necessary so that when communicating with others, (particularly the designer), and especially when communicating by phone, all parties know the location of the test nail in relation to the nearest test borings. In the absence of a specific identification number (I.D. No.) on the plans, references to specific wall stations and elevations are appropriate for describing the production and test nail locations.

Additional items that should be noted include:

- Any variance between the **actual** ground surface elevations along the wall line and those shown on the plans. **This check should be made well in advance of the wall contractor mobilizing to the site.** Any deviations should be brought to the immediate attention of the project engineer and designer so that the wall can be redesigned (if necessary) **prior** to the wall contractor starting construction. This action will help prevent a subsequent claim dispute and/or construction delay.

- Any slope above the wall that should be cut to grade **prior** to excavation.
- Right-of-way limitations. Normally, soil nails will not be allowed to extend beyond the right-of-way unless there is a construction or permanent easement.
- Location of all utilities or other known obstructions in the ground that could affect or be affected by soil nail construction.
- Horizontal and vertical spacing of soil nails.
- The maximum allowable height of each staged lift of excavation.
- Any limits placed on the mass excavation adjacent to the wall excavation.
- The maximum time allowed for shotcrete closure of finish wall line excavations.
- Minimum soil nail length; minimum drillhole diameter; hole inclination; corrosion protection requirements; tendon steel grade and diameter; and required grout cover.

Soil/Rock and Groundwater Conditions

Before construction begins, the inspector should review the **project geotechnical report** and, if possible, discuss the anticipated ground conditions with the geotechnical designer. The following specific items should be noted:

- The soil/rock types expected to be encountered during construction. For example: cohesive (clay) soils versus cohesionless (sand) soils; fractured versus massive soil/rock structure; nail soil-grout adhesion values specified or anticipated, etc.
- Expected stand-up time for the anticipated soil/rock types.
- Expected groundwater conditions.
- The boring logs and subsurface profile developed from the geotechnical investigation.
- Construction considerations outlined in the geotechnical report or deemed most important by the designer in relation to soil nail installation and retaining wall construction.

Especially noteworthy are any special conditions unique to the site that might affect soil nail construction. Examples of such conditions follow:

- Variable groundwater elevation in the soil profile.
- Visual evidence of landslide or slope stability problems.
- Presence of distinctly different ground conditions at the site (i.e., clays versus sands versus cobbles and boulders, versus weathered or unweathered rock).
- Potential for caving or sloughing of soils.
- Possible presence of obstructions such as buried structures, piles, or utilities that could hinder soil nail installation.
- Structures close to the excavation that could be damaged by any excavation-related ground movement.
- Zones of weak or loose soils. This includes surficial fills that may be in a loose condition.
- Swelling (expansive) or frost-susceptible soils.

With this information in mind, the inspector will know what to expect, and can verify the geotechnical design conditions in the early stages of construction. **The stability of the soil nail wall could be jeopardized by site conditions that vary substantially from those assumed during design. The design engineer should be contacted as soon as possible if unexpected ground conditions are encountered.** In addition, verifying the assumed geotechnical design

conditions and identifying and documenting differing site conditions will assist in resolution of related disputes.

Construction Sequencing

Construction sequencing is especially important in soil nail wall construction. Soil nail wall systems are designed so that the excavation must proceed in staged lifts, with each lift defined by a single row of nails. Specifications for permanent soil nail walls typically require that each lift (including nail installation, shotcrete facing, and test acceptance) be completed prior to excavation and installation of an underlying row of soil nails. The specified excavation procedures and limitations presented in the contract documents must be adhered to at all times. **Failure to enforce these provisions could result in intolerable deformations of the wall under construction and possible failure or structural damage of the wall or existing adjacent structures located behind the wall.**

PART I. PRECONSTRUCTION PREPARATION

Chapter 4. Corrosion Protection Considerations

Introduction

Longterm performance of soil nails depends on their ability to withstand corrosive attack from the environment. Corrosion protection is an integral and extremely important aspect of soil nail construction/inspection.

The common methods of soil nail corrosion protection include encapsulation, epoxy coating, grout protection, or some combination of these measures. Each of these measures results in **isolating** the tendon from the corrosive environment to varying degrees. The degree and type of corrosion protection required will be noted in the plans and specifications. **It should be emphasized that soil nail corrosion protection requirements are carefully considered during design, and that substitution of less effective corrosion protection should not be allowed without engineering approval.**

Encapsulated Corrosion Protection

"Encapsulated" corrosion protection most commonly consists of encasing the tendon in a grout filled corrugated PVC (poly-vinyl chloride) or HDPE (high density polyethylene) tube. The annular space between the tendon and the corrugated tube, commonly specified as a minimum of 5 mm (0.2 inches), is filled with neat cement grout. Internal spacers are used to achieve the specified grout cover inside the encapsulation. Encapsulated corrosion protection is often referred to as "**double**" corrosion protection. Specifications most commonly require the encapsulation to be fabricated by the tendon supplier **at the factory**, where better quality control can be achieved, prior to shipment to the job site.

Epoxy Corrosion Protection

Epoxy corrosion protection consists of a fusion-bonded epoxy coating applied to the tendon prior to shipment to the construction site. The minimum required thickness of epoxy coatings will typically be specified in the contract documents. A minimum thickness of 0.3 mm (12 mils or 0.012 inch) is common. Bearing plates and nuts that will be encased in a structural wall facing will be protected by the concrete cover, and typically are not epoxy coated.

Grout Corrosion Protection

In this application, the Portland Cement grout surrounding the nail tendon within the drillhole is relied upon to provide the necessary corrosion protection. This is usually acceptable only for short-term temporary applications in non-aggressive ground.

P17



P20

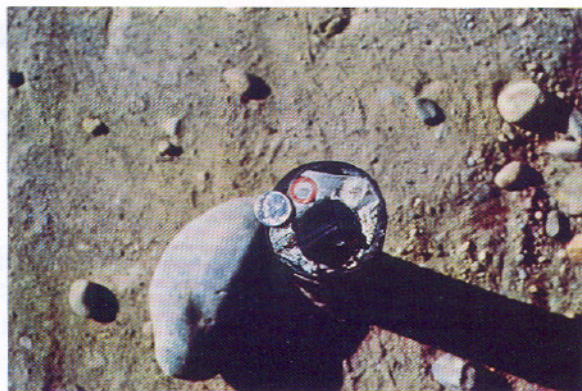

P18



P21



P19



(Note: Photos P17, P18, and P19 illustrate **good** practice. Photos P20 and P21 illustrate **poor** practice.)

- P17.** Encapsulated corrosion protection. Note corrugated PVC tube. PVC centralizers are not shown, but would be placed on corrugated sheath prior to inserting nail into drillhole.
- P18.** Epoxy corrosion protection. Note epoxy coated tendon and PVC centralizers. Note good centralizer design and fastening to tendon — allowing unobstructed grout flow around centralizers.
- P19.** Properly stored epoxy corrosion protected tendons. Also note the additional 1 m (3 foot) long encapsulation at the top of nail. This is to provide extra corrosion protection vicinity of the nail/wall facing connection (Caltrans detail).
- P20.** Improperly centered tendon inside field fabricated encapsulation. Factory fabrication recommended for better quality control.
- P21.** Excessive use of duct tape to fasten centralizer to tendon. This will obstruct grout flow.

Nail Corrosion Protection.

PART II. CONSTRUCTION INSPECTION

Chapter 1. Field Quality Control of Materials

Introduction

Quality control of construction materials is necessary to obtain a final product consistent with the contract specifications.

Materials Control on the Project

The quality of all materials used on the job is controlled by one or a combination of the following procedures:

- Visual examination on the job for defects in workmanship, contamination, or damage from handling.
- Certification by the manufacturer or supplier that the materials comply with the specification requirements.
- Laboratory testing of representative samples from materials actually delivered to the job, or set aside for shipment.

The last procedure requires that appropriate samples be obtained in accordance with the contract specifications. Also, once he/she has accepted the sampled materials, the inspector is responsible for ensuring that additional materials delivered to the site are consistent with the materials that were sampled. All materials delivered to the site should be visually examined. Any damaged or defective materials should be rejected immediately.

The steel components (which include the soil nail tendons, bearing plates, nuts, washers and facing reinforcing steel) and the centralizers and drainage materials are usually accepted on the basis of satisfactory Mill Test Certificates. The properties of the steel listed on the test certificates should be checked for conformance to the specifications. The inspector should also verify that the nail tendon centralizers have been fabricated with the specified material and are of the correct diameter. Geocomposite drainage materials and drainage piping are usually accepted based on the manufacturers' certification and product labelling.

Soil nail grout and facing shotcrete typically are accepted on the basis of engineer approval of the mix designs. Additives, such as retarders, accelerators, reinforcing fibers, or air entraining agents, must be pre-approved. Compressive strength tests will usually be specified to further ascertain acceptability of materials at the job site. In addition, the shotcrete nozzleman may be required to complete test panels prior to his/her being approved for site work.

Field Handling and Storage of Soil Nail Tendons

Soil nail tendons should be handled and stored in a manner that prevents damage or corrosion. The inspector should verify contractor care in unloading and storing the nail tendons.

Storage should be as recommended by the manufacturer, away from construction traffic, and in a protected location. Epoxy coated or encapsulated (double) corrosion protected tendons must be stacked with care to prevent damage to the epoxy coating or corrugated encapsulation.

Inspection of Corrosion Protection

Usually, corrosion protected tendons (encapsulated or epoxy coated) will be delivered to the site completely assembled. Upon delivery of the tendons, the corrosion protection should be checked for compliance with the contract specifications. In addition, it is recommended practice to check a representative number of encapsulated tendons for voids in the grout fill placed in the annular space between the tendon and the corrugated tube. This check can be accomplished by lightly tapping the encapsulation with a steel rod and listening for hollow sounds that indicate voiding. Suspected voids should be exposed to assess their seriousness. Additionally, the exterior of epoxy coatings or corrugated encapsulation should be visually examined for damage, both upon delivery and prior to insertion into the soil nail drillhole. **Bare spots cannot be tolerated, as even the smallest pinholes in corrosion protection coatings can result in severe corrosion in the presence of aggressive ground conditions.** A light amount of rust on uncoated tendons is normal and will not affect their function. Pitting of uncoated tendons is cause for rejection, and the inspector should have the ability to distinguish between surface rust and pitting. Damage like abrasion, kinks, welds and weld splatters, cuts, and nicks will impair the proper performance of the tendon and is cause for rejection. **Damaged or improperly constructed corrosion protection is unacceptable.** Inadequate corrosion protection should either be satisfactorily repaired, or rejected and removed from the site. All field repairs to corrosion protection should be completed in accordance with the appropriate manufacturer's recommendations.

Storage of Cement

Cement to be used in grout should be kept dry and stored away from construction traffic and in a protected location. Cement that has become caked or lumpy should not be used. Aggregates used for on-site batching should be stored in a way that prevents segregation or the inclusion of foreign materials.

Storage of Reinforcing Steel

Reinforcing steel should be carefully handled, and should be stored in a protected location on supports that will protect the steel from contact with the ground. Heavy corrosion or pitting of the steel should be cause for rejection by the inspector. Light rust, that has not resulted in pitting, is acceptable.

Storage of Drainage Materials

Geocomposite drainage materials should be provided in rolls wrapped with a protective covering and stored in a manner that protects the fabric from dirt, debris, and shotcrete rebound. Extended exposure to direct sunlight (ultra-violet light) should be avoided.

Field Quality Control of Materials Checklist

- For steel components, centralizers, and drainage materials, obtain samples for testing (when specified) and check all Mill Test Certificates for compliance with the specifications.
- Visually check all soil nail tendons and reinforcing steel for damage and defects upon delivery and prior to use.
- Visually check epoxy coated or encapsulated tendons for compliance with the specifications and for any damage to the corrosion protection.
- Confirm mix design compliance of soil nail grout and facing shotcrete.
- When specified, take grout (cubes) and/or shotcrete samples (test panels and cores) for testing.
- Verify compliance of geocomposite drainage materials with the contract plans/specifications.
- Verify adequacy of field storage of construction materials to prevent damage or degradation.

PART II. CONSTRUCTION INSPECTION

Chapter 2. Construction Monitoring

Introduction

Quality Assurance/Quality Control (QA/QC) monitoring includes verifying that: 1) construction is being performed in accordance with plans and specifications; 2) admissible excavation heights are not exceeded; 3) boreholes have not caved; 4) nail tendons are of the right size and composition; 5) corrosion protection systems are in compliance; 6) grouting, installation of rebar and mesh, and shotcrete are in compliance; and 7) nail pullout testing meets specifications. Normally, grout cubes and shotcrete cores are taken for strength testing of permanent walls. An essential part of the QA/QC process is monitoring of the material being excavated and drilled. The resulting information will assist in making design modifications should the material prove different from that on which the design was based.

Soil nail retaining walls typically are constructed in staged lifts using "top-down" construction with each lift completed to closure (i.e., with nail testing and shotcrete facing completed) prior to excavation of underlying lifts. Typically, the sequencing for each lift will consist of excavation to finish wall, nail installation, and facing closure. It is the inspector's overall responsibility to ensure that all construction and testing for each lift has been completed in accordance with the contract specifications and drawings.

If a performance or design/build specification is used, it is the contractor's responsibility to select a soil nail installation method that will develop the required soil nail design adhesion capacity. **However, since only a percentage of the nails will be tested (unlike tieback walls where every tieback is tested), it is very important that consistent and similar construction methods be used for all soil nails. Therefore, the inspector must accurately observe and document the installation conditions and methods of each soil nail.**

Soil/rock and groundwater conditions encountered during drilling should be recorded for each soil nail on the Soil Nail Installation Form presented in appendix A. Soil nail installation conditions should be summarized on the Soil Nail Installation Summary Form presented in appendix A. Examples of completed forms are presented in appendix B. Reference 3 is recommended as an aid in identifying soil types.

Ultimate or verification tests may be part of a performance specification. These tests, which are discussed in greater detail in the next chapter, are used to **verify** that the contractor's drilling and installation method(s) will produce a soil nail that will develop the adhesion capacity necessary to safely carry the design load.

Proof testing will generally be specified for a certain number (typically up to 5 percent) of production soil nails. During construction of production nails, the inspector should note any changes in the ground type, or methods, equipment, or drill operators from those previously used to construct successful verification or ultimate test nails. A change in ground type, methods, equipment, or operators may warrant additional ultimate or verification tests.

The inspector should make daily inspections of the area adjacent to the soil nail retaining wall construction. Special attention should be given to the geometry and structural condition of adjacent structures, such as concrete curbs, asphalt pavement, bridge abutments, etc.. Typically, the connections between the top of the nail wall and the adjacent structures will open or separate slightly as the excavation proceeds, due to normal deformation of the ground toward the excavation. **If the separations enlarge excessively, or rapidly increase in size, adverse wall deformations are indicated, and the design engineer and contractor must be immediately apprised of the situation.**

Quite often, tension cracks will form in the ground surface located immediately behind the top of the nail wall excavation. These cracks should be monitored, and the contractor and design engineer contacted, if displacements become excessive, or rapidly increase in size. Typically, surface tension cracks will either be hairline or open to a maximum of approximately 2 to 3 mm (1/16 to 1/8-inch) for low height walls, say less than 6 m (20 feet). Larger tension cracks may be observed in taller walls. Water should not be allowed to enter tension cracks.

Reconnaissance of the area behind the top of the retaining wall will also provide an assessment of surface water runoff/drainage conditions and erosion potential. **Surface drainage above the wall should be controlled and routed away from the wall, and erosion potential eliminated, prior to initiation of the excavation.** Remediation of adverse surface water runoff and/or erosion problems is difficult to implement once the excavation has been started.

On some projects, construction monitoring devices and instrumentation, such as slope inclinometers, surface survey points, load cells, or strain gauge installations, may be required. If so, these requirements will usually be covered in the plans and specifications.

Excavation

The two types of excavation that generally occur during construction of a soil nail wall are: 1) mass or general excavations conducted to provide equipment access and general site grading, and; 2) excavations required for construction of the soil nail wall, i.e., excavation to the plan finish wall line ("neat line"). Occasionally, use of a stabilizing or buffer berm, during nail installation, subsequently followed by excavation to finish wall line, will be required to maintain excavation face stability. This method is discussed in chapters 6 and 7. During mass or general excavation, the inspector must verify that the excavation does not encroach upon the partially completed soil nail wall to the extent that the stability of the wall is adversely affected.

The contractor is responsible for completing the excavation to neat line and grade, and the inspector should verify compliance. Deviations from the specifications should be brought to the attention of the contractor, and remediation completed prior to placement of the finish facing. Conditions such as overbreaks, or sloughing of the cut face, as well as the protrusion of cobbles or boulders beyond the line of the cut face, must be addressed by the contractor. Limited overbreaks can typically be backfilled with shotcrete, placed at the same time as facing shotcrete. It is recommended that acceptable methods for handling excavation overbreak problems be determined prior to actual construction, preferably during the preconstruction meeting.

The inspector should ascertain that open finish wall excavations are limited to the size that can be closed with shotcrete facing within the time restraints specified in the contract documents, and

consistent with the observed stand-up time of the soil/rock. Finish excavation cut face exposures that will not receive shotcrete facing within the specified time limit must be stabilized by berming soil back up against the exposed face, placing a temporary shotcrete flashcoat, or other approved acceptable method.

On occasion, groundwater may be encountered during excavation to the neat line. A discussion of groundwater implications and control is presented in chapters 6 and 7.

Soil Nail Hole Drilling

The soil nail drillholes should be located as shown on the plans. The drill normally will be oriented perpendicular to the wall face, and the drill steel should be inclined downward at an angle of inclination within the allowable tolerances noted on the plans. Generally, the angle of the drill mast, (as measured with a magnetic angle tool), is used to check the angle of the drillhole. Allowable inclination tolerances of ± 3 degrees are common. At locations where, to avoid obstructions, the nail drillhole has to be angled differently than the orientation shown on the plans, the wall designer should be contacted immediately to determine if any design changes are necessary. The specified minimum diameter and length should be verified for each nail drillhole.

Drill Rigs

Most soil nails are installed using small hydraulic, track-mounted drill rigs. These rigs are mostly of the rotary/percussive type that use section augers or drill rods. The rigs can work off benches as narrow as 5 m (17 feet), but are more productive if benches are 7 m (25 feet) wide, or more.

The rigs are generally operated by one operator and one or two tenders. The number of tenders used is based on the weight of the augers or drill rods, and the location and orientation of the holes.

For deeper soil nail excavations that require longer nail lengths, larger hydraulic-powered track-mounted rigs with continuous flight augers may be used. These rigs have the advantage that they can drill the entire length of the nail drillhole in a single pass without having to add sectional augers. Their main disadvantages are that they have a large mobilization cost, and require a much wider work bench than the smaller, more common drill rigs.

Drill Methods

The method of drilling selected by the specialty contractor will depend on the site and ground conditions and owned drill equipment, but is most frequently **open hole** drilling. Open hole drilling is used to install about 80 to 90 percent of all soil nails. Augering is the method most commonly used to construct open holes, with diameters generally ranging from 100mm to 300mm (4 to 12 inches). The most common grouting method used with open hole drilling is the low pressure tremie method.

Another less common open hole drilling method is the rotary-percussive method, which displaces soil by drilling and driving drill rods.

Drillholes in soil should not be allowed to remain open for longer than the time stated in the specifications (if specified), unless approved otherwise by the design engineer. The longer the hole is left open, the greater the risk of caving or destressing of the soil.

A mirror or high intensity light should be used, just prior to tendon installation, to inspect the hole for cleanliness. A practical point is that use of a mirror to inspect drillholes only works well on bright sunny days. A high intensity light (minimum 500,000 to 1,000,000 candlepower) works well anytime, and is the recommended inspection tool. Excessive slough should be removed, either by re-drilling of the hole, or by cleaning with a tool, if feasible. An alternative drilling method should be proposed by the specialty contractor, if sufficient slough cannot be removed.

Cased hole methods of drilling may be required in more difficult ground (i.e. ground with caving drillholes), and are used to install only an estimated 10 to 20 percent of drilled-in soil nails. This more expensive drilling method increases the cost of soil nail walls significantly, to the point where alternative wall construction methods may be more economical.

Cased hole methods of drilling include the single tube rotary method, which involves drilling with a single tube (drill string) and flushing the cuttings outside the tube with air, water (provided the soils are not moisture sensitive, i.e. silty or clayey), or a combination of water and air. The "duplex" rotary method is another cased hole method sometimes used, and is similar to the single tube rotary method, except that it uses both an inner and outer casing, which allows drill cuttings to be removed through the annular space between the inner and outer casing. Duplex rotary methods can also include use of casing, with an inner drill stem of rods driving a rotary cutting bit. Cased drill hole sizes are generally 90 mm to 150 mm (3.5 to 6.0 inch) in diameter. Hollow-stem augers, with grout pumped through the auger stem as the auger is withdrawn, is another cased method (often referred to as "auger-cast").

Tendon Installation

Prior to installation, the inspector should check each tendon to ensure that the tendon length, diameter, steel grade, centralizers, and corrosion protection (if required) are in accordance with the plans and specifications. The tendon must be inserted into the hole to the minimum specified length. The inability to do so indicates an unacceptable condition caused by caving/sloughing of the hole and/or insufficient drilled length.

Tendons must be handled carefully to avoid damage. Single point lifting should only be allowed for short tendons that do not bend when handled in this manner. The tendon should be picked up in a way that will not cause damage to either the tendon or the corrosion protection. Longer soil nail tendons should be picked up at two or three equally spaced points.

The inspector should ensure that centralizers (when required) are used to approximately center and fix the tendon in the hole. The centralizers should be stiff, and large enough to provide space for the minimum specified grout cover. Centralizers should be spaced closely enough to each other to keep the tendon from sagging and touching the bottom of the hole, but should not impede the free flow of tremied grout up the hole. **Openings between the centralizer support arms should not be obstructed by materials used to secure the centralizer to the tendon,**

e.g., by excessive use of duct tape (see photo P21). A minimum centralizer spacing distance will usually be specified.

When hollow-stem ("auger-cast"), or other cased methods are used, centralizers may not be required, if stiffer grout with a slump no greater than 200 mm (8 inches) is used. If this point is not covered in the specifications, the inspector should discuss it with the designer.

The inspector should verify that the total specified length of the nail tendon has been inserted into the drillhole. After the tendon has been inserted into the drillhole, the inspector should measure the protruding distance to ensure that the specified length has been achieved. If not, the tendon should be withdrawn and the hole cleaned or redrilled. **Never allow the tendon to be driven or pushed beyond the drilled length, or cut off. Either of these actions would result in an unacceptable installation.**

Grouting

To minimize the chances of hole caving, open hole tremie grouting should take place as soon as practical after drilling and tendon insertion. If grouting takes place prior to tendon insertion, the tendon should be inserted immediately following grout placement.

Grout should be injected by tremie pipe inserted to the **bottom** of the drillhole, so that the grout evenly and completely fills the hole from the bottom to the surface, and without air voids. The grout should flow continuously as the tremie pipe is withdrawn. The withdrawal rate should be controlled to ensure that the end of the tremie pipe is always **below** the grout surface.

The inspector should record the number of grout pump strokes, and calculate the actual volume of grout placed as follows: Grout Volume equals number of pump strokes times the grout volume pumped per stroke (information typically supplied by the pump manufacturer). Alternatively, the grout volume per hole is estimated by dividing the number of holes filled per total cubic meters (cubic yards) of grout batched and pumped. The estimated hole volume is computed using this formula:

$$\text{Hole Volume} = \pi \frac{D^2}{4} \times \text{grouted length of drillhole} \quad (\pi = 3.14, D = \text{drillhole diameter}).$$

The grout take is expressed as the volume of grout actually placed in the drillhole, divided by the estimated hole volume.

When hollow stem auger methods are used, the contractor should not be allowed to reverse the auger rotation during extraction. This action forces soil to mix with the grout, thus reducing grout strength. The contractor may, however, make one or more quick reversals of the auger with the auger head still at the bottom of the hole, to release the nail tendon from the auger, prior to extracting the auger.

Test nails require partial grouting of the nail drillhole in order to develop **bonded** and **unbonded** test lengths. The contractor is responsible for placing the grout to the specified test lengths, and the inspector should verify compliance. Typical methods for establishing the top of the test bonded length include placing a painted centralizer or piece of survey ribbon onto the tendon, at the desired point of grout termination (top of bonded zone), prior to insertion into the drillhole.

A high intensity light can be used to aid in observing the grout placement. If auger-cast or other cased methods are used, the bonded length can be estimated during grouting by measuring the volume of grout placed, and can later be verified by measuring the unbonded length, using a rigid tape or a piece of measured rigid tremie pipe or reinforcing steel. As an alternative, the grout can be placed to the full length of the hole, and the unbonded length can either be flushed out before the grout has set, using water delivered via a garden hose or tremie pipe, or drilled out after the grout has set. Care should be exercised not to overflush and remove grout from the **bonded** zone. The specified unbonded length should be verified and remeasured, using a rigid tape, or a piece of measured rigid tremie pipe or reinforcing steel, prior to testing. **Subsequent to testing and acceptance of the results, the unbonded length of all test nails must be filled with grout. Voids should not be left in the ground.**

Structural Wall Facing and Drainage

Once the final wall line excavation and nail installation have been completed, the geocomposite drain strips and reinforcing steel are installed, and shotcrete is applied to the lines and grades specified in the contract documents. When required by site conditions (e.g., poor cut face stand-up time), the shotcrete facing may be placed before nails are drilled and installed (if proposed by the contractor and approved by the engineer). If this approach is taken, the wall designer must approve the contractor's proposed details for drilling through the shotcrete facing (e.g., blockouts, resteel, sleeve over nail through shotcrete, etc.).

Generally, the geocomposite drain strips are placed vertically, at specified intervals. Some designs may also specify drainage strips placed horizontally at each shotcrete construction joint. Typical installation geometry for the geocomposite drain strips and example weep hole drain outlet and toe drain details are shown in figure 12. Drain strips must be continuous from the top to the bottom of the wall. Splices should be made with a minimum 300 mm (12-inch) overlap (or per specification or manufacturer's recommendations) to assure that water flow is not impeded. **Maintenance of drainage continuity and capacity is critical to the overall stability of the system and must not be jeopardized.**

Conventional shotcrete procedures are generally applicable, with the major exception being that each shotcrete lift must be applied against soil, rather than against a form board or existing concrete. The overlying cold joint must be cleaned prior to placement of the underlying lift of shotcrete. Some specialty contractors attach temporary wood stops at the bottom of each shotcrete lift (see photos P33 and P34) to minimize time and labor required to clean the cold joint. The temporary wood stops are removed after the shotcrete has set. Acceptable methods for cleaning the shotcrete joint include washing with a combination of injected water and compressed air, blowing with compressed air, or sand blasting. Care should be taken not to erode the soil cut face below the cold joint.

The most critical factor in ensuring a good quality shotcrete facing is a nozzleman who is experienced in gunning structural shotcrete. Specifications may require the nozzleman to complete a pre-qualification test panel (mock-up of the work to be completed) prior to beginning production work. Typically, core samples are taken from the test panel(s) and visual examination and compressive strength tests are performed. In addition, the specifications may require that compressive strength test panels be completed by the nozzleman and tested for compressive strength periodically throughout the project duration. The size of such "check" compressive

strength test panels is typically 300 by 300 mm square by 100 to 150 mm thick (12 by 12 inches square by 4 to 6 inches thick).

The following points summarize some basic recommended practices for applying structural shotcrete facings:

- The nozzle should be held perpendicular to the surface, except when shooting around reinforcing bars.
- Optimum nozzle distance from the surface being shot against is
 - Wet-mix: 0.6 to 1.5 m (2 to 5 feet)
 - Dry-mix: 1 to 2 m (3 to 6 feet)
- Shooting shall start at the bottom.
- Voids shall not be left behind bars or steel mesh.
- Control of alignment, grade, and thickness shall be determined by the contractor. Where sharp edges and accurate lines are required, these should be set out by screed boards, guide wires and/or depth spacers.

Temporary shotcrete facings typically consist of 75 to 100 mm (3 to 4 inches) of wire mesh or fiber-reinforced shotcrete thickness, placed directly against the soil, as the excavation proceeds in staged lifts. Once the excavation is bottomed, the permanent wall facing is built. Cast-in-place concrete, additional shotcrete, precast concrete panels, or other approved facings are used for the finish wall permanent facing.

The inspector should verify that the following construction conditions are met, in accordance with the contract specifications and drawings, prior to shotcrete placement:

- The geocomposite drainage materials have been installed at the locations and to the dimensions specified, and are connected with specified overlaps to ensure continuity of hydraulic flow, and have been secured to prevent excessive vibration during shotcrete placement.
- The welded wire mesh or reinforcing steel has been installed at the locations and to the dimensions and overlaps specified. Particular care should be given to ensure that reinforcing steel is tied securely and is clean.
- Construction joints are clean and acceptable for shotcrete placement.
- The finish grade and line will be in accordance with the specifications.
- The contractor is prepared to provide the necessary finish on the exposed shotcrete surface.
- The shotcrete will be applied, and cut face closure will occur, within the specified time limits.
- Construction equipment that can cause ground vibration detrimental to the shotcrete will not be allowed to pass close to the shotcreted face before the shotcrete has attained initial set.

Nonconformances must be brought to the attention of the contractor, and corrected prior to placement of the wall facing.

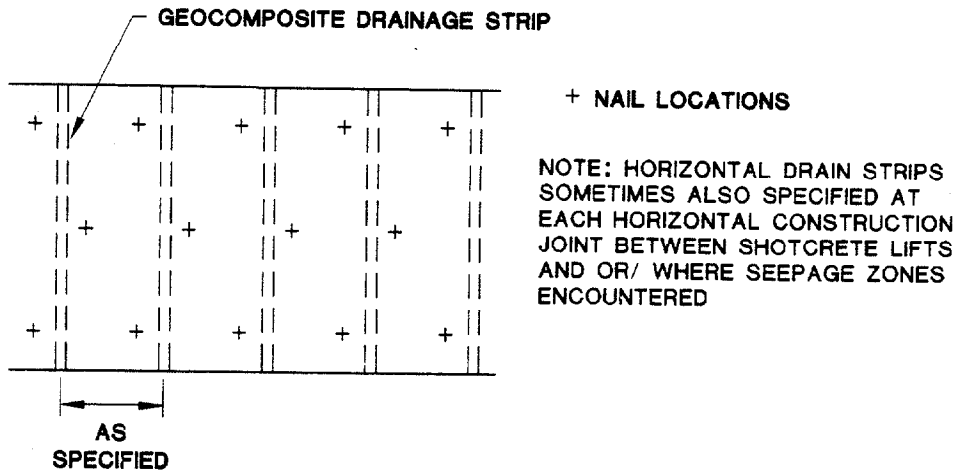

GEOCOMPOSITE DRAIN STRIPS

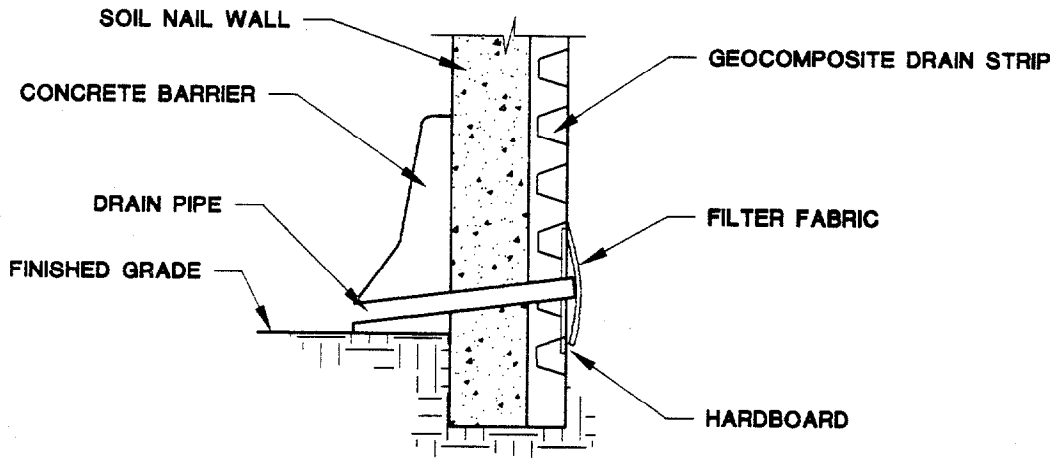

TOE DRAIN OUTLET PIPE

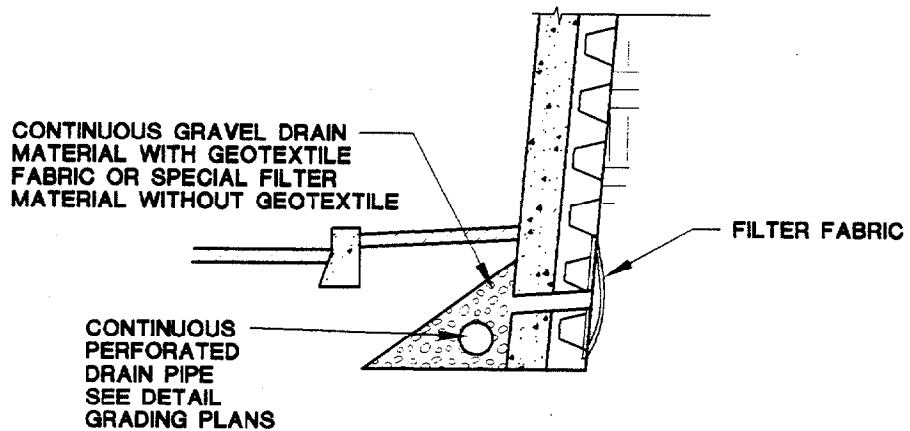

FOOTING DRAIN

Figure 12. Examples of Wall Drain Details.

P22



P23



P24



P25

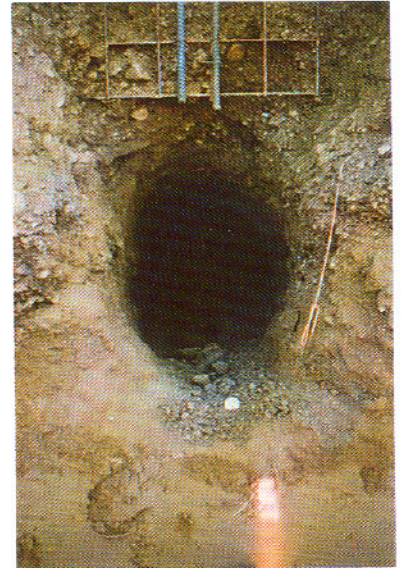

P26



- P22. Excavation of lift to finish wall line.
P23. Note compact drill rig. Can operate in limited width work area.
P24. Drilling nail hole.
P25. Completed drillhole.
P26. Drillhole cleaning tool and high intensity light (minimum 500,000 to 1 million candlepower) for inspecting drillholes.

Soil Nail Wall Construction.

P27



P30



P28



P31



P29



P32

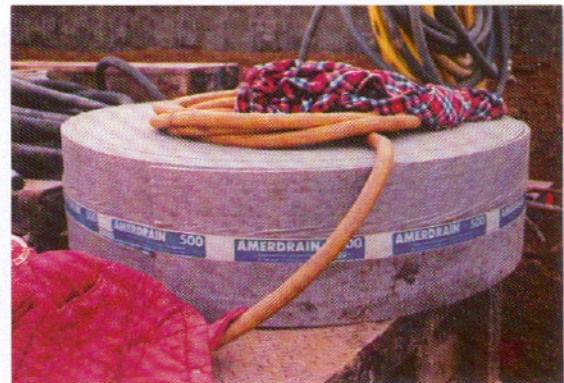

- P27. Cleaning and inspecting drillholes prior to installing nail.
- P28. Scaled PVC tube used as measuring rod to measure drillhole and nail lengths.
- P29. Soil nail tendon installation. Note centralizers.
- P30. Tremie pipe grout placement.
- P31. Installing prefab vertical geocomposite drain strips and welded wire mesh.
- P32. Prefab drain strips, shipped to job site in rolls.

Soil Nail Wall Construction.

P33



P36

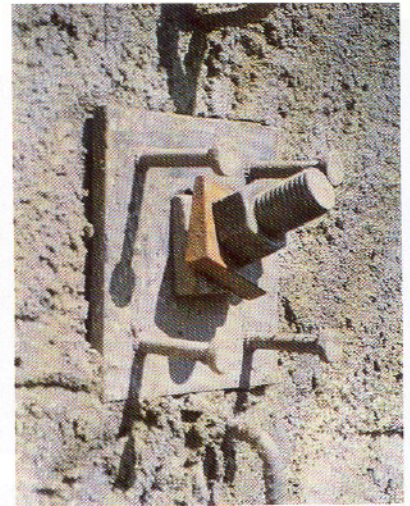

P34



P37

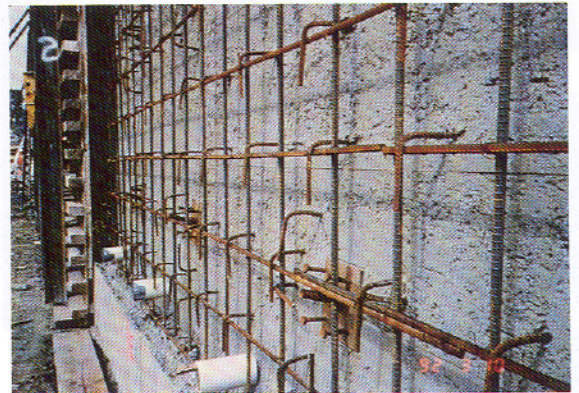

P35



P38



- P33.** Installing securing pins to support welded wire mesh prior to wall shotcreting. Also note smaller flat-headed nails used to secure drain strips to excavation face.
- P34.** Applying shotcrete. Note application from bottom of lift upward. Also note temporary soil berm and wood stop at bottom of lift to keep shotcrete off mesh overlap to next lift.
- P35.** Proper technique for shotcreting top part of drillhole. Nozzleman inserts nozzle horn into mouth of drillhole to assure non-voided backfill and prevent dirt from being blown into hole.
- P36.** Steel bearing plate, nut, and beveled washers connecting nail head to shotcrete face. Also note shear studs to connect to CIP facing.
- P37.** Face form for CIP facing. Also note drain pipe outlets at wall base.
- P38.** Drainage gutter installed behind top of wall.

Soil Nail Wall Construction.

P39



P42

P40

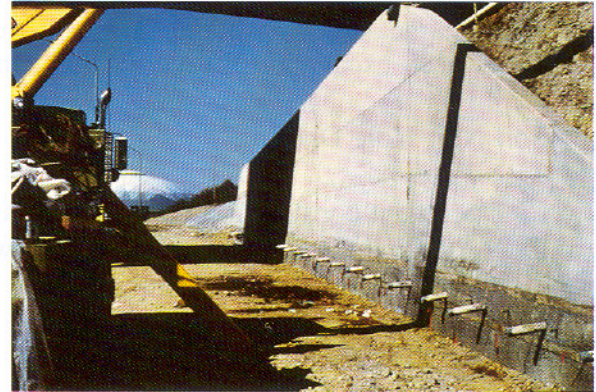

P43

P41

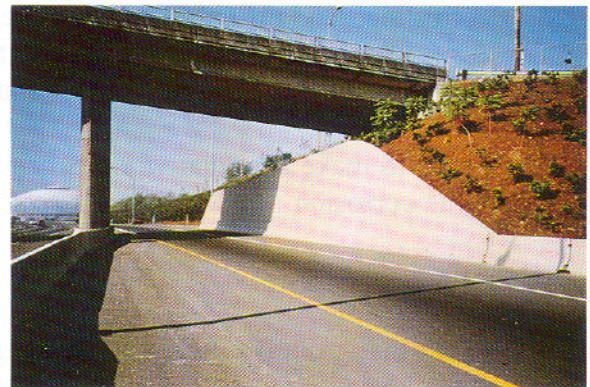

P44

- P39. Nozzleman gunning prequalification test panels.
- P40. Nozzleman applying wall shotcrete. Blowpipe operator removing rebound.
- P41. Rough screeding shotcrete back to thickness-control guide wires.
- P42. Hand finishing with rubber float to apply final face texture.
- P43. Example of permanent nail wall with full thickness structural shotcrete, I-5 Tacoma, WA.
- P44. Completed wall after placement of traffic barrier and painting with pigmented sealer, I-5 Tacoma, WA.

Shotcreting a Permanent Structural Shotcrete Wall.

Construction Monitoring Inspection Checklist

Excavation

- Prior to start of any wall construction, check for any variance between the actual ground surface elevations along the wall line and those shown on the plans.
- Frequently ascertain that stable excavation conditions are being maintained, both for general mass excavation and wall neat line face excavation. Make daily inspections of the ground next to the wall excavation.
- Verify that excavations are constructed within specification tolerances of the design line and grade.
- For each excavation lift, verify that contractor is not overexcavating.

Soil Nail Hole Drilling

- Document construction on the "Soil Nail Installation and Summary Forms" in appendix A.
- Verify that the soil nail hole is drilled within acceptable tolerances of the specified alignment, length, and minimum diameter.
- Verify that loss of ground or drillhole interconnection is not occurring.

Tendon Installation

- Inspect open soil nail holes for caving or loose cuttings using a high intensity light.
- Verify that tendons are inserted to the minimum specified length.
- Verify that centralizers are installed at the specified intervals and will provide clearance for the minimum specified grout cover and that openings through the centralizer support arms are not obstructed.
- Watch to make sure that workers handle and insert the tendons carefully to prevent damage to the corrosion protection.

Grouting

- Verify that grout is injected by tremie pipe starting at the bottom of the hole, and that the end of the tremie pipe always remains below the level of the grout as it is extracted.
- Verify that grout continues to be pumped as the grout tube, auger, or casing, is removed.
- Measure and record the volume of grout placed in the hole, and determine the "grout take".
- Verify that the contractor does not reverse the auger rotation while grouting by auger-cast methods, except as necessary to initially release the tendon.
- Verify that "auger-cast" or "cased" nails have been installed with the specified tendon length grouted.
- Verify that grout is batched in accordance with approved mix designs.
- Confirm that any required grout strength test samples have been obtained in accordance with the specifications. These are typically 50x50 mm (2x2 inch) grout cubes.
- Verify the bonded and unbonded lengths of test nails.

Structural Wall Facing and Drainage

- Verify that the geocomposite drain strips and weep hole outlet pipes are installed as specified and that drain elements are interconnected and provide continuous drainage paths.
- Verify that the reinforcing steel has been installed at the locations and to the dimensions specified. Particular care should be given to ensure it is tied securely and is clean.
- Verify that wall finish line and grade will be in accordance with the plans and specifications.
- Verify that shotcrete will be applied and cut face closure will occur within the specified time limits.
- Verify that shotcrete is applied as specified, and in accordance with recommended good practice.
- Verify that construction joints are clean and acceptable for shotcrete placement.
- Verify that shotcrete is batched in accordance with the approved mix design.
- Verify that shotcrete test panels (if specified) are prepared, cured, and transported to the testing lab in accordance with specifications.

PART II. CONSTRUCTION INSPECTION

Chapter 3. Nail Testing

Introduction

Soil nails are field tested to verify that the nail design loads can be carried without excessive movements and with an adequate safety factor for the service life of the structure. In addition, testing is used to verify the adequacy of the contractor's drilling, installation, and grouting operations prior to and during construction of production soil nails. Therefore, the soil/rock conditions as well as the method, equipment, and operator used for installing production nails **must** be the same as those used for installing test nails. If ground and/or installation procedures change, additional testing may be required. It is typical practice to complete testing in each row of nails prior to excavation and installation of the underlying row. If inadequate test results indicate faulty construction practice or adhesion capacities less than required, the contractor should be required to alter nail installation/construction methods. In the event that required design adhesion capacities are still not achievable, redesign may be necessary.

Testing criteria will be part of the specifications and may consist of "**ultimate**" and/or "**verification**" tests, which are conducted to validate the contractors installation methods and to verify compliance with the soil nail load carrying capacity and adhesion values used in design. These tests usually require loading to a maximum test load that includes the factor of safety assigned to the design soil adhesion and/or that results in pullout failure (i.e., inability to maintain constant test load without excessive soil nail movement). The number of tests will vary, depending on the size of project and the major different ground types in which nails will be installed. On smaller projects, one or two ultimate or verification tests are commonly conducted prior to beginning production nail installation, and then one or more additional such tests are often conducted in each major different ground type encountered as construction proceeds. A larger number of ultimate or verification tests may be specified for larger projects. **Ultimate and verification tests are typically performed on "sacrificial" test nails.**

During **production installation**, "**proof**" testing is conducted on a specified percentage (typically as many as 5 percent) of the total production nails installed. Some specifications allow proof testing to be performed on production nails that will be incorporated into the structure while other specifications require the proof-tested nails to be extra "sacrificial" nails that will not be incorporated into the structure.

Creep tests are typically performed as part of ultimate, verification, and proof tests. The creep test consists of measuring the movement of the soil nail at constant load over a specified period of time. This test is done to ensure that the nail design loads can be safely carried throughout the structure's service life (typically 75 to 100 years) without causing movements that could damage the structure.

Nail testing is conducted by incrementally loading (and, if specified, unloading) the soil nail tendon and measuring the movement of the soil nail head at each load increment. Typically, the tendon movement reading is recorded just after the next load increment has been applied. The loading increments, the time that each load increment is held, and the number of measurements for each load increment are determined by the type of test being performed, and will be specified in the contract documents. If not specified, recommended practice is to obtain a tendon

movement reading just after the load has been applied, and a second reading after the load has been maintained for a sufficient amount of time to ensure that tendon movement has stabilized.

Testing procedures were not "standardized" at the time this manual was written and vary amongst different Highway Agencies. Check specifications for test procedures applicable to your project.

Equipment for Testing

Figure 13 and photo P45 shows a typical soil nail testing set up. A center hole hydraulic jack and pump are used to apply the test load to the tendon. The axis of the jack and the axis of the nail must be aligned to ensure uniform loading of the tendon. Typically, a jacking frame or reaction block is installed between the shotcrete or excavation face and the jack. The jacking frame should not react directly against the nail grout column during testing. Once the jack is centered and aligned, an alignment load is applied to the jack to secure the equipment and take the "slack" out of the set-up. **The jack load should not be permitted to drop below the alignment load during subsequent test loading.** This could cause misalignment of the jacking set-up and result in misleading test results. The magnitude of the alignment load will affect test results. The alignment load should not be permitted to exceed 10 percent of the maximum test load. If higher alignment loads are required to support equipment, the contractor should provide alternative methods for externally supporting the equipment.

Movement of the nail head is measured with at least one, and preferably two dial gauges mounted on a tripod or fixed to a rigid support that is independent of the jacking set-up and wall. Two dial gauges are recommended in order to provide an "average" reading, in case the loading is slightly eccentric due to imperfect alignment of the jack and tendon, and to provide a backup if one gauge malfunctions. The dial gauges should be aligned within 5 degrees of the axis of the nail, and should be zeroed after the alignment load has been applied. The dial gauge should be capable of measuring to the nearest 0.02 mm (0.001 inch). The dial gauge should be able to accommodate a minimum travel of the estimated elastic elongation of the test nail at the maximum test load plus 1 inch, or at least 50 mm (2 inches).

A hydraulic jack and pressure gauge are used to apply and measure the load applied to the soil nail. It is recommended that the hydraulic jack have a minimum travel or "throw" of at least 150 mm (6 inches). A center hole load cell may be added in series with the jack for use during creep tests. The hydraulic jack and pressure gauge (and load cell, if used) should be calibrated as a set. Recent calibration data for the jack, pressure gauge, and load cell must be obtained from the contractor prior to testing. The identification numbers on the field test equipment must match the identification numbers on the calibration data sheets. A typical calibration data sheet and graph for a hydraulic jack is presented in appendix A and completed samples are presented in appendix B.

When **load cells** are used, care should be taken to ensure that the cell is properly aligned with the axis of the tendon and jack. **Load cells** are used mainly to detect small changes in load and allow load adjustment and maintenance of constant load holds during **creep** testing. As an example, assume that the load cell reads "440" once the creep test load is achieved. Maintaining the "440" reading on the load cell, through jack pressure adjustments, will ensure that a constant load is held throughout the creep test.

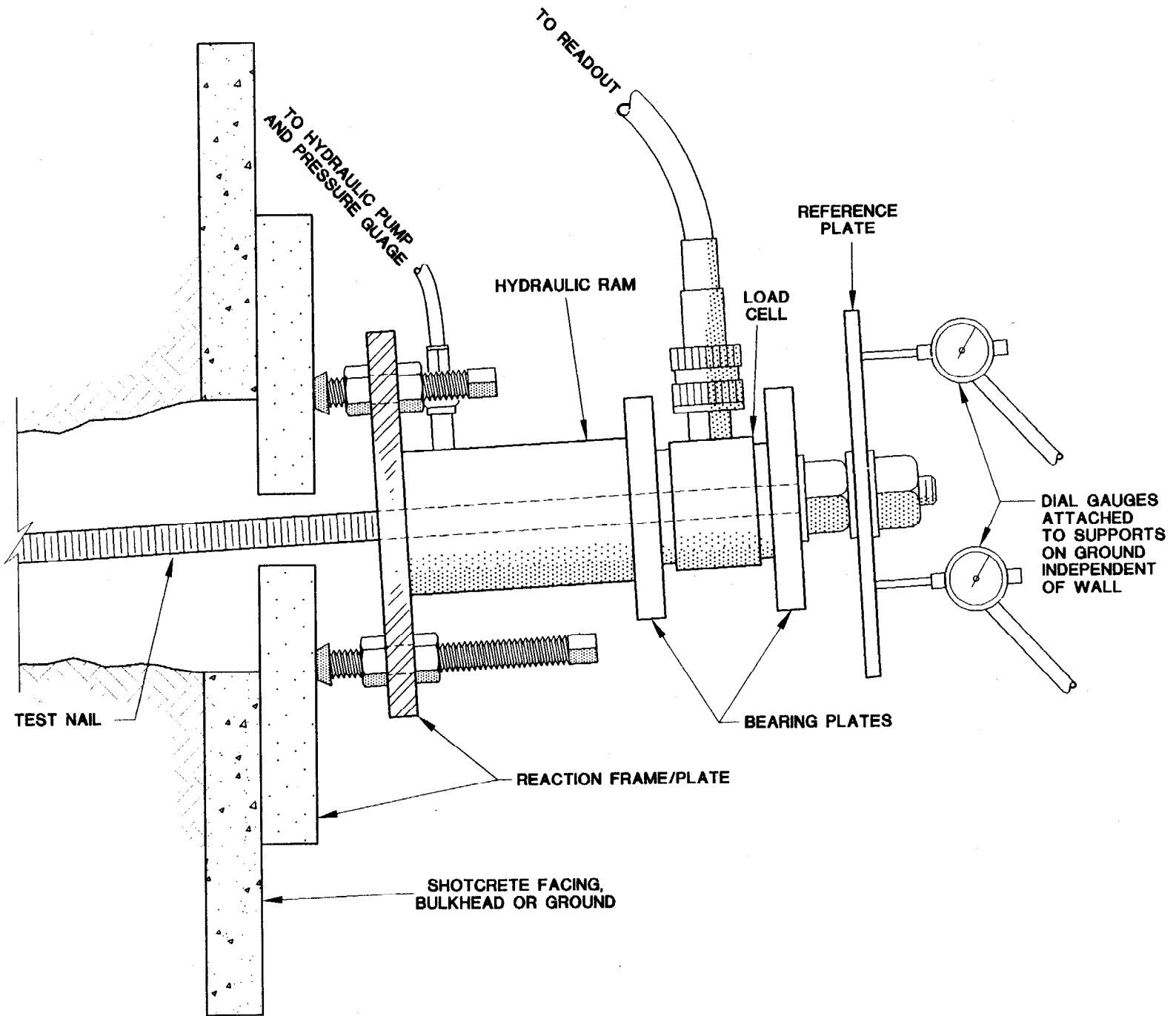

Figure 13. Typical Nail Test Setup.



P45. Typical testing setup. Note dial gauges, reference plate, load cell, centerhole hydraulic jack, reaction frame, and hydraulic pump (on ground).

Types of Tests

The maximum test load, the load increments, and the time that each load increment is held are determined by the type of test being performed. The loading schedule outlined in the contract specifications should be followed for each test type. **In no case should the soil nail tendon be stressed to more than 80 percent of its minimum ultimate tensile strength for grade 150 steel, or more than 90 percent of the minimum yield strength for grade 60 steel. Otherwise, an explosive failure of the steel can occur.** The nail tendon manufacturer provides strength data for each size of soil nail tendon based on diameter and grade of steel. Personnel should always remain clear of the testing apparatus/nail tendon, since bar failure could occur at any time, particularly at higher test loads. Copies of standard forms for recording the load test data are provided in appendix A, and examples of completed forms are provided in appendix B.

Ultimate Test

Ultimate tests (if used) are performed on non-production, "sacrificial" soil nails, and provide the following information:

- Determination of the ultimate adhesion capacity (if carried to pullout failure).
- Verification of the design adhesion factor of safety.
- Determination of the soil nail load at which excessive creep occurs.

A true "ultimate" test is performed by loading the soil nail until pullout failure takes place along the grout ground interface (pullout failure is the inability to maintain constant test load without excessive movement). Specifications will usually state a maximum test load at which the test can be terminated if pullout failure does not occur.

Verification Test

Verification tests are conducted to verify that installation methods will provide a soil nail capable of achieving the specified design adhesion capacity with a specified factor of safety. Verification test loading will typically be defined by the adhesion factor of safety and the design adhesion capacity. If the design soil adhesion factor of safety is 2.0, the maximum test load will verify 200 percent of the design adhesion capacity. Verification tests are generally completed on non-production, "sacrificial" nails as a first order of work prior to construction. In addition, "verification" testing may be required during production to verify capacities for different soil/rock conditions and/or drilling/installation methods. Verification tests may or may not test the soil nail to the point of pullout failure.

Proof Test

A proof test is typically performed on a specified number (typically up to 5 percent) of the total number of production soil nails installed. This test is a single cycle test in which the load is applied in increments until a maximum test load, typically 125 to 150 percent of the design adhesion capacity, is reached. Proof tests provide information necessary to evaluate the ability of production soil nails to safely withstand design loads without excessive structural movement or longterm creep over the structure's service life.

Creep Test

Creep tests are typically performed **as part of** the ultimate, verification, or proof test. Creep testing is conducted at a specified, constant test load, with movement recorded at specified time intervals. The deflection-versus-log-time results are plotted on a semi-log graph, and are compared with the acceptance criteria presented in the contract documents. Creep tests should utilize a calibrated load cell to monitor and adjust for small changes in load caused by jack bleed or other factors.

Test Acceptance Criteria and What They Mean

The following test acceptance criteria have been established through research and experience.

Verification/Ultimate Tests

1. Total movement at the maximum test load (typically 200 percent of design load or adhesion) must exceed 80 percent of the theoretical elastic movement of the unbonded length.
2. Creep movement between the 6 and 60 minute readings, at a specified test load (typically 150 percent of design load or adhesion), must be less than 2 mm (0.08 inch).
3. Pullout failure must not occur at the maximum test load.

Proof Tests

1. Total movement at the maximum test load (typically 125 to 150 percent of design load or adhesion) must exceed 80 percent of the theoretical elastic movement of the unbonded length.
2. Creep movement between the 1 and 10 minute readings, at maximum test load (typically 125 to 150 percent of design load or adhesion) must be less than 1 mm (0.04 inch), or
3. Creep movement between the 6 and 60 minute readings, at maximum test load, must be less than 2 mm (0.08 inch).

Meaning of Test Acceptance Criteria:

1. The measured movement of the soil nail head should exceed 80 percent of the theoretical elastic elongation of the unbonded length at maximum test load. This criterion has been established to ensure that load transfer from the soil nail to the soil is occurring only in the bonded length and that additional load transfer is not occurring in the unbonded length. The minimum acceptable movement is computed as follows:

$$\begin{aligned} \text{measured movement, } \Delta L, \text{ acceptable if } &> 0.80 \cdot P \cdot UL \cdot 10^6 / A \cdot E \text{ (SI Units)} \\ &> 0.80 \times P \times UL \times 12 / A \times E \text{ (English Units)} \end{aligned}$$

where measured movement is in millimeters (SI Units) or inches (English Units) and:

- P = Maximum applied test load (kilonewtons or kips)
- UL = Length from the back of the reference plate to the top of the bond length, i.e., the unbonded length (meters or feet)
- A = Cross-sectional area of the steel (square millimeters or square inches)
- E = Young's modulus of steel (typically 200,000 MPa or 29,000 ksi)

2. The second criteria is that the creep movement (i.e., movement at constant load) does not exceed 2 mm (0.08 inches) between the 6 and 60 minute readings. The creep test may often be terminated if less than 1 mm (0.04 inches) of movement has occurred between the 1 minute and 10 minute readings, as this criterion is a more stringent one. The specific criteria outlined in the contract should be followed. The specified time limit for each load increment should be adhered to since a significant variation will make creep results meaningless due to the log time scale. The creep movement per log cycle of time may be quickly calculated as follows:

$$\text{Creep/log cycle} = \frac{\Delta 2 - \Delta 1}{\log(T2/T1)}$$

where:

- $\Delta 1$ = measured movement (or dial reading) at time 1 in (millimeters or inches).
- $\Delta 2$ = measured movement (or dial reading) at time 2 in (millimeters or inches).
- T1 = elapsed time of first measurement in minutes.
- T2 = elapsed time of second measurement in minutes.

The creep criterion has been established to ensure that the nail design loads can be safely carried throughout the structure's service life (typically 75 to 100 years) without causing movements that could damage the structure.

Testing procedures and acceptance criteria were not "standardized" at the time this manual was written and vary amongst different Highway Agencies. Check specifications for test acceptance criteria applicable to your project.

The Soil Nail Testing Section of chapter 6 — Problem Solving on Construction — contains guidance on possible causes and actions to take if test nails **fail** to pass the acceptance criteria.

Nail Testing Inspection Checklist

- Make copies of all appropriate test forms provided in appendix A, and record all readings and other pertinent information during testing. Be certain to accurately record the test nail identification number, station, and elevation on the test form.
- Verify nail properties necessary to calculate elastic elongation, i.e. steel modulus, grade, cross-sectional area, and unbonded test length.
- Ascertain that loading in excess of the applicable tendon strength criteria will not occur.
- Verify that nail length is sufficient to accommodate all test equipment or use a coupler if allowed.
- Verify the installed test nail's bonded and unbonded lengths.
- Verify that the dial gauges are in proper working order (i.e., not broken or sticking) and have an appropriate travel length (50 mm or 2 inches recommended minimum).
- Verify that the jack is in good working order, that the jack and pressure gauge have been calibrated as a set, and that a calibration graph is provided. If a load cell is required, a calibration graph should be provided for that as well. Verify that the identification numbers on the field equipment match the identification numbers on the calibration data sheets.
- Verify that the jack bearing pads will not interfere with the nail/grout column during testing.
- Verify that the jack can incrementally load and unload the tendon (i.e., that the jack or pump has a bleed-off valve).
- Verify that the load cell and jack are in alignment with each other and with the soil nail tendon.
- Verify that the dial gauges are aligned within 5 degrees of the axis of the soil nail and the gauges are mounted independent of the nail and testing apparatus. Also verify that the dial gauges do not walk excessively on the tendon reference plate. This observation may be made by scribing a circle on the reference plate around the gauge head after the alignment load is applied.
- Verify that the jack does not drop onto the soil nail or lie on it. This could cause bending of the soil nail tendon, or eccentric loading of the tendon during testing.
- Verify that the minimum alignment load is maintained at all times.
- Periodically verify that interference between the jacking set-up and the nail tendon has not occurred due to misalignment. This could lead to erroneous readings.
- Verify that constant load is applied during the creep test. The load should be held within 25 psi if a jack pressure gauge is used, or within 200 lbs. if a load cell is used.
- Verify that the ground above the soil nail and behind the structure has been graded as required by the plans, prior to testing upper row nails.
- Verify that load increments are applied and held within the specified time limits for the test.
- Verify that the unbonded test length has been properly filled with grout after completion of the test for all test nails, including sacrificial nails. No voids should be left in the ground.

PART II. CONSTRUCTION INSPECTION

Chapter 4. Contract Documentation

Introduction

As with any construction project, the field inspector must maintain accurate and complete records during soil nail wall construction. A complete documentation file should include the following:

- A written summary of daily construction activities, i.e., a diary or daily field reports.
- Written and photographic documentation of all equipment, procedures, personnel, and materials.
- An installation log for each soil nail, which includes notes on drilling, grouting, soil types, tendon installation, etc. An example "Soil Nail Installation" form is provided in appendix A and a completed example is presented in appendix B.
- Soil test nail results in both tabular and graphical form, including calibration charts. (See typical forms for the recording and plotting of this information provided in appendix A, along with completed examples in appendix B), and
- Site photographs and soil samples of verified or disputed changed soil conditions (differing site conditions). All photographs and samples should be fully identified for future reference.

Site records will be extremely important if a dispute arises. The records should contain sufficient detail and clarity to be readable and understandable by people unfamiliar with the project. Additionally, all measurements and calculations must be accurate and complete. Calculations should always include basic units.

Contract Documentation Checklist

- Complete all appropriate forms for documentation of soil nail installation and testing.
- Record all daily construction activity in a diary or in daily field reports.
- Record and log each soil nail installation including: drilling, subsurface conditions encountered, groundwater conditions, tendon installation, and grouting. An example "Soil Nail Installation Form" is provided in appendix A.
- Record and plot test results for each soil nail test.
- Verify that all forms and calculations are complete, accurate, and up to date.
- Log dates, times, and weather conditions on all records.
- Keep all records in an organized file to allow easy referencing.
- When appropriate, keep a photographic record along with the normal written documentation.
- Collect soil samples of verified or disputed changed soil conditions (differing site conditions).

PART II. CONSTRUCTION INSPECTION

Chapter 5. Contractor Relationships

Introduction

Soil nail inspection is not an easy task to perform. The inspector is required to make astute and timely field decisions based upon his/her knowledge, experience, and understanding of the project requirements.

Soil nailing requires the inspector to maintain a diversity of skills and knowledge, and adaptability to variable project requirements. Therefore, it is difficult, if not impossible, to provide a "Cookbook" procedure for performing the tasks inherent in this service. However, certain skills and attitudes are essential to our profession, and provide the basis for professional growth as a soil nail inspector. Of primary importance is the establishment and maintenance of a good working relationship with the specialty contractor.

Soil nailing requires the **full time** presence of the inspector, and demands cooperation between the inspector and the contractor. It is the responsibility of the contractor to determine the construction methods to be employed on the project, unless a procedural specification is being used. The inspector should determine the acceptability and effectiveness of these methods with respect to their conformance to the requirements of the contract documents. **If the inspector approaches inspection responsibilities in this light, that is, joins the contractor in his/her effort to construct the best soil nailing system possible, the inspector should have little difficulty establishing a good working relationship with the contractor.** Inspectors should not assume an adversarial role with the contractor, whereby the inspector is simply trying to find fault with the construction procedures and performance. Fault-finding is not the purpose of site inspection, and will be detrimental to the job.

Experience has shown that soil nailing, like many other types of construction, is best accomplished when the contractor and inspector perform as a team and maintain a strong relationship in which each mutually respects and openly acknowledges the experience, intelligence, and opinions of the other. This relationship may be difficult to establish. However, every effort should be made to attain this level of cooperation on soil nail projects. The inspector will find such effort rewarding. The job will be much easier if this type of relationship can be established and maintained.

This does not imply that the inspector should overlook his/her responsibilities to enforce the project specifications. The inspector's **first** priority is to ensure that the project is constructed in accordance with the requirements of the contract documents. The inspector cannot waiver in the performance of this task. However, the manner in which the inspector achieves this goal is the key to establishing and maintaining a good relationship with the contractor. Each inspector is an individual, and each will express different characteristics while performing the job of construction inspection. However, there are certain basic characteristics that each inspector should demonstrate while performing inspection. The inspector may wish to consider the following items, which are intended as general guidelines for effectively accomplishing the inspection task, i.e., verifying and documenting that all construction has been performed in accordance with the requirements of the contract documents, while at the same time maintaining a professional relationship with the contractor.

- Be confident—become thoroughly knowledgeable in soil nailing inspection responsibilities and construction procedures/methods.
- Be assertive, but not overbearing.
- If questions arise, promptly discuss them with the design engineer and contractor, and provide quick responses to the contractor. Never intentionally delay the contractor's work.
- Allow the contractor to propose alternative construction procedures or methods. The contractor's experience with his/her equipment and personnel qualifies the contractor as the best party to initiate problem resolution. The inspector's job is to evaluate resolutions in terms of conformance to the contract documents and effectiveness in resolving the problem, and
- Should the relationship between the contractor and the inspector become adversarial, the inspector should contact the design/project engineer. The inspector should not become a party to the continuation of this situation and should make every reasonable effort to reverse it. Continuance of this type of relationship will be detrimental to the project.

Personal Safety on Site

Although personal safety is one of the last items to be discussed in this manual, it may be the most important. Construction sites are inherently dangerous due to the nature of the work, the equipment involved, and the unavoidability of exposure to dangerous activities. The inspector should maintain constant awareness, and employ defensive work habits while on-site. It is usually a momentary lapse of these work habits that results in "on-site injury" and related problems. A simple daily ritual of reminding oneself of the danger inherent to being present on a construction site is a recommended tool for keeping the guard up.

Provided below is a minimal list of site safety procedures that can assist the inspector in performing work in a safe manner. Again, it is important to remember that each site is different, and safety concerns must be addressed on an individual basis, as follows:

- Employ defensive work habits.
- Attend the weekly site safety meetings.
- Inform all site personnel (especially equipment operators) of your presence in the work area.
- Watch the construction activities for a short while to get a general sense of the activity and sequencing. Find a safe stand-by area, and inform the equipment operators of this area.
- Prior to entering the work area, make eye contact with the operators and ascertain that they know you are entering the work area. If necessary, request shut-down of the equipment.
- While performing the work, remain visible and constantly aware of equipment locations and work patterns. Check behind you, and always listen for backup beepers.
- Be courteous—if possible adjust to the normal work pattern, and always inform operators when your task is complete, and
- If relocating, inform the operators. Otherwise, they will not expect you to be in a different location.

While on a construction site, the inspector is not directly responsible for the safety of the contractor's personnel. This is the sole responsibility of the general contractor and subcontractors for the project. However, situations will inevitably arise wherein the inspector becomes aware of an unsafe condition. In this case, the inspector should inform the contractor's supervisor (or other "competent person", per OSHA terminology) of the condition, and proceed to contact the project engineer for further direction.

PART II. CONSTRUCTION INSPECTION

Chapter 6. Problem Solving on Construction

Introduction

The following sections describe **the more common problems** that may be encountered during a soil nailing project. They are organized under the tasks of Excavation, Soil Nail Installation, Grouting, Shotcrete Facing and Drainage Elements, and Soil Nail Testing. The problem description or important point being emphasized (in bold face) is followed by discussion and/or possible causes and solutions. This list is general in nature, since each construction problem is characterized by the individual conditions specific to the occurrence. Chapter 7 contains a discussion of methods and techniques that can be employed when more difficult ground conditions are encountered.

Excavation

The following are some basic items the inspector may consider to help identify problems associated with site excavations:

1. **Construction sequencing must be monitored to ensure that temporary grading work does not over-excavate overburden soil behind the wall (beyond that called for on the plans) prior to, during, or after soil nail installation.** Overburden confinement is critical to soil nail capacity in the upper row, near surface nails, and the specified ground cover must be maintained.
2. **Over-excavation beyond the maximum vertical excavation lift height stated in the contract documents should not be allowed.**
3. **If general or mass excavation that encroaches upon the finish wall excavation results in unstable soil/wall conditions, the over-excavated area should be backfilled immediately.** Whether the backfill needs to be compacted structural backfill or can be bermed loose soil should be determined by the design engineer.
4. **Vibrations from adjacent construction activity may induce soil sloughing from exposed cut faces.** Activities may have to be relocated or curtailed until the cut face can be closed with shotcrete.
5. **Exposed finish wall excavations that will not be closed with shotcrete within the specified time limit should not be allowed to remain open without engineering approval.** If deemed necessary, the face can be resupported with bermed soil, or covered with a temporary shotcrete flashcoat of minimum thickness and appropriate reinforcing and/or curing additives, as approved by the design engineer.

More serious excavation related problems are discussed in chapter 7—Handling Difficult Ground.

Soil Nail Installation

Soil nail installation problems are usually associated with soil and groundwater conditions and, at times, with equipment. The following are some basic items the inspector may consider to help identify problems associated with soil nail installation:

1. **Drilling of the nail drillhole through a cut face that has been excavated to finish line results in enlargement of the mouth of the drillhole and/or localized sloughing of the cut face, as shown in figure 14.** If the sloughed area is limited in size and is not causing overall mass stability problems, typical practice is to backfill the sloughed zone with additional shotcrete (usually at contractor expense) during construction of the shotcrete facing, as shown in figure 14. This condition can also often be resolved by drilling through a stabilizing berm, which protects the finish cut face during drilling, as shown in figure 15 and photos P46 to P48, with final trimming to the finish wall excavation line done after the nail installation.
2. **The soil nail hole remains open upon retraction of the drilling equipment, but caves at a later time.** This occurrence implies that open hole procedures are acceptable only if the contractor installs the nail tendon and fills the hole with grout immediately after drilling.
3. **The soil nail tendon cannot be inserted to the design bond length during open hole drilling procedures.** This occurrence indicates either that the drillhole was not drilled to sufficient depth or that subsequent caving of the hole has occurred. If the depth was not sufficient, the hole may be redrilled to the design length. If caving is occurring, the contractor must implement alternative drilling or cleaning procedures, as continued drilling will increase ground loss. (See chapter 7)
4. **The drillhole cannot be drilled at the design inclination angle and/or location.** These conditions typically occur due to incorrect or inadequate general excavation that does not provide sufficient drill rig access to the drillhole location. Drilling should not be allowed until adequate access can be obtained and the location/inclination specifications are satisfied.
5. **Drilling encounters an obstacle that prevents advancement of the drillhole to the design depth.** The first responsibility is to identify the obstacle, if possible, and inform the design engineer/contractor of the conditions. The design engineer should provide a new location for the nail. Never accept relocation of a nail (other than within the specified tolerances) without engineering approval. Any drillhole not used for nail installation should be backfilled with tremied grout and allowed to set for a minimum of 12 hours prior to drilling and installation of a nearby or relocated nail.
6. **Obstructions such as boulders, concrete, utilities, wood, and other materials are encountered.** The simplest alternative often is to slightly change the angle of inclination. More expensive specialized drilling equipment is available to drill through most obstruction materials. Care should be taken to identify manmade obstructions prior to drilling through them.
7. **Drilling in cohesive (clayey) soils results in a coating of drill cuttings lining the sidewall of the drillhole.** This coating can reduce the adhesion along the soil-grout interface and the

nail capacity. In cohesive soils, the contractor may make use of drilling methods that will roughen or ream the sidewall of the drillhole to improve adhesion.

8. **Bentonite drilling muds should not be used in soil nail holes, because the bentonite coats the hole, preventing a good bond between the grout and soil, resulting in reduced adhesion.**
9. **Air, which is the most common drilling fluid used in drilling by cased methods, sometimes will create dust hazards and, in cohesionless soils, may cause raveling and oversizing of the hole.**



P46. Mass excavation stopped short of final wall line to leave a stabilizing (buffer) berm.



P47. Drilling through stabilizing berm.



P48. Excavating stabilizing berm back to final wall line after nails have been drilled and installed through berm.

Problem Solving on Construction

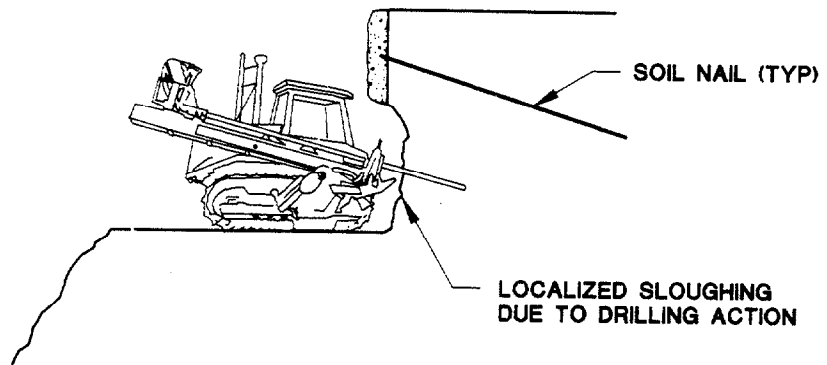

**LOCALIZED SLOUGHING
DUE TO
DRILLING ACTION**

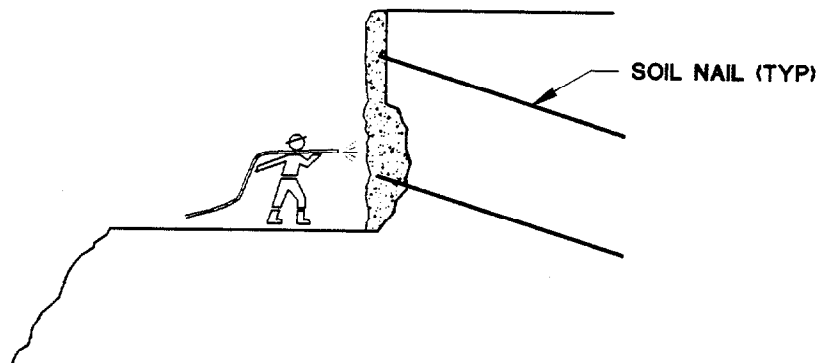

**FACE SLOUGHING
REQUIRES EXTRA SHOTCRETE**

Figure 14. Local Cut Face Instability Due To Drilling Action.

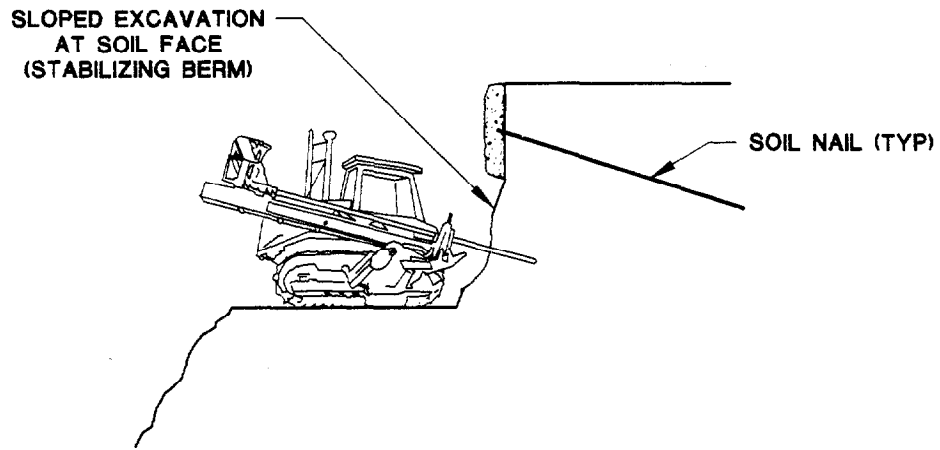

**NAIL DRILLING THRU A
PROTECTIVE STABILIZING BERM**

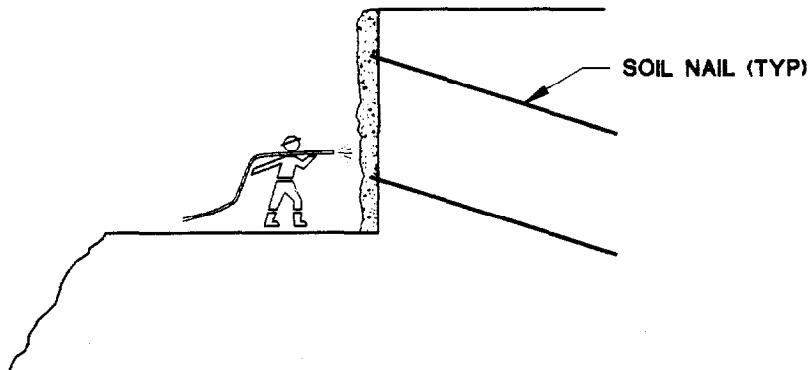

**SHOTCRETING AFTER EXCAVATION
OF STABILIZING BERM**

**Figure 15. Local Cut Face Stabilized During
Drilling With Stabilizing Berm.**

Grouting

Loss of soil-grout adhesion and reduced corrosion protection will occur if voids are left within the grout column surrounding the tendon. Either grout with too low a slump (i.e., too "stiff") or the contractor's equipment and/or procedures may result in grouting problems. The following are some basic items the inspector may consider to help identify problems associated with soil nail grouting:

1. **The tremie pipe is not being inserted to the full depth of the drillhole.** This situation is unacceptable, because the soil nail drillhole may not be completely filled with grout. A tremie pipe of sufficient length is required and must be inserted to the full depth of the drillhole.
2. **The tremie pipe is retracted from the drillhole at a haphazard and inconsistent rate.** This is not acceptable grouting procedure. To ensure a completely filled drillhole, the tremie pipe should be extracted at a uniform rate. The outlet end of the grout pipe should remain embedded in the grout column at all times during the extraction process.
3. **The grout mix is too stiff (low slump) to thoroughly fill the drillhole, resulting in a voided grout column.** Typically, awareness of this problem does not occur until nail stress testing indicates poor adhesion due to the voids. In some instances, test nails that did not provide required capacity have been extracted from the ground and found to have extensive voids along the top edge of the grout column and limited grout in the vicinity of the centralizers. Grout consistency should be kept as "flowable" (high slump) as possible without jeopardizing the strength characteristics. This practice will assure complete filling of the drillhole, which is critical to the performance and load carrying capacity of the soil nail. Also, openings between the centralizer support arms should not be obstructed by the materials (such as duct tape) used to secure the centralizer to the tendon. Shotcrete mixes should not be used in lieu of grout to backfill the entire soil nail hole. Shotcrete is very stiff, and may not completely fill the hole, resulting in voids and inadequate nail capacity.
4. **Due to the inclined angle of the nail drillhole, the grout backfill will not completely fill the drillhole flush to the excavation face.** Typically, this is not a serious concern if the void is limited in depth to approximately 300 to 600 mm (1 to 2 feet) or less. A void limited to this size can be backfilled with shotcrete during construction of the shotcrete facing or hand dry-packed (more expensive) with grout after the initial nail grout has set (see plans and specifications for acceptable methods). However, if the length of ungrouted section is greater than 600 mm (2 feet), or if there is any concern whether the shotcrete will adequately achieve a complete backfill, the mouth of the drillhole should be re-grouted or dry packed. If shotcrete is used, the nozzleman must insert the nozzle horn into the mouth of the drillhole to assure a non-voided backfill. This will also prevent soil from being blown into the drillhole.
5. **During grouting operations, an equipment malfunction or loss of grout supply results in a partially grouted nail.** It is acceptable to resume grouting in the drillhole, without special consideration, if the initial grout has not set up and created a cold joint. Assessment of this condition will depend on grout consistency at the time of placement, ambient and ground temperatures, grout age, weather conditions, and depth below ground surface of the

potential cold joint. Probing the surface of the initial grout placement with a piece of reinforcing steel or similar tool can help in making this assessment. If the grout placement cannot be resumed in time to prevent a cold joint, the design engineer and contractor should be contacted, as the nail may have to be rejected or incorporated with a reduced capacity (which should be determined by proof testing). Cold joints are acceptable in proof test nails used as production nails, due to the limited number of nails constructed in this manner.

Shotcrete Facing and Drainage

The following are some basic items the inspector may consider to help identify problems associated with shotcrete facing and drainage construction:

1. **The finish excavation cut face is irregular, resulting in shotcrete overruns beyond theoretical plan quantity.** This situation is not uncommon. In many types of ground, it is practically impossible to achieve a perfectly smooth final excavation cut face. A rough and irregular cut face can be due both to the type of ground being excavated and to the excavation process itself (i.e. type of equipment used, care and skill of the equipment operators, etc.). The amount of extra ground excavated from beyond the plan neat line is commonly referred to as "**overbreak**". Contractors are expected to use their experience and expertise to estimate the amount of overbreak and additional shotcrete that will be required beyond theoretical plan quantity, and to include it in their bids.
2. **Shotcrete placement should not displace either the drainage components or the reinforcing steel.**

Geocomposite drainage strips that become dislodged should be reinstalled to adequately secure them from further movement. Prior to shotcreting, the geocomposite drainage strips should be secured to the final excavation cut face with the geotextile side against the ground. Securing pins, e.g., steel pins 150 to 200 mm (6 to 8 inches) long with enlarged heads, placed in a grid pattern on approximately 600 mm (2-foot) centers and driven through the drain strip into the ground behind, can be used to secure the drain strips in soil and weathered rock. Where the excavation face is somewhat rough and irregular and gaps exist behind the drain strip, additional filter fabric or polyethylene film can be placed over the drain edges to prevent the shotcrete from entering. Alternatively, a slightly wider drain strip can be installed (e.g., 400 mm (16-inch) wide strip used in lieu of a 300 mm (12-inch) wide strip) and the additional polyethylene film or filter fabric omitted. The nozzleman may initially apply shotcrete to the center of the drain strip, then extend placement to the edges, in effect sealing the strip to the soil face prior to working on the wall lift.

Dislodged reinforcement steel must be realigned and resupported to prevent further movement. Typically, the reinforcement is tied off to the soil nails and steel "pins", such as 200 to 300 mm (8 to 12-inch) long, No. 4 Rebar, driven into the soil face. The installation of additional pins will typically prevent further movement of the reinforcing steel. Epoxy coated pins are recommended if the initial shotcrete layer is part of a permanent structural wall.

3. **Should temporary equipment malfunction, or loss of shotcrete delivery occur, the shotcrete placement can be terminated and construction joints constructed.** If shotcrete

closure to design line will not be completed within the specified time limit, the contractor and design engineer should agree on how the remaining shotcrete should be placed.

4. **The upper portion of the soil nail drillhole that does not get completely filled with nail grout can be backfilled with shotcrete during construction of the wall facing, if the specifications allow.** The inspector should verify that the void is completely filled. The nozzleman should pay special attention to shotcrete placement at each nail location, and the distance between the nozzle and the wall face should be reduced at each nail head to ensure full penetration and backfill of the void. This practice will also prevent soil from being blown into the drillhole.

Soil Nail Testing

When soil nail test results fail to satisfy the acceptance criteria established in the specifications, the inspector **must** discuss the results with the design engineer and contractor. The following are some basic items the inspector may consider to help identify why the test has failed and subsequent actions to take:

1. **Has the soil nail grout reached the required strength prior to testing?**
2. **Do the records indicate that the volume of grout in the soil nail bond zone is less than the theoretical value?** This situation implies inadequate grouting of the hole or caving that may have occurred after tendon insertion but before or during grouting.
3. **Check the equipment that measures elongation and load.** Is the equipment sensitive enough to accurately measure elongation and load? Does the measuring equipment need to be recalibrated? Is the equipment supported by a method that will measure movement and load independently of the soil nail?
4. **Check the jacking set-up to make sure it is not yielding under the loading test.** Is a coupler or the grout column reacting against the back of the jacking set-up or shotcrete facing?
5. **The jacking set-up should be observed during testing for large deflections and/or damage.** This finding could explain why continued jacking does not increase the soil nail load. If excessive jack ram movement is occurring, the contractor **must** alter his methods.
6. **If pressure is allowed to drop below the alignment load, the jacking set-up should be checked for misalignment, and realigned if necessary.** If realignment is required, the stress test should be restarted, using test data acquired at the last load prior to misalignment of the set-up. If misalignment should occur during creep testing, the creep test must be rerun in its entirety after realignment of the set-up. **This same procedure can be applied to resetting of the jacking apparatus should either the jack or the dial gauge run out of travel during performance of the test.** For example, assume that loading from 75 percent of design load to 100 percent of design load runs the hydraulic jack out of throw before the 100 percent load is reached. The jack should be unloaded and the ram fully withdrawn, whereupon the jacking apparatus can be reset and the tendon can be loaded back up to the 75 percent load. The dial gauge is then reset to exactly the movement reading previously

obtained at the 75 percent load, and unloading to 100 percent of design load (or higher if specified) can be completed. Again, re-setting of the jacking equipment during creep testing requires that the creep test be rerun in its entirety.

7. **Is the tendon failing within the encapsulation?** Is the failure due to the grout-soil contact or tendon-grout contact? This determination may be made if the soil nail can be removed from the drillhole.
8. **Did the drillhole cave?** Was groundwater seeping into the hole? How long was the hole left open prior to grout filling?
9. **Were there problems with the nail installation?** Did drilling or grouting equipment break down? Was the withdrawal rate of augers/casing/grout tube too fast to provide effective grouting?
10. **Are the test data calculations correct?** Were correct units and values used?
11. **Did the grout extend up into the unbonded zone?**
12. **Was the measured movement of the nail head less than 80 percent of the theoretical elastic elongation of the unbonded length at maximum test load, i.e. was measured deflection $< 0.80 PL/AE$?** Measured elongation less than 80 percent of the theoretical elongation indicates load is being transferred in the unbonded length. Possible reasons for this follow:
 - Collapse of the hole has occurred in the unbonded length.
 - The unbonded length has been inaccurately measured.
 - Grouting has occurred in the unbonded length.
 - The unbonded length is less than 1 m (3 feet) and stressing loads are being resisted by the shotcrete facing and/or the jacking set-up.
 - The tendon may be rubbing or binding against the jacking frame or structure.
 - The jack pressure gauge is giving false or improperly calibrated readings.
 - Bending or alignment problems have occurred.
 - Misalignment or movement of the dial gauges has occurred.
13. **Soil nail load test results that do not indicate achievement of the design capacity should also be evaluated by the contractor and design engineer. The inspector should provide the following information:**
 - Maximum load at which the test nail continues to pull out under constant load (pullout failure load).
 - Creep movement at maximum test load or at the preceding load increment, in the event that creep cannot be maintained at the maximum test load due to excessive movement.
 - Identification of adjacent nails that should be considered to have similar load carrying capacity, based on the information contained in the Soil Nail Installation Form. The possibility of needing this information in the future is one reason why it is important to observe and document the drilling and installation of each nail, since only a percentage of the nails are tested.

14. Good contract specifications will outline action(s) to be taken when test nails do not meet acceptance criteria. Some general guidelines are:

- Soil nails that do not meet the specification acceptance criteria cannot be incorporated into the structure at the original design load.
- The design engineer should be contacted and should examine the test data to determine if the nail can be incorporated at a lower load or if it must be rejected.
- Retesting of failed test nails should not be allowed, because previous loading will have affected the results.
- Test nail failures may require testing of additional nails (usually at contractor expense) to further evaluate installation and/or ground conditions.
- Any required redesign should be done as quickly as possible to avoid contractor downtime or delay. Correspondingly, review and approval of contractor submitted redesigns should also be performed promptly.



P49. Exhuming failed sacrificial test nail.



P50. Exhumed sacrificial test nail. Note lack of grout from bottom centralizer to tip of nail. Problem resulted from (1) not placing tremie grout pipe completely to bottom of drillhole; and (2) using too stiff a grout (e.g., shotcrete mix).

PART II. CONSTRUCTION INSPECTION

Chapter 7. Handling Difficult Ground

Introduction

This chapter is written to address those fewer soil nailing projects (an estimated 10 to 20 percent) that happen to be built in poorer ground (whether by design or as a result of encountering unexpected or unanticipated soil/rock or groundwater conditions). The following sections contain a discussion of methods and techniques that can be employed when more difficult ground is encountered during construction. They are organized under the tasks of Excavation and Drainage, Soil Nail Installation, Grouting, and Shotcrete Facing. Problem descriptions are followed by possible causes and solutions. This list is general in nature, since each construction problem is characterized by the individual conditions specific to its occurrence.

Excavation and Drainage

The following are some basic items the inspector may consider to help identify problems associated with excavation in difficult ground conditions.

1. **During excavation of the finish wall cut face, ground sloughing occurs.** If the sloughed area is limited in size (approximately 3 square meters or 30 square feet of wall area) and is not causing overall mass stability problems, typical practice is to backfill the sloughed zone with shotcrete during construction of the shotcrete facing.

A shotcrete "flashcoat" can be applied to control **limited** sloughing or ravelling of cohesionless soils exposed in the finish wall cut, as shown in figure 16. In more **severe** cases, either a shotcrete flashcoat or the full shotcrete facing can be placed prior to drilling of the nail drillhole, as shown in figure 17. Geocomposite drainage strips should be installed prior to placing shotcrete, if this can be done safely, or weepholes should be installed, as a minimum.

When overall soil stability is a concern, a typical scenario for nail installation and excavation may involve the use of a "**stabilizing**" or "**buffer**" **berm** in front of the finish wall excavation line. This berm is left in place during nail installation and buffers the finish face from caving or sloughing as a result of the drilling action. In very competent soils, the stabilizing berm may be omitted, and the face may be cut to finish line prior to drilling and nail installation. However, if sloughing occurs, a stabilizing berm can be used. Once the nails have been installed and soil nail grout has set (usually a minimum of 24 hours), the stabilizing berm is excavated to finish wall line. A typical detail of this excavation sequence is shown in figure 18.

As an alternative, or where sloughing is more severe, false forming can be placed, the finish facing shotcrete installed, and the void behind the false forming backfilled with pumped grout or controlled density fill (lean mix) once the shotcrete has attained the necessary strength. This practice will require the installation of supply and vent pipes through the top of the false forming for later grout backfilling. Such backfilling must be done slowly and carefully, as it is possible to blow the face off the wall if the backfill is placed too rapidly.

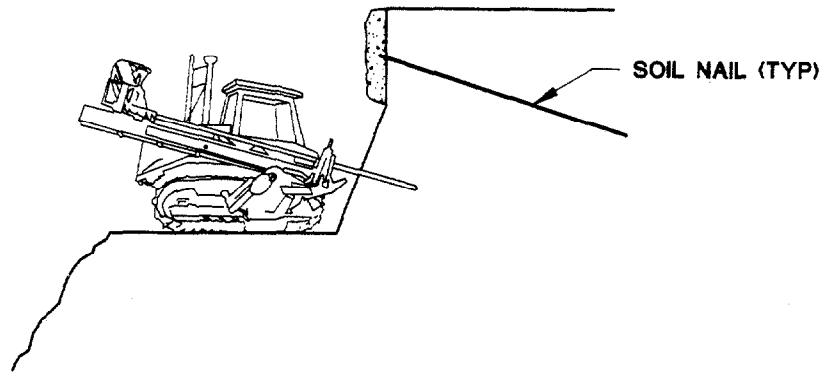

NAIL DRILLING

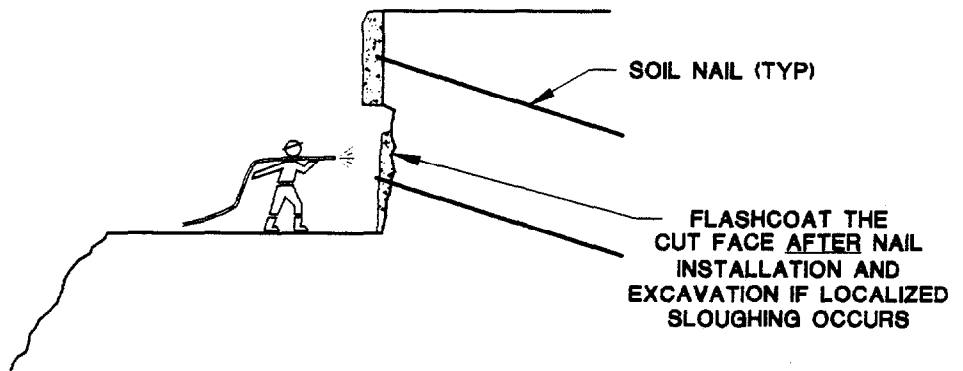

FLASHCOAT SHOTCRETING

Figure 16. Shotcrete Flashcoat To Control Limited Sloughing of Cut Face After Nail Installation.

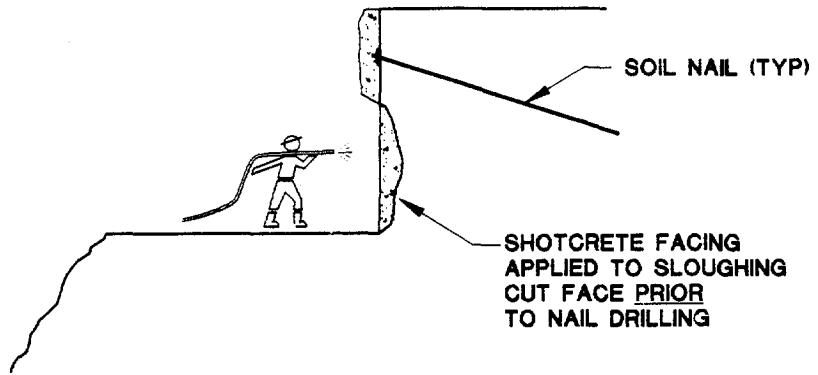

SHOTCRETE FLASHCOAT PRIOR TO DRILLING

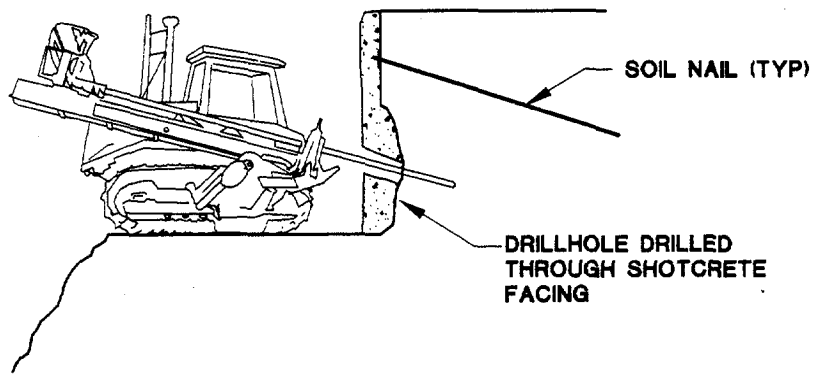

NAIL DRILLING THROUGH THE FULL SHOTCRETE FACING

Figure 17. Shotcrete Flashcoat or Full Facing To Control Sloughing of Cut Face Prior To Nail Installation.

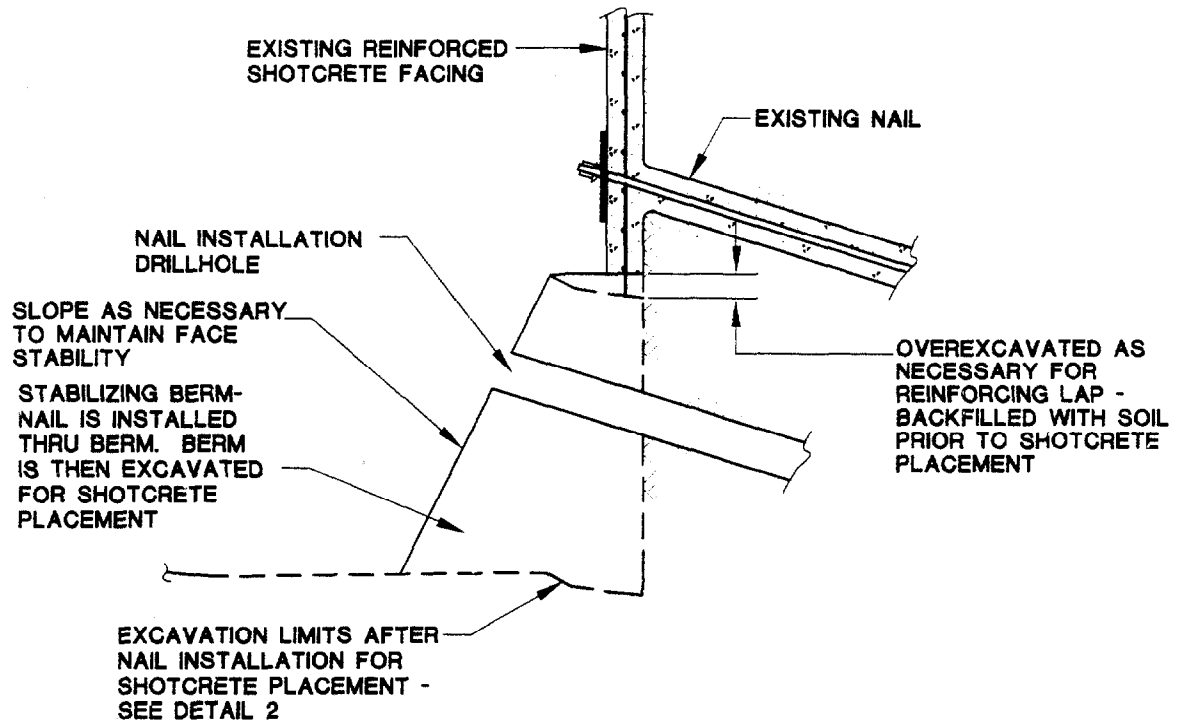

DETAIL 1
NAIL INSTALLATION THRU STABILIZING BERM

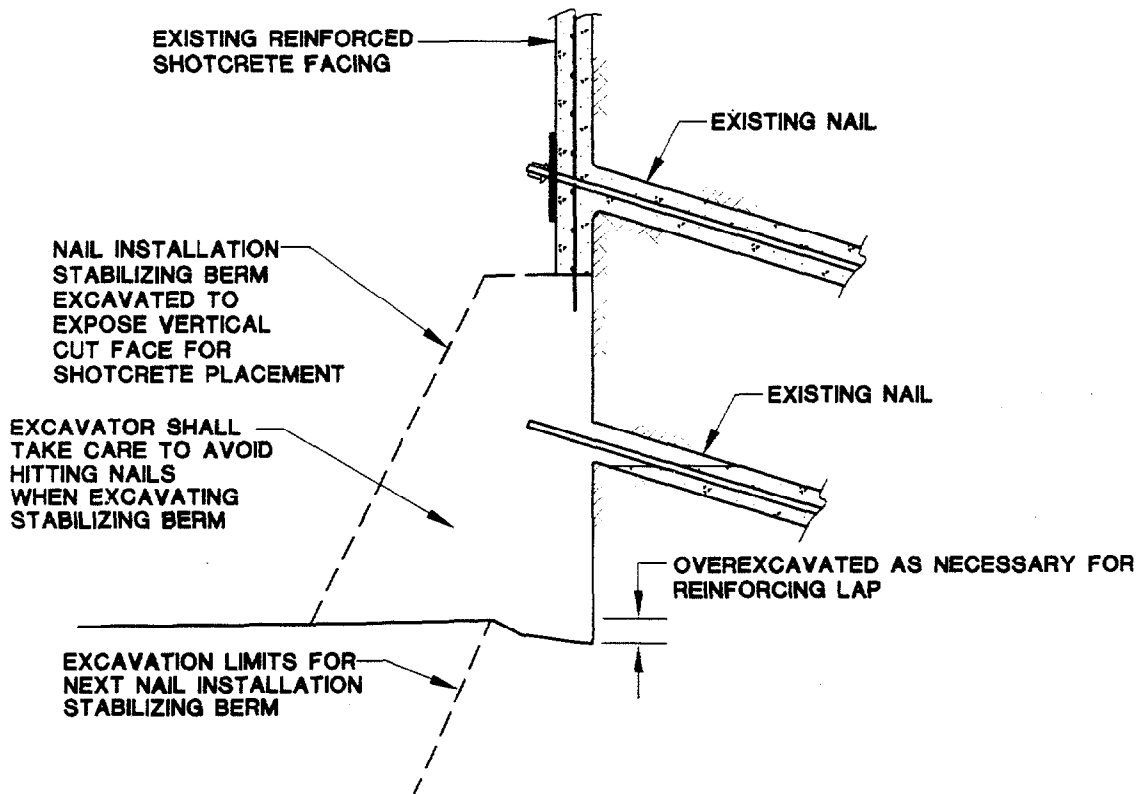

DETAIL 2
EXCAVATION OF STABILIZING BERM FOR SHOTCRETE PLACEMENT

Figure 18. Nail Installation Through Stabilizing Berm.

It is recommended that the design engineer be contacted for engineering approval if false forming is to be used.

If the sloughing or caving is so extensive that it is creating a potential for wall instability, the cut face should be resupported with bermed soil, and the design engineer should be contacted.

2. **In the event that caving ground extends behind the overlying shotcrete facing, possibly exposing overlying soil nails, the excavation face should be immediately bermed with soil and the design engineer contacted for resolution.** The limits of the caved area should be determined (prior to berming) as precisely as possible without delaying the placement of the soil berm. A typical resolution of this problem is to core through the overlying shotcrete facing at the apex of the void and backfill the void with high slump grout or controlled density fill (lean mix). Alternate excavation procedures, as described below, will be required to minimize additional caving of this type.
3. **Alternate excavation and finish wall facing procedures will be required in extreme cases of excavation instability.** Experience has shown that nail installation through a stabilizing berm, followed by segmental slot excavation or "slot-cutting" (i.e., opening the exposed face in alternating slots limited in length, height, or both) and immediately applying a shotcrete flashcoat will often stabilize the soil. A typical detail of this procedure is presented in figure 19. If necessary, the shotcrete may be fiber reinforced and may contain accelerators to reduce set time. Geocomposite drainage components should be installed prior to placing shotcrete flashcoats, if this can be done safely. Weepholes should be installed if geocomposite drains cannot. If conditions requiring slot-cutting are encountered, the inspector must contact the design engineer and contractor.
4. **Groundwater is encountered in the finish face excavation.** If the groundwater is limited in extent and volume and the soil is competent, dense cohesive material, the potential impact on face stability may be minimal, and conventional excavation drainage, shotcreting, and closure procedures may be applicable.

However, extensive groundwater flowing from a cohesionless soil (such as clean sand or silt) may result in flowing soil and very unstable face conditions. **In this case, immediate placement of a soil berm is necessary.** In cohesive soils, the excavation face may remain stable, but subsequent groundwater pressure buildup could cause the shotcrete to debond or blow off the wall face. Remediation of groundwater conditions may range from simple control at the excavation face to installation of complete dewatering systems. If groundwater is encountered on site, the inspector must contact the design engineer and contractor.

Each groundwater occurrence must be evaluated individually based on the specific soils exposed at the cut face, the quantity and flow of groundwater, the location within the cut face excavation, and stability concerns associated with the groundwater occurrence. As a general rule, groundwater must be controlled at the face to allow placement of the shotcrete, and should be diverted away from the toe of the lift to a localized sump for positive discharge from the site. If either of these procedures is not implemented, the groundwater may create adverse construction conditions that will worsen with time and continued construction.

FIRST LIFT OF WALL INSTALLED.
SECOND LIFT PARTIALLY EXCAVATED.
ALTERNATING EARTH BERMS PROVIDE
TEMPORARY SUPPORT AND
STABILIZATION OF THE CUT FACE.

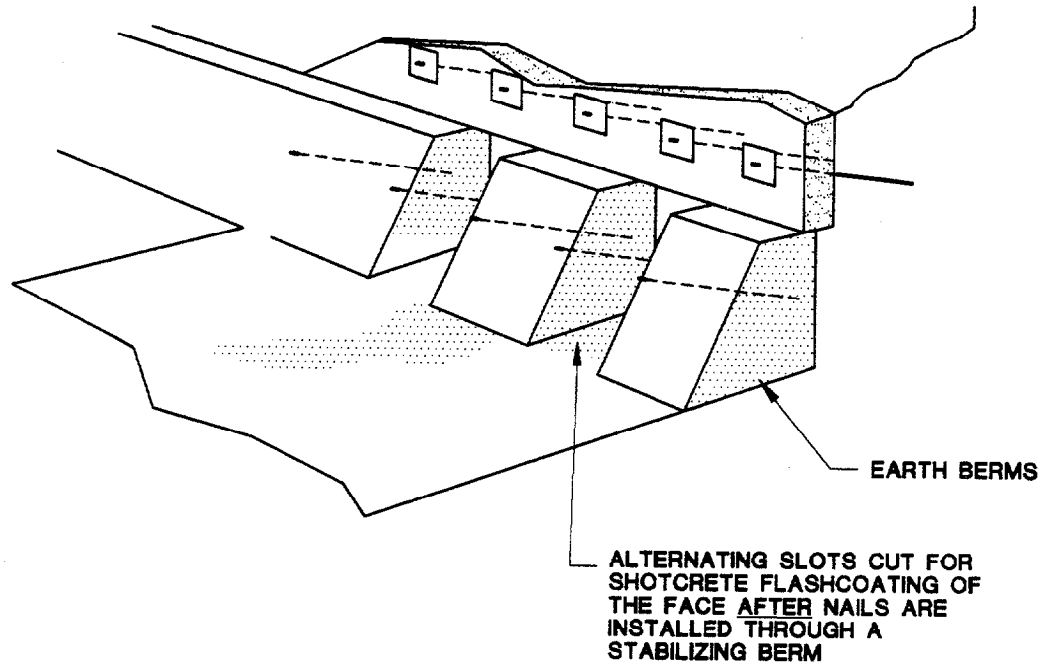

Figure 19. Typical Detail of Segmental Slot Excavations.

Two procedures for controlling and discharging limited localized groundwater that is not creating unstable cut face conditions are:

- The placement of additional geocomposite drain strips through the zone of groundwater occurrence, so that capture and discharge to the toe of the drain strips are accomplished. However, the placement of too much drain strip may result in shotcrete falling off the face due to vibration and/or inadequate shotcrete/soil adhesion.
- The installation of a toe drain at the base of the excavation lift to collect groundwater for positive discharge away from the base of the excavation.

When greater quantities of groundwater are encountered, the installation of weepholes and/or longer horizontal drains may be necessary.

Weep hole and horizontal drain pipes are typically 37.5 to 50 mm (1½ to 2 inch) diameter plastic pipe. Weep holes are typically installed on 2 to 3 m (5 to 10 foot) spacings. The spacings and depths of longer horizontal drains are dependent on the site specific groundwater conditions, but are typically installed on 8 m (25 foot) centers, and can extend to depths beyond the reinforced zone. It is good practice to protect the outlet end of deep horizontal drains by sealing around the drainpipe outlet with grout and/or using a non-slotted length of pipe to ensure that collected water will be passed through the facing and not recharge the ground directly behind the wall.

The vertical geocomposite drainage strips are used where small quantities of water are present or anticipated. They may not be suitable where large quantities of groundwater are encountered. With use of the vertical drainage strips, the water must be captured and carried to the bottom of the wall as construction progresses. This requirement may cause construction difficulties if large quantities of water have to be handled. An alternative technique that has been used successfully is to install weep holes to bring the water through the shotcrete face to and connect the weep holes to vertical drain strips placed on the front of the shotcrete face (rather than behind). This alternative drainage technique can also be used (subject to designer approval) in cases where there is very rough and irregular overbreak in the excavation face, making it very difficult to either attach the drain strips without leaving large voids behind or to prevent shotcrete from entering the voids. (See photos P57, P58, and P59 for an example of use of this technique.)

5. **The following is a general rule in soil nailing: unstable soil conditions which are encountered during any type of excavation should immediately be resupported with soil bermed back against the excavation face. The key is to berm the soil back against the face immediately; do not extend exposure time since distressing of the face increases with time and aggravates the instability of the exposure. Once the soil has been bermed back, the design engineer and contractor must be contacted for resolution of the situation.**
6. **Tables 2 and 3 summarize the causes of local instability at the cut face of soil nail wall excavations and possible control measures, respectively.**

Table 2. Causes of Local Instability at the Cut Face of Soil Nail Wall Excavations

- Excessive exposure time.
- Moisture loss (loss of capillary tension).
- Presence of one or more of the following types of groundwater above the base of the excavation:
 - High static groundwater table
 - Perched groundwater table
 - Localized seepage zone
- Weak fill material in the upper portion of the excavation.
- Cutting through utility trench backfill.
- Drilling action.
- Poor excavation practices or sequencing.
- Structural discontinuities with adverse orientation:
 - Joints and fractures in rock
 - Fissures in stiff soils
- Obstructions:
 - Cobbles and Boulders
 - Utility structures
 - Rubble fill
- High lateral stresses.
- Vibration from equipment working nearby.

Table 3. Methods of Controlling Local Instability at the Cut Face of Soil Nail Wall Excavations

- Use a battered face for the total depth of the excavation.
- Slope the top excavation lift where weak fill materials are encountered.
- Use a stabilizing berm to place nails through.
- Reduce exposure time by applying the shotcrete prior to drilling nail holes.
- Flashcoat the face with fiber reinforced shotcrete after the nails are installed.
- Dewater the slope face by means of:
 - Horizontal drains
 - Vertical dewatering wells
 - French drains
- Reduce the overall length of exposed excavation face or excavate in segments.
- Excavate in segmental slots and then flashcoat.
- Excavate one half of the vertical height of the lift at a time.
- Change to use of sheetpile, soldier pile, or tieback wall (extreme case).

Soil Nail Installation

Soil nail installation problems are usually associated with soil and groundwater conditions and, at times, with the contractor's equipment or methods. The following are some basic items the inspector may consider to help identify problems with soil nail installation in more difficult ground conditions:

1. **The soil nail hole caves upon retraction of the drilling equipment.** This occurrence indicates either that the drill operator is not using good drill technique to clean the hole or that open hole procedures are not workable due to the ground conditions. Alternative drilling methods must be implemented by the contractor.

Caving and the resulting **loss of ground** is a potential problem that may cause instability of the wall or adjacent structures, or both. As the inspector, you should monitor the drilling operation to ensure that loss of ground is not occurring. Where there is a high degree of risk to adjacent structures, vertical and horizontal deflection of both the adjacent and soil nail structures should be monitored. Obvious signs of ground loss include the following:

- Inability to withdraw drill steel.
- Large quantity of cuttings with little or no advancement of the drillhole.
- Abnormally large drill spoil pile in comparison to other drillholes. This is especially noticeable with auger drilling.
- Subsidence of ground above the drilling location.
- Inability to insert the soil nail tendon the full length of the drilled hole.

Cased drilling methods are commonly required when severe caving ground conditions or groundwater are encountered. Hollow stem ("auger-cast") or solid stem augers generally are not used in severe caving conditions, because the caving soil can be carried out of the hole by the auger flights, thereby creating an enlarged hole diameter or void in the ground. Drilling in saturated sands can result in large voids. Use of augers can continually transmit the saturated sands to the ground surface. Large voids should not be allowed to develop. Voids may be encountered during, or caused by, drilling. Small voids can be filled during soil nail grouting. Large voids may require grouting through a series of vertical holes drilled adjacent to the soil nail.

Visual identification and sampling of the soil removed by drilling, as well as the soil exposed in the excavation, is a key to identifying the source of any conditions causing caving. This information is also useful to resolve a claim situation. One or two representative soil samples should be taken at the beginning of construction, and stored in air-tight containers until the project is complete. Increased numbers of samples should be taken if the contractor indicates that changed or differing conditions are being encountered. When changed conditions are a possibility, site photographs are also recommended. In addition, the design engineer should be immediately apprised of the site conditions.

2. **Upon retraction of the drilling equipment, excessive drill cuttings or slough remain in the hole.** This indicates that sufficient cutting removal is not occurring using the current drilling procedures. The contractor must alter his/her methods to provide sufficient removal of cuttings. This alteration may involve a complete change in drilling methods, or simply the use of a hand cleaning tool. An alteration in drilling procedures (such as the addition

of compressed air to augment removal of cuttings while drilling with hollow-stem flight augers) may be appropriate. The use of water to remove drill cuttings usually is not allowed.

3. **The nail is retracted with the auger during grouting of auger-cast installations.** Typically this will occur due to concrete aggregate lodging between the tendon and the sidewall of the auger, or due to a centralizer (if used) catching on a flight connection. In either case, the tendon should be pulled from the auger, the equipment cleaned and reassembled, and the installation repeated. A screen can be placed over the hopper of the grout pump to separate coarse aggregate from the grout delivered to the drillhole.
4. **Upon retraction of the drilling equipment, the drillhole remains open, but contains groundwater.** This situation must be discussed with the design engineer, and the specialty contractor should provide an acceptable drilling/installation procedure. The variables to consider in resolving this condition include the depth of groundwater in the hole, the soil type, the time lapse between drilling and grouting, and the location of the nail(s). Use of tremie grouting may still provide acceptable results. An alternative to open hole installation under these circumstances may include auger-cast or cased installations.
5. **During drilling, the drill steel (i.e., auger, drill rods, or casing, etc.) becomes stuck or shears and breaks off in the drillhole.** Every attempt should be made to retract the drilling steel. Upon retraction of the drill steel, the condition of the drillhole should be assessed to determine whether re-drilling and completion of the hole are feasible. If hole conditions are not acceptable due to obstructions, caving, or other problems, the hole should be backfilled with tremie grout and the soil nail relocated as directed by the design engineer. The design engineer should also be contacted if retraction of the drill steel is impossible.
6. **Visual observation indicates that there is interconnection between adjacent drillholes.** One of the rarer problems encountered is interconnection between drillholes. Interconnections are very difficult to detect during auger drilling. Two possible indications of interconnection include loss of spoils returned at the hole face or the creation of slough in adjacent, previously drilled holes. Both of these conditions are unacceptable, and alternative drilling and/or grouting methods should be implemented. If compressed air is used in the drilling operation, interconnections are typically indicated by air flow from adjacent, previously drilled holes. When interconnections are noted, drilling of adjacent soil nails should be done only after tendon insertion and grouting have occurred in the current hole. To allow time for grout set-up, drilling and installation of skipped nails should not be initiated for at least 12 hours. If compressed air is noted to exit a previously grouted nail hole, the nail should be removed and reinstalled or replaced, since the integrity of the grout-to-soil bond may have been compromised.

Grouting

The following are some basic items the inspector may consider to help identify problems with soil nail grouting in more difficult ground conditions:

1. **Very high grout takes are occurring.** Excessively high grout takes may indicate an enlarged nail hole, voids in the soil or rock, or more rarely "hydraulic fracturing" (cracking) of the soil. Hydraulic fracturing can occur when high grout pressures are used, or when shallow soil overburden is present above the drillhole and pressure grouting is used.

Hydraulic fracturing can also occur during air rotary drilling if excessively high air pressure or penetration rates are used. The contractor must evaluate his drilling and grouting methods to determine if alternative methods should be implemented. Where the excessive grout take is determined to be due to natural voids in the soil or rock, use of a stiffer (sand aggregate) grout mix or containment of the grout by means of a geotextile "sock" (placed over the nail and inserted into the hole with the nail and then filled with grout), have worked successfully.

2. **During extraction of the tremie pipe, the pipe becomes stuck in the hole.** This occurrence may be due to the grout mix being too stiff and locking up the tremie pipe in the drillhole. Rather than extracting the pipe quicker, the grout mix should be proportioned with a higher slump.
3. **Test nails are failing and required design adhesion cannot be obtained with open hole tremie grouting methods.** Procedures which are available (but more costly), for increasing nail adhesion using modified tieback anchor technology, include:
 - In cohesive soils where the drillhole sidewall has been smoothed due to drilling action, the sidewall may be "roughened" by using an eccentric, protruding tooth on the drill bit.
 - Secondary high-pressure grouting can be performed throughout the entire nail length.
 - Pressure-injected or high pressure grouted soil nails may be used in cohesionless soils. Grout pressures typically are greater than 150 psi. High pressure grouting in caving soil is generally used in combination with cased or supported hole drilling methods. Augers can be used, but generally only when grout pressures are slightly above 150 psi. For this type of grouting, grout is generally tremied to the bottom of the hole through a casing or a grout tube. Grouting takes place as the casing, or grout tube, is withdrawn. It is possible to inject large volumes of grout into the ground during high pressure grout injection. The contractor must exercise careful control of the grout volume and grout pressure to avoid disturbance of the overburden soils and of adjacent soil nails, structures, and utilities.
 - Regrouted soil nails are primarily used in cohesive soils, but can be used in any ground type. Regrouting uses multiple grout injections to enlarge the soil nail grout bulb throughout the entire nail length. This technique fractures previously placed grout and wedges it out into the soil. Each injection is separated by about 24 hours. Regrouting can be used in both uncased and cased holes. A special type of grout tube is utilized for the regrouting method. The grout tube is designed with valves located as required along the entire nail length. The tubing and valves are typically secured to the nail prior to installation. A double packer is sometimes used inside the tube to selectively grout each valve. Other methods of regrouting are also used which do not allow selective regrouting.

Grouting equipment usually includes a pressure gauge at the pump. **The inspector should be aware that this gauge can clog with grout and should be checked periodically and cleaned at least daily to ensure correct readings.** Prior to the start of high-pressure grouting, the pressure head loss due to friction of grout passing through the hoses and drill rods, should be determined with the tube, auger, or casing out of the ground. The head losses should be determined using grout hose lengths and elevation differences (between the pressure gauge and exit point of the grout) similar to those that will be used during installation. The pressure required to just pump the grout through the system is the "pressure head loss". Head losses may be high if a low-slump grout is used or if the length of hoses and drill rod is very long. A minimum positive net pressure (i.e., a pressure that exceeds the head loss) should be maintained at all times. Voids may develop in the grout if positive net pressure is not maintained.

Shotcrete Facing

1. **Groundwater presence or caving/sloughing soils can adversely affect shotcrete placement.** Shotcrete cannot be applied to the soil face without control of groundwater. The hydrostatic pressures that build up after application of the shotcrete will inevitably result in sloughing or blow-off of the shotcrete and an inadequate finish facing. Therefore, all groundwater must be captured with the geocomposite drain strips and discharged to the toe of the lift. Discharge of collected water away from the toe of the lift must also be accomplished. If the groundwater cannot be adequately captured with the geocomposite drain strips, then weepholes and/or horizontal drains may have to be installed.
2. **Overbreaks or slough-outs that will be backfilled with shotcrete may require the installation of additional steel reinforcement to support the shotcrete.**
3. **On occasion, groundwater will bleed through the shotcrete at a specific location, resulting in continued sloughing or erosion of the shotcrete.** If this occurs, the inspector, designer, and contractor should agree on how to proceed. Experience has shown that the installation of a short piece of small diameter flexible surgical tubing at the point of discharge provides a conduit for groundwater flow, and may resolve the sloughing condition. In time, flow from the tubing should cease as the wall attains strength and the drainage system captures the groundwater. The tubing can then be cut off and the penetration hole finished off with shotcrete, or dry-packed.
4. **The placement of too much drainage matting may result in sloughing or fall-off of shotcrete.** Typically, this occurrence is due to vibration of the matting and/or lack of adequate ground surface area to which the shotcrete can bond. The amount of matting should be reduced, if approved by the design engineer. If the amount of matting cannot be reduced, it must be better secured to the cut face to prevent vibration.
5. **Shotcrete placement against cohesionless soils results in pull-off or sloughing of the shotcrete before a sufficient lift thickness can be achieved.** This situation usually can be remediated by slowly building up the thickness, or by first placing a light shotcrete flashcoat over the exposed soils and allowing it to set up prior to initiating a full lift placement. This flashing cements the cohesionless soil grains together and will sometimes provide the necessary strength for the soil to then support the full weight of the shotcrete.

P51

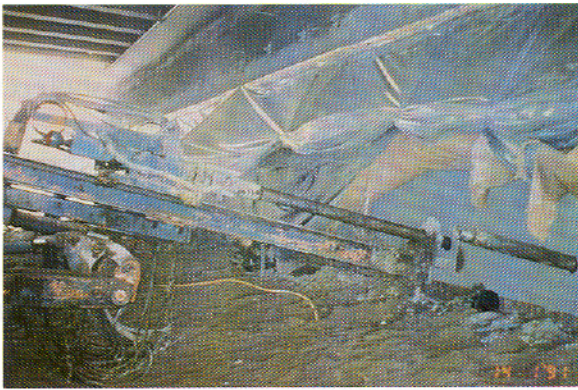

P54

P52



P55

P53

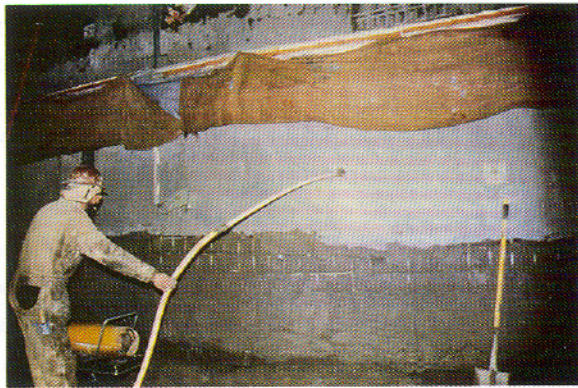

P56

- P51. Drilling through shotcrete facing and using casing due to caving ground.
- P52. Shotcreting against wood "false form" to repair sloughed excavation face. Note that continuity of drain strips is maintained.
- P53. Backfilling void behind false forming with grout after shotcrete facing has set up. Requires grout and vent holes drilled through the shotcrete.
- P54. Use of segmental slot excavations to prevent face sloughing.
- P55. Shotcrete and excavation to finish face in segmental slot excavations.
- P56. Completed shotcrete face closure in segmental slot excavations. CIP final facing was later placed over shotcrete.

Handling Difficult Ground.

P57



P59



P58



P60



- P57. Example of PVC pipe weepholes through shotcrete face where heavier seepage areas were encountered in excavation.
- P58. Vertical prefab drain strips placed over weepholes on shotcrete front face.
- P59. Closeup of prefab drain strip attached to shotcrete front face and over weepholes. Note outlet drain holes are also provided through the final CIP facing at base of drain strips.
- P60. One example of "final resolution" of "dispute" between field inspector, contractor, and wall designer (before partnering!).

Handling Difficult Ground.

GLOSSARY OF TERMS

GENERAL

Alignment Load: A nominal minimum load maintained on a test soil nail to keep the testing equipment positioned.

Bar Coupler: A threaded connector for joining two nail tendons.

Coarse-Grained Soils: Soils with more than 50 percent of the material larger than the 0.074 mm (U.S. No. 200) sieve size.

Construction Slope: A slope excavated for general construction purposes (mass excavation). A slope other than the excavation cut face of the soil nail wall.

Contractor: The person/firm responsible for construction of the soil nail wall system. In the case of design/build projects, also the person/firm responsible for design.

Corrosion Protection: The coating(s) installed around the nail tendon to protect against corrosion. May consist of encapsulation, epoxy coating, grout or some combination of these measures.

Creep Movement: The total movement that occurs during the creep test of a soil nail.

Creep Test: A test to determine the movement of the soil nail at constant load during a specified period of time. Creep tests are typically performed as part of other types of tests, such as ultimate, verification or proof tests.

Design Adhesion: The allowable interface adhesion or bond between the ground and the soil nail grout. Same as allowable bond stress. Usually expressed as capacity (force) per unit length of nail (e.g., N/m or plf, newtons per meter, or pounds per lineal foot) or as bond stress per unit interface area (e.g., Pa or psf or psi, pascals or pounds per square foot, or pounds per square inch). Equal to Ultimate Adhesion reduced by the adhesion design factor of safety.

Design Load: The maximum load anticipated to be applied to the soil nail during its service life multiplied by the factor of safety used in the design of the nailed structure.

Elastic Movement: The recoverable movement of a soil nail tendon measured during a load test.

Excavation Lift: The vertical height of excavation that is completed in stages as each row of nails is installed. Typically, the upper and lower limits of each lift are centered between the nail rows, with the height of the lift equal to the vertical spacing between nail rows. Nominal over-excavation is typically performed at the bottom of the lift to accommodate minimum lapping of the reinforcing steel.

Fiber-Reinforced Shotcrete: Shotcrete batched with either steel or polypropylene fiber additives.

Fine-Grained Soils: Soils with at least 50 percent of the material smaller than the 0.074 mm (U.S. No. 200) sieve size.

Finish Wall Excavation Line: The design back of wall excavation line ("neat line"), as shown on the plans.

Geocomposite Drain: Pre-manufactured drainage components used for control and discharge of water from behind the soil nail wall. Specifications/plans will detail acceptable materials and installation procedures.

Minimum Ultimate Tensile Strength: The minimum breaking strength (MPa or ksi) of the nail tendon, as determined in tension, according to applicable AASHTO/ASTM Specifications. Applicable to "high-strength" deformed prestressing bars, i.e. Grade 150 (GR150) bars conforming to AASHTO M275/ASTM A722.

Permanent Soil Nail: A soil nail that is to remain in service longer than 18 months.

Proof Test: Non-destructive pullout load test performed on either a sacrificial or production soil nail to evaluate its ability to safely withstand design loads without excessive structure movement or long term creep.

Pullout Failure: Pullout failure occurs when the ground-grout (or nail-grout) adhesion is overcome and the test nail pulls out of the ground (or grout). Attempts to increase the test load simply result in continued pullout movement of the nail.

Pullout Failure Load: The maximum load at which the test nail experiences pullout failure.

Reinforcing Steel: Grade 60 (GR60) deformed reinforcing bars conforming to AASHTO M31/ASTM A615, welded smooth wire fabric conforming to AASHTO M55/ASTM A185, and welded deformed wire fabric conforming to AASHTO M221/ASTM A497.

Residual Movement: The non-elastic (non-recoverable) movement of a test nail measured during a pullout load test.

Shotcrete: Mortar or concrete pneumatically projected on to a surface at high velocity by either the wet-mix or dry-mix process. Same as pneumatically applied concrete. Shotcrete is composed of specified water, cement, sand and/or coarse aggregate, and admixtures (when allowed). "Wet-mix" shotcrete is shotcrete in which all of the ingredients, including water, are mixed before introduction into the delivery hose. Compressed air is introduced to the material flow at the nozzle. "Dry-mix" shotcrete is shotcrete in which most of the mixing water is added at the nozzle. "Guniting" is a general term used to describe the dry-mix process and is no longer recommended terminology.

Shotcrete Flashcoat: A thin (typically 25 to 50 mm or 1 to 2 inch) layer of shotcrete placed to protect soil from erosion, or to stabilize soil sloughing from the finish wall excavation line.

Typically, it will be unreinforced or only lightly reinforced and may contain reinforcing fibers and/or strength accelerators.

Shotcrete Rebound: Shotcrete material leaner than the original mixture that ricochets off the receiving surface.

Soil Nail Assembly: The complete soil reinforcing assembly, consisting of steel tendon, centralizers, grout, corrosion protection (when required), bearing plates, beveled washers, and nuts. The term "soil nail" as used in this manual, is intended as a "generic" term applying to nails installed in any type of ground.

Soil Nail Drillhole: A hole in the ground created with a drill rig and into which the soil nail tendon is placed and then filled with grout. This term is interchangeable with "soil nail borehole."

Soil Nail Length: The total grouted (bonded) length of a completed production soil nail.

Soil Nail Wall System: Soil nails and structural facing, used to retain vertical, stepped or battered excavations. The soil nail wall system includes the soil nail assembly, corrosion protection coatings, couplers if used, drainage system, and reinforced wall facing.

Stand-Up Time: The duration of time over which ground exposed in finish wall excavation cut faces will remain stable without excessive or detrimental sloughing or caving.

Temporary Soil Nail: A soil nail that is to remain in service for a period of 18 months or less.

Ultimate Adhesion: The ultimate capacity of the adhesion or bond between the ground and the soil nail grout. Same as "ultimate bond stress." Usually expressed as capacity (force) per unit length of nail (e.g. N/m or plf, newtons per meter or pounds per lineal foot) or as bond stress per unit interface area (e.g. Pa or psf or psi, pascals or pounds per square foot or pounds per square inch).

Ultimate Test: A destructive pullout load test performed on a sacrificial test soil nail until pullout failure takes place along the grout-ground interface. Used to define the ultimate adhesion capacity.

Verification Test: A load test performed on a sacrificial test soil nail to confirm that the soil nail is capable of achieving the specified design adhesion capacity with a specified acceptable factor of safety.

Welded Wire Mesh: Welded smooth or deformed wire fabric, typically used to reinforce shotcrete facings.

Yield Strength: Specified minimum yield strength or yield point (MPa or ksi) of reinforcement and nail tendons, as determined in tension according to applicable AASHTO/ASTM Specifications. Applicable to "mild steel" deformed reinforcing bars, e.g. Grade 60 (GR60) bars conforming to AASHTO M31/ASTM A615.

PRODUCTION SOIL NAILS (Refer to Figure 5)

Bearing Plate/Nut/Beveled Washer: The steel plate, nut, and washer that secure the nail to the shotcrete facing.

Centralizer: PVC, steel, or other approved material installed along the soil nail tendon at intervals sufficient to approximately center the tendon in the drillhole and/or provide the specified minimum grout cover.

Drilled Length: The soil nail drillhole length as specified in the contract documents.

Tendon: Nail steel consisting of a deformed bar.

Tendon Length: The total length of the nail tendon.

TEST SOIL NAILS (Refer to Figure 6)

Bonded Test Length: The length of the test nail tendon that is bonded to the ground with grout and that develops adhesion during testing.

Jack: A center-hole hydraulic jack and pressure gauge used to apply load to the nail tendon during testing.

Jacking Frame: A reaction plate or frame used to resist loads induced during nail testing and to limit displacement of the test apparatus.

Load Cell: An electronic device capable of measuring small changes in load.

Reference Plate: Steel plate placed on the tendon for the purpose of measuring tendon elongation during testing. This may be a bearing plate.

Test Nail Length: The combined length of the bonded and unbonded portions of the test nail.

Unbonded Test Length: The length of the portion of the test nail tendon that is not bonded to the ground with grout and is free to elongate during testing.

REFERENCES

The intent of this manual is to provide a brief overview of soil nailing, how it works, and what it requires in terms of field construction inspection. More detailed discussions on the technical aspects of soil nails are beyond the scope of this manual. If additional information is desired, the following references are recommended:

1. AASHTO Standards:

- M85: Portland Cement
- M183: Structural Steel
- M252: Corrugated Polyethylene Drainage Tubing
- M275: Uncoated High-Strength Steel Bar
- M284: Epoxy-Coated Reinforcing Bars

2. ASTM Standards:

- A-53: Steel Pipe
- A-1785: Specification for Poly Vinyl Chloride (PVC) Plastic Pipe, Schedule 40, 80 and 120
- E-74: Practice for Calibration of Force Measuring Instruments for Verifying the Load Indication of Testing Machines
- E-380 Standard Practice for the Use of the International System of Units (SI) (The Modernized Metric System).

3. American Association of State Highway and Transportation Officials, Manual on Subsurface Investigations, 1988.
4. American Concrete Institute (ACI), Building Code Requirements for Reinforced Concrete (ACI 318-83), 1984.
5. American Concrete Institute (ACI), Guide to Shotcrete (ACI 506R), Guide to Certification of Shotcrete Nozzlemen (ACI 506.3R), and Specification for Materials, Proportioning and Application of Shotcrete (ACI 506.2).
6. AASHTO-AGC-ARTBA, Task Force 27 Report, Ground Anchor Inspector's Manual, 1990.
7. ASTM E380-92, Standard Practice for Use of the International System of Units (SI), 1992.
8. National Institute of Building Sciences, Metric Guide for Federal Construction, 1st Edition, 1991.
9. Post-Tensioning Institute, Recommendations for Prestressed Rock and Soil Anchors, 1986.

APPENDIX A
BLANK FORMS

SOIL NAIL INSTALLATION FORM

Structure _____ Nail Number _____ Date _____

Inspector _____ Contract _____ Location _____ Station _____

Method _____ Rig Type _____

Hole Diameter _____ Inclination _____ Tolerance Deviation _____

Remarks _____

NAIL

Bar Diameter _____ Bar Length _____ Total Steel Area _____

Bond Length _____ Unbonded Length _____ Design Load _____

Remarks _____

GROUTING

Cu. Ft./Stroke _____ Start Time _____ Finish Time _____

Pump Pressure _____

Pumped Volume _____ x _____ = _____

Hole Volume _____ x _____ = _____

Grout Take (Ratio Pump Vol./Hole Vol.) _____

Remarks _____

UNBONDED ZONE BACKFILL

Date _____ Placement Method _____

Start Time _____ Finish Time _____ Estimated Grout Volume _____

Remarks _____

Soil Nail Accepted _____ Date _____

Remarks _____

JACK CALIBRATION CHART

Calibration Performed by: _____

FIRM INFORMATION:

INDIVIDUAL INFORMATION:

Name: _____

Name: _____

Address: _____

Signature: _____

Date: _____

Date: _____

Phone No.: () _____

JACK NO.: _____ PRESSURE GAGE NO.: _____ REFERENCE GAGE NO.: _____

Increment Number	PRESSURE (psi)	LOAD (lbs)	CALC. LOAD (lbs)	ERROR (%)
1				
2				
3				
4				
5				
6				
7				
8				
9				
10				
11				
12				
13				
14				
15				
16				
17				
18				
19				
20				

CALIBRATION OF JACKING SYSTEM

Reference Guage: _____

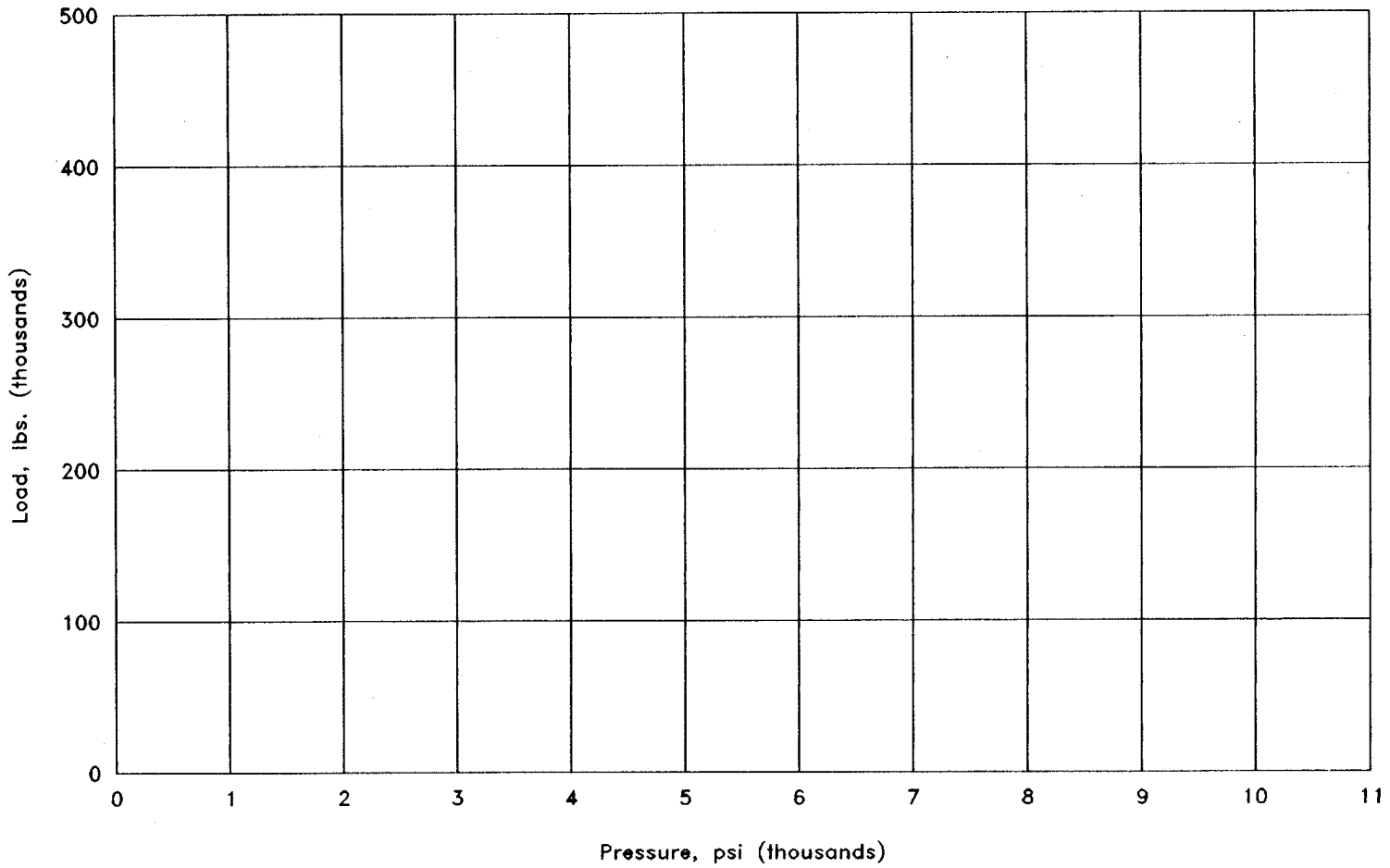

Serial Number: _____

ELASTIC MOVEMENT

Project: _____ Soil Nail No.: _____
 Project No.: _____ Bonded Length: _____
 Date: _____ Unbonded Length: _____
 Bar Size: _____ Bar Dia.: _____ (in.) Cross-sectional Area: _____ (sq.in.)

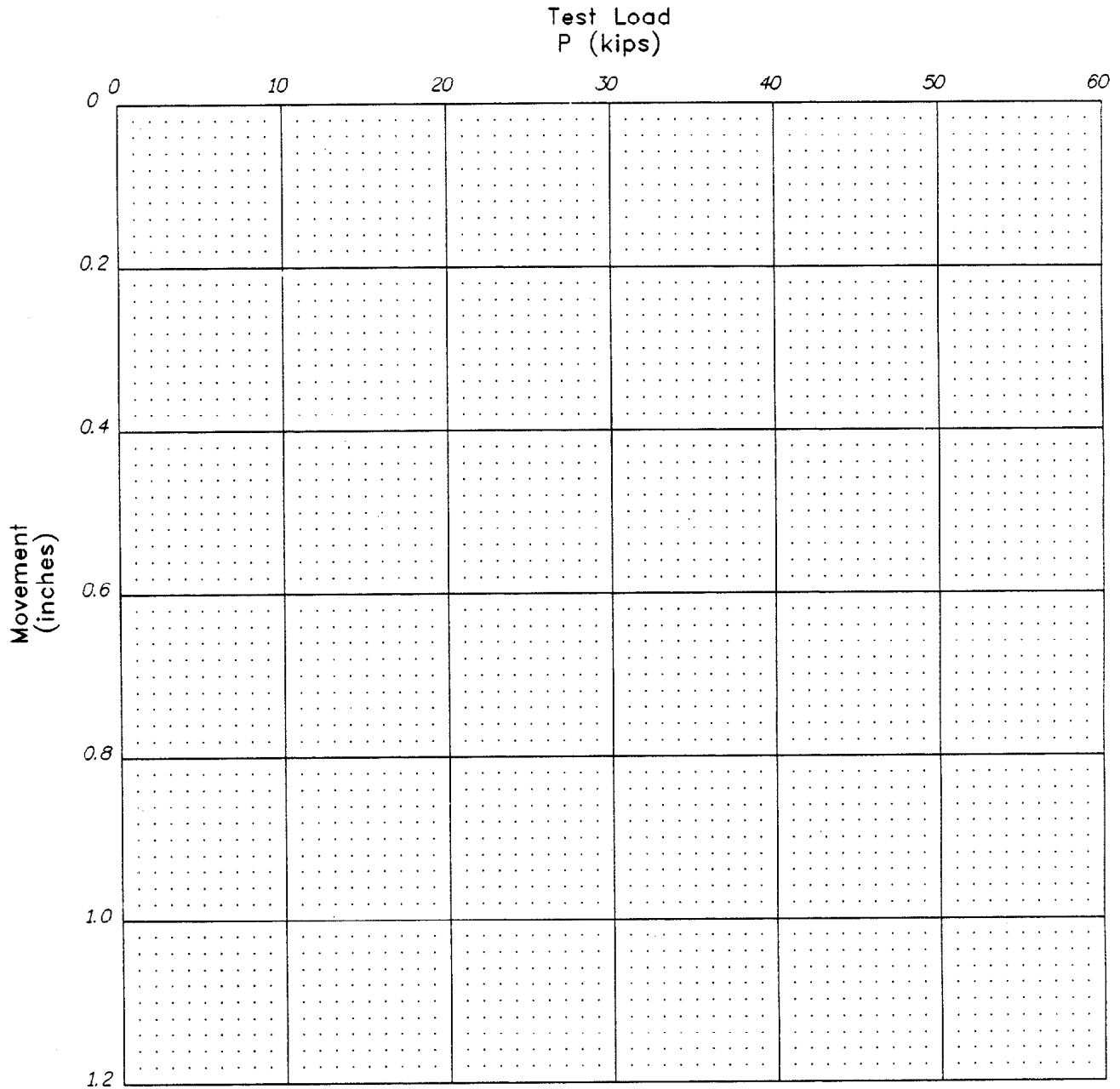

Test Acceptance Criteria:

$$\text{Meas. Movement} > \frac{0.8 \times P \times UL \times 12}{A \times E} \quad ?$$

Where:

- A = area of tendon (sq.in.)
- UL = unbonded length (ft.)
- P = test load (Kips)
- E = 29,000 Ksi

TEST NAIL CREEP MOVEMENT

Project: _____

Soil Nail No.: _____

Project No.: _____

Date: _____

Creep Movement (inches)

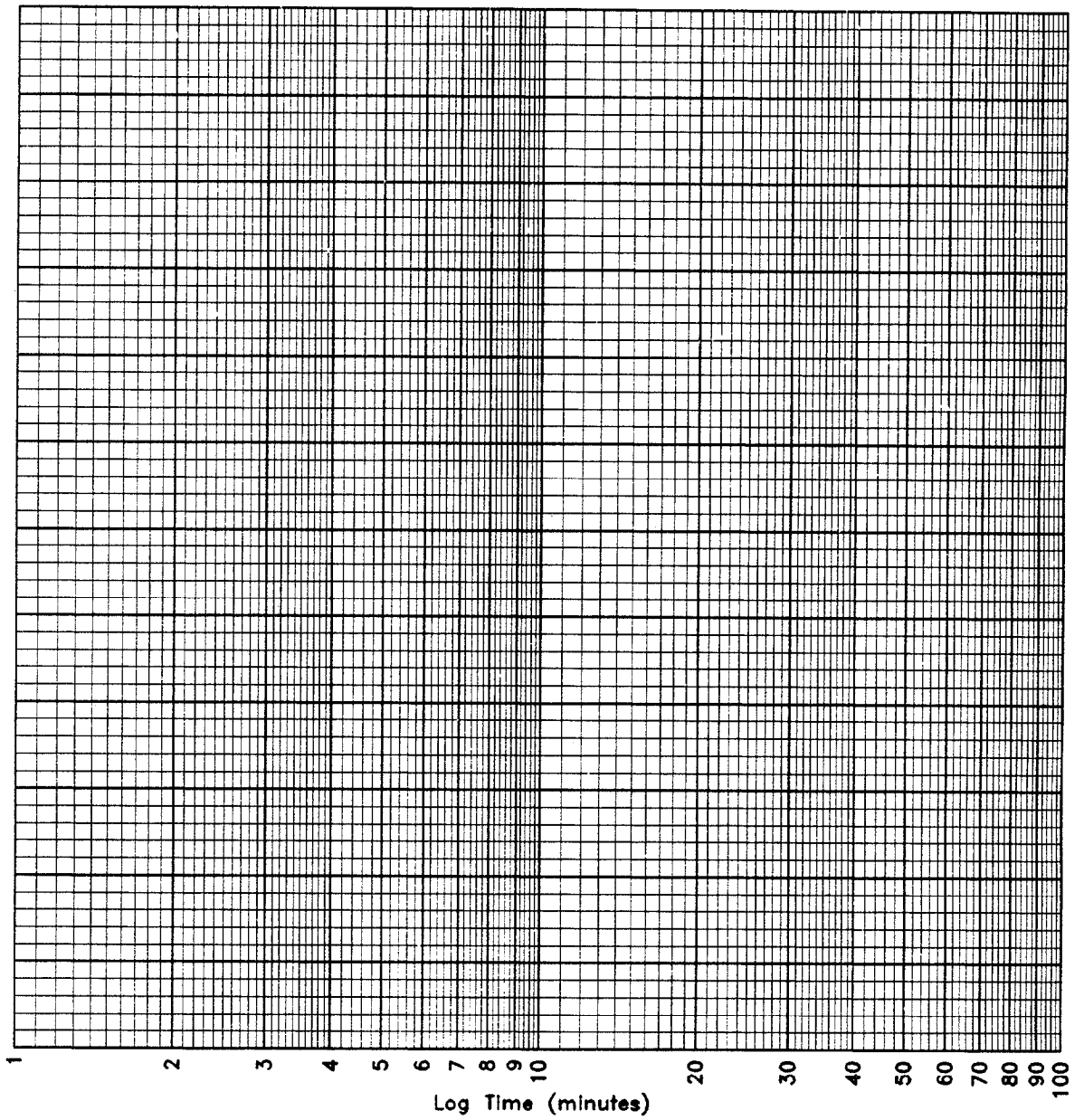

APPENDIX B
EXAMPLES OF COMPLETED FORMS

SOIL NAIL INSTALLATION FORM

Structure Retaining Wall #10 Nail Number Row 1, #5 Date 7/20/92
Inspector J. Smith Contract SN-3223 Location SR5 Main Blvd. Station 20+00
Method Open Hole Rig Type Klem Advancing 6" Dia. Solid Stem Auger
Hole Diameter 6 in. Inclination 15° Tolerance Deviation None
Remarks 0'-4' = SILTY SAND (Fill)
4'-20' = SANDY SILT (Native); No Groundwater

NAIL

Bar Diameter 1 in. Bar Length 18 ft. Total Steel Area 0.85 sq. in.
Bond Length 15 ft. Unbonded Length 3 ft. Design Load 24 Kips
Remarks Epoxy coating; centralizers; and installation
procedures conform with specifications

GROUTING

Cu. Ft./Stroke 0.13 Start Time 1:07 pm Finish Time 1:10 pm
Pump Pressure 75 - 100 psi
Pumped Volume 28 strokes x 0.13 cu. ft./stroke = 3.64 cu. ft.
Hole Volume 15 ft. x 0.1964 sq. ft. = 2.95 cu. ft.
Grout Take (Ratio Pump Vol./Hole Vol.) 1.23
Remarks Grout placed by Tremie pipe in 15 ft. bonded
length for proof test; no grouting problems

UNBONDED ZONE BACKFILL

Date 7/24/92 Placement Method Tremie Pipe
Start Time 8:00 am Finish Time 8:05 am Estimated Grout Volume 0.6 cu. ft.
Remarks Grout returns via vent tube - adequate grout backfill

Soil Nail Accepted _____ Date 7/24/92
Remarks Soil nail installation; grouting; and
proof test results conform with specifications/drawings

SOIL NAIL INSTALLATION SUMMARY

Project: SR14-WALL #10 Project No.: SR14 W10 Field Inspector: J. JONES

Soil Nail Number	Date	Diameter/Method/Length	Rig Type	Inclination	Soils	Tendon Dia./Grade/Length	Grouting	Remarks
R1-1	2-2-93	6"/OH/20'	HSA	15°	FILL/SILT	#8/60/21'	OH TRENIED	
R1-2	2-2-93	6"/OH/20'	HSA	15°	FILL/SILT	#8/60/21'	OH TRENIED	
R1-3	2-2-93	6"/OH/20'	HSA	15°	FILL/SILT	#8/60/21'	OH TRENIED	
R1-4	2-2-93	6"/OH/20'	HSA	15°	SILL/SILT	#8/60/21'	OH TRENIED	
R1-5	2-2-93	6"/OH/20'	HSA	15°	FILL/SILT	#8/60/21'	OH TRENIED	PROOF TEST NAIL
R1-6	2-2-93	6"/OH/20'	HSA	15°	FILL/SILT	#8/60/21'	OH TRENIED	(BL=15' UL=6')
R1-7	2-2-93	6"/OH/20'	HSA	15°	FILL/SILT	#8/60/21'	OH TRENIED	
R1-8	2-2-93	6"/OH/20'	HSA	15°	FILL/SILT	#8/60/21'	OH TRENIED	
R1-9	2-2-93	6"/OH/20'	HSA	15°	FILL/SILT	#8/60/21'	OH TRENIED	
R1-10	2-2-93	6"/OH/20'	HSA	15°	FILL/SILT	#8/60/21'	OH TRENIED	
R1-11	2-2-93	6"/OH/20'	HSA	15°	FILL/SILT	#8/60/21'	OH TRENIED	
R2-1	2-14-93	6"/OH/22'	HSA	15°	SANDY SILT	#8/60/23'	OH TRENIED	
R2-2	2-14-93	6"/OH/22'	HSA	15°	SANDY SILT	#8/60/23'	OH TRENIED	PROOF TEST NAIL
R2-3	2-14-93	6"/OH/22'	HSA	15°	SANDY SILT	#8/60/23'	OH TRENIED	(BL=15' UL=7')
R2-4	2-14-93	6"/OH/22'	HSA	15°	SANDY SILT	#8/60/23'	OH TRENIED	
R2-5	2-14-93	6"/OH/22'	HSA	15°	SANDY SILT	#8/60/23'	OH TRENIED	
R2-6	2-14-93	6"/OH/22'	HSA	15°	SANDY SILT	#8/60/23'	OH TRENIED	
R2-7	2-14-93	6"/OH/22'	HSA	15°	SANDY SILT/SILTY CLAY	#8/60/23'	OH TRENIED	
R2-8	2-14-93	6"/OH/22'	HSA	15°	SANDY SILT/SILTY CLAY	#8/60/23'	OH TRENIED	
R2-9	2-14-93	6"/OH/22'	HSA	15°	SANDY SILT/SILTY CLAY	#8/60/23'	OH TRENIED	
R2-10	2-14-93	6"/OH/22'	HSA	15°	SANDY SILT/SILTY CLAY	#8/60/23'	OH TRENIED	
R2-11	2-14-93	6"/OH/22'	HSA	15°	SANDY SILT/SILTY CLAY	#8/60/23'	OH TRENIED	

NOTES: HSA = HOLLOW STEM AUGER
OH = OPEN HOLE

JACK CALIBRATION CHART

Calibration Performed by: TSSI

FIRM INFORMATION:

Name: R. JACOBS
 Address: 1441 NE 1ST, PORTLAND, OR
 Date: 2-23-93
 Phone No.: (503) 907-7213

INDIVIDUAL INFORMATION:

Name: S. SMITH
 Signature: _____
 Date: 2-23-93

JACK NO.: 95-121 PRESSURE GAGE NO.: P002 REFERENCE GAGE NO.: RG11

Increment Number	PRESSURE (psi)	LOAD (lbs)	CALC. LOAD (lbs)	ERROR (%)
1	1,000	38,500	40,041	-4.00
2	2,000	80,000	81,182	-1.48
3	3,000	121,250	122,323	-0.88
4	4,000	163,000	163,464	-0.28
5	5,000	207,000	204,605	1.16
6	6,000	248,000	245,745	0.91
7	7,000	292,000	286,886	1.75
8	8,000	327,000	328,027	-0.31
9	9,000	368,500	369,168	-0.18
10	10,000	406,500	410,309	-0.94
11				
12				
13				
14				
15				
16				
17				
18				
19				
20				

CALIBRATION OF JACKING SYSTEM

Reference Gauge: RG11

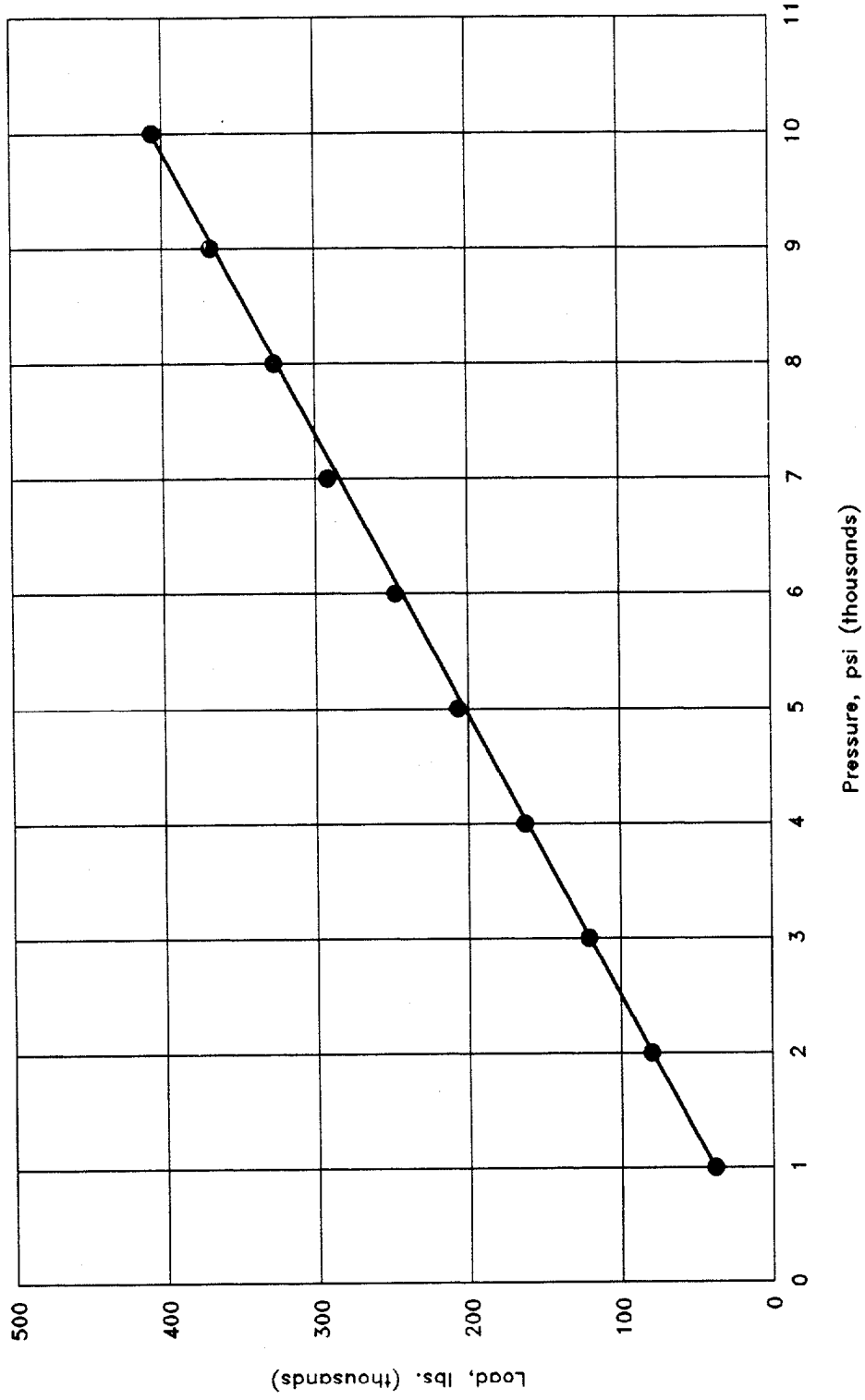

Serial Number: 95-121/P002

ELASTIC MOVEMENT

Project: SR14-WALL #10 Soil Nail No.: R1-5
 Project No.: SR14 W10 Bonded Length: 15'
 Date: 2-23-93 Unbonded Length: 6'
 Bar Size: #8 (GR 60) Bar Dia.: 1.0 (in.) Cross-sectional Area: 0.79 (sq.in.)

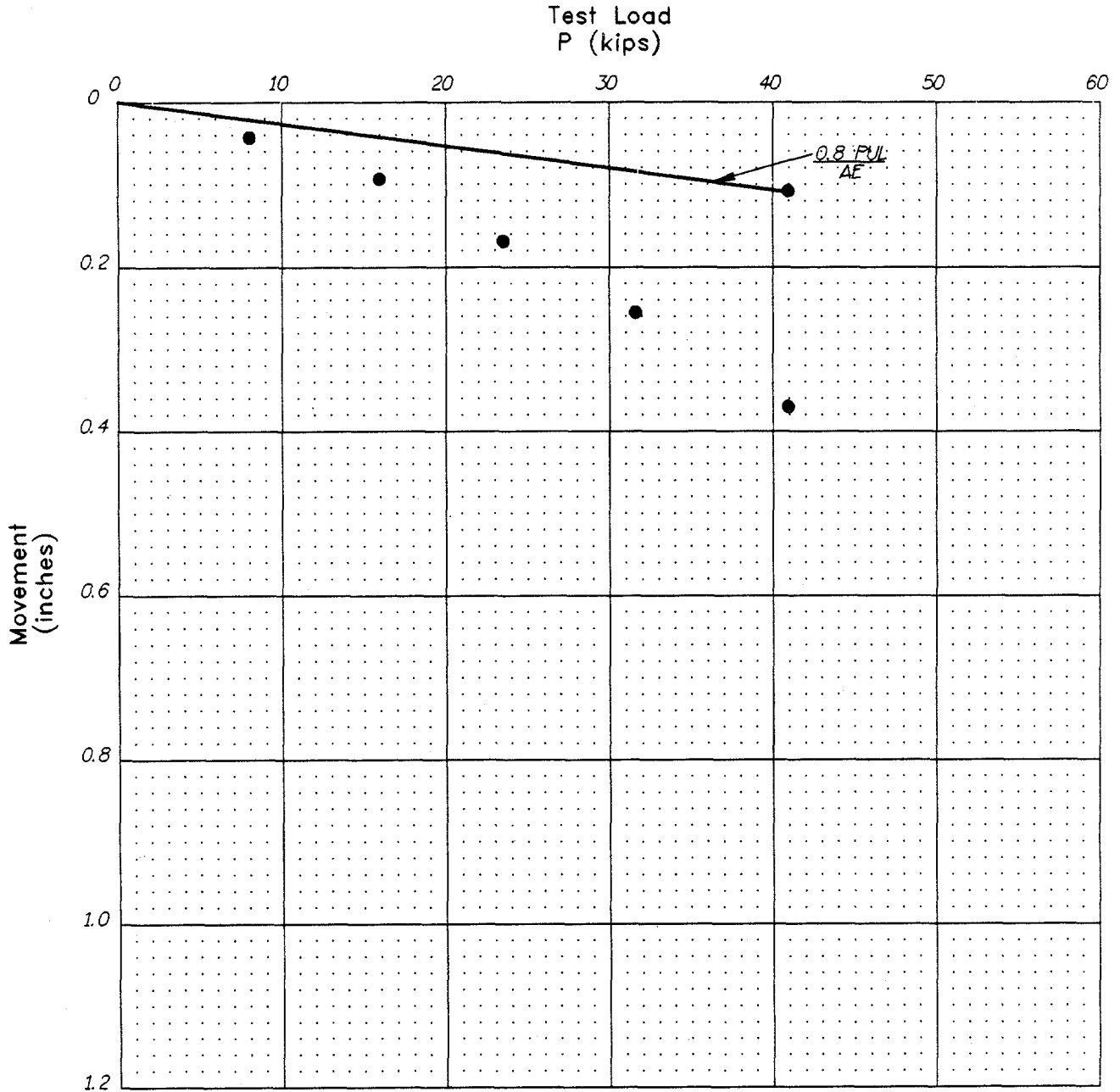

Test Acceptance Criteria:

$$\text{Meas. Movement} > \frac{0.8 \times P \times UL \times 12}{A \times E} \quad ?$$

$$\frac{(0.8)(41)(6)(12)}{(0.79)(29,000)} = 0.103$$

Meas. movement at max. P of
 41 Kips = 0.372 in. > 0.103 in.,
 Therefore Test Nail Passes Elastic Criteria

Where:

- A = area of tendon (sq.in.)
- UL = unbonded length (ft.)
- P = test load (Kips)
- E = 29,000 Ksi

TEST NAIL CREEP MOVEMENT

Project: SR14-WALL #10

Soil Nail No.: R1-5

Project No.: SR14 V10

Date: 2-23-93

