



U.S. Department of Transportation  
Federal Highway Administration

JUNE 1999

OFFICE OF BRIDGE TECHNOLOGY  
400 SEVENTH STREET, SW  
WASHINGTON, DC 20590

# GEOTECHNICAL ENGINEERING CIRCULAR No. 4

## GROUND ANCHORS AND ANCHORED SYSTEMS

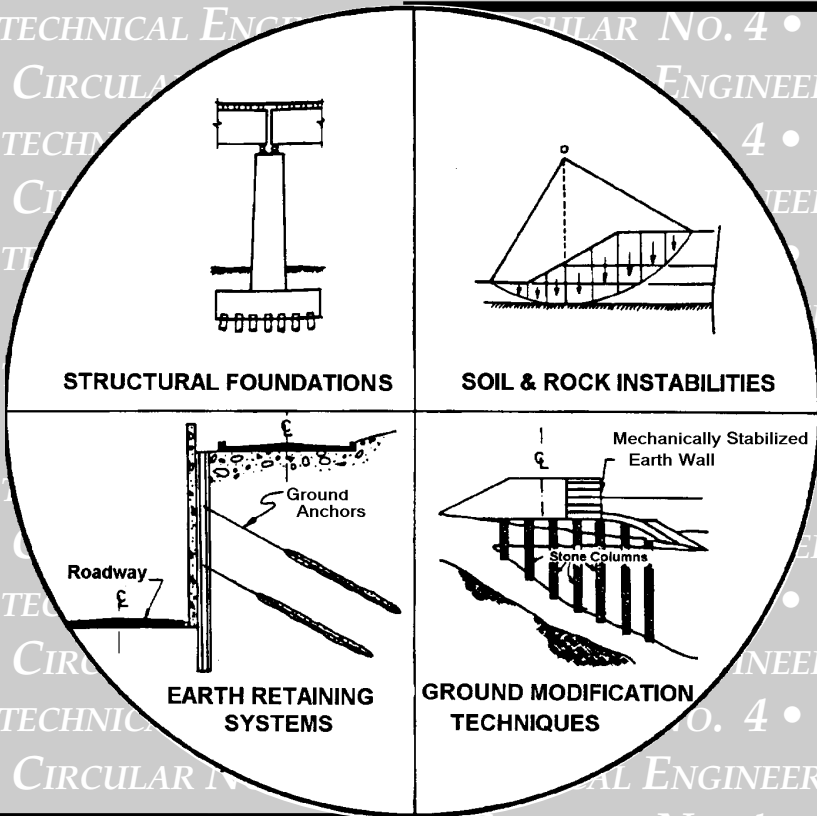

1. Report No. <b>FHWA-IF-99-015</b>		2. Government Accession No.		3. Recipient's Catalog No.	
4. Title and Subtitle  <b>GEOTECHNICAL ENGINEERING CIRCULAR NO. 4 Ground Anchors and Anchored Systems</b>				4. Report Date <b>June 1999</b>	
				6. Performing Organization Code:	
7. Author(s) <b>P.J. Sabatini, D.G. Pass, R.C. Bachus</b>				8. Performing Organization Report No.	
9. Performing Organization Name and Address <b>GeoSyntec Consultants 1100 Lake Hearn Drive Atlanta, Georgia</b>				10. Work Unit No.(TR AIS)	
				11. Contract or Grant No. <b>DTFH61-94-C-00099</b>	
12. Sponsoring Agency Name and Address <b>Office of Bridge Technology Federal Highway Administration HIBT, Room 3203 400 Seventh Street, S.W. Washington D.C. 20590</b>				13. Type of Report and Period Covered  <b>Technical Manual</b>	
				14. Sponsoring Agency Code	
15. Supplementary Notes <b>Contracting Officer's Technical Representative: Chien-Tan Chang (HIBT) FHWA Technical Consultants: Jerry DiMaggio (HIBT), Richard Cheney (HIBT)</b>					
16. Abstract: <p>This document presents state-of-the-practice information on the design and installation of cement-grouted ground anchors and anchored systems for highway applications. The anchored systems discussed include flexible anchored walls, slopes supported using ground anchors, landslide stabilization systems, and structures that incorporate tiedown anchors.</p> <p>This document draws extensively from the FHWA-DP-68-IR (1988) design manual in describing issues such as subsurface investigation and laboratory testing, basic anchoring principles, ground anchor load testing, and inspection of construction materials and methods used for anchored systems. This document provides detailed information on design analyses for ground anchored systems. Topics discussed include selection of design earth pressures, ground anchor design, design of corrosion protection system for ground anchors, design of wall components to resist lateral and vertical loads, evaluation of overall anchored system stability, and seismic design of anchored systems. Also included in the document are two detailed design examples and technical specifications for ground anchors and for anchored walls.</p>					
17. Key Words <b>Ground anchors, soldier beam and lagging walls, limit equilibrium, earth pressures, axial capacity, tiedowns, seismic design, contracting, specifications</b>			18. Distribution Statement <b>No Restrictions. This document is available to the public from the National Technical Information Service, Springfield, Virginia 22161</b>		
19. Security Classif. (of this report) <b>Unclassified</b>		20. Security Classification (of this page) <b>Unclassified</b>		21. No. of Pages <b>281</b>	22. Price

## ACKNOWLEDGEMENTS

The authors would like to express their appreciation to Mr. Richard S. Cheney, P.E., of the U.S. Department of Transportation Federal Highway Administration (FHWA) for providing significant technical assistance and review during preparation of the document. The authors would also like to thank Dr. Donald A. Bruce, C.Eng of ECO GeoSystems Inc. for providing technical assistance. Dr. Richard Jewell, C.Eng, formerly of GeoSyntec Consultants, assisted in preparing sections of the document and provided technical assistance. The authors would also like to thank the following individuals who reviewed the document and served on the Technical Working Group for this project:

- James J. Brennan, P.E. – Kansas Department of Transportation;
- Chien-Tan Chang, P.E. – FHWA;
- Joel Moskowitz, P.E., of Mueser Rutledge Consulting Engineers – Deep Foundations Institute;
- Heinz Nierlich of Dywidag-Systems International – Post Tensioning Institute;
- Monti Singla - FHWA;
- John P. Tiernan – Georgia Department of Transportation;
- David E. Weatherby of Schnabel Foundation Company – International Association of Foundation Drilling; and
- Shan-Tai Yeh – Colorado Department of Transportation.

The authors would also like to acknowledge the following firms and agencies that provided photographs and technical information:

- Dywidag-Systems International;
- Hayward Baker Inc.;
- Lang Tendons Inc.;
- Schnabel Foundation Company; and
- Williams Form Engineering Corp.

Finally, the authors would like to thank Mrs. Ann Taylor and Mr. Michael Harris of GeoSyntec Consultants who drafted the figures and assisted in the layout of the document.

## PREFACE

This document presents state-of-the-practice information on the design and installation of cement-grouted ground anchors and anchored systems for highway applications. Anchored systems discussed include flexible anchored walls, slopes supported using ground anchors, landslide stabilization systems, and structures that incorporate tiedown anchors.

This document has been written, in part, to update the design manual titled "Permanent Ground Anchors" (FHWA-DP-68-1R, 1988). This document draws extensively from the FHWA (1988) design manual in describing issues such as subsurface investigation and laboratory testing, basic anchoring principles, ground anchor load testing, and inspection of construction materials and methods used for anchored systems. Since 1988, advances have been made in design methods and from new construction materials, methods, and equipment.

Results of anchored system performance monitoring and research activities conducted since 1989 are also included in this document. Most recently, research was conducted under a FHWA research contract on the design and performance of ground anchors and anchored soldier beam and timber lagging walls. As part of that research project, performance data on model- and full-scale anchored walls were collected and analyzed. Several of the analysis methods and design procedures that were recommended based on the results of the research are adopted herein. This research is described in FHWA-RD-98-065 (1998), FHWA-RD-98-066 (1998), FHWA-RD-98-067 (1998), and FHWA-RD-97-130 (1998).

This document provides detailed information on basic principles and design analyses for ground anchors and anchored systems. Topics discussed include selection of design earth pressures, design of corrosion protection systems for ground anchors, design of wall components to resist lateral and vertical loads, evaluation of overall anchored system stability, and seismic design of anchored systems. Also included in the document are two detailed design examples and technical specifications for ground anchors and for anchored walls.

# TABLE OF CONTENTS

<b>CHAPTER 1 INTRODUCTION.....</b>	<b>1</b>
<b>1.1 Purpose .....</b>	<b>1</b>
<b>1.2 Anchored System Service Life .....</b>	<b>1</b>
<b>1.3 Background .....</b>	<b>2</b>
<b>CHAPTER 2 GROUND ANCHORS AND ANCHORED SYSTEMS.....</b>	<b>4</b>
<b>2.1 INTRODUCTION .....</b>	<b>4</b>
<b>2.2 GROUND ANCHORS .....</b>	<b>4</b>
2.2.1 General.....	4
2.2.2 Types of Ground Anchors .....	6
2.2.2.1 General.....	6
2.2.2.2 Straight Shaft Gravity-Grouted Ground Anchors .....	7
2.2.2.3 Straight Shaft Pressure-Grouted Ground Anchors .....	8
2.2.2.4 Post-grouted Ground Anchors.....	8
2.2.2.5 Underreamed Anchors .....	8
2.2.3 Tendon Materials .....	8
2.2.3.1 Steel Bar and Strand Tendons .....	8
2.2.3.2 Spacers and Centralizers .....	9
2.2.3.3 Epoxy-Coated Bar and Epoxy-Coated Filled Strand .....	10
2.2.3.4 Other Anchor Types and Tendon Materials .....	10
2.2.4 Cement Grout .....	11
<b>2.3 ANCHORED WALLS.....</b>	<b>11</b>
2.3.1 General.....	11
2.3.2 Soldier Beam and Lagging Wall.....	12
2.3.2.1 General.....	12
2.3.2.2 Soldier Beam.....	13
2.3.2.3 Lagging.....	14
2.3.2.4 Construction Sequence.....	15
2.3.3 Continuous Walls .....	15

## TABLE OF CONTENTS (Continued)

<b>2.4 APPLICATIONS OF GROUND ANCHORS.....</b>	<b>16</b>
2.4.1 Highway Retaining Walls .....	16
2.4.2 Slope and Landslide Stabilization.....	17
2.4.3 Tiedown Structures .....	17
<b>CHAPTER 3 SITE INVESTIGATION AND TESTING.....</b>	<b>19</b>
<b>3.1 INTRODUCTION .....</b>	<b>19</b>
<b>3.2 FIELD RECONNAISSANCE.....</b>	<b>19</b>
<b>3.3 SUBSURFACE INVESTIGATION .....</b>	<b>20</b>
3.3.1 General.....	20
3.3.2 Soil and Rock Stratigraphy.....	21
3.3.3 Groundwater.....	22
<b>3.4 LABORATORY SOIL AND ROCK TESTING.....</b>	<b>22</b>
3.4.1 General.....	22
3.4.2 Classification and Index Properties .....	23
3.4.3 Shear Strength.....	23
3.4.4 Consolidation.....	23
3.4.5 Electrochemical Criteria.....	24
<b>3.5 IN SITU SOIL AND ROCK TESTING.....</b>	<b>24</b>
<b>CHAPTER 4 BASIC PRINCIPLES OF ANCHORED SYSTEM DESIGN .....</b>	<b>26</b>
<b>4.1 GENERAL DESIGN CONCEPTS FOR ANCHORED WALLS .....</b>	<b>26</b>
<b>4.2 FAILURE MECHANISMS OF ANCHORED SYSTEMS.....</b>	<b>28</b>
4.2.1 General.....	28
4.2.2 Failure Mechanisms of the Ground Anchor .....	28
4.2.3 Failure of Soldier Beams .....	31
4.2.4. Failure of Lagging.....	32
<b>4.3 SELECTION OF SOIL SHEAR STRENGTH PARAMETERS FOR DESIGN .....</b>	<b>33</b>
4.3.1 General.....	33
4.3.2 Drained Shear Strength of Granular Soils .....	33
4.3.3 Undrained Shear Strength of Normally Consolidated Clay.....	33

## TABLE OF CONTENTS (Continued)

4.3.4	Undrained Shear Strength of Overconsolidated Clay.....	34
4.3.5	Drained Shear Strength of Overconsolidated Clay.....	34
<b>4.4</b>	<b>EARTH PRESSURES .....</b>	<b>36</b>
4.4.1	General.....	36
4.4.2	Active and Passive Earth Pressure .....	36
4.4.3	Earth Pressure at Rest .....	41
4.4.4	Influence of Movement on Earth Pressure .....	41
<b>CHAPTER 5</b>	<b>DESIGN OF ANCHORED SYSTEMS .....</b>	<b>46</b>
<b>5.1</b>	<b>INTRODUCTION .....</b>	<b>46</b>
<b>5.2</b>	<b>EVALUATION OF EARTH PRESSURES FOR WALL DESIGN .....</b>	<b>47</b>
5.2.1	Introduction .....	47
5.2.2	Background .....	48
5.2.3	Terzaghi and Peck Apparent Earth Pressure Diagrams .....	49
5.2.4	Recommended Apparent Earth Pressure Diagram for Sands .....	50
5.2.5	Recommended Apparent Earth Pressure Diagram for Stiff to Hard Fissured Clays .....	52
5.2.6	Recommended Apparent Earth Pressure Diagram for Soft to Medium Clays .....	57
5.2.7	Loading Diagrams for Stratified Soil Profiles .....	60
5.2.8	Sliding Wedge Analysis Method .....	60
5.2.9	Water Pressures.....	62
5.2.10	Earth Pressures Due To Surface Loads.....	64
5.2.10.1	Uniform Surcharge Loads.....	64
5.2.10.2	Point Loads, Line Loads, and Strip Loads .....	64
<b>5.3</b>	<b>GROUND ANCHOR DESIGN .....</b>	<b>65</b>
5.3.1	Introduction .....	65
5.3.2	Location of Critical Potential Failure Surface.....	65
5.3.3	Calculation of Ground Anchor Loads from Apparent Earth Pressure Diagrams .....	65
5.3.4	Design of the Unbonded Length.....	67
5.3.5	Compression Anchors.....	68
5.3.6	Design of the Anchor Bond Length.....	69

## TABLE OF CONTENTS (Continued)

5.3.7	Spacing Requirements for Ground Anchors.....	75
5.3.8	Selection of Prestressing Steel Element .....	77
<b>5.4</b>	<b>WALL DESIGN BASED ON LATERAL PRESSURES .....</b>	<b>78</b>
5.4.1	Design of Soldier Beams and Sheet-Piles.....	78
5.4.2	Design of Lagging for Temporary Support .....	81
5.4.3	Design of Wales and Permanent Facing .....	83
<b>5.5</b>	<b>LATERAL CAPACITY OF EMBEDDED PORTION OF WALL.....</b>	<b>84</b>
5.5.1	General.....	84
5.5.2	Evaluation of Ultimate Passive Resistance .....	84
5.5.2.1	Soldier Beam and Lagging Walls .....	84
5.5.2.2	Continuous Walls .....	86
5.5.3	Depth of Penetration below Excavation.....	86
5.5.4	Comparison of Wang-Reese and Broms Method for Competent Soils.....	87
<b>5.6</b>	<b>AXIAL CAPACITY OF WALL.....</b>	<b>88</b>
5.6.1	Introduction .....	88
5.6.2	Axial Load Evaluation .....	89
5.6.3	Axial Capacity Design of Driven Soldier Beams .....	90
5.6.3.1	General.....	90
5.6.3.2	Effective Stress Analysis for Driven Soldier Beams.....	90
5.6.3.3	Total Stress Analysis for Driven Soldier Beams in Clays .....	92
5.6.4	Axial Capacity Design Of Drilled-in Soldier Beams .....	93
5.6.4.1	General.....	93
5.6.4.2	Cohesionless Soils.....	93
5.6.4.3	Cohesive Soils .....	94
5.6.4.4	Design Issues for Concrete Backfill of Predrilled Soldier Beam Holes.....	95
<b>5.7</b>	<b>ANCHORED SLOPES AND LANDSLIDE STABILIZATION SYSTEMS.....</b>	<b>96</b>
5.7.1	General.....	96
5.7.2	Design Concepts.....	96
5.7.3	Limit Equilibrium Calculations .....	97
5.7.3.1	Overall Approach .....	97



## TABLE OF CONTENTS (Continued)

5.7.3.2	Method 1 Analysis .....	98
5.7.3.3	Method 2 Analysis .....	100
5.7.4	Modeling Lateral Wall Resistance in Limit Equilibrium Analyses.....	101
5.7.5	Comparison of Methods to Evaluate Required Earth Load in Homogeneous Soils .....	102
<b>5.8</b>	<b>GROUND MASS STABILITY.....</b>	<b>105</b>
5.8.1	Introduction.....	105
5.8.2	Basal Stability .....	105
5.8.2.1	General.....	105
5.8.2.2	Evaluation of Bottom Heave Potential in Soft to Medium Clays .....	105
5.8.3	External Stability .....	107
5.8.3.1	Introduction.....	107
5.8.3.2	Evaluation of External Stability Using Limit Equilibrium.....	108
<b>5.9</b>	<b>TIEDOWN DESIGN .....</b>	<b>109</b>
5.9.1	Introduction.....	109
5.9.2	Uplift Capacity of Rock Tiedown Anchors.....	109
5.9.3	Uplift Capacity of Soil Tiedown Anchors .....	110
5.9.4	Design of Tiedown Anchors to Resist Hydrostatic Uplift.....	112
<b>5.10</b>	<b>SEISMIC DESIGN.....</b>	<b>113</b>
5.10.1	Introduction.....	113
5.10.2	Internal Stability Using Pseudo-Static Theory.....	113
5.10.2.1	Lateral Earth Pressure .....	113
5.10.2.2	Wall Design Considerations .....	116
5.10.2.3	Liquefaction.....	117
5.10.3	External Stability .....	117
5.10.3.1	Pseudo-Static Analysis.....	117
5.10.3.2	Seismic Deformation Analysis.....	118
<b>5.11</b>	<b>OTHER DESIGN ISSUES.....</b>	<b>119</b>
5.11.1	Wall and Ground Movements.....	119
5.11.2	Drainage Systems for Anchored Walls and Slopes .....	120

## TABLE OF CONTENTS (Continued)

5.11.3	Wall System Appurtenances.....	121
5.11.4	Resisting the Upper Anchor Test Load .....	122
5.11.5	Anchored Walls for Fill Applications.....	122
<b>CHAPTER 6 CORROSION CONSIDERATIONS IN DESIGN .....</b>		<b>124</b>
<b>6.1</b>	<b>INTRODUCTION .....</b>	<b>124</b>
<b>6.2</b>	<b>CORROSION AND EFFECTS ON GROUND ANCHORS.....</b>	<b>124</b>
6.2.1	Mechanism of Metallic Corrosion.....	124
6.2.2	Types of Corrosion for Prestressing Steel .....	124
<b>6.3</b>	<b>CORROSION PROTECTION OF GROUND ANCHORS .....</b>	<b>126</b>
6.3.1	Requirements of Corrosion Protection Systems .....	126
6.3.2	Design of Corrosion Protection Systems .....	126
6.3.2.1	General.....	126
6.3.2.2	Anchorage Protection.....	131
6.3.2.3	Unbonded Tendon Length Protection .....	132
6.3.2.4	Tendon Bond Length Protection.....	132
6.3.2.5	Protection Against Stray Currents.....	132
6.3.2.6	Corrosion Protection of Anchors for Structures Subject to Hydrostatic Uplift .....	133
<b>6.4</b>	<b>SELECTION OF CORROSION PROTECTION LEVEL.....</b>	<b>133</b>
6.4.1	General.....	133
6.4.2	Service Life of the Anchored Structure .....	133
6.4.3	Aggressivity of the Ground Environment.....	133
6.4.4	Consequences of Failure of the Anchored System.....	135
6.4.5	Cost for a Higher Level of Protection.....	135
<b>6.5</b>	<b>CORROSION OF STRUCTURAL STEEL, CEMENT GROUT, AND CONCRETE.....</b>	<b>135</b>
6.5.1	Corrosion and Protection of Steel Soldier Beams and Sheet Piles.....	135
6.5.2	Degradation and Protection of Cement Grout and Concrete .....	136

**TABLE OF CONTENTS (Continued)**

**CHAPTER 7 LOAD TESTING AND TRANSFER OF LOAD TO THE ANCHORED SYSTEM.....137**

**7.1 INTRODUCTION.....137**

**7.2 CONCEPTS FOR MONITORING ANCHOR BOND ZONE CAPACITY.....137**

**7.3 TESTING AND STRESSING EQUIPMENT.....139**

7.3.1 General..... 139

7.3.2 Equipment Used in Load Testing ..... 140

7.3.2.1 Hydraulic Jack and Pump ..... 140

7.3.2.2 Stressing Anchorage..... 141

7.3.2.3 Pressure Gauges and Load Cells ..... 142

7.3.2.4 Dial Gauge to Measure Movement ..... 142

7.3.2.5 Jack Chair ..... 142

**7.4 ANCHOR LOAD TESTING.....142**

7.4.1 Introduction ..... 142

7.4.2 Performance Tests ..... 143

7.4.2.1 General..... 143

7.4.2.2 Procedures for Performance Test ..... 143

7.4.2.3 Recording of Performance Test Data ..... 145

7.4.2.4 Analysis of Performance Test Data ..... 146

7.4.3 Proof Tests ..... 147

7.4.3.1 General..... 147

7.4.3.2 Proof Test Procedures and Recording and Analysis of Proof Test Data ..... 147

7.4.4 Extended Creep Testing ..... 148

7.4.4.1 General..... 148

7.4.4.2 Procedures for Extended Creep Test..... 148

7.4.4.3 Recording and Analysis of Extended Creep Test Data..... 149

7.4.5 Acceptance Criteria ..... 150

7.4.5.1 General..... 150

7.4.5.2 Creep ..... 150

7.4.5.3 Apparent Free Length..... 150

## TABLE OF CONTENTS (Continued)

7.4.5.4	Ground Anchor Acceptance Decision Tree.....	152
7.4.5.5	Modification of Design or Installation Procedures.....	154
<b>7.5</b>	<b>ANCHOR LOCK-OFF LOAD .....</b>	<b>154</b>
<b>7.6</b>	<b>LIFT-OFF TESTING .....</b>	<b>155</b>
<b>CHAPTER 8</b>	<b>CONTRACTING APPROACHES .....</b>	<b>156</b>
8.1	INTRODUCTION.....	156
8.2	METHOD CONTRACTING APPROACH.....	157
8.2.1	Introduction.....	157
8.2.2	Contract Documents for Method Approach.....	158
8.3	PERFORMANCE CONTRACTING APPROACH .....	159
8.3.1	Introduction.....	159
8.3.2	Implementing Performance Contracting Approach.....	159
8.3.2.1	Pre-bid Wall Design.....	159
8.3.2.2	Pre-bid Typical Section Design.....	160
8.3.2.3	Post-bid Wall Design .....	160
8.3.3	Contract Documents for Performance Approach.....	161
8.3.4	Review and Approval.....	162
8.4	CONTRACTOR DESIGN/BUILD APPROACH.....	163
8.5	RECOMMENDATIONS.....	163
<b>CHAPTER 9</b>	<b>CONSTRUCTION INSPECTION AND PERFORMANCE MONITORING.....</b>	<b>164</b>
<b>9.1</b>	<b>INTRODUCTION .....</b>	<b>164</b>
<b>9.2</b>	<b>INSPECTION ROLES UNDER CERTAIN CONTRACT APPROACHES .....</b>	<b>164</b>
<b>9.3</b>	<b>PRE-PROJECT PREPARATION .....</b>	<b>165</b>
<b>9.4</b>	<b>INSPECTION OF CONSTRUCTION MATERIALS .....</b>	<b>165</b>
9.4.1	Introduction.....	165
9.4.2	Inspection of Wall Materials .....	166
9.4.3	Inspection of Ground Anchor Materials .....	166
9.4.4	Storage and Handling of Construction Materials .....	167

## TABLE OF CONTENTS (Continued)

<b>9.5 INSPECTION OF CONSTRUCTION ACTIVITIES.....</b>	<b>167</b>
9.5.1 Surface-Water Control.....	167
9.5.2 Vertical Wall Element Installation.....	168
9.5.2.1 Drilled-in Soldier Beams.....	168
9.5.2.2 Driven Soldier Beams.....	168
9.5.2.3 Sheet-Piles.....	169
9.5.3 Excavation.....	169
9.5.4 Anchor Construction.....	169
9.5.4.1 Introduction.....	169
9.5.4.2 Anchor Hole Drilling.....	170
9.5.4.3 Tendon Insertion.....	170
9.5.4.4 Anchor Grouting.....	171
9.5.4.5 Anchorage Installation.....	172
9.5.5 Ancillary Wall Element Installation.....	173
9.5.5.1 Timber Lagging Installation.....	173
9.5.5.2 Wall Drainage System Installation.....	173
9.5.5.3 Horizontal Drains.....	173
9.5.5.4 Permanent Facing Installation.....	174
<b>9.6 SHORT-TERM AND LONG-TERM MONITORING.....</b>	<b>174</b>
9.6.1 Monitoring of Anchor Load Tests.....	174
9.6.2 Short-Term Monitoring of Wall Performance.....	175
9.6.3 Long-Term Monitoring.....	176

## REFERENCES

## BIBLIOGRAPHY

## TABLE OF CONTENTS (Continued)

### APPENDIX

APPENDIX A	Design Examples
APPENDIX B	Development of Wang - Reese Equations
APPENDIX C	Example Calculation of Bending Moment for Wall in Weak Cohesive Soil
APPENDIX D	Predesign Load Testing Procedures to Evaluate Ultimate Ground Anchor Load
APPENDIX E	Specification for Ground Anchors
APPENDIX F	Specifications for Anchored Sheet-pile or Soldier Beam and Lagging Wall

## LIST OF TABLES

<u>Table</u>		<u>Page</u>
1	Soil density/consistency description based on SPT blowcount values (after AASHTO, 1988) .....	24
2	Summary of common in situ tests for soils.....	25
3	Typical factors influencing bond stress transfer for small diameter ground anchors .....	30
4	Typical design steps for an anchored wall (modified after FHWA-RD-81-150, 1982) ....	47
5	Summary of trapezoidal apparent pressure envelopes for temporary excavations in stiff to hard clays.....	53
6	Presumptive ultimate values of load transfer for preliminary design of small diameter straight shaft gravity-grouted ground anchors in soil.....	71
7	Presumptive average ultimate bond stress for ground/grout interface along anchor bond zone (after PTI, 1996) .....	73
8	Presumptive ultimate values of load transfer for preliminary design of ground anchors in rock.....	74
9	Properties of prestressing steel bars (ASTM A722).....	77
10	Properties of 15-mm diameter prestressing steel strands (ASTM A 416, Grade 270 (metric 1860)).....	78
11	Guidance relationship between tendon size and trumpet opening size.....	78
12	Recommended thickness of temporary timber lagging (after FHWA-RD-75-130, 1976) .....	82
13	Maximum design bending moments for wales and permanent facing (after AASHTO, 1996) .....	83
14	Recommended factors of safety for axial capacity of driven and drilled-in soldier beams.....	90
15	Bearing capacity factors for evaluation of end bearing in drilled shafts in clays .....	95
16	Procedure to evaluate total lateral earth load using slope stability computer programs .....	98

17	Procedure to evaluate total lateral earth load for anchored systems constructed in weak cohesive soils.....	101
18	Values of $K_{REQ}$ in cohesionless soil using various methods to evaluate earth pressures.....	103
19	Horizontal stress coefficient, $K$ , for pressure grouted anchors (after Kulhawy et al., 1983) .....	111
20	Corrosion protection requirements (modified after PTI, 1996) .....	131
21	Steps for the performance test.....	144
22	Test procedure for ground anchor proof test.....	147
23	Load schedule and observation periods for extended creep test for permanent anchor.....	149



## LIST OF FIGURES

<u>Figure</u>		<u>Page</u>
1	Components of a ground anchor.....	4
2	Anchorage components for a bar tendon.....	5
3	Anchorage components for a strand tendon.....	6
4	Main types of grouted ground anchors (modified after Littlejohn, 1990).....	7
5	Cut away view of bar tendon.....	9
6	Cut away view of strand tendon.....	10
7	Construction sequence for permanent soldier beam and lagging wall .....	12
8	Comparison of concrete gravity wall and anchored wall for a depressed roadway.....	16
9	Applications of ground anchors and anchored systems .....	18
10	Geotechnical boring layout for permanent anchored wall.....	20
11	Potential failure conditions to be considered in design of anchored walls.....	27
12	Contribution of ground anchors to wall stability .....	28
13	Simplified drained stress-displacement relationship for a stiff clay (modified after CIRIA, 1984)	35
14	Mobilization of Rankine active and passive horizontal pressures for a smooth retaining wall ....	37
15	Limiting active and passive horizontal pressures.....	37
16	Active and passive earth pressure coefficients (effect of wall inclination) .....	39
17	Active and passive earth pressure coefficients (effect of backslope inclination) .....	40
18	Cross section of model wall (modified after FHWA-RD-98-067, 1998) .....	42
19	Lateral wall movements and earth pressures with excavation at first anchor level (cantilever stage) (modified after FHWA-RD-98-067, 1998).....	42
20	Lateral wall movements and earth pressures during anchor stressing (modified after FHWA-RD-98-067, 1998).....	43

## LIST OF FIGURES (Continued)

<u>Figure</u>		<u>Page</u>
21	Lateral wall movements and earth pressures with excavation at lower anchor level (modified after FHWA-RD-98-067, 1998) .....	44
22	Lateral wall movements and earth pressures with excavation at design grade (modified after FHWA-RD-98-067, 1998) .....	45
23	Terzaghi and Peck apparent pressure envelopes (after Terzaghi and Peck, 1967) .....	50
24	Recommended apparent earth pressure diagram for sands.....	51
25	Measured anchor loads for seven projects (after Ulrich, 1989).....	54
26	Wall pressure envelopes (after Winter, 1990) .....	55
27	Recommended apparent earth pressure envelope for stiff to hard clays .....	56
28	Henkel's mechanism of base failure .....	58
29	Values of $K_A$ based on Terzaghi and Peck envelope and Henkel's method.....	59
30	Force equilibrium method for anchored walls (after FHWA-RD-98-065, 1998).....	61
31	Flow net for a retaining wall (after CIRIA, 1984) .....	62
32	Gross and net water pressures across a retaining wall (modified after CIRIA, 1984).....	63
33	Calculation of anchor loads for one-level wall.....	66
34	Calculation of anchor loads for multi-level wall.....	67
35	Types of compression anchors.....	69
36	Mobilization of bond stress for a tension anchor .....	72
37	Vertical and horizontal spacing requirements for ground anchors.....	76
38	Calculation of wall bending moments using hinge method.....	79
39	Calculation of wall bending moments using tributary area method.....	80
40	Relationship between lateral earth pressure, wall deflection, and depth of wall embedment .....	85
41	Broms method for evaluating ultimate passive resistance .....	86
42	Comparison of Broms and Wang-Reese method for wall in sand.....	88

## LIST OF FIGURES (Continued)

<u>Figure</u>		<u>Page</u>
43	Comparison of Broms and Wang-Reese method for wall in clay.....	88
44	Chart for estimating $\beta$ coefficient versus soil type friction angle (after Fellenius, 1991) .....	91
45	Chart for estimating $N_t$ coefficients versus soil type friction angle (after Fellenius, 1991) .....	92
46	Adhesion values for piles in cohesive soils (after Tomlinson, 1980) .....	93
47	Modeling the ground anchor force in limit equilibrium analysis (after FHWA-RD-97-130, 1998) .....	99
48	Limit equilibrium analyses used to evaluate total lateral earth load for anchored systems constructed in weak cohesive soils analysis (after FHWA-RD-97-130, 1998).....	100
49	Total passive force for example wall in cohesionless soil .....	102
50	Comparison of limit equilibrium methods for cohesive soils (after FHWA-RD-98-065, 1998).....	104
51	Analysis of basal stability (modified after Terzaghi et al., 1996).....	106
52	Failure surfaces for external stability evaluations .....	108
53	Inverted cone mechanisms for overall rock mass stability.....	110
54	Stability of structure subjected to hydrostatic uplift .....	112
55	Forces behind a gravity wall .....	115
56	Effect of seismic coefficients and friction angle on seismic active pressure coefficient (after Lam and Martin, 1986).....	116
57	Variation of failure surface inclination with horizontal acceleration coefficient .....	118
58	Permanent seismic deformation chart (after Hynes and Franklin, 1984).....	119
59	Settlement profile behind braced and anchored walls .....	120
60	Examples of corrosion protection for anchorages .....	128
61	Examples of corrosion protection classes I and II for strand tendons.....	129
62	Examples of corrosion protection classes I and II for bar tendons .....	130

## LIST OF FIGURES (Continued)

<u>Figure</u>		<u>Page</u>
63	Decision tree for selection of corrosion protection level (modified after PTI, 1996) .....	134
64	Skin friction versus strain diagrams for ground anchors .....	137
65	Stress propagation in bond length of ground anchor.....	138
66	Evaluation of critical creep tension .....	139
67	Typical equipment for load testing of strand ground anchor.....	140
68	Typical equipment for load testing of bar ground anchor .....	141
69	Plotting of performance test data (after PTI, 1996).....	145
70	Plotting of elastic and residual movement for a performance test (after PTI, 1996) .....	146
71	Plotting of proof test data (after PTI, 1996) .....	148
72	Plotting of extended creep test data (after PTI, 1996) .....	149
73	Ground anchor acceptance decision tree (after PTI, 1996).....	153
A-1	Subsurface stratigraphy and design cross section.....	A-2
A-2	Apparent earth pressure diagram and surcharge pressure diagram .....	A-4
A-3	Location of unbonded and bond lengths for ground anchors .....	A-8
A-4	Embedment depth calculations (Wang-Reese method) .....	A-12
A-5	Subsurface stratigraphy and design cross section.....	A-18
A-6	Secant residual friction angle (after Stark and Eid, 1994) .....	A-20
A-7	Slope stability analysis of existing site conditions .....	A-22
A-8	Apparent earth pressure diagram.....	A-23
A-9	Calculation of $T_{H3}$ and $M_4$ .....	A-25
A-10	Location of unbonded and bond lengths for ground anchors .....	A-27
B-1	Passive wedge failure for a soldier beam in sand (after Reese, . al., 1974).....	B-2
B-2	Intersecting failure wedges for soldier beams in sand (after Wang and Reese, 1986) .....	B-3
B-3	Plastic flow around a soldier beam toe (after Wang and Reese, 1986).....	B-4

## LIST OF FIGURES (Continued)

<u>Figure</u>		<u>Page</u>
B-4	Passive wedge failure for a soldier beam in clay (after Reese, 1958).....	B-6
B-5	Failure wedges for soldier beams in clay (after Wang and Reese, 1986) .....	B-7
D-1	Determination of critical creep tension.....	D-2
D-2	Extrapolation of creep curves for determining working tension.....	D-4

# CHAPTER 1

## INTRODUCTION

### 1.1 PURPOSE

The purpose of this document is to provide state-of-the-practice information on ground anchors and anchored systems for highway applications. Ground anchors discussed in this document are cement grouted, prestressed tendons that are installed in soil or rock. Anchored systems discussed include flexible anchored walls, slopes supported using ground anchors, slope and landslide stabilization systems, and structures that incorporate tiedown anchors. The intended audience includes geotechnical, structural, and highway design and construction specialists involved with the design, construction, contracting, and inspection of these systems.

Ground anchors and anchored systems have become increasingly more cost-effective through improvements in design methods, construction techniques, anchor component materials, and on-site acceptance testing. This has resulted in an increase in the use of both temporary and permanent anchors. The reader should recognize that, as a result of the evolving nature of anchoring practice, the information presented herein is not intended to be prescriptive. Design, construction, and load testing methods are described that are currently used in U.S. practice.

### 1.2 ANCHORED SYSTEM SERVICE LIFE

The focus of this document is on design methods and procedures for permanent ground anchors and anchored systems. Permanent anchored systems are generally considered to have a service life of 75 to 100 years. However, anchored systems are also commonly used for temporary applications. The service life of temporary earth support systems is based on the time required to support the ground while the permanent systems are installed. This document has adopted the American Association of State Highway and Transportation Officials (AASHTO) guidance which considers temporary systems to be those that are removed or become inoperative upon completion of the permanent systems. The time period for temporary systems is commonly stated to be 18 to 36 months but may be shorter or longer based on actual project conditions.

Furthermore this document has subdivided temporary systems into “support of excavation” (SOE) temporary systems and “critical” temporary systems. In general the owner will determine which temporary systems are to be designated as critical. Often that decision is based on the owner’s need to restrict lateral movement of the support system to minimize ground movements behind the support system. In this document, it is recommended that critical temporary systems be designed to the same criteria used for permanent anchored systems. Conversely, SOE anchored systems are commonly designed to less restrictive criteria than permanent anchored systems. The owner commonly assigns the responsibility for design and performance of SOE anchored systems to the contractor. The design of these SOE anchored systems is often based more on system stability than on minimizing ground movements.

In this document, the basic design recommendations pertain to both permanent anchored systems and critical temporary systems. In this document, the term “permanent anchored systems” or “permanent applications” include critical temporary systems. Whenever appropriate in this document, discussion is provided concerning the differences in design requirements for SOE systems and permanent systems. The following components of an anchored system design are generally less restrictive for temporary SOE systems as compared to permanent systems: (1) selection of timber lagging; (2) allowable stresses in structural components; (3) factors of safety; (4) design for axial load; (5) surcharge loads used to evaluate wall loadings; (6) seismic design criteria; and (7) anchor load testing.

### **1.3 BACKGROUND**

The first use of ground anchors in the U.S. was for temporary support of excavation systems. These systems were typically designed and constructed by specialty contractors. The use of permanent ground anchors for public sector projects in the U.S. did not become common until the late 1970s and today, represent a common technique for earth retention and slope stabilization for highway applications. In certain design and construction conditions, anchored systems offer several advantages over more conventional systems that have resulted in economic and technical benefits. For example, benefits of anchored walls over concrete gravity retaining walls for support of a highway cut include:

- unobstructed workspace for excavations;
- ability to withstand relatively large horizontal wall pressures without requiring a significant increase in wall cross section;
- elimination of the need to provide temporary excavation support since an anchored wall can be incorporated into the permanent structure;
- elimination of need for select backfill;
- elimination of need for deep foundation support;
- reduced construction time; and
- reduced right-of-way (ROW) acquisition.

In 1979, the U.S. Department of Transportation Federal Highway Administration (FHWA) Office of Technology Applications authorized a permanent ground anchor demonstration project. The objective of the project was to provide highway agencies with adequate information to promote routine use of permanent ground anchors and anchored walls. The purpose of the demonstration project was to: (1) study existing ground anchor technology and installation procedures; (2) determine areas where additional work was required; (3) update existing technology; (4) develop a basic design manual; and (5) solicit installations on highway projects. Between 1979 and 1982, two FHWA research reports were completed (“Permanent Ground Anchors” FHWA Report Nos. FHWA-RD- 81-150, 151, and 152 and “Tiebacks” FHWA Report No. FHWA-RD-82-047) and pilot test projects were begun by highway agencies. A design manual was developed by FHWA in 1984,

which was updated in 1988 (FHWA-DP-68-1R, 1988), as part of the demonstration project. During the demonstration project, five U.S. highway projects with permanent anchored systems were instrumented and performance data were gathered (see FHWA-DP-90-068-003, 1990). Today, ground anchors and anchored systems have become an integral component of highway design in the U.S.

This document has been written, in part, to update the FHWA (1988) design manual titled "Permanent Ground Anchors". That document provides an introduction to basic ground anchor concepts and provides the practicing highway engineer with sufficient information to contract for permanent ground anchors and anchored systems. This document draws extensively from FHWA (1988) in describing issues such as subsurface investigation and laboratory testing, basic anchoring principles, ground anchor load testing, and inspection of construction materials and methods used for anchored systems. Since 1988, advances have been made in design methods resulting from anchored system performance data and from new construction materials, methods, and equipment.

Results of research activities conducted since 1989 are also included in this document. Most recently, research was conducted under a FHWA research contract on the design and performance of ground anchors and anchored soldier beam and timber lagging walls. As part of that research project, performance data on two full-scale anchored walls and four large-scale model anchored walls were collected and analyzed. The settlement, axial load, and downdrag force on soldier beams, and lateral wall movements of the wall systems were evaluated (see FHWA-RD-98-066, 1998 and FHWA-RD-98-067, 1998). Several of the analysis methods and design procedures that were recommended based on the results of the research (see FHWA-RD-97-130, 1998) are adopted herein.

Procedures used for ground anchor acceptance testing have also been improved since FHWA (1988) was published. The AASHTO Task Force 27 report "In-Situ Soil Improvement Techniques" (1990) included both a generic construction specification for permanent ground anchors and a ground anchor inspection manual. Those documents form the basis for the construction standards developed by many highway agencies. The Post-Tensioning Institute (PTI) document titled "Recommendations for Prestressed Rock and Soil Anchors" (PTI, 1996) is a document commonly referenced that was developed collectively by owners, design consultants, specialty contractors, and material suppliers. AASHTO Task Force 27 (1990) and PTI (1996) were used as the basis for the chapters of this document on ground anchor acceptance testing and ground anchor corrosion protection. Information from those documents was also used to develop the generic ground anchor specification provided in appendix E.



## CHAPTER 2

### GROUND ANCHORS AND ANCHORED SYSTEMS

#### 2.1 INTRODUCTION

The previously referenced AASHTO Task Force 27 (1990) and PTI (1996) documents introduced standardized terminology and definitions of ground anchor components. The terminology presented in those documents is adopted and used throughout this document. Ground anchor materials, anchored system construction, and anchored system applications are presented in this chapter.

#### 2.2 GROUND ANCHORS

##### 2.2.1 General

A prestressed grouted ground anchor is a structural element installed in soil or rock that is used to transmit an applied tensile load into the ground. Grouted ground anchors, referenced simply as ground anchors, are installed in grout filled drill holes. Grouted ground anchors are also referred to as “tiebacks”. The basic components of a grouted ground anchor include the: (1) anchorage; (2) free stressing (unbonded) length; and (3) bond length. These and other components of a ground anchor are shown schematically in figure 1. The anchorage is the combined system of anchor head, bearing plate, and trumpet that is capable of transmitting the prestressing force from the prestressing

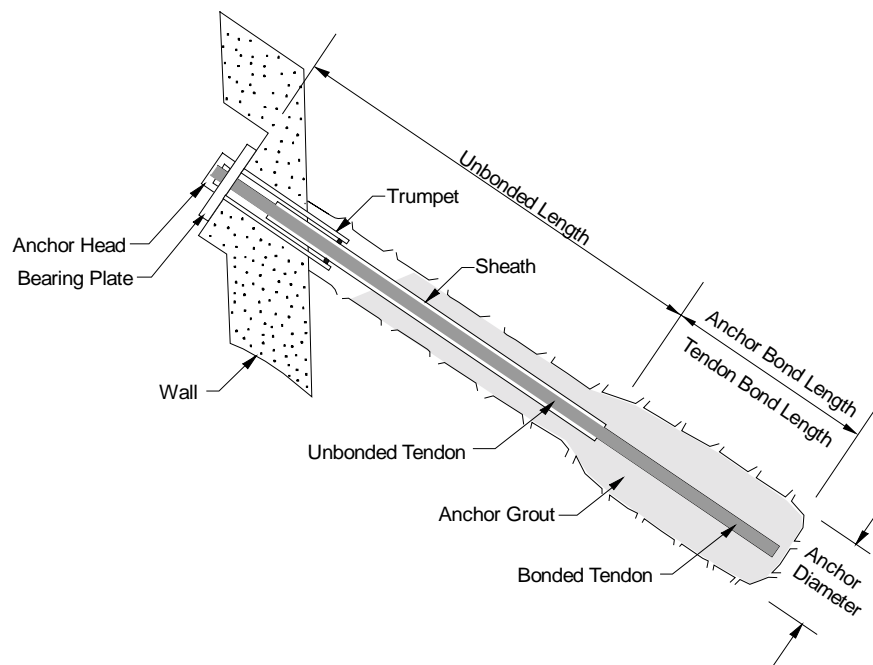

Figure 1. Components of a ground anchor.

steel (bar or strand) to the ground surface or the supported structure. Anchorage components for a bar tendon and a strand tendon are shown in figure 2 and figure 3, respectively. The unbonded length is that portion of the prestressing steel that is free to elongate elastically and transfer the resisting force from the bond length to the structure. A bondbreaker is a smooth plastic sleeve that is placed over the tendon in the unbonded length to prevent the prestressing steel from bonding to the surrounding grout. It enables the prestressing steel in the unbonded length to elongate without obstruction during testing and stressing and leaves the prestressing steel unbonded after lock-off. The tendon bond length is that length of the prestressing steel that is bonded to the grout and is capable of transmitting the applied tensile load into the ground. The anchor bond length should be located behind the critical failure surface.

A portion of the complete ground anchor assembly is referred to as the tendon. The tendon includes the prestressing steel element (strands or bars), corrosion protection, sheaths (also referred to as sheathings), centralizers, and spacers, but specifically excludes the grout. The definition of a tendon, as described in PTI (1996), also includes the anchorage; however, it is assumed herein that the tendon does not include the anchorage. The sheath is a smooth or corrugated pipe or tube that protects the prestressing steel in the unbonded length from corrosion. Centralizers position the tendon in the drill hole such that the specified minimum grout cover is achieved around the tendon. For multiple element tendons, spacers are used to separate the strands or bars of the tendons so that each element is adequately bonded to the anchor grout. The grout is a Portland cement based mixture that provides load transfer from the tendon to the ground and provides corrosion protection for the tendon.

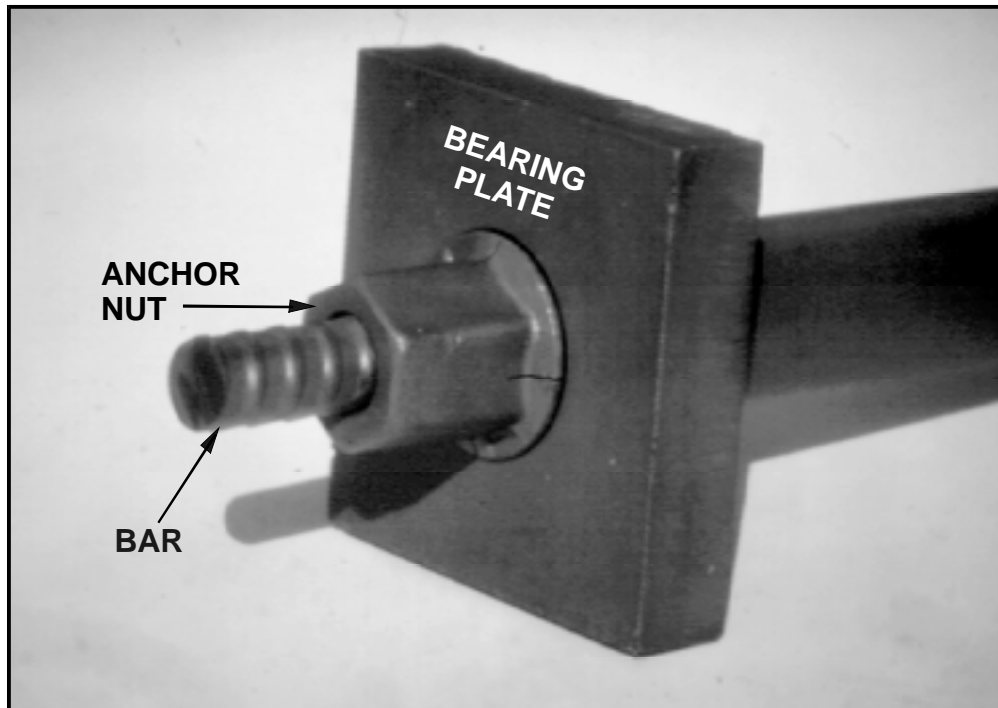

Figure 2. Anchorage components for a bar tendon.

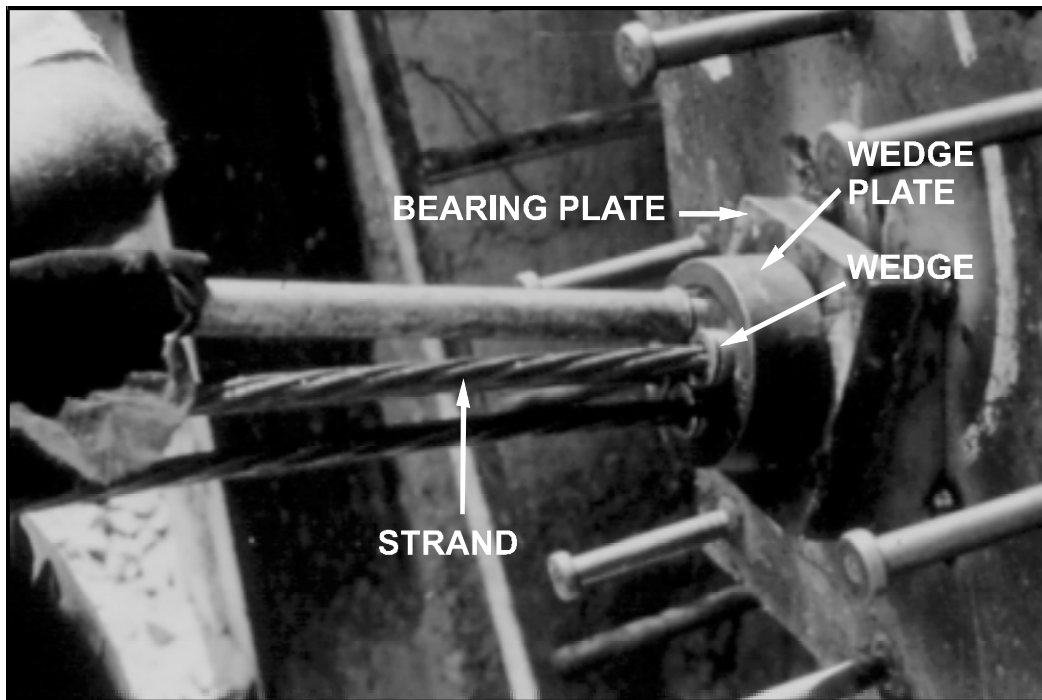

Figure 3. Anchorage components for a strand tendon.

## 2.2.2 Types of Ground Anchors

### 2.2.2.1 General

There are three main ground anchor types that are currently used in U.S. practice: (1) straight shaft gravity-grouted ground anchors (Type A); (2) straight shaft pressure-grouted ground anchors (Type B); and (3) post-grouted ground anchors (Type C). Although not commonly used today in U.S. practice, another type of anchor is the underreamed anchor (Type D). These ground anchor types are illustrated schematically in figure 4 and are briefly described in the following sections.

Drilling methods for each of the three main soil and rock ground anchors include rotary, percussion, rotary/percussive, or auger drilling. Detailed information on these drilling techniques may be found in Bruce (1989). The procedures and methods used to drill holes for ground anchors are usually selected by the contractor. The choice of a particular drilling method must also consider the overall site conditions and it is for this reason that the engineer may place limitations on the drilling method.

The drilling method must not adversely affect the integrity of structures near the ground anchor locations or on the ground surface. With respect to drilling, excessive ground loss into the drill hole and ground surface heave are the primary causes of damage to these structures. For example, the use of large diameter hollow stem augered anchors should be discouraged in sands and gravels since the auger will tend to remove larger quantities of soil from the drill hole as compared to the net volume of the auger. This may result in loss of support of the drill hole. In unstable soil or rock, drill casing is used. Water or air is used to flush the drill cuttings out of the cased hole. Caution should be exercised when using air flushing to clean the hole. Excess air pressures may result in unwanted

removal of groundwater and fines from the drill hole leading to potential hole collapse or these excess pressures may result in ground heave.

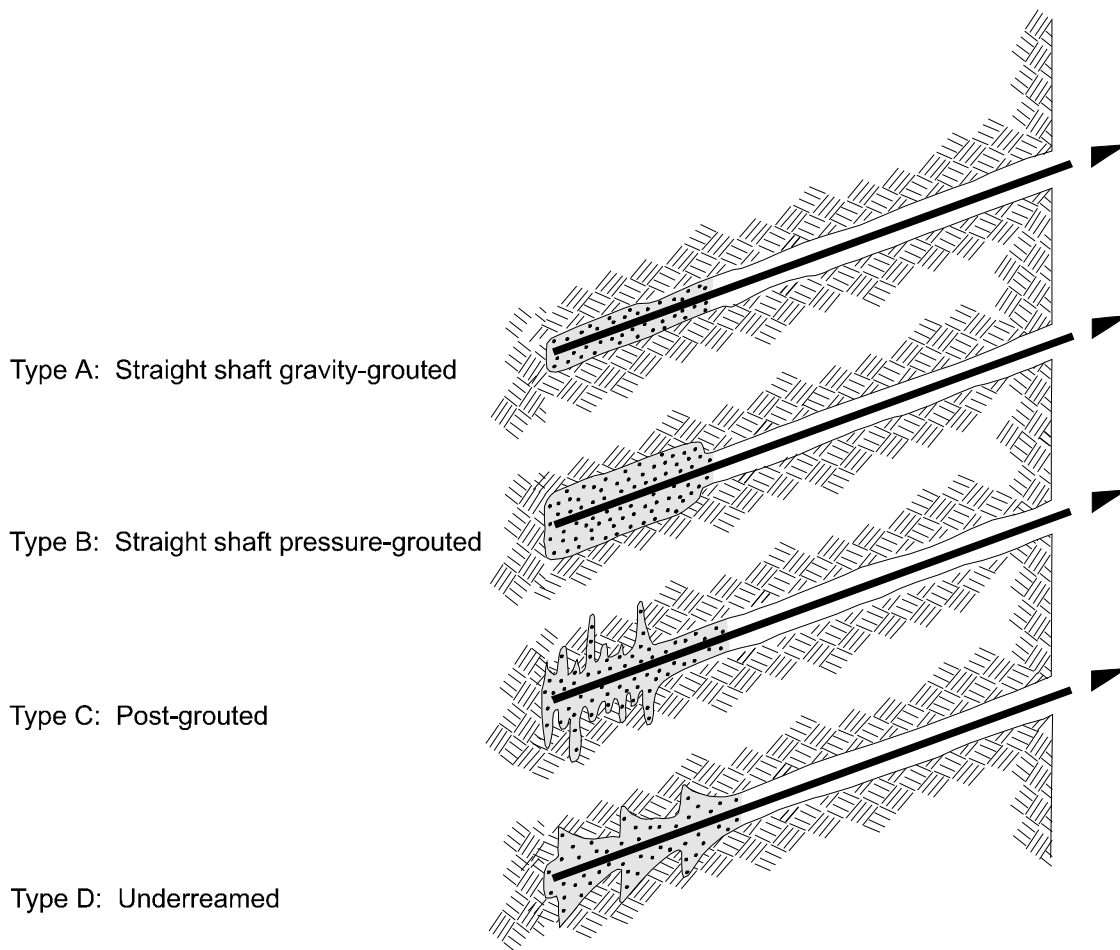

Figure 4. Main types of grouted ground anchors (modified after Littlejohn, 1990, “Ground Anchorage Practice”, Design and Performance of Earth Retaining Structures, Geotechnical Special Publication No. 25, Reprinted by permission of ASCE).

#### 2.2.2.2 Straight Shaft Gravity-Grouted Ground Anchors

Straight shaft gravity-grouted ground anchors are typically installed in rock and very stiff to hard cohesive soil deposits using either rotary drilling or hollow-stem auger methods. Tremie (gravity displacement) methods are used to grout the anchor in a straight shaft borehole. The borehole may be cased or uncased depending on the stability of the borehole. Anchor resistance to pullout of the grouted anchor depends on the shear resistance that is mobilized at the grout/ground interface.

### 2.2.2.3 Straight Shaft Pressure-Grouted Ground Anchors

Straight shaft pressure-grouted ground anchors are most suitable for coarse granular soils and weak fissured rock. This anchor type is also used in fine grained cohesionless soils. With this type of anchor, grout is injected into the bond zone under pressures greater than 0.35 MPa. The borehole is typically drilled using a hollow stem auger or using rotary techniques with drill casings. As the auger or casing is withdrawn, the grout is injected into the hole under pressure until the entire anchor bond length is grouted. This grouting procedure increases resistance to pullout relative to tremie grouting methods by: (1) increasing the normal stress (i.e., confining pressure) on the grout bulb resulting from compaction of the surrounding material locally around the grout bulb; and (2) increasing the effective diameter of the grout bulb.

### 2.2.2.4 Post-grouted Ground Anchors

Post-grouted ground anchors use delayed multiple grout injections to enlarge the grout body of straight shafted gravity grouted ground anchors. Each injection is separated by one or two days. Postgrouting is accomplished through a sealed grout tube installed with the tendon. The tube is equipped with check valves in the bond zone. The check valves allow additional grout to be injected under high pressure into the initial grout which has set. The high pressure grout fractures the initial grout and wedges it outward into the soil enlarging the grout body. Two fundamental types of post-grouted anchors are used. One system uses a packer to isolate each valve. The other system pumps the grout down the post-grout tube without controlling which valves are opened.

### 2.2.2.5 Underreamed Anchors

Underreamed anchors consist of tremie grouted boreholes that include a series of enlargement bells or underreams. This type of anchor may be used in firm to hard cohesive deposits. In addition to resistance through side shear, as is the principal load transfer mechanism for other anchors, resistance may also be mobilized through end bearing. Care must be taken to form and clean the underreams.

## 2.2.3 Tendon Materials

### 2.2.3.1 Steel Bar and Strand Tendons

Both bar and strand tendons are commonly used for soil and rock anchors for highway applications in the U.S. Material specifications for bar and strand tendons are codified in American Society for Testing and Materials (ASTM) A722 and ASTM A416, respectively. Indented strand is codified in ASTM A886. Bar tendons are commonly available in 26 mm, 32 mm, 36 mm, 45 mm, and 64 mm diameters in uncoupled lengths up to approximately 18 m. Anchor design loads up to approximately 2,077 kN can be resisted by a single 64-mm diameter bar tendon. For lengths greater than 18 m and where space constraints limit bar tendon lengths, couplers may be used to extend the tendon length. As compared to strand tendons, bars are easier to stress and their load can be adjusted after lock-off.

Strand tendons comprise multiple seven-wire strands. The common strand in U.S. practice is 15 mm in diameter. Anchors using multiple strands have no practical load or anchor length limitations. Tendon steels have sufficiently low relaxation properties to minimize long-term anchor load losses. Couplers are available for individual seven-wire strands but are rarely used since strand tendons can be manufactured in any length. Strand couplers are not recommended for routine anchor projects as the diameter of the coupler is much larger than the strand diameter, but strand couplers may be used to repair damaged tendons. Where couplers are used, corrosion protection of the tendon at the location of the coupler must be verified.

### 2.2.3.2 Spacers and Centralizers

Spacer/centralizer units are placed at regular intervals (e.g., typically 3 m) along the anchor bond zone. For strand tendons, spacers usually provide a minimum interstrand spacing of 6 to 13 mm and a minimum outer grout cover of 13 mm. Both spacers and centralizers should be made of non-corrosive materials and be designed to permit free flow of grout. Figure 5 and figure 6 show a cut away section of a bar and a strand tendon, respectively.

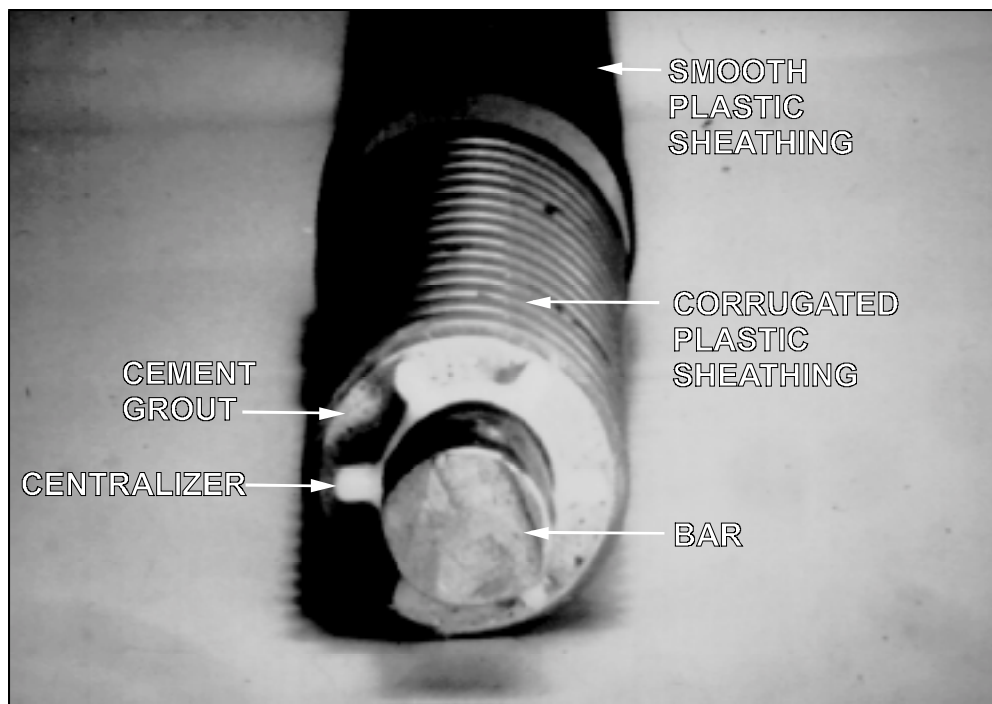

Figure 5. Cut away view of bar tendon.

### 2.2.3.3 Epoxy-Coated Bar and Epoxy-Coated Filled Strand

Epoxy-coated bar (AASHTO M284) and epoxy-coated filled strand (supplement to ASTM A882), while not used extensively for highway applications, are becoming more widely used for dam tiedown projects. The epoxy coating provides an additional layer of corrosion protection in the unbonded and bond length as compared to bare prestressing steel.

For epoxy-coated filled strand, in addition to the epoxy around the outside of the strand, the center wire of the seven-wire strand is coated with epoxy. Unfilled epoxy-coated strand is not recommended because water may enter the gaps around the center wire and lead to corrosion. Unlike bare strand, creep deformations of epoxy-coated filled strands themselves are relatively significant during anchor testing. When evaluating anchor acceptance with respect to creep, the creep of the epoxy-coated filled strands themselves must be deducted from the total creep movements to obtain a reliable measurement of the movements in the bond zone. Estimates of intrinsic creep movements of epoxy-coated filled strand are provided in PTI (1996).

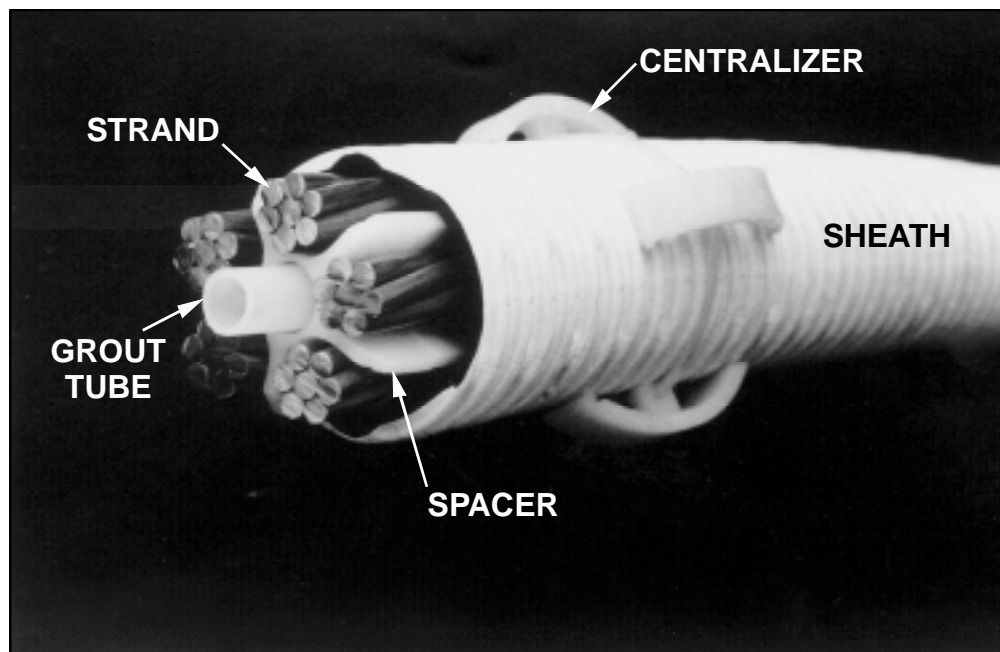

Figure 6. Cut away view of strand tendon.

### 2.2.3.4 Other Anchor Types and Tendon Materials

In addition to cement grouted anchors incorporating high strength prestressing steels, alternative anchor types and tendon materials are used in the U.S. Examples include Grade 60 and Grade 75 grouted steel bars, helical anchors, plate anchors, and mechanical rock anchors. The design and testing methods described in this document are used for cement grouted anchors that use high strength prestressing steels. These methods may not be appropriate for use with the alternative anchor types mentioned above.

Research on the use of fiber reinforced plastic (FRP) prestressing tendons is currently being performed (e.g., Schmidt et al., 1994). FRP tendons have high tensile strength, are corrosion resistant, and are lightweight. These products, however, are not used in current U.S. construction practice. Other materials such as fiberglass and stainless steel have been used experimentally but cost and/or construction concerns have restricted widespread use.

#### **2.2.4 Cement Grout**

Anchor grout for soil and rock anchors is typically a neat cement grout (i.e., grout containing no aggregate) conforming to ASTM C150 although sand-cement grout may also be used for large diameter drill holes. Pea gravel-sand-cement grout may be used for anchor grout outside the tendon encapsulation. High speed cement grout mixers are commonly used which can reasonably ensure uniform mixing between grout and water. A water/cement (w/c) ratio of 0.4 to 0.55 by weight and Type I cement will normally provide a minimum compressive strength of 21 MPa at the time of anchor stressing. For some projects, special additives may be required to improve the fluid flow characteristics of the grout. Admixtures are not typically required for most applications, but plasticizers may be beneficial for applications in high temperature and for long grout pumping distances.

### **2.3 ANCHORED WALLS**

#### **2.3.1 General**

A common application of ground anchors for highway projects is for the construction of anchored walls used to stabilize excavations and slopes. These anchored walls consist of nongravity cantilevered walls with one or more levels of ground anchors. Nongravity cantilevered walls employ either discrete (e.g., soldier beam) or continuous (e.g., sheet-pile) vertical elements that are either driven or drilled to depths below the finished excavation grade. For nongravity cantilevered walls, support is provided through the shear and bending stiffness of the vertical wall elements and passive resistance from the soil below the finished excavation grade. Anchored wall support relies on these components as well as lateral resistance provided by the ground anchors to resist horizontal pressures (e.g., earth, water, seismic, etc.) acting on the wall.

Various construction materials and methods are used for the wall elements of an anchored wall. Discrete vertical wall elements often consist of steel piles or drilled shafts that are spanned by a structural facing. Permanent facings are usually cast-in-place (CIP) concrete although timber lagging or precast concrete panels have been used. Continuous wall elements do not require separate structural facing and include steel sheet-piles, CIP or precast concrete wall panels constructed in slurry trenches (i.e., slurry (diaphragm) walls), tangent/secant piles, soil-cement columns, and jet grouted columns.



## 2.3.2 Soldier Beam and Lagging Wall

### 2.3.2.1 General

Soldier beam and lagging walls are the most commonly used type of anchored wall system in the U.S. This wall system uses discrete vertical wall elements spanned by lagging which is typically timber, but which may also be reinforced shotcrete. These wall systems can be constructed in most ground types, however, care must be exercised in grounds such as cohesionless soils and soft clays that may have limited “stand-up” time for lagging installation. These wall systems are also highly pervious. The construction sequence for a permanent soldier beam and lagging wall is illustrated in figure 7 and is described below.

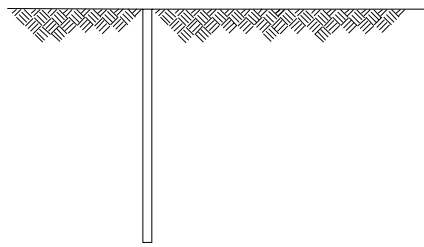

STEP 1: Install soldier beam

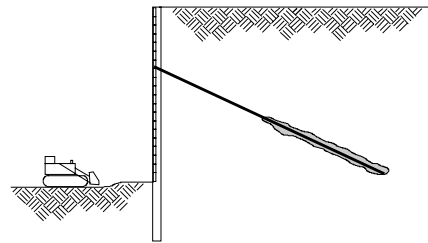

STEP 4: Complete excavation

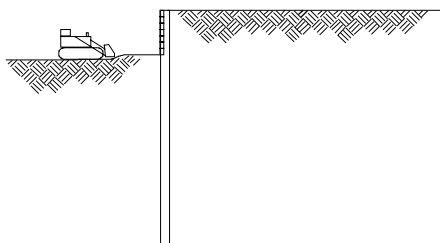

STEP 2: Excavate and install lagging

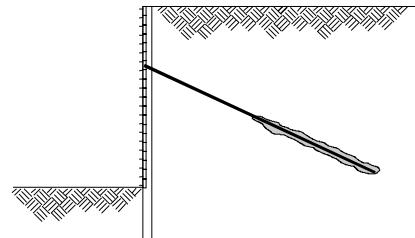

STEP 5: Install headed studs and prefabricated drainage

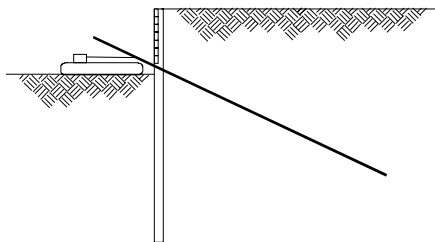

STEP 3: Install and test ground anchor

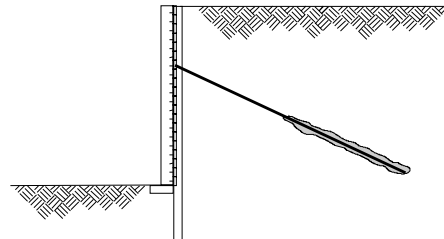

STEP 6: Pour cast-in-place facing

Figure 7. Construction sequence for permanent soldier beam and lagging wall.

### 2.3.2.2 Soldier Beam

The initial step of construction for a soldier beam and lagging wall consists of installing the soldier beams from the ground surface to their final design elevation. Horizontal spacing of the soldier beams typically varies from 1.5 to 3 m. The soldier beams may be steel beams or drilled shafts, although drilled shafts are seldom used in combination with timber lagging.

#### *Drilled-in Soldier Beams*

Steel beams such as wide flange (WF) sections or double channel sections may be placed in excavated holes that are subsequently backfilled with concrete. It is recommended that the excavated hole be backfilled with either structural or lean-mix concrete from the bottom of the hole to the level of the excavation subgrade. The selection of lean-mix or structural concrete is based on lateral and vertical capacity requirements of the embedded portion of the wall and is discussed in chapter 5. From the excavation subgrade to the ground surface, the hole should be backfilled with lean-mix concrete that is subsequently scraped off during lagging and anchor installation. Structural concrete is not recommended to be placed in this zone because structural concrete is extremely difficult to scrape off for lagging installation. Lean-mix concrete typically consists of one 94 lb bag of Portland cement per cubic yard of concrete and has a compressive strength that does not typically exceed approximately 1 MPa. As an alternative to lean-mix concrete backfill, controlled low strength material (CLSM) or “flowable fill” may be used. This material, in addition to cement, contains fine aggregate and fly ash. When allowing lean-mix concrete or CLSM for backfilling soldier beam holes, contract specifications should require a minimum compressive strength of 0.35 MPa. Like lean-mix concrete, CLSM should be weak enough to enable it to be easily removed for lagging installation.

Ground anchors are installed between the structural steel sections and the distance between the sections depends upon the type of ground anchor used. Drill hole diameters for the soldier beams depend upon the structural shape and the diameter of the anchor. Replacement anchors can be installed between the structural sections at any location along the soldier beam. The ground anchor to soldier beam connection for drilled-in soldier beams can be installed on the front face of the structural sections or between the sections. For small diameter ground anchors, the connection may be prefabricated before the soldier beams are installed. The connections for large-diameter anchors are made after the anchors have been installed.

#### *Driven Soldier Beams*

Steel beams such as HP shapes or steel sheet piles are used for driven soldier beams. Driven soldier beams must penetrate to the desired final embedment depth without significant damage. Drive shoes or “points” may be used to improve the ability of the soldier beams to penetrate a hard stratum. High strength steels also improve the ability of the soldier beams to withstand hard driving. If the soldier beams cannot penetrate to the desired depth, then the beams should be drilled-in. Thru-beam connections or horizontal wales are used to connect ground anchors to driven soldier beams.

A thru-beam connection is a connection cut in the beam for a small diameter ground anchor. Thru-beam connections are usually fabricated before the beam is driven. This type of connection is designed so the ground anchor load is applied at the center of the soldier beam in line with the web of the soldier beam. Large-diameter (i.e., greater than approximately 150 mm) ground anchors cannot be used with thru-beam connections. Thru-beam connections are used when few ground anchor failures are anticipated because when a ground anchor fails, the failed anchor has to be removed from the connection or a new connection has to be fabricated. A “sidewinder connection” may be used with a replacement anchor for a temporary support of excavation wall, but it is not recommended for a permanent wall. A sidewinder connection is offset from the center of the soldier beam, and the ground anchor load is applied to the flange some distance from the web. Sidewinder connections subject the soldier beams to bending and torsion.

Horizontal wales may be used to connect the ground anchors to the driven soldier beams. Horizontal wales can be installed on the face of the soldier beams, or they can be recessed behind the front flange. When the wales are placed on the front flange, they can be exposed or embedded in the concrete facing. If the wales remain exposed, then the ground anchor tendon corrosion protection may be exposed to the atmosphere and it is therefore necessary that the corrosion protection for the anchorage be well designed and constructed. However, since exposed wales are unattractive and must be protected from corrosion, they are not recommended for permanent anchored walls. Wales placed on the front face of the soldier beams require a thick cast-in-place concrete facing. Wales can be recessed to allow a normal thickness concrete facing to be poured. Recessed wales must be individually fabricated and the welding required to install them is difficult and expensive. If a wale is added during construction, the horizontal clear distance to the travel lanes should be checked before approval of the change.

### 2.3.2.3 Lagging

After installation of the soldier beams, the soil in front of the wall is excavated in lifts, followed by installation of lagging. Excavation for lagging installation is commonly performed in 1.2 to 1.5 m lifts, however, smaller lift thicknesses may be required in ground that has limited “stand-up” time. Lagging should be placed from the top-down as soon as possible after excavation to minimize erosion of materials into the excavation. Prior to lagging installation, the soil face should be excavated to create a reasonably smooth contact surface for the lagging. Lagging may be placed either behind the front flange of the soldier beam or on the soldier beam. Lagging placed behind soldier beam flanges is cut to approximate length, placed in-between the flanges of adjacent soldier beams, and secured against the soldier beam webs by driving wood wedges or shims. Lagging can also be attached to the front flange of soldier beams with clips or welded studs. In rare circumstances, lagging can be placed behind the back flange of the soldier beam. With either lagging installation method, gaps between the lagging and the retained ground must be backpacked to ensure good contact. Prior to placing subsequent lagging a spacer, termed a “louver”, is nailed to the top of the lagging board at each end of the lagging. This louver creates a gap for drainage between vertically adjacent lagging boards. The size of the gap must be sufficiently wide to permit drainage, while at the same time disallowing the retained soil to fall out from behind the boards. Typically, placing vertically adjacent lagging boards in close contact is considered unacceptable, however, some waterproofing methods may require that the gap between the lagging boards be eliminated. In this case, the contractor must provide an alternate means to provide drainage.

Concrete lagging has been used, but its use may be problematic due to difficulties in handling and very tight tolerances on the horizontal and vertical positioning of the soldier beam to ensure easy installation of standard length concrete lagging. Trimming of concrete lagging is very difficult and field splicing is not possible. Also, the concrete lagging near the anchor location may crack during anchor testing or stressing.

#### 2.3.2.4 Construction Sequence

Top-down installation of lagging continues until the excavation reaches a level of approximately 0.6 m below the design elevation of a ground anchor. At this point, the excavation is halted and the ground anchor is installed. Deeper excavation (i.e., greater than 0.6 m) below the level of a ground anchor may be required to allow the anchor connection to be fabricated or to provide equipment access. The wall must be designed to withstand stresses associated with a deeper excavation. The anchor is installed using appropriate drilling and grouting procedures, as previously described. When the grout has reached an appropriate minimum strength, the anchor is load tested and then locked-off at an appropriate load. Excavation and lagging installation then continues until the elevation of the next anchor is reached and the next anchor is installed. This cycle of excavation, lagging installation, and ground anchor installation is continued until the final excavation depth is reached.

When the excavation and lagging reach the final depth, prefabricated drainage elements may be placed at designed spacings and connected to a collector at the base of the wall. The use of shotcrete in lieu of timber lagging can be effective in certain situations. However, since the shotcrete is of low permeability, drainage must be installed behind the shotcrete. Drainage systems for anchored walls are discussed further in chapter 5. For permanent walls, a concrete facing is typically installed. The facing is either precast or CIP concrete.

### 2.3.3 Continuous Walls

Ground anchors are also used in continuous wall systems such as sheet-pile walls, tangent or secant pile walls, slurry walls, or soil mixed walls. Continuous walls are commonly used for temporary excavation support systems. Sheet-pile walls are constructed in one phase in which interlocking sheet-piles are driven to the final design elevation. Where difficult driving conditions are encountered, a template is often utilized to achieve proper alignment of the sheet-piles, however, it should be recognized that these wall systems may not be feasible for construction in hard ground conditions or where obstructions exist. Interlocking sheet-piles may be either steel or precast concrete, however, steel sheet-piles are normally used due to availability and higher strength than precast concrete sheet-piles. Additional information on wall construction procedures, materials, and equipment for other continuous wall systems is presented in FHWA-HI-99-007 (1999).

Unlike soldier beam and lagging walls, continuous walls act as both vertical and horizontal wall elements. Cycles of excavation and anchor installation proceed from the top of the excavation and then between the level of each anchor. Because of the relative continuity of these wall systems, water pressure behind continuous walls must be considered in design. In cases where the continuous wall must resist permanent hydrostatic forces, a watertight connection must be provided at the ground anchor/wall connection.

## 2.4 APPLICATIONS OF GROUND ANCHORS

### 2.4.1 Highway Retaining Walls

Anchored walls are commonly used for grade separations to construct depressed roadways, roadway widenings, and roadway realignments. The advantages of anchored walls over conventional concrete gravity walls have been described in section 1.2. Figure 8 provides a comparative illustration of a conventional concrete gravity wall and a permanent anchored wall for the construction of a depressed roadway. The conventional gravity wall is more expensive than a permanent anchored wall because it requires temporary excavation support, select backfill, and possibly deep foundation support. Anchored walls may also be used for new bridge abutment construction and end slope removal for existing bridge abutments (see FHWA-RD-97-130, 1998).

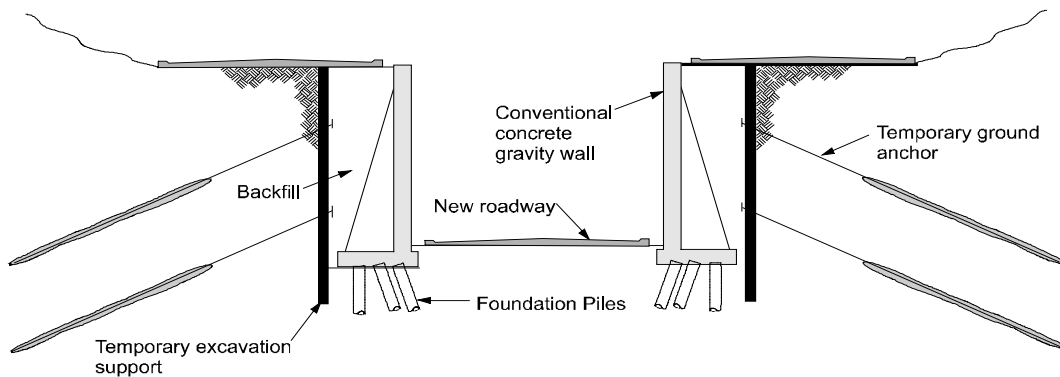

(a) Conventional Concrete Gravity Wall

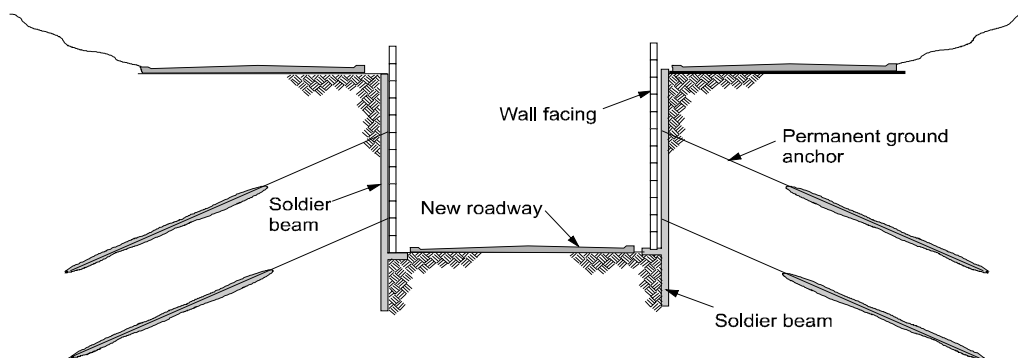

(b) Permanent Anchored Soldier Beam and Lagging Wall

Figure 8. Comparison of concrete gravity wall and anchored wall for a depressed roadway.

## **2.4.2 Slope and Landslide Stabilization**

Ground anchors are often used in combination with walls, horizontal beams, or concrete blocks to stabilize slopes and landslides. Soil and rock anchors permit relatively deep cuts to be made for the construction of new highways (figure 9a). Ground anchors can be used to provide a sufficiently large force to stabilize the mass of ground above the landslide or slip surface (figure 9b). This force may be considerably greater than that required to stabilize a vertical excavation for a typical highway retaining wall. Horizontal beams or concrete blocks may be used to transfer the ground anchor loads to the ground at the slope surface provided the ground does not “run” or compress and is able to resist the anchor reaction forces at the excavated face. Cost, aesthetics, and long-term maintenance of the exposed face will affect the selection of horizontal beams or blocks.

## **2.4.3 Tiedown Structures**

Permanent ground anchors may be used to provide resistance to vertical uplift forces. Vertical uplift forces may be generated by hydrostatic or overturning forces. The method is used in underwater applications where the structure has insufficient dead weight to counteract the hydrostatic uplift forces. An example application of ground anchors to resist uplift forces is shown in figure 9c. The advantage of ground anchors for tiedown structures include: (1) the volume of concrete in the slab is reduced compared to a dead weight slab; and (2) excavation and/or dewatering is reduced. Disadvantages of ground anchors for tiedowns include: (1) potentially large variations in ground anchor load resulting from settlement and heave of the structure; and (2) difficulty in constructing watertight connections at the anchor-structural slab interface, which is particularly important for hydrostatic applications; and (3) variations in stresses in the slab. A major uplift slab that incorporated tiedowns was constructed for the Central Artery Project in Boston, Massachusetts (see Druss, 1994).

Although not a highway application, permanent rock anchor tiedowns may be used to stabilize concrete dams (figure 9d). Existing dams may require additional stabilization to meet current safety standards with respect to maximum flood and earthquake requirements. Anchors provide additional resistance to overturning, sliding, and earthquake loadings.

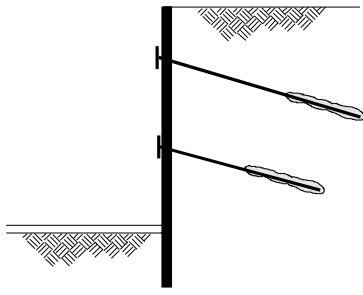

(a) Highway Retaining Wall

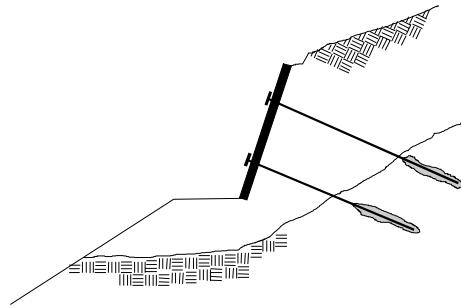

(b) Slope Stabilization

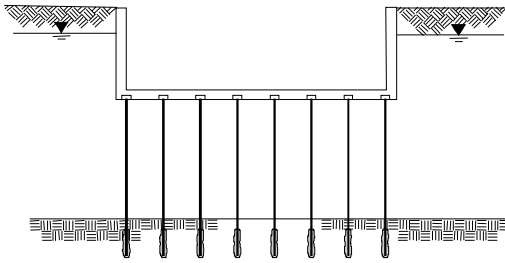

(c) Uplift Slab

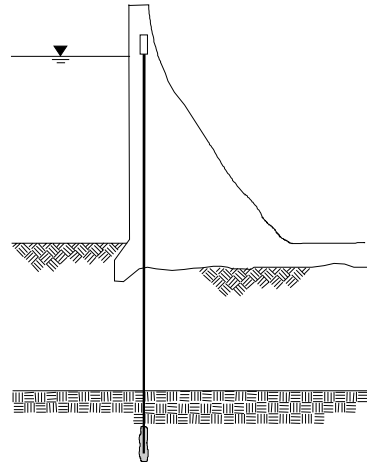

(d) Concrete Dam Stabilization

Figure 9. Applications of ground anchors and anchored systems.

## **CHAPTER 3**

### **SITE INVESTIGATION AND TESTING**

#### **3.1 INTRODUCTION**

The purpose of this chapter is to describe basic site characterization and soil and rock property evaluation for ground anchor and anchored system design. These activities generally include field reconnaissance, subsurface investigation, in situ testing, and laboratory testing. The engineering properties and behavior of soil and rock material must be evaluated because these materials provide both loading and support for an anchored system.

Site investigation and testing programs are necessary to evaluate the technical and economical feasibility of an anchored system for a project application. The extent of the site investigation and testing components for a project should be consistent with the project scope (i.e., location, size, critical nature of the structure, and budget), the project objectives (i.e., temporary or permanent structures), and the project constraints (i.e., geometry, constructability, performance, and environmental impact). Typical elements of a site investigation and testing program are described herein.

#### **3.2 FIELD RECONNAISSANCE**

Field reconnaissance involves visual inspection of the site and examination of available documents regarding site conditions. Information collected during field reconnaissance should include the following:

- surface topography and adjacent land use;
- surface drainage patterns, and surface geologic patterns including rock outcrops, landforms, existing excavations, and evidence of surface settlement;
- site access conditions and traffic control requirements for both investigation and construction activities;
- areas of potential instability such as deposits of organic or weak soils, steep terrain slide debris, unfavorably jointed or dipping rock, and areas with a high ground-water table;
- extent and condition (e.g., visible damage, corrosion) of existing above and below ground utilities and structures; and
- available right-of-way (ROW) and easements required for the installation of ground anchors and anchored systems.



### 3.3 SUBSURFACE INVESTIGATION

#### 3.3.1 General

Subsurface investigation activities for anchored systems typically involve soil borings and rock coring. Figure 10 illustrates guideline recommendations for locations of subsurface borings for a permanent anchored wall or slope. Information on the subsurface soil and rock stratigraphy and ground-water conditions are typically obtained from subsurface investigation activities. Subsurface investigation may also involve conducting in situ soil or rock tests and obtaining disturbed and undisturbed samples for laboratory testing. Detailed information and guidance on subsurface investigation are provided in AASHTO (1988) and FHWA-HI-97-021 (1997).

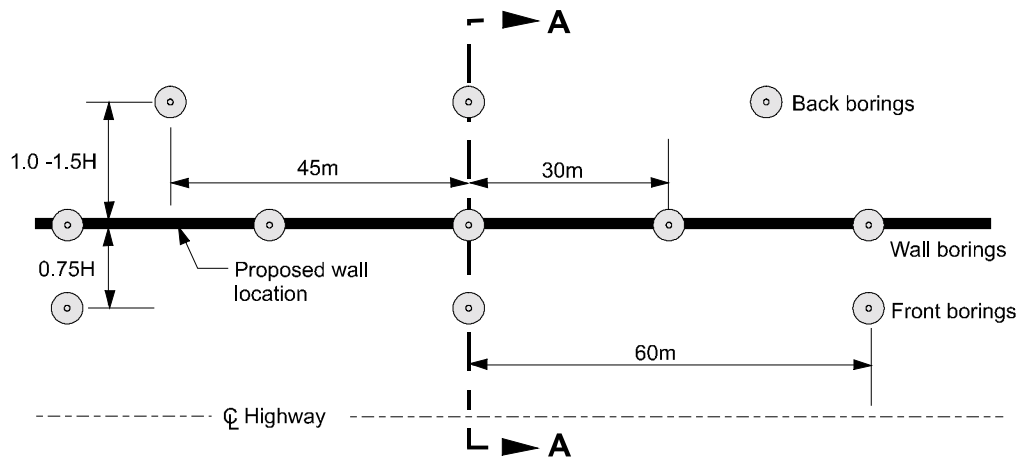

Note: Distances shown are recommended maximums.

Typical plan

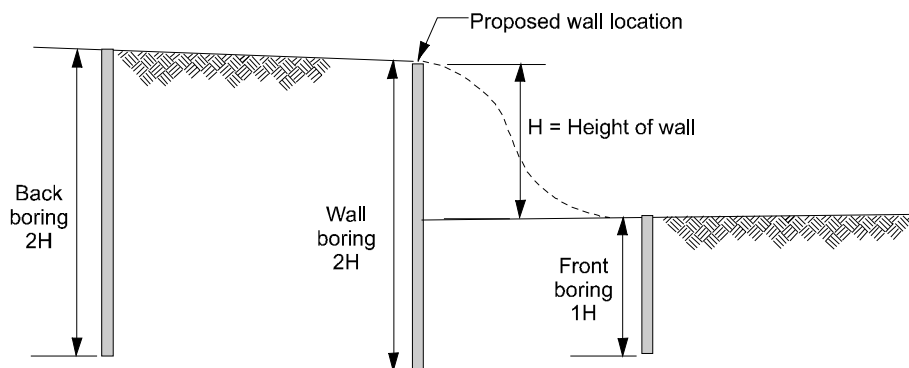

Section A - A

Figure 10. Geotechnical boring layout for permanent anchored wall.

### 3.3.2 Soil and Rock Stratigraphy

The soil and rock stratigraphy at the project site, including the thickness, elevation, and lateral extent of various layers, should be evaluated through implementation of a project-specific subsurface investigation. The following potentially problematic soils and rock should also be identified during the subsurface investigation which may significantly affect the design and construction of the anchored system:

- cohesionless sands and silts which tend to ravel (i.e., cave-in) when exposed, particularly when water is encountered, and which may be susceptible to liquefaction or vibration-induced densification;
- weak soil or rock layers which are susceptible to sliding instability;
- highly compressible materials such as high plasticity clays and organic soils which are susceptible to long-term (i.e., creep) deformations; and
- obstructions, boulders, and cemented layers which adversely affect anchor hole drilling, grouting, and wall element installation.

As shown in figure 10, subsurface borings should be advanced at regular intervals along, behind, and in front of the wall alignment or slope face. Borings should be located at the site extremities along the wall alignment so that stratigraphy information can be interpolated from the boring information. Typical boring spacing is 15 to 30 m for soil anchors and 30 to 60 m for rock anchors. The back borings are located such that the borings are advanced within the anchor bond zone so that potentially weak or unsuitable soil or rock layers can be identified. Back and wall boring depths should be controlled by the general subsurface conditions, but should penetrate to a depth below the ground surface of at least twice the wall or slope height. Front borings may be terminated at a depth below the proposed wall base equal to the wall height. Borings should be advanced deeper if there is a potential for soft, weak, collapsible, or liquefiable soils at depth. For very steeply inclined ground anchors or for vertical anchors, borings should also, at a minimum, penetrate through to the depth of the anchor bond zone. Additional borings may be required to characterize the geometry of a landslide slip surface.

As a general recommendation, soil samples should be obtained at regular, approximately 1.5 m deep, intervals and at all changes in the underlying soil strata for visual identification and laboratory testing. Methods of soil sampling include the Standard Penetration Test (SPT) (ASTM D1586) and, for cohesive soils, the use of thin-wall tubes (ASTM D1587). The cone penetration test (CPT) (ASTM D3441) may be used, if necessary, to develop a continuous subsurface soil profile.

A minimum rock core of 3 m should be recovered for subsurface conditions in which bedrock is encountered within the previously recommended investigation depths and for all designs that include rock anchors. A description of rock type, mineral composition, texture (i.e., stratification, foliation), degree of weathering, and discontinuities is generally obtained. An estimate of intact rock strength can be evaluated using percentage of core recovery and rock quality designation (RQD). The orientations (i.e., strike and dip) of discontinuities and fractures should be included whenever possible in the rock description so that the potential for sliding instability can be evaluated. This latter information may be available from rock outcrop exposures at or near the site. For jointed rock which has been infilled with soil, the joint fill material should be sampled for laboratory shear

strength testing. Soil samples and rock cores collected during the site investigation should be preserved and made available to the designer and the contractor during the design and bidding phase of a project, respectively.

### **3.3.3 Groundwater**

The groundwater table and any perched groundwater zones must be evaluated as part of a subsurface investigation program. The presence of ground water affects overall stability of the system, lateral pressures applied to the wall facing, vertical uplift forces on structures, drainage system design, watertight requirements at anchor connections, corrosion protection requirements, and construction procedures. At a minimum, the following items need to be considered for anchored systems that will be constructed within or near the groundwater table:

- average high and low groundwater levels;
- corrosion potential of ground anchors based on the aggressivity of the ground water;
- soil and/or rock slope instability resulting from seepage forces;
- necessity for excavation dewatering and specialized drilling and grouting procedures; and
- liquefaction potential of cohesionless soils.

For tiedown structures designed to resist uplift forces, unanticipated changes in groundwater levels can result in excessive consolidation settlement and a resulting decrease in ground anchor loads for cases in which the groundwater level decreases. For cases in which the groundwater level increases, ground anchor loads may increase above design loads.

Groundwater level information is often obtained by observation of the depth to which water accumulates in an open borehole at the time of, or shortly after, exploration. It is important to allow sufficient time to pass after borehole excavation so that water levels can reach equilibrium. Water levels in the subsurface may be measured more accurately using piezometers or observation wells. Water level measurements can be made over a duration of time to obtain an indication of potential water level fluctuations.

## **3.4 LABORATORY SOIL AND ROCK TESTING**

### **3.4.1 General**

Laboratory testing of soil and rock samples recovered during subsurface exploration is often performed to evaluate specific properties necessary for the design of an anchored system. In this section, laboratory tests typically performed to evaluate properties of soil and rock materials are presented along with appropriate ASTM and AASHTO testing specifications.

### **3.4.2 Classification and Index Properties**

All soil samples taken from borings and rock core samples should be visually identified in the laboratory and classified according to ASTM D2488 and ASTM D2487 or the Unified Rock Classification System (URCS). Index soil properties used in the analysis and design of anchored systems include unit weight, moisture content, gradation, and Atterberg limits. Unit weights of foundation material and retained soil are used in evaluating earth pressures and in evaluating the external stability of the anchored system. Moisture content (ASTM D2216) information and Atterberg limits (ASTM D4318; AASHTO T89, T90) may be used with existing correlations to estimate compressibility and shear strength of in situ clayey soils and to evaluate the suitability of ground anchors in cohesive soils. In addition, the presence of organic materials should be determined by either visual description or according to ASTM D2974. The results of soil grain size distribution testing (ASTM D422; AASHTO T88) can be used to develop appropriate drilling and grouting procedures for ground anchors and to identify potentially liquefiable soils.

### **3.4.3 Shear Strength**

Unconfined compression (ASTM D2166; AASHTO T208), direct shear (ASTM D3080; AASHTO T236), or triaxial compression (ASTM D4767; AASHTO T234) testing are typically performed to evaluate soil shear strength. Total stress and effective stress strength parameters of cohesive soils are typically evaluated from the results of undrained triaxial tests with pore pressure measurements. For permanent anchor applications involving cohesive soils, both undrained and drained strength parameters should be obtained, and the design of the anchored system should consider both short-term and long-term conditions. For critical applications involving cohesionless soils, direct shear or triaxial compression testing can be used to evaluate drained shear strength. Typically, however, drained shear strength of cohesionless soil is usually evaluated based on correlations with in situ test results (e.g., SPT and CPT). The selection of design soil shear strengths for anchored systems is described in chapter 4.

Laboratory strength testing of intact rock samples is not often performed for anchored system applications. For the actual field conditions, the strength of the rock mass is typically controlled by discontinuities. If, however, no adverse planes of weakness exist, the compressive strength of the intact rock, evaluated using unconfined compression (ASTM D2938), direct shear (ASTM D5607), or triaxial compression (ASTM D2664; AASHTO T226) testing, may be used to estimate ultimate bond stress (see PTI 1996).

### **3.4.4 Consolidation**

Settlement analyses are not commonly performed for anchored systems constructed in stiff soils and cohesionless soils, but should be performed for structures subjected to groundwater drawdown (both during construction and for long-term conditions) that are constructed in compressible soils. Excessive settlement in these applications may be detrimental to nearby structures and these settlements may result in long-term lateral movements of anchored systems that exceed tolerable limits. The results of index tests including moisture content and Atterberg limits can be used for initial evaluation of settlement parameters. Results of one-dimensional consolidation (ASTM D2435; AASHTO T216) tests are used to evaluate the parameters necessary for a settlement analysis.

### 3.4.5 Electrochemical Criteria

For permanent anchored systems, the aggressiveness of the ground must be evaluated. Aggressive ground conditions usually do not preclude use of anchored systems if proper corrosion protection for the anchored system is provided. Corrosion potential is of primary concern in aggressive soil applications and is evaluated based on results of tests to measure the following properties: (1) pH (ASTM G51; AASHTO T289); (2) electrical resistivity (ASTM G57; AASHTO T288); (3) chloride content (ASTM D512; AASHTO T291); and (4) sulfate content (ASTM D516; AASHTO T290). Detailed information on ground anchor corrosion and corrosion protection measures is described in chapter 6.

### 3.5 IN SITU SOIL AND ROCK TESTING

In situ testing techniques are often used to estimate several of the soil properties previously introduced in section 3.4. There are in situ testing techniques which can be used to estimate rock properties, although the use of in situ testing in rocks is not as widespread as the use in soils.

The SPT is the most common in situ geotechnical test used in evaluating the suitability of ground anchors in cohesionless soils. The SPT blowcount value N can be used to estimate the relative density (see table 1) and shear strength of sandy soils. The advantage of the SPT over other in situ tests is that its use is widespread throughout the U.S. and a disturbed sample can be obtained for visual identification and laboratory index testing. For cohesionless soils, SPT  $N < 10$  may indicate that the ground is not suitable for ground anchors. SPT blowcounts may be used to evaluate the consistency of cohesive soil strata (see table 1), but not as a reliable indication of shear strength.

Table 1. Soil density/ consistency description based on SPT blowcount values (after AASHTO, 1988).

Cohesionless Soils		Cohesive Soils	
Relative Density	SPT N (blows/300 mm)	Consistency	SPT N (blows/300 mm)
Very loose	0-4	Very soft	0-1
Loose	5-10	Soft	2-4
Medium dense	11-24	Medium stiff	5-8
Dense	25-50	Stiff	9-15
Very dense	> 51	Very stiff	16-30
		Hard	31-60
		Very hard	>61

Other in situ testing procedures may be used to evaluate the suitability of ground anchors for a particular type of ground. These include: (1) CPT; (2) vane shear test (FVT) (ASTM D2573); (3) pressuremeter test (PMT) (ASTM D4719); and (4) flat plate dilatometer test (DMT). The following studies and reports by FHWA have been devoted to the use of in situ testing techniques in soil:

- Cone Penetration Test (FHWA-SA-91-043, 1992);
- Pressuremeter Test (FHWA-IP-89-008, 1989); and

- Flat Plate Dilatometer Test (FHWA-SA-91-044, 1992).

Basic information on these tests is summarized in table 2. Empirical correlations have been developed and may be used to obtain a preliminary estimate of property values. These correlations are published elsewhere (e.g., Kulhawy and Mayne, 1990). In many parts of the country, correlations have been developed for these tests in recognition of local soils and local conditions.

Table 2. Summary of common in situ tests for soils.

Type of Test	Suitable for	Not suitable for	Properties that can be estimated
SPT	sand	soft to firm clays, gravels	Stratigraphy, strength, relative density
CPT	sand, silt, and clay	gravel	Continuous evaluation of stratigraphy, strength of sand, undrained shear strength of clay, relative density, in situ stress, pore pressures
FVT	soft to medium clay	sand and gravel	undrained shear strength
PMT	soft rock, dense sand, nonsensitive clay, gravel, and till	soft, sensitive clays, loose silts and sands	strength, $K_o$ , OCR, in situ stress, compressibility, hydraulic conductivity, elastic shear modulus
DMT	sand and clay	gravel	soil type, $K_o$ , OCR, undrained shear strength, and elastic modulus

## CHAPTER 4

### BASIC PRINCIPLES OF ANCHORED SYSTEM DESIGN

#### 4.1 GENERAL DESIGN CONCEPTS FOR ANCHORED WALLS

The concept of an anchored wall system is to create an internally stable mass of soil that will resist external failure modes at an adequate level of serviceability. The design of anchored walls concentrates on achieving a final constructed wall that is secure against a range of potential failure conditions. These conditions are illustrated in figure 11. The design should limit movements of the soil and the wall while providing a practical and economical basis for construction. The design should consider the mobilization of resistance by both anchors and wall elements in response to loads applied to the wall system.

The magnitude of the total anchor force required to maintain the wall in equilibrium is based on the forces caused by soil, water, and external loads. Anchors can provide the required stabilizing forces which, in turn, are transmitted back into the soil at a suitable distance behind the active soil zone loading the wall, as illustrated in figure 12a. This requirement that the anchor forces must be transmitted behind the active zone generally defines the minimum distance behind the wall at which the anchor bond length is formed.

The anchor bond length must extend into the ground to intersect any potentially critical failure surfaces which might pass behind the anchors and below the base of the wall as illustrated in figure 12b. The required depth to which anchors must be installed in the soil should be determined based on the location of the deepest potential failure surfaces that have an insufficient factor of safety without any anchor force.

In summary, to provide a new slope geometry by means of an excavation supported by an anchored wall, the following is necessary:

- The anchored wall should support the soil immediately adjacent to the excavation in equilibrium. This support typically governs the maximum required force in the anchors and the maximum required dimensions, strength, and bending moments in the wall section.
- The anchors should be extended sufficiently deep into the soil to beneficially affect a range of shallow and deep-seated potential failure surfaces with inadequate factors of safety. The anchor forces act on these potential slip surfaces to ensure they have an acceptable factor of safety.

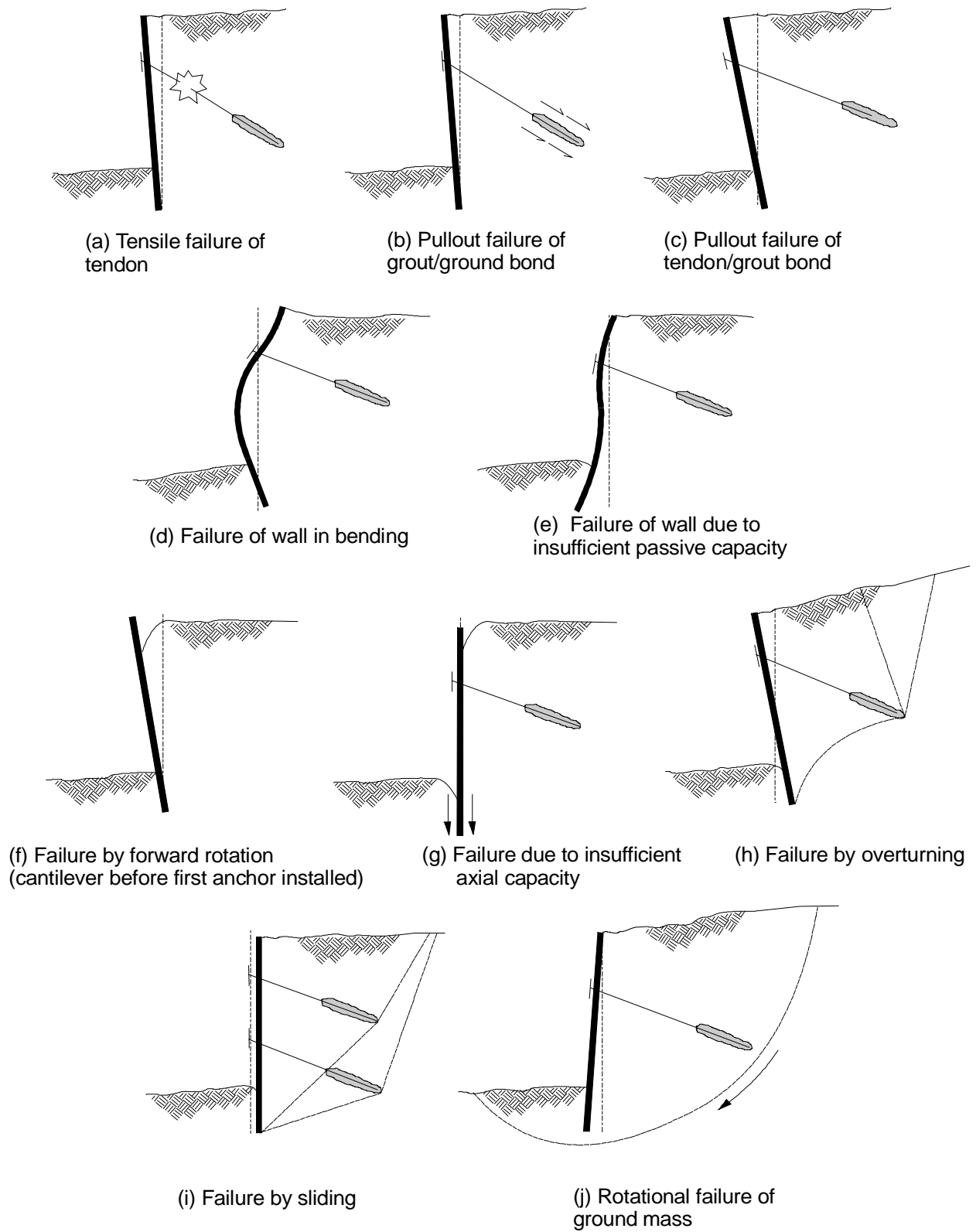

Figure 11. Potential failure conditions to be considered in design of anchored walls.



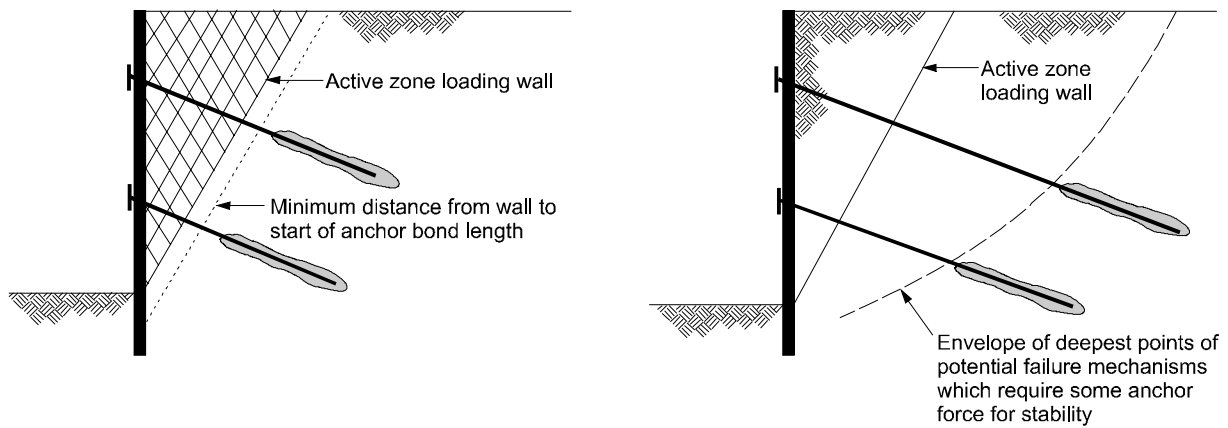

Figure 12. Contribution of ground anchors to wall stability.

## 4.2 FAILURE MECHANISMS OF ANCHORED SYSTEMS

### 4.2.1 General

Many different types of anchored systems can usually fulfill the needs of a particular project. To achieve maximum economy, the objective of the designer is to specify only those parameters that are necessary for long-term stability of the anchored system and to leave the final selection of the anchor details to the contractor. Anchor system performance is evaluated by testing each installed anchor at loads that exceed the design load. To determine the parameters that should be specified, the designer must consider various possible failure mechanisms.

### 4.2.2 Failure Mechanisms of the Ground Anchor

There are several possible failure mechanisms of ground anchors. These are usually caused by excessive static loading of an anchor. Excessive loads can be related to: (1) tension placed in the anchor during load testing or at lock-off; (2) excavation sequence; (3) surcharge by construction materials or equipment; (4) construction of adjacent structures; or (5) a combination of these causes. Ground anchor failure mechanisms may involve the steel tendon, the ground mass, the ground-grout zone, and the grout-tendon zone, as described subsequently.

#### *Failure of the Steel Tendon*

As the anchor is loaded, the steel tendon component of the anchor is stressed in tension. If the applied load is greater than the structural capacity of the tendon, failure is inevitable. Therefore, a factor of safety must be used with respect to structural failure of the steel. It is recommended that the tendon load not exceed 60 percent of the specified minimum tensile strength (SMTS) for final design and 80 percent of SMTS for temporary loading conditions (e.g., loading during testing).

### *Failure of the Ground Mass*

Failure of the soil mass, as referred to herein, involves failure resulting from anchor loads, not external forces such as landslides which potentially introduce excessive static loading to the anchor. For shallow soil anchors, failure of the ground mass is characterized by uplift of a mass of soil in front of the anchor bond zone followed by pullout of the bond zone. A shear surface develops in the soil mass ahead of the anchor as increasing stresses cause complete mobilization of resistance in the anchor bond zone. The failure surface simulates a passive earth pressure failure. Practically, failure of the soil mass is not a factor for anchors embedded more than 4.5 m below the ground surface.

For rock anchors, the likely plane of failure for shallow installations in sound bedrock is along a cone generated at approximately a 45 degree angle from the anchorage. In fractured or bedded rock, the cone shape and size varies with the distribution of bedding and cleavage planes and the grout take in fissures. Even in fractured rock, rock mass failure seldom occurs in anchors embedded more than 4.5 m below ground because the bond strength between the rock and grout or the grout and tendon is much less than the rock strength.

### *Failure of the Ground-Grout Bond*

Ground anchors mobilize skin friction between the anchor bond zone and the ground. In general, this bond is dependent on the normal stress acting on the bond zone grout and the adhesion and friction mobilized between the ground and the grout. Anchors which are underreamed may also develop the base resistance of the increased annular area.

In general, the ground-grout bond is mobilized progressively in uniform soil or rock as the stress is transferred along the bond length. Initially, as the anchor is stressed, the portion of the bond length nearest the load application elongates and transfers load to the ground. As the resistance in this portion of the bond length is mobilized, stress is transferred farther down. During this process, the anchor continues to elongate to mobilize deeper bond zones. Once the stress is transferred to the end of the bond zone and the ultimate ground-grout bond is exceeded, anchor failure by pullout occurs. Anchors which have been improperly grouted such that a column of grout exists between the bearing plate or wall and the top of the bond zone will show no load transfer into the bond length when the load is increased. Factors influencing stress transfer for small diameter ground anchors with bond lengths in a uniform soil are summarized in table 3.

Experience has shown that increasing the bond length for typical soil anchors beyond 9 to 12 m does not result in significant increases in resistance. A possible reason for this observation is that after the load has been transferred that distance down the bond zone, sufficient movement at the ground-grout interface has occurred in the upper bond length to decrease the upper ground-grout interface resistance to residual strength levels. Bond lengths greater than 12 m may be used effectively provided special procedures are used to bond the tendon to the grout such that capacity can be mobilized along the longer length.

Table 3. Typical factors influencing bond stress transfer for small diameter ground anchors.

Factor	Soil Type	
	Cohesionless	Cohesive
Soil Properties	Friction angle and grain size distribution.	Adhesion and plasticity index.
Drilling Method	Driven casing increases normal stress and friction.	Drilling without casing or with fluids decreases capacity.
Bond Length	Steady increase in anchor capacity to 6 m with moderating increases to 12 m.	Steady increase in anchor capacity for soils with undrained strength less than 96 kPa.
Hole Diameter	Slight increase in anchor capacity to 100 mm.	Anchor capacity increases to 300 mm.
Grout Pressure	Anchor capacity increases with increasing pressure.	Anchor capacity increases only with stage grouting. High initial pressures should be avoided.

Note: To ensure ground-grout bond, the drill hole should be cleaned and the grout should be placed as quickly as possible after the hole has been drilled.

Failure at the ground-grout interface may also be characterized by excessive deformations under sustained loading (i.e., creep). Soil deposits that are potentially susceptible to excessive creep deformations include: (1) organic soils; (2) clay soils with an average liquidity index (LI) greater than 0.2; (3) clay soils with an average liquid limit (LL) greater than 50; and (4) clay soils with an average plasticity index (PI) greater than 20. Conservative anchor design loads and working bond stress values are recommended for design involving permanent anchor installations in such soils, unless based on results from a predesign or preproduction test program. Predesign and preproduction test programs are described in section 5.3.6.

The LL, plastic limit (PL) and moisture content ( $w_n$ ) of a clay soil are commonly measured clayey soil index properties. The LI indicates where the moisture content of the clay falls within the range between the plastic and liquid limits. Liquidity index for a soil is defined as:

$$LI = \frac{w_n - PL}{PI} \quad \text{(Equation 1)}$$

A low LI indicates that the moisture content is relatively close to the PL of the soil, indicating a potentially overconsolidated or stiff soil. A LI close to 1.0 indicates that the moisture content is relatively close to the LL for the soil, indicating a potentially normally consolidated or soft soil.

### *Failure of Grout-Tendon Bond*

The bond between the grout and steel tendon must not be exceeded if the full strength of the supporting ground is to be mobilized. The failure mechanism of the grout-tendon bond involves three components: (1) adhesion; (2) friction; and (3) mechanical interlock. Adhesion is the physical coalescence of the microscopically rough steel and the surrounding grout. This initial bond is replaced by friction after movement occurs. The friction depends on the roughness of the steel surface, the normal stress, and the magnitude of the slip. Mechanical interlock consists of the grout mobilizing its shear strength against major tendon irregularities such as ribs or twists. This interlock is the dominant bond mechanism for threadbars where the ultimate strength of the bar may be developed in a short embedment in the grout. The grout-tendon bond on smooth steel tendons is mobilized progressively in a fashion similar to the ground-grout bond. “Slip” occurs only after the maximum intensity of grout-tendon bond resistance has been mobilized over nearly the total bond length. After this slip, the tendon will only offer frictional resistance (amounting to about half the maximum total resistance obtained) to further elongation. Experience has shown that:

- Bond resistance of the grout to the tendon is not linearly proportional to the compressive strength of the grout. Although the bond strength usually increases as the compressive strength of the grout increases, the ratio of bond to ultimate strength decreases with increasing grout strengths. For example, a 17.2 MPa bond strength for 27.6 MPa grout may only increase by 12 percent to 19.3 MPa when the grout strength is increased by 25 percent to 34.5 MPa.
- Bond resistance developed by added embedment increases as the tendon length increases, but at reduced unit values.
- Flaky rust on bars lowers the bond, but wiping off the loosest rust produces a rougher surface which develops a bond equal to or greater than an unrusted bar. Obviously pitted bars cannot be accepted even though the grout tendon bond may be adequate.
- The loose powdery rust appearing on bars after short exposures does not have a significant effect on grout-tendon bond.

Mill test reports should be requested by the owner for each lot used to fabricate the tendons. Test reports should include the results of bond capacity tests performed in accordance with the prestressing strand bond capacity test described in ASTM A981. ASTM A981 provides a standard test method to evaluate the bond strength between prestressing strand and cement grout. This specification was developed in 1997 in response to an industry initiative concerning the effects of certain residues from the manufacturing process that appeared to reduce the bond between the strand and the cement grout.

### **4.2.3 Failure of Soldier Beams**

Soldier beams are subject to both lateral and vertical loads from the retained soil mass and the forces imparted from prestressing the anchors. The lateral resistance of the soldier beam is most critical during stressing and testing of the first anchor level, and for the final excavation condition when all wall loads have been applied. In the former case, stressing of the upper anchor to the test load is

often done at shallow depths where the available passive resistance behind the soldier beam is low. Soldier beam deflections can be minimized in design by applying a safety factor of 1.5 to the passive resistance and in construction by ensuring that the upper lagging is tight against the soil and that the soil behind the soldier beam has not been removed. For the final excavation condition, the passive resistance in front of the wall must be adequate to restrain the toe of the soldier beam for long term wall loadings and for any future undercuts of the area in front of the wall.

Load transfer of the vertical loads on the soldier beams is more complex than for simple deep foundation elements. As the excavation for the wall deepens, vertical load is transferred above grade to the soil behind the back face of the soldier beam, but the magnitude of the load that is transferred is difficult to estimate. Theoretically, if adequate downward movement of the soldier beam (relative to the soil) occurs, load will be transferred to the soil mass behind the wall. However, this load transfer also results in the development of a negative interface wall friction angle for the active block of soil behind the wall resulting in an increase in the earth pressures behind the wall. In this document, it is assumed that no load transfer (i.e., interface wall friction angle =  $0^\circ$ ) occurs above the excavation base since: (1) relative movements between the soldier beam and soil are small; (2) removal of soil from the excavation face may reduce the “bond” between the soldier beam and soil; and (3) the actual amount of load transferred is usually small. Other design procedures which utilize load transfer above the excavation base can be used if appropriate documentation can be provided on relative movements required to develop load transfer.

Vertical load capacity below the excavation base is calculated using common procedures for deep foundations (i.e., driven piles or drilled shafts). Two issues, however, are unique to evaluating axial capacity for soldier beam walls and must be considered. These issues are described below.

- Stress relief in front of the wall caused by excavation will reduce the effective stresses acting on the embedded portion of the soldier beam. This reduction in stress may vary with depth based on the width of the excavation. Common practice is to assume the effective stress is equal to the average of the effective stress imparted by the retained soil height behind the wall and by the depth of the soil in front of the wall.
- Structural sections are commonly placed in predrilled holes which are filled with concrete. In the case of a structural concrete filling, it is usually assumed that axial and lateral load are shared by the steel and the concrete and lateral capacity computations may be performed on the basis of the hole diameter. However, in the case of nonstructural (i.e., “lean-mix”) concrete, the shear capacity between the structural section and the lean-mix concrete fill may not be adequate to provide load sharing between the steel and the concrete. This shear capacity should therefore be checked as part of the determination of axial and lateral soldier beam capacity.

#### **4.2.4. Failure of Lagging**

In general, the timber lagging is only used for support of temporary loads applied during excavation, however, pressure-treated timber lagging has been used to support permanent loads. The contribution of the temporary lagging is not included in the structural design of the final wall face. Temporary timber lagging is not designed by traditional methods, rather lagging is sized from charts

developed based on previous project experience which accounts for soil arching between adjacent soldier beams (FHWA-RD-75-130, 1976).

## **4.3 SELECTION OF SOIL SHEAR STRENGTH PARAMETERS FOR DESIGN**

### **4.3.1 General**

The purpose of this section is to provide guidance on selection of soil shear strength parameters for anchored system design. Shear strength parameters of the retained soil are required to evaluate earth pressures acting on a wall, axial and lateral capacity of the embedded portion of a wall, and external stability of an anchored system. The evaluation of shear strength parameters for temporary walls constructed in normally to lightly overconsolidated soft to medium clays and for temporary and permanent walls constructed in heavily overconsolidated stiff to hard clays is emphasized herein.

### **4.3.2 Drained Shear Strength of Granular Soils**

The drained shear strength of granular soil is conventionally represented by a drained effective stress friction angle,  $\phi'$ . Because the undisturbed sampling of granular soil deposits is difficult, the representative friction angle to be used for wall design may be estimated using the results of in situ penetration tests such as the SPT and the CPT.

### **4.3.3 Undrained Shear Strength of Normally Consolidated Clay**

Instability under undrained conditions develops mainly under the condition of contractive shear, i.e., the mechanism of deformation which attempts to mobilize frictional shearing resistance also causes the soil to want to contract under the prevailing confining stresses. This tendency to contract during shear is typical for normally to lightly overconsolidated soft to medium clay soils. Since this tendency cannot be realized, due to the clay soil permeability in relation to the rate of shearing, positive porewater pressures are generated in the soil which reduce the effective stress and hence the mobilized frictional shearing resistance. In such cases the short term undrained shearing resistance in the soil is less than would have been the case if drainage (contraction of the soil volume) could have occurred. The short term condition is critical for temporary anchored walls constructed in normally to lightly overconsolidated clay soils.

The undrained shear strength,  $S_u$ , may be determined by in situ (e.g., CPT, FVT) and laboratory testing methods. A detailed discussion of the methods used to evaluate  $S_u$  is beyond the scope of this document, but this information may be found elsewhere (e.g., Kulhawy and Mayne, 1990). Typically  $S_u$  is evaluated using laboratory triaxial tests on nominally undisturbed cohesive soil samples at the natural water content of the soil. The preferred method to evaluate the undrained strength in the laboratory is through consolidated undrained triaxial testing with pore pressure measurements. The use of unconfined compression tests and/or unconsolidated undrained triaxial tests may lead to erroneous measured strengths due to sampling disturbance and the omission of a reconsolidation phase.

The undrained shear strength is not a fundamental property of a soil and is affected by the mode of testing, boundary conditions, rate of loading, initial stress state, and other variables. Consequently, the measured undrained shear strength should be different depending on the type of test performed. The designer should consider how the actual undrained shear strength mobilized under field loading conditions differs from that measured using laboratory or in situ testing methods. For example, for a temporary anchored wall in soft to medium clay, the undrained shear strength used to evaluate the earth pressures acting on the wall may be determined from a triaxial compression test. The lateral capacity of the wall toe, however, is more appropriately evaluated using the undrained strength from a triaxial extension test. The extension loading path more accurately approximates the unloading caused by soil excavation as compared to a compression loading path and, more importantly, experience has shown that strength in the passive zone (inside the excavation) can be less than that in the active zone (in the retained ground) for certain clay soils. Alternatively, correlations may be used to “convert” the undrained strength measured in a conventional triaxial compression test into an undrained strength for a different loading path (see Kulhawy and Mayne, 1990).

#### **4.3.4 Undrained Shear Strength of Overconsolidated Clay**

In clay soils subjected to unloading conditions that result from excavation to form an anchored wall, the soil attempts to expand as it mobilizes frictional shearing resistance. This is resisted causing negative porewater pressure to be developed which increases the effective stress in the soil and hence increases the mobilized frictional shearing resistance. Thus, in an overconsolidated clay subject to excavation, the short-term (undrained) strength and stability potentially exceeds that which would apply once drainage has occurred.

Temporary and permanent anchored walls are commonly constructed in stiff to hard overconsolidated clays. Heavily overconsolidated clay soils are often fissured. Due to the fissured nature of overconsolidated clays, which can permit relatively rapid local drainage at the level of the discontinuities in the clay, it is generally difficult to define with any certainty the period of time during which the enhanced undrained shear strength of the clay may reliably be assumed to apply. Therefore, in overconsolidated clays, design analyses should be performed in terms of drained, effective stress parameters. Drained strength parameters for overconsolidated clays are discussed subsequently.

#### **4.3.5 Drained Shear Strength of Overconsolidated Clay**

The behavior of an overconsolidated stiff clay can be illustrated as shown in figure 13. As the sample is sheared under drained conditions, the displacement of the soil sample is relatively uniform until the peak stress,  $\tau_p$ , is reached. After the peak, displacements begin to concentrate on the newly formed failure plane or discontinuity, and the shear stress reduces to  $\tau_d$ . The shear strength,  $\tau_d$ , of the newly formed discontinuity is approximately equal to the shear strength of the same clay constituents in a normally consolidated state (i.e., the fully softened strength), such as that produced by laboratory consolidation from a slurry. For relatively high plasticity clays, further displacement beyond that corresponding to the fully softened strength results in a continued reduction in shear stress, and, eventually, at very large displacements along a major discontinuity, the residual strength of the clay soil,  $\tau_r$ , is reached.

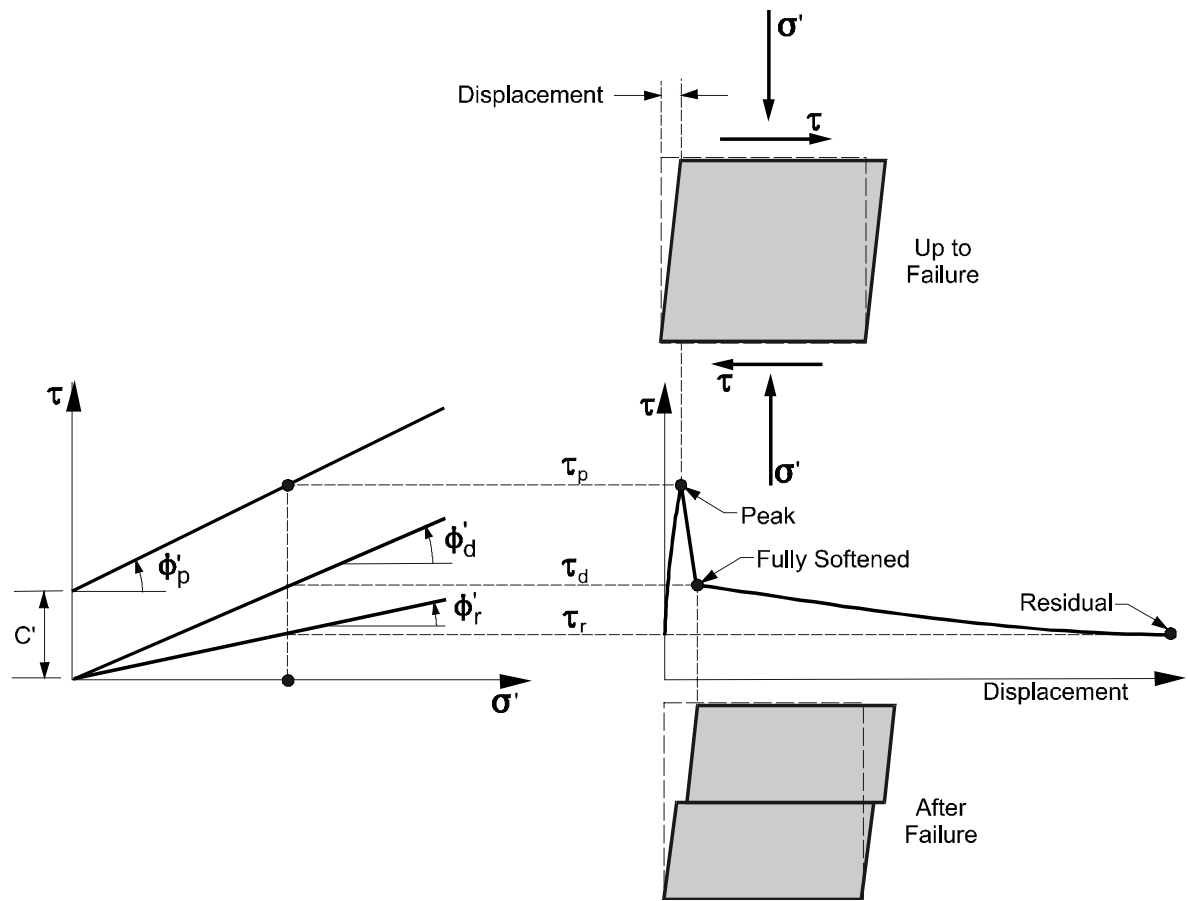

Figure 13. Simplified drained stress-displacement relationship for a stiff clay (modified after Construction Industry Research and Information Association (CIRIA), 1984).

For anchored systems in stiff to hard overconsolidated clays, the designer must decide as to which strength, i.e., peak, fully softened, or residual, should be used for design. Since the additional strength at peak resulting from cohesion ( $c'$  in figure 13) tends to reduce relatively rapidly with increasing strain beyond peak, soil deformations associated with flexible anchored walls may be sufficient to appreciably reduce this cohesion. Therefore, unless local experience indicates that a particular value of cohesion can be reliably accounted for, zero cohesion should be used in the analyses of anchored walls in stiff to hard fissured clays for long-term (drained) conditions. Conservative drained shear strength for analysis of anchored walls is therefore the fully softened strength. This strength may be evaluated using triaxial compression testing with pore pressure measurements.

Residual strengths should be used for anchored systems that are designed for a location in which there is evidence of an existing failure surface within the clay (e.g., an anchored system used to stabilize an active landslide). For these conditions, assume that sufficiently large deformations have occurred to reduce the strength to a residual value. A study by Stark and Eid (1994) presents a correlation between residual friction angle and the clay size fraction and liquid limit for clay soils.



## 4.4 EARTH PRESSURES

### 4.4.1 General

A wall system is designed to resist the lateral earth pressures and water pressures that develop behind the wall. Earth pressures develop primarily as a result of loads induced by weight of the retained soil, earthquake ground motions, and various surcharge loads. For purposes of anchored wall system design, three different lateral earth pressure conditions are considered: (1) active earth pressure; (2) passive earth pressure; and (3) at-rest earth pressure.

The distinction between actual ground behavior and conventional design assumptions is particularly important when considering earth pressures. The simple linear assumptions about active and passive pressures based on theoretical analyses are a considerable simplification of some very complex processes which depend on the following factors: (1) the mode of wall movement (rotation, translation); (2) wall flexibility; (3) soil stiffness and strength properties; (4) horizontal prestress in the ground; and (5) wall/soil interface friction. For anchored wall systems with flexible wall elements, semi-empirical “apparent earth pressure envelopes” are commonly used.

### 4.4.2 Active and Passive Earth Pressure

Active and passive horizontal earth pressures may be considered in terms of limiting horizontal stresses within the soil mass, and, for purposes of this discussion, a smooth (i.e., zero wall friction) wall retaining ground with a horizontal backslope is considered (figure 14); this case defines Rankine conditions. Consider an element of soil in the ground under a vertical effective stress,  $\sigma_v'$  (figure 15). In considering the potential movements of a retaining wall, the element may be brought to failure in two distinct ways that are fundamentally important in the context of retaining wall design. The horizontal soil stress may be increased until the soil element fails at B, when the stress reaches its maximum value  $\sigma'_{h(max)}$ . This scenario will occur when significant outward movement of the wall increases the lateral earth pressure in the soil at the base of the wall (see figure 14). Similarly, the horizontal stress may be reduced until failure at A, when the stress reaches its minimum value  $\sigma'_{h(min)}$ . This scenario models the outward movement which reduces the lateral earth pressures behind the wall (see figure 14).

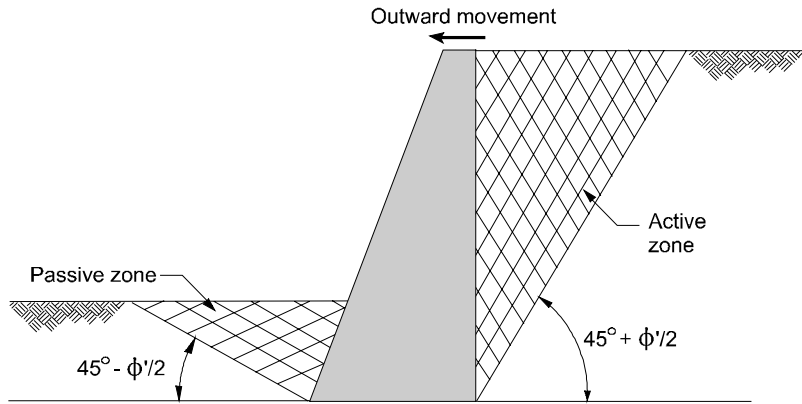

Figure 14. Mobilization of Rankine active and passive horizontal pressures for a smooth retaining wall.

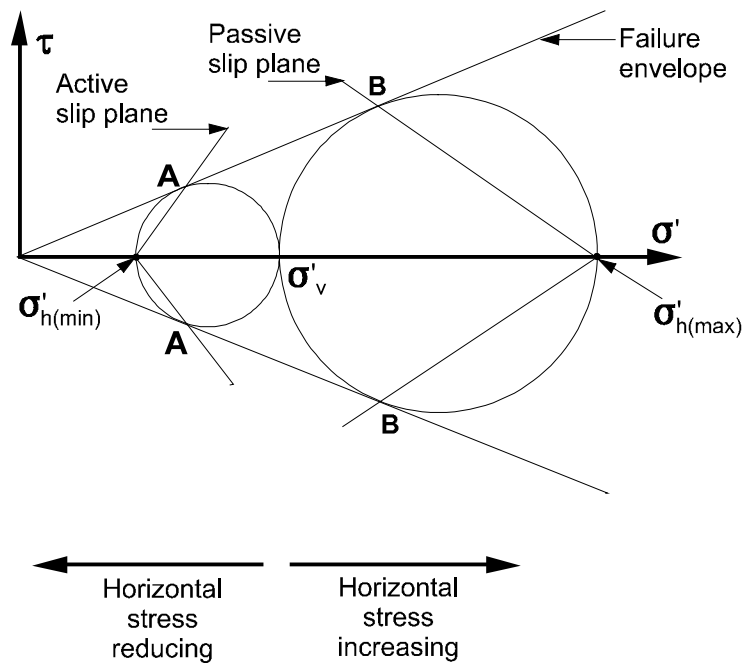

Figure 15. Limiting active and passive horizontal pressures.

The geometry of figure 15 gives the following two relationships:

$$\frac{\sigma'_{h(\min)}}{\sigma'_v} = K_A = \frac{1 - \sin \phi'}{1 + \sin \phi'} = \tan^2(45 - \phi'/2) \quad (\text{Equation 2})$$

$$\frac{\sigma'_{h(\max)}}{\sigma'_v} = K_P = \frac{1 + \sin \phi'}{1 - \sin \phi'} = \tan^2(45 + \phi'/2) \quad (\text{Equation 3})$$

where  $K_A$  is the active earth pressure coefficient and  $K_P$  is the passive earth pressure coefficient. The definitions of  $K_A$  and  $K_P$ , based on equations 2 and 3, are consistent with a Rankine analysis for a cohesionless (i.e.,  $c=0$ ) retained soil.

For a cohesive soil defined by effective stress strength parameters  $\phi'$  and  $c'$ , the active and passive earth pressure coefficients are:

$$K_A = \tan^2(45 - \phi'/2) - \frac{2c'}{\sigma'_v} \tan(45 - \phi'/2) \quad (\text{Equation 4})$$

$$K_P = \tan^2(45 + \phi'/2) + \frac{2c'}{\sigma'_v} \tan(45 + \phi'/2) \quad (\text{Equation 5})$$

For the undrained case with  $\phi = 0$  and  $c = S_u$ , the total stress active and passive earth pressure coefficients are:

$$K_{AT} = 1 - \frac{2S_u}{\sigma_v} \quad (\text{Equation 6})$$

$$K_{PT} = 1 + \frac{2S_u}{\sigma_v} \quad (\text{Equation 7})$$

where  $\sigma_v$  is the total vertical stress.

For most anchored wall applications, the effect of wall friction on active earth pressures is relatively small and is often ignored. The active earth pressure coefficient,  $K_A$ , may be evaluated using the appropriate equations from above or, for more general cases, from the lower part of figure 16 or figure 17. The earth pressure coefficients depicted in figure 16 and figure 17 are based on the assumption of log-spiral shaped failure surfaces for the active and passive sides of the wall. To evaluate the passive earth pressure coefficient,  $K_P$ , the upper part of figure 16 or 17 should be used.

It is acknowledged that in addition to the Rankine equations and the log-spiral method, a third closed-form technique, herein referred to as the Coulomb method, is often used to calculate lateral earth pressures. For this method, equations are available to calculate  $K_A$  and  $K_P$  (NAVFAC, 1982). While calculations of  $K_A$  are considered to be reasonable, the Coulomb method is unreliable for evaluating passive earth pressures since the planar shape of the assumed Coulomb failure surface is

REDUCTION FACTOR (R) OF $K_p$ FOR VARIOUS RATIOS OF $-\delta/\phi$									
$\phi$	$\delta/\phi$	-0.7	-0.6	-0.5	-0.4	-0.3	-0.2	-0.1	0.0
10		.978	.962	.946	.929	.912	.898	.881	.864
15		.961	.934	.907	.881	.854	.830	.803	.775
20		.939	.901	.862	.824	.787	.752	.716	.678
25		.912	.860	.808	.759	.711	.666	.620	.574
30		.878	.811	.746	.686	.627	.574	.520	.467
35		.836	.752	.674	.603	.536	.475	.417	.362
40		.783	.682	.592	.512	.439	.375	.316	.262
45		.718	.600	.500	.414	.339	.276	.221	.174

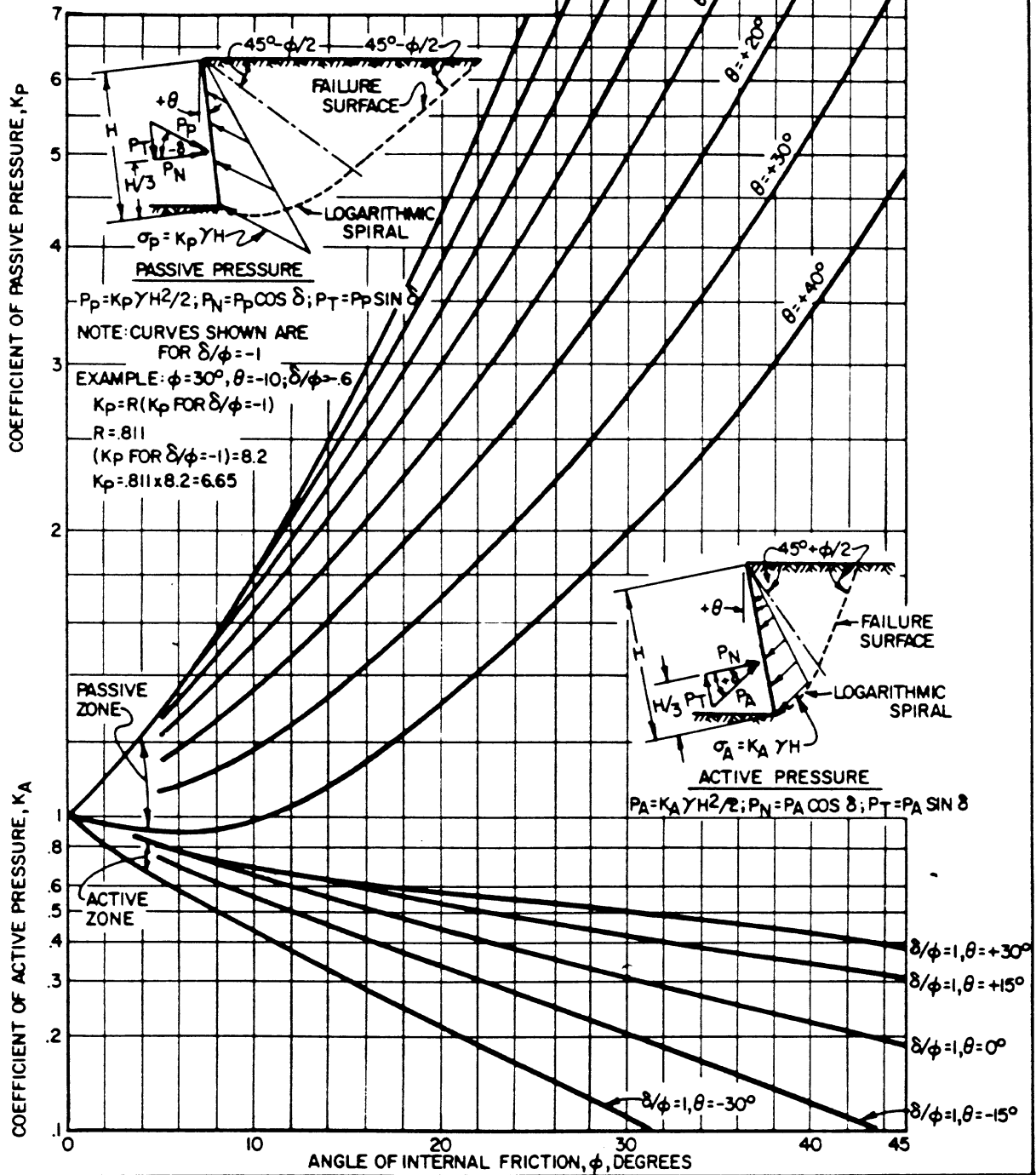

Figure 16. Active and passive earth pressure coefficients (effect of wall inclination).

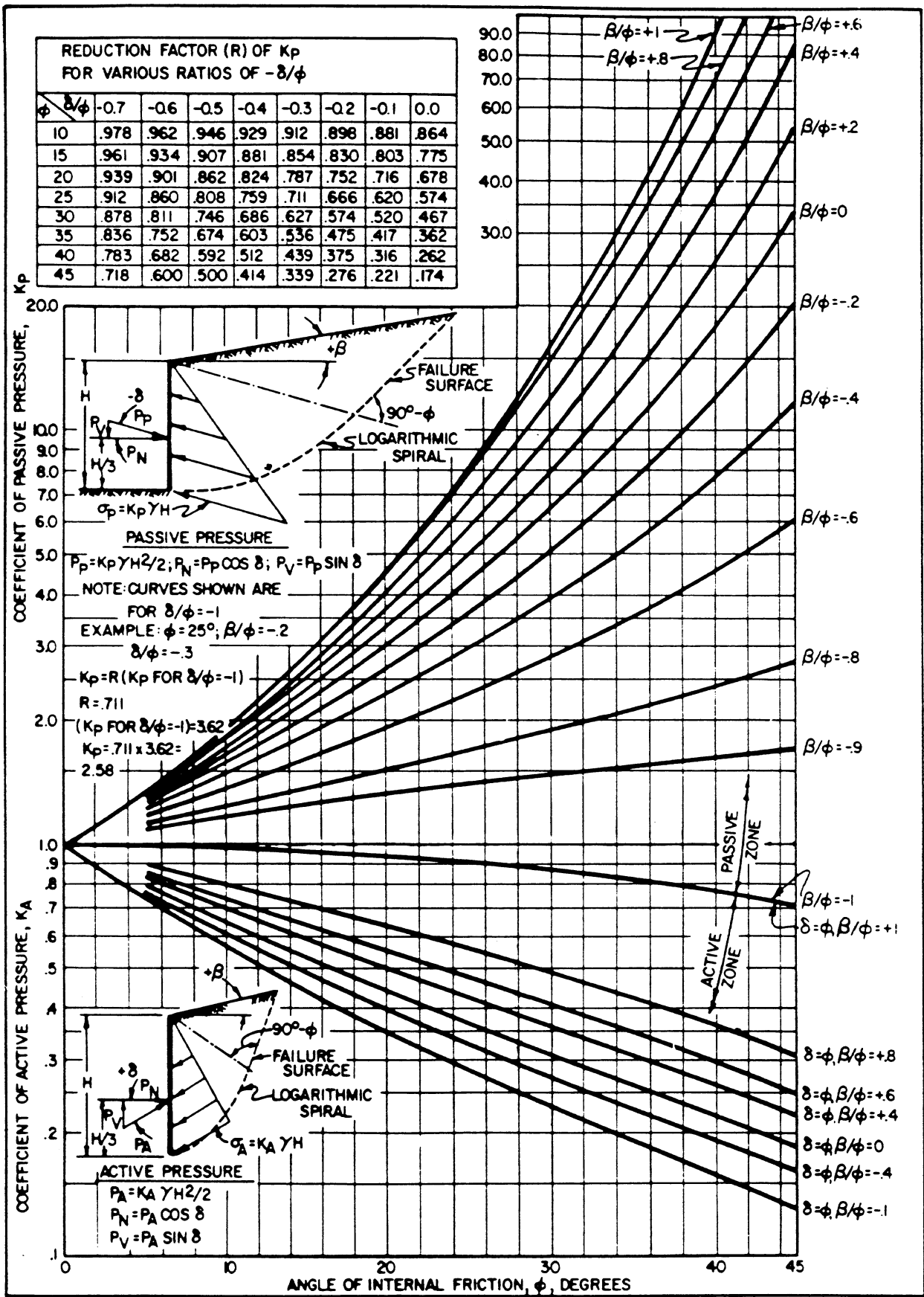

Figure 17. Active and passive earth pressure coefficients (effect of backslope inclination).

in error compared to the more accurate log-spiral shaped surfaces. Passive pressures calculated using the Coulomb theory are always higher than those based on log-spiral shaped surfaces.

The magnitude of wall friction ( $\delta$ ) typically used in evaluating design passive pressures in front of an excavation ranges from  $\delta=0.5\phi'$  to  $1.0\phi'$ . The value used for design depends on the wall material (e.g. steel or concrete), soil type, method of wall construction, and axial load transfer. For the analysis of continuous sheet-pile walls, a value of  $\delta=0.5\phi'$  is recommended. The evaluation of design passive pressures for anchored sheet-pile and soldier beam and lagging walls is described in section 5.5.

#### 4.4.3 Earth Pressure at Rest

Sand or clay, normally consolidated in the ground under the natural condition of no lateral deformation (i.e., vertical compression only) and under an incremental application of vertical load, experience a condition referenced as the earth pressure at rest. The value of the coefficient of the earth pressure at rest,  $K_o$ , is found to be in close agreement with the empirical equation:

$$K_o = \frac{\sigma'_h}{\sigma'_v} = 1 - \sin \phi' \quad (\text{Equation 8})$$

For normally consolidated clay,  $K_o$  is typically in the range of 0.55 to 0.65; for sands, the typical range is 0.4 to 0.5. For lightly overconsolidated clays ( $OCR \leq 4$ ),  $K_o$  may reach a value up to 1; for heavily overconsolidated clays ( $OCR > 4$ ),  $K_o$  values may range up to or greater than 2.

In the context of anchored wall design using steel soldier beams or sheet-pile wall elements, design earth pressures based on at-rest conditions are not typically used. Using at-rest earth pressures implicitly assumes that the wall system undergoes no lateral deformation. This condition may be appropriate for use in designing heavily preloaded, stiff wall systems, but designing to this stringent (i.e., zero wall movement) requirement for flexible anchored wall systems for highway applications is not practical. The relationship between earth pressures and movement for flexible anchored walls is discussed subsequently.

#### 4.4.4 Influence of Movement on Earth Pressure

The stress distribution behind a wall depends on the deformation to which the wall is subjected. Owing to the “top-down” method of anchored wall construction with the requisite cycles of excavation, anchor installation, anchor prestressing, and anchor lock-off, the pattern of earth pressure and deformation is typically not accurately approximated assuming fully active (i.e., linear increase in earth pressure with depth) conditions used for design of gravity or nongravity cantilevered walls. Peculiarities in the pattern of deformation can result in pressures lower than those for a fully active condition over parts of the wall, which are offset by corresponding areas where pressures are above those for the fully active condition. Where walls penetrate competent soils, lateral earth pressures are highest near the ground anchor locations and only small lateral earth pressures exist along the embedded portion of the wall.

The results from a study on the performance of a two-level model anchored wall may be used to illustrate the relationship between lateral earth pressure and wall deformation for relevant anchored wall construction stages. The model wall was 1.9 m high with a final toe embedment of 0.38 m (figure 18). The results of the model wall study are described in FHWA-RD-98-067 (1998).

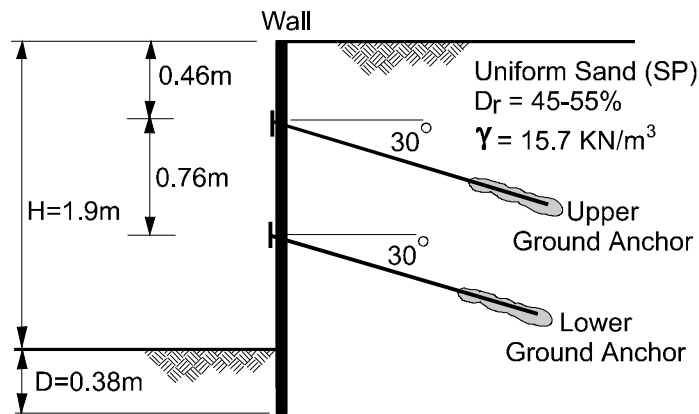

Figure 18. Cross section of model wall (modified after FHWA-RD-98-067, 1998).

- Cantilever Stage:* During the cantilever stage of construction, soil is excavated down to a level just below the elevation of the first ground anchor. For the portion of the wall above the first excavation level, the earth pressure and deformation pattern are generally consistent with that of active conditions (i.e., a triangular pressure distribution) (figure 19). The wall is in a condition of “fixed-earth support.”

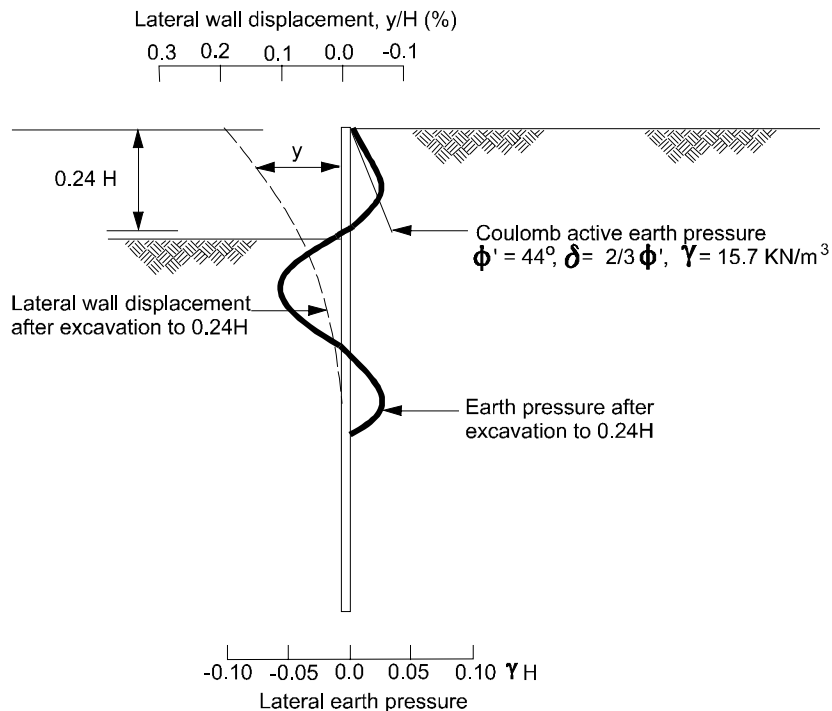

Figure 19. Lateral wall movements and earth pressures with excavation at first anchor level (cantilever stage) (modified after FHWA-RD-98-067, 1998).

- Stressing of Upper Ground Anchor:* Significant changes in lateral earth pressure occur as a result of anchor stressing (figure 20). During stressing, the soldier beam is pushed against the retained ground, resulting in a large increase in lateral pressures that may approach full passive pressures in the vicinity of the load. When the load is reduced to the lock-off load, typically 75 to 100 percent of the design load, the pressure decreases leaving a pressure bulb around the anchor. Note that this pressure is in excess of active pressures.

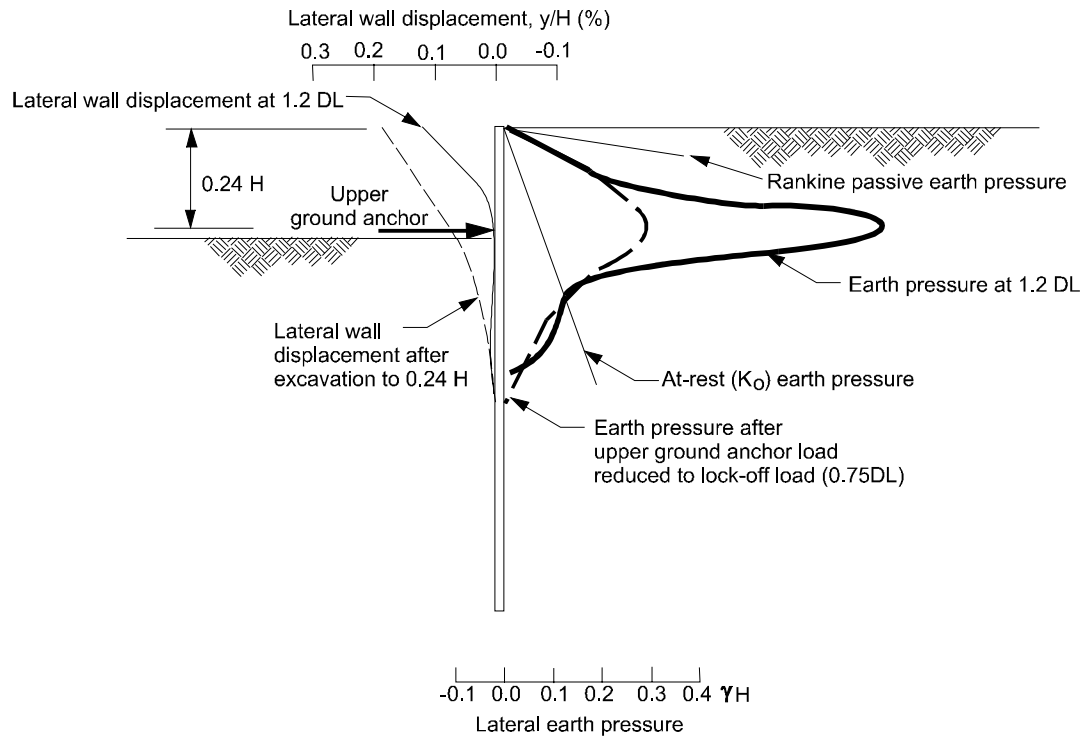

Figure 20. Lateral wall movements and earth pressures during anchor stressing (modified after FHWA-RD-98-067, 1998).



- *Excavation to Lower Anchor:* Excavation below the upper anchor results in lateral bulging of the wall and a redistribution of earth pressure (figure 21). Earth pressure between the upper anchor and the excavation subgrade is reduced and load is redistributed to the stiffer upper anchor and excavation subgrade resulting in earth pressure increases in these areas.

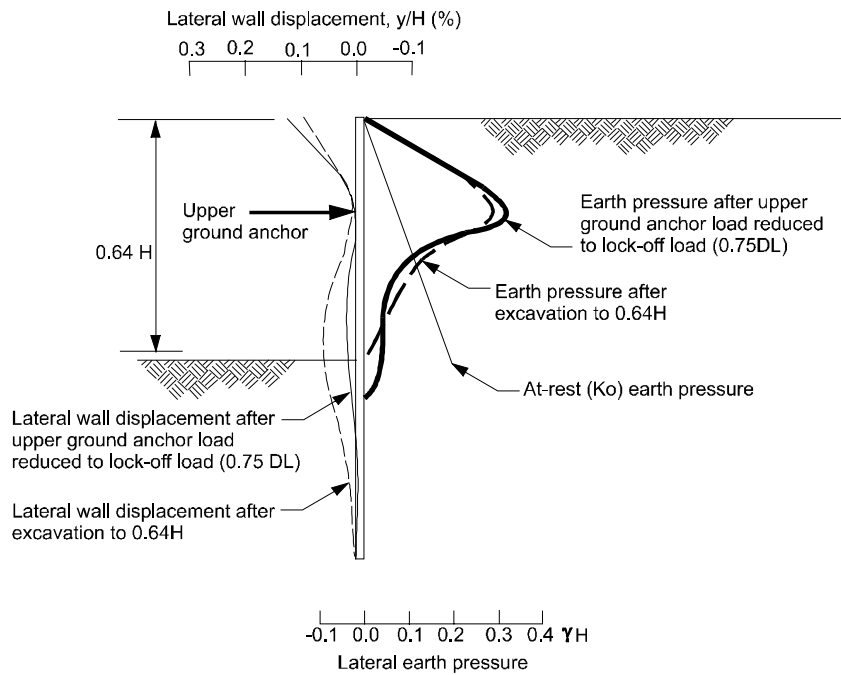

Figure 21. Lateral wall movements and earth pressures with excavation at lower anchor level (modified after FHWA-RD-98-067, 1998).

- *End of Construction:* Stressing of the lower ground anchor results in a local wall deformation pattern similar to that resulting from stressing the upper anchor (figure 22). A pressure bulb also develops at the location of the lower anchor. As a result of excavation to the final design grade, lateral bulging occurs between the lower anchor and the excavation subgrade.

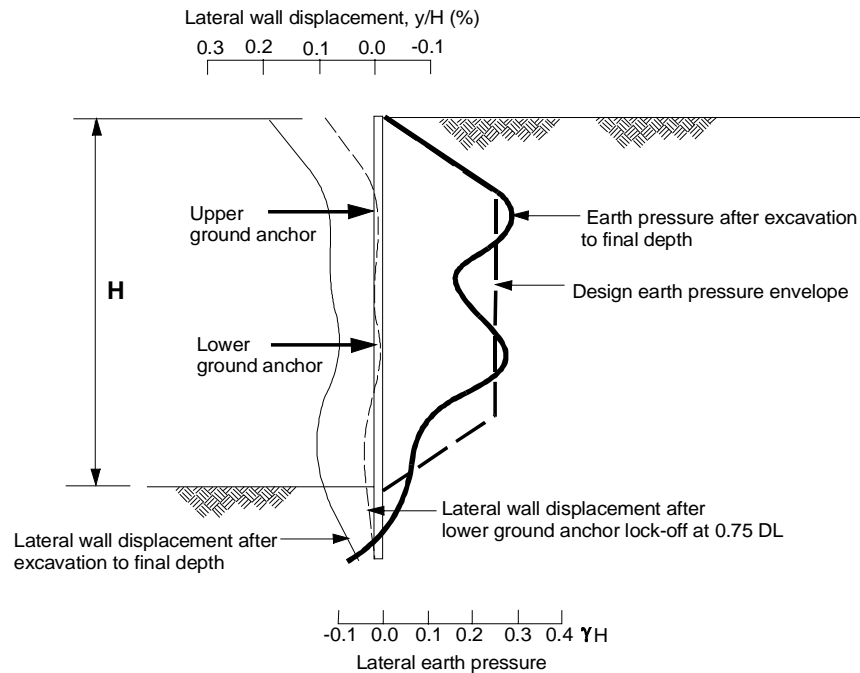

Figure 22. Lateral wall movements and earth pressures with excavation at design grade (modified after FHWA-RD-98-067, 1998).

A trapezoidal-shaped envelope of earth pressure is also shown on figure 22. This envelope is referred to as an “apparent earth pressure envelope” and closely approximates the shape and magnitude of the earth pressures after completion of the wall. Apparent earth pressure envelopes are described in detail in chapter 5. It is noted that earth pressure envelopes which assume fully active conditions (i.e., triangular pressure distribution) would overestimate the earth pressures near the excavation subgrade, resulting in overly conservative estimates of wall bending moments and required wall embedment depth, and underestimate anchor loads and wall bending moments at upper tier supports.

The results described above were for a flexible model wall constructed in competent ground where load redistribution from the ground to the supports occurred. This pattern of earth pressure and deformation may not be appropriate for walls embedded in weak ground which may experience relatively large outward rotation of the wall near the excavation subgrade resulting in the development of full active earth pressure conditions. Walls in weak ground are discussed further in chapter 5.

## CHAPTER 5

### DESIGN OF ANCHORED SYSTEMS

#### 5.1 INTRODUCTION

The purpose of this chapter is to present analysis procedures for the design of ground anchors and anchored systems. As previously discussed in chapter 1, design concepts for permanent systems are also applicable to critical temporary systems. The emphasis of this chapter is on the design of permanently anchored soldier beam and lagging walls, as these systems are most commonly used for highway applications. Other systems discussed include temporary support of excavation (SOE) anchored walls (either sheet-pile or soldier beam and lagging), landslide and slope stabilization systems, and tiedown structures. For consistency, when concepts and procedures are generally applicable to all anchored systems, including walls, the term “anchored system” will be referenced. If a concept or procedure is specifically applicable to anchored wall systems, the term “anchored wall” will be referenced.

A general flow chart for anchored wall design (temporary and permanent) is shown in table 4. This table was developed assuming that an anchored wall has been judged to be a suitable support system for a specific application. Information on selecting a particular wall type (e.g., anchored walls, soil nailed walls, mechanically stabilized walls, etc.) can be found in FHWA-SA-96-038 (FHWA, 1997). Step (1) involves establishing overall geometric requirements for the anchored system and identifying project requirements and constraints. This step involves developing the wall profile, locating wall appurtenances such as traffic barriers, utilities, and drainage systems, establishing right-of-way (ROW) limitations, and construction sequencing requirements. Project requirements and constraints may significantly affect design, construction, and cost of the wall system and should therefore be identified during the early stages of the project. Since the information in Step (1) is required prior to actual wall selection and design, further discussion is limited in this chapter regarding these issues. Steps (2) through (13) address specific geotechnical and structural requirements that are addressed when designing an anchored wall.

This chapter focuses on procedures that should be addressed in designing specific components of an anchored wall. As part of the overall design, the relationship between type of ground, selection of ground anchors, type of soldier beam, connections (ground anchor/soldier beam, soldier beam/permanent facing), and type of facing must be considered. Detailed information on these considerations is not included in this document as decisions related to these considerations are typically made by the contractor. The engineer, however, should ensure that the specific components and combinations of components used for the anchored system are consistent with all performance requirements.

Table 4. Typical design steps for an anchored wall (modified after FHWA-RD-81-150, 1982).

Step 1.	Establish project requirements including all geometry, external loading conditions (temporary and/or permanent, seismic, etc.), performance criteria, and construction constraints.
Step 2.	Evaluate site subsurface conditions and relevant properties of in situ soil and rock.
Step 3.	Evaluate design properties, establish design factors of safety, and select level of corrosion protection.
Step 4.	Select lateral earth pressure distribution acting on back of wall for final wall height. Add appropriate water, surcharge, and seismic pressures and evaluate total lateral pressure. A staged construction analysis may be required for walls constructed in marginal soils.
Step 5.	Calculate horizontal ground anchor loads and wall bending moments. Adjust vertical anchor locations until an optimum wall bending moment distribution is achieved.
Step 6.	Evaluate required anchor inclination based on right-of-way limitations, location of appropriate anchoring strata, and location of underground structures.
Step 7.	Resolve each horizontal anchor load into a vertical force component and a force along the anchor.
Step 8.	Evaluate horizontal spacing of anchors based on wall type. Calculate individual anchor loads.
Step 9.	Select type of ground anchor.
Step 10.	Evaluate vertical and lateral capacity of wall below excavation subgrade. Revise wall section if necessary.
Step 11.	Evaluate internal and external stability of anchored system. Revise ground anchor geometry if necessary.
Step 12.	Estimate maximum lateral wall movements and ground surface settlements. Revise design if necessary.
Step 13.	Select lagging. Design walers, facing drainage systems, and connection devices.

## 5.2 EVALUATION OF EARTH PRESSURES FOR WALL DESIGN

### 5.2.1 Introduction

The earth pressure distribution that develops on an anchored wall depends on the magnitude and distribution of lateral wall deformations. Some relatively flexible nongravity cantilevered walls (e.g., sheet-pile or soldier beam and lagging walls which are not anchored) can be expected to undergo lateral deformations sufficiently large to induce active earth pressures for the entire wall height. For design of these systems, theoretical active earth pressure diagrams using either Rankine or Coulomb analysis methods can be used.

For anchored wall systems constructed from the “top-down”, the deformation pattern is more complex and not consistent with the development of a theoretical Rankine or Coulomb earth pressure distribution. Soil shear strength, wall stiffness, anchor inclination, vertical spacing of the anchors, and anchor lock-off loads directly influence the wall deformation pattern and the resulting earth pressures acting on these types of walls. For example, higher than active earth pressures develop at the upper anchor location since the upper anchor restrains the wall from moving outward sufficiently to locally cause a reduction of earth pressures to the active state.

This section presents information on and makes recommendations for evaluating earth pressure distributions used in design of temporary SOE and permanent anchored walls with flexible wall elements. Methods for evaluating earth pressures for these types of anchored walls include the use of apparent earth pressure, sliding wedge-type, and limit equilibrium calculations.

### **5.2.2 Background**

Apparent earth pressure diagrams are semi-empirical diagrams that were originally developed by Terzaghi and Peck (1967) and Peck (1969) to provide loadings for conservative design of struts in internally braced excavations. Diagrams were developed for homogeneous profiles representing: (1) drained loadings in sands; (2) undrained loadings in stiff to hard fissured clays; and (3) undrained loadings in soft to medium clays. Since 1969, modifications to the original diagrams have been proposed. Two notable modifications that have been incorporated in this manual are described below:

- Henkel (1971) modified the equation used to calculate the maximum earth pressure ordinate for the Terzaghi and Peck soft to medium clay apparent earth pressure diagram. Henkel assumed a failure mechanism consistent with deep-seated movements for excavations in soft to medium clay that had not been previously used by Peck (1969). Backcalculated values of the active earth pressure coefficient for excavations in which deep-seated movements occurred indicated that Peck’s method underpredicted the active earth pressure coefficient whereas Henkel’s method more accurately predicted the active earth pressure coefficient.
- In FHWA-RD-97-130 (1998), a variation in the distribution of earth pressure calculated from Terzaghi and Peck’s (1967) apparent earth pressure diagram for sand and stiff to hard fissured clay is proposed. The earth pressures for anchored walls with flexible wall elements are greatly influenced by the prestressing and lock-off procedure used for each anchor (see section 4.4.4). Earth pressures concentrate at the anchor locations. The apparent earth pressure diagram for anchored walls in sands and stiff to hard fissured clays requires that the location of the uppermost and lowermost anchor be known. The distribution of earth pressure is therefore, in addition to being influenced by excavation depth (as is the case for the Terzaghi and Peck diagrams), also influenced by the location of the anchors.

The use of apparent earth pressure envelopes has resulted in reasonable estimates of ground anchor loads and conservative estimates of wall bending moments between anchors for flexible walls constructed in competent soils. The apparent earth pressure diagrams recommended herein are based on the Terzaghi and Peck (1967) diagrams for internally braced excavations and research results obtained from full-scale and model-scale instrumented anchored soldier beam and lagging walls. Apparent pressure diagram analyses permit relatively simple “hand-calculations” of ground anchor

loads and wall bending moments. They represent an envelope that can be used to develop an adequate anchored system for the entire history of the excavation, but they do not provide actual loads that might exist on the wall at any time. Where an assessment of the actual loads on the wall is required, staged construction analyses such as soil-structure interaction analyses (e.g., beam on elastic foundation) may be used. Staged construction analyses may also be required where: (1) the wall is influenced by loadings from nearby foundations; (2) large surcharge loadings need to be resisted by the wall; or (3) there are preexisting instabilities or planes of weakness in the retained soil.

Limit equilibrium calculations may be used for evaluating the total load required to stabilize a slope or excavation in highly stratified soils, profiles for which the potential failure surface is deep-seated or occurs along weak, well-defined interfaces, and where complicated surcharges are present. Limit equilibrium calculations may be performed using hand calculation methods such as trial wedge or using slope stability analysis computer programs. Limit equilibrium calculations are equally as valid as apparent earth pressure diagrams for evaluating required loads for walls constructed in relatively homogeneous soil profiles. However, apparent earth pressure diagrams are more expedient to use and are therefore recommended herein over limit equilibrium calculations. Comparisons between these two methods are provided in this chapter.

### **5.2.3 Terzaghi and Peck Apparent Earth Pressure Diagrams**

The apparent earth pressure diagrams developed by Terzaghi and Peck (1967) and Peck (1969), although not recommended herein in their original form, provide the framework for the diagrams that will be recommended in subsequent sections. These diagrams represent the envelope of pressures back-calculated from field measurements of strut loads in internally braced excavations. These diagrams produce conservative design loads, implying that if a strut load would be equivalent to the calculated load from the apparent pressure diagram at that location, the other strut loads would necessarily be less than that calculated from the apparent pressure diagram.

The Terzaghi and Peck apparent earth pressure envelopes are rectangular or trapezoidal in shape. These diagrams are summarized in figure 23. The maximum ordinate of the apparent earth pressure diagrams in figure 23 is denoted by  $p$ . The Terzaghi and Peck envelopes were developed based on the following factors:

- The excavation is assumed to be greater than 6 m deep and relatively wide. Wall movements are assumed to be large enough so that the full value of the soil shear strength may be mobilized.
- Groundwater is assumed to be below the base of the excavation for sands, and for clays, its position is not considered important. Specifically, loading due to water pressure was not considered in these analyses.
- The soil mass is assumed to be homogeneous and soil behavior during shearing is assumed to be drained for sands and undrained for clays, i.e., only short-term loadings are considered.

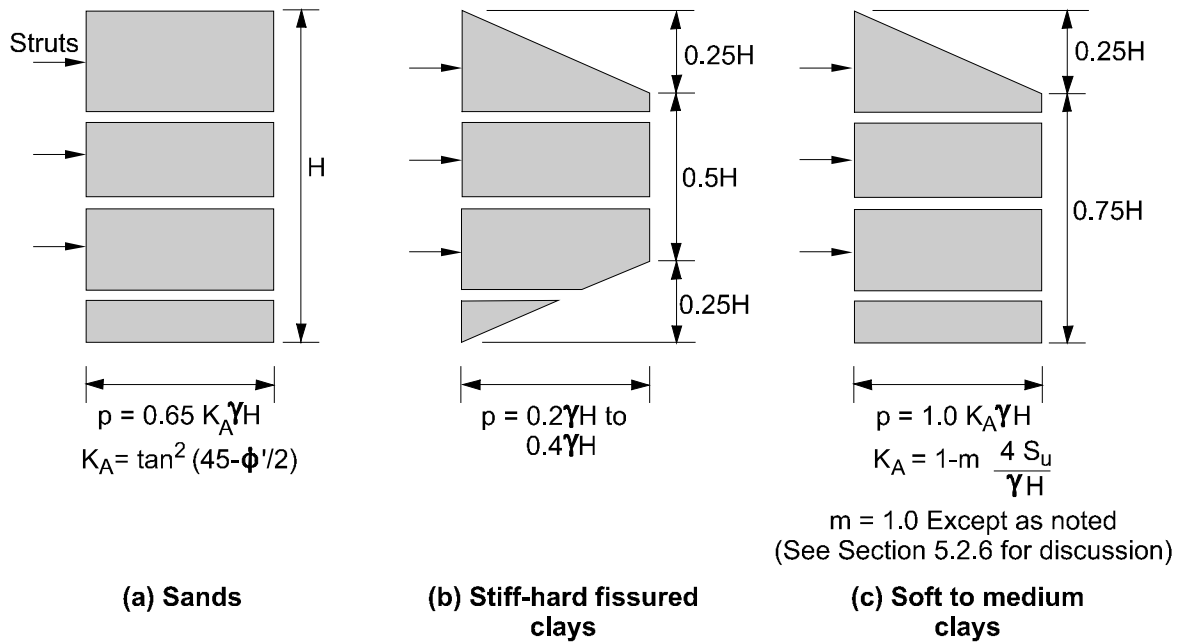

Figure 23. Terzaghi and Peck apparent pressure envelopes (after Terzaghi and Peck, 1967, Soil Mechanics in Engineering Practice, Reprinted by permission of John Wiley & Sons, Inc.).

- The loading diagrams apply only to the exposed portion of the wall and not the portion of the wall embedded below the bottom of the excavation.

For clays, the apparent earth pressure is related to the stability number,  $N_s$ , which is defined as

$$N_s = \frac{\gamma H}{S_u} \quad \text{(Equation 9)}$$

where  $\gamma$  is the total unit weight of the clay soil,  $S_u$  is the average undrained shear strength of the clay soil below the base of the excavation, and  $H$  is the excavation depth. Standard SI units are:  $\gamma$  ( $\text{kN/m}^3$ ),  $S_u$  (kPa), and  $H$  (m). As shown in figure 23, two apparent earth pressure envelopes were developed for clays to account for differences in earth pressures for clays with relatively low  $N_s$  values (i.e., stiff to hard clays) and relatively high  $N_s$  values (i.e., soft to medium clays). Using these diagrams for initial reference, specific recommendations for anchored walls are provided in subsequent sections.

#### 5.2.4 Recommended Apparent Earth Pressure Diagram for Sands

For sands, the value for  $K_A$  in figure 23a is given as:

$$K_A = \tan^2 \left( 45 - \frac{\phi'}{2} \right) \quad \text{(Equation 10a)}$$

and the maximum earth pressure ordinate is:

$$p = 0.65 K_A \gamma H$$

(Equation 10b)

where  $\phi'$  is the effective stress friction angle of the sand. Using this value of lateral earth pressure, the total lateral earth load from the rectangular apparent earth pressure diagram (figure 23a) for sands is  $0.65 K_a \gamma H^2$ . The recommended apparent earth pressure envelope for single level anchored walls and walls with two or more levels of ground anchors is trapezoidal and is shown in figure 24.

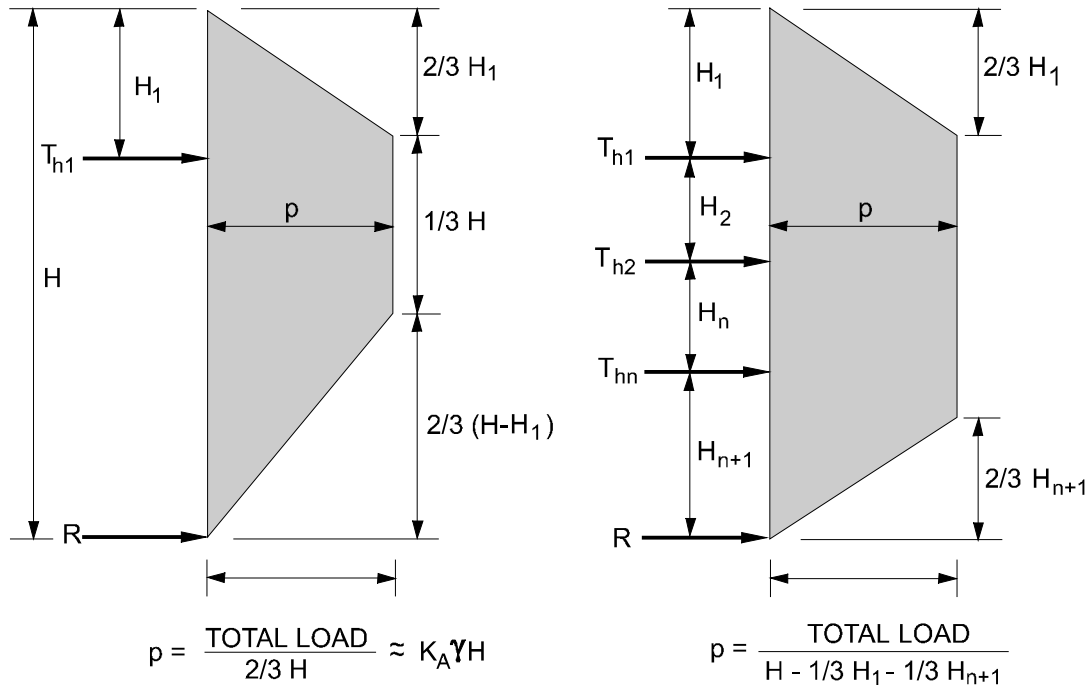

**(a) Walls with one level of ground anchors**

**(b) Walls with multiple levels of ground anchors**

$H_1$  = Distance from ground surface to uppermost ground anchor

$H_{n+1}$  = Distance from base of excavation to lowermost ground anchor

$T_{hi}$  = Horizontal load in ground anchor  $i$

$R$  = Reaction force to be resisted by subgrade (i.e., below base of excavation)

$p$  = Maximum ordinate of diagram

$$\text{TOTAL LOAD} = 0.65 K_A \gamma H^2$$

Figure 24. Recommended apparent earth pressure diagram for sands.



Unlike the Terzaghi and Peck envelopes, the diagrams recommended herein require that the location of the upper and lower ground anchors are known in order to construct the apparent earth pressure diagram. The trapezoidal diagram is more appropriate than the rectangular diagram for the following reasons:

- earth pressures are concentrated at the anchor locations resulting from arching;
- earth pressure of zero at the ground surface is appropriate for sands (provided no surcharge loading is present);
- earth pressures increase from the ground surface to the upper ground anchor location; and
- for medium dense to very dense sands, earth pressures reduce below the location of the lowest anchor owing to the passive resistance that is developed below the base of the excavation.

This diagram is appropriate for both short-term (temporary) and long-term (permanent) loadings in sands. Water pressures and surcharge pressures should be added explicitly to the diagram to evaluate the total lateral load acting on the wall.

### **5.2.5 Recommended Apparent Earth Pressure Diagram for Stiff to Hard Fissured Clays**

#### *Temporary Conditions*

Although apparent earth pressure diagrams for temporary conditions in stiff to hard fissured clays are proposed herein, the selection of an earth pressure diagram for design should be based on previous successful experience with excavations constructed in similar soils. This reliance on previous experience is particularly important for designing excavation support systems in stiff to hard fissured clays. Earth pressures in these soils are most influenced by degree of fissuring or jointing in the clay and the potential reduction in strength with time, not necessarily the shear strength of the intact clay.

Table 5 provides a summary of empirical apparent earth pressure envelopes for stiff to hard clays. Although several variations of the stiff to hard fissured clay envelope have been used in practice, a comparison of the envelopes which can be developed using the information in table 5 indicates that the range of total load is similar for each of the envelopes. The most important observation is that twice as much load must be resisted by systems that are designed using an envelope based on an upper range value of the maximum pressure ordinate as compared to systems designed using a lower range value of the maximum pressure ordinate. The selection of the maximum ordinate value should therefore be based on previous experience with excavations constructed in similar deposits.

Table 5. Summary of trapezoidal apparent pressure envelopes for temporary excavations in stiff to hard clays.

Reference	$b_1$	$b_2$	$b_3$	Range of maximum pressure ordinate, $p$	Total load
Terzaghi and Peck (1967)	0.25	0.50	0.25	$0.2\gamma H - 0.4\gamma H$	$0.15\gamma H^2 - 0.30\gamma H^2$
Schnabel (1982)	0.20	0.60	0.20	$0.2\gamma H^{(1)}$	$0.16\gamma H^2$
Winter (1990)	0.20	0.60	0.20	$0.2\gamma H - 0.32\gamma H^{(1)}$	$0.16\gamma H^2 - 0.26\gamma H^2$
Ulrich (1989)	0.25	0.50	0.25	$0.2\gamma H - 0.4\gamma H$	$0.15\gamma H^2 - 0.30\gamma H^2$
FHWA-RD-75-130 (1976)	0	1.0	0	$0.15\gamma H - 0.30\gamma H$	$0.15\gamma H^2 - 0.30\gamma H^2$
This work <sup>(2)</sup>	$0.17^{(3)}$	0.66	$0.17^{(4)}$	$0.2\gamma H - 0.4\gamma H$	$0.17\gamma H^2 - 0.33\gamma H^2$

- Notes: (1) Assumes  $\gamma = 19.6 \text{ kN/m}^3$   
 (2) Diagram for multiple levels of ground anchors  
 (3) Assumes  $H_1 = H/4$  (see figure 27)  
 (4) Assumes  $H_{n+1} = H/4$  (see figure 27)

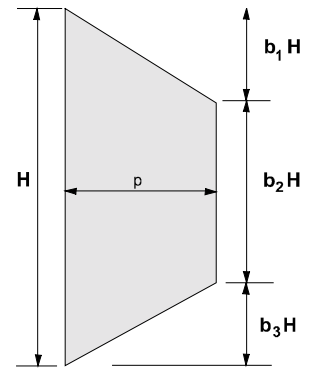

For the Terzaghi and Peck apparent earth pressure diagram for temporary loadings in stiff to hard fissured clays, (see figure 23b), the maximum ordinate,  $p$ , of the diagram ranges from  $0.2\gamma H$  to  $0.4\gamma H$ . The total load for this diagram is therefore  $0.15\gamma H^2$  to  $0.30\gamma H^2$ . For an assumed total unit weight for stiff to hard clay equal to  $20 \text{ kN/m}^3$ , the total load for this diagram is  $3H^2$  to  $6H^2$  where  $H$  is in meters and total load is in  $\text{kN/m}$  per meter of wall. Ulrich (1989) presented ground anchor load measurements for seven temporary excavation support walls, five of which were constructed in overconsolidated soils in the Houston, Texas area. For each excavation, the stability number,  $N_s$ , was less than 4. Measured loads are plotted on figure 25. In all but one case (i.e., Site 3), the maximum apparent earth pressure ordinate ranges from approximately  $0.1\gamma H$  to  $0.25\gamma H$ . These maximum pressure ordinates correspond to a total load using the Terzaghi and Peck diagram of  $1.5H^2$  to  $3.75H^2$ , respectively. For Site 3, the apparent earth pressure was between  $0.25\gamma H$  and  $0.35\gamma H$ . These maximum pressure ordinates correspond to a total load using the Terzaghi and Peck diagram of  $3.75H^2$  to  $5.25H^2$ , respectively.

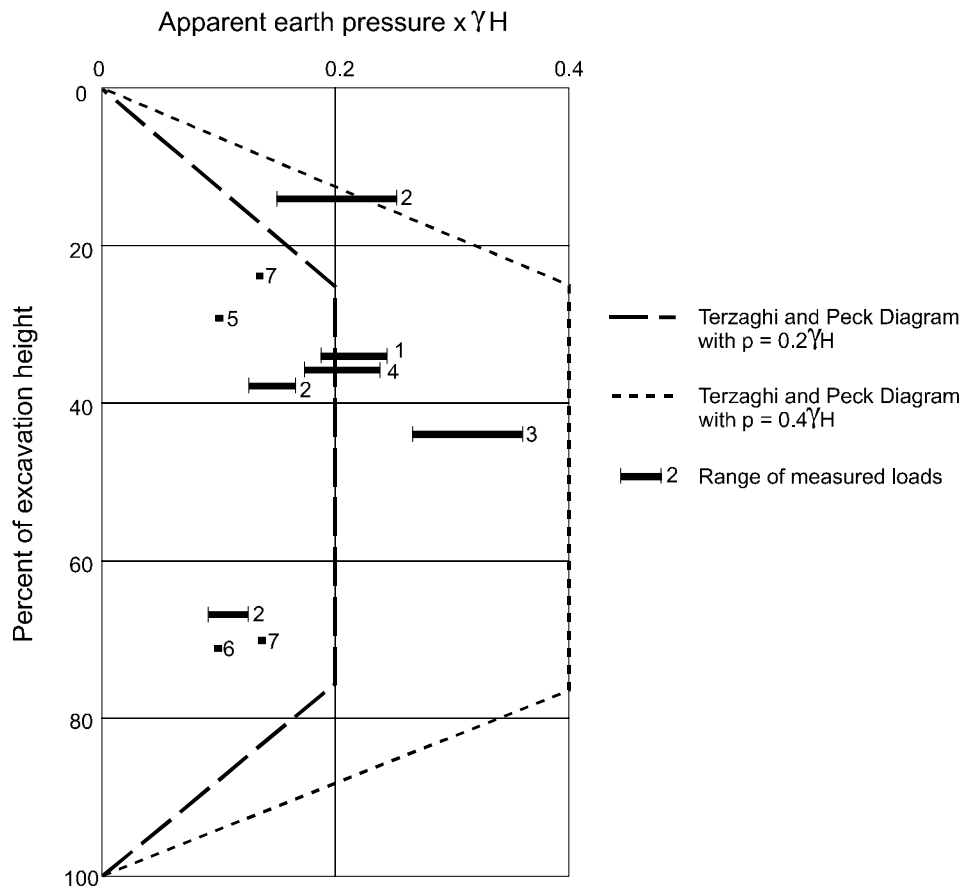

Figure 25. Measured anchor loads for seven projects (after Ulrich, 1989, “Tieback Supported Cuts in Overconsolidated Soils”, *Journal of Geotechnical Engineering*, Vol. 115, No. 4, Reprinted by permission of ASCE).

Winter (1990) presented measured ground anchor loads for a 23-m deep excavation in Seattle. Primary excavation support soils were heavily overconsolidated silts and clays. Ground anchor design loads were calculated using a trapezoidal envelope in which the pressure increased linearly from zero at the top of the wall to the maximum pressure over the upper 20 percent of the wall, and decreased linearly over the lower 20 percent of the wall back to zero at the base of the excavation. To evaluate the actual wall pressures, the anchors were locked-off at 50 percent of the design load as compared to a more common level of 100 percent of the design load. The purpose of the lower lock-off loads was to create a condition whereby the anchors would be required to resist actual loads, not just the prestressed loads. Without lower lock-off loads, the actual loads would have to be higher than the design values to register on the load measuring devices. Figure 26 shows the design pressure envelope and the recorded loads as a percentage of the design values. The design pressure envelope has a maximum pressure ordinate equal to  $30H$  psf ( $H$  in feet). The actual pressure envelopes for two test sections were  $19H$  psf and  $22H$  psf ( $H$  in feet) indicating that the actual pressures were 65 to 75 percent of the design values. For the design pressure (i.e.,  $30H$ ) envelope, the total load is  $24H^2$  lb/ft per ft of wall ( $3.77H^2$  kN/m per meter of wall). The total load from the  $19H$  and  $22H$  actual pressure envelope is  $15.2H^2$  to  $17.6H^2$  lb/ft per ft of wall ( $2.38 H^2$  to  $2.76 H^2$  kN/m per meter of wall), respectively.

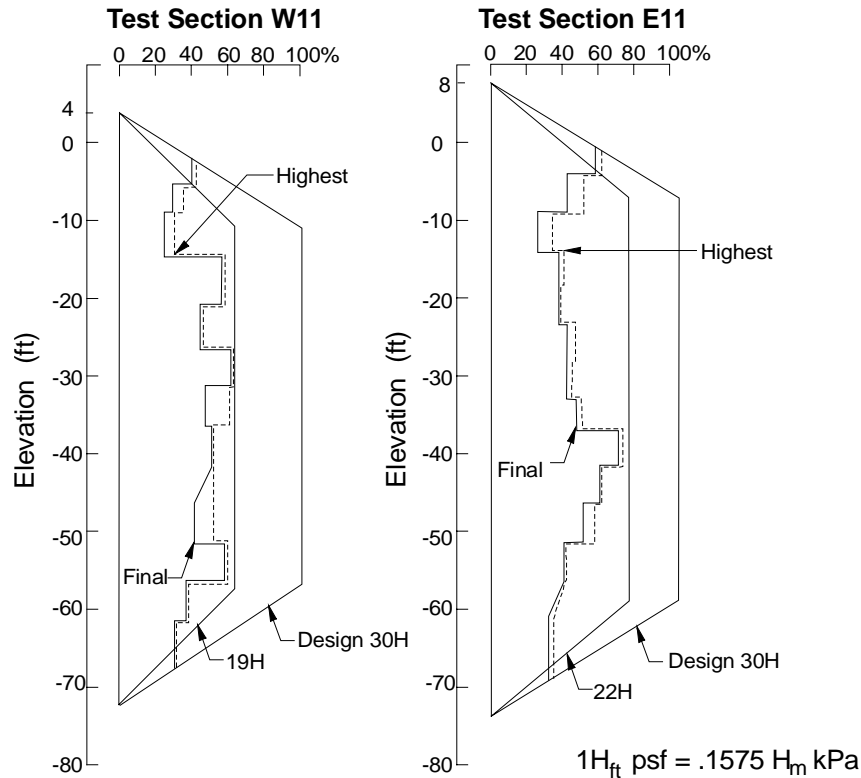
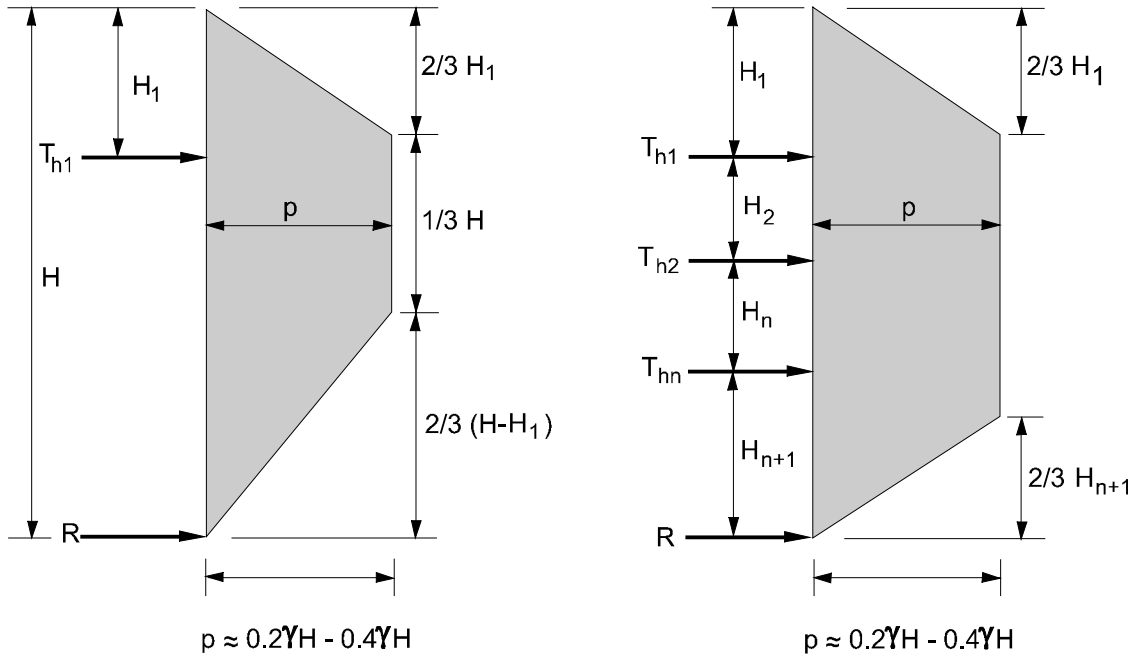

Figure 26. Wall pressure envelopes (after Winter, 1990, “Pacific First Center-Performance of the Tieback Shoring Wall”, Design and Performance of Earth Retaining Structures, Geotechnical Special Publication No. 25, Reprinted by permission of ASCE).

These results indicate that although the total load from apparent earth pressure envelopes using a maximum ordinate of  $0.2\gamma H$  represents a lower bound value for the Terzaghi and Peck envelope, measured loads from these actual projects are in reasonable agreement with this lower bound value. Total loads from apparent earth pressure envelopes using  $0.4\gamma H$  for a maximum pressure ordinate value are conservative. The recommended apparent earth pressure diagram for temporary excavations in stiff to hard fissured clays (i.e.,  $N_s \leq 4$ ) is shown in figure 27. The maximum ordinate,  $p$ , should be consistent with a total load from the diagram of approximately  $3H^2$  to  $6H^2$  kN/m per meter of wall. Some designers have developed similarly shaped, but alternative, apparent earth pressure diagrams for stiff to hard clays. These alternative apparent earth pressure diagrams may also be used provided that the total load for the diagram is at least  $3H^2$  kN/m per meter of wall. A minimum total load of  $3H^2$  kN/m per meter of wall is recommended for all cases. If an apparent earth pressure envelope with a total load of less than or approximately equal to  $3H^2$  to  $4H^2$  kN/m per meter of wall is proposed for a temporary wall used for a critical application, the owner or engineer should require that the contractor provide performance data that demonstrate that such an envelope has been successfully used for anchored systems constructed in similar ground subject to similar performance requirements.

The apparent earth pressure diagram for stiff to hard clays under temporary conditions should only be used when the temporary condition is of a controlled short duration and there is no available free

water. If these conditions are not met, an apparent earth pressure diagram for long-term (i.e., permanent) conditions using drained strength parameters should be evaluated. The permanent conditions apparent earth pressure diagram for stiff to hard clays is described subsequently.



**(a) Walls with one level of ground anchors**

**(b) Walls with multiple levels of ground anchors**

$H_1$  = Distance from ground surface to uppermost ground anchor

$H_{n+1}$  = Distance from base of excavation to lowermost ground anchor

$T_{hi}$  = Horizontal load in ground anchor  $i$

$R$  = Reaction force to be resisted by subgrade (i.e., below base of excavation)

$p$  = Maximum ordinate of diagram

$$\text{TOTAL LOAD (kN/m/meter of wall)} = 3H^2 - 6H^2 \quad (H \text{ in meters})$$

Figure 27. Recommended apparent earth pressure envelope for stiff to hard clays.

### *Permanent Condition*

The original Terzaghi and Peck apparent earth pressure diagram for stiff to hard fissured clays was developed for temporary loading conditions. This diagram and ones developed based on information in table 5 have also been used for designing permanent anchored wall systems. There are difficulties in using earth pressures associated with temporary conditions in stiff to hard fissured clays for designing permanent walls. Specifically, excavation induces negative excess porewater pressures in the soil which temporarily cause the soil to possess a greater shear strength than is available in the long term. Soil behind the wall and in front of the wall (i.e., at the base of the excavation) experience unloading to which the soil responds by drawing in water, resulting in softening (i.e., weakening) of the soil with time. Softening in some areas around the wall to a state of long-term (i.e., drained) equilibrium may occur rapidly after construction. The development of tension cracks at the surface and the possible presence of sandy or silty layers or cracks and fissures serve to increase the rate at which soil softening may occur.

Based on the above discussion, earth pressures associated with long-term drained conditions for excavations in stiff to hard fissured clays may be greater than those computed based on envelopes for temporary conditions. The total resultant force calculated using a diagram for temporary conditions can be compared to the total resultant force associated with the recommended apparent earth pressure envelope for stiff to hard clays using a total resultant force of  $0.65K_A\gamma H^2$ , where  $K_A$  is based on the drained friction angle of the clay soil. For most anchored wall applications, the drained friction angle should correspond to the fully softened friction angle. The larger of the resultant forces from the two diagrams should be used for design. For example, a fully softened drained friction angle of approximately  $39^\circ$  results in an equivalent total force to the Terzaghi and Peck envelope using  $0.2\gamma H$  for the maximum pressure ordinate. A drained friction angle of approximately  $22^\circ$  results in an equivalent total force to the Terzaghi and Peck envelope with a maximum pressure ordinate of  $0.4\gamma H$ .

### **5.2.6 Recommended Apparent Earth Pressure Diagram for Soft to Medium Clays**

Temporary and permanent anchored walls may be constructed in soft to medium clays (i.e.,  $N_s > 4$ ) if a competent layer for forming the anchor bond zone is within a reasonable depth below the excavation. Permanently anchored walls are seldom used where soft clay extends significantly below the base of the excavation.

For soft to medium clays and for deep excavations, the Terzaghi and Peck diagram shown in figure 23c has been used to evaluate apparent earth pressures for design of temporary walls in soft to medium clays. For this diagram, a total stress active earth pressure coefficient is used:

$$K_A = 1 - m \frac{4S_u}{\gamma H} \quad (\text{Equation 11})$$

where  $m$  is an empirical factor that accounts for potential base instability effects in deep excavations in soft clays. When the excavation is underlain by deep soft clay and  $N_s$  exceeds 6,  $m$  is set equal to 0.4. Otherwise,  $m$  is taken as 1.0 (Peck, 1969). As will be shown, using the Terzaghi and Peck diagram with  $m$  equal to 0.4 for cases where  $N_s > 6$  may result in an underestimation of loads on the wall and is therefore not conservative.

The Terzaghi and Peck (1967) diagrams did not account for the development of soil failure below the bottom of the excavation. Observations and finite element studies have demonstrated that soil failure below the bottom of the excavation can lead to very large movements for temporary retaining walls in these soft clays. For  $N_s$  values greater than 6, relatively large areas of the retained soil near the base of the excavation are expected to yield significantly as the excavation progresses resulting in large movements below the excavation, increased support loads on the exposed portion of the wall, and potential instability of the excavation base. Instead of using  $m=0.4$  in equation 11, an equation developed by Henkel (1971) should be used directly to obtain  $K_A$  for use in evaluating the maximum pressure ordinate for the soft to medium clay apparent earth pressure diagram (figure 23c).

Henkel's equation for the total stress earth pressure coefficient is:

$$K_A = 1 - \frac{4S_u}{\gamma H} + 2\sqrt{2} \frac{d}{H} \left( 1 - \frac{5.14S_{ub}}{\gamma H} \right) \quad (\text{Equation 12})$$

where  $d$  is the depth of the failure surface below the cut,  $S_u$  is the undrained shear strength of the soil through which the excavation extends, and  $S_{ub}$  is the strength of the soil providing bearing resistance (figure 28). For the more general case in which there is unloading at the ground surface, Henkel provided the following solution:

$$K_A = 1 - \frac{4S_u}{\gamma H} + \frac{2\sqrt{2}d}{H} \left\{ 1 + \frac{\Delta H}{H} \left( 1 + \frac{H + \Delta H}{(2-x)\sqrt{2}d} \right) - \frac{S_{ub}}{\gamma H} \left( 5.14 + \frac{2S_u \Delta H}{\sqrt{2}S_{ub}d} \right) \right\} \quad (\text{Equation 13})$$

Standard SI units are:  $d$ (m),  $S_{ub}$  (kPa),  $\Delta H$  (m), and  $x$  (m).

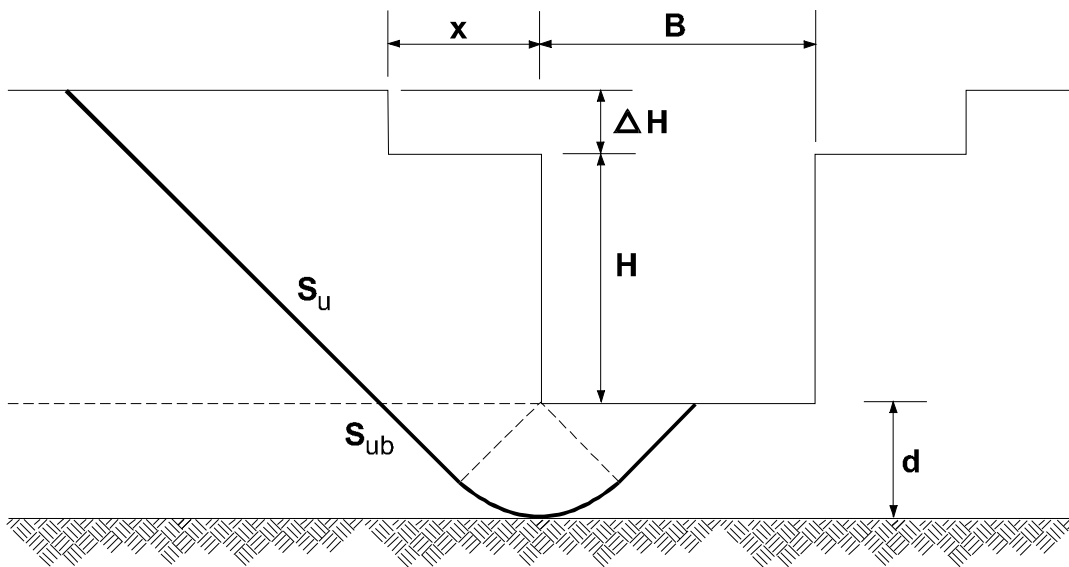

Figure 28. Henkel's mechanism of base failure.

Figure 29 shows values of  $K_A$  calculated using Henkel's method for various  $d/H$  ratios. For results shown in this figure,  $S_u = S_{ub}$ . Figure 29 indicates that for  $4 < N_s < 6$ , the Terzaghi and Peck envelope with  $m=0.4$  is overly conservative relative to Henkel. Also, for  $N_s < 5.14$ , the Henkel equation is not valid and apparent earth pressures calculated using  $m=1.0$  in the Terzaghi and Peck envelope are

unrealistically low. For the range  $4 < N_s < 5.14$ , a constant value of  $K_A$  equal to 0.22 should be used to evaluate the maximum pressure ordinate for the soft to medium clay apparent earth pressure envelope (figure 23c). At the transition value between stiff to hard clay and soft to medium clay, i.e.,  $N_s=4$ , the total load using the soft to medium clay apparent earth pressure diagram with  $K_A=0.22$  is  $0.193\gamma H^2$ . For a total load of  $0.193\gamma H^2$ , the maximum pressure ordinate of the Terzaghi and Peck stiff to hard fissured clay apparent earth pressure diagram is  $0.26\gamma H$ . Information presented on figures 25 and 26 indicates that a value of  $0.26\gamma H$  for the maximum pressure ordinate results in a calculated apparent earth pressure diagram that is consistent with measured values. The use of  $K_A=0.22$  for  $4 < N_s < 5.14$  for calculating apparent earth pressures therefore represents a rational transition value between apparent earth pressures for stiff to hard clays (i.e.,  $N_s < 4$ ) and for soft to medium clays where the Henkel solution is valid (i.e.,  $N_s > 5.14$ ).

Henkel's method is limited to cases where the clay soils on the retained side of the excavation and below the excavation subgrade can each be reasonably characterized using a constant value for undrained shear strength. Where a more detailed shear strength profile is required, limit equilibrium methods may be used to evaluate the earth pressure loadings on the wall. The use of limit equilibrium methods to develop earth pressure loadings for walls is described in section 5.7.3.

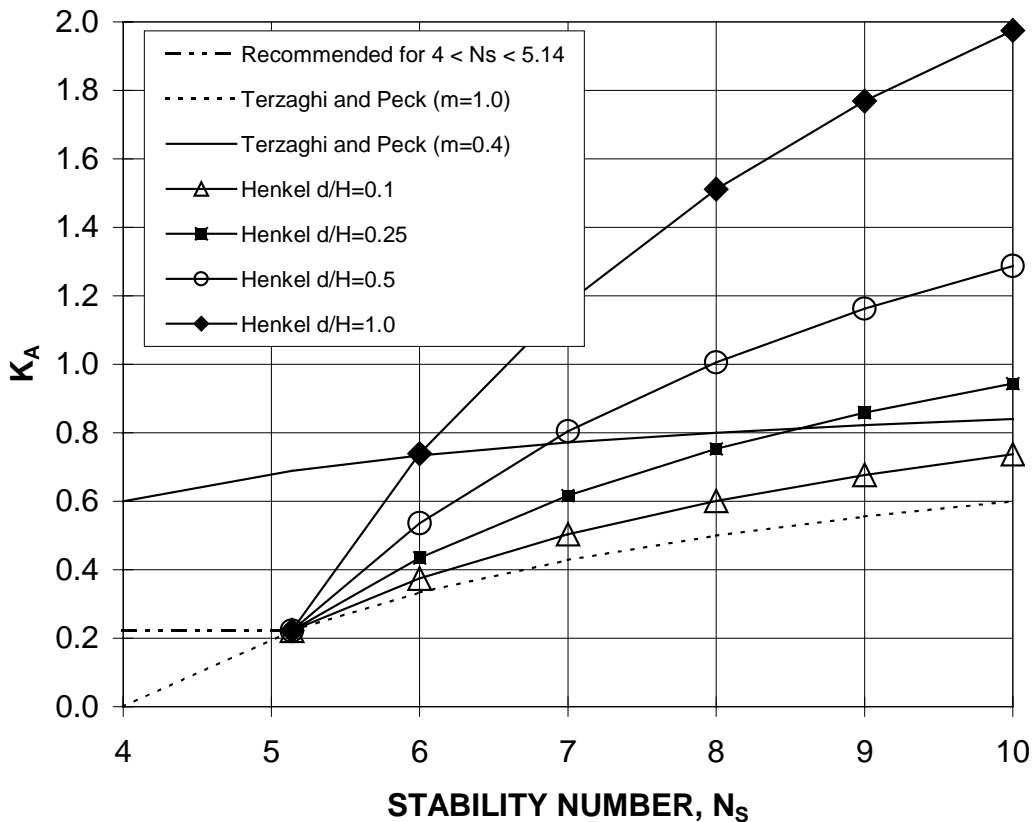

Figure 29. Value of  $K_A$  based on Terzaghi and Peck envelope and Henkel's method.



### 5.2.7 Loading Diagrams for Stratified Soil Profiles

The apparent earth pressure diagrams described above were developed for reasonably homogeneous soil profiles and may therefore be difficult to adapt for use in designing walls in stratified soil deposits. A method based on redistributing calculated active earth pressures may be used for stratified soils. This method should not be used for soil profiles in which the critical potential failure surface extends below the base of the excavation or where surcharge loading is irregular. This method is summarized as follows:

- Evaluate the active earth pressure acting over the excavation height and evaluate the total load imposed by these active earth pressures using conventional geotechnical engineering analysis methods for evaluating the total active earth pressure diagram assuming full mobilization of soil shear strength. For complicated stratification, irregular ground surface, or irregular surcharge loading, the lateral force may be evaluated using a trial wedge stability analysis.
- Increase the total load determined above by a factor of 1.3 for anchored soldier beam or sheet-pile walls. A larger value may be used where strict deformation control is required.
- Distribute the factored total force into an apparent pressure diagram using the trapezoidal distribution shown in figure 24.

Where irregular surcharges or ground surfaces are present or where potential failure surfaces are deep-seated, limit equilibrium methods using slope stability computer programs may be used to calculate earth pressure loadings. These limit equilibrium methods are described in Section 5.7.3.

### 5.2.8 Sliding Wedge Analysis Method

A sliding wedge force equilibrium method may be used to evaluate the total horizontal load required to provide stability to a vertical cut. An example failure surface, free body diagram, and force vector diagram are shown in figure 30 for a wall of height  $H$  with a soil behind and in front of the wall characterized by an effective stress friction angle,  $\phi'$ . It is assumed that the critical potential failure surface passes in front of the anchor bond zone such that full anchor loads contribute to wall stability. The shear strength is factored by the target factor of safety such that  $\phi'_{mob} = \tan^{-1}(\tan\phi'/FS)$ . Passive resistance is assumed to develop over the wall embedment depth,  $d$ . For the assumed failure surface, an interface friction angle  $\delta$  equal to  $\phi'_{mob}$  may be used to calculate the passive earth pressure coefficient.

In the analysis,  $P_{REQ}$  represents the external horizontal force required to provide stability to the vertical cut. This force represents the combined resistance provided by the horizontal component of the anchor forces,  $T \cos i$ , and the lateral resistance provided by the embedded portion of the wall,  $SP_H$ . The assumption that  $P_{REQ}$  is horizontal implies that the vertical resistance provided by the soldier beam,  $SP_V$ , is equal in magnitude and opposite in sign to the vertical component of the ground anchor loads,  $T \sin i$ . This assumption should be verified using the procedures described in

section 5.6 to evaluate axial capacity of the wall. The required resisting force,  $P_{REQ}$ , is then calculated as:

$$P_{REQ} = \frac{1}{2} \gamma H^2 \left[ \frac{(1 + \xi)^2}{\tan(\alpha)} - K_p \xi^2 \left( \sin(\delta) + \frac{\cos(\delta)}{\tan(\alpha - \phi)} \right) \right] \tan(\alpha - \phi) \quad (\text{Equation 14})$$

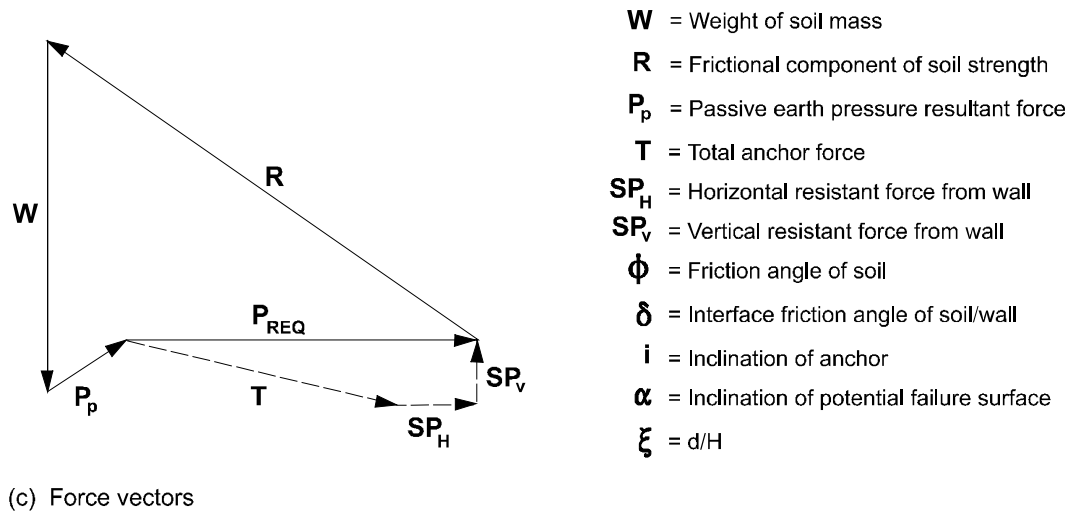
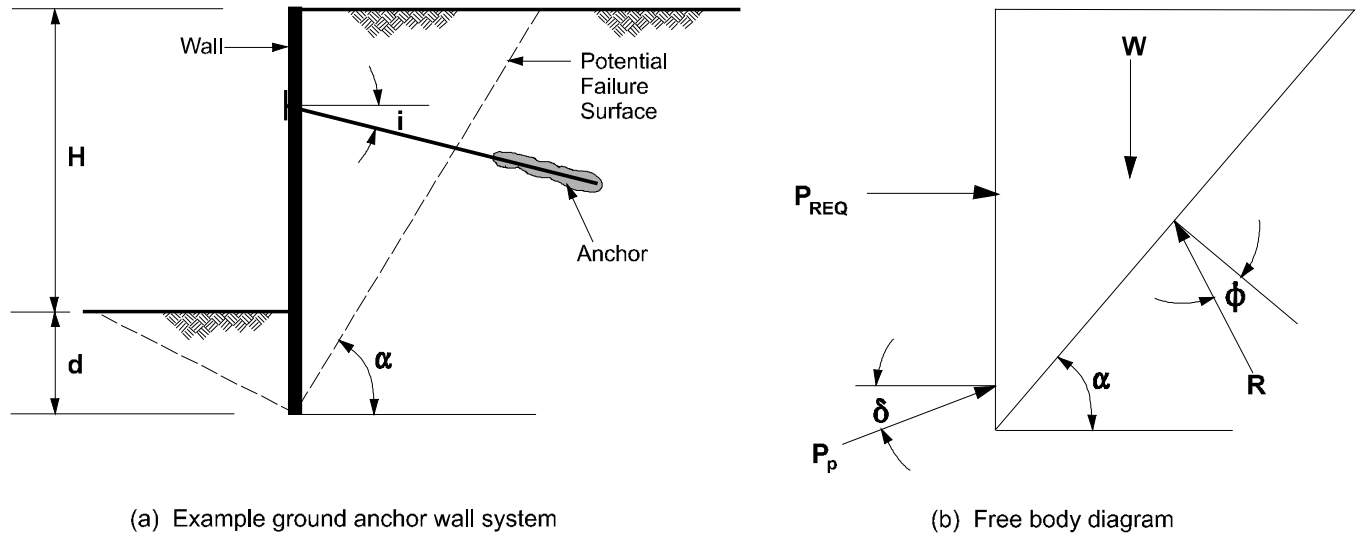

Figure 30. Force equilibrium method for anchored walls (after FHWA-RD-98-065, 1998).

where all terms are defined in figure 30. The solution is found iteratively by adjusting the angle of the potential failure surface,  $\alpha$ , and the wall embedment depth,  $d$ , until the greatest  $P_{REQ}$  is found. This load ( $P_{REQ}$ ) should then be redistributed into an apparent pressure envelope for calculating ground anchor loads and bending moments in the exposed portion of the wall. Detailed discussion on the use of this simplified method is provided in FHWA-RD-98-065 (1998).

## 5.2.9 Water Pressures

Permanent anchored soldier beam and lagging walls are typically not designed to resist large water loads. For these wall systems, drainage from the surface of the retained soil is collected in ditches at the top of the wall while subsurface water is collected using prefabricated drainage elements placed between the wall and the permanent facing. Additional information on drainage systems for anchored walls and slopes is provided in section 5.11.2. For temporary systems, it may be necessary to resist water forces associated with seepage behind and beneath the wall. A typical flownet for a retaining wall in homogeneous soil is shown in figure 31. The calculation of porewater pressure may be simplified by assuming that the head difference  $(H+i-j)$  is dissipated uniformly along the shortest potential flowpath  $(2d+H-i-j)$  which runs down the back of the wall and up the front. The porewater pressure calculated in this manner results in pressures greater than hydrostatic in front of the wall and less than hydrostatic behind the wall (figure 32).

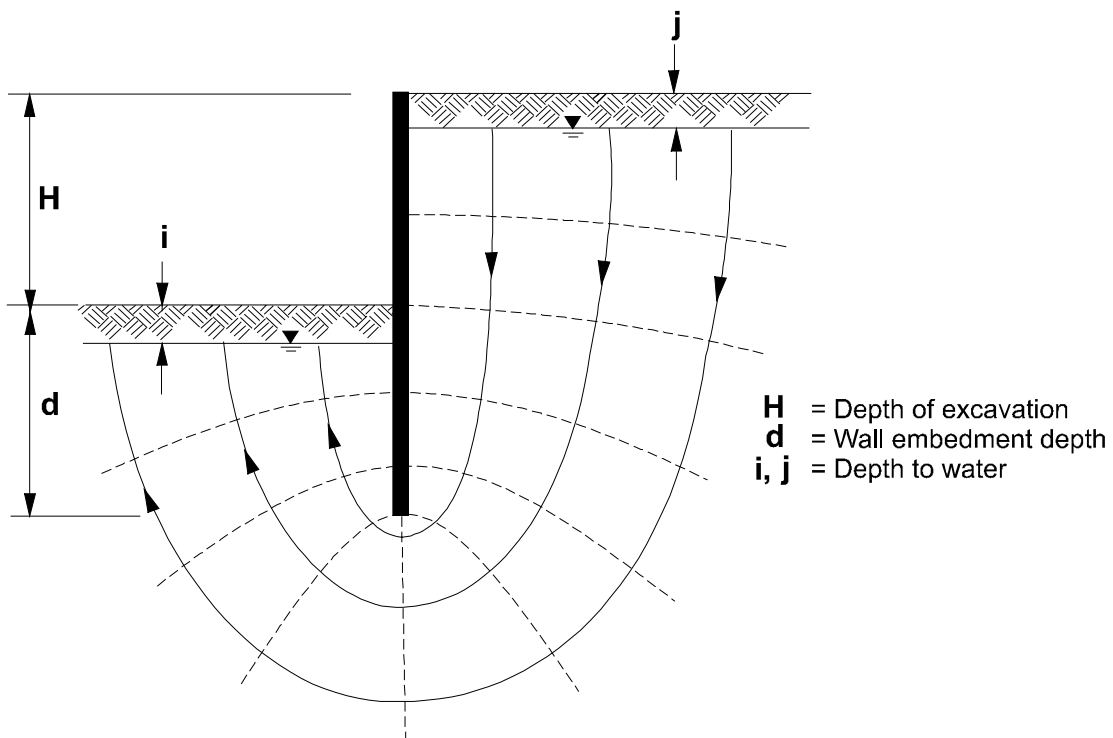

Figure 31. Flow net for a retaining wall (after CIRIA, 1984).

In figure 32, the porewater pressure at the bottom of the wall,  $U_f$ , is equal on either side of the wall. The value for  $U_f$  is given by the following:

$$U_f = \frac{2(d+H-j)(d-i)}{2d+H-i-j} \gamma_w \quad (\text{Equation 15})$$

The net water pressure acting on the wall is shown on figure 32b. The largest net water pressure occurs at the level of the water table within the excavation:

$$U_c = (H+i-j) \frac{2(d-i)}{2d+H-i-j} \gamma_w \quad (\text{Equation 16})$$

For comparison, the net water pressure for the condition in which there is no seepage is also shown on figure 32b. In that case, the net pressure is given by:

$$U_n = (H+i-j) \gamma_w \quad \text{(Equation 17)}$$

Procedures to calculate effective horizontal earth pressures including the effects of seepage are provided in CIRIA (1984) and FHWA-HI-97-021 (1997).

The effect of special drainage conditions on porewater pressures can only be assessed by using appropriate seepage flownets. If, for example, the wall acts as a drain, the porewater pressures will vary significantly with distance behind the wall. The simplified methods shown in figure 32 cannot be used for this case to calculate the pressures on the back of the wall. However, for normal designs, it is usually sufficient to use the simple flownet shown in figure 31 and procedures to calculate porewater pressures shown in figure 32.

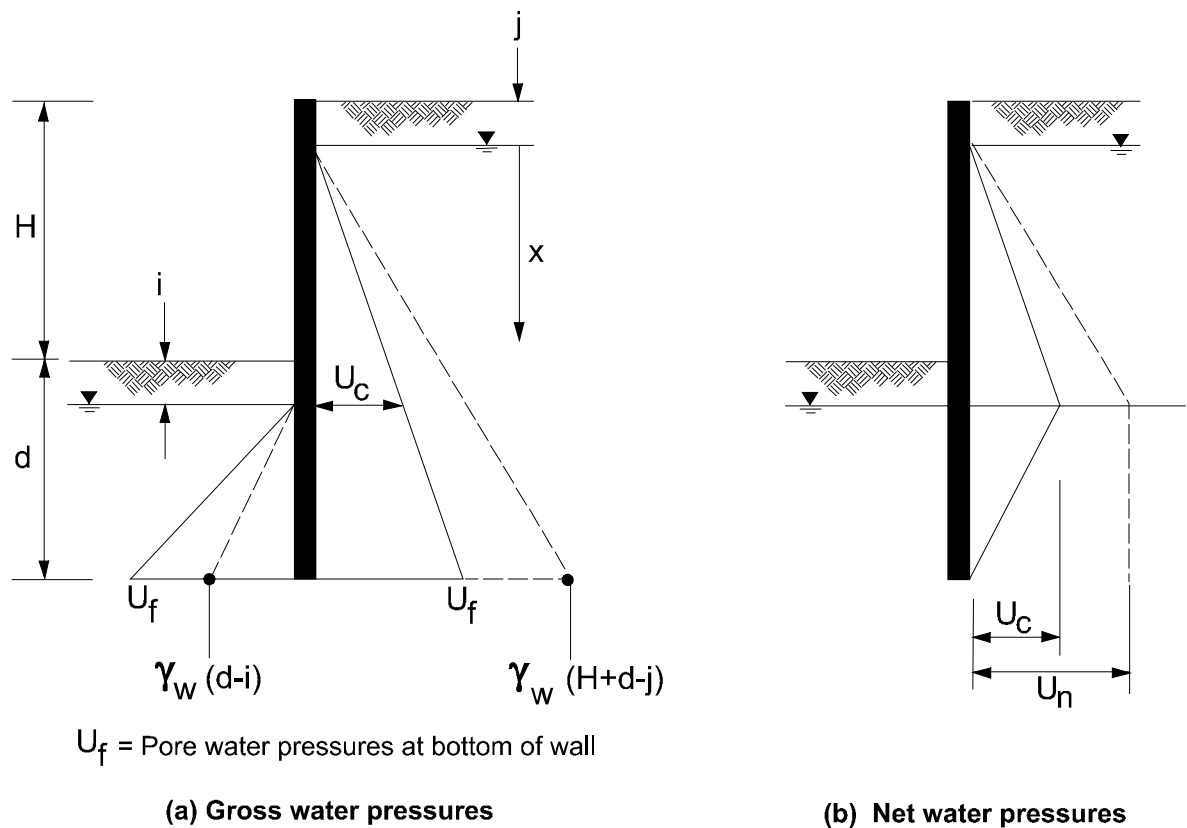

Figure 32. Gross and net water pressures across a retaining wall (modified after CIRIA, 1984).

## 5.2.10 Earth Pressures Due To Surface Loads

### 5.2.10.1 Uniform Surcharge Loads

Surcharge loads are vertical loads applied at the ground surface which are assumed to result in an assumed uniform increase in lateral stress over the entire height of the wall. The increase in lateral stress for uniform surcharge loading can be written as:

$$\Delta\sigma_h = Kq_s \quad (\text{Equation 18})$$

where:  $\Delta\sigma_h$  is the increase in lateral earth pressure due to the vertical surcharge load,  $q_s$  is the vertical surcharge stress applied at the ground surface, and  $K$  is an appropriate earth pressure coefficient. Standard SI units are:  $\Delta\sigma_h$  (kPa),  $K$  (dimensionless), and  $q_s$  (kPa). Examples of surcharge loads for highway wall system applications include: (1) dead load surcharges such as that resulting from the weight of a bridge approach slab or concrete pavement; (2) live load surcharges such as that due to traffic loadings; and (3) surcharges due to equipment or material storage during construction of the wall system. When traffic is expected to come to within a distance from the wall face equivalent to one-half the wall height, the wall should be designed for a live load surcharge pressure of approximately 12 kPa (AASHTO, 1996). For temporary walls that are not considered critical, actual surcharge loads may be evaluated and considered in the design as compared to using this prescriptive value. Both temporary and permanent wall designs should account for unusual surcharges such as large material stockpiles and heavy cranes. Calculated lateral pressures resulting from these surcharges should be added explicitly to the design earth pressure envelope. Loads from existing buildings need to be considered if they are within a horizontal distance from the wall equal to the wall height.

### 5.2.10.2 Point Loads, Line Loads, and Strip Loads

Point loads, line loads, and strip loads are vertical surface loadings which are applied over limited areas as compared to surcharge loads. As a result, the increase in lateral earth pressure used for wall system design is not constant with depth as is the case for uniform surcharge loadings. These loadings are typically calculated using equations based on elasticity theory for lateral stress distribution with depth (NAVFAC, 1982). Lateral pressures resulting from these surcharges should be added explicitly to the design earth pressure envelope.

## **5.3 GROUND ANCHOR DESIGN**

### **5.3.1 Introduction**

Ground anchors are used for temporary and permanent excavation wall support, slope and landslide stabilization, and tiedown systems. This section presents procedures that are commonly used to design a ground anchor and includes a brief discussion on analysis procedures to locate the critical potential failure surface, calculation of ground anchor loads from apparent earth pressure diagrams, design of the unbonded and bond lengths of the anchor, allowable load requirements for the prestressing steel element, and horizontal and vertical spacing and inclination of the anchor.

### **5.3.2 Location of Critical Potential Failure Surface**

The location of the critical potential failure surface must be evaluated since the anchor bond zone must be located sufficiently behind the critical potential failure surface so that load is not transferred from the anchor bond zone into the “no-load” zone. The “no-load” zone is defined as the zone between the critical potential failure surface and the wall, and is also referred to as the unbonded length. The unbonded length is typically extended either a minimum distance of  $H/5$ , where  $H$  is the height of the wall, or 1.5 m behind the critical potential failure surface. Minimum requirements on the unbonded length of the anchor and location of the anchor bond zone are described in section 5.3.4.

For walls constructed in cohesionless soils, the critical potential failure surface can be assumed to extend up from the corner of the excavation at an angle of  $45^\circ + \phi'/2$  from the horizontal (i.e., the active wedge). The sliding wedge force equilibrium method presented in section 5.2.8 may also be used to more accurately evaluate the location of the critical potential surface. Limit equilibrium methods (see section 5.7.3) and trial wedge analyses may be used for general ground conditions and can incorporate surcharge loadings and variable soil stratigraphies.

### **5.3.3 Calculation of Ground Anchor Loads from Apparent Earth Pressure Diagrams**

Ground anchor loads for flexible anchored wall applications can be estimated from apparent earth pressure envelopes. Methods commonly used include the tributary area method and the hinge method which were developed to enable hand calculations to be made for statically indeterminate systems. Both methods, when used with appropriate apparent earth pressure diagrams, have provided reasonable estimates of ground anchor loads and wall bending moments for anchored systems constructed in competent soils.

The calculations for horizontal ground anchor loads using the tributary area method and the hinge method are shown in figure 33 for a one-level wall and in figure 34 for a two-level anchored wall. Both methods, as shown, assume that a hinge (i.e., zero bending moment) develops at the excavation subgrade and that the excavation subgrade acts as a strut support. This latter assumption is reasonable for walls that penetrate into competent materials. The maximum bending moment that controls the design of the wall typically occurs in the exposed portion of the wall, i.e., above the excavation subgrade.

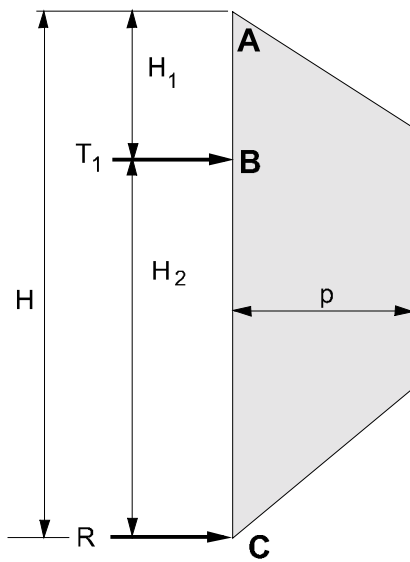

### Tributary area method

$$T_1 = \text{Load over length } H_1 + H_2/2$$

$$R = \text{Load over length } H_2/2$$

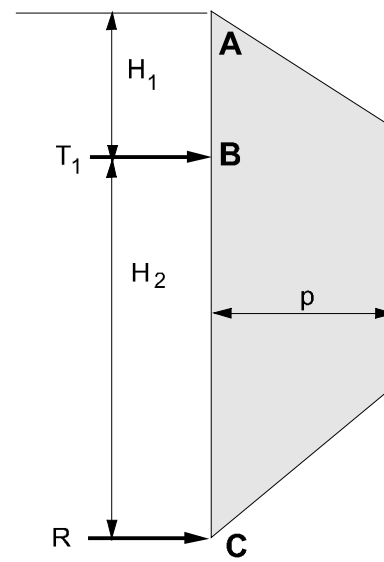

### Hinge method

$$T_1 \text{ Calculated from } \sum M_C = 0$$

$$R = \text{Total earth pressure} - T_1$$

Figure 33. Calculation of anchor loads for one-level wall.

For walls constructed in competent materials, a reaction force,  $R$ , is assumed to be supported by the passive resistance of the soil below the excavation subgrade. The wall must be embedded sufficiently deep to develop this passive resistance. In this case, the lowest anchor carries only the tributary area of the apparent pressure diagram, and the reaction force is equivalent to the load from the apparent pressure diagram from the base of the excavation to the midheight between the base of the excavation and the lowest anchor. For walls that penetrate weak materials, sufficient passive capacity below the base of the excavation may not be available to resist the reaction force regardless of the wall embedment depth. For that case, the lowest anchor may be designed to carry the same load as defined above for the lowest anchor plus the load corresponding to the reaction force. Alternatively, soil-structure interaction analyses (e.g., beam on elastic foundation) may be used to design continuous beams with small toe reactions as it may be overly conservative to assume that all load is carried by the lowest anchor.

The values calculated using figures 33 and 34 for the anchor loads are the horizontal component of the anchor load per unit width of wall,  $T_{hi}$ . The total horizontal anchor load,  $T_h$ , is calculated as:

$$T_h = T_{hi} s \quad (\text{Equation 19})$$

where  $s$  is the horizontal spacing between adjacent anchors. The anchor load,  $T$ , to be used in designing the anchor bond zone (i.e., the design load) is calculated as:

$$T = \frac{T_h}{\cos \theta} \quad (\text{Equation 20})$$

where  $\theta$  is the angle of inclination of the anchor below the horizontal. The vertical component of the total anchor load,  $T_v$ , is calculated as:

$$T_v = T \sin \theta \quad (\text{Equation 21})$$

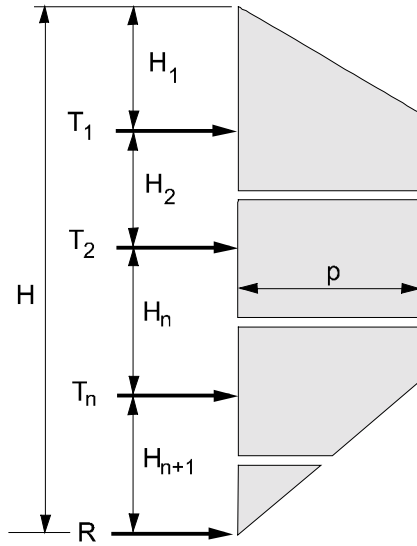

**Tributary area method**

- $T_1$  = Load over length  $H_1 + H_2 / 2$
- $T_2$  = Load over length  $H_2/2 + H_n / 2$
- $T_n$  = Load over length  $H_n/2 + H_{n+1}/2$
- $R$  = Load over length  $H_{n+1} / 2$

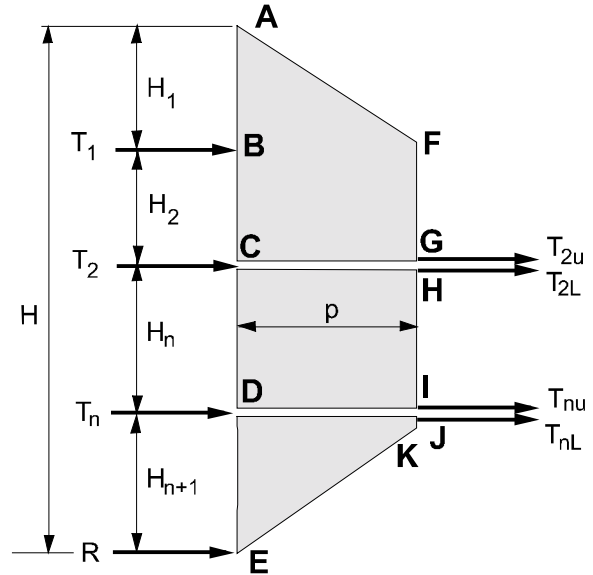

**Hinge method**

- $T_1$  Calculated from  $\sum M_C = 0$
- $T_{2u}$  = Total earth pressure (ABCGF) -  $T_1$
- $T_{2L}$  = Calculated from  $\sum M_D = 0$
- $T_{nu}$  = Total earth pressure (CDIH) -  $T_{2L}$
- $T_{nL}$  = Calculated from  $\sum M_E = 0$
- $R$  = Total earth pressure -  $T_1 - T_2 - T_n$
- $T_2$  =  $T_{2u} + T_{2L}$
- $T_n$  =  $T_{nu} + T_{nL}$

Figure 34. Calculation of anchor loads for multi-level wall.

### 5.3.4 Design of the Unbonded Length

The minimum unbonded length for rock and soil ground anchors is 4.5 m for strand tendons and 3 m for bar tendons. These minimum values are intended to prevent significant reductions in load resulting from seating losses during transfer of load to the structure following anchor load testing.



Longer unbonded lengths may be required to: (1) locate the bond length a minimum distance behind the critical potential failure surface; (2) locate the anchor bond zone in appropriate ground for anchoring; (3) ensure overall stability of the anchored system; and (4) accommodate long term movements. In general, the unbonded length is extended a minimum distance of  $H/5$  or 1.5 m behind the critical potential failure surface (see section 5.3.2) to accommodate minor load transfer to the grout column above the top of the anchor bond zone.

As a general rule, the anchor bond zone and unbonded zone should be grouted in one stage to maintain hole stability and to create a continuous grout cover for corrosion protection. However, for large diameter anchors in which the unbonded length of the anchor extends just behind the critical potential failure surface, significant strains at the top of the anchor bond zone may cause load transfer into the grout column above the anchor bond zone. Large diameter anchors have been grouted in two stages (two stage grouting). With two stage grouting, the anchor bond length is grouted (Stage 1) and the anchor is tested. The unbonded length portion of the drill hole is then grouted (Stage 2) after the anchor is tested. The two-stage procedure is not recommended since local collapse of the ground can occur which will compromise the corrosion protection provided by the grout.

### **5.3.5 Compression Anchors**

Compression anchors are anchors in which the grout body in the bond length is, at least partially, loaded in compression. For a typical tension ground anchor (see figure 1), the anchor bond length and tendon bond length coincide. For these anchors, load is transferred first at the top of the anchor and, with continued loading, progresses downward to the bottom of the anchor. For single-stage grouted tension anchors, because load is first transferred to the top of the anchor bond zone, there is the potential for load transfer into the “no-load zone”, i.e., that area of the tendon between the structure and the assumed failure plane. This is especially a concern for large diameter anchors installed in some cohesive soils for which relatively large residual movements are required to develop bond at the grout/ground interface.

Two types of compression anchors have been used. These include: (1) a ground anchor fitted with an end plate (figure 35a); and (2) a composite design where the top of the tendon bond length is extended a certain distance into the anchor bond length (figure 35b). During stressing, the entire grout column for the endplate compression anchor is loaded in compression whereas for the composite design, the portion of the anchor grout located above the top of the tendon bond length is loaded in compression. The use of compression type anchors minimizes the load transferred above the anchor bond zone into the “no-load zone.” Compression anchor design should consider expected levels of compressive strain in the grout body. Strains should be within tolerable limits to minimize the potential for the grout to fail due to compression loading. Where compression anchors are to be used for a permanent application, a predesign test program may be warranted unless the behavior and satisfactory performance of the proposed compression anchor has been verified through prior experience or research results.

Compression anchors are not commonly used for small diameter anchors in cohesionless deposits, but may be used for large diameter anchors in cohesive soils. In cohesive soils, composite design compression anchors are typically designed with a tendon bond length equal to 50 to 100 percent of the anchor bond length.

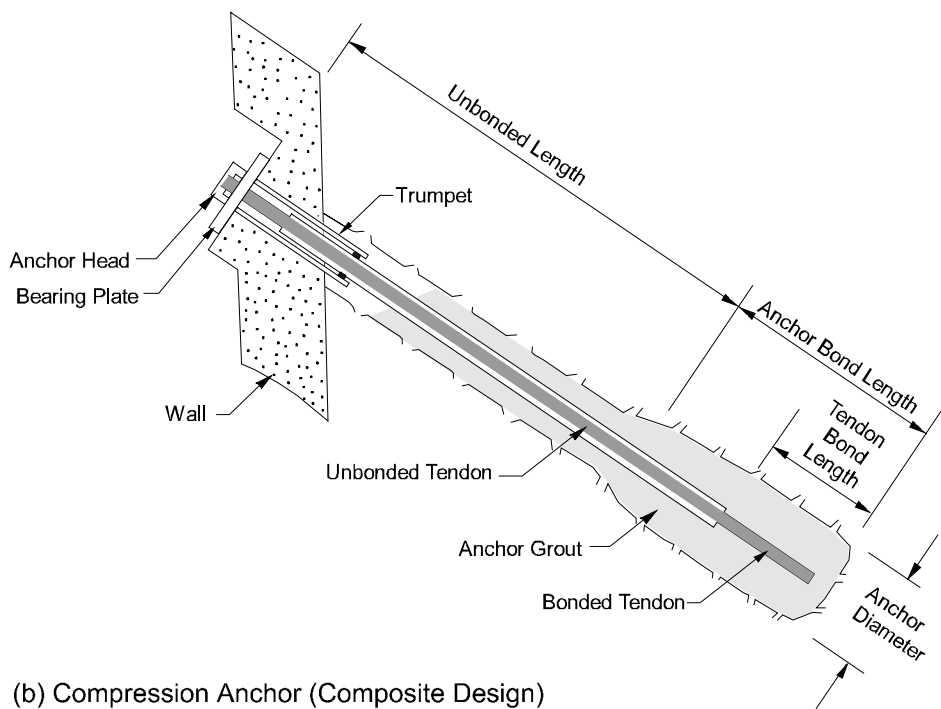
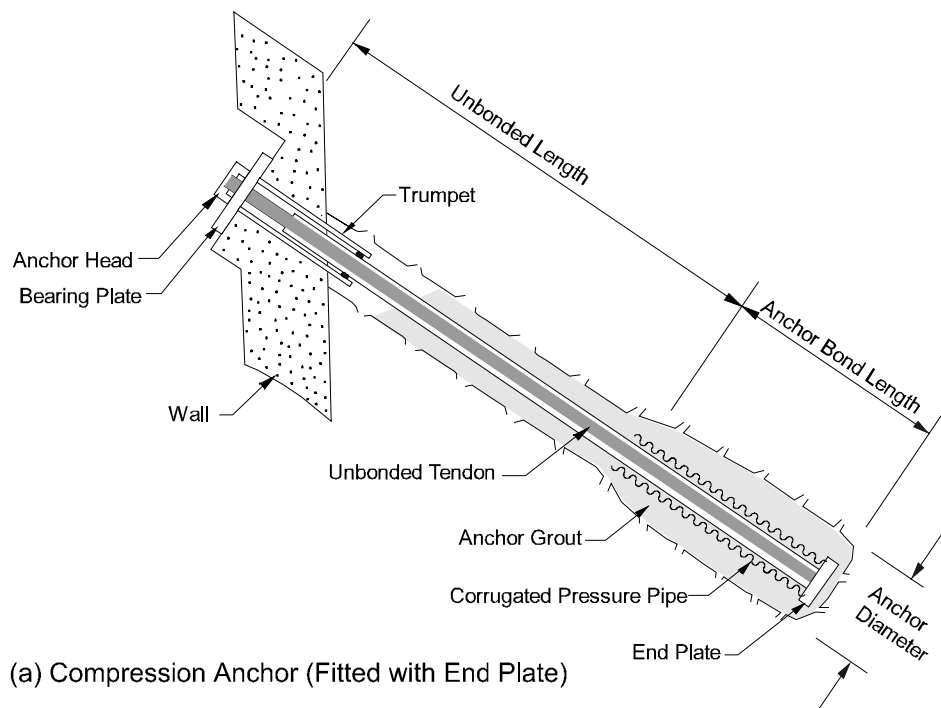

Figure 35. Types of compression anchors.

### 5.3.6 Design of the Anchor Bond Length

Estimates of load transfer capacity in the anchor bond length are typically based on previous field experience. When estimating capacities using previous field results, potential variations in capacity due to differing installation and grouting methods must be considered. In a given soil deposit, the

actual capacity achieved in the field will depend on the method of drilling including quality of drill hole cleaning and period of time that the drill hole is left open, the diameter of the drill hole, the method and pressure used in grouting, and the length of the anchor bond zone. Except for certain minimum values, the selection of these items should be left to the discretion of the specialty anchor contractor. The main responsibility for the designer is to define a minimum anchor capacity that can be achieved in a given ground type. Therefore, estimation of anchor capacity should be based on the simplest commonly installed anchor, i.e., the straight shaft gravity-grouted anchor. Estimates made assuming this anchor will be installed will produce a design capacity which may confidently be achieved while allowing specialty contractors to use more effective and/or economical anchoring methods to achieve the specific capacity. The design capacity of each anchor will be verified by testing before accepting the anchor.

Many projects have been completed using small diameter, straight shaft gravity-grouted anchors. Because of the similarity of many projects, some fairly typical anchor characteristics can be summarized. These are intended to provide a range of typical design values to engineers who are unfamiliar with anchor design.

- Design Load Between 260 kN and 1160 kN: Anchor tendons of this capacity can be handled without the need for unusually heavy or specialized equipment. In addition, stressing equipment can be handled by one or two workers without the aid of mechanical lifting equipment. The drill hole diameter is generally less than 150 mm, except for hollow stem augered anchors that are typically approximately 300 mm in diameter.
- Total Anchor Length Between 9 and 18 m: Because of geotechnical or geometrical requirements, few anchors for walls or for tiedown structures are less than 9 m long. A minimum unbonded length of 3 m for bar tendons and 4.5 m for strand tendons should be adopted. These minimum unbonded lengths are required to avoid unacceptable load reduction resulting from seating losses during load transfer and prestress losses due to creep in the prestressing steel or the soil.
- Ground Anchor Inclination Between 10 and 45 degrees: Ground anchors are commonly installed at angles of 15 to 30 degrees below the horizontal although angles of 10 to 45 degrees are within the capabilities of most contractors. Regardless of the anchor inclination, the anchor bond zone must be developed behind potential slip surfaces and in soil or rock layers that can develop the necessary design load. Steep inclinations may be necessary to avoid underground utilities, adjacent foundations, right-of-way constraints, or weak soil or rock layers. Anchors should be installed as close to horizontal as possible to minimize vertical loads resulting from anchor lock-off loads, however grouting of anchors installed at angles less than 10 degrees is not common unless special grouting techniques are used.

For a specific project, the first step in estimating the minimum allowable capacity is to assume a maximum anchor bond length. In the case of a site with no restrictions on right-of-way, a 15-degree inclination of the anchor should be assumed with a bond length of 12 m in soil or 7.5 m in rock. Anchors founded in soil and rock should be designed assuming the entire embedment is in soil, i.e., assume a bond length equal to 12 m. The bond lengths at sites with more restricted right-of-way may be evaluated assuming an anchor inclination of 30 degrees and that the bond length is equal to the distance from the end of the unbonded length to within 0.6 m of the right-of-way line. When using

these assumptions to develop a preliminary estimate of the anchor bond length, it must be verified that for the required excavation height the minimum unbonded length can be developed.

### Soil Anchors

For the purposes of preliminary design, the ultimate load transferred from the bond length to the soil may be estimated for a small diameter, straight shaft gravity-grouted anchor from the soil type and density (or SPT blowcount value) (table 6). The maximum allowable anchor design load in soil may be determined by multiplying the bond length by the ultimate transfer load and dividing by a factor of safety of 2.0.

Table 6. Presumptive ultimate values of load transfer for preliminary design of small diameter straight shaft gravity-grouted ground anchors in soil.

Soil type	Relative density/Consistency (SPT range) <sup>(1)</sup>	Estimated ultimate transfer load (kN/m)
Sand and Gravel	Loose (4-10)	145
	Medium dense (11-30)	220
	Dense (31-50)	290
Sand	Loose (4-10)	100
	Medium dense (11-30)	145
	Dense (31-50)	190
Sand and Silt	Loose (4-10)	70
	Medium dense (11-30)	100
	Dense (31-50)	130
Silt-clay mixture with low plasticity or fine micaceous sand or silt mixtures	Stiff (10-20)	30
	Hard (21-40)	60

Note: (1) SPT values are corrected for overburden pressure.

Anchor bond lengths for gravity-grouted, pressure-grouted, and post-grouted soil anchors are typically 4.5 to 12 m since significant increases in capacity for bond lengths greater than approximately 12 m cannot be achieved unless specialized methods are used to transfer load from the top of the anchor bond zone towards the end of the anchor. For anchor bond zones that function in tension, initial load increments transferred to the anchor bond zone are resisted by the soil near the top of the anchor bond zone as strains occur in the upper grout body (figure 36). As additional increments of load are transferred to the anchor bond zone, the strains in the top of the anchor bond zone may exceed the peak strain for strain sensitive soils. In that case, the bond stress begins to decrease at the top and the peak strain shifts down the anchor body. In strain sensitive soils, the shape of the stress-strain diagram will determine the actual bond length where significant load is mobilized. Attempts to mobilize larger portions of the bond length will result in small increases in

capacity as residual load transfer values develop at the top and the peak value shifts towards the bottom.

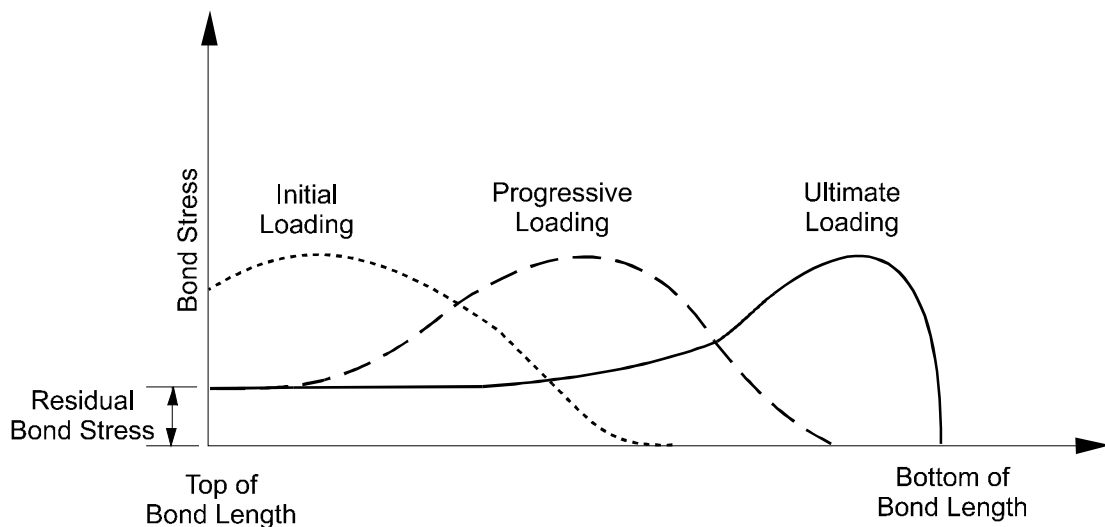

Figure 36. Mobilization of bond stress for a tension anchor.

Pressure grouting in cohesionless soils significantly increases the normal stresses acting on the grout body (i.e., increases confinement). Small increases may also be observed in the effective diameter of the anchor bond zone, but capacity estimates should be based on the as-drilled hole diameter. A range of ultimate bond stress values that have been measured for gravity-grouted and pressure-grouted soil anchors is provided in table 7 to show variation in field measured ultimate values. When reviewing ultimate bond stress values such as those presented in table 7, it is important to recognize that large bond stress values do not necessarily imply a correspondingly large anchor capacity per unit length. For example, a hollow stem augered anchor can develop more capacity per unit length than a small diameter, post-grouted anchor due primarily to the anchor diameter not the bond stress value.

Pressure grouting can be effective in increasing capacity in cohesive soils, however, post-grouting is a more effective means of increasing capacity in cohesive soils. Post grouting increases the radial stresses acting on the grout body and causes an irregular surface to be developed around the bond length that tends to interlock the grout and the ground. It is difficult to predict load capacity in post-grouted anchors owing to the complexity of the grouting procedures used, however, post-grouting of ground anchors in cohesive soil can increase load capacity of a straight shaft anchor by 20 to 50 percent or more per phase of post-grouting with three phases being the common limit (PTI, 1996).

Table 7. Presumptive average ultimate bond stress for ground/grout interface along anchor bond zone (after PTI, 1996).

Rock		Cohesive Soil		Cohesionless Soil	
Rock type	Average ultimate bond stress (MPa)	Anchor type	Average ultimate bond stress (MPa)	Anchor type	Average ultimate bond stress (MPa)
Granite and basalt	1.7 - 3.1	Gravity-grouted anchors (straight shaft)	0.03 - 0.07	Gravity-grouted anchors (straight shaft)	0.07 - 0.14
Dolomitic limestone	1.4 - 2.1	Pressure-grouted anchors (straight shaft)		Pressure-grouted anchors (straight shaft)	
Soft limestone	1.0 - 1.4	<ul style="list-style-type: none"> <li>Soft silty clay</li> </ul>	0.03 - 0.07	<ul style="list-style-type: none"> <li>Fine-med. sand, med. dense – dense</li> </ul>	0.08 - 0.38
Slates and hard shales	0.8 - 1.4	<ul style="list-style-type: none"> <li>Silty clay</li> </ul>	0.03 - 0.07	<ul style="list-style-type: none"> <li>Med.–coarse sand (w/gravel), med. dense</li> </ul>	0.11 - 0.66
Soft shales	0.2 - 0.8	<ul style="list-style-type: none"> <li>Stiff clay, med. to high plasticity</li> </ul>	0.03 - 0.10	<ul style="list-style-type: none"> <li>Med.–coarse sand (w/gravel), dense - very dense</li> </ul>	0.25 - 0.97
Sandstones	0.8 - 1.7	<ul style="list-style-type: none"> <li>Very stiff clay, med. to high plasticity</li> </ul>	0.07 - 0.17	<ul style="list-style-type: none"> <li>Silty sands</li> </ul>	0.17 - 0.41
Weathered Sandstones	0.7 - 0.8	<ul style="list-style-type: none"> <li>Stiff clay, med. plasticity</li> </ul>	0.10 - 0.25	<ul style="list-style-type: none"> <li>Dense glacial till</li> </ul>	0.30 - 0.52
Chalk	0.2 - 1.1	<ul style="list-style-type: none"> <li>Very stiff clay, med. plasticity</li> </ul>	0.14 - 0.35	<ul style="list-style-type: none"> <li>Sandy gravel, med. dense-dense</li> </ul>	0.21 - 1.38
Weathered Marl	0.15 - 0.25	<ul style="list-style-type: none"> <li>Very stiff sandy silt, med. plasticity</li> </ul>	0.28 - 0.38	<ul style="list-style-type: none"> <li>Sandy gravel, dense-very dense</li> </ul>	0.28 - 1.38
Concrete	1.4 - 2.8				

Note: Actual values for pressure-grouted anchors depend on the ability to develop pressures in each soil type.

## Rock Anchors

For rock anchors, typical bond lengths range from 3 to 10 m with a minimum of 3 m. The ultimate load transferred from the bond length to competent sound rock may be estimated from the rock type (table 8). Lower values may be recommended after input from a geologist especially if the rock mass strength is controlled by discontinuities. The maximum allowable anchor design load in competent rock may be determined by multiplying the bond length by the ultimate transfer load and dividing by a factor of safety of 3.0. This relatively high value of the factor of safety (compared to that for soil) is used to account for uncertainties associated with potential discontinuities in the rock mass such as joints, fractures, and clay-filled fissures. In weak rocks such as clay shales, bond stress transfer is relatively uniform as compared to bond stress transfer in more competent rock. These weak rocks may be termed “intermediate geomaterials” and have unconfined compressive strengths defined as varying from 0.5 to 5.0 MPa. Design values for evaluating anchor bond lengths in these materials should use a factor of safety of 2.0 on the ultimate load transfer value.

Table 8. Presumptive ultimate values of load transfer for preliminary design of ground anchors in rock.

Rock type	Estimated ultimate transfer load (kN/m)
Granite or Basalt	730
Dolomitic Limestone	580
Soft Limestone	440
Sandstone	440
Slates and Hard Shales	360
Soft Shales	150

Typical ranges of ultimate bond stress values for the rock/grout interface which have been measured are provided in table 7. Alternatively, PTI (1996) suggests that the ultimate bond stress between rock and grout can be approximated as 10 percent of the unconfined compressive strength of the rock up to a maximum value for ultimate bond stress of 3.1 MPa.

In the calculation of bond length, the implicit assumption is that the bond at the rock-grout interface is mobilized uniformly. This is unlikely to be the case unless the anchor bond zone is formed in soft or weak rock. For conditions where the ratio of the elastic modulus of the grout to the elastic modulus of the rock is less than one (e.g., in competent rock), load is transferred from the tendon to the rock only in the upper 1.5 to 3 m of the anchor bond zone; any additional length of anchor bond zone may be considered to provide an additional margin of safety. Therefore, use of average bond stress values such as those provided in table 7 may result in calculated bond lengths significantly greater than that which is required to resist the design load.

### *Predesign and Preproduction Load Testing*

Predesign load tests are occasionally performed to evaluate ultimate anchor load-carrying capacity and/or creep behavior of anchors installed in creep susceptible soils. When the capacity of individual anchors is critical to the design, it may be desirable to install and test several test anchors. Predesign load tests may be performed for cases where the required capacity of the anchors exceeds local experience or the required construction method is unusual. In general, predesign load tests are not commonly used and when they are conducted they are performed as part of a separate contract that is paid for by the owner.

Anchors used for predesign load tests are generally not incorporated into the final structure as load carrying elements because of the damage that may be induced by the high testing loads required to evaluate ultimate anchor capacity. If possible, the anchors should be fabricated and installed exactly as planned for the production anchors. If testing loads will exceed 80 percent of SMTS of the production anchors, additional tendon capacity should be provided (i.e., increase the number of strands or use larger bar diameter). Procedures used for a predesign testing program are provided in appendix D. The objective of most predesign test programs is to establish the anchor load at which the creep rate becomes unacceptable. Complete documentation of a predesign test program for the I90 project in Seattle, Washington is contained in FHWA-DP-90-068-003 (1990). In general, however, predesign load testing test programs are rarely executed due to time and cost factors.

Preproduction anchor testing programs, which can provide similar information concerning acceptable anchor loads, are commonly performed. With a preproduction testing program, the contractor performs performance tests on several anchors. Performance tests (see section 7.3.2) involve incremental loading and unloading of an anchor in progressively increasing load increments to a maximum test load equal to 133 percent of the design load. Extended creep tests (see section 7.3.4) are commonly used in the preproduction testing program to evaluate the creep behavior of the anchor at all test loads from 25 to 133 percent of the design load. The advantages of preproduction load testing as compared to predesign load testing includes: (1) less expensive since contractor only mobilizes to site on one occasion; (2) less time consuming (e.g., one day) when compared to predesign testing (e.g., five days); and (3) ability to duplicate ground conditions for production anchors. The results of the early-on performance tests carried out as part of a preproduction load testing program may be used to verify anchor bond zone load transfer rates or as a means to optimize wall design through use of a higher load transfer rate as compared to the load transfer rate used to develop the original design.

#### **5.3.7 Spacing Requirements for Ground Anchors**

Each ground anchor in an anchored system is commonly designed assuming that the anchor carries a tributary area of load based on the horizontal and vertical spacing between adjacent anchors. The size and strength of the anchor tendon, drilling and grouting procedures, and diameter and length of the anchor are selected to ensure that the ground anchor can carry this load throughout its service life. The horizontal and vertical spacing of the ground anchors will vary depending on project specific requirements and constraints, which may include: (1) necessity for a very stiff system (i.e., closely spaced anchors) to control lateral wall movements; (2) existing underground structures that may affect the positioning and inclination of the anchors; and (3) type of vertical wall elements selected for the design.



The vertical position of the uppermost ground anchor (i.e., the ground anchor closest to the ground surface) should be evaluated considering the allowable cantilever deformations of the wall. The vertical position of the uppermost anchor must also be selected to minimize the potential for exceeding the passive capacity of the retained soil during anchor proof and performance load testing. During load testing, permanent anchors are typically loaded to 133 percent of the design load resulting in movement of the wall into the retained ground. If the design load for the uppermost ground anchor is relatively large, as is the case where large surcharge or landslide loads must be resisted, or if the soils are disturbed or relatively weak, the passive capacity of the soil may be exceeded during load testing. If the passive capacity is exceeded, the soldier beams or sheet pile will move excessively into the retained ground; for soldier beam wall systems, the timber lagging may bend and crack excessively. A method to check the passive capacity of the soil at the location of the uppermost anchor is provided in section 5.11.4.

For ground anchors installed in soil, a minimum overburden of 4.5 m over the center of the anchor bond zone is required (figure 37a). This is required to prevent grout leakage during installation of pressure grouted anchors and to prevent heave at the ground surface resulting from large grouting pressures. For gravity-grouted anchors, the minimum overburden criterion is required to provide the necessary soil overburden pressure to develop anchor capacity.

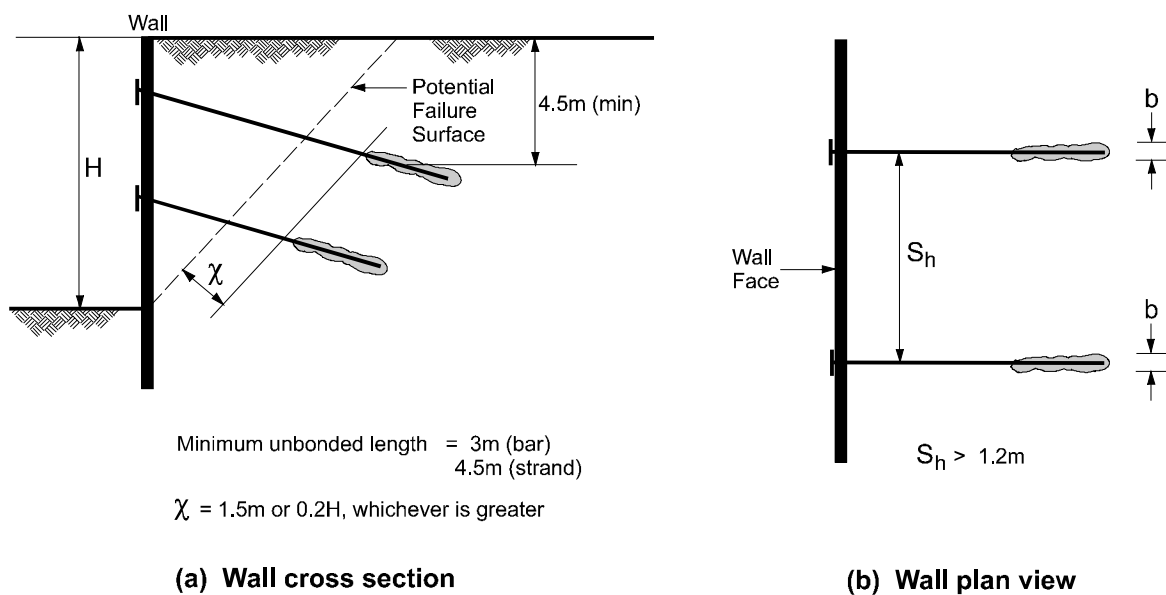

Figure 37. Vertical and horizontal spacing requirements for ground anchors.

The maximum horizontal spacing between anchors is based on allowable individual ground anchor loads and flexural capacity of individual soldier beams or sheet pile sections. Typical horizontal spacing for soldier beams is 1.5 m to 3 m for driven soldier beams and up to 3 m for drilled-in soldier beams. The minimum horizontal spacing between anchors shown in figure 37b ensures that group effects between adjacent ground anchors are minimized and that anchor intersection due to drilling deviations is avoided. Group effects reduce the load carrying capacity of individual ground anchors.

### 5.3.8 Selection of Prestressing Steel Element

The prestressing steel element of the tendon (i.e., strand or bar) must be capable of safely transmitting load in the anchor bond zone to the structure without tendon breakage. For the design load and the lock-off load, separate factors of safety are applied with respect to the potential failure mechanism of tendon breakage. The design load shall not exceed 60 percent of the specified minimum tensile strength (SMTS) of the prestressing steel. The lock-off load shall not exceed 70 percent of the SMTS and the maximum test load shall not exceed 80 percent of the SMTS.

For example, if the maximum test load is 133 percent of the design load, then the ground anchor should be selected based on a maximum allowable design load of  $(0.8/1.33)$  SMTS or 0.6 SMTS. If the maximum test load is 150 percent of the design load, then the maximum allowable design load is  $(0.8/1.5)$  SMTS or 0.53 SMTS.

Dimensions and strengths of bars and strands commonly used in the U.S. for highway applications are provided in table 9 and table 10, respectively. Larger size strand tendons (i.e., strand tendons with more strands than those shown in table 10) are available for applications requiring greater ground anchor design loads. Information on 13-mm diameter strand or Grade 250 (metric 1725) strand can be found in ASTM A416.

Table 9. Properties of prestressing steel bars (ASTM A722).

Steel grade	Nominal diameter	Ultimate stress $f_{pu}$	Nominal cross section area $A_{ps}$	Ultimate strength $f_{pu} A_{ps}$	Prestressing force		
					$0.8 f_{pu} A_{ps}$	$0.7 f_{pu} A_{ps}$	$0.6 f_{pu} A_{ps}$
(ksi)	(in.)	(ksi)	(in. <sup>2</sup> )	(kips)	(kips)	(kips)	(kips)
150	1	150	0.85	127.5	102.0	89.3	76.5
	1-1/4	150	1.25	187.5	150.0	131.3	112.5
	1-3/8	150	1.58	237.0	189.6	165.9	142.2
	1-3/4	150	2.66	400.0	320.0	280.0	240.0
	2-1/2	150	5.19	778.0	622.4	435.7	466.8
160	1	160	0.85	136.0	108.8	95.2	81.6
	1-1/4	160	1.25	200.0	160.0	140.0	120.0
	1-3/8	160	1.58	252.8	202.3	177.0	151.7
(ksi)	(mm)	(N/mm <sup>2</sup> )	(mm <sup>2</sup> )	(kN)	(kN)	(kN)	(kN)
150	26	1035	548	568	454	398	341
	32	1035	806	835	668	585	501
	36	1035	1019	1055	844	739	633
	45	1035	1716	1779	1423	1246	1068
	64	1035	3348	3461	2769	2423	2077
160	26	1104	548	605	484	424	363
	32	1104	806	890	712	623	534
	36	1104	1019	1125	900	788	675

Table 10. Properties of 15-mm diameter prestressing steel strands (ASTM A416, Grade 270 (metric 1860)).

Number of 15-mm diameter strands	Cross section area		Ultimate strength		Prestressing force					
					0.8 $f_{pu}A_{ps}$		0.7 $f_{pu}A_{ps}$		0.6 $f_{pu}A_{ps}$	
	(in. <sup>2</sup> )	(mm <sup>2</sup> )	(kips)	(kN)	(kips)	(kN)	(kips)	(kN)	(kips)	(kN)
1	0.217	140	58.6	260.7	46.9	209	41.0	182	35.2	156
3	0.651	420	175.8	782.1	140.6	626	123.1	547	105.5	469
4	0.868	560	234.4	1043	187.5	834	164.1	730	140.6	626
5	1.085	700	293.0	1304	234.4	1043	205.1	912	175.8	782
7	1.519	980	410.2	1825	328.2	1460	287.1	1277	246.1	1095
9	1.953	1260	527.4	2346	421.9	1877	369.2	1642	316.4	1408
12	2.604	1680	703.2	3128	562.6	2503	492.2	2190	421.9	1877
15	3.255	2100	879.0	3911	703.2	3128	615.3	2737	527.4	2346
19	4.123	2660	1113.4	4953	890.7	3963	779.4	3467	668.0	2972

The type and size of the anchors should be evaluated prior to design of the anchor bond zone because the required hole diameter varies as a function of the tendon size. Table 11 can be used to estimate the minimum trumpet opening for strand or bar tendons.

Table 11. Guidance relationship between tendon size and trumpet opening size.

Tendon type	Minimum suggested trumpet opening size (mm)	
	Class II corrosion protection	Class I corrosion protection
Number of 15-mm diameter strands		
4	102	150
7	115	165
9	127	178
11	140	191
13	153	203
17	165	216
Bar diameter (mm)		
26	64	89
32	70	95
36	76	102

## 5.4 WALL DESIGN BASED ON LATERAL PRESSURES

### 5.4.1 Design of Soldier Beams and Sheet-Piles

Anchored soldier beam and lagging walls and sheet-pile walls are designed to resist lateral loads resulting from apparent pressure envelopes including appropriate surcharges, water forces, and seismic forces. Figure 38 illustrates the method used to calculate wall bending moments for single-level and multi-level walls for the exposed portion of the wall using the hinge method. The exposed portion of the wall refers to the height of wall between the ground surface and the bottom of the excavation. Figure 39 shows the equations that may be used to calculate wall bending moments for

single-level and multi-level walls using the tributary area method. For walls constructed in competent soils such as most sands and stiff clays, the maximum bending moment,  $M_{\max}$ , occurs in the exposed portion of the wall. For walls that penetrate deep deposits of weak material, the maximum bending moment may occur in the embedded portion of the wall. The embedded portion of the wall refers to the length of wall that is below the base of the excavation. Bending moment calculation for the embedded portion of the wall is provided in section 5.5.

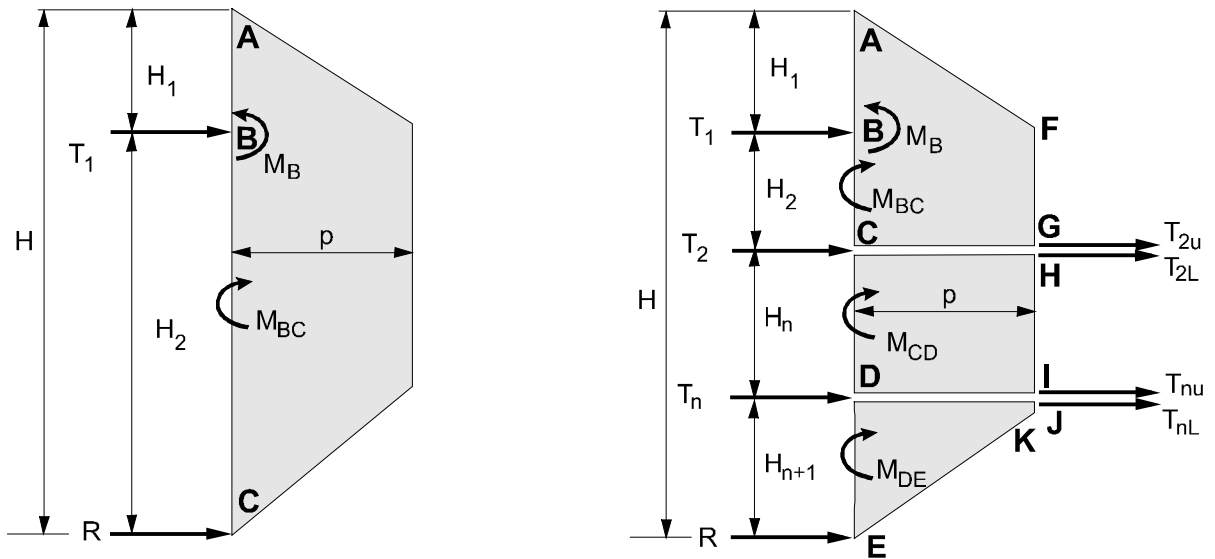

$$M_B = \sum M_B$$

$M_{BC}$  = Maximum moment between B and C;  
located at point where shear = 0

$$M_B = \sum M_B$$

$$M_C = M_D = M_E = 0$$

$M_{BC}$  = Maximum moment between B and C;  
located at point where shear = 0

$M_{CD}$ ;  $M_{DE}$  : Calculated as for  $M_{BC}$

(a) Walls with one level of ground anchors

(b) Walls with multiple levels of ground anchors

Figure 38. Calculation of wall bending moments using hinge method.

Selection of an appropriate wall section is based on the calculated maximum bending moment in the vertical wall element. The negative bending moment calculated at the location of the first anchor is evaluated by summing moments about the first anchor location. The vertical wall elements are commonly assumed to be continuous between each support location. The maximum positive bending moment between each ground anchor is, for the tributary area method, assumed equal to  $1/10 pl^2$  where  $p$  is the maximum ordinate of the apparent pressure envelope and  $l$  is the vertical spacing between adjacent anchors. For the hinge method, the maximum positive bending moment between each ground anchor corresponds to the point of zero shear. These methods provide conservative estimates of the calculated bending moments, but may not accurately predict the specific location. For continuous sheet-pile walls, the bending moment per unit of wall is used to select an appropriate sheet-pile section. To evaluate the maximum bending moment for design of a

soldier beam, the maximum bending moment per unit of wall calculated from figure 38 and 39 is multiplied by the center-to-center spacing of the soldier beams.

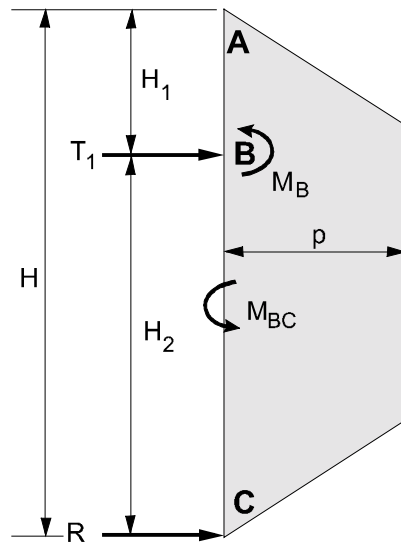

$$M_B = \frac{13}{54} H_1^2 p$$

$$T_1 = \frac{(23H^2 - 10HH_1)}{54(H-H_1)} p$$

$$R = \frac{2}{3} Hp - T_1$$

Solve for point of zero shear

$$x = \frac{1}{9} \sqrt{(26H^2 - 52HH_1)}$$

$$M_{BC} = Rx - \frac{px^3}{4(H-H_1)}$$

(a) Walls with single level of ground anchors

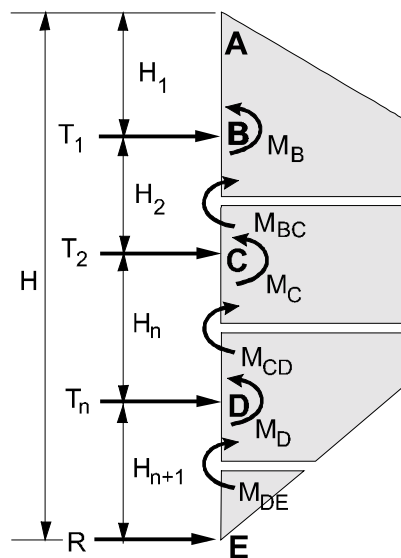

$$M_B = \frac{13}{54} H_1^2 p$$

$$T_1 = \left( \frac{2}{3} H_1 + \frac{H_2}{2} \right) p$$

$$T_2 = \left( \frac{H_2}{2} + \frac{H_n}{2} \right) p$$

$$T_n = \left( \frac{H_n}{2} + \frac{23H_{n+1}}{48} \right) p$$

$$R = \left( \frac{3}{16} H_{n+1} \right) p$$

Maximum moment below B =  $pL^2/10$   
 where L is the larger of  $H_2, H_n, H_{n+1}$

(b) Walls with multiple level of ground anchors

Figure 39. Calculation of wall bending moments using tributary area method.

For permanent walls and temporary walls that are considered critical, an allowable bending stress in the soldier beam,  $F_b$ , of  $0.55 F_y$ , where  $F_y$  is the yield stress of the steel, is recommended. Steel sheet-pile and soldier beams are commonly either Grade 36 ( $F_y = 248$  MPa) or Grade 50 ( $F_y = 345$  MPa). For temporary SOE walls, a 20 percent increase in the allowable stress may be allowed for positive wall bending moments between anchor locations; no allowable stress increase is recommended for negative wall bending movements at the anchor locations. The required section modulus  $S_{req}$ , is calculated as:

$$S_{req} = \frac{M_{max}}{F_b} \quad (\text{Equation 22})$$

Standard SI units are  $S(\text{mm}^3)$ ,  $M_{max}$  (kN-m), and  $F_b$  (MPa). In most cases, several available steel sections will typically meet this requirement. The actual wall section selected will be based on contractor/owner preference, cost, constructability, and details of the anchor/wall connection.

When designing permanent anchored walls in relatively uniform competent materials, it is usually only necessary to check the final stage of construction provided that: (1) the ground can develop adequate passive resistance below the excavation to support the wall; (2) apparent earth pressure diagrams are used to assess the loading on the wall; and (3) there is minimal over excavation below each anchor level (FHWA-RD-97-130, 1998). For cases where there are large concentrated surcharges or berms at the ground surface, it is prudent to check wall bending moments for the initial cantilever stage (i.e., stage just prior to installation and lock-off of uppermost anchor).

Where the final excavation height is not the most critical condition, designers commonly use a staged construction analysis where the maximum wall bending moment, wall deflections, and wall embedment depth are evaluated for several stages of construction. An analysis is required for this case since the maximum bending moment may occur at an intermediate stage of construction (i.e., before the final excavation depth is reached). Intermediate construction stages may be critical when: (1) triangular earth pressure diagrams are used to design the wall; (2) the excavation extends significantly below an anchor level prior to stressing that anchor; (3) a cutoff wall is used to maintain the water level behind the wall; (4) the soil below the bottom of the excavation is weak resulting in active earth pressures that are greater than available resistance provided by the toe of the wall; and (5) structures are located near the wall.

#### **5.4.2 Design of Lagging for Temporary Support**

The thickness of temporary timber lagging for soldier beam and lagging walls is based primarily on experience or semi-empirical rules. Table 12 presents recommended thicknesses of construction grade lumber for temporary timber lagging. For temporary SOE walls, contractors may use other lagging thicknesses provided they can demonstrate good performance of the lagging thickness for walls constructed in similar ground.

Permanent timber lagging has been used in lieu of a concrete face to carry permanent wall loads. For permanent applications, the timber grade and dimensions should be designed according to structural guidelines. Several problems may exist for permanent timber lagging including: (1) need to provide fire protection for the lagging; (2) limited service life for timber; and (3) difficulty in providing

Table 12. Recommended thickness of temporary timber lagging (after FHWA-RD-75-130, 1976)

	Soil Description	Unified Soil Classification	Depth (m)	Recommended thickness of lagging (roughcut) for clear spans of:					
				1.5 m	1.8 m	2.1 m	2.4 m	2.7 m	3.0 m
<b>COMPETENT SOILS</b>	Silt or fine sand and silt above water table	ML, SM-ML	0 - 8	50 mm	75 mm	75 mm	75 mm	100 mm	100 mm
	Sands and gravels (medium dense to dense)	GW, GP, GM, GS, SW, SP, SM							
	Clays (stiff to very stiff); non-fissured	CL, CH	8 - 18	75 mm	75 mm	75 mm	100 mm	100 mm	125 mm
	Clays, medium consistency and $\frac{\gamma_H}{S_u} < 5$	CL, CH							
<b>DIFFICULT SOILS</b>	Sand and silty sand (loose)	SW, SP, SM							
	Clayey sands (medium dense to dense) below water table	SC	0 - 8	75 mm	75 mm	75 mm	100 mm	100 mm	125 mm
	Clay, heavily overconsolidated, fissured	CL, CH	8 - 18	75 mm	75 mm	100 mm	100 mm	125 mm	125 mm
	Cohesionless silt or fine sand and silt below water table	ML, SM-SL							
<b>POTENTIALLY DANGEROUS SOILS</b>	Soft clays $\frac{\gamma_H}{S_u} > 5$	CL, CH	0 - 5	75 mm	75 mm	100 mm	125 mm	-----	-----
	Slightly plastic silts below water table	ML	5 - 8	75 mm	100 mm	125 mm	150 mm	-----	-----
	Clayey Sands (loose), below water table	SC	8-11	100 mm	125 mm	150 mm	-----	-----	-----
Notes: 1) In the category of "potentially dangerous soils", use of soldier beam and lagging wall systems is questionable. 2) The values shown are based on construction grade lumber. 3) Local experience may take precedence over recommended values in this table.									

corrosion protection to the ground anchor. Additional information on design of timber lagging for permanent facings is provided in section 5.6.6 of AASHTO (1996). As previously mentioned, concrete lagging is not recommended for anchored walls due to construction difficulties in top-down placement of the lagging.

### 5.4.3 Design of Wales and Permanent Facing

For anchored walls, wales and permanent facing should be designed to resist apparent earth pressures, surcharges, water pressures, and seismic pressures. Maximum bending moments in wales and permanent facings can be estimated using table 13.

Table 13. Maximum design bending moments for wales and permanent facing (after AASHTO, 1996).

Support and soil condition	Maximum moment in a 1 m height
Simple span No soil arching (e.g., soft cohesive soils; rigid concrete facing placed tightly against soil)	$p^2/8$
Simple span Soil arching (e.g., granular soil or stiff cohesive soil with flexible facing; rigid facing where space is available to allow in place soil to arch)	$p^2/12$
Continuous facing No soil arching (e.g., soft cohesive soils; rigid concrete facing placed tightly against soil)	$p^2/10$
Continuous facing Soil arching (e.g., granular soil or stiff cohesive soil with flexible facing; rigid facing where space is available to allow in place soil to arch)	$p^2/12$

Note:  $p$  = maximum ordinate of the total pressure envelope along span  
 $s$  = span between supports

Permanent facings that are cast-in-place (CIP) are typically 200 to 300 mm thick. This thickness will typically ensure that the wall is structurally sound and allow for some deviations in soldier beam placement. Significant deviations, however, in soldier beam alignment may require that additional concrete in excess of that required for the nominal thickness of the wall be used so that the finished wall face is properly aligned. Precast concrete facing may be cost-effective if there is a local fabricator and if there is adequate on-site storage. Precast panels are designed as simple spans between the soldier beams.

Wale design bending moments will depend on the fixity of the wale/soldier beam connection (i.e., shear or full moment connection). Bending moments in wales that extend over less than three spans should be calculated as  $p^2/8$ . Three spans or more should be considered continuous and should be designed using a maximum bending moment of  $p^2/10$ . External wales are not commonly used in permanent applications due to aesthetics, corrosion protection requirements, and other factors associated with the protrusion of the anchors. Internal wales (i.e., between the flanges of adjacent soldier beams) have been used in situations where replacement anchors were required.



## **5.5 LATERAL CAPACITY OF EMBEDDED PORTION OF WALL**

### **5.5.1 General**

Anchored walls derive support from the ground anchors installed above the final excavation grade and from passive soil resistance provided over the depth of the embedded portion of the wall. The wall elements are subjected to various lateral loading conditions depending on the stage of construction. Prior to stressing the first anchor, the wall acts as a nongravity cantilevered wall and all resistance is provided by passive soil resistance along the embedded portion of the wall. After installation of the first anchor and during subsequent excavations for lower anchors, the wall embedment provides temporary resistance for the unanchored height. At final height, the anchors carry most of the load from above the base of the excavation while the embedded portion of the wall is designed to carry loads associated with the lower portion of the apparent pressure envelope (i.e., the reaction force  $R$  on previous figures) and active earth pressure loads acting along the back side of the embedded portion of the wall.

The overall stability of an anchored wall system and the stress level developed within the wall elements depend on the relative stiffness of the wall, the depth of wall penetration, and the soil strength and stiffness. Figure 40 shows the general relationship between depth of penetration, lateral earth pressure distribution, and deflected wall shape for an anchored wall. Case (a) refers to a condition of “free earth support”. For this case, the passive pressures in front of the wall are insufficient to prevent lateral deflection and rotation at point D. Designs based on free earth support conditions assume that the soil in front of the wall is incapable of producing effective restraint to the extent necessary to induce negative bending moments. The wall element is extended just deep enough to assure stability.

Cases (b), (c), and (d) in figure 40 show the effect of increasing the depth of wall penetration. In case (b) and (c), the passive pressures are sufficient to prevent lateral deflection at point D, but rotation at the bottom of the wall still occurs. For case (d), passive pressures have developed sufficiently on both sides of the wall to prevent both lateral deflection and rotation at point D. Case (d) refers to a condition of “fixed earth support”.

### **5.5.2 Evaluation of Ultimate Passive Resistance**

#### **5.5.2.1 Soldier Beam and Lagging Walls**

The passive side of the embedded portion of an anchored wall (i.e., the excavation side) must resist the lateral load resulting from the reaction force at the base of the excavation,  $R$ , with an adequate factor of safety. The passive resistance for walls with discrete elements (i.e., soldier beams) below excavation subgrade has been typically evaluated using relationships developed by Broms (1965) for laterally loaded piles (figure 41). In cohesionless soils and for drained conditions in cohesive soils, passive resistance at depth is assumed to be developed over three times the soldier beam width,  $b$ , with a magnitude determined using the Rankine passive earth pressure coefficient. In cohesive soils, passive resistance is assumed to develop over one soldier beam width and to be constant over most of the beam depth with a magnitude of nine times the soil undrained shear strength. As shown in

figure 41c, no passive resistance is assumed to develop over a depth of 1.5 times the soldier beam width.

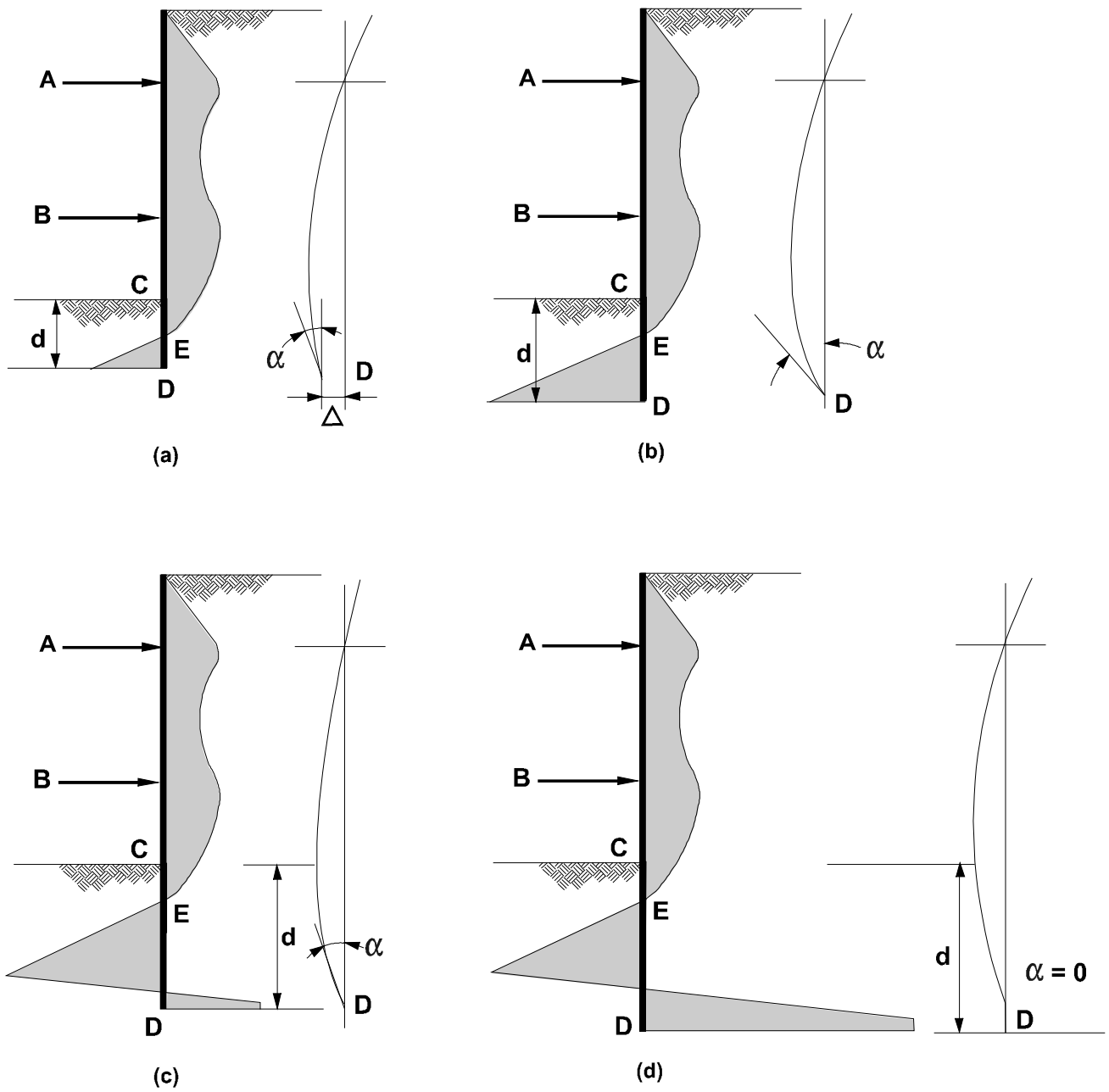

Figure 40. Relationship between lateral earth pressure, wall deflection, and depth of wall embedment.

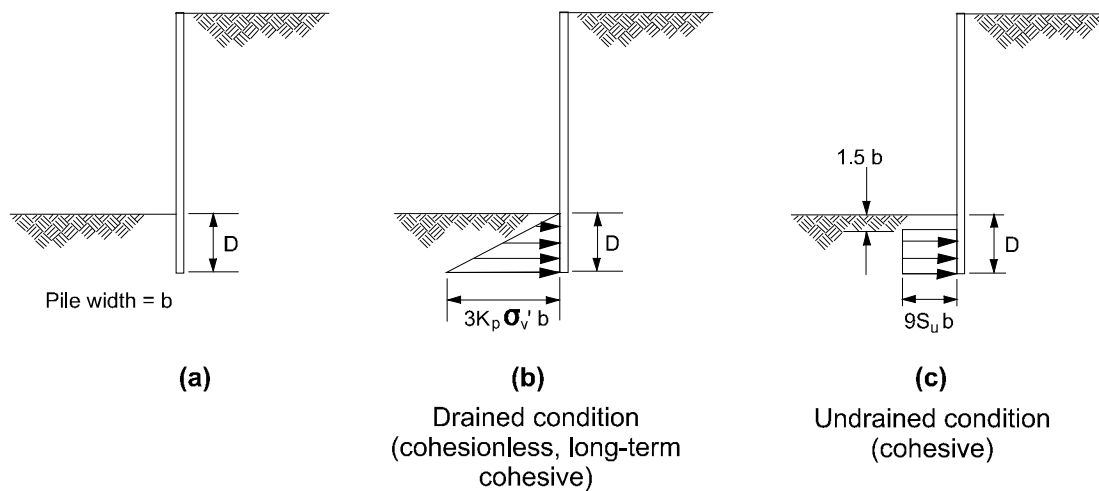

Figure 41. Broms method for evaluating ultimate passive resistance.

Back calculated passive resistances for laterally loaded piles and soldier beam and lagging walls also compared favorably with passive resistance calculations developed by Wang and Reese (1986) for cantilevered drilled shaft walls. The Wang-Reese equations consider several potential failure mechanisms for laterally loaded piles in sands and clays. The effects of spacing between adjacent piles and the potential for soil to squeeze between adjacent piles are also considered. These mechanisms and the calculations developed for evaluating ultimate passive resistance for cohesionless and cohesive soils are provided in appendix B. Comparisons of the Broms method and the Wang-Reese method are provided in subsequent sections.

For driven soldier beams, the flange width of the soldier beam should be used for lateral resistance calculations. For drilled-in soldier beams backfilled with structural concrete, the full diameter of the soldier beam should be used for lateral resistance calculations. For drilled-in soldier beams backfilled with lean-mix concrete, the full diameter of the beam may be used for lateral resistance calculations provided the lean-mix concrete backfill has a compressive strength of no less than 0.35 MPa.

### 5.5.2.2 Continuous Walls

The evaluation of passive resistance for walls with continuous elements involves calculating the passive soil resistance according to the methods described in section 4.4.2. When evaluating the passive earth pressure coefficient for cohesionless soils (see figure 16 and 17), an interface friction angle,  $\delta$ , varying from  $0.5\phi'$  to  $1.0\phi'$  is typically used. The specific value will depend on method of construction, type of wall element (i.e., steel sheet-pile, tangent/secant pile, slurry wall), and axial load transfer in the embedded portion of the wall.

### 5.5.3 Depth of Penetration below Excavation

#### *Competent Soil Conditions*

The depth of penetration of vertical wall elements based on lateral capacity is generally calculated using a factor of safety with respect to lateral capacity of 1.5. When using the Wang-Reese

equations, the required embedment depth corresponds to the depth at which the ratio of ultimate passive resistance to the reaction force,  $R$ , is greater than or equal to 1.5. When calculating passive resistance using the Broms method or for the analysis of continuous sheet-pile walls, the passive earth pressure coefficient is reduced by a factor of safety of 1.5 to calculate the passive resistance for comparison directly to the reaction force. For the Broms method, the Rankine passive earth pressure coefficient with  $\delta = 0^\circ$  is used. When using the Wang-Reese equations to calculate the ultimate passive resistance in competent sands and clays, the envelope of minimum resistance calculated from the various failure mechanisms should be used to evaluate the required embedment depth.

The reaction force was previously defined as being computed from the area of the apparent pressure diagram from the base of the excavation to the midheight between the base of the excavation and the lowermost anchor (see section 5.3.3). For the calculations of required embedment for cohesionless soils, the active earth pressure that acts below the bottom of the excavation over the width of the soldier beam or over a unit-width of sheet-pile is also considered to be a driving force. For competent cohesive soils, the active earth pressure may be negative and is therefore neglected in the embedment calculation.

#### *Weak Underlying Layer*

Lateral load capacity is limited below the base of the excavation in very loose to loose granular soils or soft to medium clays. In very loose to loose granular soils, the wall elements must experience relatively large movements to fully develop passive resistance. The vertical wall element may become overstressed prior to achieving these movements. When undrained conditions are assumed in soft to medium clays with stability number  $N_s > 4$ , the net pressure remains on the active side of the excavation regardless of the embedment depth, thus no passive resistance can be developed. Penetration of the vertical wall elements (i.e., sheet-pile or soldier beam) should be limited to a nominal minimal depth of approximately 20 percent of the excavation depth unless deeper embedments are necessary to develop sufficient capacity to resist vertical loads (see section 5.6), provide basal stability (see section 5.8.2), or limit ground movements.

For these cases, the embedded portion of the wall should be designed as a cantilever fixed at the lowest anchor. An example calculation for a wall in a cohesive deposit is shown in appendix C. For design, the wall section should be selected based on the maximum bending moment evaluated, i.e., either the maximum bending moment in the exposed portion of the wall above the lowermost anchor or the calculated cantilever bending moment about the lowermost anchor as shown in appendix C.

#### **5.5.4 Comparison of Wang-Reese and Broms Method for Competent Soils**

Calculated required embedment depths based on the Wang-Reese method and the Broms method are compared in figure 42 for an example wall constructed in sand and figure 43 for an example wall constructed in clay. The reaction force was calculated based on apparent pressure envelopes for sands and stiff to hard clays. Spreadsheet calculations for these examples are included in appendix B. For the examples shown, for a factor of safety of 1.5, the Wang-Reese method predicts less embedment as compared to the Broms method. For design of anchored walls, either method may be used.

The computer program COM624P (FHWA-SA-91-048, 1993) can be used to verify fixity conditions (i.e., free earth support or fixed earth support) for the embedment depth calculated using either the

Wang-Reese or the Broms analysis. A reversal of curvature in the deflected shape of the wall along the embedded portion of the wall indicates fixed-earth support conditions.

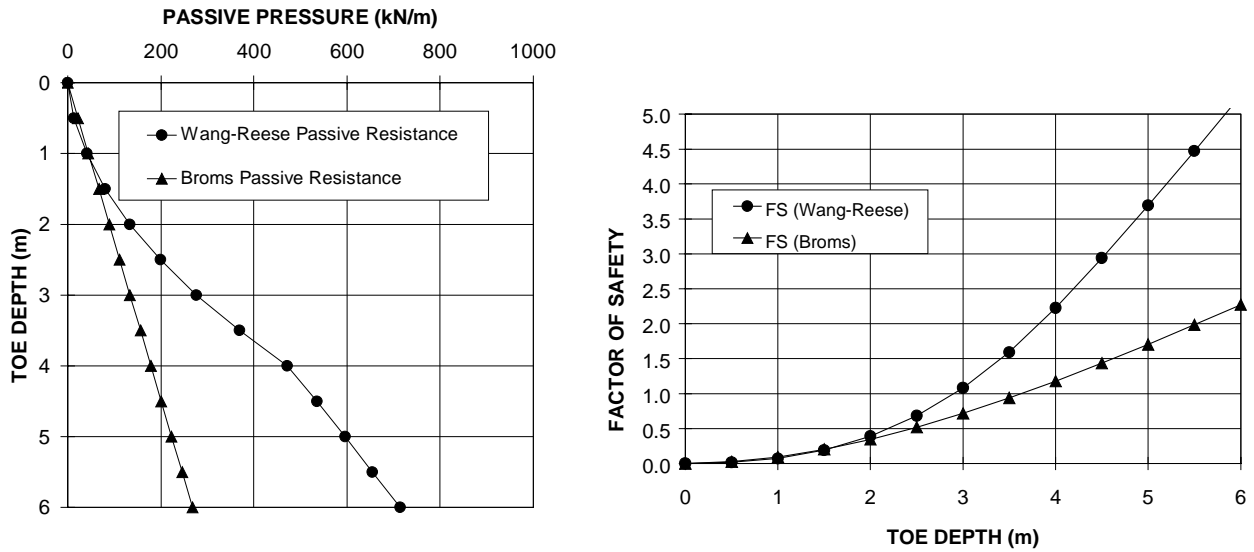

Figure 42. Comparison of Broms and Wang-Reese Method for wall in sand.

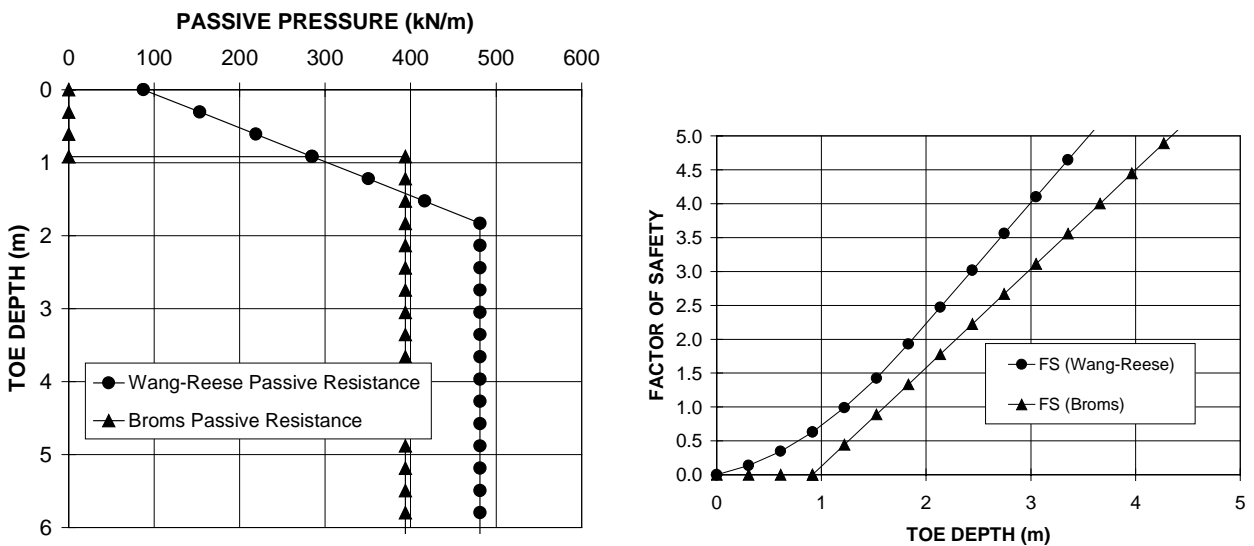

Figure 43. Comparison of Broms and Wang-Reese Method for wall in clay.

## 5.6 AXIAL CAPACITY OF WALL

### 5.6.1 Introduction

The sum of the vertical component of each ground anchor load and other vertical loads (e.g., dead weight of wall, permanent live loads) must be considered in the design of the wall elements to minimize potential of a bearing failure and/or excessive vertical wall movement. Soldier beams for

anchored walls are either driven or they are placed in pre-drilled holes that are subsequently backfilled with lean-mix or structural concrete. Conventional analyses of axial load capacity for driven piles and drilled shafts may be used to design the vertical wall elements of anchored walls. Analysis methods presented herein are described in greater detail in FHWA-HI-97-013 (1996) for driven piles and FHWA-SA-99-019 (1999) for drilled-in piles.

### 5.6.2 Axial Load Evaluation

External vertical loads on an anchored wall include: (1) vertical ground anchor forces; (2) dead weight of the wall elements (e.g., soldier beams, lagging, concrete facing); and (3) other external loads. Other loads that may be significant for anchored walls, but which are relatively difficult to evaluate a priori include: (1) load transferred to the retained ground above the excavation subgrade; and (2) downdrag loads that result when the retained ground settles relative to the wall. The method recommended herein for designing vertical wall elements of permanent walls for axial capacity assumes that all external vertical loads are resisted by side friction and end bearing resistance in the embedded portion of the wall. Target factors of safety for calculating the allowable axial load are recommended based on soil type.

Research results (see FHWA-RD-97-066, 1998) and review of limited case history information indicate that:

- axial load will be transferred from the wall to the ground above the excavation subgrade in dense to very dense sands or stiff to hard clays, however the length of time is unknown as to when these loads may be transferred to the embedded portion of the wall;
- axial load may be minimized by installing anchors as near to horizontal as possible;
- downdrag loads are reduced to zero when the wall settles approximately 2.5 mm relative to the supported ground; and
- downdrag loads will likely act on walls constructed in soft to medium clays or loose to medium dense sands that are founded on a relatively firm stratum.

These observations support the conservative assumption that all external loads should be designed to be supported by the embedded portion of the wall.

Table 14 presents recommended factors of safety (FS) for calculating the allowable axial capacity of driven and drilled-in soldier beams for permanent walls. Lower factors of safety may be justified based on the results of site-specific load testing. These factors of safety (table 14) were developed based on the requirement that vertical wall movements are minimized. The allowable axial capacity,  $Q_a$ , of driven and drilled-in soldier beams is defined as:

$$Q_a = \frac{Q_{ult}}{FS} \quad (\text{Equation 23})$$

Methods to calculate the ultimate axial capacity,  $Q_{ult}$ , are described subsequently.

Table 14. Recommended factors of safety for axial capacity of driven and drilled-in soldier beams.

Soil Type	Factor of Safety on Skin Friction	Factor of Safety on End Bearing
Clays	2.5	2.5
Sands	2.0	2.5

For temporary SOE applications, designs may consider the potential for axial load support above the excavation subgrade and thus, axial capacity for SOE wall elements may be based on lower factors of safety than are listed in table 14. Lower factors of safety can be used if the designer can provide data or be able to demonstrate that the vertical settlement of the wall will be relatively small. Tolerable vertical settlement is necessary to assure that the ground anchor/wall connection does not become overstressed and that lateral movements of the wall resulting from vertical wall movement will be acceptable.

### 5.6.3 Axial Capacity Design of Driven Soldier Beams

#### 5.6.3.1 General

The following guidance on the design of driven piles for axial capacity has been excerpted from FHWA Report No. FHWA-HI-97-013 (1996). That document should be consulted for supplementary information.

#### 5.6.3.2 Effective Stress Analysis for Driven Soldier Beams

The ultimate axial load carrying capacity of driven piles in cohesionless soils or for effective stress analysis of drained loading conditions in cohesive soils is given by:

$$Q_{ult} = f_s A_s + q_t A_t \quad (\text{Equation 24})$$

where  $Q_{ult}$  is the ultimate pile capacity,  $f_s$  is the unit skin friction resistance,  $A_s$  is the perimeter of the of the pile,  $q_t$  is the unit end bearing resistance, and  $A_t$  is the enclosed cross section area of the “box” section. For piles founded on predominantly gravelly soils or rock, the actual steel area of the pile should be used for  $A_t$ . Standard SI units are:  $Q_{ult}$  (kN);  $f_s$  (kPa);  $q_t$  (kPa);  $A_s$  (m<sup>2</sup>); and  $A_t$  (m<sup>2</sup>).

The unit skin friction resistance,  $f_s$ , is calculated from the following expression:

$$f_s = \beta p_o \quad (\text{Equation 25})$$

where the beta coefficient,  $\beta = K_s \tan \delta$ ,  $p_o$  is the average vertical effective stress along the pile shaft,  $K_s$  is an earth pressure coefficient, and  $\delta$  is the interface friction angle between the pile and the soil. Standard SI units are:  $\beta$  (dimensionless);  $p_o$  (kPa);  $K_s$  (dimensionless); and  $\delta$  (degrees).

In equation 25,  $p_o$  is evaluated using elastic superposition of the vertical effective stress on both sides of the midpoint of the embedded portion of the soldier beam. For uniform soil deposits,  $p_o$  is computed as 0.5 times the height of excavation times the unit weight of the soil plus 0.5 times the embedded soldier beam length times the unit weight of the soil.

The unit end bearing resistance,  $q_t$ , may be calculated from the following expression:

$$q_t = N_t p_t \tag{Equation 26}$$

where  $N_t$  is the toe bearing coefficient and  $p_t$  is the vertical effective stress at the pile tip which is calculated based on the depth of the pile tip measured relative to the base of the excavation. Standard SI units are:  $N_t$  (dimensionless) and  $p_t$  (kPa).

Charts for estimating  $\beta$  and  $N_t$  based on the drained friction angle of the soil are provided in figures 44 and 45, respectively. The designer should, if possible, confirm the selection of  $\beta$  and  $N_t$  in a particular soil with local correlations between static capacity calculations and static load tests.

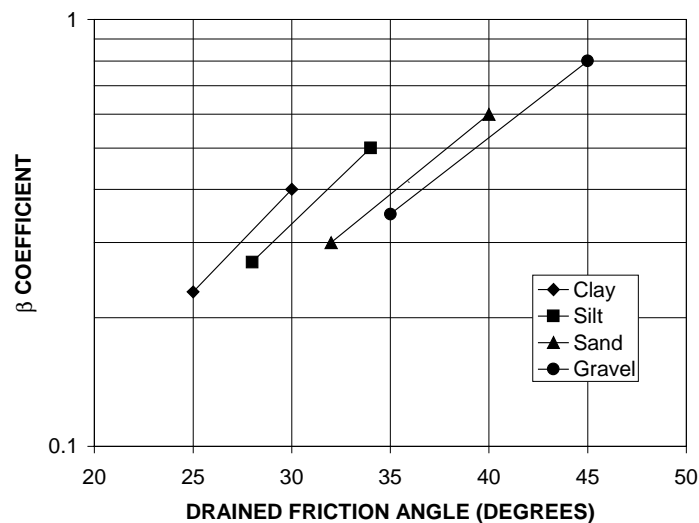

Figure 44. Chart for estimating  $\beta$  coefficient versus soil type friction angle (after Fellenius, 1991).



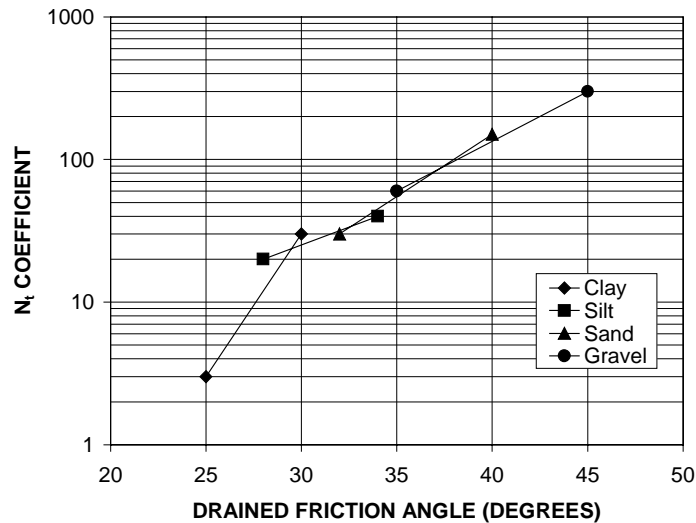

Figure 45. Chart for estimating  $N_t$  coefficient versus soil type friction angle (after Fellenius, 1991).

### 5.6.3.3 Total Stress Analysis for Driven Soldier Beams in Clays

For driven soldier beams in clay, a total stress analysis may be used where the ultimate capacity is calculated from the undrained shear strength of the clay. The unit shaft resistance,  $f_s$ , may be calculated from:

$$f_s = c_a = \alpha S_u \quad (\text{Equation 27})$$

where  $c_a$  is the adhesion between the pile and the soil at failure,  $\alpha$  is an empirical adhesion factor for reduction of the average undrained shear strength of the undisturbed clay along the embedded length of the pile. Figure 46 shows recommended adhesion values for cohesive soils. For driven H-piles, the appropriate corrugated steel pile curve should be used and applied over the “box” surface area of the pile.

The unit end bearing resistance in a total stress analysis for cohesive soil can be expressed as:

$$q_t = S_u N_c \quad (\text{Equation 28})$$

The term  $N_c$  is a dimensionless bearing capacity factor that depends on the pile diameter and the depth of embedment. The bearing capacity factor,  $N_c$ , should be taken as 9 in this total stress analysis for anchored wall applications.

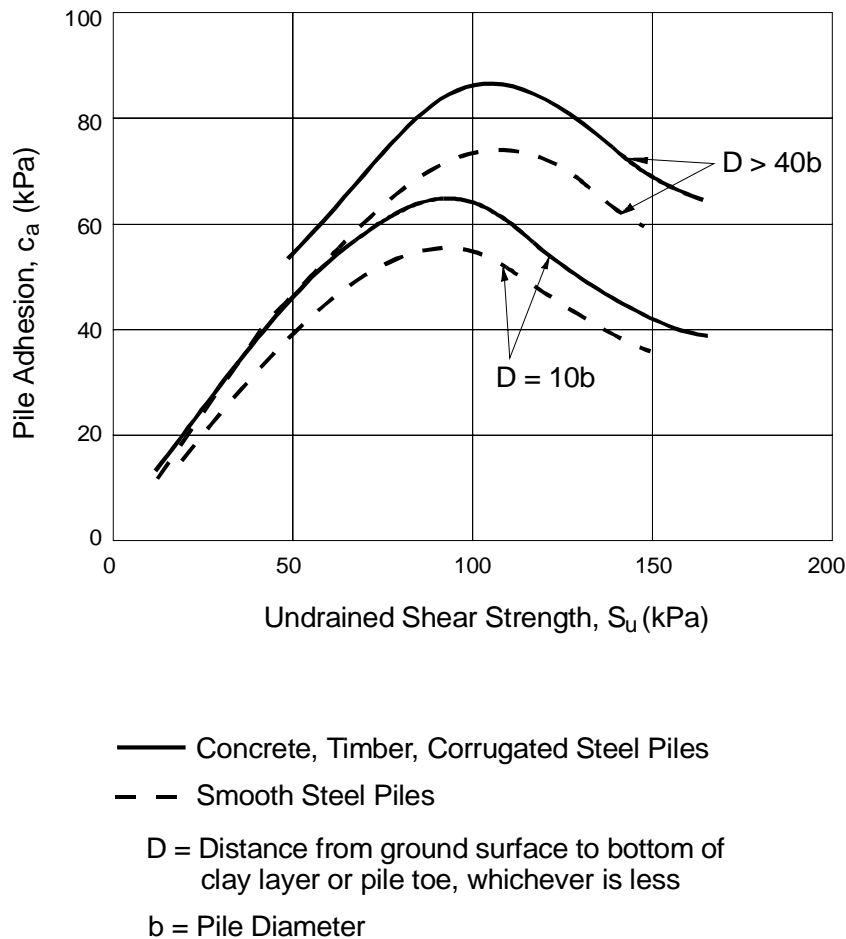

Figure 46. Adhesion values for piles in cohesive soils (after Tomlinson, 1980).

## 5.6.4 Axial Capacity Design Of Drilled-in Soldier Beams

### 5.6.4.1 General

The following guidance may be used to estimate axial capacity for drilled-in soldier beams in cohesionless or cohesive deposits. For more complex soil types (e.g., intermediate geomaterials) or rock, axial capacity should be computed from methods described in FHWA Report No. FHWA-SA-99-019 (1999).

### 5.6.4.2 Cohesionless Soils

The axial capacity of a drilled-in soldier beam in cohesionless soils may be calculated based on conventional design methods for drilled shafts. The ultimate axial capacity is given by equation 24 where  $A_s$  is the surface area of the drilled-in soldier beam and  $A_t$  is the cross section area of the drilled-in soldier beam.

The unit skin friction resistance is given by the following expression:

$$f_s = \beta p_o \quad (\text{Equation 29})$$

where:  $p_o$  = average vertical effective stress;

$\beta = 1.5 - 0.42z^{0.34}$ ,  $0.25 \leq \beta \leq 1.2$ , for sands with SPT  $N \geq 15$  blows/300 mm ( $z$  in meters);

$\beta = N/15 (1.5 - 0.42z^{0.34})$  for sands with SPT  $N < 15$  blows/300 mm; and

$\beta = 2.0 - 0.15z^{0.75}$  for gravelly soils.

The  $\beta$  factor in equation 29 is a factor used to account for the effects of lateral stress changes due to open hole drilling, introduction of fluid concrete, and interface friction between granular soil and concrete. In calculating the  $\beta$  factor,  $z$  is the depth measured from the top of the wall to the midpoint of the embedded soldier beam in the case of uniform soils. For uniform soil deposits,  $p_o$  is computed as 0.5 times the height of excavation times the unit weight of the soil plus 0.5 times the embedded soldier beam length times the unit weight of the soil. For cases where the soldier beam is embedded in a multiple soil layer system, the  $\beta$  factor should be evaluated at the midpoint of each layer.

The unit end bearing resistance,  $q_t$ , may be calculated as:

$$q_t \text{ (kPa)} = 57.5N \quad (\text{Equation 30})$$

where  $N$  is the uncorrected average SPT  $N$  value within two times the diameter of the base of the shaft. Values calculated according to equation 30 are ultimate values corresponding to drilled shaft settlements of approximately five percent of the base diameter.

#### 5.6.4.3 Cohesive Soils

For drilled-in soldier beams in clay, a total stress analysis is used to evaluate the ultimate axial capacity under undrained conditions. The unit skin friction is calculated as:

$$f_s = \alpha S_u \quad (\text{Equation 31})$$

where:  $\alpha = 0.29 + 0.19 S_u/p_o$ , and  $S_u$  = undrained shear strength determined from consolidated undrained triaxial tests.

The unit end bearing resistance is calculated as described below.

- Depth to Shaft Base ( $D$ )  $\geq 5B$

$$q_t = N_c^* S_u \quad (\text{Equation 32})$$

where  $D$  is the depth of embedment measured from the base of the excavation,  $B$  is the diameter of the shaft, and  $S_u$  is the undrained shear strength determined from unconsolidated undrained (UU) triaxial tests, and  $N_c^*$  is a bearing capacity factor (table 15).

Table 15. Bearing capacity factors for evaluation of end bearing in drilled shafts in clays.

$S_u$ (kPa)	$N_c^*$
24	6.5
48	8.0
96	8.7
>96	9.0

- Depth to Shaft Base (D) < 5B

$$q_t = [0.667 + 0.0667(D/B)] N_c^* S_u \quad (\text{Equation 33})$$

#### 5.6.4.4 Design Issues for Concrete Backfill of Pre drilled Soldier Beam Holes

General design recommendations for concrete backfill of pre drilled holes include the use of structural concrete from the bottom of the hole to the excavation base and lean-mix concrete for the remainder of the hole. The design concept is to provide maximum strength and load transfer in the permanently embedded portion of the soldier beam while providing a weak concrete fill in the upper portion which can easily be removed and shaped to allow lagging installation. However, contractors often propose to use lean-mix concrete backfill for the full depth of the hole to avoid the delays associated with providing two types of concrete in relatively small quantities.

When using structural concrete with a minimum compressive strength of 21 MPa and appropriate concrete placement procedures, the vertical load from the exposed portion of the wall is transferred from the steel beam to the concrete and that the entire drilled shaft cross section is effective in resisting the vertical load. For this case, the wall can be analyzed as a drilled shaft using the methods presented in section 5.6.4.2 and 5.6.4.3. However, for lean-mix backfilled drilled shafts, the lean-mix concrete may not be sufficiently strong to allow vertical load transfer from the soldier beam to the concrete. The soldier beam may “punch” through the lean-mix, in which case the drilled shaft cross section will not be effective in transferring load to the surrounding soil.

When designing the embedded portion of a permanent drilled-in soldier beam wall that is backfilled with lean-mix concrete, the following two analyses should be performed, and the analysis that results in the greater required embedment depth should be used:

Analysis 1: Compute the required embedment depth assuming the drilled-in soldier beam can be analyzed as a drilled shaft. Use the procedures described in section 5.6.4.2 and 5.6.4.3 and assume the full cross section of the shaft is effective in resisting vertical load.

Analysis 2: Compute the required embedment depth assuming that the soldier beam will “punch” through the lean-mix concrete. The analysis procedures for driven soldier beams (section 5.6.3.2 and 5.6.3.3) should be used as follows: (1) use equation 25 to evaluate skin friction resistance assuming that  $K_s = 2$ ,  $\delta = 35^\circ$ , and the “box” perimeter of the beam is used to evaluate  $A_s$ ; and (2) use equation 26 or 28, depending on the soil type at the bottom of the shaft, to evaluate end bearing resistance and use the “box” area of the beam.

## **5.7 ANCHORED SLOPES AND LANDSLIDE STABILIZATION SYSTEMS**

### **5.7.1 General**

Ground anchors may be used in combination with walls, horizontal beams, or anchor blocks to stabilize unstable slopes and landslides. Prestressed ground anchors act against the thrust of the potential slip surface and increase the normal stress on the potential slip surface. Both of these actions contribute to increase stability of the slopes. Also, by compressing the soil, softening processes that tend to weaken the soil with time are inhibited (Morgenstern, 1982). Issues related to structural and global stability analyses of anchored systems for slopes and landslides are presented herein.

Anchored slopes and landslide stabilization systems are designed to restrain forces associated with unstable ground masses. Restraint forces calculated based on the apparent earth pressure envelopes (section 5.2) may significantly underestimate the required restraint force necessary to stabilize an unstable slope or landslide to a particular target factor of safety. For this case, limit equilibrium analyses should be used to evaluate ground anchor and wall loads for anchored slopes and landslide stabilization systems. Details on the use of limit equilibrium analysis methods for modeling these anchored systems are discussed subsequently. Where failure surfaces are steep, however, calculated required restraint forces may be greater when apparent pressure diagrams are used as compared to limit equilibrium methods. For that case, design loadings should be based on apparent pressure diagrams.

### **5.7.2 Design Concepts**

The target slope stability factor of safety for slopes and landslide stabilization systems is typically 1.2 to 1.3. Higher values, although not common, may be required depending on the criticality of the structure, requirements with respect to deformation control, and confidence in the selected shear strength parameters. When analyzing slopes and landslides, the factor of safety should be calculated for all potential failure surfaces since several surfaces (both planar and circular) may have factors of safety less than the target value. Also, the stability of the downslope ground in front of the wall or slope face must be verified. If the downslope material is unstable, potential exists for downslope movements to occur resulting in a reduction in passive capacity of the soil in front of the wall.

Information on soil and bedrock hydraulic head (i.e., porewater pressures) is required for slope stability analyses of anchored systems. The available piezometer and hydraulic head data for each water-bearing zone should be evaluated, but note that these hydraulic heads are likely to change as a result of seasonal changes in precipitation and construction activities that change or interrupt water flow paths. For stability analyses, an envelope of maximum heads measured at different times of the year should be conservatively assumed.

The required restraint force that must be developed by the anchors and the wall will depend on the location of the wall relative to the sliding surface and the amount of material to be stabilized. Required restraint forces are relatively small for steeply inclined failure surfaces and relatively large for long, shallow failure surfaces because of the size of the mass requiring restraint. For very long, unstable slopes, multiple anchored walls along the slope may be more cost effective than one wall.

For anchored walls that are used to stabilize an unstable or moving slope, a minimum design consists of either one level of ground anchors and a wall that penetrates the critical failure surface or two levels of ground anchors and a wall that does not penetrate the failure surface. This minimum design ensures that there are at least two points of restraint at the wall location.

### 5.7.3 Limit Equilibrium Calculations

#### 5.7.3.1 Overall Approach

Slope stability computer programs that incorporate limit equilibrium methods of slices are routinely used for analyzing the stability of slopes and embankments. They may also be used to examine the stability of anchored walls, slopes, and landslide stabilization systems. However, the current state-of-the-practice does not include a generally accepted method of modeling the restraint force provided by the prestressed ground anchors. Methods used in practice distribute the anchor forces to slices in different ways and each slope stability computer program includes one or several of these methods. For this reason, caution should be exercised when using limit equilibrium methods to calculate required forces to restrain a slope. Calculated forces should be reviewed critically and compared to solutions based on simpler “hand-calculation” methods. A detailed discussion on the use of limit equilibrium methods for the analysis of anchored systems is provided in FHWA-RD-98-065 (1998). Two methods that may be used to model the ground anchor restraint forces are introduced below.

- *Method 1: Apply Surcharge or Concentrated Force to Wall or Slope Face:* If a surcharge or concentrated force equivalent to the total ground anchor restraint force is applied at the wall or slope face, a very large vertical force component will be transmitted to the slice base on which it acts. The calculated factor of safety for this slice will be unrealistically high. This method seems realistic in that the large compressive forces imposed by ground anchors are applied at the face. However, the large increase in vertical force to only one slice while nearby slices remain unaffected seems incorrect since ground anchors presumably increase the normal forces on the critical failure surface in a more widespread fashion.
- *Method 2: Apply Concentrated Force to Slice Base Where Failure Surface Crosses Anchor:* With this method, the normal stress on the slice where the failure surface and the anchor intersect is increased while nearby slices remain unaffected. This method is commonly used for modeling geosynthetic reinforcement. This method suffers from the same limitation as Method 1 in that the increase in normal force on the failure surface is highly localized.

For both of these methods, the increase in normal stress on the critical potential failure surface is highly localized and not likely to be consistent with the actual distribution of stresses imposed by the ground anchors. For a case where the failure plane is at a constant inclination and the soil strength along the failure plane is homogeneous, both of these methods provide similar results. For failure surfaces that are irregular and for highly stratified soils, it is likely that these two methods will result in different calculated factors of safety.

A reasonable approach to using limit equilibrium methods for evaluating anchored slopes and landslides is to perform an analysis using either Method 1 or Method 2 and to compare the calculated factor of safety for a given anchor restraint force from the analysis to the design target value (typically 1.3). Ideally, analyses using both methods should be performed and the results from each

compared to the design target factor of safety. If available, a slope stability computer program that has the capability to search for critical failure surfaces using a slice equilibrium method that satisfies both moment and force equilibrium should be used. If this feature is not available, the search for the critical failure surface may be performed using simpler force or moment equilibrium methods. Some programs may not offer the capability to use a method that satisfies both force and moment equilibrium to perform a *general* search for a critical potential failure surface, but does offer the capability to use a method that satisfies both force and moment equilibrium to calculate the factor of safety for a *specific* failure surface.

If the calculated factors of safety from one or both analyses exceed the target value, then the calculated anchor restraint force can be used for design. If the calculated factors of safety are less than the target value, then the anchor force can be increased until the target value is reached. The user should evaluate whether the calculated restraint force required to meet the target factor of safety is reasonable. If the calculated restraint force seems excessively large or small or if changes in analysis parameters (e.g., inclination of failure surface) result in very large variations in calculated factors of safety, then additional analyses should be performed.

Both of these methods for evaluating the total stabilizing load for an anchored wall or slope are described herein. The analyses should be performed for each critical design cross section. Noncircular (i.e., planar) failure surfaces should be used where the soils are predominantly cohesionless or where the failure surface is located along a well-defined interface. For analysis of temporary walls constructed in weak (i.e., soft to medium) cohesive soils, a circular failure surface should be used. Table 16 provides a general outline for performing the analysis.

Table 16. Procedure to evaluate total lateral earth load using slope stability computer programs.

Step 1.	Develop cross section geometry including subsurface stratigraphy, external surcharge loadings, and water pressures.
Step 2.	Assign shear strength and unit weight to each soil and/or rock layer.
Step 3.	Select limit equilibrium method that satisfies both force and moment equilibrium and appropriate critical surface search parameters.
Step 4.	Apply surcharge or concentrated force(s) to wall or slope face (Method 1) or model the ground anchors as reinforcements (Method 2). For vertical walls, model the wall face with a slight batter to avoid anomalous numerical instabilities.
Step 5.	Evaluate critical surface and factor of safety for the load applied in Step 4.
Step 6.	Repeat steps 4 and 5, increasing the surcharge or concentrated force(s) (Method 1) or reinforcement tension (Method 2), until the target factor of safety is obtained.

### 5.7.3.2 Method 1 Analysis

In using Method 1, the following cases are considered: Case 1 - the wall penetrates the potential critical failure surface; and Case 2 - the wall does not penetrate the potential critical failure surface. These cases are illustrated in figure 47. For Case 1, it is assumed that the vertical component of the anchor load is transmitted below the critical failure surface at the wall location, thus only the horizontal component of the ground anchor force is transmitted to the failure surface. The total surcharge load must be resisted by the ground anchors and the lateral capacity of the portion of the

wall that extends below the failure surface. A method to model the lateral capacity of the portion of the wall that extends below the failure surface is described in section 5.7.4. For Case 2, both the vertical and horizontal component of the anchor load are transmitted to the failure surface.

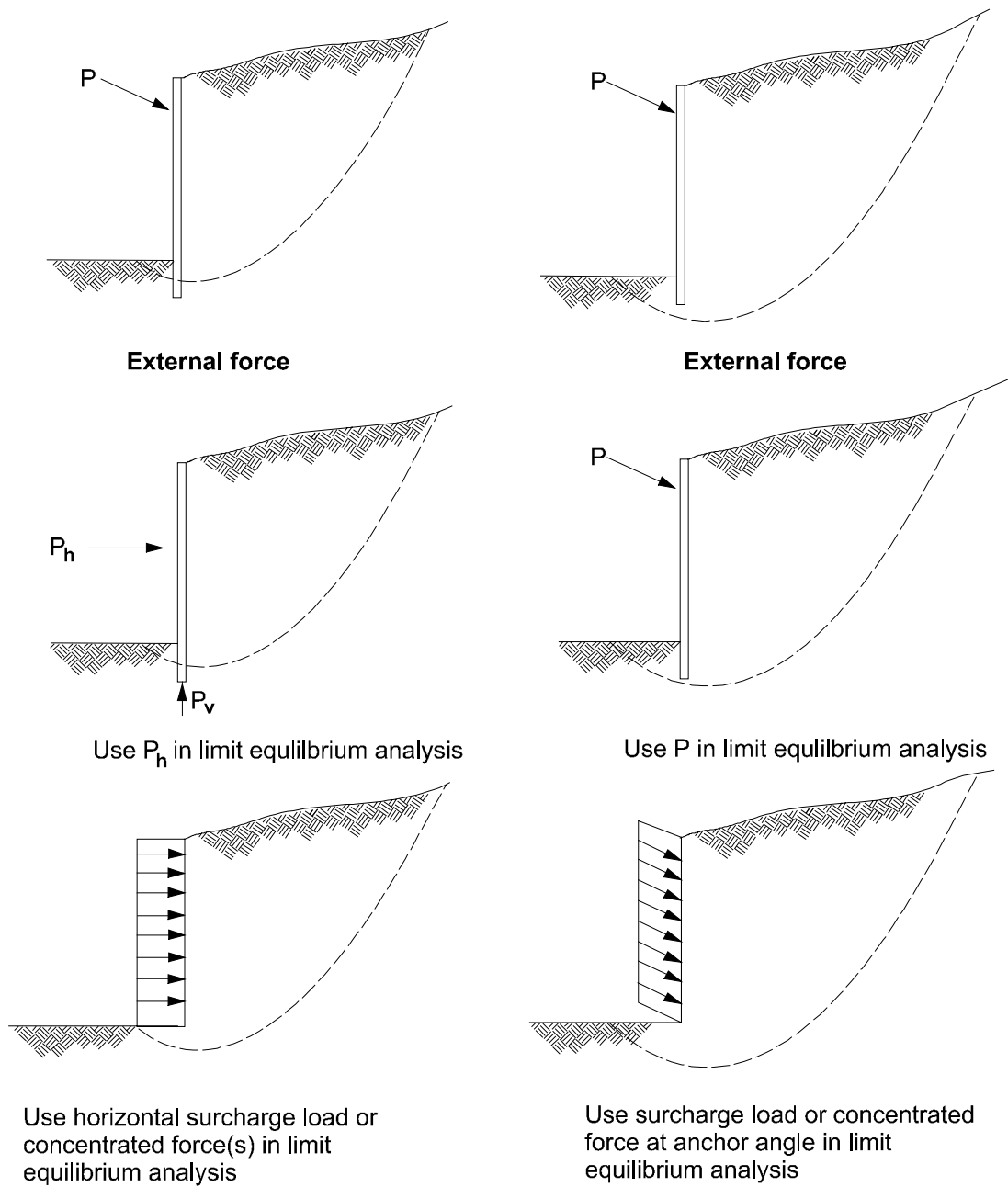

**Case 1:**  
Wall penetrates failure surface

**Case 2:**  
Wall does not penetrate failure surface

Figure 47. Modeling the ground anchor force in limit equilibrium analysis (after FHWA-RD-97-130, 1998).



For cases where homogeneous weak cohesive soil extends far below the base of the excavation (at least approximately 20 percent of the wall height), the potential critical failure surface may likely penetrate significantly below the bottom of the excavation. For these cases, relatively large loads will need to be resisted by the lower anchors. When modeling the ground anchor restraint force using Method 1 and the procedure outlined in table 16, the resultant of the surcharge or concentrated force(s) used to model the ground anchor restraint force should be located between  $0.3H$  and  $0.5H$  measured from the bottom of the excavation. A procedure for evaluating the total load required to stabilize a cut, for which the failure surface penetrates significantly below the wall, is described in table 17 and is illustrated on figure 48. With this procedure, the location of the resultant of the total load required to stabilize the system to the target factor of safety will get progressively lower in the wall as the failure surface penetrates deeper.

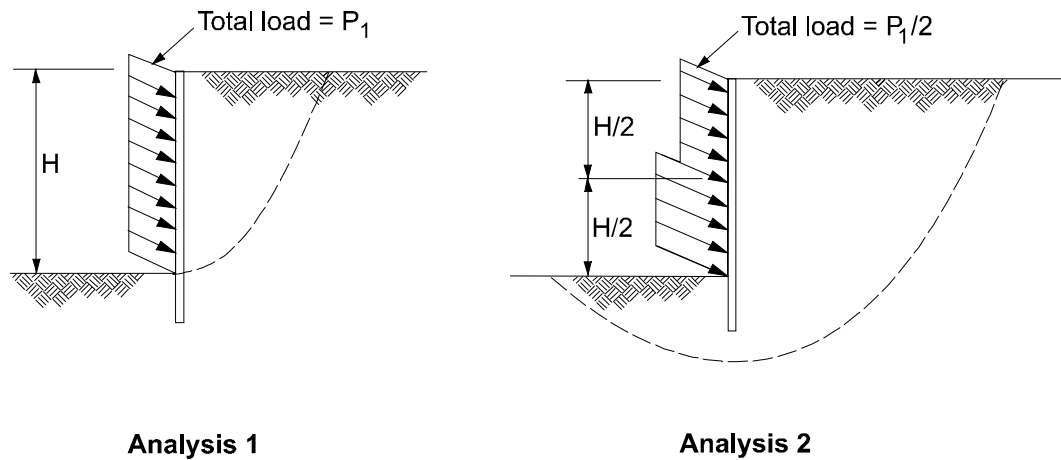

Figure 48. Limit equilibrium analyses used to evaluate total lateral earth load for anchored systems constructed in weak cohesive soils (after FHWA-RD-97-130, 1998).

### 5.7.3.3 Method 2 Analysis

With this method, the ground anchor is considered to be a high capacity reinforcement. The axial anchor force is modeled along the length of the anchor and the anchor bond zone. The axial force in the reinforcement is assumed to vary linearly from the full anchor capacity for all positions in front of the anchor bond zone, to zero force for the end of the ground anchor. This concept is similar to stability analyses involving soil nails as described in FHWA-DP-96-69R (1998). Multiple levels of anchors may be modeled, so the user should assume a reasonable layout of anchors and anchor inclinations in performing the analysis. If the failure surface crosses the wall, the additional restraint provided by the wall may be modeled (see section 5.7.4).

Table 17. Procedure to evaluate total lateral earth load for anchored systems constructed in weak cohesive soils.

Step 1.	Same as table 16.
Step 2.	Same as table 16.
Step 3.	Perform a limit equilibrium analysis wherein the failure surface intersects the bottom of the excavation. Use a slice equilibrium method that satisfies both force and moment equilibrium and assume a circular failure surface.
Step 4.	Apply surcharge or concentrated force(s) to wall or slope face to model the restraint force of the ground anchor(s). For vertical walls, model the wall face with a slight batter to avoid anomalous numerical instabilities.
Step 5.	Evaluate factor of safety for failure surface intersecting the bottom of the excavation for the load applied in Step 4.
Step 6.	Repeat steps 4 and 5, increasing the surcharge or concentrated force(s), until the target factor of safety is obtained.
Step 7.	Perform a second limit equilibrium analysis that searches for the most critical potential failure surface. Apply uniform surcharge or concentrated force(s) over upper half of wall or slope equivalent to one-half the total load calculated from Step 6. Apply uniform surcharge or concentrated force(s) over lower half of wall and increase this force until the target factor of safety is achieved for the critical potential failure surface.

#### 5.7.4 Modeling Lateral Wall Resistance in Limit Equilibrium Analyses

When the critical potential failure surface intersects the embedded portion of the wall, the additional resistance provided by the wall may be included in a limit equilibrium analysis. The resisting force to be used in the limit equilibrium analysis is the lesser of the following: (1) the shear capacity of the wall; or (2) the total passive force that may be developed in the soil over the length of the wall from the failure surface to the bottom of the wall. The shear capacity of the wall is constant and is assumed to be equal to the allowable shear capacity of the vertical wall element.

The methods presented in section 5.5 may be used to calculate the total passive force that may be developed over the length of the wall below the failure surface. Figure 49 shows the total passive force developed over a 6 m embedded portion of the example wall in cohesionless soil described in section 5.5.4.

The force to be modeled in the limit equilibrium analysis,  $F_p$ , may be modeled as a one-unit wide element with a cohesive strength equal to the minimum passive force as described above. For analyses involving soldier beam walls, this force should be reduced by the soldier beam spacing to provide the restraint force on a per unit basis for the limit equilibrium analysis.

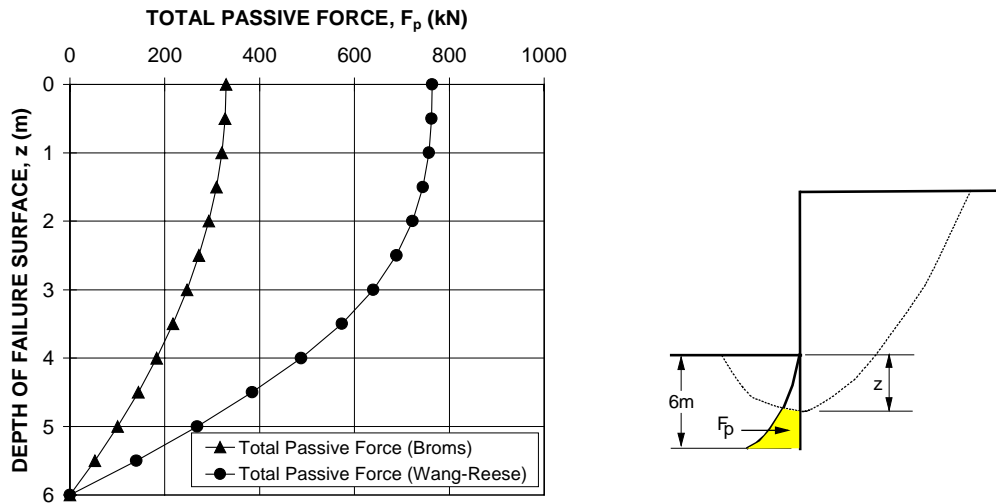

Figure 49. Total passive force for example wall in cohesionless soil.

### 5.7.5 Comparison of Methods to Evaluate Required Earth Load in Homogeneous Soils

This section provides comparisons between apparent earth pressure and limit equilibrium based calculations for evaluating required restraint forces in relatively homogeneous soils. These comparisons were performed for vertical walls with either planar or circular failure surfaces and where the soil strength properties ( $\phi'$  or  $S_u$ ) were constant for the entire profile analyzed.

#### *Cohesionless Soils*

Three methods have been described for evaluating the required total earth load,  $P_{REQ}$ , to stabilize a cut in cohesionless soils. For design of the wall, the ground anchors and the reaction force at the excavation subgrade carry this total earth load. In table 18, the normalized total earth load ( $K_{REQ} = P_{REQ}/\frac{1}{2}\gamma H^2$ ) required to stabilize a cut in cohesionless soil is compared for the following three methods: (1) apparent earth pressure envelope for sands; (2) sliding wedge analysis (section 5.2.8); and (3) limit equilibrium method (section 5.7.3). The apparent earth pressure envelope produces a total earth load equal to  $0.65K_A\gamma H^2$ , which is 1.3 times greater than that for active Rankine conditions. For the sliding wedge and limit equilibrium analysis, a factor of safety of 1.3 on the shear strength was used. For the limit equilibrium analysis, a uniform horizontal surcharge was applied to the wall face and increased until the target factor of safety was achieved (i.e., Method 1 from section 5.7.3).

The results indicate that all three methods give similar results, especially for higher strengths. When designing anchored walls in reasonably homogeneous cohesionless soils for which competent soils exist below the wall excavation, any of these methods will provide reasonable results, but using the apparent earth pressure envelope to calculate the required anchor loads is the most expedient.

Table 18. Values of  $K_{REQ}$  in cohesionless soil using various methods to evaluate earth pressures.

$\phi'$	Apparent Earth Pressure Envelope	Sliding Wedge	Limit Equilibrium	Percent Difference (%) <sup>(1)</sup>
25	0.53	0.58	0.59	10
30	0.43	0.46	0.46	7
35	0.35	0.38	0.37	7
40	0.28	0.31	0.29	8

Note: (1) Percent Difference = ((Maximum - Minimum)/Maximum) \*100

### *Cohesive Soils*

Limit equilibrium methods were also assessed for evaluating the total earth load for anchored systems in purely cohesive soils. For temporary anchored systems in soft to medium clays with  $N_s > 4$ , computed earth loads were compared using Henkel's method (equation 12), Rankine's method, and limit equilibrium solutions. These results are shown in figure 50. Limit equilibrium methods used include Bishop's method, Spencer's method, and the Corps of Engineer's method. Of these limit equilibrium methods, Spencer's method is the only one that satisfies both moment and force equilibrium. Results indicate that limit equilibrium methods compare favorably to Rankine analyses where the failure surface intersects the corner of the wall. When the failure surface extends below the excavation (e.g.,  $d/H = 0.2$  in figure 50), Henkel's method and Bishop's method are in reasonable agreement and are upper bounds. For cases where the critical potential failure surface extends below the base of the excavation and where  $N_s > 5$ , the Rankine analysis results are unconservative. For those cases, either Henkel's method or limit equilibrium analysis methods should be used to evaluate the total earth load. The total load should then be redistributed into an apparent pressure diagram using the Terzaghi and Peck diagram for soft to medium clays (figure 23c).

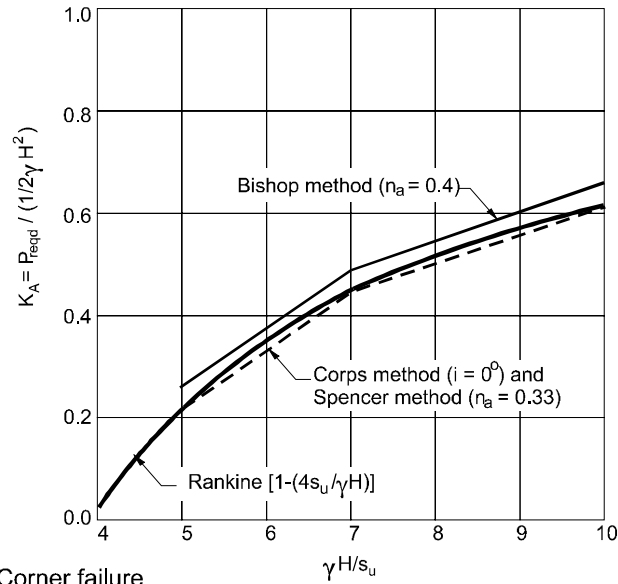

(a) Corner failure

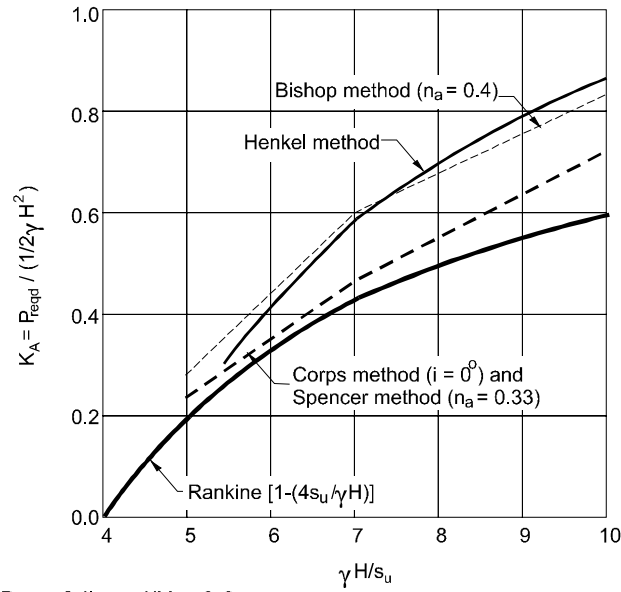

(b) Base failure d/H = 0.2

Figure 50. Comparison of limit equilibrium methods for cohesive soils (after FHWA-RD-98-065, 1998).

## 5.8 GROUND MASS STABILITY

### 5.8.1 Introduction

The stability analyses presented herein focus on whether the shear strength of the soil mass and the location and magnitude of the restraint forces provided by the ground anchors and other structural components are sufficient to provide an acceptable factor of safety with respect to several potential ground mass instabilities. Potential ground mass instabilities that should be analyzed include: (1) internal stability; (2) basal stability; and (3) external stability. Internal stability calculations are used to locate the anchor bond zone behind the critical potential failure surface and have been described in section 5.3.2.

### 5.8.2 Basal Stability

#### 5.8.2.1 General

The common failure modes with respect to basal stability include bottom heave at the base of excavations in cohesive soils and piping for excavations in cohesionless soils. Bottom heave occurs when the soils at the base of the excavation are relatively weak compared to the overburden stresses induced by the retained side of the excavation. Bottom heave may be a critical issue for temporary anchored systems constructed in soft to medium clays, but is not considered critical for other soil types. Piping occurs if there is sufficient water head to produce critical velocities at the base of the excavation. Piping is not discussed herein because, for most soldier beam and lagging walls, excessive water head is not a concern since the excavation typically takes place in the dry, or the ground-water table is lowered prior to the start of excavation.

#### 5.8.2.2 Evaluation of Bottom Heave Potential in Soft to Medium Clays

Significant basal heave and substantial increases in lateral earth pressures result when the weight of the retained soil exceeds or approaches the soil bearing capacity at the base of the excavation. Traditional methods for assessing the potential for bottom heave are based on the performance of braced excavations in soft to medium clays. These braced excavation analysis methods will likely produce conservative results for anchored walls as the mechanism of failure does not consider the shear resistance provided by the grouted anchor body. Figure 51 shows a cut in soft clay H deep and B wide. The block of retained soil exerts a vertical pressure  $q_{\text{applied}}$  on strip cd equal to its weight minus the shear resistance of the soil along plane bd. The bearing capacity of a cohesive soil is equal to  $N_c S_u$  where  $N_c$  is the bearing capacity factor. For cuts of infinite length, the factor of safety against basal heave can be estimated as the ratio of the bearing capacity to the bearing pressure as:

$$FS = \frac{N_c S_u}{H \left( \gamma - \frac{S_u}{B'} \right)} \quad (\text{Equation 34})$$

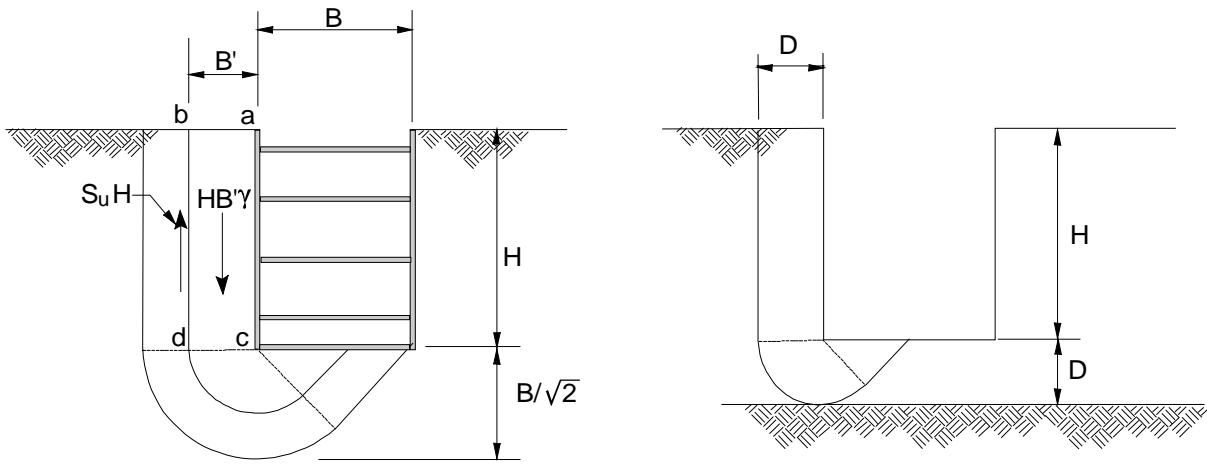

(a) Failure planes, deep deposits of weak clay

(b) Failure plane, stiff layer below bottom of excavation

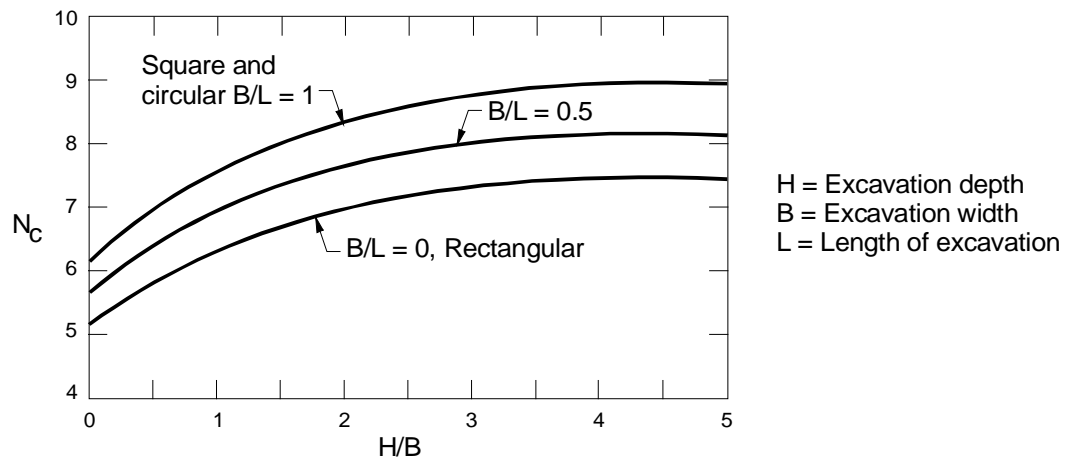

(c) Bearing Capacity Factor,  $N_c$

Figure 51. Analysis of basal stability (modified after Terzaghi et al., 1996, Soil Mechanics in Engineering Practice, Reprinted by permission of John Wiley & Sons, Inc.).

Based on the geometry of the failure surface,  $B'$  cannot exceed  $B\sqrt{2}$ . Thus, the minimum FS for equation 34 is:

$$FS = \frac{N_c S_u}{H \left( \gamma - \frac{S_u \sqrt{2}}{B} \right)} \quad \text{(Equation 35)}$$

The width,  $B'$ , is restricted if a stiff stratum is near the bottom of the cut (figure 51). For this case,  $B'$  is equal to depth  $D$ . Substituting  $D$  for  $B'$  in equation 34, results in:

$$FS = \frac{N_c S_u}{H \left( \gamma - \frac{S_u}{D} \right)} \quad (\text{Equation 36})$$

In relation to anchored wall designs in shallow deposits, equation 36 may be used. However in moderate to deep soil deposits where the width of the excavation is very large, the contribution of the shearing resistance along the exterior of the failure block is negligible and equations 34 and 35 reduce to:

$$FS = \frac{N_c}{\gamma H / S_u} = \frac{N_c}{N_s} \quad (\text{Equation 37})$$

where  $N_s$  is the stability number defined as  $\gamma H / S_u$ . The bearing capacity factor used in equation 37 is affected by the height/width ratio ( $H/B$ ), and the plan dimensions of the cut ( $B/L$ ). Values of the bearing capacity factor,  $N_c$ , proposed by Janbu et al. (1956) for analysis of footings may be used in equation 37 and these values are shown on figure 51. Note from figure 51 that  $N_c$  values are greater for excavations constructed in short lengths (e.g., slotted excavation) as compared to excavation of the entire length of the wall. Unless the designer specifically requires staged lengths of excavation, the design should be based on the assumption that the contractor will remove the entire length of each lift of excavation.

Significant ground movements towards the excavation will occur when the bearing capacity of the underlying soil is approached regardless of the strength of the supports. O'Rourke and O'Donnell (1997) concluded that for excavation width to height ratios ( $B/H$ ) between 0.5 and 4, factors of safety for deep rotational stability (i.e., external stability) are likely to be less than those calculated for basal heave. Current practice is to use a minimum factor of safety against basal heave of 2.5 for permanent facilities and 1.5 for support of excavation facilities. As the factor of safety decreases, loads on the lowest ground anchor increase. Factors of safety below these target values indicate that more rigorous procedures such as limit equilibrium methods or Henkel's method should be used to evaluate design earth pressure loadings.

### 5.8.3 External Stability

#### 5.8.3.1 Introduction

Conventional limit equilibrium methods for slope stability can be used to evaluate the external stability of an anchored system. An anchored system is externally stable if potential slip surfaces passing behind or through the anchors have a factor of safety that exceeds the target factor of safety. External stability analyses are particularly important in evaluating systems close to nearby structures or for situations in which soft soil exists below the wall.

For temporary SOE anchored systems constructed in soft to medium clay soils, external stability should be evaluated using short-term (i.e., undrained) strength parameters and temporary loading conditions. For permanent anchored systems constructed in soils, external stability for both short-term and long-term conditions should be checked. For systems constructed in stiff clays, external stability for short-term conditions may not be critical, but long-term conditions, using drained shear strength parameters, may be critical. Selection of shear strength parameters has been discussed in



chapter 4. External stability of walls supported by rock anchors is normally adequate; however, if the rock mass has planes of weakness which are oriented in a direction that may affect stability, external stability should be checked for failure surfaces passing along these weak planes.

A minimum acceptable factor of safety for external stability is 1.3. For permanent applications that are critical, a higher factor of safety (e.g., 1.5) may be used.

### 5.8.3.2 Evaluation of External Stability Using Limit Equilibrium

To evaluate the external stability of an anchored system, potential failure surfaces passing behind or through the anchors need to be checked. For walls with multiple levels of anchors, failure surfaces should be checked that pass just behind each anchor (figure 52). In checking a failure surface that passes behind a level of anchors, the failure surface may cross in front of or through the anchor bond zone of another level(s) of anchors. In this case, the analysis may be amended to include a portion of the restraint force from the other anchor(s). If the failure surface passes in front of an anchor, the full design load can be modeled as a restraint force. If the failure surface crosses the anchor, a proportional magnitude of load assuming that anchor bond stress is distributed uniformly over the anchor bond length can be modeled. Where external stability requirements cannot be met, the anchors may be lengthened or methods to improve anchor bond or load transfer mechanisms may be used.

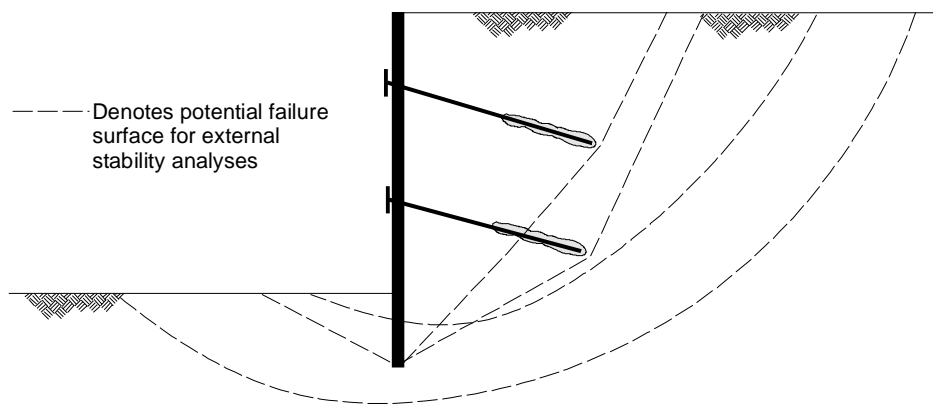

Figure 52. Failure surfaces for external stability evaluations.

## 5.9 TIEDOWN DESIGN

### 5.9.1 Introduction

Tiedowns refer to vertical or downward inclined ground anchors subjected to uplift forces. Examples of tiedowns include foundation elements for structures subject to overturning or uplift such as transmission towers and vertical anchors used to resist hydrostatic uplift forces in gravity dams and underwater slabs. Tiedowns are designed to resist two possible failure mechanisms: (1) individual anchor capacity to resist uplift pressures; and (2) overall stability of the ground mass wherein the tiedown group geometry is sufficient to envelope a mass of ground to resist uplift forces. The following information is presented in this section: (1) evaluation of overall ground mass stability for individual and groups of rock and soil tiedown anchors; and (2) design of tiedown anchors for slabs subjected to hydrostatic loads.

### 5.9.2 Uplift Capacity of Rock Tiedown Anchors

The potential failure mechanisms commonly considered for designing rock tiedown anchors include: (1) overall rock mass stability where an inverted cone or wedge of rock is engaged (i.e., cone breakout in figure 53); (2) failure in shear along the grout/rock interface; and (3) failure in shear along the tendon/grout interface.

The uplift capacity of a rock tiedown anchor depends on the relative depth of the anchor bond zone, defined as  $h/D$ , where  $h$  is the depth of the top of the anchor bond zone and  $D$  is the diameter of the anchor. For values of  $h/D > 15$ , the dominant failure mechanism in rock is failure at the grout/rock interface. Test results indicate that, more specifically, failure occurs at the rock/grout interface in weak rocks such as mudstones and shales whereas failure occurs at the tendon/grout interface in strong rocks. For shallow anchors in weak mudstones, a combination of interface shear at the rock/grout interface and cone breakout may occur.

For relatively deep anchors in weak rocks or where interface shear along the rock/grout interface dominates, the uplift capacity of the rock tiedown anchor may be evaluated according to the methods described in section 5.3.6.

For shallow anchors or where overall rock mass stability dominates, the uplift capacity of a rock tiedown anchor is typically assumed to be equivalent to the effective weight of a cone- or wedge-shaped failure mechanism as shown in figure 53a. In the analysis, the shear strength of the rock mass is often ignored. If the weight of the rock within the contained cone is greater than the design ground anchor load, the anchor is considered safe since rock shear strength has been ignored. Designers commonly assume that the apex of the failure mechanism is located at the top, midpoint, or bottom of the anchor bond zone and the included angle of the mechanism ranges from 60 to 90 degrees. The recommendations shown in figure 53a should be used in the absence of model or full-scale load test results. For cases where soil overburden is above the rock anchoring strata, the failure mechanism is assumed to be cylindrical in shape above the rock/soil interface. For anchors with overlapping cones, the stability of the ground is analyzed as shown in figure 53b. The overlapping of the zones of influence between adjacent anchors results in anchor uplift capacity less than that for a single anchor.

A wide range of factors of safety with respect to overall rock mass stability may be calculated based on the assumed geometry of the failure mechanism. Factors of safety for design with respect to overall rock mass stability are typically 2 to 3 (British Standards Institution BS8081, 1989). This factor of safety may be reduced owing to the conservative assumption that the shear strength of the rock is neglected in the analysis, particularly for competent rocks that are not highly fissured. However, in highly fissured or loose rock strata, an increase in the factor of safety may be required.

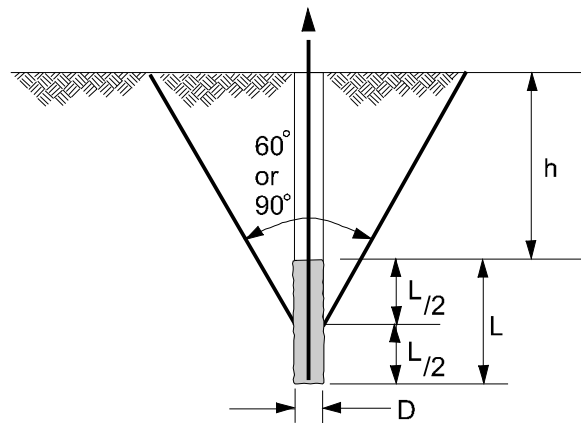

(a) Geometry of cone

Note:

60° used when rock mass is soft, heavily fissured or weathered

90° used in all other rock conditions

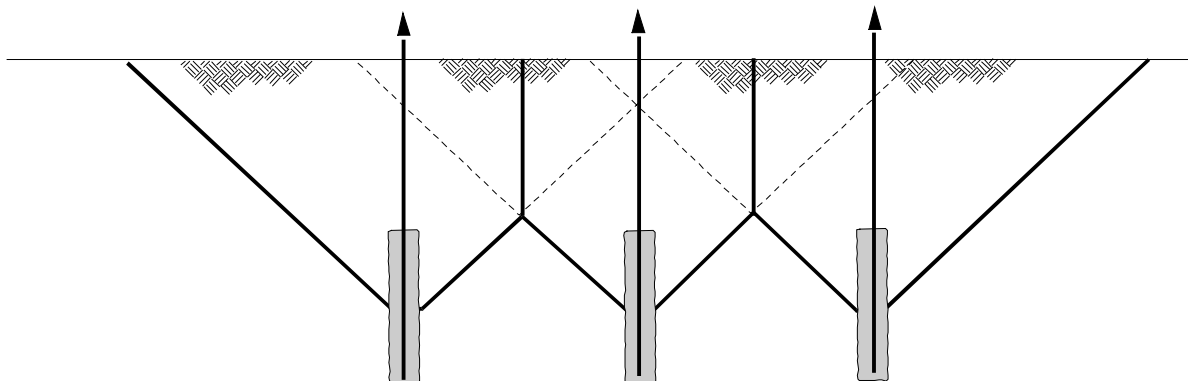

(b) Interaction of cones for overall stability analysis

Figure 53. Inverted cone mechanisms for overall rock mass stability.

### 5.9.3 Uplift Capacity of Soil Tiedown Anchors

For tiedown anchors installed in soils, the failure mechanisms of cone breakout and interface shear along the soil/grout interface are analyzed. Like rock anchors, the cone breakout mechanism dominates for shallow anchors whereas interface shear dominates for relatively deep anchors. A grouted soil anchor subjected to uplift behaves similarly to a small diameter drilled shaft subjected to uplift.

Soil anchors typically used to resist uplift are relatively deep (i.e.,  $h/D$  is relatively large) so that the governing failure mechanism is the mobilization of grout/ground interface shear resistance. Uplift resistance may be calculated as:

$$Q_u = Q_{tu} + Q_{su} \quad \text{(Equation 38)}$$

where:  $Q_u$  is the uplift capacity,  $Q_{tu}$  is the tip resistance, and  $Q_{su}$  is the side resistance. Tip resistance that may develop from suction is commonly assumed to be zero for drained (long-term) uplift capacity of drilled-in elements. Therefore, the uplift capacity of a grouted soil anchor primarily results from interface skin resistance between the grout and the ground. Uplift capacity may be evaluated using the procedures described in section 5.3.6 for soil anchors or may be calculated according to (Kulhawy, 1985):

$$Q_{su} = \pi D \frac{K}{K_o} \sum_{i=1}^N (\sigma'_v)_i (K_o)_i \tan[\phi_i (\delta/\phi)_i] \Delta z_i \quad \text{(Equation 39)}$$

where:  $\Delta z_i$  = thickness of layer  $i$ ,  $D$  = anchor diameter, and  $K/K_o$  = stress modification factor to adjust for construction influences. The remaining parameters are evaluated at the mid-depth of each layer:  $\sigma'_v$  = vertical effective stress,  $\delta$  = effective stress angle of friction for the shear surface interface,  $K_o$  = in-situ horizontal stress coefficient, and  $\phi$  = effective stress friction angle for the soil. The anchor depth and perimeter terms are computed simply from the anchor geometry, while the vertical effective stresses are computed from the effective soil unit weight.

For soil anchors,  $\delta/\phi$  may be assumed equal to 1. For gravity anchors, the in situ value of  $K_o$  may be modified based on anchor installation effects with typical values of  $K/K_o$  ranging from 2/3 to 1.  $K/K_o$  values of 1 may be used for relatively dry installations with minimal drill hole disturbance. For anchors installed under water or where very loose or running sands are encountered and significant hole disturbance occurs,  $K/K_o$  values less than 2/3 may be appropriate.

For low pressure (i.e., grouting pressures less than 1 MPa) grouted anchors and gravity-grouted anchors, no increase in  $K$  above the at-rest,  $K_o$ , value is warranted. For high pressure grouted anchors, however, an increase in  $K$  is appropriate. The guidelines presented in table 19 are recommended for use. Owing to the numerous factors that influence the  $K$  value including grout pressure, construction method, and soil type, it is recommended that load tests be carried out to confirm design values.

Table 19. Horizontal stress coefficient,  $K$ , for pressure grouted anchors (after Kulhawy et al., 1983).

Soil	Density		
	Loose	Compact	Dense
Silt	1	4	10
Fine Sand	1.5	6	15
Medium Sand	5	12	20
Coarse Sand, Gravel	10	20	30

### 5.9.4 Design of Tiedown Anchors to Resist Hydrostatic Uplift

Tiedowns may be used to provide resistance to uplift forces caused by hydrostatic pressures. A notable use of tiedown anchors in the U.S. was to resist hydrostatic uplift of a depressed roadway section as part of the Boston Central Artery project (see Druss, 1994). The primary issues related to the use of anchors for such tiedown applications are: (1) general stability of the enclosed ground mass; (2) changes in anchor loads resulting from movement (i.e., surface heave, consolidation settlements, creep deformations) in the enclosed ground mass; and (3) corrosion protection and watertightness of the ground anchor. Corrosion protection and water tightness are discussed in chapter 6.

General stability of a structure subjected to uplift is shown in figure 54. The system is in equilibrium when  $U=W_1+W_2$ , where  $W_1$  and  $W_2$  are total weights of the structure and the enclosed ground, respectively, and  $U$  is the total uplift resulting from the uplift pressure  $\gamma_w h$ . The geometry of the soil mass assumed to be mobilized at failure may be evaluated as shown in figure 54. Frictional resistance that may develop between the ground and the sidewalls of the structure may be conservatively neglected.

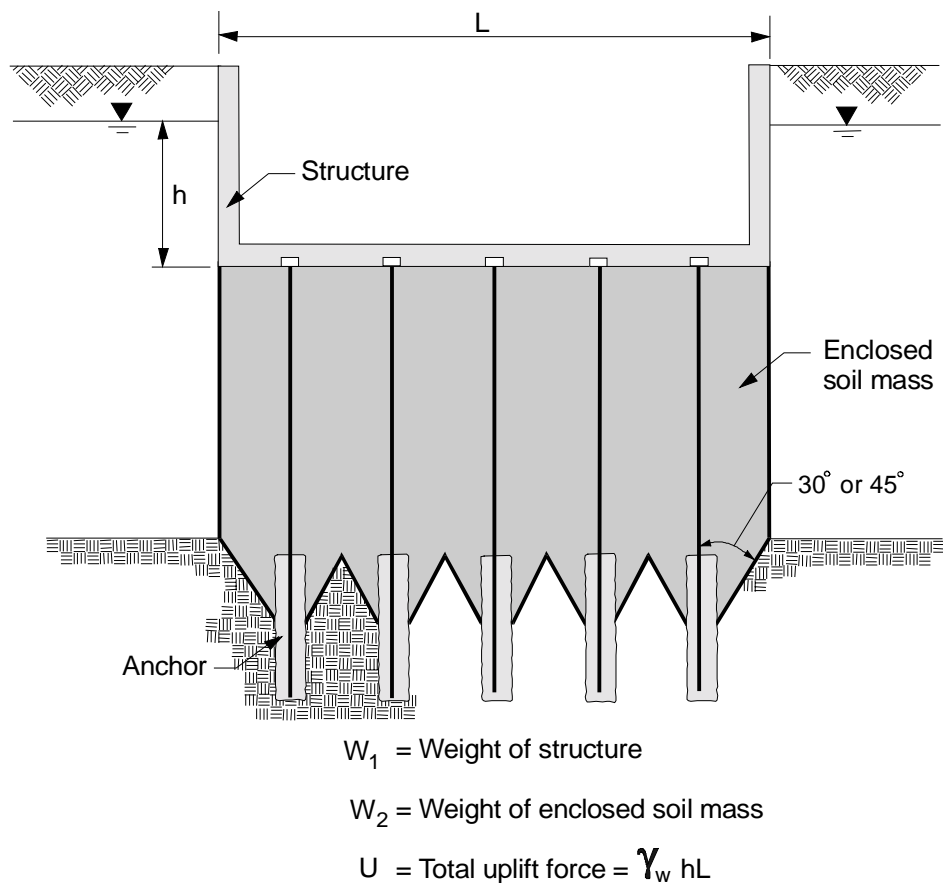

Figure 54. Stability of structure to hydrostatic uplift.

For conditions where the uplift structure is founded on relatively compressible ground, movements associated with construction activities, fluctuations in groundwater levels, consolidation of the soil,

and soil creep may induce significant changes in ground anchor loads during the service life of the structure. These movements are assumed to cause cycles of tensioning and detensioning in the ground anchor tendon. If the tendon may be subjected to additional tensioning after lock-off, it is important that the size of the prestressing steel be based on the maximum load that the anchor will be subjected to during the service life.

## **5.10 SEISMIC DESIGN**

### **5.10.1 Introduction**

Few observations of the seismic performance of anchored walls have been made. Those observations that are available indicate overall good performance of anchored wall systems subject to strong ground motions in earthquakes. Most of the retaining wall failures reported during recent earthquakes have occurred along quay wall gravity retaining wall systems and have been associated with liquefaction of the backfill or the foundation soils. Following the Whittier, California earthquake of 1987, Ho, et al. (1990) conducted a survey of the response of ten anchored walls in the Los Angeles area. Only one of the ten anchored walls was designed to withstand seismic forces and the authors concluded that the anchored walls examined performed very well and experienced little to no loss of integrity due to the earthquake. The same conclusion was drawn following a survey of the performance of anchored walls conducted following the 1994 Northridge earthquake (Ho, personal communication, 1998).

Two modes of earthquake-induced failure for anchored walls are considered for design: internal failure and external failure. Internal failure is characterized by failure of an element of the wall system such as the tendons, ground anchors, or wall itself. External failure is characterized by a global failure of the wall similar to that which occurs in many slope stability problems, with the failure surface passing beyond the end of the anchors and below the toe of the wall.

To assess the internal and external seismic stability of an anchored wall, the effect of seismic loading on the active and passive earth pressures, the resulting loads on the anchors, and force equilibrium of potential sliding (or rotating) masses must be evaluated. The seismic loading on anchored walls is most commonly evaluated using pseudo-static analysis, as described subsequently. Information presented herein has been excerpted from FHWA Report No. FHWA-SA-97-076 (FHWA, 1997), hereafter referred to as GEC No. 3. GEC No. 3 should be consulted for additional information on seismic site characterization and design.

### **5.10.2 Internal Stability Using Pseudo-Static Theory**

#### **5.10.2.1 Lateral Earth Pressure**

The most commonly used method for seismic design of retaining structures is the pseudo-static method developed by Okabe (1926) and Mononobe (1929). The so-called Mononobe-Okabe method is based on Coulomb earth pressure theory. In developing their method, Mononobe and Okabe assumed the following:

- the wall is free to move sufficiently to induce active earth pressure conditions;

- the backfill is completely drained and cohesionless; and
- the effect of the earthquake ground motion is represented by a horizontal pseudo-static inertia force,  $k_h W_s$  and a vertical pseudo-static inertia force  $k_v W_s$  if the vertical force acts upward, or  $-k_v W_s$ , if the vertical force acts downward.

In figure 55,  $W_s$  is the weight of the sliding wedge and  $k_h$  and  $k_v$  are the horizontal and vertical seismic coefficients, respectively. The seismic coefficient  $k_h$  and  $k_v$  are expressed as a fraction of the acceleration of gravity  $g$ .

Using Mononobe-Okabe theory, the dynamic earth pressures in the active ( $P_{AE}$ ) and passive ( $P_{PE}$ ) state are given by the following:

$$P_{AE} = \frac{1}{2} K_{AE} \gamma H^2 (1 - k_v) \quad (\text{Equation 40})$$

$$P_{PE} = \frac{1}{2} K_{PE} \gamma H^2 (1 - k_v) \quad (\text{Equation 41})$$

$$K_{AE} = \frac{\cos^2(\phi - \theta - \beta)}{\cos \theta \cos^2 \beta \cos(\beta + \delta + \theta) D} \quad (\text{Equation 42})$$

$$D = \left[ 1 + \left[ \frac{\sin(\phi + \delta) \sin(\phi - \theta - i)}{\cos(\delta + \beta + \theta) \cos(i - \beta)} \right]^{\frac{1}{2}} \right]^2 \quad (\text{Equation 43})$$

$$K_{PE} = \frac{\cos^2(\phi - \theta + \beta)}{\cos \theta \cos^2 \beta \cos(\delta - \beta + \theta) D'} \quad (\text{Equation 44})$$

$$D' = \left[ 1 + \left[ \frac{\sin(\phi + \delta) \sin(\phi + i - \theta)}{\cos(\delta - \beta + \theta) \cos(i - \beta)} \right]^{\frac{1}{2}} \right]^2 \quad (\text{Equation 45})$$

$$\theta = \tan^{-1} (k_h / (1 - k_v)) \quad (\text{Equation 46})$$

where:  $\gamma$  = effective unit weight of the backfill;  
 $H$  = height of the wall;  
 $\phi$  = angle of internal friction of the backfill;  
 $\delta$  = angle of friction of the wall/backfill interface;  
 $i$  = slope of the surface of the backfill;  
 $\beta$  = slope of the back of the wall;  
 $k_h$  = horizontal seismic coefficient expressed as a fraction of  $g$ ;  
 $k_v$  = vertical seismic coefficient expressed as a fraction of  $g$ ; and  
 $g$  = acceleration of gravity.

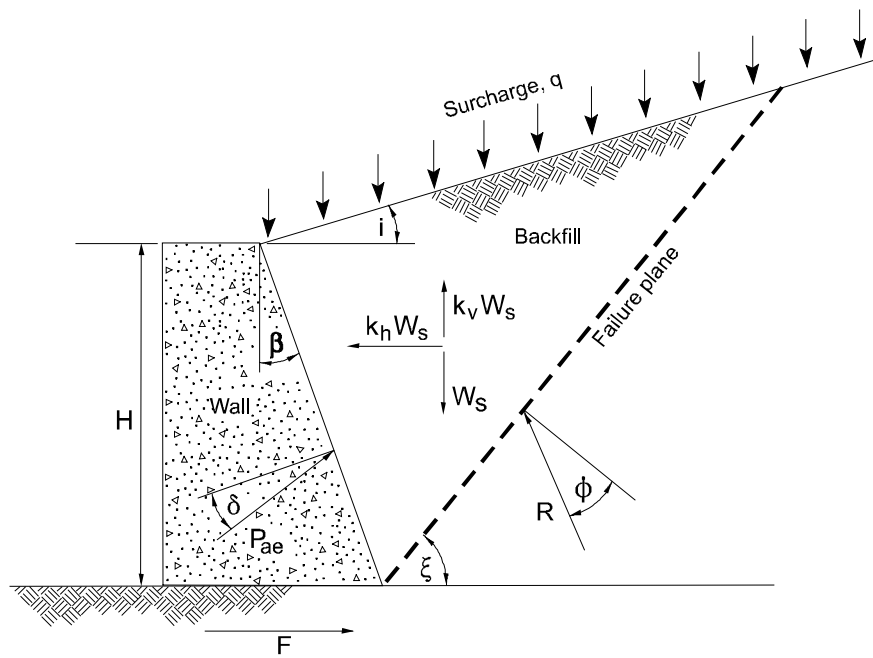

Figure 55. Forces behind a gravity wall.

Figure 56 presents values for  $K_{AE}$  for values of  $\phi$  from 20 to 45 degrees for vertical walls with level backfill. The figure was derived for a wall/backfill interface friction angle set to  $\phi/2$ . The horizontal and vertical seismic coefficients (i.e.,  $k_h$  and  $k_v$ ) vary from 0 to 0.5 and from 0 to 0.2, respectively. The major challenges in applying the Mononobe-Okabe theory are the selection of an appropriate seismic coefficient to determine the magnitude of the seismic earth pressure and the distribution of earth pressure or location of the seismic earth pressure resultant. As noted in GEC No. 3, use of a seismic coefficient from between one-half to two-thirds of the peak horizontal ground acceleration divided by gravity would appear to provide a wall design that will limit deformations in the design earthquake to small values acceptable for highway facilities. Similar to slope stability analyses, the vertical acceleration is usually ignored in practice in the design of anchored structures. Vertical motions are not considered capable of applying significant loads to the anchors.

The total seismic active earth pressure may be assumed to be uniformly distributed over the height of the wall, meaning that the earth pressure resultant acts at the mid-height of the wall. Therefore, place the resultant active earth pressure calculated using the Mononobe-Okabe equations at mid-height of wall for design analysis. The resultant passive pressure at the toe of the wall should also be placed at mid-height of the embedded section.



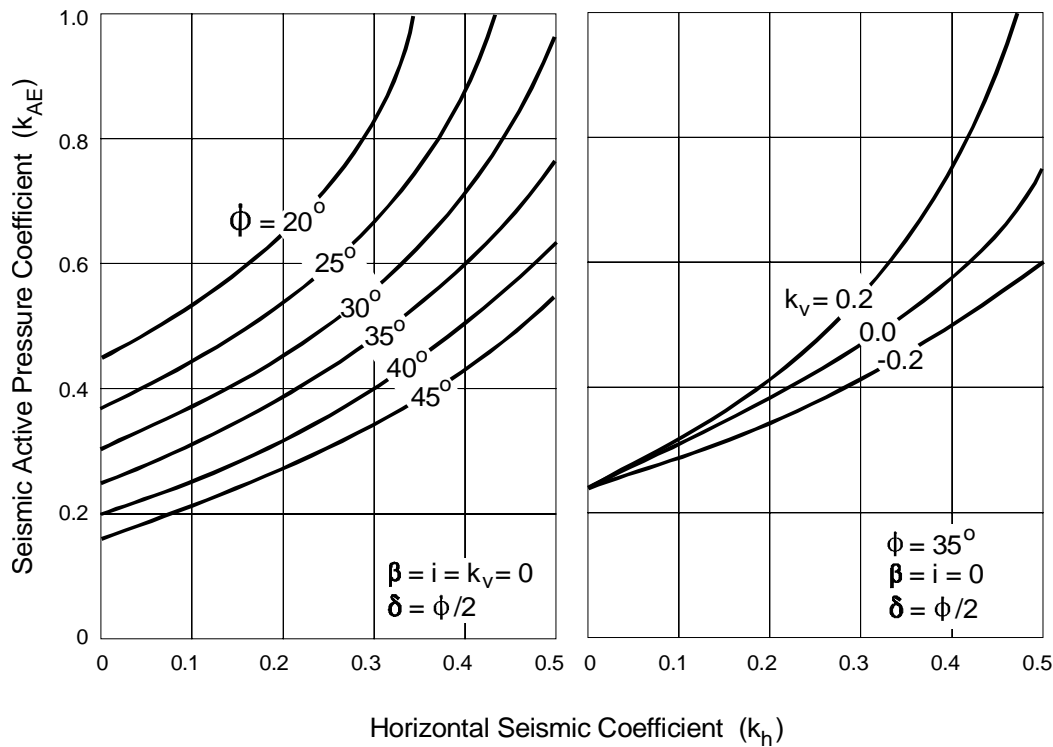

Figure 56. Effects of seismic coefficients and friction angle on seismic active pressure coefficient (after Lam and Martin, 1986).

### 5.10.2.2 Wall Design Considerations

Design of brittle elements of the system, (e.g., the grout/tendon bond (see section 4.2.2)) should be governed by the peak force. Therefore, the peak ground acceleration (PGA), adjusted to account for the effect of local soil conditions and the geometry of the wall, should be used with the Mononobe-Okabe equation to calculate these peak forces. A factor of safety of 1.1 on these elements is recommended for brittle failure modes.

Design of ductile elements (e.g., tendons, steel sheet pile and soldier beam walls, and sometimes the grout/ground bond (this bond may also be brittle, depending on soil type)) should be governed by cumulative permanent seismic deformation. In these cases, in lieu of a formal seismic deformation analysis, a pseudo-static analysis with resultant forces calculated by the Mononobe-Okabe equation using  $k_h$  equal to 0.5 times the PGA should be appropriate. This recommendation is based upon the results of numerous Newmark seismic deformation analyses for translational failures of slopes which indicate the cumulative permanent seismic deformation for a system with a yield acceleration equal to half the PGA is relatively small (e.g., no more than several centimeters) for earthquakes of all magnitudes. A factor of safety of 1.1 on these elements is recommended for ductile failures.

Values of the PGA used in design should consider both the effect of local soil conditions and the geometry of the wall. The free field PGA, including the effect of local soil conditions, may be assumed to act at the base of the wall. The PGA at the top of the wall should be evaluated from the free field PGA by considering the potential for amplification of the free field PGA by wall geometry. The PGA used in the Mononobe-Okabe equation may then be assumed to be the average of the PGA at the top and bottom of the wall.

### 5.10.2.3 Liquefaction

Where economically feasible, potentially liquefiable soils behind or in front of an anchored wall should be stabilized to mitigate the potential for liquefaction. Stabilization techniques that may be employed for potentially liquefiable soils include densification, either prior to wall construction (for foundation soils) or during or after backfill placement and penetration grouting. If potentially liquefiable soil cannot be stabilized, it should be assumed to exert an equivalent fluid pressure on the wall based upon the saturated unit weight of the soil. The anchor bond zone should not be formed in liquefiable soil.

## 5.10.3 External Stability

### 5.10.3.1 Pseudo-Static Analysis

The external stability of an anchored wall is evaluated by performing pseudo-static limit equilibrium stability analysis of the wall system. The failure surfaces analyzed should pass behind the back of the ground anchors and beneath the toe of the wall. The pseudo-static analysis will provide the location of the critical failure surface or surfaces. The location of critical failure surface may be used to verify the length of the proposed ground anchor. The anchor bond zone should be located outside of the active Mononobe-Okabe wedge of soil. As the acceleration increases, the slope of the active failure wedge flattens according to the following equation:

$$\rho_A = (\phi - \theta) + \tan^{-1} \left( \frac{\{\tan(\tan a + \cot b)[1 + \tan(\delta + \beta + \theta) \cot b]\}^{1/2} - \tan a}{1 + \tan(\delta + \beta + \theta)(\tan a + \cot b)} \right) \quad (\text{Equation 47})$$

where  $\rho_A$  is the inclination with respect to the horizontal of the failure surface;  $a = \phi - i - \theta$ ;  $b = \phi - \beta - \theta$ ; and  $\theta$ ,  $i$ ,  $\phi$ , and  $\beta$  were defined previously.

As the slope flattens, the Mononobe-Okabe failure surface extends farther in the horizontal direction. Figure 57 shows the variation of  $\rho_A$  and the coefficient of dynamic active and passive earth pressure as a function of the horizontal seismic coefficient  $k_h$ . Because of the extension of the Mononobe-Okabe failure surface, the length of the ground anchors calculated in static design may need to be increased to provide full anchorage of the ground anchors under seismic conditions.

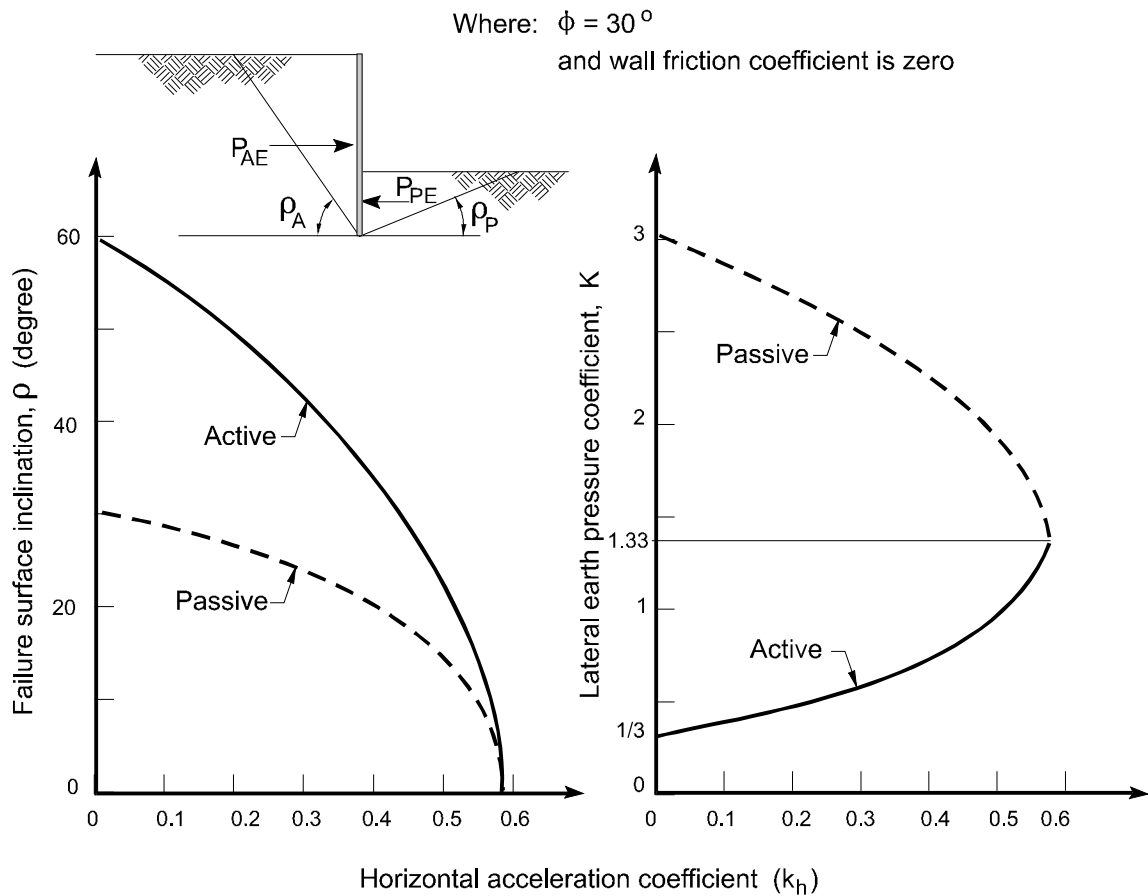

Figure 57. Variation of failure surface inclination with horizontal acceleration coefficient.

AASHTO (1996) recommends using a seismic coefficient  $k_h$  equal to  $0.5A$  in pseudo-static external stability analysis, where  $A$  is the PGA obtained from the seismic risk map published in AASHTO Specifications. This value corresponds to an acceleration with a 10 percent probability of exceedance in 50 years. A minimum factor of safety of 1.1 is recommended for the pseudo-static external stability analysis.

### 5.10.3.2 Seismic Deformation Analysis

As an alternative to the pseudo-static design approach, external stability may be assessed using a Newmark type seismic deformation analysis. In this approach, a pseudo-static external stability analysis is carried out to evaluate the yield acceleration,  $k_y$ , for failure surfaces passing behind the back of the ground anchors. The yield acceleration is defined as the smallest horizontal acceleration (seismic coefficient) that will reduce the factor of safety obtained in a pseudo static stability analysis to 1.0. The ratio of the yield acceleration to the PGA can then be used to evaluate the earthquake induced permanent displacement either by using design charts such as those presented in figure 58 or by performing a formal Newmark analysis (FHWA-SA-97-076, 1997). The free field PGA should be used in the analysis. The free field PGA considers the influence of local site conditions while the PGA at top of the wall may be amplified. The free field PGA should be more representative of the

average value of ground acceleration throughout the height of the excavation than the amplified PGA.

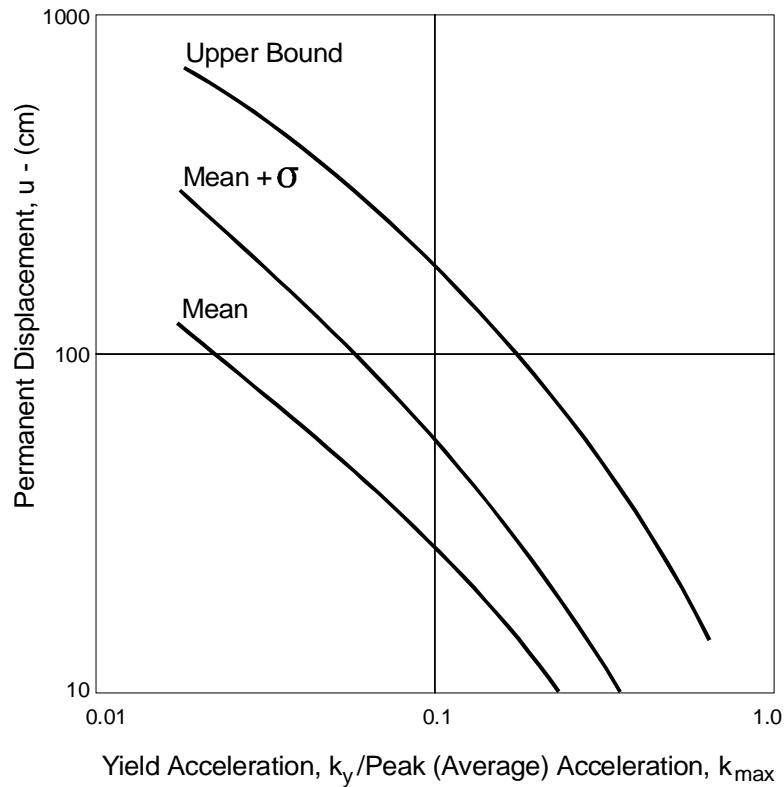

Figure 58. Permanent seismic deformation chart (after Hynes and Franklin, 1984).

## 5.11 OTHER DESIGN ISSUES

### 5.11.1 Wall and Ground Movements

Depending on project constraints, requirements with respect to control of wall and ground movements will vary. For example, permanent anchored walls constructed in granular soils with no nearby structures pose little concern with respect to movements. Wall and ground movements, however, may be the primary design issue for a temporary excavation support system located in a major urban area. Estimates of wall and ground movements are typically made using semi-empirical relationships developed from past performance data.

Maximum lateral wall movements for anchored walls constructed in sands and stiff clays average approximately 0.2%H with a maximum of approximately 0.5%H where H is the height of the wall. Maximum vertical settlements behind a wall constructed in these materials average approximately 0.15%H with a maximum of approximately 0.5%H.

To evaluate the settlement profile behind an anchored wall, the curves shown on figure 59 may be used. Curves I and II are commonly used for permanent anchored walls. Settlements increase rapidly for walls constructed in soft to medium clays where basal stability is marginal.

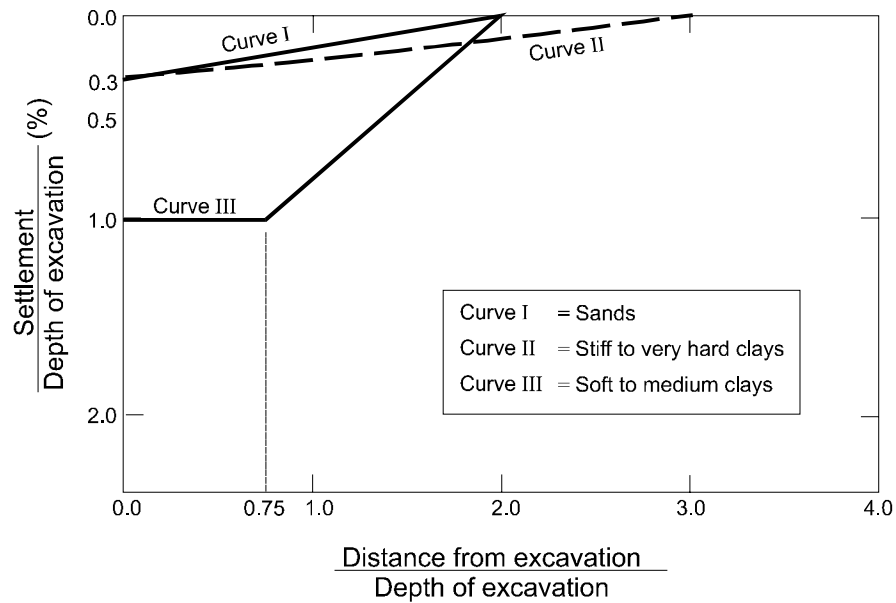

Figure 59. Settlement profile behind braced and anchored walls.

Several types of movement are associated with flexible anchored walls. These include: (1) cantilever movements associated with installation of first anchor; (2) wall settlement associated with mobilization of end bearing; (3) elastic elongation of the anchor tendon associated with a load increase; (4) anchor yielding or load redistribution in the anchor bond zone; and (5) mass movements behind the ground anchors. The last three components of deformation result in translation of the wall and are relatively small for anchored walls constructed in competent soils. Excessive vertical settlements of the wall may induce significant lateral wall movements in addition to causing high stresses at the wall/anchor interface. Wall settlements may be minimized by installing ground anchors at flat angles and by designing the embedded portion of the wall to carry applied axial loads.

### 5.11.2 Drainage Systems for Anchored Walls and Slopes

For anchored wall systems with a cast-in place (CIP) concrete wall facing, collection of subsurface flow is usually achieved with prefabricated drainage elements placed between the wall and the lagging. Full length elements are usually attached to the timber lagging after the design final excavation grade is reached. Single strips can be placed at designed horizontal spacings along the wall. Where shotcrete is used in lieu of timber lagging, special considerations are required to insure drainage behind the shotcrete. Typically, prefabricated vertical drains are installed in segments against the soil face with spikes. The segments are spliced by shingling the next segment over the previously placed length after each lift is complete. An overlap length of one strip width is adequate.

Where precast concrete facings are used, the space between the temporary wall face and the permanent facing may be backfilled with gravel. The gravel backfill acts as drainage element. Water intercepted in a drainage element flows downward to the base of the wall where it is removed by collector pipes or conveyed through the permanent facing in longitudinal/outlet pipes or weepholes.

In applications where subsurface flow rates are large, horizontal drains may be used to remove water from behind the wall. A horizontal drain is a small diameter perforated pipe that is advanced into a

nearly horizontal drill hole in an existing slope. For example, an anchored wall constructed on or at the base of a steep slope will likely interfere with pre-existing natural drainage paths. This interference may cause hydrostatic pressures resulting from trapped water to build-up against the wall. To relieve these pressures, horizontal drains can be installed at appropriate vertical and horizontal spacing along the wall alignment. Horizontal drains extend back from the wall face a sufficient distance to intercept subsurface flow beyond the critical potential failure surface. Several factors related to the construction of horizontal drains have limited their use for anchored system applications. These factors are described below.

- Horizontal drains should not be installed until the final excavated grade is reached unless a perched water table exists above the final excavated grade. This higher drain installation may result in water flowing into the excavation during construction.
- The alignment of the drains must be carefully controlled to avoid interference with the ground anchors. Splaying of multiple drains from a single entry point is not recommended.
- Horizontal drains usually cannot achieve lowering of the water to a finished road grade as the lowest elevation at the wall or slope face is controlled by construction equipment height and the drains are sloped upward.
- Special designs are required to collect the effluent from the drains to preserve aesthetics of the wall face.

Surface drainage for anchored walls is usually achieved by directing water away from the wall face either by grading or by collecting and transporting surface water in ditches or pipes. To minimize surface water that can enter the excavation during construction and weaken the soils inside the excavation, dikes can be constructed on the ground surface near the top of the wall or the vertical wall element can be extended above the ground surface grade.

### **5.11.3 Wall System Appurtenances**

Pre-existing and proposed appurtenances may have a significant effect on design, construction, and cost of an anchored system and should therefore be identified during the early stages of project implementation. Examples of appurtenances for wall systems associated with highway applications include: (1) pre-existing and proposed facilities such as underground utilities and drainage systems; (2) traffic barriers and parapet walls; and (3) noise walls.

As part of a site investigation, all pre-existing and proposed facilities that might affect wall system design and construction need to be identified and located. Underground utilities such as telephone cables and gas and water lines located in close proximity to the proposed wall system alignment may become overly stressed and damaged as a result of abrupt changes in vertical and horizontal deformation of the wall system. In such cases, it may be necessary to relocate the utilities or incorporate protective measures during construction, either of which will increase overall construction time and wall system cost. The location of underground utilities will influence the inclination and spacing of anchors, and therefore the overall design and sequence of construction.

Earth pressures resulting from dead weight and impact loads from traffic barriers and parapet walls must be accounted for in the design of a wall system. Loading requirements are provided in

AASHTO (1996). Noise walls are often incorporated into earth retaining system designs for urban areas. The foundation of a noise wall is designed to resist lateral forces resulting from wind loads. Noise walls may be integrally cast to anchored walls or they may be designed with a foundation that is independent of the anchored wall.

#### 5.11.4 Resisting the Upper Anchor Test Load

When the ground behind the upper portion of the wall is disturbed or the ground anchor load is high, the soldier beam may deflect excessively during testing of the upper ground anchor. To resist the applied test load, the ground behind the soldier beam must develop sufficient passive resistance. For all wall designs, the passive capacity of the ground at the location of the uppermost anchor must be checked.

The passive capacity of the soldier beam required to resist the test load applied to the upper ground anchor may be calculated using equation 48 (FHWA-RD-97-103, 1998). For this calculation, it is assumed that the passive resistance,  $F_p$ , will be developed over a depth of 1.5 times the distance to the upper ground anchor.

$$F_p = 1.125K_p\gamma h_1^2s \quad (\text{Equation 48})$$

In equation 48,  $K_p$  is determined using either figure 16 or 17, and  $h_1$  is the depth to the upper ground anchor. In using equation 48, a factor of safety of 1.5 is applied to the maximum capacity to obtain the allowable resistance. The allowable resistance should be greater than the upper ground anchor test load.

#### 5.11.5 Anchored Walls for Fill Applications

Anchored walls for highway applications are most often constructed from the top of the wall to the base of the excavation (i.e., top-down construction). Anchored walls have been constructed in fill situations from the base of the excavation to the top of the wall (i.e., bottom-up construction). This construction method only has application in rehabilitating existing walls. Examples of wall rehabilitation with anchors are shown in FHWA-DP-90-068-003 (1990). New construction of walls in fill is usually accomplished by employing mechanically stabilized earth techniques. Significant differences exist with respect to the design, construction, and anchor load testing for an anchored wall built from the bottom-up as compared to a wall built from the top-down. This section highlights several of these differences.

The sequence of construction for a fill anchored wall with, for example, two levels of ground anchors, can be described as follows:

- Install the soldier beams or, in the case of most wall repairs, determine if the existing wall can sustain the concentrated anchor load.
- Backfill behind the wall and place lagging as required concurrently up to approximately the midheight between the bottom level anchors and the top level anchors.
- Install the bottom level of anchors.

- Stress the bottom level ground anchors to a load that will not result in significant inward wall movement. This load may be less than the design lock-off load.
- Backfill behind the wall and place lagging as required concurrently up to a minimum of 1 m above the level of the top anchors.
- Restress the bottom level anchors to the designed lock-off load.
- Install and temporarily stress the top level ground anchors.
- Backfill and place lagging up to finished grade.
- Restress the top level ground anchors to the designed lock-off load.

When constructing fill anchored walls, use select backfill material to permit compaction at low energies to specified density requirements. Small compaction equipment should be used to avoid damaging the tendons. If the wall backfill settles significantly as a result of poor backfill material or compaction, the anchors will be subjected to bending forces at the anchor/soldier beam connection. Anchors are not designed to carry significant bending forces.

Design loadings for fill anchored walls are based on earth pressures acting on the wall when the wall is completely backfilled and all surcharge loadings are applied. During initial anchor installation, the backfill may not reach the necessary height to permit the anchors to be load tested to 133 percent of the design load at this stage. Typically, the anchors will be stressed to a small nominal load and temporarily locked-off to remove slack from the anchors. As additional increments of backfill are placed, the loads in the lower anchors will likely increase above the small nominal lock-off load and the wall will deflect outward unless restressing is performed. After the backfill has been placed to finished grade, the anchors may be able to be load tested to 133 percent of the design load if sufficient passive resistance is available and if the wall face can sustain the test load.

With this type of incremental backfilling and staged load testing, the ground anchors will typically be designed to carry actual earth pressure loads as compared to loads from apparent earth pressure envelopes as may be used for anchored systems constructed from the top-down. The pattern of wall movement for a fill anchored wall is consistent with theoretical earth pressure envelopes.

Standard anchor testing may not be possible in the case of wall rehabilitation. In that case, it is necessary to move to an area on the site and install preproduction anchors through ground similar to that for the production anchors. These anchors should be subjected to performance test requirements and then loaded to 200 percent of production anchor design loads. If these preproduction anchors pass acceptability criteria, then it is concluded that the production anchors for the fill wall would pass acceptability criteria at 133 percent of the design load.



## CHAPTER 6

### CORROSION CONSIDERATIONS IN DESIGN

#### 6.1 INTRODUCTION

Protecting the metallic components of the tendon against the detrimental effects of corrosion is necessary to assure adequate long-term durability of the ground anchor. Corrosion protection for ground anchor tendons includes either one or more physical barrier layers which protect the tendon from the corrosive environment. The barrier layers include anchorage covers, corrosion inhibiting compounds, sheaths, encapsulations, epoxy coatings, and grouts. The selection of the physical barrier depends on the design life of the structure (i.e., temporary or permanent), aggressivity of the ground environment, the consequences of failure of the anchored system, and the additional cost of providing a higher level of protection.

#### 6.2 CORROSION AND EFFECTS ON GROUND ANCHORS

##### 6.2.1 Mechanism of Metallic Corrosion

Corrosion is an electrochemical reaction involving a base metal, oxygen, and water in which the metal returns to its natural oxidized state. In the context of a ground anchor, corrosion is most common on steel tendons that are improperly stored at a construction site. Less common are reactions that occur with galvanic corrosion in which, for an electrolytic ground environment, metal is lost with the flow of current from one location on the prestressing steel to another location, or to a nearby metal object. These may occur between: (1) nearby locations on the surface of the prestressing steel; (2) locations on the prestressing steel and a nearby metal object; and (3) locations on the prestressing steel in aerated soils (e.g., soils above the groundwater table and in fill and sands) and in nonaerated soils (e.g., soils below the groundwater table and in clays). Corrosion can occur when significant variations exist in the ground along the ground anchor length, particularly with variations in pH and resistivity. The potential for excessive loss of metal by corrosion in soil is high in the following environments: (1) soil near the groundwater table; (2) soil exhibiting low pH; (3) soils with high concentrations of aggressive ions such as chlorides or sulfides; and (4) sites where stray currents are present.

##### 6.2.2 Types of Corrosion for Prestressing Steel

Corrosion of prestressing steel may be classified according to the following six major types: (1) general corrosion; (2) localized corrosion; (3) stress corrosion/hydrogen embrittlement; (4) fatigue corrosion; (5) stray current corrosion; and (6) bacterial attack. Corrosion of unprotected prestressing steel usually initiates during storage with general corrosion. General corrosion causes an insignificant amount of metal loss. However, general corrosion may lead to localized or stress corrosion/hydrogen embrittlement which are the major causes of documented ground anchor failures (FIP, 1986). The last three types of corrosion need only be considered under special loading or ground conditions.

General corrosion occurs as a thin layer of rust uniformly distributed on the bare surface of unprotected prestressing steel. This type of corrosion is often observed on bare prestressing steel left exposed to weather during on-site storage. Where exposure times are limited or adequate protection is provided, general corrosion usually involves only negligible loss of metal. In general, a light surface coating of rust is not considered detrimental to the tendon. The inspector can easily determine if the surface rust can be removed by wiping the rust from a short section and examining the exposed steel area for pits or cracks. Lightly rusted tendons can be inserted into the drill hole without rust removal.

Localized corrosion occurs as pitting or crevices at one or more locations on the unprotected prestressing steel. In very aggressive ground conditions, unprotected prestressing steel may become severely pitted after only a few weeks of exposure. Complete encapsulation of the tendon is required in aggressive soils to prevent localized corrosion.

Stress corrosion/hydrogen embrittlement occurs as cracks in steel at pit locations and is of particular concern for high strength steels used to manufacture prestressing elements. As stress corrosion progresses, tensile stresses present in the steel become highly concentrated. This stress concentration may cause a crack to develop. This crack may advance into the uncorroded metal at the bottom of a pit. With time, cracks may propagate into the metal to a sufficient depth to result in rupturing of the prestressing element. Pits or cracks on the tendon surface are adequate reason for rejection of the tendon.

Fatigue corrosion develops under cyclic loading as a progression of corrosion from its initiation to a cracking of a prestressing element. This type of corrosion is relatively uncommon in prestressing steel as most ground anchors are not subject to severe cyclic loading.

Stray current corrosion occurs as pitting of prestressing steel when subject to prolonged exposure to stray electrical currents. Stray currents in the ground result from the discharge of direct electrical current from power sources such as electric rail systems, electrical transmission systems, and welding operations and is particularly damaging in the marine environment. Power sources beyond a distance of 30 to 60 m from a ground anchor are believed to not cause a significant amount of stray current corrosion (FHWA-SA-96-072, 1995). Protection of anchors from stray currents commonly involves complete electrical isolation of the prestressing steel from the ground environment with a nonconducting barrier such as plastic.

Bacterial attack occurs as pitting of unprotected prestressing steel. The potential for bacterial attack should be considered in marshy ground and sulfate bearing clay soils located below the ground water table. Such ground conditions are considered aggressive and therefore, encapsulated tendons should be used in these types of ground. Field and laboratory tests used to evaluate the presence of sulfates and sulfides are listed in section 3.4.5.

A detailed discussion of the effects of corrosion of prestressing steel is provided in FHWA-RD-82-047 (1982).

## **6.3 CORROSION PROTECTION OF GROUND ANCHORS**

### **6.3.1 Requirements of Corrosion Protection Systems**

Corrosion protection systems (protection systems) protect the ground anchor from corrosion by providing one or more impervious physical barrier layers around the tendon. Protection systems should satisfy the following criteria:

- ensure that the service life of the anchor with respect to corrosion failure is at least equal to the anticipated service life of the anchored system;
- produce no adverse impacts on the environment or reduce the capacity of the anchor;
- allow unrestricted movement of the tendon along the unbonded length such that all load is transferred to the bond length;
- comprise materials that are chemically stable and nonreactive with adjacent materials;
- require no maintenance or replacement (with few exceptions) during the service life of the anchor;
- be sufficiently strong and flexible to withstand deformations that occur during stressing of the tendon; and
- be durable enough to withstand handling without damage during manufacture, transport, storage, and installation.

The NCHRP Project 24-13 “Evaluation of Metal Tensioned Systems in Geotechnical Applications” is in progress and is expected to be complete in 2001. Information from this project will include methods to evaluate the aggressivity of the ground, evaluation of the remaining service life of an in-place system, and estimation of the design life of a new installation.

### **6.3.2 Design of Corrosion Protection Systems**

#### **6.3.2.1 General**

The design of corrosion protection systems is performed to protect the steel components of the ground anchor. The three major parts of the tendon include: (1) the anchorage; (2) the unbonded length; and (3) the bond length. The corrosion protection system consists of components that combine to provide an unbroken barrier for each part of the tendon and the transitions between them. Steel components of the anchor include the anchor head, bearing plate, trumpet, prestressing steel, and couplers (where used). Components of the corrosion protection system include: (1) for the anchorage, a cover or concrete embedment, a trumpet, and corrosion inhibiting compounds or grout; (2) for the unbonded length, grout and a sheath filled with a corrosion inhibiting compound or grout; and (3) for the bond length, grout and encapsulations with centralizers and/or epoxy coatings. These components are shown for bar and strand tendons in figures 60 to 62 and brief descriptions of these components are provided below. Requirements for installation of the components of the corrosion protection system are in this section.

- Anchorage covers: Anchorage covers protect the anchor head and the exposed prestressing steel from corrosion and physical damage and are fabricated from steel or plastic.
- Trumpet: The trumpet protects the back of the bearing plate and prestressing steel in the transition from the anchorage to the unbonded length and is fabricated from steel or PVC pipe.
- Corrosion inhibiting compounds: These compounds protect steel components of the anchorage and unbonded length, are nonhardening, and include greases and waxes.
- Grout: Grout protects the prestressing steel in the unbonded and bond lengths and may either be cement-based or polyester resin. Polyester resin grout is not generally considered to provide a corrosion protection layer, as gaps in the resin coverage will leave the prestressing steel unprotected. Grouts are also used to fill sheaths, encapsulations, covers, and trumpets.
- Sheaths: Sheaths are smooth or corrugated plastic tube, smooth pipe, or extruded tubing used to protect the prestressing steel in the unbonded length. Individual strand sheaths commonly contain corrosion inhibiting compound and are either pulled-on or extruded. A tendon sheath covers all prestressing elements and is commonly pulled-on and filled with grout. Smooth sheaths can function as a bondbreaker, however corrugated sheaths require a separate bondbreaker.
- Heat shrinkable sleeves: These sleeves are mainly used to protect couplers that connect lengths of prestressing bar and as sheaths for bar tendons.
- Encapsulations: Encapsulations are corrugated or deformed pipe or tube that protect the prestressing steel in the bond length.
- Centralizers: Centralizers are commonly made from steel or plastic and are used to support the tendon in the drill hole or within an encapsulation so that a minimum grout cover is provided around the tendon.

Three levels of minimum corrosion protection are commonly specified in U.S. practice for ground anchors. In order of descending levels of protection these are: (1) Class I protection; (2) Class II protection; and (3) no protection (see table 20). For the anchorage and unbonded length, Class I and II protection assume that aggressive ground conditions exist and require that multiple barrier layers be provided for the tendon. For the bond length, Class I protection assumes that aggressive conditions exist and also provides multiple barrier layers whereas for Class II only one barrier layer is provided. Class I and Class II protected tendons are also referred to as encapsulated tendons and grout-protected tendons, respectively. No protection against corrosion is required in ground known to be nonaggressive for anchors used for temporary support of excavation applications. The impact of aggressive ground conditions on unprotected metallic elements can be evaluated using information from FHWA-SA-96-072 (1996). A decision tree that may be used to select an appropriate level of corrosion protection consistent with project-specific constraints is described in section 6.4.

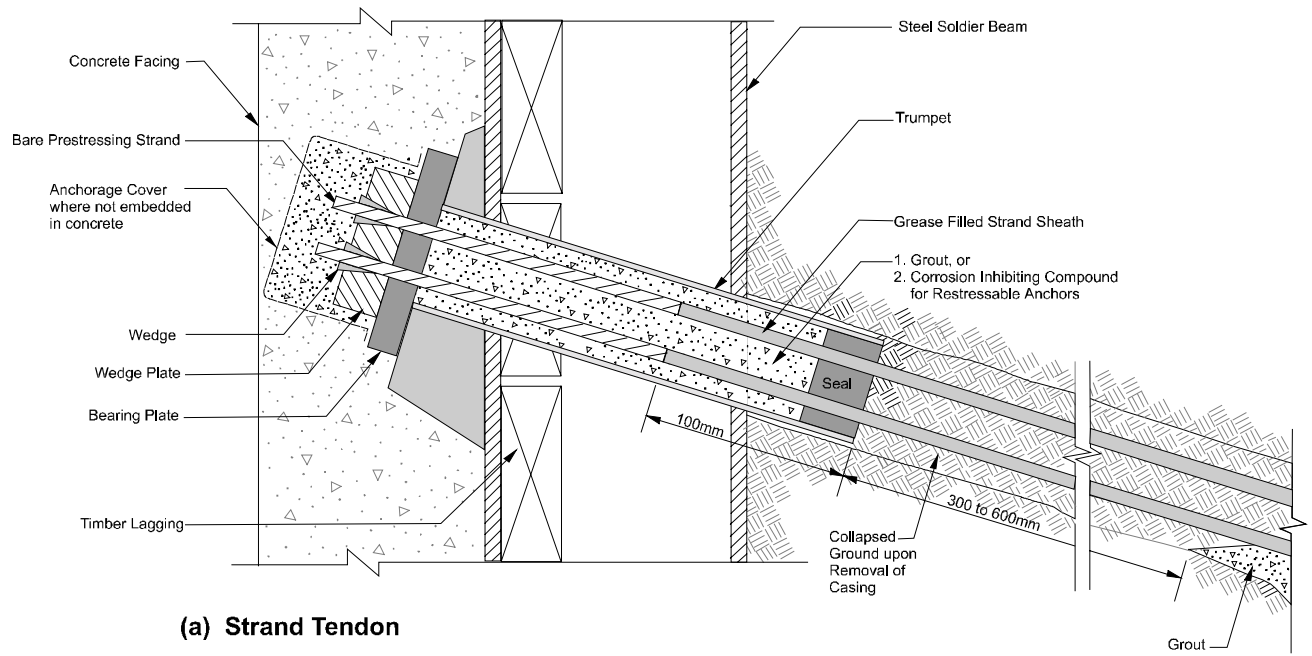

**(a) Strand Tendon**

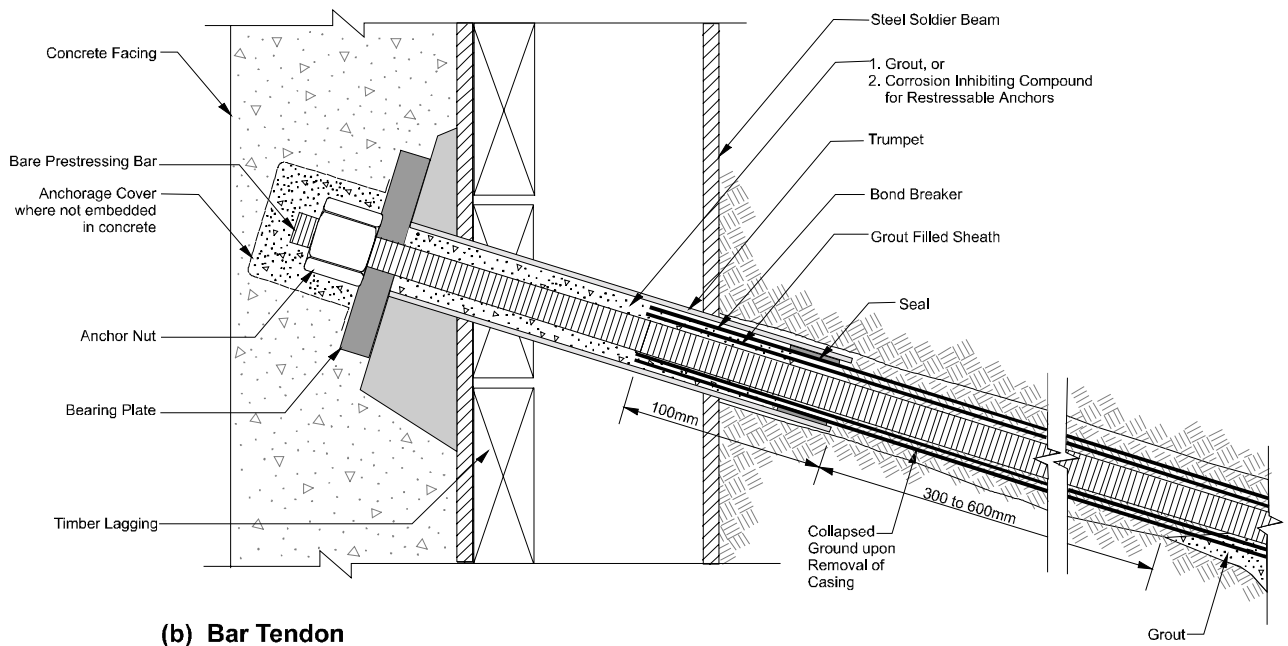

**(b) Bar Tendon**

Figure 60. Examples of corrosion protection for anchorages.

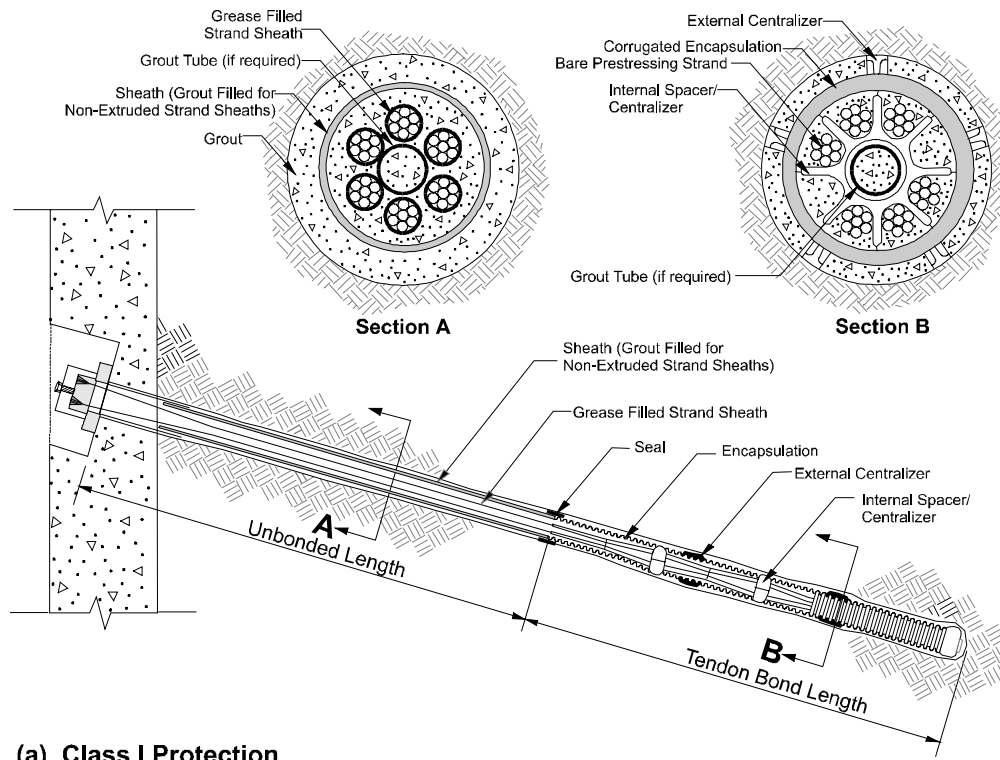

(a) Class I Protection

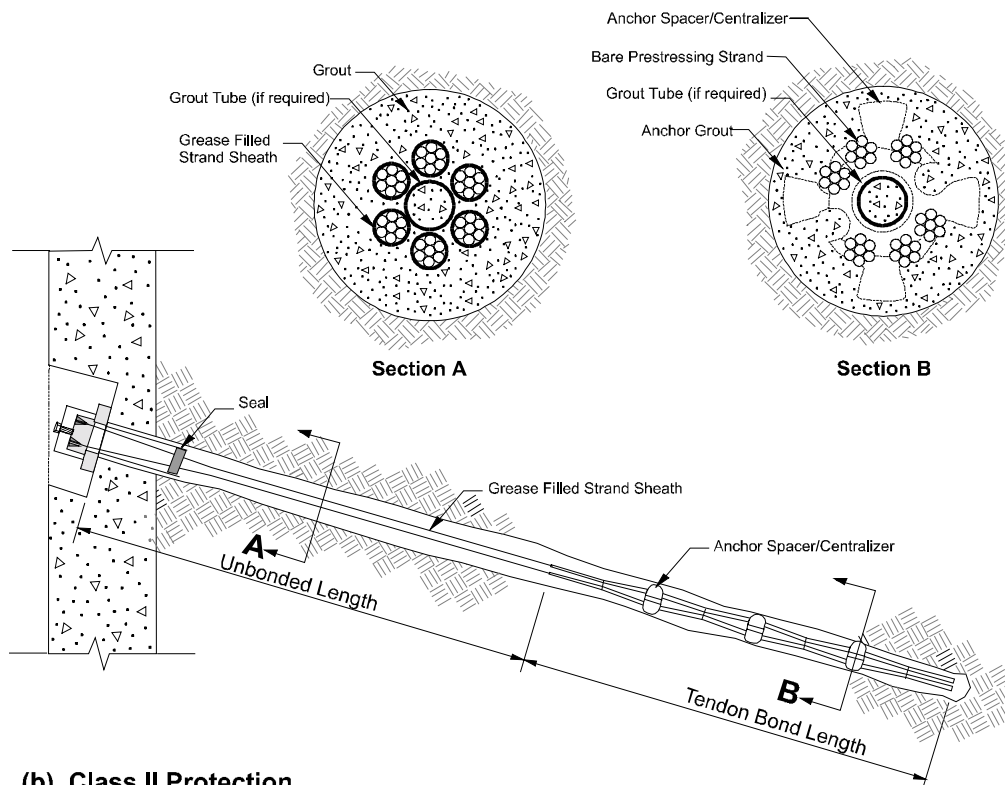

(b) Class II Protection

Figure 61. Examples of corrosion protection classes I and II for strand tendons.

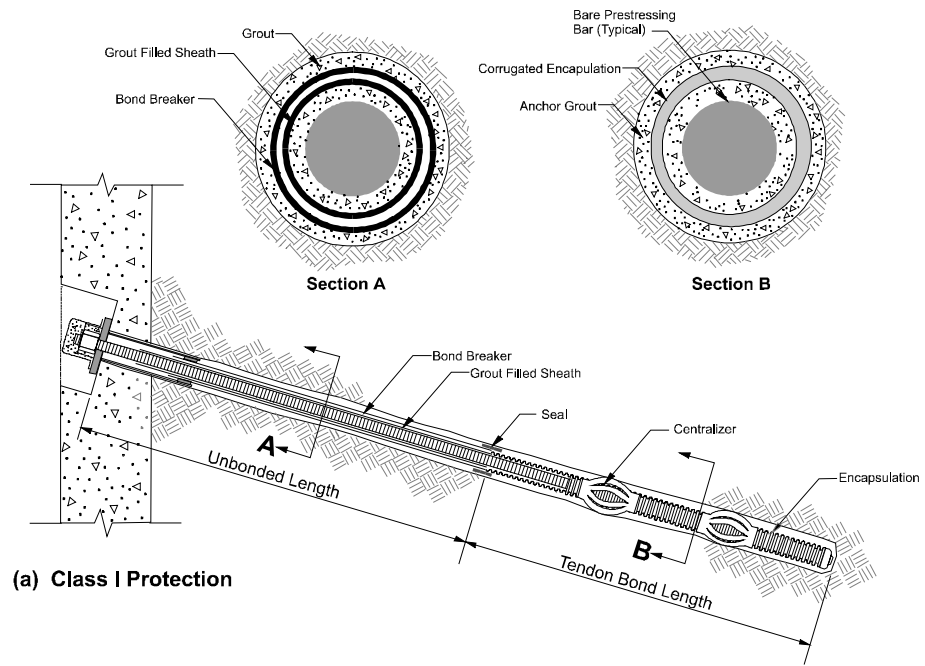

(a) Class I Protection

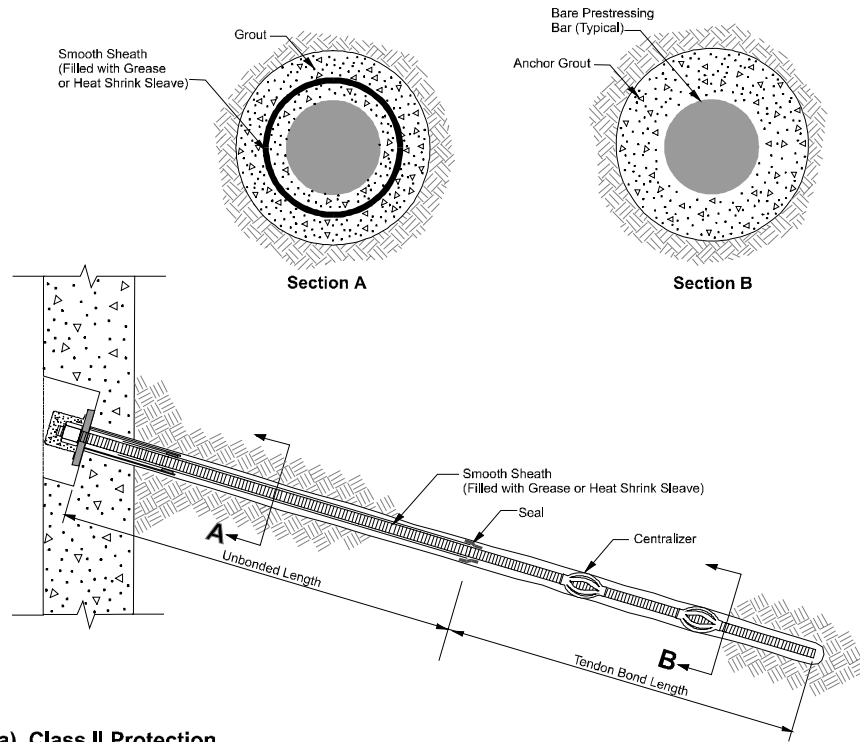

(a) Class II Protection

Figure 62. Examples of corrosion protection classes I and II for bar tendons.

Table 20. Corrosion protection requirements (modified after PTI, 1996)

Class	Protection Requirements		
	Anchorage	Unbonded Length	Tendon Bond Length
I (Encapsulated Tendon)	1. Trumpet 2. Cover if exposed	1. Encapsulate tendons composed of individual grease filled extruded strand sheaths with a common smooth sheath 2. Encapsulate tendons composed of individual grease filled strand sheaths with grout filled smooth sheath 3. Use smooth bondbreaker over grout filled bar sheath	1. Grout-filled encapsulation or 2. Fusion-bonded epoxy
II (Grout protected tendon)	1. Trumpet 2. Cover if exposed	1. Grease-filled sheath, or 2. Heat shrink sleeve	Grout

### 6.3.2.2 Anchorage Protection

Few anchor failures due to corrosion of the prestressing steel and/or anchorage have been reported. However, most reported anchor failures have occurred within 2 m of the anchorage. Careful attention should be given when installing corrosion protection at this part of the tendon. The trumpet should be attached to the bearing plate to provide a water tight seal. This seal is usually made by welding the trumpet to the bearing plate. The trumpet should be long enough to overlap the unbonded length corrosion protection by at least 100 mm and should be completely filled with grout after anchor lock-off unless restressing is anticipated.

Grout used to fill the trumpet should not escape into the unbonded length so as to slump in the trumpet. To retain the grout in the trumpet either a seal should be provided at the bottom of the trumpet which must function at least until the grout sets or the trumpet should fit tightly over the unbonded length corrosion protection for a minimum of 300 mm. Expansive admixtures or multigroutings may be required to ensure that the trumpet is completely filled with grout. For restressable anchors, the trumpet should be filled with a corrosion-inhibiting compound and a permanent seal should be provided at the bottom of the trumpet. A restressable anchor has a special anchor head that permits measuring of lift-off load throughout the service life of the structure. For corrosion-inhibitor filled trumpets care should be taken to ensure that seals will not leak.

The bearing plate may be protected by painting both sides with a bitumastic or other protective coating. The protective material used to paint the bearing plate should be compatible with other protective materials used above and below the bearing plate. Cast-in-place concrete facing that completely embeds the bearing plate will also provide required protection.

Protection of the anchor head and exposed bare prestressing steel may be provided by using either a plastic or steel cover or by embedding the bare tendon in at least 50-mm thick layer of concrete during installation of the wall facing. When a cover is used, the cover should be filled with grout. For restressable anchorages, the cover should be filled with a corrosion-inhibiting compound. As with the trumpet, special care must be taken to ensure that the cover is completely filled with grout.



### 6.3.2.3 Unbonded Tendon Length Protection

Next to the anchorage, the prestressing steel in the unbonded length is most vulnerable to corrosion. Sheaths used to protect the unbonded length should extend into the trumpet but not so far so as to come into contact with either the bearing plate or the anchor head during stressing. Sheaths should be filled either with a corrosion-inhibiting compound or grout in a manner that does not leave voids. Strands should be individually coated with a corrosion-inhibiting compound, without leaving voids between wires.

For class I protection of strand tendons, a common smooth sheath encapsulation should be used over tendons composed of extruded grease filled strand sheaths, or a grout filled common smooth sheath encapsulation should be used over tendons composed of individual grease filled strand sheaths.

Where corrugated pipe is used as a sheath, a bondbreaker must be present. A bondbreaker is a smooth sheath used in the unbonded length that allows the prestressing steel to freely elongate during testing and stressing, and to remain unbonded to the surrounding grout after lock-off.

For Class I protection of bar tendons, the couplers must be protected. Couplers may be protected using either a corrosion proof compound or wax impregnated cloth tape and a smooth plastic tube.

### 6.3.2.4 Tendon Bond Length Protection

No corrosion failures have been reported when the tendon has been properly grouted (e.g., centralized and grouted in such a manner as to leave no voids around the tendon). In rock, where groundwater seepage around the tendon may be significant, drill hole waterproofing may be necessary to ensure that the grout remains in place. A watertightness test (see section 7.4 of PTI, 1996) can be performed to determine the need for special waterproofing measures. If waterproofing is indicated, consolidation grout is commonly placed in the hole and redrilled approximately 18 hours after placement. Encapsulations are used for Class I protection of the tendon bond length. Encapsulations may be pregrouted or grouted on-site prior to or after insertion of the tendon into the drill hole. Where grouted on-site, care must be taken so as to leave no voids in the grout. Centralizers are used inside the encapsulation to ensure grout coverage of the prestressing steel and used outside the encapsulation to provide a minimum 12 mm of grout coverage over the encapsulation.

### 6.3.2.5 Protection Against Stray Currents

For ground anchor applications in which stray currents are present, tendons should be electrically isolated from the ground environment. Tendons that are encapsulated using a nonconductive sheath, usually plastic, along the tendon bond length and unbonded length are considered electrically isolated. However, for grout protected or epoxy protected tendons, the bearing plate, anchor head, and trumpet should be isolated with insulation from the wall elements. For tiedown anchors, components of the anchorage should be electrically isolated from the reinforcing steel in the uplift slab. The effectiveness of the sheath to provide electrical isolation may be verified in the field by testing after installation of the tendon and prior to grouting. Information on electrical isolation testing may be found in Draft European Standard (1994).

### 6.3.2.6 Corrosion Protection of Anchors for Structures Subject to Hydrostatic Uplift

The design of a corrosion protection system for anchors used to resist hydrostatic uplift of a structure requires careful attention to prevent water from entering the tendon through a breach in the corrosion protection. Water entering will likely migrate up the tendon to the anchorage between the corrosion protection barrier and the prestressing elements. A Class I protection system is always required for anchors used for this application. Voids between prestressing elements and between the individual wires of a strand must be completely filled with a corrosion-inhibiting compound and seals provided at the anchor head. Seals at the anchor head must remain watertight after the tendon undergoes elongation during testing or in the event of tendon elongation after lock-off (due to increased uplift loads). In addition, a watertight seal will often be required at the anchorage where the tendon penetrates the structure. Leakage through penetrations at the anchorage may accelerate corrosion of the anchorage. Seals at the anchorage are more susceptible to leakage under high water pressures. In this case, water tightness testing of seals may be considered prior to construction.

## 6.4 SELECTION OF CORROSION PROTECTION LEVEL

### 6.4.1 General

The minimum level of corrosion protection for ground anchors should be selected considering the service life of the anchored system, the aggressivity of the ground environment, the consequences of failure of the anchored system, and the cost of providing a higher level of corrosion protection. A selection flowchart for corrosion protection is shown in figure 63.

### 6.4.2 Service Life of the Anchored Structure

Service life is used to distinguish between a temporary support of excavation and a permanent anchor as noted in section 1.2. If the service life of a temporary support of excavation anchor is likely to be extended due to construction delays, an evaluation should be made to determine whether or not to provide additional corrosion protection for the tendon, particularly in aggressive ground conditions.

### 6.4.3 Aggressivity of the Ground Environment

Ground anchors in environments classified as aggressive or of unknown aggressivity will require the highest class of corrosion protection listed for each service life classification, Class II corrosion protection for temporary support of excavation anchors and Class I corrosion protection for permanent anchors. Tests and/or field observations are used to classify the aggressivity of the ground environment.

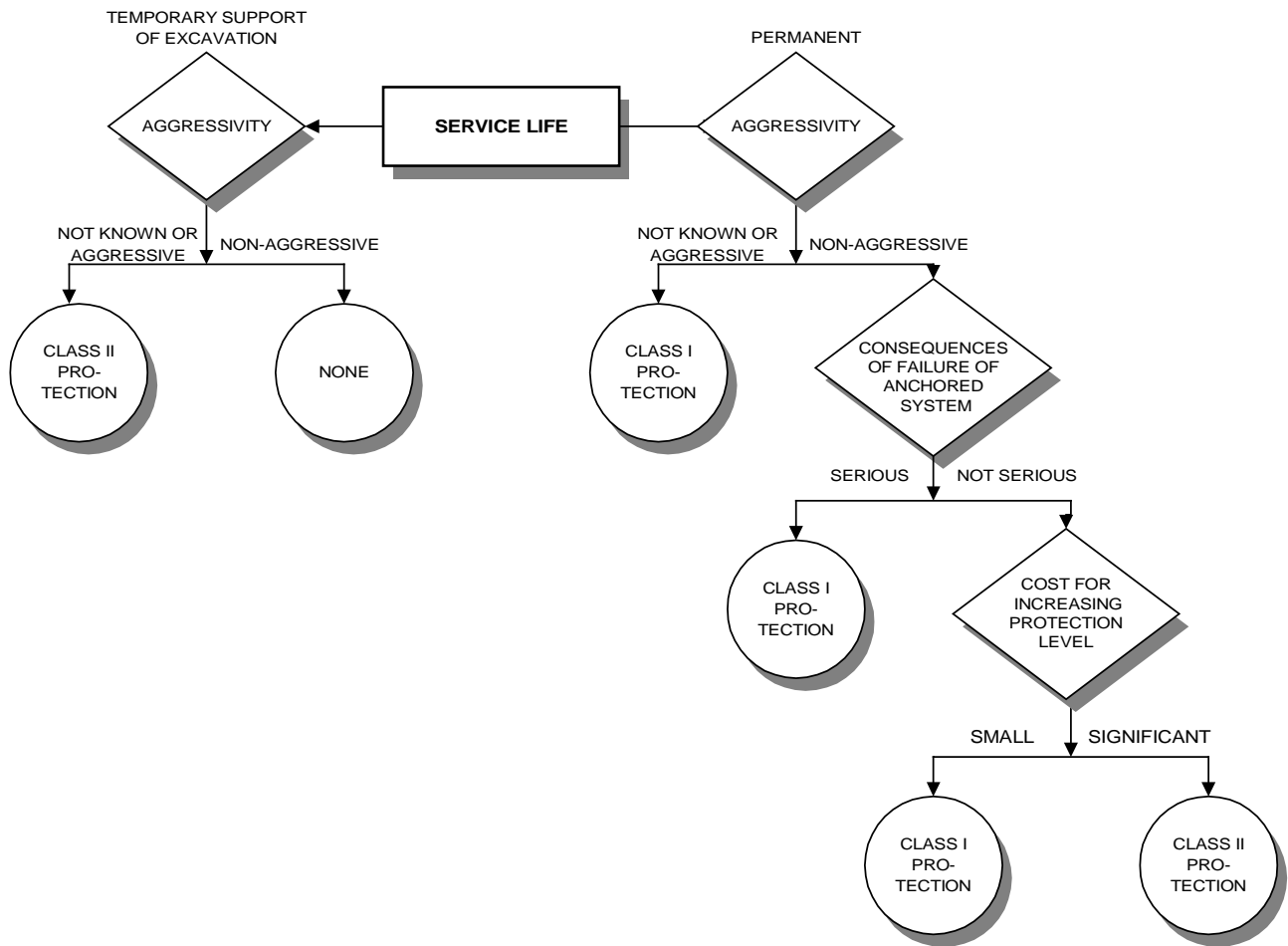

Figure 63. Decision tree for selection of corrosion protection level (modified after PTI, 1996).

In general, ground environments may be classified as aggressive if any one of the following conditions are present in the ground or may be present during the service life of the ground anchor (PTI, 1996): (1) a pH value of soil or groundwater less than 4.5; (2) a resistivity of the ground of less than 2000 ohm-cm; (3) the presence of sulfides; (4) the presence of stray currents; or (5) buried concrete structures adjacent to the anchored system project which have suffered from corrosion or direct chemical (acid) attack. Tests used to measure pH and resistivity and to identify the presence of sulfides are discussed in chapter 3. Tests from a nearby site can be used to evaluate the aggressivity of the site if the designer can establish that the ground conditions are similar. Otherwise, if aggressivity tests are not performed, then the ground should be assumed to be aggressive.

The following ground environments are always considered aggressive: (1) soil or groundwater with a low pH; (2) salt water or tidal marshes; (3) cinder, ash, or slag fills; (4) organic fills containing humic acid; (5) peat bogs; and (6) acid mine drainage or industrial waste. Classification of ground aggressivity should consider the possibility of changes during the service life of the ground anchor,

which may cause the ground to become aggressive, such as, might occur near mining operations, chemical plants, or chemical storage areas.

#### **6.4.4 Consequences of Failure of the Anchored System**

For permanent anchors, if failure of the anchored system could result in serious consequences such as loss of life or significant financial loss, a minimum of Class I protection is required. The consequences of failure are considered serious for: (1) anchored systems used in urban areas where there are nearby structures behind the wall; (2) anchored systems used for a highway retaining wall where the closure of one or two lanes would cause a major disruption of traffic; and (3) landslide stabilization walls where the retained slope has experienced past movement.

#### **6.4.5 Cost for a Higher Level of Protection**

The final criterion for selecting the minimum class of corrosion protection is the increased cost for changing from Class II protection to Class I protection. For the same tendon, Class I protected anchors require a larger drill hole as compared to a Class II protected anchor. Encapsulating an anchor tendon increases the required drill hole size which may result in increased installation costs. In an uncased drill hole, the additional drilling costs can be small, and the owner may elect to use Class I protection. In a cased hole or in rock, the additional drilling costs can be higher, and the owner will decide if the benefit of providing a higher level of corrosion protection is worth the additional cost. The increase in drill hole diameter may result in a need to increase bearing plate dimensions, trumpet diameter, and the opening in the soldier beam to insert the tendon.

### **6.5 CORROSION OF STRUCTURAL STEEL, CEMENT GROUT, AND CONCRETE**

#### **6.5.1 Corrosion and Protection of Steel Soldier Beams and Sheet Piles**

Structural steels used in anchored walls (i.e., soldier beams and sheet piles) are less susceptible to failure by corrosion than are high strength steels used to fabricate prestressing elements for ground anchors. In most ground environments, a small loss in thickness may be expected which will not significantly reduce the strength of the structural steel. In very aggressive ground conditions, the potential for loss of thickness is significant, and the structural steel elements must be protected.

Below the excavation subgrade, drilled-in soldier beams are surrounded by either lean-mix or structural concrete and therefore are not considered susceptible to corrosion. Driven soldier beams and sheet piles are in direct contact with the ground and are therefore more susceptible to corrosion. Driven soldier beams and sheet piles may be protected by: (1) coatings; (2) increasing the thickness of the steel; and (3) using a higher strength steel in place of a lower strength steel. Coatings must be durable enough to survive driving. Coatings such as coal-tar epoxy and fusion-bonded epoxy may decrease pile capacity. Guidance on the increase in steel thickness is provided in FHWA-HI-97-013 (1998). AASHTO Provisional Standard PP36-97 contains a procedure for estimating the expected service life of soldier beams and sheet piling for non-marine applications.

## 6.5.2 Degradation and Protection of Cement Grout and Concrete

Although there have been no recorded anchor failures resulting from chemical attack of the cement-grout or concrete, the deterioration of the grout leaves prestressing steel vulnerable to corrosion. The primary mechanism for degradation of cement-based grout and concrete is chemical attack in high sulfate environments, such as in marshy areas and in sulfate bearing clays.

The common approach to minimizing the potential deterioration of grout (and concrete) in high sulfate environments is to select a cement type based on the soluble sulfate ion ( $\text{SO}_4$ ) content of the ground. The sulfate in the ground can be estimated using AASHTO T-290. For a sulfate content between 0.1 and 0.2 percent, Type II portland cement should be used and for a sulfate content between 0.2 percent and 2 percent, Type V portland cement should be used. For a sulfate content above 2.0 percent, Type V portland cement plus a pozzolan should be used. In addition, the rate of both sulfate and chloride attack may be significantly reduced by the use of dense grout or concrete of low permeability. The density of grout can be controlled through placement method and the selection of water/cement ratio.

## CHAPTER 7

# LOAD TESTING AND TRANSFER OF LOAD TO THE ANCHORED SYSTEM

### 7.1 INTRODUCTION

For anchored system applications, each ground anchor is tested after installation and prior to being put into service to loads that exceed the design load. This load testing methodology, combined with specific acceptance criteria, is used to verify that the ground anchor can carry the design load without excessive deformations and that the assumed load transfer mechanisms have been properly developed behind the assumed critical failure surface. After acceptance, the ground anchor is stressed to a specified load and the load is “locked-off.”

### 7.2 CONCEPTS FOR MONITORING ANCHOR BOND ZONE CAPACITY

The bond zone of an anchor develops resistance in the surrounding ground by straining in response to tensile loads applied at the anchorage. For anchor bond lengths in tension, the strains in the tendon are greatest at the top and decrease along the length of the anchor bond zone. The amount of load transfer to the ground at any particular strain will depend on the stress-strain characteristics of the ground. Figure 64 illustrates two possible skin friction versus strain diagrams for a ground anchor. Curve A represents a soil or rock where very little strain is required to mobilize most of the skin friction. Curve B represents a weaker soil or rock where more strain is required to mobilize a peak skin friction and where continued straining results in a reduction of skin friction to a residual value.

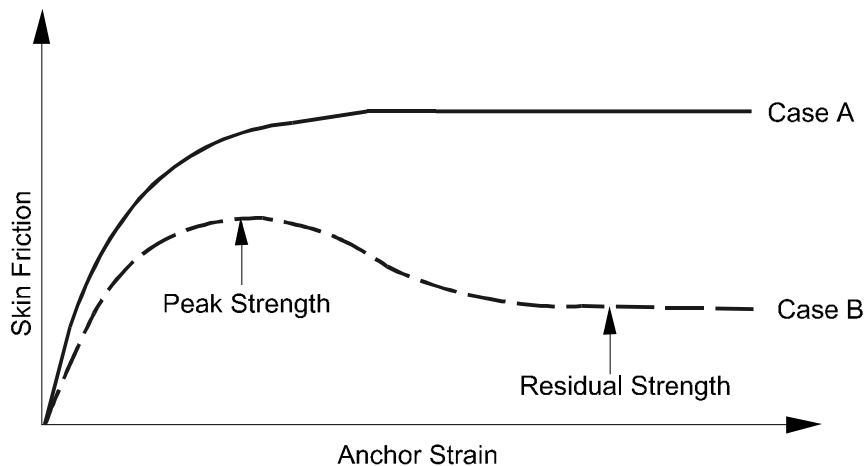

Figure 64. Skin friction versus strain diagrams for ground anchors.

Early concepts for anchor testing were based on a uniform propagation of load transfer down the bond length as tensile loads were increased. Figure 65 shows how the centroid of load, referred to as the “fictitious anchorage point” (FAP), in the grout body was assumed to migrate toward the end of the tendon. The assumption that all load transfer was mobilized when the FAP approached the midpoint of the bond length formed the basis for early acceptance testing. However, this concept of uniform load transfer is not valid for soil anchors and only approximates behavior of most rock anchors.

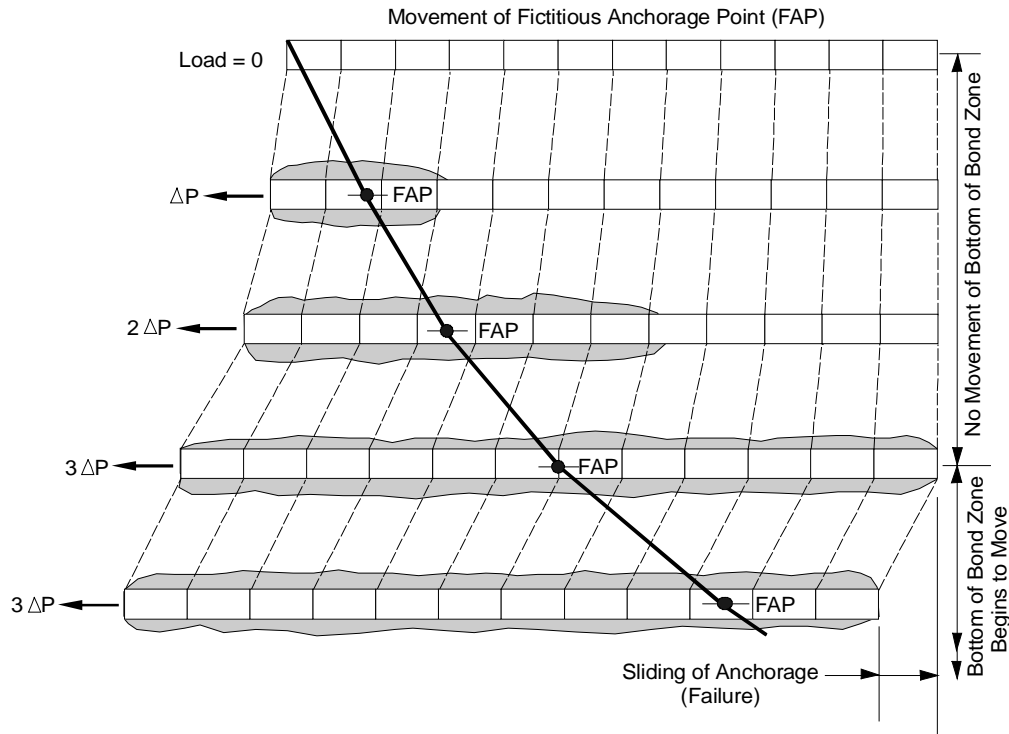

Figure 65. Stress propagation in bond length of ground anchor.

The current approach to monitoring bond zone capacity in soils has been used since the 1970s and is based on creep of the grouted body under a constant load. As shown in figure 66a, the rate of creep of the bond zone is directly related to the applied load. Creep tests on numerous anchors have shown that when the creep rate exceeds 2 mm per log cycle of time, additional loads applied to the tendon will result in unacceptable continuing grout body movements. As shown in figure 66b, a maximum load,  $T_c$ , defined as the critical creep tension does exist for each bond zone. This critical creep tension corresponds to the load at which the creep rate exhibits a sharp upward break. Monitoring small creep movements (typically less than 1 mm) under constant applied tension loads requires appropriate testing equipment. Both the absolute value of applied load and, more importantly, the ability to maintain a constant load for a substantial period of time must be addressed.

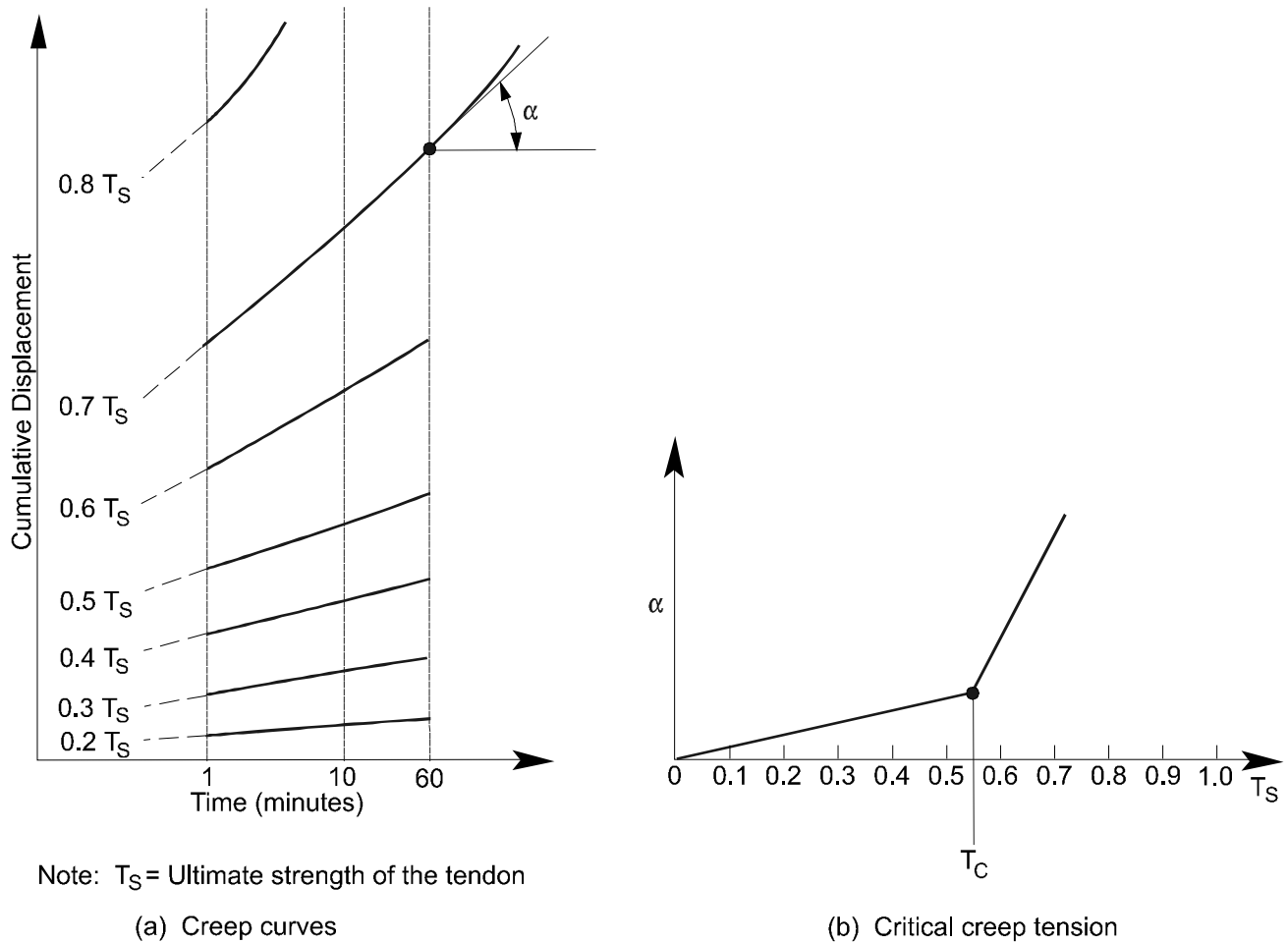

Figure 66. Evaluation of critical creep tension.

### 7.3 TESTING AND STRESSING EQUIPMENT

#### 7.3.1 General

Each ground anchor is load tested to verify its capacity. The load test is performed at the ground surface and consists of tensioning the prestressing steel element (i.e., strand or bar) and measuring load and movement. In this section, equipment that is commonly used for load testing is described. A typical load test setup for a strand and bar tendon is shown in figures 67 and 68, respectively. Typical load test equipment includes: (1) hydraulic jack and pump; (2) stressing anchorage; (3) pressure gauges and load cells; (4) dial gauge to measure movement; and (5) jack chair.



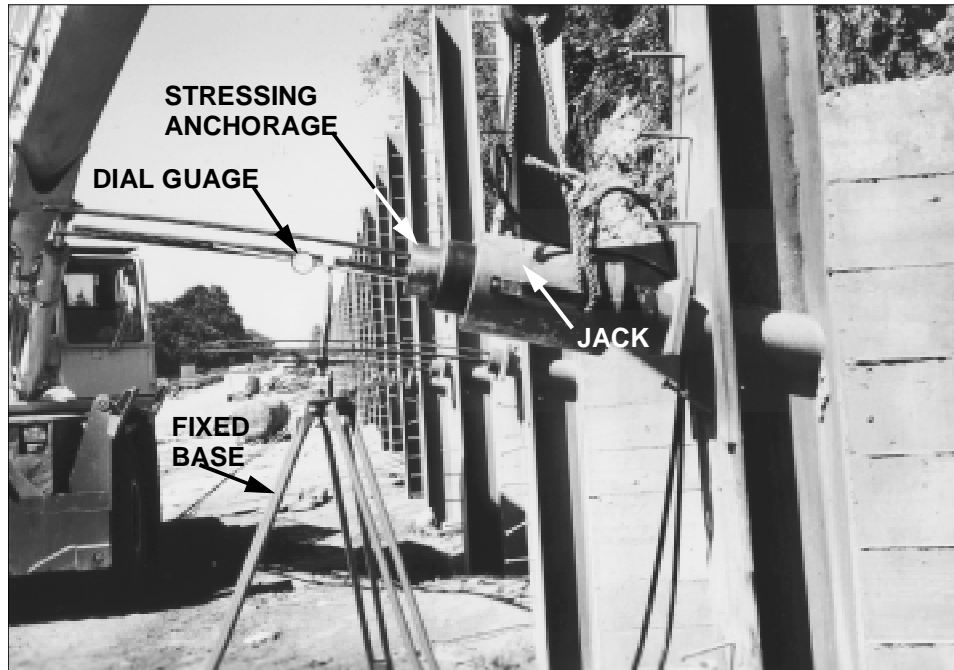

Figure 67. Typical equipment for load testing of strand ground anchor.

## 7.3.2 Equipment Used in Load Testing

### 7.3.2.1 Hydraulic Jack and Pump

A hydraulic jack and pump are used to apply load to the tendon either at the anchor head or at a pulling head attached to the prestressing steel. The hydraulic jack must be capable of applying a concentric load to the tendon. The load should be transferred to all of the prestressing elements of the tendon simultaneously. Applying the load to a single strand of a multistrand tendon should not be allowed. The ram travel shall be at least 152 mm and preferably not be less than the theoretical elongation of the tendon at the maximum test load. If elongations greater than 152 mm are required, restroking can be allowed. In addition, the hydraulic jack should be capable of:

- applying and releasing load incrementally, as required by test procedures;
- applying each load increment within 60 seconds; and
- applying the maximum test load (termed the test load) within 75 percent of the pressure rating of the jack and pump system.

When long, high capacity ground anchors are used, it may not be possible to apply each load increment within 60 seconds. For this case, deformation measurements should begin when the load is achieved.

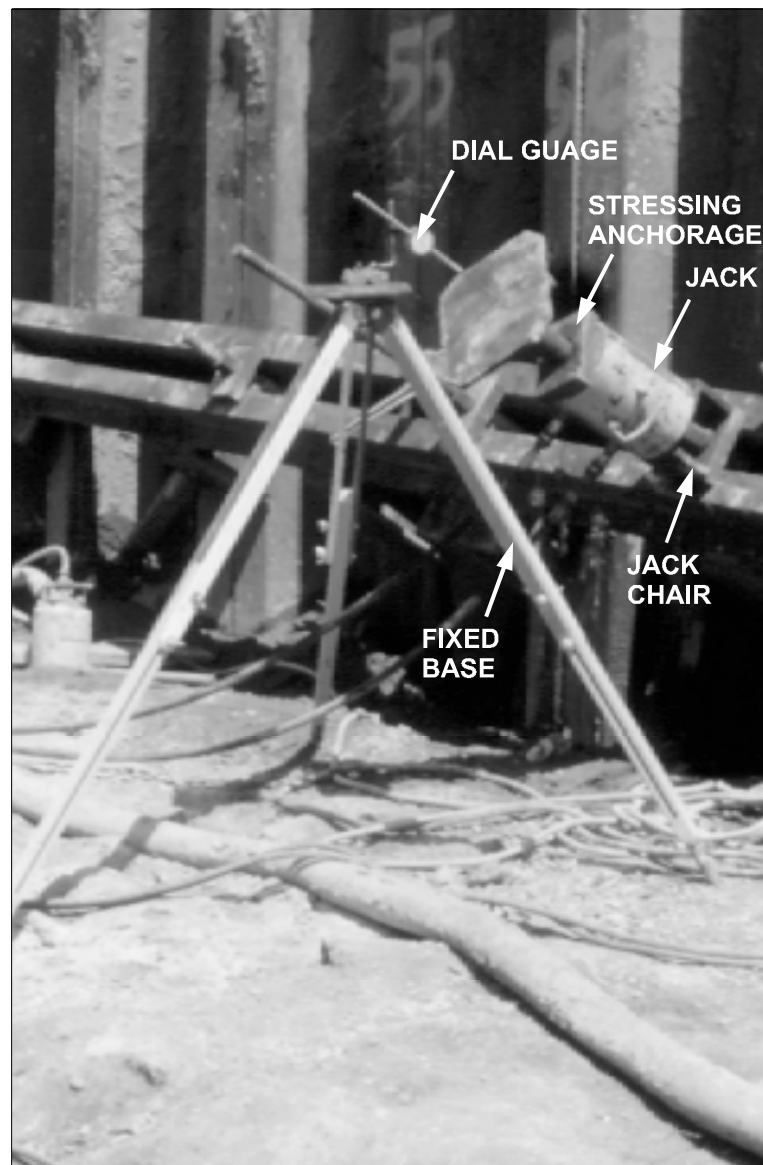

Figure 68. Typical equipment for load testing of bar ground anchor.

### 7.3.2.2 Stressing Anchorage

A stressing anchorage is used in front of the jack head to grip the prestressing steel element during loading. For bar tendons, the stressing anchorage generally consists of a bearing plate with a countersunk hole and a nut. Common practice is to order the production bar tendons to the actual in-place length and use a short bar segment and coupler to extend the bar at the stressing head for testing. For strand tendons, the stressing anchorage can be similar to the anchor head. The stressing anchorage rests on a bearing plate; the bearing plate sits on front of the jack.

### 7.3.2.3 Pressure Gauges and Load Cells

The standard device used to monitor load is a pressure gauge attached to the jack pump, either alone or in concert with a center hole load cell mounted in the stressing train. The readings on the jack pressure gauge are used to determine the absolute value of applied load. For extended load hold periods, load cells are used as the means to monitor a constant applied load while the pump is incrementally adjusted. Over extended periods of time, any load losses in the jack will not be reflected with sufficient accuracy using a pressure gauge. Also, temperature changes can affect the hydraulic jack and/or pressure gauge readings. For proof tests and for lift off tests, a pressure gauge alone is usually used for measuring load. For all tests involving extended load hold periods (i.e., all creep tests), a load cell should be used in concert with a pressure gauge.

Calibration of pressure gauges and load cells should be performed within 45 working days of the date when they are submitted for approval for the project. Calibration certifications and graphs for pressure gauges and load cells must be provided by the contractor before use. A second certified pressure gauge should be kept on-site to be used for periodic check of jack pressure gauges. The pressure gauge shall be graduated in increments of 690 kPa or less.

### 7.3.2.4 Dial Gauge to Measure Movement

Total movement of the tendon is commonly measured using a dial gauge fixed to a tripod or other support device that is independent of the structure. Dial gauges should be capable of measuring and being read to the nearest 0.025 mm. A dial gauge should be used that has sufficient travel to be able to measure in excess of the maximum elongation of the tendon. Care should be taken to ensure that the dial gauge is aligned perpendicular to the end of the tendon or other plane of measurement. Dial gauges with travels greater than 100 mm are not recommended. Where a tendon is expected to elongate in excess of 100 mm during a load test, two or more gauges with shorter travel lengths may be used together with the gauges being reset at interim points during the load test.

### 7.3.2.5 Jack Chair

For bar anchors, a jack chair is placed over the anchor head and it rests on the bearing plate. The jack chair enables testing to be performed on bar anchors with the nut already in place and permits access to the nut during transfer of the lock-off load. The jack chair must be capable of transferring 100 percent of the specified minimum tensile strength (SMTS) of the prestressing steel element to the bearing plate. Jack chairs can also be used on strand tendons to permit the wedges to be placed on the strands and set after the completion of the test.

## 7.4 ANCHOR LOAD TESTING

### 7.4.1 Introduction

A unique aspect of ground anchors, as compared to other structural systems, is that every ground anchor that is to be part of a completed structure is load tested to verify its load capacity and load-deformation behavior before being put into service. The acceptance or rejection of ground anchors is

determined based on the results of: (1) performance tests; (2) proof tests; and (3) extended creep tests. In addition, shorter duration creep tests (as opposed to extended creep tests) are performed as part of performance and proof tests. Proof tests are the most common and are performed on the majority of the ground anchors for a particular project. The number of performance and extended creep tests that are performed for a project depends upon whether the anchors are for a temporary support of excavation or permanent application and the type of ground.

Every ground anchor is tested using one of the particular tests introduced above. The results of these tests are compared to specified acceptance criteria to evaluate whether the ground anchor can be put into service. The acceptance criteria are based on allowable creep and elastic movements of the anchor during load testing. A brief discussion of each test type follows.

## **7.4.2 Performance Tests**

### **7.4.2.1 General**

Performance tests involve incremental loading and unloading of a production anchor. The performance test is used to verify anchor capacity, establish load-deformation behavior, identify causes of anchor movement, and to verify that the actual unbonded length is equal to or greater than that assumed in the anchor design. The results of a performance test may also be used to assist in the interpretation of the simpler proof test.

Performance tests are commonly performed on the first two or three production anchors installed and thereafter on a minimum of two percent of the remaining production anchors. Additional performance testing may be required where creep susceptible soils are suspected to be present or where varying ground conditions are encountered. Where ground conditions are variable, performance test anchors should be located near geotechnical borings, if possible, to facilitate the interpretation of test measurements.

### **7.4.2.2 Procedures for Performance Test**

The load schedule for a performance test is shown in the first three columns of table 21. The first step in a performance test comprises applying a nominal load to the anchor tendon. This load, termed the alignment load, is typically no more than five percent of the design load and its purpose is to ensure that the stressing and testing equipment are properly aligned. The displacement measuring equipment is zeroed upon stabilization of the alignment load, AL, as shown on figure 69. During the first load cycle, the load is raised to 25 percent of the design load and the incremental movement is recorded (i.e., Point 1 on figure 69). The load is then reduced back to the alignment load. This procedure is repeated, using load increments as shown on table 21, until the maximum testing load, referred to as the test load, is achieved. The test load may vary from 120 to 150 percent of the design load with 133 percent being commonly used for permanent applications and 120 percent being commonly used for temporary applications. A test load of 150 percent may be used for anchors in potentially creeping soils or when an independent reference cannot be established for the dial gauge.

Table 21. Steps for the performance test.

Step	Loading	Applied Load	Record and Plot Total Movement ( $\delta_{ti}$ )	Record and Plot Residual Movement ( $\delta_{ri}$ )	Calculate Elastic Movement ( $\delta_{ei}$ )
1	Apply alignment load (AL)				
2	Cycle 1	0.25DL	$\delta_{t1}$		$\delta_{t1} - \delta_{r1} = \delta_{e1}$
		AL		$\delta_{r1}$	
3	Cycle 2	0.25DL	$\delta_{t2}$		$\delta_{t2} - \delta_{r2} = \delta_{e2}$
		0.50DL	$\delta_{t2}$		
		AL		$\delta_{r2}$	
4	Cycle 3	0.25DL	$\delta_{t3}$		$\delta_{t3} - \delta_{r3} = \delta_{e3}$
		0.50DL	$\delta_{t3}$		
		0.75DL	$\delta_{t3}$		
		AL		$\delta_{r3}$	
5	Cycle 4	0.25DL	$\delta_{t4}$		$\delta_{t4} - \delta_{r4} = \delta_{e4}$
		0.50DL	$\delta_{t4}$		
		0.75DL	$\delta_{t4}$		
		1.00DL	$\delta_{t4}$		
		AL		$\delta_{r4}$	
6	Cycle 5	0.25DL	$\delta_{t5}$		$\delta_{t5} - \delta_{r5} = \delta_{e5}$
		0.50DL	$\delta_{t5}$		
		0.75DL	$\delta_{t5}$		
		1.00DL	$\delta_{t5}$		
		1.2DL	$\delta_{t5}$		
		AL		$\delta_{r5}$	
7	Cycle 6	0.25DL	$\delta_{t6}$		
		0.50DL	$\delta_{t6}$		
		0.75DL	$\delta_{t6}$		
		1.00DL	$\delta_{t6}$		
		1.2DL	$\delta_{t6}$		
		1.33DL	$\delta_{t6}$ , zero reading for creep test		
8	Hold load for 10 minutes while recording movement at specified times. If the total movement measured during the load hold exceeds the specified maximum value then the load hold should be extended to a total of 60 minutes.				
9	Cycle 6 cont'd.	AL		$\delta_{r6}$	Cycle 6: $\delta_{tn} - \delta_{r6} = \delta_{e6}$
10	Adjust to lock-off load if test results satisfy acceptance criteria, otherwise see section 7.4.5.4				
Notes: AL = Alignment Load, DL = Design Load, $\delta_i$ = total movement at a load other than maximum for cycle, i = number identifying a specific load cycle.					

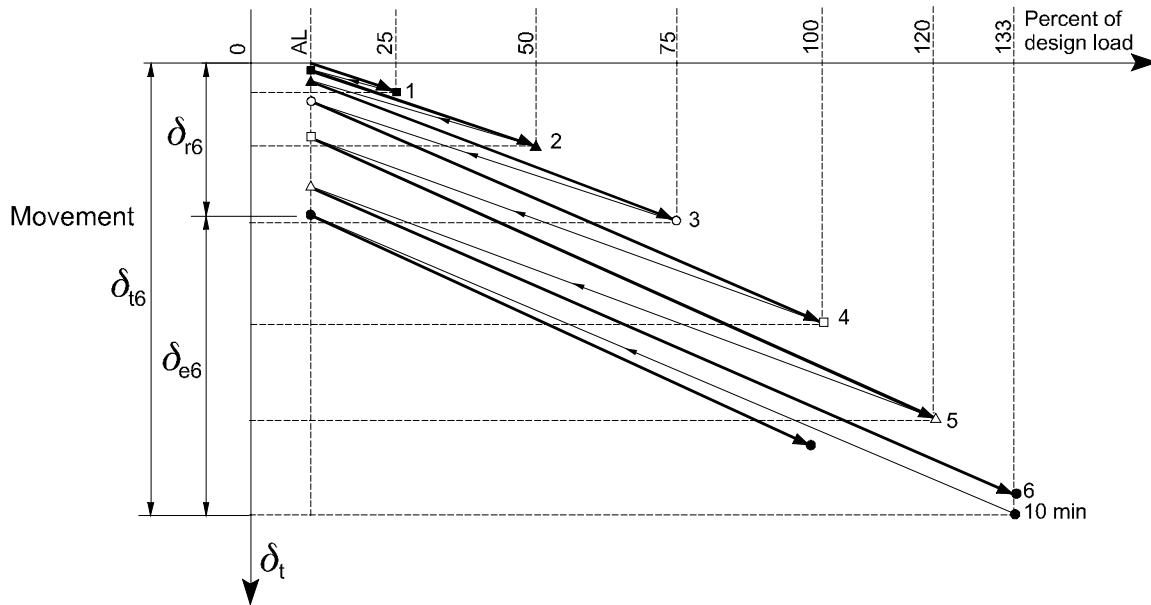

Figure 69. Plotting of performance test data (after PTI, 1996).

At the test load, a constant load is held for ten minutes prior to reducing the load to the lock-off load. During this ten minute load hold period, movements are measured and recorded at 1, 2, 3, 4, 5, 6, and 10 minutes. The purpose of this load hold is to measure time-dependent (i.e., creep) movements of the anchor. This portion of the performance test is referred to as a creep test. If the total movement between 1 and 10 minutes exceeds the specified maximum creep movement (see section 7.4.5.2), the test load is maintained for an additional 50 minutes and total movement is recorded at 20, 30, 40, 50 and 60 minutes. If the results of a creep test for a specific anchor indicate that creep movements are excessive relative to specified criteria, the anchor may be incorporated into the structure at a reduced load, the anchor may be replaced, or, only in the case of postgroutable anchors, the anchor may be regouted and then retested.

#### 7.4.2.3 Recording of Performance Test Data

The magnitude of each load is determined from the jack pressure gauge. During creep testing, a load cell is monitored to insure that the jack load remains constant. The load-deformation data obtained for each load increment in a performance test are plotted as shown in figure 70. Movement is recorded at each load increment and for the alignment load. The total movement ( $\delta_t$ ) that is measured consists of elastic movement and residual movement. Acceptance criteria for anchors require that the elastic movement of the anchor be known. Elastic movements ( $\delta_e$ ) result from elongation of the tendon and elastic movements of the ground anchor through the ground. Residual movement ( $\delta_r$ ) includes elongation of the anchor grout and movement of the entire anchor through the ground. The residual movement for a given increment of load is the movement that corresponds to the net “irrecoverable” movement that occurs upon application of a load increment and the subsequent relaxation of the load to the alignment load (see figure 69 for definition of  $\delta_{r6}$ ). The

elastic movement is therefore the arithmetic difference between the total movement measured at the maximum load for a cycle and the movement measured at the alignment load (see table 21). Although not used for anchor acceptance, residual movement is an indicator of the stress-strain behavior of the ground-grout bond in the anchor bond zone.

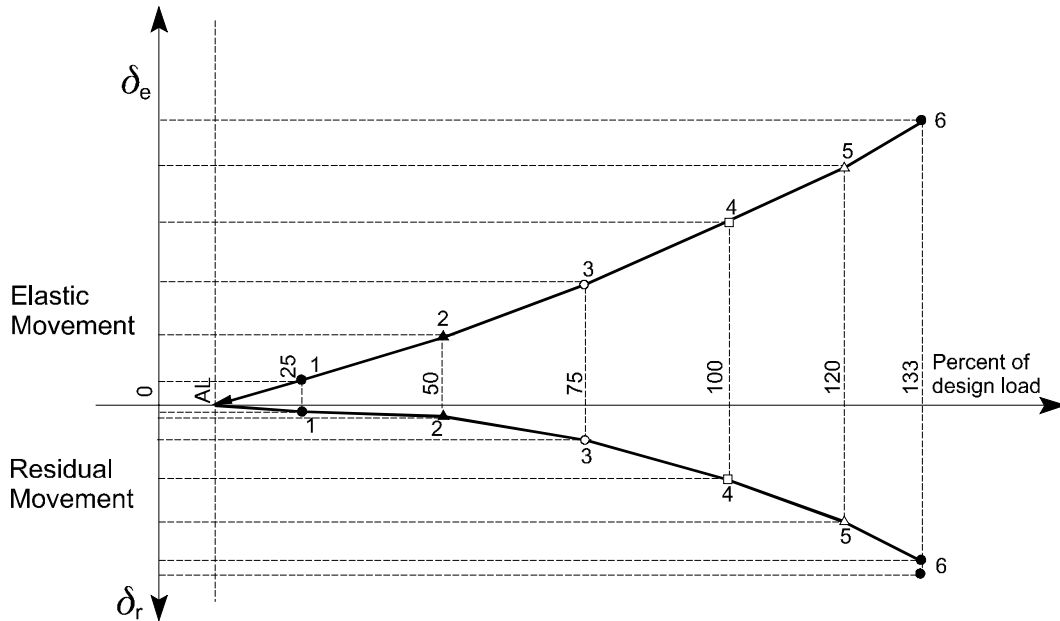

Figure 70. Plotting of elastic and residual movement for a performance test (after PTI, 1996).

During the creep test portion of the performance test, the movement measured at specified times (i.e., 1, 2, 3, 4, 5, 6, and 10 minutes) is recorded. The time at which the total movement is measured for the test load (i.e., time at which point 6 on figure 69 is measured) represents the start time for the creep test. The movement from one to ten minutes after this starting time is recorded and compared to the acceptance criteria with respect to creep. If the creep acceptability criterion is not satisfied, the test load is held on the anchor for an additional 50 minutes. The total amount of movement between 6 and 60 minutes is recorded and compared to specified criteria.

Creep acceptability criteria were established for anchors using bare prestressing strand. For epoxy-coated filled strand tendons, the creep movements of the strand itself are significant during load testing. The creep movements of the strand should be deducted from the total movement measured during a load test so that the creep movements within the ground can be accurately calculated.

#### 7.4.2.4 Analysis of Performance Test Data

One of the acceptability criterion for ground anchors is based on measured elastic movements of the ground anchor during load testing. The elastic movements calculated from a load increment during a performance test are evaluated using the equations shown in table 21. These elastic movements

should be calculated for each load cycle and plotted versus each load as shown on figure 70. The residual movement curve should also be plotted. For a soil anchor to be considered acceptable with respect to elastic movements, the elastic movement at the test load must exceed a specified minimum value. For a rock anchor, the elastic movement must be bounded by a specified minimum and a specified maximum value. The acceptability criteria with respect to elastic movement are described in section 7.4.5.3.

### 7.4.3 Proof Tests

#### 7.4.3.1 General

The proof test involves a single load cycle and a load hold at the test load. The magnitude of the applied load is measured using the jack pressure gauge. Load cells are only required for creep tests in soils where the performance tests show a creep rate exceeding 1 mm per log cycle of time. The proof test provides a means for evaluating the acceptability of anchors that are not performance tested. Data from the proof test are used to assess the adequacy of the ground anchor considering the same factors as for performance test data. Where proof test data show significant deviations from previous performance test data, an additional performance test is recommended on the next adjacent anchor.

#### 7.4.3.2 Proof Test Procedures and Recording and Analysis of Proof Test Data

The proof test is performed in accordance with the procedure outlined in table 22. The total movement from each load cycle in a proof test should be plotted as shown in figure 71. If an unload cycle is included (Step 4 in table 22), residual movements and elastic movements should be calculated for the test load. This calculation is the same as that previously described for performance tests. If an unload cycle is not performed, an estimate of residual movement can be based on performance tests on other production anchors from the same project.

Table 22. Test procedure for ground anchor proof test.

Step 1.	Apply the alignment load at which total movement is assumed equal to zero.
Step 2.	Successively apply and record total movements for the following load increments to the test load: 0.25DL, 0.50DL, 0.75DL, 1.00DL, 1.20DL, 1.33DL (i.e., the test load). Note that the test load for an anchor for a temporary support of excavation application may be set at 1.20 DL.
Step 3.	Hold test load for ten minutes and record total movement.
Step 4.	(Optional) Unload to alignment load and record residual movement.
Step 5.	If test results satisfy acceptance criteria, reduce load to the lock-off load (or if Step 4 was used, increase load to lock-off load), otherwise follow guidance provided in section 7.4.5.4.



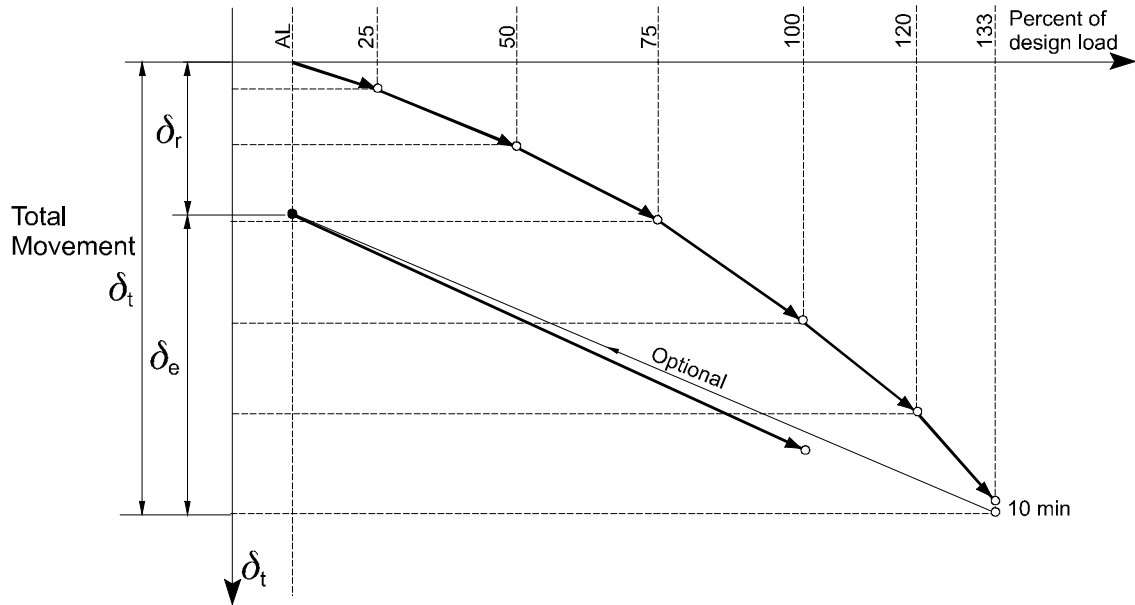

Figure 71. Plotting of proof test data (after PTI, 1996).

## 7.4.4 Extended Creep Testing

### 7.4.4.1 General

An extended creep test is a long duration test (e.g., approximately 8 hours) that is used to evaluate creep deformations of anchors. These tests are required for anchors installed in cohesive soil having a plasticity index (PI) greater than 20 or liquid limit (LL) greater than 50. For these ground conditions, a minimum of two ground anchors should be subjected to extended creep testing. Where performance or proof tests require extended load holds, extended creep tests should be performed on several production anchors.

### 7.4.4.2 Procedures for Extended Creep Test

The test arrangement for an extended creep test is similar to that used for performance or proof tests. The increments of load for an extended creep test are the same as those for a performance test. At each load cycle, the load is held for a specific period of time and the movement is recorded. During this observation period, the load should be held constant. The load is assumed to remain reasonably constant if the deviation from the test pressure does not exceed 0.35 MPa. The loading schedule and observation periods for each load cycle in an extended creep test for a permanent anchor are provided in table 23. Information on extended creep tests for temporary anchors is provided in FHWA-RD-82-047 (1982).

Table 23. Load schedule and observation periods for extended creep test for permanent anchor.

Loading Cycle	Maximum Cycle Load	Total Observation Period (min)	Movements measured at following times (min)
1	0.25DL	10	1, 2, 3, 4, 5, 6, 10
2	0.50DL	30	1, 2, 3, 4, 5, 6, 10, 15, 20, 25, 30
3	0.75DL	30	1, 2, 3, 4, 5, 6, 10, 15, 20, 25, 30
4	1.00DL	45	1, 2, 3, 4, 5, 6, 10, 15, 20, 25, 30, 45
5	1.20DL	60	1, 2, 3, 4, 5, 6, 10, 15, 20, 25, 30, 45, 60
6	1.33DL	300	1, 2, 3, 4, 5, 6, 10, 15, 20, 25, 30, 45, 60, 300

#### 7.4.4.3 Recording and Analysis of Extended Creep Test Data

The test data for an extended creep test should be plotted as shown in figure 72. The creep movement at any time is the difference between the total movement and the movement measured at one minute. Creep curves for a typical extended creep test are shown on figure 72. Each curve is for a separate load hold. The creep rate is defined as the slope of the curve per log cycle of time.

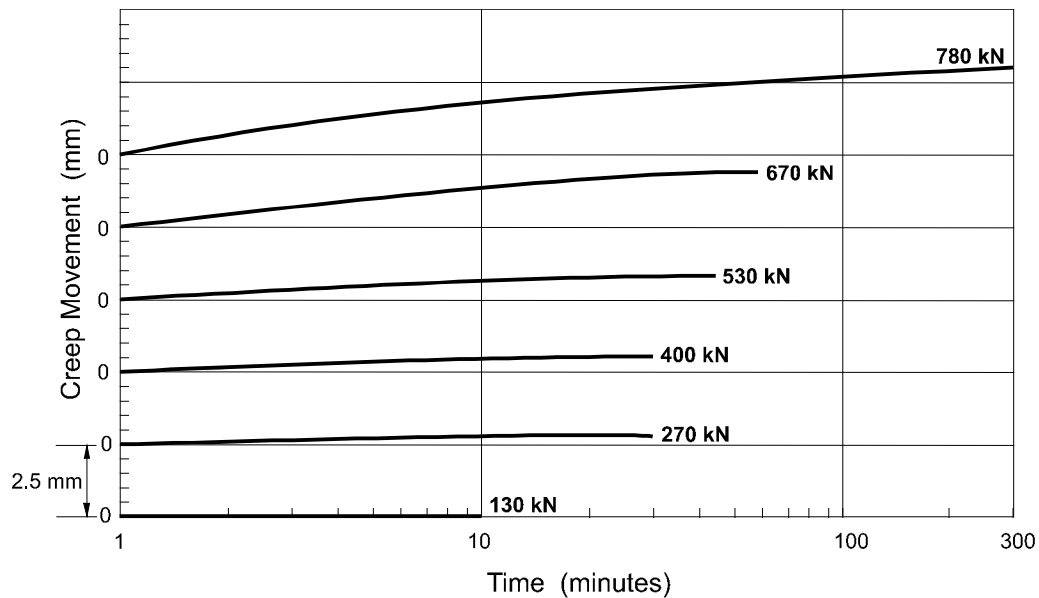

Figure 72. Plotting of extended creep test data (after PTI, 1996).

Extended creep test data are used in evaluating the acceptability of an anchor with respect to the creep acceptance criteria. Creep rates should be evaluated for each of the curves shown in figure 72. These creep rates are compared to the maximum specified rate.

## 7.4.5 Acceptance Criteria

### 7.4.5.1 General

An anchor may be put into service at the lock-off load following load testing if certain specified acceptability criteria are satisfied. These criteria, which are described herein, prescribe acceptable limits of creep (i.e., movement during load holds) and elastic movement measured during anchor load tests. The creep and elastic movement criteria have been integrated into an acceptance decision tree that is described in this section. This decision tree describes procedures that are to be used in the event that a specific criterion is not satisfied.

### 7.4.5.2 Creep

Creep testing, either as part of a performance or proof test or as an extended creep test, is performed on each production anchor to evaluate creep movement of the anchor grout body through the ground. For an anchor to be accepted, total movements measured during load holds must be below a specified limit.

For performance and proof tests, the measured total movement for the required load hold at the test load should not exceed 1 mm between 1 and 10 minutes. If the movements are less than the 1 mm for this period, the anchor is considered acceptable with respect to creep. As previously discussed, for load tests in which the measured total movement exceeds the criteria described above, the load is held for an additional 50-minute period of time. If the measured total movement over this additional time period does not exceed 2 mm between 6 and 60 minutes, then the anchor is considered acceptable with respect to creep.

For extended creep testing, the total movement for any load hold should not exceed 2 mm per logarithmic cycle of time (PTI, 1996) over the final log cycle of time of each load increment. Alternatively, the anchor load may be reduced to 50 percent of the load where acceptable creep movements were measured over the final log cycle of time.

### 7.4.5.3 Apparent Free Length

The apparent free length of a tendon forms the basis for evaluating the acceptability of a ground anchor with respect to elastic movement. The apparent free length is defined as the length of the tendon that is, based on measured elastic movements at the test load, not bonded to the surrounding ground or grout. The apparent free length,  $L_a$ , may be calculated using the following equation:

$$L_a = \frac{A_t E_s \delta_e}{P} \times \frac{1}{10^9} \quad (\text{Equation 49})$$

where:  $A_t$  is the cross sectional area of the prestressing steel,  $E_s$  is the Young's modulus of the prestressing steel,  $\delta_e$  is the elastic movement at the test load, and  $P$  is equal to the test load minus the alignment load. Standard SI units are:  $L_a$  (m);  $A_t$  ( $\text{mm}^2$ );  $E_s$  (kPa);  $\delta_e$  (mm); and  $P$  (kN). For proof

tests where the residual movement is not measured or estimated, the apparent free length may be calculated using the total movement in place of the elastic movement.

For long multistrand tendons, it is likely that the elastic modulus of the multistrand tendon will be less than the manufacturers elastic modulus for a single strand. Because of this, PTI (1996) recommends that a reduction in the manufacturers reported elastic modulus of 3 to 5 percent be allowed for satisfying apparent free length criteria.

#### *Minimum Apparent Free Length Criterion*

If the apparent free length is greater than the specified minimum apparent free length, it is assumed that the unbonded length has been adequately developed. The minimum apparent free length is defined as the jack length plus 80 percent of the design unbonded length. An apparent free length less than the specified minimum apparent free length may indicate that load is being transferred along the unbonded length and thus within the potential slip surface assumed for overall stability of the anchored system. Alternately, an apparent free length less than the specified minimum apparent free length may be caused by friction due to improper alignment of the stressing equipment or tendon within the anchorage. Where test results do not satisfy this criterion, the anchor may be subjected to two cycles of loading from the alignment load to the test load in an attempt to reduce friction along the unbonded length. The apparent free length is then recalculated based on the elastic movement at the test load for the reloaded anchor. A value greater than the jack length plus 80 percent of the design unbonded length may be used to define the specified minimum apparent free length for cases in which the redistribution of friction along the unbonded length could cause unacceptable structural movement or where there is the potential for prestressing loads to be transferred in the unbonded length by tendon friction.

#### *Maximum Apparent Free Length Criterion*

The acceptance criterion based on maximum apparent free length was used in the past when load transfer along the bond length was assumed to propagate at a uniform rate as the applied load was increased (see figure 65). For that assumption, the maximum value of apparent free length was restricted to elastic movements of 100 percent of the free length plus 50 percent of the bond length plus the jack length. However the concept of uniform distribution of bond is not valid for soil anchors and only approximates the behavior of most rock anchors. The primary use of this criterion is as an alternate acceptance criterion for proof tests in sound rock where creep tests are waived. Anchors that do not pass this preliminary criterion are subsequently creep tested to determine acceptability before a decision is made to reject the anchor.

#### 7.4.5.4 Ground Anchor Acceptance Decision Tree

PTI (1996) developed a ground anchor acceptance decision tree that is shown in figure 73. The decision tree does not include the maximum apparent free length criterion as this criterion is not routinely used. The purpose of the decision tree is to provide recommendations as to the field procedures that should be followed in the event that an anchor does not satisfy specified acceptance criteria. Anchors that do not satisfy the requirements for lock off at the design lock-off load may be locked off at a reduced load or replaced.

Whether an anchor satisfies the minimum apparent free length criterion is the first decision to be made using the decision tree. The ground anchor acceptance decision tree indicates that for an anchor to be put into service at the design lock-off load, the elastic movement (i.e., minimum apparent free length) criterion must be satisfied. The following sections provide information of the recommended procedures to be used for an anchor that has passed the minimum apparent free length criterion and for an anchor that has failed the minimum apparent free length criterion.

##### *Anchors That Pass Apparent Free Length Criterion*

For anchors which pass the minimum apparent free length criterion, but which do not pass the requirements of the creep test, the anchor may, if possible, be post-grouted. Those anchors that can be post-grouted will be retested and subject to an enhanced creep test and a more stringent acceptance criterion as compared to creep and extended creep tests. For this enhanced creep test, movements are monitored during a load hold at the test load for 60 minutes. The anchor may be locked off at the design test load if the total movement does not exceed 1 mm between 1 and 60 minutes. If the anchor does not satisfy this criteria, it can be either rejected and replaced or locked off at 50 percent of the load that the anchor holds without detectable movement. If the anchor cannot be post-grouted, it may either be rejected and replaced or locked-off at 50 percent of the load that the anchor holds without detectable movement.

##### *Anchors That Fail Minimum Apparent Free Length Criterion*

Anchors which fail the minimum apparent free length criterion may be either locked-off at a load no greater than 50 percent of the maximum load attained during testing or rejected and replaced. Replacement anchors must satisfy all project specifications. Changes in ground anchor locations require approval from the design engineer. Where anchors are installed using prefabricated connections to steel beams or sheet-piles, the failed anchor must be removed from the connection or a new connection must be fabricated. Connections may not be offset from the center of a soldier beam for a permanent anchor. Off-center connections will induce adverse bending and torsional stress on the soldier beam and bending stresses in the tendon.

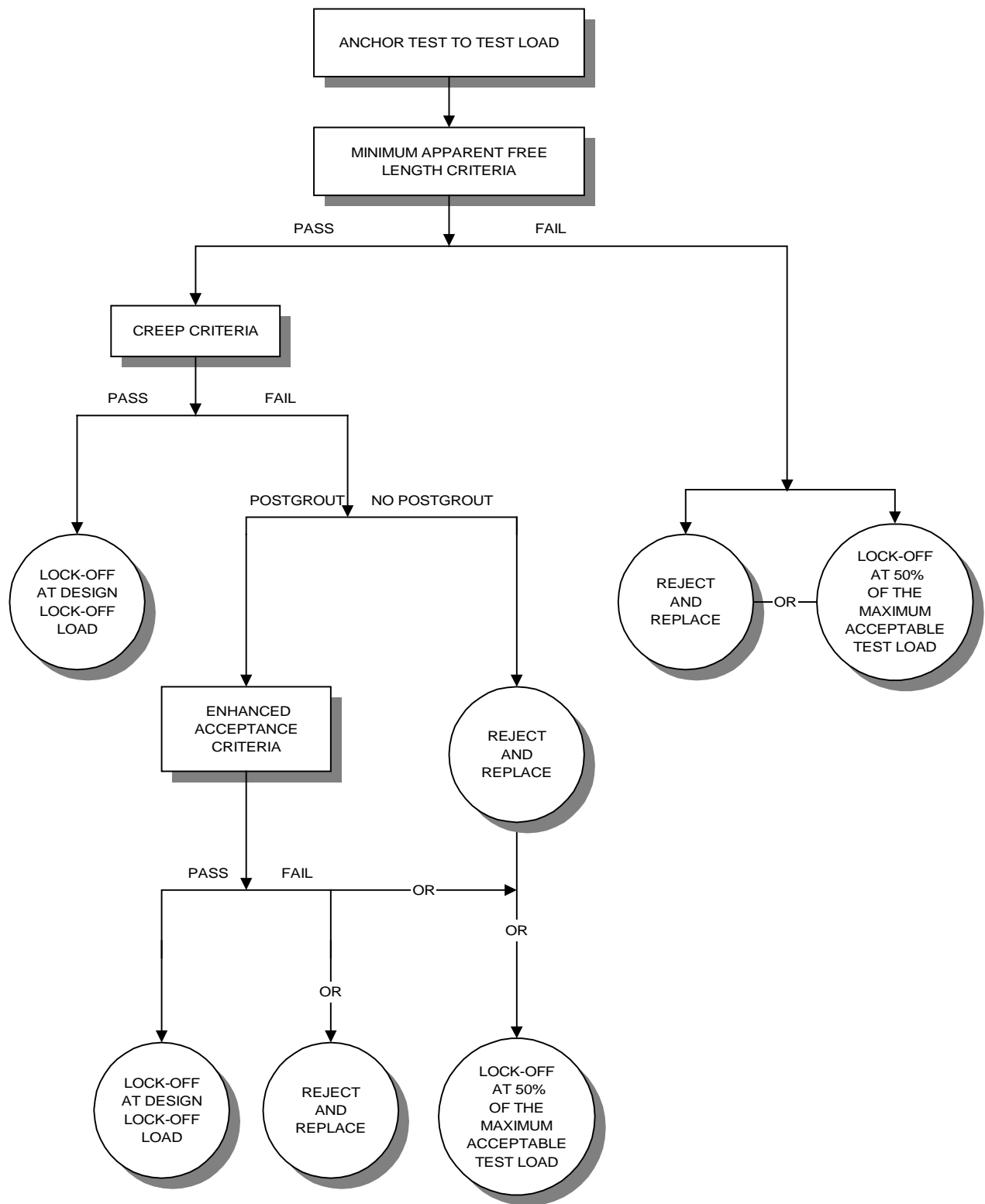

Figure 73. Ground anchor acceptance decision tree (after PTI, 1996).

#### 7.4.5.5 Modification of Design or Installation Procedures

Multiple failures early in construction or multiple failures of adjacent anchors should be cause to reassess subsurface conditions and/or design and installation procedures. Modifications to design and installation procedures commonly include: (1) changing installation methods or anchor type; (2) increasing the anchor length or anchor bond length or changing the inclination of the anchor; or (3) reducing the anchor design load by increasing the number of anchors. A description of any proposed changes should be submitted to the owner in writing for review and approval prior to implementing the changes.

### 7.5 ANCHOR LOCK-OFF LOAD

After load testing is complete and the anchor has been accepted, the load in the anchor will be reduced to a specified load termed the “lock-off” load. When the lock-off load is reached, the load is transferred from the jack used in the load test to the anchorage. The anchorage transmits this load to the wall or supporting structure.

The lock-off load is selected by the designer and generally ranges between 75 and 100 percent of the anchor design load, where the anchor design load is evaluated based on apparent earth pressure envelopes. Lock-off loads of approximately 75 percent of the design load may be used for temporary support of excavation systems where relatively large lateral wall movements are permitted. Since apparent earth pressure diagrams result in total loads greater than actual soil loads, lock-off at 100 percent of the design load typically results in some net inward movement of the wall. Lock-off loads greater than 100 percent of the design load may be required to stabilize a landslide. For this case, structural elements must be sized to transmit potentially large landslide forces into the ground. Loads consistent with the required landslide restraint force to obtain a target slope stability factor of safety are selected for the lock-off load.

When transferring the lock-off load to the anchorage, the load will inevitably be reduced owing to mechanical losses associated with the physical transfer of load between two mechanical systems (i.e., the jack and the anchorage). These losses are referred to as seating losses and are generally on the order of 1.6 mm for bar tendons and 6.4 mm for bare strand tendons (FHWA-DP-68-1R, 1988). For strand tendons, seating losses occur as the jack ram is retracted and the wedges are pulled in around the tendon. The wedges must be seated at a load no less than 50 percent of the ultimate load for the tendon. This will prevent possible strand slip through the wedges if the load in the tendon increases above the lock-off load during the service life. For epoxy coated strand, the wedges must bite through the epoxy coating; this results in additional seating losses. To account for seating losses, after the tendon is loaded to the lock-off load, the jack ram is extended by an amount equivalent to the anticipated seating loss.

In the long-term, the load will also reduce due to relaxation in the prestressing steel. Long-term load losses may be estimated as 4 percent for strand tendons and 2 percent for bar tendons (FHWA-DP-68-1R, 1988). Specific information on relaxation losses should be obtained from the tendon supplier. To account for these load losses, the load that is transferred to the anchorage may be

increased above the desired load based on results of a lift-off test. After the losses, the transferred load will reduce presumably to the desired long-term load.

## **7.6 LIFT-OFF TESTING**

After the load has been transferred to the anchorage, a lift-off test is performed. The purpose of a lift-off test is to verify the magnitude of the load in the tendon. For strand tendons, the lift-off test is performed by gradually reapplying load to the tendon until, for restressable anchor heads, the wedge plate lifts off the bearing plate (without unseating the wedges) or, for cases where the hydraulic jack rests on the anchor head, the wedges are lifted out of the wedge plate. For bar tendons, the lift-off test is performed by gradually reapplying load to the tendon until the anchor nut lifts off the bearing plate (without turning the anchor nut). Lift-off is evidenced by a sudden decrease in the rate of load increase as observed on the jack pressure gauge. The load measured during the lift-off test should be within five percent of the specified lock-off load. Where this criterion is not met, the tendon load should be adjusted accordingly and the lift-off test repeated.



## CHAPTER 8

### CONTRACTING APPROACHES

#### 8.1 INTRODUCTION

The purpose of this chapter is to describe contracting approaches that are commonly used in developing construction contract documents for permanent anchored systems. Three contracting approaches may be used for anchored systems and are described herein. These include: (1) method approach; (2) performance approach; and (3) contractor design/build approach. The responsibilities of the owner and the contractor with respect to design, construction, and performance of the wall vary for each of these approaches. However, many years of experience in contracting for anchored walls has shown that the owner should not specify the installation details of the anchor. All contracting approaches should use performance based acceptance criteria for the anchors. Contracting approaches for anchored walls and other wall systems are also described elsewhere (e.g., Nicholson and Bruce, 1992; Deaton, 1994; FHWA-DP-96-69R, 1998; FHWA-RD-97-130, 1998).

- *Method Approach:* Method specifications are used for owner or material-supplier designs. In the contract documents, wall construction materials and the execution of construction are explicitly specified except for the selection of the anchor type and the anchor installation details. This contracting approach is discussed further in section 8.2.
- *Performance Approach:* This type of contracting specification, also referred to as an *end result* specification, uses approved or generic wall systems or components. Included in the contract documents are lines and grades, as well as specific geometric, design, and performance criteria. For this approach, the contractor submits project-specific design calculations and plans for owner review in conjunction with normal working drawing submittals. This contracting approach is discussed further in section 8.3.
- *Contractor Design/Build Approach:* This type of contracting approach is similar to the performance approach, except the responsibility for design, construction, and performance of the completed anchored wall is placed solely on the specialty contractor. This method requires a strict prequalification process as part of the selection of the specialty contractor. Performance-based submittals should be provided to the owner at key times during design and construction. This contracting approach is discussed further in section 8.4.

Each of these contracting approaches may be used for an anchored wall, if properly implemented. Often the approach will be selected based on the experience of the owner and their engineering consultants with anchored systems, the complexity of the project, the availability of specialty contractors or material suppliers, and the local highway agency philosophy with respect to contracting methods.

Regardless of which contracting approach is chosen for a specific project, it is highly desirable that each owner develops a formal policy with respect to design and contracting of anchored systems. The general objectives of such a policy are to:

- obtain local highway agency uniformity in selection of anchored systems and other earth retaining system alternatives;
- establish standard policies and procedures for technical review and acceptance of proprietary and generic anchored systems and other earth retaining systems;
- establish internal agency responsibility for the acceptance of new anchored systems and other earth retaining systems and/or components, and for plan preparation, design review, and construction control;
- develop uniform design and performance criteria standards and construction and material specifications for anchored systems and other earth retaining systems; and
- establish guidelines for the selection of method, performance, or contractor design/build contracting approaches.

## **8.2 METHOD CONTRACTING APPROACH**

### **8.2.1 Introduction**

The method contracting approach includes the development of a detailed set of plans and material and construction specifications for the bidding documents. However, the selection and installation of the anchors should be the responsibility of the contractor. The contract documents should only establish minimum dimensions for drill hole diameter, unbonded length, and bond length. The contractor should select the necessary anchor installation dimensions and techniques to successfully pass the acceptance tests. In no case should the owner specify the installation details for the anchors. The advantage of the method approach is that the complete design and specifications are developed and reviewed over an extended design period. This approach enables the owner's engineers to examine various options during design, but requires an engineering staff trained in all areas of earth retaining system technology. The method contracting approach is best suited where the owner has developed significant experience in design and construction of anchored walls.

A disadvantage of the method approach is that for alternate bids, more sets of designs must be reviewed. Therefore, agency resources must be expended even though only one wall system will be constructed. Another disadvantage is that agency personnel may be unfamiliar with newer and potentially more cost-effective systems and may not consider them during the design stage. Similarly, proprietary equipment and methods used by particular anchored system contractors may be unfamiliar to agency personnel and will therefore not be considered.

When a method contracting approach is adopted, the owner and the owner's inspector are fully responsible for the design and performance of the anchored wall provided the contractor has constructed the system in full accordance with the specifications. In the event that changes are necessary, the owner must be prepared to direct and pay for the contractor's work.

## 8.2.2 Contract Documents for Method Approach

The contract documents in the method approach consist of drawings, specifications, and bidding items and quantities. The contract can be bid on a lump sum basis or following a detailed unit price list. Drawings prepared using the method approach should typically include at least the following items:

- horizontal alignment of the wall identified by stations and offset from the horizontal control line to the face of the wall and all appurtenances that affect construction of the wall;
- elevation at the top and bottom of the wall, beginning and end stations for wall construction, horizontal and vertical positions at points along the wall, and locations and elevations of the final ground line;
- cross sections showing limits of construction, existing underground interferences such as utilities or piles supporting adjacent structures, any backfill requirements, excavation limits, as well as mean high water level, design high water level, and drawdown conditions, if applicable;
- notes required for construction including general construction procedures and all construction constraints such as staged construction, vertical clearance, right-of-way limits, construction easements, noise and air quality requirements, etc.;
- typical sections and special details;
- dimensional and alignment tolerances during construction;
- all details for connections to traffic barriers, copings, parapets, noise walls, and attached lighting; and
- payment limits and quantities.

In addition to the items described above, other items specific to anchored walls should be included in the bidding documents. These include:

- size, type, location, method of installation, and minimum embedment depth of all wall elements;
- thickness of timber lagging and all details for facing installation, thickness, size, type, and finish, and final facing connections to soldier piles or sheet-piles and/or walers;
- location of all ground anchors and structural connection details for the anchor to the sheet-pile, soldier beam, or waler system;
- corrosion protection requirements or details for the anchorage, the unbonded length, and the bond length;
- required ground anchor capacity, inclination, minimum unbonded length, and minimum

anchor bond length for each anchor; and

- requirements or details for methods and frequency of proof, performance, extended creep, and lift-off testing of anchors, ground anchor acceptance criteria, and required lock-off load.

## **8.3 PERFORMANCE CONTRACTING APPROACH**

### **8.3.1 Introduction**

For the performance contracting approach, the owner establishes the scope of work and prepares drawings showing the geometric requirements of the anchored wall, design loadings, material specifications or components that may be used, performance requirements, and any instrumentation or monitoring requirements.

The performance approach offers several benefits over the method approach when used with appropriate specifications and prequalification of suppliers, specialty contractors, and materials. Design of the structure is the responsibility of the contractor and is usually performed by a trained and experienced contractor or engineering consultant. This enables engineering costs and manpower requirements for the owner to be decreased since the owner's engineer is not preparing a detailed design, and transfers some of the design cost to construction.

The disadvantage of the performance approach is that the owner's engineers may not be experienced with anchored system technology and, therefore, may not be fully qualified to review and approve the wall design and any construction modifications. Newer and potentially more cost-effective methods and equipment may be rejected due to the lack of confidence of owner personnel to review and approve these systems.

Three principal methods have been used to implement the performance approach for anchored walls. These methods are referred to as *pre-bid wall design*, *pre-bid typical section design*, and *post-bid design* and are described in subsequent sections. Differences between these methods are associated with the required time to perform the design. Other methods such as *two-phase bidding* and *negotiated work* proposals have been used for specialized anchor projects (see Nicholson and Bruce, 1992).

### **8.3.2 Implementing Performance Contracting Approach**

#### **8.3.2.1 Pre-bid Wall Design**

Contract documents for pre-bid wall designs are prepared to allow for various retaining wall alternates. With this method, the owner contacts specialty contractors and informs them that a retaining wall is being proposed for a site. The owner requests that the contractors prepare detailed wall designs prior to the advertisement of the bid. The designs are based on owner-provided line and grade information, geotechnical and subsurface information, and design requirements. Approved designs are then included in the bid documents. This approach allows the owner to review design details based on submittals from several contractors. Because of the detail that must be provided with this type of a submission, only those contractors who have significant expertise and experience

in anchored systems are likely to prepare the required submission. The owner should prepare and include a generic wall system design in the bid documents to enable general contractors to decide whether they want to use the generic design or a design from a specialty contractor.

#### 8.3.2.2 Pre-bid Typical Section Design

With pre-bid typical section design, schematic or conceptual plans are developed by prequalified specialty contractors based on geometric and performance requirements specified by the owner. Sufficient detail must be provided by the specialty contractor to enable the owner to judge whether the approach of the contractor is acceptable. Contractors will typically exclude details which they believe are unique to their design. The advantage of this approach compared to pre-bid wall design is that specialty contractors are more likely to submit their solutions for review and inclusion in the bid documents. With this approach, only limited preparation effort is required by the contractor, and development of a detailed design and working drawings is only necessary if they are the successful bidder.

The disadvantage of this approach is that total project requirements are less well defined and may lead to misunderstandings and claims. In cases where the general contractor will not be constructing the anchored system, the apparent lack of detail using this approach may result in problems during construction because the general contractor does not fully understand the design. For example, the approved tolerances on soldier beam installation may require additional concrete for the facing than the general contractor anticipated (Deaton, 1994).

#### 8.3.2.3 Post-bid Wall Design

Like pre-bid wall design and pre-bid typical section design, the post-bid wall design approach allows for various prequalified contractor-designed wall alternates. In the bid documents, each wall and acceptable alternates are identified. Design requirements for each wall type are contained in the special provisions or standard agency specifications. General contractors receive bids from prequalified specialty contractors and subsequently select a specialty contractor-prepared wall design and wall price to include in their bid. Once the contract is awarded, if the general contractor decides to build the anchored system, he then requests that the selected specialty contractor prepare detailed design calculations and a complete set of working drawings for owner review and approval. Upon approval, the walls are built in accordance with the working drawings. When an owner uses this type of contract, they benefit from the experience of the wall contractors or supplier. However, they do not have as much control over the finished product as they do when they require the pre-bid approval of the working drawings. Also, since the general contractor wants to minimize risk, he will likely not select an alternate design unless the construction cost savings is significant.

### 8.3.3 Contract Documents for Performance Approach

Regardless of which performance approach is used, the owner must prepare and include as part of the contract documents geometric and site data, design guidelines, and performance requirements. Also, for performance specifications, an instrumentation and monitoring program is usually included as part of the design. For anchored systems, this monitoring program will typically include requirements with respect to performance, proof, and extended creep tests. Minimum levels of instrumentation to be used by the contractor and threshold values against which the monitoring data will be evaluated are also included. Required information is listed below:

#### *Geometric and Site Data*

- horizontal alignment of the wall identified by stations and offset from the horizontal control line to the face of the wall and all appurtenances that affect construction of the wall;
- elevation at the top and bottom of the wall, beginning and end stations for wall construction, horizontal and vertical positions at points along the wall, and locations and elevations of the final ground line;
- cross sections showing limits of construction, any backfill requirements, excavation limits, as well as mean high water level, design high water level, and drawdown conditions, if applicable;
- all construction constraints such as staged construction limitations, vertical clearance, right-of-way limits, construction easements, etc.;
- location of utilities, signs, etc., and any loads that may be imposed by these appurtenances; and
- data obtained as part of a subsurface investigation and geotechnical testing program;

#### *Design Guidelines*

- reference to specific governing sections of appropriate agency design manuals (materials, structural, hydraulic, and geotechnical), construction specifications, and special provisions; if none are available, reference to current AASHTO Standard Specifications may be used;
- magnitude, location, and direction of external loads due to bridges, overhead signs and lights, and traffic surcharges;
- limits and requirements of drainage features beneath, behind, above, or through the structure;
- seismic design requirements;
- minimum factors of safety for potential failure mechanisms such as overall stability, pullout failure of the anchor, rupture of the anchor tendon, axial and lateral wall capacity, etc.;
- geotechnical design parameters such as friction angle, cohesion, and unit weight, as well as

electrochemical properties of the soils to be utilized; and

- type, size, and architectural treatment of permanent facing;

#### *Performance Requirements*

- design life for the structure and corrosion protection requirements;
- all testing requirements and acceptance criteria for ground anchors;
- tolerable horizontal and vertical movements of the structure and methods of measuring these movements when movement sensitive structures exist behind the wall; in general, the owner should consider the need for movement control when structures are located within a horizontal distance from the top of the wall equal to one-half the wall height; and
- permissible range of variation in ground water levels and methods of ground water level measurement; in general the owner should consider the need for ground water control when existing structures are located near the wall.

#### **8.3.4 Review and Approval**

Where a performance contracting approach is used, the review process may be made prior to or after the bid, depending on the method used. The evaluation by agency structural and geotechnical engineers must be rigorous and consider as a minimum the following items:

- conformance to the project line and grade;
- conformance of the design calculations to the agency standards or special provisions or codes such as the current AASHTO Standard Specifications with respect to design methods;
- corrosion protection details;
- development of design details at obstructions such as drainage structures or other appurtenances;
- external and internal drainage features and details;
- architectural treatment of the wall face;
- monitoring methods as required by the performance specifications; and
- field testing program details for evaluating the capacity of the anchors.

## **8.4 CONTRACTOR DESIGN/BUILD APPROACH**

For the contracting approaches previously described, the owner and contractor share responsibility in the design and construction of the anchored system. With the contractor design/build method, the owner outlines the project requirements, obtains complete subsurface and geotechnical information, and provides construction quality assurance. The specialty contractor is responsible for the complete design, construction, and performance of the anchored system. A design/build proposal may be submitted either before the bid advertisement (pre-bid) or after the contract award (post-bid). This method is most often used for securing bids on temporary ground anchor projects. This method has been used on permanent anchored wall projects. The key elements for a successful contract are communication of basic design concepts to the owner and the joint development of a quality assurance plan prior to construction.

## **8.5 RECOMMENDATIONS**

The three contracting approaches described above have been used to contract ground anchor and anchored system work. Regardless of the contracting approach selected, a performance based approach should be used for the construction details of the anchor. Specialty contractors have developed various anchored systems, construction equipment, and construction methods which are appropriate for specific soil/site conditions. It is in the competitive interest of the specialty contractor to remain current on latest innovations in the field. Public agencies can, therefore, benefit from these innovations by specifying anchor performance requirements rather than specific components of the anchored system. The owner must specify certain minimum requirements such as corrosion protection for the ground anchors and other components, minimum unbonded and bond length, and inclination and total anchor length based on right-of-way restrictions and acceptance/rejection criteria for the anchor system and anchor system components. It is recommended that construction details should be the sole responsibility of the contractor.

Prequalification of specialty contractors is essential. Prequalification should be based on successful experience in design and construction of anchored systems in similar ground conditions and in the region where the proposed anchored system is to be constructed.



## **CHAPTER 9**

# **CONSTRUCTION INSPECTION AND PERFORMANCE MONITORING**

### **9.1 INTRODUCTION**

The purpose of this chapter is to provide guidance regarding construction inspection and performance monitoring of anchored systems. Inspection is the primary mechanism to assure that the anchored system is constructed in accordance with the project plans and specifications. Short-term and long-term monitoring are conducted to assess the performance of the anchored system. Construction inspection activities can be carried out by the owner agency, the contractor, or a combination of both, depending on the contracting approach (i.e., method, performance, or design-build), while performance monitoring is usually conducted by the owner agency. Inspection and monitoring of permanent anchored systems which are constructed using performance specifications are described in this chapter.

Inspection activities, if properly conducted, play a vital role in the production of a high-quality anchored system because conformance to project plans and specifications should result in an anchored system that will perform adequately for the intended service life. Inspection may involve evaluation of the following: (1) conformance of system components to material specifications; (2) conformance of construction methods to execution specifications; and (3) conformance to short-term performance specifications. A valuable source of information on proper anchor construction inspection practices is provided in the Ground Anchors Inspector's Manual which is contained in the AASHTO Task Force 27 report (AASHTO, 1990).

Monitoring activities may include short-term or long-term measurements of anchored system performance. Short-term (during construction) monitoring is usually limited to monitoring measurements of anchored system performance during load testing (i.e., performance, proof, and extended creep tests). In some cases, short-term monitoring may include, for example, monitoring lateral wall movements and ground surface settlements, and more extensive measurements for anchors, oftentimes motivated by performance requirements. Long-term monitoring of the anchored system usually includes a continuation of measurements from short-term monitoring.

### **9.2 INSPECTION ROLES UNDER CERTAIN CONTRACT APPROACHES**

For an anchored system contracted using the method approach, inspection activities are carried out by the owner agency based on comprehensive material and procedural requirements of owner-provided plans and specifications. The contractor responsibility is to follow the project plans and specifications. The owner's inspection is conducted to assure strict compliance with each component of the specification

For the performance contracting approach, the contractor carries out many inspection activities. The owner agency will carry out a limited number of inspection activities as required by project specifications, primarily to verify that requirements are met for materials, equipment, construction

tolerances, and sequencing. The contractor selects the equipment and construction procedures used and he is responsible for demonstrating that the final constructed system satisfies specified performance criteria.

For the design-build approach, the performance of all required inspection activities are carried out by the contractor or are the responsibility of the contractor in accordance with the quality assurance plan approved by the owner. Random quality control tests are done by the owner agency.

### **9.3 PRE-PROJECT PREPARATION**

Prior to construction, the inspector must have an understanding of the project and specification requirements, particularly as related to inspection responsibilities, site and subsurface conditions, and material and construction requirements. Inspection responsibilities should be defined at a preconstruction meeting with the general contractor and all subcontractors (e.g., wall contractor and excavation contractor) involved in the wall construction. The inspector must understand the intended function of the anchored system and individual system components, particularly as they relate to the stability of the system. Sources of information should include geotechnical reports, contract plans, and specifications. The inspector should contact the project engineer at the start of the project to discuss critical design aspects and potentially difficult site and subsurface conditions.

### **9.4 INSPECTION OF CONSTRUCTION MATERIALS**

#### **9.4.1 Introduction**

Contract specifications for anchored systems include a description of acceptable materials and prefabricated elements for use as wall and ground anchor components. General wall components include steel beams, structural and lean-mix concrete, timber lagging, various drainage elements including geosynthetics, aggregate, and pipes, and either cast-in-place or precast facing elements. General anchor components include prefabricated tendons (or materials for on-site fabrication), anchorage components, grout, spacers, centralizers, and various corrosion inhibiting materials such as greases and concrete.

Specifications describe minimum requirements for wall and ground anchor materials and prefabricated elements. These minimum requirements may be defined explicitly or by reference to standard specifications such as those set forth by AASHTO and ASTM. Standard specifications for wall and anchor components are referenced in the materials section of the example specifications provided in appendix E and F of this document. Explicit requirements may be in the form of a prequalified product such as a particular precast facing or characteristics such as shape, dimensions, or material property. Recommendations for the storage and handling of selected materials are commonly included in specifications.

Conformance to a specification requirement is commonly assessed in one of the following ways: (1) reviewing manufacturer or supplier certification submitted by the contractor; (2) reviewing of product literature and visual inspection; or (3) conformance testing. All materials and prefabricated elements delivered to the site must be visually examined prior to installation to verify required

geometry and dimensions and to identify any defects in workmanship, contamination, or damage by handling. All nonconforming materials are unacceptable, unless appropriate corrections are made in accordance with specifications or by written approval of the project engineer.

#### **9.4.2 Inspection of Wall Materials**

Steel elements including sheet-piles and soldier beams are generally accepted based on satisfactory Mill Test Certificates. The properties listed on the Mill Test Certificate must be checked for conformance with specifications. There should be no observable damage to sheet-piles or soldier beams. Sheet-piles should be straight, uniform in shape, and have interlocks in good condition. The lengths of soldier beams must be verified against the schedule on the approved working drawings.

Cement grout for the ground anchor is generally accepted based on successful testing of the completed ground anchor and use of approved cement types. Admixtures may only be used as allowed by specifications or upon approval by the design engineer. Random grout cubes may be taken during grouting of the anchor but are usually only tested for diagnosing the cause of an anchor failure.

Structural and lean-mix concrete must conform to minimum strength requirements and cement type as detailed in specifications. Admixtures must only be used as allowed by specifications or approval of the design engineer. The exposed face of precast panels should have a uniform finish and be in accordance with specifications. The face not exposed to view should have a uniform surface without significant pockets or surface distortions.

Geocomposite drains, drainage pipe, drainage gravel, and timber lagging should be accepted based on review of manufacturer's certification and/or product labeling to verify conformance to project specifications. For geocomposite drains, the contractor should submit certification from the manufacturer stating that the proposed geocomposite drain is capable of withstanding design loadings at all planned locations without appreciably decreasing the hydraulic capacity of the geocomposite drain. Drainage gravel should meet minimum specified requirements with respect to gradation. Where specified, stress grading and preservative treatment of timber lagging must be verified by material certification provided by the contractor. Preservative treatments are usually only specified for lagging used as permanent wall facing. If specified, minimum lagging thickness should also be verified.

#### **9.4.3 Inspection of Ground Anchor Materials**

Materials used to fabricate bar and strand tendons (i.e., prestressing steels, encapsulations, spacers, centralizers, corrosion inhibiting compounds) must conform to minimum requirements as described in the specification. For each tendon, the diameter of the tendon, total length of the tendon, and length of unbonded and bonded zones should be verified. Submittal requirements with respect to the ground anchors are provided in the ground anchor specification (appendix E).

Corrosion protection of the tendon must be checked for strict compliance with the level of corrosion protection and component dimensions required by the plans and specifications. The quality of

fabrication and condition of the corrosion protection must be verified, particularly that: (1) the steel is undamaged; (2) for encapsulated tendons, the complete filling with grout between the prestressing steel and the encapsulation tube and the undamaged condition of the encapsulation tube; (3) for epoxy-coated tendons, the unbroken coverage of coatings; (4) the continuity of corrosion protection transition between the unbonded and bonded lengths; and (5) corrosion inhibitors cover prestressing steel elements in individual strand and tendon sheaths.

On-site assembly of tendons must be performed using approved materials in accordance with manufacturer's procedures. When encapsulated tendons are pregrouted, methods should be used to ensure that voids do not form in the grout. Voids are commonly minimized by proper selection of centralizers and grouting with the tendons on an inclined, rigid frame or bed and injecting the grout from the low end of the tendon. Encapsulations for strand anchors are commonly grouted within the borehole simultaneously with anchor grouting.

#### **9.4.4 Storage and Handling of Construction Materials**

Tendons and steel reinforcement should be stored and handled in accordance with manufacturer's recommendations. Steel tendons should be stored above the ground surface and be protected against mechanical damage and exposure to weather. Tendons should be lifted using fiber ropes or webbing and should be supported at several locations along the tendon to prevent excessive bending. Epoxy coated steel should be transported and stored on wooden or padded supports. Repairs to epoxy coatings should be performed in accordance with manufacturer's recommendations.

Cement and resin based materials should be stored in a dry location and in such a way as to prevent deterioration. Cement that is caked or lumpy should not be used. Resin grouts and all grouts in cartridge form should be stored in accordance with manufacturer's recommendations and should not be used after expiration of the recommended shelf life.

Timber should be neatly stacked. Untreated material should be stacked above the ground and in such a way as to permit the proper circulation of air around the timbers. Treated timber should be handled without breaking or penetrating outer wood fibers.

Care should be taken during storage, handling, and hoisting of precast facing panels to prevent cracking or damage. Lifting devices should be used in a manner that does not cause damaging torsional or bending forces. Geocomposite rolls should be wrapped to protect from precipitation and debris. Exposure of geocomposite to direct sunlight should be avoided.

### **9.5 INSPECTION OF CONSTRUCTION ACTIVITIES**

#### **9.5.1 Surface-Water Control**

Appropriate drainage measures to prevent surface-water from entering wall construction limits should be maintained throughout the construction period. After excavation for each anchor level, the excavated surface should be graded away from the wall to maintain a relatively dry working area. Drainage measures should be employed to prevent surface-water from overtopping the wall.

If required, permanent drainage systems must be in place at the end of construction. Water should be directed away from the wall face both at the final excavation level and the ground surface above the wall usually either by grading or by collecting and transporting surface water in ditches and pipes. Permanent drainage systems should not allow surface-water to enter the wall drains.

## **9.5.2 Vertical Wall Element Installation**

### **9.5.2.1 Drilled-in Soldier Beams**

The installation of soldier beams by predrilling is used to: (1) set soldier beams at precise locations (as may be required for precast facing); (2) penetrate very hard soils, ground with cobbles or boulders, or rock; (3) allow for prefabrication of ground anchor connection devices to soldier beams; and (4) minimize noise and vibration, where required. During drilling, the inspector should carefully observe to identify any significant deviation from ground conditions assumed for design.

Care should be taken to prevent caving of the hole, particularly where nearby structures or utilities may be subject to settlement damage. Where caving occurs, casing or approved drilling fluids should be used. After drilling is completed, the hole should be cleaned out to the elevation shown on the working drawings. A nominal thickness of concrete may then be placed at the bottom of the hole to assist in aligning the soldier beam prior to placement of concrete backfill. The soldier beam is then inserted, properly oriented, and plumbed and braced. The plan location and elevation of the top of the soldier beam should be measured to verify compliance with specified tolerances. The hole is then backfilled with either structural or lean-mix concrete to the final excavation level. From the final excavation level to the existing ground surface, the hole is backfilled with lean-mix concrete.

### **9.5.2.2 Driven Soldier Beams**

Where soldier beams are driven, the pile driving equipment should be appropriately sized and in good working order. Crane supported leads should support the pile hammer and soldier beam in alignment during driving to provide a concentric impact for each blow. Prior to the start of driving, a survey of the condition of nearby structures should be performed and the clearance of overhead utilities by pile driving equipment checked. Driven soldier beams and sheet-piles produce vibrations that may damage adjacent structures. Information on evaluating the potential for vibration-induced damage may be found in NCHRP Synthesis 253 (1997).

Driven soldier beams must penetrate to the tip elevation shown on the plans without damage. Where pile alignment tolerances are very small or penetration of the ground is difficult, a driving shoe should be attached to the pile tip to prevent damage to the pile. If prefabricated ground anchor connections are used, the soldier beams must not penetrate beyond the targeted elevation to permit the anchor to be installed at the planned elevation.

All pile tops should be inspected for damage after driving is complete. Driving records of adjacent piles should be compared. Differences in records may indicate that different ground conditions have been encountered and that pile driving procedures may need to be changed. Soldier beams which are improperly driven, damaged, or which deviate from planned locations and alignment, may need to be

removed and replaced based on the recommendations of the design engineer. Where measurements of lateral wall movement are required, a slope inclinometer may be attached to the soldier beam. Prior to driving, a steel angle is welded between the flange and the web of the soldier beam to accommodate the inclinometer casing. If soldier beams become excessively damaged from pile driving, then soldier beams should be drilled-in. Additional information on inspection of driven piles is provided in FHWA-HI-97-013 (1996).

### 9.5.2.3 Sheet-Piles

Sheet-piles are usually driven into the ground using either impact or vibratory hammers. When impact hammers are used, the pile hammer and driving cap should be properly selected to prevent excessive damage to the top of the pile and to keep adjacent piles from being driven out of their interlock. When driving through relatively hard soils, regular inspection should be performed to assess damage to sheet-pile tops and the ball and socket of the interlock. Vibratory driving is especially suited for rounded-grain cohesionless soils and soft soils.

Sheet piles are usually driven in pairs or in panels. Installation should lead with the ball of the sheet-pile. If installation leads with the socket of the sheet-pile, the socket may clog with soil and make it difficult to install the adjacent pile. A guide frame (or template) is often utilized to achieve proper horizontal and vertical sheet-pile alignment. If the specifications require, after installation the tops of sheet-piles should be neatly cut off in a straight line at the elevation shown on the plans.

## 9.5.3 Excavation

Excavation to the top elevation of the wall is performed prior to installation of vertical wall elements. The sequence of wall excavation and anchor installation outlined in project plans and specifications is designed to maintain stability of the wall system and integrity of surrounding structures. It is imperative that the specified construction sequence and excavation methods (i.e., mass excavation or slotted) be adhered to and that overexcavation below the elevation of each anchor be limited to 0.6 m, or as defined in the specifications. Excavation below a level of anchors must not begin until all nearby anchors at that level are installed and locked off. Any changes in the construction sequence must be approved by the design engineer prior to implementation.

## 9.5.4 Anchor Construction

### 9.5.4.1 Introduction

In this section, key inspection activities associated with the construction of ground anchors are described. Personnel providing inspection services for any anchored system should be familiar with the detailed recommendations for anchor construction and inspection provided in PTI (1996) and AASHTO (1990). Unless specified in project documents, the selection of drilling methods and equipment for construction of the ground anchor should be left to the discretion of the contractor. The inspector must observe and record the method of installation and installation problems. Where installation problems occur, the inspector should discuss with the contractor how to modify

procedures to correct the problem. Any modifications of procedures which are not allowed by project specifications must be approved in writing by the design engineer prior to implementation. The inspector must also have an understanding of anchor construction methods that may be utilized and be able to identify when certain practices are inappropriate.

#### 9.5.4.2 Anchor Hole Drilling

Methods for anchor hole drilling are left to the discretion of the contractor. The selection of drilling method should account for special concerns identified in project specifications such as noise, vibrations, hole alignment, and damage to existing structures. The inability of the contractor to establish a stable hole of adequate dimensions and within specified tolerances may be cause for modification of drilling methods. Potential causes of hole instability have been described in chapter 2. Additional information on drilling methods used in anchor drill hole construction is provided in Section 7.3 of PTI (1996).

Anchor holes should be drilled at specified locations and tolerances as shown on the approved drawings. Drilling tolerances include length, orientation, and diameter. Common practice is to drill beyond the design length to permit better drill hole cleaning. The ground anchor must not be drilled at a location that requires the tendon to be bent to enable the anchorage to be connected to the anchored system. Orientation of the anchor hole both vertically and horizontally should be checked at the onset and during drilling.

Soil and rock types and ground conditions should be recorded during drilling. Unexpected conditions should be carefully documented, and where appropriate, samples should be taken. Drill cuttings and soil exposed in the excavation should be visually classified to identify ground which may be susceptible to caving. Ground which may be susceptible to caving includes: (1) cohesionless soils below the groundwater table; (2) highly fractured or weathered rock; and (3) ground where artesian water pressures exist. Signs of caving include: (1) an inability to withdraw drill steel; (2) a large quantity of soil removed with little or no advancement of the hole; (3) abnormally large drill spoil pile in comparison to other holes; (4) settlement of ground above the drilling location; and (5) an inability to easily insert the anchor tendon the full length of the drill hole. Where excessive caving occurs drilling should be halted, and alternative drilling methods should be used, such as using drilling fluids or casing to stabilize the drill hole.

Drilling muds and/or foams used for drilling anchor holes must be approved in project specifications or by the design engineer. Bentonite mud should not be used in uncased holes because the bentonite mud will tend to weaken the grout/ground bond. Control and disposal of drilling fluids (i.e., water, muds, and foams) is the responsibility of the contractor.

#### 9.5.4.3 Tendon Insertion

After drilling, uncased and drilled casing holes should be thoroughly cleaned to remove loose material within the design length. For uncased holes in cohesionless soils, excessive cleaning should be avoided such as would cause significant ground loss. After cleaning is complete, uncased holes should be inspected with a mirror, high intensity light, or by probing. If the hole is to be grouted

prior to insertion of the tendon, the hole depth should be measured to ensure that the tendon can be installed to the full depth. Drill holes may be considered clean if the full length of the tendon can be easily inserted to the desired depth.

The dimensions of each tendon should be checked to ensure that the minimum bond and unbonded lengths are equal to or exceed the minimum values specified for that anchor. Anchors may have specified maximum values if right-of-way restrictions exist. Coatings, sheaths, and encapsulations must be undamaged. Damage to protective layers should be repaired; otherwise the tendon should not be used.

Just prior to insertion of the tendon, exposed steel surfaces should be inspected for unacceptable amounts of corrosion. Loose flaky rust must be removed and the tendon surface inspected for corrosion appearing to be deeper than the steel surface (i.e., pitting). Where corrosion penetrates the steel surface, the steel is unsuitable for use. The presence of light non-flaky rust is not necessarily harmful and is not cause for rejection of the tendon. The tendon bond length must be clean and free from any foreign substances. In Sason (1992), color pictures illustrating various degrees of corrosion on strands are shown. These pictures may provide a useful tool for inspectors.

Centralizers must be securely affixed to tendons at required intervals and properly sized such that grout may flow freely up the borehole around the tendon. Spacers must separate individual strands to so that an adequate thickness of grout covers each strand and to prevent the intertwining of adjacent strands. Soil anchors installed through the stem of an auger generally will not require centralizers if, during the extraction of the auger, the hole is maintained full of grout having a slump less than 225 mm. Centralizers are also not required for pressure-grouted anchors in coarse-grained soils when the grout pressure is greater than 1 MPa.

If caving occurs during installation, the tendon should be withdrawn and the hole redrilled. The tendon must not be driven, or the unbonded length cut off. In some instances, the contractor may desire to remove the tendon and cut off enough of the bond length such that the full unbonded length and shortened bond lengths can be inserted. If this is done, the bond length must still exceed the minimum specified bond length. Shortening the bond length may result in the anchor not meeting load testing acceptance criteria.

#### 9.5.4.4 Anchor Grouting

Grouting should be performed either before insertion of the anchor tendon or as soon as practical afterwards to minimize the potential for hole caving. Holes open longer than 8 to 12 hours should be recleaned prior to insertion of the tendon or grout (PTI, 1996). Grouting equipment should allow for continuous grouting and completion of grouting of each anchor in less than one hour (PTI, 1996). For strand tendons, the strands must be aligned to allow installation of the anchorage while the grout is still fluid (i.e., before the grout starts to harden).

Grouting of the tendon should be performed in one stage. In single stage grouting, the bond and unbonded lengths are filled with grout in one injection sequence. The grouting in the unbonded length should be placed under gravity or low pressure. The drill hole should be grouted to a level which will allow an approximately 300 to 600 mm gap behind the trumpet.



Grout should be injected at the lowest point in the drill hole to fill the hole without generating air voids. The grout should flow continuously as the grout tube, auger, or casing is withdrawn. The withdrawal rate should be less than the grout placement rate to maintain the grout discharge point below the grout surface in the drill hole.

Grouting equipment usually includes a pressure gauge at the pump. The gauge should be checked periodically and cleaned at least daily. Head losses over the length of the grout pipe should be calculated using grout hose lengths and elevation differences between the pressure gauge and grout discharge point that are similar to what will be used during actual installation. Head losses may be high if low slump grout is used or if the anchor is very long.

The inspector should measure and record the grout volume placed in the hole. The grout take is defined as the volume of grout actually placed divided by the estimated hole volume. Excessively high grout takes may indicate that grout is lost through a hydraulic fracturing of the surrounding ground or flowing into voids caused by caving of the hole or preexisting voids in the ground (e.g., karst regions, talus slopes). Hydraulic fracturing can occur when high grout pressures are used or when the anchor hole is overlain by only a shallow overburden and low to moderate pressures are used. In geologic conditions where high grout loss is anticipated, anchors using grout containment devices (GCDs) may be used. These are specialized or proprietary anchors wherein geotextile “socks” or folded steel tubes are installed in the ground that are subsequently filled with grout.

When hollow stem auger methods are used, the contractor should not be allowed to reverse the auger rotation while the auger head is being extracted from the bond length. This action forces soil to mix with the grout, which reduces the grout strength. The auger may, however, make one reversal at the bottom of the hole to release the bit from the auger.

Post-grouting is performed by injecting grout under high pressure after the initially placed bond zone grout has initially hardened. The tendon must be equipped for post-grouting prior to installation of the tendon.

#### 9.5.4.5 Anchorage Installation

Once grouting is complete, the anchorage should be installed. The anchorage and tendon must be properly aligned and the continuity of corrosion protection in the vicinity of the anchorage must be maintained. The trumpet must be undamaged and overlap corrosion protection in the unbonded length. The trumpet may be slip fit over the unbonded length corrosion protection, in which case a seal may not be required to contain the trumpet grout. The installation of the trumpet should not result in damage to the unbonded length corrosion protection.

The anchor bearing plate must be installed perpendicular to the tendon with the tendon centered in the bearing plate, without bending or kinking the prestressing steel elements. The corrosion protection in the unbonded length should not come in contact with the bearing plate before, during, or after stressing. Wedge holes and wedges must be clean and free of rust to prevent slippage of strands and promote proper seating of the wedges.

After anchor testing and lock-off, the trumpet should be filled with grout and a cover placed and filled in accordance with project specifications. Grout levels in the trumpet and cover must be checked after the grout has set to ensure complete filling. Regrouting should be performed as required to obtain complete filling.

## **9.5.5 Ancillary Wall Element Installation**

### **9.5.5.1 Timber Lagging Installation**

Timber lagging should be installed in sufficiently small lifts and immediately after excavation to prevent the loss of soil between soldier beams. Excavation to place the lagging should be done carefully to prevent the formation of voids behind the lagging. Lagging may be placed behind soldier beam flanges or attached to the outside of the soldier beams and separated by spacers to permit adequate drainage.

Where “running” sand is encountered, particular care must be taken to minimize soil loss. In this case lagging may need to be installed one board at a time. Thin wood shingles or plywood boards pushed into the retained soil between every few rows of lagging may help to stabilize soil retained behind the lagging.

### **9.5.5.2 Wall Drainage System Installation**

Where cast-in-place (CIP) concrete facing is used, vertical wall drainage is commonly provided using a prefabricated geocomposite drain having a geotextile fabric on one side. The geocomposite drain should be tightly secured with the fabric side against the exposed lagging face and at locations and to dimensions shown on plans. Splices should be made according to manufacturer’s recommendations ensuring continuity of drainage. If the fabric becomes torn or punctured, the damaged section should be replaced completely or repaired with a piece of fabric overlapping the damaged area.

Drains are commonly attached at midspan between soldier beams and at construction and expansion joints. Drains are extended down the face of the wall as the excavation proceeds and should be installed to provide continuous drainage from the top to the bottom of the wall. At the base of the wall, drains are connected either to a footing drain below the finished grade or to weep holes that penetrate the finished wall. Weep holes should be located and spaced as shown on plans, coinciding with the drain locations. A filter is usually placed against weep holes to prevent clogging. Drainage aggregate is usually encapsulated by the filter fabric.

Footing drains are commonly comprised of perforated pipe embedded in drainage gravel. Pipes should be sloped as shown in the project drawings.

### **9.5.5.3 Horizontal Drains**

Occasionally, horizontal drains are used to lower seepage pressures for anchored slope applications. Commonly, a small diameter uncased hole is drilled extending back from the face of the wall and

fitted the full length with a slotted PVC pipe. To ensure that water does not build up behind the facing, wall penetrations should be sealed around the drain pipe and the last section of pipe is left unperforated. The pipe outlet is commonly connected to the footing drain.

The discharge from the drain should be examined for quantities of sediment indicating internal erosion around the pipe. Pipe perforations should be appropriately sized for the surrounding soil and the pipe wrapped with geotextile to prevent soil from entering the pipe while allowing a sufficient rate of inflow into the pipe. If perforations become clogged, drains should be flushed and cleaned by pumping water into the drains.

The efficiency of horizontal drains can be assessed by measuring water levels in monitoring wells. If piezometric readings indicate a rise in groundwater level, and at the same time, the discharge from the horizontal drains decreases, it should be concluded that the efficiency of the drain is decreasing. Where flushing and cleaning does not increase the efficiency of the system to an acceptable level, additional drains should be installed. Slopes should be routinely inspected for seepage and, where observed, the source of seepage should be investigated.

#### 9.5.5.4 Permanent Facing Installation

Facing and coping usually consist of either precast concrete panels or cast-in-place (CIP) concrete and must be installed in accordance with project plans and specifications. Wall batter and alignment must be within specified tolerances and the wall finish should conform to project specifications.

Concrete forms for CIP concrete facing should be well constructed, carefully aligned, and sufficiently tight to prevent leakage of concrete. Shear studs should be welded to soldier beams. Concrete surfaces should be free from surface defects. No steel reinforcement should be exposed to view after construction is completed.

Precast panels should be placed and supported as necessary so that their final position is as shown on working drawing within specified tolerances. Precast panels are attached to the soldier beams with connection devices which must be flexible enough to allow for installation tolerances. Handling of precast members should be kept to a minimum to avoid damage.

## **9.6 SHORT-TERM AND LONG-TERM MONITORING**

### **9.6.1 Monitoring of Anchor Load Tests**

Load testing and interpretation of test data requires careful control as they serve as a basis for either acceptance or rejection of the anchor. The inspector should have copies of the appropriate forms for recording test data. Bar and strand properties required for calculations should be provided by the contractor.

During anchor load testing, the following general guidelines should be observed:

- at no time should the anchor be loaded such that tensile stresses within the tendon exceed 80 percent of the specified minimum tensile strength (SMTS) of the tendon;

- at no time should the applied load be reduced below the alignment load;
- test measurements should be plotted as the test proceeds in order to identify unusual behavior;
- for strand tendons, regripping of strands should be avoided such as would cause overlapping wedge bites or wedge bites below the anchor head;
- for fully bonded anchors, the free length must remain unbonded until after testing is complete and the anchor has been accepted; and
- after lock-off of an anchor, a lift-off test should be performed to verify that the intended load is maintained in the anchor.

The suitability of stressing and measuring equipment must be verified. The jack must be in good working order and be able to provide incremental loading and unloading. A calibration graph for the jack, pressure gauge, and load cell should be provided to the inspector. The dial gauge must be in good working order and have an appropriate travel length.

The setup of stressing and measuring equipment must be inspected before testing. The test equipment and dial gauge should be properly aligned. The dial gauge should be mounted to provide an independent reference point to measure ground anchor movements. To be sure the dial gauge remains at the fixed point in the anchor, a circle should be scribed around the dial gauge head after application of the alignment load and observed for movement during testing.

The jack must be supported during application of the alignment load. If after release of external support, the jack appears to drop, the support must be reapplied and maintained until the jack is removed.

### **9.6.2 Short-Term Monitoring of Wall Performance**

Short-term monitoring of anchored wall performance generally consists of optical surveys and frequent visual inspection. An optical survey prior to the start of excavation is performed to establish baseline locations for the tops of soldier beams. If visual inspections show signs of unexpected wall movements, survey of the tops of soldier beams should be performed. Where unexpected or adverse wall movements are identified, monitoring should be expanded to include regular measurement of load for selected anchors and subsurface movements. The frequency of measurements for an expanded monitoring program may be reduced after wall movements reduce to an acceptable rate and the anchored system becomes stable. If, after a reasonable period of time, no unusual measurements are detected, readings are discontinued.

Excessively large wall movements that occur during construction of the anchored system may indicate potential instabilities. The nature of the instability may be more clearly defined through measurement of wall movements, ground movements behind the wall, and anchor loads. The most common reason for unanticipated wall movements is overexcavation below a row of unstressed

anchors. Outward wall movements and significant load increases in the anchor may indicate that the retained ground is weaker than anticipated, resulting in increased wall loadings. Where the anchor load approaches the maximum test load, the anchor should be detensioned to the design load, additional support provided, and the cause of the load increase investigated.

In some cases, contract specifications may require that certain criteria, in addition to anchor load testing, be satisfied during construction, including: (1) limiting lateral wall movement; (2) limiting vertical wall movement; (3) limiting settlement of adjacent structures; and (4) maintaining ground-water levels. Anchored system applications for which such criteria are more commonly specified include: (1) deep excavations; (2) landslide stabilization systems; and (3) where sensitive nearby structures exist. Monitoring methods and performance criteria should be included in contract specifications, and they must be followed.

### **9.6.3 Long-Term Monitoring**

Long-term monitoring is generally not required by project specifications as a means of contract acceptance, but is conducted by the owner agency in order to monitor wall performance and/or to gain insight into overall wall behavior. Long-term monitoring of wall performance is most often specified for critically important anchored systems or anchored systems constructed in potentially marginal ground. Long-term monitoring of overall wall system behavior typically involves more extensive instrumentation such as strain gauges for anchors and soldier beams and inclinometers and settlement plates to measure ground movements and is often a continuation of short-term monitoring. A more detailed discussion of monitoring and instrumentation is provided in FHWA-RD-97-130 (1998) and Dunicliff (1988).

## REFERENCES

- AASHTO (1986). "Standard Specifications for Transportation Materials and Methods of Sampling and Testing, Part I, Specifications, 14th ed." American Association of State Highway and Transportation Officials, Washington, D.C.
- AASHTO (1988). "Manual on Subsurface Investigations." American Association of State Highway and Transportation Officials, Washington, D.C.
- AASHTO (1992). "Standard Specifications for Transportation Materials and Methods of Sampling and Testing, Part II, Tests." American Association of State Highway and Transportation Officials, Washington, D.C.
- AASHTO (1996). "The Standard Specification for Highway Bridges, 16th edition." American Association of State Highway and Transportation Officials, Washington, D.C.
- AASHTO-AGC-ARTBA (1990). Joint Committee, Subcommittee on New Highway Materials, Task Force 27 Report, "In Situ Soil Improvement Techniques." American Association of State Highway and Transportation Officials-Associated General Contractors of America-American Road and Transportation Builders Association, Washington, D.C.
- Arman, A., Samtani, N., Castelli, R., and Munfakh, G. (1997). "Subsurface Investigations Participants Manual." Report FHWA-HI-97-021, Federal Highway Administration, Washington, D.C.
- ASTM (1997). Annual Book of ASTM Standards, American Society for Testing and Materials, Philadelphia, Penn.
- Briaud, J-L., (1989). "The Pressuremeter Test for Highway Application." Report FHWA-IP-89-008, Federal Highway Administration.
- British Standards Institution (1989). Ground Anchorages. BS. 8081, British Standards Institution, London, England.
- Broms, B.B. (1965). "Design of Laterally Loaded Piles." Journal of the Soil Mechanics and Foundations Division, ASCE, Vol. 91, No. SM3, Proceedings Paper 4342, pp. 79-99.
- Bruce, D.A. (1989). "Methods of Overburden Drilling in Geotechnical Construction - A Generic Classification." Ground Engineering, London, U.K., Vol. 22, No. 7, pp. 25-32.
- Byrne, R.J., Cotton, D., Porterfield, J., Wolschlag, C., and Ueblacker, G. (1998). "Manual for Design and Construction Monitoring of Soil Nail Walls." Report FHWA-DP-96-69R, Federal Highway Administration, Washington D.C.

- Cheney, R.S. (1988). "Permanent Ground Anchors." Report FHWA-DP-68-1R, Federal Highway Administration, Washington, D.C.
- Cheney, R.S. (1990). "DP-68 Permanent Ground Anchors, Vol. 2 - Field Demonstration Project Summaries." Report FHWA-DP-90-068-003, Federal Highway Administration, Washington, D.C.
- Construction Industry Research and Information Association (CIRIA) (1984). Design of Retaining Walls Embedded in Stiff Clays." Report 104, London, U.K.
- Deaton, H.J. (1994). "Contracting for Tieback Walls on a Design-Build Basis." Serviceability of Earth Retaining Structures, ASCE Geotechnical Special Publication No. 42, pp. 17-23.
- Draft European Standard (1994). "Execution of Special Geotechnical Work: Ground Anchors." European Committee for Standardization, Central Secretariat: Rue de Stassart 36, B-1050 Brussels, Belgium.
- Druss, D.L. (1994). "Waterproofing a Structural Slab at Ground Anchor Locations." Proceedings of the Conference on the Serviceability of Earth Retaining Structures, Geotechnical Specialty Publication No. 42, ASCE, Atlanta, Georgia, pp. 77-92.
- Dunnicliff, J. (1988). Geotechnical Instrumentation for Monitoring Field Performance. John Wiley & Sons, Inc., New York, N.Y.
- Elias, V. (1995). "Corrosion/Degradation of Soil Reinforcements for Mechanically Stabilized Walls and Reinforced Soil Slopes." Report FHWA-SA-96-072, Federal Highway Administration.
- Fellenius, B.H. (1991). "Chapter 13 – Pile Foundations." In Foundation Engineering Handbook, Second Edition, H.S. Fang, Editor, Chapman and Hall, New York.
- FIP Commission on Practical Construction (1986). Corrosion and Corrosion Protection of Prestressed Ground Anchorages. Thomas Telford Ltd., Telford House, London, England.
- Goldberg, D.T., Jaworski, W.E., and Gordon, M.D. (1976). "Lateral Support Systems and Underpinning, Construction Methods." Report FHWA-RD-75-130, Federal Highway Administration, Washington, D.C.
- Hannigan, P.J., Goble, G.G., Thendean, G., Likins, G.E. and Rausche, F. (1996). "Design and Construction of Driven Pile Foundations - Vol. 1." Report FHWA-HI-97-013, Federal Highway Administration, Washington, D.C.
- Henkel, D. J. (1971). "The Calculation of Earth Pressures in Open Cuts in Soft Clays." The Arup Journal, Vol. 6, No. 4, pp. 14-15.
- Ho, C.L., Denby, G.M., and Frigaszy, R.J. (1990), "Seismic Performance of Tied-Back Walls." Design and Performance of Earth Retaining Structures, Geotechnical Special Publication No. 25, American Society of Civil Engineers, pp. 843-853.

Hynes, M.E. and Franklin, A.G. (1984). "Rationalizing the Seismic Coefficient Method." Miscellaneous Paper GL-84-13, U.S. Army Engineering Waterways Experiment Station, Vicksburg, Mississippi, 34 p.

Janbu, N., Bjerrum, L. and Kjaernsli, B. (1956). "Soil Mechanics Applied to Some Engineering Problems." in Norwegian with English summary, Norwegian Geotechnical Publication 16, Norwegian Geotechnical Institute.

Kavazanjian, E. Jr., Matosovic, N., Hadj-Hamou, T., and Sabatini, P.J. (1997). "Geotechnical Engineering Circular No. 3, Design Guidance: Geotechnical Earthquake Engineering for Highways, Volume I, Design Principles." Report FHWA-SA-97-076, Federal Highway Administration, Washington, D.C.

Kulhawy, F.H. (1985). "Uplift Behavior of Shallow Soil Anchors - An Overview." Proceedings on the Uplift Behavior of Anchor Foundations in Soil. ASCE, Detroit, Michigan, pp. 1-25.

Kulhawy, F.H., and Mayne F. (1990). "Manual on Estimating Soil Properties for Foundation Design." Electric Power Research Institute, Palo Alto, California.

Kulhawy, F.H., Trautmann, C.H., Beech, J.F., O'Rourke, T.D., McGuire, W., Wood, W.A., Capano, C. (1983). "Transmission Line Structure Foundations for Uplift-Compression Loadings." Rep. EL-2870, Electric Power Research Institute, Palo Alto, California 412 p.

Lam, I.P. and Martin, G.R. (1986). "Seismic Design of Highway Bridge Foundations - Vol. II, Design Procedures and Guidelines." Report FHWA-RD-86-102, Federal Highway Administration, McLean, Virginia.

Littlejohn, G.S., and Bruce, D.A. (1977). Rock Anchors - State-of-the Art. Foundation Publications Ltd., Brentwood, Essex, England.

Littlejohn, G.S. (1990), "Ground Anchorage Practice." Proceedings of the Conference on Design and Performance of Earth Retaining Structures." ASCE, Ithica, New York, pp. 692-733.

Long, J.H., Weatherby, D.E., and Cording, E.J. (1997) "Summary Report of Research on Permanent Ground Anchor Walls, Vol. 1, Current Practice and Limiting Equilibrium Analyses." Report FHWA-RD-98-065, Federal Highway Administration, McLean, VA.

Mononobe, N. (1929). "Earthquake-Proof Construction of Masonry Dams." Proceedings of the World Engineering Conference, Vol. 9.

Morgenstern, N.R. (1982). "The Analysis of Wall Supports to Stabilize Slopes." Proceedings of the Conference on Application of Walls to Landslide Control Problems. ASCE, Las Vegas, Nevada, pp. 19-29.



- Mueller, C.G., Long, J.H., Weatherby, D.E., Cording, E.J., Powers III, W.F., and Briaud, J-L. (1998). "Summary Report of Research on Permanent Ground Anchor Walls, Vol. 3, Model-Scale Wall Tests and Ground Anchor Tests" Report FHWA-RD-98-067, Federal Highway Administration, McLean, VA.
- Munfakh, G.A., Samtani, N.C., Castelli, R.J., and Wang, J-N. (1999). "Earth Retaining Structures Participants Manual." Report FHWA-HI-99-007, Federal Highway Administration, Washington, D.C.
- NAVFAC (1982). "Foundations and Earth Structures Design Manual 7.2." Department of the Navy, Alexandria, Virginia.
- Nicholson, P.J., Uranowski, D.D., and Wycliffe-Jones, P.T. (1982). "Permanent Ground Anchors, Nicholson Design Criteria." Report FHWA-RD-81-151, Federal Highway Administration, Washington, D.C.
- Nicholson, P.J. and Bruce, D.A. (1992). "Opportunities and Constraints for the Innovative Geotechnical Contractor." Excavation and Support of for the Urban Infrastructure, ASCE Geotechnical Special Publication No. 33, pp. 46-64.
- Okabe, S., (1926). "General Theory of Earth Pressure." Journal of Japan Society of Civil Engineering, Vol. 12, No. 1.
- O'Neill, M.W. and Reese, L.C. (1999). "Drilled Shafts: Construction Procedures and Design Methods." Report No. FHWA-SA-99-019, Federal Highway Administration, Washington, D.C.
- O'Rourke, T.D. and O'Donnell, C.J. (1997). "Deep Rotational Stability of Tiedback Excavations in Clay." Journal of Geotechnical and Geoenvironmental Engineering, ASCE, Vol. 123, No. 6, pp. 516-524.
- Peck, R.B. (1969). "Deep Excavations and Tunneling in Soft Ground, State of Art Report." Proceedings of the 7th International Conference on Soil Mechanics and Foundation Engineering, Mexico City, Mexico, pp. 225-290.
- Pfister, P., Evers, G., Guillaud, M, and Davidson, R. (1982). "Permanent Ground Anchors, Soletanche Design Criteria." Report No. FHWA-RD-81-150, Federal Highway Administration, Washington, D.C.
- PTI (1996). Recommendations for Prestressed Rock and Soil Anchors, 3rd ed. Post-Tensioning Institute, Phoenix, Arizona.
- Riaund, J. (1992). "The Cone Penetrometer Test." Report FHWA-SA-91-043, Federal Highway Administration, Washington, D.C.

- Riaund, J., and J. Miran, (1992). "The Flat Dilatometer Test." Report FHWA-SA-91-044, Federal Highway Administration, Washington, D.C.
- Sabatini, P.J., Elias, V., Schmertmann, G.R., Bonaparte, R. (1997). "Geotechnical Engineering Circular No. 2, Earth Retaining Systems." Rep. FHWA-SA-96-038, Federal Highway Administration, Washington, D.C.
- Sason, A.S. (1992). "Evaluation of Degree of Rusting on Prestressed Concrete Strand." Journal of Precast/Prestressed Concrete, Vol. 37, No. 3, pp. 25-30.
- Schnabel, H.J. (1982). Tiebacks in Foundation Engineering and Construction, McGraw-Hill Book Company, Inc., New York, N.Y.
- Schmidt, R.J., Dolan, C.W., Holte, L.E. (1994). "Anchorage of Non-Metallic Prestressing Tendons." Proceedings of Structures Congress XII, ASCE, pp. 1415-1420.
- Stark, T.D. and H.T. Eid (1994). "Drained Residual Strength of Cohesive Soils." Journal of Geotechnical Engineering, ASCE, Vol. 120, No. 5, pp. 856-871.
- Terzaghi, K., and Peck, R.G. (1967). Soil Mechanics in Engineering Practice, John Wiley & Sons, Inc., New York, N.Y.
- Terzaghi, K., Peck, R.B., Mesri, G. (1996). Soil Mechanics in Engineering Practice, 3rd ed. John Wiley & Sons, Inc., New York, N.Y.
- Tomlinson, M.J. (1980). Foundation Design and Construction, 4th ed. Pitman Advanced Publishing Program.
- Ulrich, E.J. Jr. (1989). "Tieback Supported Cuts in Overconsolidated Soils." Journal of Geotechnical Engineering, ASCE, Vol. 115, No. 4, pp. 521-545.
- Wang, S-T. and Reese, L.C. (1986). "Study of Design Methods for Vertical Drilled Shaft Retaining Walls", Texas State Department of Highways and Public Transportation, Austin, Texas.
- Wang, S-T. and Reese, L.C. (1993). "COM624P, Laterally Loaded Pile Analysis Program for the Microcomputer, Version 2.0." Report FHWA-SA-91-048, Federal Highway Administration, Washington, D.C.
- Weatherby, D.E. (1982). "Tiebacks." Report FHWA-RD-82-047, Federal Highway Administration, McLean, VA.
- Weatherby, D.E., (1998). "Design Manual for Permanent Ground Anchor Walls." Report FHWA-RD-97-130, Federal Highway Administration, McLean, Virginia.

Weatherby, D.E., Chung, M., Kim, N-K., and Briaud, J-L. (1997). "Summary Report of Research on Permanent Ground Anchor Walls, Vol. 2, Full-Scale Wall Tests and a Soil-Structure Interaction Model." Report FHWA-RD-98-066, Federal Highway Administration, McLean, VA.

Winter, D.G. (1990). "Pacific First Center Performance of the Tie-Back Shoring Wall." Proceedings of the Conference on Design and Performance of Earth Retaining Structures." ASCE, Ithica, New York, pp. 764-777.

Woods, R.D. (1997). "Dynamic Effects of Pile Installations on Adjacent Structures." NCHRP Synthesis 253, Transportation Research Board, National Research Council, Washington D.C.

## BIBLIOGRAPHY

Abramson, L. W., Boyce, G. M., Lee, T. S., Sharma, S. (1993). "Advanced Course on Soil Slope Stability: Volume I, Slope Stability Manual." Report FHWA-SA-94-005, Federal Highway Administration, Washington, D.C.

American Society of Civil Engineers (1994). "Guidelines of Practice for Braced and Tied-back Excavations." Geotechnical Special Publication No. 74.

Andersen, T.C. (1984). "Earth Retention Systems, Temporary and Permanent, Meeting Preprint." Proceedings of the 32nd Annual Soil Mechanics and Foundation Engineering Conference, Minneapolis, Minn.

Barley, A.D. (1997). "Discussion Session 3." Proceedings of the International Conference on Ground Anchorages and Anchored Structures, Thomas Telford Publishing, London, U.K., 572 p.

Bruce, D.A. (1997). "The Stabilization of Concrete Dams by Post-Tensioned Rock Anchors: The State of American Practice." Proceedings of the International Conference on Ground Anchorages and Anchored Structures." Thomas Telford Publishing, London, U.K., pp. 508-521.

Bruen, M.P., Pansic, N., Schwartz, M.I. (1996). "Creeping Suspicion." Civil Engineering, ASCE, May, pp. 60-63.

Christian, J.T. (1989). "Design of Lateral Support Systems." Proceedings, Seminar on Design, Construction, and Performance of Deep Excavations in Urban Area, Boston Society of Civil Engineers Section, ASCE.

CIRIA (1980). Design and Construction of Ground Anchors, 2nd ed. Construction Industry Research and Information Association, Report 65, London, U.K.

FHWA (1986). "Recommendations for Monitoring Applied Load During Permanent Anchor Testing." Geotechnical Engineering Notebook, Geotechnical Guideline No. 12, Federal Highway Administration, Washington, D.C.

Golder, H.Q., Gould, J.P., Lambe, T.W., Tschebotarioff, G.P., Wilson, S.D. (1970). "Predicted Performance of Braced Excavations." Journal of the Soil Mechanics and Foundations Division, ASCE, Vol. 96, No. SM3, pp. 801-836.

Hanna, T.H. (1982). Foundations in Tension, Ground Anchors. McGraw-Hill Book Company, Inc., New York, N.Y.

Institution of Civil Engineers (1997). Proceedings of the International Conference on Ground Anchorages and Anchored Structures. G.S. Littlejohn, Ed., Thomas Telford Publishing, London, U.K. 644 p.

Littlejohn, S. (1992). "Ground Anchorage Technology - A Forward Look." Proceedings of the Conference on Grouting, Soil Improvement and GeoSynthetics, Vol. 1, Geotechnical Special Publication No. 30, ASCE, New Orleans, Louisiana, pp. 39-62.

- Ludwig, H.P. and Weatherby, D.E. (1989). "Behavior of a Tieback in Cohesive Soil." Proceedings of the 12th International Conference on Soil Mechanics and Foundation Engineering, A.A. Balkema, Broodfield, VT, pp. 1023-1026.
- Neelakantan, G., and Richards, R., Jr. (1992). "Balanced Seismic Design of Anchored Retaining Walls." Journal of Geotechnical Engineering, ASCE, Vol. 118, No. 6, pp. 873-888.
- Ostermayer, H. (1974). "Construction, Carrying Behavior and Creep Characteristics of Ground Anchors." Proceedings of the Conference on Diaphragm Walls and Anchorages, Institution of Civil Engineers, London, England, pp. 141-151.
- Prakash, S. and Basavanna, B.M. (1969). "Earth Pressure Distribution Behind Retaining Walls During Earthquakes." Proceedings of the 4th World Conference on Earthquake Engineering, Santiago, Chile.
- Reese, L.C. (1958). Discussion of "Soil Modulus for Laterally Loaded Piles." by McClelland and Focht, Transactions, ASCE, Vol. 123, pp. 1071-1074.
- Reese, L.C., Cox, W.R. and Koop, F.D. (1974). "Field Testing and Analysis of Laterally Loaded Piles in Sand." Paper No. OTC 2080, Proceedings of the 5th Offshore Technology Conference, Vol. II, Houston, Texas.
- Richards, R. Jr., and Elms, D.G. (1992). "Seismic Passive Resistance of Tied-Back Walls." Journal of Geotechnical Engineering, ASCE, Vol. 118, No. 7., pp. 996-1011.
- Romanoff, M. (1957). Underground Corrosion. Circular 579, National Bureau of Standards.
- Romanoff, M. (1972). "Corrosion of Steel Pilings in Soils." Contained in National Bureau of Standards Monogram 127, NBS Papers on Underground Corrosion of Steel Pilings (1962-1972).
- Sharma, S. (1994). "XSTABL, An Integrated Slope Stability Analysis Program for Personal Computers." Interactive Software Designs, Inc., Moscow, Idaho.
- Siller, T.J. (1992). "Design of Tied-Back Walls for Seismic Loading." Journal of Geotechnical Engineering, ASCE, Vol. 118, No. 11, pp. 1804-1821.
- Siller, T.J., and Frawley, D.D. (1992). "Seismic Response of Multianchored Retaining Walls." Journal of Geotechnical Engineering, ASCE, Vol. 118, No. 11, pp. 1787-1803.
- Skempton, A.W. (1964). "Long-Term Stability of Clay Slopes." Geotechnique, Vol. 14, No. 2, pp. 75-101.
- Terzaghi, K. (1954). "Anchored Bulkheads." Transactions, ASCE, Vol. 119.
- Weatherby, D.E. (1998). "Summary Report of Research on Permanent Ground Anchor Walls, Vol. 4, Conclusions and Recommendations." Report FHWA-RD-98-068, Federal Highway Administration, McLean, VA.

Whitman, R.V. (1990). "Seismic Design of Gravity Retaining Walls." Proceedings of the Conference on the Design and Performance of Earth Retaining Structures, Geotechnical Special Publication No. 25, ASCE, pp. 817-842.

Wright, S. (1995). "UTEXAS3, A Computer Program for Slope Stability Calculation - User's Manual." Shinoak Software, Austin, Texas.

Xanthakos, P.P. (1991). Ground Anchors and Anchored Structures. John Wiley & Sons, Inc., New York, NY.

Written By : DGP Date: 99/01/28 Reviewed by: PJS Date: 99/01/30Client: FHWA Project: GEC#4 Project/Proposal No.: GE3686 Task No: G2

## **APPENDIX A**

### **DESIGN EXAMPLE 1**

#### **ANCHORED WALL SUPPORTED EXCAVATION**

##### **WALL REQUIREMENTS**

A 10-m high permanent anchored soldier beam and timber lagging wall is to be constructed as part of a depressed roadway project. When construction of the wall is completed, a 7.3-m wide entrance ramp will be constructed 3 m behind the wall. The wall is to be constructed in a medium dense silty sand profile as shown in figure A-1. No existing structures or underground utilities are located within 20 m of the top of the proposed wall location. A cast-in-place (CIP) concrete facing is to be used.

##### **SUBSURFACE CHARACTERIZATION**

Geotechnical borings drilled in front of, alongside, and behind the proposed wall alignment indicate that the subsurface stratigraphy is relatively uniform. The profile shown in figure A-1 is considered to be representative of the soil stratigraphy along the alignment of the wall. Soil properties for design are shown for individual layers in figure A-1. Groundwater was not encountered in any of the borings and it is concluded that groundwater levels at the site are below elevation 87 m MSL. Agressivity testing indicates that the site soils have a resistivity above 5,000 ohm-cm, a pH between 6.2 and 6.8, and no sulfides are present. The soils are therefore considered to be non-aggressive.



Written By : DGP Date: 99/01/28 Reviewed by: PJS Date: 99/01/30

Client: FHWA Project: GEC#4 Project/Proposal No.: GE3686 Task No: G2

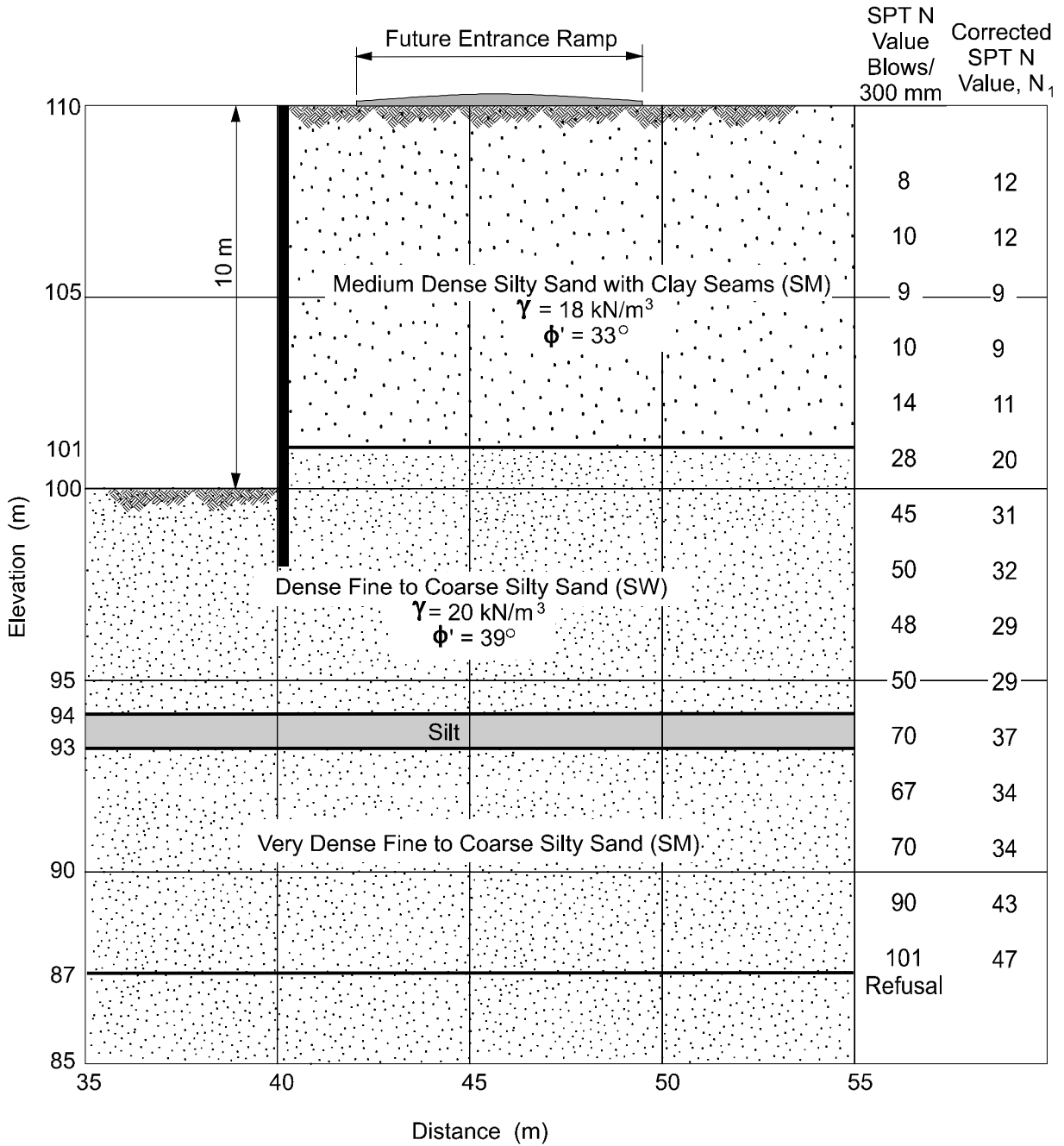

Figure A-1. Subsurface stratigraphy and design cross section.





Written By : DGP Date: 99/01/28 Reviewed by: PJS Date: 99/01/30

Client: FHWA Project: GEC#4 Project/Proposal No.: GE3686 Task No: G2

## LOAD TYPES ACTING ON WALL

Wall loads are estimated based on AASHTO (1996) recommendations for a Group I Load Combination using the Service Load design method, as follows:

$$\text{Group I Load} = [D + (L + I) + CF + E + B + SF]$$

where D is dead load; L is live load; I is live impact load; CF is centrifugal force; E is lateral earth pressure; B is buoyancy; and SF is stream flow pressure.

Wall loads are approximated as follows:

1. D: The dead load acting at the base of each soldier beam was approximated as the sum of the weight of the soldier beam, concrete backfill (if used), timber lagging, and CIP concrete facing.
2. L and I: For conditions where traffic lanes are located within half the wall height behind the wall, AASHTO (1996) recommends that a surcharge pressure equivalent to 0.6 m of soil above the wall be included in the calculation of lateral earth pressure against the wall.
3. E: The lateral earth pressure was approximated using the trapezoidal apparent earth pressure diagram for sands as shown in figure 24.
4. B, CF, and SF: These load types are not expected to be present during the construction or service life of the wall.

## LOCATION OF CRITICAL FAILURE SURFACE

The critical failure surface may be assumed to intersect the corner of the wall and exit at the ground surface and be sloped at  $45^\circ + \phi'/2$  from the horizontal where  $\phi'$  is equal to the effective stress friction angle of the soil behind the wall. Alternatively, a slope stability analysis may be performed to evaluate the location of the critical potential failure surface. When using a slope stability analysis program, a uniform lateral surcharge load is applied to the wall face to model the restraint provided by the anchors. This load is increased until a factor of safety equal to one (FS = 1.0) is achieved. Input parameters for a slope stability analysis, including geometry of the wall, subsurface stratigraphy, and soil properties, are shown in figure A-1.



Written By : DGP Date: 99/01/28 Reviewed by: PJS Date: 99/01/30

Client: FHWA Project: GEC#4 Project/Proposal No.: GE3686 Task No: G2

**APPARENT EARTH PRESSURE DIAGRAM**

The apparent earth pressure diagram for a two-tier anchored wall constructed in predominately cohesionless soils is shown in figure A-2 where  $T_{H1}$  is the horizontal anchor load per meter of wall for the upper anchor;  $T_{H2}$  is the horizontal anchor load per meter of wall for the lower anchor; and  $p_e$  is the maximum ordinate of the apparent earth pressure diagram. It was assumed that the upper anchor is located 2.5 m below the top of the wall and the lower anchor is located 6.25 m below the top of the wall.

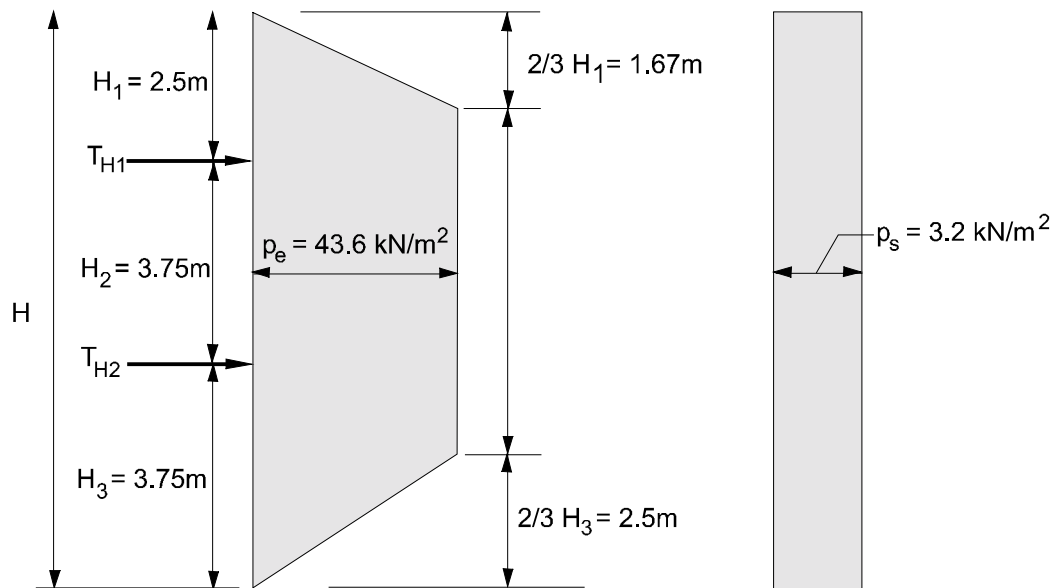

Figure A-2. Apparent earth pressure diagram and surcharge pressure diagram.

The majority of the excavation for the wall will penetrate through the upper soil layer, i.e., the medium dense silty sand layer. To develop the apparent earth pressure diagram, a unit weight of 18 kN/m<sup>3</sup> and effective stress friction angle of 33 degrees were used.

1. The value of  $p_e$  was calculated based on figure 24:

$$p_e = \frac{0.65 \left( \tan^2 \left( 45 - \frac{\phi}{2} \right) \right) \gamma H^2}{H - \frac{H_1}{3} - \frac{H_3}{3}}$$

A-4



Written By : DGP Date: 99/01/28 Reviewed by: PJS Date: 99/01/30

Client: FHWA Project: GEC#4 Project/Proposal No.: GE3686 Task No: G2

$$= \frac{0.65 \left( \tan^2 \left( 45 - \frac{33^\circ}{2} \right) \right) 18 \text{ kN/m}^3 (10 \text{ m})^2}{10 \text{ m} - \frac{2.5 \text{ m}}{3} - \frac{3.75 \text{ m}}{3}} = 43.6 \text{ kN/m}^2$$

**LATERAL EARTH PRESSURE DUE TO TRAFFIC SURCHARGE**

The traffic surcharge pressure ( $q_s$ ) applied at the ground surface is assumed to equal 0.6 m x 18 kN/m<sup>3</sup> = 11 kN/m<sup>2</sup>. The corresponding lateral pressure ( $p_s$ ) is assumed to act uniformly over the entire wall height and is calculated as follows:

$$p_s = K_A q_s$$

$$= \tan^2 \left( 45 - \frac{33}{2} \right) 11 \text{ kN/m}^2 = 3.2 \text{ kN/m}^2$$

The earth pressure diagram due to the traffic surcharge is shown in figure A-2.

**HORIZONTAL ANCHOR LOADS, MAXIMUM WALL BENDING MOMENT, AND REACTION FORCE TO BE RESISTED BY THE SUBGRADE**

The tributary area method (figure 34) was used to calculate the horizontal anchor loads,  $T_{H1}$  and  $T_{H2}$ , the maximum wall bending moment,  $M_{max}$ , and the reaction force to be resisted by the subgrade,  $R$ .

1. The horizontal anchor loads were calculated using the tributary area method, as follows:

$$T_{H1} = \left( \frac{2}{3} H_1 + \frac{H_2}{2} \right) p_e + \left( H_1 + \frac{H_2}{2} \right) p_s$$

$$= \left( \frac{2}{3} 2.5 \text{ m} + \frac{3.75 \text{ m}}{2} \right) 43.6 \text{ kN/m}^2 + \left( 2.5 \text{ m} + \frac{3.75 \text{ m}}{2} \right) 3.2 \text{ kN/m}^2$$



Written By : DGP Date: 99/01/28 Reviewed by: PJS Date: 99/01/30

Client: FHWA Project: GEC#4 Project/Proposal No.: GE3686 Task No: G2

$$= 168 \text{ kN/m (upper anchor)}$$

$$T_{H2} = \left( \frac{H_2}{2} + \frac{23}{48} H_3 \right) p_e + \left( \frac{H_2}{2} + \frac{H_3}{2} \right) p_s$$

$$= \left( \frac{3.75 \text{ m}}{2} + \frac{23}{48} 3.75 \text{ m} \right) 43.6 \text{ kN/m}^2 + \left( \frac{3.75 \text{ m}}{2} + \frac{3.75 \text{ m}}{2} \right) 3.2 \text{ kN/m}^2$$

$$= 172 \text{ kN/m (lower anchor)}$$

2. Wall bending moments were calculated for the upper anchor level ( $M_1$ ), between the upper and lower anchor level ( $M_2$ ), and between the lower anchor level and the base of the excavation ( $M_3$ ) using the tributary area method. The wall bending moment used for design,  $M_{max}$ , is the largest of  $M_1$ ,  $M_2$ , and  $M_3$ .

The value of  $M_1$  was calculated as follows:

$$M_1 = \frac{13}{54} H_1^2 p_e + p_s H_1 \frac{H_1}{2}$$

$$= \frac{13}{54} (2.5 \text{ m})^2 43.6 \text{ kN/m}^2 + 3.2 \text{ kN/m}^2 (2.5 \text{ m}) \left( \frac{2.5 \text{ m}}{2} \right)$$

$$= 76 \text{ kN - m/m}$$

The maximum bending moment below the upper anchor was calculated assuming  $H_2 = H_3 = 3.75 \text{ m}$ :

$$M_{2,3} = \frac{1}{10} (H_{2,3})^2 (p_e + p_s)$$

$$= \frac{1}{10} (3.75 \text{ m})^2 (43.6 \text{ kN/m}^2 + 3.2 \text{ kN/m}^2)$$

$$= 66 \text{ kN - m/m}$$

The wall bending moment used for design is  $M_{max}=76 \text{ kN-m/m}$ .



Written By : DGP Date: 99/01/28 Reviewed by: PJS Date: 99/01/30

Client: FHWA Project: GEC#4 Project/Proposal No.: GE3686 Task No: G2

- The reaction force to be resisted by the subgrade is assumed to act at the base of the excavation and was calculated using the tributary area method as follows:

$$R = \left( \frac{3H_3}{16} \right) | p_e + \left( \frac{H_3}{2} \right) | p_s$$

$$\left( \frac{3(3.75\text{m})}{16} \right) 43.6\text{kN/m}^2 + \left( \frac{3.75\text{m}}{2} \right) 3.2\text{kN/m}^2 = 37\text{kN/m}$$

**INITIAL TRIAL DESIGN ASSUMPTIONS**

Initial designs were developed for a soldier beam and lagging wall with bar anchors and for a soldier beam and lagging wall with strand anchors. The inclination of all anchors was assumed to be 15° and the soldier beam center-to-center spacing was assumed to be 2.5 m. A cross section view of the initial design for the wall including the bar anchors is shown in figure A-3. The wall design including the strand anchors is the same as that shown in figure A-3, except that the minimum unbonded length of the lowermost anchor is greater than that for the bar anchor configuration. A discussion of the unbonded and bond lengths for the strand and bar designs is provided subsequently.

**ANCHOR DESIGN LOAD**

- Upper anchor: The anchor design load (DL<sub>1</sub>) was calculated as follows:

$$DL_1 = \frac{T_{H1} (2.5\text{ m})}{\cos 15^\circ} = 168\text{ kN/m} \cdot \frac{2.5\text{ m}}{\cos 15} = 435\text{ kN}$$

- Lower anchor: The anchor design load (DL<sub>2</sub>) was calculated as follows:

$$DL_2 = \frac{T_{H2} (2.5\text{ m})}{\cos 15^\circ} = 172\text{ kN/m} \cdot \frac{2.5\text{ m}}{\cos 15} = 445\text{ kN}$$

The maximum calculated anchor design load is 445 kN.



Written By : DGP Date: 99/01/28 Reviewed by: PJS Date: 99/01/30

Client: FHWA Project: GEC#4 Project/Proposal No.: GE3686 Task No: G2

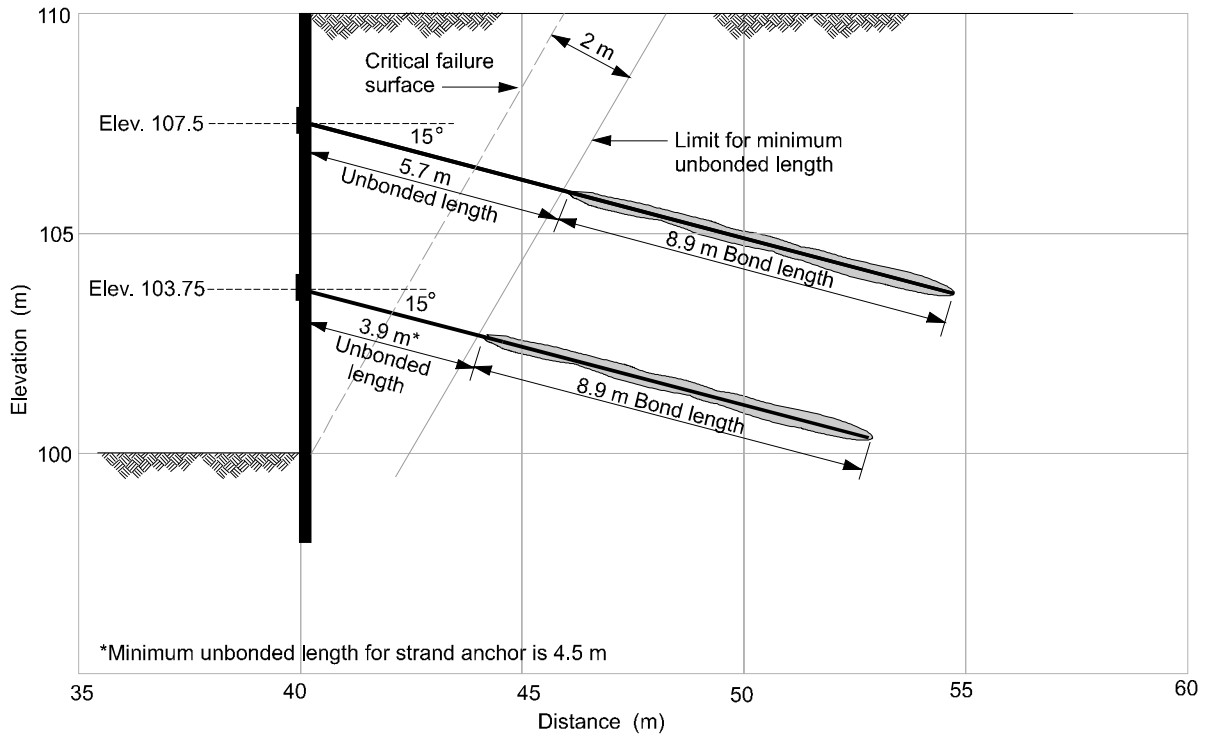

Figure A-3. Location of unbonded and bond lengths for ground anchors.

**DESIGN OF THE UNBONDED LENGTH**

For the design that includes bar anchors, the minimum unbonded length was selected to be the greater of either 3 m or the distance from the wall to a location 2 m beyond the critical failure surface. For the design that includes strand anchors, the minimum unbonded length was selected to be the greater of either 4.5 m or the distance from the wall to a location 2 m beyond the critical failure surface. These minimum values for the unbonded length are discussed in section 5.3.7.

**ANCHOR CAPACITY**

The anchor bond zones will be formed in the medium dense silty sand layer (Elevation 101 to 110 m MSL) and the dense silty sand layer (Elevation 94 to 101 m MSL). Assuming that the load transfer rate is controlled by the medium dense silty sand layer, a load transfer rate of 100 kN/m was selected (see table 6).



Written By : DGP Date: 99/01/28 Reviewed by: PJS Date: 99/01/30Client: FHWA Project: GEC#4 Project/Proposal No.: GE3686 Task No: G2

The design load with a factor of safety of 2.0 should be able to be achieved with a typical soil anchor bond length of 12 m, assuming a small diameter low pressure grouted anchor. For a length of 12 m the bond strength is  $[(100\text{kN/m})/2.0] \times 12 \text{ m} = 600 \text{ kN}$ . The allowable anchor capacity of 600 kN is larger than the maximum design load of 445 kN. This implies that the design load can be attained at this site for the assumed anchor spacings and inclination. Right of way estimates can be made based on the bond length required for mobilization of the design load, as follows:

$$\text{Maximum Bond Length} = \frac{(445 \text{ kN})(2.0)}{100 \text{ kN/m}} = 8.9 \text{ m}$$

### **EXTERNAL STABILITY**

The external stability of the anchored wall was evaluated using a slope stability analysis program. A target factor of safety of 1.3 was selected. Wall and subsurface input parameter values used are the same as those used for the stability analysis to evaluate the anchor unbonded lengths. The location of the end of each anchor bond zone is shown in figure A-3. The analysis was performed for the anchored wall including the bar anchors. The minimum calculated factors of safety for potential failure slip surfaces located behind the upper and lower anchors were calculated to be 2.5 and 2.6, respectively. Based on these calculations the anchored wall is considered stable with respect to external stability.

### **SELECTION OF TENDON**

Although the site soils are classified as nonaggressive, the consequence of failure and subsequent closure of the roadway is considered serious. Therefore, a Class I (double protection) encapsulated tendon is selected. Dimensions are calculated for both strand and bar tendons assuming a maximum test load of 1.33 DL.

A 32-mm diameter, Grade 150 prestressing bar may be selected, based on an allowable tensile capacity of 60 percent of the specified minimum tensile strength (SMTS). The allowable tensile capacity is 501 kN (see table 9) which exceeds the calculated maximum design load of 445 kN. The minimum estimated trumpet opening is 95 mm for a Class I corrosion protection system (see table 11).

A 3 strand, Grade 270 strand anchor may also be selected. The allowable tensile capacity of the tendon is 469 kN (see table 10). The minimum estimated trumpet opening is 150 mm for a Class I corrosion protection system.



Written By : DGP Date: 99/01/28 Reviewed by: PJS Date: 99/01/30

Client: FHWA Project: GEC#4 Project/Proposal No.: GE3686 Task No: G2

**SOLDIER BEAM SELECTION**

The required section modulus,  $S_{req}$ , of each soldier beam is calculated as follows:

$$S_{req} = \frac{M_{max}}{F_b}$$

where  $F_b$  is the allowable bending stress of the steel, which is equal to 55 percent of the yield stress for permanent applications. Yield stresses for Grade 36 and Grade 50 steels are 248 MPa (36 ksi) and 345 MPa (50 ksi), respectively. Using  $M_{max}$  from previous calculations, the maximum soldier beam moment is equal to (76 kN-m/m x 2.5 m) = 190 kN-m.

1. Grade 36 steel:  $S_{req} = \frac{190 \text{ kN} \cdot \text{m}}{0.55 (248 \text{ MPa})} = 0.001393 \text{ m}^3$

Two C15 x 40 channel sections provides a section modulus of 0.001524 m<sup>3</sup>.

2. Grade 50 steel:  $S_{req} = \frac{190 \text{ kN} \cdot \text{m}}{0.55 (345 \text{ MPa})} = 0.001001 \text{ m}^3$

Two MC12 x 31 channel sections provide a section modulus of 0.001109 m<sup>3</sup>.

It was assumed that a pair of MC12 x 31 Grade 50 channel sections would be used for each soldier beam. It was also assumed that each hole would be backfilled from the bottom of the hole to the elevation of the excavation base with structural concrete such that the full diameter of the shaft may be considered for axial and lateral load capacity evaluations. The minimum required diameter of the shaft was calculated based on the diagonal distance between the tips of the flanges. For a MC 12x31 section, the flange width and beam depth are 93 mm and 305 mm, respectively. Assuming a 150 mm open space between channels,  $b_{os}$ , for the tendon, the minimum required diameter is:

$$\text{minimum required diameter} = \sqrt{(2 \times \text{flange width} + b_{os})^2 + (\text{beam depth})^2}$$

$$\text{minimum required diameter} = \sqrt{(2 \times 93 \text{ mm} + 150 \text{ mm})^2 + (305 \text{ mm})^2}$$

$$\text{minimum required diameter} = 454 \text{ mm}$$

A shaft diameter of 610 mm will be used.





Written By : DGP Date: 99/01/28 Reviewed by: PJS Date: 99/01/30

Client: FHWA Project: GEC#4 Project/Proposal No.: GE3686 Task No: G2

**DESIGN OF TIMBER LAGGING**

For a soldier beam consisting of two channel sections, the required length of timber lagging may be calculated as the center-to-center spacing of the soldier beams minus the space between the channel sections of a soldier beam. This can be written as follows:

$$\text{required length of timber lagging} = s - b_{os}$$

$$\text{required length of timber lagging} = 2.5 \text{ m} - 0.15 \text{ m}$$

$$\text{required length of timber lagging} = 2.35 \text{ m}$$

A timber lagging thickness of 75 mm was selected based on table 12.

**LATERAL CAPACITY OF SOLDIER BEAM TOE**

The soldier beam must be sufficiently embedded to develop passive resistance to carry the lateral load resulting from the reaction force to be resisted by the subgrade, R, and the active pressure acting over the soldier beam width, b, (i.e., 0.6 m) along the embedded soldier beam length. A factor of safety of 1.5 is required. The lateral load, R<sub>Load</sub>, is calculated as follows:

$$R_{Load} = R_s + \frac{1}{2} DK_A \gamma (2H + D)b$$

$$R_{Load} = 37 \text{ kN/m}(2.5 \text{ m}) + \frac{1}{2} D \tan^2 \left( 45 - \frac{39^\circ}{2} \right) (2 (10 \text{ m}) + D) 0.6 \text{ m}$$

The ultimate passive resistance is assumed to be the minimum ultimate passive resistance calculated from equations B-2, B-4, B-5, and B-6 (see appendix B). The factor of safety was calculated as the ratio of the ultimate passive force, F<sub>p</sub> to R<sub>Load</sub>. Calculations were performed using the spreadsheet presented in figure A-4. Based on these calculations, a soldier beam embedment depth of 2.0 m is required to achieve a factor of safety that exceeds the target value of 1.5.



Written By : DGP Date: 99/01/28 Reviewed by: PJS Date: 99/01/30

Client: FHWA Project: GEC#4 Project/Proposal No.: GE3686 Task No: G2

Unit weight of soil ( $\gamma$ )	18	kN/m <sup>3</sup>
Height of soldier beam above final excavation level (H)	10	m
Drilled shaft diameter (b)	0.6	m
Soldier beam center to center spacing (s)	2.5	m
Clear spacing between drilled shafts ( $s_c$ )	1.9	m
soil friction angle ( $\phi$ )	39	degrees
$\beta=45+\phi/2$	64.5	degrees
$\alpha=\phi$ (for dense sands)	39	degrees
Subgrade reaction force (R)	37	kN/m
at-rest earth pressure coefficient ( $K_0$ ) = $1-\sin\phi$	0.37	
active earth pressure coefficient ( $K_a$ ) = $\tan^2(45-\phi/2)$	0.23	
passive earth pressure coefficient ( $K_p$ ) = $\tan^2(45+\phi/2)$	4.40	

Toe Depth (m)	Wedge Resistance (single pile) (Eq. B-2) (kN/m)	Wedge Resistance (intersecting wedges) (kN/m)	Flow Resistance (Eq. B-5) (kN/m)	Rankine Continuous (Eq. B-6) (kN/m)	Minimum Wang-Reese Passive Resistance (kN/m)	Total Passive Force (kN)	Total Active Force (kN)	Total Subgrade Reaction Force (kN)	Factor of Safety
0.0	0	0	0	0	0	0	0.0	92.5	0.0
0.5	60	60	490	99	60	15	12.6	92.5	0.1
1.0	194	169	980	198	169	73	25.8	92.5	0.6
1.5	401	289	1,470	297	289	187	39.6	92.5	1.4
<b>2.0</b>	<b>680</b>	<b>419</b>	<b>1,960</b>	<b>396</b>	<b>396</b>	<b>358</b>	<b>54.1</b>	<b>92.5</b>	<b>2.4</b>
2.5	1,034	559	2,449	494	494	581	69.1	92.5	3.6
3.0	1,460	710	2,939	593	593	853	84.8	92.5	4.8
3.5	1,959	870	3,429	692	692	1,174	101.0	92.5	6.1
4.0	2,532	1,041	3,919	791	791	1,545	117.9	92.5	7.3
4.5	3,178	1,222	4,409	890	890	1,965	135.4	92.5	8.6
5.0	3,897	1,414	4,899	989	989	2,435	153.6	92.5	9.9

Figure A-4. Embedment depth calculations (Wang-Reese method).

**AXIAL CAPACITY OF SOLDIER BEAM**

1. Calculate total axial load

The total axial load was calculated as the sum of the vertical anchor forces and weights of the soldier beam, concrete backfill, timber lagging, and CIP concrete facing. For the calculations, it was assumed that the embedment depth of the soldier beam was 2.5 m.



Written By : DGP Date: 99/01/28 Reviewed by: PJS Date: 99/01/30

Client: FHWA Project: GEC#4 Project/Proposal No.: GE3686 Task No: G2

- The vertical anchor forces were calculated using anchor design loads and inclinations as follows:

$$\text{Vertical force of upper anchor: } 435 \text{ kN} \times \sin 15^\circ = 113 \text{ kN}$$

$$\text{Vertical force of lower anchor: } 445 \text{ kN} \times \sin 15^\circ = 115 \text{ kN}$$

- The weight of two MC12 x 31 Grade 50 channel sections with an assumed embedment depth of 2.5 m and a unit weight of 0.452 kN/m is calculated as follows:

$$\text{Weight of soldier beam} = 2 \times 0.452 \text{ kN/m} \times 12.5 \text{ m} = 11 \text{ kN}$$

- The drill hole size selected for a soldier beam fabricated from a pair of MC12 x 31 shapes is 0.6 m. The weight of concrete backfill for a drilled-in soldier beam for a 0.6 m diameter concrete section and a unit weight of 22.6 kN/m<sup>3</sup> was calculated as follows:

$$\text{Weight of concrete backfill} = 22.6 \text{ kN/m}^3 \cdot \frac{\pi (0.6 \text{ m})^2}{4} \cdot 12.5 \text{ m} = 80 \text{ kN}$$

This weight was reduced to account for the removal of the lean-mix concrete backfill during lagging installation. The area of concrete to be removed down to the front flange of the channel beams was calculated to be 0.055 m<sup>2</sup>.

$$\text{Weight of removed concrete} = 22.6 \text{ kN/m}^3 \cdot 0.055 \text{ m}^2 \cdot 10 \text{ m} = 12 \text{ kN}$$

- The weight of timber lagging was calculated for 75-mm thick boards. The unit weight of timber lagging was assumed to be 8 kN/m<sup>3</sup>.

$$\text{Weight of timber lagging} = 8 \text{ kN/m}^3 \cdot 10 \text{ m} \cdot 2.35 \text{ m} \cdot 0.075 \text{ m} = 14 \text{ kN}$$

- The weight of the CIP concrete facing is calculated for a 254-mm thick facing. The unit weight of reinforced concrete was assumed to be 23.6 kN/m<sup>3</sup>.

$$\text{Weight of concrete facing} = 23.6 \text{ kN/m}^3 \cdot 10 \text{ m} \cdot 2.5 \text{ m} \cdot 0.254 \text{ m} = 150 \text{ kN}$$

The total axial load was calculated as the sum of the above loads and is equal to 471 kN.



Written By : DGP Date: 99/01/28 Reviewed by: PJS Date: 99/01/30

Client: FHWA Project: GEC#4 Project/Proposal No.: GE3686 Task No: G2

2. Calculate the required axial capacity

The required axial capacity of a drilled-in soldier beam was calculated using procedures described in section 5.6 for drilled-in soldier beams in cohesionless soil. The required axial capacity ( $Q_a$ ) is calculated by applying a safety factor of 2.0 to the ultimate skin friction and a factor of safety of 2.5 to the ultimate end bearing such that:

$$Q_a = \frac{f_s A_s}{2.0} + \frac{q_t A_t}{2.5}$$

End Bearing

Using the SPT blowcount value at the approximate location of the bottom of the soldier beam (use  $N=45$ ) and equation 30 results in:

$$Q_a \text{ (end bearing)} = \frac{q_t A_t}{2.5} = \left[ 57.5(45) \frac{\pi}{4} (0.6\text{m})^2 \right] / 2.5 = 293\text{kN}$$

Side Resistance

Using an assumed embedment depth,  $D$ , of 2.5 m and equation 29 results in:

$$Q_a \text{ (skin friction)} = \frac{f_s A_s}{2.0} = \frac{\beta p_o A_s}{2.0}$$

$$\beta = 1.5 - 0.42z^{0.34}; z = \frac{1}{2}(H + D)$$

$$= 1.5 - 0.42 \left( \frac{10\text{m} + 2.5\text{m}}{2} \right)^{0.34} = 0.72$$



Written By : DGP Date: 99/01/28 Reviewed by: PJS Date: 99/01/30

Client: FHWA Project: GEC#4 Project/Proposal No.: GE3686 Task No: G2

$$p_o = \frac{\gamma}{2} (H + D)$$

$$= \frac{18 \text{ kN/m}^3}{2} (10 \text{ m} + 2.5 \text{ m}) = 112 \text{ kN/m}^2$$

$$Q_a \text{ (skin friction)} = \left( \frac{0.72 \cdot 112 \text{ kN/m}^2 \cdot \pi \cdot 2.5 \text{ m} \cdot 0.6 \text{ m}}{\beta \cdot p_o \cdot A_s} \right) / 2.0 = 190 \text{ kN}$$

Total Axial Capacity

$$\text{for } D = 2.5 \text{ m, } Q_a = 293 \text{ kN} + 190 \text{ kN} = 483 \text{ kN} > 471 \text{ kN (OK)}$$

**RESISTING THE UPPER ANCHOR TEST LOAD**

The factor of safety against passive failure of the retained soil above the upper anchor level at the anchor test load is calculated as the ratio of the maximum passive resistance of the retained soil and the test load (see section 5.11.4). The test load is equal to 1.33 times the horizontal component of the design anchor load, i.e., (1.33\*435 kN cos 15° = 559 kN). The maximum passive resistance of the retained soil was calculated using the following equation:

$$F_p = 1.125 K_p \gamma H_1^2 s$$

where  $K_p = 6.0$  based on an effective stress friction angle of 33° for the upper sand layer and an assumed wall/soil interface friction angle  $\delta$  equal to  $0.5 \phi'$  (Figure 17).

$$F_p = 1.125 (6.0) (18 \text{ kN/m}^3) (2.5 \text{ m})^2 (2.5 \text{ m}) = 1,898 \text{ kN}$$

The factor of safety against passive failure is  $1,898 \text{ kN} / 559 \text{ kN} = 3.4 > 1.5$  (OK).



Written By : DGP Date: 99/01/28 Reviewed by: PJS Date: 99/01/30

Client: FHWA Project: GEC#4 Project/Proposal No.: GE3686 Task No: G2

**PERMANENT FACING DESIGN**

The 254-mm thick permanent CIP concrete facing is designed as a one-way concrete slab with supports at the soldier beam locations. The permanent facing is designed to resist apparent earth pressures and it is assumed that the timber lagging is ineffective in carrying earth pressure loadings for long-term permanent conditions. Using table 13, the maximum bending moment was estimated using a moment coefficient of 1/10. This results in:

$$M_{\max} = \frac{1}{10} (p_e + p_s) s^2$$

$$M_{\max} = \frac{1}{10} (43.6 \text{ kN/m} + 3.2 \text{ kN/m}) (2.5 \text{ m})^2 = 29.3 \text{ kN} - \text{m/m}$$

The structural design of the permanent facing should consider this maximum moment and the connection between the anchor system and the permanent facing should be performed in accordance with the latest AASHTO specifications.



Written By : DGP Date: 99/01/28 Reviewed by: PJS Date: 99/01/30

Client: FHWA Project: GEC#4 Project/Proposal No.: GE3686 Task No: G2

**SUMMARY OF INITIAL DESIGN**

**Soldier Beams**

Initial Design Results

Spacing 2.5 m  
 Diameter 0.6 m  
 Embedment 2.5 m  
 Size Two MC12 x 31 Grade 50 Channel Sections

Design Analysis Information	Required Properties	Initial Design Results
Section Modulus	0.001001 m <sup>3</sup>	0.001109 m <sup>3</sup>
Vertical Capacity	471 kN	491 kN

**Anchors**

Initial Design Results

Rows 2  
 Size 32-mm diameter Grade 150 bar or 3@15-mm diameter Grade 270 strand  
 Depth 2.5 m (upper) and 6.25 m (lower)  
 Inclination 15° for both rows

Design Analysis Information	Required Properties	Initial Design Results
Row 1, Allowable bond capacity	435 kN	600 kN
Row 2, Allowable bond capacity	445 kN	600 kN
32-mm Bar		
Allowable Capacity	445 kN	501 kN
Trumpet Diameter	95 mm	150 mm
3@15-mm Strand		
Allowable Capacity	445 kN	469 kN
Trumpet Diameter	150 mm	150 mm

**CONCLUSIONS**

The initial design is feasible. A review of the results indicates that sufficient bond capacity is available to permit a wider spacing of the soldier beams. A second iteration of the design should be performed with a wider soldier beam spacing and flatter anchor inclinations to determine the optimum design.



Written By : DGP Date: 99 / 1 / 28 Reviewed by: PJS Date: 99 / 1 / 30

Client: FHWA Project: GEC#4 Project/Proposal No.: GE3686 Task No: G2

**DESIGN EXAMPLE 2**

**ANCHORED WALL SUPPORTED SLOPE**

**WALL REQUIREMENTS**

An 8-m high permanent anchored soldier beam and timber lagging wall is to be constructed to retain an existing slope for the realignment of a section of highway. A cross section of the proposed wall is shown in figure A-5. The wall is to be located near the toe of a colluvial slope. No existing structures are located near the proposed wall. A CIP concrete facing is to be used for the permanent facing.

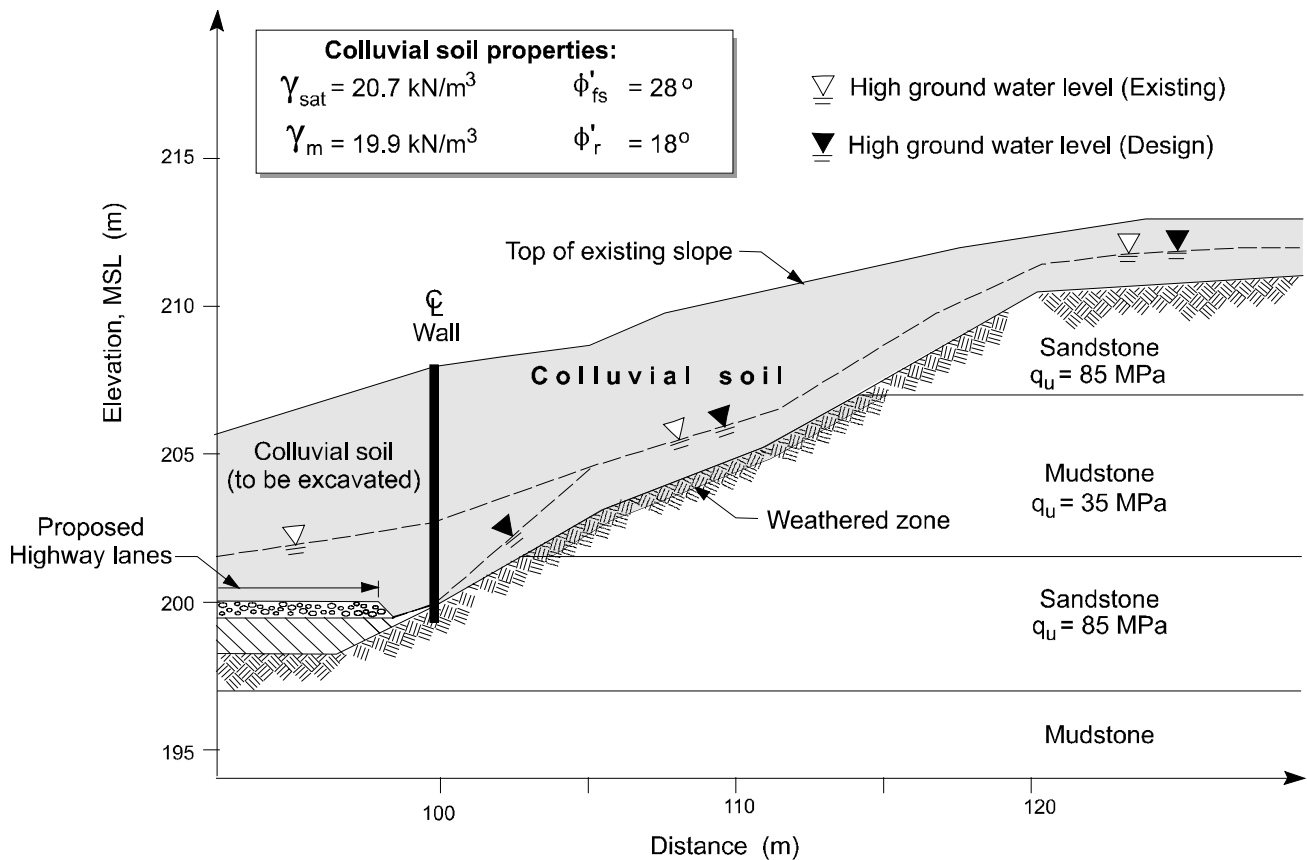

Figure A-5. Subsurface stratigraphy and design cross section.



Written By : DGP Date: 99 / 1 / 28 Reviewed by: PJS Date: 99 / 1 / 30Client: FHWA Project: GEC#4 Project/Proposal No.: GE3686 Task No: G2

## **SUBSURFACE CHARACTERIZATION**

The slope consists of colluvial soils including sandy clay and clayey sand. The colluvial soil materials overly a sequence of sandstone and mudstone bedrock units. Several geotechnical test borings were advanced along the length of the wall at a distance of 5 m and 15 m behind the wall location so that a reasonably accurate assessment could be made of the location of the colluvial soil/bedrock interface. Information from other borings that had been previously performed in the area were also used to develop the site stratigraphy. Borings were advanced until refusal and, for three borings, rock cores were obtained over a 3 m depth. The colluvial soils had SPT blowcount values ranging from 3 to 20 blows/300 mm. Disturbed samples obtained at the bedrock/colluvial soil interface indicated that these soils were very soft and saturated. Figure A-5 shows the site stratigraphy.

Soil and rock properties used for design are shown for individual soil and rock layers in figure A-5. Unconfined compressive strengths for the bedrock units were estimated based on a correlation of rock descriptions and RQD values with strength data reported for similar materials in the area. Approximately 0.3 m of the mudstone unit was moderately weathered below its intersection with the bottom of the colluvial soils. Below this, the mudstone was competent. The sandstone unit is characterized as moderately jointed and had an average RQD value of 85 percent.

The slope to be retained has experienced previous movements at the bedrock/colluvial soil interface. The shear strength of this interface was evaluated assuming that residual shear strength conditions prevail along this interface. Residual strengths were estimated based on a correlation of liquid limit, clay size fraction and effective normal stress at the colluvial soil/bedrock interface (Stark and Eid, 1994). Atterberg limits information was obtained for several samples collected at the bedrock/colluvial soil interface. Liquid limits ranged from 52 to 69 with an average of approximately 60 and the average clay size fraction was 40 percent. Using figure A-6, a residual friction angle of 18 degrees was selected for analysis. The fully softened friction angle of the colluvial soil above the weak interface was estimated to be 28 degrees. The saturated unit weight of the colluvial soil was estimated to be 20.7 kN/m<sup>3</sup> and the moist unit weight was estimated to be 19.9 kN/m<sup>3</sup>.

Groundwater levels shown in figure A-5 are based on historical well information collected over several years. The levels shown represent an approximate upper bound (i.e., worst case water pressure) condition. Geochemical testing results indicate that the ground conditions at the site are aggressive.

Written By : DGP Date: 99 / 1 / 28 Reviewed by: PJS Date: 99 / 1 / 30

Client: FHWA Project: GEC#4 Project/Proposal No.: GE3686 Task No: G2

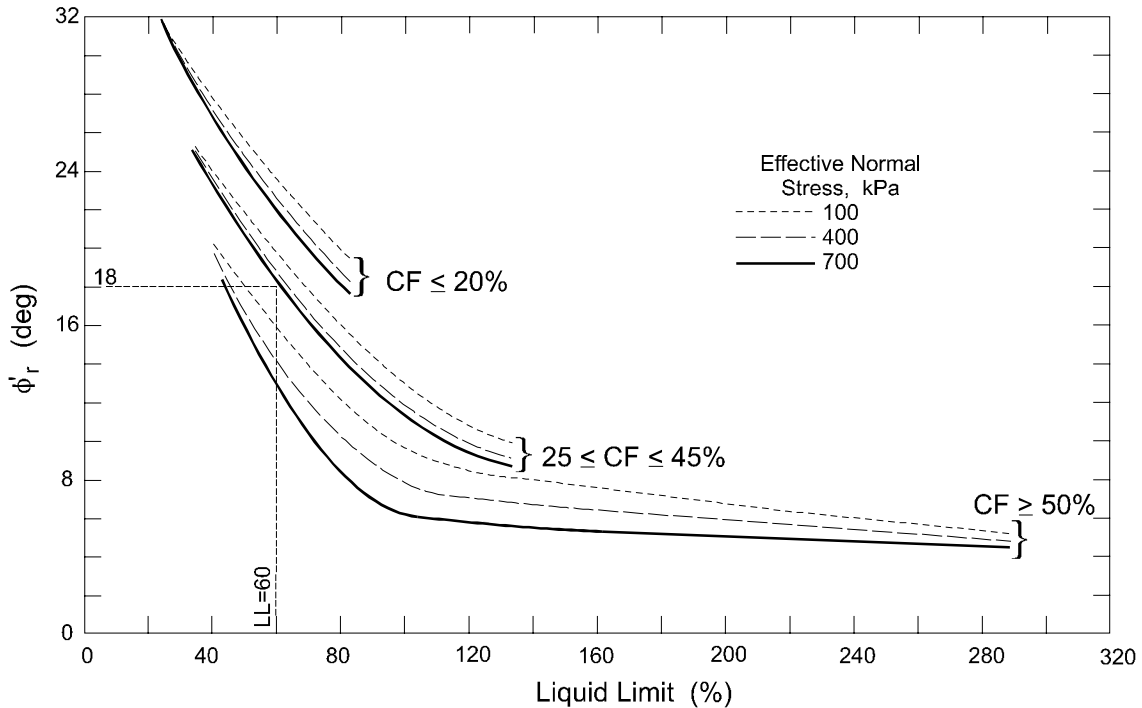

Figure A-6. Secant residual friction angle (after Stark and Eid, 1994, “Drained Residual Strength of Cohesive Soils”, Journal of Geotechnical Engineering, Vol. 120, No. 5, Reprinted by permission of ASCE).

**LOAD TYPES ACTING ON WALL**

Wall loads are estimated based on AASHTO (1996) recommendations for a Group I Load Combination using the Service Load design method, as follows:

$$\text{Group I Load} = [D + (L + I) + CF + E + B + SF]$$

where D is dead load; L is live load; I is live impact load; CF is centrifugal force; E is lateral earth pressure; B is buoyancy; and SF is stream flow pressure.

Wall loads are approximated as follows:

1. D: The dead load acting at the base of each soldier beam was approximated as the sum of the weight of the soldier beam, concrete backfill (if used), and CIP concrete facing.

Written By : DGP Date: 99 / 1 / 28 Reviewed by: PJS Date: 99 / 1 / 30Client: FHWA Project: GEC#4 Project/Proposal No.: GE3686 Task No: G2

2. L, I, CF, B, and SF: These load types are not expected to be present during the construction or service life of the wall.
3. E: The slope stability computer program XSTABL [Sharma, 1991] was used to evaluate the required load necessary to stabilize the slope to a target factor of safety. That load was redistributed into an apparent earth pressure envelope for evaluating ground anchor loads and wall bending moments.

### **LOCATION OF CRITICAL POTENTIAL FAILURE SURFACE**

As previously discussed, slope movements had previously occurred at this location. To stabilize the unstable slope, colluvial soil was removed from the top of the slope and end-dumped in an area in front of the proposed wall location to provide a buttress against continued slope movement. The geometry of the remediated slope, and that which defines the existing slope geometry, is shown in figure A-7. A slope stability analysis of the existing slope (i.e., prior to excavation for the wall) indicates that the critical potential failure surface is located along the colluvial soil/bedrock interface (figure A-7).

### **APPARENT EARTH PRESSURE DIAGRAM**

The ground anchor forces were evaluated using the computer program XSTABL and the methods described in section 5.7.3 and table 16. For the analysis, the critical potential failure surface was the same as that shown in figure A-7, except the failure surface begins at the intersection of the wall and the colluvial soil/bedrock interface. The ground anchor restraint force was modeled as a surcharge pressure inclined at 20 degrees acting on the wall face. The owner has requested that a target factor of safety of 1.3 be used for stability calculations. The surcharge pressure was increased in the stability analysis until the target factor of safety was achieved. The results of the stability analysis indicate that a total force inclined at 20 degrees of 707 kN/m is required to stabilize the slope to a factor of safety of 1.3. This value was checked by performing an analysis in which the ground anchor restraint force was modeled as a high capacity reinforcement. The reinforcement was assumed to extend at 20 degrees from the midheight of the wall to beyond the bedrock/colluvial soil interface. Using a reinforcement tension of 707 kN/m resulted in a calculated factor of safety of 1.3.

The total force calculated from the stability analysis was redistributed into an apparent pressure envelope over the wall height. In developing the apparent pressure envelope, it was assumed that



Written By : DGP Date: 99 / 1 / 28 Reviewed by: PJS Date: 99 / 1 / 30

Client: FHWA Project: GEC#4 Project/Proposal No.: GE3686 Task No: G2

negligible restraint would be provided by the toe of the wall and that the bottom of the wall would act as a cantilever fixed at the lowermost anchor. The assumption of no fixity at the base of the wall is conservative since the wall will be socketed into the sandstone to a nominal depth of 0.6 m, thus providing some lateral restraint.

Figure A-8 shows the apparent pressure envelope developed for this example. The diagram was developed assuming that three ground anchors would be used at the vertical spacings shown.

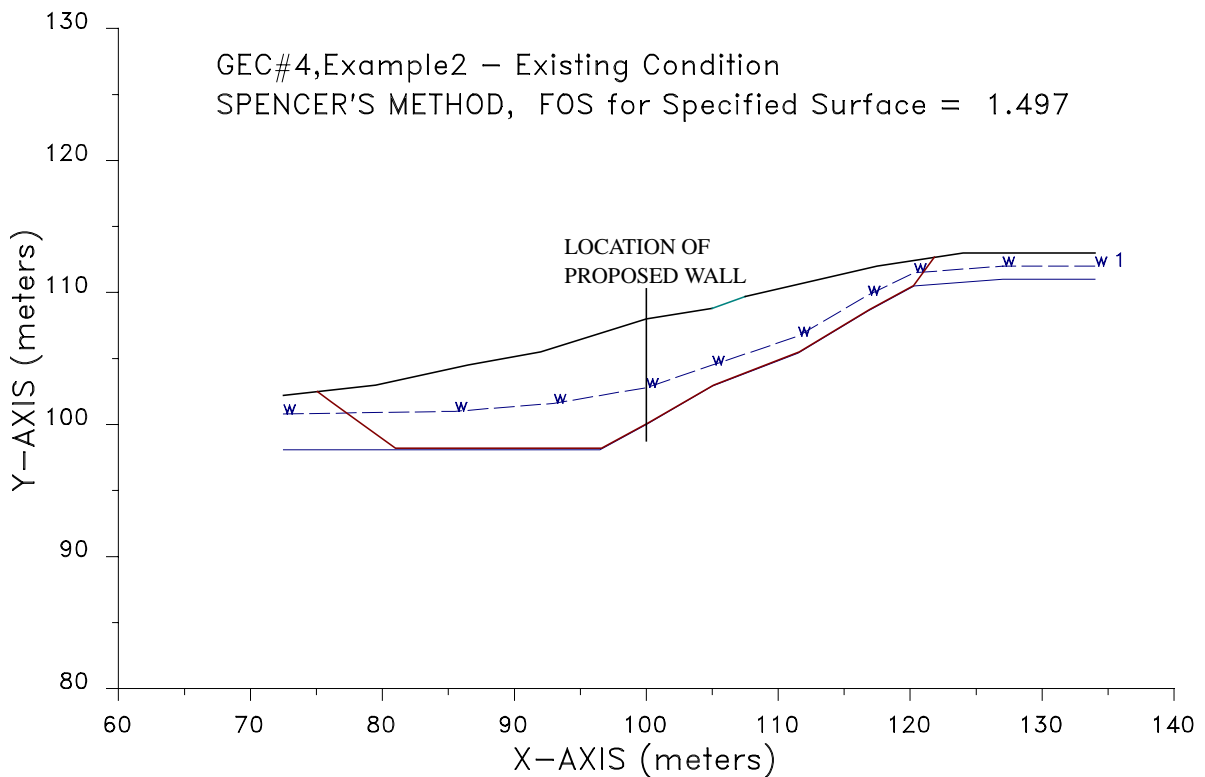

Figure A-7. Slope stability analysis of existing site conditions.



Written By : DGP Date: 99 / 1 / 28 Reviewed by: PJS Date: 99 / 1 / 30

Client: FHWA Project: GEC#4 Project/Proposal No.: GE3686 Task No: G2

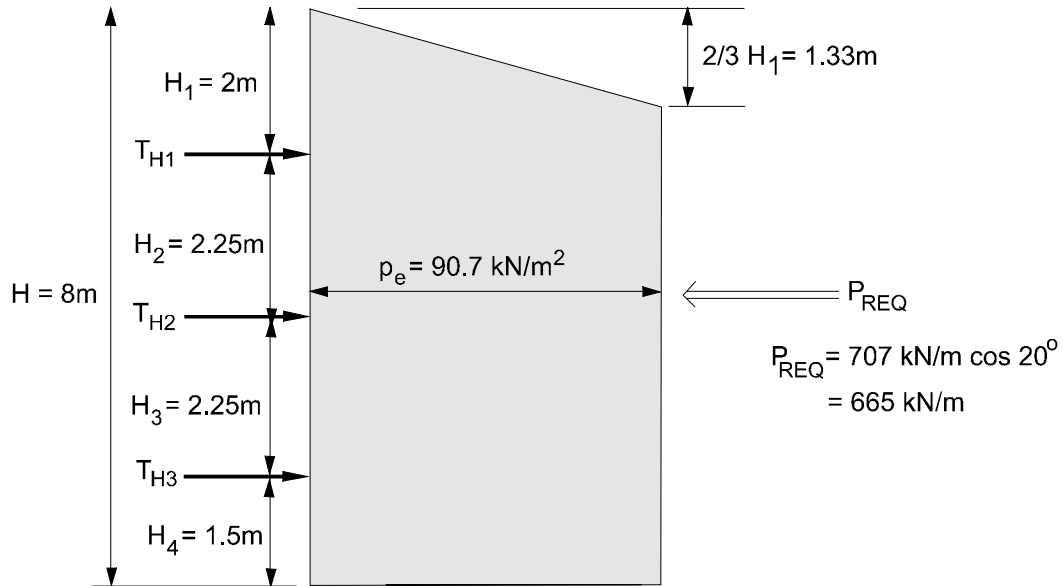

Figure A-8. Apparent earth pressure diagram.

**HORIZONTAL ANCHOR LOADS AND MAXIMUM WALL BENDING MOMENT**

The tributary area method (figure 34) was used to calculate the horizontal anchor loads,  $T_{H1}$  and  $T_{H2}$  and wall bending moments above the lower anchor level.

1. The horizontal anchor loads  $T_{H1}$  and  $T_{H2}$  were calculated using the tributary area method.

$$\begin{aligned}
 T_{H2} &= \left( \frac{H_2}{2} + \frac{H_3}{2} \right) p_e \\
 &= \left( \frac{2.25\text{ m}}{2} + \frac{2.25\text{ m}}{2} \right) 91\text{ kN/m}^2 \\
 &= 205\text{ kN/m}
 \end{aligned}$$



Written By : DGP Date: 99 / 1 / 28 Reviewed by: PJS Date: 99 / 1 / 30

Client: FHWA Project: GEC#4 Project/Proposal No.: GE3686 Task No: G2

$$\begin{aligned}
 T_{H1} &= \left( \frac{2}{3} H_1 + \frac{H_2}{2} \right) p_e \\
 &= \left( \frac{2}{3} 2.0 \text{ m} + \frac{2.25 \text{ m}}{2} \right) 91 \text{ kN/m}^2 \\
 &= 224 \text{ kN / m}
 \end{aligned}$$

The horizontal anchor load for the lower anchor,  $T_{H3}$ , was calculated to be 239 kN/m (see figure A-9(a)).

- Wall bending moments were calculated at the upper anchor level ( $M_1$ ), between the upper and middle anchor levels ( $M_2$ ), and between the middle and lower anchor levels ( $M_3$ ) using the tributary area method:

$$\begin{aligned}
 M_1 &= \frac{13}{54} H_1^2 p_e \\
 &= \frac{13}{54} (2.0\text{m})^2 91 \text{ kN/m}^2 \\
 &= 88 \text{ kN - m/m} \\
 M_{2,3} &= \frac{1}{10} (H_{2,3})^2 p_e \\
 &= \frac{1}{10} (2.25\text{m})^2 91 \text{ kN / m}^2 \\
 &= 46 \text{ kN - m / m}
 \end{aligned}$$

The wall bending moment below the lower anchor,  $M_4$ , is 103 kN-m/m (see figure A-9(b)). The wall bending moment used for design,  $M_{max}$ , is the largest of  $M_1$ ,  $M_2$ ,  $M_3$ , and  $M_4$ , and is equal to 103 kN-m/m.



Written By : DGP Date: 99 / 1 / 28 Reviewed by: PJS Date: 99 / 1 / 30

Client: FHWA Project: GEC#4 Project/Proposal No.: GE3686 Task No: G2

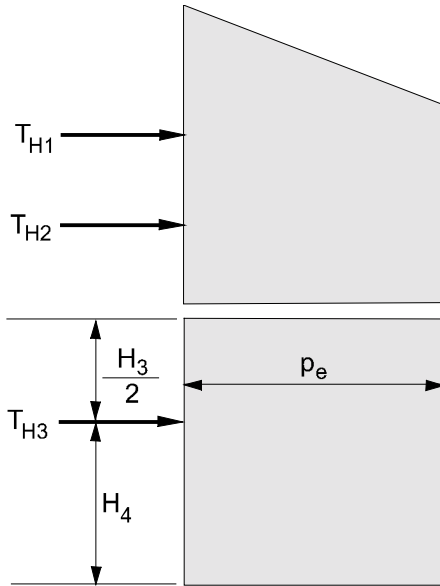

(a) Calculation of horizontal ground anchor load,  $T_{H3}$

$$T_{H3} = p_e \left( \frac{H_3}{2} + H_4 \right)$$

$$= 91 \text{ kN/m}^2 \left( \frac{2.25 \text{ m}}{2} + 1.5 \text{ m} \right) = 239 \text{ kN/m}$$

(b) Calculation of wall bending moment below lowest anchor

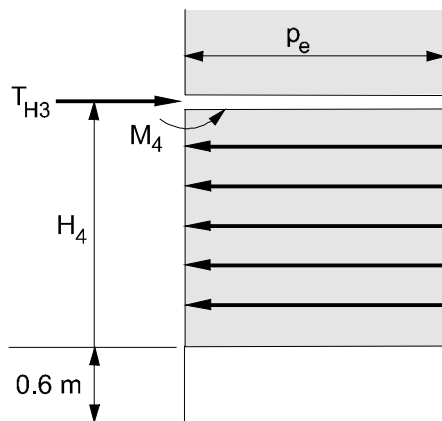

$$M_4 = p_e H_4 \left( \frac{H_4}{2} \right)$$

$$= 91 \text{ kN/m}^2 (1.5 \text{ m}) \left( \frac{1.5 \text{ m}}{2} \right) = 103 \text{ kN-m/m}$$

Figure A-9. Calculation of  $T_{H3}$  and  $M_4$ .



Written By : DGP Date: 99 / 1 / 28 Reviewed by: PJS Date: 99 / 1 / 30

Client: FHWA Project: GEC#4 Project/Proposal No.: GE3686 Task No: G2

**INITIAL TRIAL DESIGN ASSUMPTIONS**

Initial designs were developed for a soldier beam and lagging wall with bar anchors and for a soldier beam and lagging wall with strand anchors. The inclination of all anchors was assumed to be 20° and the soldier beam center-to-center spacing was assumed to be 2.5 m. A cross section view of the initial design for the wall including the strand anchors is shown in figure A-10. The wall design including the bar anchors is the same as that shown in figure A-10, except that the minimum unbonded length of the lowermost anchor is less than that for the strand anchor configuration. A discussion of the minimum unbonded and bond lengths for the strand and bar designs is provided subsequently.

**ANCHOR DESIGN LOAD**

The anchor design loads for the upper, middle and lower anchors (DL<sub>1</sub>, DL<sub>2</sub>, and DL<sub>3</sub>, respectively) were calculated as follows:

$$DL_{1,2,3} = \frac{T_{H1,H2,H3} S}{\cos 20^\circ}$$

$$DL_1 = 224 \text{ kN/m} \frac{2.5 \text{ m}}{\cos 20^\circ} = 596 \text{ kN}$$

$$DL_2 = 205 \text{ kN/m} \frac{2.5 \text{ m}}{\cos 20^\circ} = 546 \text{ kN}$$

$$DL_3 = 239 \text{ kN/m} \frac{2.5 \text{ m}}{\cos 20^\circ} = 636 \text{ kN}$$

**DESIGN OF THE UNBONDED LENGTH**

The minimum unbonded length for bar and strand anchors was 3 m and 4.5 m, respectively. For anchor bond zones that extend into the mudstone unit, the unbonded length was assumed to extend 1.6 m (=0.2H) beyond the existing 0.3-m thick layer of weathered mudstone (see figure A-10).





Written By : DGP Date: 99 / 1 / 28 Reviewed by: PJS Date: 99 / 1 / 30

Client: FHWA Project: GEC#4 Project/Proposal No.: GE3686 Task No: G2

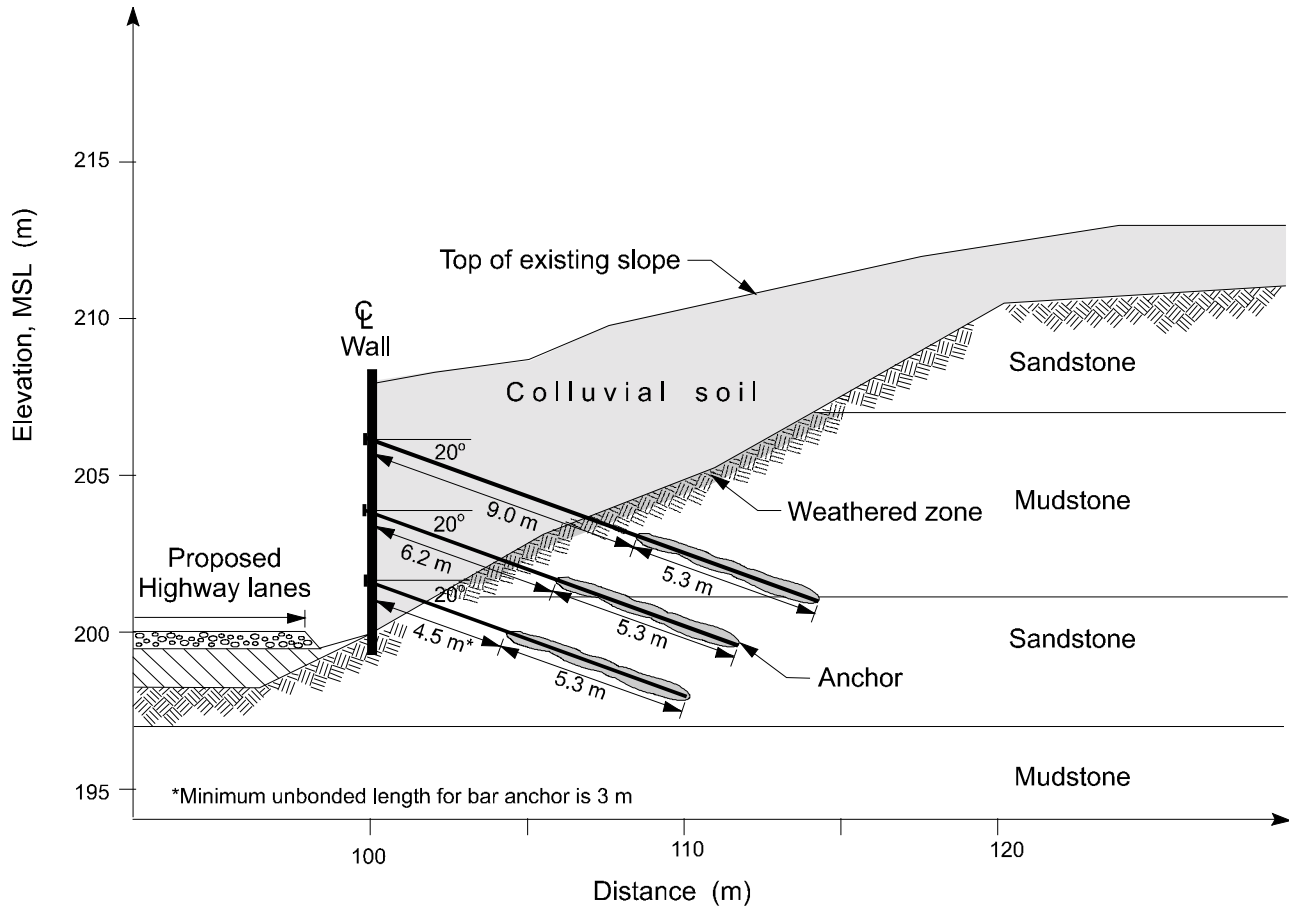

Figure A-10. Location of unbonded and bond length for ground anchors

**ANCHOR CAPACITY**

The anchor bond zones will be formed in the mudstone and sandstone units. For capacity estimates, a load transfer rate for the mudstone was used. The mudstone load transfer rate was assumed to be similar to that for hard shales and slates (see table 8), i.e., 360 kN/m.

The design load with a factor of safety of 3.0 should be able to be achieved in a typical rock anchor bond length of 7.5 m, assuming a small diameter low pressure grouted anchor. For a length of 7.5 m the bond strength is 900 kN. The allowable anchor capacity of 900 kN is larger than the maximum



Written By : DGP Date: 99 / 1 / 28 Reviewed by: PJS Date: 99 / 1 / 30Client: FHWA Project: GEC#4 Project/Proposal No.: GE3686 Task No: G2

design load of 636 kN; therefore the design load can be attained at this site for the assumed anchor spacings and inclination. Right of way estimates can be made based on the bond length required for mobilization of the design load, as follows:

$$\text{Maximum Bond Length} = \frac{(636 \text{ kN})(3.0)}{360 \text{ kN/m}} = 5.3 \text{ m}$$

### **EXTERNAL STABILITY**

The shear strength of the sandstone and mudstone units is significantly greater than the shear strength of the colluvial soil/bedrock interface. Therefore, the anchored system is externally stable since the anchors extend beyond the colluvial soil/bedrock interface.

### **SELECTION OF TENDON**

The ground at the site has been classified as aggressive and therefore a Class I (double protection) encapsulated tendon was selected. Dimensions are calculated for both bar and strand tendons assuming a maximum test load of 1.33 DL.

A 36-mm diameter, Grade 160 prestressing bar may be selected, based on an allowable tensile capacity of 60 percent of the specified minimum tensile strength (SMTS). The allowable tensile capacity is 675 kN (see table 9) which exceeds the calculated maximum design load of 636 kN. The minimum estimated trumpet opening is 102 mm for a Class I corrosion protection system (see table 11).

A 15 mm, Grade 270 5-strand prestressing tendon may also be selected. The allowable tensile capacity of the tendon is 782 kN (see table 10). The minimum estimated trumpet opening is 165 mm for a Class I corrosion protection system (see table 11).

### **SOLDIER BEAM SELECTION**

The required section modulus,  $S_{req}$ , of each soldier beam was calculated as follows:



Written By : DGP Date: 99 / 1 / 28 Reviewed by: PJS Date: 99 / 1 / 30

Client: FHWA Project: GEC#4 Project/Proposal No.: GE3686 Task No: G2

$$S_{req} = \frac{M_{max}}{F_b}$$

where  $F_b$  is the allowable bending stress of the steel, which is equal to 55 percent of the yield stress for permanent applications. Yield stresses for Grade 36 and Grade 50 steels are 248 MPa (36 ksi) and 345 MPa (50 ksi), respectively. Using the value of  $M_{max}$  from previous calculations, the maximum soldier beam moment is equal to  $(103 \text{ kN-m/m} \times 2.5 \text{ m}) = 258 \text{ kN-m}$ .

1. Grade 36 steel:  $S_{req} = \frac{258 \text{ kN} \cdot \text{m}}{0.55 (248 \text{ MPa})} = 0.001891 \text{ m}^3$

Two W12 x 45 wide flange sections provides a section modulus of  $0.001894 \text{ m}^2$ .

2. Grade 50 steel:  $S_{req} = \frac{258 \text{ kN} \cdot \text{m}}{0.55 (345 \text{ MPa})} = 0.001360 \text{ m}^3$

Two C15 x 40 channel sections provides a section modulus of  $0.001524 \text{ m}^2$ .

It was assumed that a pair of C15 x 40 Grade 50 channel sections would be used for each soldier beam. It was also assumed that each hole would be backfilled from the bottom of the hole to the elevation of the excavation base with structural concrete such that the full diameter of the shaft may be considered for axial load capacity evaluations. The minimum required diameter of the shaft was calculated based on the diagonal distance between the tips of the flanges. For a C15 x 40 section, the flange width and beam depth are 89 mm and 381 mm, respectively. Assuming a 150 mm open space between channels,  $b_{os}$ , for the tendon, the minimum required diameter is:

$$\text{min. required diameter} = \sqrt{(2 \times \text{flange width} + 150 \text{ mm})^2 + (\text{beam depth})^2}$$

$$\text{min. required diameter} = \sqrt{(2 \times 89 \text{ mm} + 150 \text{ mm})^2 + (381 \text{ mm})^2}$$

$$\text{min. required diameter} = 503 \text{ mm}$$

A shaft diameter of 610 mm will be used.



Written By : DGP Date: 99 / 1 / 28 Reviewed by: PJS Date: 99 / 1 / 30

Client: FHWA Project: GEC#4 Project/Proposal No.: GE3686 Task No: G2

**DESIGN OF TIMBER LAGGING**

For a soldier beam consisting of two channel sections, the required length of timber lagging may be calculated as the center-to-center spacing of the soldier beams minus the space between the channel sections of a soldier beam. This can be written as follows:

$$\text{required length of timber lagging} = s - b_{os}$$

$$\text{required length of timber lagging} = 2.5 \text{ m} - 0.15 \text{ m}$$

$$\text{required length of timber lagging} = 2.35 \text{ m}$$

A timber lagging thickness of 75 mm was selected based on table 12.

**AXIAL CAPACITY OF SOLDIER BEAM**

1. Calculate total axial load

The total axial load was calculated as the sum of the vertical anchor forces and weights of the soldier beam, concrete backfill, timber lagging, and concrete facing. It was assumed that the soldier beam will be socketed 0.6 m into the sandstone using structural concrete backfill.

- The vertical anchor forces were calculated using anchor design loads and inclinations as follows:

$$\text{Vertical force of upper anchor: } 596 \text{ kN} \times \sin 20^\circ = 204 \text{ kN}$$

$$\text{Vertical force of middle anchor: } 546 \text{ kN} \times \sin 20^\circ = 187 \text{ kN}$$

$$\text{Vertical force of lower anchor: } 636 \text{ kN} \times \sin 20^\circ = 218 \text{ kN}$$

- The weight of 2 C15 x 40 Grade 50 channel sections with an assumed embedded depth of 0.6 m and a unit weight of 0.584 kN/m was calculated as follows:

$$\text{Weight of soldier beam} = 2 \cdot 0.584 \text{ kN/m} \cdot 8.6 \text{ m} = 10 \text{ kN}$$

- The drill hole size selected for a soldier beam fabricated from a pair of C15 x 40 shapes is 0.6 m. The weight of structural concrete backfill for a drilled-in soldier beam for a 0.6 m diameter concrete section and a unit weight of 22.6 kN/m<sup>3</sup> was calculated as follows:



Written By : DGP Date: 99 / 1 / 28 Reviewed by: PJS Date: 99 / 1 / 30

Client: FHWA Project: GEC#4 Project/Proposal No.: GE3686 Task No: G2

$$\text{Weight of concrete backfill} = 22.6 \text{ kN/m}^3 \cdot \frac{\pi (0.6 \text{ m})^2}{4} \cdot 8.6 \text{ m} = 55 \text{ kN}$$

- The weight of timber lagging was calculated for 75-mm thick boards. The unit weight of timber lagging was assumed to be 8 kN/m<sup>3</sup>.

$$\text{Weight of timber lagging} = 8 \text{ kN/m}^3 \cdot 8 \text{ m} \cdot 2.5 \text{ m} \cdot 0.075 \text{ m} = 12 \text{ kN}$$

- The weight of the CIP concrete facing is calculated for a 254-mm thick facing. The unit weight of reinforced concrete was assumed to be 23.6 kN/m<sup>3</sup>.

$$\text{Weight of concrete facing} = 23.6 \text{ kN/m}^3 \cdot 8 \text{ m} \cdot 2.5 \text{ m} \cdot 0.254 \text{ m} = 120 \text{ kN}$$

The total axial load was calculated as the sum of the above loads and is equal to 806 kN.

2. Calculate the required axial capacity

The soldier beams will be embedded approximately 0.6 m into the sandstone unit. The axial capacity and settlement of the soldier beam is controlled by the shear strength of the sandstone, thickness of fissures in the sandstone, and number and spacing of discontinuities in the sandstone. As this sandstone material has relatively few defects, a detailed design is not required and it can be concluded that the axial capacity of the soldier beam is sufficient to withstand an axial load of 806 kN. Also, settlements are expected to be negligible.

**RESISTING THE UPPER ANCHOR TEST LOAD**

The factor of safety against passive failure of the retained soil above the upper anchor level at the anchor test load is calculated as the ratio of the maximum passive resistance of the retained soil and the test load (see section 5.11.4). The test load is equal to 1.33 times the horizontal component of the design anchor load, i.e., (1.33\*596 kN cos 20° = 745 kN). The maximum passive resistance of the retained soil was calculated using the following equation:

$$F_p = 1.125 K_p \gamma H_1^2 s$$



Written By : DGP Date: 99 / 1 / 28 Reviewed by: PJS Date: 99 / 1 / 30

Client: FHWA Project: GEC#4 Project/Proposal No.: GE3686 Task No: G2

The value for  $K_p$  was evaluated using figure 17. For an effective stress friction angle of  $28^\circ$  for the colluvial soil, an assumed wall/soil interface friction angle  $\delta$  equal to  $0.5 \phi$ , and a backslope angle of 10 degrees,  $K_p = 5.4$ . Therefore,

$$F_p = 1.125(5.4)(19.9\text{kN/m}^3)(2\text{m})^2 (2.5\text{m}) = 1209\text{ kN}$$

The factor of safety against passive failure is  $1209\text{ kN}/745\text{ kN} = 1.6 > 1.5$  (OK).

**PERMANENT FACING DESIGN**

The 254-mm thick permanent CIP concrete facing is designed as a one-way concrete slab with supports at the soldier beam locations. The permanent facing is designed to resist apparent earth pressures and it is assumed that the timber lagging is ineffective in carrying earth pressure loadings for long-term permanent conditions. The maximum ordinate of the apparent earth pressure diagram,  $p_e$ , is calculated using figure 24. For a backslope angle of  $10^\circ$  and zero wall friction,  $K_A$  is 0.327.

$$p_e = \frac{0.65 K_A \gamma H^2}{H - \frac{H_1}{3} - \frac{H_3}{3}}$$

$$= \frac{0.65 (0.327) 19.9\text{ kN/m}^2 (8\text{ m})^2}{8\text{ m} - \frac{2\text{ m}}{3} - \frac{1.5\text{ m}}{3}} = 39.6\text{ kN/m}^2$$

Using table 13, the maximum bending moment was estimated using a moment coefficient of 1/10.

$$M_{\max} = \frac{1}{10}(p_e)s^2$$

$$M_{\max} = \frac{1}{10}(39.6\text{kN/m}^2)(2.5\text{m})^2 = 24.8\text{kN-m/m}$$

The structural design of the permanent facing should consider the maximum moment and the connection between the anchor system and the permanent facing should be performed in accordance with the latest AASHTO specifications.



Written By : DGP Date: 99 / 1 / 28 Reviewed by: PJS Date: 99 / 1 / 30

Client: FHWA Project: GEC#4 Project/Proposal No.: GE3686 Task No: G2

**SUMMARY OF INITIAL DESIGN**

**Soldier Beams**

Initial Design Results

Spacing                    2.5 m  
 Diameter                 0.6 m  
 Embedment               To competent bedrock, approximately 0.6 m  
 Size                        Two C15x40 Grade 50 Channel Sections

Design Analysis Information	Required Properties	Initial Design Results
Section Modulus	0.001360m <sup>3</sup>	0.001524m <sup>3</sup>
Vertical Capacity	806 kN	>806 kN

**Anchors**

Initial Design Results

Rows                        3  
 Size                        36-mm diameter Grade 160 bar or 5@15-mm diameter Grade 270 strand  
 Depth                     2.0 m (upper), 4.25 m (middle), and 6.5 m (lower)  
 Inclination                20°

Design Analysis Information	Required Properties	Initial Design Results
Row 1, Allowable bond capacity	596 kN	900 kN
Row 2, Allowable bond capacity	546 kN	900 kN
Row 3, Allowable bond capacity	636 kN	900 kN
<b>36-mm Bar</b>		
Allowable Capacity	636 kN	675 kN
Trumpet Diameter	102 mm	150 mm
<b><u>5@15-mm</u> Strand</b>		
Allowable Capacity	636 kN	782 kN
Trumpet Diameter	165 mm	150 mm



Written By : DGP Date: 99 / 1 / 28 Reviewed by: PJS Date: 99 / 1 / 30Client: FHWA Project: GEC#4 Project/Proposal No.: GE3686 Task No: G2**CONCLUSIONS**

The initial design is feasible except for the need to increase the spacing of the channels in the soldier beam to accommodate the trumpet size required for a design involving 5@15-mm diameter strands. A review of the results indicates that sufficient bond capacity exists to permit a wider spacing of soldier beams. A second iteration of the design should be done with a wider soldier beam spacing and flatter anchor inclinations to determine the optimum design.





## APPENDIX B

### DEVELOPMENT OF WANG-REESE EQUATIONS

The development of the Wang-Reese equations for evaluating ultimate passive resistance for soldier beams embedded in cohesionless soils and cohesive soils is presented in this appendix. This presentation is based largely on information and details provided in FHWA-RD-97-130 (1998). The relevant equations have been implemented into spreadsheets which are included at the end of this appendix.

#### Cohesionless Soils

The Wang-Reese equations for ultimate passive resistance of cohesionless soils consider three potential failure mechanisms. These mechanisms include: (1) a wedge failure in front of an individual shaft (figure B-1); (2) an overlapping wedge failure for deep or closely-spaced shafts (figure B-2); and (3) plastic flow around the shaft (figure B-3). For design, the ultimate passive resistance available to resist the reaction force, R, is the minimum resistance for each of these mechanisms at any depth.

Figure B-1 shows the wedge failure for a single soldier beam in sand. The passive force,  $F_p$ , is given by Equation B-1.

$$F_p = \gamma d^2 \left[ \frac{K_o d \tan \phi \sin \beta}{3 \tan(\beta - \phi) \cos \alpha} + \frac{\tan \beta}{\tan(\beta - \phi)} \left( \frac{b}{2} + \frac{d}{3} \tan \beta \tan \alpha \right) + \frac{K_o d \tan \beta}{3} (\tan \phi \sin \beta - \tan \alpha) \right] \quad (\text{Equation B-1})$$

where:  $\gamma$  = total unit weight;

$b$  = soldier beam diameter or width;

$d$  = depth of the bottom of the soldier beam;

$K_o$  = at-rest earth pressure coefficient;

$\phi'$  = drained friction angle of the soil;

$\beta$  =  $45 + \phi'/2$ ; and

$\alpha$  =  $\phi'$  for dense sands,  $\phi'/3$  to  $\phi'/2$  for loose sands.

Equation B-1 is differentiated to give the ultimate soil resistance,  $P_{pu}$  at depth,  $d$ .

$$P_{pu} = \gamma d \left[ \frac{K_o d \tan \phi \sin \beta}{\tan(\beta - \phi) \cos \alpha} + \frac{\tan \beta}{\tan(\beta - \phi)} (b + d \tan \beta \tan \alpha) + K_o d \tan \beta (\tan \phi \sin \beta - \tan \alpha) \right] \quad (\text{Equation B-2})$$

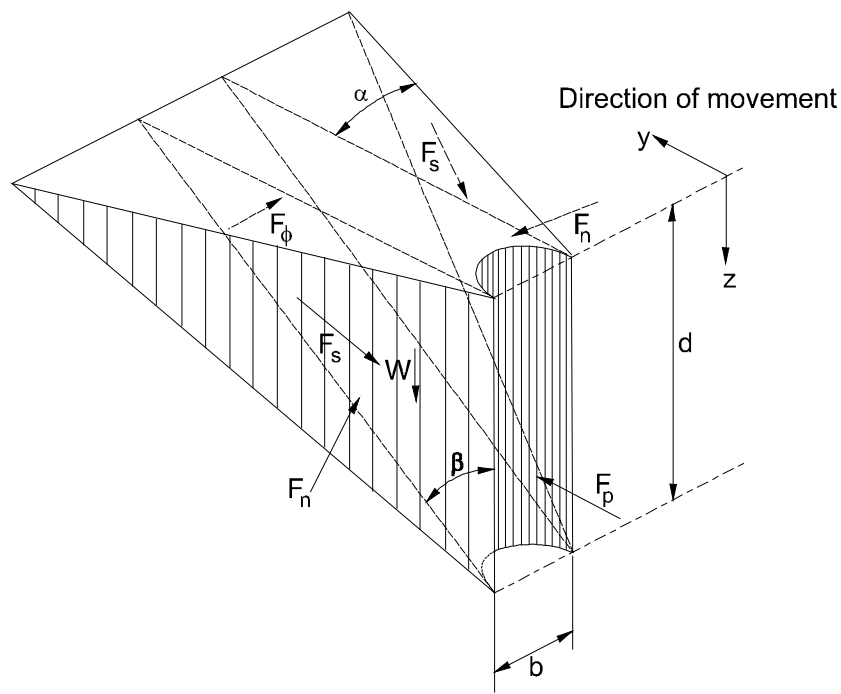

a. Failure wedge

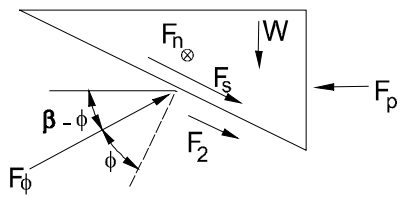

b. Forces on the wedge

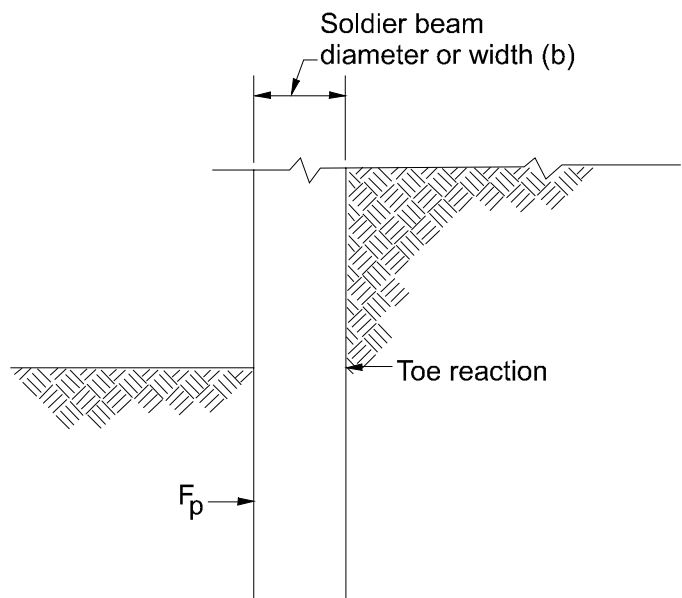

c. Forces on the soldier beam

Figure B-1. Passive wedge failure for a soldier beam in sand (after Reese et al., 1974).

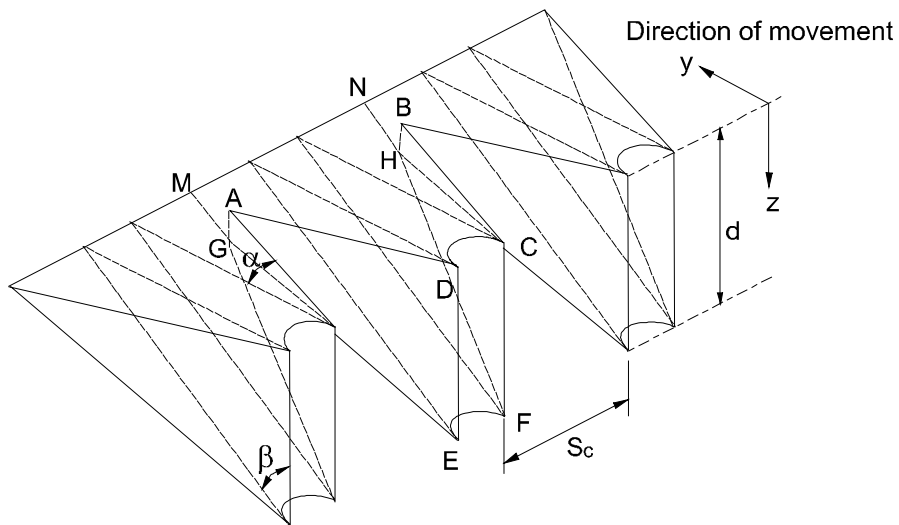

a. General view

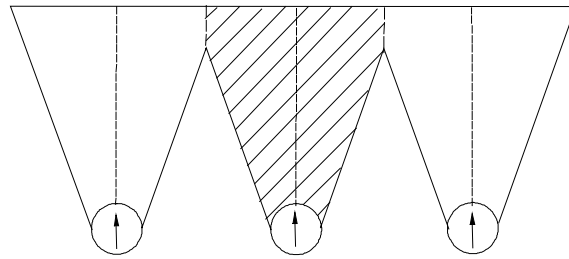

b. Plan view

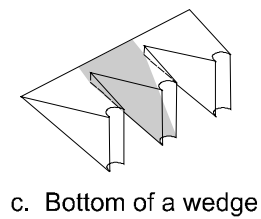
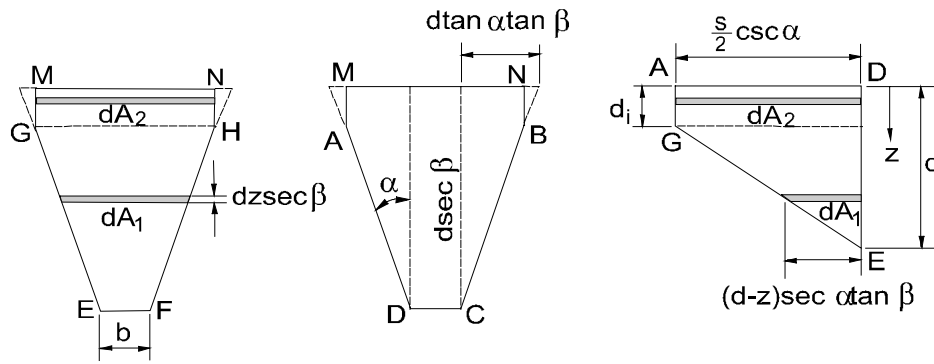

c. Bottom of a wedge

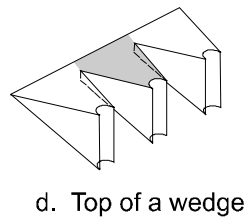

d. Top of a wedge

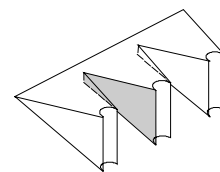

e. Side of a wedge

Figure B-2. Intersecting failure wedges for soldier beams in sand (after Wang and Reese, 1986).

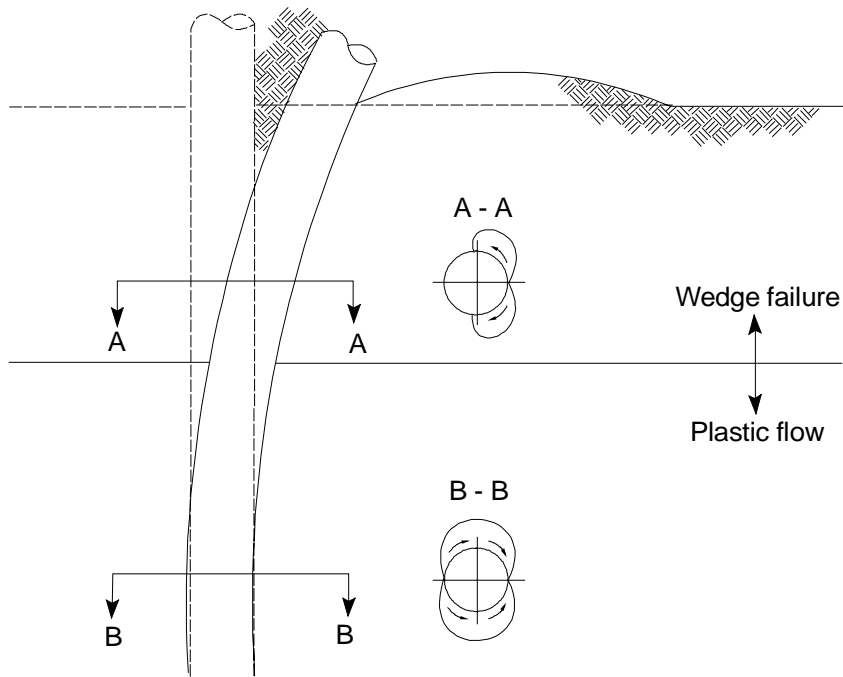

Figure B-3 Plastic flow around a soldier beam toe (after Wang and Reese, 1986).

Figure B-2 shows individual failure wedges intersecting. This may occur, based on the analysis method, for a case where adjacent soldier beams are relatively close to each other or where the depth of the bottom of the soldier beam is relatively large. Equation B-3 gives the depth of the intersection,  $d_i$ , of adjacent wedges.

$$d_i = d - \frac{s_c}{2 \tan \alpha \tan \beta} \quad (\text{Equation B-3})$$

where  $s_c$  is the clear spacing between adjacent soldier beams.

When  $d_i$  is positive, the failure wedges intersect. If  $d_i$  is negative, the failure wedges do not intersect. At depths greater than  $d_i$ , passive resistance is not affected by adjacent soldier beams, and may be computed using equation B-2. Above the point of intersection, passive resistance is reduced to account for the intersection of the failure wedges. To account for the intersection of the wedges, passive resistance computed using equation B-2 is reduced by the resistance computed for a wedge with a height  $d_i$ , and a soldier beam with a width of zero. The resistance down to the depth  $d_i$ , is given by equation B-4.

$$P_{pu} = \gamma d \left[ \frac{K_o d \tan \phi \sin \beta}{\tan(\beta - \phi)} \left( \frac{1}{\cos \alpha} - 1 \right) + \frac{d \tan \beta \tan \alpha}{\tan(\beta - \phi)} - K_o d \frac{\sin^2 \beta}{\cos \beta} \tan \phi (\tan \alpha + 1) \right] \quad (\text{Equation B-4})$$

where:  $d \leq d_i$

At depth, the ultimate lateral resistance will be limited to the resistance that can develop before soil flows between the soldier beams (figure B-3). The ultimate lateral flow resistance is given by:

$$P_{pu} = K_A b \gamma d \tan^8 \beta + K_o \gamma d \tan \phi \tan^4 \beta \quad (\text{Equation B-5})$$

Lateral resistance cannot exceed the passive resistance provided by a continuous wall in cohesionless soil, i.e.

$$P_{pu} = K_p \gamma d (s_c + b) \quad (\text{Equation B-6})$$

### Cohesive Soils

Figure B-4 shows the failure wedge for a single soldier beam in clay. Reese (1958) developed the expression for the passive resistance,  $F_p$ ,

$$F_p = S_u db [\tan \theta + (1 + K) \cot \theta] + \frac{1}{2} \gamma b D^2 + S_u D^2 \sec \theta \quad (\text{Equation B-7})$$

where:  $S_u$  = average undrained shear strength; and

$K$  = a reduction factor to apply to  $S_u$  to give the adhesion between the clay and the soldier beam.

Assuming  $\theta = 45^\circ$  and the shaft friction,  $K = 0$ , equation B-7 is differentiated to give the ultimate soil resistance at depth  $d$ :

$$P_{pu} = 2S_u b + \gamma b d + 2.83S_u d \quad (\text{Equation B-8})$$

The assumption of  $K=0$  implies that no shear strength is mobilized on the plane EFDC (see figure B-4).

If adjacent soldier beams are sufficiently close to each other, it may not be possible to mobilize the full shear resistance (forces  $F_3$  and  $F_4$  in figure B-4) on the sides of the wedge directly in front of the soldier beam. Figure B-5 shows the passive wedges in front of each soldier beam and the wedge of soil between the beams (block FDBGHI). If the space between the beams is large, block FDBGHI will be adequate to resist the side shear forces  $F_3$  and  $F_4$  from the wedges in front of the beams. If block FDBGHI is small, it is assumed that the ground in front of the wall will move together and the individual wedges in front of each beam will not develop. Equation B-9 gives the critical spacing,  $s_{cr}$ , where the behavior changes from single beam behavior to group behavior.

$$s_{cr} = \frac{2.83S_u d}{\gamma d + 6S_u} \quad (\text{Equation B-9})$$

Passive resistance for a soldier beam considering group behavior is given by Equation B-10.

$$P_{pu} = 2S_u (b + s_c) + \gamma d (b + s_c) + S_u s_c \quad (\text{Equation B-10})$$

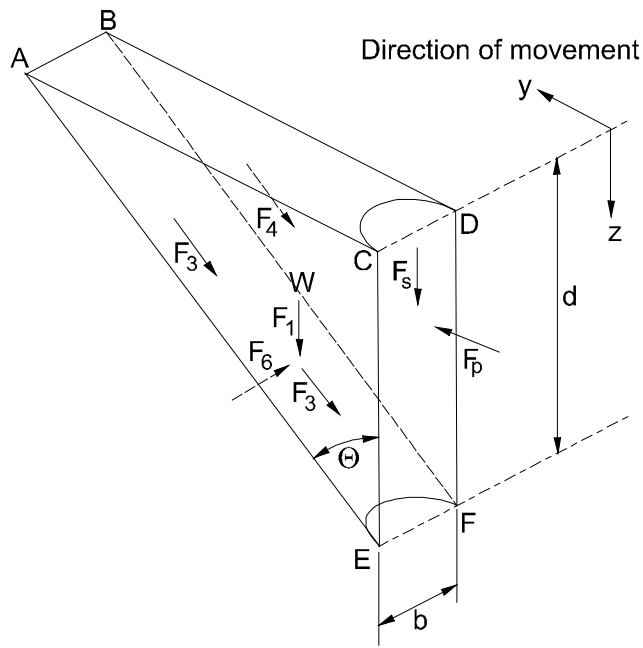

a. Failure wedge

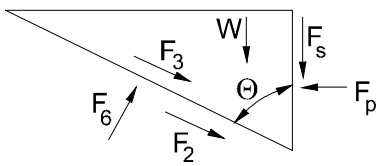

b. Forces on the wedge

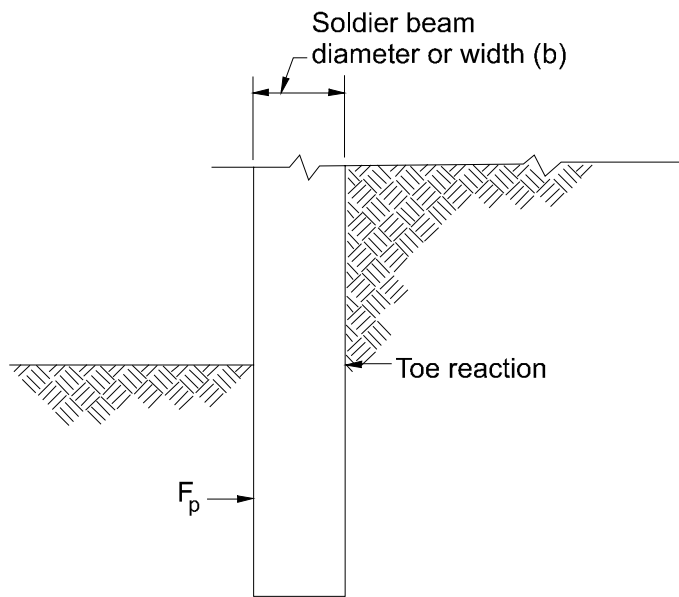

c. Forces on the soldier beam

Figure B-4. Passive wedge failure for a soldier beam in clay (after Reese, 1958, discussion of “Soil Modulus for Laterally Loaded Piles” by McClelland and Focht, Transactions, Volume 123, Reprinted by permission of ASCE).

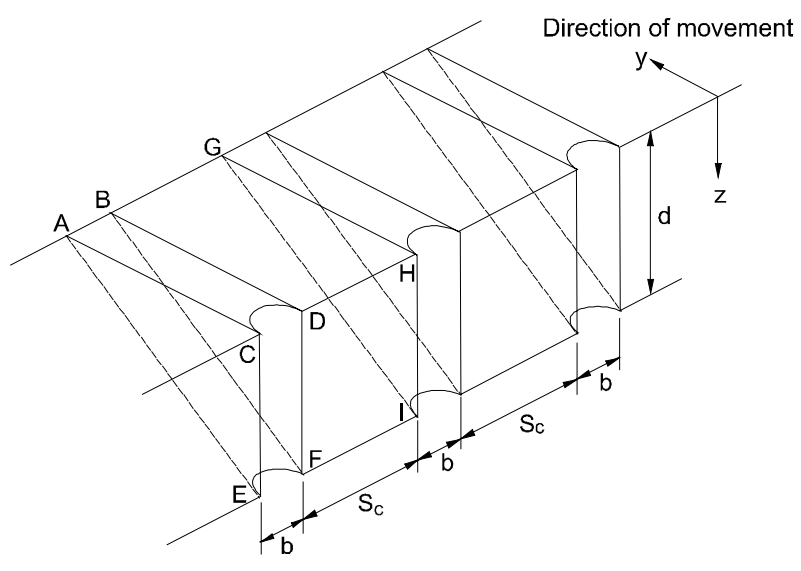

a. General view

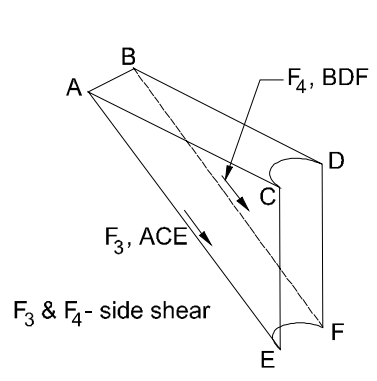

b. Wedge in front of soldier beam

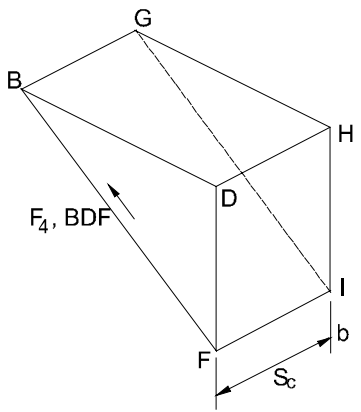

c. Block of soil between beams

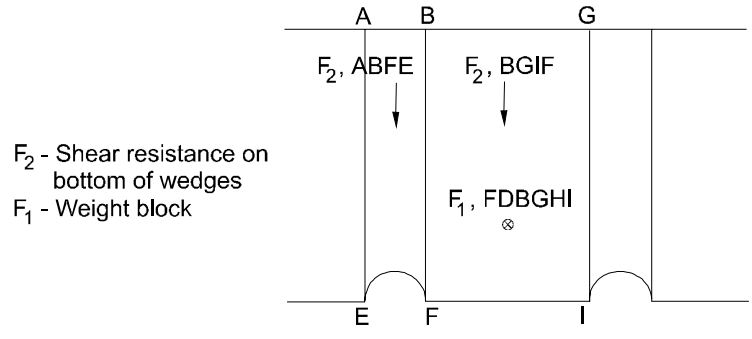

F<sub>2</sub> - Shear resistance on bottom of wedges  
F<sub>1</sub> - Weight block

d. Plan view

Figure B-5. Failure wedges for soldier beams in clay (after Wang and Reese, 1986).

If the spacing between soldier beams becomes zero and the soldier beam width is taken as unity, Equation B-10 becomes Equation B-11, the passive earth pressure equation for a continuous wall.

$$P_{pu} = 11S_u b \quad (\text{Equation B-11})$$

The soil may flow around the beam as it moves through the soil if the toe of the soldier beam becomes sufficiently deep. The failure is similar to that shown in figure B-3. Wang and Reese (1986) approximated the passive flow resistance in clay to be:

$$P_{pu} = 2S_u + \gamma d \quad (\text{Equation B-12})$$

For a wall in clay, the passive resistance at any depth  $d$ , cannot exceed the passive resistance provided by a continuous wall.

$$P_{pu} = (2S_u + \gamma d)(s_c + b) \quad (\text{Equation B-13})$$

Wang and Reese's equations are based on horizontal force equilibrium. The active pressure acting on the wall as it moves away from the retained ground is included in the calculation for cohesionless soils, but not for cohesive soils. As the Wang-Reese equations were developed for stiff clays at relatively shallow depths, the active earth pressures are negative. In neglecting the active pressure term, the tensile strength of the soil is ignored.



Passive Resistance Calculations (Sands)																
$\gamma$	16.93	(kN/m <sup>3</sup> )	$\phi$	29.0		$\tan \phi$	0.554		$K_p$	0.515						
H	9.15	(m)	$\beta$	59.5		$\tan \beta$	1.698		$K_a$	0.347						
b	0.305	(m)	$\alpha$	9.7		$\tan \alpha$	0.170		$K_p$	2.882						
s	2.44	(m)	$\beta - \phi$	30.5		$\tan (\beta - \phi)$	0.589									
$S_c$	2.135	(m)														
toe reaction	223	(kN/m)														
Toe Depth	Active Pressure	Active Force	Rankine Continuous (Eq. B-6)	$d_i$ (Eq. B-3)	Wedge Resistance (single pile) (Eq. B-2)	Wedge Resistance ( $d=d_i$ ) (Eq. B-2)	Wedge Resistance ( $d=h1, \alpha=0$ ) (Eq. B-2)	Wedge Resistance (intersecting wedges)	Flow Resistance (Eq. B-5)	Minimum Wang-Reese Passive Resistance	Broms Passive Resistance (figure 41b)	Total Passive Force (W-R)	Total Passive Force (Broms)	FS (W-R)	FS (Broms)	
0	53.75	0.00	0.00	-3.69	0.00	297.12	137.82	0.00	0.00	0.00	0.00	0.00	0.00	0.00	0.00	
0.5	56.69	8.42	59.53	-3.19	13.90	215.65	96.58	13.90	67.93	13.90	22.32	3.47	5.58	0.02	0.02	
1	59.62	17.29	119.06	-2.69	40.72	147.10	62.41	40.72	135.86	40.72	44.65	17.13	22.32	0.07	0.09	
1.5	62.56	26.61	178.58	-2.19	80.45	91.47	35.32	80.45	203.79	80.45	66.97	47.42	50.23	0.19	0.20	
2	65.50	36.37	238.11	-1.69	133.10	48.75	15.30	133.10	271.72	133.10	89.29	100.81	89.29	0.39	0.34	
2.5	68.44	46.58	297.64	-1.19	198.66	18.95	2.35	198.66	339.65	198.66	111.61	183.75	139.52	0.68	0.52	
3	71.37	57.24	357.17	-0.69	277.15	2.06	-3.53	277.15	407.59	277.15	133.94	302.70	200.91	1.08	0.72	
3.5	74.31	68.35	416.69	-0.19	368.55	-1.90	-2.33	368.55	475.52	368.55	156.26	464.12	273.46	1.59	0.94	
4	77.25	79.91	476.22	0.31	472.86	7.05	5.93	471.75	543.45	471.75	178.58	674.20	357.17	2.23	1.18	
4.5	80.18	91.91	535.75	0.81	590.10	28.91	21.27	582.46	611.38	535.75	200.91	926.07	452.04	2.94	1.44	
5	83.12	104.36	595.28	1.31	720.25	63.70	43.69	700.23	679.31	595.28	223.23	1208.83	558.07	3.69	1.70	
5.5	86.06	117.26	654.81	1.81	863.31	111.40	73.17	825.08	747.24	654.81	245.55	1521.35	675.27	4.47	1.98	
6	89.00	130.61	714.33	2.31	1019.30	172.01	109.72	957.01	815.17	714.33	267.88	1863.63	803.63	5.27	2.27	
Passive Resistance Calculations (Sands)																

**PASSIVE RESISTANCE CALCULATIONS (SANDS)**

Passive Resistance Calculations (Clays)														
$\gamma$	20.73	(kN/m <sup>3</sup> )	$S_u$	71.72	(kPa)									
H	9.15	(m)	toe reaction	270	(kN/m)									
b	0.61	(m)	depth of											
s	3.05	(m)	disturbance (Broms)	0.915	(m)									
$S_c$	2.44	(m)												
Toe Depth	Active Pressure	Active Force	Rankine Continuous (Eq. B-13)	$S_{cr}$ (Eq. B-9)	Wedge Resistance (single pile) (Eq. B-8)	Wedge Resistance (group effects) (Eq. B-10)	Flow Resistance (Eq. B-12)	Minimum Wang-Reese Passive Resistance	Total Passive Force (W-R)	Broms Passive Resistance (figure 41c)	Passive Force over Depth of Disturbance (Broms)	Total Passive Force (Broms)	FS (W-R)	FS (Broms)
0	0.00	0.00	437.49	0.00	87.50	612.49	481.24	87.50	0.00	0.00	393.74	0.00	0.00	0.00
0.305	0.00	0.00	456.78	0.14	153.26	631.77	481.24	153.26	36.72	0.00	393.74	0.00	0.14	0.00
0.61	0.00	0.00	476.06	0.28	219.02	651.06	481.24	219.02	93.49	0.00	393.74	0.00	0.35	0.00
0.915	0.00	0.00	495.34	0.41	284.78	670.34	481.24	284.78	170.32	0.00	393.74	0.00	0.63	0.00
0.9150001	0.00	0.00	495.34	0.41	284.78	670.34	481.24	284.78	170.32	393.74	393.74	0.00	0.63	0.00
1.22	0.00	0.00	514.63	0.54	350.55	689.63	481.24	350.55	267.21	393.74	393.74	120.09	0.99	0.44
1.525	0.00	0.00	533.91	0.67	416.31	708.91	481.24	416.31	384.15	393.74	393.74	240.18	1.42	0.89
1.83	0.00	0.00	553.20	0.79	482.07	728.19	481.24	481.24	521.03	393.74	393.74	360.27	1.93	1.33
2.135	0.00	0.00	572.48	0.91	547.83	747.48	481.24	481.24	667.81	393.74	393.74	480.37	2.47	1.78
2.44	0.00	0.00	591.76	1.03	613.59	766.76	481.24	481.24	814.59	393.74	393.74	600.46	3.02	2.22
2.745	0.00	0.00	611.05	1.14	679.36	786.05	481.24	481.24	961.36	393.74	393.74	720.55	3.56	2.67
3.05	0.00	0.00	630.33	1.25	745.12	805.33	481.24	481.24	1108.14	393.74	393.74	840.64	4.10	3.11
3.355	0.00	0.00	649.62	1.36	810.88	824.61	481.24	481.24	1254.92	393.74	393.74	960.73	4.65	3.56
3.66	0.00	0.00	668.90	1.47	876.64	843.90	481.24	481.24	1401.70	393.74	393.74	1080.82	5.19	4.00
3.965	0.00	0.00	688.19	1.57	942.40	863.18	481.24	481.24	1548.48	393.74	393.74	1200.92	5.74	4.45
4.27	0.00	0.00	707.47	1.67	1008.17	882.47	481.24	481.24	1695.26	393.74	393.74	1321.01	6.28	4.89
4.575	0.00	0.00	726.75	1.77	1073.93	901.75	481.24	481.24	1842.04	393.74	393.74	1441.10	6.82	5.34
4.88	0.00	0.00	746.04	1.86	1139.69	921.03	481.24	481.24	1988.81	393.74	393.74	1561.19	7.37	5.78
5.185	0.00	0.00	765.32	1.96	1205.45	940.32	481.24	481.24	2135.59	393.74	393.74	1681.28	7.91	6.23
5.49	0.00	0.00	784.61	2.05	1271.21	959.60	481.24	481.24	2282.37	393.74	393.74	1801.37	8.45	6.67
5.795	0.00	0.00	803.89	2.14	1336.98	978.89	481.24	481.24	2429.15	393.74	393.74	1921.46	9.00	7.12
6.1	0.00	0.00	823.17	2.22	1402.74	998.17	481.24	481.24	2575.93	393.74	393.74	2041.56	9.54	7.56
Passive Resistance Calculations (Clays)														

**PASSIVE RESISTANCE CALCULATIONS (CLAYS)**

Written by:           PJS           Date:   99  /1  /28   Reviewed by:   DGP           Date:   99  /1  /28  

Client:           FHWA           Project:           GEC#4           Project/Proposal No.:           GE3686           Task No:           G2          

**APPENDIX C**

**EXAMPLE CALCULATION OF BENDING MOMENT FOR WALL IN WEAK COHESIVE SOIL**

Example: Calculate cantilever bending moment about lowest anchor.

Problem: A two-level anchored wall is used to retain the excavation shown below. The stability number,  $N_s$ , is calculated to be 5.88. For conditions where the stability number is greater than 4, an unbalanced pressure condition exists over the embedded portion of the wall, i.e., no passive resistance can be developed. The depth of embedment is equal to 0.2H or 2 m.

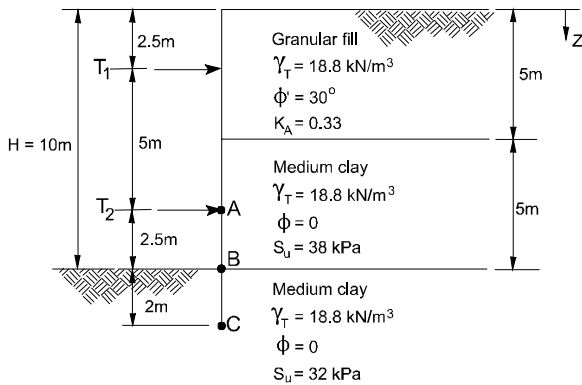

$$N_s = \frac{\gamma H}{S_u} = \frac{18.8 \text{ kN/m}^3 (5\text{m} + 5\text{m})}{32 \text{ kPa}}$$

$$N_s = 5.88$$

1. Due to the high stability number, it is reasonable to assume that there will be sufficient outward toe movement to generate full active earth pressures below the lowest anchor,  $T_2$ .
2. Calculate active and passive pressures below Pt. A.

$$P_A^A = \gamma z - 2S_u = 18.8 \text{ kN/m}^3 (7.5 \text{ m}) - 2 (38 \text{ kPa}) = 65 \text{ kPa}$$

$$P_A^{B+} = \gamma z - 2S_u = 18.8 \text{ kN/m}^3 (10 \text{ m}) - 2 (38 \text{ kPa}) = 112 \text{ kPa}$$

$$P_A^{B-} = \gamma z - 2S_u = 18.8 \text{ kN/m}^3 (10 \text{ m}) - 2 (32 \text{ kPa}) = 124 \text{ kPa}$$

$$P_A^C = \gamma z - 2S_u = 18.8 \text{ kN/m}^3 (12 \text{ m}) - 2 (32 \text{ kPa}) = 161.6 \text{ kPa}$$

$$P_P^B = \gamma z + 2S_u = 0 + 2 (32 \text{ kPa}) = 64 \text{ kPa}$$

$$P_P^C = \gamma z + 2S_u = 18.8 \text{ kN/m}^3 (2 \text{ m}) + 2 (32 \text{ kPa}) = 101.6 \text{ kPa}$$

Written by:           PJS           Date:   99  /1  /28   Reviewed by:   DGP           Date:   99  1  /28  

Client:           FHWA           Project:           GEC#4           Project/Proposal No.:           GE3686           Task No:           G2          

3. Net Pressure Diagram

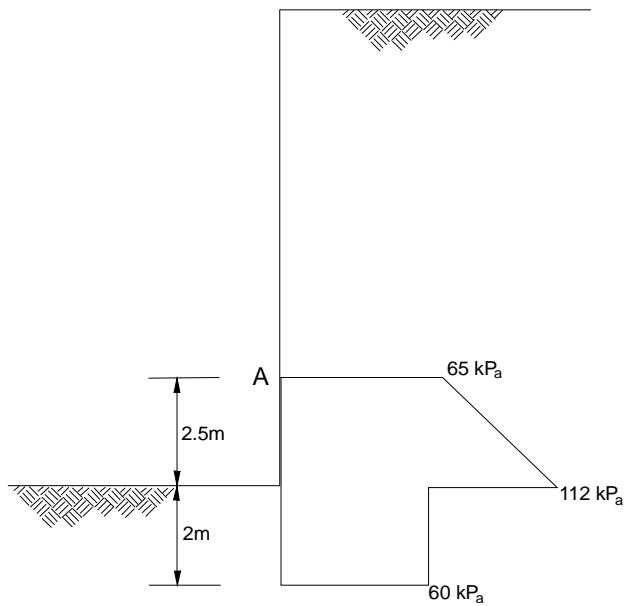

4. Calculate bending moment at A

$$\begin{aligned}
 M_A &: (65 \text{ kPa}) (2.5 \text{ m}) (1.25 \text{ m}) + \frac{1}{2} (2.5 \text{ m}) (112 \text{ kPa} - 65 \text{ kPa}) \frac{2}{3} (2.5 \text{ m}) \\
 &+ (60 \text{ kPa}) (2 \text{ m}) (3.5 \text{ m}) \\
 &= 721 \text{ kN m/meter of wall}
 \end{aligned}$$

## APPENDIX D

### PREDESIGN LOAD TESTING PROCEDURES TO EVALUATE ULTIMATE GROUND ANCHOR LOAD

The following two test procedures require testing two anchors in uniform soil conditions to achieve the design load. The first anchor will be tested to estimate the ultimate load and establish a safe reference load for the second test anchor.

#### 1. To Verify Design Load Safety Factor

- a. An anchor design load has been proposed and the desired safety factor established for the bond length of the anchor.
- b. The tendon steel area of the two test anchors is specified such that the maximum applied load (safety factor times design load) does not exceed 50 percent of the specified minimum tensile strength (SMTS).
- c. Install the anchors to the proposed design requirement using anticipated free length, drilling method, inclination, etc.
- d. Load the first anchor in increments of 10 percent SMTS until 80 percent SMTS is attained or failure occurs (inability to maintain constant load without excessive movement).
- e. Hold each load increment constant for 1 hour and record deflection readings at 1, 2, 5, 10, 20, 30, and 60 minutes.
- f. If failure occurs, the last successfully held load will be used as the reference value for the second test. If failure does not occur, the critical creep tension will be determined as shown in figure D-1. In the latter case, the reference value for the second test will be the smaller of either the proposed design load times the safety factor or 90 percent of the critical creep tension.
- g. The second test anchor shall be loaded, in increments of 10 percent of the reference value obtained above, up to 100 percent of the reference load. Each increment up to and including the reference load shall be held constant for 1 hour and deflection readings made as in (e) above. Unless the creep curves show increasing upward concavity as in figure D-1, the reference load should be cycled back to 90 percent of the reference and held until deflection stabilizes. The load may be recycled to the reference load for a 72 hour hold for situations where total elongation is critical or where the reference curve may be extrapolated to the 72 hour stage. Adequate deflection readings should be taken to define the semilog plot of displacement versus time such as shown in figure D-2. Upward concavity of the previous mentioned creep curves indicates excessive creep and a need to reduce the reference load.

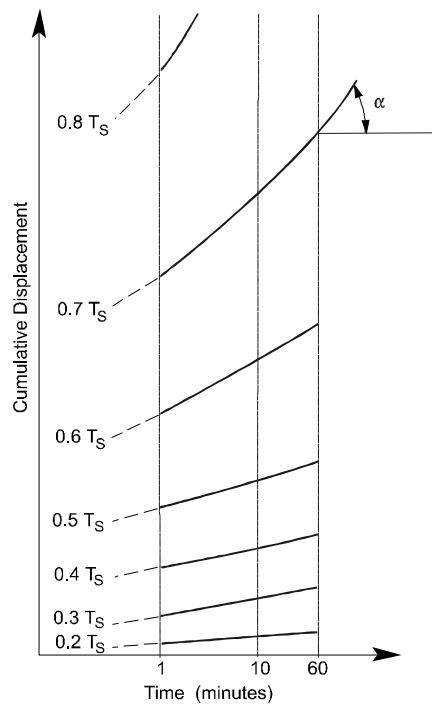
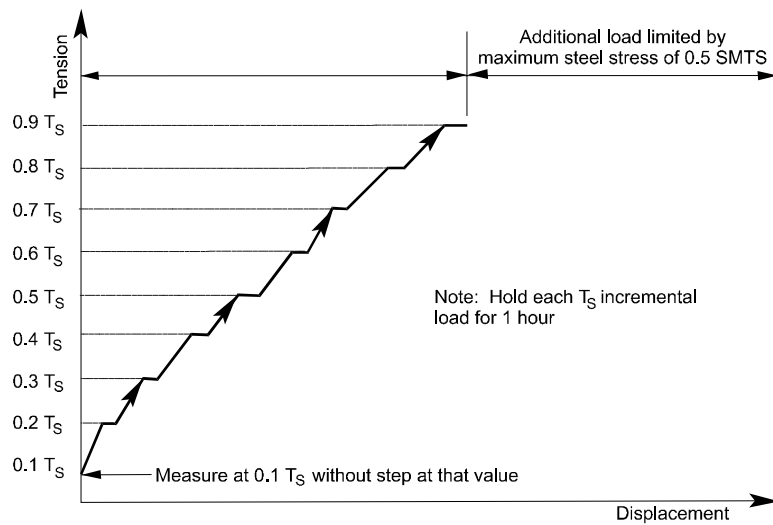

(a) Creep curves

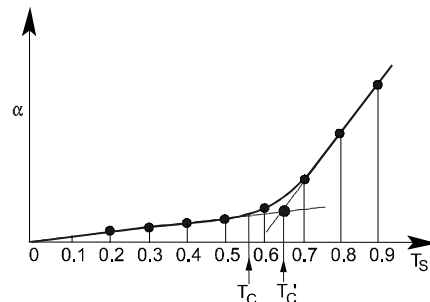

(b) Critical creep tension

1. Plot the deflection at each time increment on semi-log paper as in (a).
2. Measure the angle  $\alpha$  at the  $T_1 + 60$  minute reading and plot results as in (b).
3. The critical creep tension,  $T_c$ , occurs at the sharp upward break. If  $T_c$  is not easily identifiable,  $T'_c$  may be found from the intersection of the two tangents as in (b). In that case, the value of  $T_c$  is taken as  $0.9T'_c$ .
4. If the plot in (b) is a straight line, the critical creep tension has not been reached and a value of  $0.6 T_s$  should be assumed.

Figure D-1. Determination of critical creep tension.

The reference load is acceptable if the creep curves for similar loads in the first and second tests reasonably coincide, and if the absolute displacement between the end of the 1<sup>st</sup> hour and the end of the 72<sup>nd</sup> hour are less than or equal to 0.0002 times the free stressing length. Steel creep may be deducted, but is usually not significant as the reference load is usually less than 0.5 SMTS. If the first and second tests do not reasonably coincide, additional tests must be done at the reference load. If the tests do coincide, but the absolute displacement is too great (see load curve 4 in figure D-2), the maximum load is found by extrapolating the creep curves of lower loads until the criteria is met (as done for load curve 3 in figure D-2).

## 2. To Establish the Design Load

- a. Estimate the ultimate pullout capacity of the bond zone.
- b. The tendon steel area of the two test anchors is specified such that an applied load of 150 percent of the estimated ultimate capacity does not exceed 80 percent SMTS.
- c. Install the anchors to proposed criteria, but limit the bond length to less than 12.2 m.
- d. Load the first anchor in increments of 10 percent SMTS until 80 percent SMTS is attained or failure occurs (inability to maintain constant load without excessive movement).
- e. Hold each load increment constant for 1 hour and record deflection readings at 1, 2, 5, 10, 20, 30, and 60 minutes.
- f. If failure occurs, the last successfully held load will be used for the reference load for the second test.

If failure does not occur, the critical creep tension will be determined as shown in figure D-1. In such case, the reference value will be 90 percent of the critical creep tension. If the critical creep tension is not reached, the reference value will be 60 percent SMTS.

- g. The second test anchor shall be loaded in increments of 10 percent of the reference value obtained above. Each increment up to and including the reference load shall be held constant for 1 hour and appropriate deflection readings made as in item (e) above. Unless the creep curves show increasing upward concavity as in figure D-1, the load should be cycled back one increment and held until deflection stabilizes. The load may be recycled to the reference load for a 72-hour hold where total elongation is critical or the reference curve may be extrapolated to the 72 hour stage. Adequate deflection readings should be taken to define the semilog plot of displacement versus time shown in figure D-2.

Upward concavity of the reference creep curve indicates excessive creep and requires the reference load to be reduced to the nearest load for which the creep curve is about a straight line. In figure D-1 the creep curves become increasingly upward concave above  $0.5T_G$ . Therefore, the  $0.5T_G$  load is the highest acceptable creep curve.

- h. The reference load is acceptable if the creep curves in the first and second tests reasonably coincide, and if the absolute displacement between the end of the 1<sup>st</sup> hour and the end of the

72<sup>nd</sup> hour are less than or equal to 0.0002 times the free stressing length. Steel creep may be deducted, but it is not a significant part of this value as the reference load is usually below 0.5 SMTS.

If the first and second tests do not coincide, additional tests must be done to establish a representative set of creep curves on which to select the design load. If the tests do coincide, but the absolute displacement is too great (see curve 4 in figure D-2), the maximum design load may be found by extrapolating the creep curves for lower loads until the criteria is met (as done for load curve 3 in figure D-2).

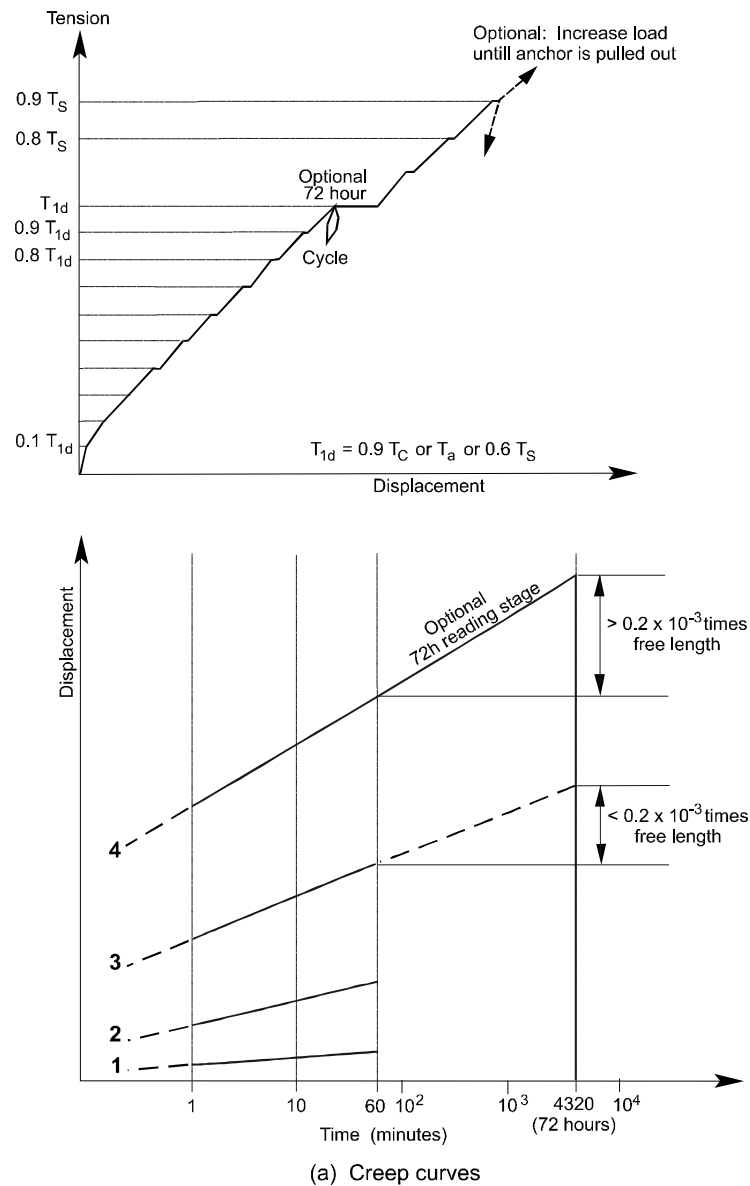

Figure D-2. Extrapolation of creep curves for determining working tension.



## APPENDIX E

### SPECIFICATION FOR GROUND ANCHORS

#### PART 1 GENERAL

##### 1.01 DESCRIPTION

- A. The Contractor shall furnish all labor, materials, tools, supervision, transportation, installation equipment, and incidentals necessary to complete the work specified herein and shown on the Contract Drawings. The work shall include but not be limited to mobilization, surveying, drilling, inserting, grouting, stressing, load testing, and lock-off of ground anchors at the appropriate locations.
- B. Unless otherwise directed, the Contractor shall select the ground anchor type, drilling method, grouting method, grouting pressures, and, subject to the minimum values in the contract documents, determine the bond length, free-stressing (unbonded) length, and anchor diameter. The Contractor shall be responsible for installing ground anchors that will develop the load-carrying capacity indicated on the Contract Drawings in accordance with the testing subsection of this Specification.
- C. The anchor tendon shall be protected from corrosion as shown on the Contract Drawings and in accordance with the requirements of this Specification.

#### COMMENTARY

*This Specification is a performance specification for a single ground anchor. The Contractor is given the responsibility for the ground anchor design, construction and performance. This specification assumes that the location and the capacity of the ground anchors have been chosen.*

*If the Designer is unable to estimate a reasonable ground anchor capacity for a particular site, it may be desirable to allow the Contractor to select the ground anchor capacity. This Specification can be modified to enable the Contractor to select the ground anchor capacities and their locations. Then the Contractor will be required to redesign those portions of the structure affected by the ground anchors.*

*This Specification applies to permanent ground anchors and may, if the Owner so desires, be used for ground anchors used as part of a temporary application. Such temporary applications will have design and performance requirements that are similar to those for permanent systems. This Specification is not intended to be used for ground anchors used for temporary support of excavation systems.*

##### 1.02 DEFINITIONS

**Admixture:** Substance added to the grout to either control bleed and/or shrinkage, improve flowability, reduce water content, or retard setting time.

**Alignment Load (AL):** A nominal minimum load applied to an anchor during testing to keep the testing equipment correctly positioned.

**Anchor:** A system, used to transfer tensile loads to the ground (soil or rock), which includes the prestressing steel, anchorage, corrosion protection, sheathings, spacers, centralizers, and grout.

**Anchor Head:** The means by which the prestressing force is permanently transmitted from the prestressing steel to the bearing plate. The anchor head includes wedges and a wedge plate for strand tendons or an anchor nut for bar tendons.

**Anchor Nut:** The threaded device that transfers the prestressing force in a bar to a bearing plate.

**Anchorage:** The combined system of anchor head, bearing plate, trumpet, and corrosion protection that is capable of transmitting the prestressing force from the prestressing steel to the surface of the ground or the supported structure.

**Anchorage Cover:** A cover to protect the anchorage from corrosion and physical damage.

**Anchor Grout:** See Primary Grout.

**Apparent Free Tendon Length:** The length of tendon which is apparently not bonded to the surrounding grout or ground, as calculated from the elastic load extension data during testing.

**Bearing Plate:** A steel plate under the anchor head that distributes the prestressing force to the anchored structure.

**Bond Length:** The length of the tendon that is bonded to the primary grout and capable of transmitting the applied tensile load to the surrounding soil or rock.

**Bondbreaker:** A sleeve placed over the anchor tendon in the free stressing length to ensure unobstructed elongation of the tendon during stressing.

**Centralizer:** A device to support and position the tendon in the drill hole so that a minimum grout cover is provided.

**Coarse-Grained Soils:** Soils with more than 50 percent, by weight, of the material larger than the No. 200 sieve size.

**Cohesive Soils:** Soils that exhibit plasticity. Atterberg limits are commonly used to determine plasticity and better define a soil as cohesive or non-cohesive.

**Consolidation Grout:** Portland cement grout that is injected into the hole prior to inserting the tendon to either reduce the permeability of the rock surrounding the hole or improve the ground conditions.

**Construction Quality Assurance (CQA) Inspector:** The person/firm responsible for construction quality assurance (CQA) testing, monitoring, and other duties related to assuring the quality of construction and adherence to the Contract Drawings and Specifications.

**Contract Drawings:** The approved plans, profiles, typical cross sections, working drawings, and supplemental drawings which show the location, dimensions, and details of the work to be done.

**Contractor:** The person/firm responsible for performing the anchor work.

**Corrosion Inhibiting Compound:** Material used to protect against corrosion and/or lubricate the prestressing steel.

**Coupler:** The means by which the prestressing force can be transmitted from one partial-length of a prestressing tendon to another (mainly for bars).

**Creep Movement:** The movement that occurs during the creep test of an anchor under a constant load.

**Creep Test:** A test to determine the movement of the ground anchor at a constant load.

**Design Load (DL):** Anticipated final maximum effective load in the anchor after allowance for time-dependent losses or gains. The design load includes appropriate load factors to ensure that the overall structure has adequate capacity for its intended use.

**Detensionable Anchor Head:** An anchor head that is restressable and, in addition, permits the tendon to be completely detensioned in a controlled way at any time during the life of the structure.

**Downward Sloped Anchor:** Any prestressed anchor that is placed at a slope greater than 5 degrees below the horizontal.

**Elastic Movement:** The recoverable movement measured during an anchor test.

**Encapsulation:** A corrugated or deformed tube protecting the prestressing steel against corrosion in the tendon bond length.

**Engineer:** The engineer shall be appointed by the Owner to undertake the duties and powers assigned to the Engineer by the Contract Documents. The engineer is responsible for approving all design and specification changes and making design clarifications that may be required during construction.

**F<sub>PU</sub>:** Specified minimum tensile strength of the tendon as defined in the pertinent ASTM Specification.

**Fine-Grained Soils:** Soils with at least 50 percent, by weight, of the material smaller than the No. 200 sieve size.

**Free Stressing (Unbonded) Length:** The designed length of the tendon that is not bonded to the surrounding ground or grout during stressing.

**Fully Bonded Anchor:** Anchor in which the free stressing length without bondbreaker is grouted after stressing and so bonded to the surrounding structure or ground.

**Horizontal Anchor:** Any prestressed anchor that is placed at a slope within ( $\pm 5$  degrees) of the horizontal.

**Lift-Off:** The load (lift-off load) in the tendon which can be checked at any specified time with the use of a hydraulic jack, by lifting the anchor head off the bearing plate.

**Lock-Off Load:** The prestressing force in an anchor immediately after transferring the load from the jack to the stressing anchorage.

**Non-Cohesive Soils:** Material that is generally nonplastic.

**Permanent Anchor:** Any prestressed ground anchor that is intended to remain and function as part of a permanent structure. A permanent anchor has to fulfill its function for an extended period of time and thus requires special design, corrosion protection, and supervision during installation.

**Performance Test:** Incremental cyclic test loading of a prestressed anchor in which the total movement of the anchor is recorded at each increment.

**Primary Grout:** Portland cement grout that is injected into the anchor hole prior to or after the installation of the anchor tendon to provide for the force transfer to the surrounding ground along the bond length of the tendon. Primary grout is also known as anchor grout.

**Proof Test:** Incremental loading of a prestressed anchor recording the total movement of the anchor at each increment.

**Pulling Head:** Temporary anchoring device behind the hydraulic jack during stressing.

**Relaxation:** The decrease of stress or load with time while the tendon is held under constant strain.

**Residual Movement:** The non-elastic (i.e., non-recoverable) movement of an anchor measured during load testing.

**Restressable Anchor Head:** An anchor head that permits the anchor load, throughout the life of the structure, to be measured by lift-off checking and adjusted by shimming/unshimming or thread-turning.

**Safety Factor:** The ratio of the ultimate capacity to the working load used for the design of any component or interface.

**Sheath:** A smooth or corrugated pipe or tube protecting the prestressing steel in the free stressing length against corrosion.

**Shop Drawings:** All drawings, diagrams, illustrations, schedules, performance charts, brochures, and other data which are prepared for or by the Contractor or any subcontractor, manufacturer, supplier, or distributor and which illustrate the equipment, material, or any other matter relating to the work.

**Spacer:** A device to separate elements of a multiple-element tendon to ensure full bond development of each prestressing steel element.

**Stressing Anchorage:** See Anchorage.

**Subcontractor:** The Subcontractor is a person/firm who has a direct or indirect contract relationship with the Contractor to perform any of the work.

**Supplier:** Any person/firm who supplies materials or equipment for the work, including that fabricated to a special design, and may also be a Subcontractor.

**Support of Excavation Anchor:** A prestressed ground anchor which functions temporarily, generally 18 to 36 months in duration, and which is not considered by the owner to fulfill a critical function.

**Temporary Critical Anchor:** Any prestressed ground anchor for a temporary use that is judged by the owner to provide a critical function. Temporary critical anchors are commonly designed using the same criteria as permanent anchors. Temporary critical anchors installed in corrosive environments may require corrosion protection.

**Tendon:** The complete anchor assembly (excluding grout) consisting of prestressing steel, corrosion protection, sheathings, and coating when required, as well as spacers and centralizers.

**Test Load (TL):** The maximum load to which the anchor is subjected during testing.

**Trumpet:** Device to provide corrosion protection in the transition length from the anchorage to the free stressing length.

**Unbonded Anchor:** Anchor in which the free stressing length remains permanently unbonded.

**Upward Sloped Anchor:** Any prestressed anchor that is placed at a slope greater than 5 degrees above the horizontal.

**Wedge:** The device that transfers the prestressing force in the strand to the wedge plate.

**Wedge Plate:** The device that holds the wedges of multistrand tendons and transfers the anchor force to the bearing plate.

**Working Load:** Equivalent term for Design Load.

### 1.03 CONTRACTOR QUALIFICATIONS

- A. The Contractor performing the work described in this Specification shall have installed permanent ground anchors for a minimum of three (3) years.
- B. The Contractor shall assign an engineer to supervise the work with at least three (3) years of experience in the design and construction of permanent anchored structures. The Contractor may not use consultants or manufacturer's representatives in order to meet the requirements of this section. Drill operators and on-site supervisors shall have a minimum of one (1) year experience installing permanent ground anchors with the Contractor's organization.

## COMMENTARY

*This Specification assumes that a specialty contractor will perform the ground anchor work. If the Prime Contractor is expected to install the ground anchors, the following paragraph should be used: "Inadequate proof of the qualifications, as judged by the Engineer, shall be cause for withholding contract award or for rejection of the bid. The Engineer may suspend the ground anchor work if the Contractor substitutes unqualified personnel for approved personnel during construction." Highway agencies are encouraged to develop a process where qualified specialty anchor contractors can be pre-approved for anchor work.*

### 1.04 SUBMITTALS

- A. The Contractor shall submit a list containing at least five (5) projects completed within the last five (5) years. For each project, the Contractor shall include with this submittal, at a minimum: (1) name of client contact, address, and telephone number; (2) location of project; (3) contract value; and (4) scheduled completion date and actual completion date for the project.
- B. Resumes of the Contractor's staff shall be submitted to the Owner for review as part of the Contractor bid. Only those individuals designated as meeting the qualification requirements shall be used for the project. The Contractor cannot substitute for any of these individuals without written approval of the Owner or Owner's Engineer (Engineer). The Engineer shall approve or reject the Contractor's qualifications and staff within fifteen (15) working days after receipt of the submission. Work shall not be started on any anchored wall system nor materials ordered until the Contractor's qualifications have been approved by the Engineer. The Engineer may suspend the work if the Contractor substitutes unqualified personnel for approved personnel during construction. If work is suspended due to the substitution of unqualified personnel, the Contractor shall be fully liable for additional costs resulting from the suspension of work and no adjustment in contract time resulting from the suspension of work will be allowed.
- C. The Contractor shall prepare and submit to the Engineer for review and approval Working Drawings and a design submission describing the ground anchor system or systems intended for use. The Working Drawings and design submission shall be submitted thirty (30) working days prior to the commencement of the ground anchor work. The Working Drawings and design submission shall include the following:
  - 1. A ground anchor schedule giving:
    - a. Ground anchor number;
    - b. Ground anchor design load;
    - c. Type and size of tendon;
    - d. Minimum total anchor length;
    - e. Minimum bond length;
    - f. Minimum tendon bond length; and
    - g. Minimum unbonded length.
  - 2. A drawing of the ground anchor tendon and the corrosion protection system including details for the following:

- a. Spacers and their location;
  - b. Centralizers and their location;
  - c. Unbonded length corrosion protection system;
  - d. Bond length corrosion protection system;
  - e. Anchorage and trumpet; and
  - f. Anchorage corrosion protection system.
3. Certificates of Compliance for the following materials, if used. The certificate shall state that the material or assemblies to be provided will fully comply with the requirements of the contract.
- a. Prestressing steel, strand or bar;
  - b. Portland cement;
  - c. Prestressing hardware;
  - d. Bearing plates; and
  - e. Corrosion protection system.
- D. The Engineer shall approve or reject the Contractor's Working Drawings and design submission within thirty (30) working days after receipt of the submission. Approval of the design submittal does not relieve the Contractor of his responsibility for the successful completion of the work.
- E. The Contractor shall submit to the Engineer for review and approval or rejection mill test reports for the prestressing steel and the bearing plate steel. The Engineer may require the Contractor to provide samples of any ground anchor material intended for use on the project. The Engineer shall approve or reject the prestressing steel and bearing plate steel within five (5) working days after receipt of the test reports. The prestressing steel and bearing plates shall not be incorporated in the work without the Engineer's approval.
- F. The Contractor shall submit to the Engineer for review and approval or rejection calibration data for each test jack, load cell, primary pressure gauge and reference pressure gauge to be used. The Engineer shall approve or reject the calibration data within five (5) working days after receipt of the data. Testing cannot commence until the Engineer has approved the jack, load cell, primary pressure gauge and reference pressure gauge calibrations.
- G. The Contractor shall submit to the Engineer within twenty (20) calendar days after completion of the ground anchor work a report containing:
- 1. Prestressing steel manufacturer's mill test reports for the tendons incorporated in the installation;
  - 2. Grouting records indicating the cement type, quantity injected and the grout pressures;
  - 3. Ground anchor test results and graphs; and
  - 4. As-built drawings showing the location and orientation of each ground anchor, anchor capacity, tendon type, total anchor length, bond length, unbonded length, and tendon bond length as installed and locations of all instruments installed by the Owner.

## 1.05 REFERENCES

- A. Contract Drawings, entitled \_\_\_\_\_, dated \_\_\_\_\_.

- B. Ground Anchor Inspector's Manual, from "In-Situ Soil Improvement Techniques", American Association of State Highway and Transportation Officials - Associated Contractors of America - American Road and Transportation Builders Association (AASHTO-AGC-ARTBA), Task Force 27 Report, 1990.
- C. Latest version of American Society for Testing and Materials (ASTM) standards:
1. ASTM A 53 Standard Specification for Steel Pipe
  2. ASTM A 500 Standard Specification for Cold-formed Welded and Seamless Carbon Steel Structural Tubing in Rounds and Shapes
  3. ASTM A 536 Standard Specification for Ductile Iron Castings
  4. ASTM A 775 Standard Specification for Epoxy-Coated Reinforcing Steel Bars
  5. ASTM A 779 Standard Specification for Steel Strand, Seven Wire, Uncoated, Compacted, Stress-relieved for Prestressed Concrete
  6. ASTM A 882 Standard Specification for Epoxy-Coated Seven-Wire Prestressing Steel Strand
  7. ASTM A 981 Standard Test Method for Evaluating Bond Strength for 15.2 mm (0.6 in.) Diameter Prestressing Steel Strand, Grade 270, Uncoated, used in Prestressed Ground Anchors
  8. ASTM C 109 Standard Test Method for Compressive Strength of Hydraulic Cement Mortars (Using 2 inch or 50 mm Cube Specimens)
  9. ASTM C 143 Standard Test Method for Slump of Hydraulic Cement Concrete
  10. ASTM D 1248 Standard Specification for Polyethylene Plastic Molding and Extrusion Materials
  11. ASTM D 1784 Standard Specification for Rigid Poly Vinyl Chloride (PVC) Compounds and Chlorinated Poly Vinyl Chloride (CPVC) Compounds
  12. ASTM D 1785 Standard Specification for Poly Vinyl Chloride (PVC) Plastic Pipe, Schedule 40, 80 and 120
  13. ASTM D 2241 Standard Specification for Poly Vinyl Chloride (PVC) Pressure-Rated Pipe (SDR Series)
  14. ASTM D 4101 Standard Specification for Propylene Plastic Injection and Extrusion Materials
  15. ASTM G 57 Standard Method for Field Measurements of Soil Resistivity under the Wenner Four Electrode Method
- D. Latest version of American Association of State Highway and Transportation Officials (AASHTO) standards:
1. AASHTO M 85 Portland Cement
  2. AASHTO M 183 Structural Steel
  3. AASHTO M 203 Uncoated Seven-wire Stress-relieved Steel Strand
  4. AASHTO M 222 High-strength Low-alloy Structural Steel with 50,000 psi Minimum Yield Point to 4 Inches Thick
  5. AASHTO M 252 Corrugated Polyethylene Drainage Tubing
  6. AASHTO M 275 Uncoated High-strength Steel Bar
  7. AASHTO M 284 Epoxy-coated Reinforcing Bars
  8. AASHTO T 288 Determining Minimum Laboratory Soil Resistivity
  9. AASHTO T 289 Determining pH of Soil for Use in Corrosion Testing
  10. AASHTO T 290 Determining Water Soluble Sulfate Ion Content in Soil



- E. American Water Works Association (AWWA) C 105, “Notes on Procedures for Soil Survey Tests and Observations and Their Interpretation to Determine Whether Polyethylene Encasement Should Be Used,” Appendix A
- F. Latest version of Post Tensioning Institute (PTI) standards:
  - 1. PTI, “Post Tensioning Manual”
  - 2. PTI, “Specification for Unbonded Single Strand Tendons”
  - 3. PTI, “Recommendations for Prestressed Rock and Soil Anchors”

## **1.06 EXISTING CONDITIONS**

- A. Prior to beginning work, the Owner shall provide utility location plans to the Contractor. The Contractor is responsible for contacting a utility location service to verify the location of underground utilities before starting the work.
- B. The Contractor shall survey the condition of adjoining properties and make records and photographs of any evidence of settlement or cracking of any adjacent structures. The Contractor’s report of this survey shall be delivered to the Owner before work begins.

### *COMMENTARY*

*Installation of ground anchors has the potential to induce movements in the ground which could adversely affect or be perceived to adversely affect adjacent structures. It is the intention of this section to provide baseline information to the Owner to protect the interest of the Owner in the event of potential future litigation.*

## **1.07 CONSTRUCTION QUALITY ASSURANCE**

- A. The Construction Quality Assurance (CQA) Inspector will monitor all aspects of anchored wall construction. The CQA Inspector will perform material conformance testing as required. The Contractor shall be aware of the activities required by the CQA Inspector and shall account for these activities in the construction schedule. The Contractor shall correct all deficiencies and nonconformities identified by the CQA Inspector at no additional cost to the Owner.

### *COMMENTARY*

*The purpose of this section is to identify to the Contractor the Owner's interest to inspect and monitor contractor compliance with all aspects of the project specifications. In general, projects that are subject to independent CQA monitoring perform better in the long-term than those that do not require independent CQA monitoring.*

## **PART 2 MATERIALS**

### **2.01 GENERAL**

- A. The Contractor shall not deliver materials to the site until the Engineer has approved the submittals outlined in Part 1.04 of this Specification.

- B. The designated storage location or locations shall be protected by the Contractor from theft, vandalism, passage of vehicles, and other potential sources of damage to materials delivered to the site.
- C. The Contractor shall protect the materials from the elements by appropriate means. Prestressing steel strands and bars shall be stored and handled in accordance with the manufacturer's recommendations and in such a manner that no damage to the component parts occurs. All steel components shall be protected from the elements at all times. Cement and additives for grout shall be stored under cover and protected against moisture.

## **2.02 ADMIXTURES**

- A. Admixtures which control bleed, improve flowability, reduce water content, and retard set may be used in the grout subject to the approval of the Engineer. Admixtures, if used, shall be compatible with the prestressing steels and mixed in accordance with the manufacturer's recommendations. Expansive admixtures may only be added to the grout used for filling sealed encapsulations, trumpets, and anchorage covers. Accelerators shall not be permitted.

### *COMMENTARY*

*Expansive admixtures are not permitted in the bond length grout because they are only effective if they are used in a confined space, i.e., a sealed encapsulation or trumpets. Expansive admixtures achieve expansion by the generation of gas. In an open ground anchor drill hole, the expansion occurs upward and the resulting grout is weakened. Expansive admixtures which generate hydrogen gas (molecular hydrogen, H<sub>2</sub>) can be used. There is no evidence that they will cause hydrogen embrittlement of the prestressing steel. Hydrogen embrittlement is caused when nascent hydrogen (ionic hydrogen, H<sup>+</sup>) combines inside the steel to form molecular hydrogen disrupting the structure of the steel.*

*Accelerators are not permitted because of concern that some accelerators may cause corrosion of the prestressing steel.*

## **2.03 ANCHORAGE DEVICES**

- A. Stressing anchorages shall be a combination of either a steel bearing plate with wedge plate and wedges, or a steel bearing plate with a threaded anchor nut. The steel bearing and wedge plate may also be combined into a single element. Anchorage devices shall be capable of developing 95 percent of the specified minimum ultimate tensile strength (SMTS) of the prestressing steel tendon. The anchorage devices shall conform to the static strength requirements of Section 3.1.6 (1) and Section 3.1.8 (1) and (2) of the PTI "Guide Specification for Post-Tensioning Materials."
- B. The bearing plate shall be fabricated from steel conforming to AASHTO M 183 or M 222 specifications, or equivalent, or may be a ductile iron casting conforming to ASTM A 536.
- C. The trumpet shall be fabricated from a steel pipe or tube or from PVC pipe. Steel pipe or tube shall conform to the requirements of ASTM A 53 for pipe or ASTM A 500 for tubing. Steel trumpets shall have a minimum wall thickness of 3 mm for diameters up to 100 mm and 5 mm

for larger diameters. PVC pipe shall conform to ASTM A 1785, Schedule 40 minimum. PVC trumpets shall be positively sealed against the bearing plate and aligned with the tendon to prevent cracking during stressing.

- D. Anchorage covers shall be fabricated from steel or plastic with a minimum thickness of 2.3 mm. The joint between the cover and the bearing plate shall be watertight.
- E. Wedges shall be designed to preclude premature failure of the prestressing steel due to notch or pinching effects under static and dynamic strength requirements of Section 3.1.6 (1) and Section 3.1.8 (1) and 3.1.8 (2) of the PTI "Post Tensioning Manual." Wedges shall not be reused.
- F. Wedges for epoxy coated strand shall be designed to be capable of biting through the epoxy coating and into the strand. Removal of the epoxy coating from the strand to allow the use of standard wedges shall not be permitted. Anchor nuts and other threadable hardware for epoxy coated bars shall be designed to thread over the epoxy coated bar and still comply with the requirements for carrying capacity.

#### **2.04 BONDBREAKER**

- A. The bondbreaker shall be fabricated from a smooth plastic tube or pipe having the following properties: (1) resistant to chemical attack from aggressive environments, grout, or corrosion inhibiting compound; (2) resistant to aging by ultra-violet light; (3) fabricated from material nondetrimental to the tendon; (4) capable of withstanding abrasion, impact, and bending during handling and installation; (5) enable the tendon to elongate during testing and stressing; and (6) allow the tendon to remain unbonded after lock-off.

#### **2.05 CEMENT GROUT**

- A. Type I, II, III, or V Portland cement conforming to AASHTO M 85 shall be used for grout. The grout shall be a pumpable neat mixture of cement and water and shall be stable (bleed less than 2 percent), fluid, and provide a minimum 28-day compressive strength of at least 21 MPa measured in accordance with ASTM C 109 at time of stressing.

#### *COMMENTARY*

*The type of cement that is selected for grout that will be in contact with the ground shall take into account the known or possible presence of aggressive substances. Soil samples may be necessary to evaluate the aggressivity of the soil. A laboratory test, according to AASHTO T 290, "Determining Water Soluble Sulfate Ion Content in Soil", shall be required to determine the soluble sulfate content. The ground is considered aggressive to Type I Portland cement if the water-soluble sulfate ( $SO_4$ ) content on the soil exceeds 0.10 percent. Type II Portland cement shall be used if the sulfate content is between 0.1 and 0.2 percent and Type V cement shall be used if the sulfate content is between 0.2 percent and 2 percent. Type V cement plus a pozzolan should be used if the sulfate content exceeds 2.0 percent or if nearby concrete structures have experienced sulfate attack.*

*Normally, strength testing shall not be required as system performance will be measured by testing each anchor. Grout cube testing may be required if admixtures are used or if irregularities occur during anchor testing.*

## **2.06 CENTRALIZERS**

- A. Centralizers shall be fabricated from plastic, steel or material which is nondetrimental to the prestressing steel. Wood shall not be used. The centralizer shall be able to support the tendon in the drill hole and position the tendon so a minimum of 12 mm of grout cover is provided and shall permit grout to freely flow around the tendon and up the drill hole.
- B. Centralizers are not required on pressure injected anchors installed in coarse grained soils when the grouting pressure exceeds 1 MPa, nor on hollow stem-augered anchors when they are grouted through the auger with grout having a slump of 225 mm or less.

## **2.07 CORROSION INHIBITING COMPOUND**

- A. The corrosion inhibiting compound placed in either the free length or the trumpet area shall be an organic compound (i.e., grease or wax) with appropriate polar moisture displacing, corrosion inhibiting additives and self-healing properties. The compound shall permanently stay viscous and be chemically stable and nonreactive with the prestressing steel, the sheathing material, and the anchor grout.

### *COMMENTARY*

*Corrosion inhibiting compounds conforming to the requirements of Section 3.2.5 of the PTI, "Specification for Unbonded Single Strand Tendons" have performed well.*

## **2.08 GROUT TUBES**

- A. Grout tubes shall have an adequate inside diameter to enable the grout to be pumped to the bottom of the drill hole. Grout tubes shall be strong enough to withstand a minimum grouting pressure of 1 MPa. Postgrout tubes shall be strong enough to withstand postgrouting pressures.

## **2.09 HEAT SHRINKABLE SLEEVES**

- A. Heat shrinkable sleeves shall be fabricated from a radiation crosslinked polyolefin tube internally coated with an adhesive sealant. Prior to shrinking, the tube shall have a nominal wall thickness of 0.6 mm. The adhesive sealant inside the heat shrinkable tube shall have a nominal thickness of 0.5 mm.

## **2.10 PRESTRESSING STEEL**

- A. Ground anchor tendons shall be fabricated from single or multiple elements of one of the following prestressing steels:
  - 1. Steel bars conforming to AASHTO M 275
  - 2. Seven-wire, low-relaxation strands conforming to AASHTO M 203

3. "Compact" seven-wire, low-relaxation strands conforming to ASTM A 779
  4. Epoxy coated strand conforming to ASTM A 882.
  5. Epoxy coated reinforcing steel bars conforming to ASTM A 775.
- B. Centralizers shall be provided at maximum intervals of 3 m with the deepest centralizer located 0.3 m from the end of the anchor and the upper centralizer for the bond zone located no more than 1.5 m from the top of the tendon bond length. Spacers shall be used to separate the steel strands of strand tendons. Spacers shall be provided at maximum intervals of 3 m and may be combined with centralizers.

## **2.11 PRESTRESSING STEEL COUPLERS**

- A. Prestressing steel bar couplers shall be capable of developing 100 percent of the minimum specified ultimate tensile strength of the prestressing steel bar. Steel strands used for a soil or rock anchor shall be continuous with no splices, unless approved by the Engineer.

## **2.12 SHEATH**

- A. A sheath shall be used as part of the corrosion protection system for the unbonded length portion of the tendon. The sheath shall be fabricated from one of the following:
1. A polyethylene tube pulled or pushed over the prestressing steel. The polyethylene shall be Type II, III or IV as defined by ASTM D 1248 (or approved equal). The tubing shall have a minimum wall thickness of 1.5 mm.
  2. A hot-melt extruded polypropylene tube. The polypropylene shall be cell classification B55542-11 as defined by ASTM D 4101 (or approved equal). The tubing shall have a minimum wall thickness of 1.5 mm.
  3. A hot-melt extruded polyethylene tube. The polyethylene shall be high density Type III as defined by ASTM D1248 (or approved equal). The tubing shall have a minimum wall thickness of 1.5 mm.
  4. Steel tubing conforming to ASTM A 500. The tubing shall have a minimum wall thickness of 5 mm.
  5. Steel pipe conforming to ASTM A 53. The pipe shall have a minimum wall thickness of 5 mm.
  6. Plastic pipe or tube of PVC conforming to ASTM D 1784 Class 13464-B. The pipe or tube shall be Schedule 40 at a minimum.
  7. A corrugated tube conforming to the requirement of the tendon bond length encapsulation (Part 2.14).

### *COMMENTARY*

*The sheath shall be made of a material with the following properties: (1) resistant to chemical attack from aggressive environments, grout or corrosion inhibiting compound; (2) resistant to aging by ultra-violet light; (3) fabricated from material nondetrimental to the tendon; (4) capable of withstanding abrasion, impact and bending during handling and installation; (5) enable the tendon to elongate during testing and stressing; and (6) allow the tendon to remain unbonded after lock off.*

*The smooth sheath may also function as a bondbreaker. Sheaths fabricated from a corrugated tube or a heat-shrinkable tube require a separate bondbreaker applied over them.*

### **2.13 SPACERS**

- A. Spacers shall be used to separate elements of a multi-element tendon and shall permit grout to freely flow around the tendon and up the drill hole. Spacers shall be fabricated from plastic, steel or material which is nondetrimental to the prestressing steel. Wood shall not be used. A combination centralizer-spacer may be used.

### **2.14 TENDON BOND LENGTH ENCAPSULATIONS**

- A. When the Contract Drawings require the tendon bond length to be encapsulated to provide additional corrosion protection, the encapsulation shall be fabricated from one of the following:
  - 1. High density corrugated polyethylene tubing conforming to the requirements of AASHTO M 252 and having a minimum wall thickness of 1.5 mm except pregrouted tendons which may have a minimum wall thickness of 1.0 mm.
  - 2. Deformed steel tubing or pipes conforming to ASTM A 52 or A 500 with a minimum wall thickness of 5 mm.
  - 3. Corrugated, polyvinyl chloride tubes manufactured from rigid PVC compounds conforming to ASTM D 1784, Class 13464-B.
  - 4. Fusion-bonded epoxy conforming to the requirements of AASHTO M 284.

#### *COMMENTARY*

*The tendon bond length encapsulation shall be: (1) capable of transferring stresses from the grout surrounding the tendon to the bond length grout; (2) able to accommodate movements during testing and after lock-off; (3) resistant to chemical attack from aggressive environments, grout or grease; (4) resistant to aging by ultra-violet light; (5) fabricated from materials nondetrimental to the tendon; (6) capable of withstanding abrasion, impact and bending during handling and installation; and (7) capable of resisting internal grouting pressures developed during grouting.*

### **2.15 WATER**

- A. Water for mixing grout shall be potable, clean, and free of injurious quantities of substances known to be harmful to Portland cement or prestressing steel.

## **PART 3 DESIGN CRITERIA**

- A. Unless otherwise directed, the Contractor shall select the type of tendon to be used. The tendon shall be sized so the design load does not exceed 60 percent of the specified minimum tensile strength (SMTS) of the prestressing steel. The lock-off load for the tendon shall be chosen based on anticipated time or activity dependent load changes, but shall not exceed 70 percent of the SMTS of the prestressing steel. The prestressing steel shall be sized so the maximum test load does not exceed 80 percent of the SMTS of the prestressing steel.

- B. The Contractor shall be responsible for determining the bond length necessary to develop the design load indicated on the Contract Drawings or the approved Working Drawings in accordance with Part 6 of this Specification. The minimum bond length shall be 4.5 m for strand tendons in rock and 3 m for bar tendons in rock. The minimum bond length shall be 4.5 m for strand and bar tendons in soil. The minimum tendon bond length shall be 3 m.
- C. The free stressing length (unbonded length) for rock and soil anchors shall not be less than 3 m for bar tendons and 4.5 m for strand tendons. The free stressing length (unbonded length) shall extend at least 1.5 m or 20 percent of the height of the wall, whichever is greater, behind the critical failure surface. The critical failure surface shall be evaluated using slope stability or similar procedures.

## **PART 4 CORROSION PROTECTION**

### **4.01 PROTECTION REQUIREMENTS**

- A. Corrosion protection requirements shall be determined by the Owner and shall be shown on the Contract Drawings. The corrosion protection systems shall be designed and constructed to provide reliable ground anchors for temporary and permanent structures.

#### *COMMENTARY*

*There are two classes of corrosion protection: (1) Class I, Encapsulated Tendons (often referred to as double corrosion protection); and (2) Class II, Grout Protected Tendons (often referred to as single corrosion protection). The type and the extent of the corrosion protection shall be based on the service life of the structure, aggressivity of the environment, consequences of tendon failure, life-cycle costs, tendon type and installation methods.*

*The site investigation shall identify, if expected, nearby buried concrete structures which have suffered corrosive or chemical attack. Test and/or field observations are used to classify the aggressivity of the environment. Ground should be considered aggressive if it has a pH value less than 4.5, the resistivity less than 2000 ohm-cm, sulfides or stray currents are present, or the ground has caused chemical attack to other concrete structures. In addition, aggressive atmospheric conditions need to be considered. If the aggressivity of the ground has not been determined by testing, then aggressive conditions are assumed in: (1) soils with a low pH; (2) salt water or tidal marshes; (3) cinder, ash or slag fills; (4) organic fills containing humic acid; (5) peat bogs; and (6) acid mine or industrial waste.*

*Electrical resistivity of the soil shall be determined using the soil box method described in ASTM G 57 or by AASHTO T 288. The resistivity shall be determined for the soil at the natural moisture content, and again when it is saturated with distilled water. The lowest resistivity shall be used when determining the ground anchor corrosion protection requirements.*

*Hydrogen ion concentration (pH) of the soil shall be measured using the method described in AASHTO T 289. For rock anchors, the pH value of the groundwater in the bond zone shall be measured.*

*The presence of sulfides shall be determined by a field test using the method described by AWWA C 105. A laboratory test, according to AASHTO T 290 shall be required to determine the soluble sulfate content.*

*Existing impressed current and sacrificial anode cathodic protection systems in the vicinity of the ground anchors shall be identified. Potential sources of stray direct currents shall also be noted.*

#### **4.02 ANCHORAGE PROTECTION**

- A. All stressing anchorages permanently exposed to the atmosphere shall be grout-filled cover, except, for restressable anchorages, a corrosion inhibiting compound must be used. Stressing anchorages encased in concrete at least 50 mm thick do not require a cover.
- B. The trumpet shall be sealed to the bearing plate and shall overlap the unbonded length corrosion protection by at least 100 mm. The trumpet shall be long enough to accommodate movements of the structure and the tendon during testing and stressing. On strand tendons, the trumpet shall be long enough to enable the tendon to make a transition from the diameter of the tendon along the unbonded length to the diameter of the tendon at the wedge plate without damaging the encapsulation.
- C. The trumpet shall be completely filled with grout, except restressable anchorages must use corrosion inhibiting compounds. Compounds may be placed any time during construction. Compound-filled trumpets shall have a permanent seal between the trumpet and the unbonded length corrosion protection. Grout must be placed after the ground anchor has been tested and stressed to the lock-off load. Trumpets filled with grout shall have either a temporary seal between the trumpet and the unbonded length corrosion protection or the trumpet shall fit tightly over the unbonded length corrosion protection for a minimum of 100 mm.

#### *COMMENTARY*

*The most critical area to protect from corrosion is in the vicinity of the anchorage. Below the bearing plate, the corrosion protection over the unbonded length is terminated to expose the bare tendon. Above the bearing plate, the bare tendon is gripped by either wedges or nuts. Regardless of the type of tendon, the gripping mechanism creates stress concentrations at the connection. In addition, an aggressive corrosive environment may exist at the anchor head since oxygen is readily available. The vulnerability of this area is demonstrated by the fact that most tendon failures occur within a short distance of the anchorage device. Extreme care is required in order to insure that the prestressing steel is well protected in this area.*

*The trumpet provides the continuity between the anchorage and the unbonded length corrosion protection. If the trumpet is filled with grout, a seal can be placed at the bottom of the trumpet or the trumpet can tightly fit over the unbonded length protection and overlap the protection by at least 25 mm. The seal on grout-filled trumpets is only required to function until the grout sets. Grouted trumpets can be filled with grout after the ground anchor has been tested and just prior to stressing or the trumpet must be designed so the grout can be placed after the ground anchor has been stressed. Expansive admixtures or multi-groutings are necessary to make sure the trumpet and the anchorage cover are completely filled with grout.*

*Permanent seals for use with corrosion inhibitors are very difficult to maintain, therefore, unless the anchorage is restressable, corrosion inhibiting compounds should not be used for filling trumpets.*



#### **4.03 UNBONDED LENGTH PROTECTION**

- A. Corrosion protection of the unbonded length shall be provided by a combination of sheaths, sheath filled with a corrosion inhibiting compound or grout, or a heat shrinkable tube internally coated with a mastic compound, depending on the tendon class. The corrosion inhibiting compound shall completely coat the tendon elements, fill the void between them and the sheath, and fill the interstices between the wires of 7-wire strands. Provisions shall be made to retain the compound within the sheath.
- B. The corrosion protective sheath surrounding the unbonded length of the tendon shall be long enough to extend into the trumpet, but shall not come into contact with the stressing anchorage during testing. Any excessive protection length shall be trimmed off.
- C. For pregrouted encapsulations and all Class I tendons, a separate bondbreaker or common sheath shall be provided for supplemental corrosion protection or to prevent the tendon from bonding to the grout surrounding the unbonded length.

#### *COMMENTARY*

*Fusion bonded epoxy over the bare steel can provide an additional layer of protection.*

#### **4.04 UNBONDED LENGTH/BOND LENGTH TRANSITION**

- A. The transition between the corrosion protection for the bonded and unbonded lengths shall be designed and fabricated to ensure continuous protection from corrosive attack.

#### **4.05 TENDON BOND LENGTH PROTECTION FOR GROUT PROTECTED TENDONS (Class II)**

- A. Cement grout can be used to protect the tendon bond length in non-aggressive ground when the installation methods ensure that the grout will remain fully around the tendon. The grout shall overlap the sheathing of the unbonded length by at least 25 mm.
- B. Centralizers or grouting techniques shall ensure a minimum of 12 mm of grout cover over the tendon bond length.

#### **4.06 TENDON BOND LENGTH PROTECTION FOR ENCAPSULATED TENDONS (Class I)**

- A. A grout-filled, corrugated plastic encapsulation or a grout-filled, deformed steel tube shall be used. The prestressing steel can be grouted inside the encapsulation prior to inserting the tendon into the drill hole or after the tendon has been placed.
- B. Centralizers or grouting techniques shall ensure a minimum of 12 mm of grout cover over the encapsulation.

#### **4.07 EPOXY (Class I)**

- A. Fusion-bonded epoxy may be used to provide a layer of protection for the steel tendon in addition to the cement grout.

#### *COMMENTARY*

*Epoxy coatings for bar and strand are not equivalent. ASTM A 775 for bars specifies a coating thickness of 0.18 to 0.30 mm and allows an average of 3 holidays per linear meter of bar, while ASTM A 882 for strand specifies a film thickness of 0.64 to 1.14 mm and allows only 2 holidays per 30 linear meters of strand.*

*Removal of the epoxy at the anchorage not only voids the corrosion protection that the epoxy normally provides, but can also severely damage the strand.*

#### **4.08 COUPLER PROTECTION**

- A. On encapsulated bar tendons (Class I), the coupler and any adjacent exposed bar sections shall be covered with a corrosion-proof compound or wax-impregnated cloth tape. The coupler area shall be covered by a smooth plastic tube complying with the requirements set forth in Part 2.12 of this Specification, overlapping the adjacent sheathed tendon by at least 25 mm. The two joints shall be sealed each by a coated heat shrink sleeve of at least 150 mm length, or approved equal. The corrosion-proof compound shall completely fill the space inside the cover tube.
- B. Corrosion protection details for strand couplers, if specifically permitted by the contract documents, shall be submitted for approval of the Engineer.

### **PART 5 CONSTRUCTION**

#### **5.01 TENDON STORAGE AND HANDLING**

- A. Tendons shall be handled and stored in such a manner as to avoid damage or corrosion. Damage to the prestressing steel, the corrosion protection, and/or the epoxy coating as a result of abrasions, cuts, nicks, welds and weld splatter will be cause for rejection by the Engineer. The prestressing steel shall be protected if welding is to be performed in the vicinity. Grounding of welding leads to the prestressing steel is forbidden. Prestressing steel shall be protected from dirt, rust, or deleterious substances. A light coating of rust on the steel is acceptable. If heavy corrosion or pitting is noted, the Engineer shall reject the affected tendons.
- B. The Contractor shall use care in handling and storing the tendons at the site. Prior to inserting a tendon in the drill hole, the Contractor and the CQA Inspector shall examine the tendon for damage to the encapsulation and the sheathing. If, in the opinion of the CQA Inspector, the encapsulation is damaged, the Contractor shall repair the encapsulation in accordance with the tendon supplier's recommendations. If, in the opinion of the CQA Inspector, the smooth sheathing has been damaged, the Contractor shall repair it with ultra high molecular weight polyethylene tape. The tape should be spiral wound around the tendon

to completely seal the damaged area. The pitch of the spiral shall ensure a double thickness at all points.

- C. Banding for fabricated tendons shall be padded to avoid damage to the tendon corrosion protection. Upon delivery, the fabricated anchors or the prestressing steel for fabrication of the tendons on site and all hardware shall be stored and handled in such a manner to avoid mechanical damage, corrosion, and contamination with dirt or deleterious substances.
- D. Lifting of the pre-grouted tendons shall not cause excessive bending, which can debond the prestressing steel from the surrounding grout.
- E. Prestressing steel shall not be exposed to excessive heat (i.e., more than 230°C).

## **5.02 ANCHOR FABRICATION**

- A. Anchors shall be either shop or field fabricated from materials conforming to Part 2 of the Specification and as shown in the approved Working Drawings and schedules.
- B. Prestressing steel shall be cut with an abrasive saw or, with the approval of the prestressing steel supplier, an oxyacetylene torch.
- C. All of the tendon bond length, especially for strand, must be free of dirt, manufacturers' lubricants, corrosion-inhibitive coatings, or other deleterious substances that may significantly affect the grout-to-tendon bond or the service life of the tendon.
- D. Pregrouting of encapsulated tendons shall be done on an inclined, rigid frame or bed by injecting the grout from the low end of the tendon.

### *COMMENTARY*

*Epoxy coated strand tendons stored on reels will have a larger cast (curvature) than uncoated strands. This cast can affect the tendon alignment and should be straightened by hand during fabrication or installation.*

## **5.03 DRILLING**

- A. Drilling methods shall be left to the discretion of the Contractor, whenever possible. The Contractor shall be responsible for using a drilling method to establish a stable hole of adequate dimensions, within the tolerances specified. Drilling methods may involve, amongst others, rotary, percussion, rotary/percussive or auger drilling; or percussive or vibratory driven casing.
- B. Holes for anchors shall be drilled at the locations and to the length, inclination and diameter shown on the Contract Drawings or the approved Working Drawings. The drill bit or casing crown shall not be more than 3 mm smaller than the specified hole diameter. At the ground surface the drill hole shall be located within 300 mm of the location shown on the Contract Drawings or the approved Working Drawings. The drill hole shall be located so the longitudinal axis of the drill hole and the longitudinal axis of the tendon are parallel. In particular, the ground anchor hole shall not be drilled in a location that requires the tendon to

be bent in order to enable the bearing plate to be connected to the supported structure. At the point of entry the ground anchor shall be installed within plus/minus three (3) degrees of the inclination from horizontal shown on the Contract Drawings or the approved Working Drawings. At the point of entry the horizontal angle made by the ground anchor and the structure shall be within plus/minus three (3) degrees of a line drawn perpendicular to the plane of the structure unless otherwise shown on the Contract Drawings or approved Working Drawings. The ground anchors shall not extend beyond the right-of-way or easement limits shown on the Contract Drawings.

#### **5.04 TENDON INSERTION**

- A. Tendons shall be placed in accordance with the Contract Drawings and details and the recommendations of the tendon manufacturer or specialist anchor contractor. The tendon shall be inserted into the drill hole to the desired depth without difficulty. When the tendon cannot be completely inserted, the Contractor shall remove the tendon from the drill hole and clean or redrill the hole to permit insertion. Partially inserted tendons shall not be driven or forced into the hole.
- B. Each anchor tendon shall be inspected by field personnel during installation into the drill hole or casing. Damage to the corrosion protection system shall be repaired, or the tendon replaced if not repairable. Loose spacers or centralizers shall be reconnected to prevent shifting during insertion. Damaged fusion-bonded epoxy coatings shall be repaired in accordance with the manufacturer's recommendations. If the patch is not allowed to cure prior to inserting the tendon in the drill hole, the patched area shall be protected by tape or other suitable means.
- C. The rate of placement of the tendon into the hole shall be controlled such that the sheathing, coating, and grout tubes are not damaged during installation of the tendon. Anchor tendons shall not be subjected to sharp bends. The bottom end of the tendon may be fitted with a cap or bullnose to aid its insertion into the hole, casing, or sheathing.

#### **5.05 GROUTING**

- A. The Contractor shall use a neat cement grout or a sand-cement grout. The cement shall not contain lumps or other indications of hydration. Admixtures, if used, shall be mixed in accordance with the manufacturer's recommendations.
- B. The grouting equipment shall produce a grout free of lumps and undispersed cement. A positive displacement grout pump shall be used. The pump shall be equipped with a pressure gauge to monitor grout pressures. The pressure gauge shall be capable of measuring pressures of at least 1 MPa or twice the actual grout pressures used by the Contractor, whichever is greater. The grouting equipment shall be sized to enable the grout to be pumped in one continuous operation. The mixer should be capable of continuously agitating the grout.
- C. The grout shall be injected from the lowest point of the drill hole. The grout may be pumped through grout tubes, casing, hollow-stem-augers, or drill rods. The grout can be placed before or after insertion of the tendon. The quantity of the grout and the grout pressures shall

be recorded. The grout pressures and grout takes shall be controlled to prevent excessive heave or fracturing.

- D. After the tendon is installed, the drill hole may be filled in one continuous grouting operation except that pressure grouting shall not be used in the free length zone. The grout at the top of the drill hole shall not contact the back of the structure or the bottom of the trumpet.
- E. If the ground anchor is installed in a fine-grained soil using drill holes larger than 150 mm in diameter, then the grout above the top of the bond length shall be placed after the ground anchor has been tested and stressed. The Engineer will allow the Contractor to grout the entire drill hole at the same time if the Contractor can demonstrate that his particular ground anchor system does not derive a significant portion of its load-carrying capacity from the soil above the bond length portion of the ground anchor.
- F. If grout protected tendons are used for ground anchors anchored in rock, then pressure grouting techniques shall be utilized. Pressure grouting requires that the drill hole be sealed and that the grout be injected until a minimum 0.35 MPa grout pressure (measured at the top of the drill hole) can be maintained on the grout for at least five (5) minutes.
- G. The grout tube may remain in the hole on completion of grouting if the tube is filled with grout.
- H. After grouting, the tendon shall not be loaded for a minimum of three (3) days.

#### COMMENTARY

*Pressure grouting of ground anchors anchored in rock is used in lieu of watertightness testing. When a 0.35-MPa grout pressure can be maintained, the drill hole is considered sealed such that grout will not flow into the ground.*

*Pressure grouting of ground anchors anchored in rock can be accomplished in two ways: (1) Using tremie methods, fill the drill hole with grout from the lowest point in the hole. Continue pumping grout until fresh uncontaminated grout is observed flowing from the drill hole. At this point, a pressure cap should be installed over the drill hole (including the tendon) to seal the hole. Then grout should be pumped into the drill hole until a 0.35 MPa grout pressure (measured at the top of the drill hole) can be maintained on the grout for five (5) minutes; or (2) Using tremie methods, fill the drill hole with grout from the lowest point in the hole. Continue pumping grout until fresh uncontaminated grout is observed flowing from the drill hole. At this point, inflate a packer located in the unbonded length of the tendon to seal the hole. Then grout should be pumped into the bond length until a 0.35 MPa grout pressure (measured at the top of the drill hole) can be maintained on the grout for five (5) minutes.*

*If pressure grouting is not utilized when installing grout protected ground anchors in rock, then water pressure testing should be required. Water pressure testing is used for the following reasons: (1) To identify fractured rock formations where grout can be lost from around the bond length of a ground anchor if it is not properly grouted (even if a grout protected ground anchor can be successfully tested, grout loss could leave the prestressing steel unprotected from corrosion); (2) To identify rock formations where artesian or any type of water flow exists around the bond length (artesian or flowing water may dilute or wash away the grout); or (3) To identify rock formations where interconnections exist*

*between drill holes (interconnecting drill holes can cause recently placed grout to be contaminated by drilling activity in an adjacent drill hole).*

*A pressure test is performed by filling the entire hole in the rock with water which is subject to a pressure of 0.35 MPa as measured at the top of the hole. If the unbonded length portion of the hole is in fractured rock or soil, a packer or casing is used to allow the bond length portion of the hole to be pressure tested. If the leakage from the hole over a ten (10) minute period exceeds 9.5 liters of water, then the hole should be consolidation grouted, redrilled and retested. Should the subsequent water-tightness test fail, the entire process shall be repeated until results are attained which are within leakage allowances.*

*Grout pressures given in this Specification are assumed to be measured at the top of the casing or the top of the drill hole. The pressure may be measured with a pressure gauge located at this point, or the pressure may be measured at the grout pump and corrected for line losses by subtracting the pressure required to pump the grout to the top of the casing or the drill hole.*

## **5.06 ANCHORAGE INSTALLATION**

- A. The anchor bearing plate and the anchor head or nut shall be installed perpendicular to the tendon, within plus/minus three (3) degrees and centered on the bearing plate, without bending or kinking of the prestressing steel elements. Wedge holes and wedges shall be free of rust, grout, and dirt.
- B. The stressing tail shall be cleaned and protected from damage until final testing and lock-off. After the anchor has been accepted by the Engineer, the stress tail shall be cut to its final length according to the tendon manufacturer's recommendations.
- C. The corrosion protection surrounding the unbonded length of the tendon shall extend up beyond the bottom seal of the trumpet or 100 mm into the trumpet if no trumpet seal is provided. If the protection does not extend beyond the seal or sufficiently far enough into the trumpet, the Contractor shall extend the corrosion protection or lengthen the trumpet.
- D. The corrosion protection surrounding the unbonded length of the tendon shall not contact the bearing plate or the anchor head during testing and stressing. If the protection is too long, the Contractor shall trim the corrosion protection to prevent contact.

### *COMMENTARY*

*Electrical isolation of the anchorage and trumpet is not necessary, provided that the unbonded and bond length of the tendon are electrically isolated from the ground.*

## **PART 6 STRESSING, LOAD TESTING, AND ACCEPTANCE**

### **6.01 GENERAL**

- A. Each ground anchor shall be tested. No load greater than ten (10) percent of the design load can be applied to the ground anchor prior to testing. The maximum test load shall be no less than 1.33 times the design load and shall not exceed 80 percent of the specified minimum

ultimate tensile strength (SMTS) of the prestressing steel of the tendon. The test load shall be simultaneously applied to the entire tendon. Stressing of single elements of multi-element tendons shall not be permitted.

#### COMMENTARY

*The maximum test load for performance, proof and creep tests normally shall be 1.33 times the design load for all types of ground. The Engineer may specify a higher overload during testing. This may require an increased prestressing steel area and drill hole diameter. If a maximum test load of 1.5 times the design load is used for testing, the tendon shall be sized so that the design load does not exceed 53 percent of the specified minimum tensile strength of the prestressing steel.*

## 6.02 STRESSING EQUIPMENT

A. The testing equipment shall consist of:

1. A dial gauge or vernier scale capable of measuring to the nearest 0.025 mm shall be used to measure the ground anchor movement. The movement-measuring device shall have a minimum travel equal to the theoretical elastic elongation of the total anchor length at the maximum test load and it shall have adequate travel so the ground anchor movement can be measured without resetting the device at an interim point.
2. A hydraulic jack and pump shall be used to apply the test load. The jack and a calibrated primary pressure gauge shall be used to measure the applied load. The jack and primary pressure gauge shall be calibrated by an independent firm as a unit. The calibration shall have been performed within forty-five (45) working days of the date when the calibration submittals are provided to the Engineer. Testing cannot commence until the Engineer has approved the calibration. The primary pressure gauge shall be graduated in 0.69 MPa increments or less. The ram travel shall be at least 152 mm and preferably not be less than the theoretical elongation of the tendon at the maximum test load. If elongations greater than 152 mm are required, restroking can be allowed.
3. A calibrated reference pressure gauge shall also be kept at the site to periodically check the production (i.e., primary pressure) gauge. The reference gauge shall be calibrated with the test jack and primary pressure gauge. The reference pressure gauge shall be stored indoors and not subjected to rough treatment.
4. The Contractor shall provide an electrical resistance load cell and readout to be used when performing an extended creep test.
5. The stressing equipment shall be placed over the ground anchor tendon in such a manner that the jack, bearing plates, load cells and stressing anchorage are axially aligned with the tendon and the tendon is centered within the equipment.

#### COMMENTARY

*The primary pressure gauge is used to measure hydraulic jack pressure for the determination of load.*

*The reference pressure gauge is used to check the performance of the primary (i.e., production) pressure gauge. If the load determined by the reference pressure gauge and the load determined by the primary pressure gauge are within ten (10) percent of each other, the primary pressure gauge may be assumed to be functioning properly.*

- B. The stressing equipment, the sequence of stressing and the procedure to be used for each stressing operation shall be determined at the planning stage of the project. The equipment shall be used strictly in accordance with the manufacturer's operating instructions.
- C. Stressing equipment shall preferably be capable of stressing the whole tendon in one stroke to the specified Test Load and the equipment shall be capable of stressing the tendon to the maximum specified Test Load within 75 percent of the rated capacity. The pump shall be capable of applying each load increment in less than 60 seconds.
- D. The equipment shall permit the tendon to be stressed in increments so that the load in the tendon can be raised or lowered in accordance with the test specifications, and allow the anchor to be lift-off tested to confirm the lock-off load.
- E. Stressing equipment shall be recently calibrated within an accuracy of plus or minus two (2) percent prior to use. The calibration certificate and graph shall be available on site at all times. The calibration shall be traceable to the National Institute of Standards and Technology (NIST).

#### COMMENTARY

*When long, high capacity ground anchors are used, it may not be possible to apply each load increment within 60 seconds. For this case, deformation measurements should begin when the test load is achieved.*

### **6.03 LOAD TESTING SETUP**

- A. Dial gauges shall bear on the pulling head of the jack and their stems shall be coaxial with the tendon direction. The gauges shall be supported on an independent, fixed frame, such as a tripod, which will not move as a result of stressing or other construction activities during the operation.
- B. Prior to setting the dial gauges, the Alignment Load (AL) shall be accurately placed on the tendon. The magnitude of AL depends on the type and length of the tendon.
- C. Regripping of strands, which would cause overlapping wedge bites, or wedge bites on the tendon below the anchor head, shall be avoided.
- D. Stressing and testing of multiple element tendons with single element jacks is not permitted.
- E. Stressing shall not begin before the grout has reached adequate strength.



## COMMENTARY

*The Alignment Load is typically no more than 5 percent of the Design Load (DL). The Alignment Load is applied to secure all the components during stressing and testing and to ensure that the residual movements are accurately and consistently determined when unloading during a Performance Test.*

*The seating loss of the pull wedges must be considered in addition to the reading taken from the dial gauges.*

### **6.04 PERFORMANCE TESTS**

- A. Five (5) percent of the ground anchors or a minimum of three (3) ground anchors, whichever is greater, shall be performance tested in accordance with the procedures described below. The Engineer shall select the ground anchors to be performance tested. The remaining ground anchors shall be tested in accordance with the proof test procedures (see Part 6.05).
- B. The performance test shall be made by incrementally loading and unloading the ground anchor in accordance with the schedule provided. The load shall be raised from one increment to another immediately after recording the ground anchor movement. The ground anchor movement shall be measured and recorded to the nearest 0.025 mm with respect to an independent fixed reference point at the alignment load and at each increment of load. The load shall be monitored with the primary pressure gauge. The reference pressure gauge shall be placed in series with the primary pressure gauge during each performance test. If the load determined by the reference pressure gauge and the load determined by the primary pressure gauge differ by more than ten (10) percent, the jack, primary pressure gauge and reference pressure gauge shall be recalibrated at no expense to the Owner. At load increments other than the maximum test load, the load shall be held just long enough to obtain the movement reading.
- C. The maximum test load in a performance test shall be held for ten (10) minutes. A load cell shall be used to monitor small changes in load during constant load-hold periods.

### STEPS FOR THE PERFORMANCE TEST.

Step	Loading	Applied Load	Record and Plot Total Movement ( $\delta_i$ )	Record and Plot Residual Movement ( $\delta_{ri}$ )	Calculate Elastic Movement ( $\delta_{ei}$ )
1	Apply alignment load (AL)				
2	Cycle 1	0.25DL	$\delta_{t1}$		$\delta_{t1} - \delta_{r1} = \delta_{e1}$
		AL		$\delta_{r1}$	
3	Cycle 2	0.25DL	$\delta_2$		$\delta_{t2} - \delta_{r2} = \delta_{e2}$
		0.50DL	$\delta_{t2}$		
		AL		$\delta_{r2}$	
4	Cycle 3	0.25DL	$\delta_3$		$\delta_{t3} - \delta_{r3} = \delta_{e3}$
		0.50DL	$\delta_3$		
		0.75DL	$\delta_{t3}$		
		AL		$\delta_{r3}$	
5	Cycle 4	0.25DL	$\delta_4$		$\delta_{t4} - \delta_{r4} = \delta_{e4}$
		0.50DL	$\delta_4$		
		0.75DL	$\delta_4$		
		1.00DL	$\delta_{t4}$		
		AL		$\delta_{r4}$	
6	Cycle 5	0.25DL	$\delta_5$		$\delta_{t5} - \delta_{r5} = \delta_{e5}$
		0.50DL	$\delta_5$		
		0.75DL	$\delta_5$		
		1.00DL	$\delta_5$		
		1.2DL	$\delta_{t5}$		
		AL		$\delta_{r5}$	
7	Cycle 6	0.25DL	$\delta_6$		
		0.50DL	$\delta_6$		
		0.75DL	$\delta_6$		
		1.00DL	$\delta_6$		
		1.2DL	$\delta_6$		
		1.33DL	$\delta_{t6}$ , zero reading for creep test		
8	Hold load for 10 minutes while recording movement at specified times. If the total movement measured during the load hold exceeds the specified maximum value then the load hold should be extended to a total of 60 minutes.				
9	Cycle 6 cont'd.	AL		$\delta_{r6}$	Cycle 6: $\delta_{t6} - \delta_{r6} = \delta_{e6}$
Notes: AL = Alignment Load, DL = Design Load, $\delta_i$ = total movement at a load other than maximum for cycle, i = number identifying a specific load cycle.					

- D. The jack shall be adjusted as necessary in order to maintain a constant load. The load-hold period shall start as soon as the maximum test load is applied and the ground anchor movement, with respect to a fixed reference, shall be measured and recorded at 1 minute, 2, 3, 4, 5, 6 and 10 minutes. If the ground anchor movement between one (1) minute and ten (10) minutes exceeds 1 mm, the maximum test load shall be held for an additional 50 minutes. If the load hold is extended, the ground anchor movement shall be recorded at 15 minutes, 20, 30, 40, 50 and 60 minutes.

## 6.05 PROOF TESTS

- A. The proof test shall be performed by incrementally loading the ground anchor in accordance with the following schedule. The load shall be raised from one increment to another immediately after recording the ground anchor movement. The ground anchor movement shall be measured and recorded to the nearest 0.025 mm with respect to an independent fixed reference point at the alignment load and at each increment of load. The load shall be monitored with the primary pressure gauge. At load increments other than the maximum test load, the load shall be held just long enough to obtain the movement reading.

PROOF TEST SCHEDULE

Step	Load
1	AL
2	0.25DL
3	0.50DL
4	0.75DL
5	1.00DL
6	1.20DL
7	1.33DL
8	Reduce to lock-off load
9	AL (optional)
10	Adjust to lock-off load

- B. The maximum test load in a proof test shall be held for ten (10) minutes. The jack shall be adjusted as necessary in order to maintain a constant load. The load-hold period shall start as soon as the maximum test load is applied and the ground anchor movement with respect to a fixed reference shall be measured and recorded at 1 minute, 2, 3, 4, 5, 6 and 10 minutes. If the ground anchor movement between one (1) minute and ten (10) minutes exceeds 1 mm, the maximum test load shall be held for an additional 50 minutes. If the load hold is extended, the ground anchor movements shall be recorded at 15 minutes, 20, 30, 40, 50 and 60 minutes.

## COMMENTARY

*If needed to approximate the elastic elongation of Proof Tested anchors, the value for the residual movement of adjacent representative performance tested anchors shall be deducted from the total movement measured.*

*When the results of Performance Tests cannot be compared directly to those of Proof Tests, the anchor should be returned to AL after the 10-minute hold at Test Load and raised again to Lock-Off. This will permit the determination of permanent and elastic movements at the Test Load.*

### **6.06 EXTENDED CREEP TESTS**

- A. The Owner shall determine if extended creep testing is required and select those ground anchors that are to be creep tested. If creep tests are required, at least two (2) ground anchors shall be creep tested. The stressing equipment shall be capable of measuring and maintaining the hydraulic pressure within 0.35 MPa.

## COMMENTARY

*Extended creep tests should be required when the ground anchor is anchored in fine-grained soil with a plasticity index greater than 20 or a liquid limit greater than 50 or if proof- or performance-tested ground anchors require 60-minute load holds, or if the Engineer is concerned about the long-term, load-carrying capacity of the ground anchor.*

- B. The extended creep test shall be made by incrementally loading and unloading the ground anchor in accordance with the performance test schedule provided in Section 6.04. At the end of each loading cycle, the load shall be held constant for the observation period indicated in the creep test schedule below. The times for reading and recording the ground anchor movement during each observation period shall be 1 minute, 2, 3, 4, 5, 6, 10, 15, 20, 25, 30, 45, 60, 75, 90, 100, 120, 150, 180, 210, 240, 270 and 300 minutes as appropriate for the load increment. Each load-hold period shall start as soon as the test load is applied. In a creep test, the primary pressure gauge and reference pressure gauge will be used to measure the applied load and the load cell will be used to monitor small changes in load during constant load-hold periods. The jack shall be adjusted as necessary in order to maintain a constant load.
- C. The Contractor shall plot the ground anchor movement and the residual movement measured in an extended creep test. The Contractor shall also plot the creep movement for each load hold as a function of the logarithm of time.

## EXTENDED CREEP TEST SCHEDULE

Load	Observation period (min.)
AL	
0.25DL	10
0.50DL	30
0.75DL	30
1.00DL	45
1.20DL	60
1.33DL	300

### 6.07 GROUND ANCHOR ACCEPTANCE CRITERIA

- A. A performance-tested or proof-tested ground anchor with a 10 minute load hold shall be acceptable if the: (1) ground anchor resists the maximum test load with less than 1 mm of movement between 1 minute and 10 minutes; and (2) total elastic movement at the maximum test load exceeds 80 percent of the theoretical elastic elongation of the unbonded length.
- B. A performance-tested or proof-tested ground anchor with a 60 minute load hold shall be acceptable if the: (1) ground anchor resists the maximum test load with a creep rate that does not exceed 2 mm in the last log cycle of time; and (2) total elastic movement at the maximum test load exceeds 80 percent of the theoretical elastic elongation of the unbonded length.
- C. A ground anchor subjected to extended creep testing is acceptable if the: (1) ground anchor resists the maximum test load with a creep rate that does not exceed 2 mm in the last log cycle of time; and (2) total elastic movement at the maximum test load exceeds 80 percent of the theoretical elastic elongation of the unbonded length.

#### COMMENTARY

*The creep behavior of epoxy filled strand itself is significant and the measured anchor creep movements must be adjusted to reflect the behavior of the material. At a Test Load of 80% of  $F_{pu}$ , creep movements of epoxy filled strand are conservatively estimated to be 0.015% of the apparent free stressing length during the 6 to 60 minute log cycle, but may be higher than this value. For a Test Load of 75% of  $F_{pu}$ , this percentage can be reduced to 0.012%. These correction factors are based on limited laboratory tests but appear to be reasonable based on field observations.*

*The minimum apparent free length is calculated to verify that the anchor load is being transferred beyond any potential failure or slip plane, in accordance with the overall stability requirements of the anchor-structure system. The minimum apparent free length at the Test Load, as calculated on the basis of elastic movement, should be equivalent to not less than 80% of the designed free tendon length plus the jack length. If this criterion is not met, the anchor should be reloaded up to two times from Alignment Load to Test Load and the calculation repeated on these cycles. If the criterion is still not met, then the cause of this inefficiency in load transfer should be investigated and the anchor may be rejected or derated. The actual elastic modulus of a long multi-strand tendon may be less than the manufacturer's*

*elastic modulus value for a single strand, measured over a relatively short gauge length. A reduction in the manufacturer's elastic modulus value of 3 to 5% may be allowed in any field diagnosis.*

*A limit higher than 80% of the designed free length may be set in cases where later movements occurring as a result of redistribution of the free length friction would cause unacceptable structural movement. A higher limit may also be set where there is the possibility that significant amounts of prestress would be transferred in the "no load zone" by tendon friction along the free length. The "no load" zone is defined as being that part of the ground or structure between anchor head and bond zone which is to be anchored, and which would move unacceptably if not anchored.*

- D. The initial lift-off reading shall be within plus or minus five (5) percent of the designed lock-off Load. If this criterion is not met, then the tendon load shall be adjusted accordingly and the initial lift-off reading repeated.

## **6.08 PROCEDURES FOR ANCHORS FAILING ACCEPTANCE CRITERIA**

- A. Anchors that do not satisfy the minimum apparent free length criteria shall be either rejected and replaced at no additional cost to the Owner or locked off at not more than 50 percent of the maximum acceptable load attained. In this event, no further acceptance criteria are applied.
- B. Regroutable anchors which satisfy the minimum apparent free length criteria but which fail the extended creep test at the test load may be postgrouted and subjected to an enhanced creep criterion. This enhanced criterion requires a creep movement of not more than 1 mm between 1 and 60 minutes at test load. Anchors which satisfy the enhanced creep criterion shall be locked off at the design lock-off load. Anchors which cannot be postgrouted or regroutable anchors that do not satisfy the enhanced creep criterion shall be either rejected or locked off at 50% of the maximum acceptable test load attained. In this event, no further acceptance criteria are applied. The maximum acceptable test load with respect to creep shall correspond to that where acceptable creep movements are measured over the final log cycle of time.
- C. In the event that an anchor fails, the Contractor shall modify the design and/or construction procedures. These modifications may include, but are not limited to, installing additional anchors, modifying the installation methods, reducing the anchor design load by increasing the number of anchors, increasing the anchor length, or changing the anchor type. Any modification of design or construction procedures shall be at no change in the contract price. A description of any proposed modifications must be submitted to the Engineer in writing. Proposed modifications shall not be implemented until the Contractor receives written approval from the Engineer.

## **6.09 ANCHOR LOCK-OFF**

- A. After testing has been completed, the load in the tendon shall be such that after seating losses (i.e., wedge seating), the specified lock-off load has been applied to the anchor tendon.
- B. The magnitude of the lock-off load shall be specified by the Engineer, and shall not exceed 70%  $F_{pu}$ .

- C. The wedges shall be seated at a minimum load of 50%  $F_{pu}$ . If the lock-off load is less than 50%  $F_{pu}$ , shims shall be used under the wedge plate and the wedges seated at 50%  $F_{pu}$ . The shims shall then be removed to reduce the load in the tendon to the desired lock-off load. Bar tendons may be locked off at any load less than 70%  $F_{pu}$ .

**6.10 ANCHOR LIFT-OFF TEST**

- A. After transferring the load to the anchorage, and prior to removing the jack, a lift-off test shall be conducted to confirm the magnitude of the load in the anchor tendon. This load is determined by reapplying load to the tendon to lift off the wedge plate (or anchor nut) without unseating the wedges (or turning the anchor nut). This moment represents zero time for any long time monitoring.

**PART 7 MEASUREMENT AND PAYMENT**

- A. The quantity of ground anchors to be paid for will be the number of ground anchors installed and accepted. No change in the number of ground anchors to be paid for will be made because of the use by the Contractor of an alternative number of ground anchors. The quantity of performance and extended creep tests to be paid for will be the number of tests performed.
- B. The quantity as determined above will be paid for at the contract price per unit of measurement for the particular pay item listed below and shown in the bid schedule, which price and payment will be full compensation for the cost of furnishing all labor, equipment and material required to complete the work described in this section.
- C. Payment will be made under:

Pay Item	Pay Unit
Ground Anchors Furnished and Installed	Each
Performance Test	Each
Extended Creep Test	Each

*COMMENTARY*

*Measurement and payment for contracting approaches involving design-build, value engineering, or other non-owner designs may vary from this Specification. In general, the concepts and requirements of this ground anchor specification and the subsequent anchored wall specification could form the basis for measurement and payment by either lump sum or per wall or per unit measurement of wall (linear meters, square meters, etc.)*

*If the Owner requires water pressure tests, consolidation grouting and redrilling then separate pay items should be included for this work. If the Contractor elects to use permanent tremie-grouted rock anchors in lieu of pressure grouting, the Contractor should perform the water pressure tests and provide the consolidation grouting and redrilling at no charge in contract price. The pay items and units of measurement should be:*

<i>Pay Item</i>	<i>Pay Unit</i>
<i>Water Pressure Testing</i>	<i>Each</i>
<i>Consolidation Grouting</i>	<i>Bags of Cement (42.7 kg bag)</i>
<i>Redrilling</i>	<i>Meter of Grout Drilled</i>



## APPENDIX F

# SPECIFICATION FOR ANCHORED SHEET-PILE OR SOLDIER BEAM AND LAGGING WALL

## PART 1 GENERAL

### 1.01 DESCRIPTION

- A. The Contractor shall furnish all labor, materials, tools, supervision, transportation, installation equipment, and incidentals necessary to complete the work specified herein and shown on the Contract Drawings. The work shall include but not be limited to mobilization, surveying, and installation of wall elements (steel sheet-piles or steel soldier beams), timber lagging, drainage systems, and precast or cast-in-place concrete facing. This Specification may also be used for any Contractor-proposed alternate design of Owner furnished plans.

#### COMMENTARY

*This Specification applies to permanent soldier beam and lagging and sheet-pile anchored walls and may, if the Owner so desires, be used for systems used as part of a temporary application. Such temporary applications will have design and performance requirements that are similar to those for permanent systems. This Specification is not intended to be used for ground anchors used for temporary support of excavation systems.*

*This Specification is a performance specification for an anchored sheet-pile or soldier beam and timber lagging wall. This Specification may be used for Owner-designed anchored walls or Contractor-designed walls that are part of an alternate design proposal. For Owners that allow alternate design proposals, Part 1.05 - "Submittals for Contractor-Proposed Alternate" and Part 3 "Design Criteria" must be included in the Specification. These parts may be omitted for a specification for a Owner designed anchored wall. All work associated with the design and construction of ground anchors is covered under the specification titled "Ground Anchors." General excavation is described in this Specification although it is assumed that a contractor other than the wall contractor will construct the excavation. This Specification includes excavation, and installation of wall elements, timber lagging, drainage systems, and concrete facing.*

### 1.02 RELATED SECTIONS

- A. Specification for Ground Anchors

### 1.03 DEFINITIONS

**Construction Quality Assurance (CQA) Inspector:** The person/firm responsible for construction quality assurance (CQA) testing, monitoring, and other duties related to assuring the quality of construction and adherence to the Contract Drawings and Specifications.

**Contract Drawings:** The approved plans, profiles, typical cross sections, working drawings, and supplemental drawings which show the location, dimensions, and details of the work to be done.

**Contractor:** The person/firm responsible for performing the anchor work.

**Engineer:** The engineer shall be appointed by the Owner to undertake the duties and powers assigned to the Engineer by the Contract Documents. The engineer is responsible for approving all design and specification changes and making design clarifications that may be required during construction.

**Shop Drawings:** All drawings, diagrams, illustrations, schedules, performance charts, brochures, and other data which are prepared for or by the Contractor or any subcontractor, manufacturer, supplier, or distributor and which illustrate the equipment, material, or any other matter relating to the work.

**Subcontractor:** The Subcontractor is a person/firm who has a direct or indirect contract relationship with the Contractor to perform any of the work.

**Supplier:** Any person/firm who supplies materials or equipment for the work, including that fabricated to a special design, and may also be a Subcontractor.

### 1.04 CONTRACTOR QUALIFICATIONS

- A. The Contractor performing the design and construction of the work shall have a minimum of five (5) years of experience in anchored wall design and construction and shall submit evidence of successful completion of at least five (5) similar projects.
- B. The Contractor's staff shall include at least one registered Professional Engineer licensed to perform work in the State of \_\_\_\_\_. The Contractor shall assign an engineer to supervise the work with at least three (3) years of experience in the design and construction of anchored walls and a superintendent or foreman with a minimum of two (2) years experience in the supervision of anchored wall construction. The Contractor may not use consultants or manufacturer's representatives in order to meet the requirements of this section.

#### COMMENTARY

*The Owner should only prequalify Contractors who have demonstrated on-staff experience in constructing anchored walls.*

## **1.05 SUBMITTALS FOR OWNER-DESIGNED WALL**

- A. The Contractor shall submit a list containing at least five (5) projects completed within the last five (5) years. For each project, the Contractor shall include with this submittal, at a minimum: (1) name of client contact, address, and telephone number; (2) location of project; (3) contract value; and (4) scheduled completion date and actual completion date for the project.
- B. Resumes of the Contractor's staff shall be submitted to the Owner for review as part of the Contractor bid. Only those individuals designated as meeting the qualifications requirements shall be used for the project. The Contractor cannot substitute for any of these individuals without written approval of the Owner or Owner's Engineer (Engineer). The Engineer shall approve or reject the Contractor's qualifications and staff within fifteen (15) working days after receipt of the submission. Work shall not be started on any anchored wall system nor materials ordered until the Contractor's qualifications have been approved by the Owner. The Owner may suspend the work if the Contractor substitutes unqualified personnel for approved personnel during construction. If work is suspended due to the substitution of unqualified personnel, the Contractor shall be fully liable for additional costs resulting from the suspension of work and no adjustment in contract time resulting from the suspension of work will be allowed.
- C. The Engineer shall approve or reject the Contractor's Working Drawings and design submission including detailed calculations within thirty (30) working days after receipt of the submission. Approval of the design submittal does not relieve the Contractor of his responsibility for the successful completion of the work.

### *COMMENTARY*

*This section reiterates the Owner's intention of having only experienced project personnel perform work and identifies the Owner's responsibility to provide timely review of the Contractor Working Drawings.*

## **1.06 SUBMITTALS FOR CONTRACTOR-PROPOSED ALTERNATE**

- A. If a Contractor proposes an anchored wall alternate, the Contractor shall submit Working Drawings and detailed design calculations within 28 days of the contract award date. The submission shall be prepared and stamped by the design engineer. The design engineer must be a registered Professional Engineer in the State of \_\_\_\_\_ and shall meet the qualification requirements described under Part 1.04B of this Specification. The design engineer shall be available at any time during the life of the contract to discuss the design with the Owner. The anchored system shall be designed to safely support all earth, water, and seismic pressures, existing building loads, traffic or construction loads, and all permanent loads without permitting undesirable wall deflections and ground settlements behind the wall. The design submission shall include design calculations and drawings of the following:
  - 1. Plan, elevation, and section views of the wall, and a sufficient number of details to clearly illustrate the work.

2. Detailed calculations for all load cases showing reactions at the anchor locations and wall shears and bending moments. Calculations for lateral and axial capacity of the embedded portion of the wall and external stability shall also be provided.
  3. The relationship of the ground anchors to right-of-way and easement lines, existing buildings, other structures, utilities, streets, and other construction shall be indicated on the drawings. Owner-provided utility locations shall also be shown.
  4. Details, dimensions, and schedules of all reinforcing steel, including dowels and/or studs for attaching the concrete facing to the permanent anchored wall.
  5. Details of the anchors and wall elements including spacing, length, and size of soldier beams and sheet-piles, and spacing, inclination, and corrosion protection requirements of anchors.
  6. Detailed plans for proof and performance testing of anchors showing loading and measuring devices to be used and procedures to be followed.
  7. All details for construction of drainage facilities associated with the wall.
- B. The Engineer will be allowed 30 days to review and approve, reject, or provide comments on the final drawings and calculations. No work or ordering of materials for the structure will be done until the submittal has been approved by the Engineer. The Engineer will review each new submittal from the Contractor as a result of corrections resulting from the Engineer's review or changes that are made by the Contractor during construction as quickly as possible. The review will be completed within 30 days.
- C. The Engineer will be the sole judge of the adequacy of the information submitted. The review and acceptance of the final plans and methods of construction by the Owner shall not in any way relieve the Contractor of his responsibility for the successful completion of the work. Contractor delays due to untimely submissions and insufficient information shall not be considered as justification for time extensions.
- D. No additional compensation will be made for any additional material, equipment, design, or other items found necessary to comply with the project specifications as a result of the Engineer's review of an alternate design. Should the Contractor elect to base his bid on a redesigned wall, the bid price shall include all costs necessary to comply with the requirements of this Specification. No additional compensation shall be allowed for any subsequent changes or deviations from the Contractor's approved plan for any additional material, labor, or equipment that may be required to comply with the acceptance criteria of this specification.

#### COMMENTARY

*The purpose of this section is to clearly indicate that design alternatives are acceptable to the Owner, but that it is the Contractor's responsibility to provide complete and accurate information to the Owner for timely review by the Engineer. It is the Contractor's responsibility to assure that the alternate design is complete and in accordance with the project specifications. Time extensions are not allowable, simply because of the use/construction of an alternate design.*

## 1.07 REFERENCES

- A. Contract Drawings, entitled \_\_\_\_\_, dated \_\_\_\_\_.
- B. Latest version of American Association of State Highway and Transportation Officials (AASHTO), “Standard Specifications for Highway Bridges”
- C. Latest version of American Society for Testing and Materials (ASTM) standards:
  - 1. ASTM A 36 Standard Specification for A36 Carbon Structural Steel
  - 2. ASTM A 328 Standard Specification for A328 Steel Sheet Piling
  - 3. ASTM A 500 Standard Specification for Cold-formed Welded and Seamless Carbon Steel Structural Tubing in Rounds and Shapes
  - 4. ASTM A 572 Standard Specification for A572 High-Strength Low-Alloy Columbium-Vanadium Structural Steel
  - 5. ASTM A 615 Standard Specification for A615 Deformed and Plain Billet-Steel Bars for Concrete Reinforcement
  - 6. ASTM A 709 Standard Specification for A709 Carbon and High-Strength Low-Alloy Structural Steel Shapes, Plates, and Bars and Quenched and Tempered Alloy Structural Steel Plates for Bridges
  - 7. ASTM C 109 Standard Test Method for Compressive Strength of Hydraulic Cement Mortars (Using 2 inch or 50 mm Cube Specimens)
- D. Latest version of following standards from American Association of State Highway and Transportation Officials (AASHTO), “Standard Specifications for Transportation Materials and Methods of Sampling and Testing”
  - 1. AASHTO M 85 Standard Specification for Portland Cement
  - 2. AASHTO M 169 Standard Specification for Steel Bars, Carbon, Cold Finished, Standard Quality
  - 3. AASHTO M 183 Standard Specification for Structural Steel
  - 4. AASHTO M 202 Standard Specification for Steel Sheet Piling
  - 5. AASHTO M 222 Standard Specification for High-strength Low-alloy Structural Steel with 50,000 psi Minimum Yield Point to 4 Inches Thick
  - 6. AASHTO M 252 Standard Specification for Corrugated Polyethylene Drainage Tubing
  - 7. AASHTO M 270 Standard Specification for Structural Steel for Bridges
- E. Latest version of American Association of State Highway and Transportation Officials (AASHTO), “Guide Specifications for Highway Construction”
- F. Occupational Health and Safety Administration (OSHA) Publication
  - 1. 29 CFR 1926 Construction Industry Standards, Subpart P - Excavations
- G. Geotechnical Investigation Report

## **1.08 EXISTING CONDITIONS**

- A. Prior to beginning work, the Owner shall provide utility location plans to the Contractor. The Contractor is responsible for contacting a utility location service to verify the location of underground utilities before starting the work.
- B. The Contractor shall survey the condition of adjoining properties and make records and photographs of any evidence of settlement or cracking of any adjacent structures. The Contractor's report of this survey shall be delivered to the Owner before work begins.

### *COMMENTARY*

*Installation of anchored systems has the potential to induce movements in the ground which could adversely affect or be perceived to adversely affect adjacent structures. It is the intention of this section to provide baseline information to the Owner to protect the interest of the Owner in the event of potential future litigation.*

## **1.09 CONSTRUCTION QUALITY ASSURANCE**

- A. All aspects of anchored wall construction will be monitored by the Construction Quality Assurance (CQA) Inspector. The CQA Inspector will perform material conformance testing as required. The Contractor shall be aware of the activities required by the CQA Inspector and shall account for these activities in the construction schedule. The Contractor shall correct all deficiencies and nonconformities identified by the CQA Inspector at no additional cost to the Owner.
- B. For a Contractor-proposed alternate, the Owner may approve the design subject to the requirement that the Contractor allow for certain CQA activities to be implemented by the Owner. The Owner shall provide the Contractor with a description of the required CQA activities as part of the Owner's review of the design submission.

### *COMMENTARY*

*The purpose of this section is to identify to the Contractor the Owner's interest to inspect and monitor contractor compliance will all aspects of the project specifications. In general, projects which are subject to independent CQA monitoring perform better in the long-term than those which do not require independent CQA monitoring.*

## **PART 2 MATERIALS**

### **2.01 GENERAL**

- A. The Contractor shall not deliver materials to the site until the Engineer has approved the submittals outlined in Part 1.03 or Part 1.04 of this Specification.
- B. The designated storage location or locations shall be protected by the Contractor from theft, vandalism, passage of vehicles, and other potential sources of damage to materials delivered to the site.

- C. The Contractor shall protect the materials from the elements by appropriate means. Prestressing steel strands and bars shall be stored and handled in accordance with the manufacturer's recommendations and in such a manner that no damage to the component parts occurs. All steel components shall be protected from the elements at all times. Cement and additives for grout shall be stored under cover and protected against moisture.

## **2.02 STEEL SHEET-PILE**

- A. Steel sheet-piles shall be of the type and weight shown indicated on the Contract Drawings. Steel sheet-piles shall conform to the requirements of AASHTO M 202 (ASTM A 328) or AASHTO M 270 (ASTM A 709) Grade 50.

## **2.03 STEEL SOLDIER BEAMS**

- A. Steel soldier beams shall be of the type and weight shown indicated on the Contract Drawings. Steel soldier beams shall conform to AASHTO M 183 (ASTM A 36) or AASHTO M 223 (ASTM A 572) unless otherwise specified.

## **2.04 STEEL TUBE**

- A. Steel tube shall conform to the requirements of ASTM A 500.

## **2.05 STEEL PLATE**

- A. Steel used to fabricate steel studs and other devices shall conform to the requirements of AASHTO M 169.

## **2.06 TEMPORARY TIMBER LAGGING**

- A. Temporary timber lagging shall be construction grade rough cut and shall be a minimum of 75 mm thick. Where necessary, the Contractor shall provide certification that the timber conforms to the grade, species, and other specified requirements. If the timber is to be treated with a preservative, a certificate of compliance shall be furnished.

### *COMMENTARY*

*Construction grade, rough-cut lumber is most often used for timber lagging. Structural stress-graded lumber may be specified for permanent face applications.*

## **2.07 CEMENT**

- A. Portland cement shall be Type I or II and shall conform to AASHTO M 85.

## **2.08 STRUCTURAL CONCRETE**

- A. Structural concrete shall conform to the requirements of Section 8, "Concrete Structures" of AASHTO "Standard Specifications for Highway Bridges." Structural concrete shall be Class A with a minimum 28-day compressive strength of 21 MPa, unless otherwise noted on the Contract Drawings.

## **2.09 LEAN-MIX CONCRETE BACKFILL**

- A. Lean-mix concrete backfill shall consist of Type I or Type II Portland cement, fine aggregate, and water. Each cubic yard of lean-mix concrete backfill shall consist of a minimum of one sack (42.7 kg) of Portland cement.

### *COMMENTARY*

*Lean-mix concrete should be used to backfill the pre-drilled hole for a soldier beam from the elevation of the base of the excavation to the ground line. Lean-mix concrete can be easily removed to allow for lagging installation. Lean-mix concrete may be used to backfill the pre-drilled hole from the bottom of the wall element to the base of the excavation. As an alternative to lean-mix concrete, controlled low strength material (CLSM) or "flowable fill" may be used. When using either lean-mix concrete or CLSM, the contract specifications should require that the compressive strength of the material be a minimum of 0.35 MPa.*

## **2.10 REINFORCING STEEL**

- A. Reinforcing steel shall conform to ASTM A 615. The minimum yield stress for No. 6 reinforcing bars and for smaller diameter bars shall be 276 MPa. The minimum yield stress for No. 7 reinforcing bars and for larger diameter bars shall be 414 MPa.

## **2.11 PRECAST CONCRETE**

- A. Precast concrete elements such as panels shall conform to Section 8.13 "Precast Concrete Members" of AASHTO "Standard Specifications for Highway Bridges." Unless otherwise shown on the Contract Drawings, Portland cement concrete used in precast elements shall conform to Class A (AE) with a minimum 28-day compressive strength of 28 MPa.

## **2.12 DRAINAGE AGGREGATE**

- A. Drainage aggregate to be used as a drainage medium shall conform to subsection 620 of the AASHTO "Guide Specifications for Highway Construction."

## **2.13 PREFABRICATED DRAINAGE COMPOSITE**

- A. When required for the project and as called out on the Contract Drawings, the Contractor shall furnish prefabricated drainage composite that complies with required property values provided in Table 1. These property values will be furnished by the Owner based on project specific drainage requirements.

## **2.14 PIPE AND PERFORATED PIPE**

- A. Pipe and perforated pipe shall conform to subsections 708 and 709 of the AASHTO "Guide Specifications for Highway Construction" unless otherwise specified on the Contract Drawings.



## **PART 3 DESIGN CRITERIA**

### *COMMENTARY*

*For contractor-prepared wall designs that are submitted as part of an alternate wall proposal, wall design and performance requirements must be included in the Specification. Specifications allowing design alternates must sufficiently detail the project design parameters to permit contractors with different anchored systems to design functionally equivalent systems. For Owner-designed wall systems, this part (i.e., Part 3) of the Specification may be omitted.*

*The design and construction of an anchored wall requires an understanding of the design and construction aspects of both the ground anchors and the wall. The Contractor designing and installing the anchored wall must be familiar with all design criteria for the ground anchors as detailed in the specification "Ground Anchors." The anchored wall system must be analyzed to ensure stability of both the anchors and the earth mass being retained. The type of foundation and the location and susceptibility to movement of adjacent facilities must be taken into account in the design.*

### **3.01 GENERAL**

- A. Unless otherwise directed, the Contractor shall select the type of wall element to be used. The wall shall be designed for shear, moment, and lateral and axial capacity in accordance with procedures described in "Geotechnical Engineering Circular No. 4, Ground Anchors and Anchored Systems" (FHWA Report No. FHWA-SA-99-018, 1999). The Contractor shall be responsible for determining the length of the wall element and required section necessary to resist loadings due to earth, water, and seismic forces while controlling ground movements. Structure design life and corrosion protection requirements for sheet-piles and soldier beams will be provided on the Contract Drawings.
- B. Required geotechnical data are provided in the Geotechnical Investigation Report (GIR). The Owner may provide specific values for properties to be used in design or may require that the Contractor evaluate these properties independently based on the data provided. The GIR shall contain sufficient information to permit the following to be evaluated:
  - 1. Location and thickness of soil and rock strata.
  - 2. Engineering properties of in situ soil and rock including unit weight, shear strength, and compressibility.
  - 3. Groundwater conditions including worst-case water pressure condition.
  - 4. Ground surface topography.
  - 5. Geochemistry of soil and groundwater.
  - 6. Freezing index.
- C. The Contractor shall be familiar with the requirements for ground anchors described in the specification – "Ground Anchors." The Contractor shall incorporate all dimensional and location restrictions on ground anchor locations, spacing, and length of anchor bond length and unbonded length that may affect the design of the wall system covered by this Specification.

### 3.02 DESIGN LOADINGS AND STRUCTURAL WALL REQUIREMENTS

- A. The wall system shall be designed to resist maximum anticipated loadings calculated for the effects of earth pressure, water pressures, seismic pressures, backfill compaction, live load, dead load, and wind load from any traffic barrier, lights, overhead sign, or other appurtenance located on top or adjacent to the wall. These loadings are shown on the Contract Drawings.
- B. The wall shall be designed to ensure stability against passive failure of the embedded portion of the vertical wall elements (below the base of the excavation). The minimum FS shall be \_\_\_\_.
- C. The axial load carrying capacity of the embedded portion of the vertical wall elements (below the base of the excavation) shall be evaluated. The minimum FS shall be \_\_\_\_.  
The wall shall be designed to resist vertical loads including vertical anchor forces and the weight of the lagging and the vertical wall elements. Relying on transfer of vertical load into the soil behind the wall by friction shall not be permitted, unless approved by the Engineer.

#### COMMENTARY

*On small projects, where drilled-in soldier beams are used, some contractors use lean-mix backfill for the entire pre-drilled hole. Unlike structural concrete, the shear capacity between the steel soldier beam and the lean mix backfill in the embedded portion of the wall may not be adequate to insure load sharing between the steel and the concrete. For this reason, the full cross section of the concrete may not be effective in transferring lateral and axial load. If the Contractor plans to use lean-mix backfill for the embedded portion of the wall, the assumptions with respect to load sharing between the steel soldier beam and lean mix backfill should be clearly stated.*

- D. The wall shall be designed considering loadings from seismic forces and shall be designed in accordance with the latest AASHTO requirements with respect to seismic design of anchored retaining walls.
- E. Permanent facing shall be precast or cast-in-place reinforced concrete. Architectural facing treatments, if required, shall be as indicated on the Contract Drawings. The facing shall extend a minimum of 0.6 m below the gutterline or, if applicable, the ground line adjacent to the wall unless otherwise indicated on the Contract Drawings.

#### COMMENTARY

*In general, the owner should consider the need for movement control when structures are located within a horizontal distance from the top of the wall equal to one-half the wall height.*

### 3.03 EXTERNAL STABILITY REQUIREMENTS

- A. The external stability of the wall shall be evaluated. Failure surfaces extending beyond the ends of the ground anchors and below the bottom of the wall shall be checked using slope stability calculations. The minimum FS with respect to external stability shall be \_\_\_\_ for the wall system.

- B. The external stability of the wall system subjected to the seismic acceleration provided in the Contract Drawings shall be evaluated using slope stability calculations. The minimum FS shall be \_\_\_\_\_.

### **3.04 DRAINAGE SYSTEM REQUIREMENTS**

- A. The drainage system shall operate by gravity and shall be capable of relieving water pressures on the back face of the wall under anticipated worst case water pressure conditions. When drainage systems are incorporated into the specific design, hydrostatic head on the back of the wall shall not exceed 150 mm above the elevation of the drainage collection pipe.

## **PART 4 CONSTRUCTION**

### **4.01 GENERAL**

- A. Wall elements for anchored walls designed and constructed in accordance with this Specification shall be either continuous interlocking steel sheet-piles or steel soldier beams that are either driven or placed in predrilled holes that are subsequently backfilled with lean mix or structural concrete.

#### *COMMENTARY*

*The selection of either sheet-piles or soldier beams for use as the wall element will depend primarily on the ground conditions. In most cases, soldier beams are used for permanent anchored walls where lagging can be easily placed without significant ground loss into the excavation. Walls constructed in running sands or soft clays may employ sheet-piles to prevent soil from running or flowing into the excavation.*

### **4.02 EXCAVATION**

- A. The Contractor constructing the wall shall be familiar with the sequence of wall excavation described in the project plans. Excavation below a level of anchors shall be limited to 0.6 m below the anchor level and shall not commence below this level until anchors at that level have been installed, load tested, locked-off, and accepted by the Owner. Placement of timber lagging shall immediately follow excavation in front of the wall.

### **4.03 DRIVEN SHEET-PILE AND SOLDIER BEAM INSTALLATION**

- A. Driven sheet-piles and soldier beams shall be advanced to the specified minimum tip elevation shown on the Contract Drawings. The Contractor shall select a sheet-pile or soldier beam section that satisfies all design criteria. The Contractor shall select a driving method and pile driving and ancillary equipment consistent with the expected ground conditions at the site. The sheet-pile or soldier beam shall be driven to the specified minimum tip elevation or to the approved elevation based on bearing capacity without

damaging the sheet-pile or soldier beam. The interlocks between adjacent sheet-piles shall not be damaged. Equipment shall be used to permit the impact energy to be distributed over the tops of the sheet-pile or soldier beam.

#### COMMENTARY

*Where connections for ground anchors have been prefabricated on the soldier beams or sheet-piles, the wall elements must penetrate to exactly the design tip elevation so the anchor connections will be at the designed anchor depths. Redesign of the wall may be required to account for any deviations from the design tip elevations.*

*In certain ground, it may be difficult to install driven soldier beams or sheet-piles to the specified alignment tolerances. Installing timber lagging and the permanent facing for a wall that is significantly misaligned may result in increased construction costs.*

#### 4.04 SOLDIER BEAM INSTALLATION IN PREDRILLED HOLES

- A. Excavations required for soldier beam placement shall be performed to the dimensions and elevations shown on the Contract Drawings. The methods and equipment used shall be selected by the Contractor.
- B. The Contractor shall ensure that the sidewalls of the predrilled holes (i.e., shafts) do not collapse during drilling. Uncased shafts may be used where the sides and the bottom of the shaft are stable and may be visually inspected prior to placing the soldier beam and concrete. Casing or drilling muds shall be used where the sides of the shaft require additional support.
- C. The Contractor shall provide equipment for checking the dimensions and alignment of each shaft excavation. The dimensions and alignment shall be determined by the Contractor but shall be observed by the CQA Inspector. The CQA Inspector will check the alignment of the drilling equipment at the beginning of shaft construction and periodically thereafter. Final shaft depth shall be measured after final cleaning by the Contractor.
- D. Loose material shall be removed from the bottom of the shaft. No more than 0.6 m of standing water shall be left in the bottom of the shaft prior to beginning soldier beam installation.
- E. The soldier beam shall be placed in the shaft without difficulty and aligned prior to general placement of concrete. The Contractor may place up to 0.6 m of concrete at the bottom of the shaft to assist in aligning the soldier beam. The soldier beam shall be blocked or clamped in place at the ground surface, prior to placement of concrete.
- F. For shafts constructed without casing or drilling muds, concrete (either structural or lean-mix backfill) may be placed by free-falling the concrete from the ground surface down the shaft and around the soldier beam. If casing is used, the placement of concrete shall begin prior to casing removal. Remove the casing while the concrete remains workable. For shafts constructed using slurry, concrete shall be placed using the tremie method from the bottom of the shaft. The tremie pipe shall be withdrawn slowly as the level of the concrete

risers in the shaft and the level of the tremie pipe outlet shall never exceed the height of the slurry.

#### **4.05 WALL TOLERANCES**

- A. Soldier beams shall be placed at the locations shown on the Contract Drawings and shall not deviate by more than 300 mm along the horizontal alignment of the wall. The wall shall not deviate from the vertical alignment shown on the Contract drawings by more than 100 mm in each plane.
- B. The soldier beam or sheet-pile tip shall be installed to within 300 mm of the specified tip elevation shown on the Contract Drawings.
- C. The Contractor shall provide corrective measures for any wall element that does not meet the tolerance requirements described in this Specification. Any proposed corrective measure must be approved by the Owner in writing.

#### **4.06 WELDING AND SPLICING**

- A. Splicing of sheet-piles or soldier beams shall not be permitted, unless approved by the Owner. All structural welding of steel and steel reinforcement shall be performed by certified welders qualified to perform the type of welding shown on the Shop Drawings. All sheet-piles or soldier beams shall be cutoff to a true plane at the elevations shown on the Contract Drawings. All cutoff lengths shall remain the property of the Contractor and shall be properly disposed.

#### **4.07 TIMBER LAGGING INSTALLATION**

- A. Timber lagging shall be placed from the top-down in sufficiently small lifts immediately after excavation to prevent erosion of materials into the excavation. Prior to lagging placement, the soil face shall be smoothed to create a contact surface for the lagging. Large gaps behind the lagging shall be backfilled and compacted prior to applying any loads to the ground anchors.
- B. A gap shall be maintained between each vertically adjacent lagging board for drainage between adjacent lagging sections. In no case shall lagging be placed in tight contact to adjacent lagging.

#### *COMMENTARY*

*Judgment must be exercised in the field as to the maximum height of excavation that can remain unsupported without lagging. The objective is to ensure that intimate contact can be developed between the lagging and the retained soil.*

*Concrete lagging has been used, but is not recommended due to difficulties in handling and very tight tolerances on the horizontal and vertical positioning of the soldier beam to ensure easy installation of standard length concrete lagging. Trimming of concrete lagging is very difficult and field splicing is not possible. Concrete lagging should never be used with driven soldier beams.*

#### **4.08 DRAINAGE SYSTEM INSTALLATION**

- A. The Contractor shall handle the prefabricated drainage composite in such a manner as to ensure the composite is not damaged in any way. Care shall be taken during placement of the composite not to entrap dirt or excessive dust in the composite that could cause clogging of the drainage system. Delivery, storage, and handling of the drainage composite shall be as provided in the plans or based on manufacturer's recommendations.
- B. Drainage composite strips shall be placed and secured tightly against the timber lagging with the fabric facing the lagging. A continuous sheet of drainage composite that spans between adjacent soldier beams shall not be allowed. Seams and overlaps between adjacent composites shall be made according to the special provisions or manufacturer's recommendations and specifications. Repairs shall be performed at no additional cost to the Owner and shall conform to the plans or manufacturer's recommendations.
- C. Where drainage aggregate is used to construct a vertical drain behind the permanent wall and in front of the lagging, the drainage aggregate shall be placed in horizontal lifts. The construction of the vertical drain should closely follow the construction of the precast facing elements. Care should be exercised to ensure that connection devices between wall elements and facing elements are not damaged during the placement of the drainage aggregate.
- D. Perforated collector pipe shall be placed within the permeable material to the flow line elevations and at the location shown on the Contract Drawings. Outlet pipes shall be placed at the low end of the collector pipe and at other locations shown or specified in the Contract Drawings.

#### *COMMENTARY*

*Requirements for drainage system materials and construction may vary significantly depending on the specific project application. For anchored wall systems with a cast-in-place concrete wall facing, collection of subsurface flow is usually achieved with prefabricated drainage elements such as drainage composites that extend vertically over the full height of the wall. Where precast concrete facings are used, the space between the temporary wall face and the permanent facing may be backfilled with drainage aggregate. The backfill acts as drainage element. Water intercepted in the drainage elements flows downward to the base of the wall where it is removed using longitudinal/outlet pipes or weepholes.*

#### **4.09 CONCRETE FACING INSTALLATION**

- A. For permanent cast-in-place and precast concrete facings, concrete manufacture, handling, placement, and finishing shall conform to the requirements in Section 8 "Concrete Structures" of AASHTO "Standard Specifications for Highway Bridges." Connections used to secure the facing to wall elements shall conform to the details shown on the Contract Drawings. The exposed surface of the concrete facing shall receive a Class I finish as specified in Section 8 "Concrete Structures", unless a special architectural treatment is specified.

**PART 5 MEASUREMENT AND PAYMENT**

- A. The accepted wall will be measured in square meter exposed face plus required burial below finish grade as shown on the Contract Drawings. Payment at the contract unit price shall be full compensation for all labor and costs of backfill, timber lagging, wales, soldier beams, sheet-piles, and drainage and all other materials and equipment necessary to complete the work described in this Specification.
- B. Additional area of wall required due to unforeseen foundation conditions or other reasons and approved in writing by the Owner will be paid at the contract unit price bid per square meter of wall.
- C. In the event that a decrease in the wall area is required, payment shall be reduced at the contract unit price bid per square meter of reduced wall area.
- D. Payment will be made under:

Pay Item	Pay Unit
Anchored Wall	Square meter of wall face

*COMMENTARY*

*The Owner and Contractor may negotiate a separate unit price for additional or reduced wall area. Contractor-designed anchored wall systems necessarily involve design of both the anchor details and the wall details. The owner may achieve economy in designs by permitting the specialty contractors to use their expertise to achieve the optimal combination of sheet-pile or soldier beam spacing, size, and length with a compatible anchor spacing, length, and size.*

**TABLE 1**  
**GEOCOMPOSITE DRAINAGE MATERIAL PROPERTY VALUES**

<b>PROPERTIES</b>	<b>QUALIFIER</b>	<b>UNITS</b>	<b>SPECIFIED VALUES<sup>(1)</sup></b>	<b>TEST METHOD</b>
Polymer composition	Minimum	%		
Weight	Minimum			
Nominal thickness	Minimum	mm		
Compressive strength	Minimum	MPa		
Apparent opening size	Maximum	mm		
In-plane flow rate	Minimum	m <sup>2</sup> /s		

Notes:

1. All values represent minimum average roll values.