

# STATE OF MAINE HIGHWAY SAFETY PLAN

TOWARD ZERO DEATHS: EVERY LIFE COUNTS!

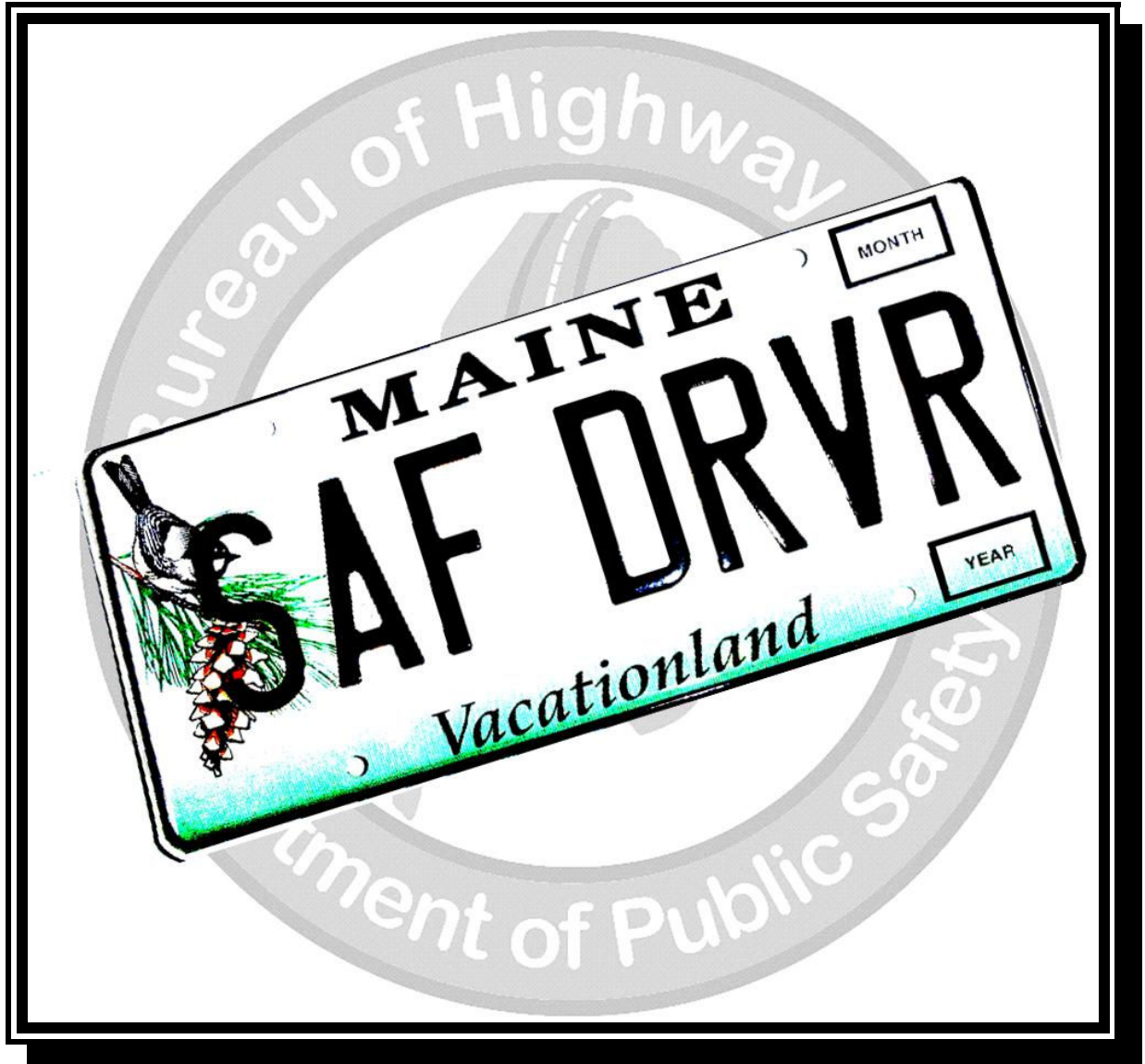

MAINE DEPARTMENT OF PUBLIC SAFETY  
BUREAU OF HIGHWAY SAFETY  
Paul R. Lepage, Governor  
John E. Morris, Commissioner

HIGHWAY SAFETY PLAN  
FEDERAL FISCAL YEAR  
(October 1, 2011 - September 30, 2012 )

PREPARED FOR:

U.S. Department of Transportation  
National Highway Traffic Safety Administration

BY:

Maine Bureau of Highway Safety  
Lauren V. Stewart, Director

## **Table of Contents**

Letter from the Director	4
Mission of the Bureau	5
Maine Facts	6
About the Maine Bureau of Highway Safety	7
Highway Safety Organizational Chart	9
HSP Planning Process Overview	10
Priority Program Areas	13
Problem Identification Process Overview	17
Goal Development Process	18
Performance Goals	19
Crash Data/Trends Graphs	22
Funded Countermeasures	43
Financial Summary	57
Certifications and Assurances	61



**Paul R. Lepage**  
Governor

STATE OF MAINE  
Department of Public Safety  
***Bureau of Highway Safety***  
164 State House Station  
Augusta, Maine  
04333-0164



**John E. Morris**  
Commissioner

**Lauren V. Stewart**  
Director

Dear Maine Citizens:

The Maine Bureau of Highway Safety (MeBHS) strives to eliminate traffic deaths and injuries. We do this by making grants available to local and state organizations for programs that help them enforce traffic laws, educate the public in traffic safety, and provide a varied and effective means of reducing fatalities, injuries and economic losses from traffic crashes.

The MeBHS draws funds from several federal government funding sources for these grants. We mount public awareness campaigns and act as the primary traffic safety resource in order to enlist the help of the general public and the media to encourage traffic safety on all of our roads and highways.

The MeBHS strives to be results-oriented in all that we do and to be a leader in the traffic safety arena. We proactively respond to emerging traffic safety issues through innovative and evidential-based programs and technologies. Through extensive data analysis, we are able to pin-point Maine's top traffic safety problems, such as impaired driving, distraction and speed, and implement programs and projects that will ultimately reduce the incidence of fatalities, crashes and injuries associated with these driver behaviors. Also, we work more effectively through public and private partnerships with key stakeholders, and continue to explore methods that enable traffic safety practitioners to do their jobs more efficiently.

With the support of Governor Paul R. Lepage and Commissioner John E. Morris, the Governor's Representative for Highway Safety, our legislature, and through the efforts of all of our partners in traffic safety, we have seen a steady decrease in traffic fatalities over the past several years. However, one fatality will always be too many.

We maintain the vision of *Toward Zero Deaths: Every Life Counts!* The 2012 Highway Safety Plan details the State of Maine's strategies to achieve our overall goals of continuing to reduce fatalities, injuries, and property damage costs resulting from motor vehicle crashes. It also serves as our application for Section 402 federal funds for federal fiscal year 2012 as required by 23CFR 1200.10 – 1200.13.

We are proud of the success realized here in Maine in traffic safety and will continue to strive toward coordinating, funding and implementing programs which will make significant impacts on traffic safety in Maine.

Sincerely,

Lauren V. Stewart, Director

---

Buckle Up. Drive Safely.

---



Offices Located At:  
Central Maine Commerce Center  
45 Commerce Dr, Suite 1  
Augusta, ME 04330

## **Mission of the Bureau**

The Bureau of Highway Safety is the agency, tasked under M.R.S.A. Title 25 §2902, with developing and implementing a process for obtaining information about highway safety programs that are administered by DPS other state and local agencies, and to provide and facilitate for the provision of financial and technical assistance to other state agencies and political subdivisions for the purposes of developing and carrying out highway safety programs.

The mission of the Maine Bureau of Highway Safety is to save lives and reduce injuries on Maine roads and highways; through strong leadership, partnerships with other public and private organizations, innovation, facilitation, project and program support, and through the effective and efficient administration of traffic safety grant funds.

# Maine Facts



- Population of Maine in 2000: 1,274,923
- Land Area: 33,215 square miles
- Length of coastline: 3,500 miles
- Forest: 17 million acres
- Persons per square mile: 41.3
- Home ownership rate (2000): 71.6%
- Largest city by population: Portland
- 1,016,827 licensed drivers plus 102,763 licensed motorcyclists (2009)
- 1,519,008 registered vehicles (2009)
- State Capital: Augusta
- 16 Counties
- Nearly 500 municipalities
- 146 law enforcement agencies: 123 local agencies, 16 County Sheriffs' offices, and 7 Maine State Police troops
- 5.2% under age 5; 78.5 % 18 years and over; 14.1% age 65 and over
- 96.6% white; .7% African American; .5% American Indian and Alaska Native; .8% Asian; .4% other; .9% Hispanic or Latino

## **About the Maine Bureau of Highway Safety**

The Federal Highway Safety Act of 1966 directed the National Highway Traffic Safety Administration (NHTSA) and Federal Highway Administration (FHWA) of the United States Department of Transportation to jointly administer various highway safety programs and projects. This federal grant program provides funds administered through the Maine Department of Public Safety (MeDPS), Bureau of Highway Safety (MeBHS) to eligible entities to be used, in part, for traffic safety education and enforcement to decrease the deaths and injuries that occur on Maine roads and highways.

The MeBHS is tasked with the responsibility of effectively administering and utilizing Section 402 State and Community Highway Safety Funds and related grant funds received from NHTSA and FHWA. These funds are to be used for planning, implementing and evaluating short-term behavioral highway safety programs and projects with the intent that other sources of funding will sustain these programs over the long-term. The MeBHS is the leader in coordinating the safety efforts of federal, state and local organizations involved in Maine traffic safety. Our programs are intended to improve the behavior of and instill a sense of responsibility in drivers, passengers, pedestrians and cyclists. Our goal is to ultimately reduce the number of fatalities, injuries and property damage costs caused by highway crashes.

In addition to administering federal grant funds, the MeBHS is also responsible for:

- Managing Maine's Implied Consent Program under Title 29A subchapter 4 §2521- 2528. This is a statewide program that tests drivers suspected of being impaired by alcohol or other drugs. Maine's Implied Consent and Operating Under the Influence laws mandate that all drivers arrested for suspected OUI must take a blood alcohol test. Failure to do so results in even longer mandatory license suspension periods. The Maine Supreme Judicial Court has ruled that our

law mandating the testing of all individuals involved in fatal accidents is both constitutional and enforceable.

- Developing and administering the Maine Driving Dynamics Driver Improvement Program under Title 23 §4208. This is a five-hour driver improvement course that allows for point reduction on a driver's record. Each year, approximately 5,000 people attend a Maine Driving Dynamics class.
- Administration of the Federal Fatal Analysis Reporting System (FARS). This system records data on fatal crashes in Maine for input into a larger national record-keeping system of statistical data. The FARS data is analyzed by the MeBHS and the Maine State Police to determine enforcement priorities and schedules.



# Maine Bureau of Highway Safety

## 2011 Organizational Chart

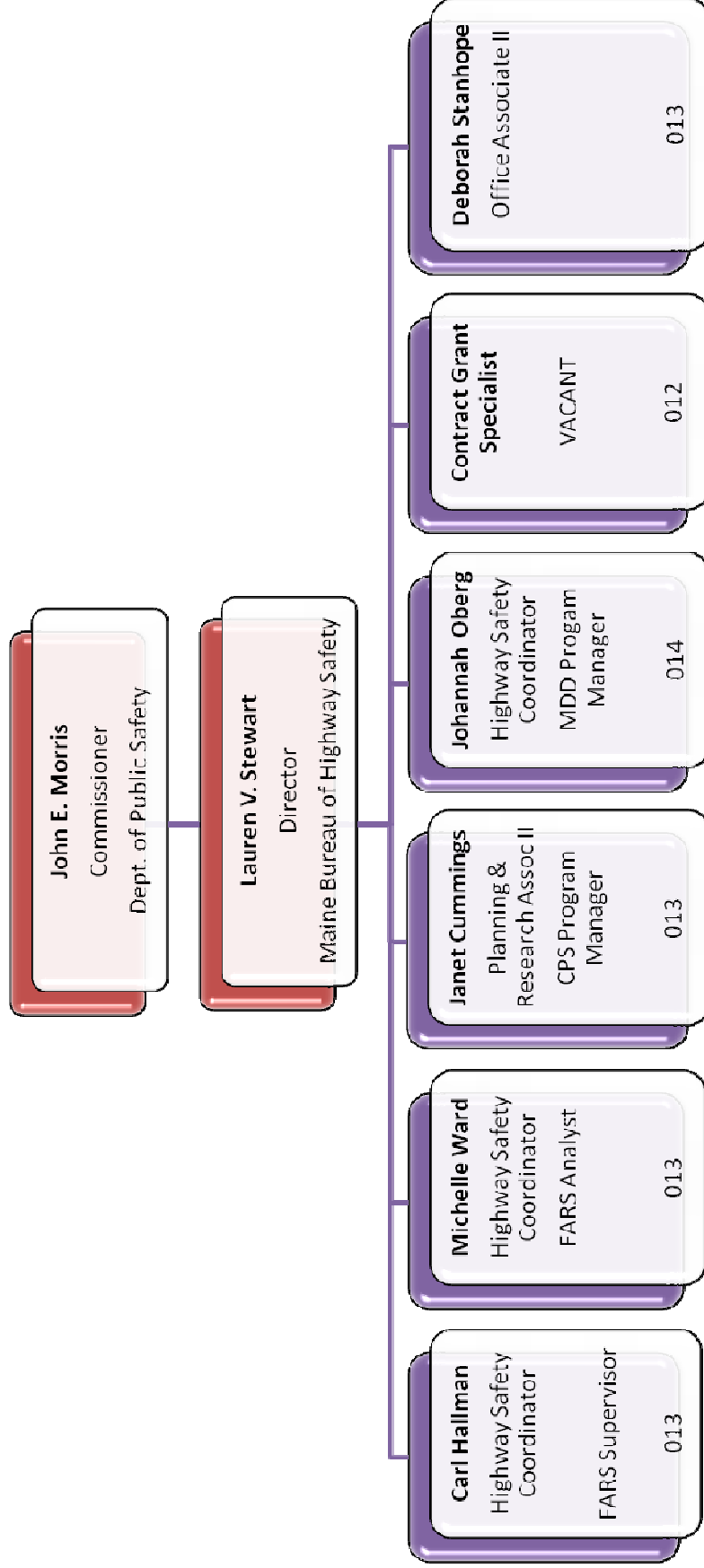

## **HSP Planning Process Overview**

In accordance with 23 CFR1200.12, each September 1, the MeBHS must provide NHTSA with a comprehensive plan to reduce traffic crashes and resulting deaths, injuries and property damage. The Highway Safety Plan (HSP) serves as Maine's application for available federal funds for these specific purposes. The HSP describes Maine's top highway safety problems, identifies activities and countermeasures, provides qualitative and quantitative performance measures to determine goals and objectives and gives descriptions of continuing and grants and new projects.

In 2011, the MeBHS instituted a comprehensive Request for Proposal (RFP) process as part of the HSP planning process. The RFP process is used to streamline the projects the MeBHS will focus on, create a definitive evaluation system for RFP projects, and bring in new highway safety partners.

The HSP development calendar is listed on the next page.

## HSP Planning Process Cycle

October	Federal Fiscal Year begins Begin implementation of HSP projects approved by NHTSA
November-December	Annual Report prepared and submitted
January-April	Initiate partnership meetings Obtain input and project ideas for future HSP planning and problem identification processes Evaluate and monitor project progress Release RFPs for future HSP projects
May-July	Proposals due and future projects agreed upon On-site grantee visits begin Data compilation and final review
June-August	HSP developed Grantees notified of project acceptance
September	Annual HSP/402 Application due to NHTSA Federal Fiscal Year ends All grants finalized

The MeBHS solicits input and requests for HSP projects to all eligible state, public and private agencies outlining opportunities to participate in MeBHS programs and the requirements to compete for available funds. The RFPs are released and publicized across Maine to alert Maine's communities and organizations of available funding for highway safety related projects. Proposals are submitted addressing traffic safety problems from all interested and eligible agencies.

The MeBHS reviews proposals and selects the most qualified candidates to partner with for the following federal fiscal year. Since the MeBHS may not have sufficient funds for all submitted proposals, a comprehensive review is part of the proposal selection process. We review all proposals against several criteria including: potential traffic safety impact, crash and fatality statistics (specifically high crash locations), seriousness of identified problem(s), and performance on previous grants.

The MeBHS coordinators function as liaisons with private and public sector traffic safety leaders to track successful programs and encourage collaborative efforts. This approach encourages widespread participation in MeBHS programs and gives us a broad base from which to select the most effective and cost-efficient countermeasure programs possible. The Governor's Representative for Highway Safety, the MeBHS Director and highway safety coordinators regularly attend meetings of the Maine Chiefs of Police Association, Maine Sheriffs Association, Maine Chiefs Traffic Safety Committee, and others to further gather input on needs and potential solutions and to explain federal guidelines, MeBHS policy and the application process. In addition to the RFP solicitation process, the MeBHS considers information developed by staff members through contacts with grantees, potential grantees, and other highway safety professionals and non-profit agencies.

The MeBHS program goals help local communities develop traffic safety programs which will contribute toward the reduction in traffic crashes, injuries and deaths. Our grants touch as many state and local agencies as possible. The grants are distributed statewide.

## Priority Program Areas

The National Highway Traffic Safety Administration has identified eight priority program areas for eligible grant funding. These programs, administered by the MeBHS, are:

**Alcohol/Drugs and Impaired Driving:** The program goal is to reduce deaths and injuries attributable to alcohol and drug involvement, by adults and teens, by removing alcohol- and drug-impaired drivers from the roads.

**Occupant Protection and Child Passenger Safety:** These two programs share a goal to increase compliance with both adult and child safety restraint laws including the correct and consistent use of infant and child safety seats.

**Pedestrian and Bicycle Safety:** The program goal is to increase safety awareness among pedestrians, bicyclists and motorists through various approaches including education, enforcement and engineering.

**Traffic Records:** The program goal is to establish/improve record systems that aid in identifying existing and emerging traffic safety problems and aid in evaluating program performance. Accurate and current records are needed to support problem identification and to evaluate countermeasure effectiveness.

**Emergency Medical Services:** The program goal is to ensure that persons involved in motor vehicle collisions receive rapid and appropriate medical treatment through a coordinated system of emergency medical care.

**Police Traffic Services:** The program goal is to reduce motor vehicle collisions through selective enforcement, education and deterrence. PTS programs seek to encourage compliance with safety belt use, impaired driving, speed limit and other traffic laws.

**Motorcycle Safety:** The program goal is to improve motorcycle safety by training and educating motorcycle riders on the effectiveness and need for safety equipment and educating the motoring public on the presence of motorcycles in the traffic environment.

**Teen Drivers and Senior Drivers:** These two programs share a common goal of keeping our most vulnerable drivers safe, reducing the number of crashes and injuries

by teen and elder drivers and providing alternate means of transportation when necessary.

In addition, the Secretary has declared distracted driving to be a major concern of his Administration. Recognizing the need for education and awareness, the Bureau includes **Distracted Driving** as a program area that receives attention. The Maine Legislature recently passed a no-texting while driving law that prohibits a person from operating a motor vehicle while engaging in text messaging. This law will take effect in mid-September of 2011.

This Highway Safety Plan addresses these national priority program areas as they are administered by the MeBHS. Activities to be undertaken in FFY 2012 for these priority areas will include:

- various activities and programs that counter the incidence of impaired driving by adults and teens, including enforcement, education, support of the National Campaigns, and continued actions toward supporting a Traffic Safety Resource Prosecutor (TSRP);
- continuing our focus on increasing adult, teen and child safety restraint usage through support of the National Campaigns, child passenger safety technician training, and educational outreach through new partnerships and well publicized enforcement mobilizations;
- enhancing partnerships that increase our opportunity for data analysis and evaluation;
- increasing participation of law enforcement in our enforcement activities through use of the BHS Law Enforcement Liaison;
- identifying activities to decrease the incidence of speed related fatalities and crashes and providing opportunities for enforcement and education;
- using crash data to understand the distracted driving problem in Maine;
- activities to decrease the incidence of crashes related to distractions;

- continuing our focus on reducing the number of motorcycle fatalities through our partnerships with the Bureau of Motor Vehicles, Maine DOT, MTSC and various motorcycle rider associations.
- Other activity identified in the state's Strategic Highway Safety Planning Process.

Special attention will continue toward identifying more highway safety partners at the community and grassroots level for emphasis in those areas of the state where data indicates the greatest problem in all behavioral highway safety areas. The MeBHS, the Commercial Motor Vehicle Division and the MeDOT Safety Office continue to update the Strategic Highway Safety Planning Plan and the MTSC Data Book to be sure that all highway safety and traffic safety efforts compliment each other and that all potential partners and activities have been identified. We are thankful for the continued participation and dedication of all of our partners and especially our law enforcement partners in assisting us with our highway safety efforts.

## Priority Program Area Assignments

<b>Alcohol/Drugs and Impaired Driving</b>	<p>Carl J. Hallman, Highway Safety Coordinator  <a href="mailto:Carl.j.hallman@maine.gov">Carl.j.hallman@maine.gov</a>                      (207) 626-3843</p>
<b>Occupant Protection &amp; Child Passenger Safety</b>	<p>Janet Cummings, Child Passenger Safety Coordinator  <a href="mailto:Janet.Cumming@maine.gov">Janet.Cumming@maine.gov</a>                      (207) 626-3848</p>
<b>Pedestrian and Bicycle Safety</b>	<p>Johannah Oberg, Highway Safety Coordinator  <a href="mailto:Johannah.Oberg@maine.gov">Johannah.Oberg@maine.gov</a>                      (207)626-3844</p>
<b>Traffic Records</b>	<p>Lauren V. Stewart, Director  <a href="mailto:Lauren.v.stewart@maine.gov">Lauren.v.stewart@maine.gov</a>                      (207) 626-3840</p>
<b>Emergency Medical Services</b>	<p>Lauren V. Stewart, Director  <a href="mailto:Lauren.v.stewart@maine.gov">Lauren.v.stewart@maine.gov</a>                      (207) 626-3840</p>
<b>Police Traffic Services</b>	<p>Carl J. Hallman, Highway Safety Coordinator  <a href="mailto:Carl.j.hallman@maine.gov">Carl.j.hallman@maine.gov</a>                      (207) 626-3843</p>
<b>Motorcycle Safety</b>	<p>Carl J. Hallman, Highway Safety Coordinator  <a href="mailto:Carl.j.hallman@maine.gov">Carl.j.hallman@maine.gov</a>                      (207) 626-3843</p>
<b>Teen Drivers</b>	<p>Michelle Ward, Highway Safety Coordinator  <a href="mailto:Michelle.ward@maine.gov">Michelle.ward@maine.gov</a>                      (207) 626-3845</p>
<b>Senior Drivers</b>	<p>Johannah Oberg, Highway Safety Coordinator  <a href="mailto:Johannah.Oberg@maine.gov">Johannah.Oberg@maine.gov</a>                      (207) 626-3844</p>
<b>Distracted Driving</b>	<p>Johannah Oberg, Highway Safety Coordinator  <a href="mailto:Johannah.Oberg@maine.gov">Johannah.Oberg@maine.gov</a>                      (207) 626-3844</p>



## **Problem Identification Process Overview**

The specific highway safety problems in Maine as outlined in this document were identified by analyzing available data that include traffic crashes, traffic citation information, OUI arrests, FARS data, CODES data, NHTSA data, the *State Strategic Highway Safety Plan*, HSIP, Commercial Vehicle Safety Plan, surveys and other input from state, county and local agencies interested in addressing highway safety issues.

This analysis helps to identify when, where, why and to whom specific safety problems occur. We analyze our data using mapping and crash data capabilities from the Maine Department of Transportation, injury data from Maine CDC, FARS, CODES, available NHTSA data, *Maine Transportation Safety Coalition* data and other data sources.

Isolating and identifying contributing factors is a great advantage in the planning and selection of countermeasures. Problem identification and solution development are ongoing throughout the year.

Our most recent analysis of available data indicates that despite our specific education and enforcement efforts, Maine continues to experience traffic fatalities related to: unrestrained occupants in vehicles; drivers and motorcycle operators with alcohol content in excess of .08; excessive speed and non-use of helmets on motorcycle riders. From a behavioral stand-point, those are the priority areas that we hope to address in our highway safety planning activities.

## Goal Development Process

The goals identified in this report were determined together with the problem identification process. The goals were established for the various program priority areas; the targets were based on a five-year average based on past trends and our Maine specific experiences. The goals in this HSP are shown together with appropriate performance measures. Performance measures include: absolute numbers (fatalities, serious injuries); percentages (speed-related or alcohol-involved crashes); and rates (fatality rate/100 MVMT). Graphs and charts are used to present trends and goals. Five-year averages were used in setting the base periods.

The MeBHS recognizes that achievement of goals is not solely dependent upon the activities performed within our office, but is inclusive of collaborative and ongoing efforts of a multitude of government and private entities.

The NHTSA and the Governor's Highway Safety Association (GHSA) have agreed to a minimum set of performance measures to be used by States and Federal agencies in the development and implementation of behavioral highway safety plans and programs. An expert panel of highway safety professionals from NHTSA, GHSA, FHWA, IACP, AASHTO, State Highway Safety Offices, and academic and research organizations, among others, assisted in developing the measures. NHTSA will use the core measures as an integral part of its reporting to Congress, the public and others.

The minimum set of performance goals contains 15 measures: ten core outcome measures, one core behavior measure, an attitudinal measure and three activity measures. The measures cover the major areas common to State highway safety plans and use existing state data systems.

## **Performance Goals**

### **Core Outcome Measures**

#### **Traffic Fatalities (FARS)**

C-1) To decrease traffic fatalities by 5% from the 5 year average of 169.2 for 2006-2010 to 160.74 by December 31, 2015.

#### **Serious Traffic Injuries (State Crash Data Files)**

C-2) To decrease serious traffic injuries 5% from the 5 year average of 868.6 for 2006-2010 to 825.17 by December 31, 2015.

#### **Mileage Death Rate (FARS)**

C-3a) To decrease the mileage death rate 5% from the 5 year average of 1.14 for 2006-2010 to 1.08 by December 31, 2015.

#### **Rural Mileage Death Rate**

C-3b) To decrease the rural mileage death rate 5% from the 5 year average of 1.33 for 2006-2010 to 1.26 by December 31, 2015.

#### **Urban Mileage Death Rate**

C-3c) To decrease the urban mileage death rate 5% from the 5 year average of .60 for 2006-2010 to .57 by December 31, 2015.

#### **Unrestrained Passenger Vehicle Occupant Fatalities (FARS)**

C-4) To decrease unrestrained passenger vehicle occupant fatalities by 5% from the 5 year average of 55.4 for 2006-2010 to 52.6 by December 31, 2015.

#### **Alcohol Impaired Driving Fatalities (FARS)**

C-5) To decrease alcohol impaired driving fatalities by 5% from the 5 year average for 2006-2010 of 45.6 to 43.3 by December 31, 2015.

### **Speeding Related Fatalities (FARS)**

C-6) To decrease speeding related fatalities by 5% from the 5 year average of 68.8 for 2006-2010 to 65.4 by December 31, 2015.

### **Motorcyclist Fatalities (FARS)**

C-7) To decrease motorcyclist fatalities by 5% from the 5 year average of 21 for 2006-2010 to 20 by December 31, 2015.

### **Unhelmeted Motorcyclist Fatalities (FARS)**

C-8) To decrease unhelmeted motorcyclist fatalities by 5% from the 5 year average of 14.6 for 2006-2010 to 13.9 by December 31, 2015.

### **Drivers Age 20 or Younger Involved in Fatal Crashes (FARS)**

C-9) To decrease drivers age 20 or younger involved in fatal crashes by 5% from the 5 year average of 22.2 for 2006-2010 to 21.1 by December 31, 2015.

### **Pedestrian Fatalities (FARS)**

C-10) To reduce pedestrian fatalities by 10% from the 5 year average of 11 for 2006-2010 to 10.5 by December 31, 2015.

## **BEHAVIOR MEASURE \***

### **Seat Belt Usage Rate (Observed Seat Belt Use Survey)**

B-1) To increase statewide seat belt compliance by 2% from the 2010 survey results from 82.0% to 83.6% by December 31, 2015.

## **ACTIVITY MEASURES**

A-1) To monitor seat belt citations issued during grant-funded enforcement activities.

A-2) To monitor impaired driving arrests made during grant-funded enforcement activities.

A-3) To monitor speeding citations issued during grant-funded enforcement activities.

## **ATTITUDINAL MEASURES\***

### **Impaired Driving**

A-1) In the past 60 days, how many times have you driven a motor vehicle within 2 hours after drinking alcoholic beverages?

A-2) In the past 30 day, have you read, seen or heard anything about alcohol impaired driving (or drunk driving) enforcement by police?

A-3) What do you think the chance are of someone getting arrested if they drive after drinking?

### **Safety Belts**

B-1) How often do you use safety belts when you drive or ride in a car, van, sports utility vehicle or pick up?

B-2) In the past 60 days, have you read, seen or heard anything about seat belt law enforcement by police?

B-3) What do you think the chance are of getting a ticket if you don't wear your safety belt?

### **Speeding**

S-1) On a local road with a speed limit of 30 mph, how often do you drive faster than 35 mph? – most of the time, half the time, rarely, never.

S-1b) On a road with a speed limit of 65 mph, how often do you drive faster than 70 mph?  
- most of the time, half the time, rarely, never.

S-2: In the past 30 days, have you read, seen or heard anything about speed enforcement by police?

S-3) What do you think the chance are of getting a ticket if you drive over the speed limit?

\* Results of the observational & attitudinal surveys are not available until late fall and will be report in the MeBHS annual report.

## Crash Data / Trends

5 Year Averages

Progress Report Data 2006-2010

	2001	2002	2003	2004	2005	2006	2007	2008	2009	2010
C-1: Fatalities (Actual)	192	216	207	194	169	188	183	155	159	161
C-2: # of Serious Injuries	1,222	1,237	1,091	1,119	1,030	996	978	862	732	775
C-3a: Fatality Rate /100 million VMT	1.3	1.5	1.4	1.3	1.1	1.2	1.22	1.08	1.10	1.11
C-3b: Rural Mileage Death Rate				1.56	1.50	1.49	1.51	1.08	1.32	1.23
C-3c: Urban Mileage Death Rate				0.53	0.19	0.59	0.45	0.64	0.51	0.79
C-4: # of Unrestrained Passenger Vehicle Occupant Fatalities	78	72	87	75	64	65	76	45	50	41
C-5: # of Fatalities Involving Driver or Motorcycle Operator w/ $\geq$ .08 BAC	54	40	56	50	47	46	61	42	44	35
C-6: # of Speeding-Related Fatalities	73	83	79	90	86	61	86	53	61	83
C-7: # of Motorcyclist Fatalities	14	13	20	22	15	23	23	18	23	18
C-8: # of Unhelmeted Motorcyclist Fatalities	5	8	12	11	9	17	15	14	17	10
C-9: # of Drivers Age 20 or Younger Involved in Fatal Crashes	17	21	13	21	16	23	25	19	20	24
C-10: # of Pedestrian Fatalities	12	14	13	10	9	10	10	12	11	12
B-1: % Observed Belt Use for Passenger Vehicles - Front Seat Outboard Occupants	59.0%	59.2%	59.2%	72.3%	75.8%	77.2%	79.8%	83.0%	82.6%	82%
A-1: # of Seat Belt Citations Issued During Grant-Funded Enforcement Activities	0	245	0	2166	2568	1725	1566	5997	6,650	9856
A-2: # of Impaired Driving Arrests Made During Grant-Funded Enforcement Activities	269	272	321	275	330	301	359	506	545	456
A-3: # of Speeding Citations Issued During Grant-Funded Enforcement Activities	0	0	0	0	0	3312	2947	3963	4887	11,732

**Goal: C-1: Fatalities (Actual) - Reduce 5 year average by 5% by December 2015**  
**Baseline - 5 year average of 169.2 to 160.74**

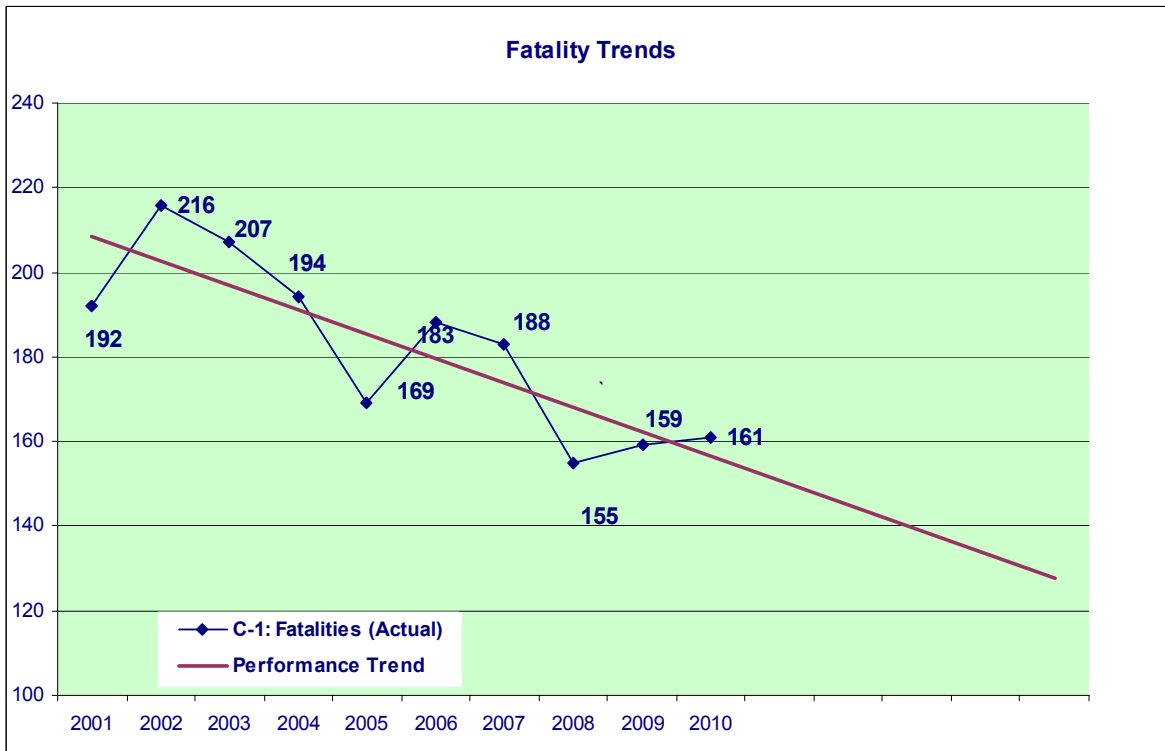

**Goal: C-2: # Serious Injuries - Reduce 5 year average by 5% by December 2015**  
**Baseline - 5 year average of 868.6 to 825.17**

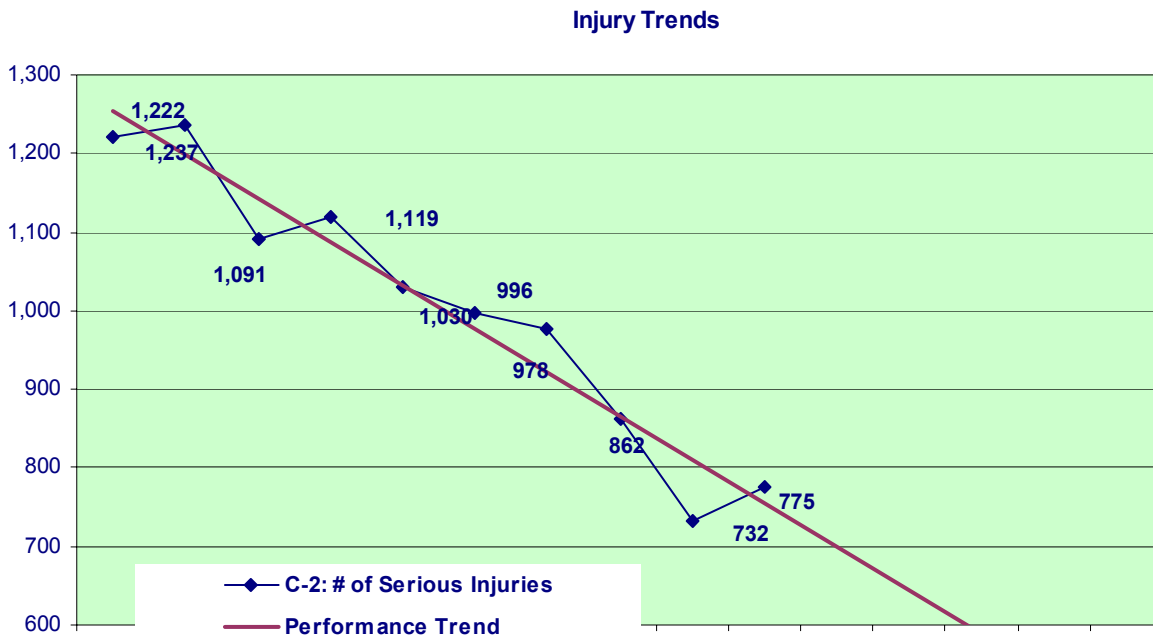

**Goal: C-3a: Fatality Rate - Reduce 5 year average by 5% by December 2015**  
**Baseline - 5 year average of 1.14 to 1.08**

**Fatality Rate**

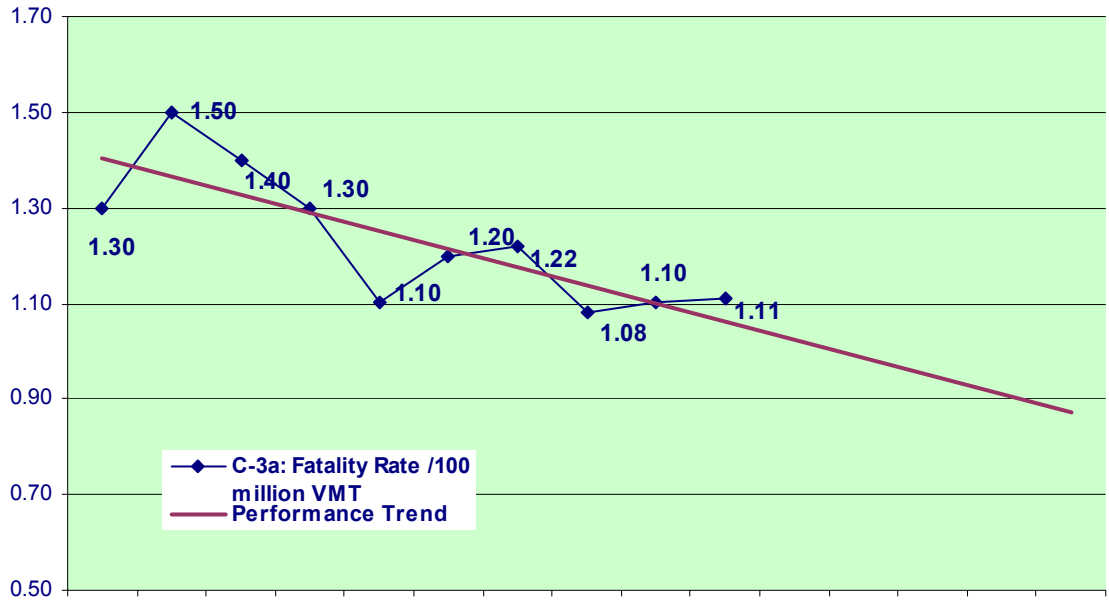

**Goal: C-3b Rural Mileage Death Rate -Reduce 5 year average by 5% by December 2015**  
**Baseline - 5 year average of 1.33 to 1.26**

**Rural Rate**

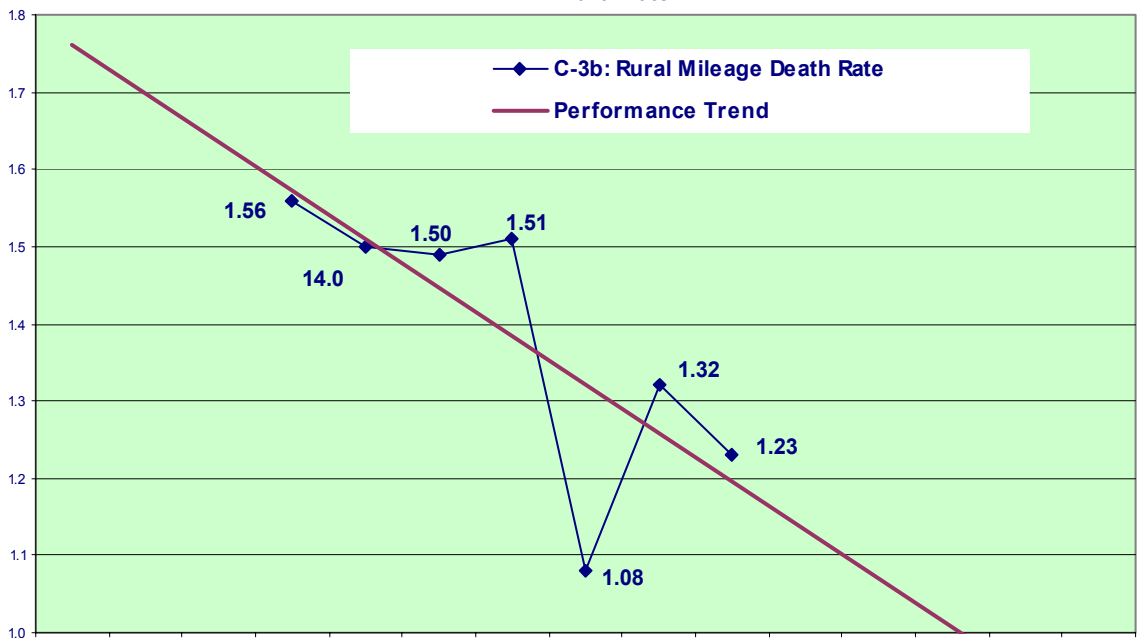



**Goal: C-3c Urban Mileage Death Rate - Reduce 5 year average by 5% by December 2015**

**Baseline - 5 year average of .60 to .57**

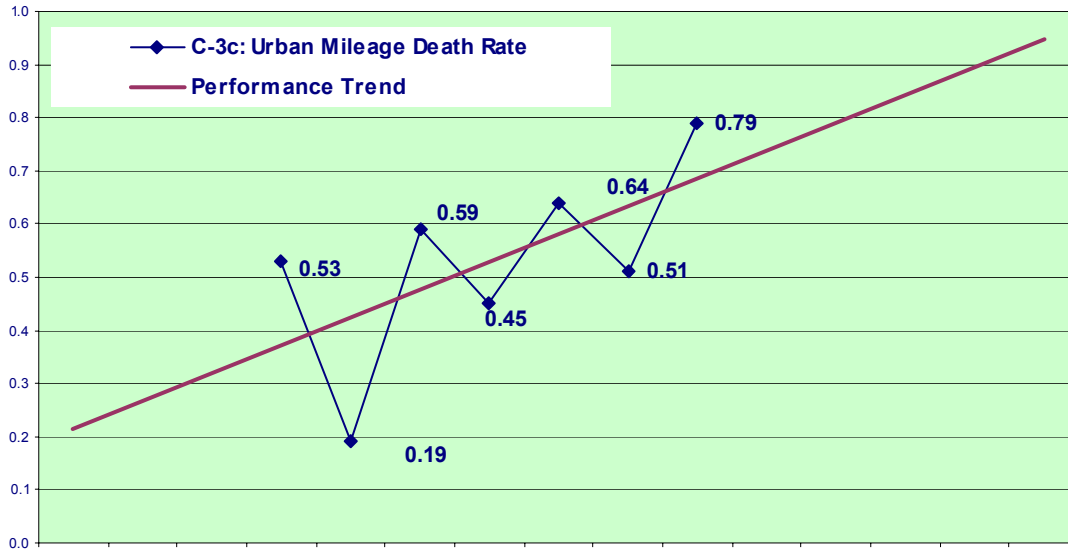

**Goal: C-4 Unrestrained Fatalities - Reduce 5 year average by 5% by December 2015**

**Baseline - 5 year average of 55.4 to 52.6**

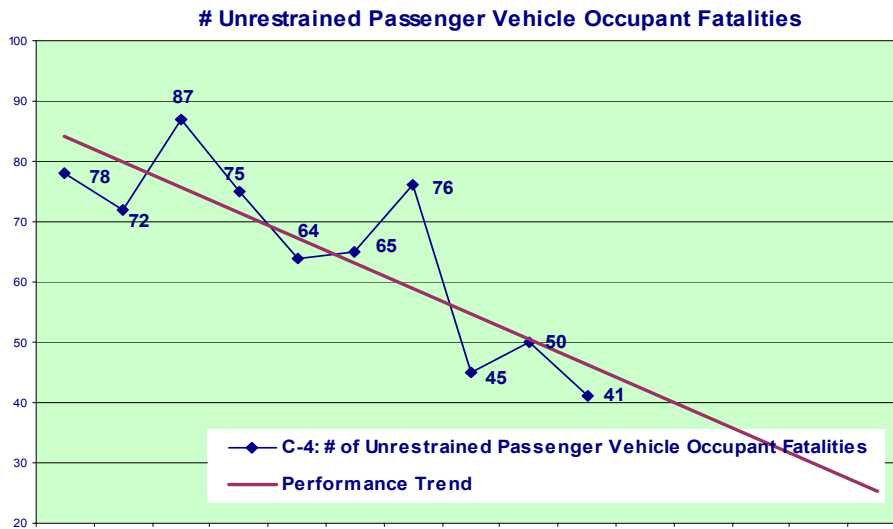

**Goal: C-5 Fatalities at .08 or Above - Reduce 5 year average by 5% by December 2015**  
**Baseline - 5 year average of 45.6 to 43.3**

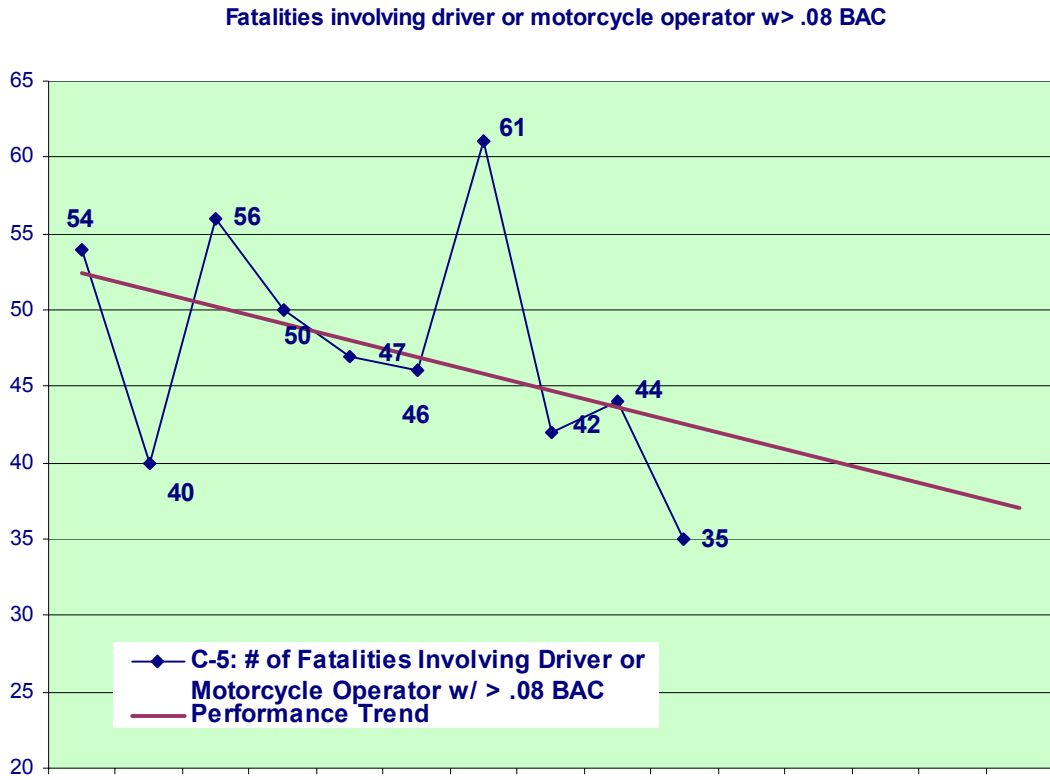

**Goal: C-6 Speeding Related Fatalities - Reduce 5 year average by 5% by December 2015**  
**Baseline - 5 year average of 69.8 to 65.4**

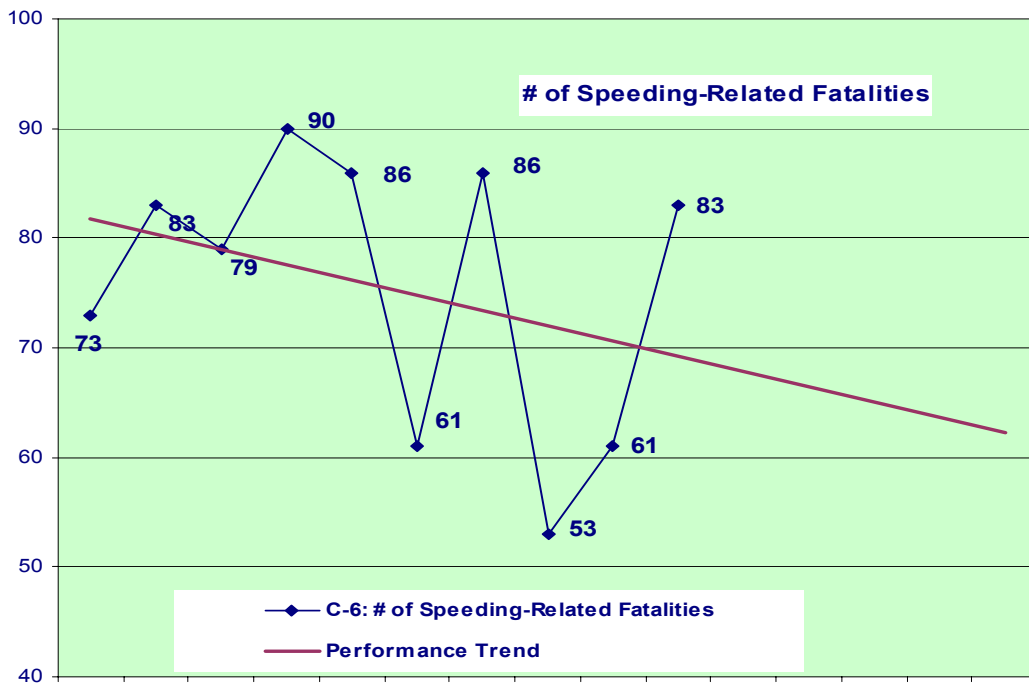

**Goal: C-7 Motorcycle Fatalities - Reduce 5 year average by 5% by December 2015**  
**Baseline - 5 year average of 21 to 20**

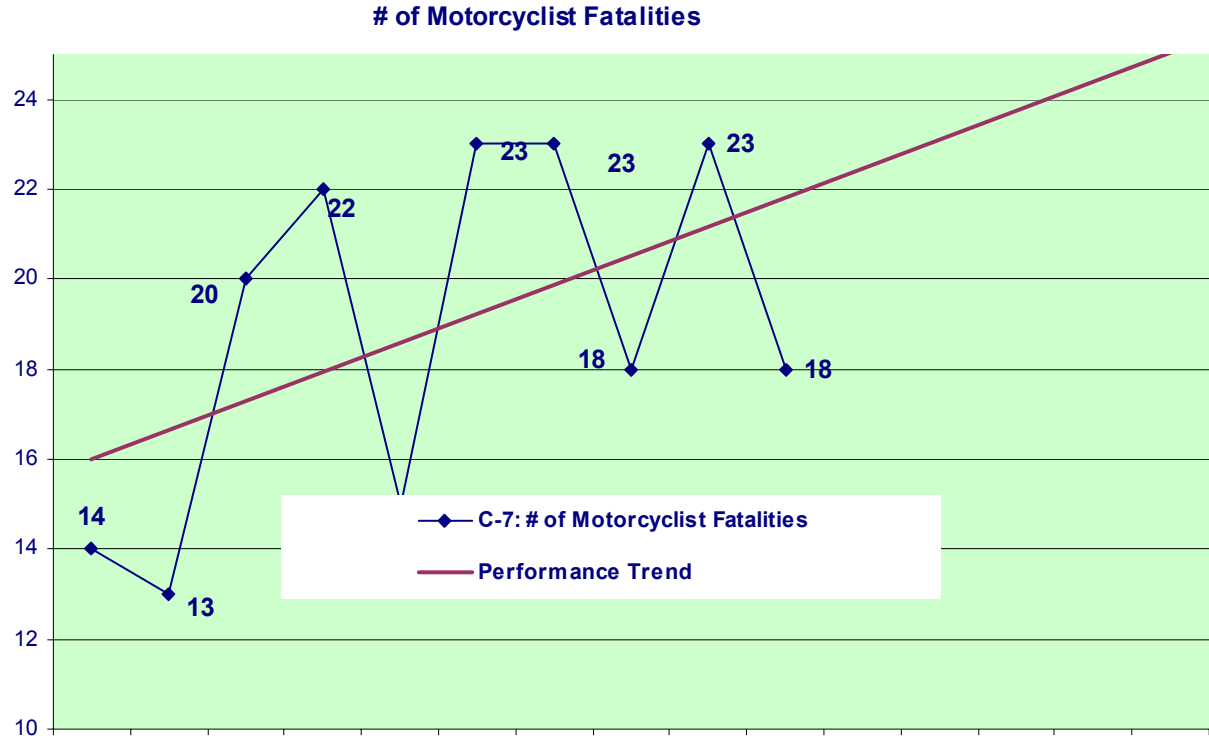

**Goal: C-8 Unhelmeted Motorcyclists - Reduce 5 year average by 5% by December 2015**  
**Baseline - 5 year average of 14.6 to 13.9**

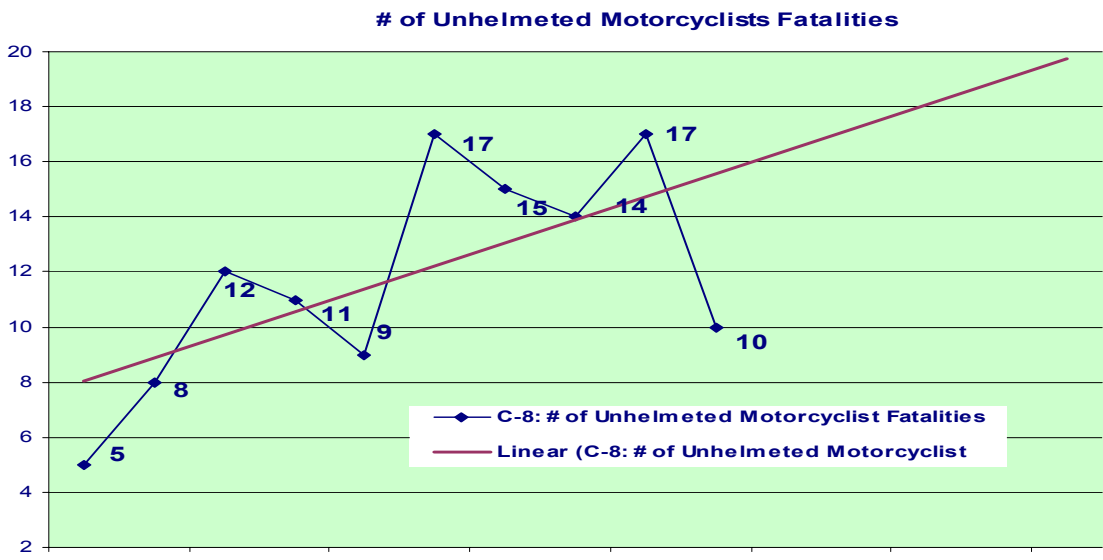

**Goal: C-9 Drivers 20 & Under - Reduce 5 year average by 5% by December 2015**  
**Baseline - 5 year average of 22.2 to 21.1**

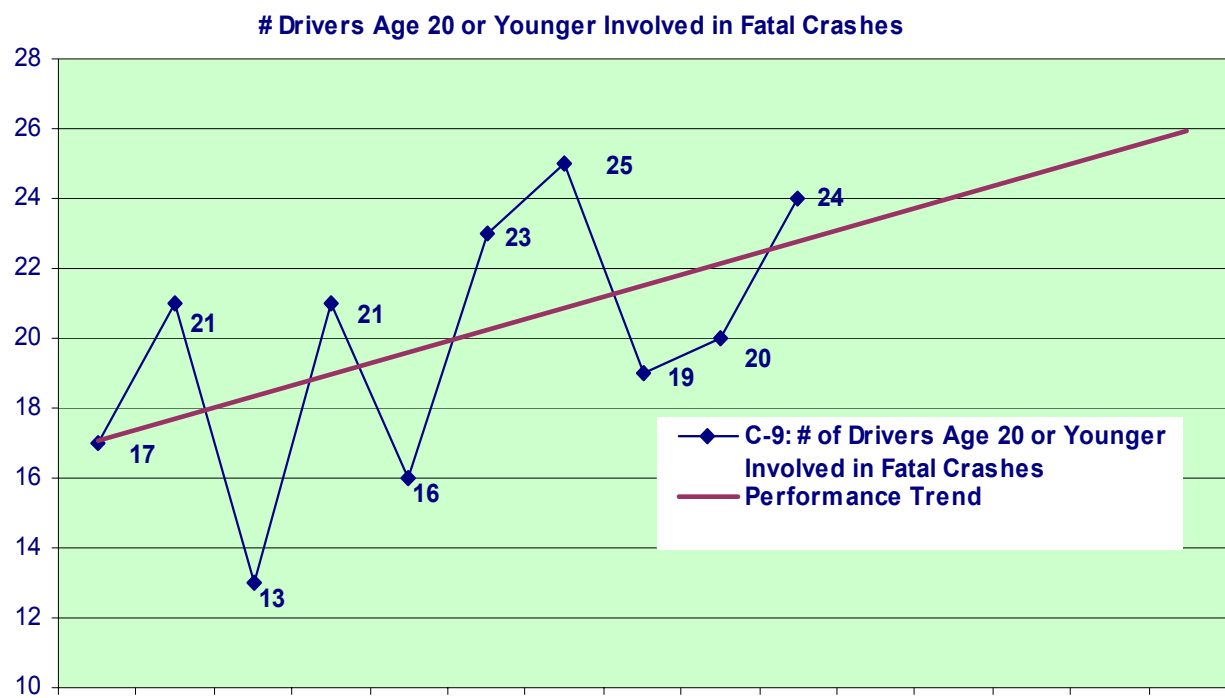

**Goal: C-10: Pedestrian Fatalities - Reduce 5 year average by 10% by December 2015**  
**Baseline - 5 year average of 11 to 10.5**

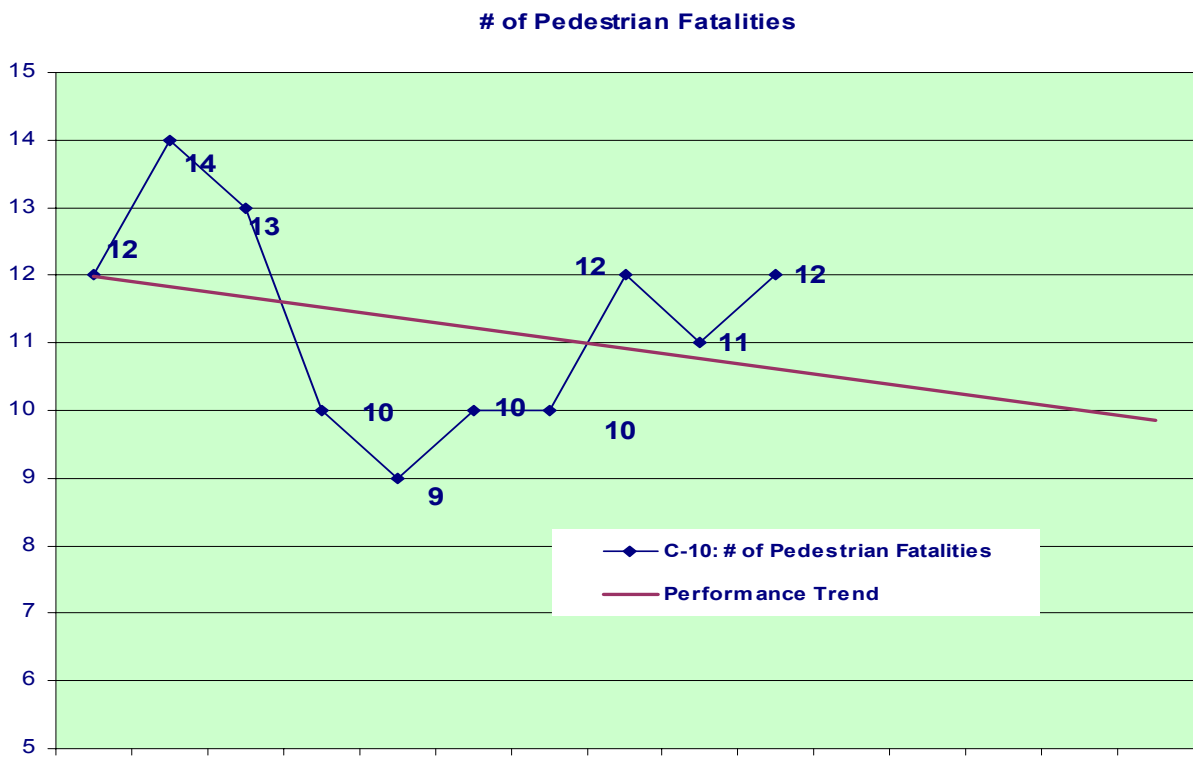

**Goal: B-1: Observed Belt Use - Increase Seat Belt Usage by 2% to 83.63% by December 2015**  
**Baseline - Based on 2010 survey data**

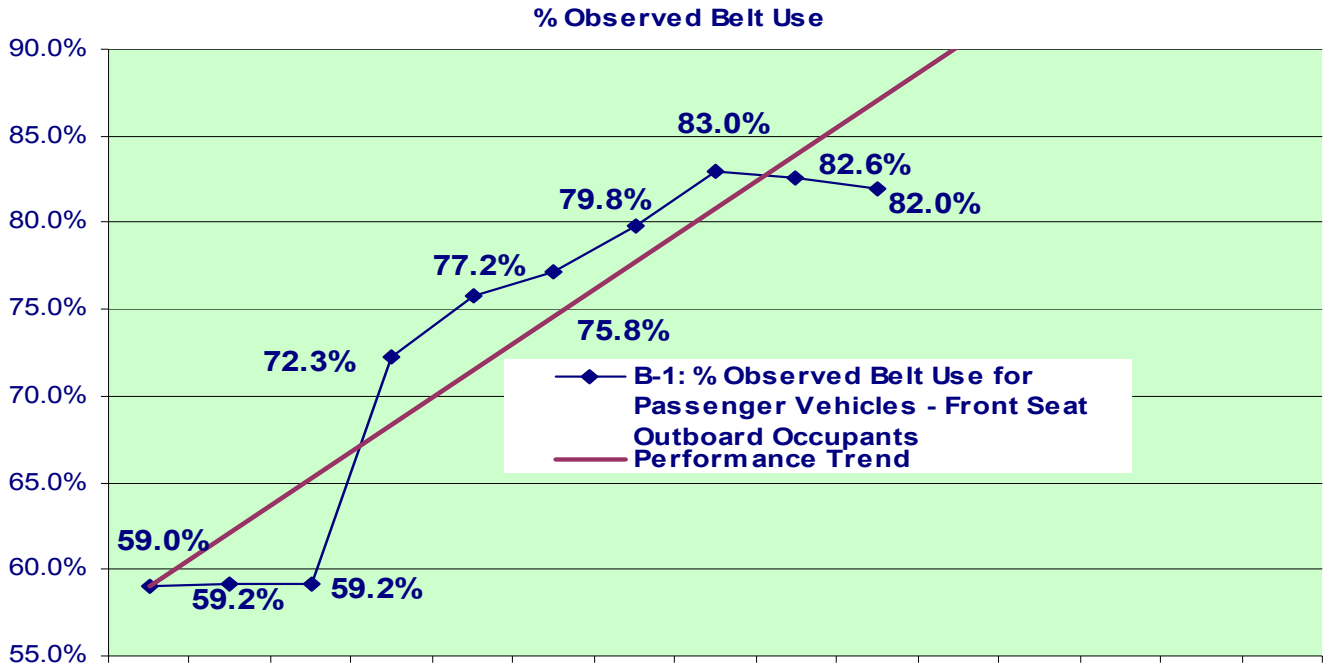

**Goal: A-1: # Seat Belt Citation Monitor**  
**Baseline - 5 year average of 5159**

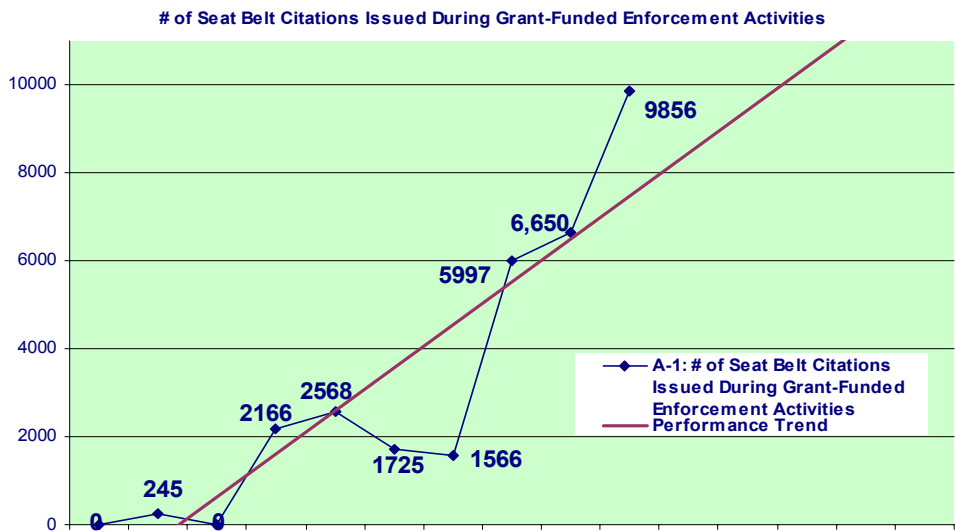

**Goal: A-2: Impaired Driving Arrests - Monitor**

Baseline - 5 year average of 433

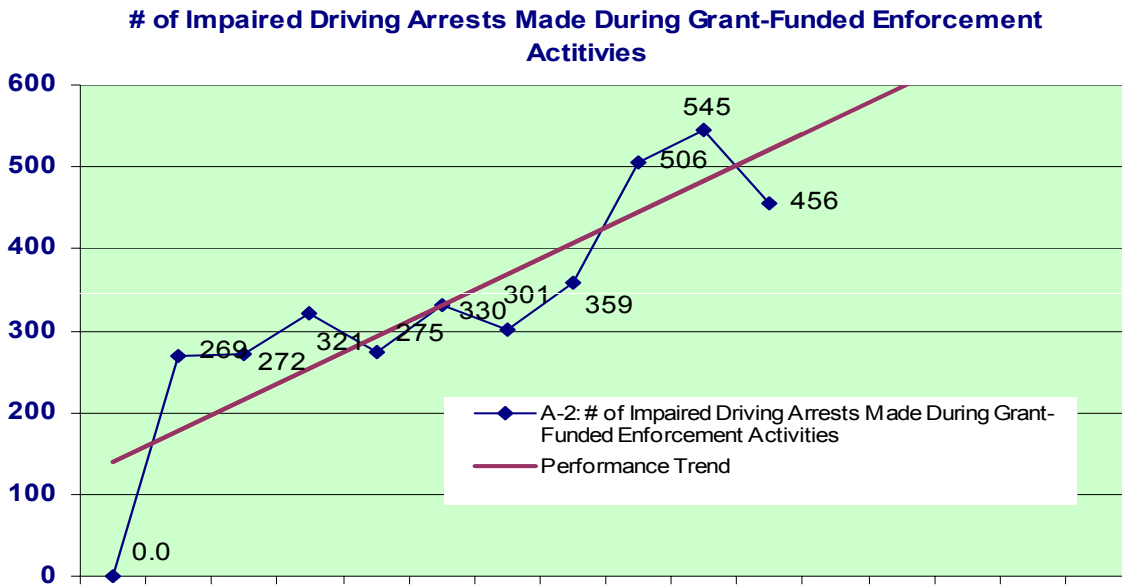

**Goal: A-3: Speeding Citations - Monitor**

Baseline - 5 year average of 5367

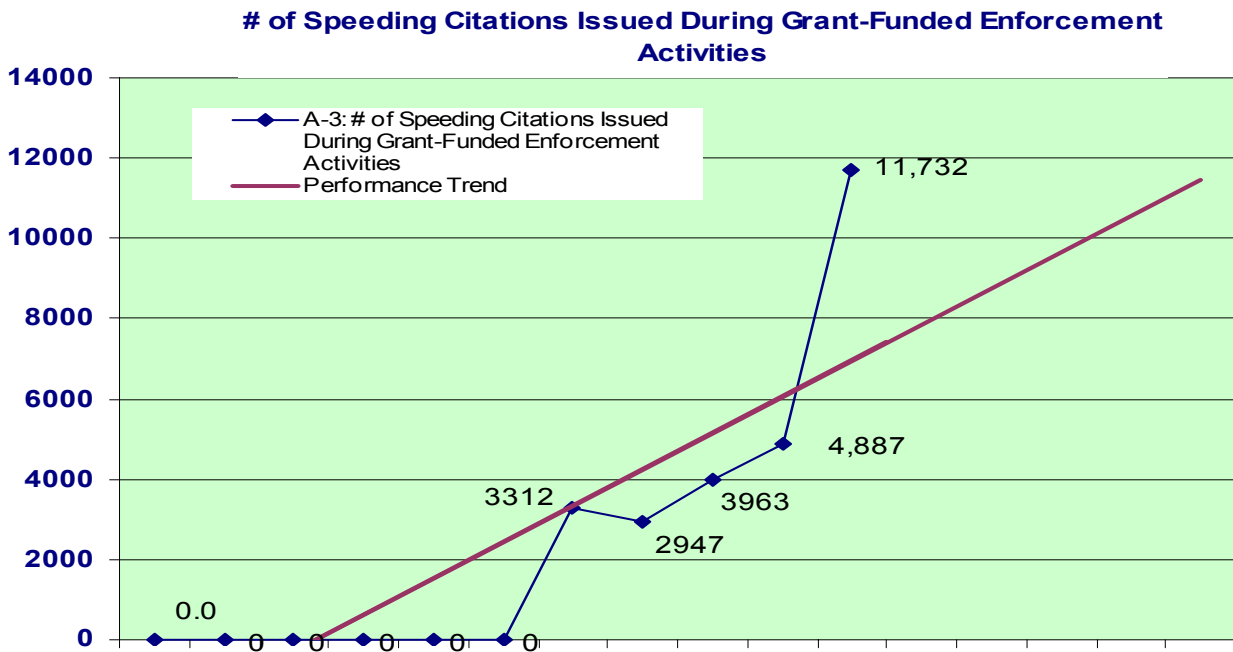

# Charts Provided from Maine's Strategic Highway Safety Plan

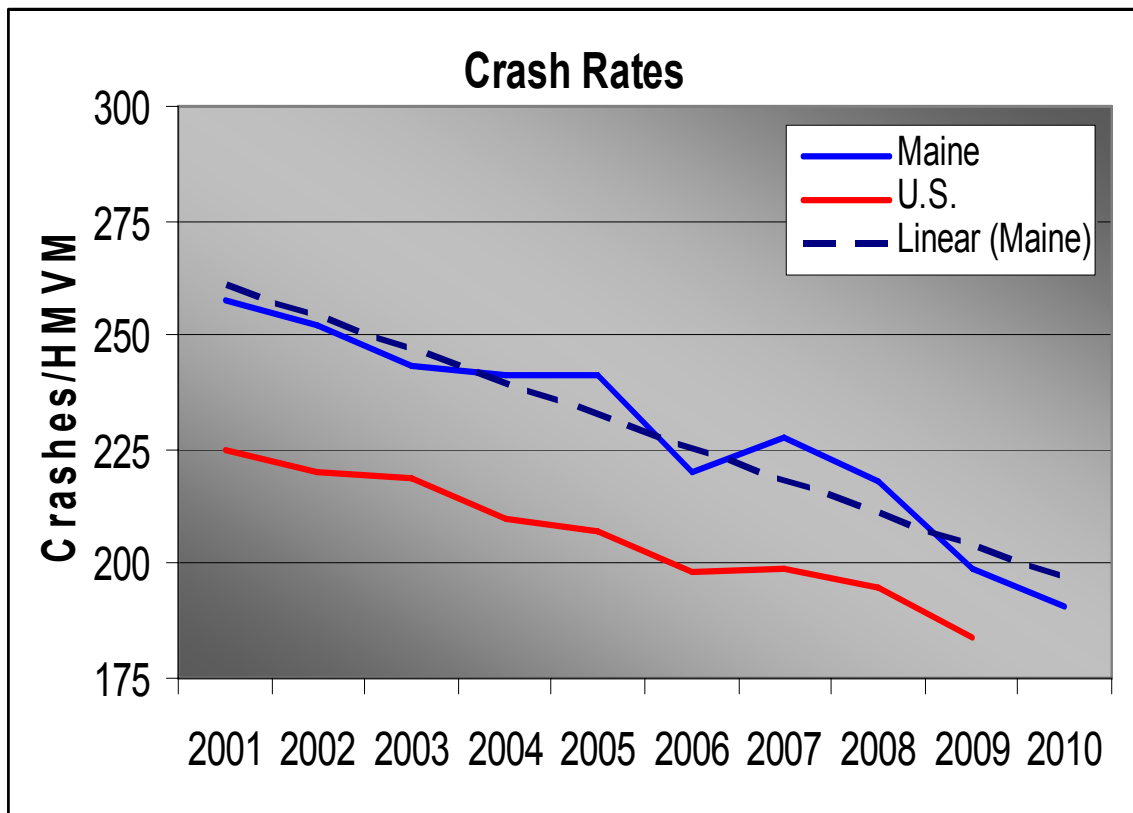
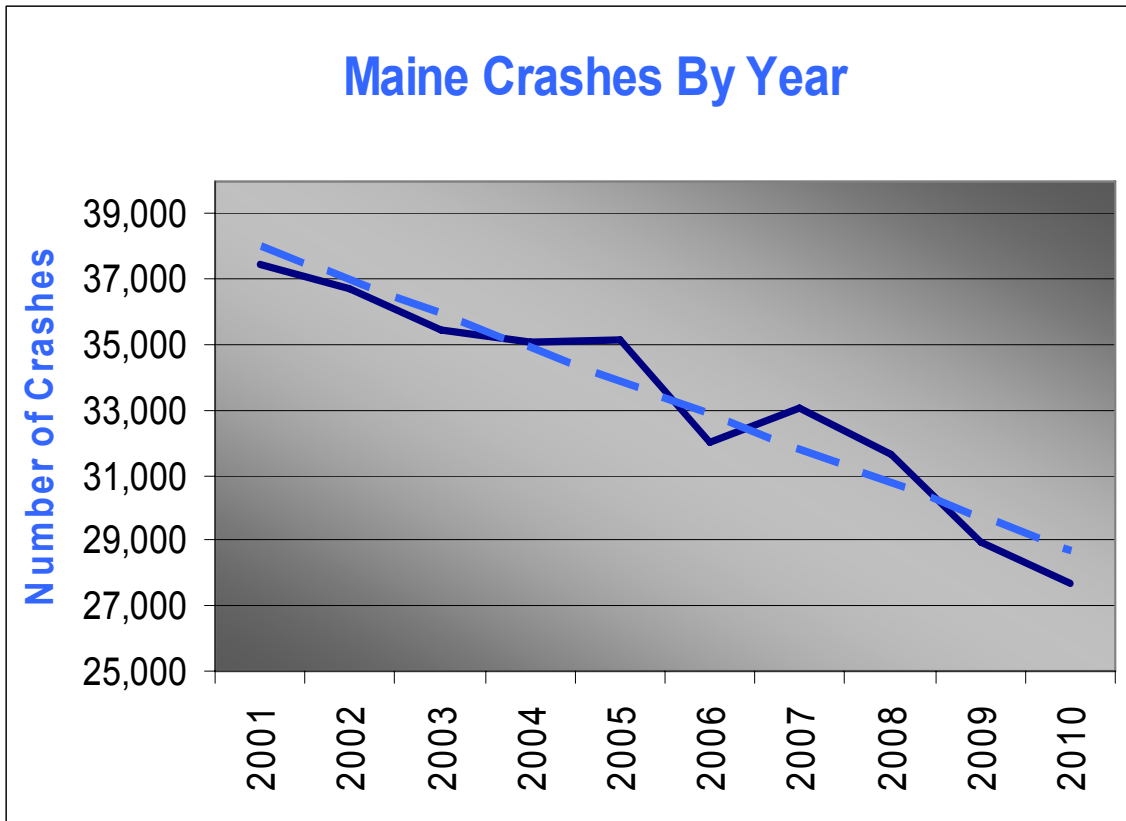

### Maine Lane Departure 2001-2010

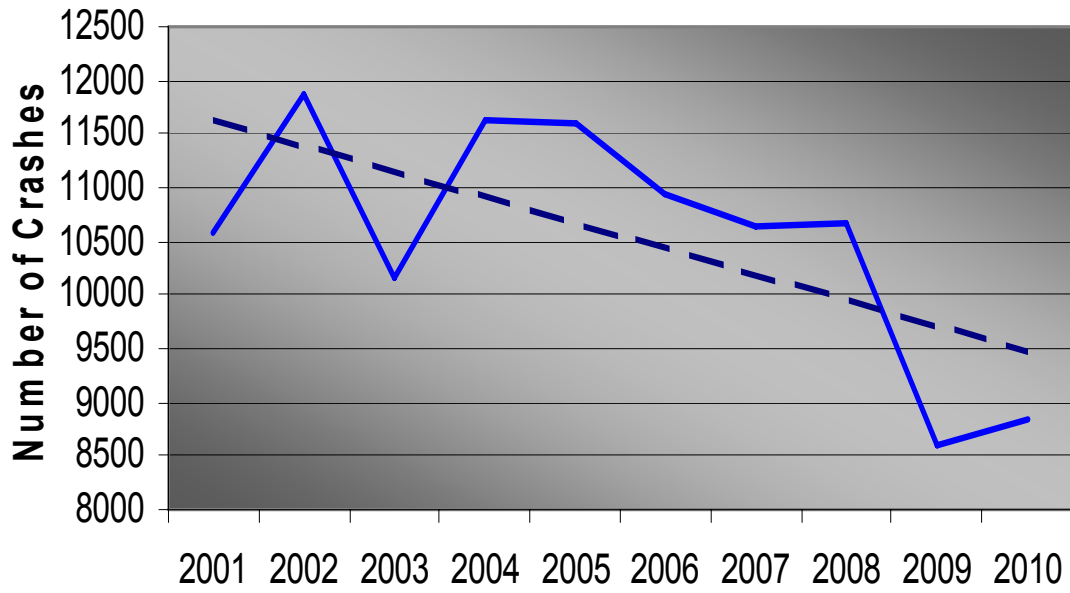

### Maine Lane Departure Fatalities 2001-2010

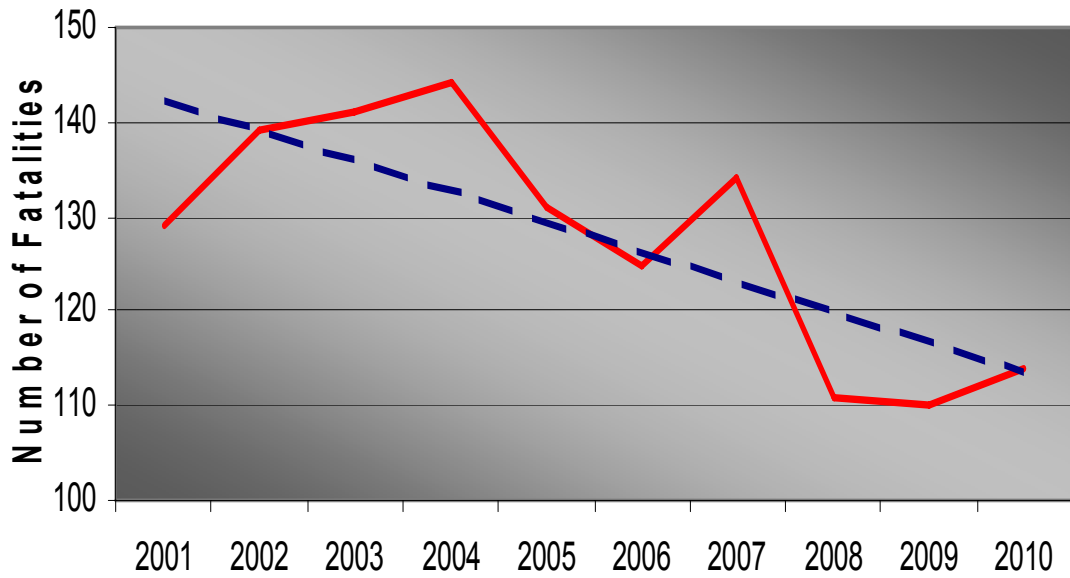



### Illegal/Unsafe Speed Crashes

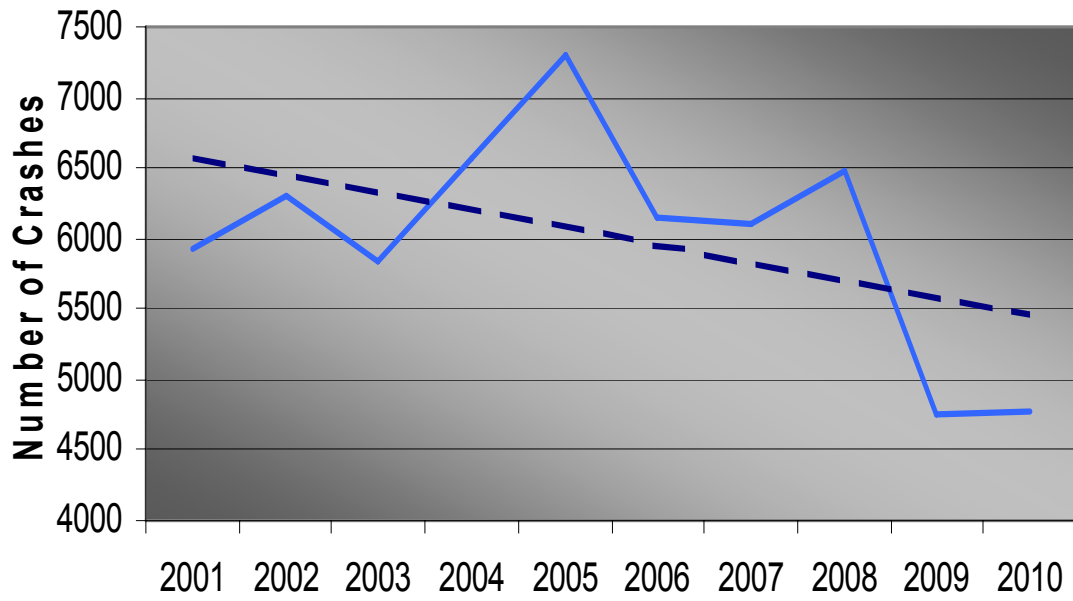

### Illegal/Unsafe Speed Fatalities

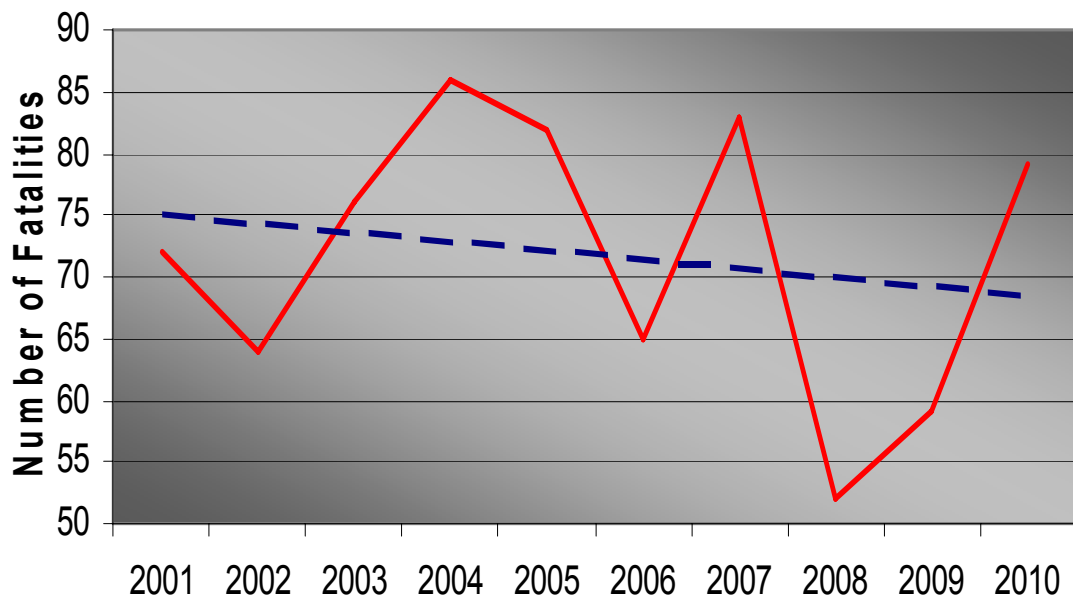

### 16-24 Year Old Driver Crashes

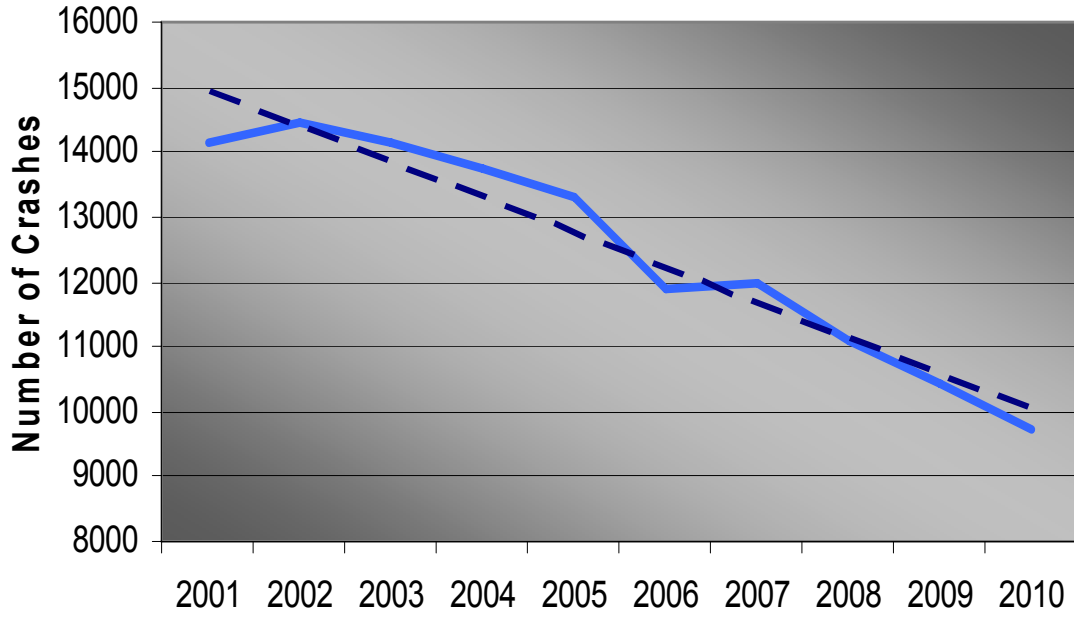

### 16-24 Year Old Fatalities

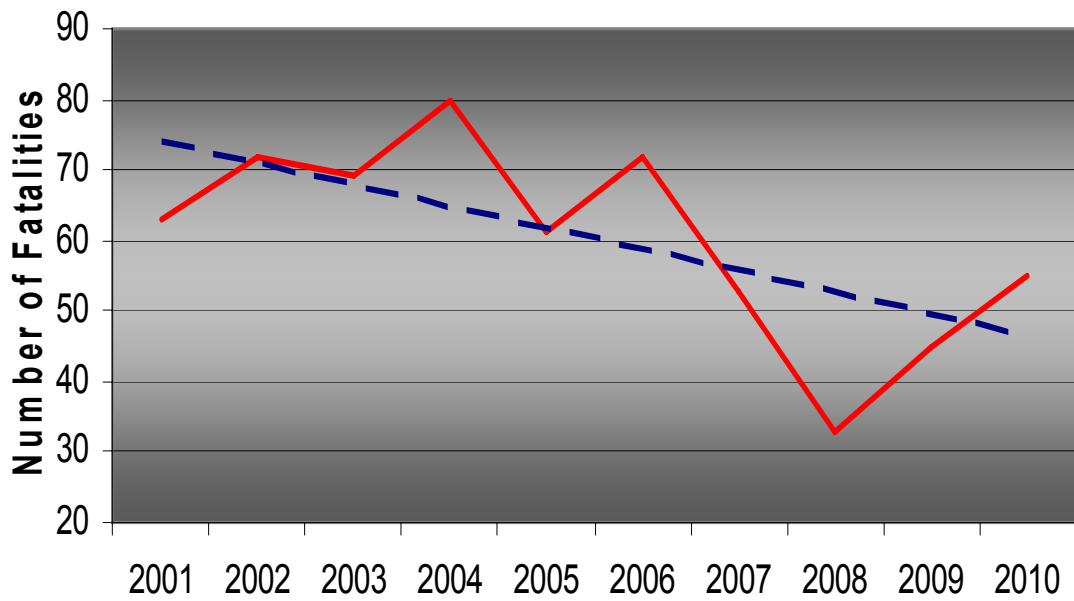

### Impaired Driver Crashes (Alcohol)

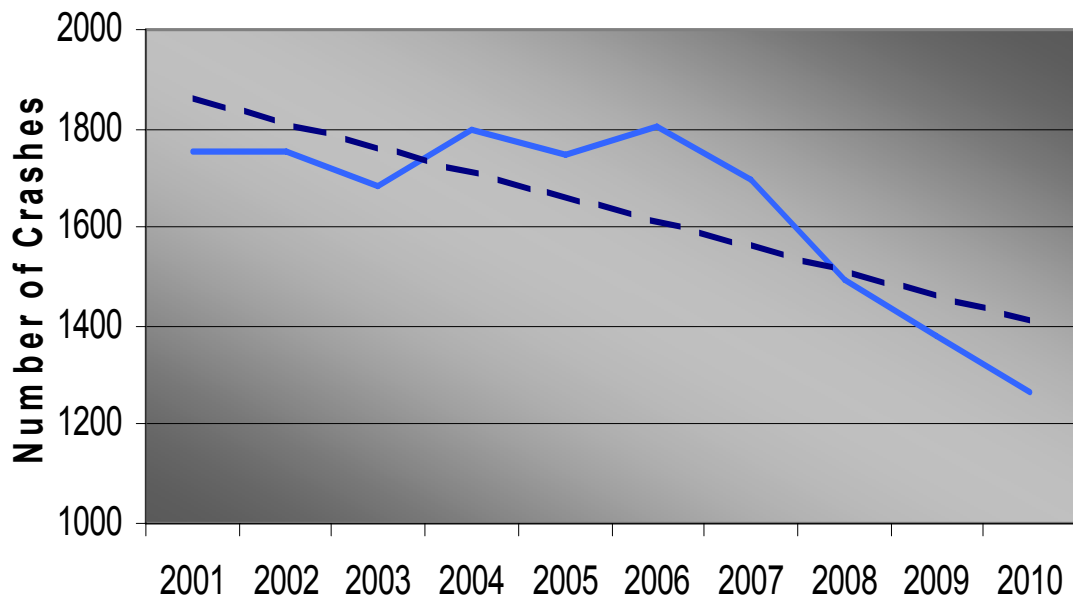

### Impaired Driving Fatalities (Alcohol)

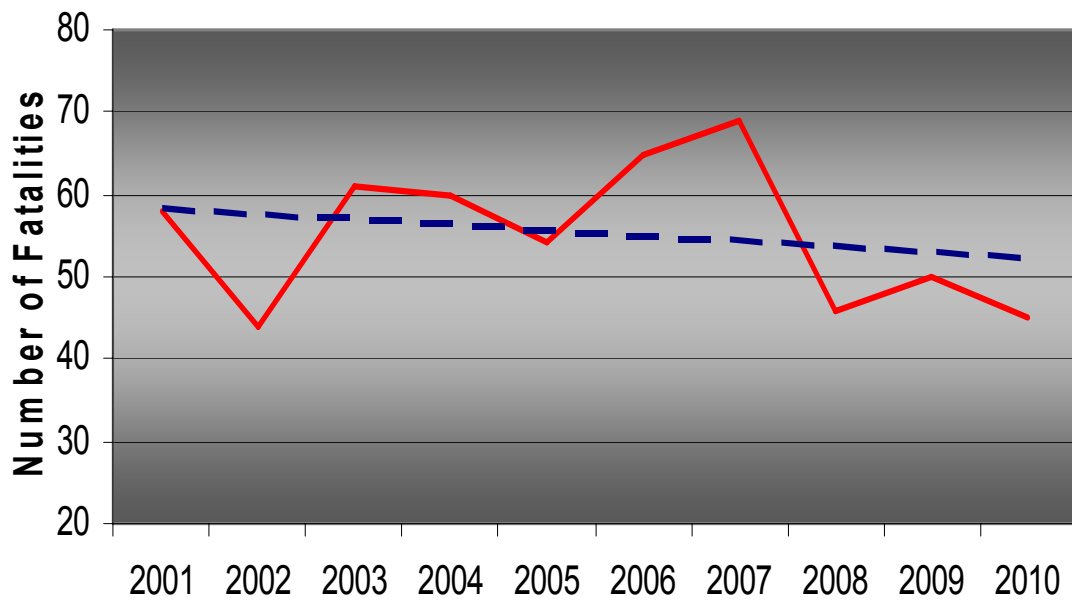

### Distracted Driving Crashes

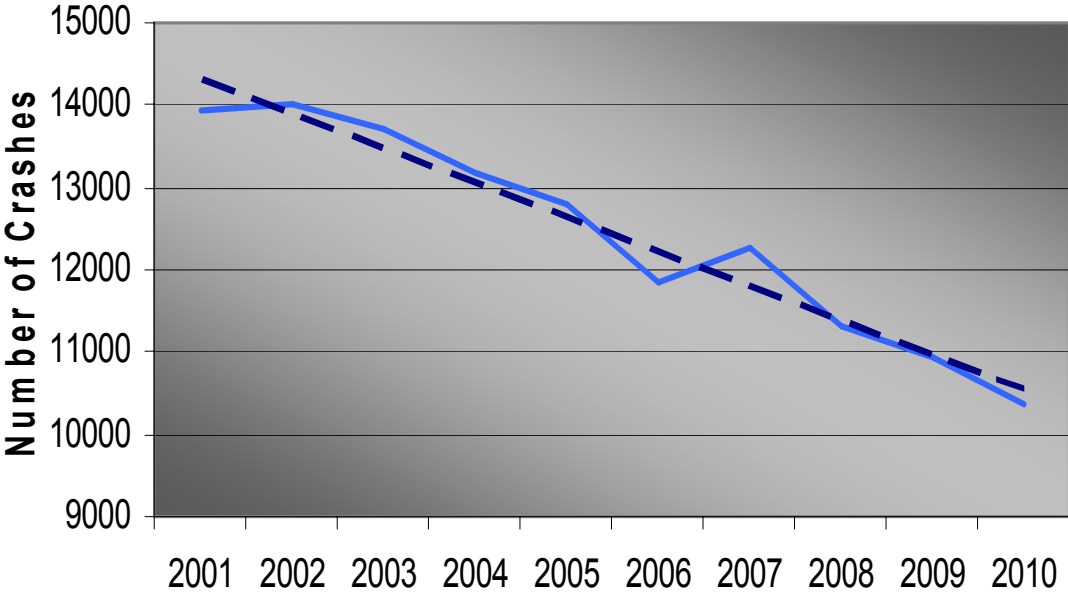

### Distracted Driving Fatalities

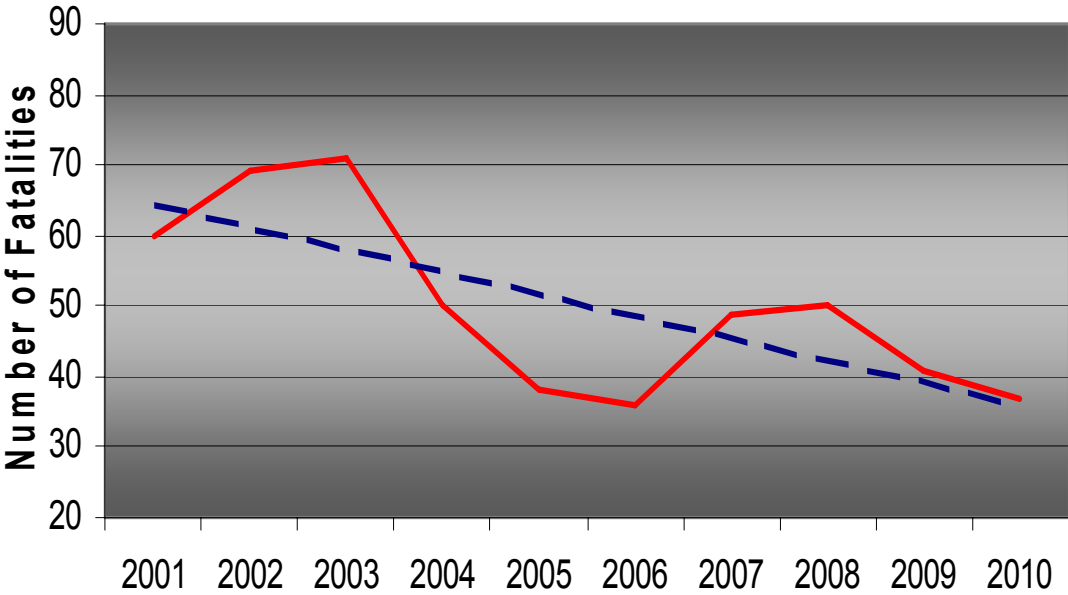

### Mature Driver Crashes (65+)

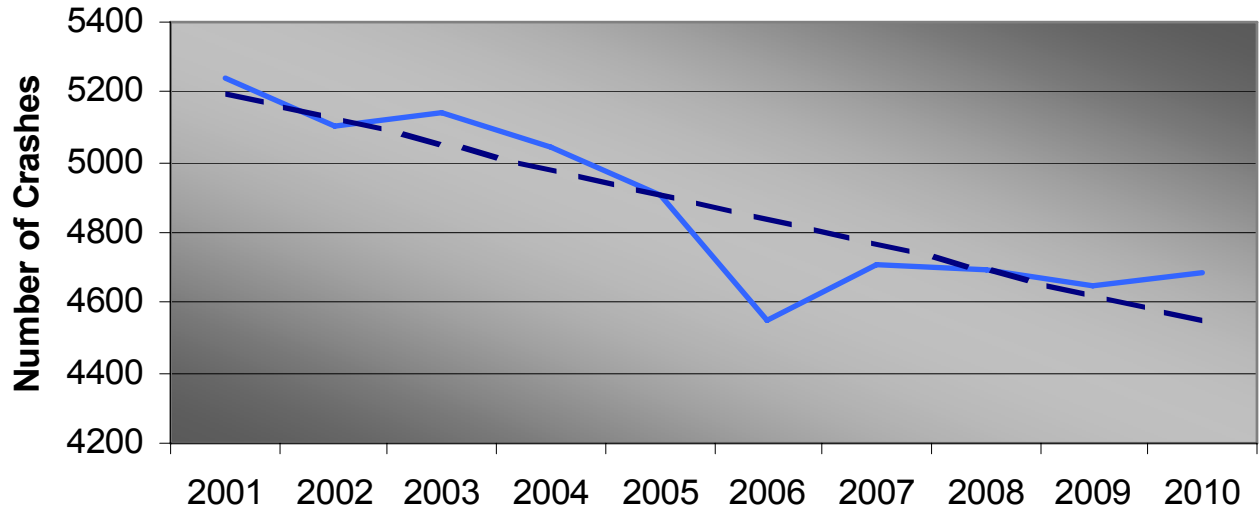

### Mature Fatalities (65+)

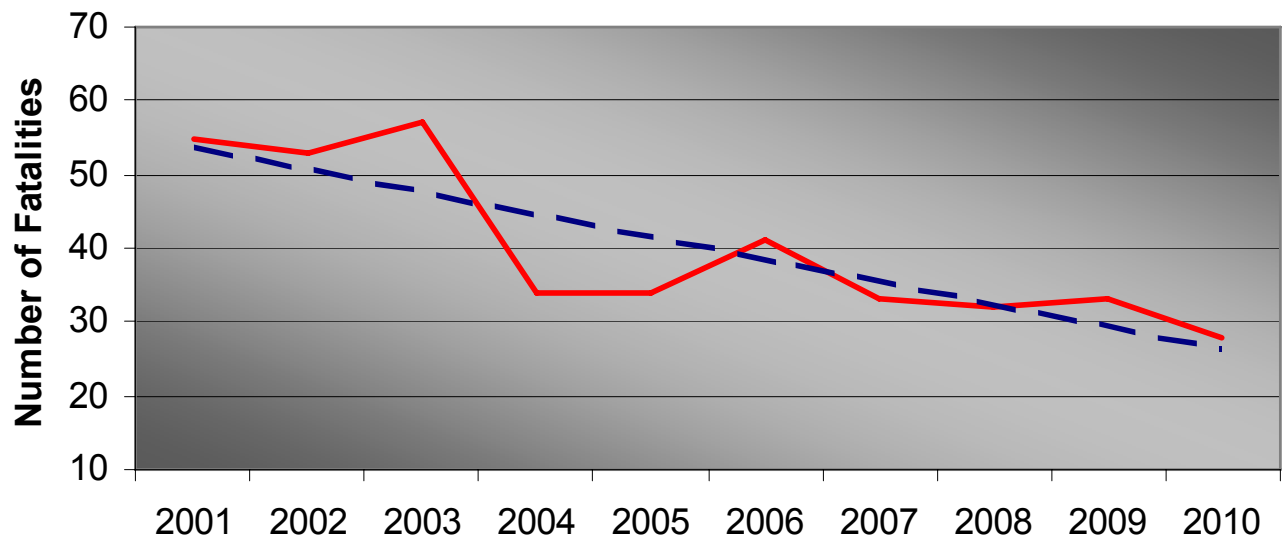

### Motorcycle Crashes

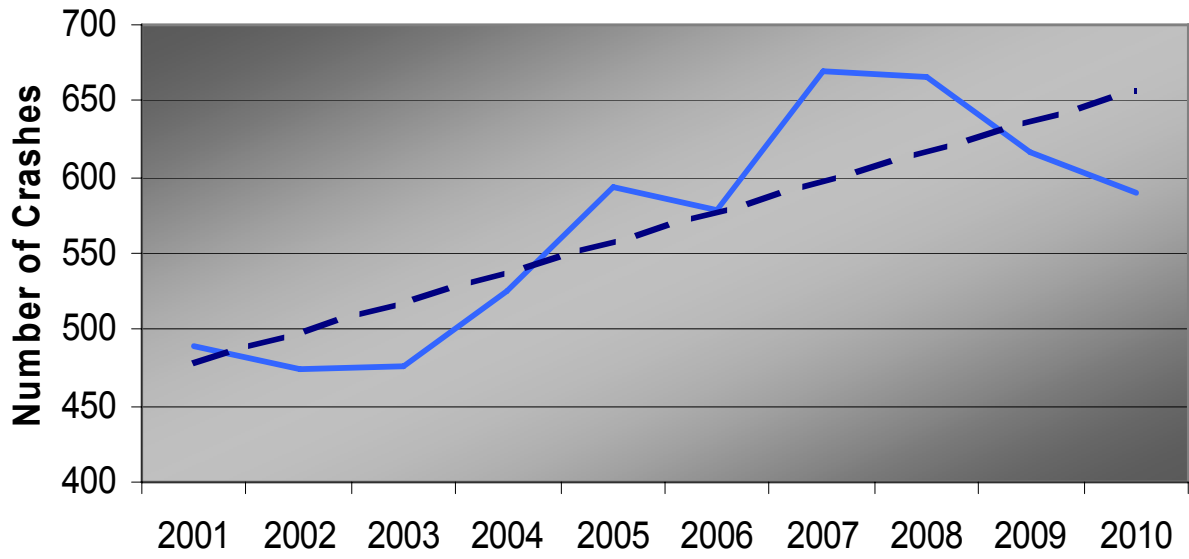

### Motorcycle Fatalities

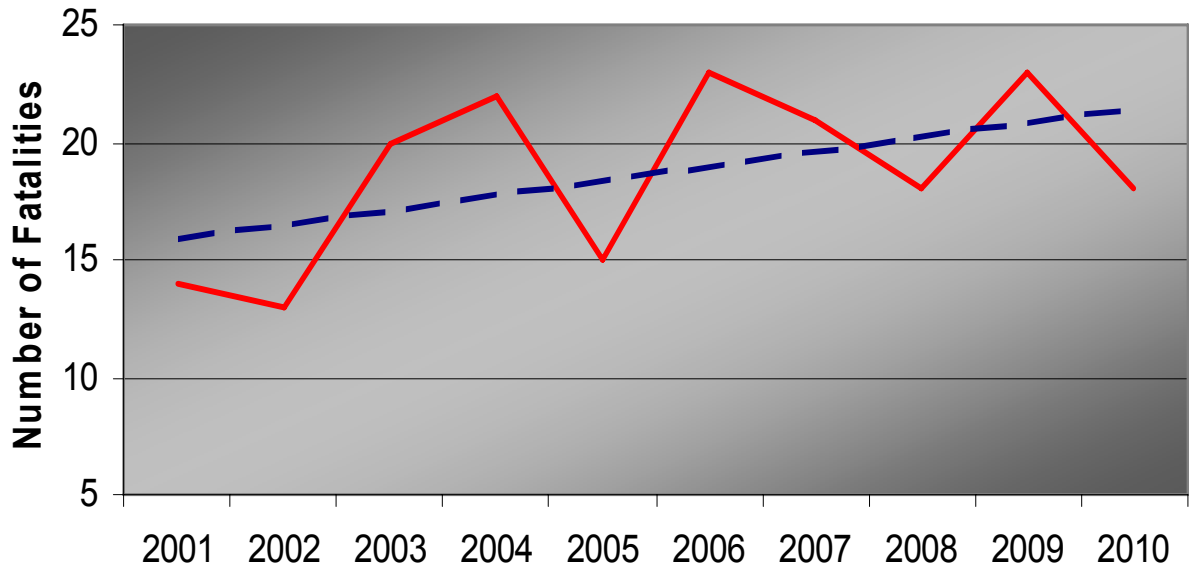

## Problem Identification – Supporting Data

Data Provided by the Maine Department of Transportation

### Alcohol Related Crashes by County 2010

County name	Number of Crashes
Cumberland	286
York	223
Kennebec	111
Penobscot	103
Androscoggin	85
Hancock	71
Aroostook	57
Oxford	56
Somerset	44
Franklin	41
Lincoln	41
Waldo	38
Washington	38
Knox	36
Sagadahoc	32
Piscataquis	7
<b>TOTAL</b>	<b>1269</b>

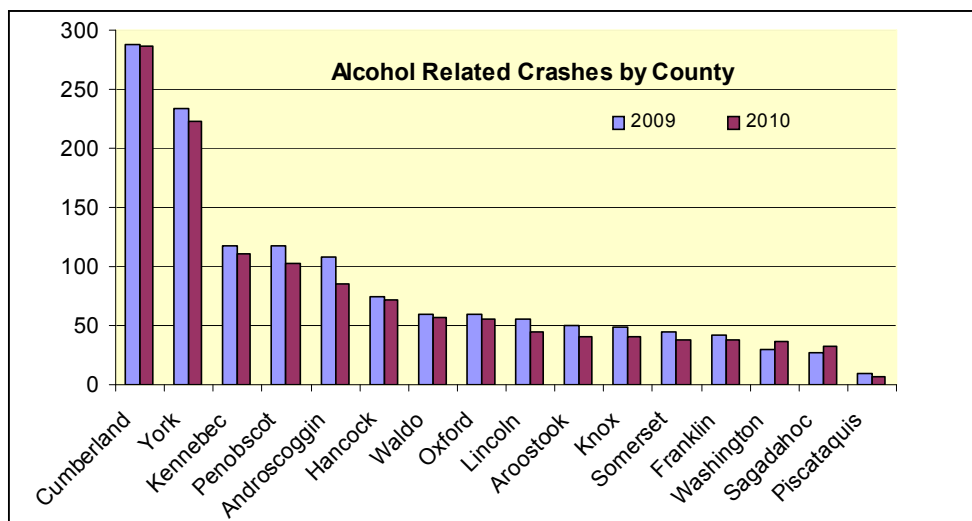

### Alcohol Related Crashes by Time of Day 2010

Hour of day	Number of Crashes
1 am - 2 am	149
9 pm - 10 pm	103
12 am - 1 am	100
11 pm - 12 am	99
10 pm - 11 pm	93
8 pm - 9 pm	87
2 am - 3 am	83
6 pm - 7 pm	83
5 pm - 6 pm	70
7 pm - 8 pm	59
4 pm - 5 pm	55
3 am - 4 am	54
3 pm - 4 pm	45
2 pm - 3 pm	28
4 am to 5 am	26
5 am - 6 am	26
12 pm - 1 pm	21
1 pm to 2 pm	18
10 am - 11 am	17
6 am - 7 am	11
7 am - 8 am	11
8 am - 9 am	11
9 am - 10 am	11
11 am - 12 pm	9
<b>TOTAL</b>	<b>1269</b>

### Alcohol Related Crashes by Day of Week 2010

Day of week	Number of Crashes
SATURDAY	272
SUNDAY	237
FRIDAY	224
THURSDAY	172
WEDNESDAY	125
MONDAY	122
TUESDAY	117
<b>TOTAL</b>	<b>1032</b>

### Alcohol Related Crashes by Age 2010

Driver age	Number of Crashes
21	81
23	73
22	70
24	52
25	47
29	45
28	42
20	39
26	37
27	37
18	35
19	35
39	34
30	31
32	30
40	30
31	27
37	27
43	27
47	26
38	25
51	24
36	23
46	23
33	21
49	21
34	20
17	19
45	19
53	19
35	18
50	18
42	16
44	16
41	15
48	15
52	15
56	14
55	11
54	10
63	9
64	8
60	7
57	6
59	6
65	6
58	5
61	5

Driver age	Number of Crashes
16	4
66	4
71	4
62	3
68	3
69	3
15	2
70	2
73	2
77	2
82	2
14	1
72	1
74	1
75	1
80	1
81	1
83	1
86	1
<b>TOTAL</b>	<b>1278</b>

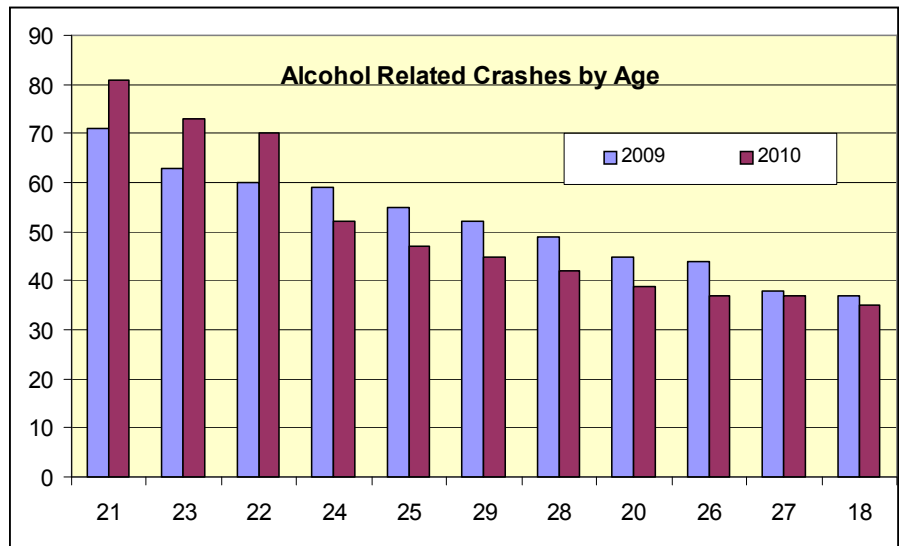



**Speed Related Crashes  
by County  
2010**

County name	Number of Crashes
Cumberland	840
Penobscot	593
York	555
Kennebec	549
Androscoggin	342
Somerset	277
Oxford	268
Hancock	245
Aroostook	205
Franklin	200
Waldo	193
Washington	166
Sagadahoc	113
Knox	109
Lincoln	109
Piscataquis	34
<b>TOTAL</b>	<b>4798</b>

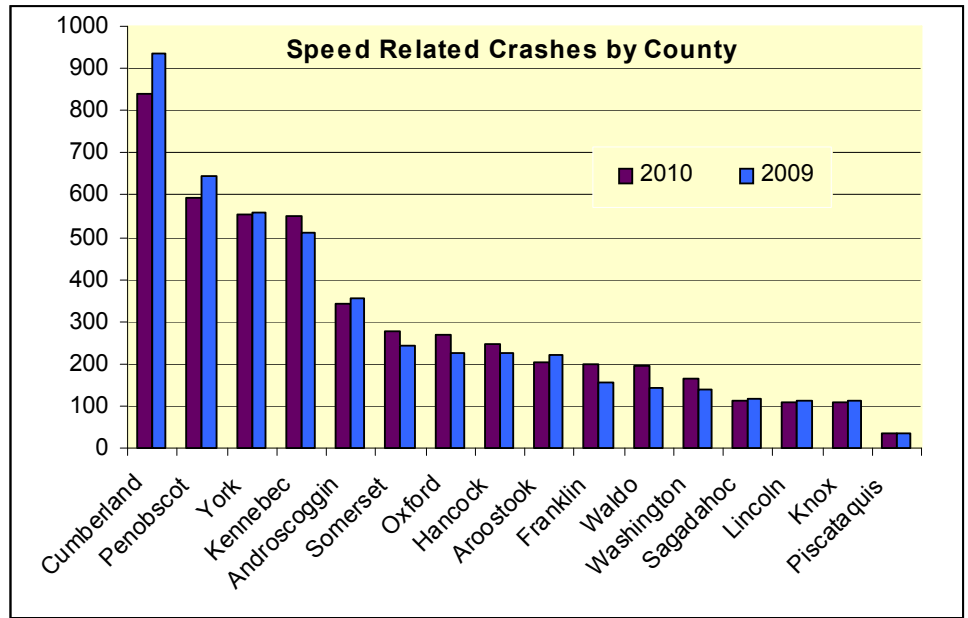

**Speed Related Crashes  
by Time of Day  
2010**

**Speed Related Crashes  
by Day of Week  
2010**

Day of Week	Number of Crashes
MONDAY	803
FRIDAY	784
WEDNESDAY	739
SATURDAY	672
TUESDAY	622
THURSDAY	621
SUNDAY	559
<b>TOTAL</b>	<b>4241</b>

Hour of day	Number of Crashes
5 pm - 6 pm	353
4 pm - 5 pm	325
7 am - 8 am	316
3 pm - 4 pm	297
6 pm - 7 pm	268
8 am - 9 am	264
12 pm - 1 pm	247
2 pm - 3 pm	247
1 pm to 2 pm	220
9 am - 10 am	214
11 am - 12 pm	214
8 pm - 9 pm	212
6 am - 7 am	198
10 am - 11 am	194
9 pm - 10 pm	190
7 pm - 8 pm	174
11 pm - 12 am	156
10 pm - 11 pm	150
1 am - 2 am	124
12 am - 1 am	123
5 am - 6 am	112
2 am - 3 am	80
3 am - 4 am	66
4am - 5 am	56
<b>TOTAL</b>	<b>4800</b>

### Speed Related Crashes by Driver Age 2010

Driver age	Number of Crashes
18	299
17	243
19	241
20	238
21	224
22	175
23	174
16	171
26	145
25	143
24	142
29	125
28	118
27	116
30	108
32	83
45	82
31	81
50	76
38	74
34	73
35	72
39	72
40	71
41	67
37	66
46	64
47	64
44	63
48	62
42	61
43	60
49	59
51	59
55	58
36	56
52	55
33	52
54	51
57	49
53	47
56	42
60	38
63	35
59	34
62	31

Driver age	Number of Crashes
58	30
61	30
67	25
65	24
66	23
69	22
64	21
70	17
71	16
68	14
75	13
73	12
15	10
79	10
77	8
72	7
74	6
76	6
82	5
78	4
83	4
85	4
86	4
80	3
84	3
87	2
14	1
<b>TOTAL</b>	<b>4843</b>

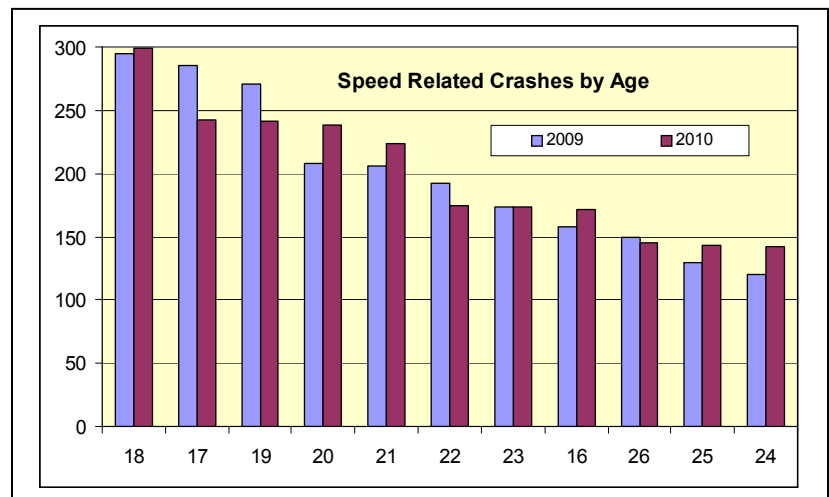

## **Section 402 Funded Countermeasures**

### **Planning and Administration Program Area**

**Project Number:** 2012-12PA

**Project Title:** MeBHS 402 P&A

**Project Description:** Funds will support a portion of the costs associated with the administration of the state highway safety office and highway safety plan performance goals. Costs include salaries, operational costs and expenses, training, travel, dues and necessary highway safety system accounting upgrades.

**Project Cost:** \$458,000.00

---

### **Paid Media Program Area**

**Project Number:** 2012-12PM

**Project Title:** Paid Media to support national crackdowns and other highway safety countermeasures.

**Project Description:** Funds will support the development plan, retagging (of other states PSAs) and purchase of radio, TV and print media that support all areas of program approved traffic safety countermeasures, but that specifically include education and high visibility enforcement for Maine's priority traffic safety areas (seat belt, impaired driving, child passenger safety, speed, teen driving and distractions).

**Project Cost:** \$100,000.00

---

### **Occupant Protection Program Area**

**Project Number:** 2012-12OP

**Project Title:** Occupant Protection Program Management

**Project Description:** Costs associated with public information, education, procurement and distribution of printed materials and promotional information, attendance of MeBHS employees and representatives at trainings, conferences and workshops for Occupant Protection.

**Project Cost:** \$150,000.00

---

**Project Number:** 2012-12OP

**Project Title:** Seat Belt Education Position

**Project Description:** This full-time position allows for seat belt education and outreach to individuals of all ages through the use of convincer and roll-over simulator demonstrations and public presentations. This program reaches thousands of Maine citizens each year and provides education to all Maine school grades K-12, private business and state agencies. This position has been filled by a Request for Proposal and contract process.

**Project Cost:** \$100,000.00

---

**Project Number:** 2012-12OP

**Project Title:** Convincer, Rollover, and CPS Trailer Operations & Maintenance

**Project Description:** Costs associated with the use, purchase, and maintenance of highway safety vehicles and equipment. *No equipment in excess of \$5K will be purchased without express approval in writing by NHTSA.*

**Project Cost:** \$50,000.00

---

**Project Number:** 2012-12OP

**Project Title:** CIOT HVE Campaigns (May and November)

**Project Description:** Funds will support dedicated overtime costs associated with daytime and nighttime enforcement and education for the 2012 NHTSA May and November CIOT HVE Campaigns.

**Project Cost:** \$400,000.00

---

**Project Number:** 2012-12OP

**Project Title:** Annual Observational Seat Belt Usage Survey including new methodology

**Project Description:** Funds will support the sole service contract with the University of Southern Maine, Muskie Research Center for the MeBHS annual observational and attitudinal surveys including reporting and redesign based on NHTSA requirements.

**Project Cost:** \$200,000.00

---

**Project Number:** 2012-12OP

**Project Title:** Occupant Protection Minority Outreach Efforts

**Project Description:** Costs associated with promoting a dedicated outreach program to educate Maine minority populations regarding the benefits of using seat belts and child restraints. Projects with organizations such as the Catholic Charities of Maine, Maine Department of Labor and Multi-Cultural Affairs and others may include print materials and paid media as well as in-school education.

**Project Cost:** \$100,000.00

---

**Project Number:** 2012-12OP

**Project Title:** CIOT Incentive Equipment

**Project Description:** Funds will support the purchase of traffic safety related equipment as an incentive program to encourage increased law enforcement participation in the May and November CIOT campaigns. Equipment may include traffic safety items such as radar detectors, LED lights, cones, etc. No items in excess of \$5,000.00 will be purchased without prior approval from NHTSA.

**Project Cost:** \$150,000.00

---

### **Alcohol and Impaired Driving Program Area**

**Project Number:** 2012-12AL

**Project Title:** Impaired Driving Program Management

**Project Description:** Funding will support attendance of MeBHS employees at trainings, conferences, and workshops for Impaired Driving. Funds will also support public information and education materials.

**Project Cost:** \$150,000.00

---

**Project Number:** 2012-12AL

**Project Title:** Impaired Driving HVE Campaigns

**Project Description:** Funding for this project will support overtime for law enforcement to participate in impaired driving enforcement details and checkpoints for both motor vehicles and motorcycles during the December 2011 and August 2012 National HVE Enforcement and Education Programs.

**Project Cost:** \$500,000.00

---

**Project Number:** 2012-12AL

**Project Title:** Educational Partnership with Colleges and Universities and Underage Drinking Projects related to Highway Safety

**Project Description:** funds will support a partnered impaired driving and alcohol educational program consisting of demonstrations, discussion and materials. The program is a partnership between the BHS, OSA, law enforcement and colleges and universities designed mostly for incoming freshman and parents/caregivers.

**Project Cost:** \$50,000.00

---

**Project Number:** 2012-12AL

**Project Title:** Regional Impaired Driving Task Force-Pilot Project

**Project Description:** funds will support overtime and equipment necessary to implement a pilot project to organize a Regional Impaired Driving Enforcement Team (RIDE). The pilot will run for 6-8 months, and include numerous checkpoint and saturation patrol details in a variety of location within a county. Locations of details will be determined by crash and fatal data analysis.

**Project Cost:** \$100,000.00

---

### **Emergency Medical Services Program Area**

**Project Number:** 2012-12EM

**Project Title:** Transporting Children in Ambulances Training Materials

**Project Description:** These funds will support the efforts of the EMS community in training and equipment necessary to transport children safely in ambulances as defined in the State Strategic Highway Safety Plan.

**Project Cost:** \$10,000.00

---

### **Traffic Records Program Area**

**Project Number:** 2012-12TR

**Project Title:** Traffic Records Program Management

**Project Description:** Funds will support MeBHS employees at meetings, trainings and workshops associated with Traffic Records as well as program management. In addition, funds will support a contract position to provide technical assistance related to the Bureau HSP data needs, the TR data projects and the Maine Crash Reporting System, and to the MeBHS website. This position will result from an RFP.

**Project Cost:** \$50,000.00

---

**Project Number:** 2012-12TR

**Project Title:** Reporting/Studies Product from CODES project

**Project Description:** These funds will support costs associated with a Maine CDD/CODES study or report on a highway safety identified problem or issue. Previous studies have been done for motorcycle, speed and older driver crashes and fatalities.

**Project Cost:** \$50,000.00

---

**Project Number:** 2012-12TR

**Project Title:** Traffic Records – Data Analyst Position or contract

**Project Description:** These funds will support costs associated with a full time data analyst for the Bureau. Duties will include studying and analyzing all of the states available data for crashes, fatalities, locations, EMS run information, CODES, DDACTS, etc. This position will participate in Traffic Records, CODES, EMS and other data related meetings and will be responsible for the Bureau’s databases, HSP analysis, etc. This position must be filled through the State RFP and contracting process. (See also S. 408)

**Project Cost:** \$100,000.00

---

### **Police Traffic Services Program Area**

**Project Number:** 2012-12PT

**Project Title:** Equipment Procurement (individual items under \$5,000.00)

**Project Description:** Funds will support law enforcement in the procurement of various traffic enforcement equipment and other tools necessary to enforce Maine’s traffic laws. Equipment can include items such as radars, video cameras, portable printers and other items necessary for traffic enforcement. *No equipment in excess of \$5k will be purchased without approval in writing by NHTSA.*

**Project Cost:** \$650,000.00

---

**Project Number:** 2012-12PT

**Project Title:** PTS Program Management

**Project Description:** Funds will support public information, education, procurement and distribution of printed materials and promotional information items, attendance of MeBHS employees at trainings, conferences and workshops.

**Budget:** \$100,000.00

---

**Project Number:** 2012-12PT

**Project Title:** MSP, Local & County Law Enforcement Speed Enforcement

**Project Description:** Funds will support dedicated speed enforcement overtime for select law enforcement agencies to address and evaluate their high-crash and high-fatality problem locations.

**Project Cost:** \$224,854.10

---

**Project Number:** 2012-12PT

**Project Title:** Law Enforcement Chiefs Challenge

**Project Description:** Funds will cover the costs associated with the Maine Law Enforcement Chiefs Challenge. The Chiefs Challenge is an assessment and evaluation tool of Maine law enforcement traffic safety programs.

**Project Cost:** \$100,000.00

---

**Project Number:** 2012-12PT

**Project Title:** Law Enforcement Liaison

**Project Description:** Funds will support the full-time Law Enforcement Liaison for the Bureau of Highway Safety. Primary responsibilities of the LEL include: serving as the liaison between the law enforcement community and key partners and the Bureau, encouraging more law enforcement participation in HVE campaigns, assisting with grant applications, encouraging use of DDACTS and other proven countermeasures and evaluation measures, and solicits input from stakeholders and others for funded projects. A more detailed description of the Maine LEL is available upon request.

**Project Cost:** \$150,000.00

---

**Project Number:** 2012-12PT

**Project Title:** Law Enforcement OAS & Mini Grants

**Project Description:** Funds will support various mini grants to Maine law enforcement agencies for police traffic services and community outreach efforts.

**Project Cost:** \$150,000.00

---

### **Child Passenger Safety Program Area**

**Project Number:** 2012-12CR

**Project Title:** Child Passenger Safety Program Management

**Project Description:** Funds will support a full time CPS Coordinator within the MeBHS to oversee the CPS grants and agreements, a CPS needs assessment, the acquisition of child safety seats, site supplies and materials, special needs safety seats, education and materials for Maine fitting stations and for income eligible voucher sites.

**Project Cost:** \$150,000.00

---



**Project Number:** 2012-12CR

**Project Title:** Child Safety Seats for Fitting Stations and Voucher Sites

**Project Description:** Funding for this project will support new safety seats, supplies and materials, and special needs safety seats for Maine fitting stations and for income eligible voucher sites.

**Project Cost:** \$150,000.00

---

**Project Number:** 2012-12CR

**Project Title:** Child Passenger Safety Technician and Instructor Training Coordinator

**Project Description:** Funds will support the training and recertification of technicians and instructors.

**Project Cost:** \$75,000.00

---

**Project Number:** 2012-12CR

**Project Title:** Child Passenger Safety Roving Instructor Program

**Project Description:** Funds will support two instructors, one to cover northern Maine, and one to cover southern Maine, which will travel to sites on an as needed basis to provide seat sign-offs for technicians that have been unable to attend seat check events.

**Project Cost:** \$25,000.00

---

**Project Number:** 2012-12CR

**Project Title:** CPS Awareness Training for Law Enforcement (online)

**Project Description:** Funds will support the development of an online child passenger safety awareness training course for all Maine law enforcement.

**Project Cost:** \$30,000.00

---

**Project Number:** 2012-12CR

**Project Title:** CPS Annual Conference for Technicians and Instructors

**Project Description:** Funds will support an annual conference to provide training, education and networking for CPST.

**Project Cost:** \$50,000.00

---

**Project Number:** 2012-12CR

**Project Title:** CPS Booster Seat Education in Schools

**Project Description:** Funds will support the costs associated with promoting booster seat education to school age children up to age 12.

**Project Cost:** \$8,000.00

## Section 405 Funded Countermeasures

**Project Number:** 2012-12OPS

**Project Title:** Annual Observational & Attitudinal Surveys

**Project Description:** Funds will support the costs associated with administration of the annual observational seat belt usage rate survey and the new required attitudinal survey.

**Project Cost:** \$150,000.00

---

**Project Number:** 2012-12OPS

**Project Title:** HVE Enforcement for May and November CIOT campaign

**Project Description:** Funds will support the costs associated with administration of the National CIOT seat belt enforcement grants.

**Project Cost:** \$100,000.00

---

**Project Number:** 2012-12OPS

**Project Title:** Increase use of seat belts for Teen Drivers

**Project Description:** Funds will assist in supporting the costs associated with administration of projects identified by the SHSP Teen Focus Group and the Teen Driver Safety Committee, as well as pilot projects resulting from discussions with the NHTSA TAT TEAM to increase law enforcement for teen safety belt violations.

**Project Cost:** \$139,430.57

---

**Project Number:** 2012-12OPS

**Project Title:** LE Awareness Training (TOPS)

**Project Description:** Funds will support the costs associated with development and administration of a law enforcement specific training for occupant protection. (TOPS)

**Project Cost:** \$50,000.00

---

## Section 406 Funded Countermeasures

**Project Number:** 2012-12PBL

**Project Title:** 406 P&A

**Project Description:** Funds will support the costs associated with administration of P&A activities for Section 406 activities.

**Project Cost:** \$53,871.00

---

**Project Number:** 2012-12PM

**Project Title:** Paid Media to Support all Program Areas

**Project Description:** Funds will support a second year paid media contract with activities including: high visibility enforcement campaigns for seat belt and impaired driving, child passenger safety efforts, speed, teen driving, distractions and police traffic services.

**Project Cost:** \$150,000.00

---

**Project Number:** 2012-12PM

**Project Title:** Distracted Driving Education and Awareness Campaign

**Project Description:** Funds will support materials necessary for educating all Maine drivers about the dangers of distracted driving, including texting while driving. Maine has recently acquired two driving simulators. This project will include the use of those simulators, training and evaluation.

**Project Cost:** \$159,000.00

---

**Project Number:** 2012-12PT

**Project Title:** Sports Marketing

**Project Description:** Funds will support allowable costs associated with Sports Marketing specific to national crackdown activities. A RFP process to secure a sports marketing agency must be completed.

**Project Cost:** \$150,000.00

---

**Project Number:** 2012-12PT

**Project Title:** BMV Teen Driver Booklet

**Project Description:** Funds will support a Teen Driver Booklet to be distributed to newly licensed drivers and their parents through the BMV and other driver education associations.

**Project Cost:** \$25,845.89

---

## Section 408 Funds

**Project Number:** 2012-12TR

**Project Title:** Electronic Collection of EMS Run Report Data

**Project Description:** These funds will support costs associated with the continued roll out and upgrade to the EMS Run Reporting System.

**Project Cost:** \$150,000.00

---

**Project Number:** 2012-12TR

**Project Title:** Data Warehouse Projects

**Project Description:** These funds will support costs associated with the TRCC approved Data Warehousing projects.

**Project Cost:** \$275,737.78

---

**Project Number:** 2012-12TR

**Project Title:** E-Citation Working Group and Projects

**Project Description:** These funds will support costs associated with the TRCC approved e-citation project and working group. More information can be found in the State TR Plan.

**Project Cost:** \$500,000.00

---

**Project Number:** 2012-12TR

**Project Title:** MCRS2 Upgrade and Projects

**Project Description:** These funds will support costs associated with the TRCC approved completion of the MRCS projects.

**Project Cost:** \$757,000.00

---

**Project Number:** 2012-12TR

**Project Title:** Traffic Records – Data Analyst Position or contract

**Project Description:** These funds will support costs associated with a full time data analyst for the Bureau. Duties will include studying and analyzing all of the states available data for crashes, fatalities, locations, EMS run information, CODES, DDACTS, etc. This position will participate in Traffic Records, CODES, EMS and other data related meetings and will be responsible for the Bureau's databases, HSP analysis, etc. This position must be filled through the State RFP and contracting process. (See also S. 402)

**Project Cost:** \$50,000.00

## Section 410 Funds

**Project Number:** 2012-12K8

**Project Title:** Sustained High Visibility Enforcement

**Project Description:** Funds will support the impaired driving HVE efforts by law enforcement (in addition to 402 funds) to support national crackdowns and sustain enforcement efforts for the entire year.

**Project Cost:** \$250,000.00

---

**Project Number:** 2012-12K8

**Project Title:** Traffic Safety Resource Prosecutor

**Project Description:** Funds will support a position for a full time Traffic Safety Resource Prosecutor to assist Maine law enforcement and prosecutors with impaired driving cases and training. This position will result from an RFP.

**Project Cost:** \$150,000.00

---

**Project Number:** 2012-12K8

**Project Title:** 410 P&A

**Project Description:** Funds will support the costs associated with administration of P&A activities for Section 410.

**Project Cost:** \$305,000.00

---

**Project Number:** 2012-12AL

**Project Title:** Law Enforcement Incentive Equipment for participation in sustained impaired driving enforcement HVE campaigns.

**Project Description:** Funding will support the procurement of equipment to assist LE in the detection and prosecution of impaired drivers. Equipment will include in-cruiser video cameras. *No equipment in excess of \$5k will be purchased without approval in writing by NHTSA.*

**Project Cost:** \$1,000,000.00

---

**Project Number:** 2012-12AL

**Project Title:** Purchase of a DUI BAT Mobile for Impaired Driving Enforcement including the new Task Force and RIDE activities (see also S. 402)

**Project Description:** Funds will support the procurement of a new or used mobile unit to assist Maine law enforcement in dedicated efforts to combat impaired driving. This mobile unit will work with the new Task Force/RIDE team. Procurement must be handled using the State procurement rules for capital equipment. *No purchase will be made without consultation with and written approval from NHTSA. The Bureau has made arrangements to view the mobile unit from New Hampshire.*

**Project Cost:** \$253,362.28 estimated

---

**Project Number:** 2011-11PT

**Project Title:** Specialized LE Training- Drug Recognition Experts/SFST

**Project Description:** Funds will support specialized training, travel and/or materials for state, local, and county law enforcement in the area of SFST and Drug Recognition in the campaign against driving under the influence of drugs, and expenses for the yearly national DRE conference.

Project Cost: \$50,000.00

---

**Project Number:** 2011-11PT

**Project Title:** Purchase of Intoxilyzer 8000 units for Impaired Driving Detection

**Project Description:** Funds will support the purchase of new and additional Intoxilyzer 8000's for the statewide detection of impaired drivers. *No equipment in excess of \$5k will be purchased without approval in writing by NHTSA.*

Project Cost: \$1,000,000.00

---

**Project Number:** 2012-12AL

**Project Title:** Regional Impaired Driving Task Force-Pilot Project

**Project Description:** funds will support overtime and equipment necessary to implement a pilot project to organize a Regional Impaired Driving Enforcement Team (RIDE). The pilot will run for 6-8 months, and include numerous checkpoint and saturation patrol details in a variety of location within a county. Locations of details will be determined by crash and fatal data analysis. See also S.402

**Project Cost:** \$50,000.00

---

## Section 2010 Funds

**Project Number:** 2012-12MC

**Project Title:** Maine Bureau of Motor Vehicles Motorcycle Safety Awareness, Training & Education Program

**Project Description:** Funds will support the Bureau of Motor Vehicles, and other group and community efforts to increase motorcycle safety training, increase the instructor base, share the road education and awareness. Funds will be used to enhance the State MC curriculum, provide educational materials and other allowable uses under S.2010.

**Project Cost:** \$439,162.46

---

## Section 2011 Funds

**Project Number:** 2011-11CP

**Project Title:** Maine Child Passenger Technician and Instructor Training and Incentives

**Project Description:** Funding for this project will support training of CPS instructors and technicians. These funds will be used in conjunction with Section 402 funds to further the program.

**Project Cost:** \$124,265.74

---

**Project Number:** 2010-11CP

**Project Title:** Maine Child Passenger Informational Materials

**Project Description:** Funding for this project will support increasing the outreach and availability of the CPS program to all families including minority populations. Efforts include identifying and marketing for technicians, instructors, materials and stations or sites.

**Project Cost:** \$100,000.00

---

**Project Number:** 2010-11CP

**Project Title:** Maine Child Passenger Seats

**Project Description:** Funding for this project will support 402 funds in the purchase of seats for the Maine CPS Program.

**Project Cost:** \$ 75,000.00

---



## Financial Summary

	402	405	406	408	410	2010	2011	Total	% of Total
<b>P&amp;A</b>	\$458,000		\$53,871		\$305,000			\$816,871	7.21%
<b>Paid Media</b>	\$100,000		\$484,846					\$584,846	5.27%
<b>TR</b>	\$200,000			\$1,732,738				\$1,932,738	17.43%
<b>AL</b>	\$800,000				\$2,753,362			\$3,553,362	32.05%
<b>OP</b>	\$1,150,000	\$439,431						\$1,589,431	14.33%
<b>Police Traffic Services</b>	\$1,374,854							\$1,374,854	12.40%
<b>EMS</b>	\$10,000							\$10,000	0.09%
<b>Child Restraint</b>	\$488,000					\$299,266		\$787,266	7.10%
<b>Motorcycle</b>						\$439,162		\$439,162	3.96%
<b>TOTAL</b>	\$4,580,854	\$439,431	\$538,717	\$1,732,738	\$3,058,362	\$439,162	\$299,266	\$11,088,530	100.00%

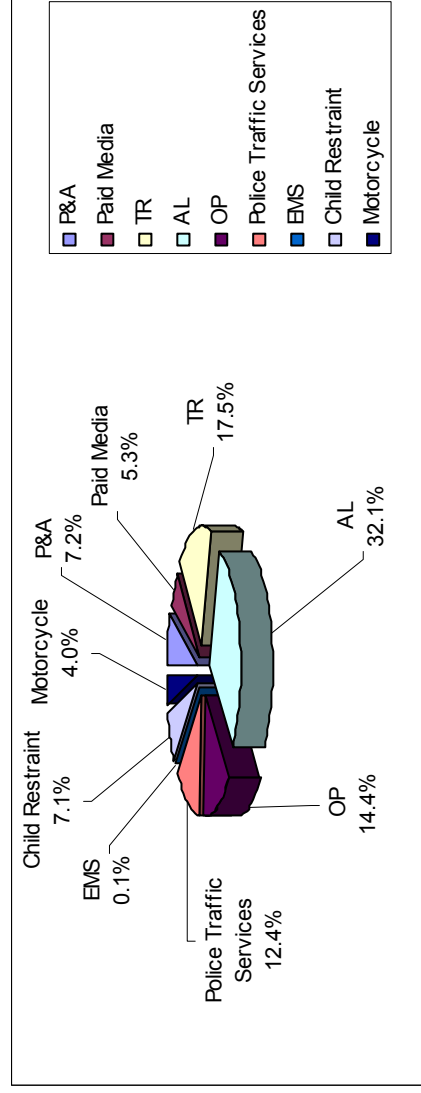

U.S. Department of Transportation National Highway Traffic Safety Administration  
**Highway Safety Plan Cost Summary**

State: Maine

Page: 1

Report Date: 08/18/2011

**2012-HSP-1**

For Approval

Program Area	Project	Description	Prior Approved Program Funds	State Funds	Previous Bal.	Incre/(Decre)	Current Balance	Share to Local
<b>NHTSA</b>								
<b>NHTSA 402</b>								
<b>Planning and Administration</b>								
	PA-2012-00-00-00		\$ .00	\$458,000.00	\$ .00	\$458,000.00	\$458,000.00	\$ .00
	<b>Planning and Administration Total</b>		<b>\$ .00</b>	<b>\$458,000.00</b>	<b>\$ .00</b>	<b>\$458,000.00</b>	<b>\$458,000.00</b>	<b>\$ .00</b>
<b>Alcohol</b>								
	AL-2012-00-00-00		\$ .00	\$267,000.00	\$ .00	\$800,000.00	\$800,000.00	\$320,000.00
	<b>Alcohol Total</b>		<b>\$ .00</b>	<b>\$267,000.00</b>	<b>\$ .00</b>	<b>\$800,000.00</b>	<b>\$800,000.00</b>	<b>\$320,000.00</b>
<b>Emergency Medical Services</b>								
	EM-2012-00-00-00		\$ .00	\$334.00	\$ .00	\$10,000.00	\$10,000.00	\$4,000.00
	<b>Emergency Medical Services Total</b>		<b>\$ .00</b>	<b>\$334.00</b>	<b>\$ .00</b>	<b>\$10,000.00</b>	<b>\$10,000.00</b>	<b>\$4,000.00</b>
<b>Occupant Protection</b>								
	OP-2012-00-00-00		\$ .00	\$384,000.00	\$ .00	\$1,150,000.00	\$1,150,000.00	\$1,000,000.00
	<b>Occupant Protection Total</b>		<b>\$ .00</b>	<b>\$384,000.00</b>	<b>\$ .00</b>	<b>\$1,150,000.00</b>	<b>\$1,150,000.00</b>	<b>\$1,000,000.00</b>
<b>Police Traffic Services</b>								
	PT-2012-00-00-00		\$ .00	\$458,300.00	\$ .00	\$1,374,854.10	\$1,374,854.10	\$550,000.00
	<b>Police Traffic Services Total</b>		<b>\$ .00</b>	<b>\$458,300.00</b>	<b>\$ .00</b>	<b>\$1,374,854.10</b>	<b>\$1,374,854.10</b>	<b>\$550,000.00</b>
<b>Traffic Records</b>								
	TR-2012-00-00-00		\$ .00	\$67,000.00	\$ .00	\$200,000.00	\$200,000.00	\$80,000.00
	<b>Traffic Records Total</b>		<b>\$ .00</b>	<b>\$67,000.00</b>	<b>\$ .00</b>	<b>\$200,000.00</b>	<b>\$200,000.00</b>	<b>\$80,000.00</b>
<b>Child Restraint</b>								
	CR-2012-00-00-00		\$ .00	\$162,667.00	\$ .00	\$488,000.00	\$488,000.00	\$195,200.00
	<b>Child Restraint Total</b>		<b>\$ .00</b>	<b>\$162,667.00</b>	<b>\$ .00</b>	<b>\$488,000.00</b>	<b>\$488,000.00</b>	<b>\$195,200.00</b>
<b>Paid Advertising</b>								
	PM-2012-00-00-00		\$ .00	\$34,000.00	\$ .00	\$100,000.00	\$100,000.00	\$40,000.00

U.S. Department of Transportation National Highway Traffic Safety Administration  
**Highway Safety Plan Cost Summary**

State: Maine

Page: 2

Report Date: 08/18/2011

**2012-HSP-1**

For Approval

Program Area	Project	Description	Prior Approved Program Funds	State Funds	Previous Bal.	Incre/(Decre)	Current Balance	Share to Local
	<b>Paid Advertising Total</b>		\$ .00	\$34,000.00	\$ .00	\$100,000.00	\$100,000.00	\$40,000.00
	<b>NHTSA 402 Total</b>		\$ .00	\$1,831,301.00	\$ .00	\$4,580,854.10	\$4,580,854.10	\$2,189,200.00
<b>405 OP SAFETEA-LU</b>								
	K2-2012-00-00-00		\$ .00	\$1,318,292.00	\$ .00	\$439,430.57	\$439,430.57	\$176,000.00
	<b>405 Occupant Protection Total</b>		\$ .00	\$1,318,292.00	\$ .00	\$439,430.57	\$439,430.57	\$176,000.00
	<b>405 OP SAFETEA-LU Total</b>		\$ .00	\$1,318,292.00	\$ .00	\$439,430.57	\$439,430.57	\$176,000.00
<b>NHTSA 406</b>								
	K4PA-2012-00-00-00		\$ .00	\$ .00	\$ .00	\$53,871.00	\$53,871.00	\$ .00
	<b>406 Planning and Administration Total</b>		\$ .00	\$ .00	\$ .00	\$53,871.00	\$53,871.00	\$ .00
	<b>406 Safety Belts Incentive Total</b>		\$ .00	\$ .00	\$ .00	\$484,845.89	\$484,845.89	\$350,000.00
<b>406 Safety Belts Incentive Total</b>			\$ .00	\$ .00	\$ .00	\$484,845.89	\$484,845.89	\$350,000.00
	<b>NHTSA 406 Total</b>		\$ .00	\$ .00	\$ .00	\$538,716.89	\$538,716.89	\$350,000.00
<b>408 Data Program SAFETEA-LU</b>								
	K9-2012-00-00-00		\$ .00	\$433,184.00	\$ .00	\$1,732,737.78	\$1,732,737.78	\$693,100.00
	<b>408 Data Program Incentive Total</b>		\$ .00	\$433,184.00	\$ .00	\$1,732,737.78	\$1,732,737.78	\$693,100.00
	<b>408 Data Program SAFETEA-LU Total</b>		\$ .00	\$433,184.00	\$ .00	\$1,732,737.78	\$1,732,737.78	\$693,100.00
<b>410 Alcohol SAFETEA-LU</b>								
	K8-2012-00-00-00		\$ .00	\$8,260,086.00	\$ .00	\$2,753,362.28	\$2,753,362.28	\$2,000,000.00
	<b>410 Alcohol SAFETEA-LU Total</b>		\$ .00	\$8,260,086.00	\$ .00	\$2,753,362.28	\$2,753,362.28	\$2,000,000.00
<b>410 Alcohol Planning and Administration</b>								
	K8PA-2012-00-00-00		\$ .00	\$305,000.00	\$ .00	\$305,000.00	\$305,000.00	\$ .00
	<b>410 Alcohol Planning and Administration Total</b>		\$ .00	\$305,000.00	\$ .00	\$305,000.00	\$305,000.00	\$ .00
	<b>410 Alcohol SAFETEA-LU Total</b>		\$ .00	\$8,565,086.00	\$ .00	\$3,058,362.28	\$3,058,362.28	\$2,000,000.00

U.S. Department of Transportation National Highway Traffic Safety Administration  
**Highway Safety Plan Cost Summary**

State: Maine

Page: 3

Report Date: 08/18/2011

**2012-HSP-1**

For Approval

Program Area	Project	Description	Prior Approved Program Funds	State Funds	Previous Bal.	Incr/(Decre)	Current Balance	Share to Local
<b>2010 Motorcycle Safety</b>								
	K6-2012-00-00-00		\$ .00	\$ .00	\$ .00	\$ 439,162.46	\$ 439,162.46	\$ 300,000.00
	<b>2010 Motorcycle Safety Incentive Total</b>		<b>\$ .00</b>	<b>\$ .00</b>	<b>\$ .00</b>	<b>\$ 439,162.46</b>	<b>\$ 439,162.46</b>	<b>\$ 300,000.00</b>
	<b>2010 Motorcycle Safety Total</b>		<b>\$ .00</b>	<b>\$ .00</b>	<b>\$ .00</b>	<b>\$ 439,162.46</b>	<b>\$ 439,162.46</b>	<b>\$ 300,000.00</b>
<b>2011 Child Seats</b>								
	K3-2012-00-00-00		\$ .00	\$ 299,265.74	\$ .00	\$ 299,265.74	\$ 299,265.74	\$ 299,265.74
	<b>2011 Child Seat Incentive Total</b>		<b>\$ .00</b>	<b>\$ 299,265.74</b>	<b>\$ .00</b>	<b>\$ 299,265.74</b>	<b>\$ 299,265.74</b>	<b>\$ 299,265.74</b>
	<b>2011 Child Seats Total</b>		<b>\$ .00</b>	<b>\$ 299,265.74</b>	<b>\$ .00</b>	<b>\$ 299,265.74</b>	<b>\$ 299,265.74</b>	<b>\$ 299,265.74</b>
	<b>NHTSA Total</b>		<b>\$ .00</b>	<b>\$ 12,447,128.74</b>	<b>\$ .00</b>	<b>\$ 11,088,529.82</b>	<b>\$ 11,088,529.82</b>	<b>\$ 6,007,565.74</b>
	<b>Total</b>		<b>\$ .00</b>	<b>\$ 12,447,128.74</b>	<b>\$ .00</b>	<b>\$ 11,088,529.82</b>	<b>\$ 11,088,529.82</b>	<b>\$ 6,007,565.74</b>

## **Certifications and Assurances**

---

Failure to comply with applicable Federal statutes, regulations and directives may subject State officials to civil or criminal penalties and/or place the State in a high risk grantee status in accordance with 49 CFR 18.12.

Each fiscal year the State will sign these Certifications and Assurances that the State complies with all applicable Federal statutes, regulations, and directives in effect with respect to the periods for which it receives grant funding. Applicable provisions include, but not limited to, the following:

- 23 U.S.C. Chapter 4 - Highway Safety Act of 1966, as amended
- 49 CFR Part 18 - Uniform Administrative Requirements for Grants and Cooperative Agreements to State and Local Governments
- 23 CFR Chapter II - (§§1200, 1205, 1206, 1250, 1251, & 1252) Regulations governing highway safety programs
- NHTSA Order 462-6C - Matching Rates for State and Community Highway Safety Programs
- Highway Safety Grant Funding Policy for Field-Administered Grants

### **Certifications and Assurances**

#### **Section 402 Requirements**

The Governor is responsible for the administration of the State highway safety program through a State highway safety agency which has adequate powers and is suitably equipped and organized (as evidenced by appropriate oversight procedures governing such areas as procurement, financial administration, and the use, management, and disposition of equipment) to carry out the program (23 USC 402(b) (1) (A));

The political subdivisions of this State are authorized, as part of the State highway safety program, to carry out within their jurisdictions local highway safety programs which have been approved by the Governor and are in accordance with the uniform guidelines promulgated by the Secretary of Transportation (23 USC 402(b) (1) (B));

At least 40 per cent of all Federal funds apportioned to this State under 23 USC 402 for this fiscal year will be expended by or for the benefit of the political subdivision of the State in carrying out local highway safety programs (23 USC 402(b) (1) (C)), unless this requirement is waived in writing;

This State's highway safety program provides adequate and reasonable access for the safe and convenient movement of physically handicapped persons, including those in wheelchairs, across curbs constructed or replaced on or after July 1, 1976, at all pedestrian crosswalks (23 USC 402(b) (1) (D));

**The State will implement activities in support of national highway safety goals to reduce motor vehicle related fatalities that also reflect the primary data-related crash factors within the State as identified by the State highway safety planning process, including:**

- **National law enforcement mobilizations,**
- **Sustained enforcement of statutes addressing impaired driving, occupant protection, and driving in excess of posted speed limits,**
- **An annual statewide safety belt use survey in accordance with criteria established by the Secretary for the measurement of State safety belt use rates to ensure that the measurements are accurate and representative,**
- **Development of statewide data systems to provide timely and effective data analysis to support allocation of highway safety resources.**

**(23 USC 402 (b)(1)(E));**

**The State shall actively encourage all relevant law enforcement agencies in the State to follow the guidelines established for vehicular pursuits issued by the International Association of Chiefs of Police that are currently in effect. (23 USC 402(l)).**

### **Other Federal Requirements**

Cash drawdowns will be initiated only when actually needed for disbursement. 49 CFR 18.20

Cash disbursements and balances will be reported in a timely manner as required by NHTSA. 49 CFR 18.21.

The same standards of timing and amount, including the reporting of cash disbursement and balances, will be imposed upon any secondary recipient organizations. 49 CFR 18.41.

Failure to adhere to these provisions may result in the termination of drawdown privileges.

The State has submitted appropriate documentation for review to the single point of contact designated by the Governor to review Federal programs, as required by Executive Order 12372 (Intergovernmental Review of Federal Programs);

Equipment acquired under this agreement for use in highway safety program areas shall be used and kept in operation for highway safety purposes by the State; or the State, by formal agreement with appropriate officials of a political subdivision or State agency, shall cause such equipment to be used and kept in operation for highway safety purposes 23 CFR 1200.21

The State will comply with all applicable State procurement procedures and will maintain a financial management system that complies with the minimum requirements of 49 CFR 18.20;

## **Federal Funding Accountability and Transparency Act (FFATA)**

The State will comply with FFATA guidance, OMB Guidance on FFATA Subaward and Executive Compensation Reporting, August 27, 2010,

([https://www.fsrs.gov/documents/OMB\\_Guidance\\_on\\_FFATA\\_Subaward\\_and\\_Executive\\_Compensation\\_Reporting\\_08272010.pdf](https://www.fsrs.gov/documents/OMB_Guidance_on_FFATA_Subaward_and_Executive_Compensation_Reporting_08272010.pdf)) by reporting to FSRS.gov for each sub-grant awarded:

- Name of the entity receiving the award;
- Amount of the award;
- Information on the award including transaction type, funding agency, the North American Industry Classification System code or Catalog of Federal Domestic Assistance number (where applicable), program source;
- Location of the entity receiving the award and the primary location of performance under the award, including the city, State, congressional district, and country; , and an award title descriptive of the purpose of each funding action;
- A unique identifier (DUNS);
- The names and total compensation of the five most highly compensated officers of the entity if-- of the entity receiving the award and of the parent entity of the recipient, should the entity be owned by another entity;

(i) the entity in the preceding fiscal year received—

(I) 80 percent or more of its annual gross revenues in Federal awards; and (II) \$25,000,000 or more in annual gross revenues from Federal awards; and (ii) the public does not have access to information about the compensation of the senior executives of the entity through periodic reports filed under section 13(a) or 15(d) of the Securities Exchange Act of 1934 (15 U.S.C. 78m(a), 78o(d)) or section 6104 of the Internal Revenue Code of 1986;

- Other relevant information specified by OMB guidance.

The State highway safety agency will comply with all Federal statutes and implementing regulations relating to nondiscrimination. These include but are not limited to: (a) Title VI of the Civil Rights Act of 1964 (P.L. 88-352) which prohibits discrimination on the basis of race, color or national origin (and 49 CFR Part 21); (b) Title IX of the Education Amendments of 1972, as amended (20 U.S.C. §§ 1681-1683, and 1685-1686), which prohibits discrimination on the basis of sex; (c) Section 504 of the Rehabilitation Act of 1973, as amended (29 U.S.C. §794) and the Americans with Disabilities Act of 1990 (42 USC § 12101, *et seq.*; PL 101-336), which prohibits discrimination on the basis of disabilities (and 49 CFR Part 27); (d) the Age Discrimination Act of 1975, as amended (42U.S.C. §§ 6101-6107), which prohibits discrimination on the basis of age; (e) the Drug Abuse Office and Treatment Act of 1972 (P.L. 92-255), as amended, relating to nondiscrimination on the basis of drug abuse; (f) the comprehensive Alcohol Abuse and Alcoholism Prevention, Treatment and Rehabilitation Act of 1970(P.L. 91-616), as amended, relating to nondiscrimination on the basis of alcohol abuse of alcoholism; (g) §§ 523 and 527 of the Public Health Service Act of 1912 (42 U.S.C. §§ 290 dd-3 and 290 ee-3), as amended, relating to confidentiality of alcohol and drug abuse patient records; (h) Title VIII of the Civil Rights Act of 1968 (42 U.S.C. §§ 3601 *et seq.*), as amended, relating to

nondiscrimination in the sale, rental or financing of housing; (i) any other nondiscrimination provisions in the specific statute(s) under which application for Federal assistance is being made; The Civil Rights Restoration Act of 1987, which provides that any portion of a state or local entity receiving federal funds will obligate all programs or activities of that entity to comply with these civil rights laws; and, (k) the requirements of any other nondiscrimination statute(s) which may apply to the application.

**The Drug-free Workplace Act of 1988(41 U.S.C. 702;):**

The State will provide a drug-free workplace by:

- a. Publishing a statement notifying employees that the unlawful manufacture, distribution, dispensing, possession or use of a controlled substance is prohibited in the grantee's workplace and specifying the actions that will be taken against employees for violation of such prohibition;
- b. Establishing a drug-free awareness program to inform employees about:
  1. The dangers of drug abuse in the workplace.
  2. The grantee's policy of maintaining a drug-free workplace.
  3. Any available drug counseling, rehabilitation, and employee assistance programs.
  4. The penalties that may be imposed upon employees for drug violations occurring in the workplace.
- c. Making it a requirement that each employee engaged in the performance of the grant be given a copy of the statement required by paragraph (a).
- d. Notifying the employee in the statement required by paragraph (a) that, as a condition of employment under the grant, the employee will --
  1. Abide by the terms of the statement.
  2. Notify the employer of any criminal drug statute conviction for a violation occurring in the workplace no later than five days after such conviction.
- e. Notifying the agency within ten days after receiving notice under subparagraph (d) (2) from an employee or otherwise receiving actual notice of such conviction.
- f. Taking one of the following actions, within 30 days of receiving notice under subparagraph (d) (2), with respect to any employee who is so convicted -



1. Taking appropriate personnel action against such an employee, up to and including termination.
  2. Requiring such employee to participate satisfactorily in a drug abuse assistance or rehabilitation program approved for such purposes by a Federal, State, or local health, law enforcement, or other appropriate agency.
- g. Making a good faith effort to continue to maintain a drug-free workplace through implementation of paragraphs (a), (b), (c), (d), (e), and (f) above.

### **BUY AMERICA ACT**

The State will comply with the provisions of the Buy America Act (49 U.S.C. 5323(j)) which contains the following requirements:

Only steel, iron and manufactured products produced in the United States may be purchased with Federal funds unless the Secretary of Transportation determines that such domestic purchases would be inconsistent with the public interest; that such materials are not reasonably available and of a satisfactory quality; or that inclusion of domestic materials will increase the cost of the overall project contract by more than 25 percent. Clear justification for the purchase of non-domestic items must be in the form of a waiver request submitted to and approved by the Secretary of Transportation.

### **POLITICAL ACTIVITY (HATCH ACT).**

The State will comply, as applicable, with provisions of the Hatch Act (5 U.S.C. §§1501-1508 and 7324-7328) which limit the political activities of employees whose principal employment activities are funded in whole or in part with Federal funds.

### **CERTIFICATION REGARDING FEDERAL LOBBYING**

Certification for Contracts, Grants, Loans, and Cooperative Agreements

The undersigned certifies, to the best of his or her knowledge and belief, that:

1. No Federal appropriated funds have been paid or will be paid, by or on behalf of the undersigned, to any person for influencing or attempting to influence an officer or employee of any agency, a Member of Congress, an officer or employee of Congress, or an employee of a Member of Congress in connection with the awarding of any Federal contract, the making of any Federal grant, the making of any Federal loan, the entering into of any cooperative agreement, and the extension, continuation, renewal, amendment, or modification of any Federal contract, grant, loan, or cooperative agreement.

2. If any funds other than Federal appropriated funds have been paid or will be paid to any person for influencing or attempting to influence an officer or employee of any agency, a Member of Congress, an officer or employee of Congress, or an employee of a Member of Congress in connection with this Federal contract, grant, loan, or cooperative agreement, the undersigned shall complete and submit Standard Form-LLL, "Disclosure Form to Report Lobbying," in accordance with its instructions.

3. The undersigned shall require that the language of this certification be included in the award documents for all sub-award at all tiers (including subcontracts, subgrants, and contracts under grant, loans, and cooperative agreements) and that all subrecipients shall certify and disclose accordingly.

This certification is a material representation of fact upon which reliance was placed when this transaction was made or entered into. Submission of this certification is a prerequisite for making or entering into this transaction imposed by section 1352, title 31, U.S. Code. Any person who fails to file the required certification shall be subject to a civil penalty of not less than \$10,000 and not more than \$100,000 for each such failure.

### **RESTRICTION ON STATE LOBBYING**

None of the funds under this program will be used for any activity specifically designed to urge or influence a State or local legislator to favor or oppose the adoption of any specific legislative proposal pending before any State or local legislative body. Such activities include both direct and indirect (e.g., "grassroots") lobbying activities, with one exception. This does not preclude a State official whose salary is supported with NHTSA funds from engaging in direct communications with State or local legislative officials, in accordance with customary State practice, even if such communications urge legislative officials to favor or oppose the adoption of a specific pending legislative proposal.

### **CERTIFICATION REGARDING DEBARMENT AND SUSPENSION**

#### **Instructions for Primary Certification**

1. By signing and submitting this proposal, the prospective primary participant is providing the certification set out below.

2. The inability of a person to provide the certification required below will not necessarily result in denial of participation in this covered transaction. The prospective participant shall submit an explanation of why it cannot provide the certification set out below. The certification or explanation will be considered in connection with the department or agency's determination whether to enter into this transaction. However, failure of the prospective primary participant to furnish a certification or an explanation shall disqualify such person from participation in this transaction.

3. The certification in this clause is a material representation of fact upon which reliance was placed when the department or agency determined to enter into this transaction. If it is later determined that the prospective primary participant knowingly rendered an erroneous

certification, in addition to other remedies available to the Federal Government, the department or agency may terminate this transaction for cause or default.

4. The prospective primary participant shall provide immediate written notice to the department or agency to which this proposal is submitted if at any time the prospective primary participant learns its certification was erroneous when submitted or has become erroneous by reason of changed circumstances.

5. The terms **covered transaction, debarred, suspended, ineligible, lower tier covered transaction, participant, person, primary covered transaction, principal, proposal, and voluntarily excluded**, as used in this clause, have the meaning set out in the Definitions and coverage sections of 49 CFR Part 29. You may contact the department or agency to which this proposal is being submitted for assistance in obtaining a copy of those regulations.

6. The prospective primary participant agrees by submitting this proposal that, should the proposed covered transaction be entered into, it shall not knowingly enter into any lower tier covered transaction with a person who is proposed for debarment under 48 CFR Part 9, subpart 9.4, debarred, suspended, declared ineligible, or voluntarily excluded from participation in this covered transaction, unless authorized by the department or agency entering into this transaction.

7. The prospective primary participant further agrees by submitting this proposal that it will include the clause titled "Certification Regarding Debarment, Suspension, Ineligibility and Voluntary Exclusion-Lower Tier Covered Transaction," provided by the department or agency entering into this covered transaction, without modification, in all lower tier covered transactions and in all solicitations for lower tier covered transactions.

8. A participant in a covered transaction may rely upon a certification of a prospective participant in a lower tier covered transaction that it is not proposed for debarment under 48 CFR Part 9, subpart 9.4, debarred, suspended, ineligible, or voluntarily excluded from the covered transaction, unless it knows that the certification is erroneous. A participant may decide the method and frequency by which it determines the eligibility of its principals. Each participant may, but is not required to, check the list of Parties Excluded from Federal Procurement and Non-procurement Programs.

9. Nothing contained in the foregoing shall be construed to require establishment of a system of records in order to render in good faith the certification required by this clause. The knowledge and information of a participant is not required to exceed that which is normally possessed by a prudent person in the ordinary course of business dealings.

10. Except for transactions authorized under paragraph 6 of these instructions, if a participant in a covered transaction knowingly enters into a lower tier covered transaction with a person who is proposed for debarment under 48 CFR Part 9, subpart 9.4, suspended, debarred, ineligible, or voluntarily excluded from participation in this transaction, in addition to other remedies available to the Federal Government, the department or agency may terminate this transaction for cause or default.

**Certification Regarding Debarment, Suspension, and Other Responsibility Matters-Primary Covered Transactions**

(1) The prospective primary participant certifies to the best of its knowledge and belief, that its principals:

(a) Are not presently debarred, suspended, proposed for debarment, declared ineligible, or voluntarily excluded by any Federal department or agency;

(b) Have not within a three-year period preceding this proposal been convicted of or had a civil judgment rendered against them for commission of fraud or a criminal offense in connection with obtaining, attempting to obtain, or performing a public (Federal, State or local) transaction or contract under a public transaction; violation of Federal or State antitrust statutes or commission of embezzlement, theft, forgery, bribery, falsification or destruction of record, making false statements, or receiving stolen property;

(c) Are not presently indicted for or otherwise criminally or civilly charged by a governmental entity (Federal, State or Local) with commission of any of the offenses enumerated in paragraph (1)(b) of this certification; and

(d) Have not within a three-year period preceding this application/proposal had one or more public transactions (Federal, State, or local) terminated for cause or default.

(2) Where the prospective primary participant is unable to certify to any of the Statements in this certification, such prospective participant shall attach an explanation to this proposal.

**Instructions for Lower Tier Certification**

1. By signing and submitting this proposal, the prospective lower tier participant is providing the certification set out below.

2. The certification in this clause is a material representation of fact upon which reliance was placed when this transaction was entered into. If it is later determined that the prospective lower tier participant knowingly rendered an erroneous certification, in addition to other remedies available to the Federal government, the department or agency with which this transaction originated may pursue available remedies, including suspension and/or debarment.

3. The prospective lower tier participant shall provide immediate written notice to the person to which this proposal is submitted if at any time the prospective lower tier participant learns that its certification was erroneous when submitted or has become erroneous by reason of changed circumstances.

4. The terms **covered transaction, debarred, suspended, ineligible, lower tier covered transaction, participant, person, primary covered transaction, principal, proposal, and voluntarily excluded**, as used in this clause, have the meanings set out in the Definition and Coverage sections of 49 CFR Part 29. You may contact the person to whom this proposal is submitted for assistance in obtaining a copy of those regulations.

5. The prospective lower tier participant agrees by submitting this proposal that, should the proposed covered transaction be entered into, it shall not knowingly enter into any lower tier covered transaction with a person who is proposed for debarment under 48 CFR Part 9, subpart 9.4, debarred, suspended, declared ineligible, or voluntarily excluded from participation in this covered transaction, unless authorized by the department or agency with which this transaction originated.

6. The prospective lower tier participant further agrees by submitting this proposal that it will include the clause titled "Certification Regarding Debarment, Suspension, Ineligibility and Voluntary Exclusion -- Lower Tier Covered Transaction," without modification, in all lower tier covered transactions and in all solicitations for lower tier covered transactions. (See below)

7. A participant in a covered transaction may rely upon a certification of a prospective participant in a lower tier covered transaction that it is not proposed for debarment under 48 CFR Part 9, subpart 9.4, debarred, suspended, ineligible, or voluntarily excluded from the covered transaction, unless it knows that the certification is erroneous. A participant may decide the method and frequency by which it determines the eligibility of its principals. Each participant may, but is not required to, check the List of Parties Excluded from Federal Procurement and Non-procurement Programs.

8. Nothing contained in the foregoing shall be construed to require establishment of a system of records in order to render in good faith the certification required by this clause. The knowledge and information of a participant is not required to exceed that which is normally possessed by a prudent person in the ordinary course of business dealings.

9. Except for transactions authorized under paragraph 5 of these instructions, if a participant in a covered transaction knowingly enters into a lower tier covered transaction with a person who is proposed for debarment under 48 CFR Part 9, subpart 9.4, suspended, debarred, ineligible, or voluntarily excluded from participation in this transaction, in addition to other remedies available to the Federal government, the department or agency with which this transaction originated may pursue available remedies, including suspension and/or debarment.

**Certification Regarding Debarment, Suspension, Ineligibility and Voluntary Exclusion -- Lower Tier Covered Transactions:**

1. The prospective lower tier participant certifies, by submission of this proposal, that neither it nor its principals is presently debarred, suspended, proposed for debarment, declared ineligible, or voluntarily excluded from participation in this transaction by any Federal department or agency.

2. Where the prospective lower tier participant is unable to certify to any of the statements in this certification, such prospective participant shall attach an explanation to this proposal.

## POLICY TO BAN TEXT MESSAGING WHILE DRIVING

In accordance with Executive Order 13513, Federal Leadership On Reducing Text Messaging While Driving, and DOT Order 3902.10, Text Messaging While Driving, States are encouraged to:

- (1) Adopt and enforce workplace safety policies to decrease crashes caused by distracted driving including policies to ban text messaging while driving—
  - a. Company-owned or –rented vehicles, or Government-owned, leased or rented vehicles; or
  - b. Privately-owned when on official Government business or when performing any work on or behalf of the Government.
  
- (2) Conduct workplace safety initiatives in a manner commensurate with the size of the business, such as –
  - a. Establishment of new rules and programs or re-evaluation of existing programs to prohibit text messaging while driving; and
  - b. Education, awareness, and other outreach to employees about the safety risks associated with texting while driving.

## **ENVIRONMENTAL IMPACT**

The Governor's Representative for Highway Safety has reviewed the State's Fiscal Year highway safety planning document and hereby declares that no significant environmental impact will result from implementing this Highway Safety Plan. If, under a future revision, this plan will be modified in such a manner that a project would be instituted that could affect environmental quality to the extent that a review and statement would be necessary, this office is prepared to take the action necessary to comply with the National Environmental Policy Act of 1969 (42 USC 4321 et seq.) and the implementing regulations of the Council on Environmental Quality (40 CFR Parts 1500-1517).

  
\_\_\_\_\_  
**John E. Morris, Commissioner/Governor's Representative for Highway Safety**

Maine  
**State or Commonwealth**

2012  
**For Fiscal Year**

August 19, 2011  
**Date**