



# USNS *Comet*

Design Type: C3-ST-14A

Official Number: T-AKR 7



## GENERAL CHARACTERISTICS

LENGTH (BP): 465'  
 LENGTH (OA): 499'  
 BEAM (MOLDED): 78'  
 DESIGNED OPERATING DRAFT: 22'  
 DISPLACEMENT: 16,489 LONG TONS  
 DEADWEIGHT: 6,489 LONG TONS  
 GROSS REGISTERED TONNAGE: 13,790  
 NET REGISTERED TONNAGE: 8,920  
 MAXIMUM CONTINUOUS  
     SHAFT HORSEPOWER: 13,200  
 NORMAL SHAFT HORSEPOWER: 12,000  
 SERVICE SPEED: 18 KNOTS  
 CRUISING RADIUS AT 18 KNOTS:  
     13,000 MILES



USNS *COMET* WAS THE FIRST PURPOSE-BUILT, DEEP-DRAFT, OCEAN-GOING VESSEL DESIGNED FOR ROLL-ON/ROLL-OFF HANDLING OF VEHICLES AND OTHER WHEELED CARGO.

THE NAVY'S BUREAU OF SHIPS, WORKING WITH THE MARITIME ADMINISTRATION, DESIGNED THE *COMET* AS A VEHICLE CARGO SHIP FOR POINT-TO-POINT OCEAN TRANSPORT OF FULLY LOADED DEPARTMENT OF DEFENSE SELF-PROPELLED WHEELED AND TRACKED VEHICLES. THE SHIP IS BUILT OF WELDED AND RIVETED STEEL AND SUBDIVIDED BY TRANSVERSE BULKHEADS INTO SEVEN COMPARTMENTS, INCLUDING FOUR FOR CARGO AND ONE FOR THE ENGINE MACHINERY. THE SHIP IS FITTED WITH A STERN RAMP, FOUR SIDE VEHICLE-LOADING PORTS, AND A SEQUENCE OF INTERNAL RAMPS THAT ALLOW VEHICLES TO BE WHEELED DIRECTLY INTO THE HOLDS. KINGPOSTS AND CARGO BOOMS ALONG THE LENGTH OF THE MAIN DECK ALLOW CARGO TO BE LIFTED ON AND OFF THROUGH DECK HATCHES AS WELL. THE PROPULSION SYSTEM COMPRISES TWO BOILERS SUPPLYING STEAM TO GEARED TURBINES DRIVING TWIN SCREWS. THE SHIP'S SUPERSTRUCTURE CONSISTS OF A SINGLE DECKHOUSE POSITIONED NEAR AMIDSHIPS OVER THE MACHINERY SPACES. THE SUBSTANTIAL CONSTRUCTION OF THE KINGPOSTS AND BOOMS AS WELL AS THE PAIRS OF VEHICLE-LOADING PORTS FITTED ON EACH SIDE AND THE FOLDING STERN RAMP FITTED AT THE STERN DISTINGUISH THE SHIP FROM A STANDARD BREAK-BULK FREIGHTER OF ITS DAY, WHICH IT OTHERWISE STRONGLY RESEMBLES.

PHOTO SHOWING VEHICLE LOADING RAMP AT STERN



THE IMAGES ON THIS SHEET WERE FOUND IN US NAVY REPORTS LOCATED ON THE SHIP.

PLANNING DIAGRAM FOR LOADING HELICOPTERS

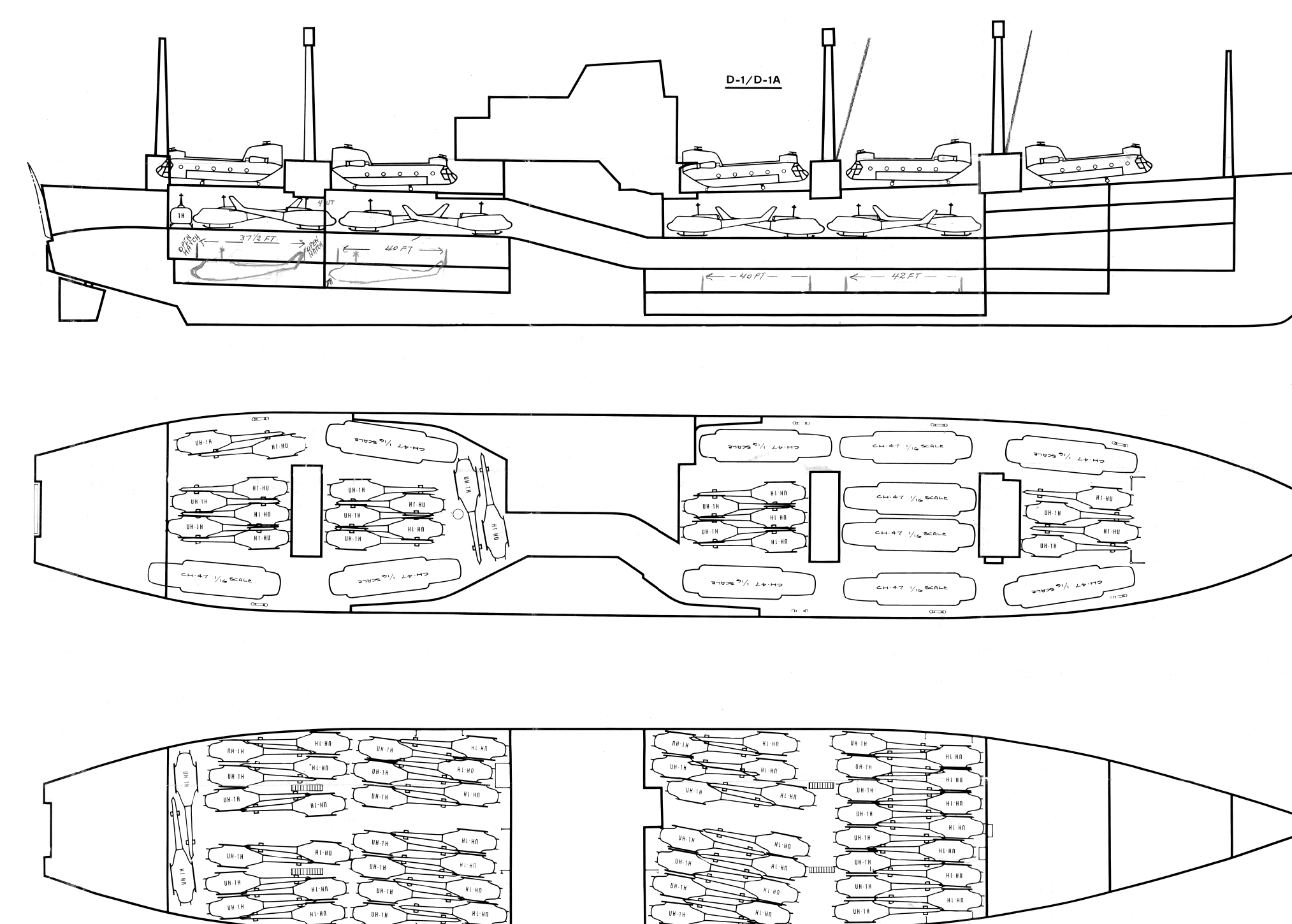

THIS RECORDING PROJECT WAS COSPONSORED BY THE HISTORIC AMERICAN ENGINEERING RECORD (HAER) AND THE U.S. MARITIME ADMINISTRATION (MARAD). THE VESSEL WAS DOCUMENTED UNDER THE DIRECTION OF TODD A. CROTEAU, HAER MARITIME PROGRAM COORDINATOR AND BARBARA VOULGARIS, MARAD HISTORIAN. TEAM MEMBERS INCLUDED ARCHITECTS ASHLEY T. WALKER, PHOTOGRAPHER JET LOWE AND HISTORIAN MICHAEL R. HARRISON.



# HISTORIC AMERICAN ENGINEERING RECORD

## USNS *COMET*

HAER No. CA-348

**Location:** Suisun Bay Reserve Fleet, Benicia vicinity, Solano County, California

**Type of Craft:** Roll-on, roll-off vehicle cargo ship

**Trade:** Transport of military vehicles and other rolling equipment

**MARAD Design No.:** C3-ST-14a

**Builder's Hull No.:** 601

**Navy Designation:** T-AKR-7 (formerly T-LSV-7; originally T-AK-269)

**Principal Measurements:**

Length (bp):	465'
Length (oa):	499'
Beam (molded):	78'
Designed operating draft:	22'
Displacement (full load; 27' draft):	16,489 long tons
Deadweight (on 22' draft):	6,489 long tons
Gross registered tonnage:	13,790
Net registered tonnage:	8,920
Maximum continuous shaft horsepower:	13,200
Normal shaft horsepower:	12,000
Service speed:	18 knots
Cruising radius at 18 knots:	13,000 miles

(The listed dimensions are as built, but it should be noted that draft, displacement, and tonnages are subject to alteration over time as well as variations in measurement.)

**Propulsion:** Steam turbines

**Dates of Construction:** Keel laid, May 15, 1956; launched, July 31, 1957; delivered, January 24, 1958

**Designer:** George G. Sharp, Inc., naval architects, New York, New York

**Builder:** Sun Shipbuilding and Dry Dock Co., Chester, Pennsylvania

**Original Owner:** U.S. Navy

**Present Owner:** Maritime Administration  
U.S. Department of Transportation

**Disposition:** Laid up in the National Defense Reserve Fleet



**Significance:** USNS *Comet* was the first purpose-built, deep-draft, ocean-going vessel designed for roll-on/roll-off handling of vehicles and other wheeled cargo.

**Historian:** Michael R. Harrison, 2010

**Project Information:** This project is part of the Historic American Engineering Record (HAER), a long-range program to document historically significant engineering and industrial works in the United States. The Heritage Documentation Programs of the National Park Service, U.S. Department of the Interior, administers the HAER program.

The project was prepared under the direction of Todd Croteau (HAER Maritime Program Coordinator), who also generated the vessel drawings. Jet Lowe (HAER Photographer) produced the large-format photographs, and Michael R. Harrison (Historian) wrote the historical report.



## PART I. HISTORICAL INFORMATION

### A. Physical History

**1. Dates of construction:** The contract for the *Comet*'s construction was awarded June 29, 1955. Workers laid the ship's keel May 15, 1956. The ship was launched July 31, 1957, and delivered January 24, 1958.

**2. Designer:** The Military Sea Transportation Service (MSTS), an agency within the Department of the Navy, undertook the preliminary development studies. The U.S. Navy Bureau of Ships, working with the Maritime Administration (MARAD) and the U.S. Army Transportation Corps, then contracted the *Comet*'s design to George G. Sharp, Inc., naval architects of New York City. The Bureau of Ships formulated the initial design criteria and forwarded this data along with preliminary drawings to the naval architects in April 1954. In close consultation with the Bureau of Ships, the naval architects with George G. Sharp, Inc. developed a preliminary design over the next four months. They then developed the contract plans between late August 1954 and early February 1955. The navy tested the lines of the ship's hull using models at the David Taylor Model Basin in late August or early September 1954.<sup>1</sup>

**3. Builder:** Sun Shipbuilding and Dry Dock Company, Chester, Pennsylvania. The ship was built for the U.S. Navy under the supervision of the Maritime Administration. It was constructed on the yard's shipway no. 2, and was sponsored at its launch by Bertha Sabin (née Bresnahan), wife of Vice Admiral Lorenzo S. Sabin, Jr., the U.S. Atlantic Fleet amphibious force commander.<sup>2</sup>

**4. Original plans:** The navy's Bureau of Ships, working with the Maritime Administration, designed the *Comet* as a vehicle cargo ship for point-to-point ocean transport of fully loaded Department of Defense self-propelled wheeled and tracked vehicles. The ship is built of welded and riveted steel and subdivided by transverse bulkheads into seven compartments, including four for cargo and one for the engine machinery. The ship is fitted with a stern ramp, four side vehicle-loading ports, and a sequence of internal ramps that allow vehicles to be wheeled directly into the holds. Kingposts and cargo booms along the length of the Main Deck allow cargo to be lifted on and off through deck hatches as well. The propulsion system comprises two boilers supplying steam to geared turbines driving twin screws. The ship's superstructure consists of a single deckhouse positioned near amidships over the machinery spaces. The substantial construction of the kingposts and booms as well as the pairs of vehicle-loading ports fitted on each side and the folding stern ramp fitted at the

---

<sup>1</sup> George G. Sharp, Inc., *Design History for V-5050 Vehicle Cargo Ship*, pp. 1-11, copy in National Archives and Records Administration, College Park, Md. [NARA], Records of the Maritime Administration (RG 357), Ship Specification Files 1936-2004, box 48.

<sup>2</sup> J. M. Hart, Sun Shipbuilding press release, July 26, 1957, in Hagley Museum and Library, Wilmington, Del., Sun Shipbuilding and Dry Dock Co. Records (acc. 1718), series v: Records of Individual Ships, USNS *Comet*. Mrs. Sabin's full name was located in a biographical document dated Dec. 3, 1957, Hoover Institution Archives, Stanford, Cal., Lorenzo S. Sabin, Jr. Papers (1909-78), box 1, folder: Biographical file—Biographical Sketches.



stern distinguish the ship from a standard break-bulk freighter of its day, which it otherwise strongly resembles.

A full-scale mock-up of one of the ship's cargo decks was painted on a parking lot at the Army Transportation Corps's headquarters at Fort Eustis, Virginia, in 1954 to test the cargo loading and stowage arrangements. Drivers maneuvered military vehicles of all kinds through the mock-up to test loading and unloading.<sup>3</sup> As further design insurance, the construction contract required the builders to furnish the navy two models demonstrating aspects of the cargo handling arrangements. The first was a "model of the ramp between the main deck and second deck, 1/2 inch to the foot, showing all surrounding structure with proper clearances. . . . Side bulkheads of ramp shall be made of transparent plastic, so that model vehicles may be observed on ramp." The second model was a 1/2 inch-to-the-foot hand-operable mock-up of the kingposts, booms, and cargo rigging between frames 48 and 102. These models were in addition to a display model for exhibition purposes, also to be supplied by the builders.<sup>4</sup> Additionally, a modification to the builder's contract in the amount of \$5,800 from December 1957 covered the expense of an army vehicle demonstration.<sup>5</sup>

**5. Original cost:** The price specified in the original contract between the Maritime Administration and Sun Shipbuilding was \$10,942,023. Twenty-four contract modifications listed in MARAD's records added approximately \$173,037 to the price, bringing the *Comet's* construction cost to just over \$11.12 million.<sup>6</sup>

**6. Alterations and additions:** Documentation of significant alterations to the ship's form or machinery has not been found.

## B. Historical Context

The Military Sea Transportation Service (MSTS) was established within the Department of the Navy in 1949 to bring together in a single agency all army and navy ocean cargo operations. Initially, the service acquired ships from its predecessor agencies and from the reserve fleet administered by the Maritime Commission (predecessor to MARAD), and it operated commercial ships under charter. In fiscal year 1954, its core fleet of government-owned, civilian-manned vessels comprised 233 ships, nearly all built during World War II.

---

<sup>3</sup> George G. Sharp, Inc., *Design History*, 6; Peter Lawton, "Sun Ship's 'Floating Garage' Goes to Sea," reprint from *Our Sun* (spring 1958), [2], copy in Ralph E. Cropley Scrapbooks, Transportation Collections, National Museum of American History, Washington, D.C.

<sup>4</sup> *Specifications for Construction of a Vehicle Cargo Ship (Roll-on/roll-off) T-AK269, Maritime Administration Design C3-ST-14a*, typeset copy dated Jan. 1955 including modifications of May 26 and June 2, 1955, p. 9. Copy in NARA, RG 357, Ship Specification Files 1936-2004, box 48.

<sup>5</sup> "Changes under the contract C3-ST-14a," notations inside front cover of *Specifications for Construction of a Vehicle Cargo Ship (Roll-on/roll-off) T-AK269, Maritime Administration Design C3-ST-14a*, draft typescript copy dated Jan. 21 and 24, 1955, with change orders noted from Nov. 1955 to May 1958. Copy in NARA, RG 357, Ship Specification Files 1936-2004, box 48.

<sup>6</sup> "Sun Shipbuilding gets contract," *Wall Street Journal*, June 30, 1955, 8; "Changes under the contract C3-ST-14a."



These hulls carried about 24 percent of the U.S. military's dry cargo (forty-five ships), all of its passengers (sixty-one ships), and about 72 percent of its petroleum (sixty-nine ships). The balance of the service's cargoes was carried in commercial vessels operated under charter and special tariff agreements.<sup>7</sup>

Pressure from private carriers to reduce what they perceived as unfair government competition for cargoes led during the early years of the Eisenhower administration to congressional pressure on MSTS to expand its use of private charters and to work more closely with the Maritime Administration (MARAD) to encourage private industry to build the sorts of ships MSTS needed for its defense missions. There were certain types of special-purpose vessels the military wanted, however, whose commercial value was either limited or unknown, and the navy was able, in the midst of a flurry of legislation designed to aid private shippers, to secure funding in 1954 for eight specialized ships.<sup>8</sup> Seven of these were designed for Arctic service and incorporated icebreaking capabilities and other cold-environment adaptations. The eighth, *Comet*, was intended to test the practicality and effectiveness of roll-on, roll-off vehicle carrying.<sup>9</sup>

A roll-on, roll-off ship is a vessel intended for ocean service into which self-propelled vehicles and equipment can be loaded as cargo under their own power, without the need to hoist them aboard through deck hatches. Such ships can also carry full trailers of cargo without the need to break bulk. Roll-on, roll-off cargo handling greatly reduces loading and discharge times in port, lowers crating and packaging expenses, and reduces opportunities for dockside pilferage, but the space occupied by wheeled chassis in the hold also reduces a ship's revenue-producing capacity. Today, vessels of this kind are called "ro-ro" or "ro/ro" ships, but this shorthand only developed after about 1965.

The concept was first tested on a large scale during World War II, when British and American designers developed a variety of landing craft to deliver troops, tanks, trucks, and other equipment directly onto unimproved beaches. British entrepreneur Frank Bustard's Atlantic Steam Navigation Company started the first commercial roll-on, roll-off ferry

---

<sup>7</sup> Rene De La Pedraja, *A Historical Dictionary of the U.S. Merchant Marine and Shipping Industry Since the Introduction of Steam* (Westport, Conn.: Greenwood Press, 1994), 400–402; House Committee on Merchant Marine and Fisheries, *Operations of Military Sea Transportation Service in Relation to Maintenance and Development of the Merchant Marine*, 83rd Cong., 2d sess., Aug. 19, 1954, H. Rep. 2672, 5.

<sup>8</sup> House Committee, *Operations of Military Sea Transportation Service*, 21; U.S. Department of Commerce, *Annual Report of the Federal Maritime Board and Maritime Administration*, 1955, 2, 8.

In August 1954, Congress enacted several significant aids to private shipping, including revised federal mortgage assistance for ship construction, authorizations for MARAD and the navy to charter new tankers, and the Cargo Preference Act, which required half of all government cargoes to travel in privately owned, U.S.-flag commercial vessels. "Congress passes shipping aid bill," *New York Times*, Aug. 19, 1954, 45; Murray A. Bloom, "The Cargo Preference Act of 1954 and Related Legislation," *Journal of Maritime Law and Commerce* 39, no. 3 (July 2008): 289–91.

<sup>9</sup> The seven ships built for the MSTS Arctic program were the unique cargo ship dock *Point Barrow*, the 3,450-dwt tankers *Alatna* and *Chattahoochee*, and the 2,500-gross-ton cargo ships *Eltanin*, *Mirfak*, and *Mizar*. "Navy reveals arctic ships," *Washington Post*, Nov. 14, 1955, 7; "2 big new liners to be built in U.S.," *New York Times*, Nov. 14, 1955, 51; *Annual Report of the Federal Maritime Board and Maritime Administration*, 1955, 10.



service in 1946 by chartering and converting wartime tank landing ships (LSTs), which operated initially between Tilbury, England, and Hamburg, West Germany, and, from 1948, between Preston, England, and Larne, Northern Ireland.<sup>10</sup>

The idea appealed to U.S. coastal and short-sea shippers, who saw in it a way to reduce costs while speeding deliveries, and a number of companies purchased war-surplus landing ships to begin small-scale operations. American coastal operators, however, received no construction or operating subsidies, and, until Congress made mortgage insurance available to unsubsidized carriers in 1954, they were unable to raise the capital needed to develop new roll-on, roll-off ships and infrastructure. Overseas cargo carriers, many of whom benefited from subsidies, were cool to the concept because of the hold space it wasted, and took no steps to invest in this experimental cargo-handling technique. The *Comet* became, therefore, not just the military's prototype for what a purpose-built roll-on, roll-off ship could be, but private industry's as well. A writer for Sun Shipbuilding's staff magazine noted, "The *Comet* represents the maritime industry's first opportunity, after years of inconclusive experience with converted vessels, to evaluate realistically the merits of roll-on, roll-off cargo handling. If her performance proves up to expectations, the *Comet* may well spark a dramatic change in the water transportation of dry cargo."<sup>11</sup>

The *Comet's* performance in service impressed military leaders, who felt an "urgent need" for more ships like it. The month after MARAD awarded the *Comet's* construction contract, Maritime Administrator Clarence G. Morse stated his intention to work with the Department of Defense to create "an available source of privately owned roll-on-roll-off ships to provide ocean transportation for mobile military equipment." The primary difficulty was that the design failed to impress private industry, and the navy had to return to Congress to secure funding for a second vessel.<sup>12</sup> In the interim, MSTS was able to acquire two other ships to meet the military's vehicle-cargo needs. The first was USNS *Taurus*, a wartime dock landing ship (LSD) completed under a federal mortgage guarantee as the trailership *Carib Queen* in 1957. Its original owner, TMT Trailer Ferry, Inc., of Miami, was not able to make the ship pay commercially, and it defaulted on the ship's mortgage. MARAD repossessed the ship in 1958 and transferred it to MSTS in 1959, where it became a running mate for the *Comet* in transatlantic shuttle service.<sup>13</sup> In 1962, MSTS chartered *Transglobe*, the

---

<sup>10</sup> In September 1957, four months before *Comet* entered service, Atlantic Steam Navigation Co. took possession of the first purpose-built British roll-on, roll-off ship, the 2,700-gross-ton MV *Bardic Ferry*, built by William Denny & Bros. at Dumbarton, Scotland. A sister vessel, *Ionic Ferry*, entered service in October 1958. "Clyde-built ferry's maiden voyage," *Glasgow Herald*, Sept. 4, 1957, 9; John Kerr, "Roll-on/Roll-Off British Style," *Marine Engineering/Log* 63, no. 7 (July 1958): 76-77.

<sup>11</sup> Quote from Lawton, "Sun Ship's 'Floating Garage' Goes to Sea," [1]; "3 lines win funds for trailer ships," *New York Times*, Aug. 26, 1955, 38; John Bunker, "Trailers to go down to the sea? U.S. builds up steam for truck-toting ships," *Christian Science Monitor*, Nov. 1, 1955, 3.

<sup>12</sup> Quotes from "U.S. seeking to spur ship trade to build roll-on-roll-off types," *New York Times*, July 19, 1955, 54. Werner Bamberger, "Navy to acquire 'roll-on' vessel," *New York Times*, Jan. 14, 1959, 46.

<sup>13</sup> *Carib Queen* made the first transatlantic crossing by a commercial roll-on, roll-off ship in 1957. The first westbound cargo comprised 110 foreign-made automobiles and twelve Swiss and German trailers packed with wines, cognacs, cheese, machine parts, and tires. "Trailers cross Atlantic," *New York Times*, Feb. 26, 1957, 58; Brian Cudahy, *Box Boats: How Container Ships Changed the World* (New York: Fordham University Press, 2006), 22;

converted 1944-built C4 hospital transport *Marine Wolf*.<sup>14</sup> Finally, in 1963, Congress appropriated funds for the navy to order a second purpose-built roll-on, roll-off ship. The result was USNS *Sea Lift*, launched in 1965 and delivered in 1967. Renamed USNS *Meteor* in 1975, the ship was an enlarged adaptation of the *Comet*'s design, incorporating numerous design changes based on experience gained operating the *Comet*.<sup>15</sup>

Efforts by the navy to secure funding for additional purpose-built vehicle-cargo ships met strong resistance from commercial shippers and members of Congress (as detailed in section I.C, "Operational History," below), and it was not until 1965, after deep-sea shippers across the globe had begun to develop the commercial possibilities of the ro-ro concept, that the navy was able to work out an arrangement that allowed further construction. In exchange for a guaranteed long-term charter from MSTS, the American Export-Isbrandtsen Co., owner of the subsidized American Export-Isbrandtsen Lines, co-financed the construction of a ro-ro with Sun Shipbuilding and Dry Dock Company. The resulting ship, the gas-turbine-powered *Adm. Wm. M. Callaghan*, was delivered in 1967, and Sun Shipbuilding developed a class of ro-ros for U.S.-flag commercial operation based on its design.<sup>16</sup>

As of 2010, Military Sealift Command (as MSTS became in 1970) maintains an inventory of twenty-seven ro-ro ships. While ro-ros now deliver most of the world's vehicle exports to their destination markets, the specialized pure car carriers (PCC) and pure car/truck carriers (PCTC) that engage in this trade are almost entirely developed, built, and registered overseas.

In 1991, *Baltimore Sun* reporter John H. Gormley, Jr. wrote that the *Comet*

is one of those quiet, unassuming pioneers bound to live out their old age in obscurity despite youthful accomplishments. . . .

Tied up at Dundalk Marine Terminal and disgorging a steady stream of Army vehicles returning from the Persian Gulf, the USN[S] *Comet* looked to the casual observer like just another pale gray military cargo ship. The only clue to her special status in the history of the maritime industry was stenciled

---

Naval Historical Center, "Taurus," *Dictionary of American Naval Fighting Ships*, <http://www.history.navy.mil/danfs/t3/taurus-ii.htm>; Werner Bamberger, "Navy to acquire 'roll-on' vessel," *New York Times*, Jan. 14, 1959, 46.

<sup>14</sup> Werner Bamberger, "Navy will order a vehicle vessel," *New York Times*, Apr. 21, 1963, 88.

<sup>15</sup> "Plan for new 'Comet' OK'ed by BuShips and MSTS," *Sealift Magazine* 13, no. 5 (May 1963): 11; Naval Historical Center, "Sea Lift," *Dictionary of American Naval Fighting Ships*, [http://www.history.navy.mil/danfs/s8/sea\\_lift.htm](http://www.history.navy.mil/danfs/s8/sea_lift.htm).

<sup>16</sup> Charles Zeien, "Development of Large Commercial Roll On/Roll Off Ships, Trailerships, and Car Carriers," in *A Half Century of Maritime Technology 1943-1993*, ed. Harry Benford and William A. Fox (Jersey City: Society of Naval Architects and Marine Engineers, 1993), 228; H. P. Drewry (Shipping Consultants) Limited, *RO/RO Shipping: An Appraisal of its Role in Dry Cargo Trade* (London: HPD Shipping Publications, 1977), 5, 12; *Sealift Magazine* 16, nos. 1-2 (Jan.-Feb. 1966): 3, 20.

in unobtrusive black letters under the wings of the ship's bridge: "THE MOTHER OF ALL RO/RO'S."<sup>17</sup>

### C. Operational History

The *Comet* sailed on its maiden voyage under the command of Capt. Harry D. Chemnitz from Philadelphia to St. Nazaire, France, on January 28, 1958. The cargo included 399 vehicles. It took drivers twelve hours to load this cargo, an operation the navy estimated would have taken three days on a standard cargo ship, and which they hoped could be accomplished in four hours when the crew was fully trained and accustomed to loading the new ship. The *Comet* then sailed for Bremerhaven, Germany, where it discharged its eastbound cargo and took on passenger cars for delivery to the Brooklyn Army Terminal in New York Harbor. "After discharging here," the *New York Times* reported, "Comet will sail Monday for Hampton Roads, Va., to load 300 two-and-a-half-ton trucks for France and Germany."<sup>18</sup>

In the spring, the *Comet* participated in Operation Sea Life for Security, the navy's ninth annual summer supply mission to U.S. installations along the Labrador and Newfoundland coasts north of the Arctic Circle. In early summer, the *Comet* carried 62' Redstone missiles to Europe for installation at American bases in West Germany. During late July and early August, the *Comet* supported Operation Bluebat, a military intervention that landed upwards of 14,000 troops in Lebanon to support the country's government. The ship met with logistical difficulties loading tanks at Bremerhaven for transport to Beirut. "The lack of loading ramps and the narrow pier aprons at Bremerhaven . . . prevented roll-on loading," historian Gary H. Wade has written, "but crane loading took no longer than for conventional vessels. Once aboard, the vehicles were driven to their parking areas." At the end of the operation, the *Comet* loaded tanks and other equipment at Beirut for transfer to the Incirlik Air Base near Adana in Turkey.<sup>19</sup>

In November, the *Comet* took part in Operation Gyroscope, the army's program for rotating units to and from bases overseas. In this case, the ship carried the household goods of 200 families belonging to the 82nd Airborne Division's 504th Battle Group from the U.S. to Europe. Ordinarily, household goods would be boxed at soldiers' homes, taken to an army warehouse for crating, and then shipped break bulk. In this case, boxed possessions were loaded directly onto thirty commercial tractor-trailers, which carried them from Fort Bragg, North Carolina, to Norfolk, Virginia. "The vans, attached to their individual tractors, were

---

<sup>17</sup> John H. Gormley, Jr., "Navy's Comet is old and gray but still hauling cargo," *Baltimore Sun*, June 21, 1991, 1B.

<sup>18</sup> "USNS Comet, prototype vehicle cargo ship," clipping in Cropley Scrapbooks; Lawton, "Sun Ship's 'Floating Garage,' Goes to Sea," [2]; "New ship rolls vehicles to pier," *New York Times*, Feb. 21, 1958, 45.

<sup>19</sup> "Arctic supply job is begun by navy," *New York Times*, May 24, 1958, 42; Jack Raymond, "U.S. Army abroad to get Redstone," *New York Times*, June 4, 1958, 13; Lt. Col. Gary H. Wade, *Rapid Deployment Logistics: Lebanon, 1958*, Combat Studies Institute Research Survey No. 3 (Fort Leavenworth, Kans.: U.S. Army Command and General Staff College, Oct. 1984), 38; Waldo Drake, "U.S. sending more troops to Lebanon," *Los Angeles Times*, Aug. 3, 1958, 6; "2 bombs shake truce in Beirut," *Baltimore Sun*, Aug. 9, 1958, 9.



rolled aboard the *Comet* at the Hampton Roads Army Terminal. When the cargo vans were in place the tractors were disengaged and returned to the pier," the *New York Times* reported. "At Bremerhaven, Germany, the *Comet* will be met by another fleet of tractors, which will haul the vans to the prepared residences of the families." Using the *Comet* eliminated the expense, time, and waste of crating and reduced the number of times possessions had to be handled.<sup>20</sup>

Unlike World War II landing craft, the *Comet* was not designed to deliver vehicles directly onto a beach. To allow ship-to-shore cargo landing in unimproved harbors, the army commissioned an experimental beach discharge lighter in 1959. The *Lt. Col. John U. D. Page* was designed to dock stern-to-stern with the *Comet* and load vehicles from the latter's lowered stern ramp. It would then run itself on shore and discharge its cargo through its own bow ramp. The first transfer test using the two vessels was performed off Fort Eustis, Virginia, on August 26, 1959. Experience quickly established that maneuvers using the two ships could be "exceptionally difficult" and even "dangerous." Operations were, therefore, limited to conditions where the relative motion between the two vessels was 4' or less. "Since this condition occurs at relatively low sea states (upper sea state two)," a 1967 report noted, "the usefulness of these ships for mating is severely compromised." Nevertheless, the *Page* and the *Comet* saw extensive and successful use in Vietnam.<sup>21</sup>

In 1963, the navy let the contract for its second purpose-built roll-on, roll-off vehicle cargo ship, USNS *Sea Lift* (now USNS *Meteor*), but when the Department of Defense sought funds for a third, shipping-industry executives, fearing that additional navy cargo ships would siphon military cargoes away from commercial operators, argued that ships of this type were not a sound use of government money. Jones F. Devlin, vice president of operations for United States Lines, a subsidized cargo and passenger line, argued in congressional hearings that ships like the *Comet* were not self-sustaining and needed "specialized conditions such as shoreside ramps, specially bulkheaded piers or an expensive satellite craft which can only be used in calm waters if it happens to be there at the same time" to unload their cargo. "Ideal conditions for loading and unloading cargo," he stated, "are seldom available in wartime." Andrew D. Warwick, Jr., president of the stevedoring firm T. Hogan & Sons, Inc., noted that wheels and chassis took up valuable space that could

---

<sup>20</sup> "Army families shifted by van," *New York Times*, Nov. 21, 1958, 51.

<sup>21</sup> Technical specifics for USAV *Lt. Col. John U. D. Page* are: length, 338'; beam, 65'; displacement, 2,200 tons; engines, two 1,200-bhp diesels; speed, 10 knots without cargo; capacity, 1,000 tons; capacity with 4' draft at bow, 600 tons; range, 4,800 miles; crew, eight warrant officers and thirty-six enlisted men, plus berth space for 125 vehicle drivers. Ira S. Varner, "Army Beach Discharge Lighter," *Naval Engineers Journal* 80, no. 1 (Feb. 1968): 59, reprinting an article from *The Military Engineer* (Sept.-Oct. 1967); "Cargo transfer test," *Washington Post*, Aug. 28, 1959, A4; quotations from T. Hsieh, C. C. Hsu, et al., *Rough Water Mating of Roll-on/Roll-off Ships with Beach Discharge Lighters* (Hydronautics, Inc., technical report 636-1, July 1967), 1. This study concluded, "[T]he roll characteristics of the *Comet* are essentially those of a conventional dry cargo vessel while the corresponding characteristics of the *Page* are similar to those of a barge, with high initial stability and short rolling periods. Mating problems would be simplified if motion characteristics were essentially the same. To obtain such conditions requires the use of similar hulls, of about the same size, or some radical method of changing motion characteristics. . . . [T]here appears to be no promising method for greatly improving the existing mating method."

otherwise be filled with cargo. Against these arguments military planners countered that the *Comet* provided speed of deployment. Defense Secretary Robert McNamara told the House Merchant Marine subcommittee that just four roll-on/roll-off ships would give MSTs “the capacity to move one whole armored division overseas and get it into action considerably sooner than if the vehicles had to be hoisted in and out of the holds of conventional cargo ships.”<sup>22</sup>

To evaluate these questions, the navy organized two tests to compare the *Comet*'s performance to that of a high-speed but otherwise conventional cargo ship, the United States Lines freighter *American Charger*. In the first test, the *Comet* sailed from Norfolk on July 12, 1963, and arrived in Bremerhaven on the twenty-first, where a full cargo of 297 trucks, ammunition carriers, and howitzers was unloaded in two hours, twenty-three minutes. The *American Charger* sailed from Norfolk on July 15 and also arrived in Bremerhaven on the twenty-first. Stevedores unloaded its cargo of 187 pieces of rolling equipment in six hours, fourteen minutes.<sup>23</sup>

The *American Charger* represented United States Lines' newest class of ships, the so-called *Challenger* class. Although the ship's normal operating speed was 21 knots, as a subsidized liner built under a federal construction-differential subsidy, it had 10 percent reserve engine horsepower built in for times of national emergency. Normally, the Maritime Administration prohibited carriers from using their vessels' reserve horsepower except in emergencies, but in this case it appears permission was given. The *American Charger* averaged 24.9 knots on the first test crossing, with the best day's run averaging 25.26 knots – a very high speed for a cargo ship, and, in fact, the fastest crossing of the Atlantic by a cargo ship to that date.<sup>24</sup>

In the second test, the *Comet* departed Norfolk on August 15 and arrived in Bremerhaven nine days later. The 2,441-ton cargo, comprising 336 tanks, personnel and ammunition carriers, trucks, and other equipment, was discharged onto barges in the Weser River in three hours, twenty-six minutes. Both the heavy-lift booms and the stern ramp were used for offloading. The *American Charger* left Norfolk on August 8, loaded with 191 vehicles weighing 2,491 tons. After a crossing of five days, twenty-one hours, twenty-one minutes

---

<sup>22</sup> Senate Committee on Appropriations, *Department of Defense Appropriations for 1964: Hearings on H.R. 7179*, 88th Cong., 1st sess., 1963, 1344–46, 1352; Werner Bamberger, “Navy cargo ship sails in contest,” *New York Times*, July 13, 1963, 44. Devlin and Warwick also testified against the *Comet* before the House Appropriations Committee; see House Committee on Appropriations, *Department of Defense Appropriations for 1964: Hearings on H.R. 7179*, 88th Cong., 1st sess., 1963, part 6: 777–87.

<sup>23</sup> Senate Committee, *Defense Appropriations for 1964*, 1349; Werner Bamberger, “Navy ship to race in valuation test,” *New York Times*, June 27, 1963, 66; idem, “Navy cargo ship sails in contest,” 44; “Comet wins port unloading test,” *Baltimore Sun*, Aug. 7, 1963, 25; House Committee on Appropriations, *Defense Appropriations for 1965: Hearings on H.R. 10939*, 88th Cong., 2d sess., 1964, part 5: 551; Senate Committee on Appropriations, *Defense Appropriations for 1965: Hearings on H.R. 10939*, 88th Cong., 2d sess., 1964, part 2: 671; *Sealift Magazine* 13, no. 11 (Nov. 1963): 3–5, 16; *Sealift Magazine* 14, no. 1 (Jan. 1964): 20.

<sup>24</sup> “U.S. freighter sets mark for Atlantic,” *New York Times*, July 26, 1963, 52; Allen R. Ferguson, et al., *The Economic Value of the United States Merchant Marine* (Evanston, Ill.: Transportation Center at Northwestern University, 1961), 57.

where the ship's speed averaged 25.17 knots, stevedores unloaded the *Charger's* cargo onto barges in six hours, twenty-six minutes. The *Comet's* total performance in the second test was clocked at eight days, four hours, twenty-six minutes; the *American Charger's*, six days, four hours, two minutes.<sup>25</sup>

For both ships the military created as near to perfect conditions for cargo operations as possible. Jones Devlin of United States Lines witnessed the operations in the Weser and marveled,

Surely nowhere else could an operation like this be duplicated except by the U.S. Army and the U.S. Navy because every available U.S. Army flat lighter and commercial tug was placed in service to the end that not one hatch ever suffered from delay in lift-off operation. Certainly in two world wars in the European theater, never has such concentration of lighter and tug equipment been available for the dispatch of one vessel. It was spectacular and completely unrealistic.<sup>26</sup>

Which ship won? Shipping industry representatives felt the *American Charger's* shorter crossing time made it the clear winner. But, as John Callahan wrote in the *New York Times*, "the Navy argues that its prime consideration in planning for such ships is the turnaround time in port, not the speed with which a vessel can get to the port." In the end, heavy lobbying by industry based on these tests persuaded Congress not to appropriate money for additional navy roll-on, roll-off ships.<sup>27</sup>

The tests attracted a fair amount of attention from the press, and MSTS made certain photographers were on hand to record the cargo operations. The *Comet's* crew discovered, however, that when the stern ramp was lowered, the ship's name, painted on the ramp's outer side, disappeared against the dock. To make certain the ship could be identified in photographs, the crew painted "U.S. Naval Ship Comet" on a large signboard and hung it over the stern whenever the ramp was down. Within the year, the name was permanently painted above the entrance to the stern driveway so the ship could always be identified regardless of whether the ramp was up or down.<sup>28</sup>

---

<sup>25</sup> Edward A. Morrow, "Hare-tortoise race in roll-on ship test goes into last lap," *New York Times*, Aug. 17, 1963, 46; "Charger sets speed mark," *Baltimore Sun*, Aug. 19, 1963, 21; Werner Bamberger, "Cargo race ends; results awaited," *New York Times*, Aug. 29, 1963, 42; *Sealift Magazine* 13, no. 11 (Nov. 1963): 4; Senate Committee, *Defense Appropriations for 1965*, part 2: 671. The timings for the second test voyage given in the Senate hearings do not agree with those given in press accounts. As the press accounts uniformly agree, their numbers have been quoted.

<sup>26</sup> House Committee, *Defense Appropriations for 1965*, part 5: 551-52.

<sup>27</sup> House Committee, *Defense Appropriations for 1965*, part 5: 549-55; Senate Committee, *Defense Appropriations for 1965*, part 2: 670-74; John P. Callahan, "U.S. Lines opposes navy cargo plan," *New York Times*, Aug. 7, 1963, 66; "Groups criticize defense request," *Baltimore Sun*, Mar. 20, 1964, 27; Werner Bamberger, "3d roll-on craft for navy studied," *New York Times*, Mar. 27, 1964, 48.

<sup>28</sup> *Sealift Magazine* 13, no. 11 (Nov. 1963): 4.



In January 1964, the *Comet* unloaded a cargo of 386 vehicles in fifty-five minutes at Bremerhaven, the ship's fastest performance yet. MSTS credited "an experimental method of stowing vehicles in an athwartship position" for the speed of the offloading. Further tests in the summer of 1964 sought to simulate wartime conditions. Drivers loaded a cargo of 297 pieces in blackout conditions at the Hampton Roads Army Terminal in three hours, three minutes, then offloaded them in similar conditions at Bremerhaven in one hour, twenty-one minutes.<sup>29</sup>

The navy originally classified the *Comet* as a cargo ship, T-AK-269. Officials changed its classification to vehicle landing ship, T-LSV-7, in 1963, and then changed it again to vehicle cargo ship, T-AKR-7, in 1969.<sup>30</sup>

In 1965, the *Comet* and its MSTS running mates, USNS *Taurus*, and SS *Transglobe*, were shifted together from transatlantic service and began making voyages between American bases in the Pacific and Vietnam in support of army operations in southeast Asia. The *Comet* worked for at least five years on a twenty- to twenty-two-day circuit linking Naha, Okinawa; Cab Ranh Bay, Vietnam; and Sattaship, Thailand. Each summer the ship called in Japan for an annual overhaul. The shores of Cam Ranh Bay were unimproved, but the *Comet* worked in tandem with the beach discharge lighter Lt. Col. John U. D. Page to land vehicles quickly in the absence of piers or wharfs. Tests conducted at the Hampton Roads Army Terminal before the *Comet* sailed for the Pacific determined that the ship could launch army LARC-V amphibious vehicles directly into the water from its stern ramp, and the ship subsequently delivered large numbers of these craft to the war zone in Vietnam.<sup>31</sup>

After the end of U.S. involvement in Vietnam, the *Comet* returned to operations in the Atlantic, where it supported ongoing American activities in Western Europe. In 1985, the navy transferred the ship to the Maritime Administration, and it entered the Ready Reserve Fleet at Suisun Bay, California. In April of the next year, as part of a congressionally mandated effort to disperse the Ready Reserve Fleet among a greater number of ports, MARAD "outported" the *Comet* to Portland, Oregon. It was from this port that the ship was activated for service in Operations Desert Shield and Desert Storm in 1990 and 1991.<sup>32</sup>

Reporter John Gormley visited the *Comet* as it offloaded cargo in Baltimore in June 1991, and Capt. William Mahoney told him the ship had "been one of the most reliable in the fleet." "He attributes the performance to the qualities of the crew as much as the ship," Gormley wrote. "Captain Mahoney noted that only heavy-duty equipment such as tanks or other

---

<sup>29</sup> *Sealift Magazine* 14, no. 10 (Oct. 1964): 5; "Transport new and notes," *New York Times*, Feb. 3, 1964, 50; "Test on war cargo made by military," *New York Times*, Sept. 6, 1964, 58; *Sealift Magazine* 14, no. 12 (Dec. 1964): 14.

<sup>30</sup> *The Naval Institute Guide to Ships and Aircraft of the U.S. Fleet*, 18th ed (Annapolis: Naval Institute Press, 2005), 319.

<sup>31</sup> *Sealift Magazine* 15, nos. 8-9 (Aug.-Sept. 1965): 6-7; 16, no. 4 (Apr. 1966): 20; and 19, no. 6 (June 1969): 8-9.

<sup>32</sup> Maritime Administration property management record and custody cards for *Comet*, <https://pmars.marad.dot.gov/detail.asp?Ship=1077>; "Equipment arrives," *Wilmington (N.C.) Morning Star*, Aug. 25, 1983, 6B; "Army exercise gave port a military look," *Wilmington (N.C.) Morning Star*, Aug. 30, 1983, 6B; "Navy picks Portland for 4 ships," *Anchorage Daily News*, Sept. 20, 1985, C7.

military equipment would be able to ascend the stern ramp. 'She was designed for rugged military vehicles. You wouldn't want to drive a Toyota up here. Coming up here you'd probably lose part of the oil pan.'"<sup>33</sup>

The ship made numerous round trips from the east coast to the Persian Gulf, before returning to California for continued outporting at Alameda. The ship carried a cargo of Patriot missile launchers to South Korea in April 1994 to support the deployment of an army battalion from Ft. Bliss, Texas. It was activated a final time between February and May 2003 for Operation Enduring Freedom, then returned to Ready Reserve at Alameda. MARAD downgraded the ship to National Defense Reserve Fleet status in July 2006, and the vessel remains laid up at Suisun Bay today.<sup>34</sup>

## PART II. STRUCTURAL / DESIGN INFORMATION

### A. General Description

**1. Overall:** The *Comet* is a roll-on, roll-off vehicle cargo ship built of welded and riveted steel with a single deckhouse placed near amidships. Specifically designed for roll-on, roll-off operation, the ship's cargo-handling arrangements are its primary distinguishing features. As the ship's hull specifications declare,

The loading and discharge of vehicles will be between ship and piers, lighters, or other suitable craft. External and internal ramps have been provided and arranged for vehicle traffic to be maintained without excessive maneuvering of the larger types. In addition, regular cargo gear has been provided to assure efficient handling of vehicles when circumstances do not permit use of the external ramps. This gear is also suitable for general cargo in case the ship would be employed in this trade.<sup>35</sup>

The hull has a double bottom and is subdivided by six watertight bulkheads into four holds, engine room, and the fore- and afterpeaks. The fore to aft arrangement is as follows:

- Forepeak with boatswain's stores and chain locker above forepeak tank for seawater ballast.
- Hold No. 1, comprising space on three decks, over nos. 1 and 2 deep tanks for seawater ballast.
- Hold No. 2, comprising space on four decks, over no. 3 deep tank (for seawater ballast) and no. 4 deep tank (for ballast or fuel oil).
- Hold No. 3, on four decks, for vehicles.
- Engine space and vehicle cargo ramps. The bridge deckhouse lies above the engine compartment.

---

<sup>33</sup> Gormley, "Navy's Comet is old and gray but still hauling cargo," 1B.

<sup>34</sup> "Missile Launchers to head for Asia," *Lodi (Calif.) News-Sentinel*, Mar. 31, 1994, 5; Maritime Administration property management record for *Comet*.

<sup>35</sup> *Specifications for Construction*, 1.

- Hold No. 4, on three decks, for vehicles.
- Afterpeak with stern driveway located over the steering-gear room, with two seawater ballast tanks under.
- Six additional fuel-oil or seawater ballast tanks are located under the engine room and Holds 3 and 4.

**2. Decks:** The *Comet's* navigation spaces and crew quarters are located in the ship's five-deck near-midships deckhouse. Vehicle ramps coming up from the Platform Deck emerge at Main Deck level under the deckhouse. The Main Deck contains fourteen crew cabins; butcher shop; cargo office; dry stores; and hospital. The 01 Level holds five petty officers' cabins; three vehicle-directors' cabins; six crew cabins; galley; crew's and officers' mess rooms; crew's, officers', and vehicle-directors' lounges; and crew's and officers' pantries. The 02 Level contains fourteen officer's staterooms; captain's office; and chief engineer's offices. The 03 Level encompasses the wheelhouse; chartroom; radar and gyro room; radio room; captain's and chief engineer's staterooms; captain's sea cabin; and a fan room. The 04 Level holds the emergency generator room, located inside the false funnel.

**3. Cargo holds:** The *Comet* was built with four cargo holds. The main vehicular cargo holds, Nos. 3 and 4, are located fore and aft of the machinery space. Each is 130' long, and together they enclose 60,000 sq. ft. of deck space. Hold No. 3 spans four levels; No. 4, three. Each is equipped with a pair of side cargo doors (port and starboard) at Second Deck level. The ship's stern ramp provides direct access into Hold No. 4, and a series of ramps link No. 4 to No. 3. These same ramps provide driving access up to the open Main Deck, as well. The naval architects designed the two remaining holds, No. 1 (spanning three levels) and No. 2 (spanning four), for non-vehicular cargo.

Sun Shipbuilding and Dry Dock Company boasted when the *Comet* was new that the vessel could carry "one-sixth of the vehicles attached to an armored division." This amounted to 703 vehicles, although the exact number that could be carried depended on the size and type of cargo loaded. Along with jeeps, trucks, trailers, tanks, and other wheeled and tracked vehicles of all kinds, the ship is recorded to have carried missiles, howitzers, and helicopters from time to time as well.<sup>36</sup> This multiplicity of cargoes was made possible by deliberate design decisions. MSTS and the Bureau of Ships determined when the ship was planned that its deck scantlings should be of sufficient strength to support "any loaded vehicle that could enter the space within the headroom limitation."<sup>37</sup> The "headroom limitation" itself was made as generous as possible by building the decks within the vehicle holds without sheer. In other words, the decks were laid parallel to the keel, without any of the fore-to-aft curvature that in the mid-1950s was still a standard shipbuilding practice. Without sheer in the vehicle holds, the architects were able to provide a minimum 12'-6" clearance between the Main and Second decks and a 12'-6" clearance through all the side ports.<sup>38</sup>

---

<sup>36</sup> Lawton, "Sun Ship's 'Floating Garage' Goes to Sea," [2].

<sup>37</sup> George G. Sharp, Inc., *Design History*, 5.

<sup>38</sup> George G. Sharp, Inc., *Design History*, 6.

All cargo doors, ramps, ports, and hatches are hydraulically operated with the exception of the stern ramp, which is operated using chains hauled by electric winches.<sup>39</sup> These arrangements received significant notice in the trade press:

An interesting aspect of the *Comet* is the 883 tons of diversified hydraulic cargo-handling equipment aboard. Unusually massive main and tween-deck hatch covers, the latter capable of sustaining closely stowed 40-ton army tanks and vehicles on their flush surfaces, huge internal horizontal and vertical watertight sliding doors linking the vehicle holds and equally immense hinged vehicle ramps and side ports, all operate smoothly and quietly at the touch of a hydraulic control lever.<sup>40</sup>

Two small self-service passenger elevators are provided in the holds to carry drivers and vehicle directors. One is located at the aft end of Hold No. 3; the other is at the forward end of Hold No. 4. Both travel from the tank top to the Main Deck.<sup>41</sup>

**4. Crew accommodations:** As with all MSTS ships, a civilian crew manned the *Comet* for the navy. Berths were provided for the sixty-nine men in the ship's normal complement plus four spares. The officers were accommodated in private quarters, the crew in two-man cabins, and the vehicle directors in four-man cabins. By the end of the ship's career, its normal complement had been reduced to forty-four.<sup>42</sup>

**5. Safety:** The *Comet* is equipped with systems for the detection of smoke, vehicle exhaust gases, and fumes from fuel leaks in addition to an extensive fresh-air ventilation system throughout the cargo holds. It has a carbon-dioxide fire-suppression system and a wash and drainage system for handling spilled gasoline, oil, mud, and grease on the vehicle decks. The extensive system of watertight doors is hydraulically operated.<sup>43</sup>

The *Comet* is also furnished with two hand-propelled aluminum seventy-person lifeboats, each 30' x 10' x 4'-1-1/2". Each is launched from gravity davits fitted at the superstructure's 02 Level; boarding is accomplished with the boats lowered to the 01 Level.<sup>44</sup> Canister life rafts supplement the lifeboats, but are not original ship's equipment.

---

<sup>39</sup> *Specifications for Construction*, 198-99.

<sup>40</sup> "USNS *Comet*: Sun delivers prototype vehicle cargo ship at MSTS," clipping in Hagley Museum and Library, Sun Shipbuilding and Dry Dock Co. Records (acc. 1718), series v: Records of Individual Ships, USNS *Comet*.

<sup>41</sup> *Specifications for Construction*, 16 and 199.

<sup>42</sup> *Specifications for Construction*, 2, 80-85; *Naval Institute Guide*, 318.

<sup>43</sup> Lawton, "Sun Ship's 'Floating Garage' Goes to Sea," [2].

<sup>44</sup> *Specifications for Construction*, 70.



## B. Mechanical Features

**1. Engine Plant:** The ship is propelled by a pair of single-cylinder geared turbines. These are coupled to the drive shafts and twin screws through double-helical, double-reduction gears. Each turbine is rated at 6,600 maximum continuous shp and generates 124 rpm at the propellers. Normal power is 6,000 shp for each turbine, for a combined normal power of 12,000 shp and a service speed of 18 knots. The General Electric Company manufactured the turbines and reduction gearing.<sup>45</sup>

**2. Boilers:** Steam generation is handled aboard the *Comet* by two oil-burning, forced-draft, water-tube boilers. The system was designed to supply steam to the turbine chests at 600 psig and 855 degrees F. To accommodate the design of the vehicle ramps, each boiler is fitted with separate uptakes leading to twin stacks abreast a false funnel atop the deckhouse.<sup>46</sup>

**3. Electrical system:** Two 600 kW steam-turbine generator sets made by General Electric produce the electrical supply for the ship. A diesel emergency generator rated at 100kW is also fitted.<sup>47</sup>

**4. Cargo handling arrangements:** As Sun Shipbuilding's in-house magazine described it in 1958,

Vehicles are driven off or onto the *Comet* on portable ramps through the side ports or over the stern ramp. All ports open onto the second deck. From this level vehicles can either be driven topside to the weather deck [Main Deck], which provides an additional 15,000 square feet of parking space, or down to stowage locations at lower levels. Vehicle drivers are directed through the *Comet*'s maze of ramps and U-turns by a traffic control signal system. Twelve vehicle directors stationed aboard the vessel supervise all traffic movement. Each has a telephone in a sound-proof booth for communication within the ship.<sup>48</sup>

Another author noted,

One gets the impression that practically every square foot of decks and bulkheads is mechanized in one form or another, for this, the world's largest application, involves over 24,000 square feet of hydraulically operated equipment. MacGregor-Comarain, Inc., has designed, delivered and fabricated all of these devices.<sup>49</sup>

---

<sup>45</sup> "USNS *Comet*: Sun delivers prototype"; *Specifications for Construction*, 103-16.

<sup>46</sup> "USNS *Comet*: Sun delivers prototype"; *Specifications for Construction*, 140-45.

<sup>47</sup> "USNS *Comet*: Sun delivers prototype"; *Specifications for Construction*, 208-09.

<sup>48</sup> Lawton, "Sun Ship's 'Floating Garage' Goes to Sea," [2].

<sup>49</sup> "USNS *Comet*: Sun delivers prototype."

The ship's internal ramps are inclined at 14 degrees and fitted with raised treads to prevent vehicles from slipping down their steel surfaces. Winches are installed at the head of each ramp to move stalled vehicles. The ship's original equipment also included a diesel tractor with a winch to haul, push, or pull inoperative vehicles. An overhead dotted line of red-painted metal plates, suspended from the deck beams in Holds Nos. 3 and 4, leads drivers through the vessel's cargo spaces. Easier to see from the hatches of a tank than lines painted on the deck would be, these guides are probably a subsequent addition to the ship's original traffic control system.<sup>50</sup>

Recessed vehicle securing points are provided throughout the cargo holds. Raised securing points are welded across the Main Deck as well.

Two portable ramps are carried to allow cargo operations through the vessel's side ports. In service, these were normally stowed on deck atop the No. 3 forward and No. 4 forward hatches and lowered into position between ship and pier using the cargo booms. Pairs of ramp attachment points are welded to the hull below each of the four side ports. Six additional pairs of attachment points allow the ramps to be positioned for direct vehicle access to the Main Deck.

The stern ramp lies along the ship's centerline. It is straight and non-slewing and is raised and lowered by chains hauled by electric winches. When at dock, the ramp has a maximum load of 60 long tons. When transferring cargo to lighters, the load is 50 long tons. The ramp can descend to a maximum angle of 20 degrees below horizontal. This slope appears to have been too steep for some vehicles, and two portable ramps, which functioned as a right/left pair, were procured at some point to increase the stern-ramp's functional length and decrease its slope.<sup>51</sup>

The *Comet* is also fitted with kingposts and twenty-two cargo booms in order to lift vehicles from the holds in situations where the ramps cannot be used. Certain booms also serve the two non-vehicle holds. Theoretically, this cargo gear allows the entire vessel to be used for break-bulk service, but the vehicle holds are not well suited to this kind of use. The booms range from 10- to 60-ton capacity. All cargo, topping, and vang winches are electric.<sup>52</sup>

Number of cargo booms of each type:	
Conventional rig, 10 ton	4
Farrel rig, 15 ton	14
Conventional rig, 15 ton	2
Farrel rig, 60 ton heavy lift	2

---

<sup>50</sup> *Specifications for Construction*, 198; *United States Naval Ship Comet*, n.p., booklet in Hagley Museum and Library, Sun Shipbuilding and Dry Dock Co. Records (acc. 1718), series v: Records of Individual Ships, USNS *Comet*.

<sup>51</sup> "Cargo Operations," sheet found aboard *Comet*, 1990s; *Specifications for Construction*, 198.

<sup>52</sup> "USNS *Comet*: Sun delivers prototype;" "Cargo Operations"; *Specifications for Construction*, 196-98.

### PART III. SOURCES OF INFORMATION

#### A. Primary Sources

George G. Sharp, Inc. *Design History for V-5050 Vehicle Cargo Ship*. Ship Specification Files 1936–2004. Records of the Maritime Administration (RG 357). National Archives and Records Administration, College Park, Md.

*Specifications for Construction of a Vehicle Cargo Ship (Roll-on/roll-off) T-AK269, Maritime Administration Design C3-ST-14a*, draft typescript copy dated Jan. 21 and 24, 1955, with change orders from Nov. 1955 to May 1958 noted inside cover. Ship Specification Files 1936–2004. Records of the Maritime Administration (RG 357). National Archives and Records Administration, College Park, Md.

*Specifications for Construction of a Vehicle Cargo Ship (Roll-on/roll-off) T-AK269, Maritime Administration Design C3-ST-14a*, typeset copy dated Jan. 1955 including modifications of May 26 and June 2, 1955. Ship Specification Files 1936–2004. Records of the Maritime Administration (RG 357). National Archives and Records Administration, College Park, Md.

Sun Shipbuilding and Dry Dock Company Records (acc. 1718). Hagley Museum and Library, Wilmington, Del.

#### B. Secondary Sources

Bloom, Murray A. "The Cargo Preference Act of 1954 and Related Legislation." *Journal of Maritime Law and Commerce* 39, no. 3 (July 2008): 289–313.

Cudahy, Brian. *Box Boats: How Container Ships Changed the World*. New York: Fordham University Press, 2006.

De La Pedraja, Rene. *A Historical Dictionary of the U.S. Merchant Marine and Shipping Industry since the Introduction of Steam*. Westport, Conn.: Greenwood Press, 1994.

Ferguson, Allen R., et al. *The Economic Value of the United States Merchant Marine*. Evanston, Ill.: Transportation Center at Northwestern University, 1961.

Friedman, Norman. *U.S. Amphibious Ships and Craft*. Annapolis: Naval Institute Press, 2002.

H. P. Drewry (Shipping Consultants) Limited. *RO/RO Shipping: An Appraisal of its Role in Dry Cargo Trade*. London: HPD Shipping Publications, 1977.

Hsieh, T., C. C. Hsu, et al., *Rough Water Mating of Roll-on/Roll-off Ships with Beach Discharge Lighters*. Hydronautics, Inc., technical report 636-1, July 1967.

Kerr, John. "Roll-on/Roll-Off British Style." *Marine Engineering/Log* 63, no. 7 (July 1958): 76–77.

Lawton, Peter. "Sun Ship's 'Floating Garage' Goes to Sea." Reprint from *Our Sun*, spring 1958. Copy in Ralph E. Cropley Scrapbooks, Transportation Collections, National Museum of American History, Washington, D.C.

Maritime Administration property management record and custody cards for *Comet*.  
<https://pmars.marad.dot.gov/detail.asp?Ship=1077>.

Naval Historical Center. *Dictionary of American Naval Fighting Ships*.  
<http://www.history.navy.mil/danfs/index.html>.

*The Naval Institute Guide to Ships and Aircraft of the U.S. Fleet*, 18th ed. Annapolis: Naval Institute Press, 2005.

U.S. Congress. Senate. Committee on Appropriations. *Department of Defense Appropriations for 1964: Hearings on H.R. 7179*. 88th Cong., 1st sess., 1963.

U.S. Congress. House. Committee on Appropriations. *Department of Defense Appropriations for 1964: Hearings on H.R. 7179*. 88th Cong., 1st sess., 1963.

U.S. Congress. Senate. Committee on Appropriations. *Department of Defense Appropriations for 1965: Hearings on H.R. 10939*. 88th Cong., 2d sess., 1964.

U.S. Congress. House. Committee on Appropriations. *Department of Defense Appropriations for 1965: Hearings on H.R. 10939*. 88th Cong., 2d sess., 1964.

U.S. Congress. House. Committee on Merchant Marine and Fisheries. *Operations of Military Sea Transportation Service in Relation to Maintenance and Development of the Merchant Marine*. 83rd Cong., 2d sess., Aug. 19, 1954. H. Rep. 2672.

U.S. Department of Commerce. Annual Reports of the Federal Maritime Board and Maritime Administration. Washington, D.C.: Government Printing Office, 1954–58.

Varner, Ira S. "Army Beach Discharge Lighter." *Naval Engineers Journal* 80, no. 1 (Feb. 1968): 59–62. Reprints an article from *The Military Engineer* (Sept.–Oct. 1967).

Wade, Lt. Col. Gary H. *Rapid Deployment Logistics: Lebanon, 1958*. Combat Studies Institute Research Survey No. 3. Fort Leavenworth, Kans.: U.S. Army Command and General Staff College, Oct. 1984.

Zeien, Charles. "Development of Large Commercial Roll On/Roll Off Ships, Trailerships, and Car Carriers." In *A Half Century of Maritime Technology 1943–1993*, edited by Harry Benford and William A. Fox, 227–34. Jersey City: Society of Naval Architects and Marine Engineers, 1993.

### **C. Newspaper Articles**

"Congress passes shipping aid bill." *New York Times*, Aug. 19, 1954, 45.

"Sun Shipbuilding gets contract." *Wall Street Journal*, June 30, 1955, 8.

"U.S. seeking to spur ship trade to build roll-on-roll-off types." *New York Times*, July 19, 1955, 54.

"3 lines win funds for trailer ships." *New York Times*, Aug. 26, 1955, 38.

Bunker, John. "Trailers to go down to the sea? U.S. builds up steam for truck-toting ships." *Christian Science Monitor*, Nov. 1, 1955, 3.

"2 big new liners to be built in U.S." *New York Times*, Nov. 14, 1955, 51.

"Navy reveals arctic ships." *Washington Post*, Nov. 14, 1955, 7.

"Trailers cross Atlantic." *New York Times*, Feb. 26, 1957, 58.



- "Clyde-built ferry's maiden voyage." *Glasgow Herald*, Sept. 4, 1957, 9.
- "New ship rolls vehicles to pier." *New York Times*, Feb. 21, 1958, 45.
- "Arctic supply job is begun by navy." *New York Times*, May 24, 1958, 42.
- Raymond, Jack. "U.S. Army abroad to get Redstone." *New York Times*, June 4, 1958, 13.
- Drake, Waldo. "U.S. sending more troops to Lebanon." *Los Angeles Times*, Aug. 3, 1958, 6.
- "2 bombs shake truce in Beirut." *Baltimore Sun*, Aug. 9, 1958, 9.
- "Army families shifted by van." *New York Times*, Nov. 21, 1958, 51.
- Bamberger, Werner. "Navy to acquire 'roll-on' vessel." *New York Times*, Jan. 14, 1959, 46.
- "Cargo transfer test." *Washington Post*, Aug. 28, 1959, A4.
- Bamberger, Werner. "Navy will order a vehicle vessel." *New York Times*, Apr. 21, 1963, 88.
- Bamberger, Werner. "Navy cargo ship sails in contest." *New York Times*, July 13, 1963, 44.
- Bamberger, Werner. "Navy ship to race in valuation test." *New York Times*, June 27, 1963, 66.
- "U.S. freighter sets mark for Atlantic." *New York Times*, July 26, 1963, 52.
- "Comet wins port unloading test." *Baltimore Sun*, Aug. 7, 1963, 25.
- Callahan, John P. "U.S. Lines opposes navy cargo plan." *New York Times*, Aug. 7, 1963, 66.
- Morrow, Edward A. "Hare-tortoise race in roll-on ship test goes into last lap." *New York Times*, Aug. 17, 1963, 46.
- "Charger sets speed mark." *Baltimore Sun*, Aug. 19, 1963, 21.
- Bamberger, Werner. "Cargo race ends; results awaited." *New York Times*, Aug. 29, 1963, 42.
- "Transport new and notes." *New York Times*, Feb. 3, 1964, 50.
- "Groups criticize defense request." *Baltimore Sun*, Mar. 20, 1964, 27.
- Bamberger, Werner. "3d roll-on craft for navy studied." *New York Times*, Mar. 27, 1964, 48.
- "Test on war cargo made by military." *New York Times*, Sept. 6, 1964, 58.
- "Equipment arrives." *Wilmington (N.C.) Morning Star*, Aug. 25, 1983, 6B.
- "Army exercise gave port a military look." *Wilmington (N.C.) Morning Star*, Aug. 30, 1983, 6B.
- "Navy picks Portland for 4 ships." *Anchorage Daily News*, Sept. 20, 1985, C7.
- Gormley, Jr., John H. "Navy's Comet is old and gray but still hauling cargo." *Baltimore Sun*, June 21, 1991, 1B.
- "Missile Launchers to head for Asia." *Lodi (Calif.) News-Sentinel*, Mar. 31, 1994, 5.

**APPENDIX I: ORIGINAL COMPLEMENT OF USNS COMET**  
 From *Specifications for Construction of a Vehicle Cargo Ship (Roll-on/roll-off) T-AK269,*  
*Maritime Administration Design C3-ST-14a*

Department	Officers	C.P.O.s	Men	Total
<b>Deck</b>				
Captain	1			
First mate	1			
Second mate	1			
Third mate	1			
Junior third mate	1			
Radio officer	1			
Bosun		1		
Carpenter		1		
AB seamen			6	
AB maintenance			5	
Ordinary seamen			3	
<b>Total deck department</b>	<b>6</b>	<b>2</b>	<b>14</b>	<b>22</b>
<b>Engineering</b>				
Chief engineer	1			
First assistant engineer	1			
Second assistant engineer	1			
Third assistant engineer	1			
Junior third assistant engineer	1			
Junior engineers	3			
Electrician		1		
Second electricians		3		
Oilers		3		
Firemen		3		
Wipers		3		
Engine – utility		1		
<b>Total engineering department</b>	<b>8</b>	<b>1</b>	<b>11</b>	<b>20</b>
<b>Steward's</b>				
Chief steward	1			
Chief cook		1		
Cook-baker			1	
Second cook			1	
Third cook			1	
Messmen			2	
Utility			6	
<b>Total steward's department</b>	<b>1</b>	<b>1</b>	<b>11</b>	<b>13</b>
<b>Purser's</b>				
Purser	1			
Yeoman-storekeeper		1		
<b>Total purser' department</b>	<b>1</b>	<b>1</b>		<b>2</b>
<b>Grand total – crew</b>	<b>16</b>	<b>5</b>	<b>36</b>	<b>57</b>
Vehicle directors			12	12
<b>Total</b>				<b>69</b>

**APPENDIX II: CARGO CAPACITY OF USNS COMET**  
 Transcribed with minor corrections from a sheet posted on board

LEVEL NAME	DECK	SQUARE FOOTAGE	CUBIC CAPACITY	OVERHEAD CLEARANCE	HATCH OPENING
Upper 'tween No. 1	Platform	2,283	14,929	6'-0"	18' x 20'
Lower 'tween No. 1	Second	1,727	14,309	7'-0"	18' x 18'
Hold No. 1	1st Platform	1,017	17,061	15'-0" forward 13'-6" aft	18' x 18'
Upper 'tween No. 2	Platform	3,138	20,496	6'-3"	17'-6" x 30'
Lower 'tween No. 2	Second	2,773	21,204	7'-8"	17'-6" x 28'
Upper Hold No. 2	1st Platform	2,282	26,222	13' forward 11' aft	17'-6" x 28'
Lower Hold No. 2	2nd Platform	2,059	17,366	7'-0"	17'-6" x 28'
Upper 'tween No. 3	Second	9,288	13,5076	16' forward 12'-1" aft	40' x 30'
Lower 'tween No. 3	1st Platform	8,737	84,766	10'-6"	40' x 28'-4"
Upper Hold No. 3	2nd Platform	7,463	54,782	7'-0"	40' x 28'-4"
Lower Hold No. 3	Hold (Tank Top)	7,452	55,254	7'-0"	40' x 28'-4"
Upper 'tween No. 4	Second	9,360	10,7168	12'-7"	37'-6" x 30'
Lower 'tween No. 4	1st Platform	7,981	74,458	10'-2"	37'-6" x 28'-4"
Hold No. 4	Hold (Tank Top)	6,755	40,764	7'-0"	37'-6" x 28'-4"
Main Deck over Hold No. 1		2,645			
Main Deck over Hold No. 2		3,000			
Main Deck over Hold No. 3		8,865			
Main Deck over Hold No. 4		8,489			

Total square footage: 96,439 (including 1,125 in the stern driveway)

Weight capacities (Holds Nos. 3 and 4, per square foot)

Main Deck: 360 lbs  
 Second Deck: 380 lbs  
 First Platform Deck: 430 lbs  
 Second Platform Deck: 620 lbs  
 Hold (Tank Top): 1,740 lbs

Side port openings: 12'-9" h x 15' w

Stern ramp opening: 12' h x 15' w

# HISTORIC AMERICAN ENGINEERING RECORD

## INDEX TO PHOTOGRAPHS

USNS *COMET*  
Suisan Bay Reserve Fleet  
Benicia vicinity  
Solano County  
California

HAER CA-348

## INDEX TO BLACK AND WHITE PHOTOGRAPHS

Jet Lowe, photographer, February 2009

- CA-348-1 Starboard bow showing ship's name, anchor chain, and mooring lines.
- CA-348-2 Forecastle, looking forward over the anchor windlass.
- CA-348-3 View of forward main deck taken from wheelhouse top. Hold No. 3 after hatch is in the foreground; No. 3 forward hatch is on the far side of the first pair of king posts.
- CA-348-4 View of forward king posts on the main deck taken from the starboard side. Note vehicle anchor points welded to the deck and 60-ton heavy-lift boom secured between the king posts.
- CA-348-5 Detail view, main deck, starboard side looking toward bow, showing forward cargo handling gear and vehicle anchor points welded along the deck.
- CA-348-6 View of main deck aft, starboard side, showing forward Hold No. 4 hatch and cargo-handling gear.
- CA-348-7 Perspective view of deckhouse and cargo-handling gear looking aft from the starboard side of the main deck.
- CA-348-8 Detail view of blocks and tackle at end of the starboard 15-ton boom at the No. 4 forward hatch.
- CA-348-9 Hatches for Holds Nos. 1 and 2, looking aft.

USNS *COMET*  
HAER CA-348  
INDEX TO PHOTOGRAPHS

- CA-348-10 View astern from starboard side of the deckhouse 02 Level.  
Note 60-ton heavy-lift boom secured between the king posts.
- CA-348-11 View looking aft from deckhouse 03 Level; 15-ton boom in foreground.
- CA-348-12 Main deck forward, port side looking aft. Hold No. 2 hatch in foreground. Note vehicle anchor points welded to the deck.
- CA-348-13 Main deck forward, starboard side looking aft, Hold No. 2 hatch in foreground, driveway for vehicles through the deckhouse in the distance.
- CA-348-14 3/4 view of deckhouse from main deck aft, looking into the vehicle driveway leading to the bow. Note ventilation trunks in center frame for vehicle decks below.
- CA-348-15 View inside the main deck driveway, looking forward, showing watertight door and bulkhead enclosing vehicle-loading ramp leading down to the second deck.
- CA-348-16 Starboard forward cargo door from exterior; compare with interior view HAER No. CA-348-51.
- CA-348-17 View of false funnel and door to wheelhouse, 03 Level, port side.
- CA-348-18 Deckhouse 04 Level, 3/4 view of false funnel from port side looking forward. Note starboard boiler-exhaust stack in right background.
- CA-348-19 View looking aft from deckhouse 04 Level.
- CA-348-20 Detail view of king posts between hatches nos. 2 and 3 forward showing 60-ton heavy-lift boom secured for sea.
- CA-348-21 Mail box on deckhouse 01 Level, port side.
- CA-348-22 Detail view of ramp brackets forward on the starboard side with removable bulwark section above.
- CA-348-23 Main deck aft.
- CA-348-24 Main deck aft showing stern vehicle ramp in raised position and variable angle mooring sheave at left.



USNS *COMET*  
HAER CA-348  
INDEX TO PHOTOGRAPHS

- CA-348-25 3/4 view of stern. Photograph taken from the cargo ship *Cape Girardeau*.
- CA-348-26 3/4 view of starboard quarter showing the stern vehicle ramp. Photograph taken from the ro-ro ship *Meteor*.
- CA-348-27 Detail of stern ramp from main deck looking aft.
- CA-348-28 Deckhouse 01 Level, starboard side aft, looking forward at windows into crew lounge.
- CA-348-29 Detail view of smoke detecting alarm panel, Deckhouse 03 Level, port side.
- CA-348-30 View of wheelhouse looking to starboard.
- CA-348-31 Cargo office, 01 Level.
- CA-348-32 Crew's lounge, 01 Level, starboard side.
- CA-348-33 Captain's stateroom, 02 Level, starboard side.
- CA-348-34 Crewmen's stateroom, main deck.
- CA-348-35 Boiler control panel in the engine room on the second platform deck, looking forward.
- CA-348-36 Boiler gage board, second platform deck, starboard side, looking to port.
- CA-348-37 Main gage board and throttles in the engine room, Second platform deck, looking to port.
- CA-348-38 View of the steering-gear room, looking aft.
- CA-348-39 View of steering-gear room, looking forward.
- CA-348-40 Lowest level of the engine room looking aft between the boilers toward the condenser.
- CA-348-41 Steam turbine, second platform deck looking forward.
- CA-348-42 Hold No. 1, first platform deck, looking forward.
- CA-348-43 View of upper tween Hold No. 4, second deck, looking aft from the port side. Note lifeboats secured in the after hatchway.
- CA-348-44 Upper tween Hold No. 4, second deck, looking forward. Note lifeboats secured in the after hatchway.

USNS *COMET*  
HAER CA-348  
INDEX TO PHOTOGRAPHS

- CA-348-45 View looking forward of starboard vehicle ramp in lower tween Hold No. 4, first platform deck.
- CA-348-46 View looking aft of fixed vehicle ramp leading from lower tween Hold No. 3 on the first platform deck to upper Hold No. 3 on the second platform deck below.
- CA-348-47 View looking aft in upper tween Hold No. 4, second deck. Note door to stern vehicle-loading ramp in center distance.
- CA-348-48 View of driveway leading from upper tween Hold No. 4 to the stern vehicle-loading ramp, looking aft.
- CA-348-49 View of driveway leading into the ship from the stern vehicle-loading ramp, looking forward toward the closed door to upper tween Hold No. 4.
- CA-348-50 View of lower tween Hold No. 4, first platform deck, looking forward, showing two vehicle ramps.
- CA-348-51 Interior view of forward port-side cargo door, upper tween Hold No. 3, second deck.
- CA-348-52 Interior general view of upper tween Hold No. 3, looking to starboard.
- CA-348-53 View of portable ramp secured in lower Hold No. 3.

INDEX TO COLOR TRANSPARENCIES

Jet Lowe, photographer, February 2009

- CA-348-54 (CT) Detail view, main deck, starboard side looking toward bow, showing forward cargo handling gear and vehicle anchor points welded along the deck.
- CA-348-55 (CT) View of forward king posts on the main deck taken from the starboard side. Note vehicle anchor points welded to the deck and 60-ton heavy-lift boom secured between the king posts.
- CA-348-56 (CT) View of forward main deck taken from wheelhouse top. Hold No. 3 after hatch is in the foreground; No. 3 forward hatch is on the far side of the first pair of king posts.



USNS *COMET*  
HAER CA-348  
INDEX TO PHOTOGRAPHS

CA-348-57 (CT)

View of false funnel and door to wheelhouse, 03 Level, port side.

HISTORIC AMERICAN ENGINEERING RECORD  
SEE INDEX TO PHOTOGRAPHS FOR CAPTION

HAER No. CA-348-001



HISTORIC AMERICAN ENGINEERING RECORD  
SEE INDEX TO PHOTOGRAPHS FOR CAPTION

HAER No. CA-348-002





HISTORIC AMERICAN ENGINEERING RECORD  
SEE INDEX TO PHOTOGRAPHS FOR CAPTION

HAER No. CA-348-003





HISTORIC AMERICAN ENGINEERING RECORD  
SEE INDEX TO PHOTOGRAPHS FOR CAPTION

HAER No. CA-348-005



HISTORIC AMERICAN ENGINEERING RECORD  
SEE INDEX TO PHOTOGRAPHS FOR CAPTION

HAER No. CA-348-006



HISTORIC AMERICAN ENGINEERING RECORD  
SEE INDEX TO PHOTOGRAPHS FOR CAPTION

HAER No. CA-348-007





HISTORIC AMERICAN ENGINEERING RECORD  
SEE INDEX TO PHOTOGRAPHS FOR CAPTION

HAER No. CA-348-008

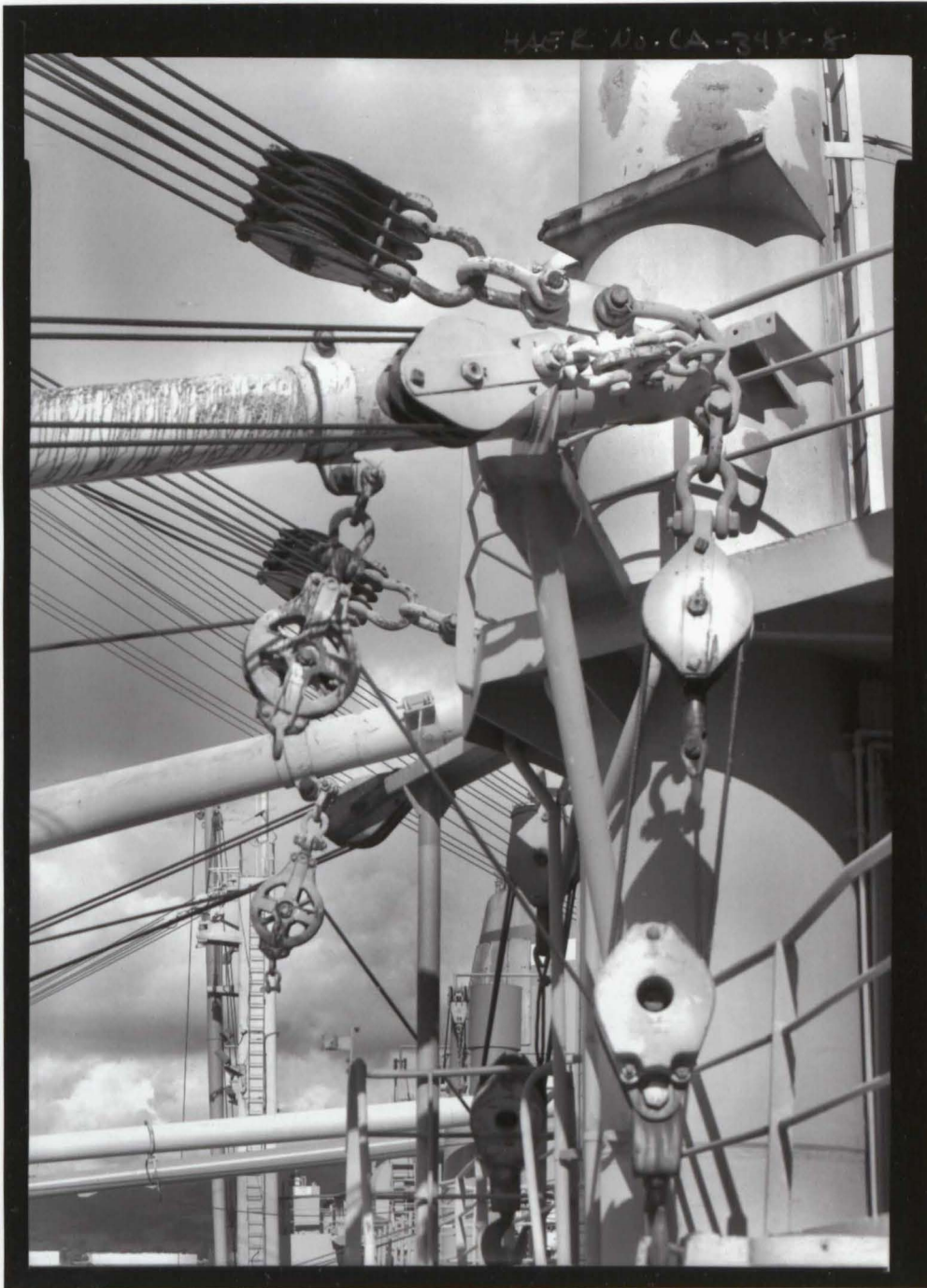

HISTORIC AMERICAN ENGINEERING RECORD  
SEE INDEX TO PHOTOGRAPHS FOR CAPTION

HAER No. CA-348-009



HISTORIC AMERICAN ENGINEERING RECORD  
SEE INDEX TO PHOTOGRAPHS FOR CAPTION

HAER No. CA-348-010





HISTORIC AMERICAN ENGINEERING RECORD  
SEE INDEX TO PHOTOGRAPHS FOR CAPTION

HAER No. CA-348-011



HISTORIC AMERICAN ENGINEERING RECORD  
SEE INDEX TO PHOTOGRAPHS FOR CAPTION

HAER No. CA-348-012





HISTORIC AMERICAN ENGINEERING RECORD  
SEE INDEX TO PHOTOGRAPHS FOR CAPTION

HAER No. CA-348-013



HISTORIC AMERICAN ENGINEERING RECORD  
SEE INDEX TO PHOTOGRAPHS FOR CAPTION

HAER No. CA-348-014



HISTORIC AMERICAN ENGINEERING RECORD  
SEE INDEX TO PHOTOGRAPHS FOR CAPTION

HAER No. CA-348-015





HISTORIC AMERICAN ENGINEERING RECORD  
SEE INDEX TO PHOTOGRAPHS FOR CAPTION

HAER No. CA-348-016



HISTORIC AMERICAN ENGINEERING RECORD  
SEE INDEX TO PHOTOGRAPHS FOR CAPTION

HAER No. CA-348-017

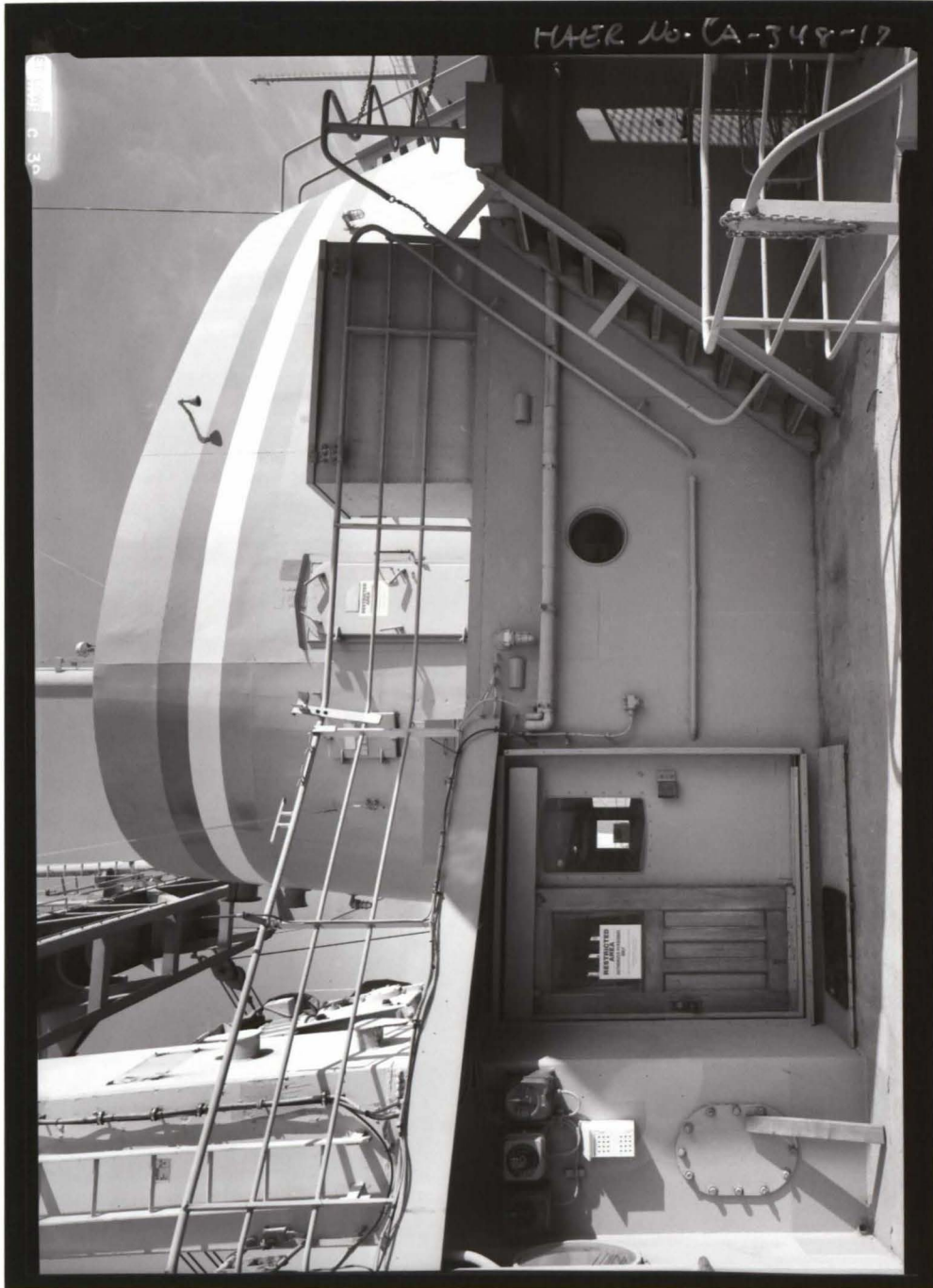

HISTORIC AMERICAN ENGINEERING RECORD  
SEE INDEX TO PHOTOGRAPHS FOR CAPTION

HAER No. CA-348-018





HISTORIC AMERICAN ENGINEERING RECORD  
SEE INDEX TO PHOTOGRAPHS FOR CAPTION

HAER No. CA-348-019



HISTORIC AMERICAN ENGINEERING RECORD  
SEE INDEX TO PHOTOGRAPHS FOR CAPTION

HAER No. CA-348-020





HISTORIC AMERICAN ENGINEERING RECORD  
SEE INDEX TO PHOTOGRAPHS FOR CAPTION

HAER No. CA-348-021



HISTORIC AMERICAN ENGINEERING RECORD  
SEE INDEX TO PHOTOGRAPHS FOR CAPTION

HAER No. CA-348-022



HISTORIC AMERICAN ENGINEERING RECORD  
SEE INDEX TO PHOTOGRAPHS FOR CAPTION

HAER No. CA-348-023





HISTORIC AMERICAN ENGINEERING RECORD  
SEE INDEX TO PHOTOGRAPHS FOR CAPTION

HAER No. CA-348-024



HISTORIC AMERICAN ENGINEERING RECORD  
SEE INDEX TO PHOTOGRAPHS FOR CAPTION

HAER No. CA-348-025

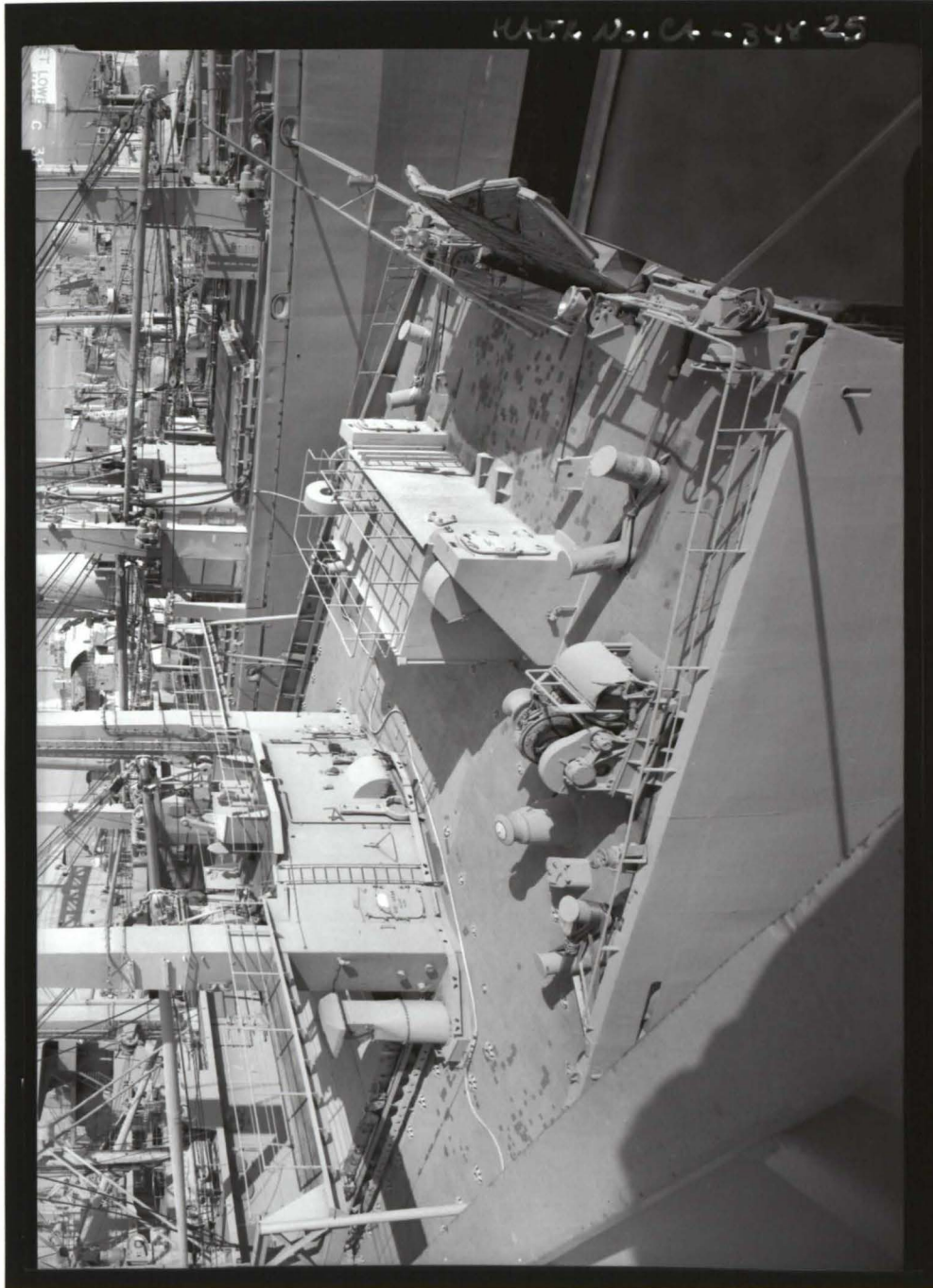

HISTORIC AMERICAN ENGINEERING RECORD  
SEE INDEX TO PHOTOGRAPHS FOR CAPTION

HAER No. CA-348-026





HISTORIC AMERICAN ENGINEERING RECORD  
SEE INDEX TO PHOTOGRAPHS FOR CAPTION

HAER No. CA-348-027

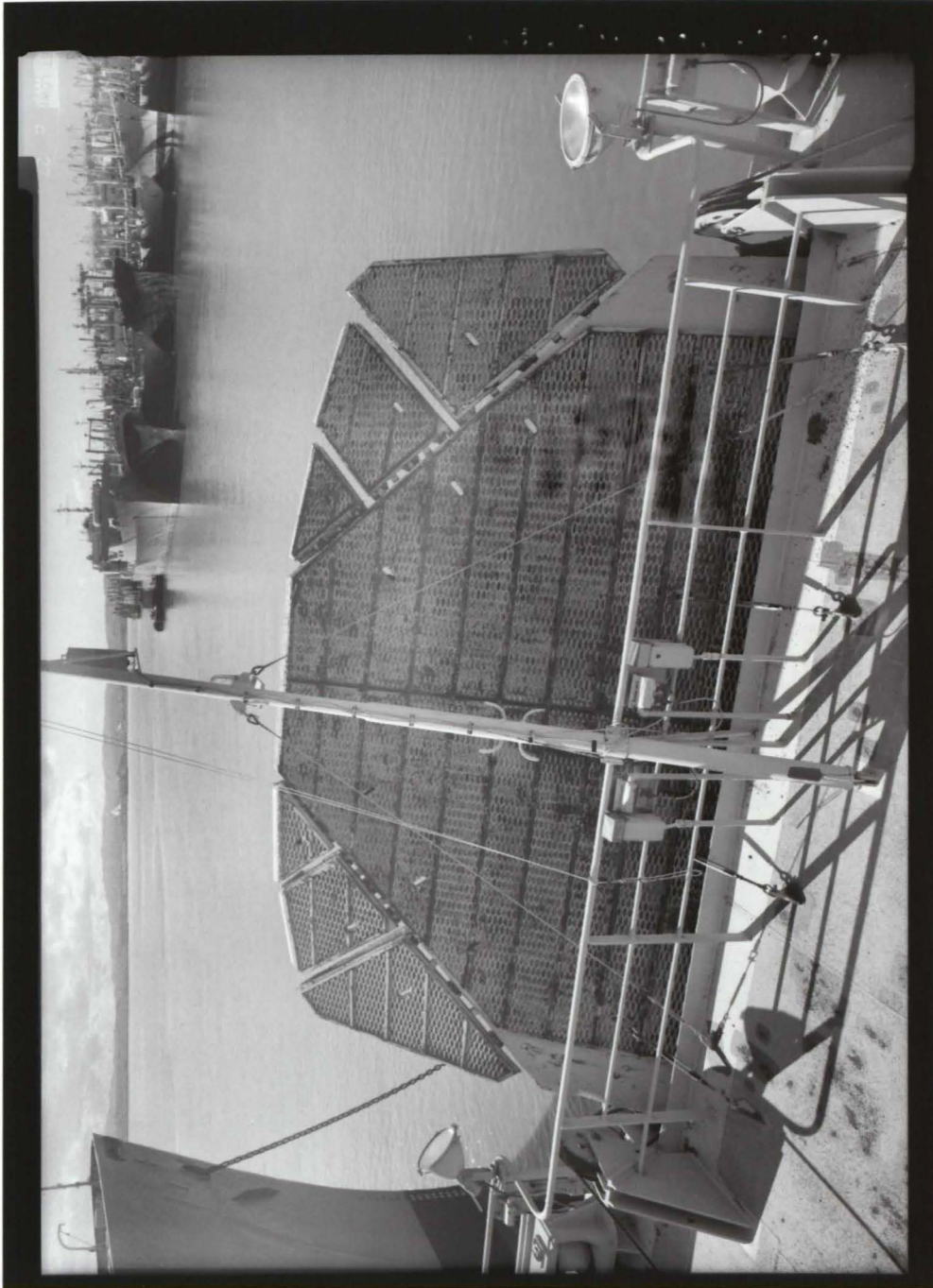



HISTORIC AMERICAN ENGINEERING RECORD  
SEE INDEX TO PHOTOGRAPHS FOR CAPTION

HAER No. CA-348-028



HISTORIC AMERICAN ENGINEERING RECORD  
SEE INDEX TO PHOTOGRAPHS FOR CAPTION

HAER No. CA-348-029

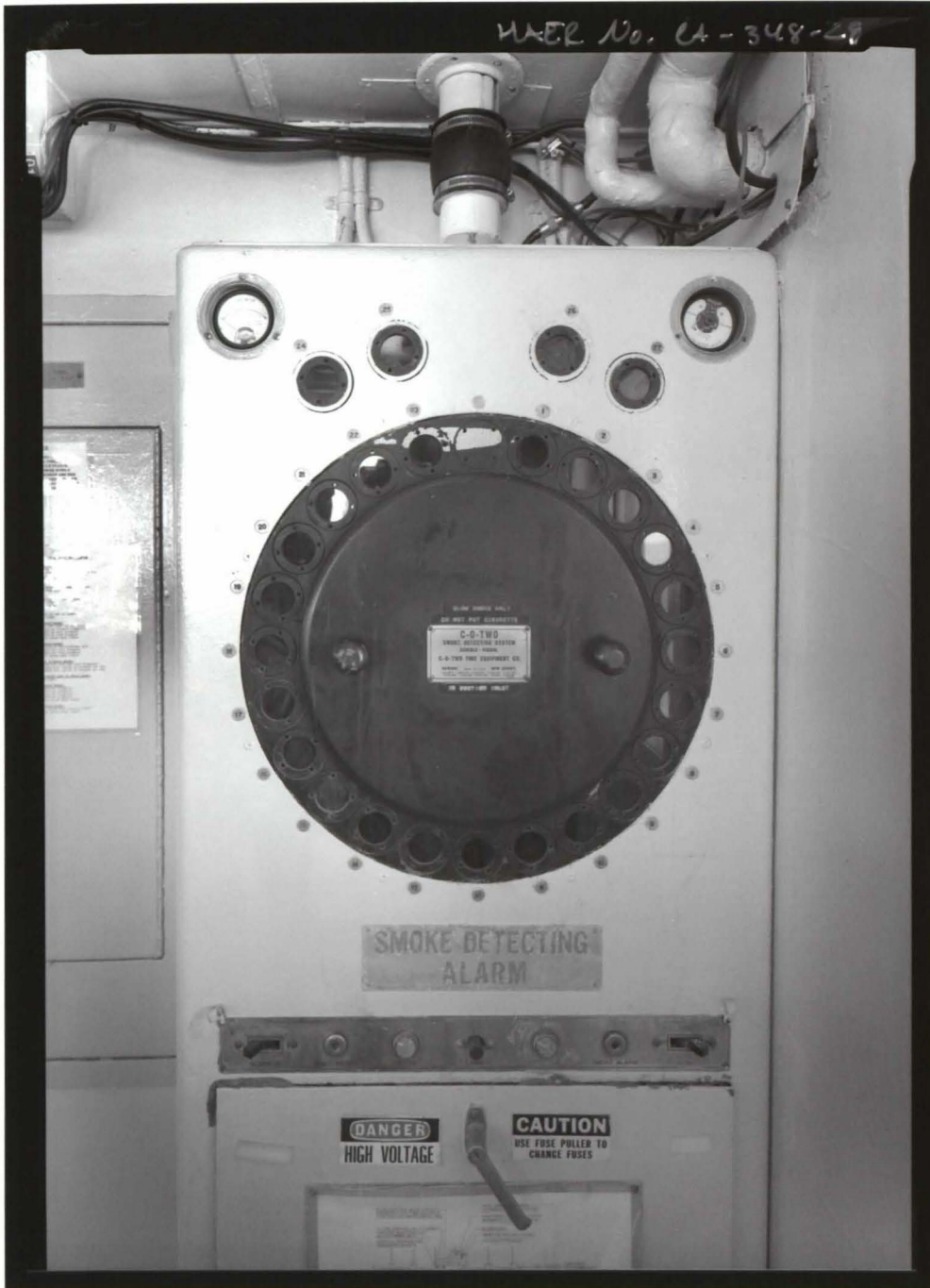

HISTORIC AMERICAN ENGINEERING RECORD  
SEE INDEX TO PHOTOGRAPHS FOR CAPTION

HAER No. CA-348-030





HISTORIC AMERICAN ENGINEERING RECORD  
SEE INDEX TO PHOTOGRAPHS FOR CAPTION

HAER No. CA-348-031



HISTORIC AMERICAN ENGINEERING RECORD  
SEE INDEX TO PHOTOGRAPHS FOR CAPTION

HAER No. CA-348-032





HISTORIC AMERICAN ENGINEERING RECORD  
SEE INDEX TO PHOTOGRAPHS FOR CAPTION

HAER No. CA-348-033



HISTORIC AMERICAN ENGINEERING RECORD  
SEE INDEX TO PHOTOGRAPHS FOR CAPTION

HAER No. CA-348-034



HISTORIC AMERICAN ENGINEERING RECORD  
SEE INDEX TO PHOTOGRAPHS FOR CAPTION

HAER No. CA-348-035



HISTORIC AMERICAN ENGINEERING RECORD  
SEE INDEX TO PHOTOGRAPHS FOR CAPTION

HAER No. CA-348-036





HISTORIC AMERICAN ENGINEERING RECORD  
SEE INDEX TO PHOTOGRAPHS FOR CAPTION

HAER No. CA-348-037

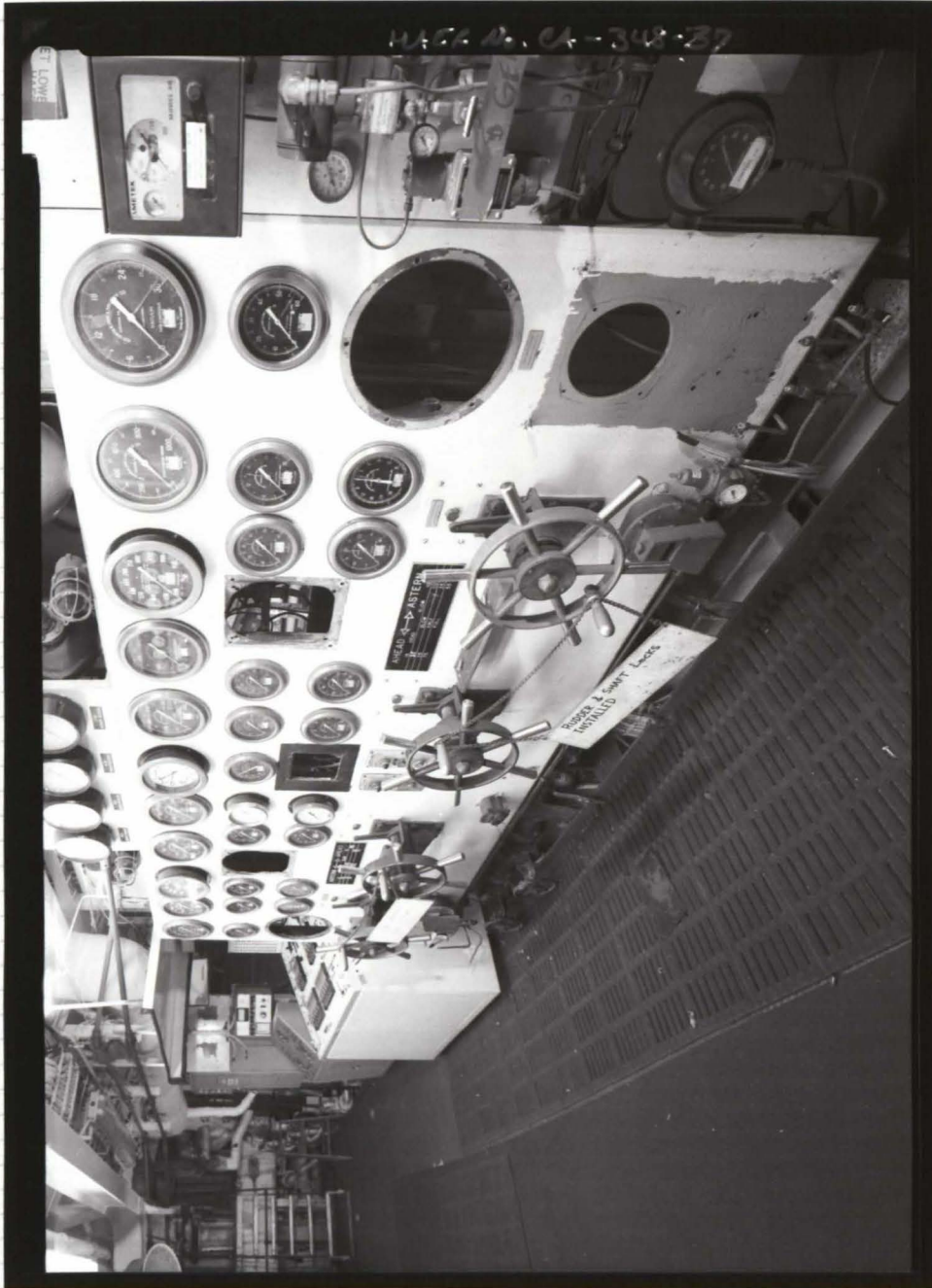



HISTORIC AMERICAN ENGINEERING RECORD  
SEE INDEX TO PHOTOGRAPHS FOR CAPTION

HAER No. CA-348-038

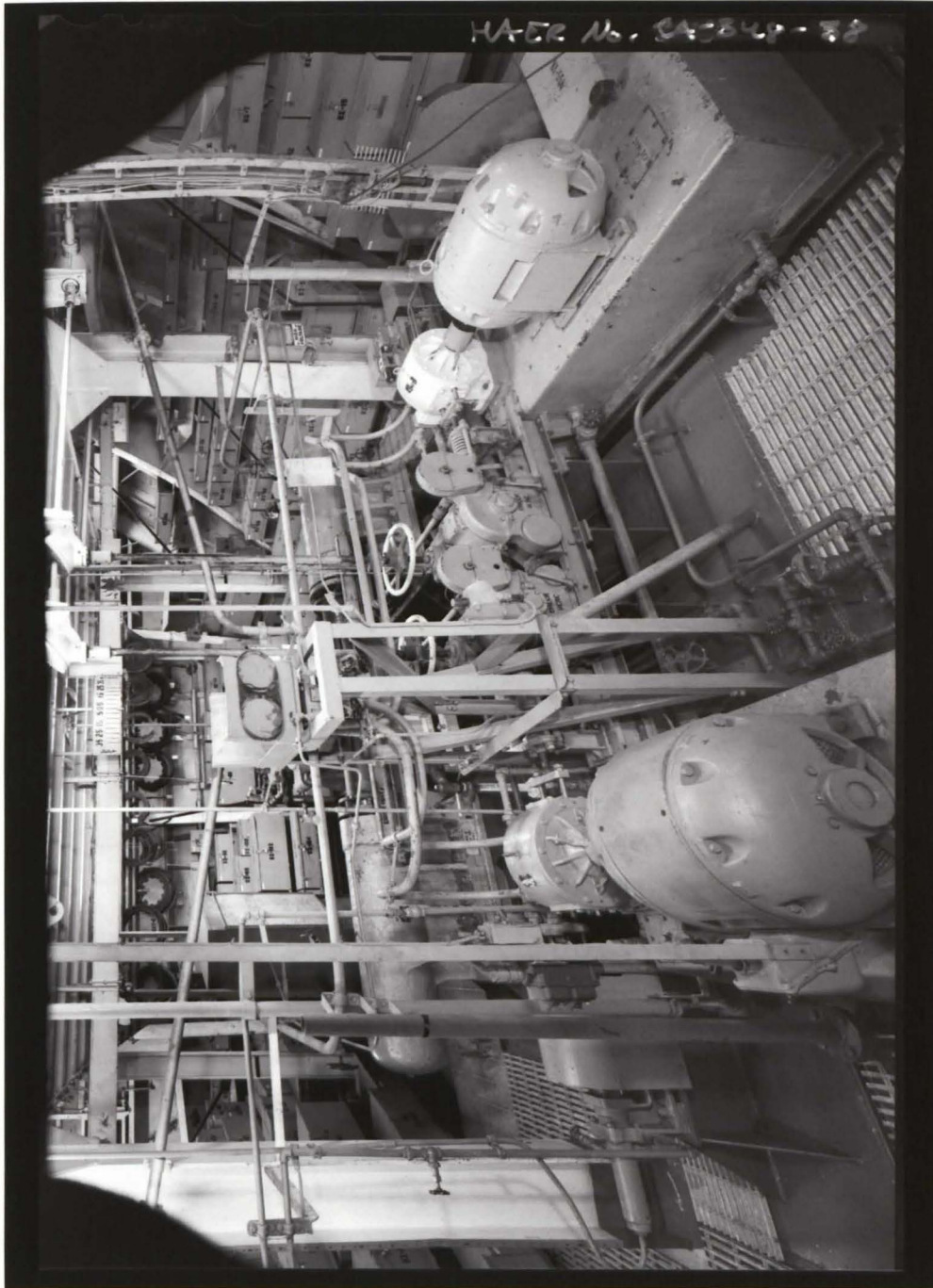

HISTORIC AMERICAN ENGINEERING RECORD  
SEE INDEX TO PHOTOGRAPHS FOR CAPTION

HAER No. CA-348-039

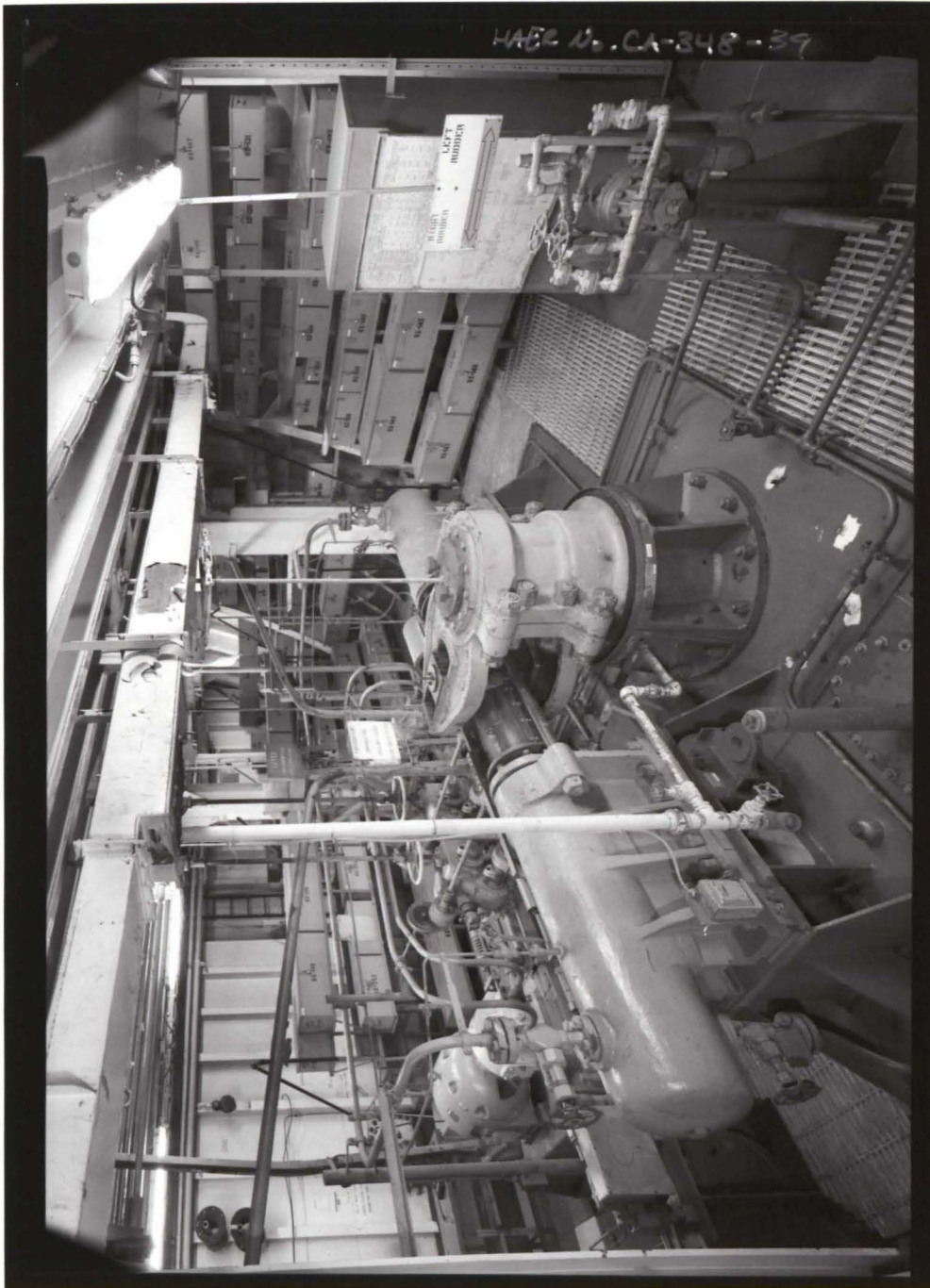

HISTORIC AMERICAN ENGINEERING RECORD  
SEE INDEX TO PHOTOGRAPHS FOR CAPTION

HAER No. CA-348-040

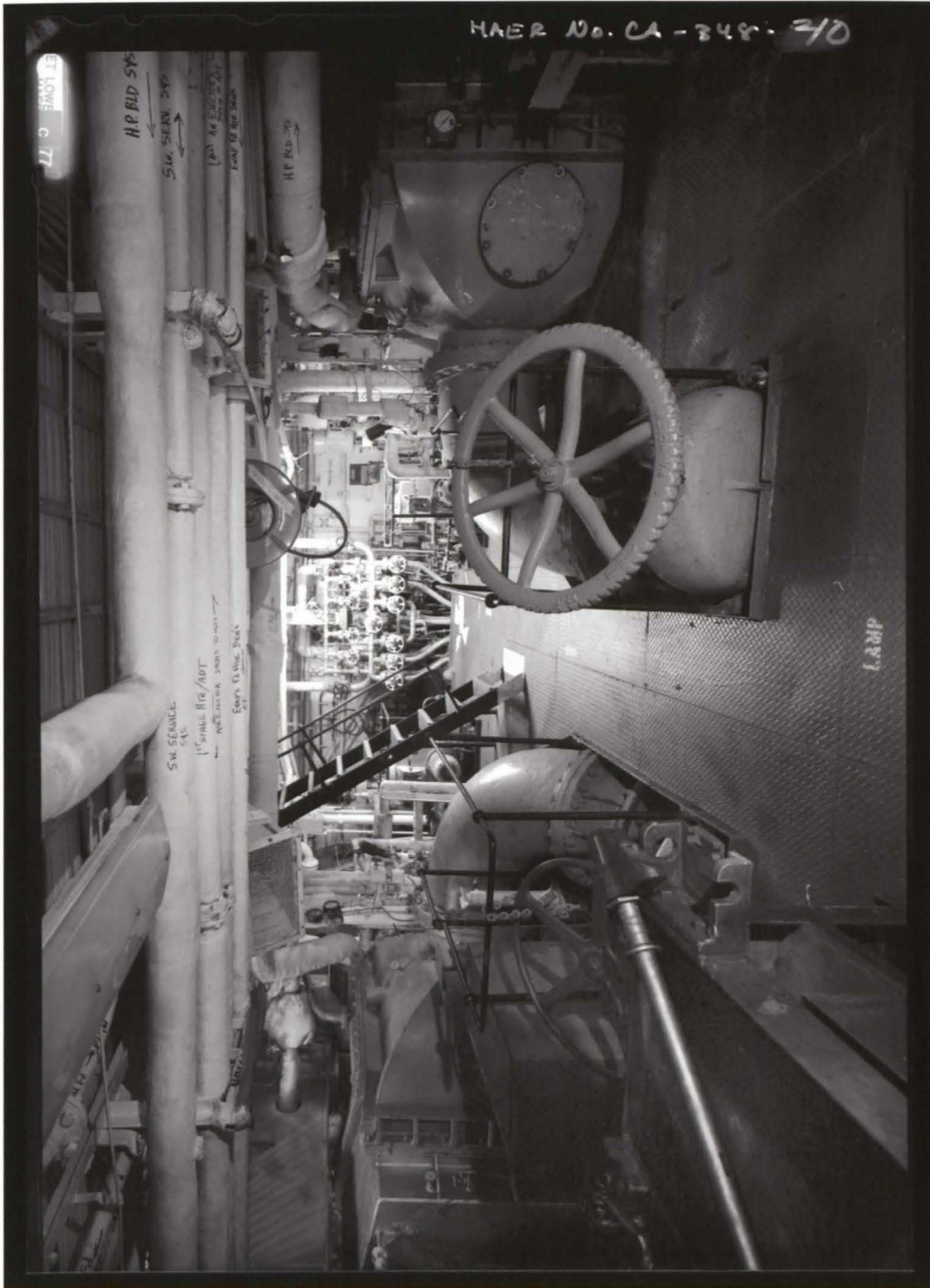



HISTORIC AMERICAN ENGINEERING RECORD  
SEE INDEX TO PHOTOGRAPHS FOR CAPTION

HAER No. CA-348-041





HISTORIC AMERICAN ENGINEERING RECORD  
SEE INDEX TO PHOTOGRAPHS FOR CAPTION

HAER No. CA-348-042

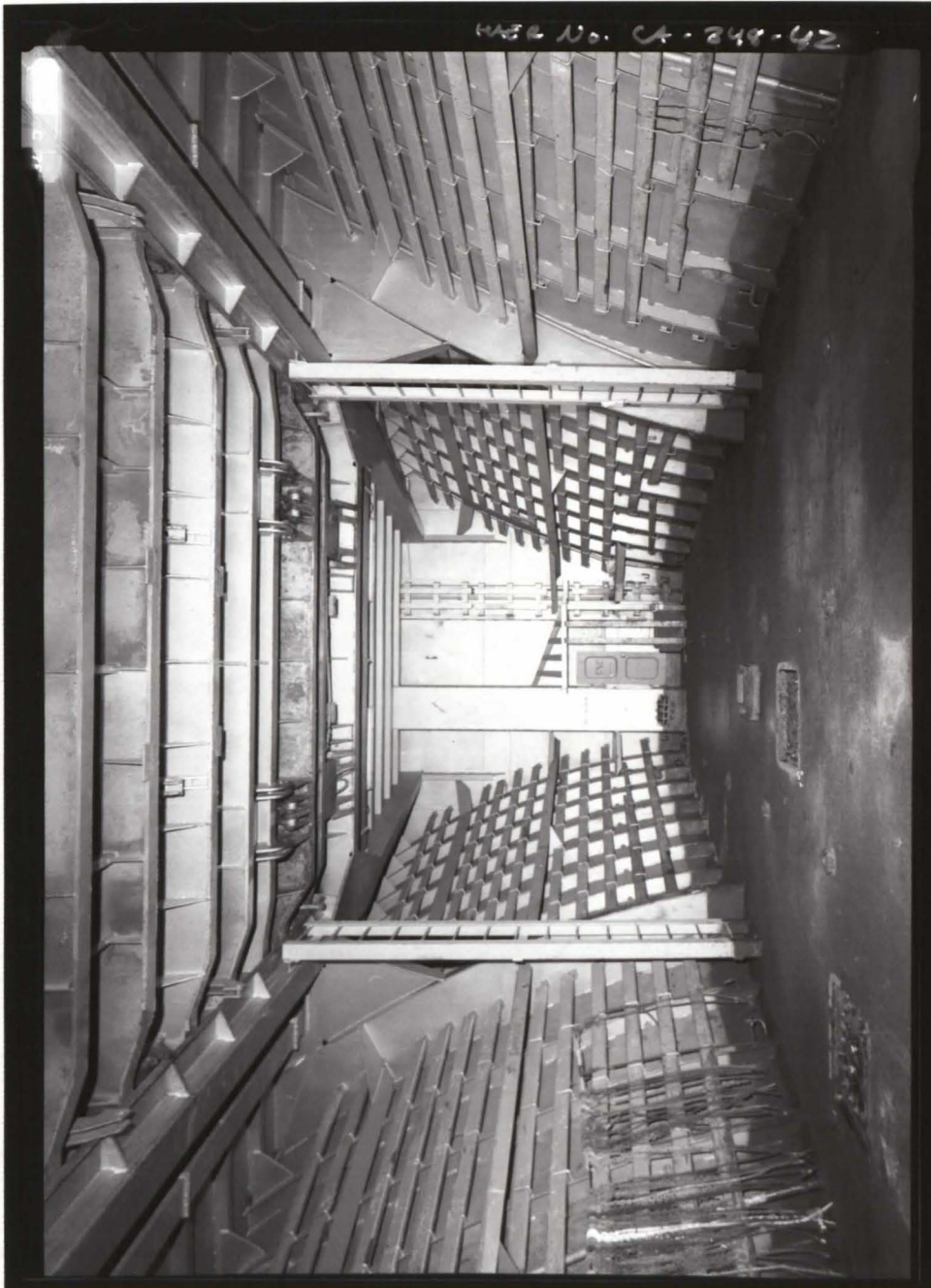

HISTORIC AMERICAN ENGINEERING RECORD  
SEE INDEX TO PHOTOGRAPHS FOR CAPTION

HAER No. CA-348-043



HISTORIC AMERICAN ENGINEERING RECORD  
SEE INDEX TO PHOTOGRAPHS FOR CAPTION

HAER No. CA-348-044

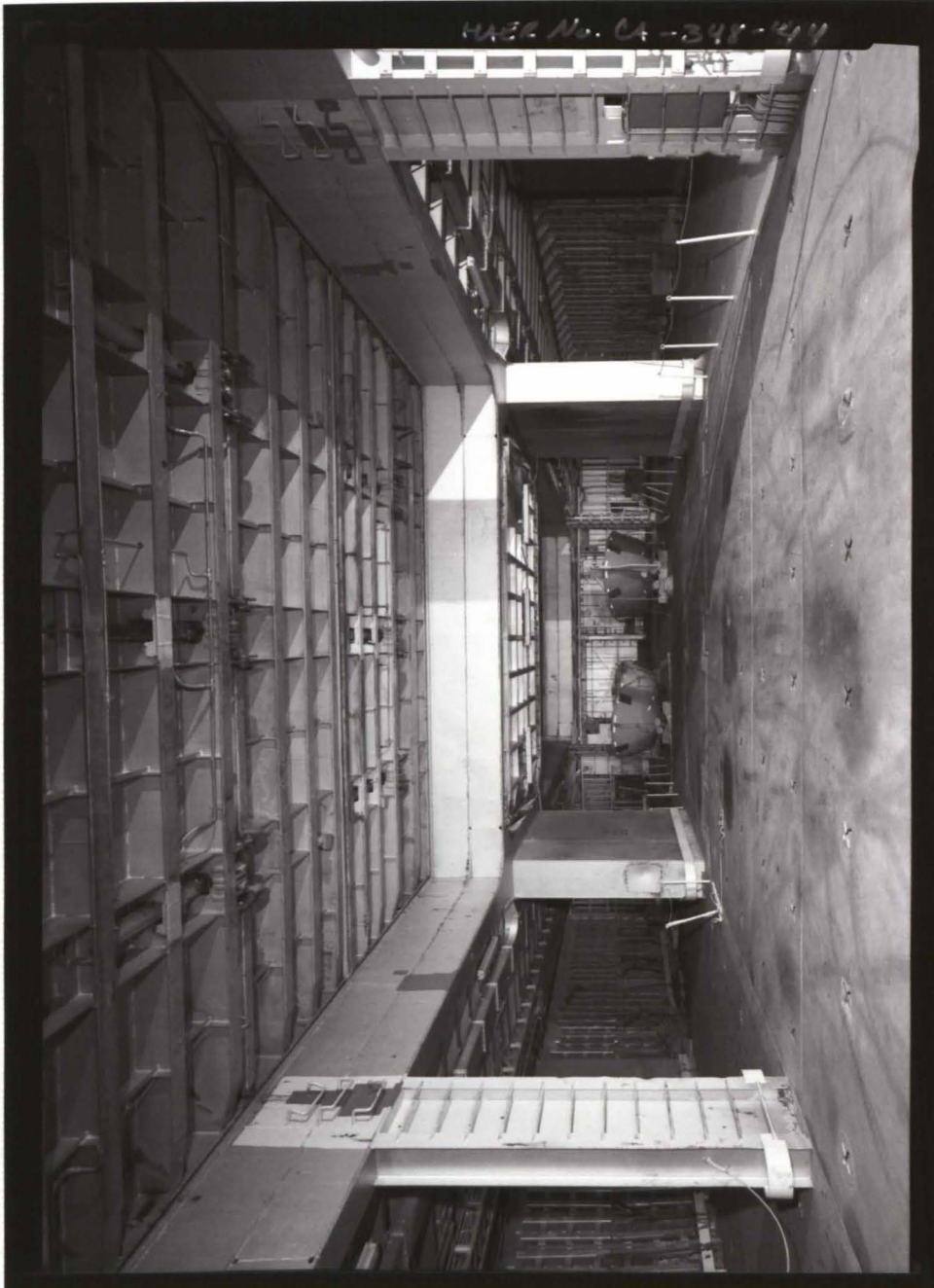



HISTORIC AMERICAN ENGINEERING RECORD  
SEE INDEX TO PHOTOGRAPHS FOR CAPTION

HAER No. CA-348-045





HISTORIC AMERICAN ENGINEERING RECORD  
SEE INDEX TO PHOTOGRAPHS FOR CAPTION

HAER No. CA-348-046



HISTORIC AMERICAN ENGINEERING RECORD  
SEE INDEX TO PHOTOGRAPHS FOR CAPTION

HAER No. CA-348-047



HISTORIC AMERICAN ENGINEERING RECORD  
SEE INDEX TO PHOTOGRAPHS FOR CAPTION

HAER No. CA-348-048





HISTORIC AMERICAN ENGINEERING RECORD  
SEE INDEX TO PHOTOGRAPHS FOR CAPTION

HAER No. CA-348-049





HISTORIC AMERICAN ENGINEERING RECORD  
SEE INDEX TO PHOTOGRAPHS FOR CAPTION

HAER No. CA-348-050

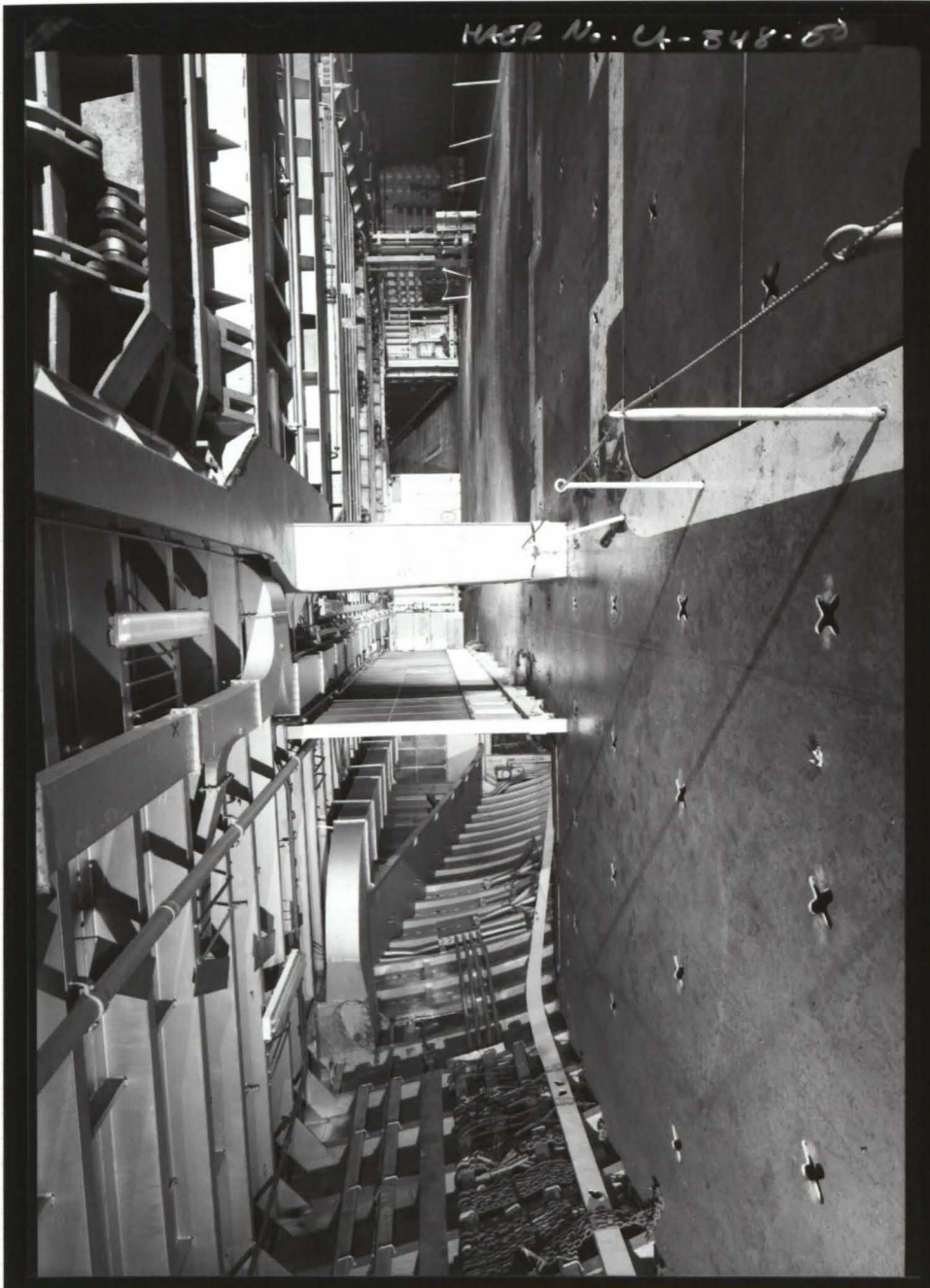

HISTORIC AMERICAN ENGINEERING RECORD  
SEE INDEX TO PHOTOGRAPHS FOR CAPTION

HAER No. CA-348-051

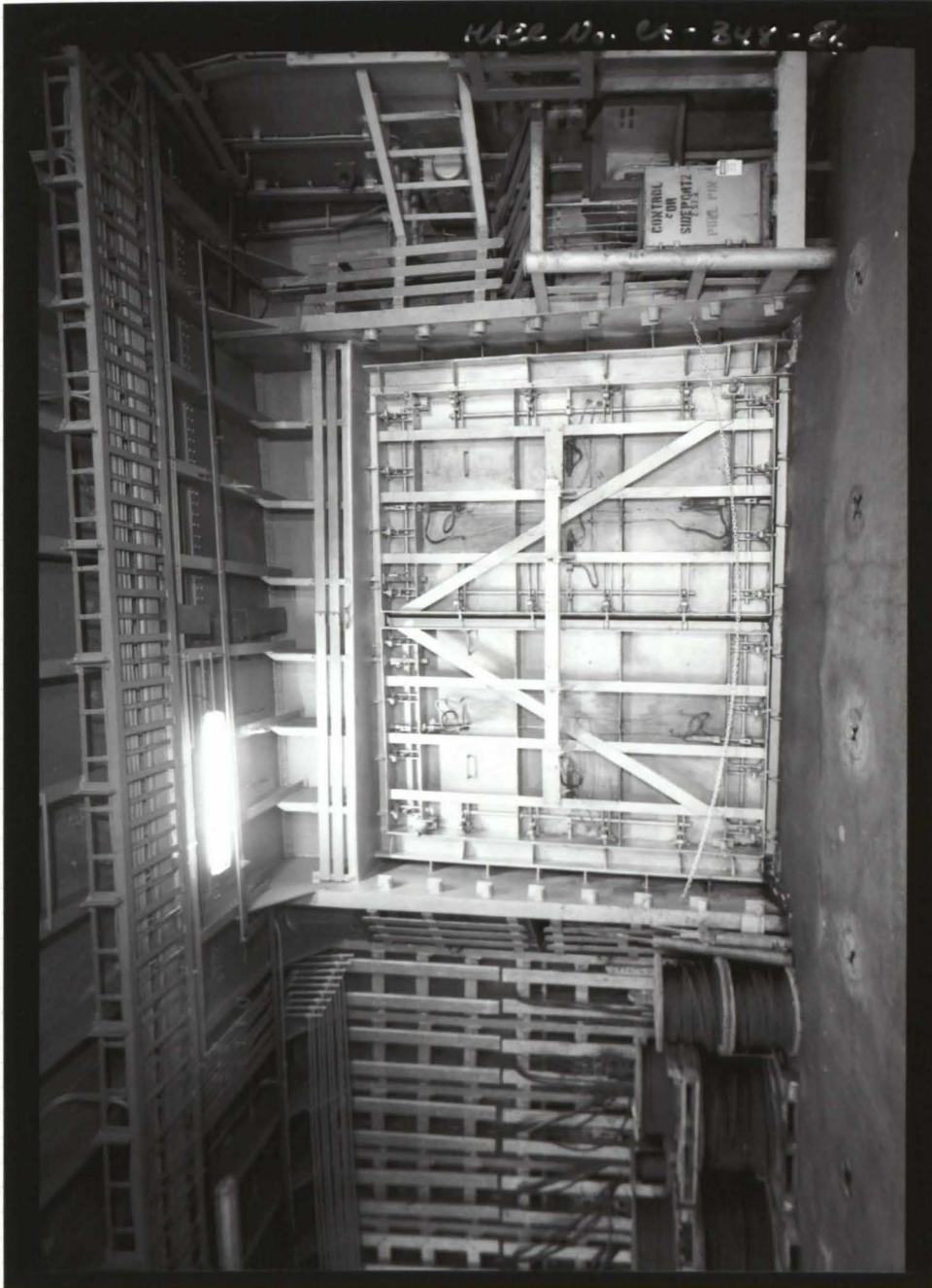

HISTORIC AMERICAN ENGINEERING RECORD  
SEE INDEX TO PHOTOGRAPHS FOR CAPTION

HAER No. CA-348-052





HISTORIC AMERICAN ENGINEERING RECORD  
SEE INDEX TO PHOTOGRAPHS FOR CAPTION

HAER No. CA-348-053





HISTORIC AMERICAN ENGINEERING RECORD  
SEE INDEX TO PHOTOGRAPHS FOR CAPTION

HAER No. CA-348-054 (CT)



HISTORIC AMERICAN ENGINEERING RECORD  
SEE INDEX TO PHOTOGRAPHS FOR CAPTION

HAER No. CA-348-055 (CT)





HISTORIC AMERICAN ENGINEERING RECORD  
SEE INDEX TO PHOTOGRAPHS FOR CAPTION

HAER No. CA-348-056 (CT)



HISTORIC AMERICAN ENGINEERING RECORD  
SEE INDEX TO PHOTOGRAPHS FOR CAPTION

HAER No. CA-348-057 (CT)









# USNS Comet

THIS DRAWING IS A SCAN OF AN ORIGINAL DESIGN DRAWING AND REFORMATTED TO FIT THE SHEET. THE DIMENSIONS AND LAYOUTS WERE NOT VERIFIED IN THE FIELD. THE DRAWING WAS LISTED AS MARITIME ADMINISTRATION PLAN No. 42-59-0-3 LOCATED AT THE MARITIME ADMINISTRATION.

## Profiles

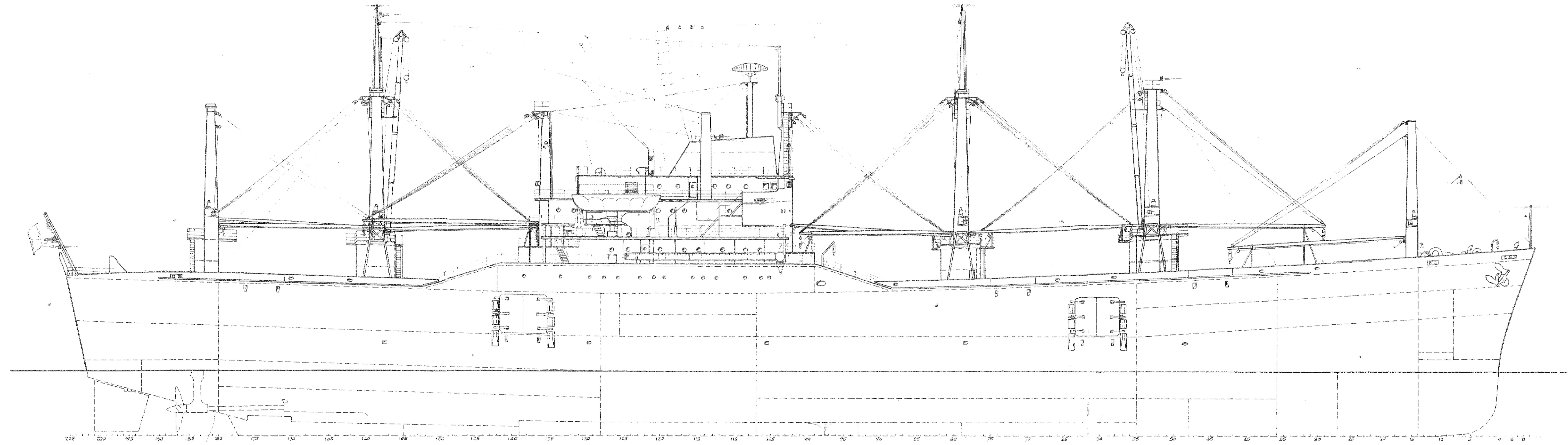

**OUTBOARD PROFILE**  
SCALE: 1/16"=1'-0"  
DESIGN C3-ST-144  
SHEET NO. 3 OF 7

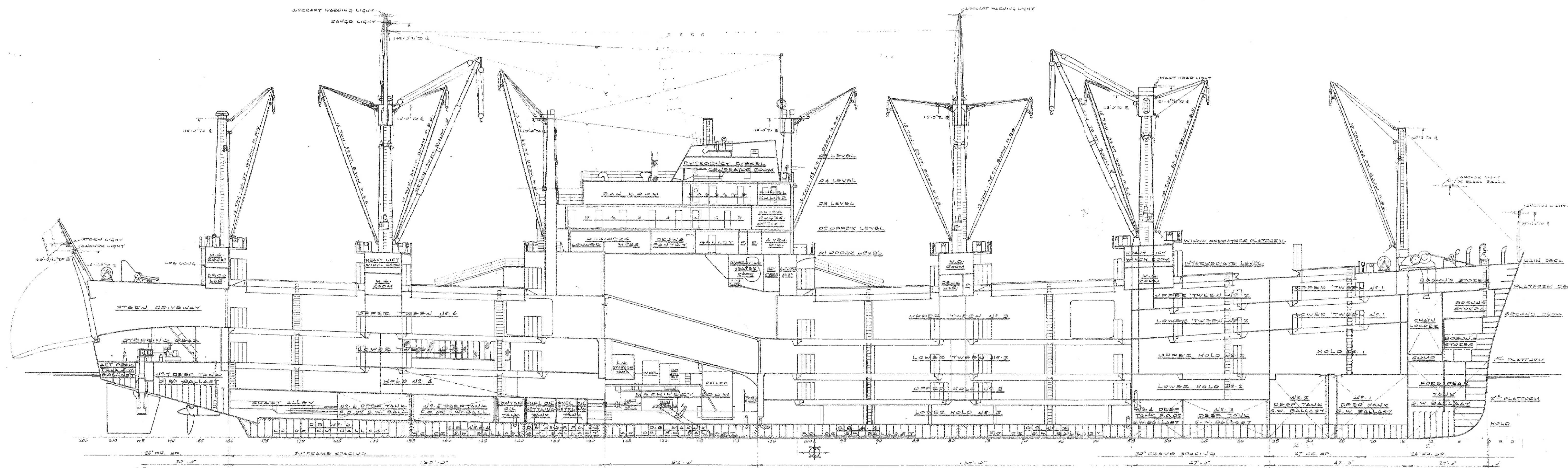

**INBOARD PROFILE**  
SCALE: 1/16"=1'-0"  
DESIGN C3-ST-144  
SHEET NO. 3 OF 7

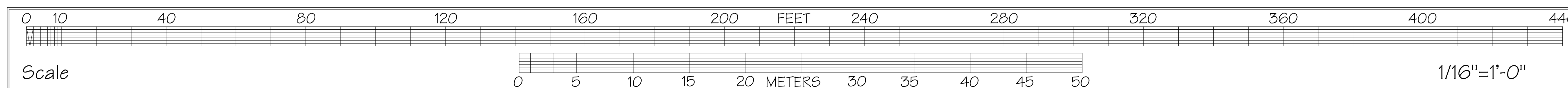

HISTORIC AMERICAN ENGINEERING RECORD  
NO. 1000  
CA-348  
SHEET 3 OF 7  
CALIFORNIA  
USNS COMET  
SOLANO COUNTY  
BENICIA VICINITY  
HAER MARITIME RECORDING PROGRAM  
NATIONAL PARK SERVICE  
UNITED STATES DEPARTMENT OF THE INTERIOR  
DELIMITED BY: REFORMATTED BY TODD A. GROTEAU 2010



# USNS Comet

THIS DRAWING IS A SCAN OF AN ORIGINAL DESIGN DRAWING AND REFORMATTED TO FIT THE SHEET. THE DIMENSIONS AND LAYOUTS WERE NOT VERIFIED IN THE FIELD. THE DRAWING WAS LISTED AS MARITIME ADMINISTRATION PLAN No. 42-59-0-3 LOCATED AT THE MARITIME ADMINISTRATION.

Plans

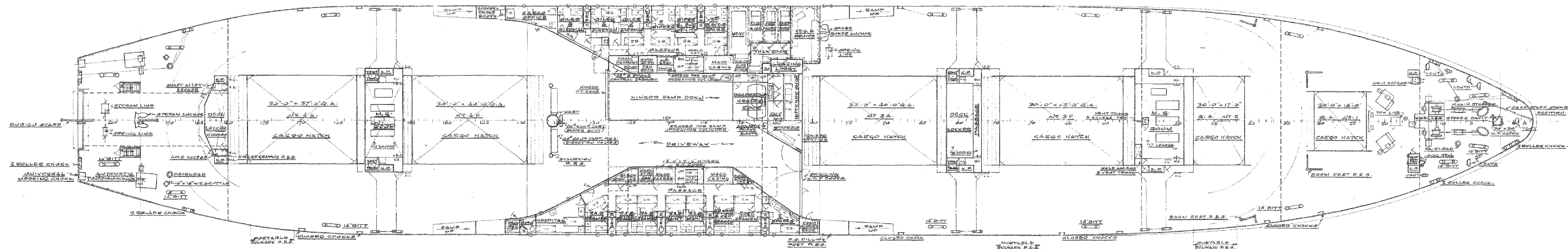

**MAIN DECK**  
SCALE: 1/8" = 1'-00"  
DESIGN CS-ST-14a  
SHEET 4 OF 7

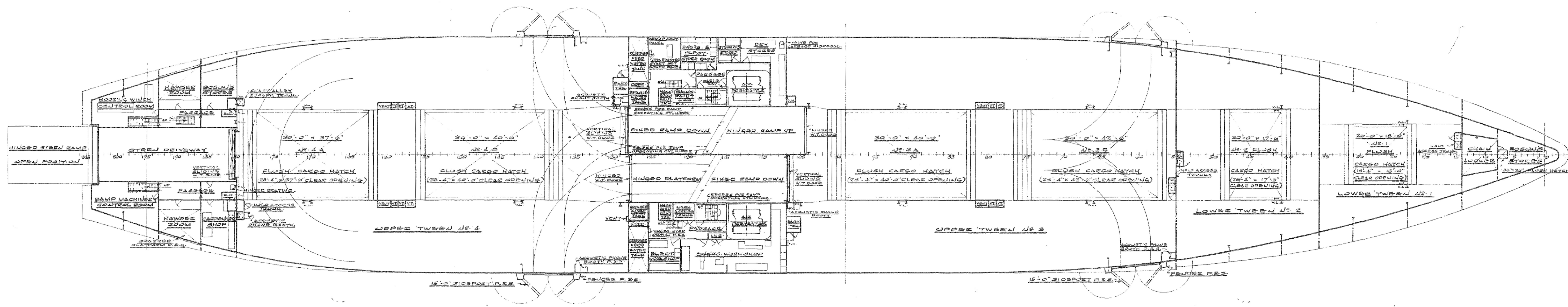

**SECOND DECK**  
SCALE: 1/8" = 1'-00"  
DESIGN CS-ST-14a  
SHEET 10 OF 16

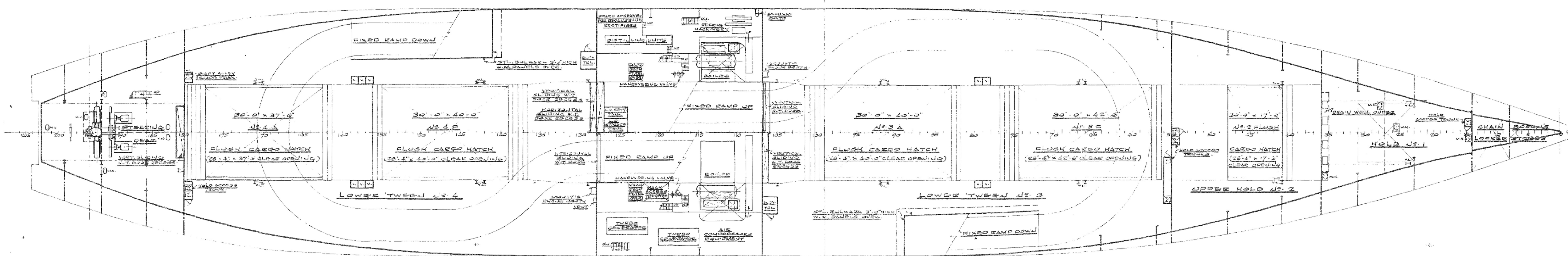

**FIRST PLATFORM**  
SCALE: 1/8" = 1'-00"  
DESIGN CS-ST-14a  
SHEET 11 OF 16

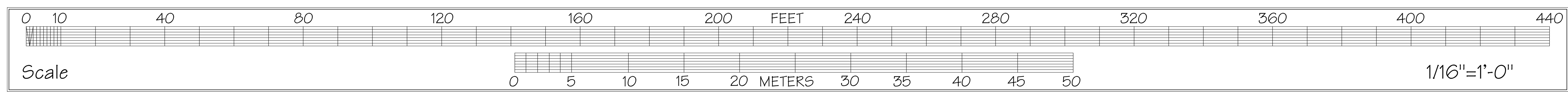

HISTORIC AMERICAN ENGINEERING RECORD  
CA-348  
SHEET 4 OF 7  
CALIFORNIA  
USNS COMET  
SOLANO COUNTY  
BENICIA VICINITY  
DELIMITED BY: REFORMATTED BY TODD A. GROTEAU 2010  
HAER MARITIME RECORDING PROGRAM  
NATIONAL PARK SERVICE  
UNITED STATES DEPARTMENT OF THE INTERIOR



# USNS Comet

THIS DRAWING IS A SCAN OF AN ORIGINAL DESIGN DRAWING AND REFORMATTED TO FIT THE SHEET. THE DIMENSIONS AND LAYOUTS WERE NOT VERIFIED IN THE FIELD. THE DRAWING WAS LISTED AS MARITIME ADMINISTRATION PLAN No. 42-59-0-3 LOCATED AT THE MARITIME ADMINISTRATION.

Plans

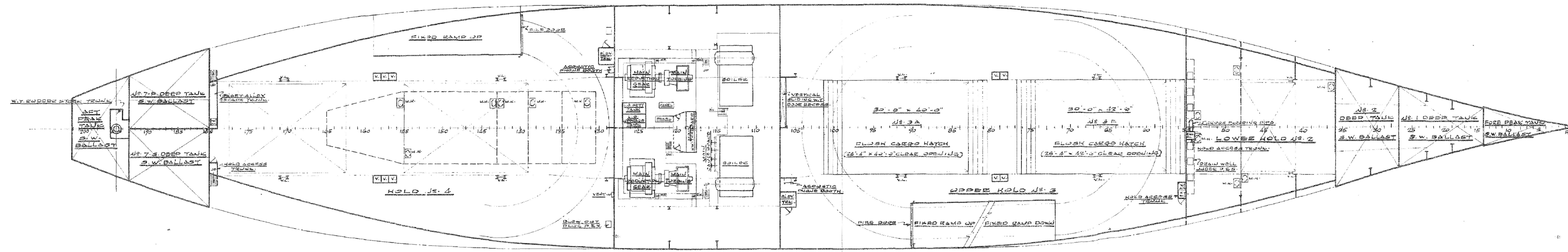

**SECOND PLATFORM**  
 SCALE: 1/16"=1'00"  
 DESIGN C3-ST-14a  
 SHEET NR. 12 OF 18

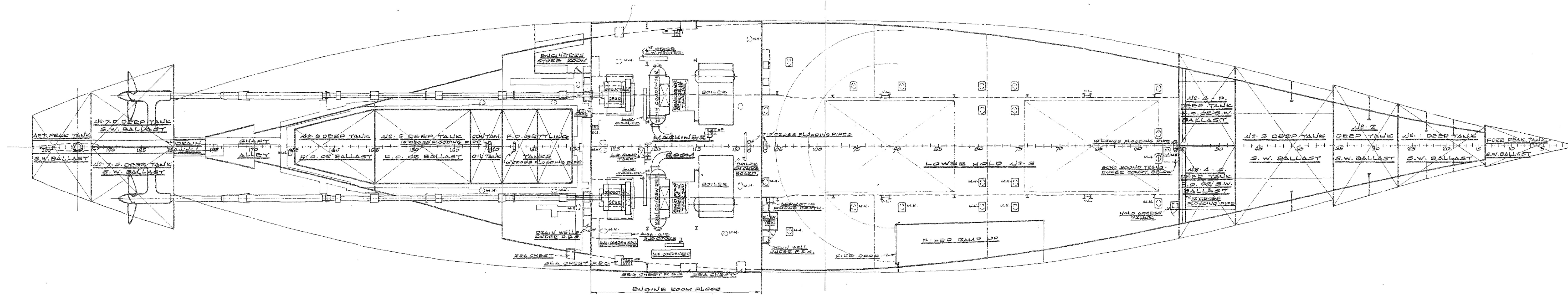

**HOLD**  
 SCALE: 1/16"=1'00"  
 DESIGN C3-ST-14a  
 SHEET NR. 13 OF 18

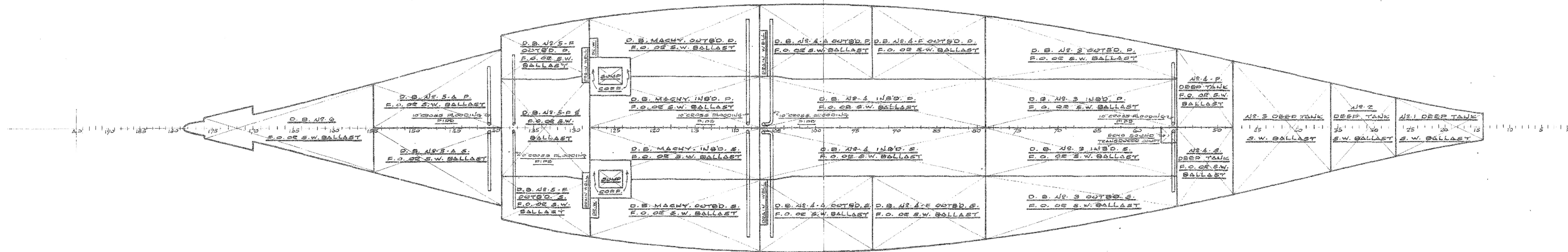

**INNERBOTTOM**  
 SCALE: 1/16"=1'00"  
 DESIGN C3-ST-14a  
 SHEET NR. 14 OF 18



HISTORIC AMERICAN ENGINEERING RECORD  
 CA-348  
 SHEET 5 OF 7  
 CALIFORNIA  
 USNS COMET  
 SOLANO COUNTY  
 BENICIA VICINITY  
 DELINEATED BY REFORMATTED BY TODD A. GROTEAU 2010  
 NAVAL MARITIME RECORDING PROGRAM  
 NATIONAL ARCHIVE SERVICE  
 UNITED STATES DEPARTMENT OF THE INTERIOR



# USNS Comet

THIS DRAWING IS A SCAN OF AN ORIGINAL DESIGN DRAWING AND REFORMATTED TO FIT THE SHEET. THE DIMENSIONS AND LAYOUTS WERE NOT VERIFIED IN THE FIELD. THE DRAWING WAS LISTED AS MARITIME ADMINISTRATION PLAN No. 42-59-0-3 LOCATED AT THE MARITIME ADMINISTRATION.

Plans

HISTORIC AMERICAN  
ENGINEERING RECORD  
NO. 1000

SHEET  
6 OF 7

CALIFORNIA

USNS COMET  
SOLANO COUNTY

BENICIA VICINITY

DELIMITED BY REFORMATTED BY TODD A. GROTEAU 2010  
HAER MARITIME  
RECORDING PROGRAM  
NATIONAL ARCHIVE SERVICE  
UNITED STATES DEPARTMENT OF THE INTERIOR

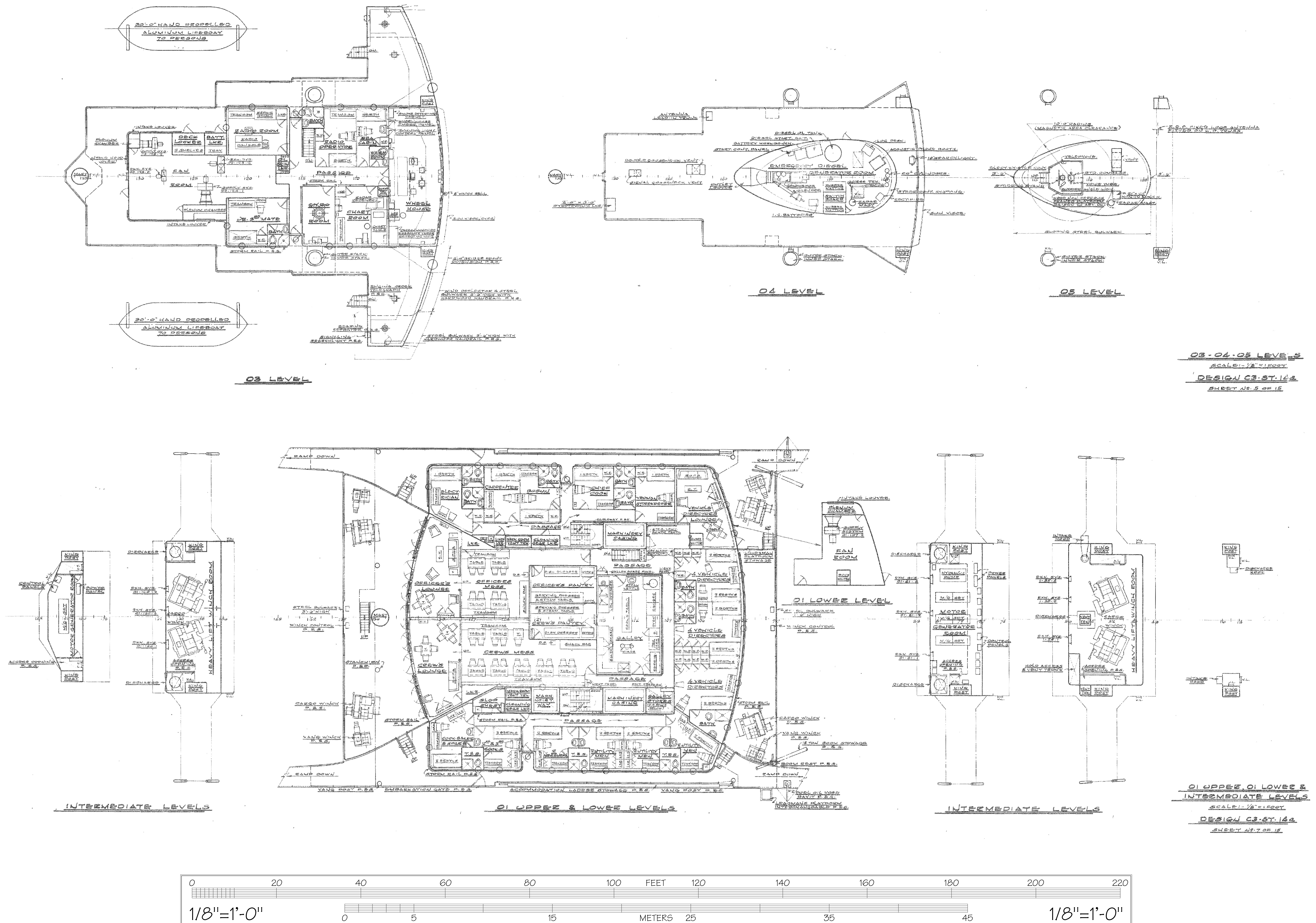



# USNS Comet

THIS DRAWING IS A SCAN OF AN ORIGINAL DESIGN DRAWING AND REFORMATTED TO FIT THE SHEET. THE DIMENSIONS AND LAYOUTS WERE NOT VERIFIED IN THE FIELD. THE DRAWING WAS LISTED AS MARITIME ADMINISTRATION PLAN No. 42-59-0-3 LOCATED AT THE MARITIME ADMINISTRATION.

Plans/Sections

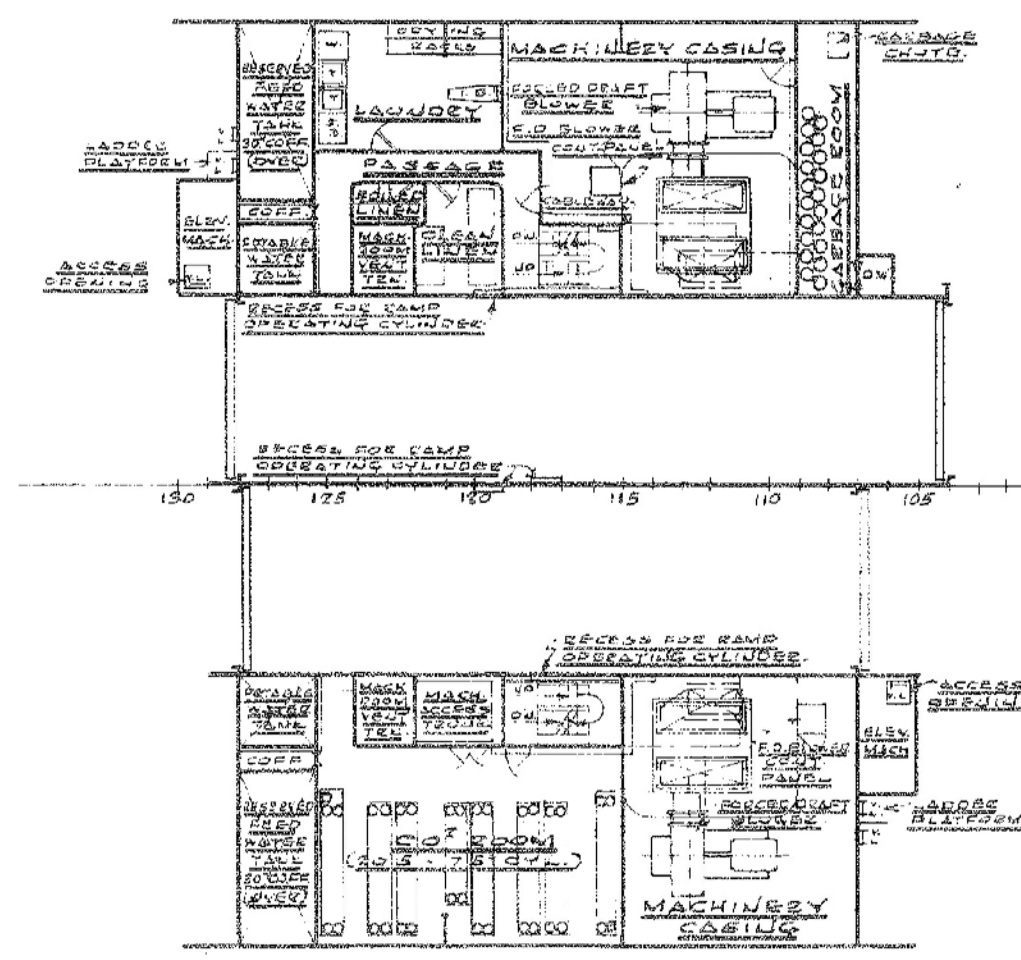

STORES FLAT

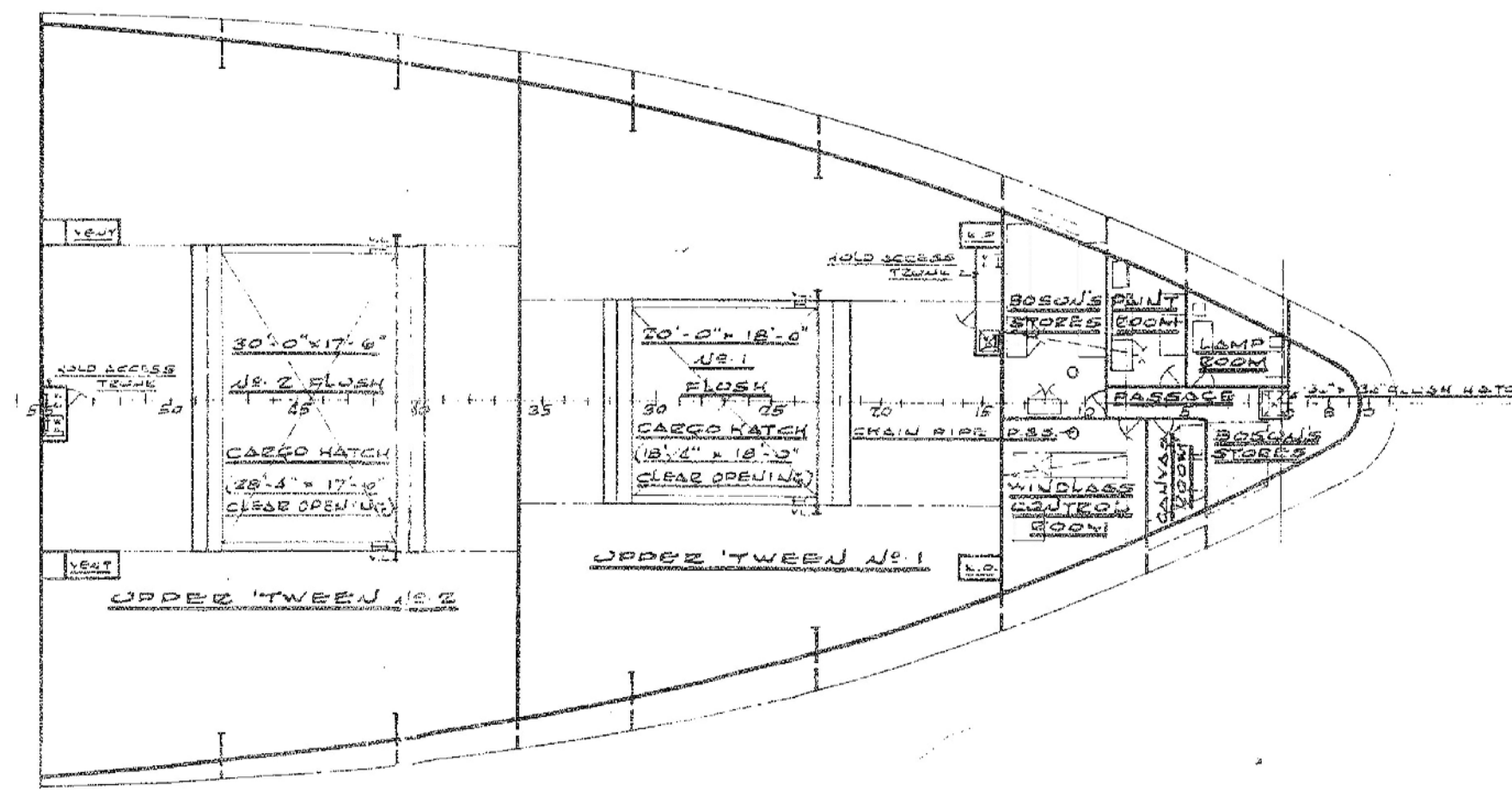

PLATFORM DECK

STORES FLAT & PLATFORM DECK  
SCALE: 1/16" = 1'-0"  
DESIGN CS-ST-1A2  
SHEET NO. 7 OF 7

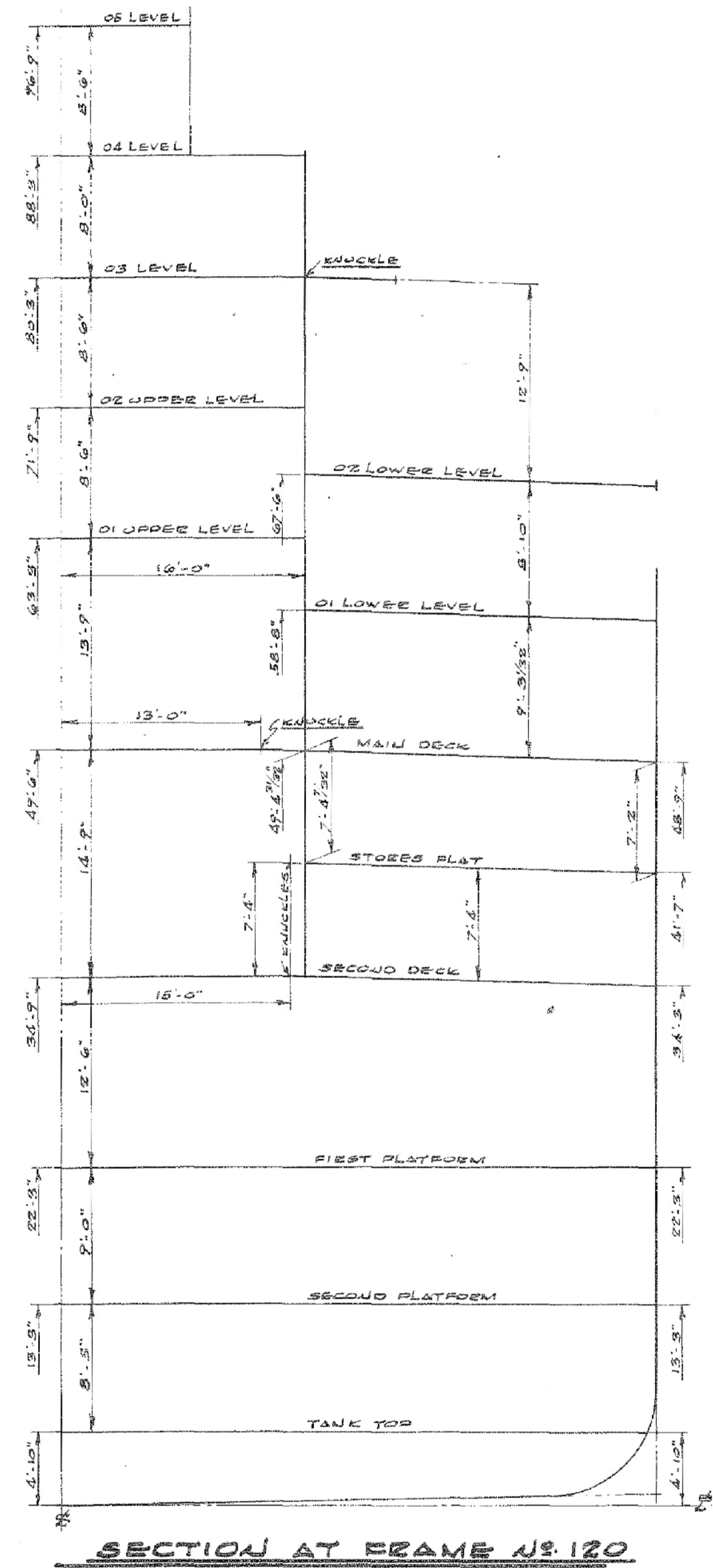
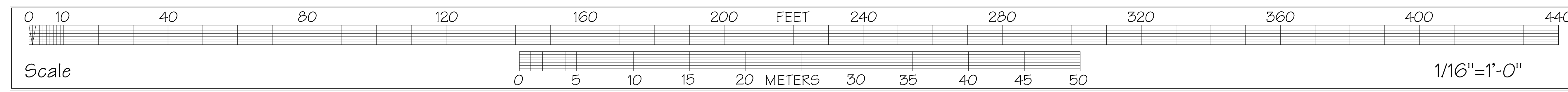

SECTION AT FRAME #120

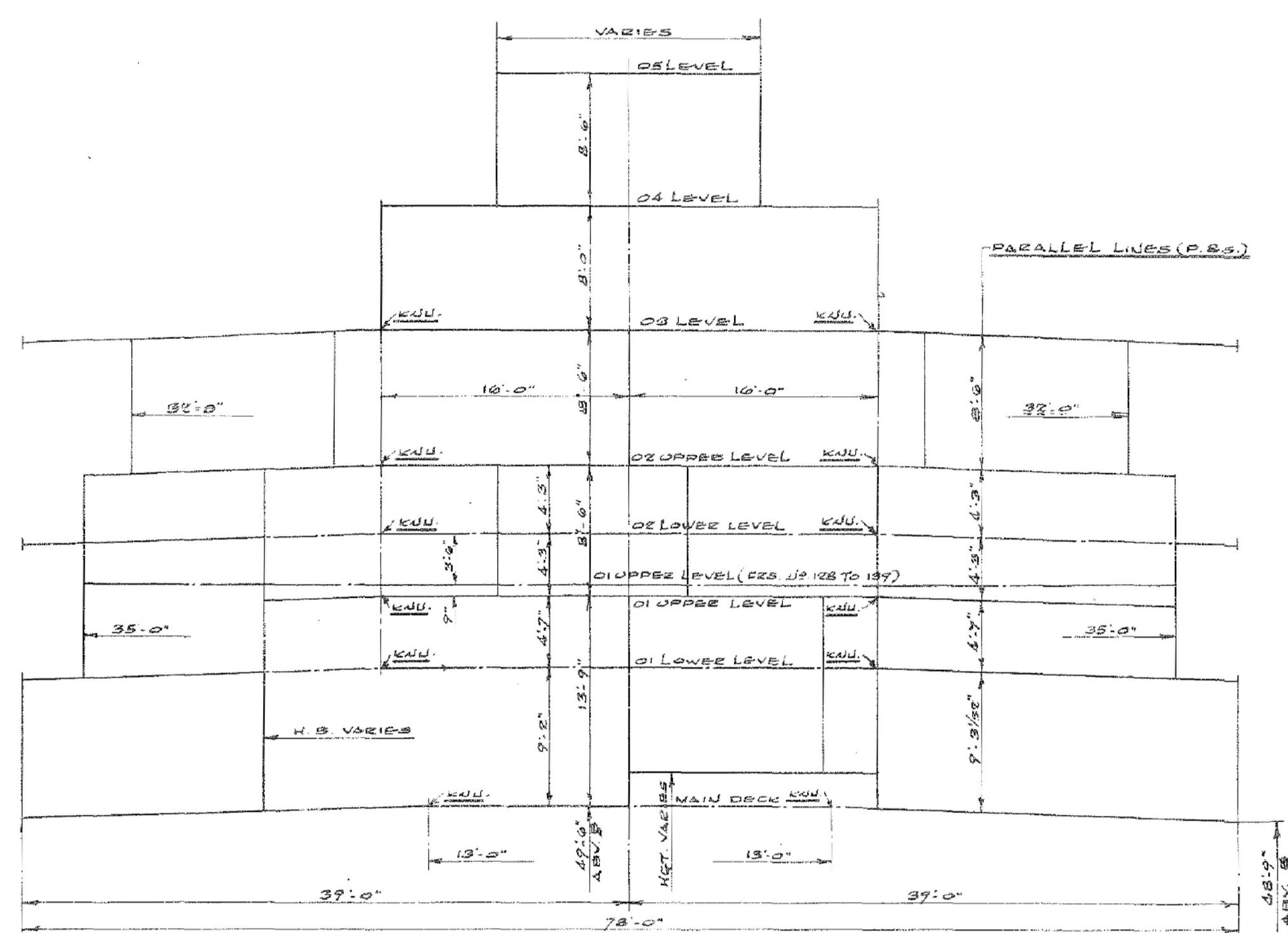

SECTION O-Art #107 (LOOKING AFT)

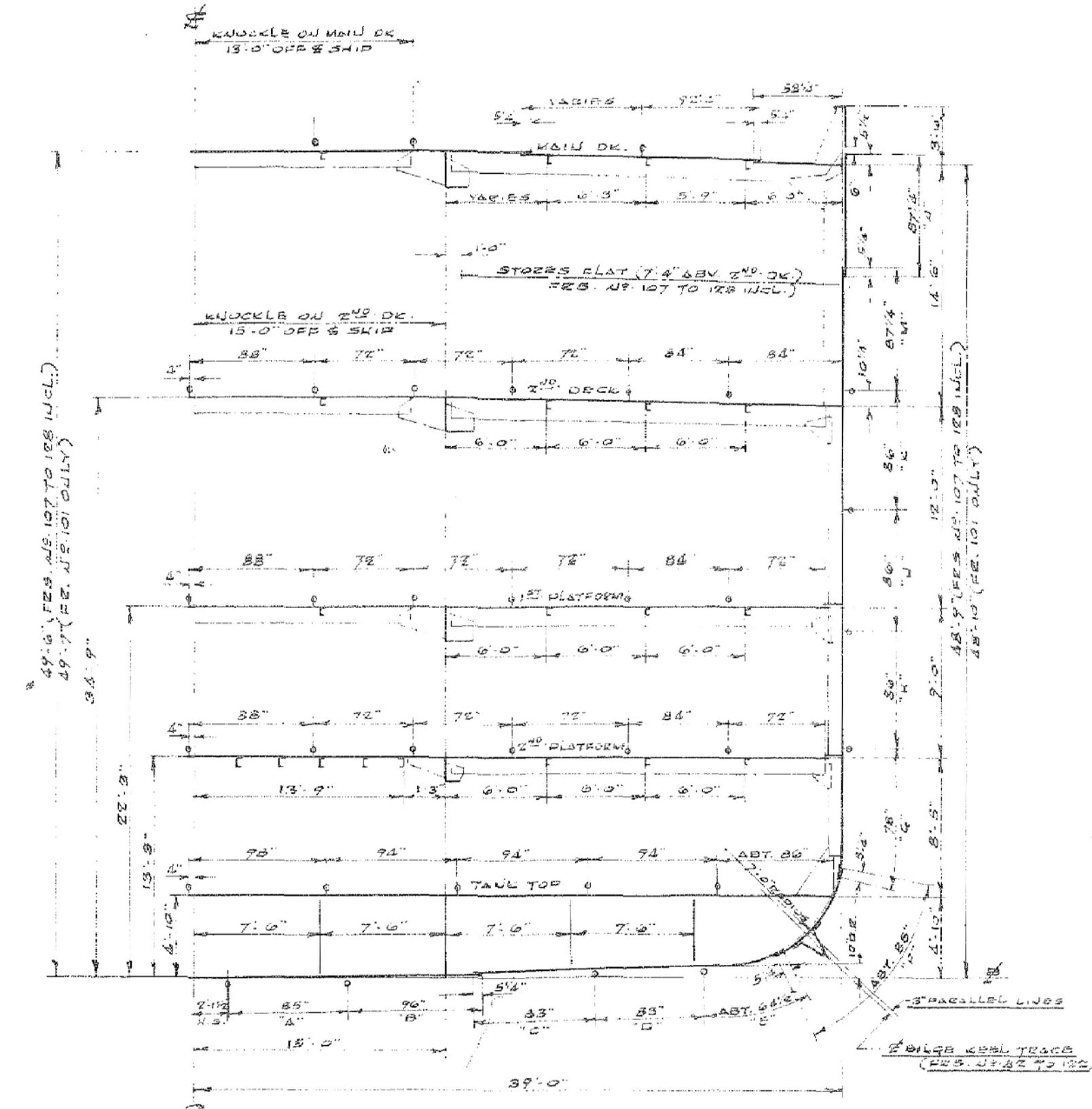

MIDSHIP SECTION

NOTES -  
1. SECTION ABOVE IS THE MAX. SECTION AT DECK (EXCEPT MAIN DECK HEAD)  
2. THIS MIDSHIP SECTION IS SEE. NO. 11.

MIDSHIP SECTIONS  
SCALE: 1/8" = 1'-0"  
DESIGN CS-ST-1A2  
SHEET NO. 15 OF 15

