

TRAFFIC CONTROL SYSTEMS HANDBOOK

Prepared for

FEDERAL HIGHWAY ADMINISTRATION

By

DUNN ENGINEERING ASSOCIATES

In association with

Siemens Intelligent Transportation Systems

OCTOBER 2005

Notice

This document is disseminated under the sponsorship of the Department of Transportation in the interest of information exchange. The United States Government assumes no liability for its contents or use thereof. This report does not constitute a standard, specification, or regulation.

The United States Government does not endorse products or manufacturers. Trade and manufacturers' names appear in this report only because they are considered essential to the object of the document.

Technical Report Documentation Page

1. Report No. FHWA-HOP-06-006	2. Government Accession No	3. Recipient's Catalog No	
4. Title and Subtitle Traffic Control Systems Handbook		5. Report Date October 2005	6. Performing Organization Code
7. Authors Robert L. Gordon, P.E., Warren Tighe, P.E.		8. Performing Organization Report No.	
9. Performing Organization Name and Address Dunn Engineering Associates, P.C. 66 Main Street Westhampton Beach, NY 11978		10. Work Unit No. (TRAIS)	11. Contract or Grant No.
12. Sponsoring Agency Name and Address Office of Transportation Management Federal Highway Administration 1200 New Jersey Ave, SE Washington, DC 20590		13. Type of Report and Period Covered	
15. Supplementary Notes FHWA Contracting Officer Technical Representative (COTR): David Gibson, Office of Operations R&D (HRDO-4)		14. Sponsoring Agency Code	
<p>16. Abstract</p> <p>The <i>Traffic Control Systems Handbook</i> updates the 1996 edition (FHWA-SA-96-032). It serves as a basic reference in planning, designing and implementing traffic control systems.</p> <p>Specific chapters include introduction, summary of available and emerging traffic control system technology, control concepts for urban and suburban streets (traffic control parameters, descriptions of traffic control concepts and their application), a brief summary of control and management concepts for freeways, traffic detectors, local controller operation, traffic control system architectures, a brief summary of traffic control system communications, traveler information systems, the processes required for selection of a system, design and implementation, and systems management. The Handbook concludes with a discussion of ITS plans and programs.</p> <p>The <i>Traffic Control Systems Handbook</i> references other FHWA handbooks for more detailed information on freeway management, communications, and traffic detectors.</p>			
17. Key Words Traffic control systems, traffic signal controllers, intelligent transportation systems, traveler information systems		18. Distribution Statement No restrictions.	
19. Security Classification (of this report) Unclassified	20. Security Classification (of this page) Unclassified	21.No. of Pages 367	22.Price

Table of Contents

Chapter 1 Introduction

Section	Page
1.1	Scope and Objectives 1-2
1.2	Summary of Handbook Contents 1-3
1.3	Role and Impact of Traffic Control Systems 1-6
1.4	Travel Demand Management (TDM)..... 1-6
1.5	System Evolution..... 1-7
1.6	Present Status-Traffic Surveillance and Control 1-10
1.7	National ITS Architecture..... 1-11
	Logical Architecture..... 1-14
	Market Packages 1-14
	ITS Standards..... 1-17
1.8	Relationship to Other FHWA Handbooks..... 1-17
References 1-20

Chapter 2 Available and Emerging Traffic Control System Technology

2.1	Introduction..... 2-2
2.2	Control and Management Functions..... 2-3
2.3	Integrated Transportation Management Systems..... 2-4
	Information Sharing Among Agencies and Management Centers 2-4
	Coordination of Operations Among Agencies 2-4
2.4	Range of Agency Needs and Range of Available Options..... 2-5
	Transportation Systems Management (TSM) Relationship 2-7
	Control System Options 2-9
	Criteria for Selection 2-9
2.5	Available Technology..... 2-11
	Hardware..... 2-11
	Software 2-12
2.6	A Look to the Future..... 2-12
	Hardware in the Loop..... 2-12
	Non-Pavement Invasive Traffic Detectors 2-13
	Support of Emergencies and Evacuations 2-14
	Advanced Transportation Controller..... 2-14
	Advanced Signal State Transition Logic..... 2-14

Table of Contents

Chapter 2 (Continued)

Section	Page
Improved Transit Priority Systems.....	2-14
References	2-15

Chapter 3

Control Concepts – Urban and Suburban Streets

3.1	Introduction.....	3-3
3.2	Control Variables.....	3-4
3.3	Sampling	3-9
3.4	Filtering and Smoothing	3-9
3.5	Traffic Signal Timing Parameters	3-15
3.6	Traffic Signal Phasing.....	3-15
	Phasing Options	3-16
	Left-Turn Phasing.....	3-16
	Phase Sequencing	3-18
3.7	Isolated Intersections	3-18
	Traffic Flow	3-20
	Types of Control	3-21
	Intersection Timing Requirements	3-21
	Pretimed Controller.....	3-21
	Traffic-Actuated Control	3-21
	Timing Considerations.....	3-28
	Cycle Length and Split Settings.....	3-28
	Intersection Delay	3-31
	Critical Lane Groups.....	3-32
	Traffic Actuated Control.....	3-33
	Other Considerations	3-33
3.8	Arterial and Network Control	3-34
	Basic Considerations.....	3-34
	Information from Prior Research and Experience.....	3-38
	Simulation.....	3-39
	Time-Space Diagram	3-40
	Timing Plan Elements	3-40
	Traffic Flow Variations.....	3-40
	Timing Plan Development	3-43
	Manual Techniques.....	3-43
	Offline Computer Techniques.....	3-45
	Considerations for Closed Networks	3-47
	Need for Signal Retiming	3-47
	Determination of Central System Control Category	3-49
	Online Network Traffic Control Techniques	3-53

Table of Contents

Chapter 3 (Continued)

Section	Page
UTCS Control	3-54
Control Algorithms for Closed Loop Systems	3-56
Traffic Responsive Control Systems	3-56
Traffic Adaptive Control Systems	3-62
Saturated Flow Conditions	3-65
Regulatory Approaches	3-69
Congestion Pricing Approaches	3-69
Network Simulation	3-69
CORSIM	3-71
SimTraffic	3-72
Paramics	3-72
VISSIM	3-73
3.9 Special Controls.....	3-74
Closely Spaced Intersections	3-74
Directional Controls and Lane Control Signals	3-79
Preemption Systems	3-81
Priority Systems	3-83
Changeable Lane Assignment Systems (CLAS)	3-85
3.10 Benefits.....	3-85
Fuel Consumption	3-85
Vehicle Emissions	3-86
Estimating Highway User Costs	3-87
Impacts of Traffic Signal System Improvement	3-93
Project Level Impacts	3-93
Network Impacts	3-94
Cost-Effectiveness Comparisons	3-96
3.11 Measures of Effectiveness.....	3-97
References	3-105

Chapter 4

Control and Management Concepts for Freeways

4.1 Introduction.....	4-2
4.2 Congestion.....	4-3
4.3 Forms of Freeway Management	4-5
4.4 Relationship between Freeways and Surface Streets	4-8
References	4-9

Table of Contents

Chapter 5 Control and Management Concepts – Integrated Systems

Section	Page
5.1 Introduction	5-2
5.2 Traffic Management on Surface Streets	5-3
Monitoring Traffic Conditions and Adjusting Signal Timing.....	5-3
Detecting Incidents and Advising Motorists.....	5-4
Advising Motorists of Traffic Problems in the Area.....	5-4
Monitoring Traffic Conditions Resulting from Special Events and Advising Motorists.....	5-4
Assisting with Parking Information.....	5-5
5.3 Use of Transit Vehicles on Surface Streets as Probes for Traffic Incident Detection	5-5
5.4 Bus Rapid Transit Corridors	5-5
References	5-7

Chapter 6 Detectors

6.1 Introduction	6-2
6.2 Detector Operations Summary	6-4
Detector-Controller Relationship.....	6-4
Low-Speed Approaches.....	6-8
High-Speed Approaches.....	6-9
6.3 Vehicle Detector Location and Configuration	6-14
Isolated Actuated Intersection Control.....	6-14
Small-Area Detectors.....	6-14
Large-Area Detectors.....	6-14
Left-Turn Lanes.....	6-18
Control of Arterial and Network Intersections.....	6-20
Detector Locations for Conventional Traffic Systems.....	6-21
Link Selection.....	6-21
Longitudinal Placement.....	6-21
Lateral Detector Placement.....	6-22
General Guidelines for Spotting Detectors.....	6-22
References	6-24

Table of Contents

Chapter 7 Local Controllers

Section	Page
7.1 Introduction	7-2
7.2 Types of Operation	7-4
7.3 Range of Applications	7-5
Types of Signal Operation.....	7-5
Protected, Protected / Permissive, and Permissive Operation	7-7
Special Controls	7-7
7.4 Controller Evolution	7-8
7.5 Controller Characteristics	7-9
Signal Timing and Coordination	7-9
Interval Control versus Phase Control.....	7-9
Controller and Cabinet Components	7-12
Pattern Selection.....	7-13
Internal time-of-day schedule	7-13
Hardwire interconnect.....	7-13
External command	7-13
Synchronization for Coordination.....	7-14
Manual	7-14
Hardwire pulse.....	7-14
External command	7-14
Third-party time source.....	7-15
Actuated Controller Operation	7-15
Phasing Other Than Eight-Phase Dual-Ring.....	7-20
Diamond Interchange Operation	7-25
Single Point Freeway Interchange Operation.....	7-31
System Capabilities.....	7-34
7.6 NEMA, Advanced Transportation Controller, and Model 170 Standards	7-34
Controller Selection and Migration.....	7-39
References	7-42

Chapter 8 System Control

8.1 Introduction	8-2
8.2 Architectures for Conventionally Coordinated Traffic Control Systems.	8-2
Three Distributed Computation Level Architecture.....	8-2
Two Distributed Computation Level Architecture.....	8-5
Central Control Architecture.....	8-5
8.3 Traffic Response and Traffic Adaptive Systems	8-8

Table of Contents

Chapter 8 (Continued)

Section	Page
8.4 Time Base Coordination	8-10
8.5 Traffic Management Centers	8-11
Functions of Surface Street TMCs	8-11
Traffic Signal Timing	8-11
Size and Staffing Requirements of TMCs	8-12
Coordination between Traffic Systems and Traffic Agencies	8-14
References	8-15

Chapter 9 Communications

9.1 Introduction	9-2
9.2 Functions of a Communication System	9-3
9.3 Alternative Communication Technologies	9-3
9.4 NTCIP	9-5
References	9-6

Chapter 10 Traveler Information Systems

10.1 Introduction	10-2
10.2 Static Signs	10-2
10.3 Advanced Methods of Information Dissemination	10-7
10.4 Advantages and Disadvantages of Various Methods of Information Dissemination	10-10
Uses of Traveler Information Devices on Surface Streets	10-10
References	10-15

Table of Contents

Chapter 11 Selection of a System

Section	Page
11.1 Introduction	11-2
11.2 Federal-Aid Requirements	11-3
11.3 Systems Engineering and System Selection Process	11-3
Concept of Operations.....	11-5
Requirements	11-7
References	11-8

Chapter 12 Design and Implementation

12.1 Introduction	12-3
12.2 System Implementation	12-3
System Design.....	12-3
High Level Design	12-4
Detailed Design.....	12-5
12.3 Procurement Approach	12-6
Engineer (Consultant) / Contractor Approach.....	12-6
Systems Manager Approach.....	12-7
Design / Build Approach.....	12-8
12.4 Design Plans and Specifications	12-9
Design Plans.....	12-9
Specifications	12-10
Sources of Specifications.....	12-11
Closed versus Open Specifications	12-11
Standard Specifications.....	12-12
Contract Documents.....	12-12
Invitation to Bid	12-13
Instructions to Bidders	12-13
Bid Proposal.....	12-13
Bonds	12-13
Agreement.....	12-14
Conditions.....	12-14
Contractor Qualifications.....	12-14
Pre-Bid Conference.....	12-15
Precedence	12-15
Technical Specifications	12-16
Definition of Terms	12-16
Installation of Traffic Signals	12-16
Specifications for Materials and Equipment	12-17
Software, Database, Performance and System Test	12-17

Table of Contents

Chapter 12 (Continued)

Section	Page
12.5 Deliverable Services	12-21
Systems Management.....	12-21
Documentation	12-22
Training	12-24
Startup Assistance	12-26
Warranties / Guarantees	12-27
Maintenance	12-27
System Acceptance Tests	12-28
12.6 Project Management.....	12-31
Contract Administration	12-31
Scheduling.....	12-33
Critical Path Method (CPM)	12-33
Bar Charts	12-34
Gantt Charts	12-35
12.7 Implementation Pitfalls	12-35
Inexperienced Contractors.....	12-35
Construction Management	12-38
Maintenance and Protection of Traffic (MPT) During Construction	12-39
Database Development.....	12-39
Insufficient Staff for Operations and Maintenance	12-40
Utility Coordination	12-40
Planned Use of Untested Facilities or Techniques	12-40
Alienation of Maintenance Staff	12-41
Privatization of Operations and Maintenance	12-41
References	12-42

Chapter 13 Systems Management

13.1 Introduction.....	13-2
13.2 An Integrated System Management Concept.....	13-3
13.3 Operations.....	13-6
Practical Aspects	13-6
Control and Supervisory Periods	13-7
Typical Work Tasks	13-7
Specific Operational Tasks for Intersection Control Systems.....	13-9
13.4 Maintenance	13-17
Types of Maintenance	13-18
Functional	13-18
Hardware.....	13-19
Software.....	13-20
Results of Inadequate Maintenance.....	13-21

Table of Contents

Chapter 13 (Continued)

Section	Page
Staff Requirements.....	13-21
13.5 Evaluation.....	13-22
Techniques.....	13-23
Before and After Measurements.....	13-23
Sampling Considerations.....	13-25
References.....	13-26

Chapter 14 ITS Plans and Programs

14.1 Introduction.....	14-2
14.2 ITS Program Planning in the United States.....	14-3
14.3 The ITS Planning Process.....	14-4
National.....	14-4
Regional / Statewide.....	14-5
Agency.....	14-6
References.....	14-8

List of Figures

Figure No	Page
1-1	Rochester N.Y. Regional Traffic Operations Center..... 1-2
1-2	Interconnected traffic control system chronology..... 1-10
1-3	Overview of physical entities..... 1-14
2-1	Traffic signal..... 2-2
2-2	Hardware in the loop configuration..... 2-13
3-1	Time-space diagram display from Synchro 4..... 3-3
3-2	Speed measurements using presence detectors..... 3-8
3-3	Headway determination..... 3-8
3-4	Deterministic and random components when demand is constant..... 3-11
3-5	Deterministic component of volume during a.m. peak period..... 3-12
3-6	Effect of variation in smoothing coefficient on random component..... 3-13
3-7	Filter response and output to deterministic component and error..... 3-14
3-8	Two-phase signal sequence..... 3-16
3-9	Four-phase signal sequence..... 3-16
3-10	Dual-ring left-turn phasing options..... 3-17
3-11	Primary phasing options for 8-phase dual-ring control (left-turn first)..... 3-19
3-12	Recommended selection guidelines..... 3-22
3-13	Traffic detection on intersection approach..... 3-24
3-14	Example of actuated phase intervals..... 3-25
3-15	Fundamental Attributes of Flow at Signalized Intersections..... 3-29
3-16	Symbols, definitions, and units for fundamental variables of traffic flow at signalized intersections..... 3-30
3-17	Cycle length vs. demand for two phase signal..... 3-32
3-18	Signal networks..... 3-35
3-19	Simple case of platoon dispersion..... 3-36
3-20	Benefits of signal coordination..... 3-38
3-21	Time-space diagram and graphic technique..... 3-41
3-22	Typical time-space diagram..... 3-42
3-23	Closed network node definitions..... 3-48
3-24	Principles of the SCOOT traffic model..... 3-58
3-25	The RHODES hierarchical architecture..... 3-63
3-26	Implementation of the rolling horizon approach in OPAC..... 3-64
3-27	Reverse progression signal offset..... 3-67
3-28	External metering..... 3-68
3-29	Relationship between mean journey speed and number of vehicles on town centre network.... 3-70
3-30	Relationship between mean journey speed of vehicles and total vehicle mileage on network... 3-71
3-31	Example of one controller for two adjacent intersections..... 3-76
3-32	Examples of one controller for a diamond interchange..... 3-77
3-33	Bus priority provision zone..... 3-85
3-34	Fuel economy as a function of vehicle speed..... 3-86
3-35	Time-space diagram for stop and delay computations for urban street control..... 3-103
3-36	Throughput and component MOEs..... 3-103
4-1	INFORM (Long Island, NY) control center..... 4-2
4-2	Generalized relationships among speed, density, and flow rate on uninterrupted-flow facilities..... 4-4
4-3	Freeway management categories..... 4-6
4-4	CMS on a freeway..... 4-8
5-1	Diversion advisory message in the INFORM (Long Island, NY) corridor..... 5-2

List of Figures

Figure No	Page
6-1	Radar detector..... 6-2
6-2	Inductive loop detector length for loop occupancy control..... 6-9
6-3	Dilemma zone for vehicle approaching an intersection at 40 mi/h (64 km/h)..... 6-10
6-4	Loop location for extended call-delay design with 55 mi/hr (88.6 km/hr) approach design speed..... 6-11
6-5	Two methods of multiple point detection systems for approach speeds up to 55 mi/hr (88.6 km/hr)..... 6-15
6-6	Contrast between small-area and large-area detection..... 6-16
6-7	Typical detector designs..... 6-17
6-8	Left-turn detection inductive loop configuration used by Illinois..... 6-19
6-9	Extended detection on left-turn lanes..... 6-20
7-1	Model 2070 Controller in ATC cabinet..... 7-2
7-2	Three-phase controller phase sequence for single-ring controller..... 7-11
7-3	Phase sequence for dual-ring controller..... 7-11
7-4	Dual-ring basic phase sequence options..... 7-19
7-5	Example of special phase sequence for conditional service of left-turn phase..... 7-24
7-6	Diamond interchange phasing (3-phase)..... 7-27
7-7	Diamond interchange phasing (3- and 4-phase)..... 7-28
7-8	Typical detector configuration for 3-phase, lag-lag, and 4-phase (with overlap) special sequences..... 7-29
7-9	Computer controlled diamond interchange operation..... 7-30
7-10	Single point urban interchange (SPUI)..... 7-32
7-11	Typical SPUI 3-phase sequence..... 7-33
8-1	Traffic management center (TMC)..... 8-2
8-2	Typical architecture for three computation level distributed (closed loop) system..... 8-4
8-3	Typical arrangement for central control architecture..... 8-6
9-1	Installing communications cable..... 9-2
10-1	Traveler information kiosk..... 10-2
10-2	Active sign..... 10-5
10-3	Static sign hybrid..... 10-5
10-4	LED illuminated static yield sign..... 10-7
10-5	Illuminated fluorescent sign..... 10-7
10-6	CMS on surface street..... 10-8
11-1	Selection of a system..... 11-2
11-2	“V” representation of the systems engineering life cycle..... 11-4
11-3	Relationship of system engineering practices identified in Part 940 to the system engineering life cycle..... 11-5
11-4	Developing the concept of operations..... 11-6
12-1	CADD workstation and operator..... 12-3
12-2	Sample specification—system acceptance..... 12-30
12-3	Example of CPM network diagram..... 12-34
12-4	Greensboro, NC traffic control project milestone schedule..... 12-36
13-1	Traffic signal maintenance..... 13-2
13-2	System management team concept..... 13-5
13-3	Typical daily control and operations architecture..... 13-10
13-4	Typical aggregate MOE contour timing plan graphic..... 13-12

List of Figures

Figure No	Page
13-5 Typical flow chart for system modification and update for non-adaptive traffic control systems.....	13-14
14-1 The ITS Program Structure	14-2

List of Tables

Table No		Page
1-1	User service bundles and user services	1-12
1-2	Market packages.....	1-15
1-3	Relationship to other FHWA handbooks	1-19
2-1	Typical system functions.....	2-6
2-2	Signal system options.....	2-10
3-1	Control variable definitions.....	3-5
3-2	Traffic data components.....	3-9
3-3	Signal timing variable definitions.....	3-15
3-4	Additional left-turn phasing options.....	3-18
3-5	Vehicle headway data.....	3-20
3-6	Proposed signal control at specific intersections along arterials.....	3-23
3-7	Proposed signal control at specific intersections in grid systems.....	3-23
3-8	Interval settings.....	3-26
3-9	TRANSYT analytical model.....	3-37
3-10	Recommended values of platoon dispersion factor (PDF).....	3-37
3-11	Directional flow conditions.....	3-43
3-12	Manual timing plan development.....	3-44
3-13	Performance categories for traffic control systems.....	3-50
3-14	Characteristics of traffic signal system performance categories.....	3-52
3-15	UTCS first generation traffic-responsive control algorithm.....	3-55
3-16	SCOOT optimization process.....	3-57
3-17	Enhanced SCOOT features.....	3-59
3-18	SCATS control levels.....	3-60
3-19	Definitions of lane control signal displays.....	3-80
3-20	Transportation related SIP requirements for carbon monoxide nonattainment areas by classification.....	3-87
3-21	Passenger car operating costs, United States, 2003.....	3-88
3-22	Motor vehicle traffic fatalities and injuries - 1997.....	3-89
3-23	Motor vehicle traffic fatalities and injuries by highway types - 1997.....	3-91
3-24	Costs per accident, 2002.....	3-93
3-25	Benefits of signal system improvement.....	3-93
3-26	Annual benefits from optimization on arterial.....	3-94
3-27	Texas TLS program annual benefits and costs.....	3-94
3-28	Annual benefits from optimization on network.....	3-95
3-29	Seattle MMDI evaluation: system efficiency impacts.....	3-95
3-30	Seattle MMDI evaluation: energy and emissions impacts.....	3-95
3-31	Measures of effectiveness (MOE).....	3-98
6-1	Strengths and weaknesses of commercially available sensor technologies.....	6-5
6-2	Traffic output data (typical), communications bandwidth, and cost of commercially available sensors.....	6-7
6-3	Detector location and timing parameters.....	6-8
6-4	Dilemma zone boundaries.....	6-10
6-5	Conventional detector-controller unit configurations for high-speed approaches.....	6-12
7-1	Definition of controller terms.....	7-3
7-2	Traffic signal controller functions.....	7-3
7-3	Isolated versus coordinated signal modes.....	7-4
7-4	Types of signal operation.....	7-5
7-5	Application of signal control types.....	7-6
7-6	Actuated controller definitions.....	7-16

List of Tables

Table No		Page
7-7	Actuated controller basic timing parameters.....	7-17
7-8	Phase sequence options.....	7-18
7-9	Inputs per phase.....	7-21
7-10	Inputs per ring.....	7-22
7-11	Inputs per controller unit.....	7-23
7-12	Special phase sequencing.....	7-26
8-1	Performance levels for traffic signal systems.....	8-3
8-2	Coordination commands.....	8-7
8-3	Representative results of adaptive system performance testing.....	8-9
8-4	Advantages and disadvantages of adaptive traffic control systems.....	8-9
8-5	Comparison of various traffic signal system TMCs in the US.....	8-13
9-1	Communications technology subclassifications.....	9-4
10-1	Static sign use.....	10-4
10-2	Applications of CMS on surface streets.....	10-8
10-3	Advantages and disadvantages of methods of information dissemination.....	10-11
12-1	Types of design plans.....	12-10
12-2	Items in traffic signal installation specification.....	12-17
12-3	Guidelines for representative sections of specifications.....	12-18
12-4	Representative system software elements.....	12-20
12-5	Typical hardware documentation requirements.....	12-23
13-1	Suggested routine operations tasks.....	13-8
13-2	MOE formats.....	13-12
13-3	Basic staffing skills.....	13-16
13-4	Staffing factors.....	13-17

**CHAPTER 1
INTRODUCTION**

Table of Contents

Section	Page
1.1 Scope and Objectives	1-2
1.2 Summary of Handbook Contents	1-3
1.3 Role and Impact of Traffic Control Systems	1-6
1.4 Travel Demand Management (TDM).....	1-6
1.5 System Evolution.....	1-7
1.6 Present Status-Traffic Surveillance and Control	1-10
1.7 National ITS Architecture.....	1-11
Logical Architecture.....	1-14
Market Packages	1-14
ITS Standards.....	1-17
1.8 Relationship to Other FHWA Handbooks.....	1-17
References	1-20

CHAPTER 1 INTRODUCTION

1.1 Scope and Objectives



Figure 1-1 Rochester N.Y. Regional Traffic Operations Center.

In 1985, the Federal Highway Administration published the second edition of the *Traffic Control Systems Handbook* to present basic technology used in planning, designing, and implementing traffic monitoring and control systems for urban street and freeway applications. That publication presented a compendium of applicable technology, concepts, and practices in the traffic control field. It proved useful in:

- Fostering understanding and acceptance of such systems, and
- Implementing proven advances in traffic monitoring and control.

This handbook was updated in 1996. In addition to describing signal system improvements since 1985, the 1996 edition provided considerable information on freeway management techniques and equipment.

The current edition updates signal system technology and broadens it into other methods for achieving surface street traffic management. Much of the freeway related material has been removed or abridged as the material is currently covered in the newly revised *Freeway Management and Operations Handbook* (FMOH) (1).

This updated version of the *Traffic Control Systems Handbook* maintains the following major objectives:

- Provide a compendium of existing traffic control system technology,
- Aid understanding of the basic elements of traffic control systems,
- Broaden the viewpoint of the traffic management field,
- Serve as a basic reference for the practicing traffic engineer in planning, designing, and implementing new and effective traffic control systems, and
- Serve as a training aid in the field of traffic control systems.

The Handbook targets a wide range of potential users – administrators, roadway designers, and traffic operations engineers, both experienced and newly assigned.

1.2 Summary of Handbook Contents

This section summarizes the contents of each Handbook chapter.

CHAPTER 2 - AVAILABLE AND EMERGING TRAFFIC CONTROL SYSTEM TECHNOLOGY

This chapter presents an overview of control and management functions. It discusses the issues involving inter-agency coordination and identifies potential needs and issues in selecting a traffic system. The chapter also introduces a classification system for traffic signal system categories and discusses likely future developments.

CHAPTER 3 – CONTROL CONCEPTS – URBAN AND SUBURBAN STREETS

This chapter addresses the following topics:

- Basic variables associated with surface street traffic flow and their properties.
- Capacity, cycle length and split.
- Signal phasing.
- Need for signal coordination and off line signal timing software.
- Categories of coordinated control.
- Signal timing strategies and guidance for applying strategies.
- Special control situations.
- Benefits and measures of effectiveness.

CHAPTER 4 – CONTROL AND MANAGEMENT CONCEPTS FOR FREEWAYS

This chapter provides a brief summary of the nature of freeway congestion, the types of freeway management and the relationship to surface streets. The newly revised *Freeway Management and Operations Handbook* (1) should be consulted as the primary reference on freeway control.

CHAPTER 5 – CONTROL AND MANAGEMENT CONCEPTS – INTEGRATED SYSTEMS

This chapter covers the non-traditional surface street control functions that are currently becoming more widely implemented.

CHAPTER 6 – DETECTORS

This chapter summarizes detector technology that is applicable to signal systems as well as installation requirements. The newly revised *Traffic Detector Handbook* (2) is the primary source of information on this subject.

CHAPTER 7 – LOCAL CONTROLLERS

This chapter covers the following major topics:

- Type of controller operations.
- Controller operation under isolated and coordinated control.
- Controller timing parameters.
- Phasing options and sequences.
- Controller types (NEMA, ATC and Model 170).

CHAPTER 8 – SYSTEM CONTROL

This chapter discusses architectures for conventional traffic control systems and adaptive systems, and covers time base coordination. The functions of signal system traffic management centers and some examples of the characteristics of these centers are provided.

CHAPTER 9 – COMMUNICATIONS

This chapter provides an overview of communications alternatives for surface street systems. It also briefly discusses the National Transportation Communications for ITS Protocol (NTCIP). The primary source of information for traffic system communications is the newly revised *Communications Handbook for Traffic Control Systems* (3).

CHAPTER 10 – TRAVELER INFORMATION SYSTEMS

This chapter provides an overview on the use of static signs and changeable message signs for surface street systems. It also discusses other types of motorist information devices. The primary source of information for traveler information systems is the *Freeway Management and Operations Handbook* (1).

CHAPTER 11 – SELECTION OF A SYSTEM

Chapters 11, 12 and 13 provide an overview of the systems engineering process life cycle.

After providing an introduction to federal aid requirements, this chapter describes the steps in the development of high level system requirements (scoping). Methods for evaluating candidate alternatives, utility cost analysis and benefit cost analysis are discussed.

CHAPTER 12 – DESIGN AND IMPLEMENTATION

The material in this chapter:

- Places system design, procurement, and installation tasks in perspective with respect to total system planning and implementation
- Describes alternative approaches to the procurement of systems, including contractor selection
- Describes the various elements of the design process, with particular emphasis on the contents of bid documents
- Describes elements of an approach to manage system installation.

CHAPTER 13 – SYSTEMS MANAGEMENT

This chapter describes the functions involved in managing a traffic system and a traffic operations center and the staffing resources required. Maintenance requirements and staffing issues are discussed. The need for system evaluation and techniques for accomplishing it are also described.

CHAPTER 14 – ITS PLANS AND PROGRAMS

This chapter discusses ITS America and TEA-21, and provides an overview of the ITS planning process at the national, regional / statewide and agency levels.

1.3 Role and Impact of Traffic Control Systems

The traffic signal impacts virtually everyone every day. Even on uncongested routes, stops at traffic signals punctuate an urban or suburban area trip. School children obediently wait for a traffic signal to interrupt traffic so they can cross a busy thoroughfare. Drivers confidently place their own and their passengers' physical safety in a signal's allocation of right-of-way.

People accept and in some cases demand traffic signals to assure safety and mobility. Drivers usually assume that the responsible agency can efficiently operate signals, so motorists usually report only the most obvious failures. Inefficient operation annoys some motorists but produces no strong public reaction. However, inefficiencies silently steal dollars from the public in increased fuel cost and longer trip times. Users normally perceive signals as working if they turn red and green; if they operate suboptimally, this becomes a concern, not a crisis.

Research and application demonstrate the effectiveness of signal system improvements in reducing:

- Delays,
- Stops,
- Fuel consumption,
- Emission of pollutants, and
- Accidents

The systematic *optimization of signal timing plans* in most signal systems represents an essential continuing element of traffic control system management. This optimization is labor intensive and costly for many existing traffic control systems. As a result, the number of timing plans and the frequency of updating the timing plans are often limited by the resources available to perform these functions.

Certain traffic systems have been termed *adaptive*, i.e., they have the capability to automatically change signal timing in response to both short term and longer term variations in traffic. These systems not only provide more effective control of traffic but also require fewer human and financial resources to update the system's database. However, they often require more intense deployment of traffic detectors.

1.4 Travel Demand Management (TDM)

A highly developed system of streets, highways, freeways, and some form of public transportation serves most North American cities. Growth in travel demand, however, seems to outpace the ability to provide new or expanded facilities and service. This

pressure places great emphasis on reducing travel demand to *reduce the loading of facilities*, particularly at peak hours.

The wide spectrum of TDM actions includes:

- Promotion of non-auto modes of travel,
- Preferential treatment for high occupancy vehicles (HOV),
- Preferential parking for HOV,
- Incentives to reduce peak period travel,
- Telecommuting,
- Non-standard work week such as four 10-hour days, and
- Transit and paratransit service improvements.

Many TDM measures impact or depend on the efficient and effective use of:

- Traffic signal systems,
- Freeway traffic management systems, and
- Traveler information systems.

Efforts to promote transit usage become less effective if buses meet unnecessary delay from inefficiently operated signals. Vanpool and transit usage become more attractive if these vehicles can travel on uncongested high occupancy vehicle freeway lanes.

Thus, urban and freeway control systems and traveler information systems can prove critical to the operational effectiveness of multimodal transportation facilities.

1.5 System Evolution

The development of traffic control systems for urban streets has paralleled the development and use of the automobile. After World War I, rapid growth in automobile traffic led to requirements for special personnel, signals and systems to address the problem.

In typical urban areas, approximately two-thirds of all vehicle-miles of travel, and even a higher percentage of vehicle-hours of travel, take place on facilities controlled by traffic signals (4). To a major extent, therefore, the quality of traffic signal operation determines urban vehicular traffic flow quality.

Traffic signals originated with signaling system technology developed for railroads. In 1914 (5), Cleveland, Ohio installed the first electric traffic signal in the United States. In 1917, Salt Lake City introduced an interconnected signal system that involved manually controlling six intersections as a single system (6). In 1922, in Houston, Texas, 12 intersections were controlled as a simultaneous system from a central traffic tower. This system proved unique in its use of an automatic electric timer.

The year 1928 saw the introduction of a flexible-progressive pretimed system. Municipalities quickly accepted these pretimed systems and widespread installation followed in virtually every U.S. city.

Their success resulted from:

- Simplicity (almost any electrician could understand them),
- Reliability (rugged components resulted in minimum maintenance), and
- Relatively low cost.

However, early pretimed systems had limited flexibility. They could respond only to predicted traffic changes via preset changes on a time clock. But predicting traffic conditions proved difficult because of the needed data collection efforts. Agencies usually avoided timing changes because of the staffing and time resources required to make changes at each local intersection controller.

Traffic-actuated local controllers using pressure detectors became available during the period 1928-1930. These controllers proved a first step toward traffic-actuated control but applied only to isolated intersections.

In 1952, Denver, Colorado advanced the state-of-the-art of traffic control systems by developing and installing an analog computer control system. This system applied some actuated isolated intersection control concepts to signalized networks. Sampling detectors input traffic flow data, and the system adjusted its timing on a demand rather than time-of-day (TOD) basis. Over one hundred systems of this type were installed in the United States in the period 1952-1962.

In 1960, Toronto conducted a pilot study using a digital computer to perform centralized control functions (7). The amount of traffic data available from this form of control proved a fortunate by-product. While the computer used for the test was archaic by today's standards - an IBM 650 with about 2,000 words of drum memory - the success of this control system approach encouraged Toronto to proceed with full-scale implementation. The city placed 20 intersections under computer control in 1963, and later expanded the system to 885 intersections by 1973.

International Business Machines (IBM) began a cooperative development in 1964 with the City of San Jose, California, to further develop a computer traffic control system (8).

The project used an IBM 1710 computer. Control concepts developed and implemented proved successful in significantly reducing stops, delays, and accidents.

Beginning in 1965, the City of Wichita Falls, Texas, contracted for the delivery of an IBM 1800 process control computer for traffic control. This system was placed in daily operation in 1966, controlling 56 intersections in the central business district. It was later expanded to include 78 intersections. San Jose, California, shortly thereafter made a transition to an IBM 1800 computer, and similar systems were installed in Austin and Garland, Texas; Portland, Oregon; Fort Wayne, Indiana and New York City. In these systems, traffic signals were controlled by using stored timing plans developed off-line.

In 1967, the Bureau of Public Roads, currently the Federal Highway Administration (FHWA), began to develop the Urban Traffic Control System (UTCS) Project. The system was installed in Washington, D.C., to develop, test, and evaluate advanced traffic control strategies (9). Completed in 1972, it contained 512 vehicle detectors whose outputs determined signal timing at 113 intersections. Extensive data processing, communications, and display capabilities were made available to support traffic control strategy research. Later efforts produced the Extended and Enhanced versions of the software package that implemented these concepts.

The 1970s also saw continuing research and development of software packages and models for digital computer and microprocessor based traffic control systems. The Transport and Road Research Laboratory (TRRL) in Great Britain developed the advanced centrally controlled traffic system, Split, Cycle and Offset Optimization Technique (SCOOT), in the 1970s with implementation taking place in Glasgow and other cities in the 1980s. SCOOT has been installed in several North American cities including Toronto, ON. Another advanced system, Sydney Coordinated Adaptive Traffic System (SCATS), developed in Australia, has been implemented in many cities throughout the world. SCOOT and SCATS initiated the deployment of *responsive* control systems. *Adaptive* control techniques, represented by Optimized Policies for Adaptive Control (OPAC) and RHODES, have also begun to be implemented.

Figure 1-2 summarizes the historical development of coordinated traffic control systems.

The experience gained during this evolution shows that substantial reductions in travel delays, stops, fuel consumption, and vehicle emissions can accrue from control system efficiency and aggressive traffic signal management. However, in conventional (non-adaptive) systems, full realization of benefits depends on the frequent updating of timing plans to optimize traffic flow.

The ACS-Lite program is a current FHWA research initiative that seeks to migrate certain techniques used in adaptive systems into the environment of simpler closed loop systems.

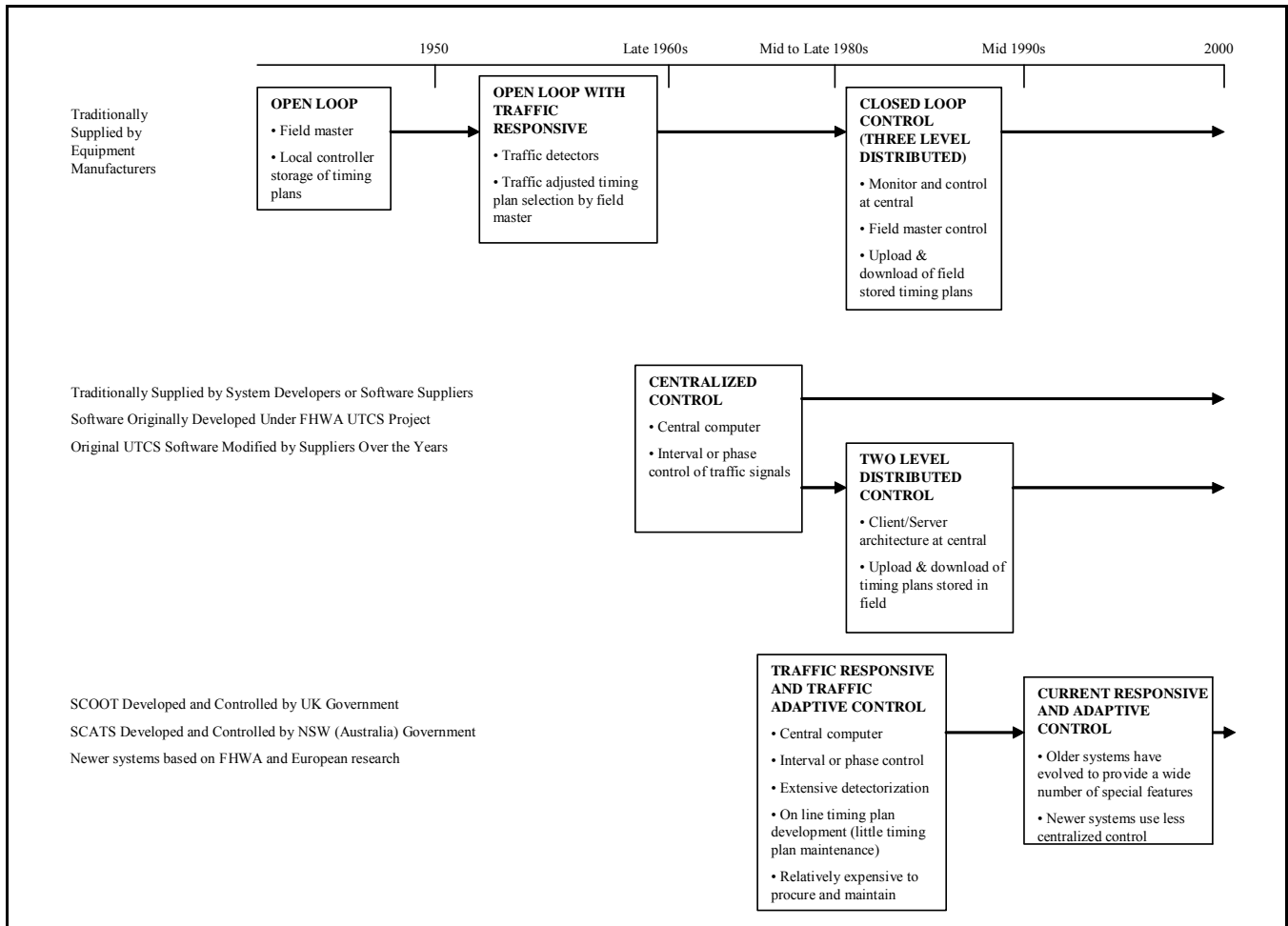

Figure 1-2 Interconnected traffic control system chronology.

Driver information systems have expanded as well, using a whole spectrum of media including:

- On-freeway and on-street dynamic signing and highway advisory radio,
- Commercial media,
- Displays at major traffic generators,
- Internet, and
- In-vehicle information and displays.

1.6 Present Status-Traffic Surveillance and Control

The 1980s and early 1990s have witnessed widespread acceptance and implementation of advanced traffic control and management systems for both freeways and urban streets.

Use of the computer has become the accepted way to control streets and highways and has been accelerated by the revolutionary advances and associated cost reductions in computer, communications and electronic technology. Local microprocessor controllers have virtually eliminated operational constraints previously imposed by hardware capability. Today, constraints on effective system operation are generally not technical but institutional, jurisdictional or financial.

Present activity in traffic monitoring and control systems has advanced beyond experimentation to deployment of effective operational tools. Basic control concepts have been refined through the experience of multiple users. An effective network of system designers, manufacturers, and suppliers exists to offer choices in system selection. The cooperative participation of governmental agencies (Federal, state, local) and commercial and professional organizations (manufacturers, consultants) continues in the development efforts of hardware and software. Prime examples include the development of the 2070 Advanced Transportation Controller, which provides an open architecture for controller hardware and software and the National Transportation Communications for ITS Protocol (NTCIP), which facilitates equipment interoperability.

1.7 National ITS Architecture

The National ITS Architecture (10) provides a common framework for planning, defining, and integrating intelligent transportation systems. It is a mature product that reflects the contributions of a broad cross-section of the ITS community (transportation practitioners, systems engineers, system developers, technology specialists, consultants, etc.). The architecture defines:

- The functions (e.g., gather traffic information or request a route) that are required for ITS.
- The physical entities or subsystems where these functions reside (e.g., the field or the vehicle).
- The information and data flows that connect these functions and physical subsystems together into an integrated system.

The National ITS Architecture defines the user service bundles and user services shown in Table 1-1. Figure 1-3 shows an overview of the *physical* architecture. Key components of the National ITS Architecture are summarized below:

Table 1-1 User service bundles and user services.

1 Travel and Traffic Management

User Services	
1.1	Pre-trip Travel Information
1.2	En-route Driver Information
1.3	Route Guidance
1.4	Ride Matching And Reservation
1.5	Traveler Services Information
1.6	Traffic Control
1.7	Incident Management
1.8	Travel Demand Management
1.9	Emissions Testing And Mitigation
1.10	Highway Rail Intersection

2 Public Transportation Management

User Services	
2.1	Public Transportation Management
2.2	En-route Transit Information
2.3	Personalized Public Transit
2.4	Public Travel Security

3 Electronic Payment

User Services	
3.1	Electronic Payment Services

4 Commercial Vehicle Operations

User Services	
4.1	Commercial Vehicle Electronic Clearance
4.2	Automated Roadside Safety Inspection
4.3	On-board Safety And Security Monitoring
4.4	Commercial Vehicle Administrative Processes
4.5	Hazardous Material Security And Incident Response
4.6	Freight Mobility

Table 1-1 User services bundle and user services (continued).

5 Emergency Management

User Services	
5.1	Emergency Notification And Personal Security
5.2	Emergency Vehicle Management
5.3	Disaster Response And Evacuation

6 Advanced Vehicle Safety Systems

User Services	
6.1	Longitudinal Collision Avoidance
6.2	Lateral Collision Avoidance
6.3	Intersection Collision Avoidance
6.4	Vision Enhancement For Crash Avoidance
6.5	Safety Readiness
6.6	Pre-crash Restraint Deployment
6.7	Automated Vehicle Operation

7 Information Management

User Services	
7.1	Archived Data Function

8 Maintenance And Construction Management

User Services	
8.1	Maintenance And Construction Operations

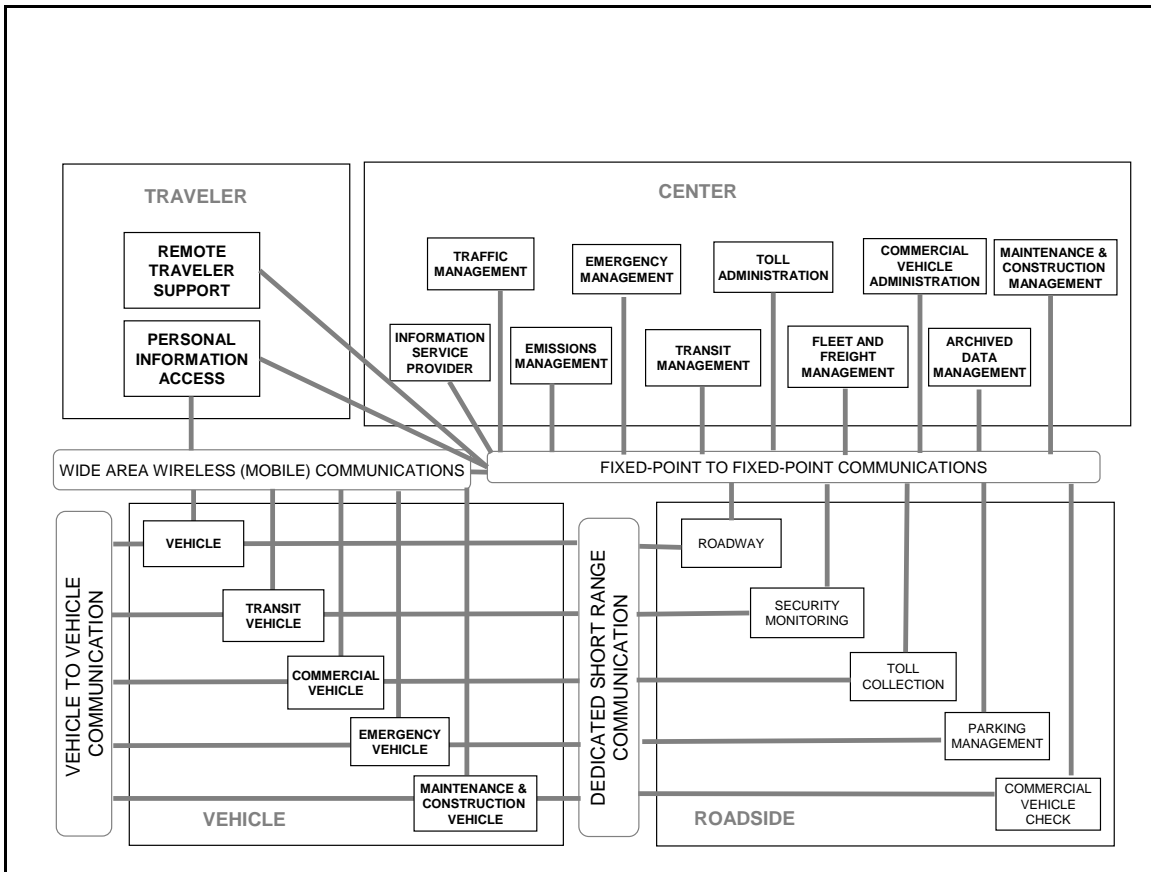

Figure 1-1 Overview of physical entities.

Logical Architecture

The Logical Architecture defines the processes (the activities and functions) that are required to provide the required user services. Many different processes must work together and share information to provide a *user service*. The processes can be implemented via software, hardware, or firmware. The *logical architecture* is independent of technologies and implementations. The *logical architecture* is presented to the reader via data flow diagrams (DFDs) or bubble charts and Process Specifications (PSpecs).

Market Packages

Market packages represent slices of the *physical architecture* that address specific services like surface street control. A market package collects several different subsystems, equipment packages, terminators, and architecture flows that provide the desired service. Table 1-2 identifies the market packages.

Table 1-2 Market packages.

Service Area	Market Package	Market Package Name
ARCHIVED DATA MANAGEMENT	AD1	ITS Data Mart
	AD2	ITS Data Warehouse
	AD3	ITS Virtual Data Warehouse
PUBLIC TRANSPORTATION		
	APTS1	Transit Vehicle Tracking
	APTS2	Transit Fixed-Route Operations
	APTS3	Demand Response Transit Operations
	APTS4	Transit Passenger and Fare Management
	APTS5	Transit Security
	APTS6	Transit Maintenance
	APTS7	Multi-modal Coordination
	APTS8	Transit Traveler Information
TRAVELER INFORMATION	ATIS1	Broadcast Traveler Information
	ATIS2	Interactive Traveler Information
	ATIS3	Autonomous Route Guidance
	ATIS4	Dynamic Route Guidance
	ATIS5	ISP Based Route Guidance
	ATIS6	Integrated Transportation Management / Route Guidance
	ATIS7	Yellow Pages and Reservation
	ATIS8	Dynamic Ridesharing
	ATIS9	In-Vehicle Signing

Table 1-2 Market packages (continued).

Service Area	Market Package	Market Package Name
TRAFFIC MANAGEMENT	ATMS01	Network Surveillance
	ATMS02	Probe Surveillance
	ATMS03	Surface Street Control
	ATMS04	Freeway Control
	ATMS05	HOV Lane Management
	ATMS06	Traffic Information Dissemination
	ATMS07	Regional Traffic Control
	ATMS08	Traffic Incident Management System
	ATMS09	Traffic Forecast and Demand Management
	ATMS10	Electronic Toll Collection
	ATMS11	Emissions Monitoring and Management
	ATMS12	Virtual TMC and Smart Probe Data
	ATMS13	Standard Railroad Grade Crossing
	ATMS14	Advanced Railroad Grade Crossing
	ATMS15	Railroad Operations Coordination
	ATMS16	Parking Facility Management
	ATMS17	Regional Parking Management
	ATMS18	Reversible Lane Management
	ATMS19	Speed Monitoring
	ATMS20	Drawbridge Management
	ATMS21	Roadway Closure Management
VEHICLE SAFETY	AVSS01	Vehicle Safety Monitoring
	AVSS02	Driver Safety Monitoring
	AVSS03	Longitudinal Safety Warning
	AVSS04	Lateral Safety Warning
	AVSS05	Intersection Safety Warning
	AVSS06	Pre-Crash Restraint Deployment
	AVSS07	Driver Visibility Improvement
	AVSS08	Advanced Vehicle Longitudinal Control
	AVSS09	Advanced Vehicle Lateral Control
	AVSS10	Intersection Collision Avoidance
	AVSS11	Automated Highway System

Table 1-2 Market packages (continued).

Service Area	Market Package	Market Package Name
EMERGENCY MANAGEMENT	EM01	Emergency Call-Taking and Dispatch
	EM02	Emergency Routing
	EM03	Mayday Support
	EM04	Roadway Service Patrols
	EM05	Transportation Infrastructure Protection
	EM06	Wide-Area Alert
	EM07	Early Warning System
	EM08	Disaster Response and Recovery
	EM09	Evacuation and Reentry Management
	1M10	Disaster Traveler Information
MAINTENANCE & CONSTRUCTION MANAGEMENT	MC01	Maintenance and Construction Vehicle and Equipment Tracking
	MC02	Maintenance and Construction Vehicle Maintenance
	MC03	Road Weather Data Collection
	MC04	Weather Information Processing and Distribution
	MC05	Roadway Automated Treatment
	MC06	Winter Maintenance
	MC07	Roadway Maintenance and Construction
	MC08	Work Zone Management
	MC09	Work Zone Safety Monitoring
	MC10	Maintenance and Construction Activity Coordination

ITS Standards

ITS Standards are fundamental to the establishment of an open ITS environment, the goal originally envisioned by the U.S. Department of Transportation (USDOT). Standards facilitate deployment of interoperable systems at local, regional, and national levels without impeding innovation as technology advances and new approaches evolve. The National ITS Architecture is a reference framework that spans all of these ITS Standards activities and provides a means of detecting gaps, overlaps, and inconsistencies between the standards. The National ITS Architecture references specific applicable standards sites and provides connections to them.

1.8 Relationship to Other FHWA Handbooks

This handbook is one of a series of FHWA handbooks that have been recently issued or revised. The following handbooks provide information which is closely related to a number of chapters in the *Traffic Control Systems Handbook* (TCSH):

- *Freeway Management and Operations Handbook* (FMOH) (1)
- *Traffic Detector Handbook* (TDH) (2)
- *Telecommunications Handbook for Transportation Professionals: The Basics of Telecommunications* (TH) (3)

Table 1-3 summarizes the relationship of the material in those handbooks to this document.

Table 1-3 Relationship to other FHWA handbooks.

TRAFFIC CONTROL SYSTEMS HANDBOOK (TCSH) CHAPTER	OTHER FHWA HANDBOOK	RELATIONSHIP
1 Introduction	FMOH	FMOH provides additional information on the National ITS Architecture.
4 Control and Management Concepts for Freeways	FMOH	FMOH is the prime source on this subject. TCSH provides a brief overview.
6 Detectors	TDH	TDH is the prime source on this subject. TCSH material is primarily related to installation issues.
8 System Control	FMOH	FMOH provides additional information on traffic management centers.
9 Communications	TH	TH is the prime source on this subject. TCSH discussion is limited to the relationship of communication technologies to surface streets.
10 Traveler Information Systems	FMOH	FMOH is the prime source on this subject. TCSH provides information on static signing, use of CMS on surface streets, summary of advantages and disadvantages of different technologies.
11 Selection of a System	FMOH	FMOH provides additional information on the system design cycle.

References

1. Neudorff, L.G., J.E. Randall, R. Reiss, and R. Gordon. "Freeway Management and Operations Handbook." Federal Highway Administration Report No. FHWA-OP-04-003, Washington, DC, September 2003.
2. Klein, L. "Traffic Detector Handbook." Federal Highway Administration Report, Washington, DC. To be published.
3. Leader, S. "Telecommunications Handbook for Transportation Professionals: The Basics of Telecommunications." Federal Highway Administration Report No. FHWA-HOP-04-034, Washington, DC, September 2004.
4. Wagner, F.A. "Overview of the Impacts and Costs of Traffic Control System Improvements." Federal Highway Administration Office of Highway Planning, Washington, DC, March 1980.
5. Mueller, E.A. "The Transportation Profession in the Bicentennial Year - Part II." *Traffic Engineering*, Vol. 46, No. 9, pp. 29-34, 1976.
6. Sessions, G.M. "Traffic Devices - Historical Aspects Thereof." Institute of Traffic Engineers. Washington, DC, 1971.
7. Irwin, N.A. "The Toronto Computer-Controlled Traffic Signal System." *Traffic Control Theory and Instrumentation*. Plenum Press, New York, 1965. (See also: Casicato, L., and S. Cass. "Pilot Study of the Automatic Control of Traffic Signals by a General Purpose Electric Computer." *Highway Research Board Bulletin 338*, 1962).
8. "San Jose Traffic Control Study." IBM Corp., March 1965 (Initial Report).
9. "The Urban Traffic Control System in Washington, DC." Federal Highway Administration, U.S. Department of Transportation, Washington, DC, September 1974.
10. "The National ITS Architecture, Version 5.0." Federal Highway Administration, 2003.

**CHAPTER 2
AVAILABLE AND EMERGING TRAFFIC CONTROL SYSTEM
TECHNOLOGY**

Table of Contents

Section	Page
2.1 Introduction.....	2-2
2.2 Control and Management Functions.....	2-3
2.3 Integrated Transportation Management Systems.....	2-4
Information Sharing Among Agencies and Management Centers	2-4
Coordination of Operations Among Agencies	2-4
2.4 Range of Agency Needs and Range of Available Options.....	2-5
Transportation Systems Management (TSM) Relationship	2-7
Control System Options	2-9
Criteria for Selection	2-9
2.5 Available Technology.....	2-11
Hardware.....	2-11
Software	2-12
2.6 A Look to the Future.....	2-12
Hardware in the Loop.....	2-12
Non-Pavement Invasive Traffic Detectors	2-13
Support of Emergencies and Evacuations	2-14
Advanced Transportation Controller.....	2-14
Advanced Signal State Transition Logic.....	2-14
Improved Transit Priority Systems.....	2-14
References	2-15

CHAPTER 2 AVAILABLE AND EMERGING TRAFFIC CONTROL SYSTEM TECHNOLOGY

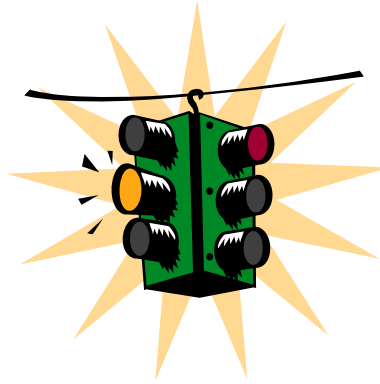

Figure 2-1 Traffic signal.

2.1 Introduction

This Handbook assists users in *defining, evaluating, and selecting systems* that match their needs. This chapter presents a broad overview of system functions and available options for both hardware and software.

Since the 1996 edition of the *Traffic Control Systems Handbook*, surface street traffic control systems technology has seen significant advances in the following areas (1):

- Improved traffic signal controllers.
- Increased use of CCTV and changeable message signs (CMS) on surface streets.
- Increased use of non-pavement-invasive detectors.
- Improved transit priority strategies and equipment based on the use of GPS technology.
- Increased use of fiber optic cable for interconnection of traffic signal controllers and communication with other field devices.
- Increased use of standardized protocols to migrate data between intersection controllers and field master controllers or traffic management centers.

The period since the last edition of the *Traffic Control Systems Handbook* has also witnessed the following improvements in control strategies and operations:

- Greater information migration among adjacent and nearby traffic management centers.
- Increased coordination of signals across neighboring jurisdictions and traffic control systems.
- Increased use of adaptive traffic control systems.
- Improved coordination of surface street and freeway operations.
- Provision of traffic control systems with software that facilitates the automatic migration of signal timing plan data derived from signal timing programs into the traffic control system database.

2.2 Control and Management Functions

Control and management functions may include the following:

- Collection of data for development of signal timing plans and other functions (identification of control section boundaries and provision of parameters in the traffic control systems).
- Development of timing plans and the remainder of the traffic control system database.
- Implementation of signal timing plans, such as:
 - Pretimed.
 - Traffic responsive.
 - Operator selection of timing plans based on data provided by the traffic control system, CCTV and other information sources.
- Implementation of motorist information by means of changeable message signs, highway advisory radio, independent service providers, media and websites.
- Management of incidents on surface streets.
- Evaluation of system performance.

2.3 Integrated Transportation Management Systems

The National ITS Architecture (2) provides the methodology to coordinate transportation related services in a region (Regional ITS Architecture). Integration is achieved through:

- Information sharing among agencies and management centers.
- Coordination of operations among agencies.

Information Sharing Among Agencies and Management Centers

Information is commonly shared among agencies by means of voice communications and data communications. The Regional ITS Architecture establishes the general data flow requirements between agencies and from each agency's management center to the field equipment or other equipment that it communicates with or controls. To perform data communication between management centers, a common language and frame of reference is required. *Protocols* for the sharing of transportation related information are being established at the time of this writing by the National Transportation Communications for ITS Protocol (NTCIP) and are available on its website (<http://www.ntcip.org>).

In essence, the information may be put into the proper high level language by the use of the Traffic Management Data Dictionary (TMDD). The TMDD provides the definition and format for the data and the Message Sets for External Traffic Management Communications (MS / ETMCC) which organizes the TMDD elements into relevant messages. Different protocols are included in the NTCIP standards for transmitting these messages between management centers.

Coordination of Operations Among Agencies

Agencies and TMCs may each partly contribute to the improvement of transportation issues in a region. For example, information flow between a transit property and traffic control system may result in the provision of signal priority to transit vehicles. Similarly, a transit property might be able to detect and confirm traffic related incidents on the surface street system, and communicate this information to the TMC operating the signal system. Coordination of traffic signals across jurisdictional boundaries is a common interagency issue.

An appropriate way to address these issues when system design requirements are being established is the development of a *Concept of Operations*. This document establishes the way agencies will relate their operations to each other and also establishes how the agency will manage its internal traffic system operations. The following material is extracted from Reference 3.

In its simplest definition, a concept of operations for a TMC defines what the center accomplishes, and how it goes about accomplishing it. Thus, it defines functions (what is accomplished) and processes (how they are accomplished). The concept of operations ideally addresses both operations and maintenance of the TMC, and the resources for which it is responsible. It describes the interactions that occur within the TMC, and between the TMC and its partners (firms and agencies) and customers (motorists, media, etc.) in managing transportation. As a tool developed primarily in the planning stage, it often works at a summary level. It is not intended to serve as an operations manual, although it may follow a similar outline.

The outline for a TMC concept of operations contains the following topics:

- The Systems
- Operational Facility Needs
- Integration and Testing
- Coordination
- Performing or Procuring Operations and Maintenance
 - Workload and Performance
 - Organization
 - Nonstandard Operations
 - Fault Detection and Correction
 - System maintenance
 - Training and Documentation
 - Operational Procurement and Contracting

2.4 Range of Agency Needs and Range of Available Options

Although each agency with responsibility for traffic control systems represents a unique entity, with no two exactly alike, many similarities exist. Table 2-1 lists typical system functions.

Table 2-1 Typical system functions.

System Type	Potential Systems	Special Features
Urban and Suburban Street	<ul style="list-style-type: none"> • Network of closely spaced intersections in a central business district (CBD) • Arterial systems • Isolated intersections 	<ul style="list-style-type: none"> • Railroad preemption • Fire preemption • Lane control • Peak-hour turn restrictions • Special events • Transit priority
Integrated	Combinations of freeway control and urban street systems	Communication compatibility with freeway control, urban streets and traveler information systems

In most jurisdictions, traffic control hardware represents an accumulation of different age equipment from multiple manufacturers, purchased over an extended time, using low-bid procurement techniques. Maintenance level of effort and quality greatly affect the hardware's current condition. For example, though the hardware's characteristics permit integration into a system, its physical condition and reliability may preclude continued use. In other cases, existing field hardware might not prove compatible with the desired control system, again precluding continued use. Recent years have seen significant effort in standardizing traffic controller hardware and facilitating equipment interchangeability. This will simplify future replacement.

The conditions which create a need to *upgrade* or *install* new traffic systems include:

- Growth and / or changes in traffic demand create a need to examine the adequacy of existing traffic control systems. When traffic flows well below available capacity and no recurrent congestion (or motorist perception of congestion) occurs, little public sentiment develops for control system improvement. However, as flows approach capacity and congestion becomes evident, demand for, and need of, improved control system operation increases. Although agencies should not postpone control system improvements until congestion appears, significant funding for major improvements generally follows public perception of need. Changes in traffic demand may also highlight the functional inadequacy of the existing control system in achieving full use of available capacity.
- Frequent failure of older equipment that results in degraded and inefficient on-street operation.

- The need to obtain improved traffic control through the use of modern hardware and software technologies not supported by existing equipment.

Experience has shown that the agency should establish specific traffic control system objectives in the following areas:

- *Traffic Operations* - The ability to respond to existing and anticipated future traffic operations requirements. Specific goals might include:
 - Obtain maximum efficiency in terms of minimum delay, minimum stops, and maximum capacity utilization consistent with the safety of operation,
 - Improve vehicle, pedestrian and bicycle safety, or
 - Provide motorists with real-time traffic or routing information.
- *System Reliability* - Issues include:
 - Minimizing control system downtime,
 - Minimizing cost of maintenance, and
 - Improvement of automated detection and reporting of equipment failures.
- *Adaptability* - The ability to satisfy traffic operation requirements over a long period of time under changing conditions.
- *Implementation* - Ease of installation or changeover from an old system to a new one with minimum technical problems and disruption of traffic flow.
- *Ease of Operation* - The ability to easily develop and maintain system databases including generation and maintenance of timing plans.

Transportation Systems Management (TSM) Relationship

Since first introduced in the mid-1970s, *transportation systems management* (TSM) has evolved from a list of about 150 low-cost actions to the productive use of existing transportation resources through their coordinated operations and improved management. TSM implies "a philosophy about planning, programming, implementation, and operations that calls for improving the efficiency and effectiveness of the transportation system by improving the operations and / or services provided" (4). TSM, then, provides an umbrella philosophy that aims to:

- Analyze the total system, and

- Improve operation and safety before capital-intensive projects add significant capacity.

Roark (5) classifies TSM actions within 9 different urban operating environments, including:

- Freeway corridor,
- Arterial corridor,
- Central business district (CBD),
- Regional operating environment,
- Neighborhood,
- Major employment site (non-CBD),
- Outlying commercial center,
- Major activity center, and
- Modal transfer point.

In contrast, Wagner uses two primary strategies - *supply* and *demand* (6). *Supply* strategies focus on changing the *quality* of vehicular flow, whereas *demand*-oriented strategies target decreasing the *quantity* of vehicular travel. Supply actions include:

- Arterial signal coordination,
- Signal removal or flashing operation,
- Freeway monitoring and control,
- Incident management,
- Parking prohibition,
- Turn controls, and
- Bottleneck-removal programs.

Demand actions include:

- Carpools,

- Vanpools,
- High occupancy vehicle (HOV) priority treatments, and
- Variable work hours.

In both classification schemes, traffic control systems and their effective operation predominantly affect TSM and prove vital to the full realization of several other TSM actions. For example, it does little good to entice drivers to ride the bus or join a vanpool if inefficiently operating traffic signals stop or delay *all* vehicles (including buses and vans).

Control System Options

Operational objectives of traffic control systems include making the best use of existing roadway and freeway network capacity and reducing trip times, without creating adverse environmental impacts (7).

Controlling the movement of vehicles through signalized intersections provides the major effect on traffic flow in urban areas. The control strategies shown in Table 2-2 can achieve signalized intersection control. Table 2-2 provides a summary of the features of different categories of traffic control systems. These categories and their characteristics are discussed in greater detail in Section 3.8.

Criteria for Selection

The previous discussion describes the range of alternative systems available to meet a jurisdiction's traffic control needs. Making the most appropriate selection requires critical self-examination and consideration of life-cycle issues concerning:

- System acquisition,
- Operation, and
- Maintenance.

Matching a control system's capabilities to a set of *identified* agency requirements proves the most crucial element in system selection. Viable candidates should satisfy these requirements in a cost effective way.

Table 2-2 Signal system options.

Categories	Main Characteristics	Control Technique	Method	Application
Isolated Intersection Control	Does not consider timing for adjacent signalized intersections	Fixed Time (Pretimed)	Assigns right-of-way according to a pre-determined schedule. Computer programs used with average demand volumes for period to compute timing off line.	Intersection sufficiently isolated from adjacent signalized intersection so that arriving vehicles do not exhibit strong platooning characteristics
		Traffic Actuated	Adjusts green time according to real-time demand measured by detectors on one or more approaches	Intersection timing requirements inconsistent with remaining signal section
Time Base Coordination	Coordinates based on common time synchronization.	Pretimed coordination	Computer programs used with average demand volumes for period to compute timing off line.	Signals sufficiently closely spaced to require coordination
Interconnected Control	Signals are networked together using wireline or wireless techniques Provides field equipment status Downloads timing plans from traffic management center	Pretimed coordination Operator selection of timing plans	Computer programs used with average demand volumes for period to compute timing off line. Operator selection based on special events or external information on incidents or traffic conditions	Pretimed coordination commonly used where variation in day-to-day demand is not excessive Operator selection used for special situations
Traffic Adjusted Control	Conventional traffic adjusted operation	Use of traffic sensors to provide traffic adjusted capability	Traffic adjusted selection of timing plans Often provides more timing plans than for interconnected control	Traffic adjusted capability employed where variations in day-to-day demand may vary significantly at a particular time

Table 2-2 Signal system options (continued).

Categories	Main Characteristics	Control Technique	Method	Application
Traffic Responsive Control	Timing plans generated rapidly and automatically using system sensors	Changes split within a cycle. Changes cycle offset within a few minutes	Uses upstream sensor data to optimize objective function such as delay or controls to level of congestion	Where variations in day-to-day demand may vary significantly or where variations result from unusual traffic patterns or events
Traffic Adaptive Control	Phase change based on prediction from traffic measurement at each signalized approach	Uses predictive data change phase. Does not use explicitly defined signal cycles, splits or offsets	Predicts vehicle flow at intersection from sensor data	Same as traffic responsive control. Also responds to random variations in traffic flow

The agency should also match the system's sophistication to the staff's anticipated ability to operate and maintain it. Similarly, to assure system success, the agency must demonstrate its commitment to ongoing staffing and maintenance costs. As described in Federal regulations (see chapter 11), the availability of funds to procure traffic control systems must also include a similar commitment to provide adequate resources for operation and maintenance.

Chapter 11 provides a more detailed discussion of a suggested system selection process that uses an effectiveness-analysis approach. The chapter also describes a utility / cost analysis approach.

2.5 Available Technology

Available control system technology has progressed to the point where current hardware and software capabilities provide the designer with a wide range of control concepts. The transportation engineer or control system designer now has a large array of hardware and software options from which to choose in defining alternative control systems. The challenge is to use them effectively in achieving improved on-street traffic performance.

Hardware

Subsequent chapters in this Handbook describe in-depth the various hardware elements of a control system. Components and subsystems include: detectors, local controllers, changeable message signs, CCTV, operator displays, central computers and field masters.

Software

Chapters 3, 4, and 8 describe software used in traffic control systems. This includes real-time control software, optimization software and simulation software.

Real-Time Control software developed for local controllers allows the controller to function as a signal switching unit by:

- Receiving detector inputs,
- Processing status data,
- Computing timing, and
- Driving signal lamp load switches.

Manufacturers of standard NEMA controller units provide such software (or firmware) as a part of the device. By contrast, both manufacturers and users have developed software for the Model 170, Model 2070 and advanced transportation controllers.

Many conventional traffic systems feature the UTCS First Generation (1-GC) signature matching algorithm for real-time traffic-responsive control. Unlike earlier UTCS, these contemporary systems usually store signal timing plans at the intersection and select a plan based on detector data patterns. An alternative strategy selects the cycle, split and offset individually based on detector data for each of these parameters. Conventional systems often feature the ability to update timing plan databases from signal timing programs with a minimum of manual operation.

Traffic adjusted systems are being installed in increasing numbers. Chapters 3 and 8 describe both conventional systems and traffic adjusted systems.

Chapter 3 describes the use of offline timing plan development programs. These include TRANSYT 7F, the PASSER family, SYNCHRO and aaSIDRA.

2.6 A Look to the Future

Current research as well as emerging trends are likely to lead to the following areas for changes in traffic systems in coming years.

Hardware in the Loop

Recent research (8,9) has resulted in the development of systems that enable traffic controller equipment to be tested under simulated traffic conditions. Figure 2-2 provides an example of the implementation of this concept. A microscopic simulation program such as CORSIM is interfaced to a physical traffic controller by a controller interface

device (CID). A software link in the form of a dynamic link library (dll) transfers information between the computer on which the simulation is running to the CID. A network of traffic controllers may be interfaced to the simulation in this way.

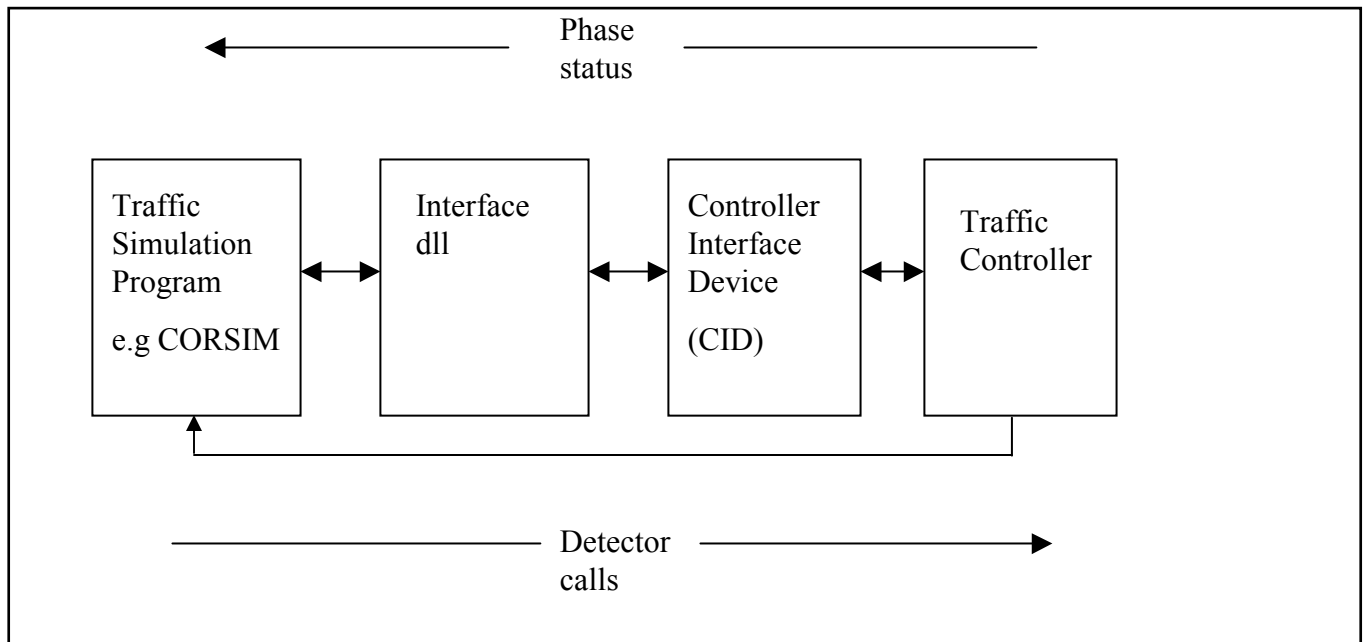

Figure 2-2 Hardware in the loop configuration.

This technique provides the capability to:

- Achieve a high level of fine-tuning after controller settings prior to implementing the settings in the field.
- Prove out controller software.
- Study the performance of new or modified traffic control algorithms.

Non-Pavement Invasive Traffic Detectors

These detectors generally have a number of desirable operational features including low maintenance cost, ease of maintenance, ability to more easily change detected locations, and a variety of traffic data preprocessing capabilities. Nevertheless, their accuracy for detection of traffic responsive control parameters has generally not yet approached that of inductive loop detectors. It is anticipated that continued development of these devices will result in performance improvement in this regard.

Support of Emergencies and Evacuations

Regional architectures increasingly require the interchange of data and video between traffic management centers and other agencies responsible for emergency operations. Traffic control equipment capability such as the ability to change timing plans to support emergencies, to make CCTV images available, and to communicate with motorists provides an increasingly useful tool to support emergency operations.

Advanced Transportation Controller

With the recent development of standards, the Advanced Transportation Controller (ATC) will assume traffic signal control functions as well as other transportation system control and management functions. The ATC is an open architecture platform. By employing an applications programming interface (API), the same applications software may be implemented in ATC controllers with different processors and operating systems. ATC will provide the capability to migrate control software into controllers using different microprocessors and operating systems. This will enable operating agencies to employ different controller models interchangeably, while still achieving the same performance capability with each unit. This will facilitate maintenance by avoiding the issue of equipment obsolescence and discontinuance of support by controller and component suppliers.

Advanced Signal State Transition Logic

The objective of this research program (NCHRP Project 3-66) is to make use of the ability of advanced traffic sensors to develop additional traffic state information that might be used to improve the control of traffic signal states.

Improved Transit Priority Systems

The increased use by transit vehicles of advanced equipment such as on board processors, terminals for drivers, GPS equipment, passenger counters and door position monitors in conjunction with computer aided dispatch systems enables the development of signal priority strategies for transit vehicles.

References

1. Gordon, R.L., R.A. Reiss, H. Haenel, E.R. Case, R.L. French, A. Mohaddes, and R. Wolcott. "Traffic Control Systems Handbook." Dunn Engineering Associates, Federal Highway Administration Report No. FHWA-SA-95-032, Washington, DC, February 1996.
2. "The National ITS Architecture, Version 5.0." Federal Highway Administration, 2003.
3. "Transportation Management Center Concepts of Operation, Implementation Guide." Federal Highway Administration, December 1999.
4. "Urban Transportation Planning." *Federal Register*. Vol. 46, pp. 5702-5719, 1981.
5. Roark, J.J. "Experiences in Transportation System Management." *National Cooperative Research Program Synthesis of Highway Practice 81*. Transportation Research Board, Washington, DC, November 1981.
6. Wagner, Frederick A. "Energy Impacts of Urban Transportation Improvements." Institute of Transportation Engineers, Washington, DC, August 1980.
7. "Assessment of Advanced Technologies for Relieving Urban Traffic Congestion." *National Cooperative Highway Research Program Report 340*. Transportation Research Board, Washington, DC, 1991.
8. Bullock, D. and A. Catarella. "Real-Time Simulation Environment for Evaluating Traffic Signal Systems." *Transportation Research Record 1634*. pp. 130-135, 1998.
9. Engelbrecht, R., C. Poe, and K. Balke. "Development of a Distributed Hardware-in-the-Loop Simulation System for Transportation Networks." *Proceedings of the 78th Annual Conference of the Transportation Research Board*. Washington, DC, 1999.

CHAPTER 3
CONTROL CONCEPTS – URBAN AND SUBURBAN STREETS

Table of Contents

Section	Page
3.1 Introduction.....	3-3
3.2 Control Variables.....	3-4
3.3 Sampling.....	3-9
3.4 Filtering and Smoothing.....	3-9
3.5 Traffic Signal Timing Parameters.....	3-15
3.6 Traffic Signal Phasing.....	3-15
Phasing Options.....	3-16
Left-Turn Phasing.....	3-16
Phase Sequencing.....	3-18
3.7 Isolated Intersections.....	3-18
Traffic Flow.....	3-20
Types of Control.....	3-21
Intersection Timing Requirements.....	3-21
Pretimed Controller.....	3-21
Traffic-Actuated Control.....	3-21
Timing Considerations.....	3-28
Cycle Length and Split Settings.....	3-28
Intersection Delay.....	3-31
Critical Lane Groups.....	3-32
Traffic-Actuated Control.....	3-33
Other Considerations.....	3-33
3.8 Arterial and Network Control.....	3-34
Basic Considerations.....	3-34
Information from Prior Research and Experience.....	3-38
Simulation.....	3-39
Time-Space Diagram.....	3-40
Timing Plan Elements.....	3-40
Traffic Flow Variations.....	3-40
Timing Plan Development.....	3-43
Manual Techniques.....	3-43
Offline Computer Techniques.....	3-45
Considerations for Closed Networks.....	3-47
Need for Signal Retiming.....	3-47
Determination of Central System Control Category.....	3-49
Online Network Traffic Control Techniques.....	3-53
UTCS Control.....	3-54
Control Algorithms for Closed Loop Systems.....	3-56
Traffic Responsive Control Systems.....	3-56
Traffic Adaptive Control Systems.....	3-62
Saturated Flow Conditions.....	3-65
Regulatory Approaches.....	3-69

	Congestion Pricing Approaches.....	3-69
	Network Simulation.....	3-69
	CORSIM.....	3-71
	SimTraffic.....	3-72
	Paramics.....	3-72
	VISSIM.....	3-73
3.9	Special Controls.....	3-74
	Closely Spaced Intersections.....	3-74
	Directional Controls and Lane Control Signals.....	3-79
	Preemption Systems.....	3-81
	Priority Systems.....	3-83
	Changeable Lane Assignment Systems.....	3-85
3.10	Benefits.....	3-85
	Fuel Consumption.....	3-85
	Vehicle Emissions.....	3-86
	Estimating Highway User Costs.....	3-87
	Impacts of Traffic Signal System Improvement.....	3-93
	Project Level Impacts.....	3-93
	Network Impacts.....	3-94
	Cost-Effectiveness Comparisons.....	3-96
3.11	Measures of Effectiveness.....	3-97
	References.....	3-105

CHAPTER 3 CONTROL CONCEPTS – URBAN AND SUBURBAN STREETS

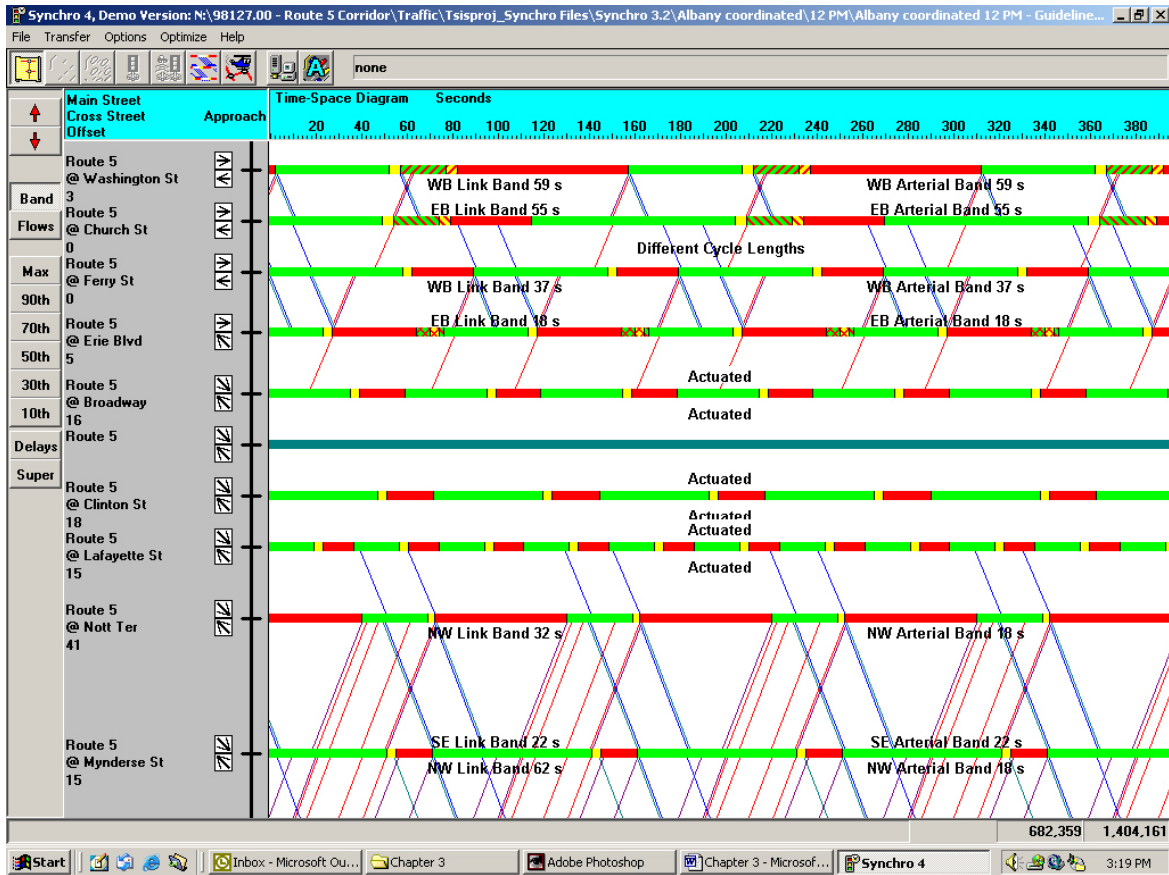

Figure 3-1 Time-space diagram display from Synchro 4.

3.1 Introduction

This chapter discusses traffic control concepts for urban and suburban streets. In planning and designing a traffic signal control system, one must first understand the applicable operational concepts related to signalized intersection control and signal-related special control.

Signalized intersection control concepts include:

- Isolated intersection control – controls traffic without considering adjacent signalized intersections.
- Interchange and closely spaced intersection control – provides progressive traffic flow through two closely spaced intersections, such as interchanges. Control is typically done with a single traffic controller.

- Arterial intersection control (open network) – provides progressive traffic flow along the arterial. This is accomplished by coordination of the traffic signals.
- Closed network control – coordinates a group of adjacent signalized intersections.
- Areawide system control – treats all or a major portion of signals in a city (or metropolitan area) as a total system. Isolated, open- or closed-network concepts may control individual signals within this area.

Signal-related special control concepts include:

- High occupancy vehicle (HOV) priority systems.
- Preemption – Signal preemption for emergency vehicles, railroads, and drawbridges.
- Priority Systems – Traffic signal control strategies that assign priority for the movement of transit vehicles.
- Directional controls – Special controls designed to permit unbalanced lane flow on surface streets and changeable lane controls.
- Television monitoring.
- Overheight vehicle control systems.

A number of commonly used proprietary traffic systems and simulations are discussed in this chapter. These discussions provide illustrations of the technology and are not intended as recommendations. As these and similar products continue to be improved, the reader is advised to contact the supplier for the latest capabilities of these products.

3.2 Control Variables

Control variables measure, or estimate, certain characteristic of the traffic conditions. They are used to select and evaluate on-line control strategies and to provide data for the off-line timing of traffic signals. Control variables commonly used for street control include:

- Vehicle presence,
- Flow rate (volume),
- Occupancy and density,

- Speed,
- Headway, and
- Queue length.

Generally, presence detectors (refer to Chapter 6) sense these traffic variables. Table 3-1 describes the verbal and mathematical definition of these variables.

In addition, certain environmental factors influence traffic performance. Environmental conditions include:

- Pavement surface conditions (wet or icy),
- Weather conditions (rain, snow or fog).

Table 3-1 Control variable definitions.

Variable	Definition	Equation
Vehicle Presence	Presence (or absence) of a vehicle at a point on the roadway	N/A
Flow Rate (Volume)	Number of vehicles passing a point on the roadway during a specified time period	$Q = N/T \quad (3.1)$ <p>Q = Vehicles/hour passing over detector</p> <p>N = Number of vehicles counted by detector during time period, T</p> <p>T = Specified time period, in hours</p>
Occupancy	Percent of time that a point on the roadway is occupied by a vehicle	$\theta = \frac{100}{TL} \sum_{i=1}^N (t_i - D) \quad (3.2)$ <p>Where:</p> <p>θ = Raw occupancy, in percent</p> <p>T = Specified time period, in seconds</p> <p>t_i = Measured detector pulse presence, in seconds</p> <p>N = Number of vehicles detected in the time period, T</p> <p>D = Detector drop out time – detector pickup time</p>
Speed	Distance traveled by a vehicle per unit time	<p>Either one or two detectors can measure speed (see Figure 3-2).</p> $V = \frac{3.6 \times 10^6 d}{5,280(t_1 - t_0)} \quad (3.3)$

Table 3-1 Control variable definitions (continued).

Variable	Definition	Equation
<p>Speed (Continued)</p>		<p>Where: One Detector (passage time)</p> <p>V = Speed, in mi/hr d = Mean vehicle length plus effective loop length, in ft t₀ = Time when detector turns on, in millisecc(ms) t₁ = Time when detector turns off, in ms</p> <p>Two Detector (speed trap) d = Distance between detectors, in ft t₀ = Time upstream detectors turns on, in ms t₁ = Time downstream detector turns on, in ms</p> <p>Traffic control systems commonly use this equation, which assumes a vehicle moves at constant velocity through the two-detector <i>speed trap</i>. Speed traps are more commonly used for freeway surveillance.</p> <p>The vehicle length, L_v, in ft may be determined from a speed-trap measurement as follows:</p> $L_v = \left(\frac{1}{2}\right) [(t_{11} - t_{01}) + (t_{12} - t_{02})] \left(\frac{5,280V}{3.6 \times 10^6}\right) \quad (3.4)$ <p>Where:</p> <p>V = Speed determined from the speed-trap calculation, in mi/hr t_{oi} = Time when ith detector of speed-trap turns on, in milliseconds t_{1i} = Time when ith detector of speed-trap turns off, in milliseconds</p> <p>An alternative method shown in equation 3.5 can compute the average speed over a cycle T from volume and occupancy (1)</p> $V = C \frac{Q}{\theta} \quad (3.5)$ <p>Where C is a calibration coefficient best obtained experimentally</p>

Table 3-1 Control variable definitions (continued).

Variable	Definition	Equation
Density	Number of vehicles per lane mi (km)	$Q = K\bar{U}s \quad (3.6)$ <p>Where:</p> <p>Q = Volume of traffic flow, in v/hr K = Density of traffic flow, in v/mi $\bar{U}s$ = Space-mean speed, in mi/hr</p> <p>While density is an important quantity in traffic flow theory, most traffic control systems do not use this parameter directly for implementing flow control. Density (K) may be directly computed from count and speed measurements by equation 3.7.</p> $K = \left(\frac{1}{T}\right) \sum_{i=1}^N \left(\frac{1}{V_i}\right) \quad (3.7)$ <p>Where:</p> <p>N = The number of vehicles detected during time, T V_i = Speed of vehicle i crossing a detector in a lane K = Density of detectorized lane</p>
Headway	Time spacing between front of successive vehicles, usually in one lane of a roadway	Time difference between beginning of successive vehicle detections (see Figure 3-3)
Queue Length	Number of vehicles stopped in a lane behind the stopline at a traffic signal	N/A

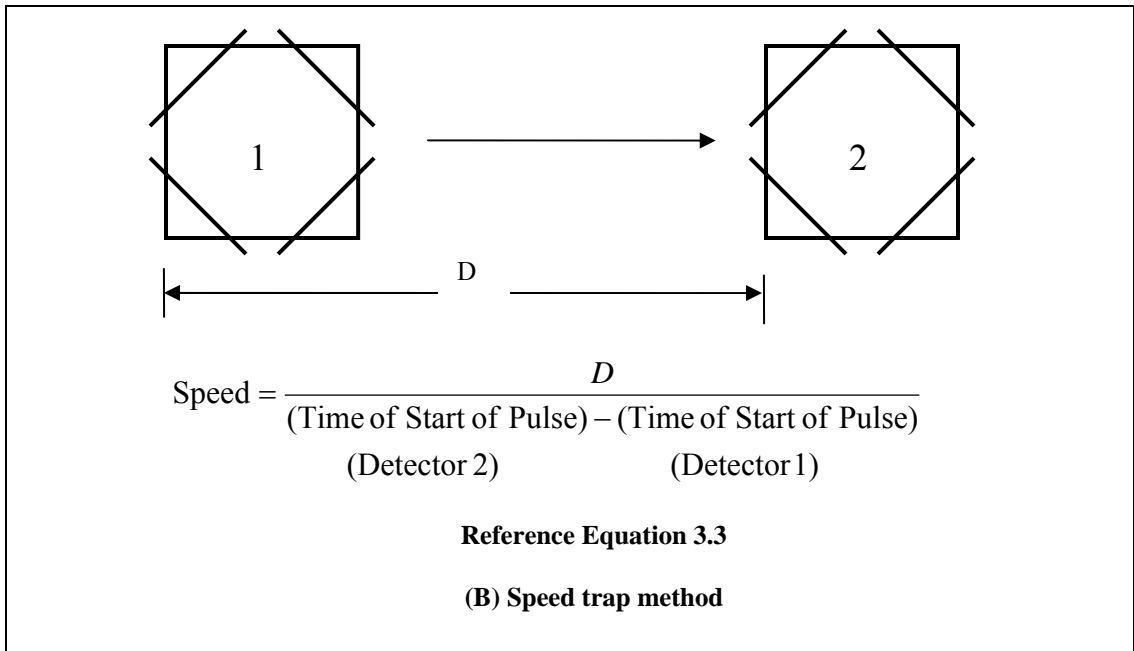
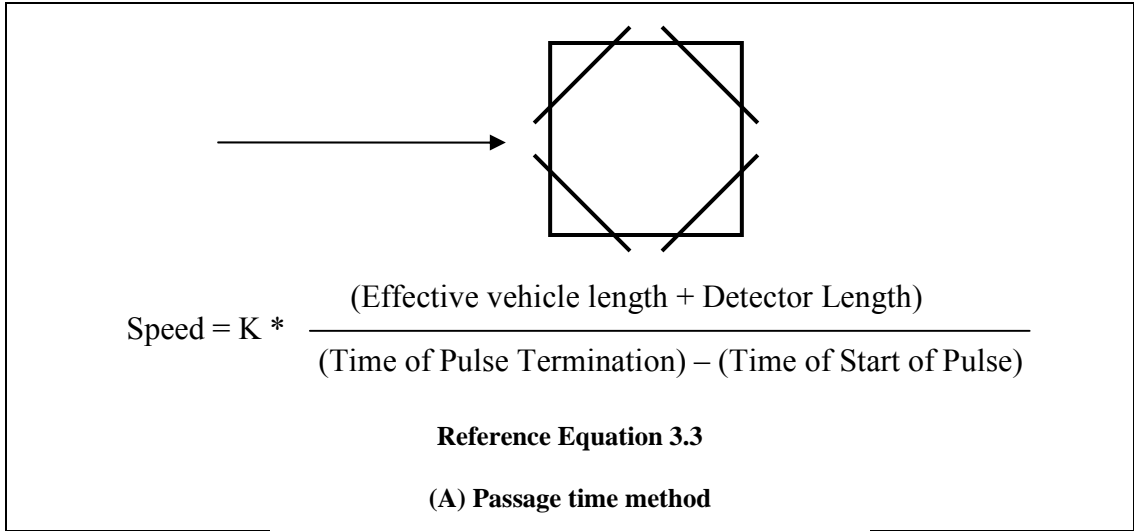

Figure 3-2 Speed measurements using presence detectors.

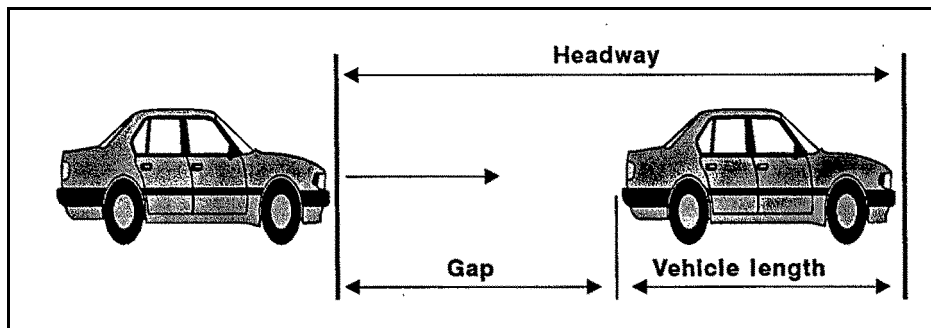

Figure 3-3 Headway determination.

3.3 Sampling

A microprocessor at the field site usually samples presence detectors to establish the detector state, thus replicating the detector pulse. The finite time between samples generates an error in the pulse duration that leads to errors in speed (most noticeable) and occupancy.

Equation 3.8 represents the maximum percentage error for any vehicle:

$$\% E = \frac{100S}{T-S} \quad (3.8)$$

Where:

% E = Percent error in occupancy

S = Inverse of the sampling rate, seconds per sample

T = Presence time for a vehicle with an average length at a given speed.

Based on its statistical distribution, the standard deviation of the percentage error becomes:

$$\% E_{SD} = 100 \frac{S}{\sqrt{6} T} \quad (3.9)$$

Averaging data over a period of time reduces this error. Most modern traffic control systems provide a sufficiently small value of S so that the sampling error is negligible.

3.4 Filtering and Smoothing

Traffic data, may be viewed as consisting of two distinct components, nonrandom and random. These components are described in Table 3-2 (2).

Table 3-2 Traffic data components.

Component	Characteristic	Source
Nonrandom	Deterministic	<ul style="list-style-type: none"> • Changes in basic service demand • Ability of intersection to service demand
Random	Varies about deterministic component Characterized by a Poisson or other probability distribution	<ul style="list-style-type: none"> • Nondeterministic changes in value from cycle to cycle

Figure 3-4 (a) shows a typical 30-minute sample of detector volume data obtained during a period when the deterministic component remained essentially constant. Figure 3-4 (b) shows the occupancy data for that period during which the signal system operated with a 1-minute cycle and without smoothing (to be discussed later). Thus, the volumes represent actual counts sensed by the detector.

Figure 3-5 shows a typical example of a deterministic component representing an A.M. peak period condition (2). In many conventional traffic control systems, the traffic-responsive control law should respond quickly and accurately to the deterministic data components. Because both the deterministic and random components appear together in the detector data, this objective can only be accomplished imperfectly. A first order data filter often provides data smoothing to suppress the random component. The smoothing equation that performs this function is:

$$\bar{x}(m) = \bar{x}(m-1) + K(x(m) - \bar{x}(m-1)) \quad (3.10)$$

Where:

- $\bar{x}(m)$ = Filter output after the mth computation
- $x(m)$ = Filter input data value (average value of variable between m-1 and m instants)
- K = Filter coefficient in the range 0 to 1.0; (K=1 represents no filtering)

Figure 3-6 shows the smoothing effect of the filter on the traffic data of Figure 3-4 (a) when processed by Equation 3.10 with various values for K (2).

Although the filter reduces the effect of the random component, it develops an error in the faithful reproduction of the deterministic component when that component is changing.

Figure 3-7 (a) shows the lag in the filter output. Figure 3-7 (b) shows the magnitude of this error for the input data of Figure 3-5.

Gordon describes a technique for identifying the appropriate coefficient by determining the coefficient which equates the errors developed by both components (2).

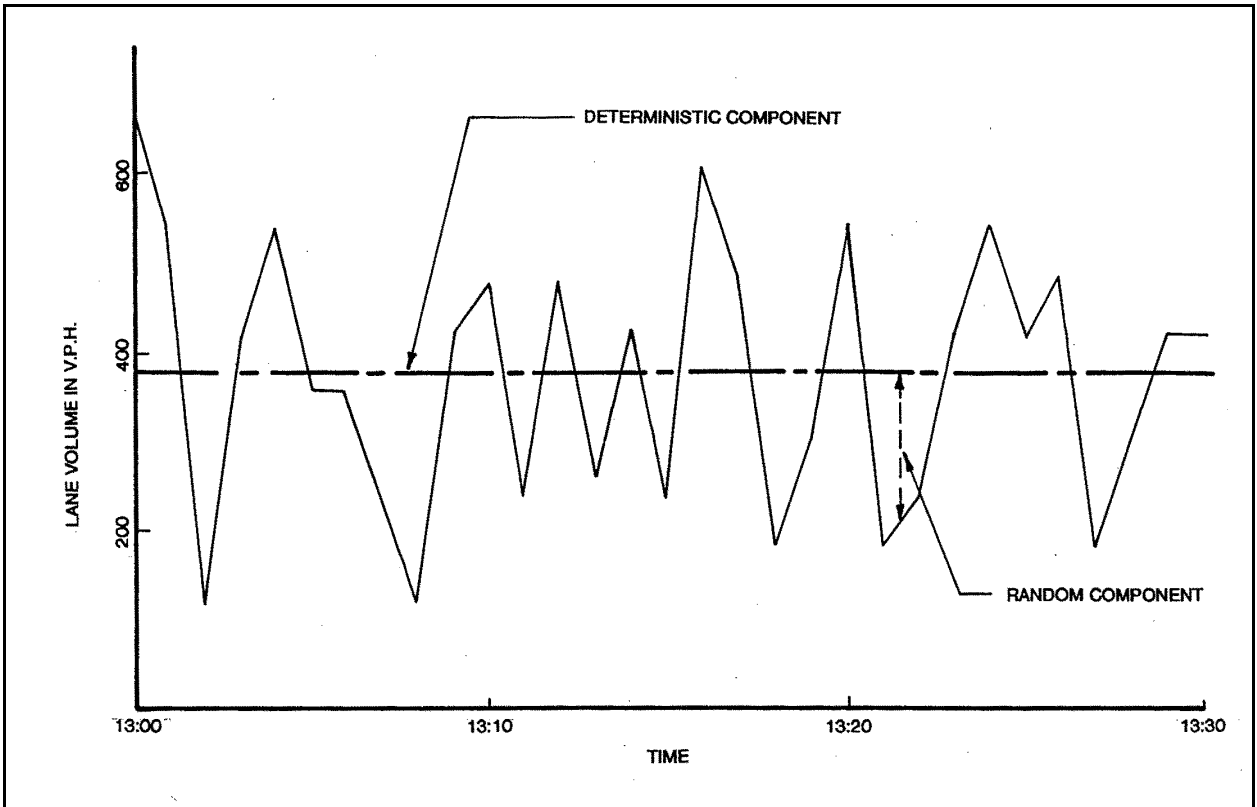

(a). Volume.

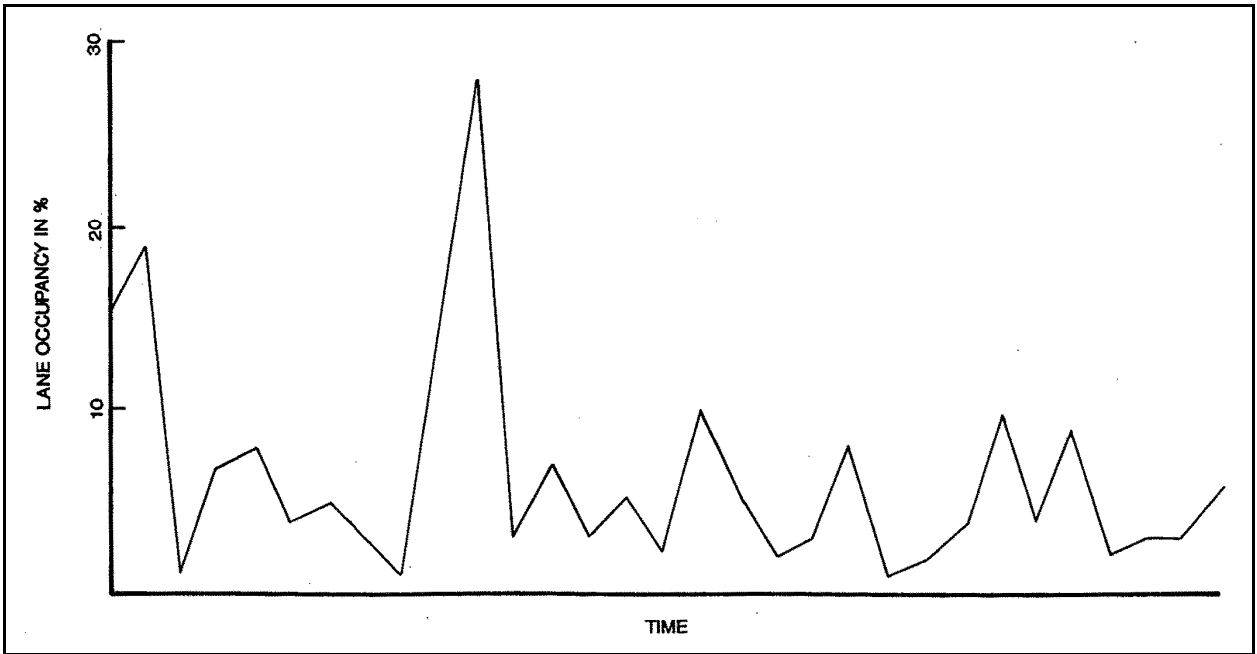

(b). Occupancy.

Figure 3-4 Deterministic and random components when demand is constant.

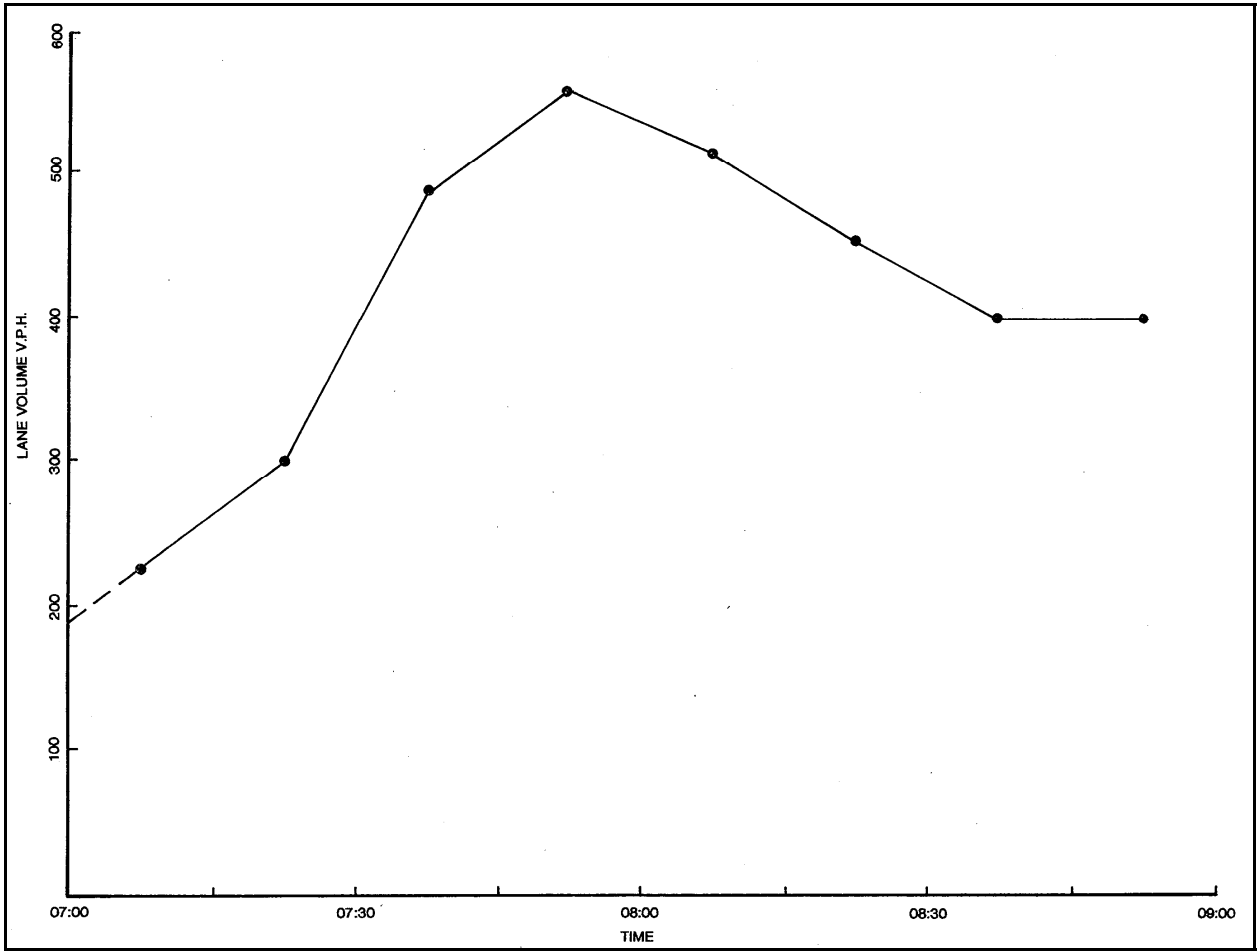

Figure 3-5 Deterministic component of volume during A.M. peak period.

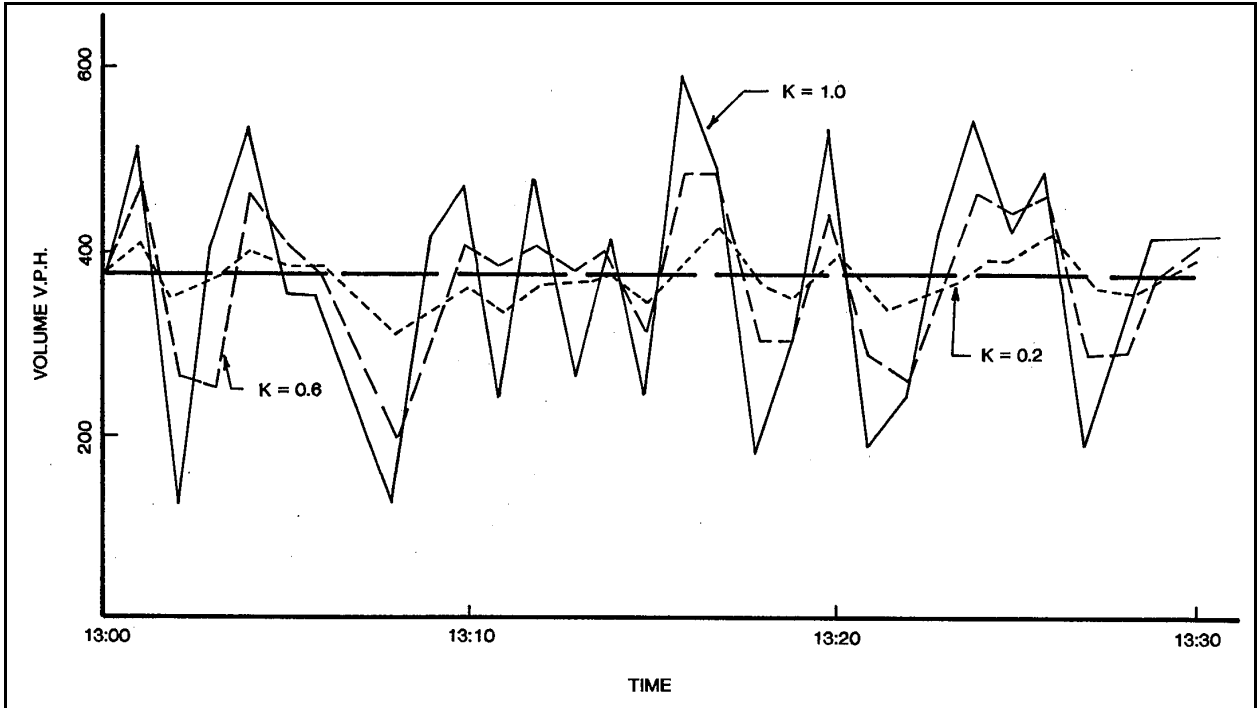
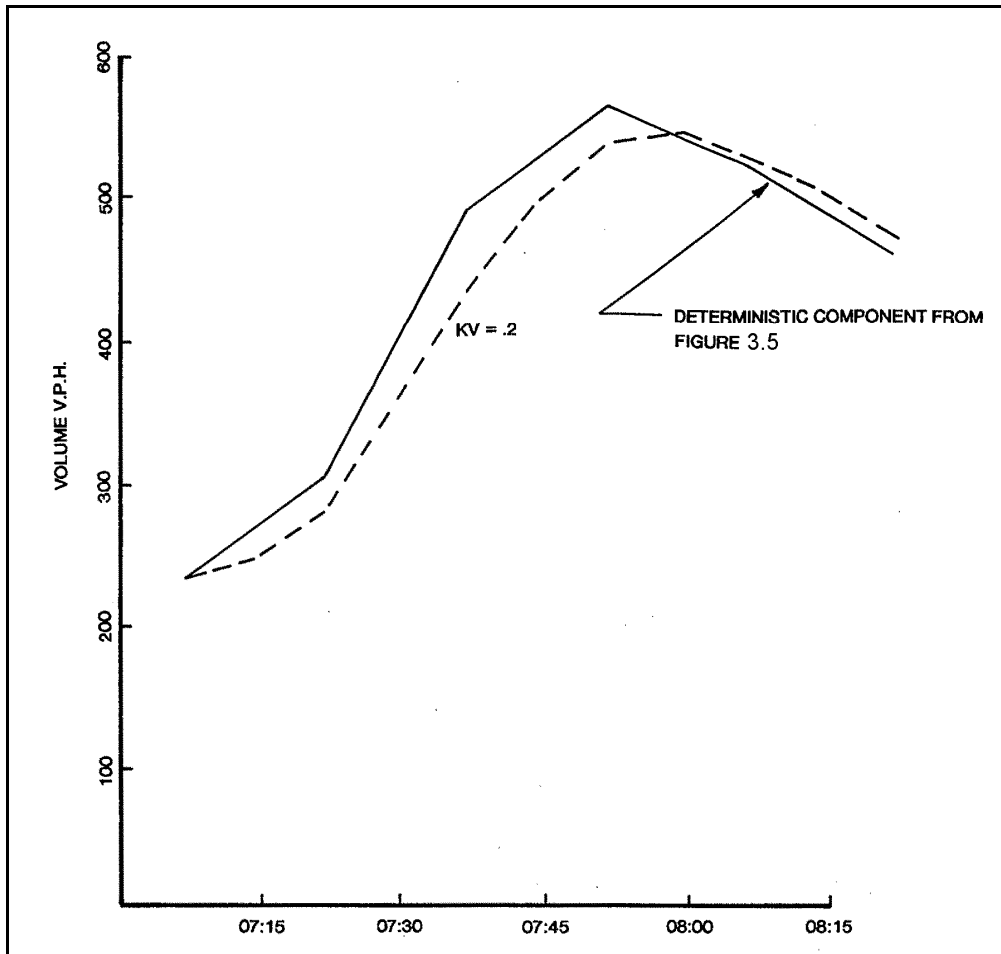
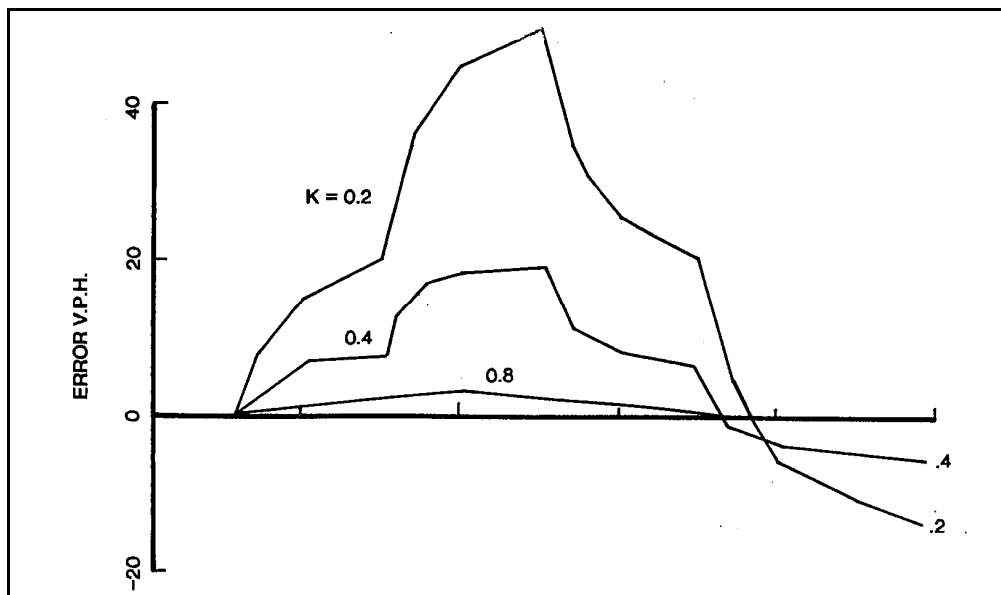

Figure 3-6 Effect of variation in smoothing coefficient on random component.



(a). Filter response to deterministic component.



(b). Deterministic error at filter output.

Figure 3-7 Filter response and output to deterministic component and error.

3.5 Traffic Signal Timing Parameters

Table 3-3 provides definitions of the fundamental signal timing variables.

Table 3-3 Signal timing variable definitions.

Variable	Definition
Cycle Length	The time required for one complete sequence of signal intervals (phases).
Phase	The portion of a signal cycle allocated to any single combination of one or more traffic movements simultaneously receiving the right-of-way during one or more intervals.
Interval	A discrete portion of the signal cycle during which the signal indications (pedestrian or vehicle) remain unchanged.
Split	The percentage of a cycle length allocated to each of the various phases in a signal cycle.
Offset	The time relationship, expressed in seconds or percent of cycle length, determined by the difference between a defined point in the coordinated green and a system reference point.

3.6 Traffic Signal Phasing

Phasing reduces conflicts between traffic movements at signalized intersections. A phase may involve:

- One or more vehicular movements,
- One or more pedestrian crossing movements, or
- A combination of vehicular and pedestrian movements.

The National Electrical Manufacturers Association (NEMA) has adopted and published precise nomenclature for defining the various signal phases to eliminate misunderstanding between manufacturers and purchasers (95). Figure 3-8 illustrates the assignment of right-of-way to phases by NEMA phase numbering standards and the common graphic techniques for representing phase movements. In this figure, the signal cycle consists of 2 primary phase combinations (Phases 2 + 6 and Phases 4 + 8), which provide partial conflict elimination. This arrangement separates major crossing movements, but allows left-turn movements to conflict. This may prove acceptable if left-turn movements remain light; but if heavy, these movements may also require separation. Figure 3-9 illustrates a 4-phase sequence separating all vehicular conflicts. Section 7.7 more fully discusses the NEMA phase designations.

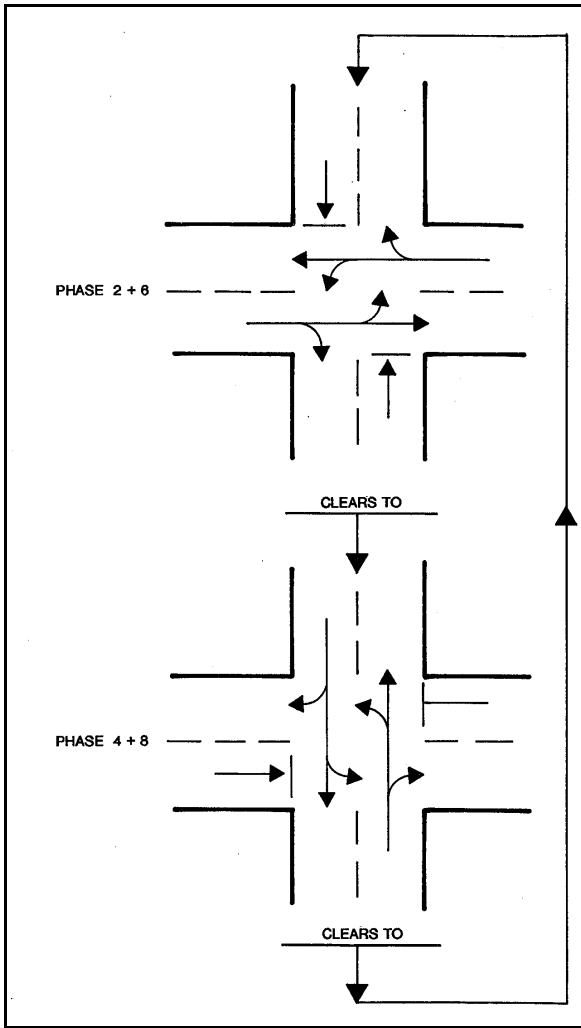

Figure 3-8 Two-phase signal sequence.

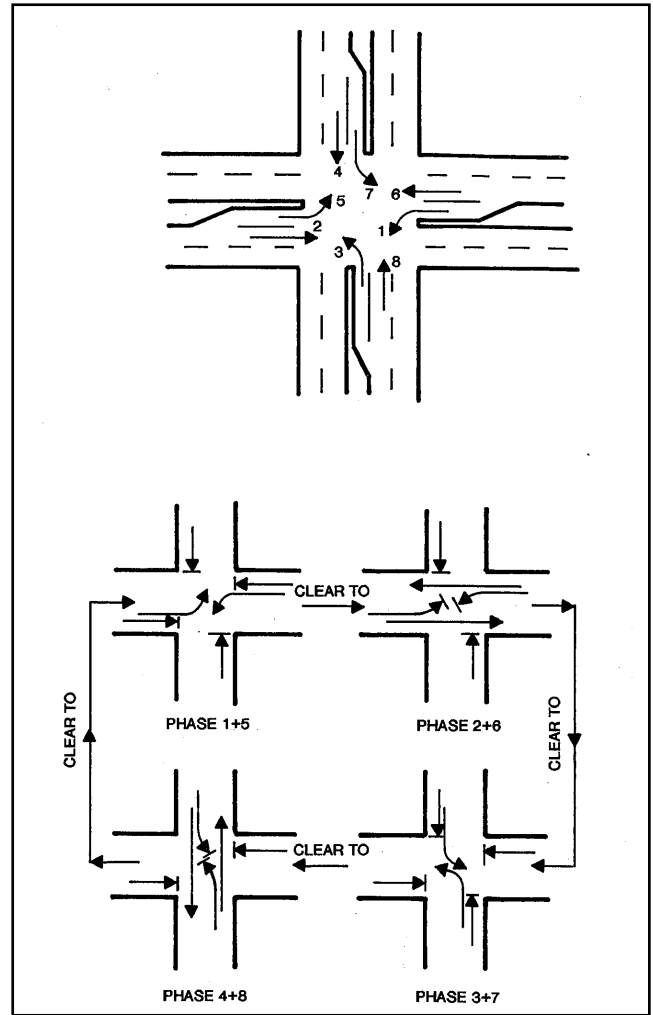

Figure 3-9 Four-phase signal sequence.

Phasing Options

Left-Turn Phasing

As suggested by the previous discussion, phasing becomes primarily a left-turn issue. As left-turns and opposing through volumes increase, the engineer should consider left-turn phasing. Figure 3-10 identifies left-turn phasing options.

The most common practice allows opposing left-turns to move simultaneously as concurrently timed phases.

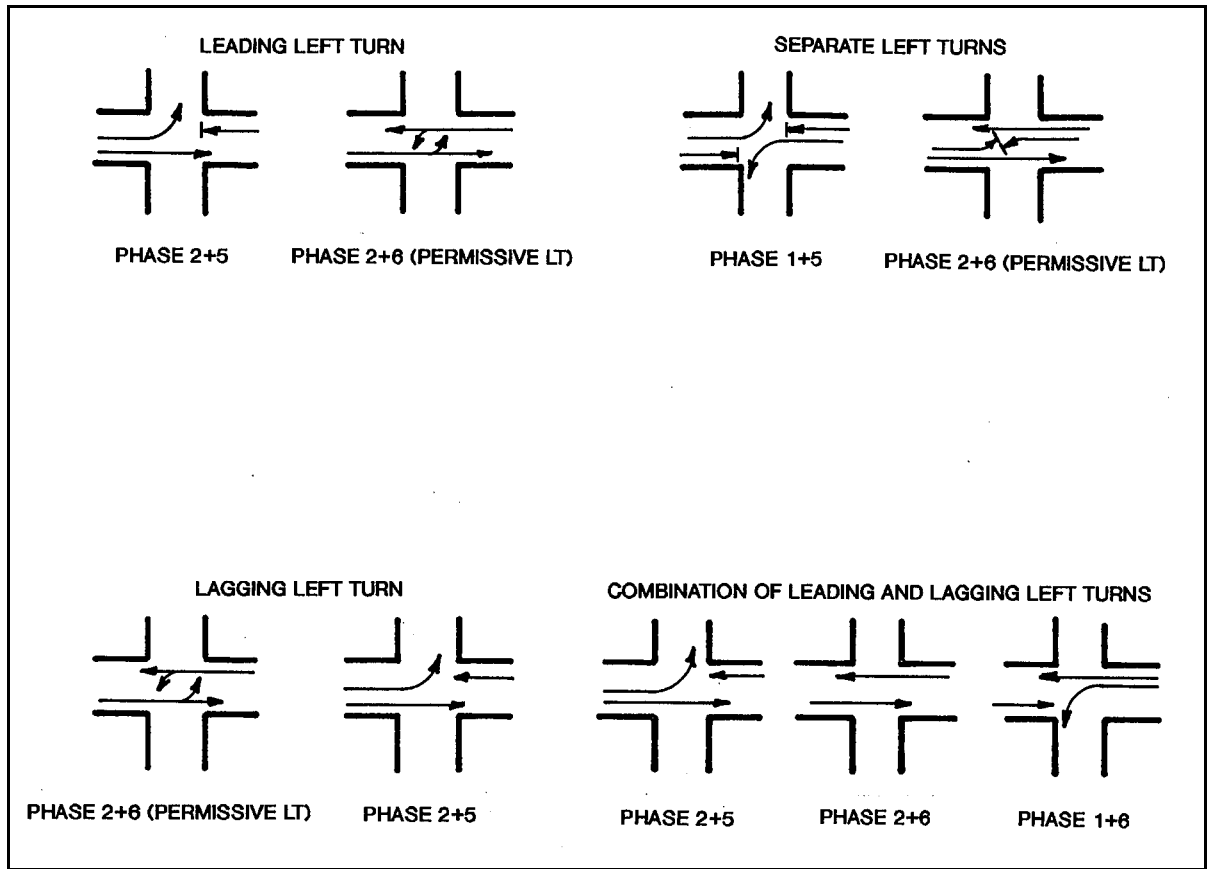

Figure 3-10 Dual-ring left-turn phasing options.

Holding the number of phases to a minimum generally improves operations. As the number of phases increases, cycle lengths and delays generally increase to provide sufficient green time to each phase. The goals of improving safety (by adding left-turn phases) and operations at a signalized intersection may conflict, particularly with pretimed control.

Table 3-4 shows advantages and disadvantages of other options for left-turn phasing.

Although the Manual on Uniform Traffic Control Devices (MUTCD) (3) does not provide warrants for left-turn phasing, several States and local agencies have developed their own guidelines. The Manual of Traffic Signal Design and the Traffic Control Devices Handbook summarize representative examples of these guidelines (4, 5).

Reference 6 provides a set of guidelines for left-turn protection. The report provides guidance on:

- Justification of protected left-turn phasing,
- Type of left-turn protection, and

- Sequencing of left-turns.

Table 3-4 Additional left-turn phasing options.

Option	Advantage	Disadvantage
Use traffic actuated instead of pretimed left-turn phase	Gives unused left-turn phase time to related through traffic movement	Requires additional detectors
Provide protected / permissive left-turn movement	Reduces delay and queuing	High speeds, blind or multilane approaches or other circumstances may preclude this technique
Change left-turn phase sequences with timing plan changes	Improves progression	Motorists may not expect changed phase sequences

Phase Sequencing

Operational efficiency at a signalized intersection, whether isolated or coordinated, depends largely on signal phasing versatility. Variable-sequence phasing or skip-phase capability proves particularly important to multiphase intersections where the number of change intervals and start-up delay associated with each phase can reduce efficiency considerably. Each set of stored timing plans has a distinct phase sequence.

Full-actuated traffic control illustrates variable-sequence phasing. In the upper part of Figure 3-11, all approach lanes have detectors. Using these detectors, actuated control skips phases with no traffic present and terminates certain movements when their traffic moves into the intersection. This capability produces a variation in the phasing sequence. The lower part of Figure 3-11 illustrates primary phasing options for a full-actuated intersection. The phasing options selected may be changed with the signal timing plan.

3.7 Isolated Intersections

The major considerations in the operation of an isolated intersection are:

- Safe and orderly traffic movement,
- Vehicle delay, and
- Intersection capacity.

Vehicle delay results from:

- Stopped time delay (time waiting during red), and

- Total delay (stopped time delay plus stop and start-up delay).

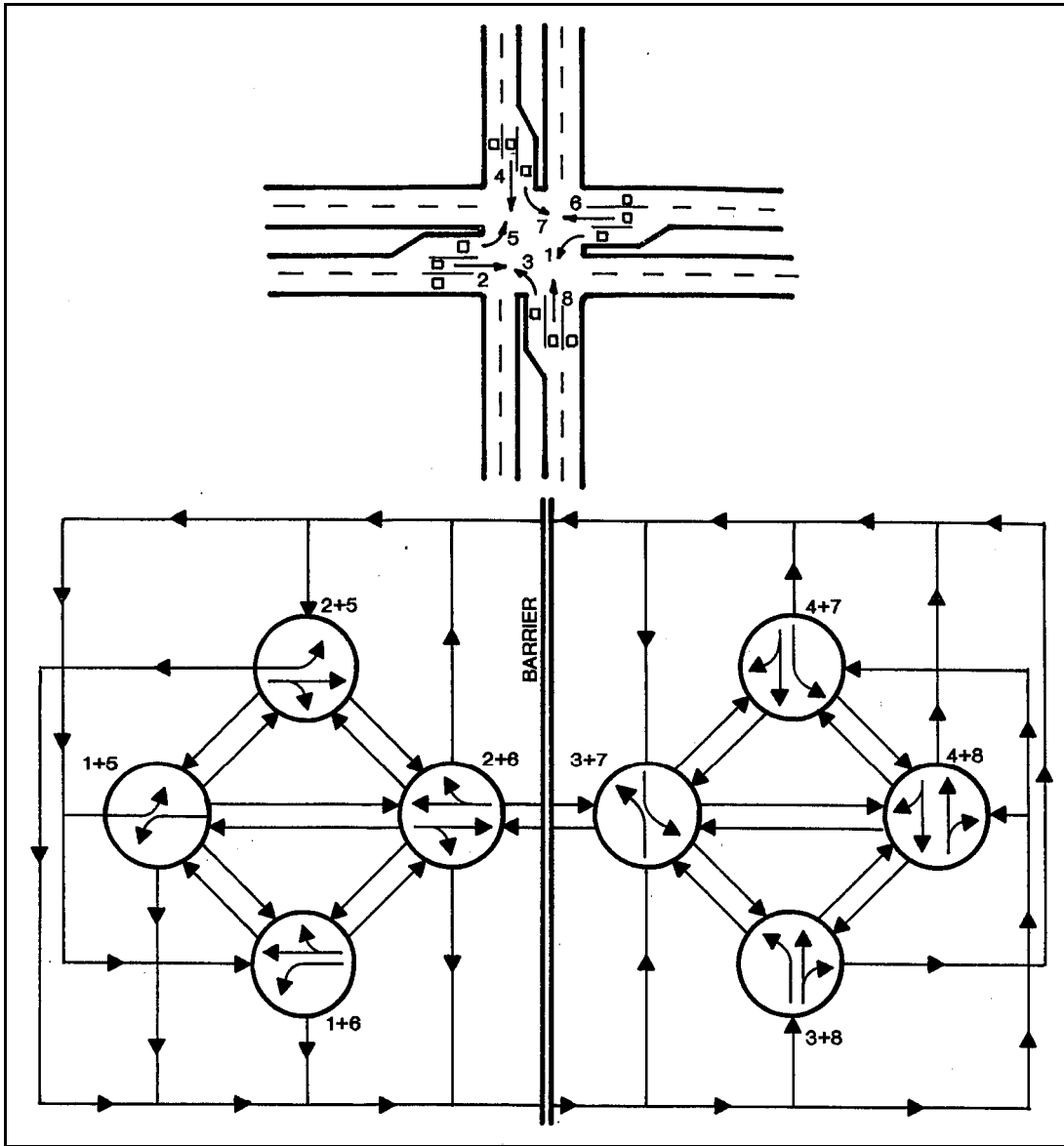

Figure 3-11 Primary phasing options for 8-phase dual-ring control (left-turn first).

Ideally, the objectives of minimizing total delay will:

- Maximize intersection capacity, and
- Reduce the potential for accident-producing conflicts.

However, these two objectives may not prove compatible. For example, using as few phases as possible and the shortest practical cycle length lessens delay. However,

reducing accidents may require multiple phases and longer cycles, as well as placement of approach detectors to eliminate effects of a possible dilemma zone (see section 6.3). This placement may not be the optimum choice to reduce delays. Therefore, it is necessary to apply sound engineering judgment to achieve the best possible compromise among these objectives.

Traffic Flow

Flow characteristics of traffic are fundamental in analyzing intersection delay or capacity. Vehicles occupy space and, for safety, require space between them. With vehicles moving continuously in a single lane, the number of vehicles passing a given point over time will depend on the average headway. For example, for an average headway of 2 seconds, a volume of 1800 v/hr (3600 sec/hr x 1 v/2 sec) results.

Two factors influence capacity at a signalized intersection:

- Conflicts occur when two vehicles attempt to occupy the same space at the same time. This requires allocation of right-of-way to one line of vehicles while the other line waits.
- The interruption of flow for the assignment of right-of-way introduces additional delay. Vehicles slow down to stop and are also delayed when again permitted to proceed.

These factors (interruption of flow, stopping, and starting delay) reduce capacity and increase delay at a signalized intersection as compared to free-flow operations. Vehicles that arrive during a red interval must stop and wait for a green indication and then start and proceed through the intersection. The delay as vehicles start moving is followed by a period of relatively constant flow.

Table 3-5 presents data on typical vehicle headways (time spacing) at a signalized intersection as reported by Greenshields (7). These data illustrate basic concepts of intersection delay and capacity.

Table 3-5 Vehicle headway data.

Position in Line	Observed Time Spacing (Sec)	Time Spacing at Constant Flow (Sec)	Added Startup Time (Sec)
1	3.8	2.1	1.7
2	3.1	2.1	1.0
3	2.7	2.1	0.6
4	2.4	2.1	0.3
5	2.2	2.1	0.1
6 and over	2.1	2.1	0.0

Source: Reference 7

Types of Control

Traffic signal control for isolated intersections falls into two basic categories:

- Pretimed, and
- Semi- and fully traffic actuated.

Each type offers varying performance and cost characteristics depending on the installation and prevailing traffic conditions.

Chang (8) provides guidelines and information to aid the engineer in selecting the appropriate type of signal control as shown in Figure 3-12. As shown in Tables 3-6 and 3-7, Skabardonis (17) also provides guidelines. Figure 3-13 shows possible arrangements for inductive loop detectors for actuated approaches and Figure 3-14 shows an example of actuated phase design.

Intersection Timing Requirements

Pretimed Controller

For pretimed control at isolated intersections, the engineer must determine:

- Cycle length,
- Phase lengths or cycle split (green interval plus yellow change interval), and
- Number and sequence of phases.

Traffic-Actuated Control

Traffic detectors on an actuated approach working in conjunction with timing values for each of the phases (see Table 3-8) determine the phase length.

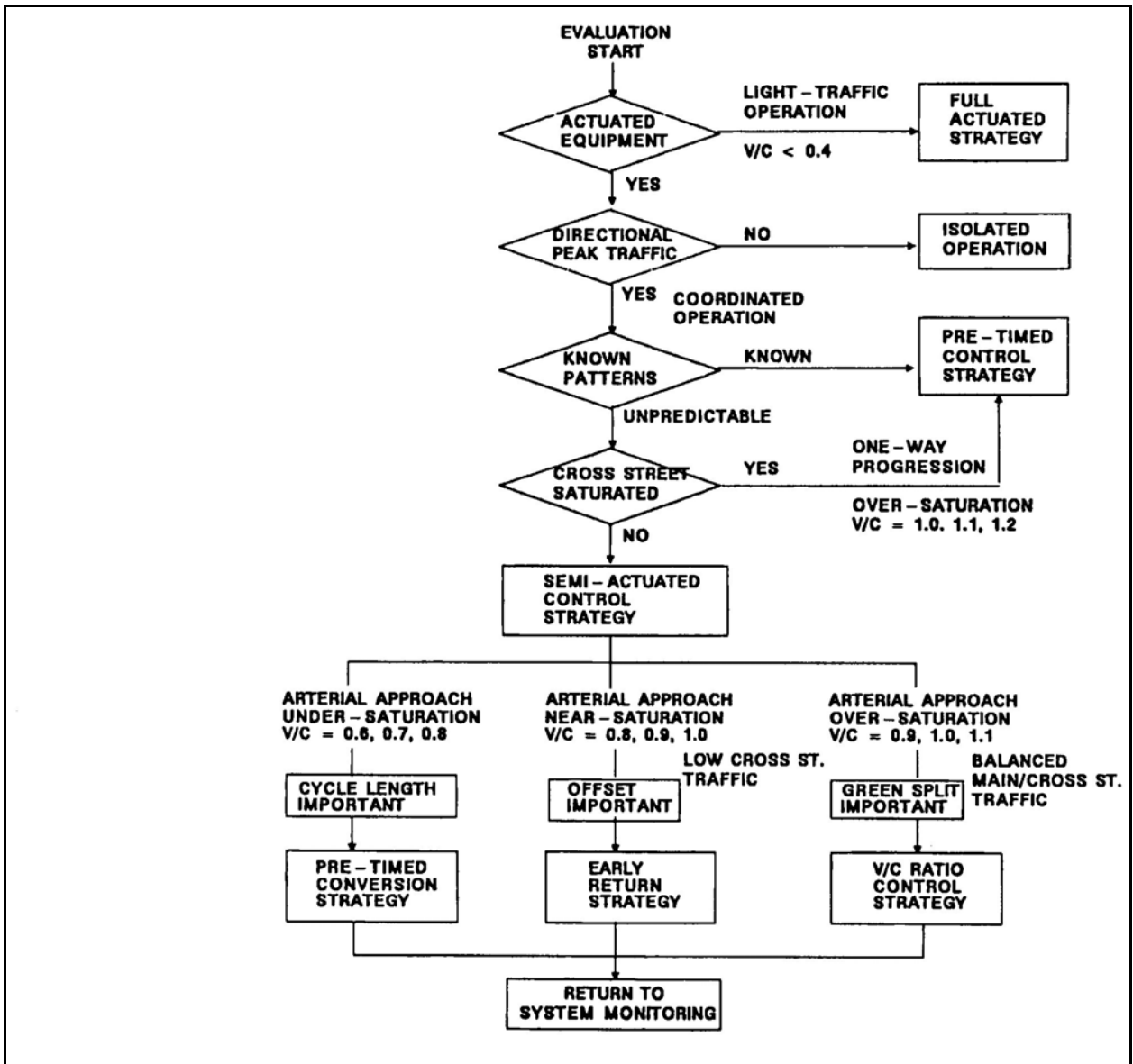

Figure 3-12 Recommended selection guidelines.

Table 3-6 Proposed signal control at specific intersections along arterials.

Cross Street Traffic V/C	Turning Movements*	Arterial Volume/Cross Street Volume	
		≤ 1.3	> 1.3
Low to Moderate V/C ≤ 0.8	≤ 20 Percent	Actuated (1)	Actuated (2)
	> 20 Percent	Actuated (2)	Actuated
High V/C ≥ 0.8	< 20 Percent	Pretimed	Pretimed
	> 20 Percent	Pretimed	Pretimed

* Percent of Arterial Through Traffic.

Notes:

1. Pretimed control at intersection with balanced volumes and high turning traffic from the cross street without exclusive lanes.
2. Pretimed operation if the early start of the green leads to additional stops and delay at the downstream signal. Also, boundary intersections may operate as pretimed if they are critical to the arterial's time-space diagram and define the leading edge of the green bandwidth.

Table 3-7 Proposed signal control at specific intersections in grid systems.

Network Configuration	Intersection V/C	Number of Phases		
		2	4	8
Crossing Arterials	≤ 0.80	Pretimed	Actuated (1)	Actuated (1)
	> 0.80	Pretimed	Pretimed (2)	Pretimed (2)
Dense Network	≤ 0.80	Fully Actuated (3)	Actuated	Fully Actuated
	> 0.80	Pretimed	Actuated	Fully Actuated

Notes:

1. The through phases may operate as pretimed if the volumes on each arterial are approximately equal, or semi-actuated operated leads to additional stops at the downstream signal(s).
2. Left turn phases at critical intersections may operate as actuated. Any spare green time from the actuated phases can be used by the through phases.
3. Intersections that require a much lower cycle than the system cycle length and are located at the edge of the network where the progression would not be influenced.

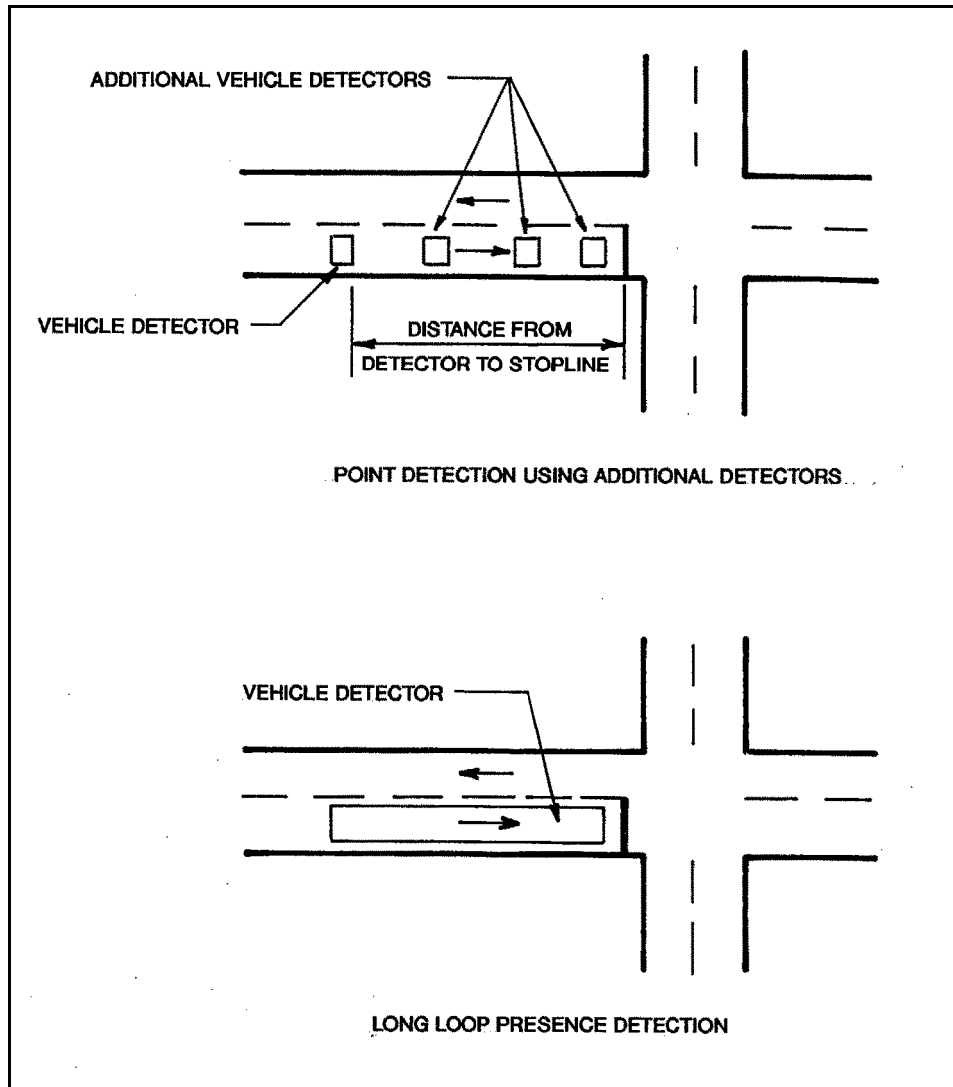

Figure 3-13 Traffic detection on intersection approach.

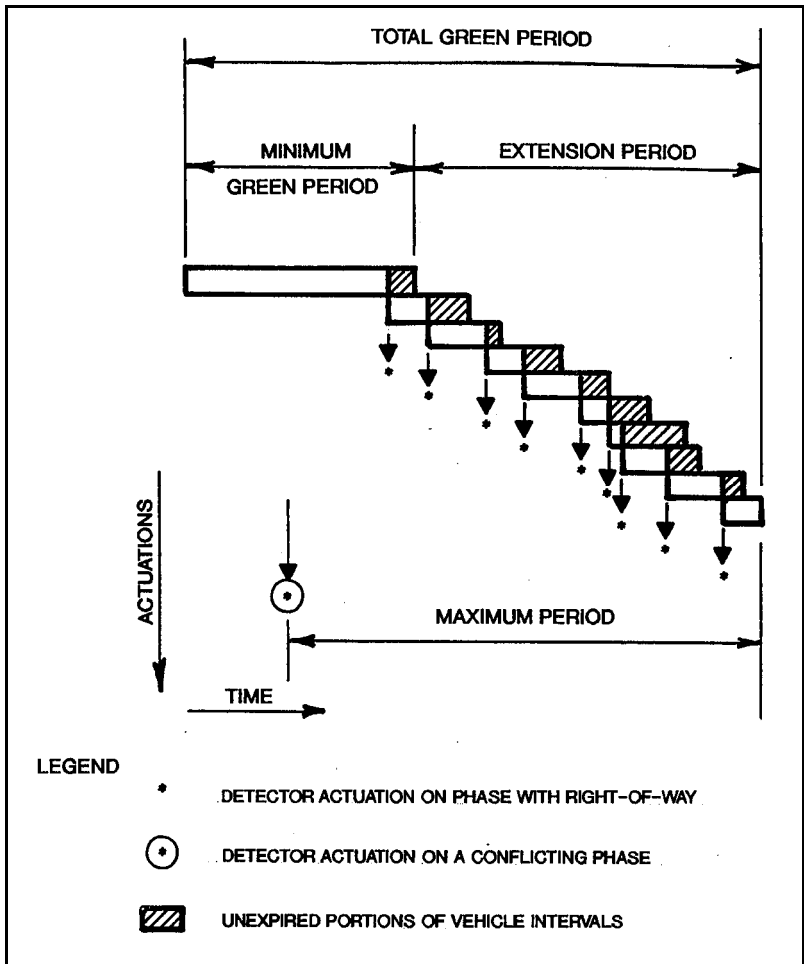

Figure 3-14 Example of actuated phase intervals.

Table 3-8 Interval settings.

Interval	Requirement	Calculation / Operation
Minimum Green	<p>Basic (no Volume-Density Feature):</p> <ul style="list-style-type: none"> • Service number of cars potentially stored between detector and stopline or the number normally stopped if a single detector is located a significant distance from the stopline • Remains constant 	<p>Point detection:</p> <p>Compute minimum green interval times for various detector setback distances assuming:</p> <ul style="list-style-type: none"> • Start-up delay of 4 seconds • Average headway between discharging vehicles of 2 seconds • Minimum green time at least $(4 + 2 N)$, where N is number of vehicles between detector and stopline <p>Compute N assuming an average vehicle length of 26 ft (7.9 m)</p> <p>For detectors located approximately 120 ft (36.6 m) or more from the stopline, minimum green may equal 14 seconds or longer. The length of minimum green time reduces ability to respond to traffic demand changes. Therefore, consider 120 ft (36.6 m) as upper limit for single detector placement and at speeds of 35 mi/hr (56.3 km/hr) or less.</p> <p>Where pedestrians cross and no separate pedestrian crossing indications exist, (e.g., WALK-DON'T WALK), minimum green time should ensure adequate pedestrian crossing time.</p> <p>Long loop presence detection (or a series of short loops):</p> <p>Set initial interval close to zero when the detector loop ends at the stopline. If the loop ends at some distance from the stopline, use this distance to determine initial interval with point detection. See Chapter 6 for further discussion of vehicle detector placement and relationship to approach speed.</p>
	<p>Traffic-Actuated (Volume-Density Feature):</p> <p>Initial interval based on number of vehicle actuations stored while other phases serviced</p>	<p>When there are serviceable calls on opposing phases, and no additional vehicles cross the detector, terminate phase at the end of this minimum green time. Where pedestrians cross and no separate pedestrian crossing indications exist, (e.g., WALK-DON'T WALK), minimum green time should ensure adequate pedestrian crossing time.</p>

Table 3-8 Interval settings (continued).

Interval	Requirement	Calculation / Operation
<p>Passage Time (Vehicle interval, extension interval, or unit extension)</p>	<p>Time required by a vehicle to travel from detector to intersection. With a call waiting on an opposing phase, represents the maximum time gap between vehicle actuations that can occur without losing the green indication. As long as the time between vehicle actuations remains shorter than the vehicle interval (or a present minimum gap), green will be retained on that phase subject to maximum interval.</p>	<p>Once the passage time interval timing is initiated and an additional vehicle is detected, present vehicle interval timing is canceled and a new vehicle interval timing initiated. This process is repeated for each additional vehicle detection until:</p> <ul style="list-style-type: none"> • Gap-out occurs (the gap between detections is greater than the vehicle interval or a present minimum gap). • Max-out occurs (the interval timing reaches a preset maximum and a pedestrian or a vehicle call has been placed for another phase). <p>In either of these two cases, the timing of a yellow change interval is initiated and the phase terminated. If the vehicle interval is not completely timed out (because of the maximum override), then a recall situation is set and the timing will return to this phase at the first opportunity. Figure 3-14 illustrates the situation where:</p> <ul style="list-style-type: none"> • Successive actuations occurred. • Gaps shorter than passage time interval. • Preset maximum green interval reached. <p>Long loop presence detection:</p> <p>Set passage time interval close to zero because the signal controller continuously extends the green as long as loop is occupied. In this case, critical time gap is time required for a vehicle to travel a distance equal to the loop length plus the vehicle length. For a series of short loops, treat them as a long loop, provided that the distance between loops is less than the vehicle length; otherwise, use a short vehicle interval to produce the equivalent effect of a single long loop.</p>
<p>Maximum Green (Total green time or vehicle extension limit)</p>	<p>Maximum length of time a phase can hold green in presence of conflicting call</p>	<p>Reference 9 provides detailed guidance.</p>

Timing Considerations

Cycle Length and Split Settings

HCM 2000 (10) provides a detailed description of computational procedures for cycle and split settings. The following discussion summarizes some of the key items in the HCM.

Figure 3-15 depicts the traffic signal cycle, and Figure 3-16 provides definitions for this figure. Equation 3.11 provides an estimate of lost time (t_L) for each signal phase. A value of 4 seconds is suggested unless local measurements provide a more accurate value.

$$t_L = l_1 + l_2 = l_i + Y_i - e \quad (3.11)$$

$$\text{Effective phase green time } (g_i) = G_i + Y_i - t_L \quad (3.12)$$

HCM 2000 provides worksheets that facilitate the estimation of critical lane volume VCL.

Following the selection of a phasing plan, critical volumes (CV) are established for each phase. These are then used to calculate the cycle as follows.

A cycle length that will accommodate the observed flow rates with a degree of saturation of 1.0 is computed by Equation A10-1 in HCM 2000 and shown in equation 3.13 below. If the cycle length is known, that value should be used.

$$C = \frac{L}{1 - \left[\frac{\min(CS, RS)}{RS} \right]} \quad (3.13)$$

where:

- C = cycle length (s),
- L = total lost time (s),
- CS = critical sum (veh/h), flow rate
- RS = reference sum flow rate ($1,710 * PHF * f_a$) (veh/h),
- PHF = peak-hour factor, and
- f_a = area type adjustment factor (0.90 if CBD, 1.00 otherwise).

RS is the reference sum of phase flow rates representing the theoretical maximum value that the intersection could accommodate at an infinite cycle length. The recommended value for the reference sum, RS, is computed as an adjusted saturation flow rate. The

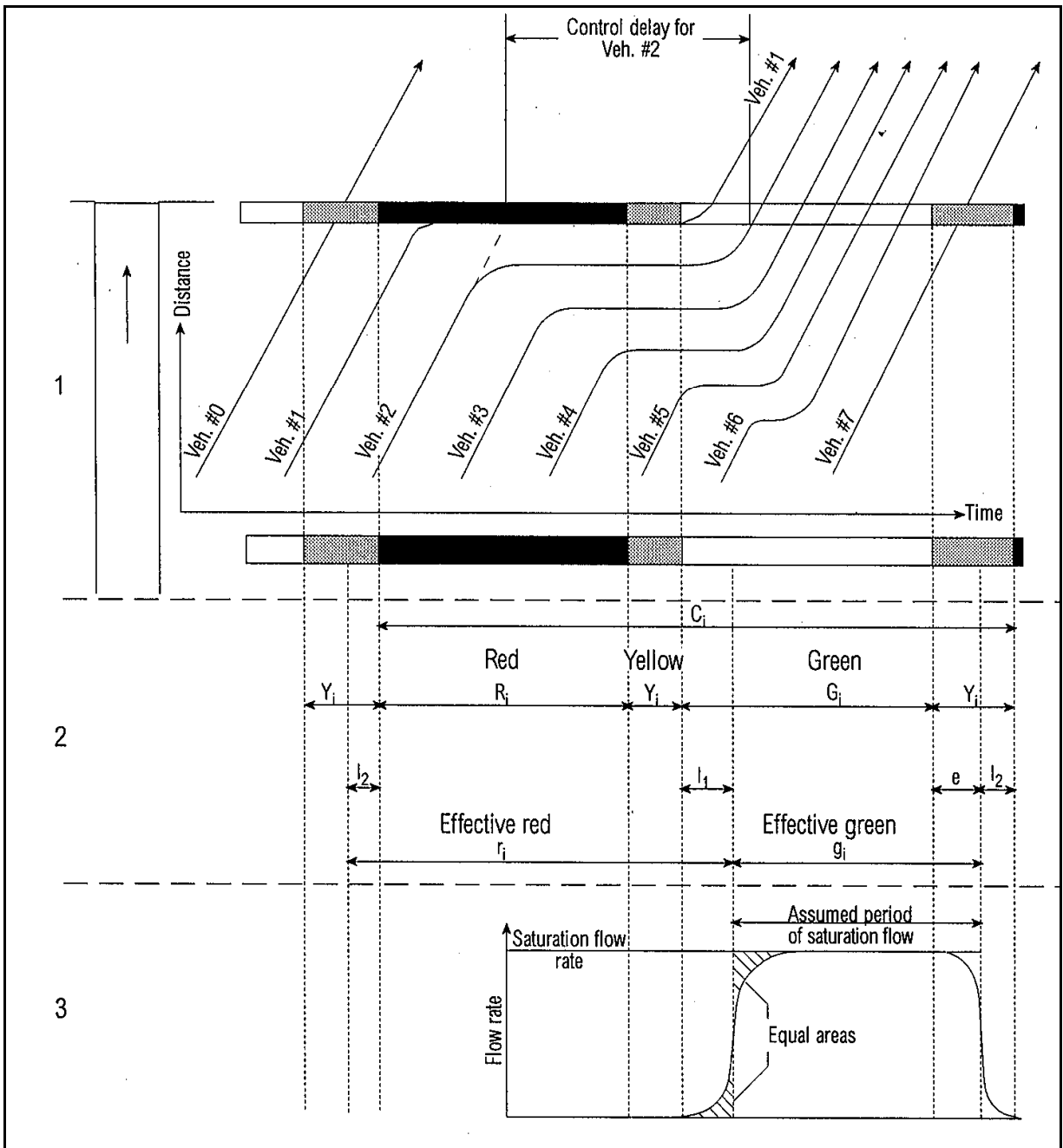

Figure 3-15 Fundamental attributes of flow at signalized intersections.

Name	Symbol	Definition	Unit
Change and clearance interval	Y_i	The yellow plus all-red interval that occurs between phases of a traffic signal to provide for clearance of the intersection before conflicting movements are released	S
Clearance lost time	l_2	The time between signal phases during which an intersection is not used by any traffic	S
Control delay	d_i	The component of delay that results when a control signal causes a lane group to reduce speed or to stop; it is measured by comparison with the uncontrolled condition	S
Cycle		A complete sequence of signal indications	
Cycle length	C_i	The total time for a signal to complete one cycle length	S
Effective green time	g_i	The time during which a given traffic movement or set of movements may proceed; it is equal to the cycle length minus the effective red time	S
Effective red time	r_i	The time during which a given traffic movement or set of movements is directed to stop; it is equal to the cycle length minus the effective green time	S
Extension of effective green time	e	The amount of the change and clearance interval, at the end of the phase for a lane group, that is usable for movement of its vehicles	S
Green time	G_i	The duration of the green indication for a given movement at a signalized intersection	S
Interval		A period of time in which all traffic signal indications remain constant	
Lost time	t_L	The time during which an intersection is not used effectively by any movement; it is the sum of clearance lost time plus start-up lost time	S
Phase		The part of the signal cycle allocated to any combination of traffic movements receiving the right-of-way simultaneously during one or more intervals	
Red time	R_i	The period in the signal cycle during which, for a given phase or lane group, the signal is red	S
Saturation flow rate	s_i	The equivalent hourly rate at which previously queued vehicles can traverse an intersection approach under prevailing conditions, assuming that the green signal is available at all times and no lost times are experienced	veh/h
Start-up lost time	l_1	The additional time consumed by the first few vehicles in a queue at a signalized intersection above and beyond the saturation headway, because of the need to react to the initiation of the green phase and to accelerate	S
Total lost time	L	The total lost time per cycle during which the intersection is effectively not used by any movement, which occurs during the change and clearance intervals and at the beginning of most phases.	S

Figure 3-16 Symbols, definitions, and units for fundamental variables of traffic flow at signalized intersections.

value of 1,710 is about 90 percent of the base saturation flow rate of 1,900 pc/h/ln. The objective is to produce a 90 percent v/c ratio for all critical movements.

The CS volume is the sum of the critical phase volume for each street. The critical phase volumes are identified in the quick estimation control delay and LOS worksheet on the basis of the phasing plan selected from Exhibit A10-8 in HCM 2000.

The cycle length determined from this equation should be checked against reasonable minimum and maximum values. The cycle length must not exceed a maximum allowable value set by the local jurisdiction (such as 150 s), and it must be long enough to serve pedestrians.

The ability to service traffic demand may be increased, up to a point, by increasing the cycle length. It is seen from Equation 3.13 that increasing the critical sum flow relative to the reference sum flow requires a higher cycle length to service the demand. Figure 3-17 shows the required cycle length for a two phase intersection (Lost time = 8 seconds).

The total cycle time is divided among the conflicting phases in the phase plan on the basis of the principle of equalizing the degree of saturation for the critical movements. The lost time per cycle must be subtracted from total cycle time to determine the effective green time per cycle, which must then be apportioned among all phases. This is based on the proportion of the critical phase flow rate sum for each phase determined in a previous step (10). The effective green time, g , (including change and clearance time) for each phase can be computed using Equation 3.14

$$g = (C-L)(CV/CS) \quad \text{where } CV \text{ is the critical lane volume} \quad (3.14)$$

Intersection Delay

The values derived from the delay calculations represent the average control delay experienced by all vehicles that arrive in the analysis period, including delays incurred beyond the analysis period when the lane group is oversaturated. Control delay includes movements at slower speeds and stops on intersection approaches as vehicles move up in queue position or slow down upstream of an intersection (10).

The average control delay per vehicle for a given lane group is given by Equation 15-1 in HCM 2000 as

$$d = d_1(PF) = d_2 + d_3 \quad (3.15)$$

where:

- d = control delay per vehicle (s/veh);
- d_1 = uniform control delay assuming uniform arrivals (s/veh);
- PF = uniform delay progression adjustment factor, which accounts for effects of signal progression;
- d_2 = incremental delay to account for effect of random arrivals and oversaturation queues, adjusted for duration of analysis period and type of signal control; this delay component assumes that there is no initial queue for lane group at start of analysis period (s/veh); and
- d_3 = initial queue delay, which accounts for delay to all vehicles in analysis period due to initial queue at start of analysis period (s/veh)

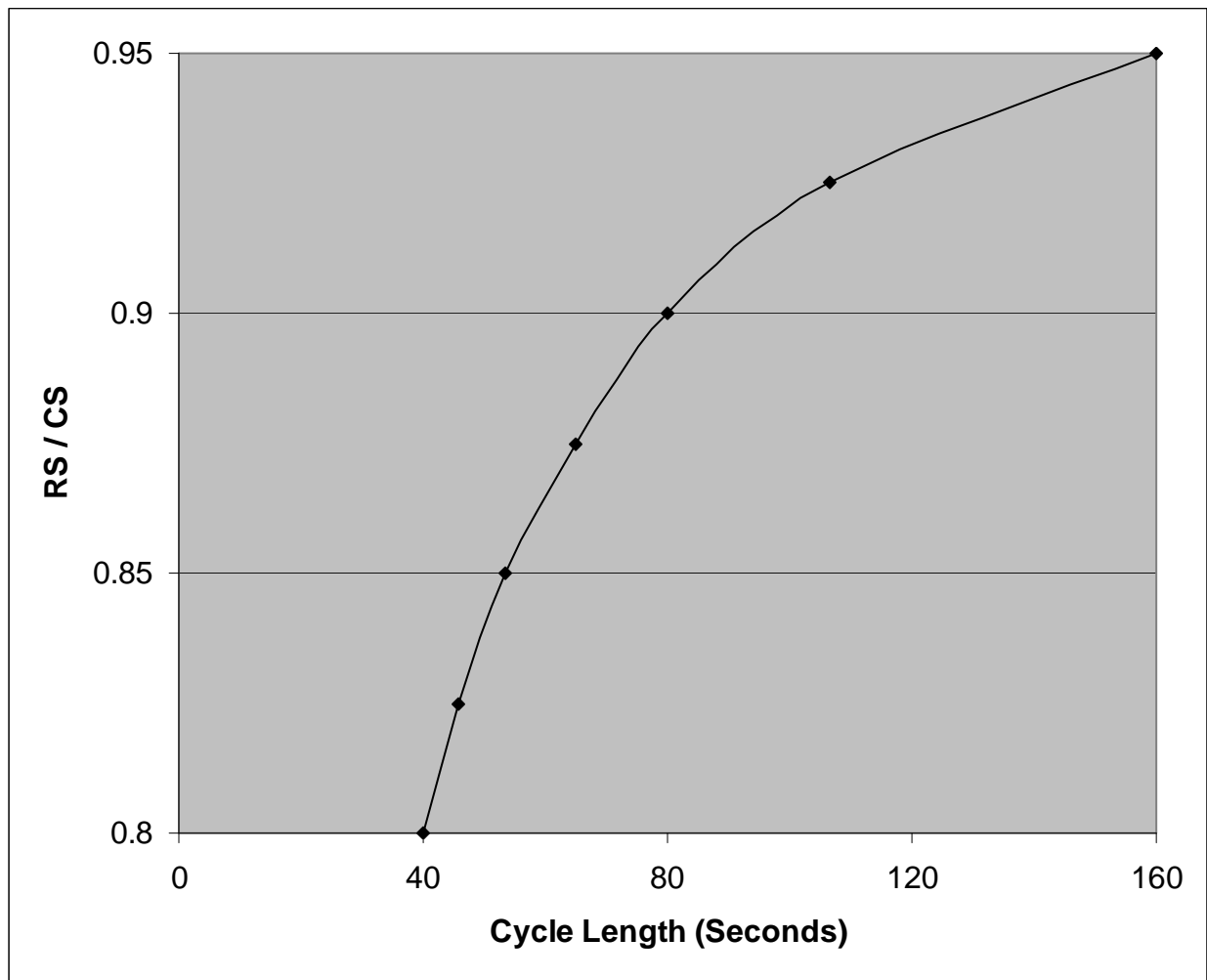

Figure 3-17 Cycle length vs. demand for two phase signal.

Details for the estimation of d_1 , PF, d_2 and d_3 are provided in HCM 2000.

Critical Lane Groups

HCM 2000 uses the concept of critical lane groups. A critical lane group is the lane group that has the highest flow ratio (ratio of volume to saturation flow) for the phase. The critical lane group determines the green time requirements for the phase.

Critical lane groups are used to identify a number of parameters in the signal timing process. One measure of the relative capacity of the intersection is the critical volume to capacity ratio for the intersection (X_C). It is given by:

$$X_c = \sum \left(\frac{v}{s} \right)_{ci} \left(\frac{C}{C-L} \right)$$

Where:

$$\sum \left(\frac{v}{s} \right)_{ci} = \text{summation of flow ratios for all critical lane groups } i;$$

$$C = \text{cycle length (s); and}$$

$$L = \text{total lost time per cycle, computed as lost time } t_L, \text{ for critical path of movement (s)}$$

Traffic-Actuated Control

Using traffic-actuated control at isolated intersections enables the timing plan to continuously adjust in response to traffic demand. However, the potential to minimize delay and maximize capacity will only be realized with careful attention to:

- Type of equipment installed,
- Mode of operation,
- Location of detectors, and
- Timing settings.

Traffic-actuated control equipment automatically determines cycle length and phase lengths based on detection of traffic on the various approaches. The major requirement is to set the proper timing values for each of the functions provided by the controller unit (See Table 3-8).

Other Considerations

Methods are available for developing timing plans and are discussed in the following references:

- *Traffic Engineering Handbook* (11),
- *Manual on Uniform Traffic Control Devices* (3),
- *Manual of Traffic Signal Design* (4), and
- *Traffic Engineering Theory and Practice* (12).

In addition to cycle length and split calculations, the traffic engineer should consider several other important factors in developing timing plans for signal control.

Pedestrian movement often governs a timing plan. The engineer must provide sufficient green for pedestrians to cross the traveled way (see reference 11 for example). Where equipment permits, the pedestrian phase should be activated when the pedestrian- phase interval exceeds the vehicle interval. A number of publications (e.g. Reference 9) provide guidelines for timing pedestrian intervals.

Another important consideration is the length of the phase-change period. This period may consist of only a yellow change interval or may include an additional all-red clearance interval. The yellow interval warns traffic of an impending change in the right-of-way assignment. For a detailed discussion of these intervals refer to Reference 9.

In considering control concepts and strategies for isolated signalized intersections, the engineer must consider:

- Traffic flow fluctuations, and
- The random nature of vehicle and pedestrian arrivals.

The daily patterns of human activity influence traffic flow; it usually exhibits three weekday peak periods (A.M., midday, P.M.). Drew (13) has shown that even within a peak hour the 5-minute flow rates can prove as much as 15 to 20 percent higher than the average flow rate for the total peak hour period. He has further shown that a Poisson distribution best predicts vehicle arrivals for isolated intersections, indicating that considerable variation in arrival volume can occur on a cycle-to-cycle basis.

3.8 Arterial and Network Control

Basic Considerations

Arterial street control gives preference to *progressive* traffic flow along the arterial. In contrast with isolated intersections, the signals must operate as a system.

Arterial street control recognizes that a signal releases *platoons* that travel to the next signal. Arterial street signal systems form an *open* network, as compared to a *closed* network, as illustrated in Figure 3-18. To maintain the flow of these platoons, the system must coordinate timing of adjacent intersections. The system accomplishes this by establishing a time relationship between the beginning of arterial green at one intersection and the beginning of arterial green at the next intersection. By doing this, static queues receive a green indication on their approach in advance of arriving platoons. This permits continuous traffic flow along an arterial street and reduces delay.

The previous sections have discussed the concepts of control of isolated intersections as well as maintaining vehicle progressions on arterials and in a grid system. The following discussion on the need for signal coordination is adapted from Gordon (14).

While coordination of adjacent signals often provides benefits, the traffic systems engineer must decide, in each case, whether better performance will be achieved with coordinated or isolated operation.

When a platoon of vehicles is released from a traffic signal, the degree to which this platoon has dispersed at the next signal (difference from profile at releasing signal) in part determines whether significant benefits can be achieved from signal coordination.

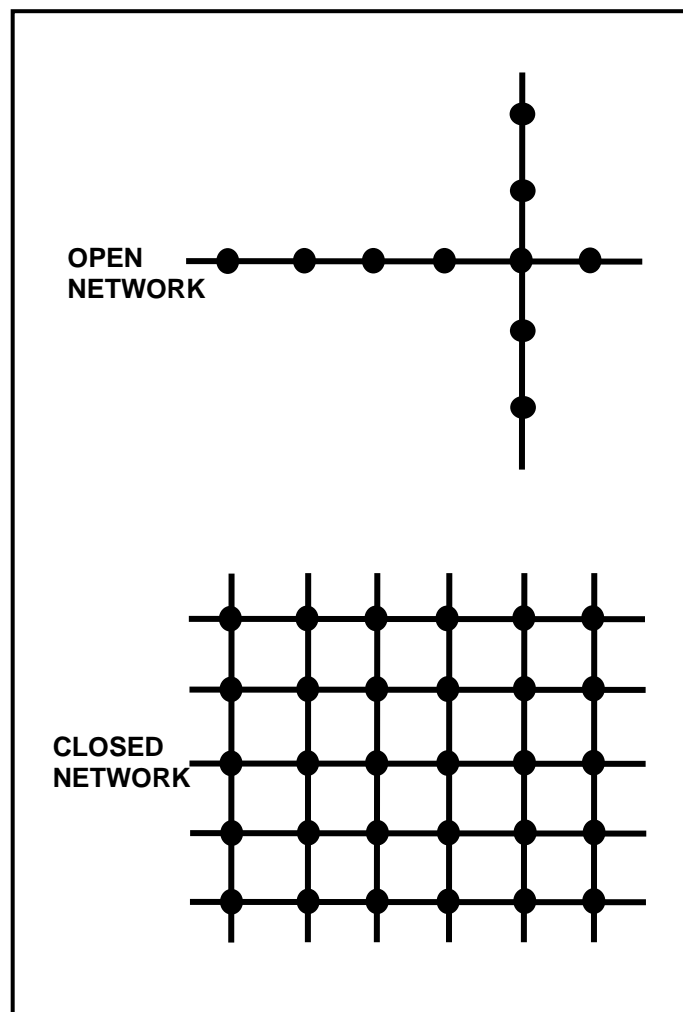

Figure 3-18 Signal networks.

The Traffic Network Study Tool (TRANSYT) has become one of the most widely used models in the United States and Europe for signal network timing. It was developed in

1968 by Robertson of the UK Transport and Road Research Laboratory (TRRL) (15), which has since released several versions. This handbook discusses TRANSYT-7F (16), where "7" denotes the seventh TRRL version, and "F" symbolizes the Federal Highway Administration's version using North American nomenclature for input and output. While features of TRANSYT-7F are discussed later in the section, the present discussion relates to the TRANSYT platoon dispersion model.

The model represents the dispersion of a vehicle platoon departing from a signalized intersection as illustrated in Figure 3-19 (16). The figure also shows percentage saturation (a measure of volume) as a function of time at three points along the roadway when no downstream queue is present.

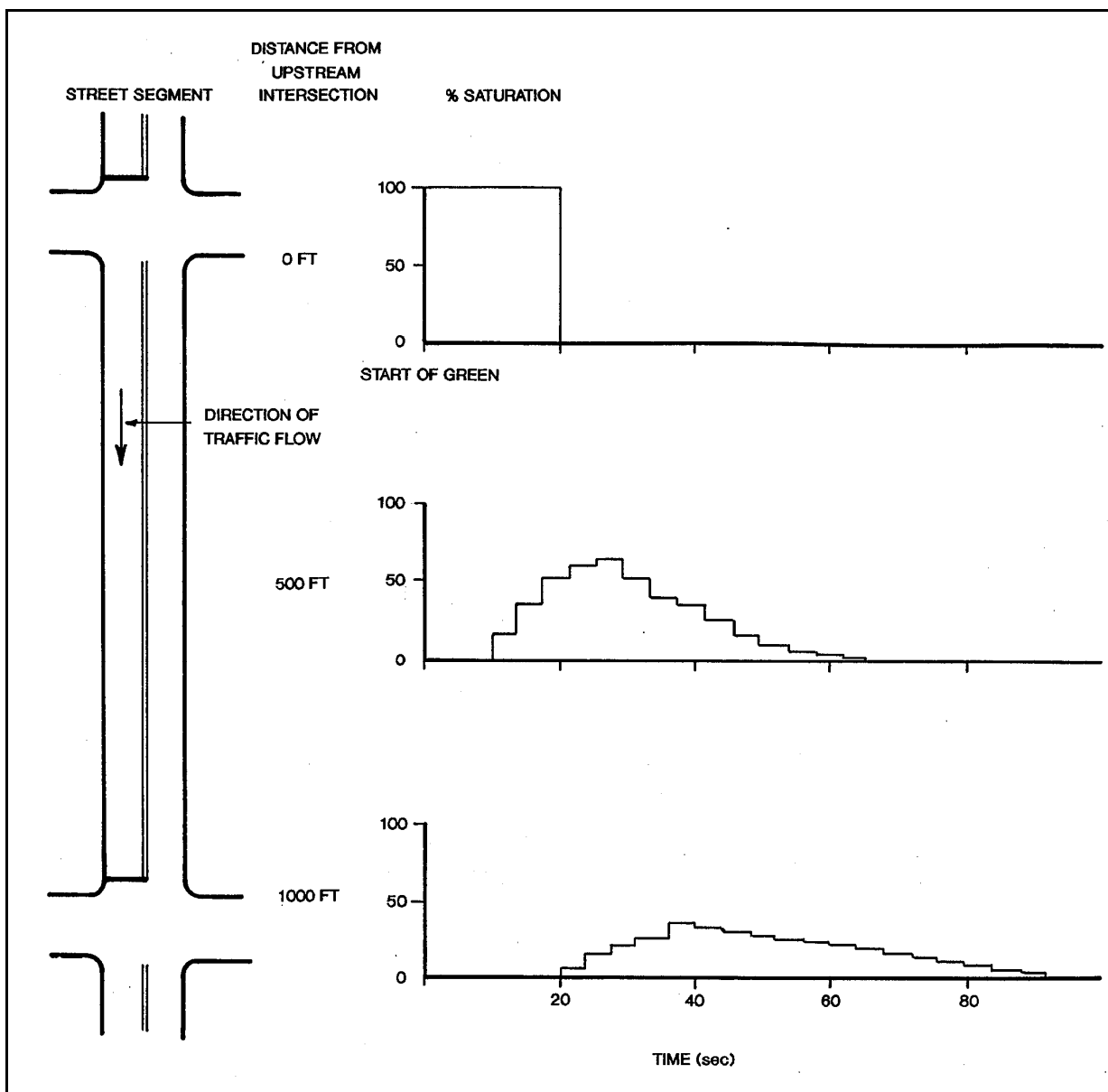

Figure 3-19 Simple case of platoon dispersion.

TRANSYT assumes that the average flow demand at an approach remains constant, i.e., the flow patterns for each cycle repeat. For each computation time interval t , Table 3-9 (16) provides the analytical model for the arrival flow at the downstream stopline. Table 3-10 shows recommended values of platoon dispersion factor (PDF). PDF is a function of travel time to the downstream signal and roadway impedance to traffic flow or “friction”. Based on the TRANSYT model, Figure 3-20 (17) depicts the reduction in delay as a function of travel time and PDF.

Table 3-9 TRANSYT analytical model.

$q'(t+T) = F * q_t + [(1 - F) * q'(t+T - 1)]$ (3.16)	
Where:	
$q'(t+T)$ =	Predicted flow rate (in time interval $t+T$) of the predicted platoon, where T is defined below:
q_t =	Flow rate of the interval platoon during interval t
T =	0.8 times the cruise travel time on the link
F =	A smoothing factor where:
	$F = 1 / (1 + aT)$ (3.17)
	and “ a ” is a constant, called the platoon dispersion factor (PDF).

Table 3-10 Recommended values of platoon dispersion factor (PDF).

PDF Value	Roadway Characteristics	Conditions
0.5	Heavy friction	Combination of parking, moderate to heavy turns, moderate to heavy pedestrian traffic, narrow lane width. Traffic flow typical of urban CBD.
0.35	Moderate friction	Light turning traffic, light pedestrian traffic, 11 to 12 ft (3.4 to 3.7 m) lanes, possibly divided. Typical of well-designed CBD arterial.
0.25	Low friction	No parking, divided, turning provisions 12ft (3.7 m) lane width. Suburban high type arterial.

Two general techniques are commonly used to determine coordination needs:

- Information from prior research and experience, and
- Simulation.

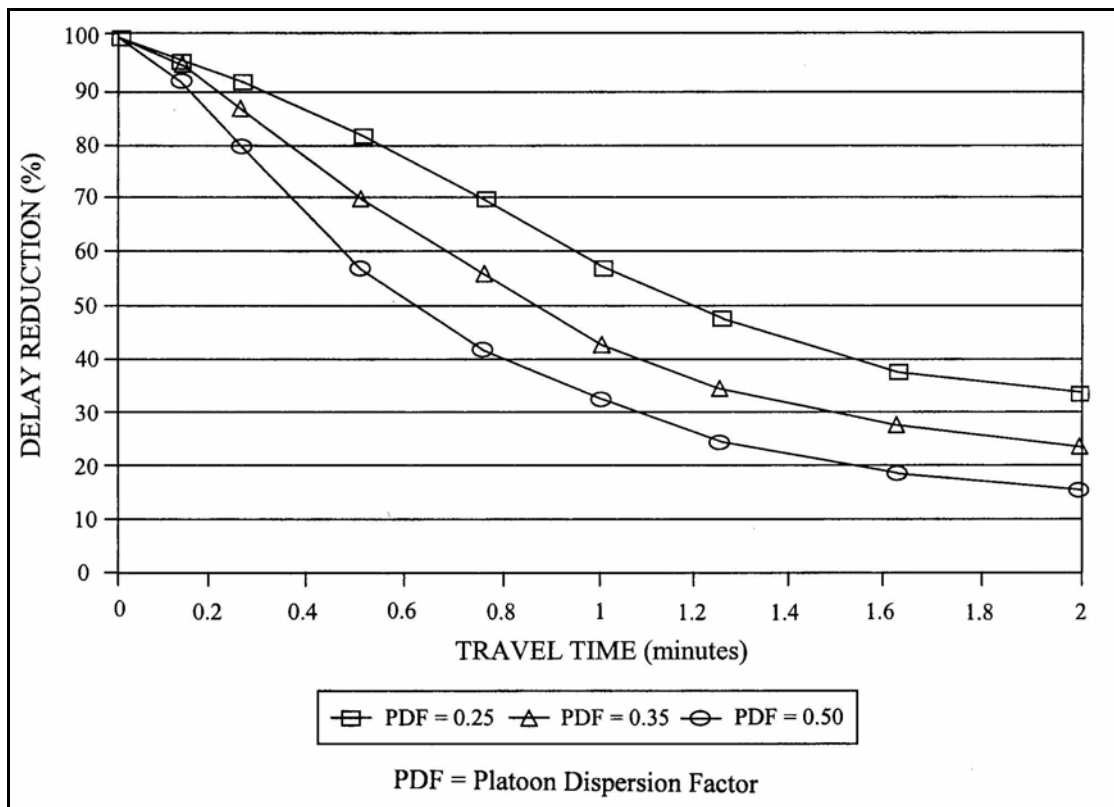

Figure 3-20 Benefits of signal coordination.

Information from Prior Research and Experience

A number of simple criteria have been used that do not directly incorporate a platoon dispersion model. These include:

- Reduction in the queue (18)
- $K = Q/(200(1 + t))$
 Where K = reduction in the queue (number of vehicles)
 Q = travel volume (number of vehicles/hr)
 T = travel time between intersections (minutes)
- Criterion for good progression (19)
 Good progression when signal spacing is fairly uniform and
 $0.40 < \text{Travel time} / \text{cycle length} < 0.60$
- Criterion for coordinating signals (20)
 Coordinate signals within 0.5 miles

- Criterion for coordinating signals (21)
 $I = V/L, I > 0.5$
 Where V = two way peak hour link volume (VPH)
 L = Link length (feet)

Chang and Messer developed the intercoordination desirability index (22) described below:

$$I = \left(\frac{0.5}{1+t} \right) * \left(\frac{q_{MAX}}{q_T} - (N - 2) \right)$$

t = link travel time in minutes

q_{MAX} = straight through flow from upstream intersection (VPH)

q_T = sum of traffic flow at the downstream approach from the right turn, left turn, and through movements of the upstream signals, divided by the number of arrival links at the upstream intersection.

N = Number of arrival lanes feeding into the entering link of the downstream intersection.

I may range from 0 to 1.0. Interconnection is recommended when I exceeds 0.35.

These criteria may also be employed to establish boundaries between sections of coordinated signals.

Simulation

Simulation is often used to determine coordination requirements and benefits, particularly when performed in connection with retiming of traffic signals. The systems engineer may employ a general model such as CORSIM, together with a signal timing program, or may use the evaluative features of a signal timing program such as TRANSYT 7F. In the latter case, coordination requirements and section boundary identification may be directly coordinated with the signal retiming effort.

A key issue is whether a major intersection operating at near capacity should be coordinated with a series of minor intersections (which by themselves might operate at a lower cycle length) or whether it should operate as an isolated intersection with its own cycle (17).

Time-Space Diagram

Figures 3-21 (a) and 3-21 (b) show this traffic flow control concept via a *time-space diagram*. Definitions used in this diagram include:

- Green band — The space between a pair of parallel speed lines which delineates a progressive movement on a time-space diagram.
- Band speed — The slope of the green band representing the progressive speed of traffic moving along the arterial.
- Bandwidth — The width of the green band in seconds indicating the period of the time available for traffic to flow within the band.

Timing Plan Elements

Operation of a control system for an arterial street (or open network) requires a *timing plan* for all signals in the system, which consists of the following elements:

- Cycle length - This normally is the same (or some multiple) for all signals in the system or *section* (subset of a system). The intersection with the longest cycle length requirements (as calculated via methods in section 3.7) usually governs the system cycle length.
- Splits - The length of the various signal phases must be calculated for each intersection. Phase lengths (splits) may vary from intersection to intersection.
- Offset - An offset value must be calculated for each intersection. One definition of offset is the start time of main street green relative to the green interval start for a master intersection in the system.

Figures 3-21 (a) and 3-21 (b) depict an ideal case of equal intersection spacing and splits at all intersections. When this does not occur, the bandwidth becomes narrower than the green interval at some or all signals, as shown in Figure 3-22 (11).

Traffic Flow Variations

A timing plan is developed for a specific set of traffic conditions. When these change substantially, the timing plan loses effectiveness.

Two basic types of traffic flow variations can occur:

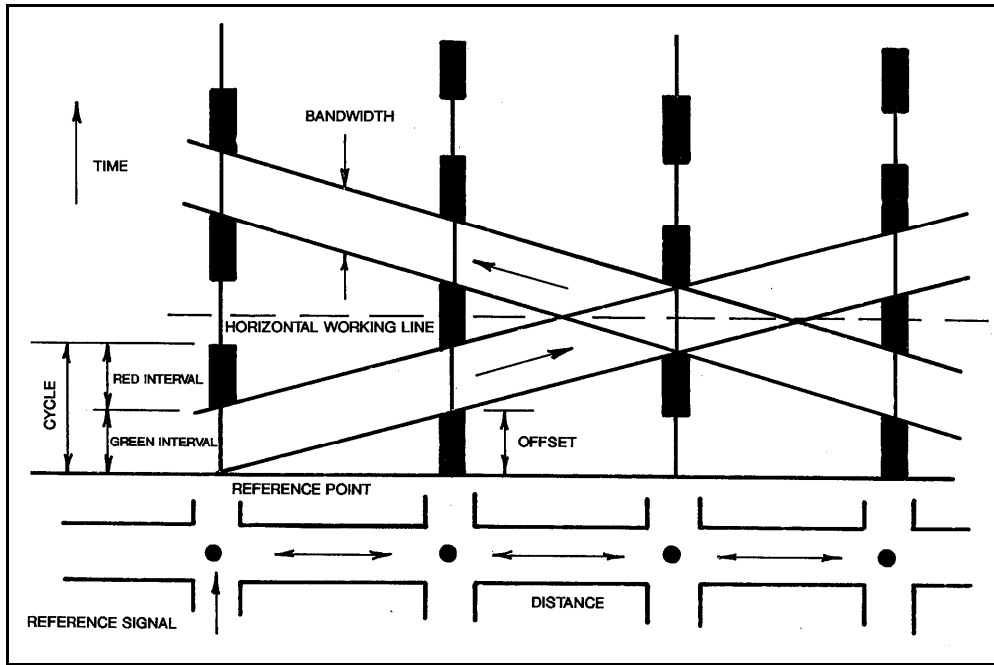

(a). Time-space diagram.

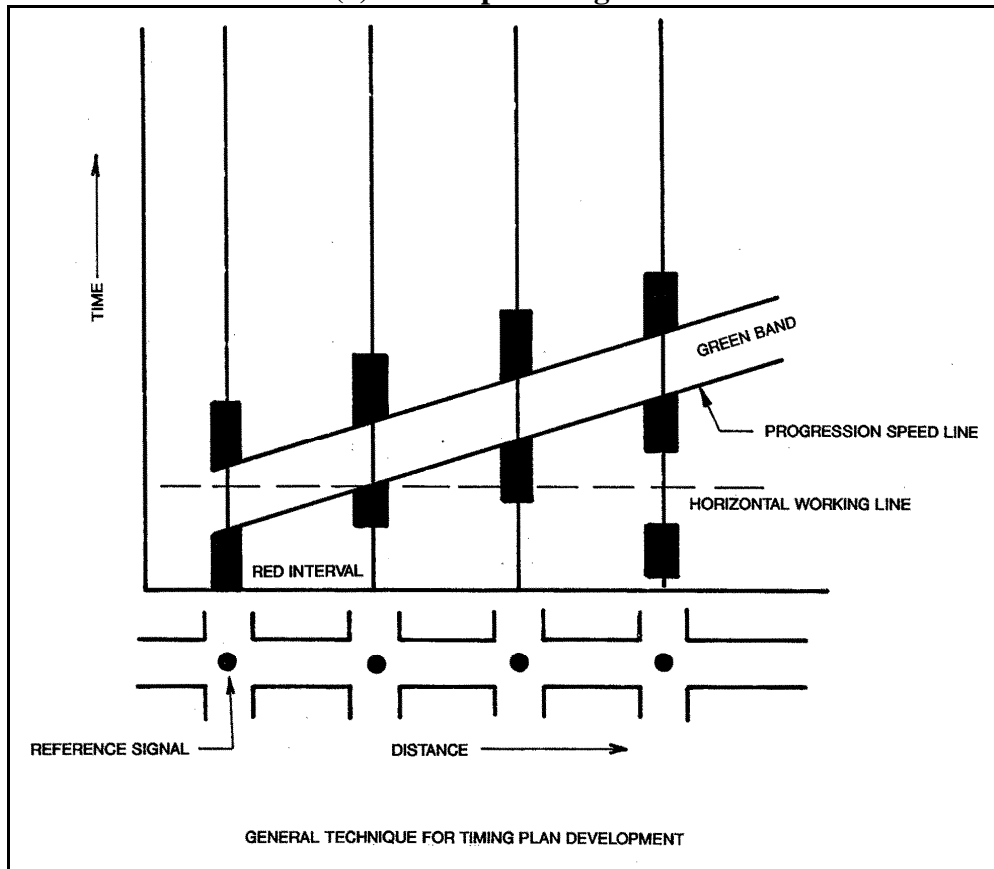

(b). General technique for timing plan development.

Figure 3-21 Time-space diagram and graphic technique.

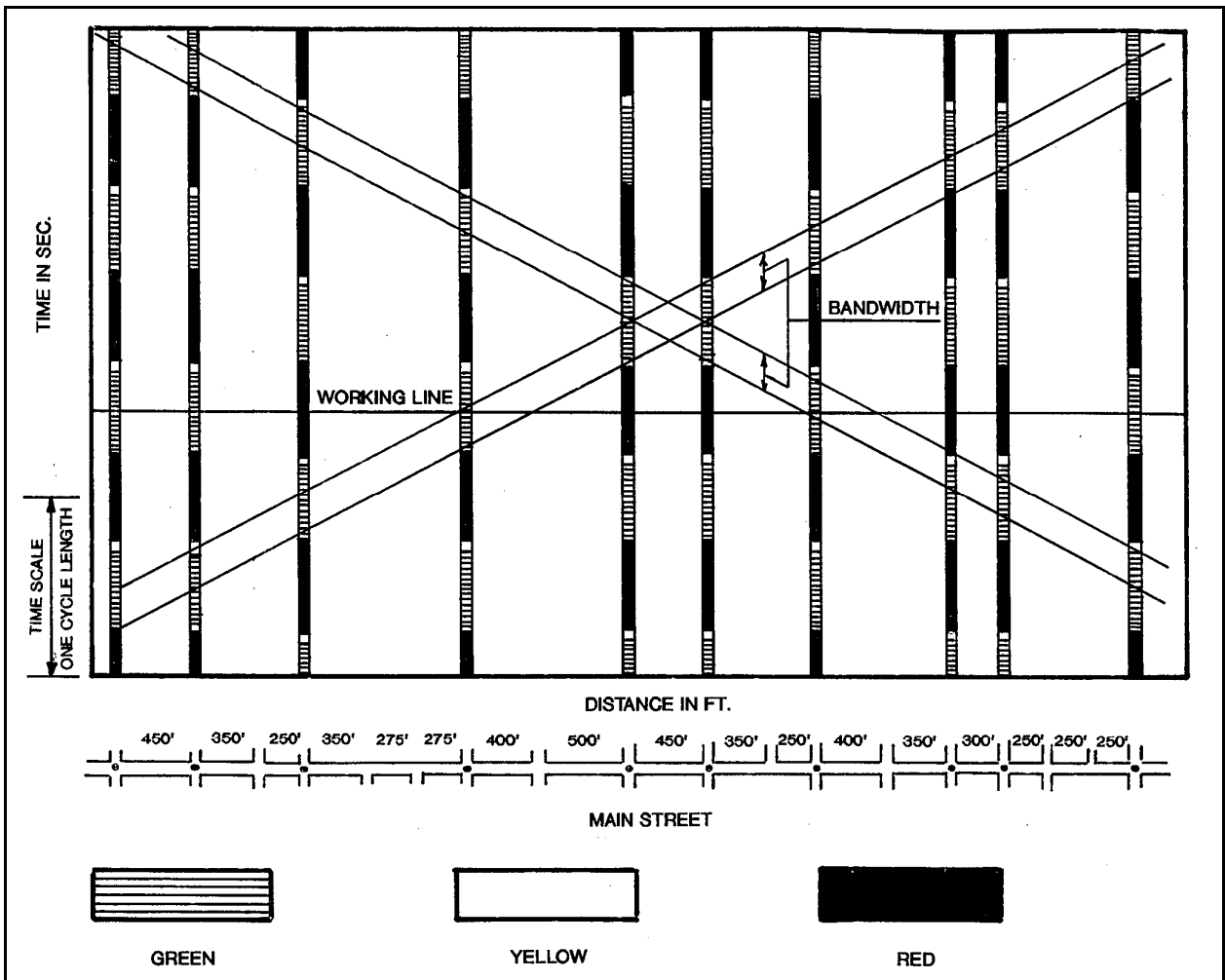

Figure 3-22 Typical time-space diagram.

- Traffic flow at individual intersections — volumes can increase or decrease at one or more signal locations. These changes can alter the cycle length or split requirements at the affected intersections.
- Traffic flow direction — flow volume can vary directionally on a two-way arterial. Table 3-11 shows the 3 basic conditions, their normal times of occurrence, and associated timing plans.

Time of day control techniques often provided at least 3 timing plans (A.M., off-peak, P.M.). *Traffic-responsive* control systems can automatically select timing plans at shorter intervals based on measured traffic flow and select from a greater number of plans.

Table 3-11 Directional flow conditions.

Conditions	Normal Time of Occurrence	Timing Plan Progressive Movement
Inbound flow exceeds outbound flow	A.M. peak	Inbound
Inbound flow approximates outbound flow	off-peak	Inbound and outbound equally
Outbound flow exceeds inbound flow	P.M. peak	Outbound

Timing Plan Development

Basic techniques for developing timing plans include:

- *Manual* calculations and / or graphic analysis determine cycle lengths, splits, and offsets.
- *Offline computer* software models make required calculations. *Offline* indicates that timing plans are generated from traffic data collected earlier. Plans are stored for use during an appropriate time-of-day or may be selected on a traffic-responsive basis using data from traffic system detectors.

Manual Techniques

With the advent of software to develop timing plans, this technique is no longer recommended. The exercise, however, provides insight into timing plan development. Developing an arterial signal system timing plan manually requires collecting the following data:

- Geometric
 - Intersection spacing (stopline to stopline), and
 - Street geometrics (width, lanes, and approaches).
- Traffic flow
 - Volumes, including turning movement counts,
 - Flow variations, and
 - Speed limitations.

Table 3-12 shows a series of steps leading to manual development of a timing plan.

Table 3-12 Manual timing plan development.

<p>1. Prepare a graphic display of the signal system, similar to figure 3-21 or 3-22.</p>	<p>* c) Draw a horizontal working line through the center of either a red or green interval for the reference signal.</p>
<p>2. For each timing plan, examine flow conditions at each intersection and evaluate cycle length and split. Use the methods discussed under isolated intersections.</p> <p>Consider increasing volumes to account for seasonal differences and increases in the next 3 to 5 years. Five (5) percent typically accounts for seasonal differences.</p>	<p>* d) Center either a red or green signal interval on the horizontal working line (as required to obtain the greatest width of the green bands) to achieve an equal bandwidth for each flow direction.</p> <p>* e) Usually the provisional green band defined by the progression lines plotted in step (b) will not pass through all the green phase intervals plotted in step (d).</p>
<p>Calculate optimum cycle length and phase interval for each signal. The longest cycle length usually becomes the system cycle.</p>	<p>For this case, adjust the provisional green band by drawing progression lines parallel to the original lines. Space these lines to define the widest bandwidth remaining within the green phase of all signals.</p>
<p>3. Conduct a graphic analysis to determine offsets for each timing plan. The graphical analysis proceeds as follows (refer to figure 3-21):</p>	<p>* f) Modestly alter the progression line slope about the signal identified in step (a) to determine whether small changes can increase bandwidth.</p>
<p>a) Identify the signal with the smallest main street green phase split.</p>	<p>* g) The preceding step results in a timing plan that provides equal bandwidths for each flow direction. If desired, modify this result to favor 1 flow direction.</p>
<p>b) Draw a progression speed line and provisional green band beginning at the start of main street green at this signal. . This speed line will have a slope representing the desired progression speed.</p>	
<p>* Applies to 2-way progression shown in Figures 3-21 (a) and 3-22.</p>	

As a general rule, the time-space diagram resulting from Table 3-12 will have the beginning of green occurring at:

- Every other signal, i.e., *single alternate*, or
- Two adjacent intersections, i.e., *double alternate*, or
- Three adjacent intersections, i.e., *triple alternate*.

The beginning of greens may not exactly coincide but will usually approximate one of the three patterns. Figure 3-21 (a) shows single alternate offset timing.

Consider the manual method in Table 3-12 as a trial- and-error procedure. For example, if the resulting progression speeds prove too slow or fast, adjust the system cycle length. A 15 percent decrease or 25 percent increase may provide the desired progression speed without significantly increasing delay. Also, modify phase timing to favor straight-through movements. A protected-permissive left-turn operation may reduce the time initially calculated for protected only left-turn phases. The modified timing plan may produce better results.

Offline Computer Techniques

Most signal timing programs provide signal timing parameters based on one or more optimization criteria such as a combination of stops and delay or maximization of bandwidth on a time-space diagram. In addition to the signal timing parameters, the programs often provide an estimate of measures of effectiveness such as stops, delays, emissions, fuel consumption and level of service. Graphical outputs may include time-space diagrams. In some cases the timing program may be coupled to a simulation that shows microscopic traffic flows. Comparative evaluations for some of these programs are provided in References 23 and 24. The following signal timing programs are commonly used by traffic engineers.

These discussions are provided as illustrations of the technology and are not intended as recommendations. As these and similar products continue to be improved, the reader is advised to contact the supplier for the latest capabilities of these products.

TRANSYT 7F

TRANSYT-7F (16) is a signal timing optimization program and a powerful traffic flow and signal timing design tool. The TRANSYT platoon dispersion model was discussed earlier in this section.

Using standard traffic data timing parameters as input, it can both *evaluate* existing timing and *optimize* new plans to minimize either:

- A linear combination of weighted delays, stops, and queue spillback, or
- Total operating cost.

This program has been extensively used in the past and has been updated to a more user-friendly format. Optimization techniques now include the hill climb method (provided in earlier versions) and genetic algorithm optimization. Treatment of queue spillback and traffic actuated signals has been added.

TRANSYT-7F also provides the capability to optimize perceived progression by *progression opportunities* (or PROS), which simply represent opportunities to get through consecutive intersections on green. Thus, signal timing may be designed for PROS alone, in which case splits remain fixed, or the PROS / DI policy yields a combination of wide bands, while still trying to lessen the disutility index. With PROS, the user can request an explicit time-space type design.

TRANSYT-7F has been used extensively for signal timing in the U.S. Numerous users have reported benefits in using this program for signal timing. Since 1983, California has implemented the Fuel-Efficient Traffic Signal Management (FETSIM) program and widely used TRANSYT-7F to optimize signal timing. Estimated benefits from the new signal timing in 61 California cities and one county show reduced (25):

- Vehicle delay (15 percent),
- Stops (16 percent), and
- Overall travel time (7.2 percent).

Synchro

This commonly used signal timing program has many user friendly features including interconnectivity to map backgrounds, more than eight phase capability and easy connectivity to traffic systems supplied by several vendors (26). Cycle and split optimization models are based on Highway Capacity Manual techniques. Actuated intersections are modeled.

PASSER

The PASSER (27) program suite consists of the following:

- PASSER II-90 – This program computes signal timing for a single arterial based on optimization of arterial bandwidth.

- PASSER III-98 – PASSER III-98 computes optimal signal timing for diamond intersections.
- PASSER IV-96 – PASSER IV-96 computes signal timing for a network based on arterial bandwidth optimization.

aaSIDRA

A version of aaSIDRA (28) based on the U.S. Highway Capacity Manual is available. aaSIDRA models actuated intersections and unsignalized intersections including stop sign controlled approaches and signalized pedestrian crossings, right-turn on red and protected-permitted left turns.

Considerations for Closed Networks

When two arterials cross at an intersection, a signal timing *interlock* must occur for progression along both arterials. Both must use the same cycle length and the timing plan must use as a reference point the timing at that intersection.

Signal timing in networks conventionally features a common cycle length. The closed topology of the network requires a constraint on the offsets, however. The sum of offsets around each loop in the network must sum equal integral number of cycle lengths. Figure 3-23 provides the node definitions for the following relationships:

$$D_{AB} + D_{BC} + D_{CF} + D_{FE} + D_{ED} + D_{DA} = n_1 C \quad (3.18)$$

$$D_{AB} + D_{BE} + D_{ED} + D_{DA} = n_2 C \quad (3.19)$$

$$D_{BC} + D_{CF} + D_{FE} + D_{EB} = (n_1 - n_2) C \quad (3.20)$$

Where:

D_{AB} = Offset between signals B and A

C = Cycle length

n_1 and n_2 are positive integers

Need for Signal Retiming

The following discussion is adapted from Reference 29.

With the exception of traffic responsive and adaptive traffic control systems, traffic systems require retiming of the signals from time to time.

The literature provides ample evidence to indicate that signal retiming provides very important and cost effective benefits (17, 25, 30, 31, 32).

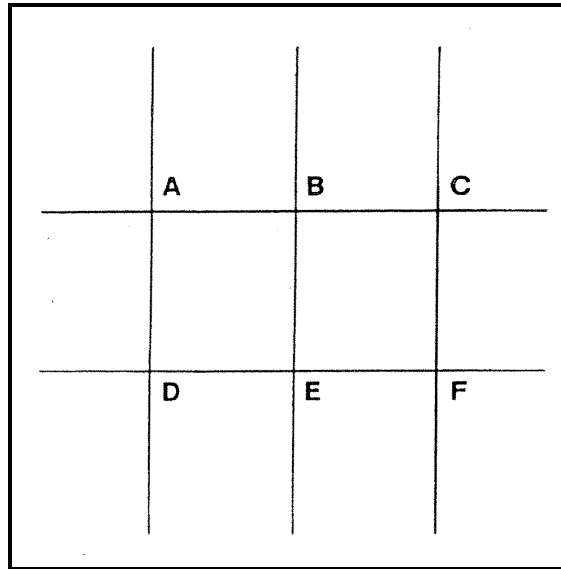

Figure 3-23 Closed network node definitions.

Factors that lead to the need for signal retiming may include:

- Changes in local or area wide traffic demands.
- Changes in peak period volumes.
- Changes in directional flow.
- Local land use changes.
- Change in intersection geometry.
- Change in number or use of lanes.

Signals will require retiming when the project includes major changes to the traffic signal system. Such changes may include:

- Introduction of coordination.
- Addition of local actuation.
- Addition of system traffic responsive capability.
- Introduction of transit priority.

Traffic signal system engineers use these factors, as well as the following, to identify the need for signal retiming:

- Accident experience.
- Comments and complaints by the public.
- Observations of signal timing performance and congestion patterns. Observations may include:
 1. Cycle failure (inability of a vehicle to pass through the intersection in one signal cycle) is a key indication of a saturated phase.
 2. Spillback from turning bays into general use lanes.
 3. Delays that may be incompatible with the volume to capacity ratio (V/C). For example, unduly long cycle lengths or improper splits may lead to excessive delay when minimal flow is observed during other portions of the green time for the phase.
 4. Imbalance in green time, i.e. high demand approach vs. low demand approach.

If signals have not been retimed within five years, the probability is high that retiming will provide significant improvement in most cases. In areas where growth or traffic generation changes are significant, more frequent timing may be appropriate. The simulation and signal timing programs, if used on a pilot section of the network, may be used to determine the need for signal retiming.

Determination of Central System Control Category

A new or improved central traffic control system may be needed to satisfy the following requirements:

- The current system is obsolete or can no longer be maintained in a cost effective way.
- A new or modified system is required to achieve such objectives as field equipment monitoring, field device interchangeability (NTCIP), communication with other ITS or information centers and interoperability with other traffic management centers.
- A control strategy resulting in a higher level of traffic system performance than currently exists is required.

Five categories of coordinated control in addition to uncoordinated control have been identified to support the last requirement. The general capability for these categories is

identified in Table 3-13. The functions for these categories and guidance for their selection is provided in Table 3-14 and is further discussed below. The local intersection control strategies discussed in Section 3.7 may be used with any of these categories, except for traffic responsive and traffic adaptive control. System installation and operating costs increase with more intensive detector and communication requirements.

Table 3-13 Performance categories for traffic control systems.

SYSTEM CATEGORY	FEATURES	IMPLEMENTATION REQUIREMENTS
<u>Uncoordinated Control</u>	<ul style="list-style-type: none"> • No coordination among traffic signals. • Provides local intersection control strategies. 	
<u>Time Base Coordinated Control</u> <ul style="list-style-type: none"> • Time of day / day of week (TOW / DOW) plans. • Local intersection strategies 	<ul style="list-style-type: none"> • Provides basic coordination. 	<ul style="list-style-type: none"> • Simple to implement. TBC provided by modern controllers. • Requires timing plan maintenance.
<u>Interconnected Control</u> <ul style="list-style-type: none"> • Time of day or operator selected timing plans. • Local intersection strategies. 	<ul style="list-style-type: none"> • TOW / DOW control • Operator can select timing plans. • Provides intersection and equipment status. • Allows download of timing plans and changes. • Provides record of system operation. 	<ul style="list-style-type: none"> • Wireline or wireless interconnect. • Two or three level distributed control or central control. • Few or no system detectors. • Requires timing plan maintenance.
<u>Traffic Adjusted Control</u> <ul style="list-style-type: none"> • Critical intersection control (centralized architecture only). • Local intersection strategies. 	<ul style="list-style-type: none"> • Provides capabilities of interconnected control category. • Timing plan selection based on system detector data. Selection not more frequent than 15 minutes. • Can display and record traffic conditions. • Provides data to analyze and assess need for and nature of timing plan changes. 	<ul style="list-style-type: none"> • Communications for interconnection. • Modest number of system detectors (average of one detector per intersection required). • Additional database development. • Requires timing plan maintenance.

Table 3-13. Performance categories for traffic control systems (continued).

SYSTEM CATEGORY	FEATURES	IMPLEMENTATION REQUIREMENTS
<p><u>Traffic Responsive Control</u></p> <ul style="list-style-type: none"> Maintains concept of cycle but changes timing plans more rapidly than traffic adjusted control. 	<ul style="list-style-type: none"> Provides capabilities of interconnected control category. Changes split within a cycle. Offsets and cycle lengths change more rapidly than for traffic adjusted control. 	<ul style="list-style-type: none"> Communications for interconnection Minimum of one or two detector per intersection approach. Less emphasis on maintenance of timing plans than for traffic adjusted control. Higher level of central processing required than for traffic adjusted control.
<p><u>Traffic Adaptive Control</u></p> <ul style="list-style-type: none"> Phase change based on prediction from traffic measurement at each signalized approach. 	<ul style="list-style-type: none"> Uses predictive data to change phase. Does not explicitly use defined signal cycles, splits or offsets. Systems provided by suppliers usually retain the capabilities of the interconnected control category. 	<ul style="list-style-type: none"> Higher speed communications than for other categories of control. Requires one or two detectors per approach depending on system. Less emphasis on maintenance of timing plans. Local algorithms may require additional computation at the intersection in the form of an additional controller card or separate unit.

Modern traffic controllers that are not interconnected by wireline or wireless means provide the capability for *time base coordination (TBC)*. Timing plans must be implemented and checked by trips to the field. This category of control does not provide status information to the TMC.

Interconnected control systems provide the capability for wireline or wireless communication with the TMC. They enable the TMC to monitor the condition of intersection equipment and to download timing plan changes. In addition to time-of-day timing plan selection, the operator may select a timing plan at any time. System detectors, if provided at all are used for general traffic monitoring by the operator and for planning purposes.

These systems usually provide for three or more weekday timing plans and other plans that may be required for weekends, holidays, special events or traffic diversion. The capability for this type of operation is provided by most commercially available traffic control systems.

Table 3-14 Characteristics of traffic signal system performance categories.

UNCOORDINATED CONTROL

- a. Isolated signal operation with local actuation.

TIME BASE COORDINATED CONTROL
Features provided in addition to uncoordinated signals

- a. Used where time of day / day of week (TOD/DOW) coordination is desired without the installation of physical communication media.

INTERCONNECTED CONTROL
Features provided in addition to time base coordination

- a. Provides capability to monitor proper operation of traffic signals.
- b. Provides split monitoring for traffic signals.
- c. Provides capability to check signal timings remotely.
- d. Provides capability to download new timing plans without field visits.
- e. Provides capability to record of failures for maintenance or legal purposes.

TRAFFIC ADJUSTED CONTROL
Features provided in addition to interconnected control

- a. Detector surveillance necessary for database development where use of more than four weekday timing plan changes is contemplated.
- b. Provides capability for traffic adjusted operation because of variability in timing plan selection periods or day-to-day or seasonal volume variations.
- c. Provides capability for surveillance to determine the need for new timing plans.
- d. Provides capability for surveillance to serve as an alternate route for diversion.
- e. Provides capability for surveillance for planning data.

TRAFFIC RESPONSIVE CONTROL
Features provided in addition to interconnected control

- a. Provides capability to respond to short term traffic flow irregularities.
- b. Minimizes timing plan development support after initial setup.
- c. Provides capability to respond to traffic condition changes for special events, street construction.
- d. Provides capability to respond to traffic condition changes due to incidents, double parking.
- e. Provides capability to respond quickly to demand changes resulting from diversion of traffic from a freeway or other arterial.

TRAFFIC ADAPTIVE CONTROL
Features provided in addition to interconnected control

- a. Provides capability to respond to random or very short term traffic flow irregularities.
- b. Minimizes timing plan development support after initial setup.
- c. Provides capability to respond to traffic condition changes for special events, street construction.
- d. Provides capability to respond to traffic condition changes due to incidents, double parking.
- e. Provides capability to respond quickly to demand changes resulting from diversion of traffic from a freeway or other arterial.

Traffic adjusted control provides a relatively slow capability to automatically select timing plans using data from traffic detectors. Control is usually provided by the UTCS First Generation Control Algorithm or by algorithms provided by closed loop systems. The UTCS algorithm selects an entire timing plan based on sensed conditions. Closed loop systems change cycle, split and offset separately according to sensed traffic conditions. These algorithms are described later in this chapter. System time constants and timing plan change algorithms require a few minutes before the timing plan change can be effected. Thus timing plan changes are usually made at greater than 15 minute intervals, and flow disturbances may be experienced during periods when these changes are being made. System detectors are required. As a general rule, the average number of system detectors is approximately equal to the number of intersections. These detectors may also be used to provide planning data; however, if planning functions are required, it is preferable to have full lane detector coverage for the sampled locations. The capability for traffic adjusted control operation is provided by most commercially available traffic control systems.

Traffic responsive control systems may change the split at each phase of the traffic signal cycle based on traffic measurements upstream of the intersection. Small changes in cycle time and offset may be made during time periods ranging from each cycle to a few minutes. The greatest benefit for traffic responsive systems is the ability to react to non-schedulable events or unpredictable events such as incidents. Other benefits include the ability to adjust timing plans without the requirement to manually generate new plans.

Systems such as SCOOT and SCATS (described later in the chapter) are examples of commercially available traffic responsive systems. While detector requirements differ with system implementation, SCOOT generally requires one detector per signalized approach. SCATS uses one detector in each major approach lane.

Traffic adaptive control strategies such as RHODES and OPAC (described later in this chapter) do not employ defined traffic cycles or signal timing plans. They utilize traffic flow models that predict vehicle arrivals at the intersection, and adjust the timing of each phase to optimize an objective function such as delay. Because they emphasize traffic prediction, these systems can respond to the natural statistical variations in traffic flow as well as to flow variations caused by traffic incidents or other unpredictable events. Intersection control equipment for adaptive systems is often more complex than for the other control categories.

Online Network Traffic Control Techniques

Online computer techniques use a computer traffic control system to:

- Collect data on traffic flow conditions,
- Make calculations to determine a desired timing plan, and

- Implement or adjust the timing plan in short time intervals such as each phase or cycle or when a different plan is required. Conventional traffic control systems select a plan from a stored plan library based on current conditions. Traffic responsive and adaptive systems provide for dynamic or real-time timing plan generation.

UTCS Control

Starting in the 1970's, a large number of U.S. cities implemented computer traffic systems using technology developed by the FHWA (under a number of related research programs) (33, 34, 35, 36, 37) and termed the Urban Traffic Control System (UTCS). FHWA established a testbed in Washington, DC which served as the prototype for many later systems. UTCS systems implemented in the 1970's and through much of the 1980's possessed the following characteristics:

- Minicomputer based central computer controls signals with commands for discrete signal state changes. Timing for commands provided at intervals of approximately one second.
- Signal timing plans stored in the central computer. Timing plan changes may result from:
 - Traffic responsive operation (based on detector inputs from the field),
 - Time-of-day selection, or
 - Operator commands (manual).
- Computation of volume and occupancy from detector data each minute. This data was used for reports and for archival purposes. The data is smoothed with a filter for use with the traffic responsive control algorithm and for the graphical display.
- A *first generation* traffic responsive control algorithm for changing *background* timing plans. Table 3-15 describes the UTCS first generation traffic responsive control algorithm. Reference 2 provides a more detailed discussion of the UTCS control algorithms.

The central computer for the initial family of computer traffic control systems provided a signal to the field controller to change each interval or phase of the traffic signal control cycle; however most of the current traffic control systems download timing plans to the field controller. The timing plans are stored in the field controller, which then times out each traffic cycle. Implementation technique notwithstanding, many of the current traffic control systems employ the UTCS First Generation Traffic-Responsive Control

Table 3-15 UTCS first generation traffic-responsive control algorithm.

Signature

The basic concept of the traffic-responsive control law associates each prestored timing plan with one or more traffic signatures. This signature comprises an array of numbers, one for each system detector in the subnetwork or section. Each number represents a linear combination of volume and occupancy data for the detector. A column matrix or vector can represent these numbers if ordered in a vertical array. Equation 3.21 represents the vector equation for the signature.

$$\overline{VPLUSKO}(SIG) = \overline{VS}(SIG) + KWT(\overline{OS}(SIG)) \quad (3.21)$$

Where:

- \overline{VS} = Vector representative of the volumes for stored signature SIG
- \overline{OS} = Similar vector for occupancy
- KWT = Weighting factor

With 2 detectors present (denoted by subscripts 1 and 2), the corresponding scalar equations become:

$$VPLUSKO_1(SIG) = VS_1(SIG) + KWT(OS_1(SIG)) \quad (3.22)$$

$$VPLUSKO_2(SIG) = VS_2(SIG) + KWT(OS_2(SIG)) \quad (3.23)$$

Match

The algorithm then matches real-time traffic data from each subnetwork detector against the signatures and selects the timing plan corresponding to the best match. Matching identifies the signature, which minimizes the sum of absolute values of the difference in each detector's match.

Equation 3.24 represents this mathematically:

$$\overline{ERR}(SIG) = \overline{VPLUSKO}(SIG) - \overline{VF} - KWT \bullet \overline{OF} \quad (3.24)$$

Where:

- VF = Current smoothed volume
- OF = Current smoothed occupancy

The components of the error vector for each signature are summed and the timing plan associated with the signature having the smallest error sum is selected. UTCS permits a limited number of signatures (often 3 or 4) to be matched at any time of day (*window*). This ensures selection of a viable timing plan.

Many UTCS can adjust the test frequency, with the usual period ranging from 4 to 15 minutes.

Sometimes, error values relative to each of 2 stored signatures may be close. In this case, random components in the traffic data may cause frequent changes in timing plans. To reduce this *oscillation*, UTCS permits implementation of a new timing plan only when it provides a significantly lower error than the current signature, i.e., it must show at least a *threshold* level of error improvement.

Algorithm described in Table 3-15. These systems are identified in the two-level distributed control block in Figure 1-2. Implementations of current system architectures are described in Chapter 8.

Control Algorithms for Closed Loop Systems

Closed loop systems are identified by the three-level distributed control block in Figure 1-2. A central computer stores and downloads signal timing plans through a field master to a signal controller. It also supervises controller operations. A field master preprocesses detector data prior to upload to the control computer. It also selects the timing plans for traffic responsive control.

The specific signal timing plan selection algorithms vary among system suppliers; however, they generally provide the following features:

- System detectors in a control section are assigned to implement either the cycle, split or offset computation. A system detector may be assigned to one or more computations.
- Selections of cycle, split and offset are made separately. The cycle selection, for example, would typically depend on volume and / or occupancy lying between pre-established thresholds. A cycle length is associated for each range of detector values lying between thresholds. Split and offset thresholds are similarly established.
- In some cases, traffic features such as directionality or queue presence may be used in the computation of cycle, split and offset. System detectors may be assigned to compute these features.
- Provisions are often made for the constraint of cycle, split and offset selections by time of day or by some other means so that the entire timing plan conforms to a plan developed by a signal timing program such as TRANSYT 7F or Synchro.

Balke, et. al. (38) provide a discussion on supplier specific parameter selection issues.

Traffic Responsive Control Systems

Traffic responsive control systems are distinguished from the systems described above in the following ways:

These systems generally respond to changes in traffic on a system-wide basis quite rapidly usually at the next phase of the traffic cycle.

- Except for initialization purposes, storage of precomputed cycle length, splits, and offset is not required, i.e. the system continually computes the traffic control plan.
- Extensive traffic detector instrumentation is required.

The following subsections describe the traffic responsive systems that are currently commonly available.

SCOOT (Split, Cycle and Offset Optimization Technique) (39, 40, 41, 42, 43)

The Transport and Road Research Laboratory (TRRL) in Great Britain developed SCOOT beginning in 1973, and by 1979 implemented it on a full-scale trial in Glasgow.

Based on detector measurements upstream of the intersection, the SCOOT traffic model computes the cyclic flow profile for every traffic link every four seconds (Figure 3-24). SCOOT projects these profiles to the downstream intersection using the TRANSYT dispersion model (Equations 3.16 and 3.17 in Table 3-9). Table 3-16 summarizes the SCOOT optimization process.

Table 3-16 SCOOT optimization process.

Timing Parameter	Process
Offset	A few seconds before every phase change, SCOOT determines whether it is better to: Advance or retard the scheduled change by up to 4 seconds, or Leave it unaltered.
Split	Once per cycle, SCOOT determines whether the performance index (PI) can be improved by reducing or increasing each offset by 4 seconds. The PI is usually a weighted sum of stops and delays.
Cycle	SCOOT varies the cycle time by a few seconds every few minutes to try, if possible, to keep the maximum degree of saturation below 90 percent on the most heavily loaded phase.

SCOOT contains provisions for weighting capabilities in the signal optimizers to give preference to specific links or routes.

Recent additions to SCOOT have enhanced its performance under congestion and saturation conditions. Table 3-17 describes the enhanced SCOOT features. Section 8.3 describes SCOOT benefits, SCOOT detector deployments and additional application information.

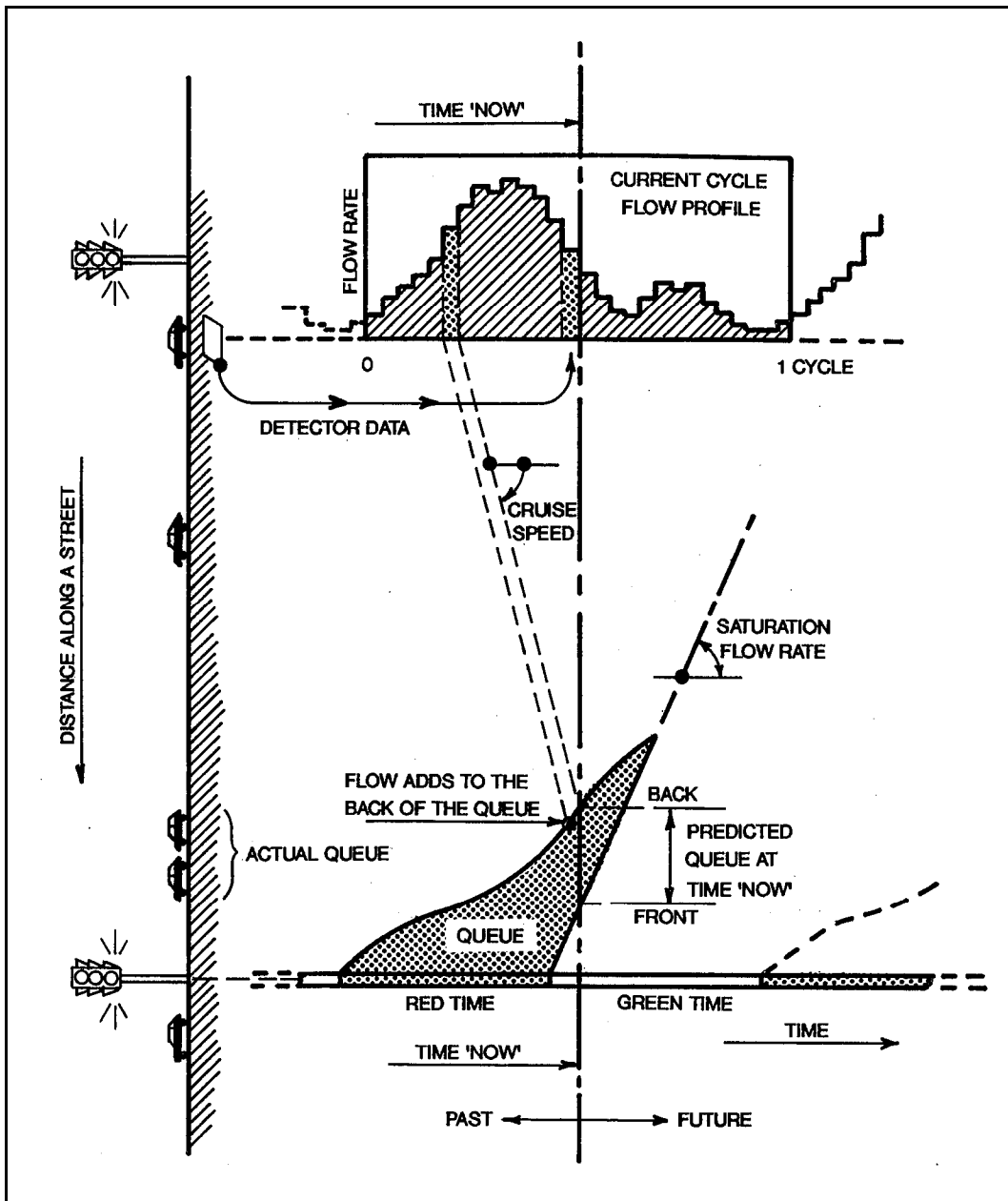

Figure 3-24 Principles of the SCOOT traffic model.

Table 3-17 Enhanced SCOOT features.

Features	Description
Congestion Offsets	Under congestion conditions, the best offset may facilitate a particular movement (to prevent spillback across an intersection or for other reasons). Under congestion situations, SCOOT provides congestion offsets that replace the criterion for optimizing the PI with a specially designed offset. Information from another link may also be used to implement offsets under congestion conditions.
Gating Logic	<p>Gated links are designated to store queues that would otherwise block bottleneck links. Thus, green time can be reduced on a gated link as a function of saturation on a remote bottleneck link.</p> <p>Green time reduction to a prescribed level is initiated when the problem is identified in the problem area as measured, for example, by degree of saturation. The green time is reduced as the problem becomes more severe, but a specified minimum green time is preserved.</p>
Automatic Calibration of Saturation Occupancy	<p>Early versions of SCOOT required the system operator to supply the appropriate value of saturation occupancy. The latest version of SCOOT provides this capability automatically, which:</p> <ul style="list-style-type: none"> • Eliminates a calibration effort, and • Improves response to the real-time changes of this value as a function of temporary conditions.
Bus Priority	Bus priority can be granted using either simple bus detectors or by means of an advanced vehicle location system. The latter capability allows priority (green extension or advance) to be implemented by importance (e.g., granting priority only to late buses). Priority may be constrained by the detection of congestion on computing phases affected by priority.
Emissions	Emissions estimates may be used as the objective function in the computation of offsets.

SCATS (Sydney Co-ordinated Traffic Control System)

The Sydney Coordinated Adaptive Traffic System (SCATS) (44, 45, 46, 47) was developed by the Roads and Traffic Authority (RTA) of New South Wales, Australia. A real-time area traffic control system, it adjusts signal timing in response to variations in traffic demand and system capacity, using information from vehicle detectors, located in each lane immediately in advance of the stopline.

SCATS uses two levels of control: strategic and tactical. Strategic control determines suitable signal timings for the areas and sub-areas based on average prevailing traffic conditions. Tactical control refers to control at the individual interaction level. Table 3-18 describes the functions of each control level.

Table 3-18 SCATS control levels.

Level	Description
Strategic	<ul style="list-style-type: none"> • A number of signals (from 1 to 10) group together to form a subsystem. • Up to 64 subsystems can link together for control by a regional computer. • Each traffic signal in a subsystem shares a common cycle time, which is updated every cycle to maintain the degree of saturation around 0.9 (or a user-definable parameter) on the lane with the greatest degree of saturation. Degree of saturation corresponds to an occupancy value measured by the detector. • Cycle time can normally vary up to 6 seconds each cycle, but this limit increases to 9 seconds when a trend is recognized. • Phase splits vary up to 4 percent of cycle time each cycle to maintain equal degrees of saturation on competing approaches, thus minimizing delay. • Offsets selected for each subsystem (i.e., offsets between intersections within the subsystem) and between subsystems linked together.
Tactical	<ul style="list-style-type: none"> • Operates under the strategic umbrella provided by the regional computer. • Provides local flexibility to meet cyclic demand variation at each intersection. For example, any phase (except the main street phase) may be: <ul style="list-style-type: none"> - omitted - terminated earlier - extended • Time saved during the cycle as a result of other phases terminating early or being skipped may be: <ul style="list-style-type: none"> - used by subsequent phases - added to the main phase to maintain each local controller at the system cycle length

SCATS has seen application in many cities throughout the world. Its first application in North America was in conjunction with the Autoscope video detector in Oakland County, Michigan, in the FAST-TRAC project.

SCATS currently has three levels of control: local, regional, and central. SCATS distributes computations between a regional computer at the traffic operations center and the field controller. Implementation in the US therefore requires special adaptation of an existing traffic controller to incorporate the SCATS field processing functions. Additional information on architecture is given in Section 8.3.

Several studies have been performed to measure the effectiveness of SCATS. RTA simulated a comparison of SCATS with a TRANSYT optimized fixed time system (45) and claims the following benefits:

- In the A.M. peak period, with traffic flow not deviating about the average, SCATS shows little improvement in delay and approximately 7-8% fewer stops.
- In the A.M. peak period, when traffic flows fluctuate 20% to 30% from the average, SCATS shows improvements as follows:
 - 8% in total vehicle stops along main roads,
 - 3% in total traffic delay,
 - 3% in total fuel consumption, and
 - 3-6% reduction in pollutant emission (CO, HC and NOx)

A study by the City of Troy, Michigan (48), found the following benefits

- Travel time reductions
 - A.M. Peak: 20%
 - Off Peak: 32%
 - P.M. Peak: 7%
- 20% reduction in stopped vehicle delay
- Although no significant decrease in the number of accidents, the percentage of incapacitating crashes reduced from 9% to 4%

Abdel-Rahim, et al. (49) found the following results in Oakland County, Michigan. The results indicated travel time decreased 8.6% in the morning peak direction of travel and 7% in the evening peak direction of travel. Off peak and non-peak direction travel times were also improved, decreasing 6.6 to 31.8%. The improved travel times observed on this major arterial, however, lead to increased average delay on minor arterial approaches:

- A.M. Peak travel time reduction: 8.6%
- P.M. Peak travel time reduction: 7%
- Off-Peak and non-peak direction travel time reduction: 6.6% - 31.8%

- Increased average delay on minor streets

Major operational advantages of SCATS include:

- The ability to automatically generate timing plans thus saving the operating agency the effort of performing this task, and
- The ability to automatically calibrate detectors, thus avoiding this task during system test and grooming

Section 8.3 provides additional application information on SCATS.

Traffic Adaptive Control Systems

Traffic adaptive control systems feature sufficient surveillance capability to provide a detailed profile of traffic approaching an intersection. Since control decisions are made during each phase, no explicit cycle length is defined in the control algorithm.

RHODES

The RHODES (50) architecture is based on decomposing the control-estimation problem into three hierarchical levels: (1) intersection control; (2) network control; and (3) network loading. Figure 3-25 shows the RHODES architecture. At the lowest level, *intersection control*, traffic flow predictions and signal phase and duration decisions are made based on observed vehicle flows, coordination constraints, flow predictions and operational constraints that are typically established by the traffic engineer. These decisions are currently made on a second-by-second basis.

At the middle level, the *network control level*, predictions of platoon flows are used to establish coordination constraints for each intersection in the network. These decisions are made periodically at an approximate interval of 200-300 seconds depending on the network characteristics.

At the highest level, the *network loading level* predicts the general travel demand over longer periods of time, typically one hour. These demands can be used proactively to determine future platoon sizes at or near the control boundaries. Many of the anticipated benefits of Advanced Traveler Information Systems (ATIS) and / or Dynamic Traffic Assignment (DTA) can be used for traffic control and management through the network loading level.

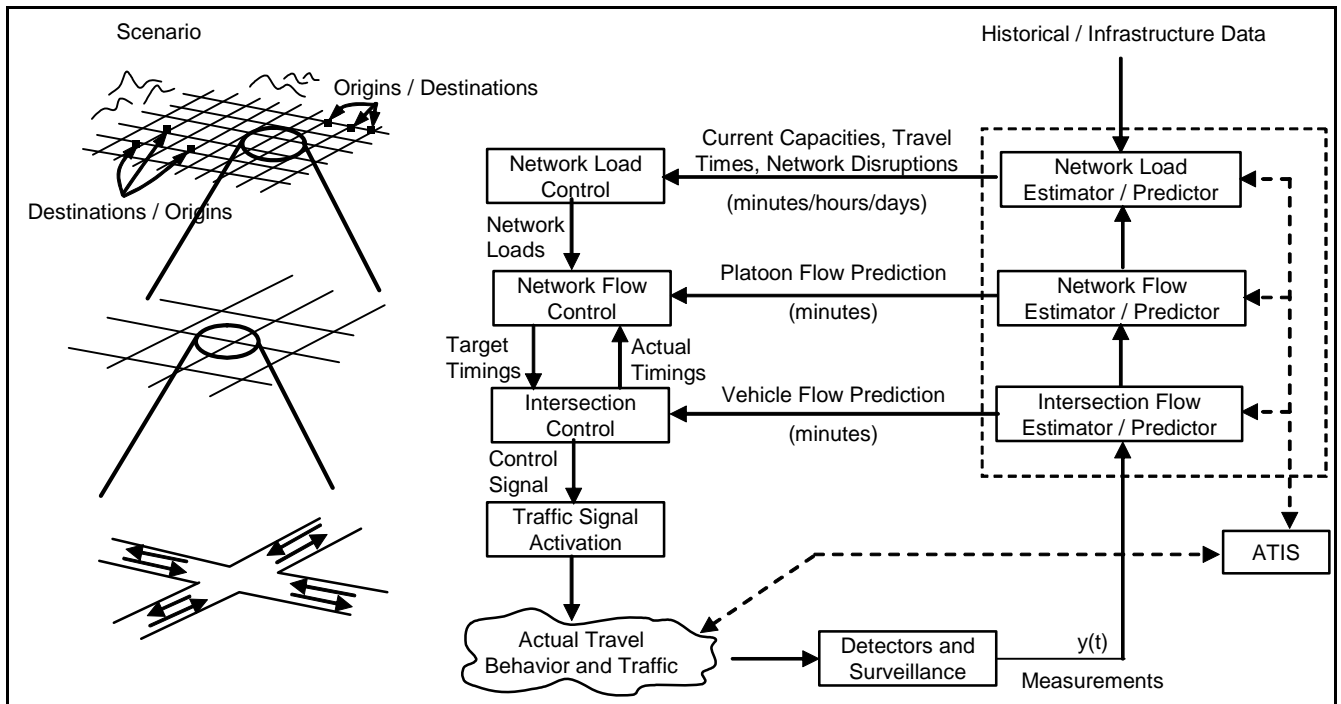

Figure 3-25 The RHODES hierarchical architecture.

OPAC

OPAC (Optimized Policies for Adaptive Control) (51) is a set of algorithms that calculate signal timings to minimize a performance function of stops and delays. OPAC was developed in a series of versions. OPAC III and OPAC IV are revisions that have been physically implemented.

OPAC III provides local intersection control. It implements a “rolling horizon” strategy to make use of flow data that are readily available from existing detection equipment without degrading the performance of the optimization procedure. In this version, the stage length consists of n intervals. The stage is called the *Projection Horizon* (or simply Horizon) because it is the period over which traffic patterns are projected and optimum phase change information is calculated. The horizon is typically taken to be equal to an average cycle length.

Figure 3-26 is an illustration of the rolling horizon procedure. From detectors placed upstream of each approach, actual arrival data for k intervals can be obtained for the beginning, or head, portion of the horizon. For the remaining $n-k$ intervals, the tail of the horizon, flow data may be obtained from a model. A simple model consists of a moving average of all previous arrivals on the approach. An optimal switching policy is calculated for the entire horizon, but only those changes which occur within the head

portion are actually being implemented. In this way, the algorithm can dynamically revise the switching decisions as more recent (i.e., more accurate) real-time data continuously become available.

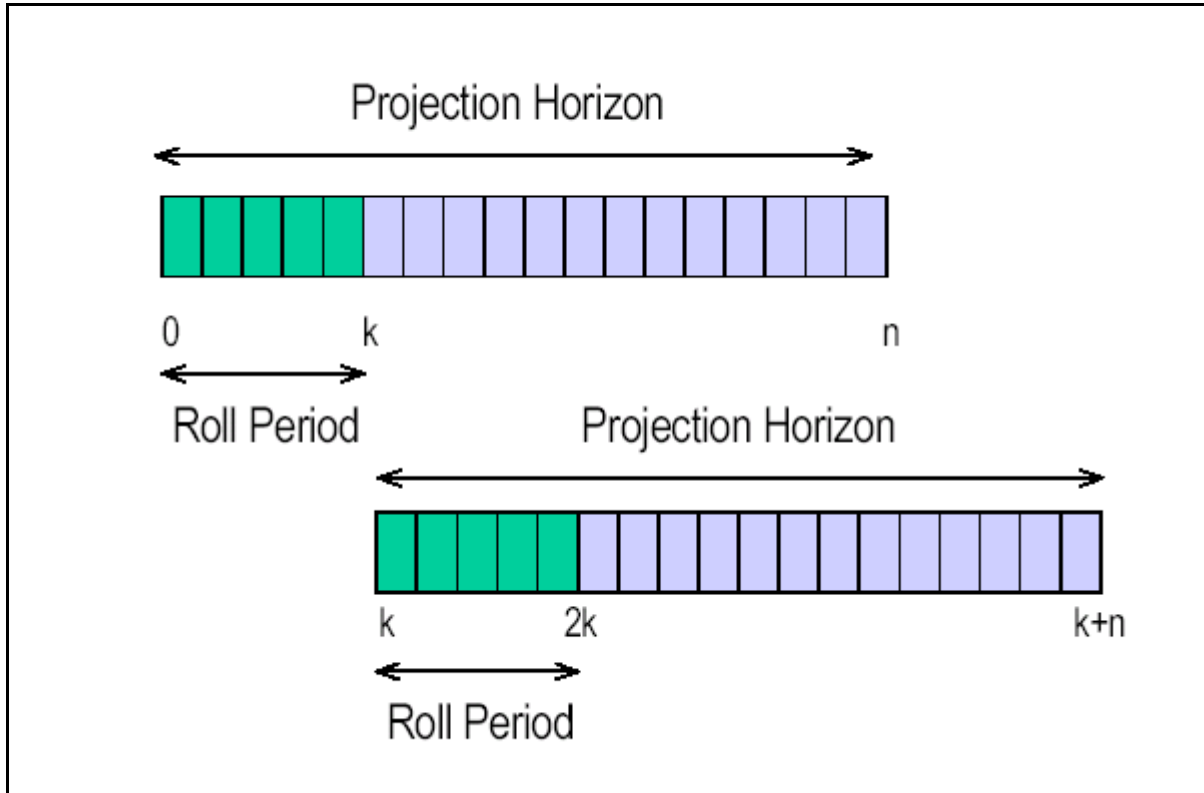

Figure 3-26 Implementation of the rolling horizon approach in OPAC.

By placing the detectors well upstream of the intersection (10 to 15 sec. travel time) one can obtain actual arrival information for the head period. This allows for a more correct calculation of delay for any given phase change decision. At the conclusion of the current head period, a new projection horizon containing new head and tail periods is defined with the new horizon beginning at (rolled to) the termination of the old head period. The calculations are then repeated for the new projection horizon. The roll period can be any multiple number of steps, including one. A shorter roll period implies more frequent calculations and, generally, closer to optimum (i.e., ideal) results.

OPAC IV is a network version of OPAC. OPAC was developed from the outset as a stand-alone “smart controller” that can be used as a building-block in a distributed control system. No explicit coordination features were imbedded; however, the algorithm has inherent self-coordination capabilities due to the tail model in the projection horizon. A system using these capabilities was successfully installed on Rt. 18 in New Jersey. As part of the RT-TRACS project, the OPAC control logic was expanded to include, at the option of the user, an explicit coordination / synchronization strategy that is suitable for implementation in arterials and in networks. This version is referred to

as *Virtual-Fixed-Cycle* OPAC (VFC-OPAC) because from cycle to cycle the yield point, or local cycle reference point, is allowed to range about the fixed yield points dictated by the virtual cycle length and the offset. This allows the synchronization phases to terminate early or extend later to better manage dynamic traffic conditions. VFC-OPAC consists of three-layer control architecture as follows:

- Layer 1: The *Local Control Layer* implements the OPAC III rolling horizon procedure. It continuously calculates optimal switching sequences for the Projection Horizon, subject to the VFC constraint communicated from Layer 3.
- Layer 2: The *Coordination Layer* optimizes the offsets at each intersection (once per cycle). This is done by searching for the best offset of the PS within a mini-network. Since this is carried out in a distributed fashion at each intersection, each SS will, in its turn, also be considered as a PS of its own mini-network.
- Layer 3: The *Synchronization Layer* calculates the network-wide virtual-fixed cycle (once every few minutes, as specified by the user). The VFC is calculated in a way that provides sufficient capacity at the most heavily loaded intersections while, at the same time, maintaining suitable progression opportunities among adjacent intersections. The VFC can be calculated separately for groups of intersections, as desired. Over time the flexible cycle length and offsets are updated as the system adapts to changing traffic conditions.

Saturated Flow Conditions

A *saturated* flow condition develops when demand at a point (or points) in a network exceeds capacity for a sustained period. This condition reveals itself at an intersection through the development of long queues, which may reach from one intersection to another.

When this condition occurs, traffic cannot move even when it receives a green light, and jam conditions develop.

To clear traffic during jam conditions requires a different concept of control. Most of the control techniques described up to this point will fail in an oversaturated traffic environment. In a network, two levels of saturated flow can occur:

- Saturated flow at a limited number of signalized intersections, and
- Widespread saturation.

The following control concepts deal with these types of saturated flow. Under NCHRP-sponsored Project 3-18, researchers at Polytechnic University developed guidelines for improving traffic operations on oversaturated street networks and documented them in NCHRP Report 194, *Traffic Control in Oversaturated Street Networks* (52). The researchers used simulation and analytical studies, field tests, and national surveys to develop the guidelines. The report enumerates several candidate treatments:

- Minimal response signal remedies — intersection,
- Minimal response signal remedies — system,
- Highly responsive signal control,
- Enforcement and prohibition,
- Turn bays and other non-signal remedies,
- Major lane assignments, and
- Disruptions to the traffic.

Arterial and network signal timing programs primarily optimize flow on unsaturated arterials and networks. These concepts provide progressive greenbands for vehicles and minimize a network performance index such as delays and stops.

However, widespread network saturation requires special coordination techniques (52, 53, 54). Quinn expresses the coordination principles (53):

"A common feature of the strategies is a change in the basic concept of what the offset between signals is supposed to accomplish. Instead of providing for forward progression of vehicle platoons, the signal timings at an upstream junction are determined by the start of green downstream, and the time taken for the front of a queue to move upstream and clear the upstream intersection. Thus, the order of calculation of signal timings is opposite to the flow of congested traffic, so that the term 'reverse offsets' is sometimes used. The principle is illustrated in Figure 3-27."

The NCHRP 3-38 study broadened these concepts. Reference 55 describes the basis for developing signal timing plans and strategies along with examples. The reference also describes other forms of metering such as *external metering* (Figure 3-28) and *release metering* (controlled rate of discharge from parking facilities).

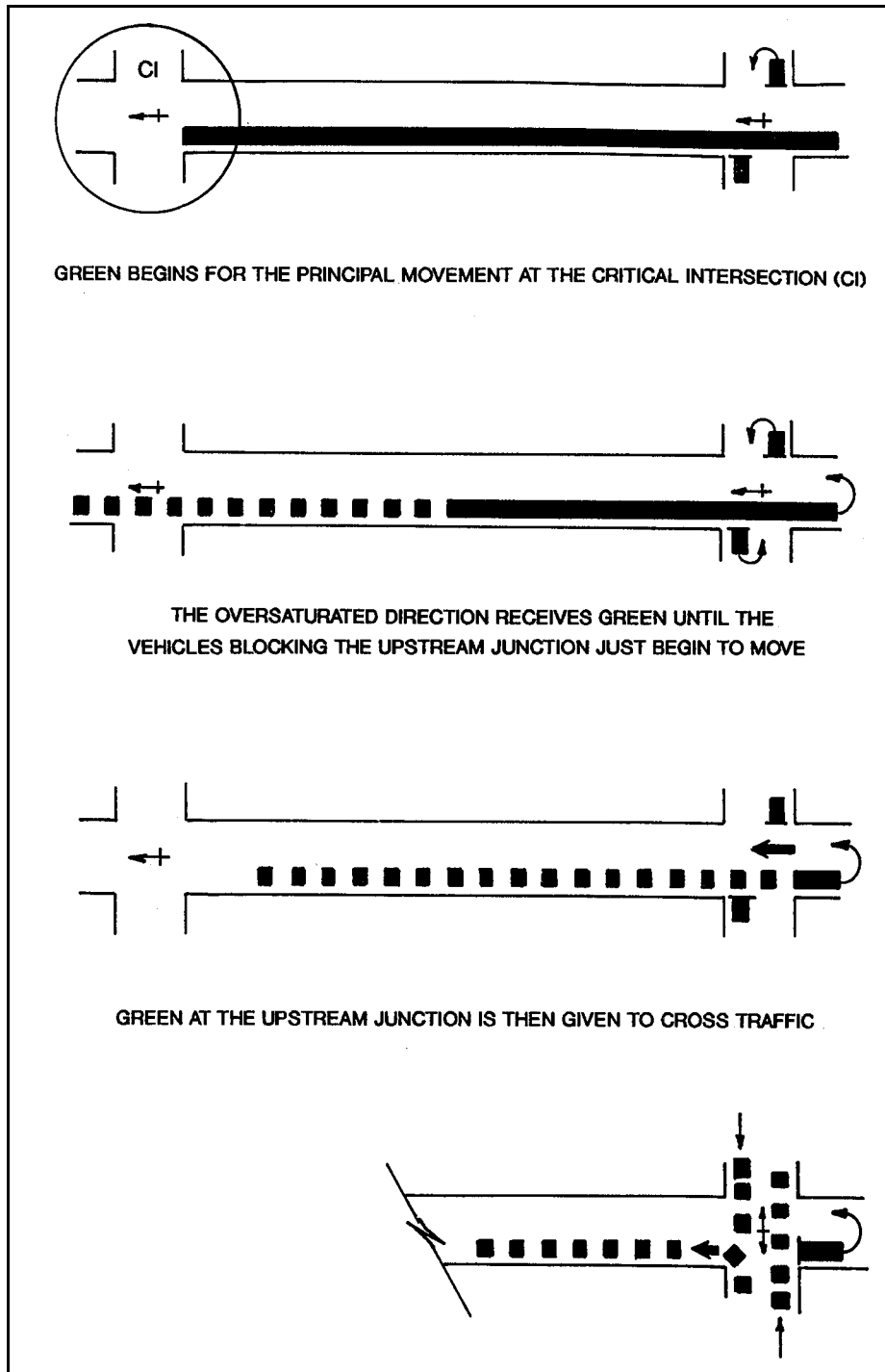

Figure 3-27 Reverse progression signal offset.

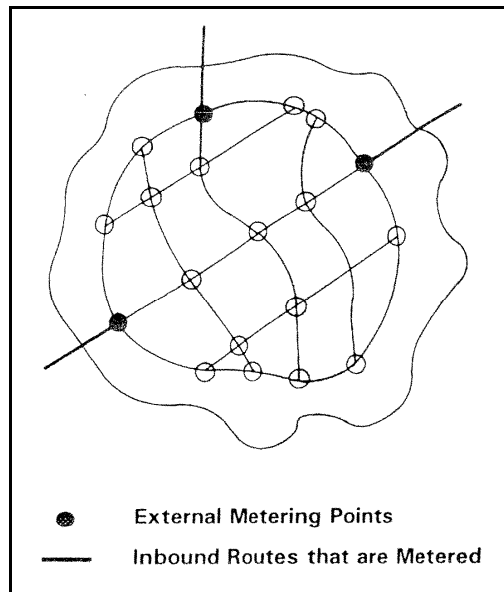

Figure 3-28 External metering.

Lieberman et al (56) describe a control policy for oversaturated approaches as follows:

“The policy principles are: (1) the signal phase durations “meter” traffic at intersections servicing oversaturated approaches to control and stabilize queue lengths and to provide equitable service to competing traffic streams; and (2) the signal coordination (i.e. offsets) controls the interaction between incoming platoons and standing queues in a way that fully utilizes storage capacity, keeps intersections clear of queue spill-back and maximizes throughput”

A number of strategies have been developed to improve the timing of these networks (57, 58). These strategies generally attempt to accomplish the following.

- Identify the queue and the queue discharge time.
- Identify the downstream storage available for queue discharge.
- Maximize throughput by avoiding the provision of green time that cannot be used or is inefficiently used because traffic cannot flow during these green periods.

The algorithms generally require a search for possible solutions. Techniques such as genetic algorithms may be used to facilitate the search.

Girianna and Benekohal (59) provide an algorithm to manage local queues by distributing them over a number of signalized intersections, and by temporarily spreading them over several signal cycles. Girianna and Benekohal (60) describe a procedure for dissipating queues on a two-way arterial.

Where widespread saturation exists, one perspective views the area as possessing a capacity to contain vehicles and manages entry flow to this capacity. Smeed provides equations to determine the capacity (61). Godfrey (62) illustrates the relationships among:

- Number of vehicles in the network,
- Throughput of the network in vehicle mi/hr (km/hr), and
- Average vehicle speed.

Figures 3-29 and 3-30 illustrate the relationship for the town center of Ipswich, England (62). The figures show that current operation provides less than maximum potential throughput at an average speed of 7.4 mi/hr (11.9 km/hr). The shape of Figure 3-29 resembles the freeway speed versus density relationship and the shape of Figure 3-30 resembles the freeway volume versus speed relationship. These curves suggest improvement of network use and travel speed through a combination of external and release metering to limit the number of vehicles accessing the network to the number that represents a maximum throughput condition.

Management policies for controlling widespread congestion may make use of regulatory or pricing approaches. Both of these techniques require participation at the highest political levels in the jurisdiction involved.

Regulatory Approaches

After the events of September 11, 2001, New York City restricted the entry of vehicles to the central business districts of Manhattan during certain periods of the day. This significantly reduced congestion during the period that these controls were in effect.

Congestion Pricing Approaches

While a number of localities have used vehicle entry pricing to congested areas, the largest scale application of this technique started in central London in February 2003. The daily congestion charge of 5 pounds (approximately \$8) resulted in considerably reduced congestion and increased speed in this highly congested area (63). The website (64) describes the collection and enforcement methodology.

Network Simulation

A number of simulations exist for modeling surface street networks. Three of these simulations also model freeway networks. All of these simulation programs have many

similar or exactly the same features. The discussions that follow touch on some of the characteristics featured by these models.

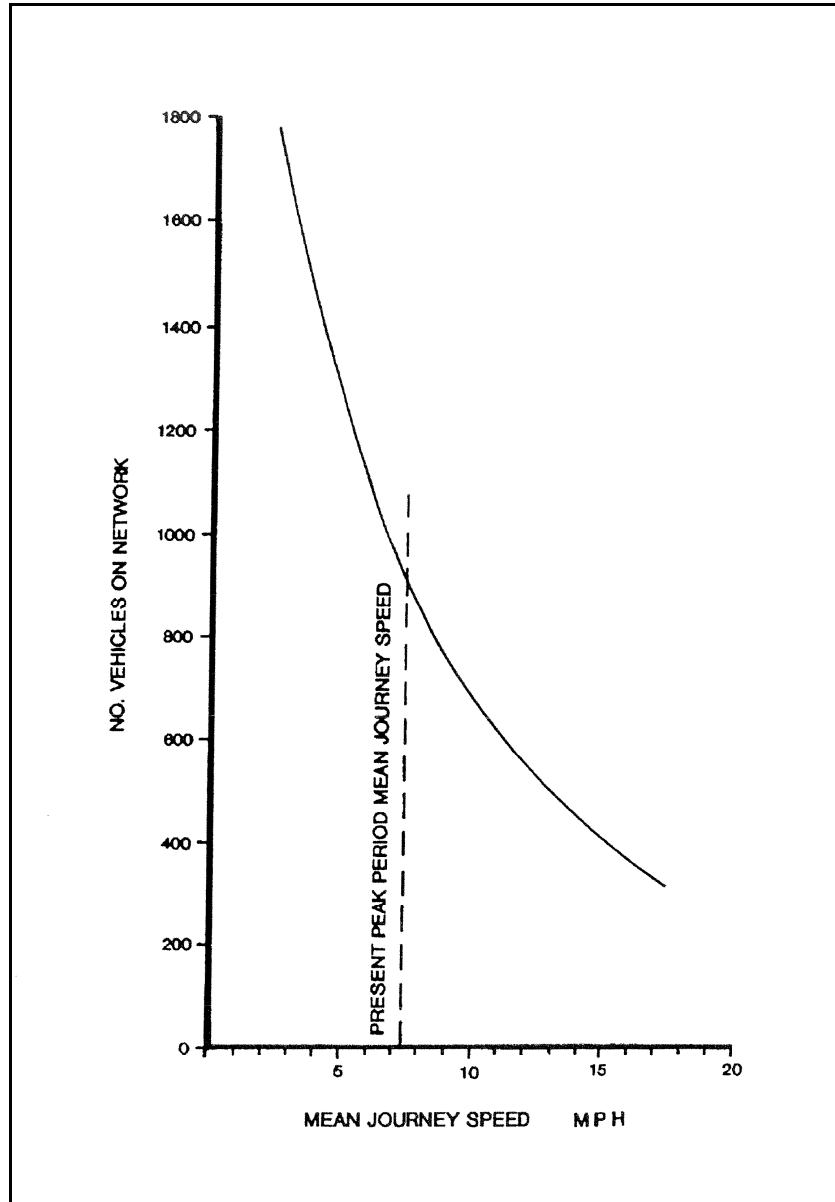

Figure 3-29 Relationship between mean journey speed and number of vehicles on town centre network.

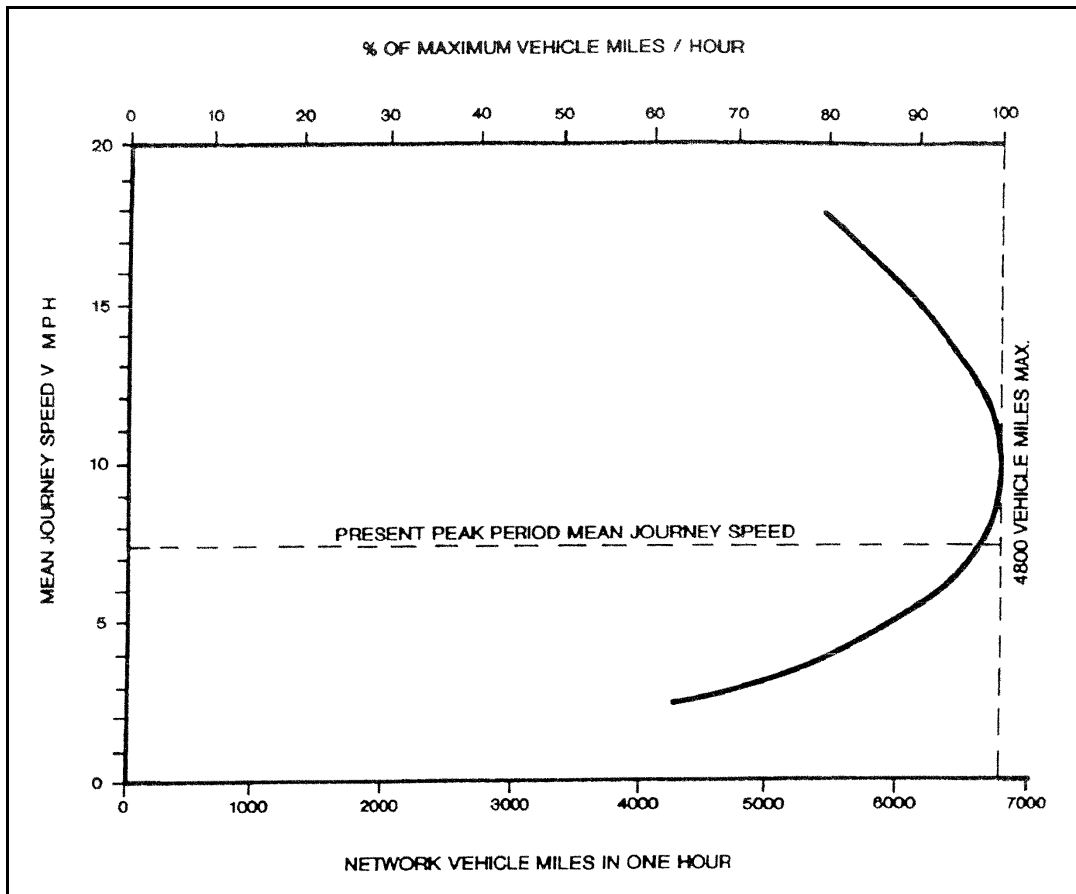

Figure 3-30 Relationship between mean journey speed of vehicles and total vehicle mileage on network.

CORSIM

CORSIM (65) is a two-part microscopic traffic simulation tool and is a part of FHWA's Traffic Software Integrated System (TSIS). The first part of CORSIM, NETSIM, simulates surface streets, and the second part, FRESIM, simulates freeways. The surface street simulation has the following capabilities:

- Graphical visualization system (TrafVu) displays and animates networks, including traffic flow, signal operation, freeway and surface street incident modeling (accidents, work zones, parking activity), sources / sinks and MOEs.
- Models pretimed and actuated signals.
- Models traffic signals, system and local actuation detectors, sign control (stop and yield), and roundabouts.

- Analyzes the network by continuously tracking all individual vehicles.
- Uses vehicle and driver behavior models.
- Models cars, trucks, and buses.
- Creates text output files for MOEs. The MOEs can be viewed graphically in TrafVu. The model provides travel times, average speed and bus statistics.
- MOEs include Control Delay (can be used to calculate LOS using the HCM method), overall vehicle delay, stops, queues, emissions (CO, HC, NOx), fuel consumption.

SimTraffic

SimTraffic (26) is a Synchro-companion program that allows visual simulation of a surface street traffic network. In SimTraffic, it is possible to create mixed networks of signalized and unsignalized intersections, model both pretimed and actuated intersections, and simulate operation of several intersections by one controller. It is possible to model sections of freeways. SimTraffic models cars, trucks, and pedestrians. SimTraffic allows the user to simulate traffic signal timings developed in Synchro and verify there are no major queues, spillbacks or phasing problems.

Paramics

Paramics (66) is a microscopic traffic simulation system developed by Quadstone Limited. The system has tools for modeling, analysis and processing of surface street and freeway network data. The resulting network can also be displayed visually. The software includes an estimating tool for costs. The software can use bitmapped background or an aerial photograph for network geometric configuration input (to build the network using the bitmap as the background). It has the following features for surface street operation:

- Three-dimensional visualization system.
- Pretimed and actuated signals
- Graphical user interface has network and simulation parameter modification tools
- Analyzes congestion by continuously tracking all individual vehicles on the network (vehicles are released on the links)

- Allows parking lot simulation, illegal or double parking simulation, and incident modeling (disabled vehicles and accidents) including rubbernecking delays on the opposite side of the road.
- Accounts for vehicle type and driver behavior type.
- Models cars, trucks, and pedestrians.
- Can model public transportation, including buses and trains.
- Has capabilities for priority intersection analysis (public transport actuated traffic signals).
- MOEs also include emissions (CO, HC, NOx), fuel consumption and noise pollution.
- Route-cost calculation module (in terms of travel time, distance and tolls).

Paramics is used in the UK, US, Australia, and in the academic environment.

VISSIM

VISSIM (67) is a microscopic traffic simulation model designed to simulate surface streets and freeways. The simulation is time step based, and it monitors all individual vehicle-driver units. The model consists of the VISSIM traffic flow simulation and the CROSSIG control program, which receives the detector input from VISSIM and determines the signal phasing. VISSIM does not have links and nodes—it uses a system of links and link connectors. Infrastructure typically allocated to nodes (signal heads, stop signs, etc.) is allocated to links in VISSIM. VISSIM produces Time-Space and Space-Speed Diagrams, and it creates an animated simulation of the vehicle movement. VISSIM is used in Europe, and, to a lesser extent, in the United States. It has the following features for surface street operation:

- Stop-sign control, pretimed and actuated signals control
- Models signals, ramp meters, detectors, and electronic message signs
- Graphical user interface allows modeling of network geometry. The network can be modeled using a bitmap image as a background.
- Analyzes queues and areas of speed reduction by continuously tracking all individual vehicles on the network, recording position, speed and acceleration of each vehicle for every second.

- Models cars, trucks, and pedestrians
- Can model public transportation, including buses, light rail and heavy rail
- Has capabilities for preemption and priority intersection modeling (buses and light rail). This may require development of an additional program.
- Typical input includes network geometry, traffic volumes, vehicle types and lengths, vehicle speeds, accelerations, signal timings, and bus stop locations and boarding times. The network model can also be imported from the transportation planning model VISUM.
- MOEs include delays, stops, queues, travel times (including delays at signals and bus stop delays), emissions and fuel consumption.

3.9 Special Controls

Closely Spaced Intersections

A special case of arterial street control involves two (or rarely three) intersections so close together that they are better controlled by the same signal controller rather than by separate controllers. A single controller may be advantageous for closely spaced intersections under any of the following conditions:

- The physical spacing between the intersections is small – say 200 feet or less.
- Careful coordination of the signals is necessary to avoid queue spill-back from one intersection that can seriously disrupt operation of the adjacent intersection.
- Both turning and through traffic movements at the upstream intersection constitute major traffic movements requiring progression through the downstream intersection.
- The closely spaced signals do not require coordination with other signals on the arterial, or require coordination only during peak periods.
- Actuated control of the signals is desired.
- One or both intersections operate near saturation during peak periods.

A single controller can provide the following operational advantages:

- The signals can operate in free mode (not coordinated) with all the efficiency advantages of fully-actuated, free operation, while still coordinating the service of major traffic movements at adjacent intersections to provide progression and avoid queue spill-back.
- Progression between intersections can be maintained even under relatively low-volume conditions when it is inefficient to use normal signal coordination due to the need for a fixed cycle length long enough to accommodate pedestrians and traffic fluctuations.
- Critical movements can remain coordinated even when normal signal coordination measures fail (e.g., clocks drift, signal interconnect fails).
- A vehicle approaching an upstream signal on a progressing movement can cause the appropriate phase at the downstream signal to be called or extended as needed.

Figure 3-31 provides an example of how two closely spaced intersections can share a normal eight-phase, dual-ring controller to good effect. Many modern controllers now offer sixteen or more phases in four or more rings, and eight or more overlaps, allowing use of a single controller even when numerous traffic movements need separate phases or overlaps and more than normal dual-ring logic. Some controllers will also support multiple cabinets, each with its own set of detectors (inputs), load switches (outputs), power supply, and conflict monitor.

As another example, signalized tight diamond interchanges often use one signal controller (68). Such implementations typically involve one of the two phasing arrangements shown in Figure 3-32, or switch between these phasing options as traffic flow patterns change during the day. One phasing scheme uses three phases per ring and is often called Three-Phase Operation. The other uses four phases per ring and is often called Four-Phase Operation.

Three-phase operation gives a green indication to both off-ramps simultaneously, and then serves all through movements followed by both left turns to the on-ramps (and their adjacent exiting-through movements). Desirably, only one barrier is imposed between the two rings (to coordinate the operation of the two intersections even when operating in free mode) following phases 1 and 5. However, some controllers don't allow for single barrier operation, and require a second barrier following phases 4 and 8. In this case both off-ramps receive identical green times.

Three-phase operation is efficient if turning traffic volumes are light, and can minimize the cycle length. However, as turning volumes increase, this scheme can lead to internal queue spillback and operational breakdown.

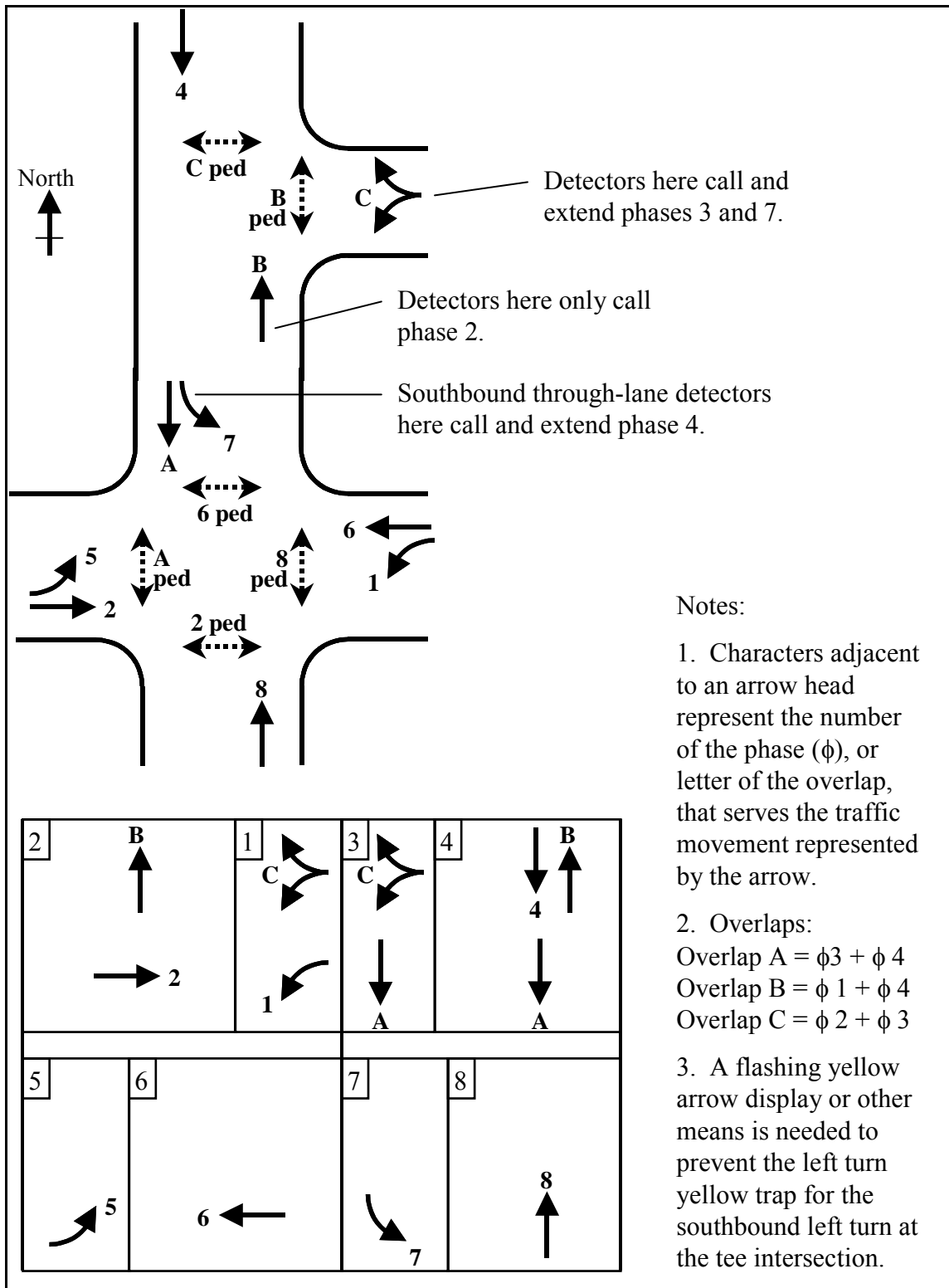

Figure 3-31 Example of one controller for two adjacent intersections.

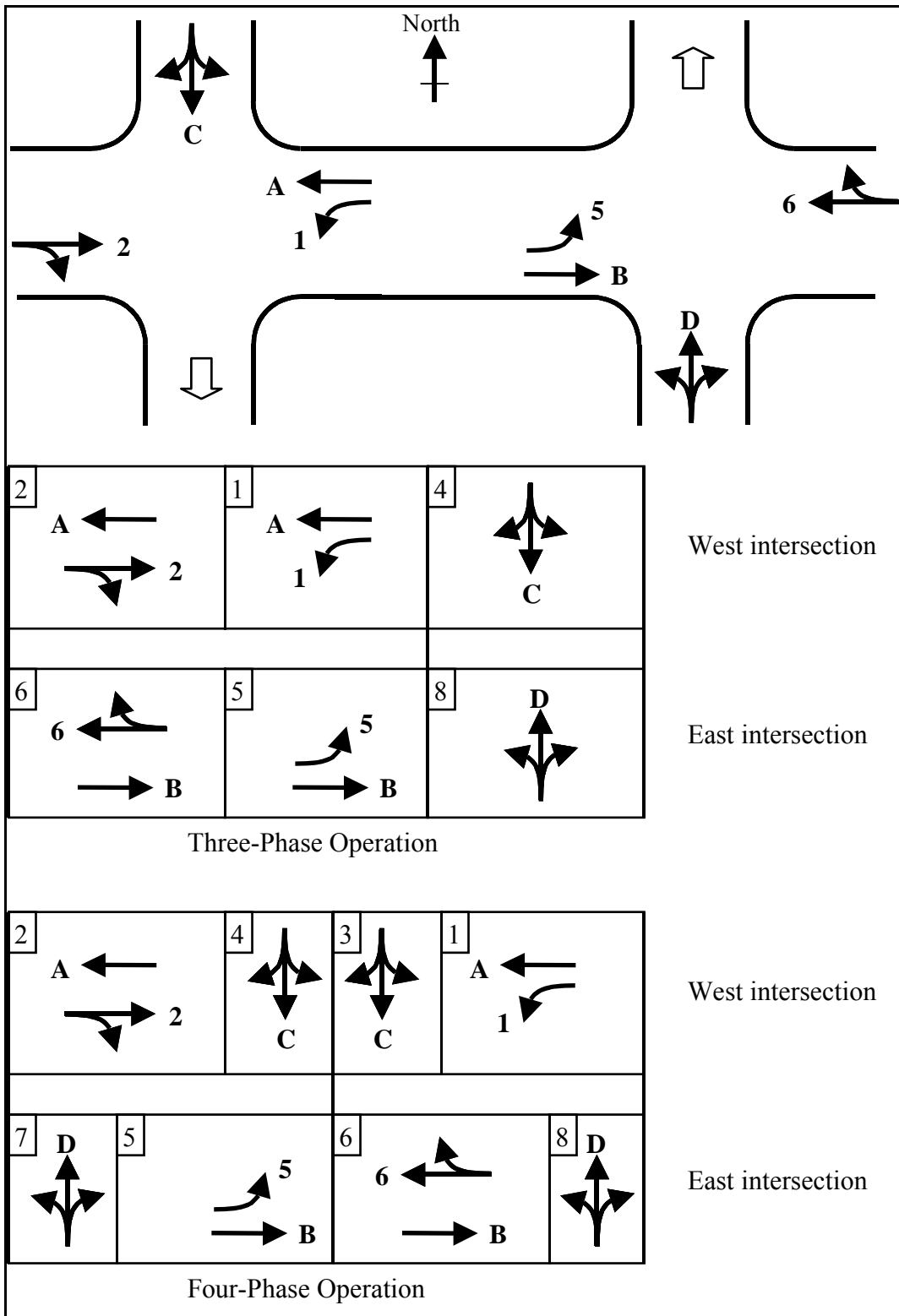

Figure 3-32 Examples of one controller for a diamond interchange.

Higher turning movement volumes (from off-ramps, or to on-ramps) can be accommodated using the four-phase scheme. In this arrangement, the off-ramps are served at different points in the cycle. The exiting-through-and-left movements at the other intersection receive a green indication for part of the off-ramp service time. The green indication for the exiting-through-and-left movements also coincides with part of the green time for entering-through traffic at the adjacent intersection. This avoids internal queue spillback problems.

In four-phase operation, phases 3 and 7 are typically served for a fixed green time, that being the travel time from one intersection to the next. This ensures that the first through vehicles on the surface street do not have to stop at the second intersection, while avoiding wasted time at the second intersection. Efficient use of this fixed phase duration requires the termination of phases 4 and 8 via advance detectors on the off-ramps. Phases 4 and 8 will typically terminate later than phases 5 and 1 respectively, as U turn movements at interchanges are rare and exiting-left-turn traffic has already had ample time to depart. Phases 4 and 8 can have a very short minimum green time.

Both of these diamond interchange phasing schemes make use of overlaps to enable a traffic movement to receive a continuous green display during two or more phases. The overlaps also drive pedestrian displays, at least for pedestrians crossing the surface street. Additional overlaps can enable a controller to be programmed with both phasing schemes simultaneously, using up to 14 phases. Either subset of phases (three-phase operation or four-phase operation) can be selected during a particular timing pattern by omitting the other phases.

Control of multiple intersections with a single controller can also have the following drawbacks, which need to be considered:

- A fault in the controller or other cabinet equipment not duplicated at each intersection can cause both intersections to go into failure-mode flash. Depending on intersection spacing and traffic patterns, this can be undesirable.
- Unless separate cabinets and power supplies are used, a single controller can require relatively long wiring runs which can exceed maximum lengths for voltage drop or detector sensitivity unless special cabling is used.
- It may not be possible to locate a single controller cabinet such that a technician can see all movements at all intersections when troubleshooting or starting the controller.

Directional Controls and Lane Control Signals

To best use existing facilities, consider unbalanced and / or reversible-lane flow. This requires special traffic controls to effect the desired movements. Two basic types of operations using surface street directional controls include:

- Reversible Flow - Dynamically operating a street as one-way inbound, one-way outbound, or two-way. Applications may include:
 - Heavy imbalance of directional traffic flow for relatively short periods such as in and out of central business districts,
 - No alternate solutions such as one-way pair or street widening,
 - Severe congestion and need to increase directional capacity, and
 - Nearby parallel street capable of handling minor directional flow during peak one-way operation.
- Off-center lane movement - Partial reversal of traffic flow where only one or two lanes are reversed. Applications are similar to reversible flow.

Current techniques for controlling directional movement use signs or a combination of signs and lane control signals. Change of operational mode is usually on a time-of-day basis.

Directional control is often used in tunnel and bridge operations for the following purposes:

- Assignment of roadway lanes to prevailing directional traffic flow requirements,
- Control of traffic flow during maintenance operations, and as
- An element in incident response plans.

Reversible lane control has proven the most common use for lane control signals (LCS). Examples include (69, 70):

- Toll booths,
- HOV lanes,
- Reversible transitways on freeways,

- Arena traffic, and
- Parking control

Other applications include:

- Restriction of traffic from certain lanes at certain hours to facilitate merging traffic from a ramp or other freeway, and
- Lane use control for:
 - Tunnels,
 - Bridges, and
 - Freeways.

The MUTCD further defines the signal displays and meaning of indications as described in Table 3-19.

Table 3-19 Definitions of lane control signal displays.

Display	Definition
Steady Downward Green Arrow	Driver permitted in the lane over which the arrow signal is located.
Steady Red X	Driver not permitted in the lane over which the signal is located. This signal shall modify the meaning of all other traffic controls present
Steady Yellow X	Driver should prepare to vacate the lane over which the signal is located, because the lane control change is being made to a steady Red X indication.
Steady white two-way left-turn arrow	Driver permitted to use a lane over which the signal is located for a left-turn. Driver further cautioned that lane may be shared with opposite flow left-turning vehicles.
Steady white one-way left-turn arrow	Driver is permitted to use a lane over which the signal is indicated for a left turn (without approaching turns in the same lane) but not for through travel.

The MUTCD further defines other characteristics of LCS including:

- Display shape and size,
- Visibility distance and angle,
- Separate or superimposed display units,

- Positioning of LCS over lane,
- Longitudinal spacing of LCS over length of controlled roadway, and
- LCS display sequencing and operations.

An ITE equipment and materials standard also exists for LCS (71). It further defines a number of other characteristics including:

- Construction,
- Lens color definitions, and
- Arrow and X shape guidelines.

Many of the factors that govern visibility of CMS messages also apply to LCS.

The most common types of LCS are:

- Fixed-grid fiberoptic, and
- Fixed-grid light emitting diode.

Lane Control Signal Technology is discussed in Chapter 8 of the *Freeway Management and Operations Handbook*.

Lane control signals are not mandatory for reversible lanes or other purposes; signing often can suffice in these applications. However, properly designed and operated lane control signals generally prove more effective and their use is steadily increasing.

Preemption Systems

Preemption of the normal cycling of a traffic signal may be used:

- To clear traffic from railroad tracks when a train is approaching an at-grade crossing within or adjacent to the signal, and to avoid giving a proceed indication to vehicular and pedestrian movements that cross the tracks, while the crossing is active, and
- To provide a proceed indication to an approaching fire truck or other emergency vehicle, thus reducing delays to such vehicles. Preemption is sometimes used similarly to reduce delays for transit vehicles, but this is rare and signal priority is typically used for this purpose (see following section).

In railroad preemption, a railroad track circuit senses the presence of an approaching train. This presence indication is a steady input to the traffic signal controller and causes the traffic signal to start a preemption sequence that may include the following stages:

- Current vehicular and pedestrian service is terminated immediately,
- A green indication is given to vehicles that may be queued on the railroad tracks, just long enough to allow vehicles to move off the tracks,
- Before the train arrives at the crossing, signal operation changes to either flashing red for all signals (pedestrian indications are dark), or cycling through a subset of the phases – those that do not conflict with the railroad crossing, and
- When the train departs and the presence input goes away, the signal resumes normal operation, but may temporarily operate special timings that help clear a queue of vehicles blocked by the train's crossing.

Emergency vehicle preemption usually involves a different set of actions. When the preemption input is first sensed, or after some fixed delay, current vehicular service is terminated if it conflicts with the emergency vehicle movement, but pedestrian service is usually allowed to complete timing of the Flashing Don't Walk indication. The signal then jumps to the phases that serve the emergency vehicle movement (typically the phase serving a through movement plus any protected left-turn phase in the same direction) and remains in these phases until the preemption input goes away or a maximum timer expires. As with railroad preemption, the signal may be configured to resume normal service at particular phases, or might be configured to start with the phases that will instantly restore the coordination offset.

Emergency vehicle preemption is usually triggered by the presence input from an emergency vehicle sensor at the intersection. Fire trucks often use a radio transmitter or a strobing infra-red light transmitter. A sensor at the intersection is continuously monitoring the approach for such a transmission, and preemption remains in effect while the transmission continues to be received. The directional transmission cannot be received after the vehicle passes through the intersection. Some transmitters periodically send the GPS-derived coordinates of the vehicle, and the receiver determines when the vehicle is close enough to require preemption and which approach it is on.

The preemption input to a traffic signal adjacent to a fire station is often triggered by a manual push button at the fire station. Less commonly, emergency vehicle preemption is triggered consecutively at a series of signals along the planned route of the fire truck, by communication from a master controller (often at the fire station) or central computer. The fire fighters provide the initial input to the computer or master unit that starts the selected route preemption sequence. Normal operation is typically resumed after a fixed amount of time, which should be sufficient for the fire truck to get through each signal.

Railroad preemption can override emergency vehicle preemption, and both can override transit priority.

Priority Systems

Priority techniques for transit vehicles on surface streets include:

- Exclusive (diamond) lanes that give buses exclusive right-of-way except for vehicles making right turns.
- Exclusive contra-flow lanes on one-way streets.
- Exclusive left turn movements.
- Lanes or roadway sections exclusively reserved for transit vehicles.
- Transit signal priority.

Bus delays at traffic signals usually represent 10 to 20 percent of overall bus trip times and nearly one-half of all delays (72). Other authors have come to similar conclusions (73, 74, 75, 76); thus, signal priority treatment for buses may be warranted in many cases. Minimizing bus delays often results in reducing total person delay for all persons using the roadway, whether in buses or private vehicles.

Conditional Signal Priority gives priority to transit vehicles at an intersection if they can effectively use the additional green time.

Some control techniques available under conditional signal priority include (73, 74, 75, 76, 77, 78, 79):

- *Phase / green extension*: desired phase green is lengthened by a maximum time. This proves helpful when the transit vehicle is detected near the end of the green and no near side bus stop is present. By extending the green a few seconds, the transit vehicle avoids stopping at the signal.
- *Phase early start or red truncation*: desired phase green is started earlier. This is helpful if the transit vehicle is detected during the desired phase red. Starting the desired phase green a few seconds earlier will save a few seconds of delay.
- *Red interrupt or special phase*: a short special green phase is injected into the cycle. This is especially helpful with near side stops serviced from a shoulder. The special phase will permit a queue jump. Buses get a special advance

phase display which allows them to get through the intersection smoothly and get back into a regular lane of travel easily.

- *Phase suppression / skipping*: logic is provided so that fewer critical phases are skipped. This can be used with logic that assesses congestion on the approaches to the skipped phase.
- *Compensation*: non-priority phases are given some additional time to make up for the time lost during priority. Other compensation techniques include limiting the number of consecutive cycles in which priority is granted.
- *Window stretching*: non-priority phases are given a core time, which must be serviced every cycle, and a variable timer which could be taken away for priority purposes. Flexible window stretching differs in that the core time is not fixed in position relative to the cycle.

Extensive treatment of priority strategies is provided in Reference 80.

Phase green extension and phase green early start are the most commonly used priority strategies. Implementation requires that the transit vehicle be detected sufficiently in advance of the intersection to facilitate termination of cross street phases.

A typical arrangement for providing a green advance or green extension priority is shown in Figure 3-33. On entering the bus priority provision zone, a priority request would be provided. The priority request would be terminated when the bus leaves the priority provision zone. If a bus stop is located on Section L1 and the bus doors are open, the priority request is terminated and reinitiated when the doors close.

The implementation of these functions requires close coordination between the traffic signal agency and the transit system operator. Some transit properties operate or plan to operate “smart buses”. Smart bus components that may be of use for signal priority include:

- DGPS receivers.
- On board computers.
- Door status sensors.
- Dedicated short range communications.
- Data communications to dispatch center.

Changeable Lane Assignment Systems

Lane use controls may be implemented by using combinations of lane control signals and conventional signal indications. While these functions are usually implemented on a time of day basis, they may also be implemented on a traffic responsive basis.

3.10 Benefits

Fuel Consumption

Vehicle fuel consumption represents a major operating expense, and is strongly influenced by road and traffic conditions. Figure 3-34 (81) shows an example of the relationship.

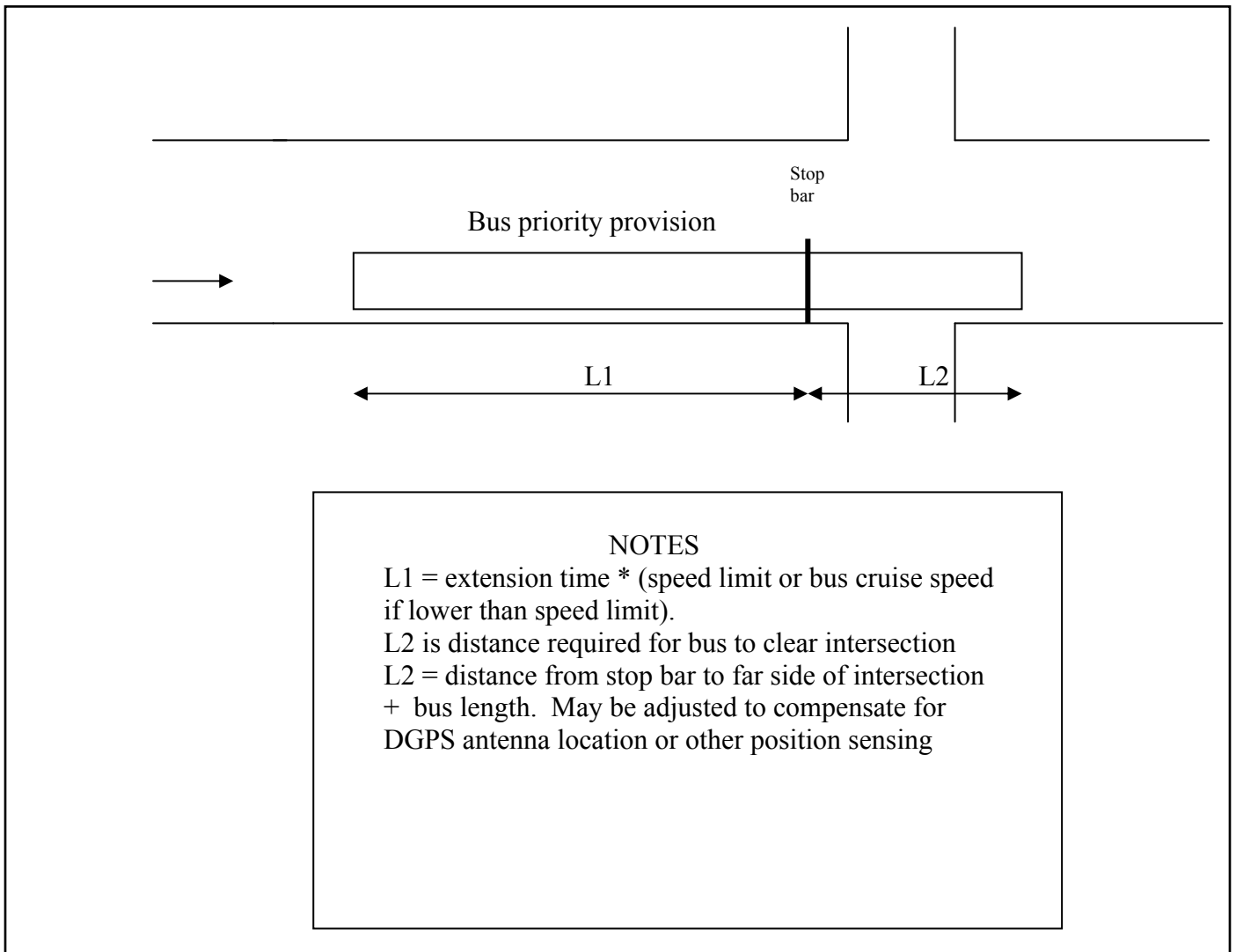

Figure 3-33 Bus priority provision zone.

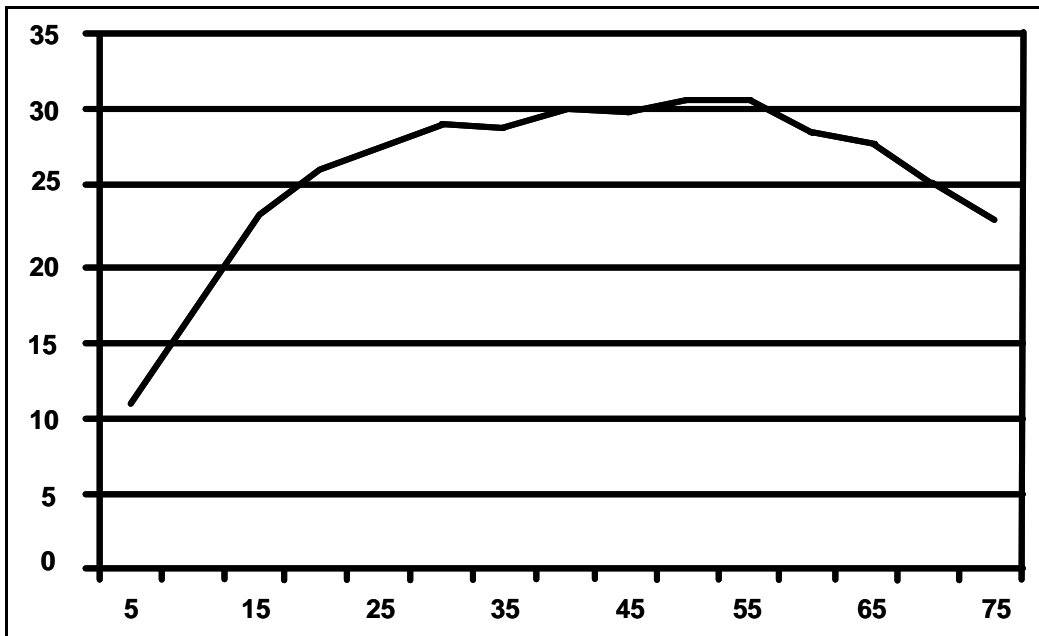

Figure 3-34 Fuel economy as a function of vehicle speed.

Vehicle Emissions

The Clean Air Act requires states to develop a state implementation plan (SIP) for each pollutant for which a nonattainment area violates the National Ambient Air Quality Standards (NAAQS). Transportation measures are a key component in SIP development. Depending on the severity of nonattainment, the CAA requires various transportation-related activities, programs and strategies. States also have the option of choosing among a variety of additional voluntary transportation measures that will best serve their needs. If these voluntary measures are included in a SIP, then they become enforceable under Federal law. As state and local transportation agencies will be required to implement these measures, it is vital that they take an active role in SIP development (82). The severity of measures required by the SIP depends on the level of nonattainment. An example of SIP requirements is shown in Table 3-20 (82).

The United States Environmental Protection Agency has mandated that the MOBILE6 (83) model be used for SIP development outside of California (84). MOBILE6 is an EPA approved emission factor model for predicting gram mile emissions from cars, trucks and motorcycles under various conditions

Table 3-20 Transportation related SIP requirements for carbon monoxide nonattainment areas by classification.

<p>Moderate <12.7 ppm:</p> <ul style="list-style-type: none">• Inventory of emissions sources every three years• Oxygenate gasoline in areas with a design value of 9.5 ppm or above• Basic inspection and maintenance program (if existing prior to 1990) <p>Moderate >12.7 ppm:</p> <ul style="list-style-type: none">• All of the requirements for moderate <12.7 ppm areas• Annual emissions reductions• Enhanced inspection and maintenance program• Vehicle miles traveled (VMT) forecasts and estimates for years prior to attainment year• Contingency measures to implement if area fails to attain or exceeds VMT forecasts• Clean-fuel vehicle program for centrally fueled fleets <p>Serious:</p> <ul style="list-style-type: none">• All of the requirements for moderate >12.7 ppm areas• Measures to offset growth in emissions due to growth in vehicle miles traveled (VMT)

Estimating Highway User Costs

Highway user costs are the total of:

- Vehicle operating costs,
- Travel time, and
- Accident costs.

Table 3-21 lists passenger car operating costs in the United States in 2003. Demonstrating the nation's reliance on highway transportation, in 1997 more than 182.7 million U.S. drivers drove more than 2.56 trillion vehicle miles in more than 211 million registered vehicles. In the same year, accidents killed 42,588 people, a rate of 1.66 deaths / 100 million vehicle miles. Tables 3-22 and 3-23 provide information on vehicle travel and accidents in 1990. Based on National Safety Council data, Table 3-24 shows accident cost rates for 2002.

Table 3-21 Passenger car operating costs, United States, 2003.

operating costs	per mile
gas and oil	7.2 cents
Maintenance	4.1 cents
tires	1.8 cents
cost per mile	13.1 cents
ownership costs	per year
comprehensive insurance	\$203
collision insurance (\$500 deductible)	\$401
bodily injury and property damage (\$100,000, \$300,000, \$50,000)	\$498
license, registration, taxes	\$205
depreciation (15,000 miles annually)	\$3,738
finance charge (20% down; loan @ 9.0%/4 yrs.)	\$744
cost per year	\$5,789
cost per day	\$15.86
added depreciation costs (per 1,000 miles over 15,000 miles annually)	\$181
total cost per mile	
15,000 total miles	per year
per year	
cost per mile x 15,000 miles	\$1,965
cost per day x 365 days ***	\$5,789
total cost per year	\$7,754
total cost per mile*	51.7 cents
20,000 total miles	per year
per year	
cost per mile x 20,000 miles	\$2,620
cost per day x 365 days ***	\$5,789
depreciation cost x 5 **	\$905
total cost per year	\$9,314
total cost per mile*	46.6 cents
10,000 total miles	per year
per year	
cost per mile x 10,000 miles	\$1,230
cost per day x 365 days * * * *	\$5,190
total cost per year	\$6,420
total cost per mile*	64.2 cents
* total cost per year ÷ total miles per year	
** excess mileage over 15,000 miles annually (in thousands)	
*** ownership costs based on a 4-year/60,000-mile retention cycle	
**** ownership costs based on a 6-year/60,000-mile retention cycle	

Source: American Automobile Association, "Your Driving Costs," 2003 (85)

Table 3-22 Motor vehicle traffic fatalities and injuries - 1997.

RELATED TO POPULATION, LICENSED DRIVERS, AND VEHICLE REGISTRATIONS

REVISED FEBRUARY 2000

STATE	POPULATION 1/				LICENSED DRIVERS 2/				REGISTERED VEHICLES 3/			
	NUMBER	ANNUAL VEHICLE MILES PER CAPITA	FATALITIES (PERSONS) RATE 4/	NONFATAL INJURED (PERSONS) RATE 4/	NUMBER	ANNUAL VEHICLE MILES PER DRIVER	FATALITIES (PERSONS) RATE 4/	NONFATAL INJURED (PERSONS) RATE 4/	NUMBER	ANNUAL VEHICLE MILES PER VEHICLE	FATALITIES (PERSONS) RATE 4/	NONFATAL INJURED (PERSONS) RATE 4/
Alabama	4,319,154	12,377	0.28	11.41	3,387,123	15,783	0.35	14.55	3,707,983	14,417	0.32	13.29
Alaska	609,311	7,200	0.13	10.26	446,247	9,831	0.17	14.00	555,860	7,892	0.14	11.24
Arizona -	4,554,966	9,548	0.21	14.98	3,119,537	13,941	0.30	21.88	3,217,039	13,519	0.30	21.22
Arkansas	2,522,819	11,129	0.26	15.82	1,878,618	14,945	0.35	21.24	1,648,141	17,035	0.40	24.21
California	32,268,301	8,851	0.11	8.83	20,385,245	14,011	0.18	13.97	25,385,985	11,251	0.15	11.22
Colorado	3,892,644	9,697	0.16	10.70	2,836,339	13,308	0.22	14.69	3,617,686	10,434	0.17	11.52
Connecticut	3,269,858	8,732	0.10	14.81	2,270,228	12,577	0.15	21.33	2,707,782	10,544	0.13	17.88
Delaware	731,581	10,945	0.20	14.51	535,712	14,946	0.27	19.81	623,612	12,840	0.23	17.02
Dist. of Columbia 5/	528,964	6,288	0.11	17.07	356,181	9,338	0.17	25.34	234,816	14,164	0.26	38.44
Florida 6/	14,653,945	9,145	0.19	16.60	11,749,244	11,406	0.24	20.71	11,077,810	12,097	0.25	21.96
Georgia	7,486,242	12,535	0.21	18.62	5,063,192	18,534	0.31	27.53	6,316,850	14,856	0.25	22.07
Hawaii -	1,186,602	6,610	0.11	9.27	738,865	10,615	0.18	14.88	714,030	10,984	0.18	15.40
Idaho	1,210,232	10,643	0.21	11.68	843,891	15,263	0.31	16.75	1,115,987	11,541	0.23	12.66
Illinois	11,895,849	8,349	0.12	10.38	7,691,750	12,912	0.18	16.06	8,624,518	11,516	0.16	14.32
Indiana	5,864,108	11,704	0.16	13.04	3,923,614	17,493	0.24	19.49	5,443,777	12,608	0.17	14.05
Iowa 6/	2,852,423	9,818	0.16	13.49	1,952,935	14,339	0.24	19.70	2,983,183	9,387	0.16	12.89
Kansas	2,594,840	10,222	0.19	12.20	1,824,944	14,534	0.26	17.35	2,199,857	12,057	0.22	14.39
Kentucky	3,908,124	11,454	0.22	14.43	2,574,662	17,386	0.33	21.90	2,819,462	15,876	0.30	20.00
Louisiana	4,351,769	8,925	0.21	12.85	2,677,845	14,504	0.35	20.89	3,448,597	11,263	0.27	16.22
Maine	1,242,051	10,664	0.15	14.22	900,844	14,703	0.21	19.61	1,086,675	12,189	0.18	16.25
Maryland 6/	5,094,289	9,189	0.12	8.27	3,346,622	13,988	0.18	12.59	3,824,645	12,240	0.16	11.01
Massachusetts	6,117,520	8,250	0.07	14.78	4,393,429	11,487	0.10	20.58	5,159,232	9,782	0.09	17.53
Michigan -	9,773,892	9,388	0.15	14.17	6,751,267	13,591	0.21	20.52	8,178,066	11,220	0.18	16.94
Minnesota	4,685,549	10,475	0.13	9.83	2,839,291	17,287	0.21	16.22	4,050,873	12,116	0.15	11.37
Mississippi	2,730,501	11,543	0.32	14.17	1,722,513	18,298	0.50	22.46	2,264,653	13,918	0.38	17.08
Missouri	5,402,058	11,659	0.22	15.09	3,744,320	16,820	0.32	21.77	4,406,034	14,294	0.27	18.50
Montana	878,810	10,687	0.30	12.16	662,418	14,178	0.40	16.13	1,001,004	9,383	0.26	10.68
Nebraska	1,656,870	10,307	0.18	18.27	1,178,880	14,486	0.26	25.68	1,524,812	11,199	0.20	19.85

Table 3-22 Motor vehicle traffic fatalities and injuries - 1997 (continued).

RELATED TO POPULATION, LICENSED DRIVERS, AND VEHICLE REGISTRATIONS

STATE	POPULATION 1/				LICENSED DRIVERS 2/				REGISTERED VEHICLES 3/			
	NUMBER	ANNUAL VEHICLE MILES PER CAPITA	FATALITIES (PERSONS) RATE 4/	NONFATAL INJURED (PERSONS) RATE 4/	NUMBER	ANNUAL VEHICLE MILES PER DRIVER	FATALITIES (PERSONS) RATE 4/	NONFATAL INJURED (PERSONS) RATE 4/	NUMBER	ANNUAL VEHICLE MILES PER VEHICLE	FATALITIES (PERSONS) RATE 4/	NONFATAL INJURED (PERSONS) RATE 4/
Nevada	1,676,809	9,726	0.21	16.15	1,186,097	13,750	0.29	22.83	1,168,981	13,951	0.30	23.16
New Hampshire 5/	1,172,709	9,552	0.11	12.25	883,064	12,685	0.14	16.27	1,174,699	9,536	0.11	12.23
New Jersey	8,052,849	7,862	0.10	15.88	5,576,064	11,354	0.14	22.94	5,910,242	10,712	0.13	21.64
New Mexico	1,729,751	12,682	0.28	17.17	1,194,284	18,368	0.41	24.87	1,545,653	14,193	0.31	19.22
New York 6/	18,137,226	6,659	0.09	15.75	10,529,855	11,470	0.16	27.14	11,007,611	10,972	0.15	25.96
North Carolina	7,425,183	11,029	0.20	20.52	5,399,301	15,168	0.27	28.23	5,855,347	13,986	0.25	26.03
North Dakota	640,883	11,114	0.16	8.94	452,163	15,753	0.23	12.67	711,127	10,016	0.15	8.06
Ohio	11,186,331	9,268	0.13	19.67	8,185,824	12,665	0.18	26.87	10,327,075	10,039	0.14	21.30
Oklahoma -	3,317,091	12,481	0.25	15.71	2,278,757	18,168	0.37	22.86	2,935,703	14,102	0.29	17.75
Oregon	3,243,487	9,949	0.16	10.92	2,276,533	14,174	0.23	15.57	2,952,977	10,927	0.18	12.00
Pennsylvania	12,019,661	8,155	0.13	11.57	8,317,715	11,784	0.19	16.72	9,007,011	10,882	0.17	15.44
Rhode Island	987,429	7,161	0.08	12.67	680,107	10,397	0.11	18.40	727,349	9,722	0.10	17.20
South Carolina	3,760,181	10,992	0.24	15.70	2,613,102	15,818	0.35	22.60	2,889,995	14,302	0.31	20.43
South Dakota	737,973	10,756	0.20	11.06	524,182	15,144	0.28	15.57	742,964	10,684	0.20	10.98
Tennessee	5,368,198	11,275	0.23	15.31	3,929,026	15,405	0.31	20.92	4,590,851	13,184	0.27	17.90
Texas	19,439,337	10,222	0.18	17.89	12,833,603	15,483	0.27	27.10	13,052,067	15,224	0.27	26.65
Utah 6/	2,059,148	9,928	0.18	15.17	1,357,064	15,065	0.27	23.02	1,552,509	13,168	0.24	20.12
Vermont 5/	588,978	10,978	0.16	5.62	475,389	13,601	0.20	6.96	514,572	12,566	0.19	6.43
Virginia -	6,733,996	10,443	0.15	12.16	4,901,088	14,348	0.20	16.70	5,764,957	12,198	0.17	14.20
Washington 6/	5,610,362	9,098	0.12	14.93	4,009,833	12,730	0.17	20.89	4,805,972	10,621	0.14	17.43
West Virginia	1,815,787	10,091	0.21	12.93	1,285,158	14,258	0.30	18.27	1,372,008	13,356	0.28	17.12
Wisconsin	5,169,677	10,524	0.14	12.22	3,672,469	14,814	0.20	17.20	4,422,743	12,301	0.16	14.28
Wyoming	479,743	15,792	0.29	13.23	352,770	21,476	0.39	17.99	568,581	13,324	0.24	11.16
U.S. Total	267,636,061	9,572	0.16	13.96	182,709,204	14,021	0.23	20.45	211,539,963	12,110	0.20	17.67

1/ July 1, 1997, estimates from U.S. Bureau of Census.

2/ Number of driver licenses shown in Table DL-1C.

3/ Number of total motor vehicle registrations shown in Table MV-1 including motorcycles.

4/ Rate in thousands of persons.

5/ Nonfatal injury data reported are incomplete.

6/ Nonfatal injury crashes, nonfatal injured persons, most serious injured, and pedestrians injured that are currently available prior to this publication.

Source: U.S. Department of Transportation Federal Highway Administration Highway Statistics, 1997 (86)

Table 3-23 Motor vehicle traffic fatalities and injuries by highway types - 1997.

HIGHWAYS

OCTOBER 1998

HIGHWAY CATEGORIES	PUBLIC ROAD MILEAGE	ANNUAL VEHICLE-MILES (MILLIONS)	INJURY CRASHES				PERSONS INJURED 1/				MOST SERIOUS INJURIES 1/ 2/		PEDESTRIANS INJURED			
			FATAL		NONFATAL 2/		FATAL		NONFATAL 2/		INJURIES 1/ 2/		FATAL		NONFATAL 2/	
			NUMBER 3/	RATE 4/	NUMBER	RATE 4/	NUMBER 3/	RATE 4/	NUMBER	RATE 4/	NUMBER	RATE 4/	NUMBER 3/	RATE 4/	NUMBER	RATE 4/
FUNCTIONAL SYSTEM																
Rural																
Interstate	32,819	240,121	2,518	1.05	60,214	25.08	3,033	1.2631132	98,705	41.11	15,322	6.38	210	0.09	1,443	0.60
Other Principal Arterial	98,257	228,704	4,491	1.96	116,349	50.87	5,373	2.3493249	200,918	87.85	29,033	12.69	312	0.14	2,386	1.04
Minor Arterial	137,498	162,777	3,795	2.33	114,785	70.52	4,448	2.7325728	192,477	118.25	26,052	16.00	289	0.18	2,022	1.24
Major Collector	432,728	201,480	5,061	2.51	174,865	86.79	5,734	2.84594	272,672	135.33	38,158	18.94	301	0.15	3,198	1.59
Minor Collector	272,350	52,327	1,652	3.16	55,479	106.02	1,844	3.5239933	83,500	159.57	9,852	18.83	85	0.16	1,070	2.04
Local	2,134,836	114,511	4,030	3.52	169,236	147.79	4,457	3.8922025	255,154	222.82	23,062	20.14	370	0.32	4,935	4.31
Total -- Rural	3,108,488	999,920	21,547	2.15	690,928	69.10	24,889	2.4890991	1,103,426	110.35	141,479	14.15	1,567	0.16	15,054	1.51
Urban																
Interstate	13,249	361,371	2,014	0.56	168,266	46.56	2,281	0.6312073	261,923	72.48	18,938	5.24	362	0.10	4,250	1.18
Other Freeways & Expressways	9,062	161,015	1,204	0.75	110,456	68.60	1,320	0.8197994	172,611	107.20	12,056	7.49	227	0.14	4,311	2.68
Other Principal Arterial	53,230	384,982	5,002	1.30	480,020	124.69	5,401	1.4029227	766,336	199.06	56,095	14.57	1,343	0.35	20,865	5.42
Minor Arterial	89,196	300,599	3,250	1.08	381,425	126.89	3,522	1.1716606	595,030	197.95	48,865	16.26	766	0.25	20,204	6.72
Collector	88,042	130,461	1,310	1.00	136,925	104.95	1,399	1.0723511	207,671	159.18	18,667	14.31	241	0.18	9,680	7.42
Local	583,330	222,024	2,953	1.33	431,623	194.40	3,155	1.4210175	656,623	295.74	35,214	15.86	801	0.36	37,251	16.78
Total -- Urban	836,109	1,560,452	15,733	1.01	1,708,715	109.50	17,078	1.0944265	2,660,194	170.48	189,835	12.17	3,740	0.24	96,561	6.19
FEDERAL-AID HIGHWAYS (RURAL & URBAN)																
Interstate System	46,068	601,492	4,532	0.75	228,480	37.99	5,314	0.8834698	360,628	59.96	34,260	5.70	572	0.10	5,693	0.95
Other National Highway System 5/	112,852	509,495	6,825	1.34	393,146	77.16	7,784	1.5277873	636,128	124.85	60,944	11.96	953	0.19	12,401	2.43
Total National Highway System	158,920	1,110,987	11,357	1.02	621,626	55.95	13,098	1.1789517	996,756	89.72	95,204	8.57	1,525	0.14	18,094	1.63

Table 3-23 Motor vehicle traffic fatalities and injuries by highway types - 1997 (continued).

HIGHWAYS

OCTOBER 1998

HIGHWAY CATEGORIES	PUBLIC ROAD MILEAGE	ANNUAL VEHICLE-MILES (MILLIONS)	INJURY CRASHES				PERSONS INJURED 1/				MOST SERIOUS		PEDESTRIANS INJURED			
			FATAL		NONFATAL 2/		FATAL		NONFATAL 2/		INJURIES 1/ 2/		FATAL		NONFATAL 2/	
			NUMBER 3/	RATE 4/	NUMBER	RATE 4/	NUMBER 3/	RATE 4/	NUMBER	RATE 4/	NUMBER	RATE 4/	NUMBER 3/	RATE 4/	NUMBER	RATE 4/
Other Federal - Aid Highways 6/	795,349	1,060,743	17,288	1.63	1,121,679	105.74	19,413	1.8301323	1,771,587	167.01	167,982	15.84	2,526	0.24	50,265	4.74
Total Federal - Aid Highways 7/	954,269	2,171,730	28,645	1.32	1,743,305	80.27	32,511	1.4970093	2,768,343	127.47	263,186	12.12	4,051	0.19	68,359	3.15
Total Non-Federal - Aid Highways 8/	2,990,328	388,642	8,635	2.22	656,338	168.88	9,456	2.4330875	995,277	256.09	68,128	17.53	1,256	0.32	43,256	11.13
U.S. Total	3,944,597	2,560,372	37,280	1.46	2,399,643	93.72	41,967	1.6390978	3,763,620	147.00	331,314	12.94	5,307	0.21	111,615	4.36
Puerto Rico	14,622	16,171	551	3.41	41,281	255.28	591	3.6546905	56,282	348.04	1,234	7.63	208	1.29	5,592	34.58
Grand Total	3,959,219	2,576,543	37,831	1.47	2,440,924	94.74	42,558	1.6517481	3,819,902	148.26	332,548	12.91	5,515	0.21	117,207	4.55

1/ Pedestrians injured are included. Most serious injuries are those categorized as incapacitating.

5/ Includes data for non-Interstate facilities, but excludes crash data for about 935 miles of locals and collectors.

2/ 1996 nonfatal injury information is shown for Arkansas, District of Columbia, Florida, Iowa, Maryland, Missouri, Puerto Rico, New York, Rhode Island, Tennessee, Utah, and Washington because of incomplete reporting prior to this publication. Illinois and West Virginia data are 1995. Most serious injuries were not submitted by the District of Columbia, Georgia, Massachusetts, New Hampshire, Puerto Rico, and Vermont.

6/ Includes urban minor arterial and collector and rural minor arterial and major collector functional systems.

7/ The category Total Federal-Aid Highways includes Other Federal-Aid Highways and Total National Highway System.

8/ Includes local roads and rural minor collectors that are not part of the NHS.

3/ Fatal crash and fatality numbers have been adjusted to agree with State totals obtained from the Fatality Analysis Reporting System (FARS) as of August 24, 1998.

4/ Per 100 million vehicle-miles of travel

Source: U.S. Department of Transportation Federal Highway Administration Highway Statistics, 1997 (86)

Table 3-24 Costs per accident, 2002.

Type	Cost
Fatal Accidents	\$1,090,000 / death
Non-fatal Disabling Accident	\$39,900 / injury
Property damage only Accident (including non-disabling injury)	\$6200 / accident

Source: National Safety Council (87)

Impacts of Traffic Signal System Improvement

The States of Texas, California, Virginia, North Carolina, Washington, and others have conducted comprehensive traffic signal system improvement programs. Percent improvement in overall average travel time, delay, or fuel consumption was the basis for evaluating the effectiveness of these projects.

Table 3-25 summarizes MOE improvement for the various traffic signal system improvement projects.

Table 3-25 Benefits of signal system improvement.

Program / Items	Year	Fuel Reduction	Delay Reduction	Stop Reduction
TLS	1992	9.1%	24.6%	14%
FETSIM	1993	7.8%	13.8%	12.5%
Tyson's Corner, VA	1999	9%	22%	6%
Seattle, WA MMDI	1999	0.8%	7%	2.7%

Project Level Impacts

The degree of improvement in overall traffic performance resulting from a given traffic signal improvement project depends, to a large extent on the control methods before project implementation. The more primitive the level and quality of the base condition, the greater the potential for improvement.

Fambro in cooperation with the Texas Governor's Energy Office and the U.S. Department of Energy (25) conducted an extensive evaluation of traffic signal improvement projects in Texas. Table 3-26 shows the overall MOE improvement. The evaluation shows that commitment to high quality signal timing efforts, including periodic updating of timing plans proves essential in all signal systems from the basic to the most advanced. The *set it and forget it* policy results in significant waste of the resources invested in traffic control systems.

Table 3-26 Annual benefits from optimization on arterial.

Coordination / Equipment Status	Percent Stops (%)	Percent Delay (%)	Percent Fuel Consumption (%)
Uncoordinated arterial with existing equipment	10	24	8
Uncoordinated arterial with new equipment	18	21	14
Partially coordinated arterial with existing equipment	6	9	3
Partially coordinated arterial with new equipment	15	18	3
Coordinated arterial with existing equipment	16	23	17
Coordinated arterial with new equipment	14	23	12

Network Impacts

Improving traffic signal operations, particularly on arterial streets, has powerful areawide impacts. With 166 projects completed in 8 large, 7 medium and 19 small cities, the Texas TLS Program realized benefits during the first year as shown in Table 3-27 (25).

Table 3-27 Texas TLS program annual benefits and costs.

Size	Stops	Delay (hrs.)	Fuel		Savings (\$)	Cost (\$)
			gal	L		
Large Cities	1,283,099,850	30,621,657	22,180,341	83,952,590	346,360,309	2,885,302
Medium Cities	239,633,625	6,926,904	4,481,237	16,961,482	77,106,148	4,032,313
Small Cities	198,936,150	5,696,696	3,409,346	12,904,375	63,171,212	972,264
TOTAL	1,721,669,625	43,245,257	30,080,724	113,855,540	486,637,668	7,889,879

As expected, the bulk of benefits occurred in large cities with the highest population and traffic volumes. However, substantial benefits also occurred in medium and small cities; the benefit / cost (B/C) ratio for small cities was 65:1. High values of B/C are obtained when capital expenditures for improvements are minimal.

The benefits for each intersection improvement depend on the before condition. For example, coordinating a series of isolated intersections generally produced greater benefits than retiming an existing coordinated system. Finally, note that signal timing optimization can increase delay or fuel consumption on side streets to improve flow along the arterial network. However, these increases in delay or fuel consumption often prove negligible in terms of total network improvement. Table 3-28 shows network improvement data from the TLS Program (25).

Table 3-28 Annual benefits from optimization on network.

Coordination / Equipment Status	Percent Stops (%)	Percent Delay (%)	Percent Fuel Savings (%)
Uncoordinated network with existing equipment	8	18	8
Uncoordinated network with new equipment	11.2	16.3	8.8
Partially coordinated network with existing equipment	4.4	20.5	8.7
Partially coordinated network with new equipment	16	26	11
Coordinated network with existing equipment	15	22	12
Coordinated network with new equipment	15	27	9

A more recent evaluation is the Seattle Metropolitan Model Deployment Initiative Evaluation (88). The following are highlights of the results of this project:

- Regional delay was reduced by 7% and the total number of stops decreased by 2.7%, while peak traffic volume increased by 0.2%.
- Because of the increase in traffic, there was very little improvement in the area of energy use and emissions.
- Overall, the expected number of crashes decreased by 2.5%, with the overall number of fatal crashes projected over a ten-year period reduced by 1.1%

Tables 3-29 and 3-30 show detailed information on the Seattle MMDI Evaluation:

Table 3-29 Seattle MMDI evaluation: system efficiency impacts.

Measure per Average A.M. Peak Period, North Corridor Subarea	Baseline	ATMS	Change	% Change
Vehicle-Hours of Delay	17,879	16,661	-1,218	-7.0%
Vehicle Throughput	209,372	209,774	+402	+0.2%
Coefficient of Trip Time Variation	0.242	0.237	-0.005	-2.1%
Vehicle-Km of Travel	3,438,000	3,455,000	+17,000	+0.4%
Total Number of Stops	1,200,000	1,167,000	-33,000	-2.7%

Table 3-30 Seattle MMDI evaluation: energy and emissions impacts.

Measure per Average A.M. Peak Period	Baseline	ATMS	Change	% Change
Fuel Consumption (l)	354,600	355,600	+1,000	+0.3% (NS)
HC Emissions (kg)	390	392.6	+2.6	+0.7% (NS)
CO Emissions (kg)	7043	7116	+73	+1.0% (NS)
Nox Emissions (kg)	846.2	850.2	+4	+0.5% (NS)

(NS) = not statistically significant vs. baseline at 90% confidence level

Cost-Effectiveness Comparisons

Traffic signal system improvements rank as one of the most cost-effective urban transportation improvement actions. The following presents results of cost-effectiveness analyses of four different signal optimization programs at different locations and time periods.

- Optimization in Tysons Corner, VA, in 1999: Annual savings to motorists traveling the network were estimated at about \$20 million. Stops were reduced by 6% (saving \$418 thousand), system delay decreased 22% (\$18 million), and fuel consumption decreased 9% (\$1.5 million). Total annual emissions for CO, Nox, and VOC was decreased by 134,600 kilograms (89).
- FETSIM (Fuel Efficient Traffic Signal Management) between 1983 and 1993: The FETSIM Program involved 163 local agencies and 334 projects, improving 12,245 signals at a cost of \$16.1 million, or \$1,091 per signal. Results show reductions of 12.5% in stops, 13.8% in delay, 7.7% in travel time, and 7.8% in fuel consumption. The benefit / cost ratio is about 17:1 (90).
- TLS Program (Traffic Light Synchronization) in 1992: The TLS Program expended \$7.9 million, approximately \$3500/intersection (equipment purchase). It resulted in annual reductions in fuel consumption, delay, and stops of 9.1% (\$30 million), 24.6% (43 million hours), and 14.2% (1.7 billion stops), respectively. The total savings to the public in the form of reduced fuel, delay, and stops was approximately \$485 million in 1993. The benefit / cost ratio is about 62:1 (25)
- SSOS (Statewide Signal Optimization Squad) in North Carolina 1987:
 - The SSOS Program average cost per retimed signalized intersection is \$481,
 - Each intersection annually saved 13,500 gallons of fuel, and \$51,815 of operating costs, and
 - The benefit cost ratio is about 108:1 (91).
- National Signal Timing Optimization (NSTO) Project by FHWA 1981: The NSTO Project cost \$456 per intersection. At an average intersection each year, 15,470 vehicle-hours of delay were reduced, 455,921 vehicle stops were eliminated and 10,526 gallons of fuel were saved. The benefit / cost ratio is 63:1 (92).

3.11 Measures of Effectiveness

Any new or modified traffic control system should satisfy a goal or set of goals. The goal may explicitly state: reduce congestion in the core area of a city by minimizing stops and delays or pledge increase accessibility to downtown business. Goals may be easy to state, but difficult to measure.

Measures of effectiveness (MOE) provide a quantitative basis for determining the capacity of traffic control systems and their strategies to attain the desired goals. To successfully determine goal attainment, the MOEs must relate to the goals. Also, with no comparative analyses, measures must be compared with baseline values to determine the quality of goal attainment. Other desirable criteria for selecting MOEs include:

- Simplicity within the constraints of required precision and accuracy,
- Sensitivity to relatively small changes in control strategy implementation, and
- Measurability on a quantitative scale within reasonable time, cost, and manpower budgets.

Common measures of effectiveness include:

- Total travel time,
- Total travel,
- Number and percentage of stops,
- Delay,
- Average speed,
- Accident rate, and
- Throughput.

These measures of effectiveness indicate the improvement in efficiency of traffic flow resulting from control.

Table 3-31 describes these MOEs and their calculation.

Several other important MOEs can be derived from those in the Table. Gasoline consumption and emissions, for example, can be computed from total travel time, stops, and delay (93).

Table 3-31 Measures of effectiveness (MOE).

MOE	Description	Calculation
Total Travel Time	A primary MOE for evaluating freeway and urban street control systems and strategies. Expressed in vehicle-hours (veh-hr), it represents the product of the total number of vehicles using the roadway during a given time period and the average travel time of the vehicles.	<p>The average travel time, tt_j, in hours over a roadway section is:</p> $tt_j = \frac{X_j}{u_j} \quad (3.25)$ <p>Where:</p> <p>X_j = Length of roadway section, in mi (km) and u_j = Average speed of vehicles over roadway section j, in mi/hr (km/hr)</p> <p>Total travel time, TTT_j, in veh-hr over section j is:</p> $TTT_j = N_j tt_j = \frac{N_j X_j}{u_j} \quad (3.26)$ <p>Where:</p> <p>N_j = Number of vehicles traveling over section j, during time period, tt_j = Average travel time of vehicles over roadway section j, in hrs</p> <p>Total travel time, TTT, in veh-hr, for all sections of a roadway is:</p> $TTT = \sum_{j=1}^K TTT_j \quad (3.27)$ <p>Where:</p> <p>TTT_j = Total travel time for section j, in veh-hr K = Number of roadway sections</p>

Table 3-31. Measures of effectiveness (MOE) (continued).

MOE	Description	Calculation
Total Travel	<p>Another common MOE used to evaluate traffic operations. Expressed in units of vehicle-miles (veh-mi) (vehicle-kilometers (veh-km)), it represents the product of the total number of vehicles using the roadway during a given time period and the average trip length of the vehicles.</p>	<p>The total travel, TT_j, in veh-mi, over a roadway section j is:</p> $TT_j = X_j N_j \quad (3.28)$ <p>Where:</p> <p>X_j = Length of roadway section j, in mi (km) N_j = Number of vehicles traveling over section j during time period, T</p> <p>Equations 3.26 and 3.28 suggest that the total travel, TT_j, in veh-mi (veh-km), over a roadway section j can be derived from total travel time and average speed for section j, as follows:</p> $TT_j = TTT_j V_j \quad (3.29)$ <p>Where:</p> <p>TTT_j = Total travel time for section j during time period, T, in veh-hr, and V_j = Average speed of vehicles over section j during time period, T, in mi/hr (km/hr)</p> <p>Total travel, TT, in veh-mi (veh-km), for all sections of a roadway is:</p> $TT = \sum_{j=1}^K TT_j \quad (3.30)$ <p>Where:</p> <p>K = Number of roadway sections</p>

Table 3-31. Measures of effectiveness (MOE) (continued).

MOE	Description	Calculation
Number and Percentage of Stops	Evaluates the quality of flow on urban streets. Stops may be obtained by floating vehicle methods or by direct observation of the intersection. Traffic control systems may have the capability to compute stops.	The calculation of the number of stops on an approach to an intersection is determined by the relationship between detector actuations and signal timing. A typical time-space diagram for number of stops computations is presented in Figure 3-35. The number of stops per cycle is the number of detector actuations that occur between T_{gc} and T_{rc} . T_{rc} is the last time that a vehicle can cross the detector during the green interval, and still clear the intersection without stopping. The values for T_{gc} and T_{rc} are based on predetermined vehicle trajectories between the detector and the intersection. In some algorithms for computing number of stops, these trajectories remain the same for all vehicles, while in others they vary according to the number of vehicles already stopped between the detector and intersection.
Delay	<p>Widely used MOE in traffic control. On urban arterials, delay is defined as the increase beyond a travel time corresponding to a baseline speed (a speed below which travel would be considered delayed).</p> <p>For urban intersections, delay is commonly defined as the time lost at the intersection by those vehicles that are stopped. Box and Oppenlander describe a technique for manually obtaining stopped delay (94).</p>	<p>For urban arterials, baseline travel time subtracted from measured total travel time for the same time period. Where computer traffic control systems compute delay, Figure 3-35 illustrates the computation of stopped-vehicle delay. Assuming all stopped vehicles clear the intersection on the next green, the delay D_i, in seconds, for the ith stopped vehicle is determined.</p> $D_i = R - (tc_i - T_r) + (td_i - T_g)$ <p>(3.31)</p> <p>Where:</p> <p>R = Length of the red interval, in seconds T_r = Time at which the red interval begins, in seconds tc_i = Predicted time at which the ith vehicle would have reached the intersection if it had not been stopped, in seconds T_g = Time at which the next green interval begins, in seconds td_i = Predicted time at which the ith vehicle clears the intersection, in seconds</p>

Table 3-31. Measures of effectiveness (MOE) (continued).

MOE	Description	Calculation
Delay (continued)		<p>Time, t_{ci}, is determined from the time, t_{aj}, at which the ith vehicle actuates the detector and a predetermined approach trajectory. Time, t_{dj}, is determined from time, T_g, at which the next green interval begins and- a predetermined departure trajectory. Some algorithms used to compute stopped-vehicle delay provide for varying the predetermined approach and departure trajectories according to the number of vehicles already stopped. Assuming all stopped vehicles clear the intersection on the next green, total stopped-vehicle delay, D, in seconds, for a cycle is determined by:</p> $D = \sum_{i=1}^n D_i$ <p>(3.32)</p> <p>Where:</p> <p>D_i = The delay of the ith vehicle stopped during the cycle, in seconds</p> <p>n = The number of vehicles stopped during the cycle</p> <p>Algorithms based on these concepts may be subject to the following additional sources of error:</p> <ul style="list-style-type: none"> • Vehicles making right-turns-on-red may not be properly accounted for • The algorithm might not properly handle saturated intersections
Average Speed	One of the most descriptive variables of freeway traffic flow. Point samples of average stream speeds or the speed traces of individual vehicles can locate problem areas and provide useful data for developing other performance measures (93).	Manually, by radar or laser guns. See Table 3-1 for calculations from system detectors.

Table 3-31. Measures of effectiveness (MOE) (continued).

MOE	Description	Calculation
Accident Rate	<p>Accident rate improvement is a common goal for traffic control systems. Rates for intersections usually are expressed in terms of accidents per million entering vehicles. Freeway accident rates are often expressed in accidents per 100 million vehicle miles.</p>	<p>Box and Oppenlander describe techniques- for determining the statistical significance of accident data (94).</p>
Throughput	<p>Although its dimension is equivalent to speed, throughput is usually used in a somewhat different way. Figure 3-36 shows plots of throughput for a baseline system (curve A) and an improved traffic control system (curve B). These plots represent a best mathematical fit of the data represented by individual sets of measurements. Throughput is represented by the slope of the line to a point on the curves. As traffic demand increases, the throughput begins to decrease.</p> <p>This approach enables the traffic engineer to more precisely measure results relative to goals. For example, if the goal is to improve congested traffic conditions, examination of curve B in the congested region indicates only marginal improvement. This might lead the traffic engineer to consider strategies to specifically target to this region (section 3.8).</p>	$\textit{Throughput} = \frac{\textit{Vehicle mi (km) per unit of time}}{\textit{Vehicle hours per unit of time}}$ <p>for one or more traffic conditions</p>

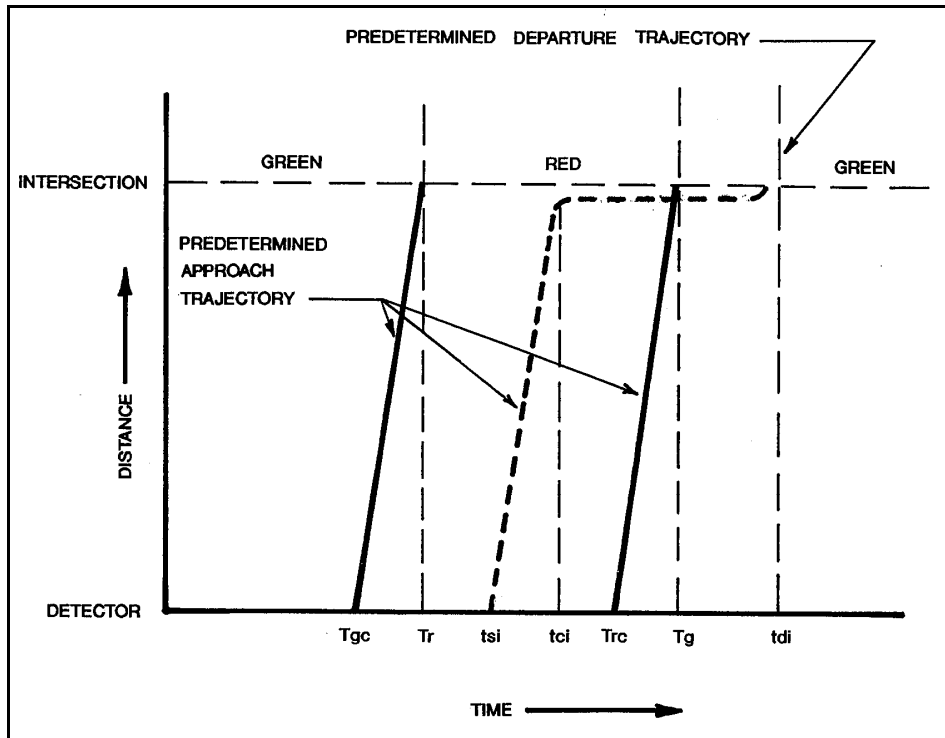

Figure 3-35 Time-space diagram for stop and delay computations for urban street control.

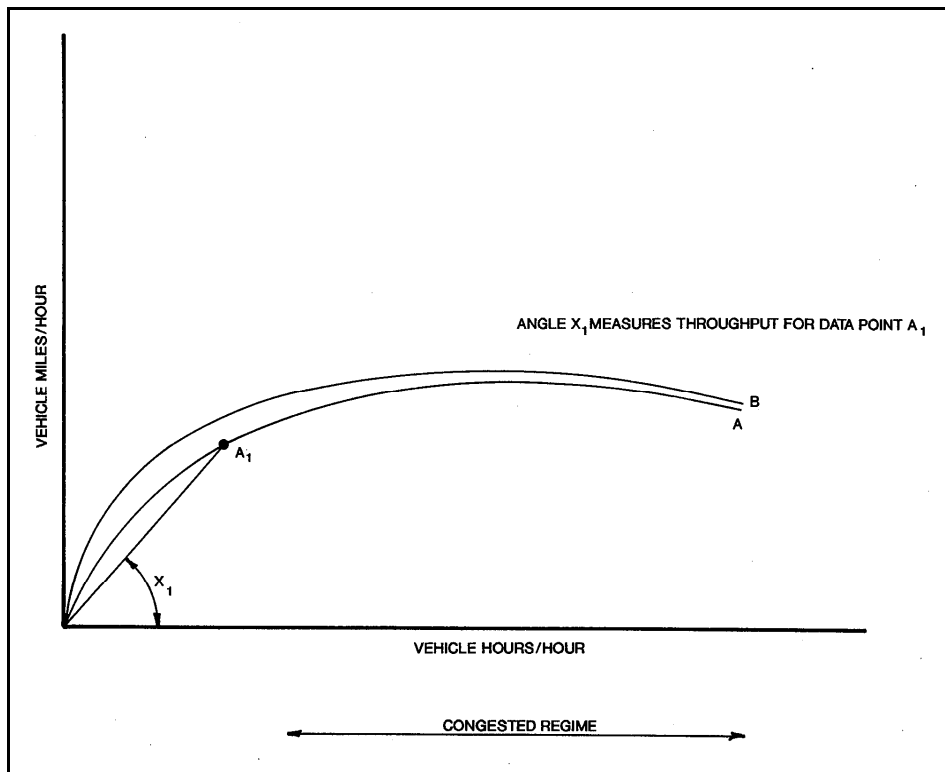

Figure 3-36 Throughput and component MOEs.

In many cases, these MOE are measured independently of traffic control system data. Box and Oppenlander (94) provide techniques and sample size requirements for performing many of these studies.

In some cases, these studies may use data generated by the traffic system. It then becomes important to:

- Identify the measurement error for these variables, and
- Specify and collect a sample size which assures statistically significant results.

Evaluation procedures must also consider the demand element. The evaluation must account for:

- Changing traffic demands between the before and after period,
- Other factors such as weather.

References

1. Kessman, R. "Urban Traffic Control System First Generation Fortran IV Overlay Software (Extended Version)." Volume 1-6, May 1979.
2. Gordon, R.L. "Surveillance and Traffic Responsive Control for First Generation UTCS." 1987.
3. "Manual of Uniform Traffic Control Devices for Streets and Highways." Federal Highway Administration, Washington, DC, 2003.
4. Kell, J.H., and I.J. Fullerton. "Manual of Traffic Signal Design." Institute of Transportation Engineers, Prentice-Hall, Inc., Englewood Cliffs, NJ, 1998.
5. Fullerton, I.J., and J.H. Kell. "Traffic Control Devices Handbook." Institute of Transportation Engineers, 2001.
6. Asante, S.A., S.A. Ardekani, and J.C. Williams. "Selection Criteria for Left-Turn Phasing, Indication Sequence and Auxiliary Sign." HPR Research Report 1256-IF, University of Texas at Arlington, Arlington, TX, February 1993.
7. Greenshields, B.D. "Traffic Performance at Urban Street Intersection." *Technical Report No. 1*, Yale Bureau of Highway Traffic, New Haven, CT, 1947.
8. Chang, E.C. "Guidelines for Actuated Controllers in Coordinated Systems." *Transportation Research Record 1554*, pp. 61-73, Transportation Research Board, Washington, DC, 1996.
9. "Signal and Lighting Design Course Workbook – June 1999." Minnesota DOT Office of Traffic Engineering, Minneapolis, MN, 1999.
10. "Highway Capacity Manual." Transportation Research Board, National Research Council, Washington, DC, 2000.
11. Pline, J.L. (editor). "Traffic Engineering Handbook, 5th Edition." Institute of Transportation Engineers, Washington, DC, 2000.
12. Pignataro, L.J. "Traffic Engineering Theory and Practice." Prentice-Hall, Inc., Englewood Cliffs, NJ, 1973.
13. Drew, D.R. "Design and Signalization of High-Type Facilities." *Traffic Engineering*. Vol. 33, No. 7, pp. 17-25, 1963.
14. Gordon, R.L. "Systems Engineering Processes for Developing Traffic Signal Systems." *NCHRP Synthesis 307*, Transportation Research Board, Washington, DC, 2003.

15. Robertson, D.I. "TRANSYT: A Traffic Network Study Tool." *Road Research Laboratory Report No. RL-253*, Grothorne, Berkshire, England, 1969.
16. Wallace, C.E, K.G. Courage, D.P. Reaves, G.W. Schoene, G.W. Euler, and A. Wilbur. "Transyt-7F User's Manual." University of Florida, October 2003.
17. Skabardonis, A., R.L. Bertini, and B.R. Gallagher. "Development and Application of Control Strategies for Signalized Intersections in Coordinated Systems." *Transportation Research Record 1634*, pp. 110-117. Transportation Research Board, Washington, DC, 1998.
18. Robertson, D.L., and P.B. Hunt. "A Method of Estimating the Benefits of Coordinating Signals by TRANSYT and SCOOT." *Traffic Engineering and Control*, Vol. 23, No. 11, pp. 527-531, 1982.
19. Christopher, P., and R. Kiddle. "Ideal Street Spacing Tables for Balanced Progression." Federal Highway Administration Report No. FHWA-RD-79-28, Washington, DC, May 1979.
20. Wilshire, R., R. Black, R. Grochoske, and J. Higinbotham. "Traffic Control Systems Handbook." Federal Highway Administration Report FHWA-1P-85-17, Washington, DC, 1985.
21. Orcutt, F.L., Jr. "The Traffic Signal Book." Prentice Hall, Englewood Cliffs, NJ, 1993.
22. Chang, E.C.P., and C.J. Messer. "Warrants for Interconnection of Isolated Traffic Signals." Report 293-1F, Texas Transportation Institute, College Station, TX, August 1986.
23. Freeman, W.J., K.Y. Ho, and E.A. McChesney. "An Evaluation of Intersection System Analysis Techniques." Presented at the 78th Annual Meeting of the Transportation Research Board, Washington, DC, 1999.
24. Benekohal, R.F., Y.M. Elzohairy, and J.E. Saak. "A Comparison of Delay from HCS, Synchro, Passer II, Passer IV, and Corsim for an Urban Arterial." Presented at the 81st Annual Meeting of the Transportation Research Board, Washington, DC, 2002.
25. Fambro, D.B., C.A. Lopez, and S.R. Sunkari. "Benefits of the Texas Traffic Light Synchronization ITLS." Grant Program I: Volume I Report, TXDOT TTI 0258-1, October 1992.
26. "Trafficware Corp." <<http://trafficware.com/>>.

27. "Signal Timing Optimization Software." 2003. Texas Transportation Institute. <<http://ttissoftware.tamu.edu/>>.
28. "The Highway Capacity Manual (HCM) version of aaSIDRA." Akcelik & Associates. <http://www.aatraffic.com/SIDRA/aaSIDRA_HCMversion.htm>
29. "Task D Technical Memorandum, Methodologies for Scoping ITS." Dunn Engineering Associates, New York State Department of Transportation, January 2003.
30. Wagner, F.A., D.L. Gerlough, and F.C. Barnes. "Improved Criteria for Traffic Signal Systems on Urban Arterials." *National Cooperative Highway Research Program Report 73*, Transportation Research Board, Washington, DC, 1969.
31. Polanis, S.F. "Signal Coordination and Fuel Efficiency; Winston-Salem's Experience." *Transportation Quarterly*, Vol. 38, No. 2, 1984.
32. Wagner, F.A., "Energy Impacts of Urban Transportation Improvements." Institute of Transportation Engineers, August 1980.
33. "Urban Traffic Control System Fortran IV Software Documentation." TRW Transportation and Environment Operations, September 1973.
34. Sperry Systems Management Division, Report Series on UTCS. Federal Highway Administration Reports:
 - FHWA-RD-73-9TUTCS/BPST Design and Installation
 - FHWA-RD-76-183TUTCS/BPST Operator's Manual
 - FHWA-RD-76-184TUTCS/BPST Maintenance Manual
 - FHWA-RD-76-160TUTCS/BPST Operations and Maintenance Manual
 - FHWA-RD-76-185TUTCS/BPST Software Manual Vol. 1
 - FHWA-RD-76-186TUTCS/BPST Software Manual Vol. 2
35. "The Urban Traffic Control System in Washington, D.C." Federal Highway Administration, U.S. Department of Transportation, Washington DC, (Undated information brochure).
36. Kessman, R. "Urban Traffic Control System First Generation Fortran IV Overlay Software (Extended Version)." Volume I-G, May 1979.
37. Honeywell Inc. - Series of Documents, 1987
 - FHWA-IP-87-11, Enhanced UTCS Software - Data Base Specifications
 - FHWA-IP-87-12, Enhanced UTCS Software - Operator's Manual
 - FHWA-IP-87-13, Enhanced UTCS Software - System Software Specification - Vol. 1

- FHWA-IP-87-14, Enhanced UTCS Software - System Software Specification - Vol. 2
FHWA-IP-87-15, Enhanced UTCS Software - System Software Specification - Vol. 3
38. Balke, K.N., S.R. Keithreddipalli, and C.L. Brehmer. "Guidelines for Implementing Traffic Responsive Mode in TXDOT Closed Loop Traffic Signal Systems." Texas Transportation Institute Research Report 2929-3F, College Station, TX, August 1997.
 39. Hunt, P.B., D.I. Robertson, R.D. Bretherton, and R.I. Winton. "SCOOT - A Traffic Responsive Method of Coordinating Signals." *Transport and Road Research Laboratory Report*, LR-1014. Crawthorne, Berkshire, England, 1981.
 40. Hunt, P.B., D.I. Robertson, R.D. Bretherton, and M.C. Rogle. "The SCOOT On-Line Traffic Signal Optimization Technique." *Traffic Engineering and Control*, pp. 190-199, April 1982.
 41. Robertson, D.I., and R.D. Bretherton. "Optimizing Networks of Traffic Signals in Real Time - The SCOOT Method." *IEEE Transactions on Vehicular Technology*, Vol. 40, No. 1, pp. 11-15, February 1991.
 42. Bretherton, R.D., and G.T. Bowen. "Recent Enhancements to SCOOT - SCOOT Version 2.4." Road Traffic Control, Institution of Electrical Engineers, London, 1990.
 43. Bretherton, D., G. Bowen, K. Wood. "Effective Urban Traffic Management and Control." Presented at 82nd Annual Transportation Research Board Meeting, Washington, DC, 2003.
 44. Lowrie, P.R. "SCATS - Sydney Co-Ordinated Adaptive Traffic System - A Traffic Responsive Method of Controlling Urban Traffic." Roads and Traffic Authority, Sydney, NSW, Australia, September 1992.
 45. Michalopoulos, P.G., R.D. Jacobson, C.A. Anderson, and J.C. Barbaresso. "Field Deployment of Autoscope in the Fast-Trac ATMS / ATIS Programme." *Traffic Engineering and Control*, pp. 475-483, September 1992.
 46. Gross, N. R., "SCATS Adaptive Traffic System." *TRB Adaptive Traffic Control Workshop*. Transcore, January 2000 <http://signalsystems.tamu.edu/documents/TRBWorkshop2000/SCATS_TRB2000Pres2.pdf>.
 47. Zabrieszach, D., and P. Petridis, "Deployment of SCATS 2 in Melbourne, Australia." 25th Australian Research Forum, Incorporating the BTRE Transport Policy Colloquium. Canberra, Australia, October 2002 <http://www.btre.gov.au/docs/atrf_02/papers/58Zabreszach%20Petridis.doc>.

48. City of Troy, Michigan, "SCATS Traffic Signal System." August 2000 <<http://www.ci.troy.mi.us/TrafficEngineering/sindex.htm>>.
49. Abdel-Rahim, A., et. al. "The Impact of SCATS on Travel Time and Delay." 8th ITS America Annual Meeting, Detroit, MI, May 1998 <<http://www.benefitcost.its.dot.gov/its/benecost.nsf/ID/AF5E7F6989F1A500852569610051E2E6?OpenDocument&Flag=Country>>.
50. Head, K.L., P.B. Mirchandani, and S. Shelby. "The Rhodes Prototype: A Description and Some Results." Presented at the 77th Annual meeting of the Transportation Research Board, Washington, DC, 1998.
51. Gartner, N.H., F.J. Poorhan, and C.M. Andrews. "Implementations and Field Testing of the OPAC Adaptive Control Strategy in RT-TRACS." Presented at the 81st Annual Meeting of the Transportation Research Board, Washington, DC, 2002.
52. Pignataro, L.J. "Traffic Control in Oversaturated Street Networks." *National Cooperative Highway Research Program Report 194*. Transportation Research Board, Washington, DC, 1978.
53. Quinn, D.J. "A Review of Queue Management Strategies." *Traffic Engineering and Control*, November 1992.
54. Rathi, A.K. "A Control Scheme for High Traffic Density Sectors." *Transportation Research*, 22B(2), pp. 81-101, 1988.
55. "Internal Metering Policy for Oversaturated Networks." Volumes 1 and 2, KLD Associates and Texas Transportation Institute, June 1992, NCHRP 3-38 (4).
56. Lieberman, E.B., J. Chang, and E.S. Prassas. "Formulation of a Real-Time Control Policy for Oversaturated Arterials." presented at the 79th Annual Meeting of the Transportation Research Board, Washington, DC, 2000.
57. Abu-Lebdeh, G., and R.F. Benekohal, "Development of Traffic Control and Queue Management Procedure for Over-Saturated Arterials." *Transportation Research Record 1603*, Transportation Research Board, Washington, DC.
58. Park, B., C.J. Messer, and T. Urbanik. "Traffic Signal Optimization Program for Over-Saturated Conditions, Genetic Algorithm Approach." *Transportation Research Record 1683*, pp. 133-142, Transportation Research Board, Washington, DC, 1999.

59. Girianna, M., and R.F. Benekohal. "Dynamic Signal Coordination for Networks with Oversaturated Intersections." presented at the 81st Annual Meeting of the Transportation Research Board, Washington, DC, 2002.
60. Girianna, M., and R.F. Benekohal. "Signal Coordination for a Two-Way Street network With Oversaturated Intersections." presented at the 82nd Annual Meeting of the Transportation Research Board, Washington, DC, 2003.
61. Smeed, R.J. "Road Capacity of City Centers." *Traffic Engineering and Control*, pp. 455-458, November 1966.
62. Godfrey, J.W. "The Mechanism of a Road Network." *Traffic Engineering and Control*, pp. 323-327, November 1969.
63. Kennedy, R. "The Day the Traffic Disappeared." *The New York Times Magazine*, pp 42-45, April 20, 2003.
64. "Transport for London." <<https://www.cclondon.com/WebCenterBrandedTR4/StaticPages/index.aspx>>.
65. "Traffic Software Integrated System." Federal Highway Administration <<http://www.fhwa-tsis.com>>.
66. "Paramics Online." Quadstone Limited <<http://www.paramics-online.com/contact/index.htm>>.
67. "ITC – World." <<http://www.itc-world.com/vissim.htm>>.
68. Nelson, E.J., D. Bullock, and T. Urbanik. "Implementing Actuated Control of Diamond Interchanges." *Journal of Transportation Engineering*, Vol. 126, No. 5, American Society of Civil Engineers, September-October 2000.
69. Gillis, R.D. "Unlocking Arena Gridlock." *Civil Engineering*, February 1990.
70. Ullman, G. "Motorists Interpretations of MUTCD Freeway Lane Control Signals." Texas Transportation Institute, January 1993.
71. "Equipment and Materials Standards of the Institute of Transportation Engineers." Institute of Transportation Engineers, January 31, 2001.
72. Levinson, H.S., C.L. Adams, and W.F. Hoey. "Bus Use of Highways: Planning and Design Guidelines." *National Cooperative Highway Research Program Report 155*, Transportation Research Board, Washington, DC, 1975.
73. Beasley, P.S., and T. Urbanik, "A State-of-the-Art Report on Bus Priority at Signalized Intersections." Texas Transportation Institute, August 9, 1993.

74. Eneveli, D.A., A.E. Radwan, and J.W. Hurley, Jr. "Evaluation of a Bus Preemption Strategy by Use of Computer Simulation." *Transportation Research Record 906*, Transportation Research Board, Washington, DC, 1983.
75. Levinson, H.S., W.F. Hoey, D.B. Sanders, and F.H. Wynn, "Bus Use Of Highways: State of the Art." *National Cooperative Highway Research Program Report 143*, Transportation Research Board, Washington, DC, 1973.
76. Turnquist, M.A. "Strategies for Improving Reliability of Bus Transit Service." *Transportation Research Record 818*, Transportation Research Board, Washington, DC, 1981.
77. Daniel, J.E., and E. Rowe. "Signal Priority for Public Transit Vehicles Using Advanced Traffic Control Systems: A Comparative Evaluation of ATSA, SCATS and SCOOT." Graduate Student Papers on Advanced Traffic Management Systems, Texas A&M University, August 1992.
78. Davies, P., C. Hill, N. Emmott, and J. Siviter. "Assessment of Advanced Technologies for Transit and Rideshare Applications." Castle Rock Consultants, Washington, DC, July 1991.
79. "Advanced Public Transportation Systems: The State of the Art, Update '92." Federal Transit Administration, Washington, DC, 1992.
80. "Improved Traffic Signal Priority for Transit." *Interim Report on TCRP Project A-16*, Transportation Research Board, Washington, DC, 1998.
81. "Model Year 2003 Fuel Economy Guide." Environmental Protection Agency, Washington, DC, 2003 <www.fueleconomy.gov>.
82. "Air Quality Planning for Transportation Officials." Federal Highway Administration, Washington, DC.
83. "MOBILE6 Vehicle Emission Modeling Software." United States Environmental Protective Agency <<http://www.epa.gov/otaq/m6.htm>>.
84. "Policy Guidance on the Use of MOBILE6 for SIP Development and Transportation Conformity." United States Environmental Protective Agency, Washington, DC, January 18, 2002.
85. "Your Driving Costs." American Automobile Association, 2003.
86. U.S. Department of Transportation, Federal Highway Administration. Highway Statistics, Washington, DC, 1997.

87. "Estimating the Costs of Unintentional Injuries." National Safety Council, 2002.
88. Wunderlich, K.E., J.A. Bunch, and J.J. Larkin. "ITS Impacts Assessment for Seattle MMDI Evaluation: Modeling Methodology and Results." Federal Highway Administration, September 1999.
89. White, J., et al., "Traffic Signal Optimization for Tysons Corner Network - Volume I: Evaluation and Summary." Virginia DOT, Report No. TPE.R7D.03.08.00, March 2000.
90. Skabardonis, A. "ITS Benefits: The Case of Traffic Signal Control Systems." Presented at the 80th Annual Meeting of the Transportation Research Board, Washington, DC, January 2001.
91. "North Carolina's Traffic Signal Management Program for Energy Conservation." *ITE Journal*, pp. 35-38, December 1987.
92. "National Signal Timing Optimization Project: Summary Evaluation Report." Federal Highway Administration, Office of Traffic Operations, and University of Florida, Transportation Research Center, May 1982.
93. Kay, J.L. "Measures of Effectiveness." *Proceedings of the International Symposium on Traffic Control Systems*, Berkeley, CA, August 1979.
94. Box, P.C., and J.C. Oppenlander. "Manual of Traffic Engineering Studies." Institute of Transportation Engineers, Arlington, VA, 2000.
95. "NEMA TS2 Traffic Controller Assemblies with NTCIP Requirements." National Electrical Manufacturers Association, 1998.

**CHAPTER 4
CONTROL AND MANAGEMENT CONCEPTS FOR FREEWAYS**

Table of Contents

Section	Page
4.1 Introduction	4-2
4.2 Congestion.....	4-3
4.3 Forms of Freeway Management	4-5
4.4 Relationship between Freeways and Surface Streets	4-8
References	4-9

CHAPTER 4

CONTROL AND MANAGEMENT CONCEPTS FOR FREEWAYS



Figure 4-1 INFORM (Long Island, NY) control center.

4.1 Introduction

A freeway is a limited access highway with high speeds, and ramps to allow entry and exit. Freeways may or may not have tolls. Freeways were originally intended to provide free-flowing, high-speed traffic flow over long distances. Very little thought was put into managing congestion because freeways were never expected to be congested. However, as cities grew and commuters moved to suburbs, freeways began mixing long-distance traffic with commuter traffic and the congestion that previously affected surface streets now also affected freeways.

This chapter provides a brief overview of freeway management. For more information, refer to the *Freeway Management and Operations Handbook* (1).

The main objectives of a freeway management system are to:

- reduce the impacts and occurrence of recurring congestion on the freeway system.

- minimize the duration and effects of nonrecurring congestion on the freeway system.
- maximize the operational safety and efficiency of the traveling public while using the freeway system.
- provide facility users with information necessary to aid them in making effective use of the freeway facilities and to reduce their mental and physical stress.
- provide a means of aiding users who have encountered problems (crashes, breakdowns, confusion, etc.) while traveling on the freeway system.

4.2 Congestion

Congestion occurs on a freeway when demand exceeds capacity. When this occurs on a freeway section, a bottleneck exists. A bottleneck occurs when:

- Demand increases to a level greater than capacity, or
- Capacity decreases to a level less than demand.

To understand what causes freeway congestion, one must understand the theory of traffic flow summarized below.

Important traffic flow parameters include:

- Flow (V) = Number of vehicles passing a certain point during a given time period, in vehicles per hour (veh / hr)
- Speed (S) = The rate at which vehicles travel (mph)
- Density (D) = Number of vehicles occupying a certain space. Given as veh / mi.

$$D = V / S$$

The fundamental diagram shown in Figure 4-2, relates flow and density. This diagram is highly idealized and actual traffic flow characteristics vary considerably. Examples of typical flow characteristics are provided in HCM 2000 (2).

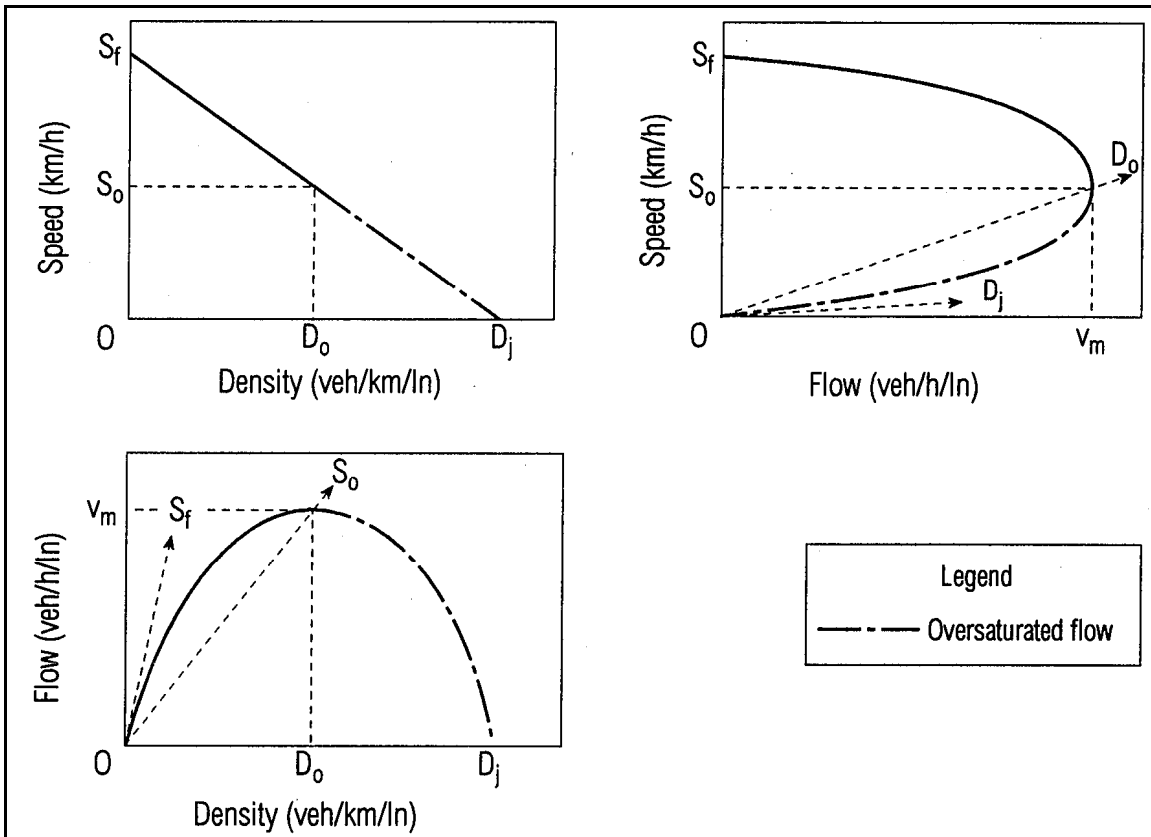

Figure 4-2 Generalized relationships among speed, density, and flow rate on uninterrupted-flow facilities.

Free flow speed (S_f) occurs during light traffic conditions. When density reaches the critical density (D_0), the freeway reaches its maximum flow (V_m). Speed at that point is decreased to S_0 . When the density increases beyond the critical density, the flow actually decreases, until the density reaches the jam density (D_j), where the flow becomes zero and all traffic is stopped. When the density is below the critical density, the flow is said to be stable, or uncongested. When the density exceeds the critical density, the flow is said to be congested, or unstable, and the freeway capacity decreases. Because more vehicles are processed when the flow is stable, it is best for the density to be as close as possible to, but below the critical value so the freeway can operate at its full capacity.

Congestion has become a daily occurrence on many portions of urban freeway networks. Even casual observers can locate points of expected congestion. Congestion commonly expected at predictable locations during approximately predictable periods of time is termed *recurrent* congestion.

In contrast, other forms of congestion result from random or less predictable events. Such *nonrecurrent* congestion results most frequently from incidents. Congestion from *special events* (e.g., sporting events, maintenance and construction activities) may be considered nonrecurrent congestion.

To measure congestion, researchers at Texas Transportation Institute developed a Roadway Congestion Index (RCI), depicted as follows (3):

$$RCI = \left[\frac{\text{Freeway VMT/Lane-Mile} \times \text{Freeway VMT} + \text{Principal Arterial Street VMT/Lane-Mile} \times \text{Principal Arterial Street VMT}}{13,000 \times \text{Freeway VMT} + 5,000 \times \text{Principal Arterial Street VMT}} \right]$$

Congestion, both recurrent and nonrecurrent, is characterized by the following conditions that cause user dissatisfaction:

- Slow travel speeds
- Erratic speeds (stop-and-go movement)
- Increased and inconsistent travel times
- Increased accident potential
- Inefficient operation

If users expect a certain level of congestion during peak periods, they can plan trips accordingly. However, nonrecurrent congestion can severely impact an otherwise satisfactory trip during peak or off-peak periods. The inability to provide a reliable, although sometimes lower, level of service may prove to be a more serious problem.

4.3 Forms of Freeway Management

Freeway management includes the categories shown in Figure 4-3.

These topics are outlined below and covered in detail in Reference 1.

- *Surveillance and incident detection:* Techniques for surveillance and incident detection include vehicle detectors, closed-circuit television (CCTV) cameras, and 911 calls.
- *Mainline / lane use control:* Lane use control makes the most efficient use of mainline capacity. Techniques include temporary shoulder utilization, reversible lanes and signs, variable speed limits, large truck restrictions and mainline metering.

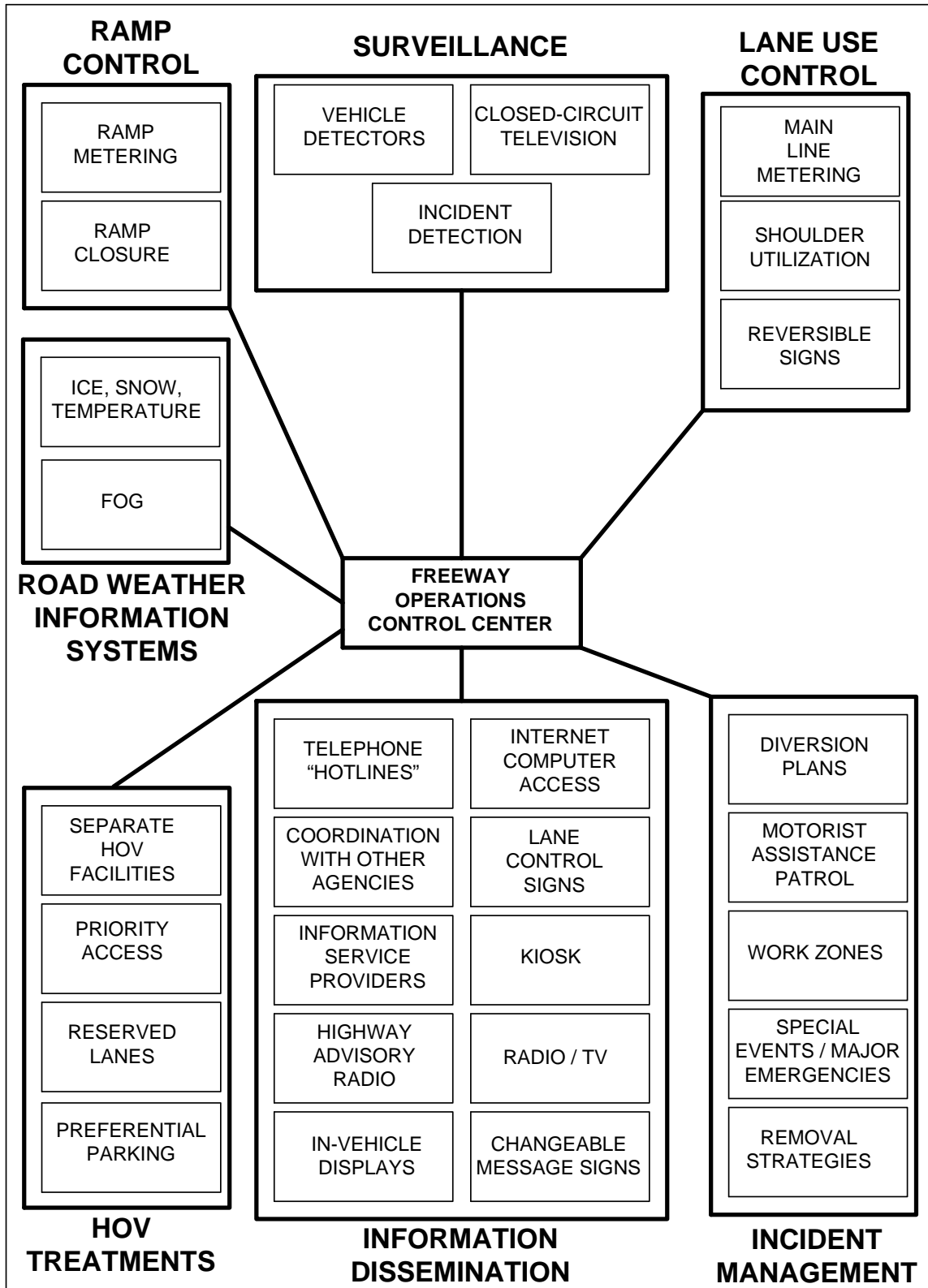

Figure 4-3 Freeway management categories.

- *High occupancy vehicle (HOV) priority treatment:* Giving priority to HOVs increases the number of people served by the facility, while possibly decreasing the number of vehicles. An example of HOV priority is having either a lane or an entire facility open only to buses or carpools. Another example is priority access, by having a special HOV lane on a metered on-ramp to allow buses or carpools to bypass the ramp queue.
- *Ramp control:* Ramp meters are special traffic signals on a freeway on-ramp that control the traffic entering the freeway, in order to keep the freeway uncongested. Ramps can also be closed under extreme circumstances.
- *Information dissemination:* Information dissemination gives real-time information to motorists, which is considered one of the most important functions of freeway management. Information can be given on incidents, adverse weather and driving conditions, speed and travel time information, construction and maintenance activities, planned special event destination, special lane and roadway control measures, and information on alternate routes. Methods used for information dissemination include Internet services, radio information, in-vehicle navigation devices, changeable message signs (CMS), and highway advisory radio (HAR). Figure 4-4 shows an example of a CMS on a freeway:
- *Freeway management system:* A freeway management system is the common interface for multiple agencies in a region. This can help coordinate different freeways and surface streets, as well as other modes of transportation.
- *Incident management:* The purpose of incident management is to detect and respond to incidents, in order to restore the freeway to full capacity as quickly as possible after an incident, as well as to provide aid to stranded or injured motorists. Incident management requires coordination among various agencies, and coordination among various human and technological resources.
- *Road weather information systems (RWIS):* RWIS consists of sensors embedded in the road and weather stations located near the road that monitor and report temperature and weather conditions. RWIS is especially useful in the winter. Fog detectors may be used in certain locations.



Figure 4-4 CMS on a freeway.

4.4 Relationship between Freeways and Surface Streets

In recent years, as both freeways and surface streets experience more congestion, it is becoming increasingly important to improve coordination between freeways and surface streets. With ramp metering, for example, some traffic may avoid the freeway, leading to increased traffic on a surface street. A few ways in which surface streets can be taken into account in freeway management include:

- CMS signs on a freeway can display information relating to congestion on surface streets, and display alternate routes to minimize congestion on both freeways and surface streets.
- Ramp metering may be reduced or suspended if congestion on surface streets is extreme, especially if the ramp meters are causing a spillback queue.
- If there is congestion or an incident on the freeway, traffic signal timing on surface streets could be modified to improve traffic flow and encourage diversion to surface streets.
- Improved signal timing and geometries at exit ramp intersections with surface streets may alleviate mainline freeway congestion at exit ramps.

References

1. Neudorff, L.G., J.E. Randall, R. Reiss, and R. Gordon. "Freeway Management and Operations Handbook." Federal Highway Administration Report No. FHWA-OP-04-003, Washington, DC, September 2003.
2. "Highway Capacity Manual." Transportation Research Board, Washington, D.C., 2000.
3. Schrank, D.L, S.M. Turner; and T.J. Lomax. "Estimates of Urban Roadway Congestion – 1990", Federal Highway Administration Report No. FHWA/TX-90/1131-5.

**CHAPTER 5
CONTROL AND MANAGEMENT CONCEPTS – INTEGRATED SYSTEMS**

Table of Contents

Section	Page
5.1 Introduction	5-2
5.2 Traffic Management on Surface Streets.....	5-3
Monitoring Traffic Conditions and Adjusting Signal Timing	5-3
Detecting Incidents and Advising Motorists	5-4
Advising Motorists of Traffic Problems in the Area	5-4
Monitoring Traffic Conditions Resulting from Special Events and Advising Motorists	5-4
Assisting with Parking Information	5-5
5.3 Use of Transit Vehicles on Surface Streets as Probes for Traffic Incident Detection	5-5
5.4 Bus Rapid Transit Corridors	5-5
References	5-7

CHAPTER 5
CONTROL AND MANAGEMENT CONCEPTS – INTEGRATED SYSTEMS

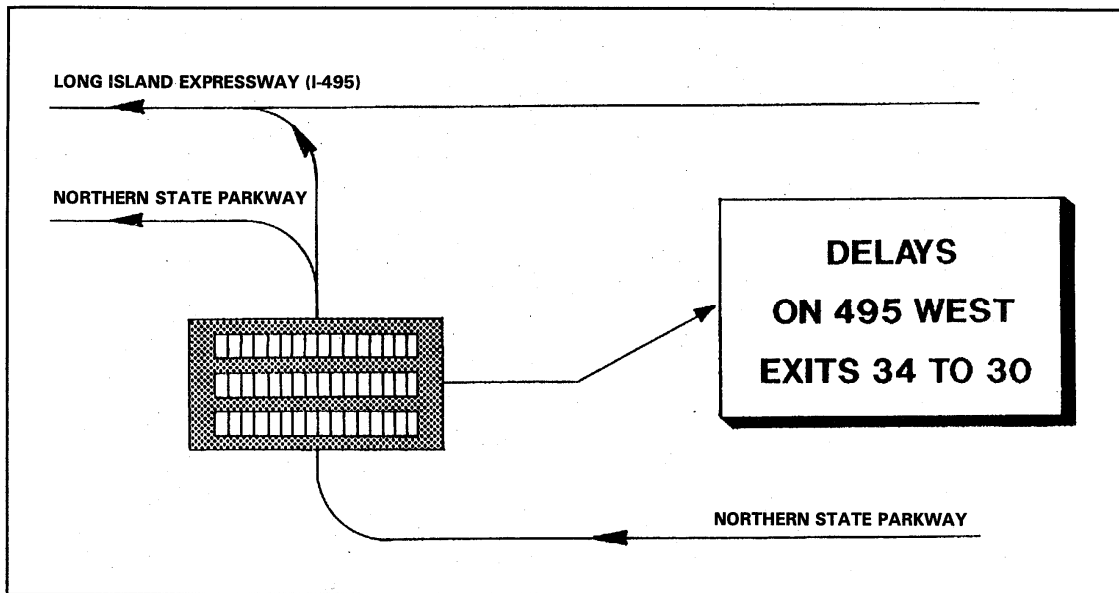

Figure 5-1 Diversion advisory message in the INFORM (Long Island, NY) corridor.

5.1 Introduction

Obtaining the most efficient traffic flow through a corridor involves coordination among the freeways and the surface streets in the corridor. *Integrated Traffic Management Systems* (ITMS) coordinate traffic control within a corridor or area. They integrate:

- Hardware with software elements
- Traffic signal systems
- Freeway management systems
- Traveler information systems (1)

Freeways in a corridor are primarily designed to serve longer trips. Where freeways are available, surface streets provide the following functions:

- Short trips
- Local land use access
- Access for freeways

- Alternates to freeways for recurrent congestion situations
- Alternates to freeways under incident conditions
- Alternates to freeway when a long queue exists on a metered ramp

Corridor control may be used to maximize throughput in a corridor consisting of a freeway and parallel surface streets. Ramp metering and motorist information devices, when appropriately used, may assist in the balancing of traffic to achieve this objective.

5.2 Traffic Management on Surface Streets

Two fundamental technologies that are used in most ITMS are closed circuit television (CCTV) cameras and changeable message signs (CMS). The following are a few ways in which CCTV and CMS can be used together to integrate freeways and surface streets in a corridor:

- Monitor traffic conditions and adjust signal timing
- Detect incidents and advise motorists
- Advise motorists of traffic problems in the area
- Monitor traffic conditions resulting from special events and advise motorists
- Assist with parking information

While signal timing is the primary means of traffic management on surface streets, a number of other techniques are described in this section for traffic management and coordinating traffic operations with freeways.

Monitoring Traffic Conditions and Adjusting Signal Timing

CCTV cameras are one of the primary methods of monitoring traffic conditions and detecting incidents. CCTV cameras allow an operator at the traffic management center (TMC) to monitor traffic on both freeways and surface streets to determine the location of congestion and incidents. If an incident or heavy congestion occurs on a freeway, traffic can be diverted to a parallel surface street, and the timing of the signals on the surface street can be modified to provide more green time in the direction parallel to the freeway.

One place where this concept is used is the INFORM system on Long Island, New York. Changeable message signs (CMS) on the freeway and at key entry ramps notify motorists of the location of incidents on the freeway. Operators at the INFORM traffic management center select appropriate signal timing plans to facilitate surface street traffic flow. Every signal has six pre-set timing plans. Three of the plans are used under normal conditions: off-peak, A.M. peak, and P.M. peak. The other three plans are used when a timing change appropriate for the incident is required. Stored incident timing plans include diversion for incidents in the eastbound and westbound directions, and in both directions. The system allows the operator to manually group signals together in the vicinity of the incident, and to select one of the incident timing plans. It is also possible to have a pre-set signal timing group, and in the case of freeway construction, all the signals in the group can be automatically set to one of the incident timing plans.

The use of CCTV on surface streets as on freeways raises the issue of privacy. CCTV cameras monitored by TMCs for traffic management purposes are not intended for the surveillance of individual vehicles or off-roadway sites. Some agencies have developed regulations to ensure that this intent is honored (2).

Detecting Incidents and Advising Motorists

One of the primary purposes of CCTV is to assist with incident detection. CCTV cameras can be located on both freeways and surface streets, and cameras are especially useful at an interchange where a camera has a view of both the freeway and the surface streets. If an incident is detected on either a freeway or surface street, CMS may be used to alert drivers and to possibly divert traffic elsewhere. CMS are discussed in greater detail in Chapter 10.

Advising Motorists of Traffic Problems in the Area

CCTV cameras can be used to find a major traffic problem, and CMS can alert drivers to the problem.

Monitoring Traffic Conditions Resulting from Special Events and Advising Motorists

CCTV cameras and CMS are useful during special events, both planned (such as a concert or a football game), as well as unplanned emergencies (such as a terrorist attack or a storm). Special events create traffic patterns that are quite different from normal. Many drivers going to a special event may not normally drive through the corridor in question, and are not familiar with alternate routes. Roadway and lane configurations may be different; for example, a normally two-way road may be converted to one-way in the peak direction, or a road may be closed for security reasons or to provide access for emergency vehicles.

Assisting with Parking Information

CCTV cameras, as well as other technologies, can monitor a large parking lot to determine which lots or sections are full, and CMS (or other methods of information dissemination) can notify drivers as to which parking lots are full or closed, and to direct drivers to parking lots that have available capacity.

5.3 Use of Transit Vehicles on Surface Streets as Probes for Traffic Incident Detection

Many transit properties have equipped or will equip transit vehicles with global positioning satellite (GPS) equipment (3). This equipment enables the geographic position of the transit vehicle to be determined. This position is then automatically communicated via bus radio to the dispatcher. When used in conjunction with computer aided dispatch (CAD) equipment, a vehicle that is later than the normally expected travel time variation from the schedule can be identified. On query from the dispatcher, the driver may confirm the presence and classification of a traffic incident. The latter step may be accomplished without voice communication through a terminal and keyboard at the driver's location.

5.4 Bus Rapid Transit Corridors

Bus rapid transit (BRT) (4) provides rapid, convenient and comfortable bus service. Components of bus rapid transit include:

- Improved running ways, including dedicated lanes and improved bus service in non-dedicated lanes.
- Enhanced and attractive stations.
- Improved vehicles.
- Frequent service.
- Simple, easily understood route structures.
- Simple lane collection and multiple door boarding, making it fast and easy to pay.
- Improved passenger information.

Running way improvements may include the following:

- Exclusive transitways.
- HOV Lanes.

- Dedicated transit lanes.
- Transit streets or malls.
- Queue jump lanes or bays.
- Signal priority for transit vehicles.

Locations in the U.S. that have deployed or are implementing BRT initiatives include:

- Los Angeles, California
- Boston, Massachusetts
- Eugene, Oregon
- Honolulu, Hawaii

References

1. "Symposium on Integrated Traffic Management Systems." *Transportation Research Circular #404*, March 1993.
2. "Policy for the Design and Operation of Closed-Circuit Television (CCTV), in Advanced Traffic Management Systems." New York State Department of Transportation, September 4, 2001.
3. "Task 3 Technical Memorandum – Transit Technology Compatibility – Route 5 Corridor Project, Capital District Transportation Authority." Dunn Engineering Associates, October 1999.
4. "BRT – Bus Rapid Transit." Transportation Research Board, 2001.

**CHAPTER 6
DETECTORS**

Table of Contents

Section	Page
6.1 Introduction	6-2
6.2 Detector Operations Summary	6-4
Detector-Controller Relationship	6-4
Low-Speed Approaches	6-8
High-Speed Approaches	6-9
6.3 Vehicle Detector Location and Configuration	6-14
Isolated Actuated Intersection Control	6-14
Small-Area Detectors	6-14
Large-Area Detectors	6-14
Left-Turn Lanes	6-18
Control of Arterial and Network Intersections	6-20
Detector Locations for Conventional Traffic Systems	6-21
Link Selection	6-21
Longitudinal Placement	6-21
Lateral Detector Placement	6-22
General Guidelines for Spotting Detectors	6-22
References	6-24

CHAPTER 6 DETECTORS



Figure 6-1 Radar detector.

6.1 Introduction

The *Traffic Detector Handbook* (1) provides a detailed discussion of traffic detectors. Klein (2) also provides extensive information, and was used as a major source in the preparation of this chapter.

Any traffic-responsive control system depends on its ability to sense traffic for local intersection control and / or system-wide adjustment of timing plans. A system accomplishes this by using one or more of the following detector types:

- Pavement Invasive Detectors
 - Inductive Loop: Most common detector technology. Consists of one or more turns of insulated loop wire wound in a shallow slot sawed in the pavement. Loop detectors come in different sizes and shapes, and various configurations can be used depending on the area to be detected, the types of vehicles to be detected, and the objective (such as queue detection, vehicle counting, or speed measurements).
 - Magnetometer: Measures changes in both the horizontal and vertical components of the earth's magnetic field. Early magnetometers could only detect the vertical component, which made them unable to operate

near the equator, where magnetic field lines are horizontal. Newer two-axis fluxgate magnetometers overcome this limitation. Magnetometers are useful on bridge decks and viaducts, where the steel support structure interferes with loop detectors, and loops can weaken the existing structure. Magnetometers are also useful for temporary installations in construction zones.

- Magnetic: Consists of a coil of wire with a highly permeable core. Measures the change in the lines of flux of the earth's magnetic field. Can only detect vehicles moving faster than a certain minimum speed, and therefore can not be used as a presence detector. Useful where pavement cannot be cut, or where deteriorated pavement or frost activity break inductive loop wires.
- Non-pavement invasive detectors
 - Microwave Radar: Transmits microwave energy toward the roadway. CW (Continuous Wave) Doppler radar can only detect flow and speed. FMCW (Frequency Modulated Continuous Wave) radar can also act as presence detector. Certain bridges with large steel structures can cause problems with radar based systems.
 - Active Infrared: Transmits infrared energy from detector and detects the waves that are reflected back.
 - Passive Infrared: Does not transmit any energy; detects energy from vehicles, roadway and other objects, as well as energy from the sun that is reflected by vehicles, roadway, and other objects.
 - Ultrasonic: Transmits ultrasonic sound energy waves, and measures the distance that the reflected wave travels. Can detect vehicle count, presence, and lane occupancy.
 - Acoustic: Measure vehicle passage, presence, and speed by passively detecting acoustic energy or audible sounds produced by vehicular traffic.
 - Video Image Processor: Video cameras detect traffic, and the images are digitized, processed and converted into traffic data. Can replace several loop detectors, and measure traffic over a limited area, rather than just a single point.
- Specialized detector function
 - Bus

- Automatic Vehicle Identification / Electronic Toll and Traffic Management
- Overheight
- Environmental
- Pedestrian
- Pre-emption

A system can use traffic detectors singly or in combination to measure variables such as presence, volume, speed, and occupancy. Occupancy refers to the percentage of time that there is a vehicle over the detector.

Systems use these variables as control parameters at individual signalized intersections, and in other advanced signal control logic.

For local control of intersections, the local controller will:

- Process these outputs,
- Compare processed detector information with some preset control parameter or parameters, and
- Make a decision on intersection phasing and timing.

This chapter discusses detector locations, configurations, and applications.

6.2 Detector Operations Summary

This section describes the detector-controller relationship and techniques for using detectors on low- and high-speed approaches. An understanding of this section will allow appropriate selection of a detector type for a given application. Tables 6-1 and 6-2 compare characteristics of different detector types.

Detector-Controller Relationship

A vital relationship exists between a controller's timing intervals and the detection techniques it employs. The appropriate combination of detector type, placement and controller settings can improve an intersection's efficiency and safety. The following discussion highlights this relationship and is based on *Guidelines for Selecting Traffic-Signal Control at Individual Intersections*, Vol. II (3).

Table 6-1 Strengths and weaknesses of commercially available sensor technologies.

Technology	Strengths	Weaknesses
Inductive Loop	<ul style="list-style-type: none"> • Flexible design to satisfy large variety of applications. • Mature, well-understood technology. • Large experience base. • Provides basic traffic parameters (e.g., volume, presence, occupancy, speed, headway, and gap). • Insensitive to inclement weather such as rain, fog, and snow. • Provides best accuracy for count data as compared with other commonly used techniques. • Common standard for obtaining accurate occupancy measurements. • High frequency excitation models provide classification data. 	<ul style="list-style-type: none"> • Installation requires pavement cut. • Improper installation decreases pavement life. • Installation and maintenance require lane closure. • Wire loops subject to stresses of traffic and temperature. • Multiple detectors usually required to monitor a location. • Detection accuracy may decrease when design requires detection of a large variety of vehicle classes.
Magnetometer (Two-axis fluxgate magnetometer)	<ul style="list-style-type: none"> • Less susceptible than loops to stresses of traffic. • Insensitive to inclement weather such as snow, rain, and fog. • Some models transmit data over wireless RF link. 	<ul style="list-style-type: none"> • Installation requires pavement cut. • Improper installation decreases pavement life. • Installation and maintenance require lane closure. • Models with small detection zones require multiple units for full lane detection.
Magnetic (Induction or search coil magnetometer)	<ul style="list-style-type: none"> • Can be used where loops are not feasible (e.g., bridge decks). • Some models are installed under roadway without need for pavement cuts. However, boring under roadway is required. • Insensitive to inclement weather such as snow, rain, and fog. • Less susceptible than loops to stresses of traffic. 	<ul style="list-style-type: none"> • Installation requires pavement cut or tunneling under roadway. • Cannot detect stopped vehicles unless special sensor layouts and signal processing software are used.
Microwave Radar	<ul style="list-style-type: none"> • Typically insensitive to inclement weather at the relatively short ranges encountered in traffic management applications. • Direct measurement of speed. • Multiple lane operation available. 	<ul style="list-style-type: none"> • CW Doppler sensors may not detect stopped vehicles. • Some models have problem when used in large steel structures. (i.e. steel bridges) • Overhead conductors within beam cone can cause problems.

Table 6-1 Strengths and weaknesses of commercially available sensor technologies (continued).

Technology	Strengths	Weaknesses
Active Infrared (Laser radar)	<ul style="list-style-type: none"> • Transmits multiple beams for accurate measurement of vehicle position, speed, and class. • Multiple lane operation available. 	<ul style="list-style-type: none"> • Operation may be affected by fog when visibility is less than ≈20 ft (6 m) or blowing snow is present. • Installation and maintenance, including periodic lens cleaning, require lane closure.
Passive Infrared	<ul style="list-style-type: none"> • Multizone passive sensors measure speed. 	<ul style="list-style-type: none"> • Passive sensor may have reduced vehicle sensitivity in heavy rain, snow & dense fog. • Some models not recommended for presence detection.
Ultrasonic	<ul style="list-style-type: none"> • Multiple lane operation available. • Capable of overheight vehicle detection. • Large Japanese experience base. 	<ul style="list-style-type: none"> • Environmental conditions such as temperature change and extreme air turbulence can affect performance. Temperature compensation is built into some models. • Large pulse repetition periods may degrade occupancy measurement on freeways with vehicles traveling at moderate to high speeds.
Acoustic	<ul style="list-style-type: none"> • Passive detection. • Insensitive to precipitation. • Multiple lane operation available in some models. 	<ul style="list-style-type: none"> • Cold temperatures may affect vehicle count accuracy. • Specific models are not recommended with slow moving vehicles in stop-and-go traffic. • Detection problems in highly elevated background noise environment.
Video Image Processor	<ul style="list-style-type: none"> • Monitors multiple lanes and multiple detection zones/lane. • Easy to add and modify detection zones. • Rich array of data available. • Provides wide-area detection when information gathered at one camera location can be linked to another. • Generally cost-effective when many detection zones within the camera field-of-view or specialized data are required. 	<ul style="list-style-type: none"> • Installation and maintenance, including periodic lens cleaning, require lane closure when camera is mounted over roadway (lane closure may not be required when camera is mounted at side of roadway) • Performance affected by inclement weather such as fog, rain, and snow; vehicle shadows; vehicle projection into adjacent lanes; occlusion; day-to-night transition; vehicle / road contrast; and water, salt grime, icicles, and cobwebs on camera lens. • Requires 50- to 70-ft (15- to 21-m) camera mounting height (in a side-mounting configuration) for optimum presence detection and speed measurement. • Some models susceptible to camera motion caused by strong winds or vibration of camera mounting structure. • Movement from other structures (i.e. span wires or overhead conductor) within field of view can cause problems.

Table 6-2 Traffic output data (typical), communications bandwidth, and cost of commercially available sensors.

Sensor Technology	Count	Presence	Speed	Output Data Occupancy	Classification	Multiple Lane, Multiple Detection Zone Data	Communication Bandwidth	Sensor Purchase Cost ^a (each in 1999 US \$)
Inductive Loop	✓	✓	✓ ^b	✓	✓ ^c		Low to Moderate	Low ⁱ (\$500 - \$800)
Magnetometer (two axis fluxgate)	✓	✓	✓ ^b	✓			Low	Moderate ⁱ (\$900 - \$6,300)
Magnetic Induction Coil	✓	✓ ^d	✓ ^b	✓			Low	Low to moderate ⁱ (\$385-\$2,000)
Microwave Radar	✓	✓ ^e	✓	✓ ^e	✓ ^e	✓ ^e	Moderate	Low to moderate (\$700-\$2,000)
Active infrared	✓	✓	✓ ^f	✓	✓	✓	Low to Moderate	Moderate to high (\$6,500-\$3,300)
Passive infrared	✓	✓	✓ ^f	✓			Low to Moderate	Low to moderate (\$700-\$1,200)
Ultrasonic	✓	✓		✓			Low	Low to moderate (Pulse model: \$600-
Acoustic Array	✓	✓	✓	✓		✓ ^g	Low to Moderate	Moderate (\$3,100-\$8,100)
Video Image Processor	✓	✓	✓	✓	✓	✓	Low to High ^h	Moderate to high (\$5,000-\$26,000)
	<p>a. Installation, maintenance, and repair costs must also be included to arrive at the true cost of a sensor solution as discussed in the text.</p> <p>b. Speed can be measured by using two sensors a known distance apart or estimated from one sensor, the effective detection zone and vehicle lengths.</p> <p>c. With specialized electronics unit containing embedded firmware that classifies vehicles.</p> <p>d. With special sensor layouts and signal processing software.</p> <p>e. With microwave radar sensors that transmit the proper waveform and have appropriate signal processing.</p> <p>f. With multi-detection zone passive or active mode infrared sensors.</p> <p>g. With models that contain appropriate beamforming and signal processing.</p> <p>h. Depends on whether higher-bandwidth raw data, lower-bandwidth processed data, or video imagery is transmitted to the TMC.</p> <p>i. Includes underground sensor and local detector or receiver electronics. Electronics options are available to receive multiple sensor, multiple lane data.</p>							

Low-Speed Approaches experience speeds less than 35 mi/hr (56.3 km/hr). Detection system requirements depend on whether the controller unit phase has been set to *locking* or *non-locking* detection memory (sometimes termed *memory ON* or *memory OFF*, respectively).

Locking Detection Memory enables a controller to *remember* or hold a vehicle call (even after the calling vehicle leaves the detection area) until satisfied by the appropriate green indication. Locking detection memory often uses small-area or point detection such as a 6- by 6-ft (1.8- by 1.8-m) loop or magnetometer. This approach minimizes detection cost. However, it cannot *screen out* false calls (such as those occurring with a right turn on red).

Most traffic engineers desire the allowable gap to range from 3 to 4 seconds, which requires locating the detector 3 to 4 seconds of travel time back from the stopline. This approach efficiently positions the detector to accurately time the end of green, after passage of the first vehicle of a queue or platoon.

However, the above technique applies only to low-speed approaches and intersections controlled by an actuated controller (without gap reduction). Using a practical allowable gap of 3 to 4 seconds, the detector setback should not exceed 170 ft (52 m). Some agencies prefer to limit this to 120 ft (37 m). See Table 6-3 for a summary of this principle (1).

Table 6-3 Detector location and timing parameters.

Approach Speed		Detector Set-Back From Stopline to Leading Edge of Inductive Loop Detector		Minimum Green Time	Passage Time
mi/hr	km/hr	feet	meters	seconds	seconds
15	24	40	12	9	3.0
20	32	60	18	11	3.0
25	40	80	24	12	3.0
30	48	100	30	13	3.5
35	56	135	41	14	3.5
40	64	170	52	16	3.5
45+	72+	Volume-density or multiple detectors recommended.			

Note: Volume-density could be considered at speeds of 35 mi/h (56 km/h) or above.

Non-locking Detection Memory sets phases through *loop-occupancy control* using large-area presence detectors, such as 6- by 50-ft (1.8- by 15.2-m) loops or multiple magnetometer detectors. In this non-locking mode, the controller phase drops (or *forgets*) a waiting call when the vehicle leaves the detection zone. This greatly simplified control strategy responds to the presence / non-presence of vehicles. The non-locking feature reduces delay by avoiding diversion of the right-of-way to an empty approach.

Loop-occupancy control was first used at intersections with a separate left-turn control, in addition to locations that permitted right-turn-on-red. In this application, a call placed during the yellow change interval cannot restore the green to an empty approach. Another potential advantage exists at intersections that permit a left-turn during the through movement (permissive left). To enhance this operation, a delay detector unit outputs a call to the controller only if a vehicle is continuously detected beyond a preset time period. The NEMA TS2 specification includes an optional delay / extension capability (4). Other controllers can achieve this capability using appropriate controller software. During light traffic conditions, left-turn and right-turn-on-red vehicles in transit over the loop are detected, but no call is placed until the preselected time delay has expired, thus reducing intersection delay by omitting unnecessary phase changes.

Often, loop-occupancy control is used for through-phase detection on approaches with low-approach speeds. This technique minimizes delay by allowing the use of a short extension interval in the range of 0 to 1.5 seconds.

The length of the detection area depends on the approach speed and the controller timing settings. For approach speeds below 30 mi/hr (48.3 km/hr), Figure 6-2 indicates a detection area length for various unit extension time settings (1). Approach speeds above 35 mi/hr (56 km/hr) require a different technique to alleviate driver indecision caused by the yellow change interval.

$$L = 1.47 S (3 - PT) - 18 \text{ in English units} \quad (6-1a)$$

$$L = 0.277 S (3 - PT) - 5.5 \text{ in metric units} \quad (6-1b)$$

Where

- L = length of detection area, ft (m)
- S = approach speed, mi/h (km/h)
- PT = passage time (unit extension), seconds.

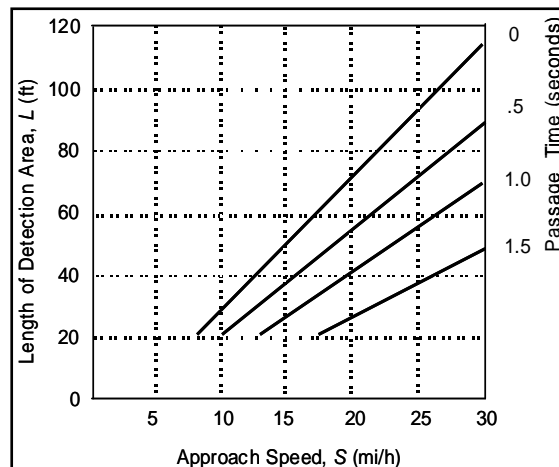

Figure 6-2 Inductive loop detector length for loop occupancy control.

High-Speed Approaches experience speeds of 35 mi/hr (56 km/hr) or greater. If the yellow change interval begins with a vehicle in an indecision zone, the driver may have

difficulty deciding whether to stop or proceed through. An abrupt stop may produce a rear-end collision, while going through on red may produce a right-angle accident. Table 6-4 shows the boundaries of the dilemma zone, and Figure 6-3 illustrates dilemma zone boundaries for a vehicle approaching an intersection at 40 mi/h (5). The data indicates that the upstream boundary of the dilemma zone, where 90 percent of motorists will decide to stop, lies 4.5 to 5 seconds from the intersection. The lower boundary, where 10 percent of the motorists will decide to stop, is 2 to 2.5 seconds from the intersection. Therefore, the duration of the dilemma zone does not exceed 3 seconds, starting approximately two seconds in advance of the stopline. Figure 6-4 shows one implementation for a high speed approach.

Table 6-4 Dilemma zone boundaries.

Approach Speed		Distances from intersection for 90% and 10% probabilities of stopping			
mi/h	km/h	90% values in feet	10% values in feet	90% values in meters	10% values in meters
35	56	254	102	77	31
40	64	284	122	87	37
45	72	327	152	100	46
50	80	353	172	108	52
55	88	386	234	118	71

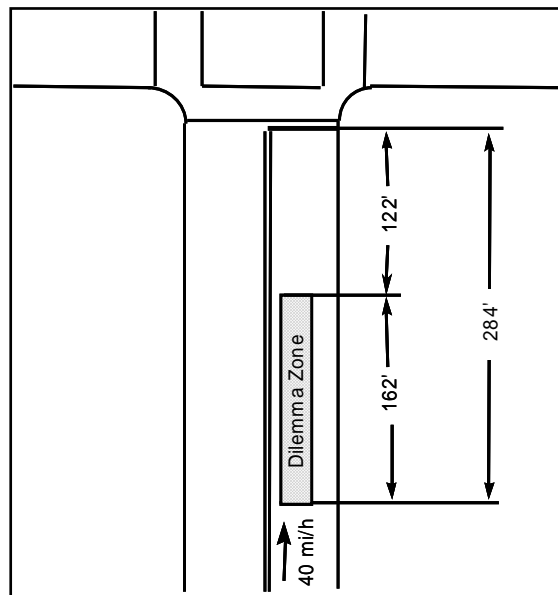

Figure 6-3 Dilemma zone for vehicle approaching an intersection at 40 mi/h (64 km/h).

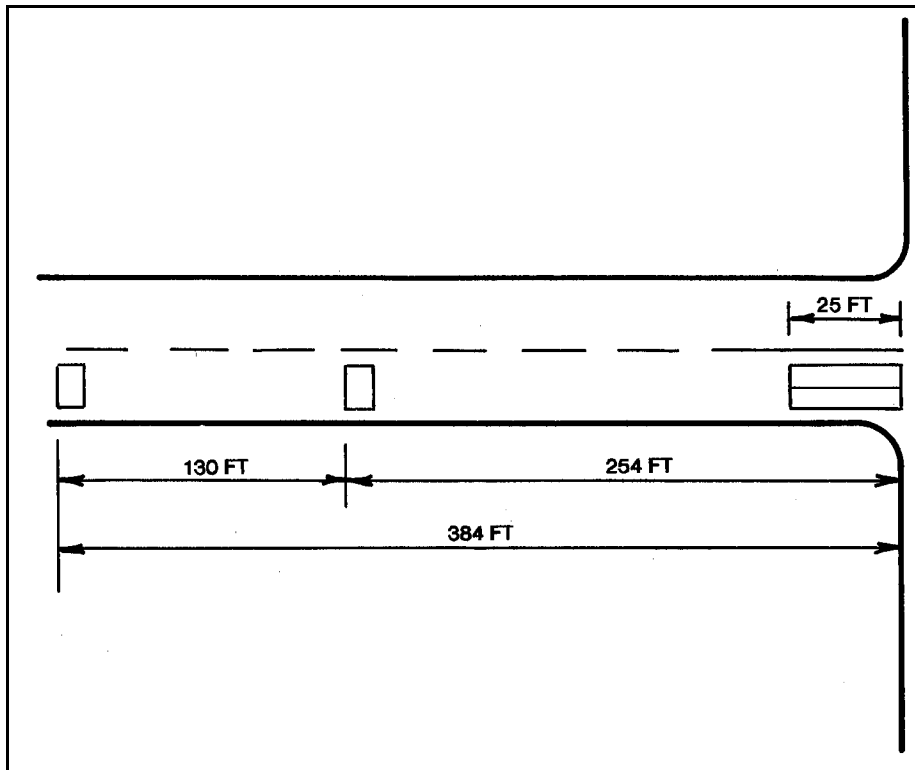

Figure 6-4 Loop location for extended call-delay design with 55 mi/hr (88.6 km/hr) approach design speed.

An actuated controller with appropriate detection can minimize inappropriate yellow change intervals. A research project examined a number of advanced detector-controller designs for high-speed, isolated approaches (6). Table 6-5 shows conventional detector-controller designs enhanced with multiple-point detection and / or a density-actuated controller (7). For details of the applications of these designs, see Chapters 10 and 11 of Reference 6. Table 6-5 demonstrates various combinations of detector-controller hardware that improve safety at high-speed intersections.

Table 6-5 Conventional detector-controller unit configurations for high-speed approaches.

Type of System	Design	Memory	Detection Type	Controller Comments
1. Green-extension systems for semi-actuated controllers	A. 2-loop B. 3-loop	Locking	Semi-actuated	Composed of extended-call detectors and auxiliary logic units to hold the controller in main street phase A, until the approaching vehicle has cleared the dilemma zone. Vehicles traveling slower than design speed or termination of green by gapout may be trapped in the dilemma zone. Increasing the passage time for protection results in an intolerable allowable gap.
2. Extended-call detection systems for basic controllers	A. Extended-call (EC) design uses 70 ft (21.3 m) loop at the stopline (normal detector output) supplemented by extended-call detector 5 seconds before the stopline B. Extended-call and delayed-call (EC-DC) design uses 25 ft (7.6 m) loop at stopline (delay-call output) supplemented by extension detector 5 seconds before stopline and a third detector between them (see figure 6-4 (8))	Non-locking	Basic full-actuated	A. The stretch setting on the extended-call detectors requires compromise between rapid operation and protection for slower vehicles. The allowable gap of the EC design is typically 5 seconds because of the stretch detector and long loop at the stopline. Appears limited to routes carrying less than 10,000 ADT. Design has lowest initial cost. B. A stretch setting of 2.2 seconds on the upstream loop will carry vehicles approaching within the speed range of 40 to 55 mi/hr (64.4 to 88.5 km/hr) through the dilemma zone. A vehicle traveling less than 40 mi/hr (64.4 km/hr) will also be protected because the yellow will appear before the vehicle has reached its dilemma zone. The 2.2 second extension time produces an allowable gap for traffic of 3.8 seconds (55 mi/hr (88.5 km/hr)) and 4.4 seconds (40 mi/hr (64.4 km/hr)). The allowable gap is actually greater than the 1 second difference of the EC design. The EC-DC design disables the stopline loops to give a decided superiority to EC design in real-world operation.
3. Multiple-point detection systems for basic controllers	A. Bierele modified method uses 5 detectors for 55 mi/hr (88.5 km/hr) approach speeds, with farthest detector placed 349 ft (106.4 m) from the stopbar. Uses special detector logic to determine approach speed and disable first 3 loops (see figure 6-5a (9))	Locking	Basic full-actuated	A. Bierele has modified his design for speeds greater than 40 mi/hr (64.4 km/hr). The first 3 detectors from the stopline are based on 40 mi/hr (64.4 km/hr) speeds and operate on 1 amplifier (speed detector). 2 additional, detectors are placed at 1 second intervals for 40 mi/hr (64.4 km/hr) until a distance of 349 ft (106.4 m) is reached, and tied to the second amplifier (standard detector). For speeds greater than 40 mi/hr (64.4 km/hr), the special detectors are disabled, and only the standard detectors extend the green to maintain a tolerable gap.

Table 6-5. Conventional detector-controller unit configurations for high-speed approaches (continued).

Type of System	Design	Memory	Detection Type	Controller Comments
<p>3. Multiple-point detection systems for basic controllers</p> <p>(Continued)</p>	<p>B. Texas Department of Highways and Public Transportation uses primary loop detector placement designs for 45 to 55 mi/hr (72.5 to 88.5 km/hr) (see figure 6-5a (9))</p>	<p>Locking</p>	<p>Basic full-actuated</p>	<p>B. This method used AASHTO stopping sight distances (based on 1 second perception-reaction time) for approach speeds up to 55 mi/hr (88.5 km/hr). This design is based on the assumption that a vehicle entering the loop field at the design speed will guarantee a safe stopping distance and a green if the speed is maintained or reduced by no more than 10 mi/hr (16.1 km/hr) between successive loops.</p>
	<p>C. Winston-Salem method employs 3 sensors for 50 mi/hr (80.5 km/hr) approach</p>	<p>Locking</p>	<p>Basic full-actuated</p>	<p>C. This method for detector placement is derived from the Bierle method, and uses stopping sight distances computed from the <i>Traffic Engineering Handbook</i>. The outermost point of initial detection is 240 ft (73.2 m) for a 50 mi/hr (80.5 km/hr) approach speed, which may not detect a vehicle before it reaches the dilemma time. Attempts to improve the design in that respect result in an allowable gap that is too long and frequently causes the controller to max-out.</p>
	<p>D. SSITE method uses 6 sensors for 50 mi/hr (80.5 km/hr) approach</p>	<p>Non-locking</p>	<p>Basic full-actuated</p>	<p>D. This multisensor design will adequately protect the driver from the dilemma zone, with its farthest detector set back 5 seconds from the stopline. However, with its 2 second vehicle interval, two-50 mi/hr (80.5 km/hr) vehicles will cause an allowable gap of 7 seconds; too long to be a design of choice.</p>
<p>4. Extended-call systems for density controllers</p>	<p>A. Single-point method composed of a presence loop at the stopline and one upstream detector</p>	<p>Non-locking</p>	<p>Density full-actuated</p>	<p>A. This method provides dilemma zone protection to vehicles operating at the design speed. The suggested 2 second vehicle interval may be insufficient for a slower vehicle to enter the usable yellow line.</p>
	<p>B. Multiple-point method employs a presence loop at the stopline and several upstream sensors</p>	<p>Non-locking</p>	<p>Density full-actuated</p>	<p>B. The multiple-point method can be configured to afford dilemma zone protection for a variety of approach speeds and operating conditions. A queue can get into motion without gapping out and false calls can be screened out because of detection at the stopline.</p>

6.3 Vehicle Detector Location and Configuration

This section focuses on alternative detector designs and their appropriate application to:

- Isolated actuated intersection control,
- Urban system control, and
- Freeway monitoring and control.

Isolated Actuated Intersection Control

Since vehicle arrivals fluctuate at individual intersections, efficiency depends on responsiveness to minute-by-minute demand variations. The actuated green interval is changeable and can be tailored to actual arrivals. This varying green interval (from minimum to maximum controller settings) is determined by the unit extensions generated by vehicles crossing the detectors. For most volume levels, full actuated control proves to be the most cost-effective method (10). Full vehicle actuation is normally preferable to pretimed or semi-actuated control.

Small-Area Detectors simply detect the passage of a vehicle at a spot location (e.g., upstream of the stopline). Small-area detectors are often called short-loop, point, or passage detectors. The magnetic detector can only be used for point detection because it covers a small area. Short-loop detectors (less than 20 ft (6.1 m) long) are the simplest and most common type.

As previously discussed, small-area loops back from the stopline act as calling detectors for high-speed approaches. Figure 6-5 illustrates a high-speed detector design using multiple short loops (11). Magnetometers also cover small areas. Some agencies use a single 6 ft (1.8 m)-long loop to cover two or more lanes. Single point detection is relatively inexpensive but gives no information on traffic between the downstream detector and stopline. Figure 6-6 illustrates the contrast between small- and large-area detection (10).

Large-Area Detectors, usually long loops, register presence of a vehicle in the detection zone as long as the detector remains occupied. In this mode, the controller holds in the extension interval until the detector clears. Thus, a very short extension interval is used. Figure 6-7 illustrates various detection designs, including both small- and large-area detection (9).

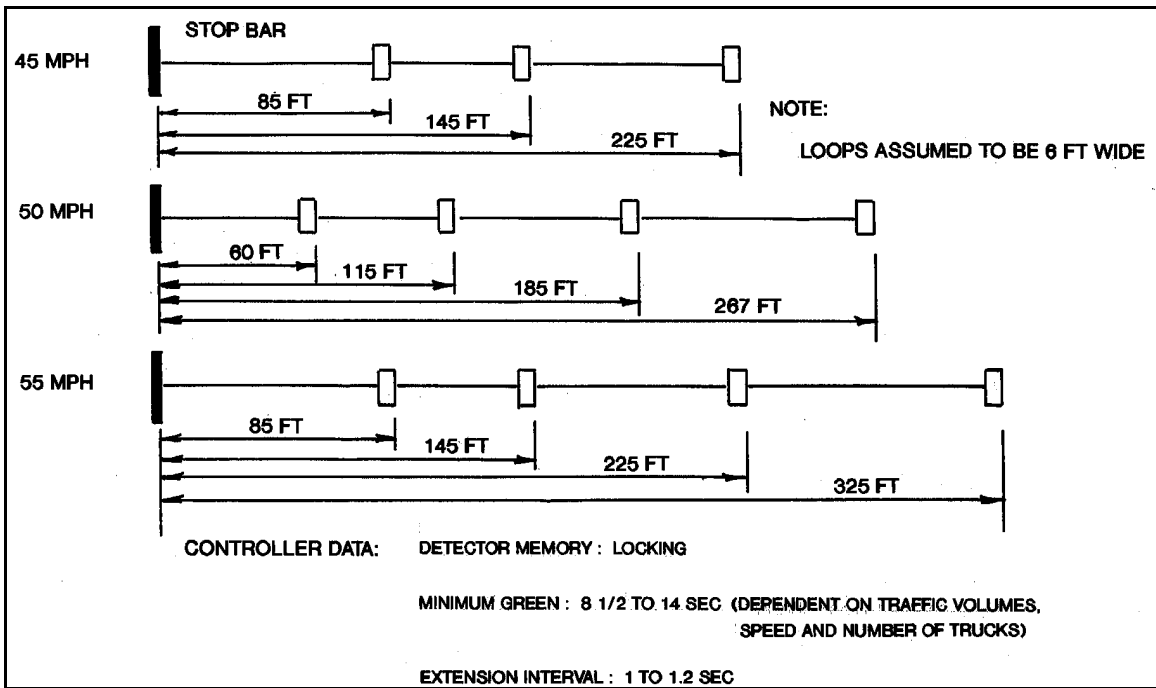

Figure 6-5 (a)

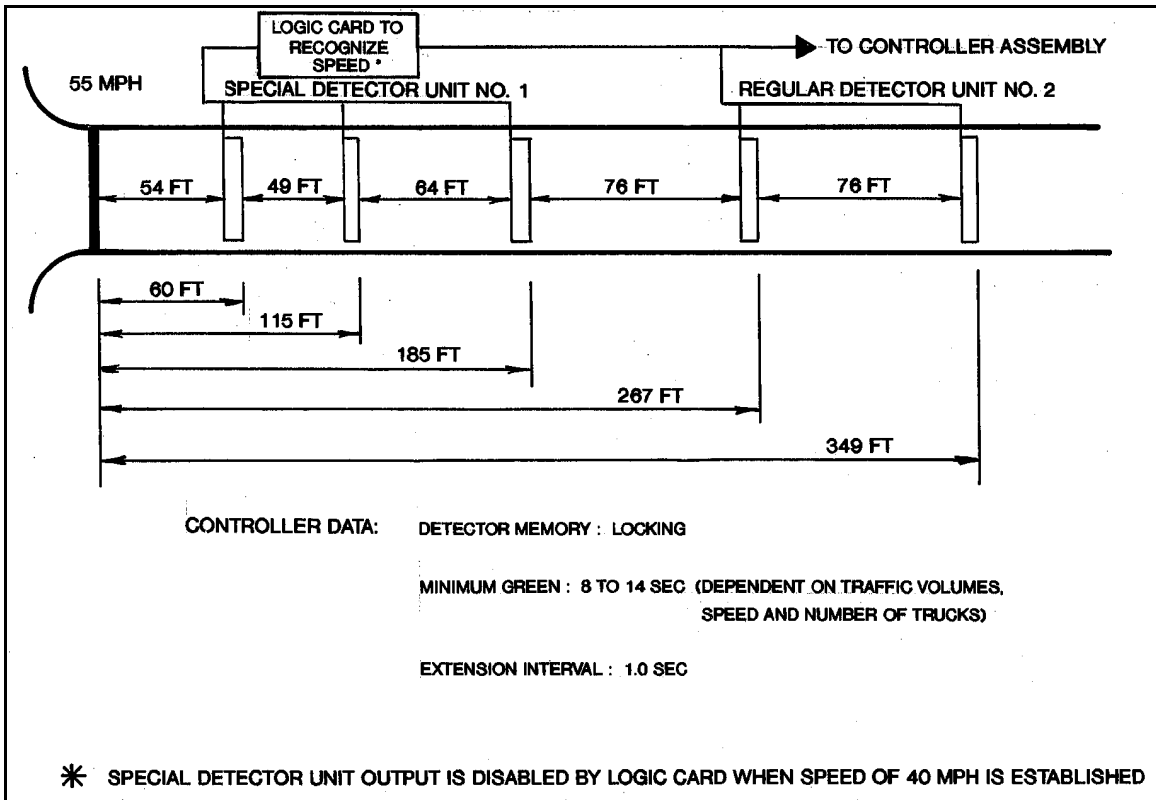

Figure 6-5 (b)

Figure 6-5 Two methods of multiple point detection systems for approach speeds up to 55 mi/hr (88.6 km/hr).

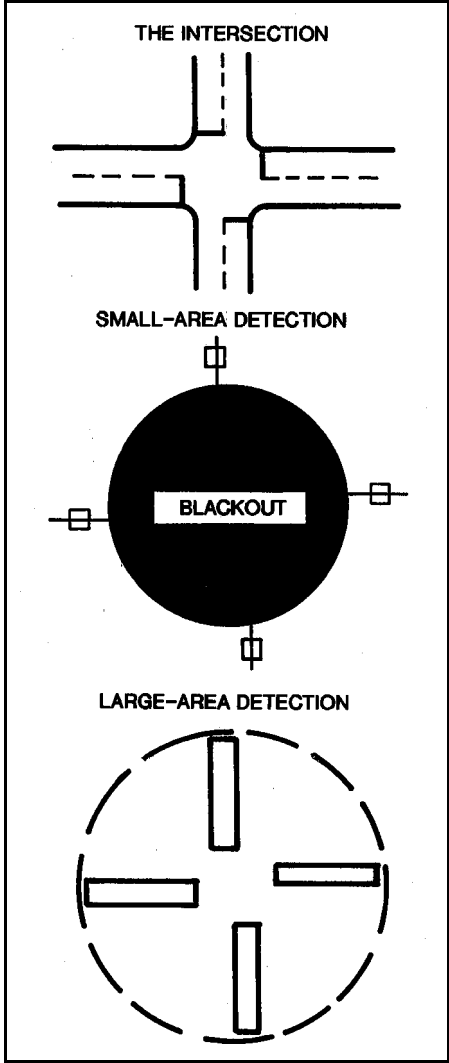

Figure 6-6 Contrast between small-area and large-area detection.

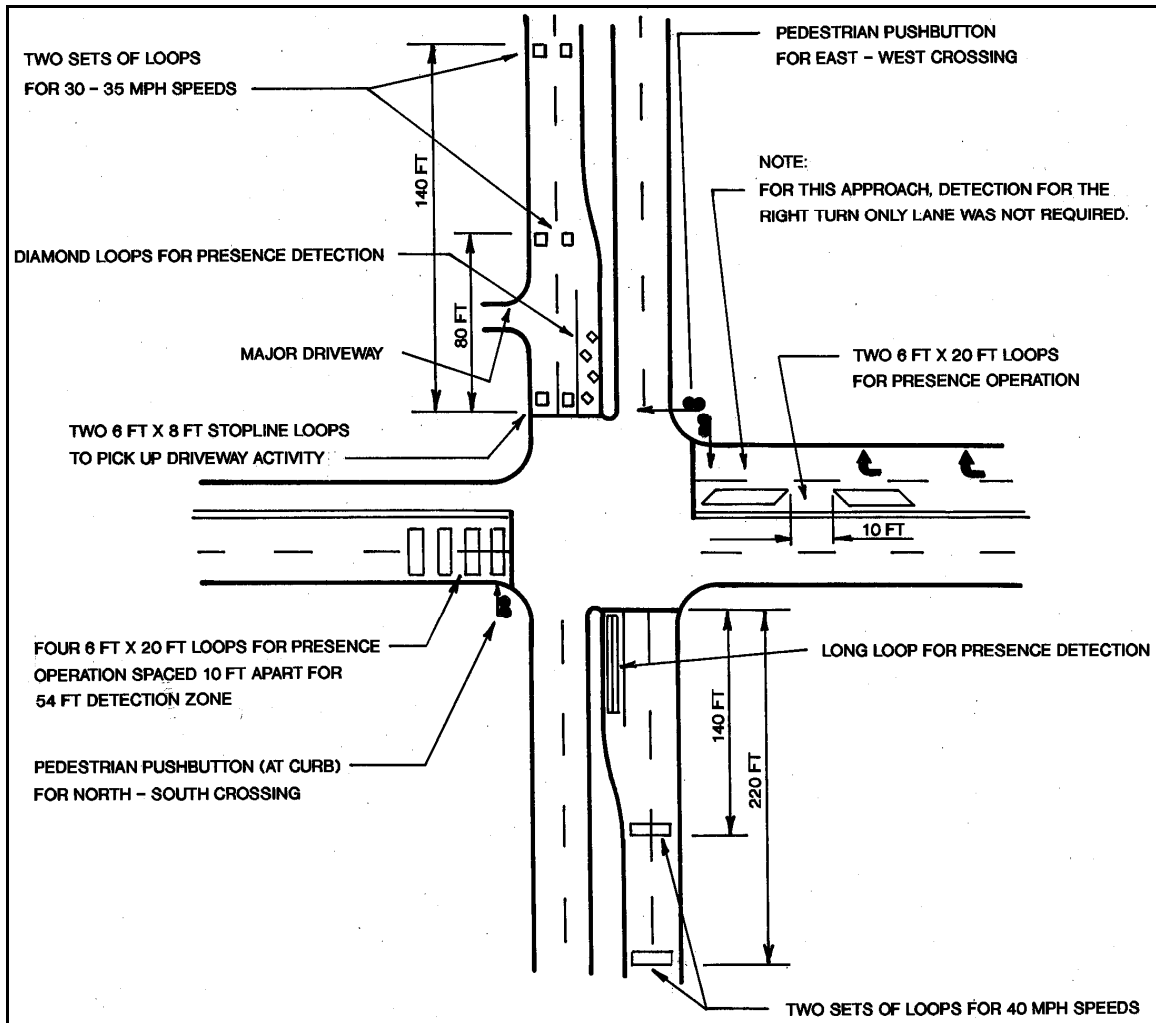

Figure 6-7 Typical detector designs.

As previously discussed, loop occupancy control uses large-area detection and non-locking detection memory. This design operates best with well-formed platoons on low-speed approaches. However, random vehicles may cause the controller to max-out when vehicle headways permit one vehicle to enter the detection zone just as the previous one leaves. Figure 6-4 shows detector placement for the extended and delayed call (EC-DC) design using large-area detection at the stopline with two small-area detectors upstream for high-speed vehicles (8). This detector configuration has proven very effective.

Disadvantages of large-area detection include:

- Higher installation costs, and
- Greater maintenance problems with long loops.

To reduce long loop problems, use a series of 6-ft (1.8-m) wide loops placed parallel to the stopline and separated by approximately 9 or 10 ft (2.7 or 3.0 m). This design allows:

- Higher loop sensitivity and protection against losing a lane of detection, and
- Operation with one or more failed loops.

Left-Turn Lanes. Efficient vehicle detection in left-turn lanes can increase intersection capacity by reducing lost green time. The Illinois Department of Transportation has designed a loop configuration for left-turn lanes that improves intersection efficiency and safety (12). Efficient presence actuation must account for:

- Driver start-up time averages 3 to 4 seconds for the first vehicle in a queue while headway averages 2 to 3 seconds between following vehicles. Loop length must accommodate longer than average reaction times to maintain green for starting vehicles.
- Trucks and other slow vehicles require a longer start-up time, often leaving a three to four car length (6 to 12 second) gap ahead of them. At locations with a relatively high percentage of trucks, loop length must account for these gaps.
- One or two vehicles require only a short green time. The detection zone length, however, must allow the following car either to reach the loop in time to maintain the green or decelerate to a stop.
- A vehicle extension interval of 1.0 seconds permits drivers to almost complete their turning radius before yellow occurs. Any additional extension becomes lost time. A shorter vehicle extension interval disturbs drivers when the yellow appears.
- A minimum loop length from the stopline of 80 ft (24.4 m).
- Vehicles allowed to turn left on the through green (permissive), normally proceed past the stopline and wait for a gap in the opposing traffic to complete their turns. Lack of a gap can strand the left-turner ahead of the detection zone that ends at the stopline. The controller will then skip the protected left-turn phase in the next cycle, if no other vehicles are waiting to turn left. The driver may complain of a malfunctioning signal resulting in an unnecessary service call. Extending the detection zone beyond the stopline may resolve this problem.

Figure 6-8 shows a minimum left-turn loop design that addresses the above requirements (12).

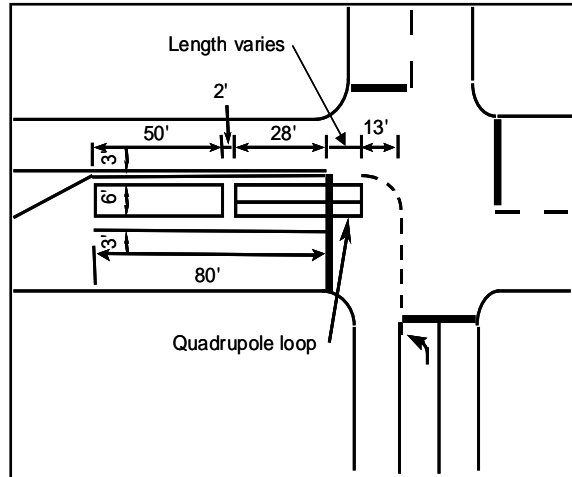

Figure 6-8 Left-turn detection inductive loop configuration used by Illinois.

The loop layout should include *advanced, local actuation detection* when:

- Left-turn demand requires storage of 150 ft (45.7 m) or more, or
- Approach speeds require a safe stopping distance.

Advanced detection using a call-extension feature, will extend the effective detection zone to accommodate heavy vehicle or truck volumes and provide for safer operation (see Figure 6-9 (12)).

In many instances, one 30 to 40 ft (9 to 12.2 m) presence loop suffices for left-turn detection and provides rapid initiation of the left-turn phase. Left-turn loop design varies with:

- Approach speed,
- Presence of heavy trucks, and
- Grade and intersection geometries.

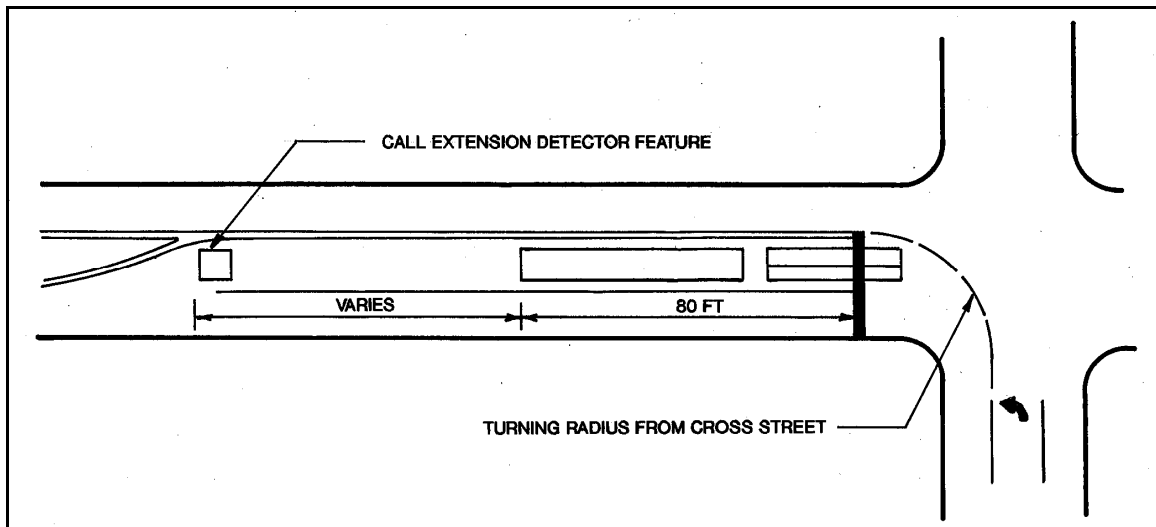

Figure 6-9 Extended detection on left-turn lanes.

Control of Arterial and Network Intersections

This section describes the data monitoring subsystem for traffic signal systems. *System* detectors are normally located in strategic locations within the system and usually require count and presence capability.

Volume and occupancy are the most commonly used variables in traffic control and are the most important factors in traffic-responsive plan selection and other real-time traffic-responsive algorithms. Volume proves to be the most easily obtained and accurate variable. Occupancy, as defined in Chapter 3, generally proves less accurate, since it can depend on vehicle profile and other factors. Measuring and detecting occupancy is extremely important, since it will continue to increase as intersections become saturated (Volume measures level off to a constant, proportional to green time divided by average vehicle headway.).

It has been observed that occupancies over twenty-five percent reliably indicate the onset of congestion (13). Accurate determinations of occupancy depend on the repeatability of the pickup and dropout characteristics of vehicles entering the detection zone and on variations in vehicle characteristics. An occupancy error is also introduced as a result of detector output being sampled by a communications unit or field microprocessor, rather than by continuous measurement. Therefore, occupancy measurements (in terms of percentage of error) tend to be more accurate at lower speeds. Chapter 3 describes several data-filtering and smoothing techniques relating to occupancy measurement.

A distinction should be made between *system* detectors and *local actuation* detectors. A local intersection detector connects directly to an actuated controller, whereas the system detector connects to the central computer or arterial master either directly or via the local controller.

Detector Locations for Conventional Traffic Systems

Data monitoring requirements for area wide traffic-responsive control depend on the control type.

Detector location for systems using the UTCS area control algorithm consists of a 3-step process that selects:

- Links,
- Longitudinal placement, and
- Lateral placement.

Link Selection is important, since cost increases in proportion with the number of detectorized links. A link is a section of roadway carrying a single direction of traffic flow between two signalized intersections. Links that approach the intersection of major arterials or the intersection of a major arterial with a moderately traveled arterial are usually selected for detector placement, as these links tend to dominate timing plan selection.

To implement timing plan selection by the UTCS algorithm, at least eight system detectors on different approaches in a single section are recommended. After 20 to 25 detector locations have been selected for a section, the value of information provided by additional detectors becomes marginal in terms of timing plan selection, but can be useful in providing additional resolution to the traffic operations engineer.

Longitudinal Placement for First Generation Control requires an accurate occupancy measurement to support the software.

Reference 14 recommends a distance of approximately 230 ft (70.1 m) from the upstream intersection stopline. Detectors should not be placed where standing queues from the downstream intersection typically extend. This distance depends on cycle length, split, and offset, but the following minimum distances are recommended:

- Urban grid areas: 200 to 250 ft (61 to 76.2 m)
- Suburban arterials: 300 to 350 ft (91.4 to 106.7 m)

The criteria based on typical queue size is considered more critical and should govern in the event of a conflict (14).

Another longitudinal-detector placement issue concerns traffic *sinks* and *sources*. Research indicates that a sink / source only minimally affects traffic in the critical lane when a facility operates as a sink; e.g., a parking garage during the morning peak. This results because vehicle turns into the sink usually occur from the curb lane, rather than

the critical lane. Measurable effects on the critical lane were observed only during the evening peak, when the facility functions as a source.

Most vehicles exiting a source wait for a sufficient gap in their target lane before entering traffic. Therefore, a critical lane detector should be located at least 50 ft (15.2 m) downstream from the source, provided that this meets the downstream intersection criteria described earlier. In general, unless the source contributes more than 40 v/hr to the critical lane, its effects on link demand are insignificant.

Lateral Detector Placement. The lateral positioning of detectors refers to the lane or lanes in which they are to be installed. In general, detectors must be capable of measuring the highest lane volume at the intersection approach. The work of Henry, Smith, and Bruggerman indicates that at the midblock location, the lane designated as the critical lane did not change over the entire daytime period for approximately 65 percent of the cases (15). To identify the high volume lane on all links when not directly obvious, recommended steps include (14):

- Identify the intersection approach requiring detectorization,
- Conduct measurements for 20 signal cycles during the A.M., P.M., and midday periods at each intersection approach,
- Collect the data by positioning manual observers at the longitudinal detector position,
- Record volume data on a 5-minute basis, and
- Analyze the data by comparing the total volumes measured for the approach lanes.

In many cases, simple observation of an intersection will establish the high volume lane. These more detailed measurements will only prove necessary in areas where short-term observation of intersection operation does not permit critical lane selection.

Balke et al (16) discusses considerations for locating detectors for closed loop traffic control systems. The guidance is generally similar to that provided for systems based on the UTCS algorithm.

General Guidelines for Spotting Detectors. Previous sections describe:

- Selecting links to be detectorized,
- Appropriate longitudinal location, and
- Detector lane placement.

After completing a detectorization plan, the engineer should walk through each link to select final detector locations. This field check should also consider:

- Access to the controller cabinet,
- Special driveway problems,
- Pavement conditions and special situations, such as pavement construction joints, and
- Manhole locations.
- Bus stop locations
- Time of day parking restrictions

General guidelines concerning field location of individual loop detectors include (14):

- Locate a detector in the center of traffic flow, not necessarily in the center of the marked lane. Identify the center of traffic flow by oil markings or tire tracks on the pavement.
- Locate the detector in areas of stable traffic flow. Avoid sections of a link with excessive weaving or entering and exiting driveways.
- When a major driveway occurs within a link, locate the detector at least 50 ft (15.2 m) downstream from the driveway, provided the detector is at least 200 ft (61 m) upstream of the stopline.
- Traffic detectors should not be located within 10 ft (3 m) of any manhole, water valve, or other appurtenance located within the roadway. This distance permits sufficient clearance for work in the manhole without disturbance to the detector.

The final location of detectors for advanced traffic control strategies blends analytical procedures and engineering judgment. Not all links yield measurements within the algorithm's required accuracy. Short links, and links with poor lane discipline; typify those not amenable to accurate instrumentation.

References

1. Klein, L. "Traffic Detector Handbook." Federal Highway Administration Report, Washington, DC. To be published.
2. Klein, L.A. "Sensor Technologies and Data Requirements for ITS." Artech House, Boston, MA, 2001.
3. Tarnoff, P.J., A.M. Voorhees, and P.S. Parsonson. "Guidelines for Selecting Traffic Signal Control at Individual Intersections." Vol. II, National Cooperative Highway Research Program, American Association of State Highway and Transportation Officials, Federal Highway Administration, Washington, DC, July 19, 1979.
4. "NEMA Standards Publications for Traffic Control Systems. TS2-1992". National Electrical Manufacturers Association (NEMA).
5. Zegeer, C.V. "Effectiveness of Green Extension Systems at High-Speed Intersections." Research Report No. 472, Kentucky Department of Transportation, Bureau of Highways, Division of Research. Lexington, KY, May 1977.
6. Sackman, H., B. Monahan; P.S. Parsonson, and A.F. Trevino. "Vehicle Detector Placement for High-Speed Isolated Traffic-Actuated Intersection Control." Vol. 2: Manual of Theory and Practice, FHWA-RD-77-32, Federal Highway Administration, Washington, DC, May 1977.
7. Parsonson, P.S. et al. "Signalization of High-Speed, Isolated Intersections." *Transportation Research Record 737*, pp. 34-42, 1979.
8. Parsonson, P.S., R.A. Day, J.A. Gaulas, and G.W. Black. "Use of EC-DC Detector for Signalization of High-Speed Intersection." *Transportation Research Record 737*, pp. 17-23, 1979.
9. Kell, J.H., and I.J. Fullerton. "Manual of Traffic Signal Design." Institute of Transportation Engineers, Prentice-Hall, Inc. Englewood Cliffs, NJ, 1982.
10. Tarnoff, P.J., and P.S. Parsonson. "Guides for Selecting Traffic Signal Control at Individual Intersections." *National Cooperative Highway Research Program Project 3-27 Research Results Digest 117*, Transportation Research Board, Washington, DC, February 1980.
11. Wu, C.S., and L. Machemehl. "Detector Configuration and Location of Signalized Intersections." Report 259-1F, Center for Transportation and Research, University of Texas, March 1983.

12. "Design of Detection Loops Specifications." Section V, Illinois Department of Transportation, pp. 24-27.
13. "Computerized Signal Systems, Student Workbook." Prepared for the Federal Highway Administration, U.S. Department of Transportation, Washington, DC, June 1979.
14. Kay, J.L., R.D. Henry, and S.A. Smith. "Locating Detectors for Advanced Traffic Control Strategies Handbook." FHWA-RD-75-91, Federal Highway Administration, Washington, DC, 1975.
15. Henry, R.D., S.A. Smith, and J.M. Bruggerman. "Locating Detectors for Advanced Traffic Control Strategies." Technical Report, FHWA-RD-75-92, Federal Highway Administration, Washington, DC, September 1975.
16. Balke, K.N., S.R. Keithreddipalli, and C.L. Brehmer. "Guidelines for Implementing Traffic Responsive Mode in TXDOT Closed Loop Traffic Signal Systems." Texas Transportation Research Report 2929-3F, College Station, TX, August, 1997.

**CHAPTER 7
LOCAL CONTROLLERS**

Table of Contents

Section	Page
7.1 Introduction	7-2
7.2 Types of Operation	7-4
7.3 Range of Applications	7-5
Types of Signal Operation.....	7-5
Protected, Protected / Permissive, and Permissive Operation	7-7
Special Controls	7-7
7.4 Controller Evolution	7-8
7.5 Controller Characteristics	7-9
Signal Timing and Coordination	7-9
Interval Control versus Phase Control.....	7-9
Controller and Cabinet Components	7-12
Pattern Selection.....	7-13
Internal time-of-day schedule	7-13
Hardwire interconnect.....	7-13
External command	7-13
Synchronization for Coordination	7-14
Manual	7-14
Hardwire pulse	7-14
External command	7-14
Third-party time source.....	7-15
Actuated Controller Operation	7-15
Phasing Other Than Eight-Phase Dual-Ring	7-20
Diamond Interchange Operation	7-25
Single Point Freeway Interchange Operation.....	7-31
System Capabilities	7-34
7.6 NEMA, Advanced Transportation Controller, and Model 170 Standards	7-34
Controller Selection and Migration.....	7-39
References	7-42

CHAPTER 7 LOCAL CONTROLLERS



Source: Eagle Products

Figure 7-1 Model 2070 Controller.

7.1 Introduction

This chapter provides detailed information on intersection traffic signal controllers so that the user can:

- Understand the principles of controller operation,
- Become familiar with various controller types, and
- Select controllers for specific applications.

Table 7-1 presents some basic definitions used throughout the chapter, while Table 7-2 summarizes functions performed by a local controller. Table 7-3 summarizes the two distinct modes of traffic signal controller operation – isolated and coordinated. A signal operating in isolated mode can also be said to be operating free or uncoordinated.

A subsequent section of this chapter discusses controller units for applications other than traffic signals. See also Chapters 3 and 4 of this Handbook for additional information on some special control concepts.

Table 7-1 Definition of controller terms.

TERMS	DEFINITIONS
Controller Assembly	The complete electrical mechanism mounted in a cabinet for controlling signal operation. The controller assembly generally includes the cabinet
Controller Unit	Portion of a controller assembly which selects and times signal displays
Intersection Controller Unit	The traditional and original usage, most commonly referred to as <i>traffic signal controller</i> .
Special Controller	Includes units for lane use control and other applications not involving the traditional assignment of right-of-way for vehicles and pedestrians at intersection or midblock locations.

Table 7-2 Traffic signal controller functions.

<ul style="list-style-type: none"> • Can Control: <ul style="list-style-type: none"> - single intersection - closely spaced multiple intersections - midblock crosswalk • Electrically switches signal indications: <ul style="list-style-type: none"> - red - yellow - green - WALK - DON'T WALK - other • Assures appropriate right-of-way assignments in accordance with pretimed or actuated intervals or phases • Times fixed clearance intervals such as: <ul style="list-style-type: none"> - flashing DON'T WALK - yellow - red clearance • Times greens and green arrows for: <ul style="list-style-type: none"> - fixed-duration (pretimed control) - variable duration (up to a predetermined maximum) according to traffic demand (actuated control) • Times special function timed intervals such as: <ul style="list-style-type: none"> - lane controls - turn controls - blank out signs

Table 7-3 Isolated versus coordinated signal modes.

Mode	Definition
Isolated (Free)	The signal controller times right-of-way assignments independently of other signals. If one or more phases are actuated, the cycle length may vary from one cycle to the next.
Coordinated	The signal controller timing is coordinated with that of one or more adjacent traffic signals to avoid stopping approaching platoons of cars. Traditionally, this involves operating this and adjacent signals at the same, fixed-duration cycle length. Adaptive coordination techniques can achieve coordination while still allowing the cycle length to change from one cycle to the next.

7.2 Types of Operation

Despite the many variations in their design, traffic signals can be classified according to operational type as:

- Pre-timed (or fixed time),
- Fully actuated, and
- Semi-actuated.

Table 7-4 describes characteristics and applications of each of these types.

An actuated traffic signal is one that employs vehicle or pedestrian detectors to activate a particular phase (change it from red to green) only when vehicles or pedestrians are present. Once activated, the duration of the green display may vary depending on the number of vehicles detected.

Pre-timed, or fixed-time, phases are served for a fixed duration every cycle regardless of the number of vehicles or pedestrians present. A signal is pre-timed if all phases are fixed, and is fully actuated if all phases use detection. A semi-actuated signal has a mixture of pre-timed and actuated phases.

Coordinated signals are often operated in a semi-actuated mode. In this case, the main-street through phases need not have detectors, and are served every cycle regardless of demand. A coordinated signal must operate with a fixed-duration cycle. In a typical semi-actuated signal, if one or more actuated phases do not require all their allocated portion of the cycle, unused time is automatically re-assigned to the main street, non-actuated phases, which always terminate (turn yellow) at the same point in the cycle regardless of how early they commence (turn green).

Table 7-4 Types of signal operation.

Operation	Characteristics
Pretimed	Occurrence and duration of all timing intervals, both vehicle and pedestrian, in all phases are predetermined.
Fully Actuated	<ul style="list-style-type: none"> • All phases are actuated (i.e., use vehicle or pedestrian detectors). • Phases are skipped (not served) if no vehicles or pedestrians are detected. • If vehicles are detected but not pedestrians, only the vehicle portion of the phase may be served. • The Green interval of phases can vary in duration, between minimum and maximum values, depending on detected traffic demand. When a vehicle leaves a detector, the green is extended by a few seconds known as passage time or green extension. The phase terminates if all detectors for the phase remain unoccupied for duration longer than the 'gap' time. • The Walk interval is usually of fixed duration, but if the signal is coordinated, the Walk interval may be allowed to extend to make use of predictable additional green time, especially for main street phases. • Other intervals (e.g., yellow, red clearance, flashing Don't Walk) are of fixed duration.
Semi-Actuated	<ul style="list-style-type: none"> • At least one phase is guaranteed to be served while others are actuated. • This phase receives a guaranteed, or fixed, minimum amount of time. • If there is no demand for actuated phases, the guaranteed phase remains green longer than its "fixed" green time. • If the signal is coordinated, a guaranteed phase is usually the main street through phase. If actuated phases terminate before using all their split allocation, the spare time can be reassigned to the guaranteed phase, causing it to receive more than the "fixed" amount of green.

Most modern traffic signal controllers support all of these types of signal operation. Even though a signal controller may provide actuation features for all phases, any or all phases may be made to operate as pretimed by use of the "call to non-actuated" input, or by using phase parameters such as recall, minimum green, and coordinated phase designation.

7.3 Range of Applications

Types of Signal Operation

Table 7-5 summarizes applications of the above-described types of signal operation, for each of the following three commonly encountered intersection environments:

- Isolated – a signalized intersection that is physically remote from other signalized intersections and therefore does not benefit from signal coordination.
- Arterial – a signalized intersection that is one of a series of adjacent signalized intersections along an arterial roadway, and benefiting from coordination during at least some times of the day - commonly found in suburban areas.

- Grid – a signalized intersection that is one of a series of adjacent signalized intersections in a grid of fairly short blocks - commonly found in older, high density urban areas and central business districts.

Table 7-5 Application of signal control types.

Type of Operation	Isolated	Arterial	Grid
Pretimed	Usually not appropriate.	Appropriate only if always coordinated and the side street volumes are high and consistent.	Appropriate
Semi-actuated	Appropriate only if main street traffic is consistently heavy.	Appropriate if always coordinated.	Appropriate to actuate left turn phases and other minor movements, and mid-block pedestrian signals.
Fully Actuated	Appropriate	Appropriate if not always coordinated.	Usually not appropriate.
Volume Option for actuated phases (see Section 7.5)	Appropriate for phases with only detectors set back more than 40 meters (125 feet).	Appropriate for phases with only detectors set back more than 40 meters (125 feet).	Usually not appropriate because slow speeds mean less detector set back.
Density Option for actuated phases (see Section 7.5)	Appropriate if high speeds, as higher initial gap can reduce stops.	Appropriate if high speeds, as higher initial gap can reduce stops.	Usually not appropriate due to low speeds.

Pretimed control best suits locations where traffic proves highly predictable and constant over a long period of time, and adjacent signals need to be coordinated at all times. These situations are commonly encountered in dense grid street networks (1).

Fully actuated control usually proves the most efficient operation at isolated intersections. On making the decision to install a traffic signal, first consider fully actuated control. Its traffic-responsive capability adjusts cycle and phase (split) lengths to fit changing demands from cycle to cycle. Rarely do approach traffic volumes at an isolated intersection remain predictably constant over a long period. Because all phases usually do not peak simultaneously, it should not be assumed that a full-actuated signal operates on a fixed cycle length even with high traffic demand.

Fully actuated control applies to a variety of signal phasing and detection schemes ranging from a simple two-phase operation to an 8-phase dual-ring configuration. Because of its skip-phase capability, the 8-phase dual-ring controller may operate as a basic two-phase controller under light traffic conditions; in the absence of demand, the controller unit ignores that phase and continues around the ring seeking a serviceable phase (1).

If an actuated signal is always coordinated, the cost of signal construction and maintenance can be reduced by using semi-actuated signal operation, with the main street through phases as pre-timed phases without vehicle detectors.

Protected, Protected / Permissive, and Permissive Operation

Traffic operations should aim to eliminate unnecessary delays at signalized intersections. Appropriate use of protected / permissive and permissive only traffic operation provides one means of reducing left- turn movement delay.

Provide separate left-turn phases only where needed, because unnecessary separate left-turn movements increase cycle length and traffic delays. Traffic control without separate left-turn operations can minimize delay for all movements including left-turns. However, conditions exist that require protected / permissive operation or justify protected (only) operation. Asante, et al. provides a set of guidelines for left-turn protection (2). The report provides guidance on:

- Justification of some form of protected left-turn phasing,
- Selection of type of left-turn protection, and
- Sequencing of left-turns.

Permanent changes from one type of operation to another may prove appropriate as traffic volumes change over time. Traffic operation can also change from protected to protected / permissive or permissive operation as traffic patterns change during the day and / or week.

When addressing left turn movement issues, it may be important to provide a left turn pocket for permissive left turn movements. However, in some cases, this will require the elimination of parking near the stop line in order to make room for the additional width needed for the left turn pocket.

Special Controls

A number of applications use special-purpose controller assemblies with electrical switching of signal indications akin to intersection controllers. Some of these applications include:

- Flashing beacons for various applications such as:
 - Roadway hazard identification,
 - Enforcement time definition for speed limits,
 - Intersection hazard identification with stop control, and
 - Use of visual-attention device with individual stop signs.

- Lane control signals (e.g, reversible lanes),
- Changeable lane use signs at intersections,
- Movable bridge signals and one-lane, two-way operation signals,
- Overheight vehicle controls to avoid structural damage by overheight commercial vehicles, and
- Audible pedestrian signals (3, 4, 5) that emit a buzzer or chirp sound for the initiation of a walk interval or phase to the visually impaired.

7.4 Controller Evolution

The evolution of traffic signal controllers parallels the evolution in related electronics industries. Signal controller unit hardware has evolved from the days of motor-driven dials and camshaft switching units to the adaptation of general-use microprocessors for a wide variety of intersection and special control applications.

In the early years of traffic signal control, virtually the only commercially available controller units were the electromechanical type. Later, several manufacturers introduced semi- and full-actuated controllers equipped with vacuum tube circuits for timing functions. The traffic engineer adjusted interval and phase timing via knobs on a control panel. Transformers and vacuum tubes in these analog units generated considerable heat, requiring forced-air circulation and filtering in controller cabinets. Some manufacturers retained solenoid-driven camshafts for lamp switching, while others used stepping relay-driven stacked rotary switches and encapsulated relays. Short component life and timing drifts characterized these controllers.

Replacement of the vacuum tube with the transistor introduced low-voltage circuitry with only a fraction of the former heat generation. The high-amperage heater circuits and high-voltage B plate circuits once required for vacuum tubes passed from the scene. The mid-1960s saw transistorized circuits first used for timing and phasing functions. Lower operating temperatures increased component life, and digital timing ensured timing accuracy and eliminated fluctuations. During this period manufacturers also introduced the solid-state load switch for lamp circuits. Wide variations in component and equipment arrangements from manufacturer to manufacturer also prevailed during the 1960s. Designs varied from those in which all timing and phasing components were placed on a single circuit board to those that used modular, plug-in phase and function-oriented designs.

The integrated circuit (IC) proved the next major step in controller evolution as microchip technology significantly reduced component size. These very small chips were linked together in circuits and sealed within an IC envelope to form the

microprocessor. This development led to microcomputers – small, lightweight, low-cost units used practically everywhere today.

The traffic control industry quickly incorporated microprocessors into new signal controller designs. They are used in all modern traffic signal controllers.

The functionality and characteristics of a modern signal controller are determined by software more than hardware. The same physical controller may operate quite differently when loaded with a different software package.

Different standards have evolved for modern traffic signal controllers, including those developed by the National Electrical Manufacturers Association (TS 2), and Caltrans, New York DOT and FHWA (Model 170). These standards, and the Advanced Transportation Controller (including the ATC 2070) are discussed in Section 7.6.

7.5 Controller Characteristics

Signal Timing and Coordination

Traffic signal controllers alternate service between conflicting traffic movements. This requires assignment of green time to one movement, then to another. If left turns have separate controls, and at complex intersections, there may be more than two conflicting movements. The length of time taken to complete one round of service for all conflicting movements is called the *cycle length*, and the allocation of the cycle length between the conflicting traffic movements is called the *split*.

To minimize traffic delay, it is desirable that a platoon of vehicles leaving one intersection arrives at the next intersection during a green display. This is called platoon progression and is achieved by coordinating the operation of adjacent signals. Signal coordination is most commonly achieved by operating adjacent signals at the same cycle length, with a pre-determined *offset* between the start of the cycle at one intersection and the start of the cycle at the next. See Chapter 3 for further discussion of coordination timing parameters.

The cycle length, split, and offset may need to change during the day as traffic volumes change. Controllers, therefore, allow the user to establish multiple sets of these basic coordination timing parameters. Each such set is referred to as a timing plan or timing pattern, and one timing plan or timing pattern is in operation at any given time. The timing plan or timing pattern in operation can be changed either by a time-of-day schedule stored in the controller or by a command from a master device.

Interval Control versus Phase Control

Traffic signal controllers available today can be categorized as interval controllers (also called pretimed) or phase controllers (also called actuated). The former allow the user to divide the cycle into any number of intervals, with the duration of each interval being set

by the user. The user then defines which output circuits are switched on during which intervals. For example, a particular interval may be used to time part of the green for one vehicle movement, part of the flashing don't walk for a pedestrian movement, the yellow for another vehicle movement, and part of the red and steady don't walk for others.

The cycle length equals the sum of the interval durations, and all intervals are timed sequentially. The user can also specify a start-of-cycle offset for signal coordination. The interval durations, output definitions, cycle length, and offset can all be varied from one pattern to another, and therefore can be varied during the day.

Modern interval controllers typically also allow a degree of actuated operation, whereby selected intervals may be skipped if there is no demand, or the duration of selected intervals can vary dynamically by detector actuations. If an interval does not use all of its allocated time, the spare time can be assigned to a following interval. Some controllers allow the user to create quite elaborate customized logic for controlling interval occurrence and duration.

Phase controllers take a different approach to signal timing. They divide the cycle into phases, with each phase having five pre-defined intervals - green, yellow and red clearance for vehicle control; and walk and flashing don't walk for pedestrian control. The user specifies the duration of each of these intervals, or in the case of the green interval, the minimum and maximum duration. If the signal is coordinated, the user also specifies a split time for each phase, and a start-of-cycle offset.

The user assigns a phase to a set of compatible vehicle and pedestrian movements. If coordinated, the split times for all phases in a ring must sum to the cycle length. Each phase is assigned to a timing ring (Figures 7-2 and 7-3). Phases assigned to the same ring time sequentially, but rings time concurrently. Therefore, if the controller is using two rings, two phases can be timing simultaneously and independently.

Phase controllers use barriers or phase concurrency groups to define conflicts between phases in different rings. Within a concurrency group (between two barriers) the phases in different rings can time independently, but all rings must cross the barrier (move to a different phase concurrency group) simultaneously.

Within a concurrency group (between two barriers) the user can specify the desired order (sequence) in which phases in the same ring are to be served. From one pattern to the next, the user may vary the cycle length, offset, split, and phase sequence.

Phase control is particularly well suited to actuated control of normal intersections, especially those with protected left turn movements. Two actuated left turn phases on the same street can time independently, with say the westbound turn phase receiving less time than the eastbound in one cycle, and the opposite occurring in the next cycle. For this reason, and their ease of setup and additional actuation features, phase controllers have become the dominant type.

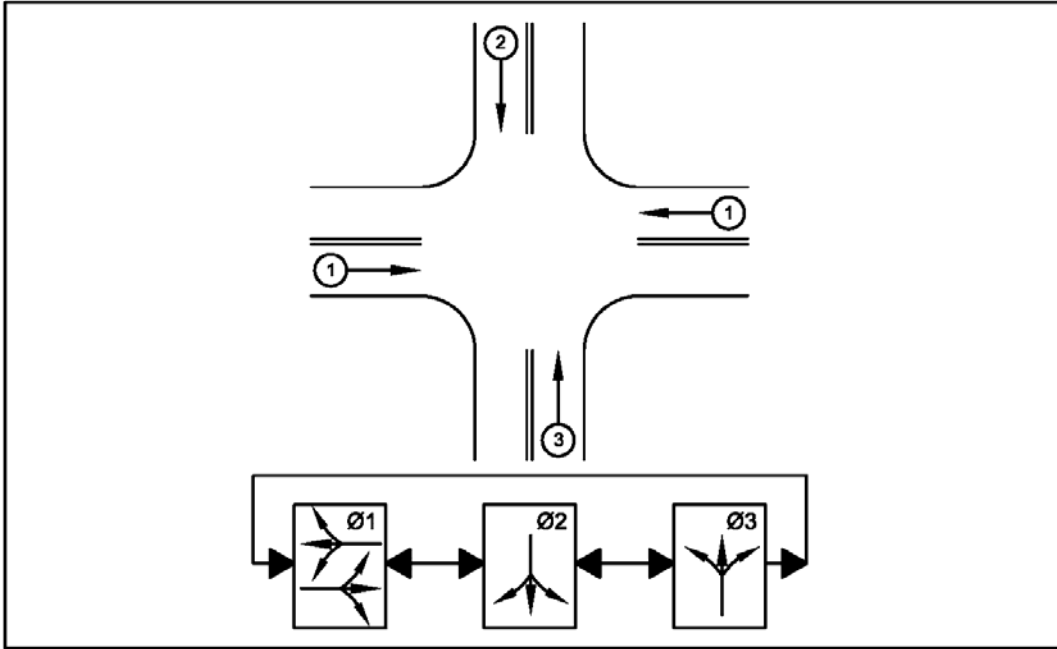

Figure 7-2 Three-phase controller phase sequence for single-ring controller.

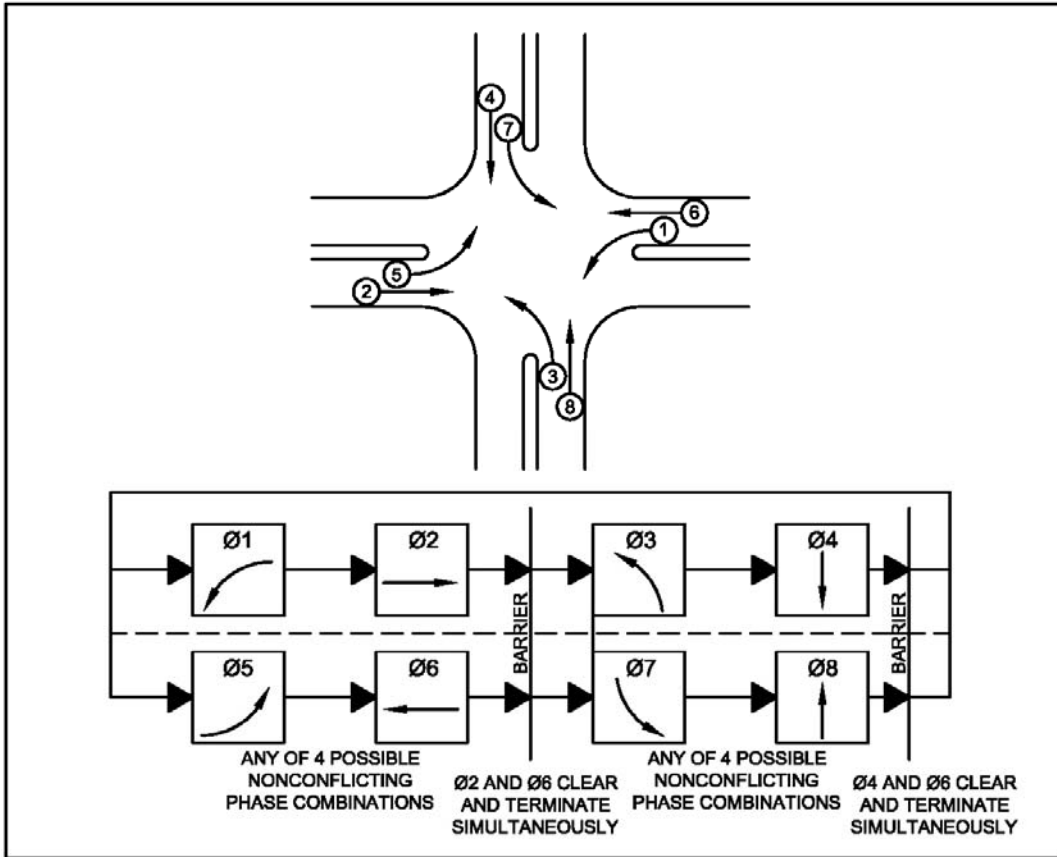

Figure 7-3 Phase sequence for dual-ring controller.

For many years, phase controllers were limited to eight phases allocated to two rings in a fixed arrangement. This works very well for most intersections, but does not provide the flexibility needed for unusually complex intersections. Also, if fixed-time control is sufficient and left turn phasing is not prevalent, such as often occurs in the central business districts of large cities, the interval controller is adequate. Interval controllers therefore have remained in use, although their numbers are dwindling as phase controllers have expanded to accommodate more phases and rings, and have added features such as redirection of outputs. Each phase in a phase controller can be operated either pretimed (fixed time) or actuated.

The National Electrical Manufacturers Association (NEMA) TS 2 standard specifies minimum functional standards for both interval and phase controllers. Most modern controllers meet most or all of these minimum requirements and most controllers also provide additional functionality not yet standardized.

Controller and Cabinet Components

Most modern traffic signal controllers have the following basic hardware components:

- User interface (keypad and display)
- Central processing unit (microprocessor, memory, etc.)
- External communications connectors (serial ports, Ethernet, USB, cabinet wiring, etc.)
- Power supply (converts 110v AC to 24v, 12v, 5v DC for internal use)
- Optional additional serial communications processor (FSK modem, RS 232)

Serial communications ports are often used for establishing a link to a master control unit or computer. Such connections may be permanent to a remote master or computer, or temporary to a laptop computer used by field personnel. Ethernet is increasingly being used instead of serial communications. As special serial port may be used to communicate with in-cabinet equipment in the case of a serial-bus cabinet (see NEMA TS 2 and ATC sections below).

Within the signal controller cabinet, and connected to the controller, are the following basic auxiliary components that interact with the controller:

- Malfunction management unit (also referred to as a conflict monitor)
- Vehicle and pedestrian detectors (sensor units, circuit isolators)
- Output circuit drivers (load switches driving signal displays)

- Optional external communications devices (external FSK modem, fiber transceiver, wireless transceiver, Ethernet switch, etc.)

Detectors are used only for actuated signals. A load switch uses a low voltage direct current output of the controller to switch a 110v AC circuit on or off, thus turning on or off a signal display viewed by motorists or pedestrians. For a particular phase, one circuit is switched off just as another is switched on.

The malfunction management unit (MMU) can be configured to check for conflicting signal indications and various other malfunctions including absence of an OK status output from the controller (watchdog output), short or missing clearance intervals, and out-of-range operating voltages. If a malfunction is detected, the MMU automatically places the signal in an all-red flashing state, overriding the outputs of the controller. Modern controllers can sense this condition and report the malfunction state to a master or central computer.

Pattern Selection

Modern controllers offer the following three alternative methods of determining which pattern or plan to operate:

Internal time-of-day schedule – the user configures a schedule that tells the controller when to change the pattern or plan, based on the day of the week and time of the day. Special schedules can be created for holidays or other dates on which traffic conditions are unusual. The controller’s clock, which keeps track of date, day of week, and time, is regularly compared to the entries in the schedule. No external communications are required. This mechanism is often used as a backup when an external pattern selection method fails. This method is commonly used.

Hardwire interconnect – multiple electrical wires (typically seven) installed between the controller and a master unit, have a steady voltage applied or removed to indicate which pattern or plan is to be used. When the combination of active (voltage on) and inactive (voltage off) wires changes, the combination is used by the controller to look up which pattern or plan to change to. Traditionally, this method was used to independently select which of several pre-defined cycle lengths, offsets, and splits to use, thus emulating the selection of dial, offset, and split keys in an electromechanical controller. Use of this method is declining.

External command – using digital communications (typically via a serial or Ethernet port on the controller), a master unit or computer sends a command message to the controller, instructing it to change to a particular pattern. This method is commonly used. If the controller loses communications with the source of pattern commands, it can automatically revert to using its internal time-of-day pattern selection schedule. The same communications link is typically used to receive status information from the controller, and to enable remote changes to controller parameters.

It is also possible for the user to manually lock a controller into a particular pattern, such that any of the above pattern selections is ignored.

Synchronization for Coordination

Signal coordination requires all controllers in a coordinated group to have a common time reference, so that start-of-cycle offsets are applied accurately. Before controllers had internal clocks, this was typically achieved by connecting the controllers to a master unit using the hardwire interconnect method described above. Once each cycle, one of the input wires changes its state for a second or two (called a pulse), thus signaling the commencement of the background cycle to all connected controllers simultaneously. Each controller then times its own offset from this common reference point. Use of this hardwire interconnect method is declining, in favor of time base coordination.

Today, controllers have internal clocks capable of keeping reasonably accurate time for at least several days. All controllers in a coordination group can be configured to use the same time of day (say midnight) as the reference point for offset calculation. The common background cycle is assumed to start at this time of day, and each controller can time its own offset from this common reference point. This is called time base coordination.

Eventually, however, the controller's clock will drift and need to be reset to standard time. Clocks can be reset using any of the following techniques:

Manual – periodically, a user goes to the controller in the field and resets the time according to an accurately set watch or other source of standard time (e.g., cell phone time display, telephone call to voice time, etc.). This method is not favored as it is laborious, error-prone, and subject to neglect. Depending on the model of controller, operationally significant drift can require manual reset after only several weeks of operation.

Hardwire pulse – a master unit pulses a hardwire input to the controller at a pre-defined time of day. When the controller senses this pulse, it sets its clock to the pre-defined time of day. As long as all controllers in the coordinated group receive the same pulse, it doesn't matter if the clock of the master unit is not entirely accurate.

External command – using digital communications (typically via a serial or Ethernet port on the controller), a master unit or traffic signals management computer sends a command to the controller (say once each day), instructing it to immediately set its clock to a time specified in the message. Even signals under the command of different central computers can be coordinated as long as each central computer has its clock set accurately.

Third-party time source – a standard time source, such as a WWV radio receiver, cell phone time monitor, or Internet connection, is installed in the cabinet and the controller either listens for periodic broadcast time updates or periodically initiates a request for a time update from a time server.

Actuated Controller Operation

Regardless of the hardware standard a controller complies with (NEMA, ATC, or Model 170), the functionality of the resident software is similar, and generally operates as defined in the NEMA TS 2 standard.

The basic timing characteristics of actuated controller units are as follows:

- Each phase has a preset minimum green interval to provide starting time for standing vehicles.
- The green interval extends for each additional vehicle actuation after the minimum green interval has timed out, provided that a gap in traffic greater than the present unit extension setting does not occur.
- A preset maximum limits green extension. Controllers provide two selectable maximum limits (commonly referred to as MAX I, and MAX II).
- Yellow change and red clearance intervals are preset for each phase. Red clearance is not always needed.

In addition to detector inputs, each phase is provided with a means for the user to permanently place a call for vehicle service (minimum or maximum green recall), or for pedestrian service (pedestrian recall). Maximum green recall places a call for the phase and when served prevents it from terminating prior to expiration of the maximum green timer.

The maximum green timer on a respective phase does not begin timing until a serviceable opposing phase detector call. Therefore, a phase with continuing demand may remain green for some time before a conflicting call is registered that starts the timing of the maximum green.

Phase control concepts related to rings and barriers are described in Table 7-6, and basic actuated timing parameters are described in Table 7-7.

Table 7-6 Actuated controller definitions.

FEATURE	DESCRIPTION
Single-Ring Controller Unit	Contains 2 to 4 sequentially timed and individually selected conflicting phases arranged to occur in an established order or sequence. Phases may be skipped in 3 and 4-phase controllers. The phases within a ring are numbered as illustrated in Figure 7-2.
Dual-Ring Controller Unit	Contains 2 interlocked rings arranged to time in a preferred sequence and allow concurrent timing of respective phases in both rings, subject to the constraint of the barriers (compatibility lines). Each ring may contain up to two phases in each of its two barrier groups, for a total of eight phases. Each of the respective phase groups must then cross the barrier simultaneously to select and time phases in the phase group on the other side. The phases within the 2 timing rings are numbered as illustrated in Figure 7-3.
Multi-Ring Controller Unit	A controller supporting more than eight phases and two rings. Any number of phases, up to the maximum supported by the controller, can be arranged in any number of rings. Conflicts between phases in different rings are specified using either barriers inserted between groups of phases, or phase concurrency lists This document has not been validated in the field. I would not recommend it's inclusion here unless disclaimer are clearly included.
Barrier (compatibility line)	A reference point in the designated sequence of dual-ring and multi-ring controller units at which rings are interlocked. Barriers ensure conflicting phases will not be selected or time concurrently. At a barrier, rings terminate the current phase and cross the barrier simultaneously, as illustrated in Figure 7-3.
Dual Entry	A mode of operating in a dual-ring and multi-ring controller units in which one phase in each ring must be in service. If a call does not exist in one of the rings when the barrier is crossed (from the other phase group), a phase is selected in that ring to be activated by the controller in a predetermined manner. For example, referring again to figure 7-3 in the absence of calls on Phases 7 and 8, Phase 2 and Phase 6 terminate to service a call on Phase 3. Programming for dual entry determines whether Phase 7 or Phase 8 will be selected and timed concurrently with Phase 3, even though no call is present on either Phase 7 or Phase 8.
Single Entry	A mode of operation in a dual-ring and multi-ring controller units in which a phase in one ring can be selected and timed alone when there is no demand for service of a non-conflicting phase in another ring. For example, referring to figure 7-3, after the termination of Phase 2 and Phase 6, the controller unit will service a call on Phase 3 in the absence of calls on either Phase 7 or Phase 8. While Phase 3 is selected and timed alone, Phases 7 and 8 (in Ring 2) will remain in the red state.

Table 7-7 Actuated controller basic timing parameters.

Setting	Description
Minimum Green	The absolute minimum duration of the phase's green indication. The phase cannot gap out or be forced off during this interval.
Variable Initial Green	A time calculated from the number of approach detector actuations during red. In the absence of a stopline detector, it allows sufficient time to service vehicles queued between the stopline and an advance detector. The phase cannot gap out or be forced off during this interval. The duration of this interval is affected by related parameters including Added Initial (amount of green added per actuation) and Maximum Initial.
Pedestrian Walk	The minimum duration of the Walk indication for pedestrians. The phase cannot gap out or be forced off during this interval.
Pedestrian Clearance	The fixed duration of the Flashing Don't Walk indication for pedestrians. The phase cannot gap out or be forced off (except for railroad or emergency vehicle preemption) during this interval.
Green Extension	The amount of time by which the green is extended after a vehicle is detected. If the minimum green, variable initial green, Walk, and FDW have all expired, and no approach detector input is currently On, the phase green can terminate (gap out) if the time gap between consecutive vehicles exceeds the green extension time plus the time the detector input remains On while the vehicle is being sensed.
Maximum Green	Even if vehicles are still approaching, the phase green will be terminated (forced off) after this amount of total green time following a call for service on a conflicting phase. This parameter overrides Green Extension, but none of the other parameters above.
Yellow Clearance	The fixed duration of the yellow indication that always follows the green indication.
Red Clearance	The time during which both the terminating phase, and the following conflicting phase(s) about to start, simultaneously present a red indication.

One or more actuated phases may also use the volume and / or density options, each being an add-on to basic actuated operation, as follows.

- The “volume” option increments an initial green interval timer each time a vehicle is detected while the phase is red. The minimum green is timed as the greater of the normal minimum green and this computed initial green, up to a maximum. In the absence of stopline detectors, it can be used to count the number of vehicles waiting in front of the advance detectors and increase the minimum green, if needed, to clear this queue.
- The “density” option reduces the gap time while the phase is green, if vehicles or pedestrians are waiting (have been detected) on other phases. The gap is reduced gradually over time, requiring a progressively greater density of approaching traffic to avoid termination of the green.

A dual-ring actuated controller allows different sequencing of left turn phases. Table 7-8 and Figure 7-4 describe phase sequence options for a signal with odd numbered phases serving left turns, and even numbered phases serving their opposing through movements. Typical left turn sequence options are leading lefts, lead-lag lefts, and lagging lefts. One such sequence can be used on one street (one barrier group), while a different sequence is used on the other street.

Table 7-8 Phase sequence options.

PHASE SEQUENCE OPTIONS	
SEQUENCE	DESCRIPTION
Leading Left Turn	Sequence begins with Phase 1 and Phase 5, the opposing turns moving together. As demand ends or maximum green is reached on either Phase 1 or Phase 5, the respective left-turn is terminated after the proper change and clearance intervals, and the opposing thru movement (Phase 2 or Phase 6) is given a green indication concurrent with its accompanying left-turn. As demand ends or maximum green is reached on the remaining left-turn movement, it is terminated after the proper change and clearance intervals, and it's opposing thru movement is released. Phase 2 and 6 then run together until demand ends or maximum green time for both phases is reached. The phases then, after display of proper change and clearance intervals, terminate simultaneously at the barrier line. As shown in figure 7-4, the above phase sequence also applies to the phases beyond the barrier line (Phases 3, 4, 7 and 8) in the other phases group.
Lead-Lag Left-Turns	Sequence begins with Phase 5, a left-turn, and its accompanying Phase 2 moving concurrently. As demand ends or maximum green is reached on Phase 5, that left-turn is terminated after the proper change and clearance intervals. The opposing thru movement, Phase 6, is released to run with Phase 2. As demand ends or maximum green for Phase 2 is reached, it is terminated after the proper change and clearance intervals, at the barrier line. As shown in figure 7-4, the above phase sequence also applies to the phases beyond the barrier line (Phase 3, 4, 7 and 8), in the other phase group. Also, it must be noted that either of the opposing left-turns in each phase group may lead the phase sequence.
Lagging Left Turns	Sequence begins with the opposing thru movements, Phases 2 and 6. As demand ends or maximum green is reached on one of the thru movements, that phase (2 or 6) is terminated after the proper change and clearance intervals, and its opposing left-turn (Phase 1 or 5) is released to run concurrently with the accompanying thru movement, that phase (2 or 6) is terminated after the proper change and clearance intervals, and its opposing left-turn (1 or 5) is released. Both left-turns run together until demand ends or maximum green on the latest released phase is reached. Phases 1 and 5 then terminates simultaneously after the proper change and clearance intervals at the barrier line. As shown in figure 7-4, the above phase sequence also applies to the phases beyond the barrier line (Phases 3, 4, 7 and 8), in the other phase group.

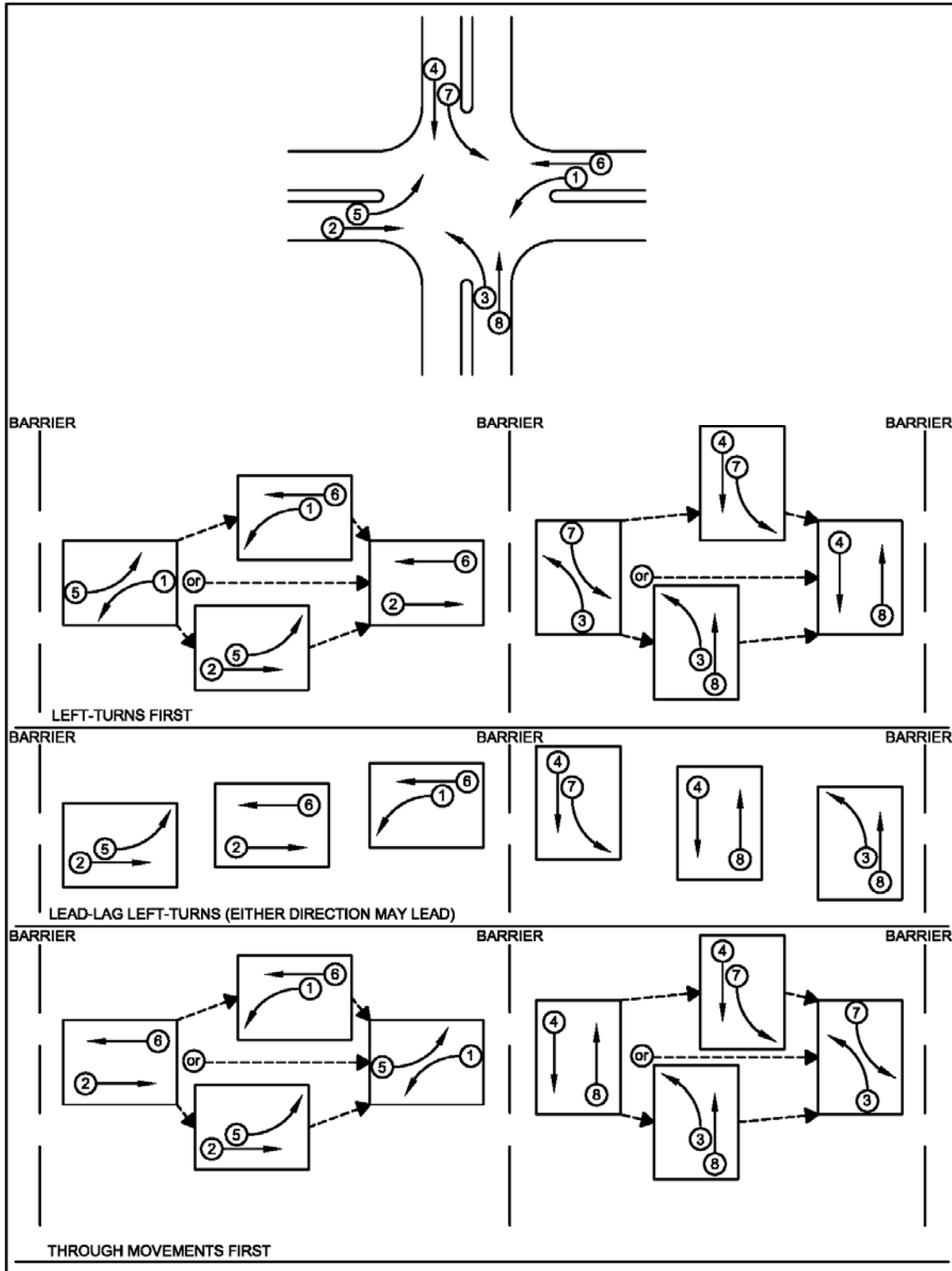

Figure 7-4 Dual-ring basic phase sequence options.

Any of these sequences can operate at all times, or can change during the day as the timing pattern changes. However, phase sequence needs to be chosen with care if the left turn movement can be made both protected and permissively, and a traditional five-section signal head is used (two left turn arrows and three balls). In this case, a phase sequence involving a lagging left turn phase, either lead-lag left turns or lagging left turns, can result in a potentially dangerous situation known as the “left turn trap”. A motorist turning left permissively and waiting for a gap in opposing traffic sees the green ball change to a yellow ball. The driver assumes the on-coming traffic also sees a yellow ball and will stop, when in fact the on-coming traffic may continue to see a green ball and not stop. This problem is eliminated by the flashing yellow arrow display for protected / permissive turn control. In this case the permissive indication (the flashing yellow arrow) tracks the opposite-direction through phase instead of the same-direction through phase.

The TS 2 standard specifies various external control inputs to the controller that modify its normal behavior. They are grouped into three categories:

- Inputs per phase (see Table 7-9)
- Inputs per ring (see Table 7-10)
- Inputs per controller unit (see Table 7-11)

Phasing Other Than Eight-Phase Dual-Ring

Many modern controllers, or controller software packages, offer sixteen or more phases in four or more rings, and eight or more overlaps, allowing control of numerous traffic movements needing separate phases or overlaps and more than normal eight-phase, dual-ring logic. Some examples of non-standard phasing used to control two closely-spaced intersections are discussed in Section 3.9 and in the following section on diamond interchanges.

Even intersections using only eight phases and two rings may have non-standard logic applied. One example is conditional re-service of a leading left turn phase following its opposing through phase (see Figure 7-5) – the left turn phase appears twice in the cycle, both before and after its opposing through phase, but only if the through movement is sufficiently light. Another example is “separated phases” logic, which can be used, for example, to prevent a leading left turn phase from operating concurrently with a lagging left turn phase from the same street if the two turning movements physically conflict in the middle of the intersection.

Table 7-9 Inputs per phase.

Input	Description
Vehicle Detector Call	Enters a vehicle demand for service into the appropriate phase of the controller unit
Pedestrian Detector Call	Enters a pedestrian demand for service into the associated phase of the controller unit
Hold	<p>Command that retains the existing right-of-way and has different responses, as follows depending upon operation in the vehicle non-actuated or actuated mode:</p> <ul style="list-style-type: none"> • For a non-actuated phase, energization of the hold input maintains the controller unit in the timed out walk period with green and walk indications displayed. Energization of the hold input while timing the WALK portion of the green interval does not inhibit the timing of this period. De-energization of the hold input and with the WALK interval timed out causes the controller unit to advance into the pedestrian clearance interval. Re-application of the hold input while timing the pedestrian clearance portion of the green interval neither inhibits the timing of this period nor the termination of the phase. • For an actuated phase, energization and de-energization of the hold input operates as follows: <ul style="list-style-type: none"> (a) Energization of the hold input allows the controller unit to time normally but inhibits its advance into the yellow change interval. Energization of the hold input inhibits the recycle of the pedestrian service unless the pedestrian recycle input is active and a serviceable call exists on the phase. The rest state signal indications for that phase are green and DONT WALK. (b) De-energization of the hold input allows the controller unit to advance into the green dwell / select state when all green periods are timed out. (c) De-energization of the hold input with all intervals timed out allows the controller unit to recycle the walk interval if there is no conflicting demand for service and a pedestrian call exists for that phase. However, if there is any serviceable demand on an opposing phase with the hold input de-energized, and with all intervals timed out, the controller unit advances into the yellow change interval and does not recycle the walk on that phase until those demands have been served.
Phase Omit	Command which causes omission of a phase, even in the presence of demand, by the application of an external signal, thus affecting phase selection. The omission continues until the signal is removed. The phase to be omitted does not submit a conflicting call to any other phase but accepts and stores calls. The activation of Phase Omit does not affect a phase in the process of timing.
Pedestrian Omit	Command which inhibits the selection of a phase resulting from a pedestrian call on the subject phase, and it prohibits the servicing of that pedestrian call. When active, the Pedestrian Omit prevents the starting of the pedestrian movement of the subject phase. After the beginning of the subject phase green, a pedestrian call is serviced or recycled only in the absence of a serviceable conflicting call and with Pedestrian Omit on the phase non-active. Activation of this input does not affect a pedestrian movement in the process of timing.

Table 7-10 Inputs per ring.

Input	Description
Force-Off	Command which provides for the terminations of green timing or WALK hold in the non-actuated mode of the active phase in the timing ring. Such termination is subject to the presence of a serviceable conflicting call. The Force-Off is not effective during the timing of Initial, WALK or pedestrian clearance. Force-Off is effective only as long as the input is sustained.
Red Rest	Requires the controller unit to rest in red in all phases of the timing ring(s) by continuous application of an external signal. The registration of a serviceable conflicting call results in the immediate advance from Red Rest to green of the demanding phase. The registration of a serviceable conflicting call before entry into the Red Rest state results in the termination of the active phase and the selection of the next phase in the normal manner, with appropriate change and clearance intervals. The registration of a serviceable call on the active phase before entry into the Red Rest state even with this signal applied, results (if Red Revert is active) in the continuation of the termination of the active phase with appropriate yellow change interval and Red display for the duration selected in Red Revert. The formerly active phase is then reassigned right-of-way.
Inhibit Maximum Termination	Disables the maximum termination functions of all phases in the selected timing ring. This input does not, however, inhibit the timing of Maximum Green.
Omit Red Clearance	Causes the omission of Red Clearance timing intervals
Pedestrian Recycle	Controls the recycling of the pedestrian movement. The operation depends on whether the phase is operating in the actuated or non-actuated mode: <ul style="list-style-type: none"> • In the actuated mode, if a serviceable pedestrian call exists on the subject and the Hold input is active, the pedestrian movement is recycled when the Pedestrian Recycle input is active, regardless of whether a serviceable conflicting call exists. • In the non-actuated mode, if the subject phase has reached the Green Dwell / Select state, the Pedestrian Omit is not active on the phase and a serviceable conflicting call does not exist, the pedestrian movement is recycled when the pedestrian recycle input is active.
Stop Timing	When activated, causes cessation of controller unit ring timing for the duration of such activation. Upon the removal of activation from this input, all portions which are timing, will resume timing. During Stop Timing, vehicle actuations on non-Green phases are recognized; vehicle actuations on Green phase(s) reset the Passage Time timer in the normal manner, and the controller unit does not terminate any interval or interval portion or select another phase, except by activation of the Interval Advance input. The operation of the Interval Advance with Stop Timing activated clears any stored calls on a phase when the controller unit is advanced through the green interval of that phase.
Maximum II (Selection)	Allows the selection of an alternate maximum time setting on all phases of the timing ring

Table 7-11 Inputs per controller unit.

Input	Description See section 3.5.5.5 of NEMA TS2 Standard (6)
Interval Input Advance	A complete On-Off operation of this input which causes immediate termination of the interval in process of timing. When concurrent interval timing exists, use of this input causes immediate termination of the interval which would terminate next without such actuation.
Manual Control Enable	Places vehicle and pedestrian calls on all phases, stops controller unit timing in all intervals, and inhibits the operation of the Interval Advance input during vehicle change and clearance intervals
Call to Non-Actuated Mode (Two per Controller Unit)	When activated, causes any phases appropriately programmed to operate in the non-actuated mode. The 2 inputs are designated Call to Non-Actuated Mode I and Call to Non-Actuated Mode II, respectively. Only phases equipped for pedestrian service are to be used in a non-actuated mode.
External Minimum Recall to All Vehicle Phases	Places recurring demand on all vehicle phases for a minimum vehicle service
External Start	Causes the controller unit to revert to its programmed initialization phase(s) and interval(s) upon application of the signal. Upon removal of this input, the controller unit commences normal timing.
Walk Rest Modifier	When activated, modifies non-actuated operation only. Upon activation, the non-actuated phase(s) remain in the timed-out WALK state (rest in WALK) in the absence of a serviceable conflicting call without regard to the Hold input status. With the input nonactive, non-actuated phase(s) do not remain in the timed-out WALK state unless the Hold input is active. The controller unit recycles the pedestrian movement when reaching the Green Dwell / Select state in the absence of a serviceable conflicting call.

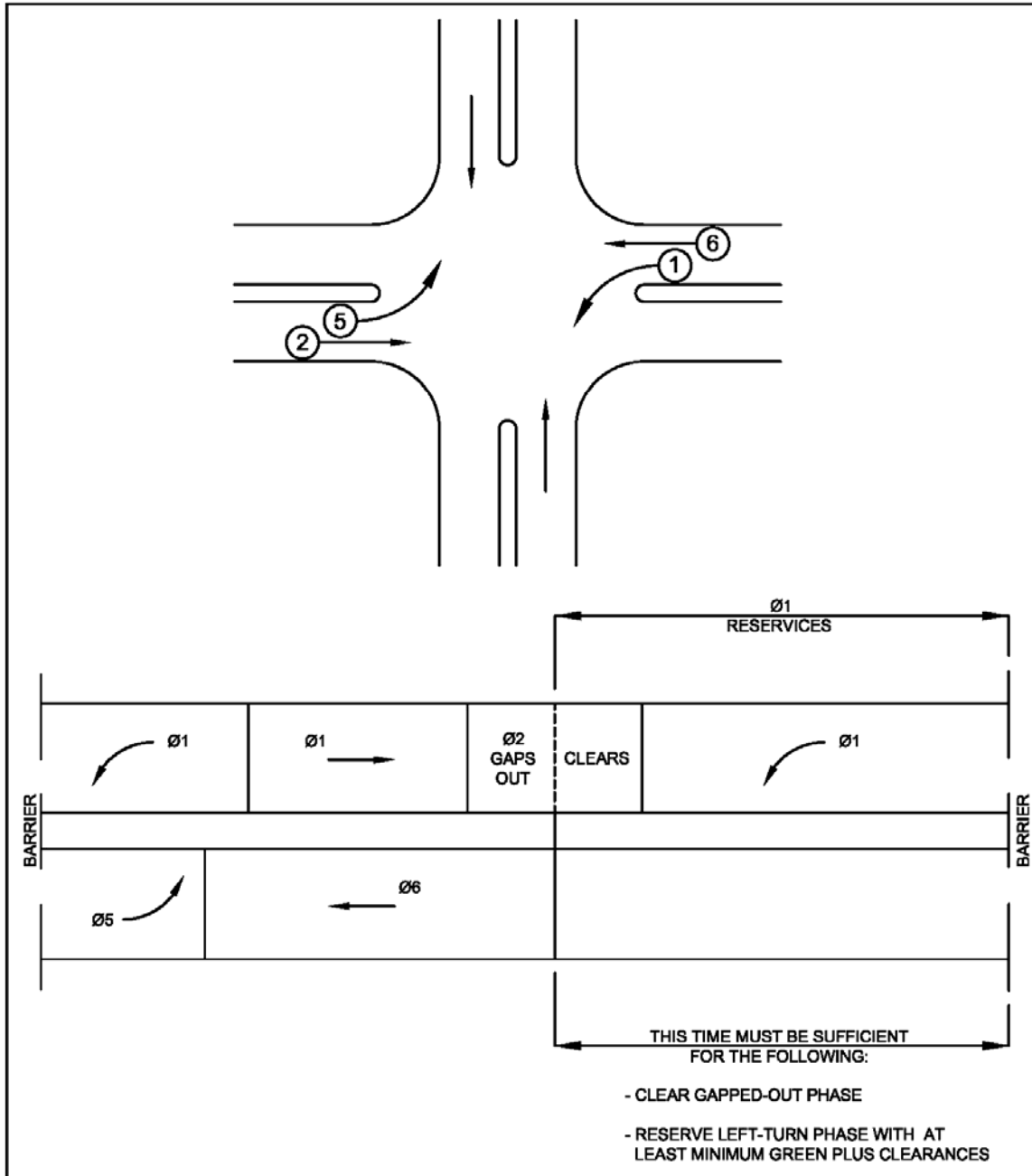

Figure 7-5 Example of special phase sequence for conditional service of left-turn phase.

Diamond Interchange Operation

Some actuated controllers provide a special mode of operation derived from the Texas Department of Transportation's historical approach to diamond interchange operation. Modern controllers can provide similar functionality without the need for a special mode of operation, as described in section 3.9.

Two particular phasing arrangements and logic for diamond interchange operation have been used in Texas (7). These are referred to as the 3-phase and 4-phase sequences and are described in Table 7-12. The operation can change between the sequence options in response to external commands. The City of Dallas provides for four sequence variations. The two sequence variations shown in Figure 7-7 are used by the Texas Department of Transportation. Typical detector locations for operation of the controller unit in 3-phase, lag-lag, or four-phase (with overlaps) sequencing, with locally produced external data, are shown in Figure 7-8. Software also provides the option for use of any compatible combination of phases at the ramp intersections, in response to computer-issued command data, as shown in Figure 7-9.

The 3-phase sequencing shown in Figures 7-6 and 7-7 can provide a shorter cycle length than the 4-phase sequencing shown in Figure 7-7. For example, Texas DOT conducted a study in which the two phase sequences shown in figure 7-7 were compared at a number of intersections during isolated full-actuated control. The cycle lengths for the 4-phase sequence were 40 to 80% longer than for the 3-phase sequence. Expect similar reductions in cycle lengths at locations in other isolated and interconnected systems, as long as the left-turn movements remain within reasonable limits, and storage is available between the off-ramp (frontage road) connections. Where turning movements are high onto and / or off of the ramp connections (frontage roads), the 4-phase sequence provides the best operation.

One of the three phase sequences shown in Figure 7-6 can also apply when certain turning movements prove heavy. If the controller includes more than one phase sequence, the sequences can be changed to accommodate operational requirements.

Table 7-12 Special phase sequencing.

Operation	Description
Left-Turn Restoration	<p>In the operation of a standard 8-phase controller unit, the service of a left-turn can be restored without first cycling through the barrier line. In this operation, the controller unit monitors the time remaining on any thru movement phase which is opposed by a thru phase which has gapped out. If the time remaining on the non-gapped phase is sufficient for at least a minimum service of its associated (parallel) left-turn phase, the controller unit terminates the gapped-out phase and reservices the left-turn. Figure 7-5 illustrates the phase sequence.</p>
Full Diamond Interchange	<p>The operation of 1 standard 8-phase controller unit with modified software for signalization of a full diamond interchange. Figures 7-6 and 7-7 show 4 sequence variations:</p> <ul style="list-style-type: none"> • A 3-phase lead-lag operation in which traffic on both ramp approaches begins simultaneously (Phase 1). Phase 2 follows Phase 3 if there is a demand (detector activation) for the phase. Phase 3 follows Phase 2 if there is a demand for the phase, and Phase 1 follows Phase 3 if there is a demand for that phase. • A 3-phase operation in which traffic on both cross street approaches begins simultaneously and is followed subsequently by Phases 2 and 3 if there is a demand for each of these phases. • A 3-phase, lag-lag operation in which the traffic on both ramp approaches is released simultaneously (Phase 1). Subsequent vehicle actuations and / or maximum green time-outs determine diagram flow from Phase 1 to 1 of the 4 overlap phases, or directly to Phase 2. Depending upon demand registered and which Phase 1 overlap was previously served, the controller unit will move to serve 1 of the 2 Phase 2 overlaps or go directly to Phase 3. In the absence of demand from either ramp approach, the controller unit may proceed from Phase 3 back to Phase 2, or to 1 of the 2 Phase 2 overlaps. • A 4-phase operation with 2 overlaps, in which traffic on one of the ramp approaches is released simultaneously with thru and left-turn traffic (on the intersecting arterial) at the other ramp intersection, thereby clearing any possible internal queue for the traffic turning left from the ramp (Phase 1). As shown in the diagram in Figure 7-6, several optional flow paths are available, any of which could be followed, based upon registered demand and / or maximum green time-outs on certain approaches. For purposes of illustration, the following flow sequences assume continuing demand on all detectors. <p>From Phase 1, the controller unit moves to Phase 1 overlap, in which the opposing traffic on the arterial (at the, as yet, unserved ramp intersection) is released while the ramp approach green continues. The Phase 1 overlap phase must be of fixed time duration since the running ramp green must be terminated to accommodate the progressive movement of the arterial traffic released at the start of the overlap phase. This fixed time period is determined by the travel time of accelerating arterial traffic from a stop at one ramp intersection, and through the other ramp intersection.</p> <p>The controller unit proceeds then to Phase 2 green to accommodate the above described approaching arterial traffic (thru and left-turns). For Phase 3 initiation, traffic on the arterial (at the, as yet, unserved ramp) is cleared and terminated for release of traffic on the ramp approach. As the diagram shows, flow continues to Phase 3 overlap and on to Phase 4, serving remaining traffic movements.</p> <p>The phase sequence described for each of the 4 sequence variations assumes that there is demand for each phase. Since the controllers are full traffic actuated, it is possible for phases to be skipped. The array of flow lines and arrows on the diagram represents all possible sequence paths the controller unit can take.</p> <p>The different sequence variations shown in Figures 7-6 and 7-7 are applicable and depend on the traffic patterns at the interchange. The software for 2 or more of the sequences can be provided in the same controller unit and changed by time-of-day or on a real-time basis as traffic patterns change.</p>

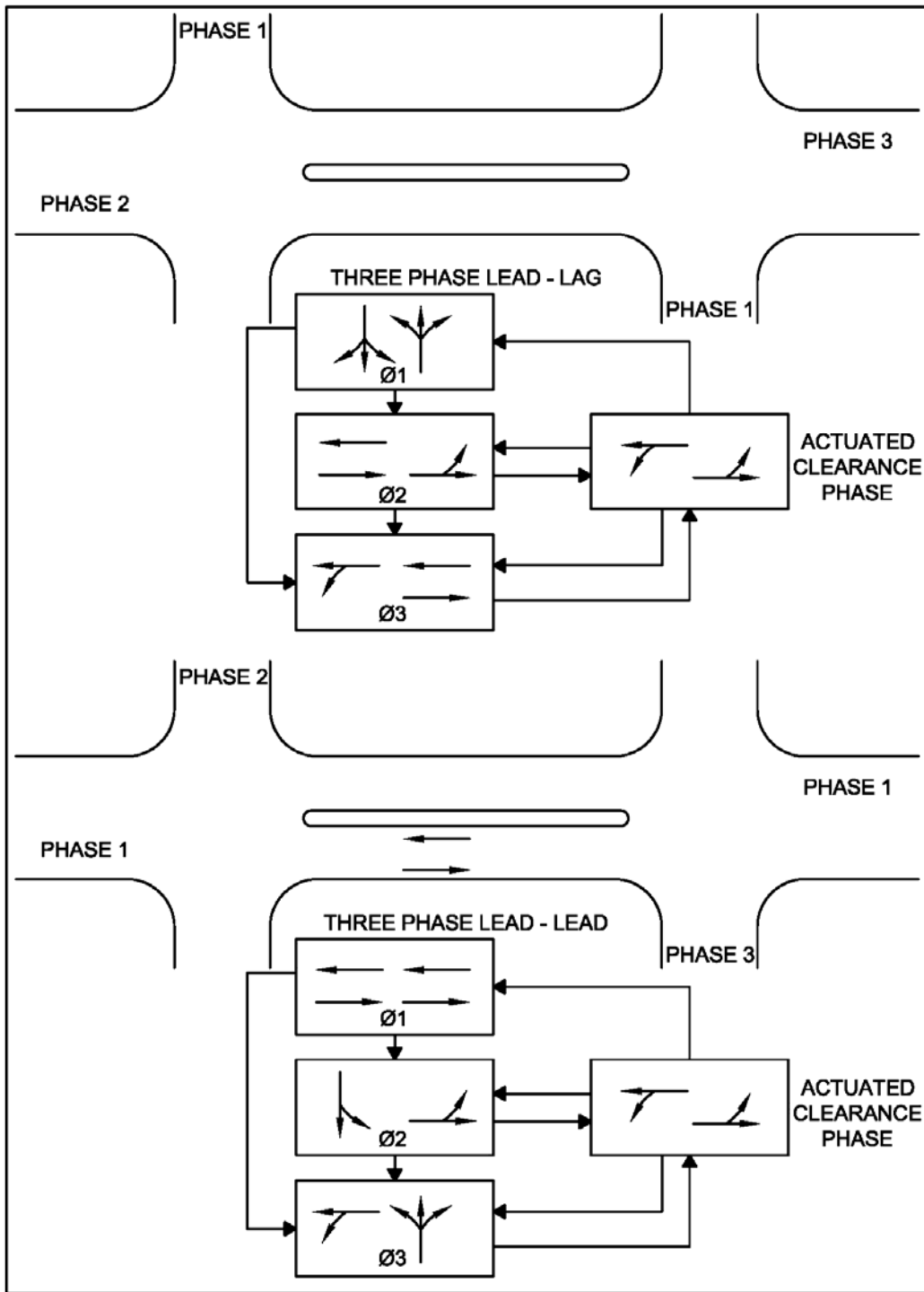

Figure 7-6 Diamond interchange phasing (3-phase).

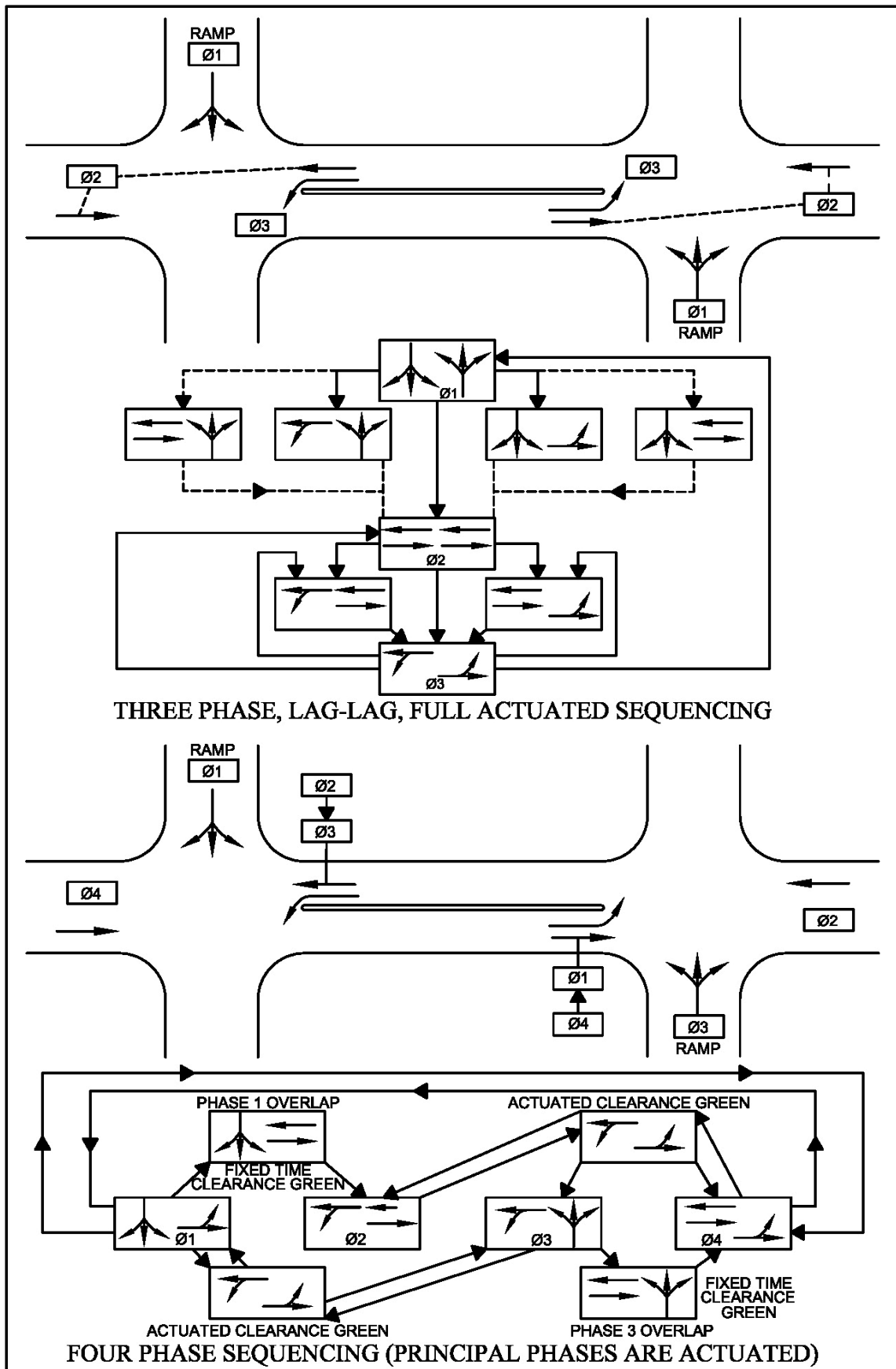

Figure 7-7 Diamond interchange phasing (3- and 4-phase).

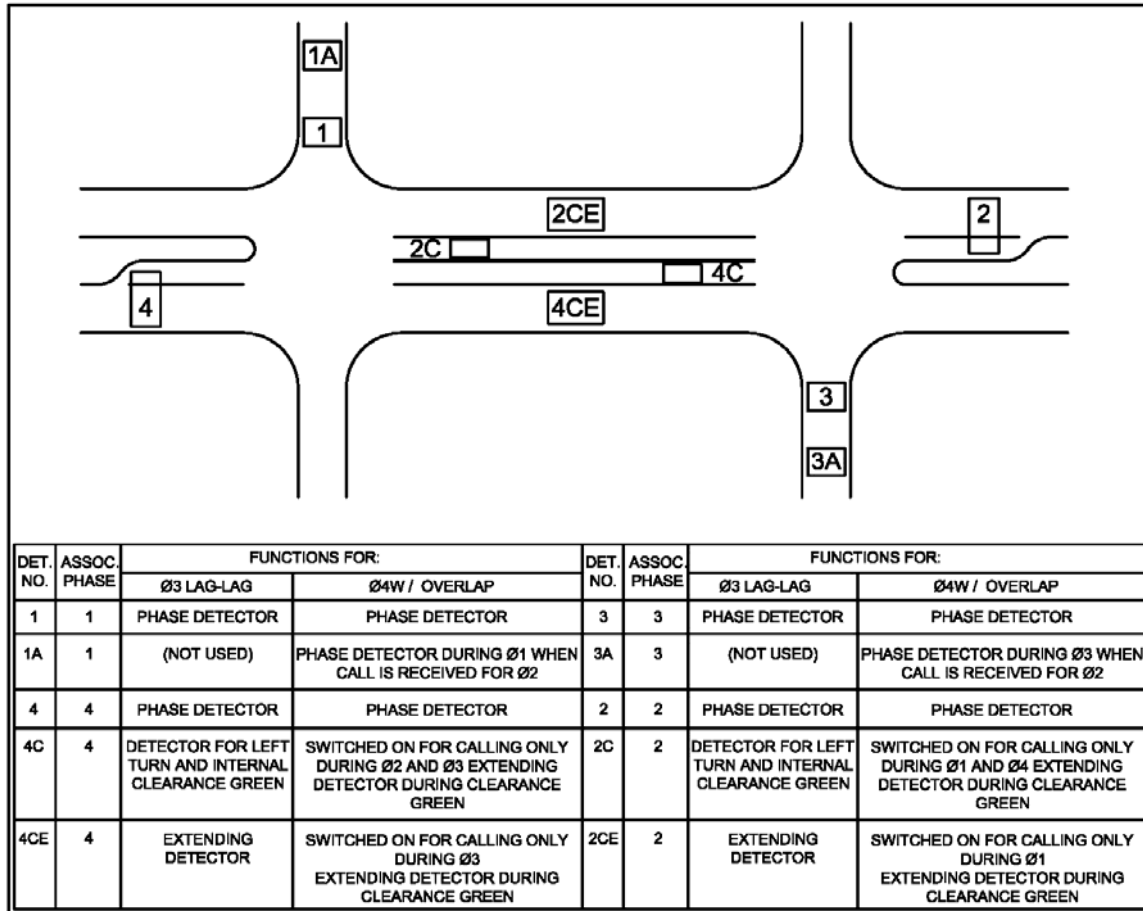

Figure 7-8 Typical detector configuration for 3-phase, lag-lag, and 4-phase (with overlap) special sequences.

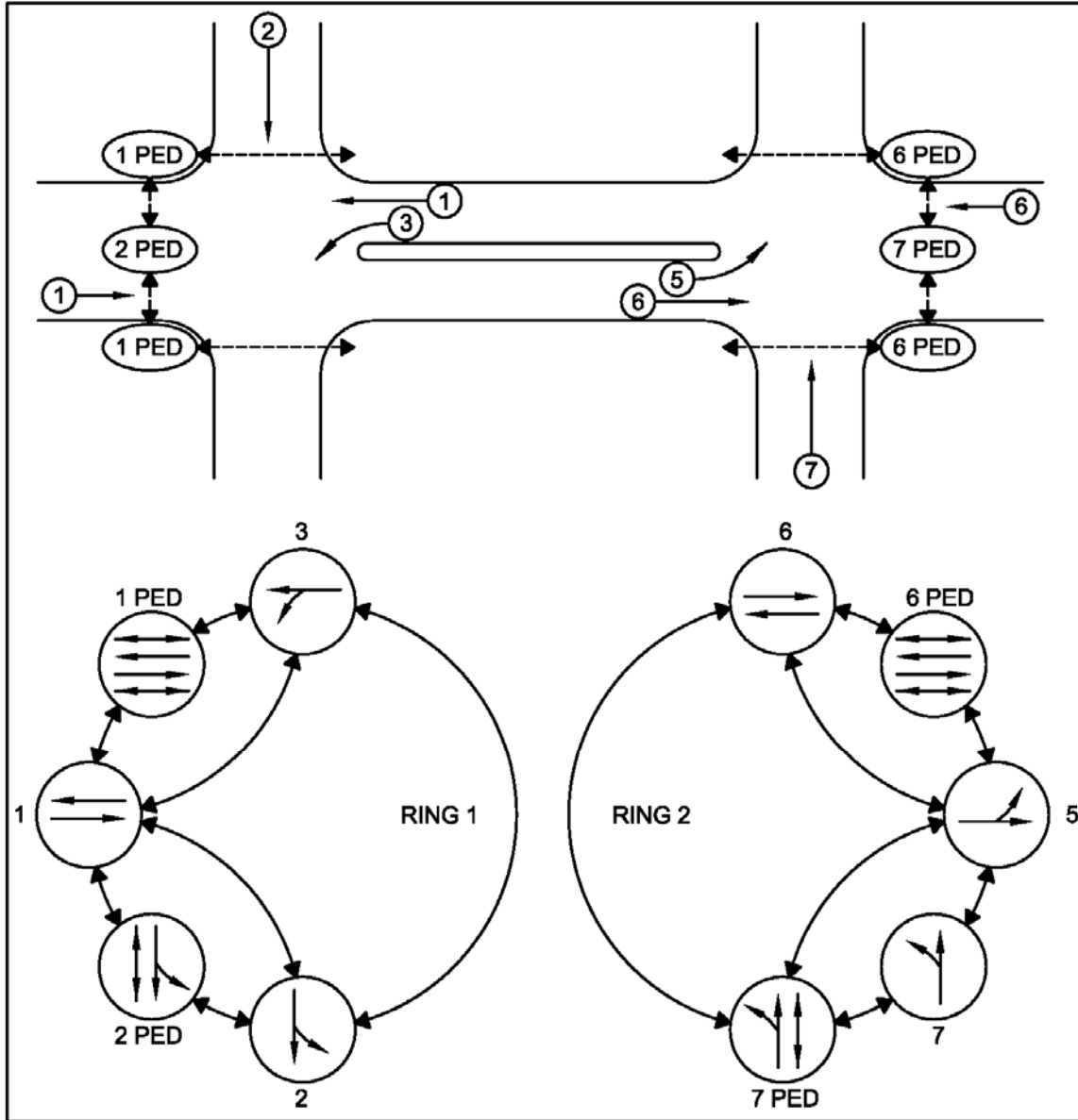

Figure 7-9 Computer controlled diamond interchange operation.

Single Point Freeway Interchange Operation

The single point urban interchange (SPUI) shown in Figure 7-10 has been installed at a number of freeway locations. The design provides a basic six movement operation as shown in Figure 7-11. It is similar to typical five-phase control at normal intersections, except that pedestrians and right turns may require special treatment. It is difficult to efficiently allow pedestrians to cross the cross-street, and pedestrians crossing the ramps may require separate controls at left and right turn slots.

The Texas Transportation Institute studied the single point design, which resulted in warrants and guidelines (8). The SPUI and the tight urban diamond interchanges with a distance of 250 to 400 ft (76 to 122 m) between ramp connections (or frontage roads) were judged viable competitors.

The study recommended the following guidelines for the SPUI:

- Equivalent left-turn volumes exceed 600 v/hr as large truck volumes are anticipated from off-ramps having left-turn volumes exceeding 300 v/hr
- SPUI becomes a good candidate with:
 - Restricted right-of-way,
 - High volumes with major congestion,
 - High incidences of left-turns and large truck volumes (see above), and
 - High accident incidence locations.
- SPUI is not a candidate at sites with:
 - Severe skew angles,
 - A wide overcrossing roadway,
 - Adverse grades on the cross street,
 - Moderate-to-high pedestrian crossing volumes, or
 - A combination of high through-volumes and low turning volumes on the cross-street.

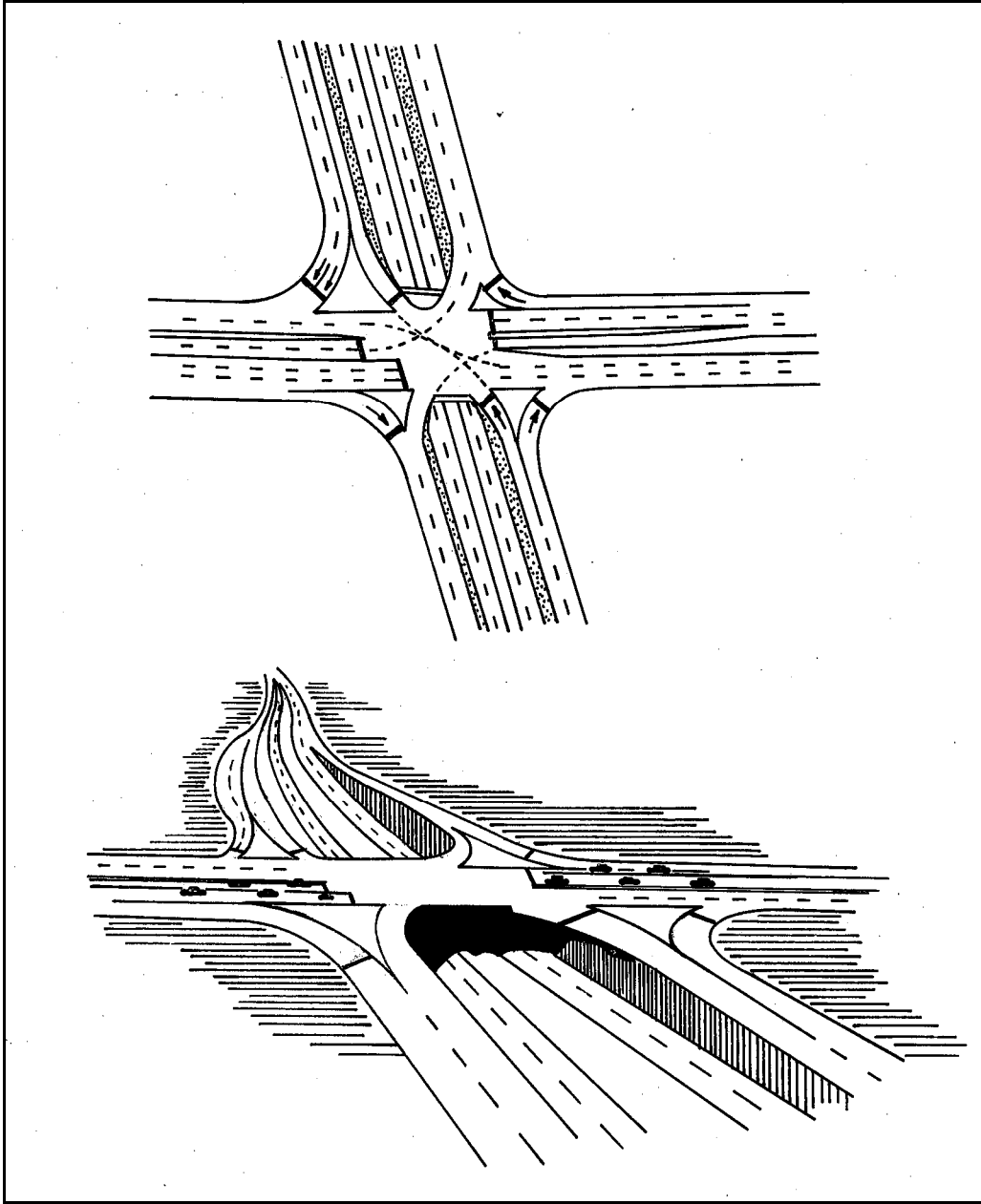

Figure 7-10 Single point urban interchange (SPUI).

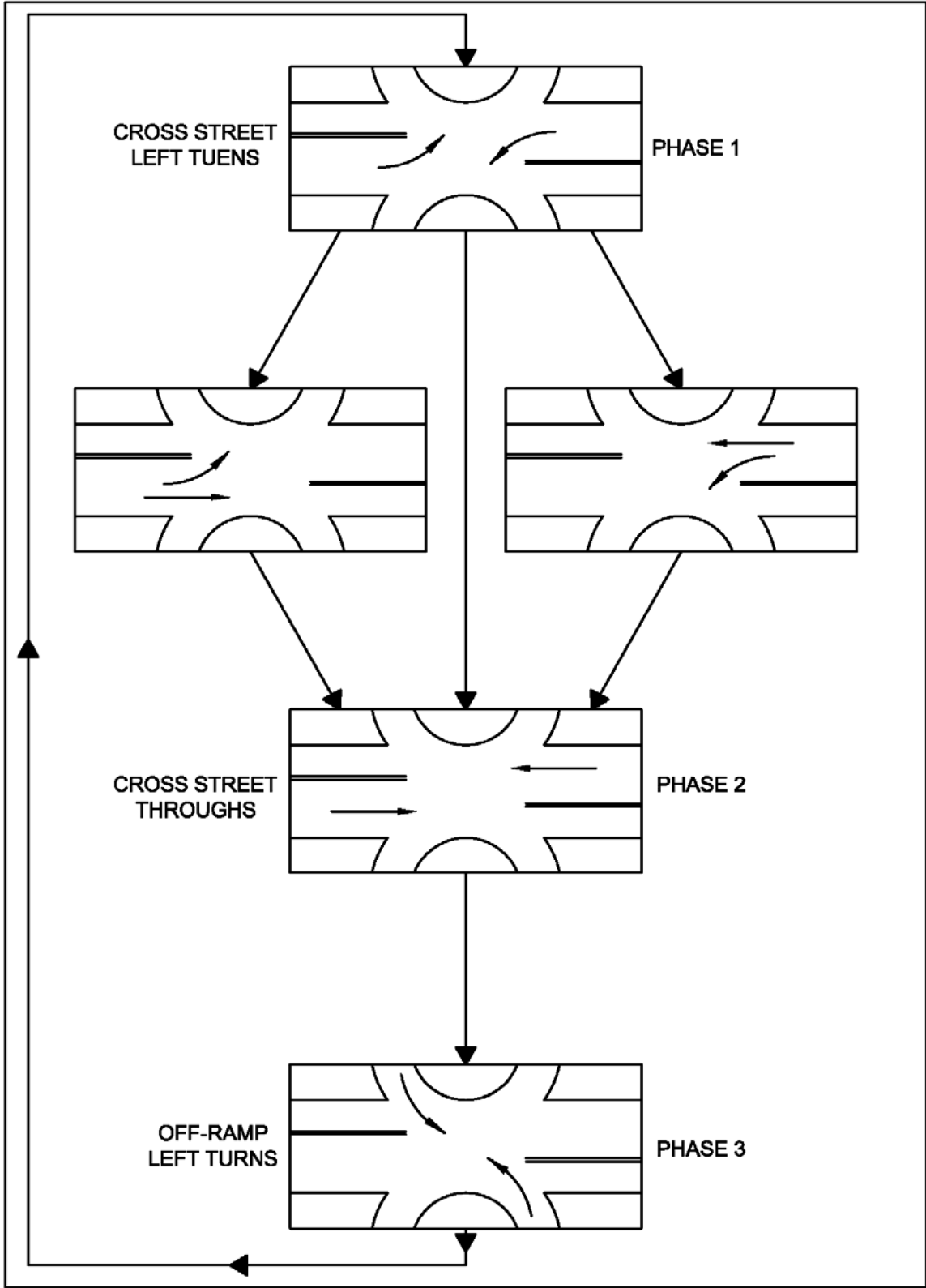

Figure 7-11 Typical SPUI 3-phase sequence.

Freeway incident management often makes use of continuous frontage roads. Due to longer cycle lengths and increased delays, the SPUI is not recommended where continuous frontage roads exist when the SPUI and the frontage roads are grade-separated with one elevated above the other.

System Capabilities

The actuated controller, when used as a local unit in a traffic signal system, can provide additional functions other than previously described. Through the use of communications to a supervising master or central computer, the controller receives and implements a variety of commands. In closed-loop systems or central computer control systems, a two-way communications system returns information from the local unit to the central facility. The control status of the local controller and timing plan in effect exemplify returned local-oriented information. In many systems using two-way communications, system detector information is also returned to the supervising master unit or central computer.

A user at a central management computer can upload and examine the controller's data set (timing parameters). A copy of the controller's data can be stored in a central database, modified, and downloaded to the controller in whole or in part.

Implementation of downloaded interval durations and phase sequences may be subject to local minimums, maximums, or other checks, or the downloaded data may overwrite existing data with no checks. Methods vary from system to system, and traffic engineers must remain aware of the resulting impacts on traffic flow and operations safety.

An in-the-field master unit may also store a copy of controller timings.

7.6 NEMA, Advanced Transportation Controller, and Model 170 Standards

The National Electrical Manufacturers Association (NEMA) maintains the TS 2 standard (6) for traffic signal controllers and related equipment. This standard defines functionality, interfaces (physical and logical), environmental endurance, electrical specifications, and some physical specifications, for the following components:

- Traffic signal controllers,
- Malfunction management units,
- Vehicle detectors,
- Load switches,

- Bus interface units,
- Facilities for signal flashing and related control transfer, and
- Cabinets.

The TS 2 standard does not specify the physical size, shape, or appearance of most components except where standardization is necessary for physical interchangeability of whole components from different manufacturers. Although maximum dimensions are specified for the controller, a manufacturer is free to make a unit of any smaller size from any material, in any shape, with internal sub-components of any type, as long as it meets the other requirements of the standard. There are no requirements that enable interchangeability of sub-components or software between controllers from different manufacturers. It is assumed that the whole controller and its software will be swapped out when a change is made. The standard specifies a range of alternative cabinet sizes, all having shelves, and a door on one side only.

The TS 2 standard includes basic specifications for interval controllers (called “pretimed” in TS 2), but provides far more detail for phase controllers (call “actuated”). Signal phasing and timing functionality discussed above applies only to phase (actuated) controllers, the predominant type in use today.

Hardware requirements for controllers are specified by NEMA TS 2 in the following areas:

- A, B, and C connectors for cabinets using the older TS 1 standard
- Serial bus for communications with MMU, detectors, and load switches
- Serial ports for communications with computers and master units (RS 232 and FSK modem)
- User interface (keypad and display, required but details not specified)
- Maximum dimensions

The NEMA TS 2 standard defines two alternative types of input / output interfaces for the controller. One consists of binary (on or off) logic wires (analog) connected to the controller via three round connectors designated as MS-A, MS-B, and MS-C. This interface was originally standardized in a prior NEMA standard - TS 1. It is still widely used, and remains an option within TS 2. It is common for NEMA-compliant controllers to provide additional input / output control wires via a non-standard connector MS-D.

The other type of input / output interface specified in TS 2 is a serial bus. This option reduces the amount of wiring in the cabinet by providing an analog-to-digital converter and aggregator close to the detectors or load switches that are the source or destination of

the inputs or outputs. Then a simple serial communications cable connects these bus interface units to the controller. Each bus interface unit supports multiple detectors or load switches.

A controller built to the physical requirements of the NEMA TS 2 standard is typically referred to as a NEMA controller. It is intended to operate in a “NEMA” cabinet meeting the NEMA TS 2 specifications, and can use either the A, B, C connectors (often called the TS 1 interface), or serial bus interface (often called the TS 2 serial interface) for cabinet inputs and outputs.

For actuated traffic signal controllers, the TS 2 standard defines functionality, primarily in the following areas:

- Phases arranged in a particular sequence in rings with barriers
- Overlaps (green outputs that can span multiple phases)
- Single and dual entry logic (what phase to select in the second ring if no call there)
- Pedestrian recycle (allowing pedestrian Walk to start other than at the start of green)
- Phase intervals and their timing (including minimum and maximum green times, yellow clearance, red clearance, and pedestrian timing)
- Coordination timing (cycle, offset, split, permissive period, time base)
- Phase selection points (when “phase next” is selected)
- Phase call storage (locking calls)
- User-specified vehicle and pedestrian recalls
- Automatic recall at forced phase termination
- Conditional re-service of a phase within a barrier group
- Simultaneous gap out
- Start up process
- Red revert time
- Preemption

- Flashing operation, dimming, diagnostics
- Remote communications (including NTCIP requirements)

The same functionality applies to NEMA controllers using either of the cabinet input / output interfaces (A, B, C connectors or serial bus).

The Advanced Transportation Controller family of standards is maintained by a consortium composed of NEMA, ITE, and AASHTO. Two standards are currently in place:

- The Advanced Transportation Controller 2070 (ATC 2070)
- The ITS Cabinet for ATCs (9)

The ATC 2070 standard (10) is based on the Caltrans Model 2070 controller specification (11) (12) (13) (14). Unlike the NEMA TS 2 standard, the ATC 2070 standard specifies every detail of the controller hardware and internal sub-components, but does not specify any application software functionality. It requires the OS-9 operating system, a minimum of 4 MB of dynamic random access memory (RAM), 512 KB of static RAM, and 4 MB of flash memory. It also specifies the form and function of the following modules and a standard chassis and card cage into which card modules from any manufacturer can be inserted:

- Power supply
- Central processor unit module
- Field input / output interface module
- FSK modem module
- RS232 serial ports module
- Fiber transceiver module
- Front panel (user interface)

In addition to the standard modules, some manufacturers offer proprietary communications modules such as Ethernet switches, and a VME card carrier, that plug into the controller's standard card cage. The original Model 2070 specification included provision for an auxiliary five-card 3U VME cage within the chassis with the central processor being on a VME card. This option is retained in the ATC 2070 specification, but has not proven popular. The VME cage and processor is rarely specified or supplied. A controller without the VME cage is often distinguished as a "2070 lite", and has its central processor located on a module in the main 2070 card cage.

Anyone can develop software for an ATC controller, for any purpose (e.g., traffic signal control, field master unit, ramp metering, count stations, dynamic message sign control, reversible lane control, etc.) knowing that it will operate on controllers from any manufacturer. Most ATC controller software for traffic signals adheres to the functionality specified in NEMA TS 2, and is functionally similar to a NEMA controller.

The ATC 2070 standard includes options for input / output interfaces that enable its use in any of the four standard traffic signal cabinets – TS 1, TS 2 serial, ITS Cabinet, and Caltrans Model 33x cabinet. The TS 1 cabinet input / output interface module includes a standardized fourth connector, called the D connector.

The ITS Cabinet standard (10) combines the best features of the Caltrans Model 33x cabinet and the NEMA TS 2 serial cabinet, while providing for additional inputs and outputs, more distributed and flexible fault monitoring, and reduced cabinet wiring. It is a rack cabinet, with optional sizes, one or two racks, and doors in both front and back. The standard includes specifications for all cabinet components except the controller, detector cards, and load switches. It can be used with the ATC 2070 controller and TS 2 detector cards and load switches.

Instead of a single Malfunction Management Unit, the ITS Cabinet standard calls for a Conflict Monitor Unit and multiple Auxiliary Monitor Units – one in each input or output rack. Instead of a Bus Interface Unit, it calls for a Serial Interface Unit that integrates the serial interface into the input or output connector, and uses a different protocol than that used in the BIU. This protocol is the same as used internally in the ATC 2070. It is a new standard and it will take some time before compliant components are readily available and large numbers of ITS cabinets are deployed. ATC 2070 controller software needs some modification to operate in an ITS Cabinet.

The ATC standards working group is developing additional controller standards that will give more flexibility for both controller hardware and software. A new version of the ATC controller will allow the use of different physical forms, different central processing units, and perhaps different operating systems. Additional communications ports and memory are also planned. An application program interface standard will facilitate the portability of software applications between controllers using different processors and operating systems, and will allow sharing of system resources between multiple applications (from different suppliers) operating simultaneously on the same controller.

Specifications jointly developed by the states of California and New York describe the Model 170 family of traffic control components (11). These standards cover the hardware for cabinets and all components, including the controller. As with the ATC standards, the Model 170 specifications do not specify software functionality. These specifications date back to the 1970s. The Model 170 controller is based on the Motorola 6800 processor, which is no longer manufactured. Processing power and memory are severely limited and software written for the Model 170 controller cannot be readily

expanded to add features such as support for more than 8 phases and two rings, or full NTCIP communications.

The Model 170 controller is widely used and will continue to be used for some time to come. As replacement parts are no longer manufactured for some components, they will have to eventually be replaced. Caltrans developed the Model 2070 controller as its replacement.

The Model 33x cabinets used with the Model 170 controller are supported by an optional Model 170 style field input / output module in the ATC 2070 standard, and it is therefore relatively easy to replace a Model 170 controller with an ATC 2070. However, Model 170 software does not automatically run on an ATC 2070.

Some manufacturers provide variations of the Model 170 controller which include:

- Improved front panel user interface,
- More capable central processor, and
- Additional memory.

Although not standardized, such enhancements provide another means of prolonging the life of the Model 170 family.

The New York State Department of Transportation uses a similar controller, the Model 179 (16). Although using a somewhat more powerful microprocessor, the Model 179 has not achieved the same acceptance as the Model 170.

Controller Selection and Migration

The selection of controller and cabinet should be based on an analysis of the agency's requirements.

For typical applications, any of the three standard controller types – NEMA, ATC, Model 170 – is adequate. However, the Model 170 controller has limited capacity for supporting advanced software applications, such as full NTCIP support or use of more than eight phases in two rings. Obsolescence of the hardware also makes the Model 170 controller a poor choice for long term applications.

Traditionally, NEMA controllers have been made to operate only in NEMA cabinets, although the latest NEMA controllers will also operate in the ITS Cabinet. The ATC controller can be used in any type of cabinet, with the appropriate field input / output module, but NEMA controllers provide a more compact and simpler option in NEMA TS 1 cabinets. Agencies often have a preference for one type of cabinet based on factors

such as training of field personnel, existing inventory of spare components, aesthetic considerations (mainly size of cabinet), and cabinet placement policies.

If an agency wants to use a small one-door cabinet (e.g., in a central business district), it needs to use a NEMA controller with a size and shape suited to that cabinet. If a large NEMA cabinet is used, either the ATC or NEMA controller may be suitable. If a rack-mount cabinet (e.g., Model 33x or ITS Cabinet) is preferred, then the ATC controller (or Model 170 if feasible) is needed.

Some manufacturers offer hybrid controllers that provide some of the features of a NEMA controller (e.g., small size and shelf-mount) and some of the features of an ATC 2070 (e.g., standard processor and operating system able to operate anyone's software, slots for ATC communications modules, and standard interfaces). Some manufacturers offer a small cabinet and integrated controller. This is often referred to as a CBD cabinet. Some such products are based on the ATC specifications but don't adhere to the ATC 2070 standard for physical size and modularity.

As more and more cabinets with traditional parallel wiring between the controller and cabinet inputs and outputs (NEMA TS 1 and Model 33x cabinets) are replaced with serial bus cabinets (NEMA TS 2 and ITS Cabinet) the distinction between NEMA and ATC controllers will be less significant. The latest NEMA and ATC controllers can operate in either of the standard serial bus cabinets, and allow the user to operate any software compatible with the ATC 2070.

The choice of software operating in the controller is often an overriding consideration. If the software that comes with a NEMA controller provides unique features that are needed, that controller may be the best choice. If that software is also available, or only available, for use on an ATC controller, then the ATC controller may be preferred. An ATC controller, and some NEMA controllers, can be purchased separately from its software, allowing more competitive procurement if a particular software package is needed.

Another consideration is the need for spare parts and user training to support different types of controllers and cabinets. It is usually preferable to limit the number of different controller and cabinet types in use.

An agency may wish to migrate from one type of controller to another, either as part of an upgrade program or to take advantage of benefits of a particular controller type. Most agencies cannot afford to perform a wholesale replacement of all controllers overnight, but do the changeover gradually.

Any consideration of controller replacement must take into account the existing cabinet and any changes planned or needed to the cabinet. If cabinets are being replaced for other reasons, this presents an opportunity to also replace the controller, and it may be appropriate to change to a different type of cabinet.

A NEMA controller generally cannot operate in a Model 33x cabinet designed for the Model 170 controller, and a Model 170 controller cannot operate in a NEMA cabinet (either TS-1 or TS-2 serial). However, an ATC can operate in any type of cabinet of sufficient size, if it has the appropriate interface module. An ATC that does not conform to the removable Field Input / Output module part of the ATC standard does not have the flexibility to be reconfigured to operate in a different parallel cabinet, but will usually include a serial port for use in a serial cabinet (e.g., NEMA TS-2 or ITS Cabinet).

Software written for the Model 170 controller will not operate on an ATC, and vice versa. Traditional NEMA controllers cannot operate software written for either the Model 170 or ATC. Therefore, a change between these types of controllers will invariably involve different software and user training for the new software.

It is common for an agency to have two types of cabinets or controllers in use at any point in time, as it migrates from one type to another. Most agencies try to avoid having more than two different types in use at the same time.

References

1. Tarnoff, P.J., and P.S. Parsonson. "Selecting Traffic Signal Control at Individual Intersections." *National Cooperative Highway Research Program Report 233*, Transportation Research Board, Washington, D.C., 1981.
2. Asante, S.A., S.A. Ardekani, and J.C. Williams. "Selection Criteria for Left-Turn Phasing, Indication Sequence and Auxiliary Sign." *HPR Research Report 1256-IF*, University of Texas at Arlington, Arlington, Texas, February 1993.
3. Oliver, M.B. "Guidelines for Audible Pedestrian Signals." *Public Roads*, pp. 33-38, September 1989.
4. Oliver, M.B., J.C. Fegan, and S.A. Ardekani. "Audible Pedestrian Signals-Current Practices and Future Needs." *Institute of Transportation Engineers Journal*, pp. 35-38, June 1990.
5. "Committee for the Removal of Architectural Barriers, Audible Pedestrian Traffic Signals for the Blind, Intersection Evaluation Procedures." *San Diego Council Policy Number 200-16*. San Diego, CA, May 1985.
6. "Traffic Controller Assemblies with NTCIP Requirements." *NEMA Standards Publication TS2-03*, National Electrical Manufacturers Association, 2003.
7. Haenel, H.E., A.H. Kosik, and B.G. Marsden. "Innovative Uses of Traffic Responsive Control in Texas." Presentation Paper, Engineering Foundation Conference, Henniker, New Hampshire, State Department of Highways and Public Transportation, Austin, TX, July 1983.
8. "Single Point Urban Interchange Design and Operations Analysis." *National Cooperative Highway Research Program Report 345*, Washington, DC, December 1991.
9. "Intelligent Transportation Systems (ITS) Standard Specification for Roadside Cabinet (ITS Cabinet)." AASHTO, ITE, NEMA, Washington, DC, 2003.
10. "ATC 2070 – Advanced Transportation Controller (ATC) Standard for the Type 2070 Controller." AASHTO, ITE, NEMA, Washington, DC, 2001.
11. Quinlin, T. "Development of an Advanced Transportation Control Computer." CALTRANS Report.
12. "Model 2070 Advanced Transportation Management System Controller Concept Description, Final Draft." CALTRANS, August 2, 1993.

13. "Transportation Electrical Equipment Specifications." California Department of Transportation, October 1994.
14. Bullock, D., and C. Hendrickson. "Software for Advanced Traffic Controllers." *Transportation Research Record 1408*, Washington, DC, 1993.
15. "Traffic Signal Control Specifications." (as amended), California Department of Transportation, January 1989.
16. "Traffic Control Hardware Specifications." Division of Traffic Engineering and Safety, New York State Department of Transportation, Albany, NY, June 1990.

**CHAPTER 8
SYSTEM CONTROL**

Table of Contents

Section	Page
8.1 Introduction	8-2
8.2 Architectures for Conventionally Coordinated Traffic Control Systems.	8-2
Three Distributed Computation Level Architecture	8-2
Two Distributed Computation Level Architecture	8-5
Central Control Architecture	8-5
8.3 Traffic Responsive and Traffic Adaptive Systems	8-8
8.4 Time Base Coordination	8-10
8.5 Traffic Management Centers	8-11
Functions of Surface Street TMCs	8-11
Traffic Signal Timing	8-11
Size and Staffing Requirements of TMCs	8-12
Coordination between Traffic Systems and Traffic Agencies	8-14
References	8-15

CHAPTER 8 SYSTEM CONTROL



Figure 8-1 Traffic management center (TMC) (1).

8.1 Introduction

Section 3.8 describes functional categories for system control of traffic signals. This chapter concentrates on the architectures and the physical implementation of these categories. Table 8-1 briefly identifies these categories and their major architecture characteristics.

8.2 Architectures for Conventionally Coordinated Traffic Control Systems.

Signal timing plans for the lower four levels of Table 8-1 are stored in the controller's database. Interconnected Control and Traffic Adjusted Control require interconnection by means of wireline or wireless techniques and provide the capability for time of day operation and operator selection of signal timing plans. The following architecture variations may be used to implement these two levels.

- Three Distributed Computation Level Architecture (also known as “closed loop” systems).
- Two Distributed Computation Level Architecture.
- Central Control Architecture.

Three Distributed Computation Level Architecture

Figure 8-2 shows how the computation, control and equipment functions are distributed among the three levels. The TMC equipment complement consists of servers, communication equipment, local area network, and peripheral equipment such as printers. The database for the system is stored in the servers and downloaded to the field master controller and then to the local intersection controllers.

Table 8-1 Performance levels for traffic signal systems.

CATEGORY OF SYSTEM OPERATION	ARCHITECTURE CHARACTERISTICS
Traffic Adaptive Control Cycle free, rapid reaction to sensed traffic conditions	<ul style="list-style-type: none"> - Distributed Control - One or two detectors per signalized approach
Traffic Responsive Control Rapid reaction to sensed traffic conditions	<ul style="list-style-type: none"> - Central control (SCOOT) or distributed control (SCATS) - One or two detectors per signalized approach
Traffic Adjusted Control <ul style="list-style-type: none"> - Area traffic adjusted control. - Critical intersection control (centralized architecture only). - Local intersection strategies. 	<ul style="list-style-type: none"> - Interconnection required - Moderate number of system detectors required for traffic responsive timing plan selection - Three distributed computation levels (closed loop) or - Two distributed computation levels or - Central control
Interconnected Control <ul style="list-style-type: none"> - Time of day or operator selected timing plans. - Local intersection strategies. 	<ul style="list-style-type: none"> - Interconnection required - No system detectors required for timing plan selection (time of day or operator selection only) - Three distributed computation levels (closed loop) or - Two distributed computation levels or - Central control
Time Base Coordination <ul style="list-style-type: none"> - Time of day plans. - Local intersection strategies. 	Provides basic coordination. <ul style="list-style-type: none"> - No interconnection required
Uncoordinated Signals	<ul style="list-style-type: none"> - No coordination among traffic signals

The architecture contains one or more field master controllers. These units may be located in controller cabinets in the field or may be located at the TMC. Their function is to break down the information from the TMC into the communication channels appropriate to each local intersection controller, and to assemble data from these controllers into an information stream for transmission to the TMC. In the case where the system is traffic adjusted, system detector data from the local field controllers is processed in the field master controller and is used to select the appropriate timing plan. The traffic responsive control algorithm for closed loop systems is described in Section 3.8.

The local intersection controller controls the traffic signal displays. It stores the library of timing plans available for control and implements the selected timing plan (the information for the selection of traffic responsive control timing plans originates at the field master controller and the information for operator selection originates at the TMC). Time of day control uses schedules downloaded from the TMC and stored in the local intersection controller.

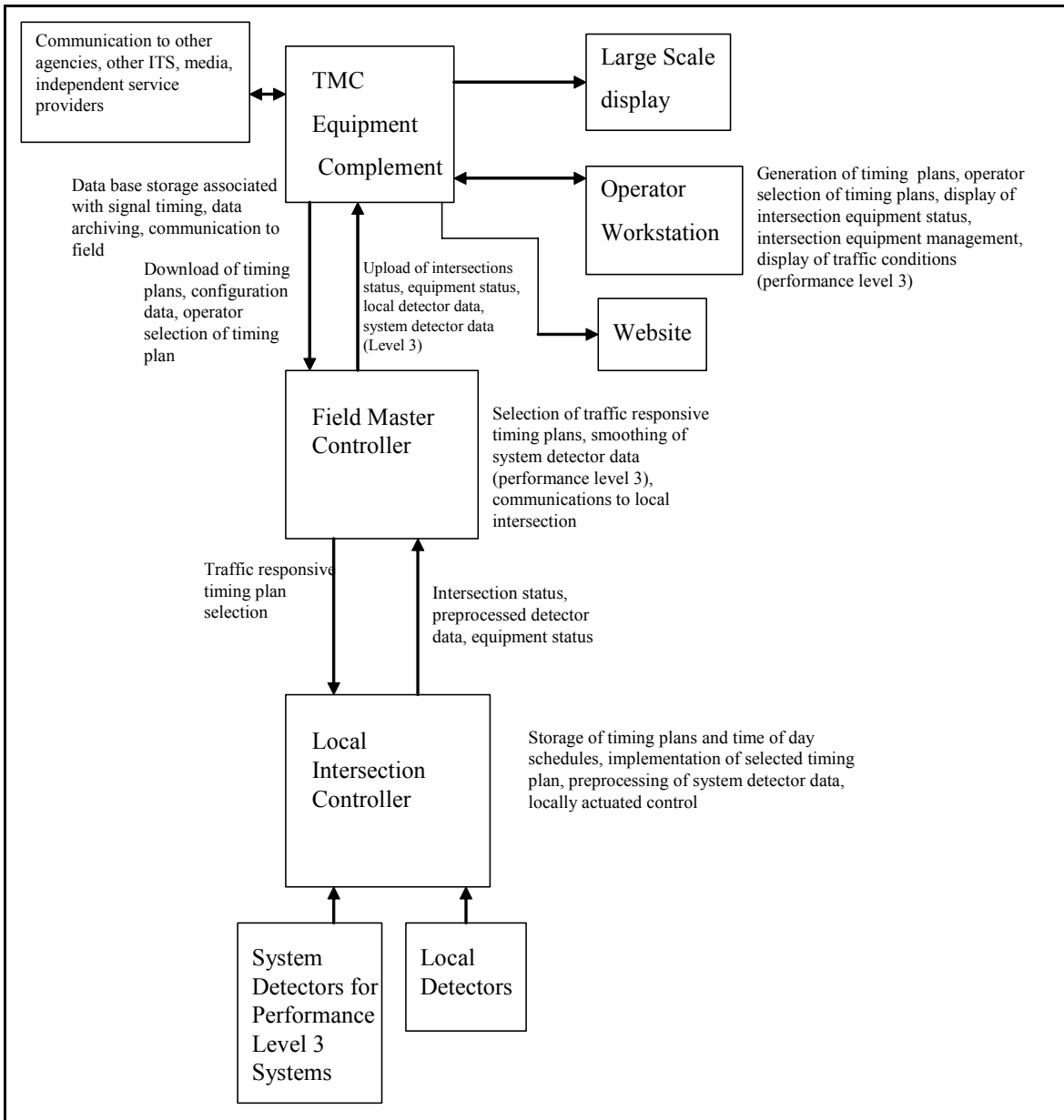

Figure 8-2 Typical architecture for three computation level distributed (closed loop) system.

The local intersection controller preprocesses the system detector data into volume and occupancy parameters that are uploaded to the higher levels at intervals that might range from several seconds to a minute. Based on data received from the local detectors, the local controller terminates actuated phases at the appropriate time.

Three level systems are often provided by traffic equipment suppliers.

Two Distributed Computation Level Architecture

The functions for this architecture are identical to those identified for the three distributed computation level architecture discussed above; however, all of the functions performed by the field master controller are performed by the TMC equipment complement. The functions of the local field controller remain unchanged. Two level systems are often provided by traffic system software suppliers.

Central Control Architecture

Figure 8-3 shows the signal flow for this architecture, which is currently used less frequently than in the past. While the TMC performs all of the computation functions as for the previously described architectures, it also performs the following major functions:

- Processes and smoothes system detector data.
- Uses system detector data to select timing plans based on a traffic responsive control algorithm. Section 3.8 describes the First Generation UTCS Control Algorithm used by many systems.
- Converts the timing plan to controller coordination commands and provides these commands to the field controller at precisely the proper time in the signal control cycle. Table 8-2 describes the functions of the coordination commands.

A remote communication unit (RCU) or, in some cases, an intelligent remote communication unit (IRCU) may be used to establish communication between the TMC and the intersection controller. Its information processing functions are generally minimal, and it primarily serves to match the interfaces and protocols required by the field controller to those used for communication with the TMC.

Under normal conditions, the computation functions in the local intersection controller are minimal. Commands from the TMC at precisely the proper time in the traffic signal cycle terminate the green interval for each phase. Indication of the state of the green interval is transmitted to the TMC for monitoring purposes. Backup timing plans are also stored in the local intersection controller to be used in case the TMC fails or communication is lost.

Since this architecture directly controls the phases (or in some cases the intervals) of the traffic cycle from the TMC, it can, in principle, facilitate the use of control strategies that may not be based on the use of stored timing plans such as certain types of transit priority strategies.

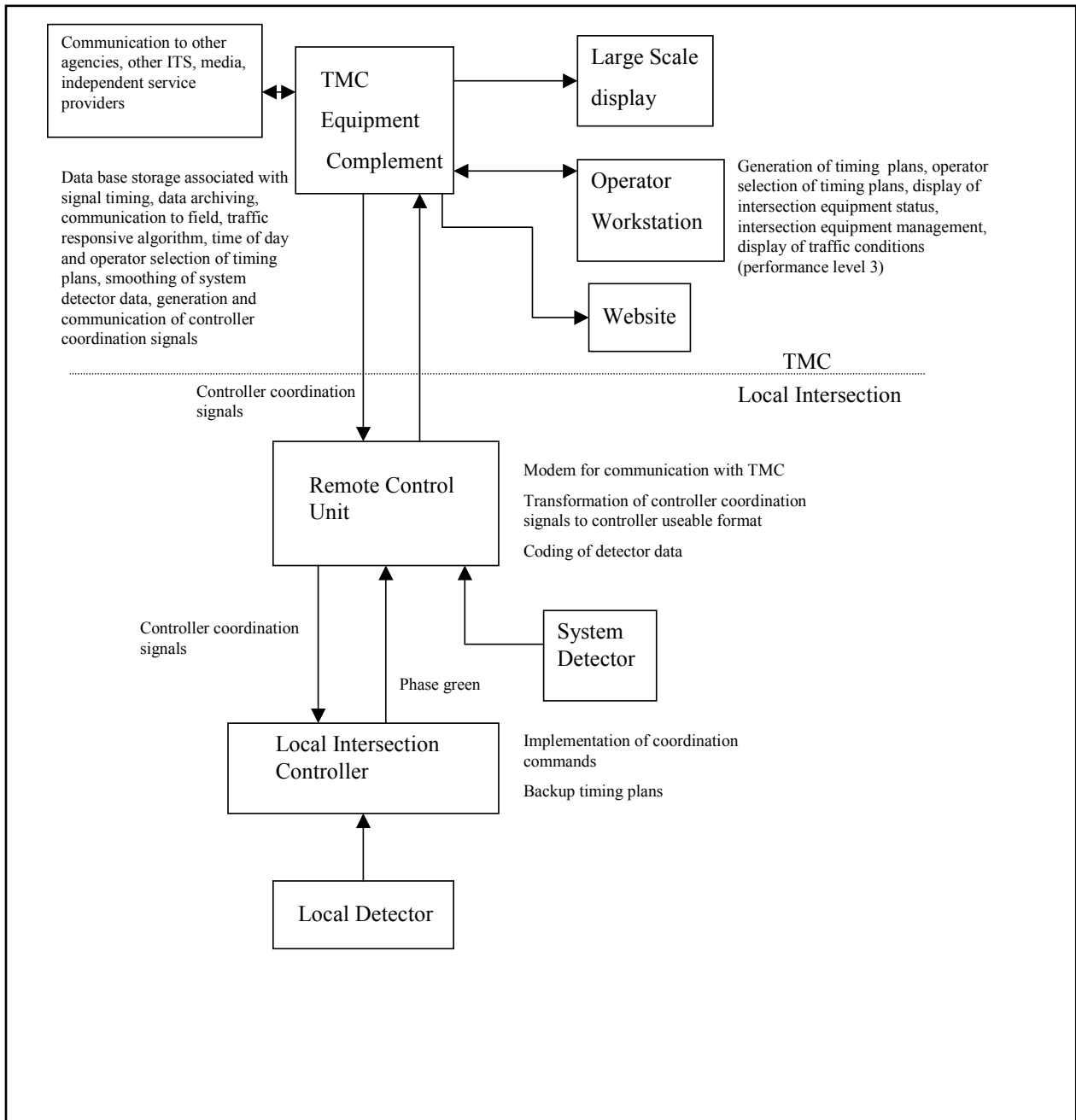

Figure 8-3 Typical arrangement for central control architecture.

Table 8-2 Coordination commands.

Name	Function
Force-Off	<p>Issued to begin termination of an actuated phase. Each assigned force-off point is located precisely in the background cycle. It is sent to the controller only if:</p> <ul style="list-style-type: none"> • Its respective phase is called and serviced, • Calls on the phase continue to (and beyond) the force-off point, or • Calls are present on any of the subsequent scheduled phases. <p>The last (actuated) phase force-off occurs only if the above listed conditions are met. If calls on any of the actuated phases terminate before the scheduled occurrence of the force-off and demand is present on the next phase, the demanding phase will be served earlier than scheduled in the background cycle time frame.</p>
Hold	<p>Issued to guarantee a certain minimum of green time to a phase. Normally used in the coordinated phase to guarantee a window of time in the background cycle for traffic progression on the major street. Thus, the coordination phase is considered non-actuated because its duration is not reliant upon vehicle calls. A hold command can be applied to a phase other than the coordinated phase.</p>
Yield	<p>By de-energizing the Hold command, the resulting yield condition begins the termination of the active phase. The yield condition, no longer recognized by NEMA as a command, is usually associated with the coordinated phase, and in the absence of demand on other (actuated) phases, the controller remains in coordinated phase green. The yield (or permissive) condition may be programmed for a certain duration. If a call subsequently appears on any of the other (actuated) phases during the yield condition, the calling phase would, conditionally, be serviced. The condition for service is that sufficient time remains before the calling phase's scheduled force-off command occurs.</p>

8.3 Traffic Responsive and Traffic Adaptive Systems

The conceptual aspects of these signal systems are discussed in Section 3.8. This section discusses the physical aspects of representative adaptive control systems as well as some of the performance tests.

Conventional traffic signal systems were discussed in Sections 8.2 and 8.3. These systems represent the largest number of systems currently in use in the United States. Timing plans for these systems are stored in the local controller, and may be selected from the traffic management center or by a field master controller in the following ways by:

- Time of day schedule.
- The operator.
- A traffic responsive algorithm. The traffic responsive algorithms, as discussed in Chapter 3, select timing plans for a section based on filtered real-time traffic data. Response times are usually in the order of a few minutes, and these timing plans are typically employed for a significant period of time (commonly exceeding one half hour). Since systems of this type implement timing plans that are prestored in the controller, the transportation management center or field master controller cannot alter the signal timing on an intracycle (phase or interval) basis.

Since the intent of traffic responsive and traffic adaptive systems is to rapidly respond to changes in traffic flow by analyzing the measured flow of upstream vehicles, the required intracycle information (from the traffic management center or in some cases from adjacent intersections) must be appropriately processed by the controller software. Thus, standard NEMA TS2 controllers generally require software modification to operate with adaptive systems. Type 2070 and ATC controllers with appropriate software are often used for adaptive systems. More intensive deployment of traffic detectors is generally required for adaptive systems as compared with conventional traffic responsive systems.

A wide range of performance improvements have been reported in the literature for these systems. While test techniques vary, the baseline for these tests has generally been pretimed systems, with considerable variation in the quality of the time of day plans. Table 8-3 provides a representative sample of results obtained in this way. The greatest benefits occur for those situations where traffic experiences significant variation from a pretimed plan. Examples include special events and arterials that support diversion from freeways during incidents.

Table 8-4 identifies some advantages and disadvantages of traffic responsive and adaptive systems.

Table 8-3 Representative results of performance testing

Adaptive Control Algorithm	Test Location	Results	Reference
OPAC	Northern Virginia	5-6% improvement in stops and delays	2
SCATS	Oakland County, Michigan	Average of 7.8 % reduction in delay	3
	Newark, Delaware	Travel time reduction up to 25%	3
SCOOT	Minneapolis, Minnesota	Delay reduction of up to 19% during special events	3
	Toronto, Ontario	8% decrease in travel time, 17% decrease in delay	4
	Durban, South Africa	7% travel time reduction	5

Table 8-4 Advantages and disadvantages of traffic responsive and traffic adaptive control systems.

ADVANTAGES
<ul style="list-style-type: none"> • May be significant advantages in stops, delays and emissions compared to pretimed systems (Level 2). Probably somewhat less improvement compared to conventional traffic responsive systems (Level 3). • No need to periodically update timing plans.
DISADVANTAGES
<ul style="list-style-type: none"> • Higher initial cost for both field equipment and traffic management center software. Higher maintenance cost for field components. • More difficult initial system setup and tuning process.

ACS-Lite, a FHWA research project, adapts certain principles developed during adaptive control system research and development to use by closed loop systems. This discussion is adapted from Reference 6.

ACS-Lite employs the concept that a TOD schedule is an appropriate way to manage traffic demand over the day and by days of the week. Within the context of a TOD schedule, ACS-Lite will adapt the particular plans that are implemented at each time of day based on the overall performance of that plan for the similar previous day. This approach to adaptive behavior uses the traditional traffic engineering assumption that average behavior of traffic on, for example, Tuesday at 3 P.M., is roughly the same on every Tuesday at 3 P.M., but drifts slowly with long-term changes in population, construction, new routes, etc.

If the performance of the baseline plan is determined to be improvable by changing cycle, splits, or offsets, then those changes will be made to the “optimized” plan stored in ACS-Lite and downloaded to the local controllers for use on the next day. The goal of being appropriately adaptive at this level is the maintenance of the timing plan over long

periods of time to address the typical degradation of plan effectiveness (e.g., 4% worse per year) and replace the very expensive task of re-timing signals on a periodic basis.

The next level of adaptivity used by ACS-Lite is on-line modification of the TOD plan parameters as the plan is running. With the assumption that the baseline optimized TOD plan is a good starting point, ACS-Lite will adapt the cycle, split, and offsets of the plan within some neighborhood of the baseline settings over the plan's intended implementation duration. ACS-Lite may also adapt the start and end time of the plan from the baseline TOD schedule according to the current conditions, considering the effectiveness of the new plan versus the one that is currently running. ACS-Lite also identifies and selects the best strategy to transition between timing plans.

8.4 Time Base Coordination

Signal coordination requires a common time reference shared by all controllers in the coordination group. They must each reference their offset to the same background cycle – a background cycle that is of the same duration and starts at the same time at all controllers. This can be achieved by a master controller transmitting a synchronization pulse or message to all the controllers at the start of the background cycle. However, such schemes fail if the communications link breaks down.

Modern controllers most commonly use time base coordination as the means of synchronizing the start of the background cycle in all controllers. This scheme uses a time-of-day clock in each controller. The clock enables each controller to know the current time to at least the nearest second. The controller considers the background cycle to have started at a particular time of the day, such as midnight, called the offset reference time. At any time during the day, the controller can determine where it is now in the background cycle by calculating the number of seconds since the offset reference time (say midnight) and dividing by the cycle length. The remainder is used to calculate when the current background cycle started. The local cycle zero point is then calculated by adding the offset time to the background cycle zero point.

Time-base coordination works regardless of the mix of controller types and software in the system. However, it only works if the clocks in all controllers are well synchronized. Each controller counts the passage of time and automatically adjusts for daylight saving time. Clocks in controllers tend to drift over time and need to be reset periodically. If the controller is connected to a master or central computer, the clock can be reset automatically.

Standard time can be obtained by computers, masters and laptops computers used by technicians using transmissions from various sources such as cellular phone systems, radio broadcast from the National Institute of Standards and Technology (radio stations WWV and WWVH), time servers on the Internet, and the Global Positioning System. Some agencies have installed wireless time-source receivers in each signal cabinet. Section 7.5 provides additional information on time base references.

8.5 Traffic Management Centers

A traffic management center (TMC) is the hub of a traffic control system. The TMC brings together human and technological components from various agencies to perform a variety of functions. TMCs may deal with freeway traffic management, surface street traffic management, transit management or some combination of these functions. Chapter 14 of the *Freeway Management and Operations Handbook* (7) gives detailed information on freeway TMCs. This section is concerned primarily with traffic signal system TMCs.

Functions of Surface Street TMCs

Typically, surface street TMCs perform the following functions (8, 9):

- Implement dynamic selection of traffic signal timings
- Implement transit signal priority
- Provide coordination among various agencies
- Monitor traffic signal equipment, and dispatch resources to fix malfunctioning equipment
- Provide traffic detection and surveillance
- Modify arterial traffic signal timing when an incident occurs on a freeway
- Manage incidents and special events or emergency evacuations
- Store data for long term archives and offline operation

Traffic Signal Timing

One of the primary purposes of a traffic signal system TMC is to manage the timing of traffic signals in urban networks and on arterial streets. Special software allows an operator at a workstation in the TMC to communicate directly with field equipment and modify traffic signal programs in real time.

One of the largest and most advanced traffic signal system TMCs is the Automated Traffic Surveillance and Control System (ATSAC) in Los Angeles, California. ATSAC has been upgraded to use the Adaptive Traffic Control System (ATCS). ATCS can operate in the following modes (9):

- Adaptive: each intersection within a group operates on a common cycle length, determined by traffic conditions within the group. Local intersection splits are based on traffic demand at the intersection, and offset is selected to

minimize number of stops on the approach link with highest flow and based on intersection separation distances.

- Time-of-day: each intersection operates on a predefined fixed program, as selected by the traffic engineer, based on the time of day.
- Operator Control: operator can override the normal program by selecting a special timing plan from the TMC. This is useful during special events and incidents.

A traffic signal system TMC is useful when helping to manage incidents. CCTV cameras, as well as other forms of surveillance, can be used to detect incidents. When an incident occurs, either an operator can manually select an incident traffic signal timing plan, or by the use of a traffic responsive expert system which automatically selects an incident timing plan. Changeable message signs, web sites and the media may be used to alert motorists.

Size and Staffing Requirements of TMCs

The size and staffing requirement of a TMC can vary greatly, depending on the size of the urban area, and the functions that the TMC provides. Table 8-5, below, shows a summary of TMC size and staffing requirements for various TMC's in the US (10, 11, 12). Since TMC functions differ among agencies, the site and staff size may not be comparable among these agencies.

Table 8-5 Comparison of various traffic signal system TMCs in the US.

Location	City / Area Approx. Population	TMC Size	Number of traffic signals on system	Staff
Los Angeles, CA (ATSAC)	3,700,000	5500 sq ft	2912	7 transportation engineers, including 1 supervisor. 2 systems analysts, 1 graphics designer, 1 traffic signal electrician, 1 secretary
Miami-Dade County, FL	2,200,000	5000 sq ft	2020	13 employees
San Antonio, TX	1,100,000	6000 sq ft	765	1 engineer, 3 technicians
Las Vegas, NV: Las Vegas Area Computer Traffic System (LVACTS)	1,500,000 (Covers Clark County)	2500 sq ft	700	4 administrative positions. 4 traffic operations positions. 4 maintenance positions
Atlanta, GA	416,000	2300 sq ft	650	Traffic signal operations: 1 engineer, 1 senior operator, 2 operators. CCTV: 1 engineer, 1 technician
Albuquerque, NM	449,000	800 sq ft	450	4 employees (2 engineers)
Denver, CO	555,000	2800 sq ft	450	No dedicated staff for TMC. Approx 1.5 FTE, more during special events
Seattle, WA	600,000	1420 sq ft	432	One supervisor, two operators
Phoenix, AZ	1,300,000	1500 sq ft	400	1 supervisor, 4 technicians
Boston, MA	590,000	2500 sq ft	320	7-8 employees
Renton, WA	53,000	700 sq ft	96	Initially, one part-time staff member. Can accommodate up to two full-time staff members
Redmond, WA	48,000	800-1400 sq ft (currently under construction) for traffic management area. 1200-1700 sq ft for signal shop area	25 (under construction)	Control room: one supervisor, one operator Signal shop: up to five maintenance staff

Source: Various TMCs, and References 10, 11, 12

Coordination between Traffic Systems and Traffic Agencies

Because a signalized arterial may cross the boundaries of traffic systems or jurisdictions, it may be necessary to coordinate the operation of the systems so that traffic progression is maintained across a boundary. This requires the following:

- Identical cycle length on opposite sides of the boundary.
- Establishment of appropriate offset between signals on opposite sides of the boundary.
- Use of a common time reference by the two systems.
- Coordination with maintenance in case of failure.

This type of coordination is facilitated by the use of common time of day schedules for the traffic systems on opposite sides of the boundary.

Where the systems lie in different jurisdictions, a memorandum of understanding between the agencies may be appropriate to establish the basis for a joint planning effort. Inter-agency coordination is discussed in Reference 13.

References

1. "Goals for a Livable City." City and County of Honolulu <<http://www.co.honolulu.hi.us/mayor/goal-5.htm>>.
2. Gartner, N.H., F.J. Poorhan, and C.M. Andrews. "Implementations and Field Testing of the OPAC Adaptive Control Strategy in RT-TRACS." Presented at the 81st Annual Meeting of the Transportation Research Board, Washington, DC, 2002.
3. Sussman, J. "What Have We learned About Intelligent Transportation Systems." Chapter 3, Federal Highway Administration Report No. FHWA-OP-01-006, December 2000.
4. "SCOOT in Toronto." *Traffic Technology*, Spring 1995.
5. "Durban SCOOT System." The Durban Metro Council, Durban, South Africa, February 27, 1996.
6. "ACS-Lite Algorithms Detail." Gardner Transportation Systems, November 19, 2002.
7. Neudorff, L.G., J.E. Randall, R. Reiss, and R. Gordon. "Freeway Management and Operations Handbook." Federal Highway Administration Report No. FHWA-OP-04-003, Washington, DC, September 2003.
8. "Transportation Management Center Concepts of Operations: Implementation Guide." Federal Highway Administration Report No. FHWA-OP-99-028 / FTA-TRI-11-99-23, Washington, DC, December 1999.
9. "ATCS: Adaptive Traffic Control System." City of Los Angeles Department of Transportation, April, 1998.
10. Freund, K. "A Comparison of Traffic Management Centers in the Puget Sound Region." *ITE Journal*. Institute of Transportation Engineers, Washington, DC, July 2003, pp. 46-50.
11. United States Census Bureau. United State Department of Commerce. 2000.
12. Federal Highway Administration, USDOT, Oak Ridge National Laboratory, U.S. Department of Transportation. "Metropolitan Intelligent Transportation Systems Infrastructure Deployment Tracking Database - FY96." January 1996.
13. "Cross-Jurisdictional System Coordination Case Studies." Science Applications International Corporation, Federal Highway Administration Research Report No. FHWA OP-02-034, February 2002.

**CHAPTER 9
COMMUNICATIONS**

Table of Contents

Section	Page
9.1 Introduction.....	9-2
9.2 Functions of a Communication System.....	9-3
9.3 Alternative Communication Technologies.....	9-3
9.4 NTCIP.....	9-5
References.....	9-6

CHAPTER 9 COMMUNICATIONS



Figure 9-1 Installing communications cable.

9.1 Introduction

Traffic control systems have traditionally used wireline communications to transfer information between field controllers and a traffic management center (TMC) or a field master controller. These systems have consisted of owned cable or leased line facilities. While these alternatives still remain, additional alternatives have become available in the last few years. The functional requirements for surface street traffic control have expanded considerably in the last few years and currently include CCTV, variable message signs and transit priority.

This chapter provides a broad overview of requirements and technologies for communications. A more detailed treatment is available in the *Telecommunications Handbook for Transportation Professionals* (1).

9.2 Functions of a Communication System

A communications system to support surface street traffic control may be required to provide communications to facilitate the following functions:

- Synchronization of timing among controllers in a traffic control section. A common time reference is required to provide a common cycle length and establish the appropriate offsets.
- Upload and download of timing plans and other parameters between the field controller and the TMC.
- Monitoring of field equipment status and reporting of equipment malfunctions.
- Selection of timing plans by the TMC or field master controller.
- Provision of any communications between the TMC and the field controller or between field controllers that may be necessary to support adaptive control algorithms.
- Communication of video information to the TMC and control of cameras by the TMC.
- Upload of logs developed by emergency vehicle signal preemption equipment.
- Support of signals required for transit priority.
- Support of traffic probe based incident detection equipment.

9.3 Alternative Communication Technologies

Among the possible communication functions, only the transmission of a considerable number of CCTV signals requires the use of broad-band communication technology. Broad-band technology supports higher data rates than usually provided by modems using standard telephone channels (e.g. 56 kilobits/second). In many cases, particularly where a number of functions are to be supported by the same communication system, it may be most practical to use broadband technology. The types of technologies that may be used are shown in Table 9-1.

Table 9-1 Communications technology subclassifications.

AGENCY OWNED TECHNOLOGIES

	BROADBAND	NARROWBAND
WIRELIN	Fiber optic cable technology. T1 or SONET techniques possibly including ATM are commonly used where multiple functions are required. Fiber optic based Ethernet are gaining in popularity at this time. Good quality CCTV capability and data capability.	<ul style="list-style-type: none"> • Copper cable. • Fiber optic cable using low data rate modems.
WIRELESS	<ul style="list-style-type: none"> • Conventional microwave. • Spread spectrum radio having good quality CCTV capability and data capability for a limited number of cameras on a channel. • Wireless Ethernet, both short range and long range are being considered by a number of agencies 	<ul style="list-style-type: none"> • Conventional low data rate microwave or spread spectrum radio. • Area radio networks with data capability.

COMMUNICATION SERVICE PROVIDER

LEASED CHANNEL SERVICE	DIAL UP DATA SERVICE	DIAL UP CHANNEL SERVICE
T1, fractional T1, POTS (plain old telephone service), DSL, cable service. Service may range from capability of good quality CCTV and data capability to no CCTV capability.	CDPD, GPRS, dial up internet, ISDN, pager. Data capability, CCTV capability poor or unavailable. Dial up service is only useful for limited traffic signal systems and other functions.	<ul style="list-style-type: none"> • Conventional dial up telephone modem connection. • Cellular telephone. • Satellite providers Data capability, CCTV capability poor or unavailable. Dial up service is only useful for limited traffic signal systems and other functions.

9.4 NTCIP

This section is adapted from the *Freeway Management and Operations Handbook* (2).

The *National Transportation Communications for ITS Protocol* (NTCIP) suite of standard communications protocols and data definitions has been designed to accommodate the diverse needs of various subsystems and user services of the National ITS Architecture. NTCIP standards are intended to handle these needs in the following two areas:

- The first type of communications is between a management system or center and multiple control or monitoring devices, such as a traffic control system communicating with intersection controllers, dynamic message signs, and control of CCTV cameras. This type is referred to as center-to-field (C2F) communications.
- The second type of communication involves messages sent between two or more central management systems, such as a freeway management system and a traffic signal control system. This type of communication is referred to as center-to-center (C2C) communications. Even if two or more of the various center subsystems are located within the same “center” or building, they are still considered logically separate. C2C involves peer-to-peer communications between any number of system computers in a many-to-many network. This type of communication is similar to the Internet, in that any center can request information from, or provide information to, any number of other centers.

NTCIP provides the mechanism whereby interchangeability and interoperability among the various components of transportation systems can be achieved, where “interchangeability” is defined as the capability to exchange devices of the same type (e.g., a signal controller from different vendors) without changing the software; and “interoperability” is defined as the capability to operate devices from different manufacturers, or different device types on the same communications channel. Specific NTCIP standards are discussed in more detail in subsequent chapters. Additional information regarding NTCIP may be found on the NTCIP website (www.ntcip.org), including the NTCIP Guide (3).

References

1. Leader, S. "Telecommunications Handbook for Transportation Professionals: The Basics of Telecommunications." Federal Highway Administration Report No. FHWA-HOP-04-034, September 2004.
2. Neudorff, L.G., J.E. Randall, R. Reiss, and R. Gordon. "Freeway Management and Operations Handbook." Federal Highway Administration Report No. FHWA-OP-04-003, Washington, DC, September 2003.
3. "The National Transportation Communications for ITS Protocol Online Resource." AASHTO, ITE, NEMA. June 2003 <<http://www.ntcip.org>>.

**CHAPTER 10
TRAVELER INFORMATION SYSTEMS**

Table of Contents

Section	Page
10.1 Introduction.....	10-2
10.2 Static Signs.....	10-2
10.3 Advanced Methods of Information Dissemination.....	10-7
10.4 Advantages and Disadvantages of Various Methods of Information Dissemination	10-10
Uses of Traveler Information Devices on Surface Streets	10-10
References	10-15

CHAPTER 10 TRAVELER INFORMATION SYSTEMS



Figure 10-1 Traveler information kiosk (1).

10.1 Introduction

From the point of view of the motorist, one of the most important functions of any traffic management system is the dissemination of information. Information dissemination to travelers includes both pre-trip planning information, as well as real-time en-route information. Although information dissemination is often associated with freeways, it has become increasingly important on surface streets as well.

10.2 Static Signs

Static signs convey only one message. Single-message displays are most useful in recurrent situations where the engineer desires the same driver response each time. Therefore, the engineer should position static signs in locations where the message always proves meaningful.

The Manual on Uniform Control Devices (MUTCD) remains the principal source of standards for static signs (2). The MUTCD also provides the traffic engineer with guidance on signs relative to:

- Use,
- Design,
- Application,
- Placement, and

- Maintenance.

The *Traffic Engineering Handbook* (3) further clarifies some terms and procedures identified in the MUTCD. The Handbook discusses practical implementation and refers to other State and Federal documents that fill in details purposely left open by the MUTCD. Many states have standards that define their implementation of the MUTCD.

Static signs are classified into three basic types:

- Regulatory signs that inform roadway users of:
 - Traffic laws or regulations, and
 - The applicability of legal requirements otherwise not readily apparent.
- Warning signs inform roadway users of potential or existing hazardous conditions on or adjacent to a highway or street.
- Guide signs inform roadway users of:
 - Directions to common destinations,
 - Roadway identification via route markers, and
 - Other valuable information.

State laws allow for enforcement of these signs by police and other local authorities.

Table 10-1 provides examples of the intended use of each basic sign type.

Though normally considered passive, static signs can be transformed into active signs by adding flashing beacon signals. An active sign's message is valid only when the signals flash. An example is:

"School Speed Limit XX MPH When Flashing."

Figure 10-2 depicts an active sign. Note the solar panels that power the flashing beacons. This display type compares favorably to changeable message signs in terms of both cost and the agencies' capability to fabricate it.

Active signs typically see use in traffic management functions and provide a lower cost solution than blank out signs (a form of changeable message sign). Section 10.3 further describes blank out signs. A time-clock switch closure or a communication signal can readily activate the flashing beacons associated with active signs.

Table 10-1 Static sign use.

Static Sign Type	Purpose	Typical Uses
Regulatory	To inform motorists of traffic laws and regulations	<ul style="list-style-type: none"> • Intersection control • Definition of right-of-way • Speed limits • Turning movement control • Pedestrian control • Exclusions and prohibitions • Parking control and limits • Regulations associated with roadway maintenance and construction • Preferential vehicle (e.g., HOV) lane use • School zone restrictions • Railroad-highway at-grade crossing control
Warning	To warn motorists of unusual existing or potentially hazardous condition (s) on or adjacent to a street or highway	<ul style="list-style-type: none"> • Roadway width and horizontal and vertical alignment changes • School areas • Crossings and entrances to streets, highways, and freeways • Impending intersection controls • Road construction and maintenance • Roadway alterations • Advisory speeds • Unexpected crossing areas • Railroad-highway at-grade crossings
Guide	To provide destination and directional information	<ul style="list-style-type: none"> • Route markings and mile markers • Destinations and directional arrows • Distances to destinations • General motorist services • Tourist, recreational and cultural interests • Roadway construction and maintenance detours • Exit numbering • Emergency evacuation routes

Traffic engineers also add extinguishable blank out text to static signs, thus creating a hybrid. The blank out text activates when applicable and supplements the static sign message. Figure 10-3 shows blank out sign text added to a static guide sign.



Figure 10-2 Active sign.



Figure 10-3 Static sign hybrid.

The MUTCD also recommends the use of diagrammatic guide signs along freeways to:

- Graphically depict the exit arrangement in relationship to the main highway. Such guide signs have proven superior to conventional guide signs for some interchange types (2).
- Use at advance guide sign locations where:
 - Splits have off-route movements to the left,
 - Optional lane splits exist, and
 - Exits where route discontinuity and left-exit-lane drops exist (2).

The MUTCD also includes standards for:

- Sign background,
- Letter color, and
- Shape and size.

Many signs for roadway maintenance and construction areas largely duplicate normal regulatory warning and guide signs. To identify their temporary character, all roadway maintenance and construction signs use an orange background.

The MUTCD also addresses signs for HOV and bicycle facilities, and provides information on the use of guidance devices such as:

- Object markers,
- Pavement markings, and
- Roadway delineators.

Recent developments in static signs include:

- Solar-powered light emitting diodes (LEDs) to further self-illuminate static sign messages, and
- The addition of yellow or red LEDs to diagrammatic guide signs to indicate congested road sections.

Figure 10-4 depicts a static yield sign with LEDs incorporated to further distinguish the sign and draw attention to it.



Figure 10-4 LED illuminated static yield sign.

Figure 10-5 shows another method of internally illuminating static signs. The enclosure contains fluorescent lamps behind the sign panel that improve the sign's visibility.



Courtesy of American Signal Company

Figure 10-5 Illuminated fluorescent sign.

10.3 Advanced Methods of Information Dissemination

Static signs are the most basic method of information dissemination. Advanced technologies provide additional methods of giving information to travelers. These methods may be broadly classified as on-roadway and in-vehicle, or off-roadway. For more detailed information on the technology used in the various methods, refer to the *Freeway Management and Operations Handbook* (4).

- On-Roadway and In-Vehicle:
 - Changeable Message Sign (CMS): CMS signs are a variety of different types of signs that display changeable messages to give motorists real-time

information on local conditions. CMS may be permanent or portable. Table 10-2 identifies some applications of CMS. Figure 10-6 shows an example of a surface street CMS.

Table 10-2 Applications of CMS on surface streets.

Category	Applications
Traffic management and diversion	<ul style="list-style-type: none"> • Surface street and freeway traffic advisory and incident conditions. • Parking availability • Special events • Adverse road conditions • Speed advisory
Warning of adverse conditions	<ul style="list-style-type: none"> • Adverse weather and environmental conditions (snow, ice, fog, slippery pavement, high water) • Evacuations and emergencies
Control during construction and maintenance operations	<ul style="list-style-type: none"> • Advisory of existing or upcoming construction / maintenance • Speed advisory • Path control
Control of special use of lanes	<ul style="list-style-type: none"> • Reversible lanes • Exclusive lanes • Contraflow lanes • Restricted roadways

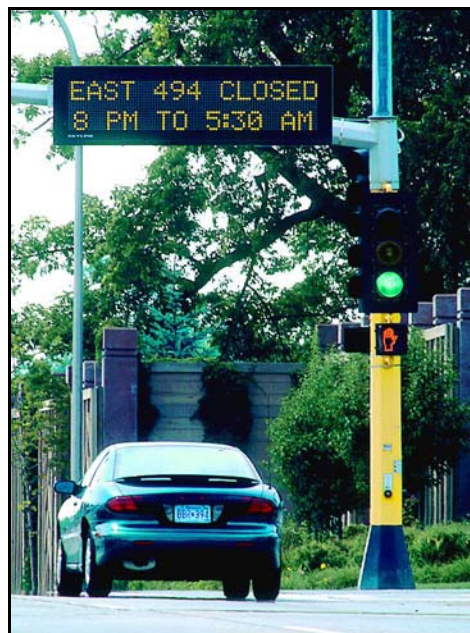

Figure 10-6 CMS on surface street.

- Highway Advisory Radio (HAR): HAR uses a special radio station to give information to travelers. A HAR system consists of a radio transmitter to transmit the information, and signs telling motorists what radio station to tune to. The signs usually include beacons that flash when there is an

important HAR message. Although primarily used for freeways, HAR may be used in limited ways on surface streets. HAR may be permanent or portable.

- Cellular Telephone Hotlines: Cellular phones can be used to access special hotlines with route-specific traffic information. In response to the U.S. Department of Transportation's petition the Federal Communication Commission (FCC) designated 511 as the national traveler information telephone number.
- Commercial Radio: Commercial radio stations often include traffic reports.
- Citizen-Band Radio: CB radios allow two-way communication between a motorist and a response agency, and are useful in a motorist aid service. Although CB radios are not as popular as they once were, they are still found in a significant number of trucks and commercial vehicles.
- In-Vehicle Route Guidance Systems: Video Display Terminals (VDTs) may be mounted on the dashboard, and provide real-time route guidance and navigational information to the motorist. They can display information either on a map, which can highlight the recommended route, or by displaying text and simple symbolic signals (such as an arrow). This type of information may also be provided by voice. Surveillance information may be used to take current traffic conditions into account in the development of route guidance paths.
- Off-Roadway: Access while not in a vehicle can be useful for pre-trip planning.
 - Television: Many commercial television stations provide traffic information, either as a scheduled part of their morning program, or by interrupting regular programming.
 - Telephones: Telephone hotlines may be used to provide pre-trip information, and also for real-time ride sharing matching.
 - Pagers: Alphanumeric pagers are another device that can be used to obtain pre-trip information. Motorists can receive hourly information on traffic and rideshare matching sent to their pagers.
 - Personal Data Assistants (PDAs): PDAs can be used in conjunction with RF communications to receive real-time traffic information, allowing more detailed information than an alphanumeric pager.

- Computers (Internet): In recent years, the internet has become one of the most important methods for information dissemination. Many areas have public agencies and private services that display real-time, route specific traffic information. The internet can also be used to access static information, such as bus schedules.
- Kiosks: Kiosks are video monitors mounted on a stand-alone cabinet, in a wall, or on a counter-top. They may have input devices such as keypads, trackballs, or touch-screen displays. Kiosks may be located in places such as hotels, restaurants, airports, service stations, and retail establishments.

10.4 Advantages and Disadvantages of Various Methods of Information Dissemination

Table 10-3 describes the advantages and disadvantages of various methods of information dissemination.

Uses of Traveler Information Devices on Surface Streets

- Congestion: Almost any form of information dissemination can be used to give information on congestion on both freeways and surface streets. For example, a CMS can be used on a surface street either to give information on the surface street itself or information on an intersecting freeway. HAR, as well as other forms of media (such as internet or television or commercial radio) can give city-wide congestion information.
- Incidents: Information dissemination is also useful in the case of an incident on a surface street. A portable CMS may be deployed at the incident location to inform motorists. Portable CMS may also be used upstream of an incident to advise of a detour if road closures are involved. HAR, as well as other forms of media, could alert motorists of the incident.
- Construction: Similar to incidents, information dissemination is useful during construction activities. Like incidents, portable CMS, HAR, and other forms of media can alert drivers to the construction, and also advise of alternate routes. For an especially major construction project, an internet service or hotline can give up to date information on the status of construction, information on road closures, and travel time information.

Table 10-3 Advantages and disadvantages of methods of information dissemination.

Method	Advantages	Disadvantages
Changeable Message Signs (CMS)	<ul style="list-style-type: none"> • Various CMS technologies are available, giving good flexibility • Provides information specific to the precise location of the driver • Portable CMS can easily be deployed in the case of an incident, construction, or special events • Information can be used by all drivers, no special equipment is needed 	<ul style="list-style-type: none"> • Most CMS only allow enough space for short messages with little detail • May be distracting to drivers, and requires them to take their eyes off the roadway to read the sign. May cause accidents, and may cause delays if drivers slow down to read and to comprehend the message on the sign • If a CMS is blank, drivers may assume it is disabled. If a CMS has a non-critical message, it may lose credibility
Highway Advisory Radio (HAR)	<ul style="list-style-type: none"> • Doesn't require any special equipment for driver. Virtually all cars have a radio • Can give longer, more detailed information than CMS. Can be used at any location within the coverage area, rather than at fixed locations where a CMS happens to be located • Information is received through a different sensory channel (audio), which reduces information overload received visually while driving. (5) 	<ul style="list-style-type: none"> • Requires action on the part of the motorist—he or she must tune to the specific radio station. May be distracting, and many drivers do not bother to tune into HAR station • Many drivers do not trust HAR and may prefer commercial radio. • Requires an FCC license, and in many cities there may be very few available frequencies that will not interfere with existing radio stations • A driver may miss the key part of the message and may have to listen again to the entire message • When used on a surface street network, it is not practical to post HAR beacon signs at every intersection. Driver notification is more difficult than for freeways.

Table 10-3 Advantages and disadvantages of methods of information dissemination (continued).

Method	Advantages	Disadvantages
Cellular Telephone Hotlines	<ul style="list-style-type: none"> • Allows drivers to access information specific to the road or region they are interested in. • Can be used while driving 	<ul style="list-style-type: none"> • Only available to drivers with cell phones • Use of cell phone while driving may cause distractions (this problem is mitigated somewhat by the use of hands free cell phones) • May require a complex menu system for the driver • May require driver to pay for cellular airtime • Driver often inadvertently provides incorrect location information
Commercial Radio	<ul style="list-style-type: none"> • Information is very easily available: virtually all cars have a radio, and most drivers have it on • Drivers generally prefer commercial radio over HAR, and trust the information more 	<ul style="list-style-type: none"> • Traffic reports are only given during the times where they are normally scheduled. This may cause a major incident to be reported late or not at all, and may cause out of date information to be reported • Only a very short period of time is allowed for traffic reports, which limits the amount of information that may be given • There can be error in interpretation of information by broadcasters
Citizen Band (CB) Radio	<ul style="list-style-type: none"> • Useful for a motorist-aid system • Allows 2-way communication between driver and response agency 	<ul style="list-style-type: none"> • Most vehicles except for trucks and commercial vehicles are not equipped with CB radios
In-Vehicle Navigation Systems)	<ul style="list-style-type: none"> • Travel information is more readily accessible to the driver (providing continuous access to current position, routing, and navigational information) • Computer-generated navigational maps and displays are logical extensions of traditional forms of providing drivers with route guidance and navigation information 	<ul style="list-style-type: none"> • Visually based systems may cause driver distraction and information overload. • Systems are limited to static route guidance only. (i.e. non-traffic related information unless an unusual level of surface street surveillance is provided)
Television	<ul style="list-style-type: none"> • Convenient for pre-trip planning, drivers can watch the television before leaving 	<ul style="list-style-type: none"> • Not available while inside vehicle

Table 10-3 Advantages and disadvantages of methods of information dissemination (continued).

Method	Advantages	Disadvantages
Telephones	<ul style="list-style-type: none"> • Can provide customized pre-trip planning information to drivers • Can be used for dynamic ridesharing 	<ul style="list-style-type: none"> • Only a cellular phone can be used while in a vehicle. See “Cellular Phones” above for more information
Pagers	<ul style="list-style-type: none"> • Can provide customized, real-time information 	<ul style="list-style-type: none"> • Can only give a very small amount of alpha-numeric information • Only available to drivers who own pagers
Personal Data Assistants (PDAs)	<ul style="list-style-type: none"> • Can give more detailed information than an alpha-numeric pager • Two-way communication allows drivers to access information specific to their needs 	<ul style="list-style-type: none"> • Only available to drivers who own a PDA • Dangerous to use while driving.
Computers (Internet)	<ul style="list-style-type: none"> • Two-way communication allows drivers to access information specific to their needs • Allows very detailed information 	<ul style="list-style-type: none"> • Usually not available while in-vehicle • Not all drivers have a computer with an internet connection
Kiosks	<ul style="list-style-type: none"> • Can give information tailored to a specific population, at a specific location 	<ul style="list-style-type: none"> • Not available while in vehicle • Many kiosks are not located where they can be reached by their target audience and are not well used

- **Route Guidance:** A variety of different methods of information dissemination can be used to provide route guidance on surface streets. In-vehicle navigation systems (video display terminals, head up systems) can give customized, turn-by-turn route guidance information. A variety of internet services also can give turn-by-turn directions between two points. In many cities, CMS can be used on the surface street network to direct motorists to the best route to a destination such as a bridge or tunnel. Often, a hybrid sign, including both a static component and a changeable component (such as arrows) can be used for this purpose.
- **Weather:** Various forms of media, including HAR, can give motorists information relating to severe weather conditions, and how it affects driving, including road closures. Portable CMS can be used on surface streets to inform motorists of severe conditions, road closures, and alternate routes.

- Special Events: Portable CMS can be used to direct motorists to special events, to give parking information, and to give alternate routes to traffic wanting to avoid the area of the special event.
- Emergencies / Evacuation: In recent years, increased attention has been given to security issues. In the event of an emergency, such as a terrorist attack, various media forms, including HAR, as well as CMS can be used to alert motorists of evacuation routes, closed roads, and restricted roads.
- Parking: CMS or HAR can be used to alert drivers of which parking lots are closed or full, and the locations of alternate parking locations.
- Transit information: Internet services, PDAs, and kiosks are useful for information relating to public transit schedules. They can deliver both static information, as well as real-time information related to delays, schedule changes, and bus route diversions.

References

1. “What are Intelligent Transportation Systems.” Hudson Valley Transportation Management Center <<http://www.hudsonvalleytraveler.com/its.html>>.
2. “Manual on Uniform Traffic Control Devices.” Federal Highway Administration, Washington DC, 2000.
3. Pline, J.L. (editor). “Traffic Engineering Handbook.” 5th Edition. Institute of Transportation Engineers, Washington, DC, 2000.
4. Neudorff, L.G., J.E. Randall, R. Reiss, and R. Gordon. “Freeway Management and Operations Handbook.” Federal Highway Administration Report No. FHWA-OP-04-003, Washington, DC, September 2003.

**CHAPTER 11
SELECTION OF A SYSTEM**

Table of Contents

Section	Page
11.1 Introduction.....	11-2
11.2 Federal-Aid Requirements	11-3
11.3 Systems Engineering and System Selection Process.....	11-3
Concept of Operations.....	11-5
Requirements	11-7
References	11-8

CHAPTER 11 SELECTION OF A SYSTEM

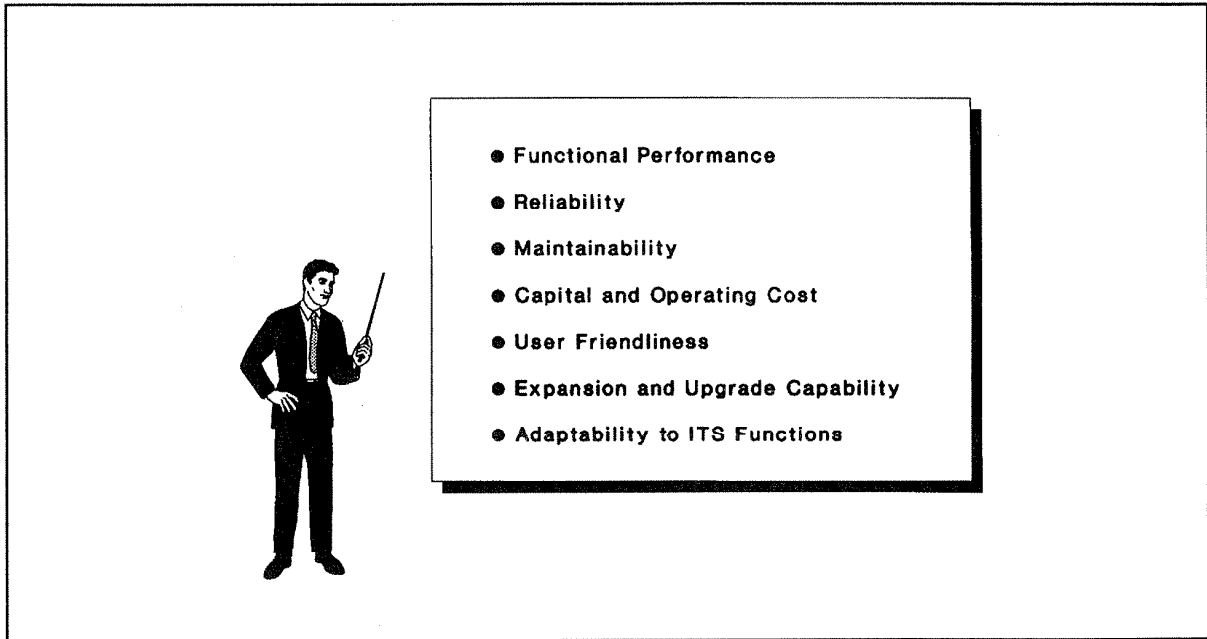

Figure 11-1 Selection of a system

11.1 Introduction

The processes of defining system requirements, design, implementation, operation and management of a traffic control system are system engineering processes and are covered in this chapter as well as Chapters 12 and 13.

In recent years there has been an increased interest in applying systems engineering techniques to ITS. For example, the National Highway Institute offers the course “Introduction to System Engineering for Advanced Transportation” (1). Gordon (2) provides an overview of how system engineering processes have been applied to traffic signal systems and provides a number of references for these processes.

A system selection *process* encourages the objective consideration of alternatives in a structured, rather than subjective, manner. Further, the structured decision approach can generate a sense of commitment to the choice among system stakeholders including:

- Participating agencies,
- Traffic system engineers, and
- The driving public.

11.2 Federal-Aid Requirements

Federal aid often provides a portion of the resources used to implement traffic control systems. Particular attention should be paid to the following sections of Title 23 of the Code of Federal Regulations (CFR).

- Part 655 (Traffic Operations), Subpart D (Traffic Surveillance and Control), Section 655.409 (Traffic Engineering Analysis).
- Part 655 (Traffic Operations), Subpart F (Traffic Control Devices on Federal-Aid and Other Streets and Highways), Section 655.6-7 (Funding).
- Part 940 (Intelligent Transportation System Architecture and Standards), Section 940.11 (Project Implementation).

Part 940 defines the manner in which the systems engineering process will be applied to the project. The identified systems engineering practices include the following:

1. Identify the portion of the regional architecture being implemented.
2. Identification of participating agencies.
3. Definition of requirements.
4. Analysis of alternatives.
5. Procurement options.
6. Standards and testing procedures.
7. Resources for operations and maintenance.

11.3 Systems Engineering and System Selection Process

System selection comprises the first three steps in the “V” representation of the systems engineering life cycle shown in Figure 11-2 (1). Most of the traffic signal systems installed are largely based on suppliers’ existing software. Traffic controllers are similarly based on existing equipment and software. Modifications may be made to incorporate the special function, interfaces and data transfers that may be revised by the project. The relationship of the system engineering practices identified in Section 11.2 to the V diagram is shown in Figure 11-3 (1). The following subsections describe the first three steps of the “V” diagram:

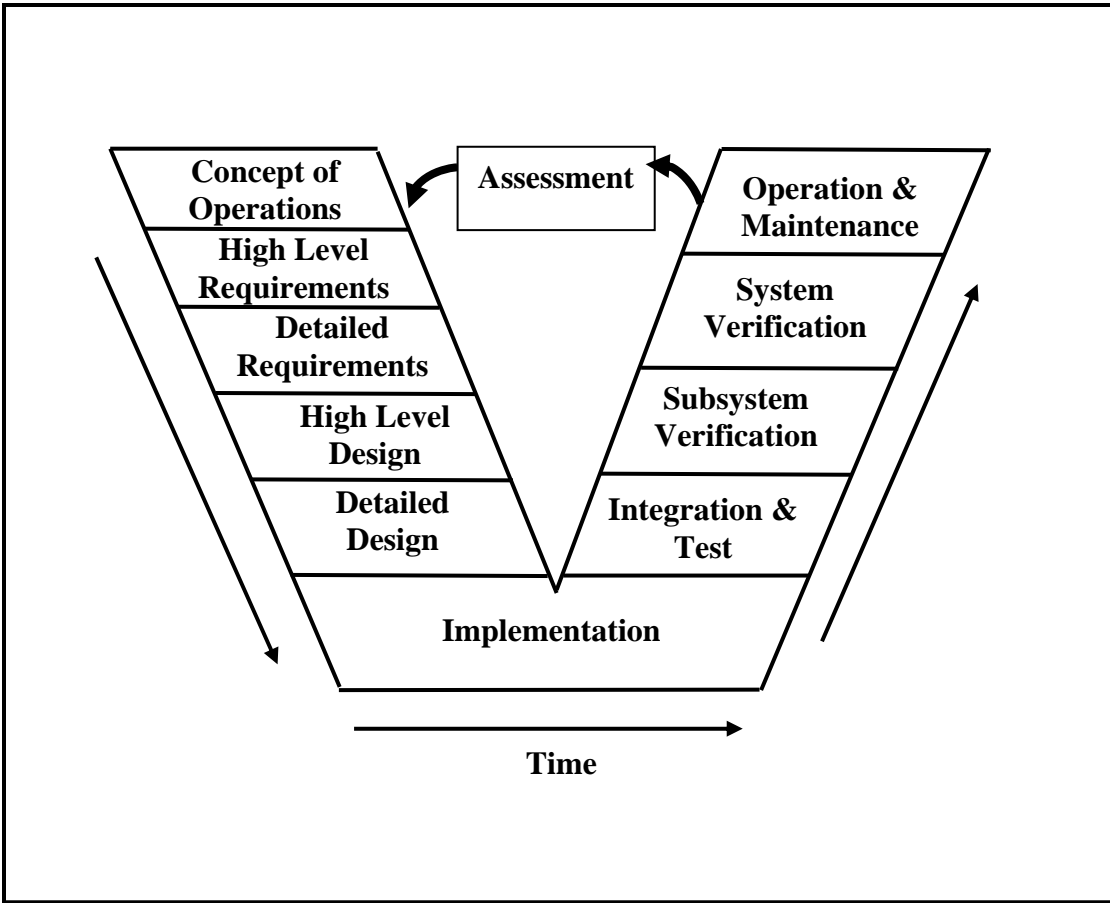

Figure 11-2 "V" representation of the systems engineering life cycle.

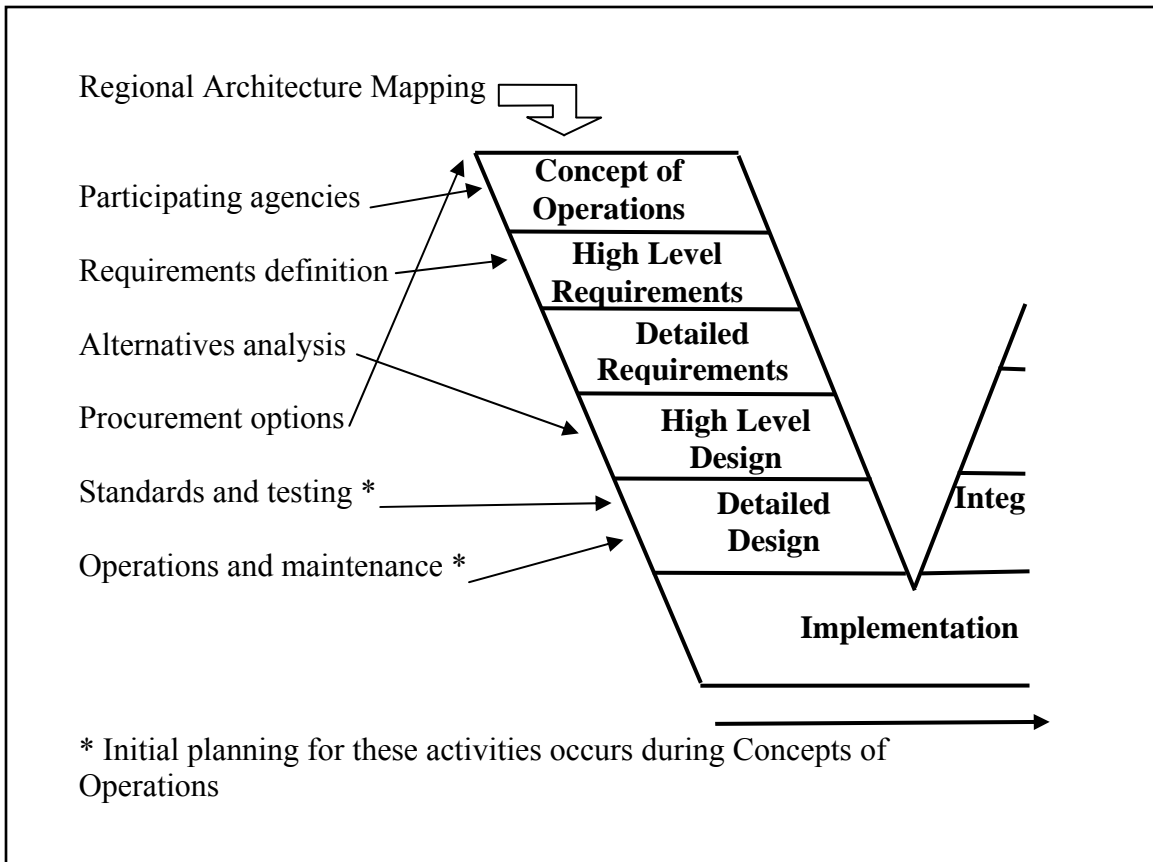

Figure 11-3 Relationship of system engineering practices identified in Part 940 to the system engineering life cycle.

Concept of Operations

The concept of operations is a document that defines the environment in which the system is to operate (1). The environment includes the relationship between the system and the agency's responsibilities, the physical environment, and expectations (performance and life). It:

- Describes the system's operational characteristics,
- Facilitates understanding of goals,
- Forms the basis for long range planning,
- Presents an integrated view of the stakeholder organization and mission.

A general process for developing the concept of operations is shown in Figure 11-4 (1).

Performance measures to express the system's capabilities should be defined during the development of the concept of operations. These performance measures will be used during the entire systems engineering life cycle.

The documentation for the concept of operations should contain the following:

- Scope
- Referenced documentation
- Current system or situation
- Justification for and nature of changes
- Concepts for the proposed system
- Operational scenarios
- Summary of impacts
- Analysis of proposed system

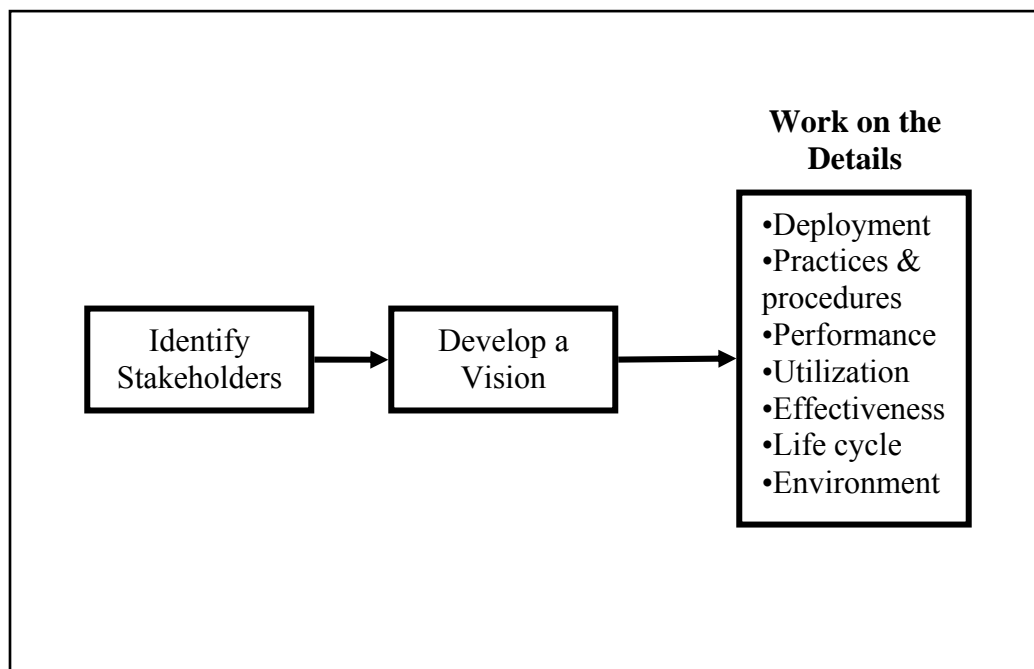

Figure 11-4 Developing the concept of operations.

Requirements

Requirements are statements of what a system should do, when it should do it, and for whom. They do not define the manner in which the system should do it (1).

Two types of requirements are discussed below, end product requirements and functional requirements.

End product requirements define the needed system capabilities. These commonly include:

- Functional requirements (what capabilities the system will provide to the operator). These may include required modifications and traffic responsive requirements.
- Performance requirements. These typically include the number of intersections serviced, number of detectors processed, number of subnetworks accommodated and special data processing requirements.
- Interface requirements (identification of the systems to be connected with and the data flows. These requirements are closely related to the Regional ITS Architecture.

Enabling requirements identify what needs to be provided in order for the system to be compatible with the organizational and environmental circumstances. Examples include:

- Development (includes special functions or other requirements).
- Deployment (includes requirements to transfer from existing equipment to new equipment).
- Testing and support to assure proper functionality, reliability and robustness.
- Training to enable the operating agency to support the system.

References

1. "An Introduction to Systems Engineering for Advanced Transportation." National Highway Institute Course No. 137024, Publication No. FHWA-NHI-01-167, April 2003.
2. Gordon, R.L. "Systems Engineering Processes for Developing Traffic Signal Systems." *NCHRP Synthesis 307*, Transportation Research Board, Washington, DC, 2003.

CHAPTER 12 DESIGN AND IMPLEMENTATION

Table of Contents

Section	Page
12.1 Introduction	12-3
12.2 System Implementation	12-3
System Design.....	12-3
High Level Design.....	12-4
Detailed Design.....	12-5
12.3 Procurement Approach	12-6
Engineer (Consultant) / Contractor Approach.....	12-6
Systems Manager Approach.....	12-7
Design / Build Approach.....	12-8
12.4 Design Plans and Specifications	12-9
Design Plans.....	12-9
Specifications.....	12-10
Sources of Specifications.....	12-11
Closed versus Open Specifications.....	12-11
Standard Specifications.....	12-12
Contract Documents.....	12-12
Invitation to Bid.....	12-13
Instructions to Bidders.....	12-13
Bid Proposal.....	12-13
Bonds.....	12-13
Agreement.....	12-14
Conditions.....	12-14
Contractor Qualifications.....	12-14
Pre-Bid Conference.....	12-15
Precedence.....	12-15
Technical Specifications.....	12-16
Definition of Terms.....	12-16
Installation of Traffic Signals.....	12-16
Specifications for Materials and Equipment.....	12-17
Software, Database, Performance and System Test.....	12-17
12.5 Deliverable Services	12-21
Systems Management.....	12-21
Documentation.....	12-22
Training.....	12-24
Startup Assistance.....	12-26
Warranties / Guarantees.....	12-27
Maintenance.....	12-27
System Acceptance Tests.....	12-28
12.6 Project Management	12-31
Contract Administration.....	12-31
Scheduling.....	12-33
Critical Path Method (CPM).....	12-33
Bar Charts.....	12-35

	Gantt Charts	12-35
12.7	Implementation Pitfalls	12-35
	Inexperienced Contractors.....	12-35
	Construction Management	12-38
	Maintenance and Protection of Traffic (MPT) During Construction	12-39
	Database Development.....	12-39
	Insufficient Staff for Operations and Maintenance	12-40
	Utility Coordination	12-40
	Planned Use of Untested Facilities or Techniques	12-40
	Alienation of Maintenance Staff	12-41
	Privatization of Operations and Maintenance	12-41
	References	12-42

CHAPTER 12 DESIGN AND IMPLEMENTATION



Figure 12-1 CADD workstation and operator.

12.1 Introduction

The material in this chapter:

- Places the system design, procurement, and installation tasks in perspective with respect to total system planning and implementation,
- Describes alternative approaches to the procurement of systems, including contractor selection,
- Describes the various elements of the design process, and
- Describes elements of an approach to manage the system installation.

12.2 System Implementation

System Design

Chapter 11 describes the system development process through the requirements step, resulting in the identification of the functional requirements for the system. The design process consists of selecting the technologies and software to implement these requirements, and to identify locations for deployment. In some cases, modifications

may be required to commercially available equipment, software or to an agency's specifications.

Traffic signal control systems are usually based, in large measure, on existing software that may be provided by a number of suppliers. These software functions may be modified or augmented by the specifications resulting from the design process. The agency procuring the traffic system may also have software or equipment specifications that require consideration during the design process. The design process described below should be considered with these issues in mind.

Agencies responsible for operation of traffic control systems often have standards for commonly employed field equipment. It may be necessary for compatibility and to simplify logistics to employ these standards for new systems to the extent possible.

The USDOT ITS JPO's Standards website (www.its-standards.net) provides current status on the ITS Standards Program. It also contains resource documents, fact sheets, testing, deployment contact, training and application area information as well as an interactive ITS Standards Forum. A link is also provided to the ITS Data Registry, a growing repository of elements of the ITS Standards.

The design phase consists of two subphases, high level design and detailed design.

High Level Design

High level design provides the transition between requirements and detailed design. It includes:

- Definition of architecture.
- Sub-system definition.
- Sub-system verification plan development.
- Interface identification.

Items such as the following may be included:

- Development, evaluation and selection of alternatives. Examples include detector and communication technology.
- Identification of functions that may be unique to the system. These may include items such as:
 - Surveillance and control strategies,

- Mode structures,
 - Graphics,
 - Controls and displays,
 - Interfaces with other systems, and
 - Operation with legacy field equipment.
- Identification of approximate equipment locations.
 - Conduct of social, economic and environmental studies to assure compliance with federal and state regulations.
 - Planning for access to utility supplied power and communication facilities that may be required.
 - Assessment of detailed maintenance and operations resources that will be required.
 - Definition of interfaces and protocols for data exchanges with other agencies and systems.
 - Development of a plan to procure the system. This is further discussed in Section 12.3.

Detailed Design

Detailed design completes the description of the system at the component level. It includes:

- Configuration item identification,
- Component level specifications,
- Code specifications,
- Hardware specifications,
- Verification procedures,
- Software specifications,
- Intersection installation plans,

- Traffic management center installation plans, and
- Detailed cost estimates.

Detailed design results in the development of a detailed set of plans, specifications and estimates (PS&E package) suitable for procuring the system. The specifications should include project test and acceptance requirements and the accompanying payment provisions. Design plans and specifications are discussed further in Section 12.4.

12.3 Procurement Approach

The feasibility study selects a preliminary design as the most appropriate to satisfy traffic control system goals. The agency should establish the procurement approach and contracting procedures as part of or subsequent to the feasibility study. The following sections describe three possible approaches:

- Engineer (consultant) / contractor,
- Systems manager, and
- Design / build.

The first two approaches must satisfy the following principles:

- An organization separate from that supplying the hardware, bidding on the project, or installing the system must develop the specifications, and
- The procurement of all hardware items must follow competitive bid requirements.

Engineer (Consultant) / Contractor Approach

The engineer (consultant) / contractor approach represents the traditional procedure for contracting within the traffic signal system community. Agencies have procured the majority of traffic control systems using this approach. On the basis of feasibility studies and system selection, the engineer (consultant) prepares the design plans, specifications, and estimates (PS&E) for the proposed system. Either an agency employee or a consultant can serve as the engineer. The agency then issues the completed PS&E to the contractor community, and receives bids in accordance with the agency's established practice.

In this approach, the contractor bids on a single set of plans and specifications and agrees to provide a complete system, comprised of hardware and software, procured, installed,

and integrated by the contractor's organization. Hardware items may be manufactured by the contractor's firm or subcontracted within the conditions imposed by the contract. The contractor also has responsibility for all systems integration tasks, documentation, and training. He may also have responsibility for system startup assistance and the development and implementation of timing plans and other database elements.

The engineer's (consultant) activities continue during system installation and may include:

- Monitoring the contractor's progress,
- Reviewing the contractor's submittals,
- Interpreting or clarifying plans and specifications,
- Inspecting the installation,
- Coordinating activities with other agencies such as utilities.

The engineer or consultant holds responsibility for the witnessing and acceptance of components, witnessing tests at all levels and accepting the entire system. The agency or its selected consultant can perform all or part of the engineer's duties.

Systems Manager Approach

The systems manager approach requires the selection of a single firm or consulting team (as systems manager) to become responsible, under an engineering services contract, for:

- System design,
- PS&E preparation,
- Systems integration,
- Documentation,
- Training,
- Management of testing, and
- Startup.

Selecting a systems manager generally follows the typical procedures for selection of an engineering consultant with negotiated cost-plus-fixed-fee contracts frequently used.

To avoid conflict of interest, the systems manager usually accepts a hardware exclusion clause which prohibits that organization from supplying any of the hardware components of the system. The system manager often provides software.

The system manager prepares the PS&E. The agency's normal bidding processes then procure the individual subsystems or services, and the systems manager subsequently oversees testing and installation of the equipment. The systems manager may also provide the integration of all hardware elements and the software to provide a total operating system.

Design / Build Approach

The design / build approach selects a single responsible entity to perform all work associated with the deployment of the traffic control system.

This procurement approach is more commonly used for large freeway based projects than for signal systems.

The public agency monitors the activity of the design / builder. The design / builder:

- Performs all design work,
- Contracts and / or constructs system elements, and
- Commissions the system and turns it over to the operating agency (1).

A feasibility study or detailed set of requirements usually forms the basis for the design build.

The design / build contract may take the form of a negotiated or cost competitive contract.

The design / build concept may not prove consistent with the procurement regulations (or the interpretation of these regulations) of the procuring agency.

After negotiation of the agreement, the design / builder completes all aspects of the project in conformance with the preliminary design. The agency and design / builder generally negotiate changes.

The design / build approach has the key attribute of complete assumption of responsibility by the design / builder. This generally allows more rapid completion because of streamlined procurement procedures and quicker resolution of problems. Also, the design / builder has an incentive to reduce its costs and risks by completing all work quickly and turning the system over to the agency. Assuming a qualified design / build team, all skills rest within the team, leading to closer coordination and cooperation.

The approach does place a burden of supervision on the agency to maintain quality. The design / builder moves at full speed and may prove reluctant to change direction, if required due to technology changes. It also may force the agency into making quick decisions.

Some local agencies such as Salem, Oregon (2) have used this approach for the design and implementation of computerized signal system projects.

When using this approach for signal systems, the responsibility for identifying and separating work efforts of the design / builder versus the operating agency, rests with the owner. Database configuration information gathering and data entry and intersection / section graphics file generation and configuration may be large areas of work effort that can lead to future contention if not assigned openly.

In December, 2002, FHWA released regulations regarding the use of design-build contracting techniques for transportation infrastructure projects that are part of the Federal-highway program (3). An AASHTO Design-Build Task Force contributed a number of recommendations regarding the program's attributes, management and organization.

12.4 Design Plans and Specifications

Construction contract documents represent tools for communication between the owner (purchaser, local government) and contractor (supplier). Properly prepared, they prevent disagreements and facilitate project completion by clearly communicating what the owner wants done and when.

The two principal elements of contract documents are plans (drawings) and specifications (4). Plans define the physical relationships of materials procured by the contract, while specifications define the *quality* and *types* of workmanship and materials. Understanding the unique role of each of these documents will produce clarity, brevity, and consistency, and avoid redundancy. Ideally, a change in requirements will not lead to inconsistencies and misinterpretations because of the failure to modify both documents.

The following sections describe typical contents of plans, specifications, and contract documents.

Design Plans

The design plans show how components of a traffic control system are constructed and installed. Table 12-1 shows the types of plans generally included.

The items in Table 12-1 provide information for the contractor and equipment supplier to prepare a project bid. The plans also serve to control the project's construction.

Table 12-1 Types of design plans.

<ul style="list-style-type: none"> • Title Sheet Shows name, location and scope of project • Summary of Quantities Shows material and equipment quantities • General Notes Frequently call special attention to critical requirements to assure they are not overlooked; must avoid conflicts with specifications • Intersection Layout Shows pole, signal, and conduit locations and other pertinent intersection information • Conduit, Cable and Signal Head Tables Indicate: <ul style="list-style-type: none"> - number designation of the run - size of conduit - size and number of cable or cables in the conduit - approximate length of conduit <p>Signal head tables outline:</p> <ul style="list-style-type: none"> - type of signal head - size and type of signal lenses - type and size of pole on which type are mounted • Intersection Phasing Diagram Indicates phasing of each intersection and includes vehicle and pedestrian intervals 	<ul style="list-style-type: none"> • Wiring Diagram Indicates color coding of wiring from local controller cabinet to signal heads and from master controller to local controllers; wiring diagrams can serve as a permanent record for maintenance purposes • Intersection and System Timing Plans Illustrates interval timing, offsets, and other intersection timing for backup timing plans • Construction Design Drawings Shows minimum requirements for construction dimensions and materials for foundations • Traffic Control Plan Indicates handling of traffic during construction, particularly addressing the need for continuous interconnected operation of existing signals • Details of Barricades, Detour Layouts, and Signing Illustrates the construction phase of the project • Diagram of Underground Utilities Shows details of location • Standard Plans Possessed by each agency, generally provide numerous standard drawings of frequently encountered details already approved for use in situations applicable to the project
--	--

Specifications

Specifications spell out the minimum acceptable requirements for the traffic control system's equipment and materials, and how the contractor should install the system. Deficient specifications can often lead to inferior equipment and materials. When defining the minimum acceptable requirements, remember that a construction contractor will, when possible, provide the lowest cost equipment meeting these requirements.

Sources of Specifications

Specifications should reflect the system's functional requirements and equipment and, as appropriate, physical requirements and constraints.

To assure conformance with available products, agencies often adopt existing specifications proven to result in acceptable equipment and materials. Agencies often use existing specifications in their entirety or modify them to fit their particular needs.

With the proliferation of traffic control systems in the last decade or two, state, county or city ITS standard specifications may be available for use by the local municipality or its agents. With the widespread use of the internet, now one often finds these specifications at respective web sites.

Several good sources for equipment and materials specifications include:

- Federal Highway Administration (FHWA),
- Institute of Transportation Engineers (ITE),
- International Municipal Signal Association (IMSA),
- National Electrical Manufacturers Association (NEMA),
- Other cities, and
- State highway or transportation departments.

Closed versus Open Specifications

Specifications should result in high quality equipment and materials. Unless interfacing to or expanding upon legacy systems, specifications should not be written around a particular manufacturer's software, equipment or material, thus precluding competitive bids. *Closed* specifications, those that specify a particular manufacturer's software, equipment or material, may not meet the intent of Federal, state, or most local procurement laws, and more than likely will lead to high, non-competitive bids. *Open* specifications allow a number of competitive bidders on equipment and materials, usually resulting in lower bids.

If agencies do not have the right to modify their existing software, closed specifications for the modification of legacy systems may be required. Often, off-the-shelf software products, such as languages or operating systems, fall into the closed category and are often identified by name.

Standard Specifications

Standard specifications, invoked by name, number, and date become a legal part of the contract. Examples include:

- Specifications previously adopted by the city or state,
- Wire specifications available from the International Municipal Signal Association (IMSA),
- Communications cable specifications from the Rural Electrification Administration (REA), interface specifications available from the Institute of Electrical and Electronic Engineers (IEEE), Electronic Industries Association (EIA), American National Standards Institute (ANSI), National Television Standards Committee (NTSC), International Consultative Committee for Telegraphy and Telephony (CCITT), International Telecommunications Union (ITU),
- Standard specifications for materials testing available from the American Society for Testing Materials (ASTM), and
- Military specifications (MIL specs) available from the U.S. Department of Defense.

The design engineer should become familiar with standard specifications and invoke them, as appropriate.

Contract Documents

Together with design plans and specifications, contract documents form the complete legal package to which the contractor must conform. Contract documents typically contain:

- Invitation to bid,
- Instructions to bidders,
- Bid proposal,
- Bonds,
- Agreement,
- Conditions of contract, and

- Qualifications.

Invitation to Bid

An invitation to bid generally takes the form of a one page document containing a brief project summary along with bidding and construction procedures. It simply advises prospective bidders about the existence of the project and enables them to decide whether it lies within their area of capability and interest. It further directs interested contractors to the source of bid documents.

Instructions to Bidders

Instructions to bidders tell each bidder how to prepare a bid so that all bids received have equivalent format for comparison and evaluation. This document systematizes bid forms, and its contents should confine themselves to that purpose. The document deals with the issue of exclusions and substitutions by a bidder to assure comparability of bids.

Bid Proposal

A bid proposal provides a uniform format to facilitate comparison and equal consideration for contract award. The instructions tell bidders what they must do. On the bid proposal form, they respond and quote their proposed price for doing it. Bid proposals, addressed to the agency, include general statements which commit the bidder to:

- Having read the documents thoroughly, and
- Being familiar with the site and the problems associated with supplying the system as designed.

The bidder should acknowledge receipt of all issued addenda, and individuals authorized to bind the bidder must sign where indicated.

Bonds

A bond serves as a legal document which binds another party into a formal contract as security that the bidder (or contractor) will perform as agreed. The following three types of bonds see common usage:

- Bid bond—posted by the bidder to assure he / she will sign the contract if awarded; frequently amounts to about 10 percent of the base bid,

- Performance bond—posted by the successful bidder to guarantee that he / she will complete the project and not default; this bond typically amounts to the full contract price, and
- Labor and materials payment bond—posted by the successful bidder to guarantee that he / she will pay for all materials and labor and not leave the agency liable for liens against the completed system; this bond generally amounts to the full contract price.

Agreement

The agreement provides the following five elements:

- Identification of the parties (who),
- Statement (perhaps by reference to another document) of the work to be performed (what),
- Statement of the consideration (how much),
- Time of performance (when), and
- Binding signatures of parties.

The agreement is often mistakenly called the contract. Actually, the contract consists of all the contract documents, while the agreement represents only one of those documents.

Conditions

The general conditions document serves as the *fine print* defining contractual relationships and procedures relative to the project. Most city and state agencies have established general conditions which apply to all their construction documents. The National Society of Professional Engineers (NSPE) (5) also publishes applicable general conditions. Agencies normally print general conditions in large quantities and issue them as standard documents. Since general conditions apply to typical construction projects, traffic systems usually require modifications called supplementary conditions. For example, an agency may require access to computer equipment during installation for database development.

Contractor Qualifications

Agencies typically require contractors to prequalify to receive project bid documents. This prequalification typically takes the form of a general review of submitted financial and experience data.

Traffic control systems represent specialized projects and require a level of expertise and experience not widespread within the contractor community. Therefore, some local and state agencies permit specification of required contractor technical experience. (Also, see Two-Step Procurement previously discussed.) This section of the contract documents should advise contractors on the minimum experience and qualifications necessary to submit a bid, and instruct them how to submit special qualification data for review. Many local and state agencies include a variety of pre-qualification requirements, such as:

- Conformance with the Equal Opportunity Act,
- Involvement as a percentage of the overall contract of:
 - Women Business Enterprise (WBE),
 - Disadvantaged Business Enterprise (DBE), and
 - Minority Business Enterprise (MBE).

These requirements prove common in most local and state agencies. Certain agencies also require that the contractor have a local office.

Pre-Bid Conference

For moderate or large scale projects a pre-bid conference often becomes advisable. The pre-bid conference reviews the instructions to bidders and elements of the specifications. The conference may identify special or unusual features of the project. The pre-bid conference usually provides prospective contractors with the opportunity to ask questions or raise pertinent issues.

Precedence

A specific hierarchy of precedence defines and clearly establishes which document governs in case of conflict within the documents. An example hierarchy (in decreasing order of control) follows:

- Agreement,
- Plans,
- Special provisions (technical specifications),
- Standard specifications,
- Supplementary conditions, and

- General conditions.

Technical Specifications

Technical specifications outline the specific requirements for materials, equipment, installation and operation. These specifications, an integral part of the contract documents, should include individual specifications for major items of material and equipment, and methods of construction and installation. They should also include items such as operating manuals, training and software. All mandatory specification must contain the word Shall in its structure. Avoid the use of qualitative phrases such as: high performance, high availability, good, “must be reliable”. Use instead quantifiable descriptions such as: “The software shall be unavailable no more then 4 hours per week on continuous operation.”

Technical specifications should include the following major categories:

Definition of Terms

The lead section should define words used frequently throughout the technical specifications. These definitions serve as a glossary for terms peculiar to the design plans, specifications, and other contract documents. Examples include:

- ITE—Institute of Transportation Engineers,
- Traffic signal - Any power-operated traffic control device, except a sign or flasher, which warns or directs traffic to take some specific action, and
- Signal system - Two or more signal installations operating in coordination.

Installation of Traffic Signals

The specification for the installation of traffic signals sets forth detailed requirements for installation of various material and equipment items.

Other standard specifications (e.g., drilled shaft foundations, reinforcing steel), adopted and published by the local governing authority, may cover certain items associated with the installation of traffic signals. Standard specifications for roadway construction can normally be obtained from public works departments of cities or state highway departments. A reference, noting the name of the publication and the effective date, usually covers specifications for parts of the signal system not pertaining directly to the traffic signal installation.

Table 12-2 shows the items which the traffic signal installation technical specification should include (6).

Table 12-2 Items in traffic signal installation specification.

Name	Description
General	The items covered by the specifications, the requirement for furnishing new stock, and the procedure for the substitution of materials and equipment
Materials furnished by contractor	Details of what materials and equipment the contractor must furnish and what materials and equipment others must furnish
Power connection	Method for furnishing power from source to controller and specifications for power line
Conduit	Methods for installing conduit, to include conduit approved by Underwriters Laboratories, methods for joining conduit, and methods for testing the usefulness of an installed conduit
Wiring	Methods for wiring controller cabinet, signal heads, and pole bases
Grounding and bonding	Requirements for grounding and bonding signal housing, controller housing, signal common, and power service common
Sealing	Requirements for sealing conduit to provide continuously sealed electrical circuit
Concrete	Standard specifications for concrete and reinforcing steel
Concrete foundation for controller cabinet and signal posts	Methods and requirements for digging, placing, finishing, and backfilling concrete foundations
Paint and painting	Items to be painted, type of paint, number of coats, and method of painting (e.g., baked-on or sprayed)
Preservation of sod, shrubbery, and trees	Requirements for the replacement of damaged sod, and the protection of shrubbery and trees
Removal and replacement of curbs and walks	Procedure for obtaining approval to cut curbs and / or sidewalks, and the method for their replacement
Controller cabinet keys	Where delivered and number of each required

The specification for installation of traffic signals can also include other items that fit particular site-specific needs.

Specifications for Materials and Equipment

Table 12-3 provides guidelines for representative portions of material and equipment specifications required by traffic signal control systems.

Software, Database, Performance and System Test

Advanced Traffic Management Systems (ATMS) offer many features, functions and alternatives not previously available. For example, systems containing a central computer and either intelligent remote communications units (for older controllers) or modern controllers (Both NEMA and programmable controllers (Types 170, 179, ATC 2070 etc., see Chapter 7) allow significant processing and decision-making to take place at the local controller while allowing system monitoring and control from a central location. Systems of this type achieve this through the functions of protocol bits and bytes and *upload / download* of various parameters.

Table 12-3 Guidelines for representative sections of specifications.

Specification	Guidelines
System master	Include both field-located arterial master and central computer
Intersection controller	Typically Type 170, 2070, ATC, or NEMA TS2; Type 170, 270, and ATC controllers may require software specifications
Mast-arm pole assembly	Include mast-arm pole, base, and anchor bolts with bolt circle requirement
Pedestal pole assembly	Include pole, base, and anchor bolts
Strain Pole	Used for span-wire mounted signal heads. Include pole, base and anchor bolts.
Signal heads	Include housing, doors, lenses, lamps, wiring, terminal blocks, terminal compartment, and mounting attachments, but with separate specifications for pedestrian signals
Signal conductor	Include covering, color coding, and physical characteristics
Signal cable	Include insulation, physical properties, electrical properties, color coding, and fillers
Detectors	Include physical properties, electrical properties, environmental conditions under which equipment must operate, controls, and methods of operation. Can include traditional detection and / or image processing detectors.
Communication cable	Include insulation, color coding, physical properties and electrical properties
Field communication or controller interface equipment	Include interface standards, data rates, physical and electrical properties
Color graphics display	Specify parameters and methods of display
Printer	Type, speed, and quality
Video terminals	Specify sample operator screens and controls, screen size, refresh rate, and colors
Computer software	Provide functional specifications for control software, compilers, assemblers, utilities, and diagnostic programs
Television (TV) monitoring	Specify monitors, cameras, and interface protocols
Changeable Message Signs(CMS)	Specify type, dimensions, method of operation, and interface protocols
Communications equipment	Specify data modems and interface devices
Utility Coordination	Include names of utilities, contractor requirements for avoidance of utility disruptions, utility services (e.g., power or telephone line tie-in) to be accessed, and method for tie-in
Testing	Include testing levels desired (component, subsystem, system), organizations responsible for preparation and approval of test specifications, conduct of tests and acceptance of results
Intellectual Property Rights	Include the desired status of rights to software (computer source code ownership, rights in use)

Traffic signal system software may reside in the following three components:

- Server in the traffic management center

- Field master controller for those closed loop systems using this architecture
- Intersection signal controller

Manufacturers supplying NEMA controller based systems provide the software for the intersection controller and field master controller already embedded in the controller. The software is provided as part of these controllers. The TMC software maybe provided as a purchased package.

Traffic controller software for systems based on the Model 170, and ATC 2070 controllers is procured separately from field controller hardware. It is usually procured as a compatible suite with the TMC software.

Most agencies that procure traffic systems usually employ the standard software provided by suppliers with little or no modification to the basic system functions. The agency may specify certain functions such as additional or modified displays and reports, data migration to other systems, maintenance software, interfaces with off-line signal timing programs and other functions such as CCTV control.

A summary of procedures and practices for the acquisition and maintenance of software that is not a standard supplier product may be found in Reference 7.

Some available central system software provides a comprehensive database that may include:

- Traffic engineering data such as intersection layout (CAD) drawings, or
- Maintenance files of system components and equipment.
- Source code and development environment or development tools for custom software

Performance of this software varies greatly. For example, some systems allow certain of these functions to operate in *real-time*. The degree of integration of CCTV images with the system can vary.

Table 12-4 lists a number of representative elements. To assure accurate and reliable performance, prepare detailed system test procedures and performance requirements.

It usually proves important that the contractor develop detailed system test procedures for system software and database handling. The agency should review these procedures prior to performance tests to assure inclusion of appropriate types of tests and duration. It is important that these tests that verify and validate the delivered system do indeed meet the specification established for the scope of the contract. Examples include the following tests:

Table 12-4 Representative system software elements.

<ul style="list-style-type: none"> • Traffic system control algorithm requirements • Graphics features for areawide map, subsystem and intersections • Upload / download requirements, magnitude of parameters • Real-time functions, definition of real-time (i.e. within 1000 milisecond) • Integration functions with CCTV, CMS, HAR • Modes of operation such as manual, traffic-responsive, time-of-day, day-of-week • Special functions such as railroad preemption, emergency vehicle preemption • Backup capabilities • Operating systems • Documentation including agency right to ownership, use and modifications, negotiation on system upgrades 	<ul style="list-style-type: none"> • Communication requirements • Field equipment diagnostic functions • Database support including: <ul style="list-style-type: none"> - System features and functions, including: <ul style="list-style-type: none"> • types of data to store • format of files • types and functions of support software • graphics • printing • historical data files • Features desired for traffic engineering applications such as: <ul style="list-style-type: none"> - Maintenance files - Level of service calculation files - Signal timing files - Intersection layout drawings • Test procedures and requirements • Life cycle requirements (i.e support and migration task related to either obsolescence of COTS software or version changes in COTS components)
--	---

- Communications,
- Upload / download,
- Algorithm performance and accuracy
- Failure mode and recovery validation
- Hardware acceptance test,
- Software acceptance, and
- System acceptance.

Many of these tests would be done by the contractor as subsystem test during the development process. It is important that the result of these tests be shared with the agency. Testing of a traffic management system is not the sole responsibility of the contractor or the agency. It is very much a team effort as problems and bugs with

software systems are often very hard to diagnose. The more information that is shared the easier it would be to track down and correct these problems. Tests of subsystems shall cumulate to integrated field test where all of the field elements are in place and the whole system can be tested to insure there are no compatibility problems. This is the recommended form that the Final System Acceptance test shall take.

In some cases, the traffic system implementation plan assigns development of the entire system database to the contractor, including signal timing plans and the various coefficients and parameters required for system operation. In other cases, the agency or its consultant provides this data to the contractor for entry into the system. The specifications should clearly assign these responsibilities.

12.5 Deliverable Services

With a continuing growth in the traffic control application of computers, local area networks and sophisticated electronic components, a need has developed to add a *deliverable services* section to the specifications. This section defines the contractor's responsibilities to provide:

- System management,
- Documentation,
- Training,
- Startup assistance,
- Warranties / Guarantees, and
- Maintenance.

This section should also identify those database preparation tasks assigned to the contractor.

The following briefly describes deliverable services:

Systems Management

Systems management includes responsibility for all project related tasks in the following areas:

- Design,
- Manufacture,

- Procurement,
- Assembly,
- Testing,
- Installation,
- Inspection (may be shared with the using or procuring agency),
- Training,
- Initial operation, and
- Initial maintenance.

The systems manager or contractor should direct, coordinate, review, monitor, and control the project to maintain a schedule for timely and adequate completion.

The specification should require submission and frequent updating of a detailed project implementation schedule.

Documentation

System documentation proves an absolute necessity for successful system operation. The specification should require documentation in sufficient detail to:

- Reflect as-built conditions, and
- Fully describe the methods of operation, maintenance, modification, and expansion of the system or any of its individual components. Any documentation related to COTS components.

Most traffic systems are usually based on a supplier's product line system, and much of the documentation reflects this situation. Descriptions of special features or functions must be added to complete the documentation.

Table 12-5 lists typical hardware documentation requirements.

The agency / consultant should require the right to review all documentation prior to project acceptance.

Software documentation and rights generally prove more difficult to specify and obtain. For many hardware elements, suppliers consider unique software provided in memory as proprietary. Such software, sometimes called *firmware*, provides all specified

Table 12-5 Typical hardware documentation requirements.

Requirement	Description
General description	General descriptions of all components comprising the system
Theory of operation	Detailed description of system operation, including schematics, logic, and data flow diagrams
Normal operating procedure	Description of the system's routine operating procedures
Maintenance	Copies of manufacturers' recommended procedures; preventive maintenance procedures; troubleshooting data necessary for isolation and repair of failures or malfunctions (corrective maintenance); and detailed instructions where failure to follow special procedures would result in damage to equipment or danger to operating or maintenance personnel
Installation	Detailed description of physical and electrical properties of the system and other pertinent information necessary for the installation and use of the equipment
Parts list	Listing and identification of various parts of system
Schematic diagrams	Complete and accurate schematics to supplement text material
Maps or drawings	Drawings of conduit layouts, cable diagrams, wiring lists, cabinet layouts, wiring diagrams, and schematics of all elements of the communication system

operational features and supports flexible operation through a wide array of user input-output options. In such cases, the user may never need access to those programs for modifications, and thus not need detailed software documentation. NEMA controllers and field masters typify such components.

In larger computer-based systems, the user may need to modify or expand the system, thus requiring access to the software. In such cases, it becomes necessary to access *source* programs. Further, a full complement of executive, utility, and basic library programs for the computer system must be specified, along with the system programmer's and user's manuals.

Generally speaking, the following three levels of software rights exist:

- Proprietary - The purchaser has no rights to proprietary software other than provided by license or use agreement.
- Semi-proprietary - The user (or purchaser) has no rights to semi-proprietary software unless needed assistance proves unavailable from the supplier.
- Full rights - Rights to use, modify, and transfer software are conveyed and restricted only as defined by specific agreement.

Control system specifications should specify the required level of purchaser rights so that all bidders can reflect these requirements in their proposal or bid.

With regard to when the contractor should provide documentation, typical requirements follow:

- Soon after the selection of a specific computer system and peripherals, programmer's and user's manuals for that system should become available for agency staff,
- Equipment manuals available for technician's study prior to maintenance training, should become available concurrently with the on-site delivery or storage of hardware elements,
- To facilitate maintenance, cable routing details and wiring diagrams reflecting as-built conditions should become available after installation and prior to use of those components,
- Application software documentation along with a draft system user's manual, should become available on-site prior to conducting operations training and placing any intersection under system control. Revisions of these manuals may be required to reflect changes made prior to system acceptance,
- The final payment for system installation should be withheld until delivery of acceptable final documentation, and
- Where a period of operational support is provided (see subsequent discussion), updates to final documentation should be required.

It is imperative that complete documentation be obtained. All submitted material should be closely studied and applied during initial system implementation to assure that all needed documentation exists, complete and clear to the operator.

Documentation becomes more valuable over time because, as the system ages, it experiences maintenance and modification, and personnel changes occur. Therefore, the agency must take responsibility for management and preservation of the provided documentation. Furthermore, the agency should develop a *troubleshooting* document(s) and tailor it for appropriate personnel such as operations and maintenance staff. Documentation may take the form of conventional manuals or reside on computer.

Most traffic control system's software documentation often reflects the supplier's most recent traffic system product – a quasi-standard product. With agency pressure, this documentation often can be made available ahead of time. Depending on the degree of documentation completeness sought and advance documentation review, the agency can consider negotiating, in advance of procurement, for more thorough documentation.

Training

Training is typically provided in the principal areas of operation, maintenance, and data base preparation. Further, such training specifically addresses the needs of each staff level:

- Management / supervisor / traffic engineer,
- System operators, and
- Maintenance technicians.

Training should provide those technical skills needed to effectively use and maintain all system features and components. In this respect, the training specified and provided should reflect the actual needs of agency personnel.

If, for example, maintenance personnel already routinely maintain microprocessor-based controller units, training should cover familiarization with the actual unit. In contrast, an agency converting from twisted wire pair to fiber optic communications should specify extensive training, perhaps even including the operation and use of test equipment.

A secondary purpose of training fosters acceptance of the new system among agency personnel. It can provide opportunities for involvement which remove those natural barriers to system acceptance.

Training may be provided at three times:

- Pre-installation,
- During installation (before use), and
- During operation.

Pre-installation training offers an early opportunity to gain skills in a non-pressured environment on subjects such as:

- Equipment configuration,
- System capabilities and features,
- Systems operation,
- Logistic support requirements,
- Programming concepts, and
- Database needs and preparation.

During the system-installation period, other opportunities for training become available. Here, maintenance personnel can be given detailed training in:

- Operation,
- Preventive maintenance, and
- Corrective maintenance (troubleshooting).

Actual hardware should remain available during this time for hands-on training.

After system acceptance and during the period of contractor operation, training may be directed toward:

- Refresher training for operations / maintenance personnel,
- Training for new personnel, or
- Additional hands-on training under operational conditions.

Regardless of when or how much system training is specified, system contractors / suppliers benefit if the user becomes knowledgeable and proficient with the system. However, formal training proves expensive—both to the contractor and user. Because of this, numerous users of successfully operating systems confirm that the *best training is gained by an active, aggressive involvement with the contractor during the system's installation, checkout, and initial operation.*

Startup Assistance

The period of initial system operation typically becomes a time of intense activity. Expect maintenance problems as a result of the full exercise of hardware, coupled with any remaining unfamiliarity with the system. Software bugs may surface and timing plans and database may need refinement. In addition, operator skills and routines develop day by day. During this time, the continued support of the systems manager or contractor can enhance successful operation of the system.

This continued support beyond system acceptance has been termed *startup assistance* and FHWA considers it an eligible item for funding. Startup assistance can include the following tasks (8):

- Provide systems engineer to assist agency operators / engineers in adapting the system to local traffic environment,
- Define and correct hardware and software deficiencies discovered through sustained operation,
- Assist in maintaining, repairing, and replacing failed system components,

- Provide on-the-job training as an extension of formal training provided earlier, and
- Prepare and provide updates to system documentation.

The startup assistance or operational support period is often included in the contract, leading to final acceptance.

Warranties / Guarantees

The specification should define the period of time after system acceptance during which the contractor guarantees work and materials. For hardware, a manufacturer may warrant the product for one year or more *from the date of delivery*. Problems arise when the contractor stores such items or does not use them in the system until later in the project. To avoid ambiguities, the specification should clearly require the contractor to guarantee all hardware items for some time beyond final *system* acceptance. Further, any remaining equipment warranties by individual hardware manufacturers should transfer to the agency.

Maintenance

The specifications should clearly spell out maintenance responsibility for hardware items. Common practice obligates the contractor to maintain equipment until system acceptance in accordance with the contract. Except for startup assistance, FHWA policy clearly defines maintenance beyond system acceptance *ineligible* for Federal funding. However, some agencies include a separate non-participating bid item for maintenance during an initial period of operation (possibly one year) to:

- Assure a source of maintenance during a critical time of system operation,
- Determine anticipated maintenance costs at system completion, and
- Place responsibility for maintenance on the contractor, encouraging quality construction and the choice of more reliable hardware.

Provision of spare parts and / or subsystems also proves important. Considered maintenance items, they cannot be purchased with Federal funds. However, the contract can include spare parts as non-participating bid items. This becomes particularly appropriate when the system requires custom-made subsystems. For certain components, it may prove desirable to permit future purchase at an established price within a specified time period.

System Acceptance Tests

Testing of the installed control system should precede system acceptance by the engineer. Testing proves essential when a third party installs a subsystem. The specifications should spell out methods for testing and test documentation. In general, acceptance testing consists of:

- **Equipment Checkout Tests**
 - Each major system component should be tested on an individual basis to verify its operation. This should include diagnostic testing of each functional feature of items such as controller units and detector electronics. Components that are newly developed or modifications of previous products may require environmental testing or certification of such testing by the manufacturer.
 - For large and / or expensive items (such as CMS or system software), it may prove appropriate to perform a level of testing (witnessed by the procuring agency or its consultant) prior to the items leaving the manufacturer's or system integrator's facility.

- **System Electrical Tests**

The specifications should require tests to determine electrical continuity. Tests should cover each conductor, including spares.

Electrical cables, wires and connection should be tested per local and the National Electrical Codes. As a minimum, DC resistance tests of each conductor and the insulation-resistance tests between conductors and between conductors and ground should be conducted.

Typical test instruments include volt-ohm-milliammeters (VOMs) and megohmmeters (meggers).

Electrical communications cable should be DC tested with respect to open circuits, short circuits, resistance, capacitance, resistance and capacitance unbalance, crosses, and insulation resistance. Signaling tests should be conducted on both copper and fiber optic communications to assure transmission quality.

Fiber optic cable and splices should be tested per ANSI / EIA standards with respect to signal levels and attenuations at various nodes and terminations. Typical test instruments include optical signal generators, optical signal level

meters, and optical time domain reflectometers, all calibrated to the applicable wavelengths.

- Computer Software Tests

The contractor should test and demonstrate each feature of the control system software. These test shall also demonstrate the performance envelope of the software. Demonstration of system failure mode and recovery procedure from the provided documentation must be a part of software testing.

- Systems Operations Tests

The installed system should be tested to determine the total system's reliability and performance.

In advanced traffic management and traveler information systems (ATMS / ATIS), involving several integrated components, specifications should include standalone tests for each subsystem such as:

- Field controller and cabinet equipment complement,
- CCTV and
- CMS.

Traffic operations center tests for hardware / software and databases should be performed. Functional system tests should be performed for various modes of operation:

- Manual,
- Conventional traffic-responsive,
- Time-of-day, and
- Adaptive.

Several iterations should be performed, documented appropriately, and focused on both function and reliability / integrity. Many of the system tests can be performed via *simulation* at the operations center prior to actual implementation. The communications system should be tested separately and certain communications tests should be performed for longer periods of time (three or more days) to assure acceptable failure rates.

Testing individual components when delivered and / or installed detects problems early and corrects them immediately. Simply testing the final system may allow small

2.8.3.4 System Acceptance Test

After installation and debugging of all central control equipment, local controllers, detectors, communications, and other system hardware and software elements, the system shall be required to satisfactorily complete a 30-day period of acceptable operation. The intent of this System Acceptance Test is to demonstrate that the total system of hardware, software, materials, and construction is properly installed; free from identified problems; complies with the specifications; and has exhibited the stable, reliable performance level required for the control of traffic. The System Acceptance Test shall fully and successfully demonstrate all system functions using live detector data and controlling all system-controlled intersections.

2.8.3.4.1 Action in Event of Hardware Failure

Failure in any hardware item during the test period, with the exception of expendable items such as bulbs and fuses, shall necessitate restarting the 30-day test period for its full 30-day duration for that item after its repair.

2.8.3.4.2 Action in Event of Software Failure

Any failure of system software or discovery of a software deficiency that causes a system malfunction or discovery of software operation that is not in compliance with the specifications shall cause the 30-day test to be halted and repeated in its entirety after correction of the software problem. If no further software problems are discovered, and if no software problems are introduced as a result of correcting the initial deficiency, the Engineer may reduce the restarted 30-day test period for software to not less than 15 days. In no case shall the total test period be reduced under 30 days.

2.8.3.4.3 Uncertain Causes of Failure

In the event a problem is discovered for which it is uncertain whether the cause is hardware or software related, the 30-day test restart and repeat shall follow the procedure defined in 2.8.3.4.2 for software.

2.8.3.4.4 Persistent Intermittent Failures

No intermittent hardware, software, communication, or control operation or other malfunctions not related to a specific hardware or software malfunction shall be permitted to persist during the test period. If such problems are encountered, the test shall be suspended until the problems are corrected.

2.8.3.4.5 System Shutdown for Testing / Correction

While it is the intent that the system be fully operational during the entire System Acceptance Test, the possibility for system shutdown for purposes of testing and correcting identified deficiencies is acknowledged. During any period that the system operation is restricted or limited in any way as a result of testing, the 30-day System Acceptance Test shall be halted and shall not continue until a period of 72 to 168 hours of successful performance, as determined by the Engineer, has proved that any corrections or modifications made are valid, the problem is corrected, and no new system problem or deficiency has been created as a result of the change. Diagnostic testing that does not result in changes to system hardware or software shall result only in the loss of acceptable test time.

2.8.3.4.6 Maximum Downtime

Total system downtime in excess of 72 hours during the 30-day test period shall cause the System Acceptance Test to be restarted. System downtime is defined as a condition which, due to central control hardware, software, or communications equipment malfunctions, causes the system to operate in a standby mode, causes the central system to cease operation, or causes any subsystem to revert to its locally generated standby timing program.

2.8.3.4.7 Documentation Updating

All system documentation having errors, omissions, or changes that may have been detected or occurred as a result of system modifications or other reasons during the 30-day test period shall be corrected and resubmitted before final system approval is granted.

2.8.3.4.8 Acceptable Performance

Final system acceptance shall not be granted until the level of performance for each hardware item and for system software as defined in this section and in all other sections of the specifications has been reached, and all other contractual elements (excluding Operational Support and Maintenance) have been met to the satisfaction of the Engineer.

Source: Reference 9

Figure 12-2 Sample specification—system acceptance.

problems to create serious problems affecting total system integrity. In either event, a final systems acceptance test is considered mandatory. Figure 12-2 (9) shows a sample specification for such a test.

The systems acceptance test should test each function of each mode. Field device states should be monitored to verify that they assume commanded states (CCTV is useful where available to simplify field verification). Traffic data collected by the system should be verified by field observation.

12.6 Project Management

Project management transforms a need into a reality in a controlled way. It primarily aims to attain the overall system goals within the project budget and timeframe. Project management techniques include:

- Provide visibility of the actions within the project,
- Establish orderly procedures for attaining ultimate goals, and
- Centralize responsibility and accountability.

Contract Administration

A critical element of system implementation and project management is the administration of the construction contract. Contract administration includes:

- Technical inspection,
- Witnessing of acceptance tests,
- Other technically oriented tasks, and
- Administrative tasks such as:
 - Processing payment requests,
 - Negotiation of change orders, and
 - Detailed record keeping in accordance with state and Federal requirements.

From a workload viewpoint, varied personnel with the required technical and administrative expertise may be required over the life of the project. A single project engineer (or project manager) performs or directs contract administration duties.

An agency should use various tools as leverage to assure successful project completion by the contractor. Such tools may include:

- Withhold payments - A certain percentage of each payment, and / or the last payment (normally 5-10% of the overall contract) is withheld until the contractor satisfactorily completes a milestone associated with that payment.
- Liquidated damages - A clause often included in the contract stating the procedures and amount of such damages and exercised in relation to performance. For example, for every day completion is past due, the contractor owes a certain amount of money to the agency as a penalty.

Courts have held that liquidated damages must not be used as a penalty, but must actually reflect a reasonable forecast of the harm that will result to the owner (10).

When disputes reach the courts, most jurisdictions will not grant both liquidated and actual damages, unless the contract states that the liquidated damages are limited to specific types of owner damages such as extended engineering or interest. The agency can then recover other damages as actual damages.

In preparing a liquidated damages clause, a reasonable estimate of damages must be used. Examples of such damages are (11, 12):

- Additional architectural and / or engineering (systems integrator's) and / or construction manager's fees,
- Claims by other third parties waiting on the completion so they can perform / finish their projects,
- Extra rental of other buildings that might be required because the one being built is not completed,
- Extra maintenance and utility costs that may be incurred either in the continued use of an old high-cost building or equipment, or in the maintenance of a new area before beneficial use,
- Interest on the investment or borrowed capital,
- Extra training required to maintain worker skills pending availability of the building or equipment,
- Additional operating costs that may result from the continued use of inefficient facility or equipment,

- Extra costs of split operations resulting from partial occupancy or use of equipment, and
- Loss of revenue, e.g., bridge tolls, sale of power from a power plant, building rentals, etc.
- Performance bond—As discussed previously, the contractor normally posts a performance bond for the contract amount.

Scheduling

Effective construction management requires a robust project scheduling technique. Project scheduling sets forth the required tasks and shows their interdependency. Commonly used methods of project scheduling include:

- Critical Path Method (CPM), and
- Bar charts.

Common scheduling software applications include those by Primavera and Microsoft Project. Often, a contract will specify one of these programs in particular, for compatibility with agency legacy scheduling software. Agency project schedule reviewers can obtain more detailed information by loading the project's specific schedule data into their program than can be commonly obtained from printouts.

Critical Path Method (CPM)

The critical path method (CPM) has proved a successful method for planning, organizing, and controlling projects. Initially, this management tool outlines the project graphically in the form of a network diagram. This representation, shown in Figure 12-3, illustrates:

- The required operational sequence,
- Which operations are concurrent, and
- Which must be completed before others can be initiated.

CPM operations are referred to as *activities*.

In Figure 12-3, an example of the application of CPM to the installation of a traffic control system, the activities necessary to complete the project are denoted by a line with an arrowhead. The circled numbers represent events which mark the beginning or completion of an activity. Dashed lines represent dummy activities which do not require any time but must be completed before another event can occur. The number below the

activity represents the amount of time required to complete the activity. The critical path represents the project duration. In the example, the critical path is represented by the activities associated with events 1-11-15-19-23-27-29-31.

In the example, if activity 7-21 required a time of 10 instead of 8, then the critical path would become 7-21-23-27-29-31, because this sequence of activities would require a longer time. In this case, the receipt of mast arm poles would establish the critical path because they must be received before they can be set in place.

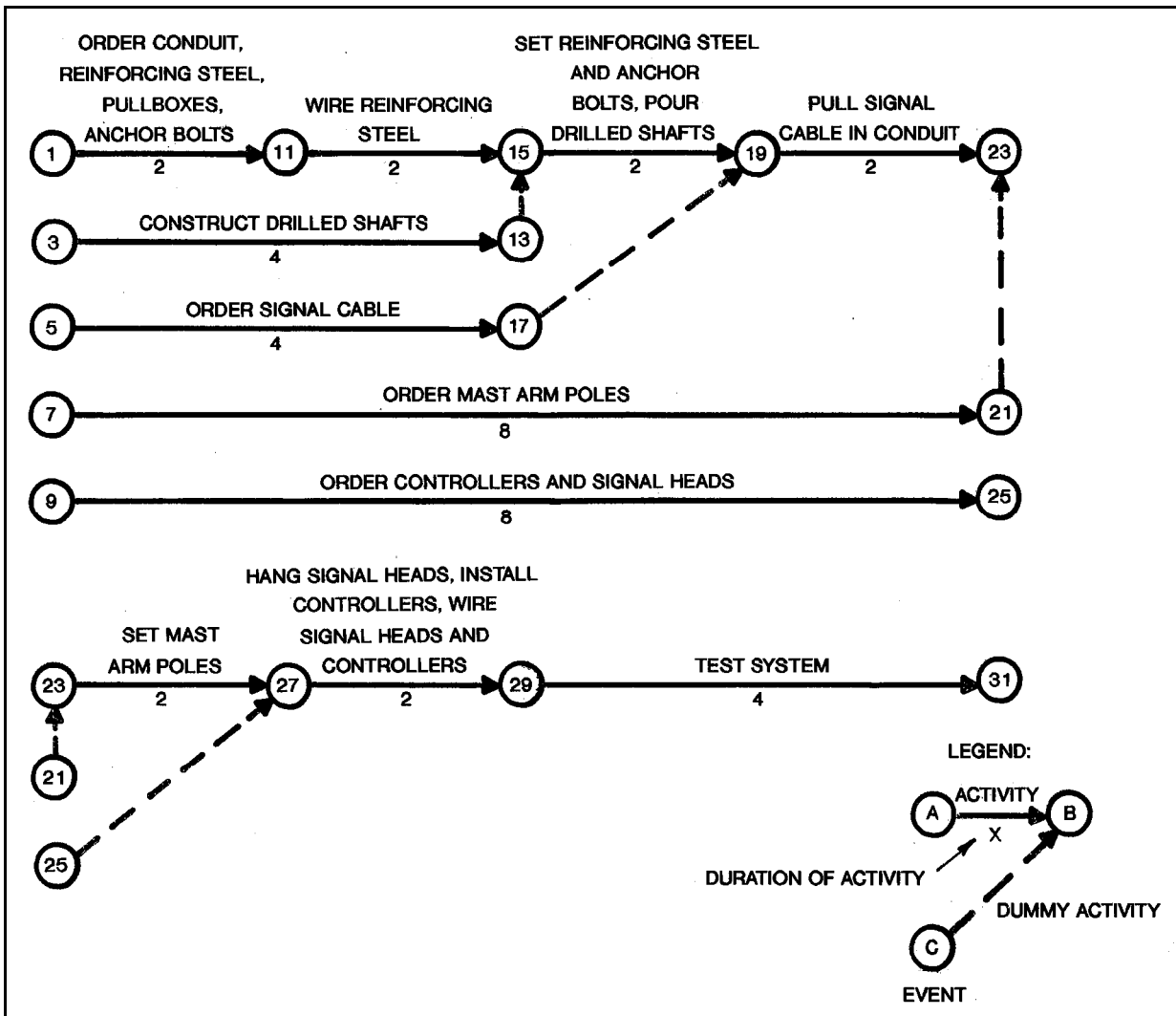

Figure 12-3 Example of CPM network diagram.

The network diagrams should be updated periodically to account for factors which would delay project completion. These factors include longer delivery dates, delays caused by weather, change orders, etc.

Software to facilitate development and updating of CPM networks is commercially available.

Bar Charts

Figure 12-4 (13) shows the use of bar charts as a method of project scheduling. This bar chart for the Greensboro, North Carolina, Traffic Control System depicts the time relationship for completion of the various project tasks. Starting and ending dates and durations are shown for the various tasks as well as milestones (the start or completion of a task). The interdependency of tasks may be indicated by a dashed line or other symbol (e.g., M6 indicates the interdependency of acceptance tests for controller assemblies and the installation of communications lines).

Gantt Charts

The Gantt Chart technique (14) uses an upper horizontal bar to present the planned schedule for the task. Another bar, just below this bar, charts the completed portion of the schedule. Colors usually facilitate legibility. Gantt Chart techniques prove most useful when the different tasks depicted are not related.

12.7 Implementation Pitfalls

The previous discussions of system design and implementation have focused on those positive steps that lead to successful system acceptance.

The following discussion presents the reverse perspective. Gleaned from the results of discussions and contact with system users, these pitfalls should assist in avoiding mistakes made in the past. In each case, the discussion presents the generalized pitfall, and then describes suggestions for avoidance. They are not presented in order of importance.

Inexperienced Contractors

Some contractors view the installation of traffic control systems as just another highway job. Failure to recognize the systems integration needs of such a project results in delays and additional costs to the contractor. In some cases, traffic control projects represent a small portion of a large general construction project. This virtually assures that a subcontractor will perform this critical element. Additional control of contractor and hardware selection may be required for this situation.

This pitfall can best be avoided by:

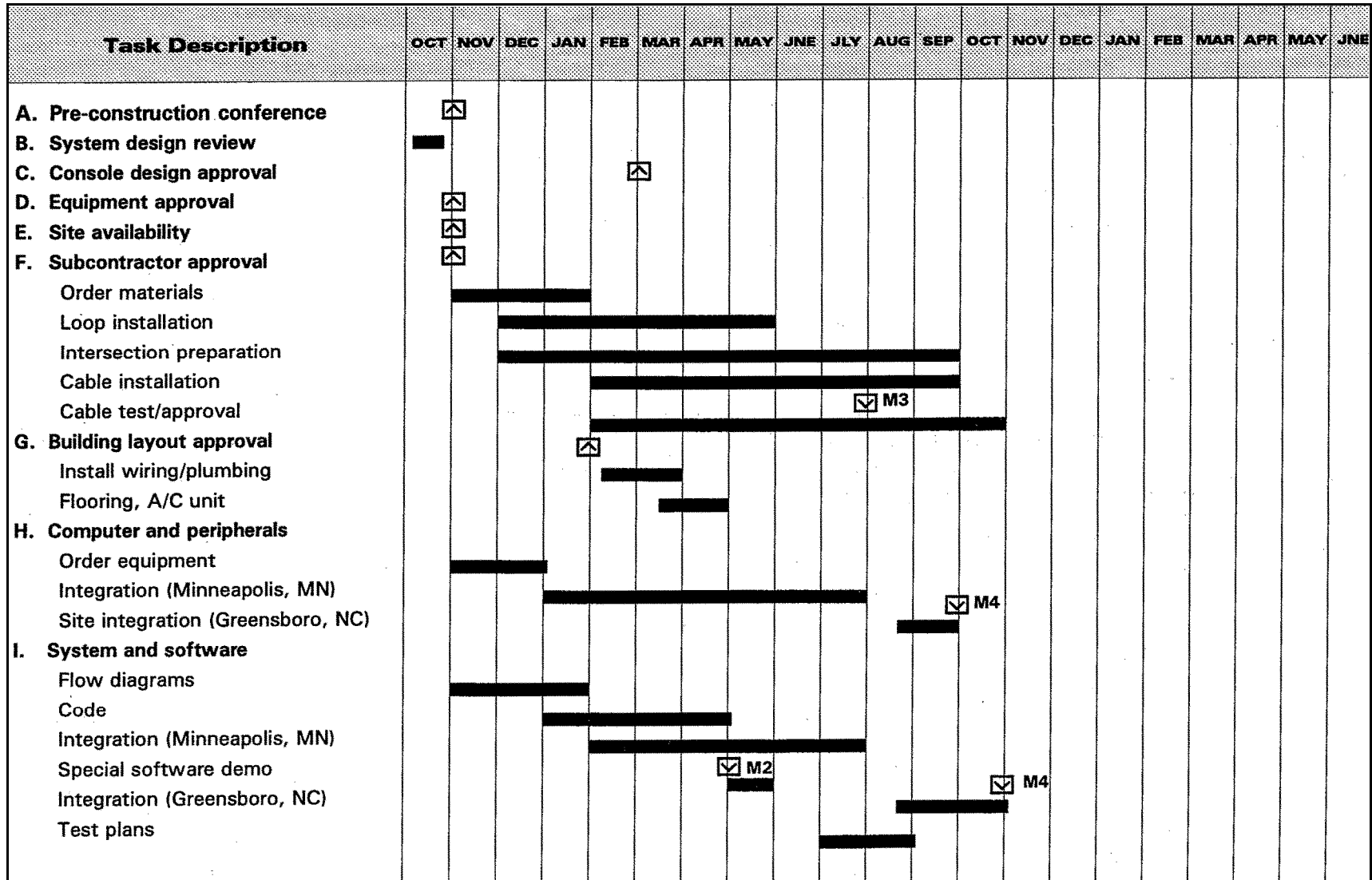

Source: Reference 13

Figure 12-4 Greensboro, NC traffic control project milestone schedule.

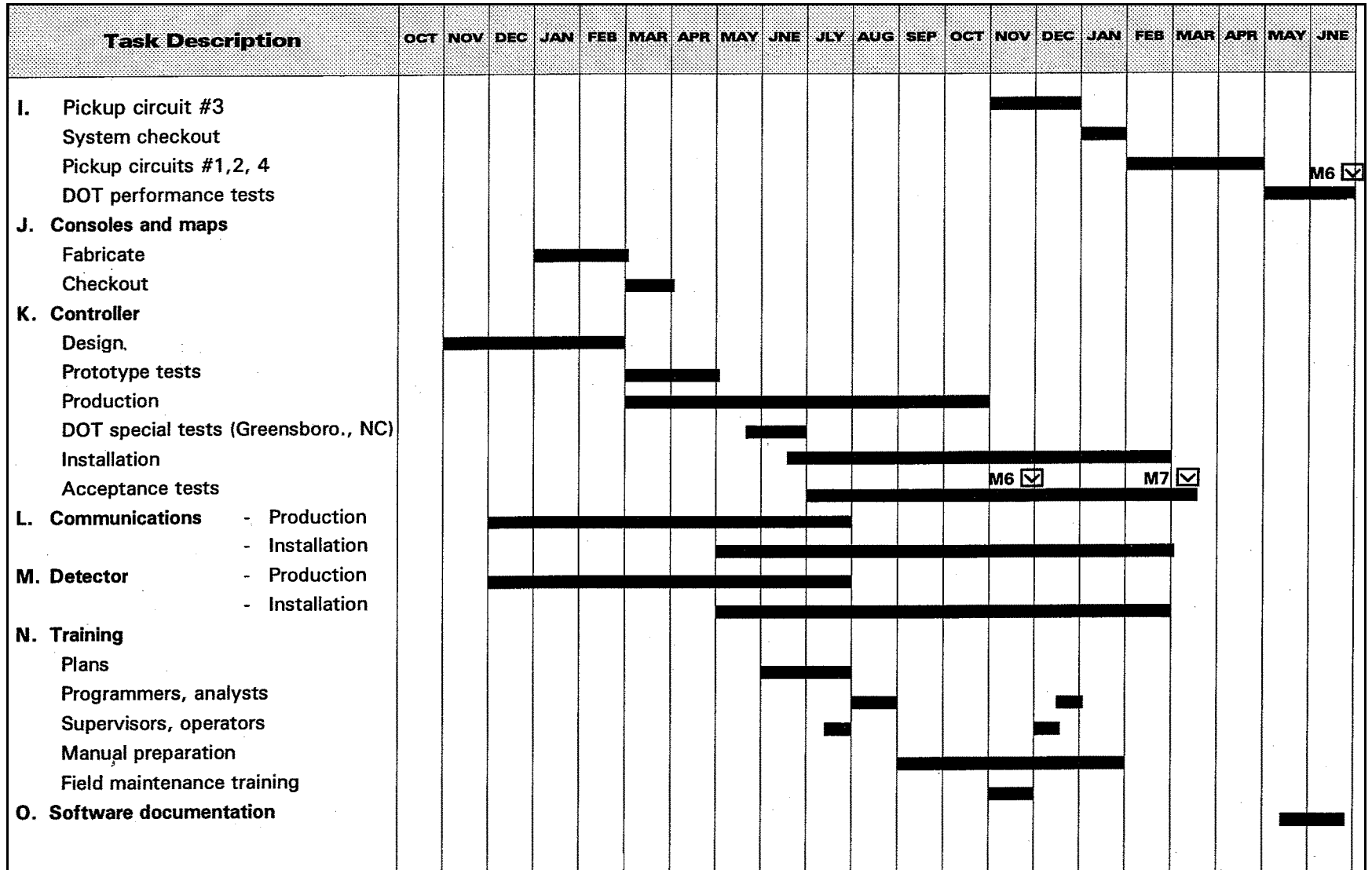

Source: Reference 13

Figure 12-4 Greensboro, NC traffic control project milestone schedule (continued).

- Separating control system elements from large projects where they may be lost, and
- Where procurement regulations permit, requiring contractor pre-qualifications on the basis of demonstrated experience.

Construction Management

Construction management entails the following activities by the project engineer:

- Inspection of day-to-day construction activities,
- Witnessing of acceptance tests, and
- Other technically oriented duties.

Further, it involves record keeping, in accordance with state and Federal requirements, of items such as:

- Review and approval of shop drawings,
- Identification of need for change orders (including negotiation with the contractor on the change and compensation), and
- Obtaining necessary reviews and approvals prior to authorization.

Construction management requires both a high degree of technical knowledge and experience in managing contracts. While typical state project engineer and inspection personnel are generally proficient in project management for typical highway construction jobs, they may lack electronics and control system technical expertise. In contrast, city traffic engineers and signal maintenance personnel may have the technical expertise but little experience in project administration. Project engineers assigned from either background may tend to retreat to the familiar, with an attendant negative impact on effective project management.

Some projects have experienced problems with the inspection of system construction, ranging from token, ineffective inspection to unyielding insistence on a strict interpretation of specifications. Most common is the failure to anticipate the contractor's schedule and pace of construction and thus not match it with qualified inspectors. In some cases, inexperienced or inadequate numbers of personnel have been assigned. The best technical inspectors for any system are individuals who will operate and maintain the system once completed. If possible, they should be assigned inspection duties and have their other routine activities rescheduled to minimize conflicts.

These needs should be carefully considered in planning the project. Desirably, a team approach will be taken, with a project engineer having access to technically qualified personnel for specialized inspection tasks as necessary.

The channels of higher authority should also be identified and a working relationship established. A formal or informal project committee may be useful so that everyone involved can:

- Periodically meet,
- Be apprised of the broad picture,
- Review progress, and
- Address potential problems before they become critical.

Maintenance and Protection of Traffic (MPT) During Construction

Disruptions to traffic during construction are expected. Most agencies require a maintenance and protection of traffic plan to be incorporated into construction contracts. These plans specify lane usage during construction and times permitted for construction to avoid peak-hour interference. These plans, however often do not incorporate provisions for construction impacts downtown during a Christmas shopping rush or, of more frequent concern, signal coordination during construction, i.e., how many signals can operate uncoordinated. To avoid such pitfalls, MPT plans for maintenance of traffic during construction are necessary should address issues such as these.

Database Development

Computer-based traffic control systems require an extensive database to operate. Database development may be required at the system level, subsystem or section level and at the local level or intersection level. Computer generated color graphics files may also be required at these levels. Frequent problems have been encountered when no specific organization was assigned responsibility for necessary traffic surveys and developing, coding, input, and debugging of database information. Without clear definition, this responsibility may inadvertently fall on the user.

Databases can be developed by:

- Agency or consultant prior to PS&E completion,
- Agency or consultant after PS&E completion,
- Contractor, or
- Shared by consultant and contractor.

It is recommended that one of the above alternatives be determined early in the process. The specifications should clearly identify the contractor's responsibilities. If a consultant prepares the database, the necessary contractual arrangements should be established.

Insufficient Staff for Operations and Maintenance

Overselling the capabilities of traffic control systems as alternatives to staff can prove a mistake. Systems must be maintained and actively managed to provide effective service. Although new hardware may indeed eliminate unreliable, high-maintenance equipment that has exceeded its useful life, perhaps even more sophisticated maintenance may then be required. In addition, equipment with greatly expanded capabilities may actually require more operations staff to realize its full potential.

The timing of staff additions is also critical. For example, system operators need to be employed and available to receive training provided by the contractor.

Utility Coordination

The installation of underground conduits and / or overhead cables may cause conflicts with other public utilities. Regardless of how thoroughly the designer locates and documents existing utilities, some will be found in unexpected locations when construction begins. The Contractor must be made to understand that utility runs shown on the plans are approximate and that it is the Contractor's responsibility to confirm utility locations.

Good documentation of existing conditions can avoid serious problems in utility coordination but unforeseen situations will undoubtedly arise. The design process should visualize the most likely problems and plan a response. For example, if plans call for reusing existing conduit, it is likely that old cable cannot be removed because of conduit collapse and therefore, the conduit cannot be reused. The planned response might include a bid item for conduit replacement to adequately compensate the contractor for attempted reuse of existing conduit followed by replacement. An alternative approach would test the conduit during the design phase to avoid expensive change orders and delays.

Planned Use of Untested Facilities or Techniques

Problems have been experienced in two different ways with the planned use of untested facilities or techniques.

First, from a construction viewpoint, one agency planned to use existing telephone company underground ducts for interconnect cables. Routing and design was based on available mapping and duct-use records of the company. No funds were allocated during the design process to rod the ducts and verify open paths—a task that was placed on the contractor. During cable installation, since a number of blocked paths were found, duct

replacement was not possible during the available timeframe. Therefore, alternate paths with inefficient routing and resulting contractor change orders were necessary.

Second, with respect to hardware and applications software, use of new technology may engender unexpected problems. Being the first to use a product, software, or technique that attempts to advance the state-of-the-art poses risks.

Alienation of Maintenance Staff

The acceptance of new traffic control systems by all levels of an operating staff proves very important to successful system operation. It is fostered by active involvement—not only during installation but also during both the design and pre-design activities.

Maintenance staff in particular may feel threatened by a new system, particularly if it contains a large amount of unfamiliar new hardware. They may have unexpressed concerns about the system's impact on their job security, doubts about their skills to maintain it, and feelings that the engineer's new toy just means a more difficult job for them. The following may minimize such fears:

- Early involvement of maintenance (and other) staff in system feasibility studies and system selection to assure proper consideration of reliability and maintainability issues,
- Assurance of early, thorough training tailored to staff needs, and
- Opportunities for involvement through construction inspection.

Privatization of Operations and Maintenance

A number of traffic agencies and jurisdictions have used contract maintenance in the past. Privatized operations have increased in recent years. Problems such as union contracts for the privatized or related positions or the alienation of the remaining staff may present problems. However, the cost savings or larger base of experienced personnel available in the private sector may outweigh these problems.

While maintenance is commonly privatized for both signal system and freeway ITS, privatization of operations is more common for freeway systems.

This discussion of *pitfalls* is by no means complete. Traffic control systems, because they must be installed in full public view and have daily impact on motorists, offer highly visible opportunities for criticism when things go wrong. Thoroughness in design and construction planning is a necessity, along with strict attention to details during construction. The hardware problems can be identified and corrected—but the people problems require constant attention.

References

1. "City of Pasadena Traffic Management System Phase 2, Preliminary Design Report." JHK & Associates, March 1993.
2. "Preliminary Engineering Report, City of Salem Traffic Signal Control System." Meyer, Mohaddes Associates, and JRH Transportation Engineering, November 1993.
3. "Federal Register." Vol. 67, No. 237, December 10, 2002 <www.access.gpo.gov/su_docs/fedreg/a021210c.html>.
4. Meier, H.W. "Construction Specifications Handbook." Prentice-Hall, Inc., 1975.
5. "Standard Forms of Agreement." Engineers' Joint Contract Documents Committee, National Society of Professional Engineers, Washington, DC, November 1983.
6. "Installation of Highway Traffic Signals." *Item 632, Standard Specifications for Construction of Highways, Streets and Bridges*. Texas State Department of Highways and Public Transportation, September 1, 1982.
7. Salwin, A.E. "The Road to Successful ITS Software Acquisition: Volume 1: Overview and Themes." Mitretek Systems, Federal Highway Administration Report No. FHWA-JPO-98-035, Washington DC, July 1998.
8. "Computer Controlled Traffic Systems Implementation Package." PRC Voorhees, Division of PRC Engineering. Federal Highway Administration Report No. FHWA-IP-82-21, Washington, DC, December 1982.
9. "Central Business District Traffic Control System (CBDTCS) System Specification." Contract Number 79-200, City of Dallas, Texas, Department of Street and Sanitation Services, 1979.
10. Simon, M.S. "Construction Contracts & Claims." McGraw-Hill Book Company, New York, 1979.
11. Hansen, G.A. "Why to Use CPM Scheduling." *Public Works*, October, 1994.
12. Rubin, R.A. et al. "Construction Claims, Analysis, Presentation, Defense." Van Nostrand Reinhold Company, New York, 1983.
13. "A Traffic Control and Surveillance System for Greensboro, North Carolina." Honeywell, Inc., Hopkins, Minnesota, October 1973.
14. Glueck, W.F. "Management." Dryden Press, Hinsdale, IL, 1980.

**CHAPTER 13
SYSTEMS MANAGEMENT**

Table of Contents

Section	Page
13.1 Introduction.....	13-2
13.2 An Integrated System Management Concept.....	13-3
13.3 Operations.....	13-6
Practical Aspects.....	13-6
Control and Supervisory Periods.....	13-7
Typical Work Tasks.....	13-7
Specific Operational Tasks for Intersection Control Systems.....	13-9
13.4 Maintenance.....	13-17
Types of Maintenance.....	13-18
Functional.....	13-18
Hardware.....	13-19
Software.....	13-20
Results of Inadequate Maintenance.....	13-21
Staff Requirements.....	13-21
13.5 Evaluation.....	13-22
Techniques.....	13-23
Before and After Measurements.....	13-23
Sampling Considerations.....	13-25
References.....	13-26

CHAPTER 13 SYSTEMS MANAGEMENT



Figure 13-1 Traffic signal maintenance.

13.1 Introduction

Increasing traffic demand and the need for reducing vehicle emissions and fuel consumption place new emphasis on management of traffic signal control systems. This will intensify with ITS deployment and more widely integrated operations.

Agencies responsible for traffic control system management have increasingly discovered that an *install-and-operate*, or a *set-it-and-forget-it* policy does not prove sufficient. The potential of the system(s) will only come to fruition with a policy of install, operate, and manage. Often, the benefits of traffic control systems are not being fully realized, largely as a result of inadequate management (1).

Managing traffic control systems includes four basic functional responsibilities:

- Teamwork,
- Operation,
- Maintenance, and

- Evaluation.

A traffic control system represents more than just a combination of hardware and software. The agency's organization and personnel become part and parcel of the system. For a traffic control system to realize its potential, the agency must have available:

- Technical skills to match the equipment, and
- Advanced management skills to assure that the entire system performs efficiently and effectively.

The flexibility and real-time evaluation capabilities of today's systems demand operational and managerial supervision. Successful traffic control systems show that such attention reaps rewards.

Signal systems are currently commonly being expanded to perform more general traffic management functions on surface streets. These functions include increased use of incident management and motorist information techniques (e.g. CCTV and changeable message signs), greater use of transit priority, and provision for emergency response and evacuation.

Traffic management becomes increasingly important because of growing requirements for reduced vehicle emissions and fuel consumption, which often requires mitigation on a region-wide basis.

In urban areas that have traffic control systems in two or more adjacent jurisdictions, all agencies must have a close working relationship to develop integrated traffic management. This includes coordination of traffic control system operation within the urban area and extends to the development of a central database for monitoring and improving operations and safety.

Reference 2 provides further details regarding management of traffic signal systems.

13.2 An Integrated System Management Concept

Effective traffic control systems require both *intra-organizational* and *inter-organizational* communications and teamwork. It proves essential to establish and maintain a team concept within an agency and among the involved governmental agencies within an urban area.

Within each agency, administrative, traffic management, design and maintenance personnel should remain involved in developing and operating the traffic control system. Enforcement personnel also should participate. These departments or organizations must work together and coordinate their activities. For example, operations, planning and enforcement personnel from each transportation related agency or department must coordinate to plan a reversible arterial lane. Similarly, a team approach applies to the

administrators (e.g., city manager, director of public works, district engineer) from the agencies in an urban area.

For integrated systems, the development of both administrative and technical teams assures the required:

- Agency support,
- Administrative support and funding,
- Resource integration,
- Information exchange, and
- Coordinated design, operation and maintenance.

As defined by the Regional ITS Architecture, agencies in an urban area should exchange historical and real-time information on a continuing basis. Historical traffic information permits each agency to analyze trends for making operational changes. Real-time information includes traffic information from vehicle detectors and information on scheduled roadwork and special events. Sharing real-time information permits joint incident management by two or more agencies. It also provides for integrated communications with:

- Motorists,
- Commuters, and
- Commercial vehicle operators.

Region-wide coordination facilitates the achievement of certain traffic control system goals such as reducing vehicle emissions and delay and improving safety. This implies that multiple agencies within an urban area should design and develop systems on a broad traffic management basis to facilitate operations across jurisdictional boundaries. Carrying out operations and maintenance jointly on an agreed level of effort can also prove beneficial.

For example, the provision of signal priority for a regional transit system that may operate within the jurisdiction of a number of agencies responsible for traffic control systems may require a common set of equipment specifications, software and operating procedures for the affected portions of all of the traffic signal systems.

A team involving city, county, state, federal and public transportation agencies provides the base for developing an integrated system within the urban area. The team also needs representation from:

- Traffic operation agencies,
- The Metropolitan Planning Organization, and
- Law enforcement agencies.

Research results can improve traffic operations. In turn, integrated system development and operation often uncovers opportunities for further research (3).

Figure 13-2 shows the interdependence of the four functional responsibilities for effective system management. They share the following relationships:

- System operation requires proper system maintenance,
- Effective and efficient operation depends on evaluation results,
- System maintenance improves with a close working relationship among operational and maintenance personnel. Information on the nature and extent of equipment failures and anomalous operation usually originates from the system operators, and
- System evaluation depends on both operation and maintenance. Effective evaluation of a control strategy requires the system to operate as error-free as possible, with a minimum of hardware failures.

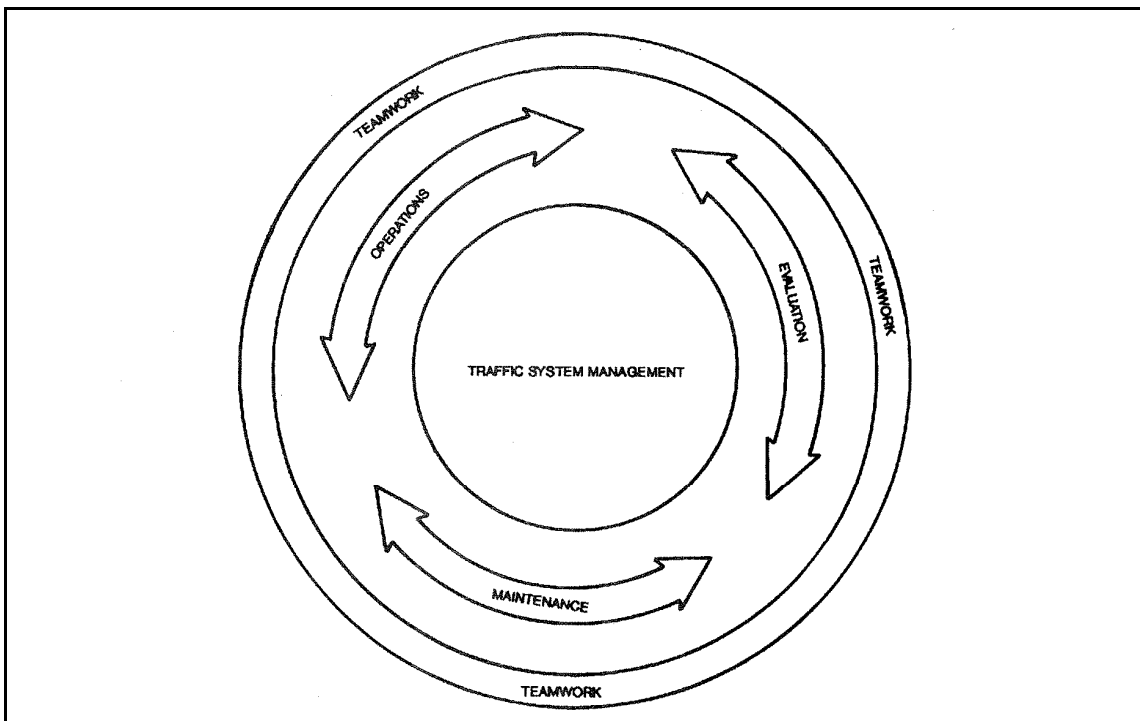

Figure 13-2 System management team concept.

Considering the above interrelationships, management must organize personnel into a cohesive unit with upward mobility in order to retain skilled workers. The resulting management team assures that the traffic control system lives up to expectations and produces the greatest benefits for the motoring public.

13.3 Operations

Successful management of a traffic control system must achieve the end result of effective operations. This section deals with the following aspects of operations:

- Practical aspects,
- Typical work tasks, and
- Staffing requirements and organization.

Practical Aspects

Traffic control systems function in the most demanding of physical environments, subject to:

- Weather extremes,
- Wide temperature variations,
- Electrical noise and disturbances,
- Physical damage from vandals,
- Knockdowns from vehicles, and
- Vibration from nearby traffic.

Yet, the system must operate reliably and continuously, 24-hours each day of the year.

The system's operational environment proves even more demanding. Its daily operation remains in public view where it directly affects each user. This justifies intense monitoring of system performance to locate equipment malfunctions and to effect timely repair. Likewise, modifications in system performance must accommodate changes in traffic flows for:

- Optimum operating safety,
- Providing support to transit and paratransit services,

- Convenience of motorists, and
- Public acceptance of the system.

It often proves difficult to interrupt traffic control system operation. Degradation due to backup or fail-safe operation may be acceptable in emergencies but should not occur over an extended period. This emphasizes the need for highly reliable and well maintained equipment, and illustrates a basic principle which influences virtually all operational decisions. The system must *work*; it must *work well*; and it must *work well virtually all the time*, to adequately serve the public.

Control and Supervisory Periods

Because systems increasingly perform a greater number of control and monitoring functions, trends point towards an increase in periods during which the transportation management center is staffed. Some agencies may not continually staff the system during the entire operational period, but periodically monitor equipment malfunctions. During off-hours, a maintenance facility terminal commonly monitors equipment operation.

Most current traffic control systems enable on-line database changes. Similarly, many modern systems support software modification in the background.

Typical Work Tasks

Effective day-to-day operation of the control system requires a number of routine tasks and procedures to:

- Assure continuity of operation,
- Obtain and retain archival data,
- Assure security of the system database and software, and
- Ensure that the system is operated by authorized personnel.

Table 13-1 lists some suggested procedures and tasks.

Table 13-1 Suggested routine operations tasks.

Task	Description
Maintain daily control log	<p>Covers entire control period. Should include checklist of items and tasks to remind each shift operator of responsibilities concerning duty routines necessary for proper system operation. Entries in the log concerning system functions or component failures serve:</p> <ul style="list-style-type: none"> • As a written record of events per shift. The log should include the implementation of backups to programs and databases. • To provide continuity in operation from one shift to the next. <p>The log can take handwritten or computer based form.</p>
Maintain event log	<p>Most computer based traffic systems provide a hard copy event log which lists:</p> <ul style="list-style-type: none"> • Equipment failures and repairs • Mode changes • Timing plan changes • Operator commands in chronological order <p>Preserve event log along with control log. The system often generates the event log at midnight for the entire day. The system usually outputs it on demand, at any time during the day. Some systems generate the event log in hard copy on a continuing basis.</p>
Maintain a ledger of timing plan modification	<p>The ledger should list:</p> <ul style="list-style-type: none"> • Date and time implemented • Requester • Type of change (temporary or database implemented) • Reason for modification <p>A computer based ledger should be stored on disk</p>

Documentation is one of the most important operation tasks. Control system performance eventually reflects incomplete, incorrect, or non-existent documentation. Careful documentation control and distribution to the management team proves essential to successful system operation and maintenance. Document every change in:

- Software,
- Timing plans,
- Operational control parameters, and
- Hardware components.

Remember to update *all copies* of the documentation. Any team member, whether technician, programmer, engineer or systems manager should document changes.

Specific Operational Tasks for Intersection Control Systems

System Monitoring / Intervention

Most intersection traffic control systems have the capability of virtually unattended operation. The system automatically invokes predetermined schedules for:

- Time-of-day control,
- Conventional traffic responsive implementation of timing plans, or
- On-line generation of timing plans.

In normal operation, the system determines when signal timing changes occur based on:

- Time-of-day, or
- Processed traffic flow data.

The system status monitoring element then verifies proper execution of the timing on the street. Figure 13-3 shows this control loop for conventional systems.

- As shown in Figure 13-3, an operator can modify the normal automatic implementation of system configuration and timing through manual control.

Manual intervention typically responds to congestion or maintenance problems to accomplish the following:

- Remove a controller unit or other component, which shows repeated intermittent failures, from system control and dispatch maintenance personnel for repair,
- Return repaired controller units or other components to system control if this does not occur automatically after the repair,
- Implement an emergency configuration and / or timing strategy,
- Select an alternative timing plan,
- Change subsystem or system timing parameters on a temporary basis,
- Change individual intersection timing parameters on a temporary basis,
- Provide information to the motorist for systems having this capability, and

- Assist in incident management where the system provides this capability.

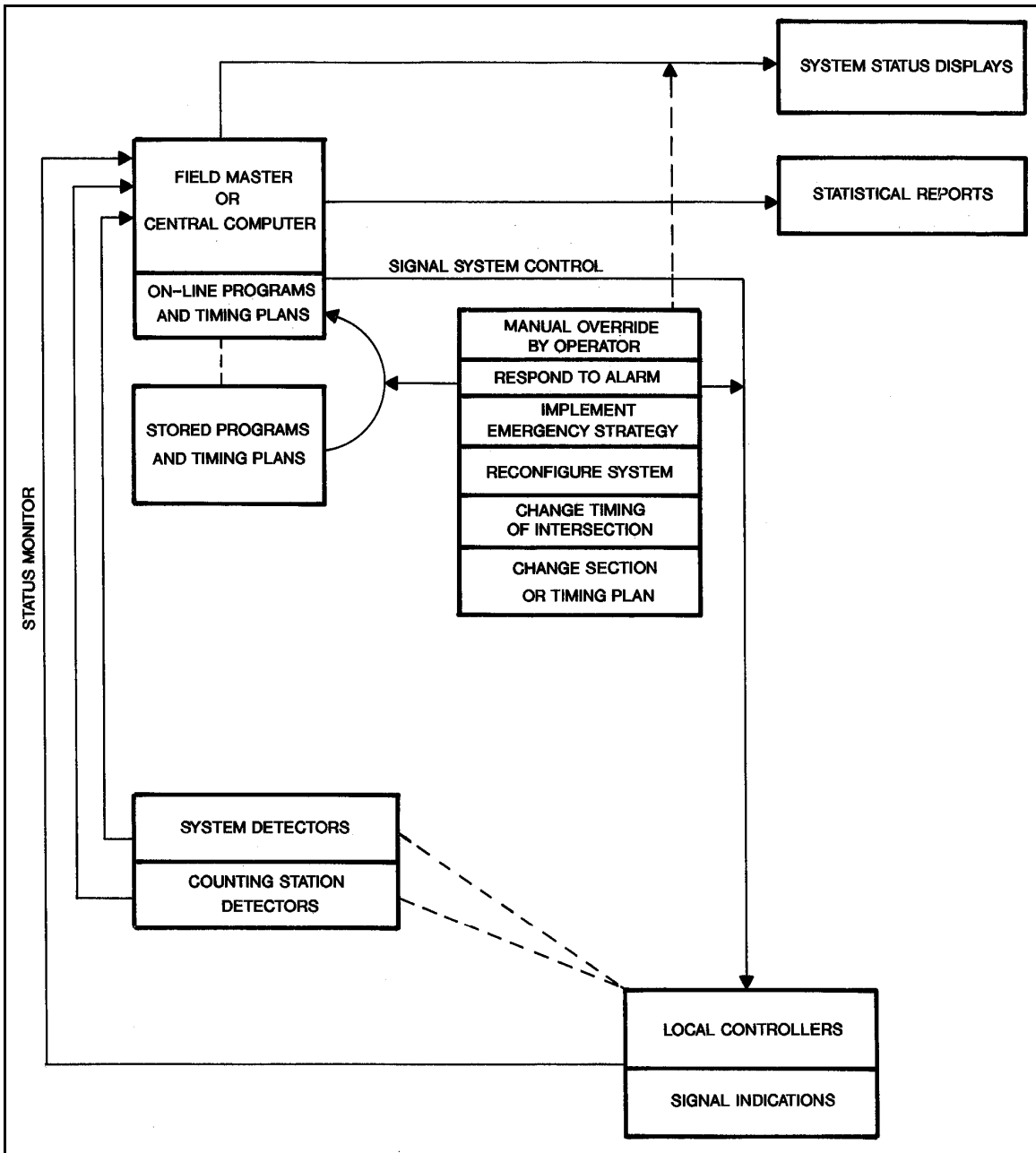

Figure 13-3 Typical daily control and operations architecture.

Data Collection and Analysis

In traffic control systems with limited data acquisition capabilities, the traffic engineer must rely on manually gathered field data and field observation to measure the effectiveness of implemented control strategies. Analysis of the data and observed field conditions provide the basis for modifying signal timing and plan scheduling. In normal operation, traffic control systems with more extensive data acquisition capability can automatically gather, tabulate and analyze significant amounts of traffic data. This tabulated and analyzed data produce measures of effectiveness (MOEs) for the system (see Section 3.11). Examples of data which generate MOEs include:

- Volume,
- Average speed,
- Occupancy,
- Queue lengths,
- Vehicle delay,
- Number of stops, and
- Travel time.

To easily analyze operational effectiveness, the system must assemble MOEs based on traffic data in usable form. To use the data effectively, personnel must understand what the respective printouts and graphics represent and how they relate to system control. The system should also aggregate link based MOEs for sections and the overall system.

Table 13-2 shows possible MOE formats for video display terminal (VDT) and hard copy and their usage.

Effective data collection and analysis establishes a structured procedure to schedule and assign a specific individual or team to review current MOEs and other data. This assures timely review of changing traffic patterns and the subsequent action needed to improve operation.

Table 13-2 MOE formats.

- A color graphic presentation of system or section aggregate MOEs in contour form showing various measures and their relationships during the implementation period of a given signal control plan, as shown in Figure 13-4
- Graphic charts and tables of aggregate MOEs by section and systemwide for an entire 24-hour period
- A level of service check for each link and group of links. This can take tabular form as a volume to capacity ratio, and average speed to calculated speed ratio. These can be shown on a computer graphics map through use of red, yellow and green lines for each section of roadway depending on the MOE. The computer printer can print the color graphic display.
- The delay and stops for each intersection approach, each intersection and each grouping of links for level of service analysis
- A list of the worst links and sections based on MOE, time-of-day, and day-of-week oriented
- The posting of some pertinent MOEs on a daily basis to keep all personnel aware of the importance of the quality of traffic flow in the system

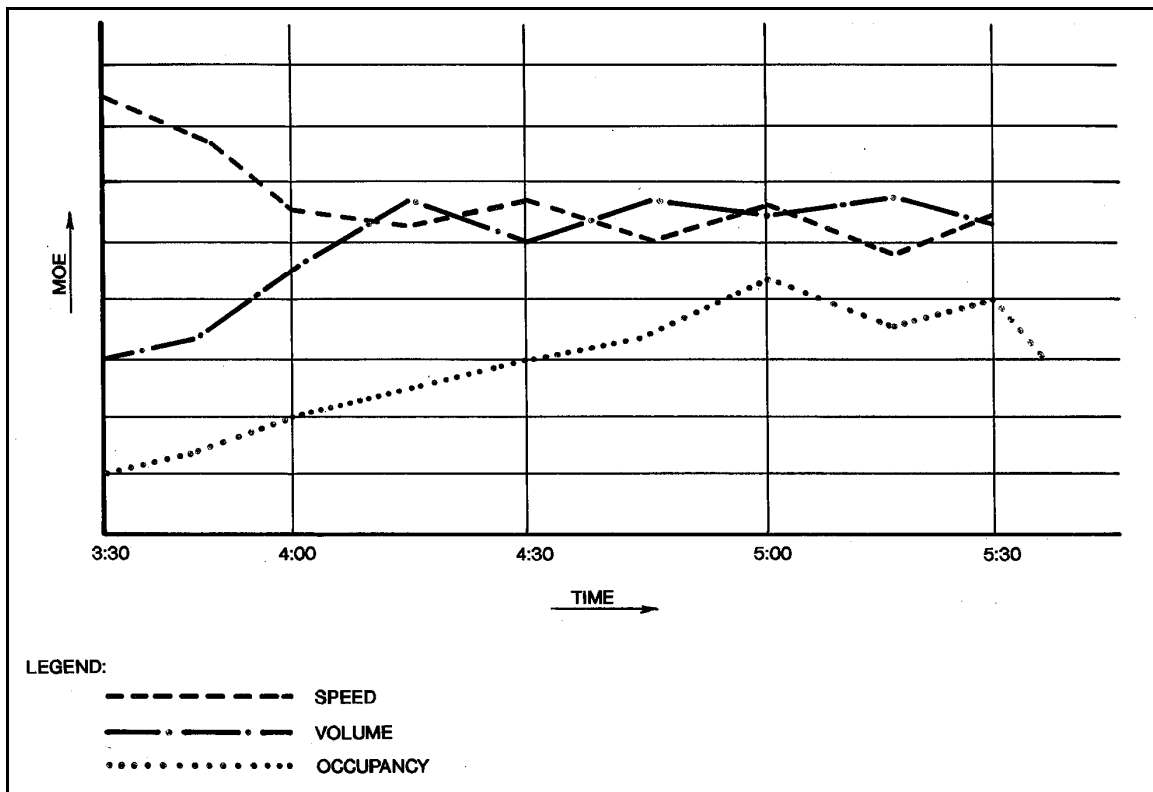

Figure 13-4 Typical aggregate MOE contour timing plan graphic.

System Modification and Updates

Traffic control systems require constant scrutiny to determine the need for operational changes. Examples of system upgrading include:

- Control strategy and timing modifications,
- Operating and control software updates, and
- Addition of new control features.

Modifications should include field review to ensure maximum effect. This includes queuing, utilization of storage space, proper progression, adequate cycle lengths, splits and offsets.

Each type of system modification has a different implementation timeframe.

In addition, the street system may undergo changes (e.g., reversible lanes, one-way pairs, intersection channelization, HOV lanes and bicycle lanes). Operational changes must take place with system upgrades and changes to the street system.

Updating System Timing

In the case of a traffic control system with few data acquisition features, the traffic engineer relies on field data acquired manually for timing plan updates and modifications. However, the engineer may use these data, together with the network's physical characteristics to run one of several available signal timing optimization programs for personal computers (PCs), such as PASSER, TRANSYT 7F and Synchro (see Section 3.8). Many traffic systems either directly support these programs or allow migration of the database from PCs to the traffic control system.

Figure 13-5 shows a typical flow chart for system modifications for non-adaptive traffic control systems. The engineer may have to collect turning movement counts to supplement system-derived data.

If a city or other agency does not have in-house personnel to develop and implement the needed plans and system timing, outside assistance can be obtained by engaging a consultant to perform this task. When a new system is being designed and installed, the design contract often includes the tasks of signal retiming and database preparation. These plans should be subsequently verified in the field, either by the consultant or by the operating agency.

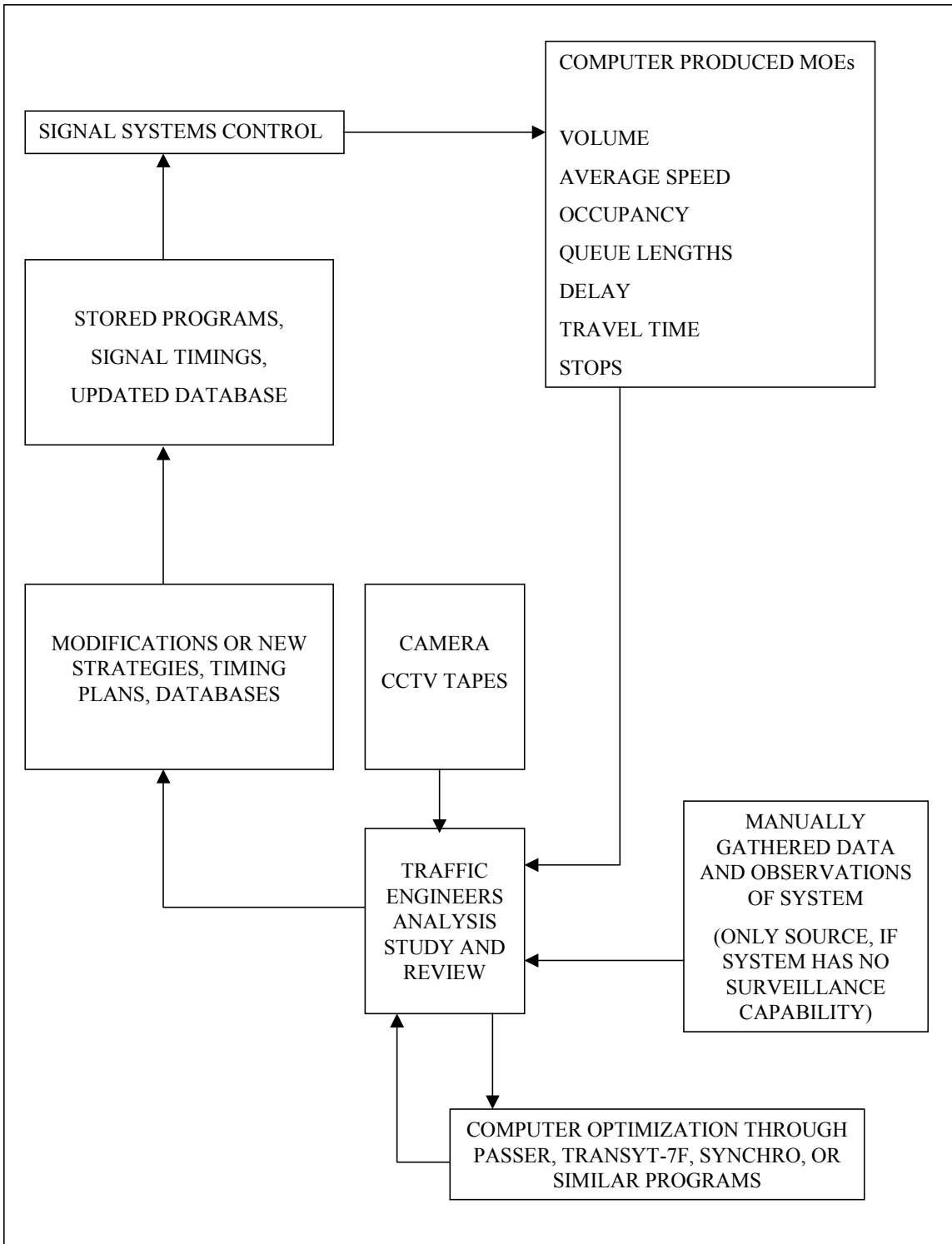

Figure 13-5 Typical flow chart for system modification and update for conventional traffic control systems.

Changes in traffic flows create a need to implement signal timing changes. Factors that change traffic flow patterns include:

- Land use and population changes,
- Addition or deletion of signals,
- Development of major traffic generators,
- Street geometric changes,
- Operational changes in a corridor, such as one-way streets,
- Provision of traffic condition, route guidance or parking information, and
- Roadway construction.

Staffing Requirements and Organization

The expanded flexibility and ever increasing capabilities in contemporary control systems allow the agency extensive opportunities for staff involvement in traffic management. However, in many existing systems full use of the system's potential remains untapped due to staff limitations. To attain full system potential, consider the operating staff as much a part of the system as the computer itself.

Staffing Examples

The experience of currently operating systems proves valuable in assessing staffing needs for various types of traffic control systems. Table 8-5 gives staffing examples for existing traffic signal systems of various types and sizes.

Factors to Consider in Staffing

Regardless of control system size, the staffing organization requires the two basic skills shown in Table 13-3.

The skills will realize the full performance potential and capabilities of a control system and accommodate modifications. While very few agencies change on-line software in-house, they often develop or modify off-line spread sheet or database management system programs to process MOE data, for example. Some agencies rely on outside contracts for programming skills, as discussed later under software maintenance.

Table 13-3 Basic staffing skills.

Skill	Required Knowledge
Traffic Operations	<ul style="list-style-type: none">• Traffic flow principles• Control concepts• Local conditions• Signal timing requirements• Conditions of existing equipment• System planning, design, installation and operation• Operation of other traffic control systems in the same area and good working relationships with their operating staff
Systems	<ul style="list-style-type: none">• Local signal controllers• Data communications• Database structure• System software structure• Programming• Equipment integration

In assessing staffing needs, agencies must consider other factors such as the level of available resources. Do not assume that the sophistication and capabilities of a traffic control system can reduce the size and / or technical talent of the operations staff.

Table 13-4 describes other factors the agency should consider in assessing staffing requirements.

Organization

Organization of a traffic control system team should center around a nucleus of a functioning traffic operations section or division of a transportation department (or an equivalent section of a comparable entity). In that nucleus lies the tradition of effective traffic control - *day-to-day* and *year-to-year* practical experience. With this organizational structure, present operations personnel can absorb the new traffic control tool and, with proper training, use it to achieve performance improvements in the street network. Likewise, new operations personnel incorporated within the team structure can benefit from the practical experience of longer term personnel.

To assure close coordination and cooperation, it can prove advantageous for the same organization to have responsibility for both operations and maintenance. This logical tie-in of two essential system management functions improves the cohesion necessary for effective operations.

Table 13-4 Staffing factors.

Factor	Description
Assignments	In smaller traffic control systems, 1 or 2 qualified individuals can perform typical operational tasks. In larger systems, specific tasks must be identified and assigned to appropriately skilled personnel. Individual team members must know their specific responsibilities and relationships with other team members to assure proper system operation and updating.
Training	<ul style="list-style-type: none"> • When systems are initially installed, the system installation contractor (see Chapter 12) typically provides training in system operation • Scheduling, supervising, and conducting in-house, on-the-job training programs • The agency must conduct on-going training because of: <ul style="list-style-type: none"> - personnel turnover - advancement of personnel to other positions - terminations <p>Regular in-service and on-the-job training should be initiated as soon as practical after system implementation. Such a program provides continuity of operation as personnel changes occur and increases general interest in operations among team members.</p>
Tours	Hosting visitors to the control center - usually most intense during the first 18 months.
Public relations	Developing public relations and citizen information programs through press releases, and compilation and printing of literature, based on the operation and performance of the control system
Shifts	<p>Traffic control systems perform their functions around the clock, handling their more critical traffic loads during recurring control periods of higher demands. Most current operating systems provide on-site personnel for operations duties covering at least the period from the beginning of the morning peak to the end of evening peak. Smaller systems may limit staffing to peak periods only.</p> <p>Other systems are staffed on a 24-hour basis. Appropriate staffing periods can be determined only by experience with the system's operation over a reasonable period of time. Start with a 2-shift operation from approximately before the onset of the morning peak to the end of the evening peak. Supplement by some form of alarm response for the balance of each 24-hour period. Staff the system at least an hour before the morning peak to:</p> <ul style="list-style-type: none"> • Clear possible system problems • Restore and repair controllers to on-line status • Alert maintenance personnel • Have staff available if an event occurs which requires manual intervention before the peak period

13.4 Maintenance

The successful performance of any operational traffic signal system depends on the commitment of the operating agency to an effective maintenance management program.

Maintenance has sometimes received insufficient emphasis in system management. Some agencies have erroneously presumed that high-technology systems possess fewer maintenance requirements and consequently underestimated budget and staffing needs

for proper system maintenance. Similarly, agencies have failed to recognize the higher personnel skill levels required to maintain complex traffic control systems. This illustrates the need for cost tradeoff analyses during the design phase to identify techniques for reducing maintenance requirements.

An effective maintenance management program requires accurate record keeping and overall system configuration documentation including:

- Up-to-date timing plans,
- Database, and
- Software and hardware information.

Updating should be performed daily.

An effective maintenance management program relies on these records to:

- Predict future maintenance needs,
- Analyze costs, and
- Use for special purposes such as litigation.

The following paragraphs focus on the management aspects of traffic control system maintenance.

Types of Maintenance

Traffic control system maintenance activities are classified as:

- Functional,
- Hardware, and
- Software.

Functional

To achieve the full potential of traffic control systems, agencies should continually expand their effort on updating the database and optimizing signal timing plans as described earlier.

Computer-based traffic control systems use extensive databases, which include:

- System control input parameters,
- Operating thresholds,
- Functional characteristics, and
- Hardware characteristics.

Typical requirements for database updates include:

- Detector relocations,
- Subsystem reconfiguration,
- System expansion,
- Changes in controller types, and
- Changes in preemption routes.

Hardware

Traffic control system hardware maintenance generally falls into three categories (4):

- Remedial,
- Preventive, and
- Modification.

Remedial, usually commanding the highest priority, results from malfunctions and equipment failures, including emergency repair activity to restore operation. Most centrally controlled computer traffic systems and closed-loop systems incorporate software which can diagnose malfunctioning field components. During operating periods when such systems are not monitored by an operator, failure reports generated by such systems may be displayed at a terminal in the maintenance shop. *Preventive* maintenance includes work done at scheduled intervals to minimize the probability of failure. *Modification* or reconstruction becomes necessary when:

- A manufacturing / design flaw is identified, or
- Changes are needed to improve equipment characteristics.

Annual budgets must fund all three categories.

Sophisticated data communications, changeable message signs and CCTV increase maintenance and require more highly trained personnel. As technology advances, special skills may become necessary to provide adequate maintenance capability. The increased numbers of detectors in adaptive traffic control systems also require added maintenance.

Maintenance personnel should regularly check the operation of local controllers and detectors which do not operate as part of an interconnected system

Scheduled maintenance includes such traditional activities as:

- Relamping, cleaning of signal heads, and
- Inspection of:
 - Poles,
 - Foundations,
 - Wiring, and
 - Pedestrian pushbuttons.

Software

Salwin (5) provides a detailed discussion of software maintenance. Software maintenance generally includes the following:

- Correction of errors and “bugs” not discovered during system acceptance and during the period the organization that installs the system is responsible for its warranty and maintenance.
- Modification or addition of features not previously included in the system. If the modifications may be accomplished by means of altering spreadsheets or database management programs, outside assistance may not be required.

If the agency has established the right to modify its software and documentation during system procurement, then either the system supplier or a third party may be used to modify and maintain the software and its documentation.

Results of Inadequate Maintenance

An inadequate maintenance program can have serious implications. For example, signal failures can directly impact accident potential. When accidents do occur, courts increasingly hold operating agencies liable if malfunctions were not corrected in a timely manner. This has resulted in increased emphasis on both maintenance and maintenance-record systems.

Maintenance also impacts the ability of a control system to optimally perform its functions. Failure of a single component may degrade system performance. For example, the real time selection and implementation of timing plans depends on input data from selected detectors. Failure of critical detectors could result in a less than optimum traffic control plan.

Maintenance deficiencies also result in the following types of equipment failure:

- Malfunction - Any event that impairs the operation of a control system without losing the display and sequencing of signal indications to all approaching traffic. Malfunctions include detector failures, loss of interconnected control, and other similar occurrences.
- Breakdown - Any event that causes a loss of signal indication to any or all phases or traffic approaches. Breakdowns include:
 - Controller failures,
 - Cable failures, and
 - Loss of power.
- Reduced life - Lack of maintenance can also reduce equipment service life.

Staff Requirements

In planning maintenance staff for an advanced traffic control system, agencies must consider the:

- Impacts of the new system on overall maintenance activity, and
- Attendant maintenance skill level requirements.

Planning should assess:

- Present and projected maintenance skill level requirements,

- Present maintenance capability with respect to:
 - Staffing,
 - Equipment,
 - Training and budget, and
- Projected workload impact associated with the new traffic control system.

Agencies may have difficulty:

- Finding competent specialists, and
- Paying competitive salaries for such personnel.

Agencies planning complex computer control systems should consider the alternative of contractual maintenance services. In cases where additional staff training and expansion prove appropriate, the training should be:

- Thorough,
- Both classroom and hands-on, and
- Intensive in troubleshooting and diagnostic techniques.

In an urban area, agencies can support each other by sharing maintenance resources on an on-going or as needed basis. For instance, one or more maintenance technicians could support systems in two nearby cities with the cities sharing salary and other costs.

The use of one type of hardware and one software package in systems increases personnel familiarity with the system reducing the time for:

- Troubleshooting,
- Training, and
- Equipment inventory.

Table 8-5 shows the number of personnel assigned to several operating traffic signal management systems.

13.5 Evaluation

Evaluation (see Figure 13-2) assesses performance levels of the design as well as the operations and maintenance functions. Evaluation should consider the effects on safety

and traffic flow quality of new systems, control strategies, and other operational improvements with *before* and *after* measurements. The measures of effectiveness are those selected during system development.

Short-term evaluations assess the immediate effects of an operational strategy or timing change.

The agency should make a more in-depth evaluation of system operation and maintenance periodically (e.g., every one to three years) and when adding new locations and functions. This assures that the system configuration still addresses overall system needs.

Traffic control system improvements are usually proposed to decision-makers based on some forecast of the resulting benefits. Evaluation sustains the credibility of the traffic system and its staff. It also identifies ways to further increase benefits.

Techniques

Evaluation techniques based on traffic measurements usually prove more credible to decision makers than simulation results; thus, it is desirable to perform at least a portion of the evaluation in this way. If staff resources are insufficient, a qualified consultant can perform the evaluation.

Certain parameters such as volume may be obtainable from the traffic system. Caution must be exercised in using MOE such as delay, stops and speed from the traffic system as these MOE may contain estimation errors or may not truly represent conditions somewhat distant from the detector. Statistical techniques may estimate the quantity of data required to provide statistically significant results in the face of measurement error.

Simulation techniques may reduce the cost of evaluation, particularly for large systems. Credible evaluations require such simulations to be validated and, if necessary, calibrated against physical measurements for a portion of the system.

Before and After Measurements

Measurement of conditions *before and after* project implementation is perhaps the most common approach for evaluating improvements. This approach establishes the before measurement as the base and assumes that the after conditions represent the effect of the improvement.

This approach can prove susceptible to errors caused by time related factors, especially when measuring the effects over a long period. Factors that may influence conditions between the *before* and *after* measurements include:

- Population growth,

- Economic fluctuations,
- Completion of major traffic generators, or
- Other changes.

As indicators of change, before and after measurements cannot easily distinguish the effects of individual improvements made at the same time.

To some extent these issues can be mitigated using the traffic system itself as an evaluation tool. For example, evaluation can use the following procedure:

- After completion of construction, restore the database to pre-construction timing plans and control strategies,
- Measure *before* conditions,
- Implement new timing plans and strategies, and
- Measure *after* conditions.

The resulting shorter time period minimizes the effects of traffic demand changes during the evaluation period. Depending on the accuracy of the algorithms, system generated MOEs may provide cost effective evaluation data.

Even when long term demand changes do not impact evaluation, intermediate or short-term demand changes usually occur. Examples include demand variations resulting from:

- Seasonal effects,
- Holiday periods,
- Weather, and
- Special events.

The effects of improvements may be confounded when implementing two or more congestion reduction techniques concurrently. Examples include:

- Roadway improvements,
- One-way streets,
- Modified signal indications, and

- Revised timing patterns.

It may prove possible to evaluate in stages to emphasize the contribution of each technique.

Before and after studies can define specific *test routes* for evaluation. This approach is often selected when the evaluation uses *floating vehicle* measurements. Alternatively, intersection based measurements may be the basis for evaluation.

Sampling Considerations

The integrity of the sampling technique used for data collection critically impacts the level of precision expected in the evaluation. The level of precision associated with a before-and-after study depends on the:

- Importance of detecting a difference,
- Expected size of the difference, and
- Cost of the data collection activity.

In cases involving research, the importance of the project may warrant high precision. Studies involving relatively small before / after differences may also require high precision because a small scale study would prove inconclusive. Studies involving major changes at a particular location can tolerate lower precision. Carefully design the sampling procedure to measure the effects of the alternative strategies efficiently and accurately.

- Box and Oppenlander (6) and other statistical methods references discuss techniques.

References

1. "Transportation Infrastructure: Benefits of Traffic Control Signal Systems Are Not Being Fully Realized." GAO Report GAO/RCED-94-105, March 1994.
2. Giblin, J., and Kraft, W. "Installation, Management and Maintenance." Institute of Transportation Engineers, Arlington, VA.
3. "Symposium on Integrated Traffic Management Systems." *Transportation Research Circular No. 404*, Transportation Research Board, Washington, DC, March 1993.
4. Baxter, D. "Contracting Maintenance for Traffic Signal Systems." New York State Department of Transportation, August 1984.
5. Salwin, A.E., "The Road to Successful ITS Software Acquisition: Volume 2: Overview and Themes." Mitretek, Federal Highway Administration Report FHWA-JPO-98-036, Washington DC, July 1998.
6. Box, P.C., and J.C. Oppenlander. "Manual of Traffic Engineering Studies." Institute of Transportation Engineers, Arlington, VA, 1983.

**CHAPTER 14
ITS PLANS AND PROGRAMS**

Table of Contents

Section	Page
14.1 Introduction.....	14-2
14.2 ITS Program Planning in the United States.....	14-3
14.3 The ITS Planning Process.....	14-4
National.....	14-4
Regional / Statewide	14-5
Agency	14-6
References	14-8

CHAPTER 14
ITS PLANS AND PROGRAMS

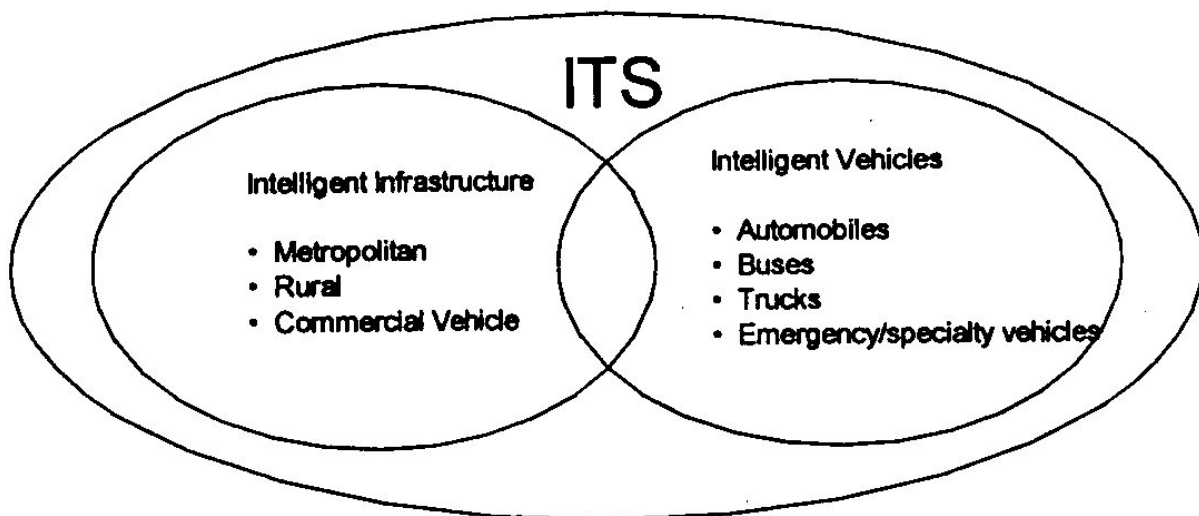

Figure 14-1. The ITS Program Structure (Reference 1).

14.1 Introduction

This chapter overviews ITS activities in the U.S. and abroad, and reviews ITS planning.

With regard to surface transportation systems, including the traffic control systems covered in this handbook, the national ITS program in the United States has a significant impact on their:

- Planning,
- Design,
- Implementation, and
- Operation.

The United States Department of Transportation (USDOT) is the administrative arm charged with moving these important technology areas from concepts to solutions that provide real benefits to travelers and motorists in the U.S. The USDOT has established an ITS Joint Program Office which is housed within the Federal Highway Administration (FHWA). The ITS Joint Program Office has been designated to provide oversight and management of the various programs to effectively and responsibly attain progress and meet goals as broadly contained within the initiatives. The FHWA, working through national forums such as the Intelligent Transportation Society of America (ITS America),

has developed ITS Strategic Plans that address national issues and concerns, functional planning, and broad implementation plans.

The Intelligent Transportation Society of America was established in 1991 to coordinate the development and deployment of ITS in the United States. ITS America also has alliances with ITS organizations in other countries, most notably in Europe and Asia. Its goals are to

- Promote ITS Research, Deployment and Operations
- Promote Leadership, Knowledge and Technical Expertise

ITS America maintains the following interest areas where news and information can be found:

- Automotive, telecommunications and consumer electronics.
- Commercial vehicle and freight mobility
- Public safety
- Public transportation
- Research, integration, training and education
- Transportation systems, operations and planning.

ITS America has published a “National ITS Program Plan! A Ten-Year Vision” (2).

14.2 ITS Program Planning in the United States

The ITS program provides for the research, development and operational testing of Intelligent Transportation Systems aimed at solving congestion and safety problems, improving operating efficiencies in transit and commercial vehicles, and reducing the environmental impact of growing travel demand. Proven technologies that are technically feasible and highly cost effective will be deployed nationwide as a component of the surface transportation systems of the United States.

The ITS program is divided into two key areas:

- Research and Development
- Deployment Incentives

USDOT, working with ITS America, maintains and updates as necessary a National ITS Program Plan.

The scope of this plan includes the following:

- Goals, objectives and milestones for ITS R&D
- Standards development activities to promote and ensure interoperability
- A cooperative process with State and local governments to develop plans for incorporating ITS into surface transportation plans

14.3 The ITS Planning Process (3)

The authority for transportation decision-making is dispersed among several levels, or “tiers”, of government, and often between several agencies with each governmental level. The concept of an integrated surface transportation network (including freeway management and operations as a part thereof) needs to be considered and supported at each of the different tiers noted below.

National

The **national** tier involves the authorizing legislation that establishes and provides direction, priorities, and resources for the federal regulations, policies, programs, and research that is initiated or implemented. The implementation of these regulations and associated programs are intended to positively influence the overall environment and how transportation management strategies and technologies are considered by the appropriate state, regional, and agency interests. These federal programs and rules, corresponding research programs, outreach and technology transfer programs, and results of the various initiatives (e.g., field operational tests, model deployments), are intended to introduce new and innovative technologies and practices, improve the capabilities of public agency staff, and advance the state-of-the-art and state-of-the-practice of local agencies – in essence, setting the bar for the minimum allowable performance of the transportation network, while encouraging agencies to go well beyond. Examples of how the national tier can influence processes and decision-making include:

- The Intermodal Surface Transportation Efficiency Act of 1991 (ISTEA) authorized the creation of the Intelligent Transportation System (ITS) program and charged U.S.DOT with the responsibility of fostering deployment of ITS products and services nation-wide. The Transportation Efficiency Act for the 21st Century (TEA-21) reaffirmed the role of U.S. DOT in advancing deployment by mainstreaming ITS funding eligibility under the federal-aid program and by creating incentive funding programs to accelerate integration of systems.
- FHWA Rule 940 implements section 5206(e) of the Transportation Equity Act for the 21st Century (TEA-21), which required Intelligent Transportation System (ITS) projects funded through the highway trust fund to conform to

the National ITS Architecture and applicable standards. This rule requires that the National ITS Architecture be used to develop a local implementation of the National ITS Architecture, which is referred to as a "regional ITS architecture."

- Federal-aid Eligibility Policy Guides are developed by FHWA to aid in determining applicability of Federal-aid funding for ITS projects. For example, a guide published in November 2001 regarding operations eligibility stated: "the operating costs for traffic monitoring, management, and control systems, such as integrated traffic control systems, incident management programs, and traffic control centers, are eligible for Federal reimbursement from National Highway System and Surface Transportation Program funding. Operating costs include labor costs, administrative costs, costs of utilities and rent, and other costs, including system maintenance costs, associated with the continuous operation of the system".

This is not just a top-down process. The state and local agencies (i.e., other tiers) interact and influence the Federal programs and national efforts. For example, Interim Guidance on Eligibility of Intelligent Transportation Systems (ITS) Projects for Federal-aid Funding indicated that the "guidance provides a broad definition of ITS projects that is based on ITS user services. Where no appropriate ITS user service currently exists that meets your partner's needs, we support the development of a unique ITS user service. Because it is expected that the National ITS Architecture will adapt over time to accommodate new user services, we ask that we be informed of any new services."

The national tier is also more than with the Federal government passing laws and authorizing funding, and FHWA publishing requirements regarding the planning, design, implementation, and operations of transportation facilities. Another function of this tier is technology transfer and support to the other tiers. Examples include the development and distribution of Handbooks (e.g., this document on Freeway Management and Operations), self – assessment guides (i.e., a tool for agencies with traffic operations responsibility to assess the effectiveness of their various programs and processes) and training courses.

Regional / Statewide

The **regional / statewide tier** involves the appropriate strategic transportation planning, programming, and coordination efforts that include a longer-range time horizon (10 –20 years). Statewide and regional transportation planning is the structured process followed by states, metropolitan planning organizations (MPOs), municipalities, and operating agencies to design both short and long-term transportation plans. Products are project-oriented, typically providing the Statewide and Regional (Constrained) Long Range Plan (LRP), Statewide Transportation Improvement Program (STIP), regional Transportation Improvement Program (TIP), and Unified Planning Work Program (UPWP).

While the process has historically focused on capital projects, it is now recognized that the statewide / regional transportation planning process must take management and operations of the transportation network, and the ITS – based systems that support operations, into consideration. This is particularly true given that ITS appears to be losing its special funding status that it enjoyed in ISTEA and TEA-21. The current trend to “mainstream” ITS (and operations) into the traditional decision-making process of transportation planning means that operations and ITS deployments will be increasingly funded through regular sources and compared with traditional transportation components, such as road widening and new construction. There is consequently a need to strengthen the ties between management and operations, ITS, and the transportation planning process

Agency

The **agency tier** is where the infrastructure comprising the surface transportation network (e.g., freeways, bridges, tunnels, surface streets, rail lines, rolling stock, traffic control / management devices) is typically owned. This level develops a multi-year program and budget that defines resources and commitments for a three to 10 year time frame, with updates every year or two. As noted in the previous chapter, providing effective highway-based transportation consists of three component parts – building the necessary infrastructure (i.e. construction), effectively preserving that infrastructure (i.e. maintenance), and effectively preserving its operating capacity by managing operations on a day-to-day basis. All three of these “legs” that make up the “highway transportation stool” are defined and developed at the agency level; and it is at this tier where the relative balance between these parts are determined, and the associated priorities, budgets, and allocation of resources are established.

Another responsibility at the agency tier, and one that has become a priority, involves assessing the vulnerabilities of the infrastructure and physical assets; developing possible countermeasures to deter, detect, and delay the impact of threats to such assets; estimating the capital and operating costs of such countermeasures, and then budgeting the required resources; and improving security operational planning for better protection against future acts of terrorism.

From the perspective of surface street traffic management and operations, it is at the agency level where the planning, design and implementation activities for the program takes place. A key product is often a strategic system plan and / or Regional ITS Architecture that focuses on the deployment of ITS technologies and strategies for the surface transportation network, including surface street controls. This plan may identify the key components of a system, future initiatives to expand the functionality or area of coverage, and identify the resources needed to support all of the life-cycle phases of the system. The general time frame with the future planning and coordination for either a system or an associated transportation operations program would be 3 - 10 years in scope. It is important that the process to develop the ITS – based strategic plan (or any such focused plan or project) support the overall transportation planning process; not compete

with it. Moreover, the end products of these “focused” processes can and should be used to feed information back into the overall transportation planning process.

References

1. “Intelligent Transportation Systems in the Transportation Equity Act for the 21st Century”, Federal Highway Administration Publication No. FHWA-jpo-99-040.
2. “National ITS Program Plan: A Ten-Year Vision”, ITS America, Washington, D.C., January 2002.
3. Obenberger, J., and W.H. Kraft, “Surface Transportation Systems: The Role of Traffic Management Centers.”



U.S. Department of Transportation
Federal Highway Administration

Office of Operations (HOP)

Mail Stop: E86-205
1200 New Jersey Ave, SE
Washington, DC 20590

Publication No. FHWA-HOP-06-006