



PHMSA RESEARCH & TECHNICAL PERSPECTIVES



Working Group 1 – Damage Prevention
Gov/Industry Pipeline R&D Forum

August 6-7, 2014



Goals of the Working Group

Focus on excavation damage/pipelines locating/ROW monitoring/protecting or potential impacts of climate change.

Objectives

1. Develop a consensus agenda of technical gaps & challenges for future R&D that does not duplicate existing efforts.
2. The output identifies both short and long term research objectives where possible for liquid/gas and transmission and distribution pipelines.
3. Conduct basic road mapping on identified technical gaps so identified research is addressing the need effectively.
4. Provide details of the ultimate research goals so appropriate end users are factored into project scopes.



Damage Prevention Research

- Stakeholder input sought/generated for Damage Prevention research at 5 Pipeline R&D Forums
- Solicited for related topics in 9 research solicitations since 2002
 - However not all solicited topics successful in becoming new research
- Related Investment: 18 technology development, product development and process improvement projects using \$4.9M (PHMSA)





Notable Outputs/Impacts



Successful deployment of digging triggers on backhoes & integration into the VA Pilot Program

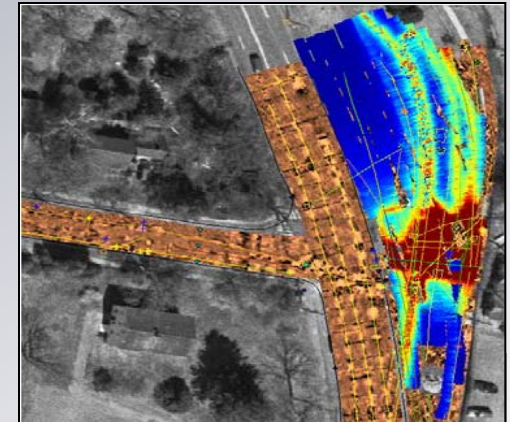

Commercial improvements to encroachment monitoring systems.

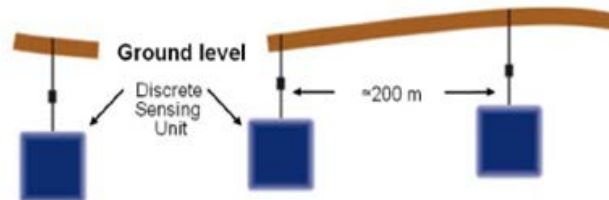
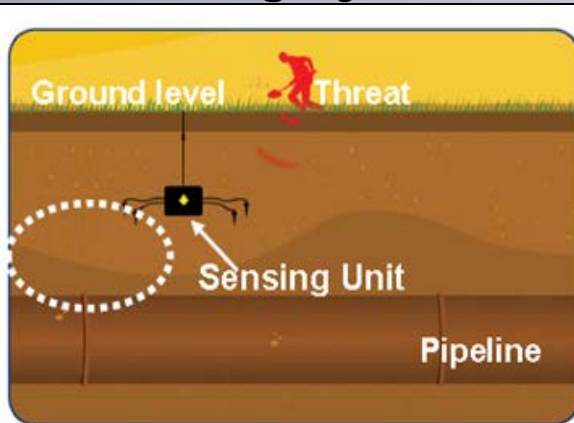

Commercial improvements to ground probing radar for sub-surface mapping



Notable Outputs/Impacts



General knowledge on the effectiveness of back fill methods



General knowledge on the effectiveness of damage prevention methods

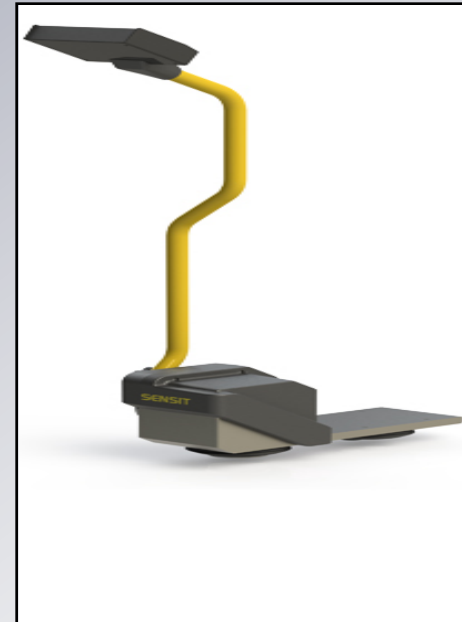

Handheld asset locator in detecting buried metallic and non-metallic pipes (PE and sewer pipes)



Current Research

Developing Technology

PIGPEN is an autonomous real-time intruder warning system that detects and reports right-of-way encroachment and excavation activity near a pipeline enabling response in time *to prevent pipeline damage*. It comprises an underground network of discrete and unattended, smart sensor packages deployed around (but not in contact with) an underground pipeline or similar protected area.

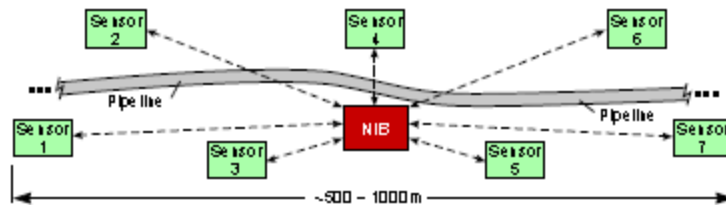
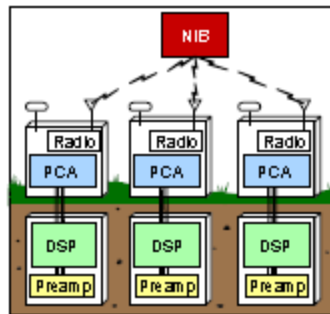

PSE&G Woodbridge NJ Pipeline

	Status	Goal
Probability of detecting threat within protected area	86%	>95%
False alarms	<7% for threats slightly outside protected area 0% for non-threats	0%



Current Research

The project developing a Subsurface Multi-Utility Asset Location Tool is aiming to ensure detection of multiple pipes in a vertical strata with separation distances between such vertical pipes.





Current Research

The project developing a Real-Time Multiple Utility Detection During Pipe Installation Using Horizontal Directional Drilling (HDD) System is aiming to ensure detection of multiple pipes in a vertical strata with separation distances between such vertical pipes.

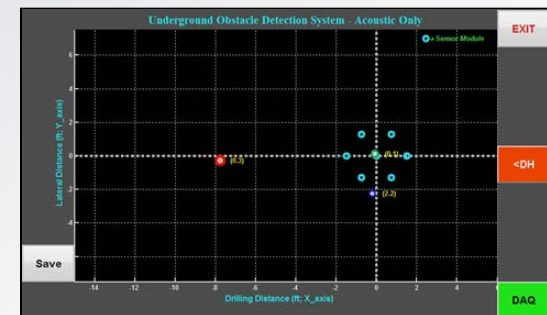



U.S. Department of Transportation
Pipeline and Hazardous Materials
Safety Administration



Damage Prevention

Jim Merritt

Department of Transportation

Office of Pipeline Safety

P(303) 683-3117

Cell: (303) 638-4758

F(303) 346-9192

Email james.merritt@dot.gov