

A Summary of Vehicle Detection and Surveillance Technologies used in Intelligent Transportation Systems

Funded by the Federal Highway Administration's Intelligent Transportation Systems Program Office



Produced by
The Vehicle Detector Clearinghouse

A multi-state, pooled-fund project managed by the Southwest Technology Development Institute (SWTDI) at New Mexico State University (NMSU), and sponsored in cooperation with the U.S. Department of Transportation, Federal Highway Administration

August 31, 2007

**SUMMARY OF VEHICLE DETECTION AND SURVEILLANCE TECHNOLOGIES
USED IN INTELLIGENT TRANSPORTATION SYSTEMS**

SUBMITTED TO:

Federal Highway Administration's (FHWA) Intelligent Transportation Systems Program Office

PREPARED BY:

**Luz Elena Y. Mimbela
Project Manager
The Vehicle Detector Clearinghouse
New Mexico State University
P.O. Box 30001
Las Cruces, NM 88003-8001**

and

**Lawrence A. Klein, Ph.D., P.E.
Klein & Associates
3 Via San Remo
Rancho Palos Verdes, CA 90275**

With Assistance From:

**Perry Kent, VDC Project Consultant
John L. Hamrick, VDC Project Consultant
Karen M. Luces, NMSU
Sylvia Herrera, NMSU**

August 31, 2007

(Latest version of this handbook can be found at <http://www.nmsu.edu/~traffic/>)

Disclaimer Notice

This document is disseminated under the sponsorship of the Department of Transportation in the interest of information exchange. The United States Government assumes no liability for its contents or use.

The contents of this summary document reflect the views of the contractor and subcontractors, who are responsible for the accuracy of the data presented herein. The contents do not necessarily reflect the official policy of the Department of Transportation.

This document does not constitute a standard, specification, or regulation.

The United States Government and the Vehicle Detector Clearinghouse do not endorse products or manufacturers. Vendor and manufacturer's names appear herein only because they are considered essential to the purpose of this document.

TABLE OF CONTENTS

CHAPTER 1 - INTRODUCTION.....	1-1
CHAPTER 2 - METHODS AND APPROACH.....	2-1
COLLECTION OF PRODUCT INFORMATION.....	2-1
COLLECTION OF USER INFORMATION.....	2-2
COMPILATION OF INFORMATION.....	2-2
CHAPTER 3 – OVERVIEW OF VEHICLE DETECTION AND SURVEILLANCE TECHNOLOGIES.....	3-1
IN-ROADWAY SENSORS.....	3-1
OVER-ROADWAY SENSORS.....	3-2
RELATIVE COST OF SENSORS.....	3-3
SENSOR TECHNOLOGY COMPARISON.....	3-4
CHAPTER 4 – IN-ROADWAY SENSOR TECHNOLOGIES.....	4-1
PNEUMATIC ROAD TUBE.....	4-1
<i>Principles of Operation.....</i>	<i>4-1</i>
<i>Applications and Uses.....</i>	<i>4-1</i>
<i>Advantages.....</i>	<i>4-1</i>
<i>Disadvantages.....</i>	<i>4-1</i>
<i>Installation Configuration.....</i>	<i>4-2</i>
INDUCTIVE LOOP DETECTORS.....	4-4
<i>Principles of Operation.....</i>	<i>4-4</i>
<i>Applications and Uses.....</i>	<i>4-5</i>
<i>Advantages.....</i>	<i>4-5</i>
<i>Disadvantages.....</i>	<i>4-5</i>
MAGNETIC SENSORS.....	4-6
<i>Principles of Operation.....</i>	<i>4-6</i>
<i>Application and Uses.....</i>	<i>4-6</i>
<i>Advantages.....</i>	<i>4-10</i>
<i>Disadvantages.....</i>	<i>4-11</i>
PIEZOELECTRIC SENSORS.....	4-12
<i>Principles of Operation.....</i>	<i>4-12</i>
<i>Applications and Uses.....</i>	<i>4-12</i>
<i>Construction.....</i>	<i>4-12</i>
<i>Bonding Materials.....</i>	<i>4-15</i>
<i>Advantages.....</i>	<i>4-15</i>
<i>Disadvantages.....</i>	<i>4-16</i>
WEIGH-IN-MOTION (WIM).....	4-17
<i>Application and Uses.....</i>	<i>4-17</i>
<i>Axle Group WIM Accuracy (%).....</i>	<i>4-20</i>
<i>Bending Plate.....</i>	<i>4-22</i>
<i>Piezoelectric.....</i>	<i>4-25</i>
<i>Load Cell.....</i>	<i>4-27</i>
<i>Capacitance Mat.....</i>	<i>4-28</i>
<i>Weigh-in-Motion System Costs.....</i>	<i>4-29</i>
CHAPTER 5 – OVER-ROADWAY SENSOR TECHNOLOGIES.....	5-1
VIDEO IMAGE PROCESSOR.....	5-1
<i>Principles of Operation.....</i>	<i>5-1</i>

<i>Signal Processing</i>	5-4
<i>Application and Uses</i>	5-6
<i>Mounting and Traffic Viewing Considerations</i>	5-7
<i>Advantages</i>	5-8
<i>Disadvantages</i>	5-12
MICROWAVE RADAR	5-13
<i>Principles of Operation</i>	5-13
<i>Application and Uses</i>	5-16
<i>Advantages</i>	5-18
<i>Disadvantages</i>	5-18
INFRARED SENSORS	5-17
<i>Active Infrared Sensor</i>	5-17
<i>Passive Infrared Sensors</i>	5-18
<i>Advantages</i>	5-22
<i>Disadvantages</i>	5-22
ULTRASONIC SENSORS	5-25
<i>Principles of Operation</i>	5-25
<i>Application and Uses</i>	5-25
<i>Advantages</i>	5-27
<i>Disadvantages</i>	5-27
PASSIVE ACOUSTIC ARRAY SENSORS	5-28
<i>Principles of Operation</i>	5-28
<i>Application and Uses</i>	5-29
<i>Advantages</i>	5-30
<i>Disadvantages</i>	5-30
CHAPTER 6 - REFERENCES	6-1
APPENDIX A:	A-1

LIST OF FIGURES

FIGURE 1.	COMBINATION TECHNOLOGY SENSORS. (PHOTOGRAPHS COURTESY OF ASIM TECHNOLOGIES, UZNACH, SWITZERLAND).	3-3
FIGURE 2.	ROAD TUBE CONFIGURATIONS FOR SINGLE AND MULTILANE HIGHWAYS. (PHOTOGRAPH COURTESY OF TIME MARK, INC., SALEM, OR).	4-2
FIGURE 3.	FRONT PANEL DISPLAY OF JAMAR TRAX-III COUNTER. (PHOTOGRAPH COURTESY OF JAMAR TECHNOLOGIES, INC., HORSHAM, PA).	4-3
FIGURE 4.	PRINCIPAL COMPONENTS OF AN INDUCTIVE LOOP DETECTOR INSTALLATION.	4-4
FIGURE 5.	MAGNETIC ANOMALY IN THE EARTH'S MAGNETIC FIELD INDUCED BY MAGNETIC DIPOLES IN A FERROUS METAL VEHICLE.	4-7
FIGURE 6.	DISTORTION OF EARTH'S MAGNETIC FIELD CREATED AS A VEHICLE ENTERS AND PASSES THROUGH THE DETECTION ZONE OF A MAGNETIC SENSOR. (DRAWING COURTESY OF NU-METRICS, UNIONTOWN, PA).4-8	8
FIGURE 7.	TWO- AND THREE-AXIS FLUXGATE MAGNETOMETER SENSORS.	4-10
FIGURE 8.	INDUCTION MAGNETOMETER SENSORS.	4-11
FIGURE 9.	VIBRACOAX PIEZOELECTRIC SENSOR MOUNTED IN ALUMINUM CHANNEL AS INSTALLED IN A ROADBED. (DRAWING COURTESY OF IRD, INC., SASKATOON, SK).	4-13
FIGURE 10.	ROADTRAX PIEZOELECTRIC BLC SENSOR MOUNTED IN ALUMINUM CHANNEL AS INSTALLED IN A ROADBED (ROADTRAX, 1995-1996).	4-14
FIGURE 11.	BENDING PLATE SENSOR. (PHOTOGRAPHS COURTESY OF IRD, INC., SASKATOON, SK).	4-23
FIGURE 12.	BENDING PLATE OR LOAD CELL WIM SYSTEM (TYPICAL).	4-24
FIGURE 13.	WIM INSTALLATION WITH FULL-LENGTH PIEZOELECTRIC SENSORS.	4-25
FIGURE 14.	LINEAS QUARTZ SENSOR (DRAWING COURTESY OF KISTLER INSTRUMENTS AG WINTERTHUR, SWITZERLAND).	4-26
FIGURE 15.	CAPACITANCE MAT SENSOR CONNECTED TO DATA ANALYSIS EQUIPMENT. (PHOTOGRAPH COURTESY OF LOADMETER, CORP., BALTIMORE, MD).	4-28
FIGURE 16.	TRIPLINE VIDEO IMAGE PROCESSORS.	5-3
FIGURE 16.	VIDEO IMAGE PROCESSORS (ALSO REFERRED TO AS MACHINE VISION PROCESSORS).	5-3
FIGURE 17.	VIDEO IMAGE PROCESSORS (CONTINUED).	5-3
FIGURE 18.	CONCEPTUAL IMAGE PROCESSING FOR VEHICLE DETECTION, CLASSIFICATION, AND TRACKING. (KLEIN, 2006)	5-5
FIGURE 19.	VEHICLE COUNT COMPARISON FROM FOUR VIPs AND INDUCTIVE LOOP DETECTORS.	5-9
FIGURE 20.	VEHICLE SPEED VS. LIGHTING VIP TEST RESULTS.	5-11
FIGURE 21.	VEHICLE COUNT VS. LIGHTING VIP TEST RESULTS.	5-11
FIGURE 22.	VEHICLE COUNT VS. SPEED VIP TEST RESULTS.	5-12
FIGURE 23.	MICROWAVE RADAR OPERATION.	5-14
FIGURE 24.	SPEED MEASUREMENT WITH AN FMCW MICROWAVE PRESENCE-DETECTING RADAR.	5-15
FIGURE 25.	SIDE-MOUNTED CONFIGURATION OF AN FMCW MICROWAVE PRESENCE-DETECTING RADAR ILLUSTRATING MULTILANE VEHICLE DETECTION. (PHOTOGRAPH COURTESY OF EIS, TORONTO, CANADA)	5-16
FIGURE 26.	CONSTANT FREQUENCY WAVEFORM.	5-17
FIGURE 27.	DOPPLER MICROWAVE RADAR SENSORS.	5-17
FIGURE 28.	PRESENCE-DETECTING MICROWAVE RADAR SENSORS.	5-18
FIGURE 29.	LASER RADAR BEAM GEOMETRY. (DRAWING COURTESY OF OSI LASERSCAN, ORLANDO, FL).	5-18
FIGURE 30.	LASER RADAR SENSORS.	5-18
FIGURE 31.	PASSIVE INFRARED SENSORS.	5-20
FIGURE 32.	EMISSION AND REFLECTION OF ENERGY BY VEHICLE AND ROAD SURFACE.	5-21
FIGURE 33.	MULTIPLE DETECTION ZONE CONFIGURATION IN A PASSIVE INFRARED SENSOR.	5-21
FIGURE 34.	ULTRASONIC SENSOR.	5-25
FIGURE 35.	MOUNTING OF ULTRASONIC RANGE-MEASURING SENSORS. (COURTESY OF MICROWAVE SENSORS, ANN ARBOR, MI).	5-26
FIGURE 36.	ACOUSTIC ARRAY SENSORS.	5-29

LIST OF TABLES

TABLE 1.	STRENGTHS AND WEAKNESSES OF COMMERCIALY AVAILABLE SENSOR TECHNOLOGIES.	3-5
TABLE 2.	TRAFFIC OUTPUT DATA (TYPICAL), COMMUNICATIONS BANDWIDTH, AND COST OF COMMERCIALY AVAILABLE SENSORS.....	3-8
TABLE 3.	RECOMMENDED TESTS FOR DETERMINING BONDING ABILITY OF AGENTS USED WITH PIEZOELECTRIC SENSORS.....	4-15
TABLE 4.	WIM SYSTEM CATEGORIES, APPLICATIONS, AND DATA ITEMS.....	4-18
TABLE 5.	ASTM PERFORMANCE REQUIREMENTS FOR WIM SYSTEMS	4-19
TABLE 6.	CALIFORNIA DEPARTMENT OF TRANSPORTATION (CALTRANS) PERFORMANCE REQUIREMENTS FOR WIM SYSTEMS	4-19
TABLE 7.	INHERENT VARIANCE COMPONENT OF SYSTEM ACCURACY (1 STANDARD DEVIATION CONFIDENCE INTERVAL)	4-20
TABLE 8.	ACCURACY SPECIFICATIONS FOR BENDING PLATE AND LOAD CELL WIM SCALES (1 STANDARD DEVIATION CONFIDENCE INTERVAL)	4-21
TABLE 9.	BUDGETARY INITIAL CAPITAL COSTS OF WIM SYSTEMS.....	4-30
TABLE 10.	LIFE-CYCLE MAINTENANCE COSTS OF WIM SYSTEMS.....	4-30
TABLE 11.	VIDEO IMAGE PROCESSOR CHARACTERISTICS IN UPSTREAM AND DOWNSTREAM VIEWING	5-8

Chapter 1 - Introduction

The surface transportation system of the United States is comprised of approximately 3.9 million miles of roads and 503 public transit systems, which accommodate 4 trillion passenger miles and 3 trillion ton miles of freight per year (Apogee/Hagler Bailly, 1998 and U.S. Department of Transportation, 2002). In 2006, the U.S. Department of Transportation estimated that America loses \$200 billion a year due to freight bottlenecks and delayed deliveries. In addition, consumers lose 3.7 billion hours and 2.3 billion gallons of fuel sitting in traffic jams.

Demands on the transportation system are growing rapidly, with a projected increase in highway miles traveled of 25 percent over the next ten years (Davis and Diegel, 2002). In order to prevent congestion at current levels from getting worse, the U.S. would have to increase the capacity of the transportation system by the same 25 percent. One option is to increase highway capacity by increasing the number of lane miles, which translates to about 4,200 lane miles of new roadway every year. At the present time, roads are being built at about two-thirds this rate.

A second option is to develop alternatives that increase capacity by improving the efficiency of the existing transportation system and promote the use of public transit systems. This option focuses on building fewer lane-miles, while investing in Intelligent Transportation Systems (ITS) infrastructure. In 1991, the Intermodal Surface Transportation Efficiency Act (ISTEA) resulted in the formation of the Federal Intelligent Transportation Systems (ITS) program to address ways to deal with the increase in travel demand on the nation's transportation systems using the second option. Follow-on legislation in 1998 created the Transportation Equity Act for the 21st Century (TEA-21). This act authorizes the Federal surface transportation programs for highways, highway safety, and transit for the 6-year period 1998-2003. The transportation authorization, "Safe, Accountable, Flexible, and Efficient Transportation Equity Act: A Legacy for Users" (SAFETEA-LU; Pub. L. 109-59, 119 Stat. 1144) marks a successful "graduation" from ISTEA and TEA-21 where ITS was based almost solely in Title V (research). SAFETEA-LU no longer treats ITS as a special niche research program, but rather has "mainstreamed" transportation funding eligibility for ITS deployment. SAFETEA-LU is a \$286.4 billion, six-

year bill that provides for a 30% increase in highway funding and 46% increase in transit funding.

The goals of ITS include the following:

- Enhance public safety;
- Reduce congestion;
- Improved access to travel and transit information;
- Generate cost savings to motor carriers, transit operators, toll authorities, and government agencies; and
- Reduce detrimental environmental impacts.

Intelligent Transportation Systems include sensor, communication, and traffic control technologies. These technologies are assisting states, cities, and towns nationwide meet the increasing demands on the surface transportation system. Vehicle detection and surveillance technologies are an integral part of ITS since they gather all or part of the data that is used in ITS. It is estimated that an investment in ITS will allow for fewer miles of road to be built, thus reducing the cost of mitigating recurring congestion by approximately 35 percent nationwide (Apogee/Hagler Bailly, 1998).

Vehicle detection and surveillance technologies are being improved to provide enhanced speed monitoring, traffic counting, presence detection, headway measurement, vehicle classification, and weigh-in-motion data. This summary document was developed to assist in the selection of vehicle detection and surveillance technologies that support traffic management and traveler information services. The information will also be useful to personnel involved in traffic data collection for planning, policy, and research purposes. Included are descriptions of common types of vehicle detection and surveillance technologies that include their theory of operation, installation methods, advantages and disadvantages, and summary information about performance in clear and inclement weather and relative cost. Following each technology description is vendor-provided information about specific sensor models, their functions and

applications, users, and installation and maintenance costs. A 3-ring binder format was selected to allow the contents to be easily updated.

The *Summary of Vehicle Detection and Surveillance Technologies Used in Intelligent Transportation Systems* will be updated periodically as long as the Vehicle Detector Clearinghouse remains in operation. The latest version of this summary document is available in electronic format at the following URL: <http://www.nmsu.edu/~traffic>.

Chapter 2 - Methods and Approach

To accomplish the objectives outlined in Chapter 1, a multi-task approach was taken using a team of experts from Southwest Technology Development Institute (SWTDI), the Vehicle Detector Clearinghouse (VDC), and Dr. Lawrence A. Klein, a private consultant in the traffic management and sensor technology areas. The following sections discuss briefly the tasks performed to complete the objectives of the project.

COLLECTION OF PRODUCT INFORMATION

Product information for vehicle detection and surveillance technologies used in ITS was obtained from the vendors and manufacturers of the equipment. To facilitate this effort, a database of vendors' and manufacturers' addresses and contact information was developed in electronic format using the Excel® worksheet software package. The information for the database was gathered from the following sources:

- Existing VDC product database;
- List supplied by FHWA;
- List supplied by private consultant;
- Internet based searches using key words;
- Intelligent Transportation Society of America's Tenth Annual Meeting and Exposition Official Exhibitor Directory; and
- Traffic Technology International, April/May 2000 issue.

Once the database of vendor and manufacturer information was compiled, vendors and manufacturers were contacted to obtain specific information on their products. The vendors and manufacturers were sent a vendor survey and a cover letter explaining the purpose of the survey. The vendors and manufacturers that were selected were contacted by regular mail, facsimile, and Email. The database included a "status" column that provided updated information, such as whether the vendor survey response was received from the corresponding vendor/manufacturer

or whether it was returned unopened. If the survey packet was returned unopened, the address was verified and corrected if necessary and a second packet was sent.

At the time the first edition was prepared, a total of 86 additional vendor survey packets had been sent; thus more responses were expected. The survey responses included product name, a general description of the equipment, sensor technology and configuration, installation time and requirements, product capabilities/functions, recommended applications, list of users, etceteras.

VDC project consultants reviewed the vendor's and manufacturer's survey responses for errors. When necessary, VDC project consultants contacted the vendors and manufacturers to obtain clarification on some of the vendor survey responses.

COLLECTION OF USER INFORMATION

User information was obtained from compiled responses to the *State Equipment Questionnaire* and the *Survey of Degree of Satisfaction of State DOT Personnel with Vehicle Detection Equipment* for the ongoing VDC project. Although the user data collected were specific to the make and model of certain types of equipment, generalizations were made based on equipment types so as not to unfairly criticize vendors and manufacturers. The generalizations were then included in this summary document in the equipment description sections.

COMPILATION OF INFORMATION

Once a response to the vendor and manufacturer survey was received, it was compiled in electronic format and added to *The Summary of Vehicle Detection and Surveillance Technologies Used in Intelligent Transportation Systems* document. In order to avoid misinterpretation of vendor and manufacturer information, the vendor survey information was entered directly into an electronic survey form identical to the one the vendor or manufacturer had filled out. The vendor and manufacturer survey responses were organized according to the type of sensor technology utilized (e.g., road tubes, piezoelectric, load cell, bending plate, capacitance mat, inductive loops, magnetometers, video image processor, microwave or laser radar, passive infrared, ultrasonic, or passive acoustic).

In addition to the vendor and manufacturer two-page survey responses, a description of each sensor technology was provided. The description included principles of operation, typical uses, relative costs, advantages and disadvantages, and other pertinent information. Also, in Chapter 3, a comparison of several technologies based on cost, applications, and other factors was presented.

Finally, the information was compiled and organized into a three-ring binder format to allow for quick removal and addition of outdated and updated information, respectively, with the most current version of the document available in electronic format at the following URL:

<http://www.nmsu.edu/~traffic/>. The hard copy version of the document does not have page numbers on the vendor and manufacturer survey responses; thus when these are taken out or added to the binder, the table of contents will remain undisturbed. The authors felt that the information contained in this summary document would be useful to a wide audience having varied technical or managerial backgrounds and different needs or applications.

Chapter 3 – Overview of Vehicle Detection and Surveillance Technologies

Sensors used for vehicle detection and surveillance may be described as containing three components, the transducer, a signal processing device, and a data processing device. The transducer detects the passage or presence of a vehicle or its axles. The signal-processing device typically converts the transducer output into an electrical signal. The data-processing device usually consists of computer hardware and firmware that converts the electrical signal into traffic parameters. Typical traffic parameters include vehicle presence, count, speed, class, gap, headway, occupancy, weight, and link travel time. The data processing device may be a part of the sensor, as with devices that produce serial output data, or may be controllers external to the sensor as utilized with sensors that have optically-isolated semiconductor or relay outputs.

The following chapters describe the operating principles, sensor measurement accuracies, costs, advantages, and disadvantages of technologies that find application in in-roadway and over-roadway sensors. The in-roadway and over-roadway terminology is that used in the *Traffic Detector Handbook* published by the U.S. Federal Highway Administration (Klein, et al., 2006). Each technology section also contains equipment-specific data supplied by the manufacturers or vendors of representative sensors.

IN-ROADWAY SENSORS

An in-roadway sensor is one that is either

- Embedded in the pavement of the roadway,
- Embedded in the subgrade of the roadway, or
- Taped or otherwise attached to the surface of the roadway.

Examples of in-roadway sensors include inductive loop detectors, which require sawcuts in the pavement; weigh-in-motion sensors, which are embedded in the pavement; magnetometers, which may be embedded or placed underneath a paved roadway or bridge structure; and tape switches, microloops, pneumatic road tubes, and piezoelectric cables, which are mounted on the roadway surface.

The operation of most of these sensors is well understood as they generally represent applications of mature technologies to traffic surveillance. The drawbacks to their use include disruption of traffic for installation and repair and failures associated with installations in poor road surfaces and use of substandard installation procedures. Resurfacing of roadways and utility repair can also create the need to reinstall these types of sensors.

OVER-ROADWAY SENSORS

An over-roadway sensor is one that is mounted above the surface of the roadway either

- Above the roadway itself or
- Alongside the roadway, offset from the nearest traffic lane by some distance.

Examples of over-roadway sensors are video image processors (i.e., machine vision based sensors) that utilize cameras mounted on poles adjacent to the roadway, on structures that span the roadway, or on traffic signal mast arms over the roadway; microwave radar sensors mounted adjacent to the roadway or over the lanes to be monitored; ultrasonic, passive infrared, and laser radar sensors normally mounted over the lanes to be monitored (some passive infrared models can be mounted adjacent to the roadway); and passive acoustic sensors mounted adjacent to the roadway. Some emerging applications for wide area surveillance envision over-roadway sensors mounted on tall buildings and radio towers near the roadway and on aerial platforms.

Recent evaluations have shown that modern over-roadway sensors produce data that meet the requirements of many current freeway and surface street applications (Klein and Kelley, 1996; Kranig J., E. Minge, and C. Jones, 1997; MnDOT, 2002; Middleton, D. and R. Parker, 2002). Similar to in-roadway sensors, the over-roadway sensors provide vehicle count, presence, and passage. However, many also provide vehicle speed, vehicle classification, and multiple-lane, multiple-detection zone coverage.

Some over-roadway sensors incorporate more than one technology. Figure 1 displays sensors that combine passive infrared with ultrasound and Doppler microwave radar. The passive infrared-ultrasound combination provides enhanced accuracy for presence and queue detection,

vehicle counting, and height and distance discrimination. The passive infrared-Doppler microwave radar sensor is designed for presence and queue detection, vehicle counting, speed measurement, and length classification. The Doppler microwave radar sensor measures high to medium speeds and the passive infrared measures vehicle count, presence, and occupancy. At medium speeds, the multiple detection zone passive infrared sensor automatically calibrates its speed measurements against the radar's. This calibration permits the infrared to measure slow vehicle speeds and detect stopped vehicles. The passive infrared-microwave radar sensor combination may also be utilized to detect wrong-way drivers. The triple technology infrared-Doppler radar-ultrasound sensor provides vehicle classification, vehicle counts and speed, presence and queue detection, occupancy and time gap data, and travel direction.

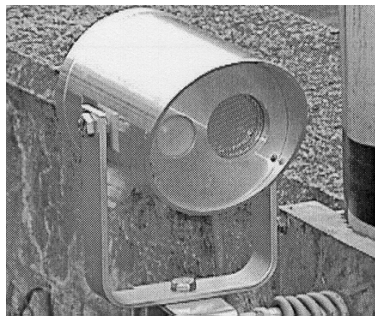

DT 272 Infrared-ultrasound sensor



DT 350 Infrared-Doppler radar sensor



TT 290 Series infrared-Doppler radar-ultrasound sensor

Figure 1. Combination technology sensors. (Photographs courtesy of ASIM Technologies, Uznach, Switzerland).

RELATIVE COST OF SENSORS

A satisfactory cost comparison between various sensor technologies can only be made when the specific application is known. For example, a relatively inexpensive ultrasonic, microwave, or passive infrared sensor may seem to be the low-cost choice at first glance for instrumenting a surface street intersection if inductive loop detectors are not desired. But when the number of sensors needed is taken into account along with the limited amount of directly measured data that may be available (e.g., speed is not measured directly by a single zone infrared sensor), a more expensive sensor such as a video image processor (VIP) may be the better choice. Consequently, if it requires twelve to sixteen conventional inductive loop detectors (or ultrasonic, microwave, infrared, etc. sensors) to fully instrument an intersection, the cost becomes comparable to that of

a VIP. Furthermore, the additional traffic data and visual information made available by the VIP may more than offset any remaining cost difference. In this example, the VIP is assumed to meet the other requirements of the application, such as the desired 100 percent detection of vehicles at the intersection. Similar arguments can be made for freeway applications using multiple sensors and requiring information not always available from the less expensive sensors.

Microwave presence-detecting radar mounted in a side-looking configuration may be another cost-effective replacement for in-roadway sensors. Presence-detecting radar sensors can monitor multilane freeway traffic flow and surface street vehicle presence and speed. In these applications, the microwave sensors replace a greater number of inductive loop detectors that are needed in the travel lanes. Furthermore, the microwave sensor potentially provides direct measurement of speed at a greater accuracy than provided by the loops.

Other factors that affect the cost and selection of sensors are the need for road closure for installation and maintenance, maturation of the designs and manufacturing processes for sensors that use the newer technologies, reduced prices through quantity buys, and availability of mounting locations and communications links at the application site. In some urban areas, the cost of trenching in the street and restoration for lead-in wire and cable to connect to a controller cabinet is very high, e.g., \$50 per foot (0.3 m) or more. Trenching thus becomes a significant part of the installation cost. In these cases, over-roadway sensors that utilize an RF, microwave, or spread spectrum radio links may be the low-cost alternative to gather and transmit sensor data to the controller.

SENSOR TECHNOLOGY COMPARISON

Table 1 compares the strengths and weaknesses of the sensor technologies that will be discussed in the following chapters with respect to installation, parameters measured, performance in inclement weather and variable lighting conditions, and suitability for wireless operation.

Table 1.
Strengths and weaknesses of commercially available sensor technologies (Klein, 2001; Rhodes, 2005; Klein, et al., 2006).

Technology	Strengths	Weaknesses
Inductive Loop	<ul style="list-style-type: none"> • Flexible design to satisfy large variety of applications. • Mature, well understood technology. • Large experience base. • Provides basic traffic parameters (e.g., volume, presence, occupancy, speed, headway, and gap). • Insensitive to inclement weather such as rain, fog, and snow. • Provides best accuracy for count data as compared with other commonly used techniques. • Common standard for obtaining accurate occupancy measurements. • High frequency excitation models provide classification data. 	<ul style="list-style-type: none"> • Installation requires pavement cut. • Decreases pavement life. • Installation and maintenance require lane closure. • Wire loops subject to stresses of traffic and temperature. • Multiple detectors usually required to monitor a location. • Detection accuracy may decrease when design requires detection of a large variety of vehicle classes.
Magnetometer (Two-axis fluxgate magnetometer)	<ul style="list-style-type: none"> • Less susceptible than loops to stresses of traffic. • Insensitive to inclement weather such as snow, rain, and fog. • Some models transmit data over wireless RF link. 	<ul style="list-style-type: none"> • Installation requires pavement cut. • Decreases pavement life. • Installation and maintenance require lane closure. • Models with small detection zones require multiple units for full lane detection.
Magnetic (Induction or search coil magnetometer)	<ul style="list-style-type: none"> • Can be used where loops are not feasible (e.g., bridge decks). • Some models are installed under roadway without need for pavement cuts. However, boring under roadway is required. • Insensitive to inclement weather such as snow, rain, and fog. • Less susceptible than loops to stresses of traffic. 	<ul style="list-style-type: none"> • Installation requires pavement cut or boring under roadway. • Cannot detect stopped vehicles unless special sensor layouts and signal processing software are used.
Microwave Radar	<ul style="list-style-type: none"> • Typically insensitive to inclement weather at the relatively short ranges encountered in traffic management applications. • Direct measurement of speed. • Multiple lane operation available. 	<ul style="list-style-type: none"> • CW Doppler sensors cannot detect stopped vehicles.
Active Infrared (Laser radar)	<ul style="list-style-type: none"> • Transmits multiple beams for accurate measurement of vehicle position, speed, and class. • Multiple lane operation available. 	<ul style="list-style-type: none"> • Operation may be affected by fog when visibility is less than ≈20 ft (6 m) or blowing snow is present. • Installation and maintenance, including periodic lens cleaning, require lane closure.

**Table 1 (continued).
Strengths and weaknesses of commercially available sensor technologies.**

Technology	Strengths	Weaknesses
Passive Infrared	<ul style="list-style-type: none"> • Multizone passive sensors measure speed. 	<ul style="list-style-type: none"> • Passive sensor may have reduced sensitivity to vehicles in heavy rain and snow and dense fog. • Some models not recommended for presence detection.
Ultrasonic	<ul style="list-style-type: none"> • Multiple lane operation available. • Capable of overheight vehicle detection. • Large Japanese experience base. 	<ul style="list-style-type: none"> • Environmental conditions such as temperature change and extreme air turbulence can affect performance. Temperature compensation is built into some models. • Large pulse repetition periods may degrade occupancy measurement on freeways with vehicles traveling at moderate to high speeds.
Acoustic	<ul style="list-style-type: none"> • Passive detection. • Insensitive to precipitation. • Multiple lane operation available in some models. 	<ul style="list-style-type: none"> • Cold temperatures may affect vehicle count accuracy. • Specific models are not recommended with slow moving vehicles in stop-and-go traffic.
Video Image Processor	<ul style="list-style-type: none"> • Monitors multiple lanes and multiple detection zones/lane. • Easy to add and modify detection zones. • Rich array of data available. • Provides wide-area detection when information gathered at one camera location can be linked to another. 	<ul style="list-style-type: none"> • Installation and maintenance, including periodic lens cleaning, require lane closure when camera is mounted over roadway (lane closure may not be required when camera is mounted at side of roadway) • Performance affected by inclement weather such as fog, rain, and snow; vehicle shadows; vehicle projection into adjacent lanes; occlusion; day-to-night transition; vehicle/road contrast; and water, salt grime, icicles, and cobwebs on camera lens. • Requires 30- to 50-ft (9- to 15-m) camera mounting height (in a side-mounting configuration) for optimum presence detection and speed measurement. • Some models susceptible to camera motion caused by strong winds or vibration of camera mounting structure. • Generally cost-effective when many detection zones within the field-of-view of the camera or specialized data are required. • Reliable nighttime signal actuation requires street lighting.

Most over-roadway sensors are compact and not roadway invasive, making installation and maintenance relatively easy. Some installation and maintenance applications may require the closing of the roadway to normal traffic to ensure the safety of the installer and motorist. All the sensors discussed operate under day and night conditions, although video-image processors may show improved performance at night when some street lighting is available (D. Bullock, 2002).

Table 2 lists the types of data typically available from each sensor technology, coverage area, communication bandwidth requirements, and purchase costs. Several technologies are capable of supporting multiple lane, multiple detection zone applications with one or a limited number of units. These devices may be cost effective when larger numbers of detection zones are needed to implement the traffic management strategy.

The communication bandwidth is low to moderate if only data and control commands are transmitted between the sensor, controller, and traffic management center. The bandwidth is larger if real-time video imagery is transmitted at 30 frame/s. The requirement for large bandwidth communications media such as T1 telephone lines, which support transmission rates of 1.544×10^6 bits/s or baud at a bandwidth of 125 MHz, and fiber can be reduced if compressed imagery (e.g., transmission rates of 256,000 bit/s at a bandwidth of 20.5 MHz) is suited for the application. The required transmission rate increases when large numbers of sensors, roadside information devices such as changeable message signs and highway advisory radio, signal timing plans, and traveler information databases are used to implement traffic management strategies.

The range of purchase costs shown for a particular sensor technology reflects cost differences among specific sensor models and capabilities. If multiple lanes are to be monitored and a sensor is capable of only single lane operation, then the sensor cost must be multiplied by the number of monitored lanes. Direct purchase cost is not the only cost associated with a sensor. Installation, maintenance, and repair should also be factored into the sensor selection decision. Installation costs include fully burdened costs for technicians to prepare the road surface or subsurface to install the sensor and mounting structure (if one is required), close traffic lanes where required, and verify proper functioning of the device after installation is complete. Maintenance and repair estimates may be obtained from manufacturers and from other agencies

Table 2.
Traffic output data (typical), communications bandwidth, and cost of commercially available sensors (Klein, 2001).

Sensor Technology	Output Data					Multiple Lane, Multiple Detection Zone Data	Communication Bandwidth	Sensor Purchase Cost ^a (each in 1999 U.S. \$)
	Count	Presence	Speed	Occu-pancy	Classifi-cation			
Inductive loop	✓	✓	✓ ^b	✓	✓ ^c		Low to moderate	Low ⁱ (\$500 to \$800)
Magnetometer (Two-axis fluxgate)	✓	✓	✓ ^b	✓			Low	Moderate ⁱ (\$900 to \$6,300)
Magnetic (Induction coil)	✓	✓ ^d	✓ ^b	✓			Low	Low to moderate ⁱ (\$385 to \$2,000)
Microwave radar	✓	✓ ^e	✓	✓ ^e	✓ ^e	✓ ^e	Moderate	Low to moderate (\$700 to \$3,300)
Active infrared	✓	✓	✓ ^f	✓	✓	✓	Low to moderate	Moderate to high (\$6,500 to \$14,000)
Passive infrared	✓	✓	✓ ^f	✓			Low to moderate	Low to moderate (\$700 to \$1,200)
Ultrasonic	✓	✓		✓			Low	Low to moderate (Pulse model: \$600 to \$1,900)
Acoustic array	✓	✓	✓	✓		✓ ^g	Low to moderate	Moderate (\$3,100 to \$8,100)
Video image processor	✓	✓	✓	✓	✓	✓	Low to high ^h	Moderate to high (\$5,000 to \$26,000)

^a Installation, maintenance, and repair costs must also be included to arrive at the true cost of a sensor solution as discussed in the text.

^b Speed can be measured by using two sensors a known distance apart or estimated from one sensor and the effective detection zone and vehicle lengths.

^c With specialized electronics unit containing embedded firmware that classifies vehicles.

^d With special sensor layouts and signal processing software.

^e With microwave radar sensors that transmit the proper waveform and have appropriate signal processing.

^f With multi-detection zone passive or active mode infrared sensors.

^g With models that contain appropriate beamforming and signal processing.

^h Depends on whether higher-bandwidth raw data, lower-bandwidth processed data, or video imagery is transmitted to the traffic management center.

ⁱ Includes underground sensor and local detector or receiver electronics. Electronics options are available to receive multiple sensor, multiple lane data.

and localities that have deployed similar sensors. The technologies listed in Table 2 are mature with respect to traffic management applications, although some may not provide the data required for a specific application. Some technologies, such as video image processing, continue to evolve by adding capabilities that measure additional traffic parameters, track vehicles, or link data from one camera to those from another.

Inductive loop detectors continue to be widely used to monitor traffic flow and control signals because of their relatively low cost, maturity, aesthetics, and policy issues. Some of the over-roadway sensor technologies, such as video image processing, multizone microwave radar, and passive infrared sensors, can replace several inductive loops. In these applications, the higher cost of the over-roadway sensor technologies can offset the costs associated with installing and maintaining multiple inductive loops. The mounting location is critical to the selection and proper operation of a traffic sensor. Experience by state DOTs has indicated that suitable mounting locations must be available with the proper elevation and proximity to the roadway in order for above- roadway sensors to function properly. Sensors selected for a first time application should be field tested under actual operating conditions that include variations in traffic flow rates, day and night lighting, and inclement weather.

The operation and applications of the following vehicle detection and surveillance technologies are discussed in the following chapters:

- Pneumatic road tube;
- Inductive loop;
- Piezoelectric cable;
- Magnetic sensor;
- Bending plate weigh-in-motion (WIM);
- Piezoelectric WIM;
- Load cell WIM;
- Capacitance mat WIM;
- Video image processor;

- Microwave radar;
- Laser radar;
- Passive infrared;
- Ultrasonic; and
- Passive acoustic array.

Chapter 4 – In-roadway Sensor Technologies

In-roadway sensors are those requiring installation on, embedded in, or installation below the road surface. The pneumatic road tube, inductive loop detector, magnetic sensors, piezoelectric cable, and weigh-in-motion sensors (piezoelectric, bending plate, load cell, and capacitance mat) are examples of in-roadway sensors, which are discussed in the following sections.

PNEUMATIC ROAD TUBE

Principles of Operation

Pneumatic road tube sensors send a burst of air pressure along a rubber tube when a vehicle's tires pass over the tube. The pressure pulse closes an air switch, producing an electrical signal that is transmitted to a counter or analysis software. The pneumatic road tube sensor is portable, using lead-acid, gel, or other rechargeable batteries as a power source.

Applications and Uses

The road tube is installed perpendicular to the traffic flow direction and is commonly used for short-term traffic counting, vehicle classification by axle count and spacing, planning, and research studies. Some models gather data to calculate vehicle gaps, intersection stop delay, stop sign delay, saturation flow rate, spot speed as a function of vehicle class, and travel time when the counter is utilized in conjunction with a vehicle transmission sensor (JAMAR Technologies).

Advantages

Advantages of road tube sensors are quick installation for permanent and temporary recording of data and low power usage. Road tube sensors are usually low cost and simple to maintain. Sensor manufacturers often supply software packages to assist with data analysis.

Disadvantages

Disadvantages include inaccurate axle counting when truck and bus volumes are high, temperature sensitivity of the air switch, and cut tubes from vandalism and truck tire wear.

Installation Configuration

Figure 2 shows some of the road tube configurations utilized on single and multilane highways to count and classify vehicles. Figure 3 displays the front panel of the JAMAR TRAX-III counter, which indicates how data analysis parameters are selected to match the tube layout.

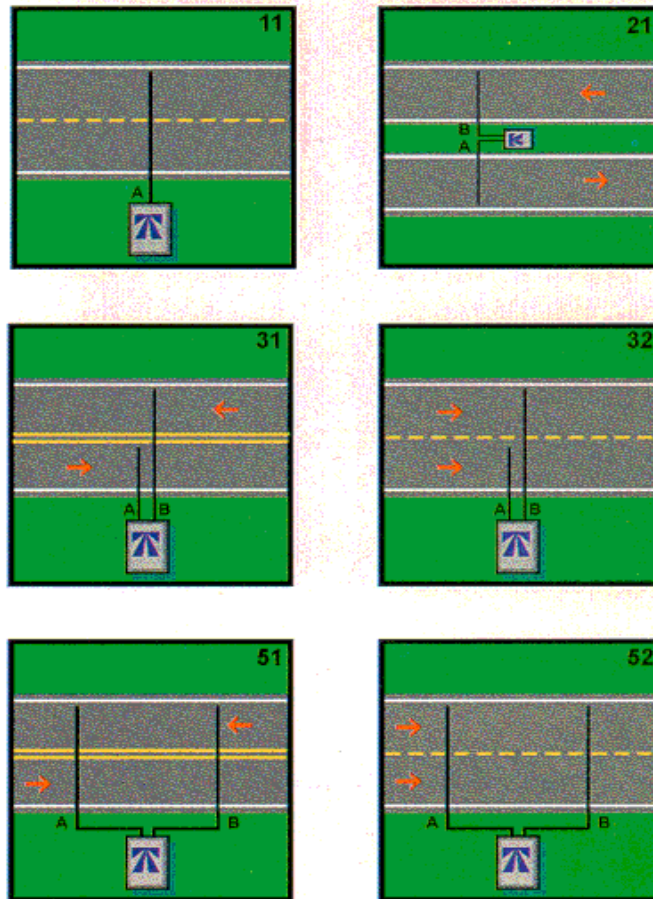

Figure 2. Road tube configurations for single and multilane highways. (Photograph courtesy of Time Mark, Inc., Salem, OR).

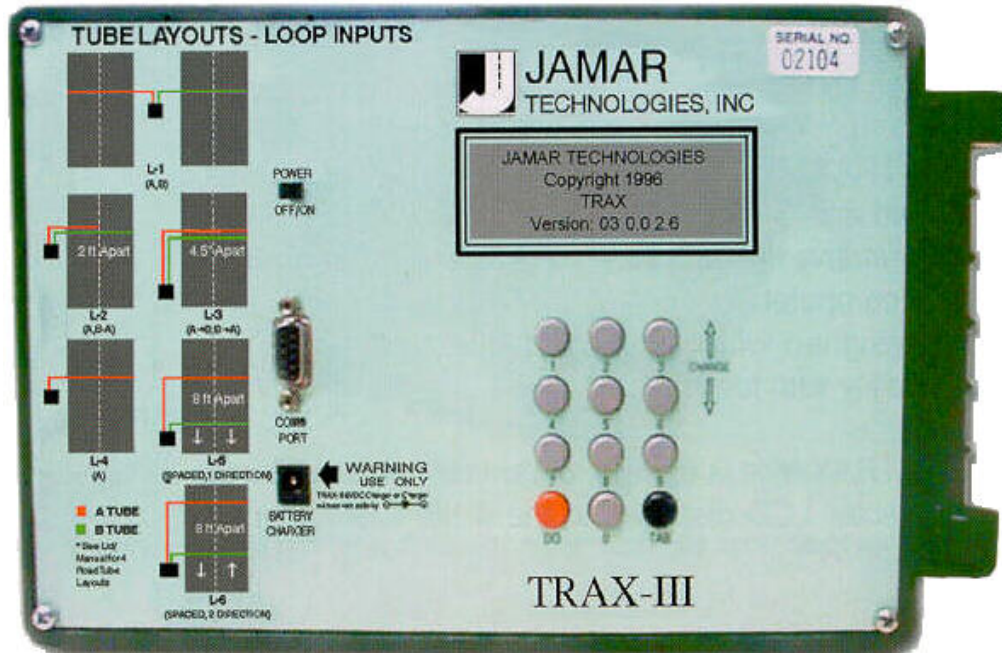

Figure 3. Front panel display of JAMAR TRAX-III counter. (Photograph courtesy of Jamar Technologies, Inc., Horsham, PA).

MANUFACTURER AND VENDOR INFORMATION

Effective Date: March 22, 2000

Manufacturer name: International Road Dynamics Inc. (IRD)

Sales representative name(s): Rod Klashinsky

Address: 702 43rd St. East
Saskatoon SK, S7K 3T9 CANADA

Address: _____

Phone number: 306-653-6600

Phone number: _____

Fax number: 306-242-5599

Fax number: _____

e-mail address: info@ird.ca

e-mail address: rod.klashinsky@ird.ca

URL address: www.irdinc.com

URL address: _____

PRODUCT NAME/MODEL NUMBER: Model TCC540 Traffic Counter Classifier

FIRMWARE VERSION/CHIP NO.: V2.6

SOFTWARE VERSION NO.: V4.73

GENERAL DESCRIPTION OF EQUIPMENT: Portable or permanent battery operated multi-lane time interval recording counter & classifier that collects traffic data

SENSOR TECHNOLOGY AND CONFIGURATION: Uses road Tube, Inductive Loops, Piezoelectric sensors, IRD Dynax[®] Sensor. Most common configuration is Loop-Piezo-Loop configuration

SENSOR INSTALLATION: Portable (On road) Permanent (In road)

INSTALLATION TIME (Per Lane): Approximately 4-5 hours in a permanent Loop-Piezo-Loop configuration. Approximately 15-20 minutes in a portable application.

INSTALLATION REQUIREMENTS: See attached Installation sheet.

MAXIMUM NUMBER OF LANES MONITORED SIMULTANEOUSLY: 8 lanes classifying, 16 lanes counting.

PRODUCT CAPABILITIES/FUNCTIONS: Collects vehicle traffic data, including vehicle classification, speed, volume, headway and gap.

RECOMMENDED APPLICATIONS: Traffic Planning, Traffic Profile, Safety, and Audit.

POWER REQUIREMENTS (watts/amps): AC Power for 6 volt, 12 amp rechargeable battery.

POWER OPTIONS: Dual battery units, solar package.

CLASSIFICATION ALGORITHMS: See attached specifications.

TELEMETRY: RS232 port with baud rates from 300 to 19,2000.

COMPUTER REQUIREMENTS: MSDOS.

DATA OUTPUT: IBM PC, Modem, Take-Away-Memory (TAM)

DATA OUTPUT FORMATS:

SUPPORTING DATA BASE MANAGEMENT SYSTEM: Trafman[®] Software

EQUIPMENT AND INSTALLATION COSTS (One-lane and four-lane): Permanent One lane – Approx. US \$5,000; 4 lanes – Approx. US \$9,000.

STATES CURRENTLY USING THIS EQUIPMENT:

<u>Country/State</u>	<u>Contact name</u>	<u>Telephone number</u>
USA/New Jersey		
Canada/Saskatchewan		
Canada/Manitoba		
Canada/Ontario		
Canada/Quebec		
Canada/Nova Scotia		
Canada/New Brunswick		
Canada/Newfoundland.		
Brazil		
Uruguay		
Venezuela		
Columbia		
India.		

MANUFACTURER AND VENDOR INFORMATION

Effective Date: March 22, 2000

Manufacturer name: International Road Dynamics Inc. (IRD)

Sales representative name(s): Rod Klashinsky

Address: 702 43rd St. East
Saskatoon SK, S7K 3T9 CANADA

Address: _____

Phone number: 306-653-6600

Phone number: _____

Fax number: 306-242-5599

Fax number: _____

e-mail address: info@ird.ca

e-mail address: rod.klashinsky@ird.ca

URL address: www.irdinc.com

URL address: _____

PRODUCT NAME/MODEL NUMBER: Model AS4XX Dynax[®] Treadle Systems

FIRMWARE VERSION/CHIP NO.: N/A

SOFTWARE VERSION NO.: N/A

GENERAL DESCRIPTION OF EQUIPMENT: Speed independent axle sensing systems.

SENSOR TECHNOLOGY AND CONFIGURATION: Pressure sensitive activation. Set in frame, using 1, 2, 3 or 4 sensors

SENSOR INSTALLATION: Frame and Treadle system are permanent, sensor installation or replacement, less than 20 minutes.

INSTALLATION TIME (Per Lane): 4-5 hours for Frame and Treadle systems; 20 minutes for sensors.

INSTALLATION REQUIREMENTS: Contact IRD for information.

MAXIMUM NUMBER OF LANES MONITORED SIMULTANEOUSLY: One treadle per lane (from stop and go traffic to 100 miles per hour).

PRODUCT CAPABILITIES/FUNCTIONS: Classification of vehicles by number of axles detected.

RECOMMENDED APPLICATIONS: Toll plaza

POWER REQUIREMENTS (watts/amps): 12 volts DC ($\pm 5\%$)

POWER OPTIONS: With voltage regulator between 15 VDC to 28 VDC

CLASSIFICATION ALGORITHMS: N/A (axle sensor output activation only)

TELEMETRY: N/A

COMPUTER REQUIREMENTS:

DATA OUTPUT: B-420-4-A Dynax[®] Interface Circuit Board outputs sensor activation only.

DATA OUTPUT FORMATS:

SUPPORTING DATA BASE MANAGEMENT SYSTEM: Customers own data base

EQUIPMENT AND INSTALLATION COSTS (One-lane and four-lane): Installation and equipment costs for 1 sensor, 8 ft systems – US \$6,500. For 4 sensors, 10 ft system – US \$8,500.

STATES CURRENTLY USING THIS EQUIPMENT:

Country/State

USA/California

USA/Colorado

USA/Delaware

USA/Florida

USA/Maine

USA/Michigan

USA/New York

USA/New Jersey

USA/Oklahoma

USA/Texas

USA/Virginia

Canada/Nova Scotia

Canada/New Brunswick

Brazil

Columbia

Uruguay

India.

MANUFACTURER AND VENDOR INFORMATION

Effective Date: March 1, 2000

Manufacturer name: _____
Traffic Monitoring Technologies

Sales representative name(s): _____
Donald Dixon

Address: _____
6510 Chantilly Drive, 1st Floor
Sykesville, Maryland 21784-8100

Address: _____
6510 Chantilly Drive, 1st Floor
Sykesville, Maryland 21784-8100

Phone number: (410) 549-8779

Phone number: (410) 549-8779

Fax number: (410) 549-5113

Fax number: (410) 549-5113

e-mail address: tmt@erols.com

e-mail address: tmt@erols.com

URL address: trafficmonitoring.com

URL address: trafficmonitoring.com

PRODUCT NAME/MODEL NUMBER: The Blocker

FIRMWARE VERSION/CHIP NO.:

SOFTWARE VERSION NO.:

GENERAL DESCRIPTION OF EQUIPMENT: A cover and protector for low-profile or mini road tube and the lead-in cable for electronic sensors. It incorporates a tough and durable polymer that is flexible enough to contour the road, yet strong enough to prevent vehicles from compressing it. Used to obtain multi-lane volume/speed/class counts and WIM data from interior lanes.

SENSOR TECHNOLOGY AND CONFIGURATION:

SENSOR INSTALLATION: The Blocker is placed over the road tube leading cable and taped to the road to prevent movement.

INSTALLATION TIME (Per Lane): 2-5 minutes

INSTALLATION REQUIREMENTS: Road tape, dry conditions

MAXIMUM NUMBER OF LANES MONITORED SIMULTANEOUSLY: The Blocker comes in 6 ft lengths, can be placed end-to-end to cover unlimited number of lanes.

PRODUCT CAPABILITIES/FUNCTIONS: Prevents vehicles from predicting in road tube and protects lead-in cables of electronic sensors so counts and WIM data can be collected from interior lanes.

RECOMMENDED APPLICATIONS: Where multiple lanes of data are needed and the road tube or sensor must cross lanes with vehicular traffic. Also used to block out turn lanes for intersection studies.

POWER REQUIREMENTS (watts/amps): None

POWER OPTIONS: None

CLASSIFICATION ALGORITHMS: N/A

TELEMETRY: N/A

COMPUTER REQUIREMENTS: N/A

DATA OUTPUT: N/A

DATA OUTPUT FORMATS: N/A

SUPPORTING DATA BASE MANAGEMENT SYSTEM: N/A

EQUIPMENT AND INSTALLATION COSTS (One-lane and four-lane): \$138 per lane, the Blocker is portable and can be used again and again over several applications

STATES CURRENTLY USING THIS EQUIPMENT:

<u>Country/State</u>	<u>Contact name</u>	<u>Telephone number</u>
USA/PETCORP (Maryland)	John Reed	(410) 381-1995
USA/STS (Florida)	Mark Knowles	(800) 786-3374
USA/The Traffic Group	Anthony Zuckert	(410) 931-6600
USA/Traffic Data Services	Ryan	(800) 837-2562

MANUFACTURER AND VENDOR INFORMATION

Effective Date: 2/22/2000

Manufacturer name: TimeMark Inc. Sales representative name(s): Mike Bonser, Kerry Penn, Tim Miner

Address: P.O. Box 12947 Address: _____
Salem, OR 97309-0947 _____

Phone number: (800) 755-5882 or Phone number: _____
(503) 363-2012

Fax number: (503) 363-1716 Fax number: _____

e-mail address: sales@timemarkinc.com e-mail address: _____

URL address: _____ URL address: _____

PRODUCT NAME/MODEL NUMBER: Delta 111B & Delta 111L

FIRMWARE VERSION/CHIP NO.: 1.02

SOFTWARE VERSION NO.: 3.2.7

GENERAL DESCRIPTION OF EQUIPMENT: 4 tube counter, classifier

SENSOR TECHNOLOGY AND CONFIGURATION: Road tube

SENSOR INSTALLATION: Road tube hardware

INSTALLATION TIME (Per Lane): 5 min.

INSTALLATION REQUIREMENTS:

MAXIMUM NUMBER OF LANES MONITORED SIMULTANEOUSLY: Four

PRODUCT CAPABILITIES/FUNCTIONS: Bi-directional volume, speed, axle classification, gap – all with one setting of counter under 5,000 ADT – volume counts on 4 lanes of traffic simultaneously

RECOMMENDED APPLICATIONS: 2 lane – same way or bi-directional 5,000 A.D.T. and above. 4 lane roadways for volume

POWER REQUIREMENTS (watts/amps):

POWER OPTIONS: 60 day rechargeable gel cell battery

CLASSIFICATION ALGORITHMS:

TELEMETRY: If needed

COMPUTER REQUIREMENTS: 486 or better – Win 95, 98, NT

DATA OUTPUT:

DATA OUTPUT FORMATS: Comma delimited, strecter, TAS plus, GK and others as needed

SUPPORTING DATA BASE MANAGEMENT SYSTEM:

EQUIPMENT AND INSTALLATION COSTS (One-lane and four-lane): \$1,950.00

STATES CURRENTLY USING THIS EQUIPMENT:

Country/State

Contact name

Telephone number

Please contact Timemark Inc. for current list of references.

MANUFACTURER AND VENDOR INFORMATION

Effective Date: 2/22/2000

Manufacturer name: TimeMark Inc. Sales representative name(s): Mike Bonser, Kerry Penn, Tim Miner

Address: P.O. Box 12947 Address: _____
Salem, OR 97309-0947 _____

Phone number: (800) 755-5882 or Phone number: _____
(503) 363-2012 _____

Fax number: (503) 363-1716 Fax number: _____

e-mail address: sales@timemarkinc.com e-mail address: _____

URL address: _____ URL address: _____

PRODUCT NAME/MODEL NUMBER: Gamma

FIRMWARE VERSION/CHIP NO.: 1.02

SOFTWARE VERSION NO.: 3.2.7

GENERAL DESCRIPTION OF EQUIPMENT: Two tube counter/classifier

SENSOR TECHNOLOGY AND CONFIGURATION: Road tube

SENSOR INSTALLATION: Road tube hardware

INSTALLATION TIME (Per Lane): 5 minutes

INSTALLATION REQUIREMENTS:

MAXIMUM NUMBER OF LANES MONITORED SIMULTANEOUSLY: Two

PRODUCT CAPABILITIES/FUNCTIONS: Bi-directional volume, speed, axle classification, gap – all with one setting of counter under 5,000 ADT

RECOMMENDED APPLICATIONS: 2 lane – same way or bi-directional roadways

POWER REQUIREMENTS (watts/amps):

POWER OPTIONS: 90 day rechargeable gel cell battery

CLASSIFICATION ALGORITHMS:

TELEMETRY:

COMPUTER REQUIREMENTS: 486 or better – Win 95, 98, NT

DATA OUTPUT:

DATA OUTPUT FORMATS: Comma delimited, strecter, TAS plus, GK and others as needed

SUPPORTING DATA BASE MANAGEMENT SYSTEM:

EQUIPMENT AND INSTALLATION COSTS (One-lane and four-lane): \$1,650.00

STATES CURRENTLY USING THIS EQUIPMENT:

Country/State

Contact name

Telephone number

Please contact Timemark Inc. for current list of references.

INDUCTIVE LOOP DETECTORS

The inductive loop detector (ILD) is the most common sensor used in traffic management applications. Its size and shape vary, including the 5-ft by 5-ft or 6-ft by 6-ft square loops, 6-ft diameter round loops, and rectangular configurations having a 6-ft width and variable length (Klein, et al., 2006). Figure 4 shows the principal components of an inductive loop detector: one or more turns of insulated wire buried in a shallow sawcut in the roadway, a lead-in cable that runs from a roadside pull box to the controller cabinet, and an electronics unit located in the controller cabinet.

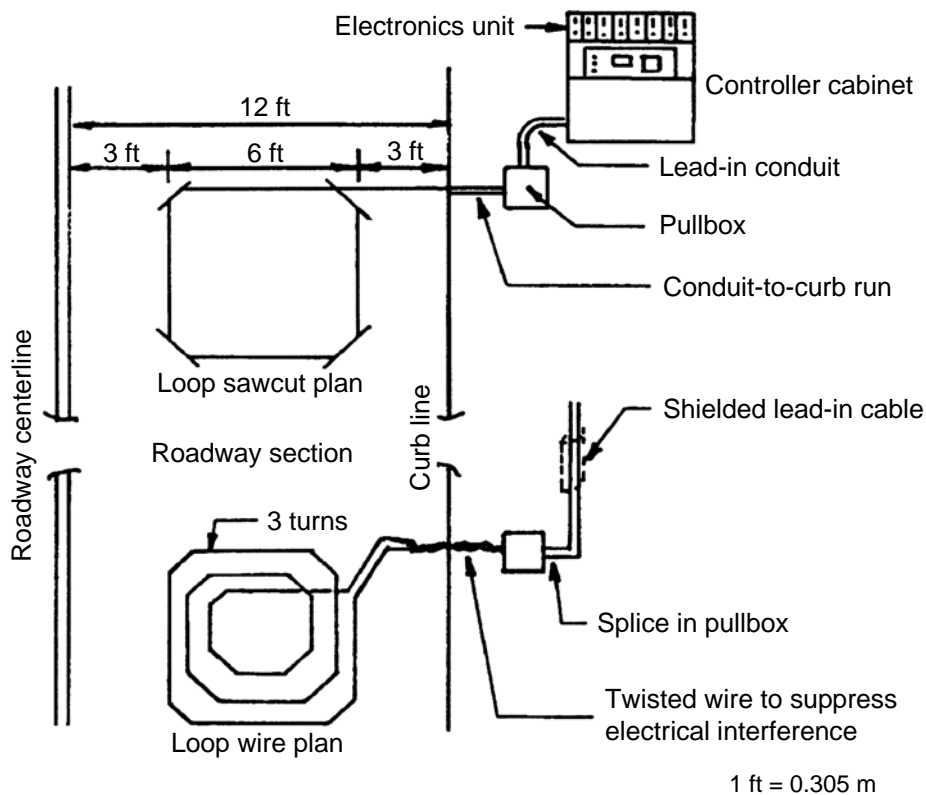

Figure 4. Principal components of an inductive loop detector installation.

Principles of Operation

The wire loop is excited with signals whose frequencies range from 10 KHz to 50 KHz and above. The loop functions as an inductive element in conjunction with the electronics unit.

When a vehicle stops on or passes over the loop, the inductance of the loop is decreased. The decreased inductance increases the oscillation frequency and causes the electronics unit to send a pulse to the controller, indicating the presence or passage of a vehicle.

Applications and Uses

The data supplied by conventional inductive loop detectors are vehicle passage, presence, count, and occupancy. Although loops cannot directly measure speed, speed can be determined using a two-loop speed trap or a single loop detector and an algorithm whose inputs are loop length, average vehicle length, time over the detector, and number of vehicles counted. Vehicle classification is supported by newer versions of the inductive loop containing electronics units that excite the wire loop at the higher frequencies that identify specific metal portions under the vehicle.

Advantages

The operation of inductive loop sensors is well understood and their application for providing basic traffic parameters (volume, presence, occupancy, speed, headway, and gap) represents a mature technology. As was the case with the pneumatic road tube, the equipment cost of inductive loop sensors may be low when compared to over-roadway sensors. Another advantage of inductive loop sensors is their suitability for a large variety of applications due to their flexible design.

Disadvantages

The drawbacks of inductive loop detectors include disruption of traffic for installation and repair, and failures associated with installations in poor road surfaces and use of substandard installation procedures. In addition, resurfacing of roadways and utility repair can also create the need to reinstall these types of sensors. The wire loops are also subject to the stresses of traffic and temperature. Therefore, installation and maintenance costs significantly increase the life-cycle cost of inductive loop detectors. In many instances multiple detectors are required to instrument a location.

MANUFACTURER AND VENDOR INFORMATION

Effective Date: April 10, 2007

Manufacturer name: Never Fail Loop Systems.

Sales representative name(s): Roland Smits

Address: 7911 NE 33rd Drive, Unit 160
Portland, OR 97211

Address: Same

Phone number: (503) 408-9248

Phone number: _____

Fax number: (503) 408-1032

Fax number: _____

e-mail address: sales@neverfail.com

e-mail address: roland@neverfail.com

URL address: www.neverfail.com

URL address: _____

PRODUCT NAME/MODEL NUMBER: Models A (asphalt overlay), C (concrete overlay), F (cut-in application), F-38 (all previous, plus temporary)

FIRMWARE VERSION/CHIP NO.: N/A

SOFTWARE VERSION NO.: N/A

GENERAL DESCRIPTION OF EQUIPMENT: Preformed Traffic Detection Loops

SENSOR TECHNOLOGY AND CONFIGURATION: Inductive Loops

SENSOR INSTALLATION: In-ground

INSTALLATION TIME (Per Lane): New pavement applications 10 minutes, existing pavement approximately 1 hour

INSTALLATION REQUIREMENTS:

MAXIMUM NUMBER OF LANES MONITORED SIMULTANEOUSLY: No maximum

PRODUCT CAPABILITIES/FUNCTIONS: Traffic control, preemption, volume count, speed count, intersection control, traffic jam detection

RECOMMENDED APPLICATIONS: Intersections, freeways

POWER REQUIREMENTS (watts/amps): N/A

POWER OPTIONS: N/A

CLASSIFICATION ALGORITHMS: N/A

TELEMETRY: N/A

COMPUTER REQUIREMENTS: N/A

DATA OUTPUT:

DATA OUTPUT FORMATS:

SUPPORTING DATA BASE MANAGEMENT SYSTEM:

EQUIPMENT AND INSTALLATION COSTS (One-lane and four-lane):

STATES CURRENTLY USING THIS EQUIPMENT:

Country/State

Contact name

Telephone number

Please contact Neverfail Loop Systems for current list of references.

MANUFACTURER AND VENDOR INFORMATION

Effective Date: 4/23/07

Manufacturer name: Peek Traffic Corp.

Sales representative name(s): Joyce Turco

Address: 2511 Corporate Way
Palmetto, Florida 34221

Address: same

Phone number: (941) 845-1200

Phone number: _____

Fax number: (941) 365-0837

Fax number: _____

e-mail address: _____

e-mail address: joyce.turco@quixotecorp.com

URL address: www.peaktrafficinc.com/products

URL address: _____

PRODUCT NAME/MODEL NUMBER: 222GP6

FIRMWARE VERSION/CHIP NO.:

SOFTWARE VERSION NO.:

GENERAL DESCRIPTION OF EQUIPMENT: 2-channel inductive loop detector.

SENSOR TECHNOLOGY AND CONFIGURATION: Monitors the change of inductance produced by a metal vehicle passing over a wire loop

SENSOR INSTALLATION: Plug-in module, plugs into card rack

INSTALLATION TIME (Per Lane): Minimal

INSTALLATION REQUIREMENTS: Must be connected to in-ground inductive loop

MAXIMUM NUMBER OF LANES/LOOPS MONITORED SIMULTANEOUSLY: Two

PRODUCT CAPABILITIES/FUNCTIONS: Monitors wire loop for inductance changes. Outputs on passage of vehicle over buried loop of wire.

RECOMMENDED APPLICATIONS: Both intersection and freeway control with 170 and 2070 controllers. Used in traffic signal systems.

POWER REQUIREMENTS (watts/amps): 10.8 to 28.8 VDC, 80 mA maximum

POWER OPTIONS:

CLASSIFICATION ALGORITHMS:

TELEMETRY:

COMPUTER REQUIREMENTS:

DATA OUTPUT:

DATA OUTPUT FORMATS:

SUPPORTING DATA BASE MANAGEMENT SYSTEM:

EQUIPMENT AND INSTALLATION COSTS (One-lane and four-lane):

STATES CURRENTLY USING THIS EQUIPMENT:

<u>Country/State</u>	<u>Contact name</u>	<u>Telephone number</u>
USA/California	Bob McMillan	(916) 654-4385
USA/New York	Mike Naumiec	(518) 783-7746

MANUFACTURER AND VENDOR INFORMATION

Effective Date: 4/23/07

Manufacturer name: Peek Traffic Corp.

Sales representative name(s): Joyce Turco

Address: 2511 Corporate Way
Palmetto, Florida 34221

Address: same

Phone number: (941) 845-1200

Phone number: _____

Fax number: (941) 365-0837

Fax number: _____

e-mail address: _____

e-mail address: joyce.turco@quixotecorp.com

URL address: www.peektrafficinc.com/products

URL address: _____

PRODUCT NAME/MODEL NUMBER: 222T GP7

FIRMWARE VERSION/CHIP NO.:

SOFTWARE VERSION NO.:

GENERAL DESCRIPTION OF EQUIPMENT: Two-channel inductive loop detector. With extend and delay timers. For TS-1 and TS-2

SENSOR TECHNOLOGY AND CONFIGURATION: Monitors the change of inductance produced by a metal vehicle passing over a wire loop

SENSOR INSTALLATION: Plug-in module, plugs into card rack

INSTALLATION TIME (Per Lane): Minimal

INSTALLATION REQUIREMENTS: Must be connected to in-ground inductive loop

MAXIMUM NUMBER OF LANES/LOOPS MONITORED SIMULTANEOUSLY: Two

PRODUCT CAPABILITIES/FUNCTIONS: Monitors wire loop for inductance changes. Outputs on passage of vehicle over buried loop of wire.

RECOMMENDED APPLICATIONS: Intersection and freeway control. Used in traffic signal systems.

POWER REQUIREMENTS (watts/amps): 10 – 30 VDC

POWER OPTIONS:

CLASSIFICATION ALGORITHMS:

TELEMETRY:

COMPUTER REQUIREMENTS:

DATA OUTPUT:

DATA OUTPUT FORMATS:

SUPPORTING DATA BASE MANAGEMENT SYSTEM:

EQUIPMENT AND INSTALLATION COSTS (One-lane and four-lane):

STATES CURRENTLY USING THIS EQUIPMENT:

Country/State

Contact name

Telephone number

Please contact Peek Traffic for current list of references.

MANUFACTURER AND VENDOR INFORMATION

Effective Date: 4/23/07

Manufacturer name: Peek Traffic Corp.

Sales representative name(s): Joyce Turco

Address: 2511 Corporate Way
Palmetto, Florida 34221

Address: same

Phone number: (941) 845-1200

Phone number: _____

Fax number: (941) 365-0837

Fax number: _____

e-mail address: _____

e-mail address: joyce.turco@quixotecorp.com

URL address: www.peektrafficinc.com/products

URL address: _____

PRODUCT NAME/MODEL NUMBER: 222 GP7

FIRMWARE VERSION/CHIP NO.:

SOFTWARE VERSION NO.:

GENERAL DESCRIPTION OF EQUIPMENT: 2-channel inductive loop detector. For TS-1 and TS-2

SENSOR TECHNOLOGY AND CONFIGURATION: Monitors the change of inductance produced by a metal vehicle passing over a wire loop

SENSOR INSTALLATION: Plug in module, plugs into card rack

INSTALLATION TIME (Per Lane): Minimal

INSTALLATION REQUIREMENTS: Must be connected to in-ground inductive loop

MAXIMUM NUMBER OF LANES/LOOPS MONITORED SIMULTANEOUSLY: Two

PRODUCT CAPABILITIES/FUNCTIONS: Monitors wire loop for inductance changes. Outputs on passage of vehicle over buried loops of wire.

RECOMMENDED APPLICATIONS: Intersection and freeway control. Used in traffic signal systems.

POWER REQUIREMENTS (watts/amps): 10 – 30 VDC

POWER OPTIONS:

CLASSIFICATION ALGORITHMS:

TELEMETRY:

COMPUTER REQUIREMENTS:

DATA OUTPUT:

DATA OUTPUT FORMATS:

SUPPORTING DATA BASE MANAGEMENT SYSTEM:

EQUIPMENT AND INSTALLATION COSTS (One-lane and four-lane):

STATES CURRENTLY USING THIS EQUIPMENT:

Country/State

Contact name

Telephone number

Please contact Peek Traffic for current list of references.

MANUFACTURER AND VENDOR INFORMATION

Effective Date: 4/23/07

Manufacturer name: Peek Traffic Corp.

Sales representative name(s): Joyce Turco

Address: 2511 Corporate Way
Palmetto, Florida 34221

Address: same

Phone number: (941) 845-1200

Phone number: _____

Fax number: (941) 365-0837

Fax number: _____

e-mail address: _____

e-mail address: joyce.turco@quixotecorp.com

URL address: www.peaktrafficinc.com/products

URL address: _____

PRODUCT NAME/MODEL NUMBER: 224 GP5

FIRMWARE VERSION/CHIP NO.:

SOFTWARE VERSION NO.:

GENERAL DESCRIPTION OF EQUIPMENT: 4-channel inductive loop detector.

SENSOR TECHNOLOGY AND CONFIGURATION: Monitors the change of inductance produced by a metal vehicle passing over a wire loop

SENSOR INSTALLATION: Plug in module, plugs into card rack

INSTALLATION TIME (Per Lane): Minimal

INSTALLATION REQUIREMENTS: Must be connected to in-ground inductive loop

MAXIMUM NUMBER OF LANES/LOOPS MONITORED SIMULTANEOUSLY: Four

PRODUCT CAPABILITIES/FUNCTIONS: Monitors wire loop for inductive changes. Outputs on passage of vehicle over buried loop of wire.

RECOMMENDED APPLICATIONS: Intersection and freeway control. Used in traffic signal systems.

POWER REQUIREMENTS (watts/amps): 10.8 to 28.8 VDC, 80 mA maximum

POWER OPTIONS:

CLASSIFICATION ALGORITHMS:

TELEMETRY:

COMPUTER REQUIREMENTS:

DATA OUTPUT:

DATA OUTPUT FORMATS:

SUPPORTING DATA BASE MANAGEMENT SYSTEM:

EQUIPMENT AND INSTALLATION COSTS (One-lane and four-lane):

STATES CURRENTLY USING THIS EQUIPMENT:

<u>Country/State</u>	<u>Contact name</u>	<u>Telephone number</u>
USA/California	Bob McMillan	(916) 654-4385
USA/New York	Mike Naumiec	(518) 783-7746

MANUFACTURER AND VENDOR INFORMATION

Effective Date: 4/23/07

Manufacturer name: Peek Traffic Corp.

Sales representative name(s): Joyce Turco

Address: 2511 Corporate Way
Palmetto, Florida 34221

Address: same

Phone number: (941) 845-1200

Phone number: _____

Fax number: (941) 365-0837

Fax number: _____

e-mail address: _____

e-mail address: joyce.turco@quixotecorp.com

URL address: www.peektrafficinc.com/products

URL address: _____

PRODUCT NAME/MODEL NUMBER: 224 GP7

FIRMWARE VERSION/CHIP NO.:

SOFTWARE VERSION NO.:

GENERAL DESCRIPTION OF EQUIPMENT: 4-channel inductive loop detector. For TS-1 and TS-2

SENSOR TECHNOLOGY AND CONFIGURATION: Monitors the change of inductance produced by a metal vehicle passing over a wire loop

SENSOR INSTALLATION: Plug in module, plugs into card rack

INSTALLATION TIME (Per Lane): Minimal

INSTALLATION REQUIREMENTS: Must be connected to in-ground inductive loop

MAXIMUM NUMBER OF LANES/LOOPS MONITORED SIMULTANEOUSLY: Four

PRODUCT CAPABILITIES/FUNCTIONS: Monitors wire loop for inductance changes. Outputs on passage of vehicle over buried loops of wire.

RECOMMENDED APPLICATIONS: Intersection and freeway control. Used in traffic signal systems.

POWER REQUIREMENTS (watts/amps): 10 to 30 VDC

POWER OPTIONS:

CLASSIFICATION ALGORITHMS:

TELEMETRY:

COMPUTER REQUIREMENTS:

DATA OUTPUT:

DATA OUTPUT FORMATS:

SUPPORTING DATA BASE MANAGEMENT SYSTEM:

EQUIPMENT AND INSTALLATION COSTS (One-lane and four-lane):

STATES CURRENTLY USING THIS EQUIPMENT:

Country/State

Contact name

Telephone number

Please contact Peek Traffic for current list of references.

MANUFACTURER AND VENDOR INFORMATION

Effective Date: 4/23/07

Manufacturer name: Peek Traffic Corp.

Sales representative name(s): Joyce Turco

Address: 2511 Corporate Way
Palmetto, Florida 34221

Address: same

Phone number: (941) 845-1200

Phone number: _____

Fax number: (941) 365-0837

Fax number: _____

e-mail address: _____

e-mail address: joyce.turco@quixotecorp.com

URL address: www.peektrafficinc.com/products

URL address: _____

PRODUCT NAME/MODEL NUMBER: 224T GP7

FIRMWARE VERSION/CHIP NO.:

SOFTWARE VERSION NO.:

GENERAL DESCRIPTION OF EQUIPMENT: 4-channel inductive loop detector. With extend and delay timers. For TS-1 and TS-2

SENSOR TECHNOLOGY AND CONFIGURATION: Monitors the change of inductance and frequency

SENSOR INSTALLATION: Plug-in module, plugs into card rack

INSTALLATION TIME (Per Lane): Minimal

INSTALLATION REQUIREMENTS: Must be connected to in-ground inductive loop

MAXIMUM NUMBER OF LANES/LOOPS MONITORED SIMULTANEOUSLY: Four

PRODUCT CAPABILITIES/FUNCTIONS: Monitors wire loop for inductance changes. Outputs on passage of vehicle over buried loop of wire.

RECOMMENDED APPLICATIONS: Intersection and freeway control. Used in traffic signal systems.

POWER REQUIREMENTS (watts/amps): 10 – 30 VDC

POWER OPTIONS:

CLASSIFICATION ALGORITHMS:

TELEMETRY:

COMPUTER REQUIREMENTS:

DATA OUTPUT:

DATA OUTPUT FORMATS:

SUPPORTING DATA BASE MANAGEMENT SYSTEM:

EQUIPMENT AND INSTALLATION COSTS (One-lane and four-lane):

STATES CURRENTLY USING THIS EQUIPMENT:

Country/State

Contact name

Telephone number

Please contact Peek Traffic for current list of references.

MANUFACTURER AND VENDOR INFORMATION

Effective Date: 4/23/07

Manufacturer name: Peek Traffic Corp.

Sales representative name(s): _____

Joyce Turco

Address: 2511 Corporate Way
Palmetto, Florida 34221

Address: same

Phone number: (941) 845-1200

Phone number: _____

Fax number: (941) 365-0837

Fax number: _____

e-mail address: _____

e-mail address: joyce.turco@quixotecorp.com

URL address: www.peaktrafficinc.com/products

URL address: _____

PRODUCT NAME/MODEL NUMBER: 535B/MS GP7

FIRMWARE VERSION/CHIP NO.:

SOFTWARE VERSION NO.:

GENERAL DESCRIPTION OF EQUIPMENT:

1 channel inductive loop detector.

SENSOR TECHNOLOGY AND CONFIGURATION: Monitors the change of inductance produced by a metal vehicle passing over a wire loop

SENSOR INSTALLATION: Shelf mount

INSTALLATION TIME (Per Lane): Minimal

INSTALLATION REQUIREMENTS: Must be connected to in-ground inductive loop

MAXIMUM NUMBER OF LANES/LOOPS MONITORED SIMULTANEOUSLY: One

PRODUCT CAPABILITIES/FUNCTIONS: Monitors wire loop for inductive changes. Outputs on passage of vehicle over buried loop of wire.

RECOMMENDED APPLICATIONS: Intersection and freeway control. Used in traffic signal systems.

POWER REQUIREMENTS (watts/amps): 110 VAC

POWER OPTIONS:

CLASSIFICATION ALGORITHMS:

TELEMETRY:

COMPUTER REQUIREMENTS:

DATA OUTPUT:

DATA OUTPUT FORMATS:

SUPPORTING DATA BASE MANAGEMENT SYSTEM:

EQUIPMENT AND INSTALLATION COSTS (One-lane and four-lane):

STATES CURRENTLY USING THIS EQUIPMENT:

Country/State

Contact name

Telephone number

Please contact Peek Traffic for current list of references.

MANUFACTURER AND VENDOR INFORMATION

Effective Date: 4/23/07

Manufacturer name: Peek Traffic Corp.

Sales representative name(s): Joyce Turco

Address: 2511 Corporate Way
Palmetto, Florida 34221

Address: same

Phone number: (941) 845-1200

Phone number: _____

Fax number: (941) 365-0837

Fax number: _____

e-mail address: _____

e-mail address: joyce.turco@quixotecorp.com

URL address: www.peektrafficinc.com/products

URL address: _____

PRODUCT NAME/MODEL NUMBER: 535T/MS GP7

FIRMWARE VERSION/CHIP NO.:

SOFTWARE VERSION NO.:

GENERAL DESCRIPTION OF EQUIPMENT: Single-channel inductive loop detector with extend and delay timing.

SENSOR TECHNOLOGY AND CONFIGURATION: Monitors the change of inductance produced by a metal vehicle passing over a wire loop

SENSOR INSTALLATION: Shelf mount

INSTALLATION TIME (Per Lane): Minimal

INSTALLATION REQUIREMENTS: Must be connected to in-ground inductive loop

MAXIMUM NUMBER OF LANES/LOOPS MONITORED SIMULTANEOUSLY: One

PRODUCT CAPABILITIES/FUNCTIONS: Monitors wire loop for inductive changes. Outputs on passage of vehicle over buried loop of wire.

RECOMMENDED APPLICATIONS: Intersection and freeway control

POWER REQUIREMENTS (watts/amps): 110 VAC

POWER OPTIONS:

CLASSIFICATION ALGORITHMS:

TELEMETRY:

COMPUTER REQUIREMENTS:

DATA OUTPUT:

DATA OUTPUT FORMATS:

SUPPORTING DATA BASE MANAGEMENT SYSTEM:

EQUIPMENT AND INSTALLATION COSTS (One-lane and four-lane):

STATES CURRENTLY USING THIS EQUIPMENT:

Country/State

Contact name

Telephone number

Please contact Peek Traffic for current list of references.

MANUFACTURER AND VENDOR INFORMATION

Effective Date: 4/23/07

Manufacturer name: Peek Traffic Corp.

Sales representative name(s): Joyce Turco

Address: 2511 Corporate Way
Palmetto, Florida 34221

Address: same

Phone number: (941) 845-1200

Phone number: _____

Fax number: (941) 365-0837

Fax number: _____

e-mail address: _____

e-mail address: joyce.turco@quixotecorp.com

URL address: www.peektrafficinc.com/products

URL address: _____

PRODUCT NAME/MODEL NUMBER: 536B/MS GP7

FIRMWARE VERSION/CHIP NO.:

SOFTWARE VERSION NO.:

GENERAL DESCRIPTION OF EQUIPMENT: 2-channel inductive loop detector.

SENSOR TECHNOLOGY AND CONFIGURATION: Monitors the change of inductance produced by a metal vehicle passing over a wire loop

SENSOR INSTALLATION: Shelf mount

INSTALLATION TIME (Per Lane): Minimal

INSTALLATION REQUIREMENTS: Must be connected to in-ground inductive loop

MAXIMUM NUMBER OF LANES/LOOPS MONITORED SIMULTANEOUSLY: 2

PRODUCT CAPABILITIES/FUNCTIONS: Monitors wire loop for inductive changes. Outputs on passage of vehicle over buried loop of wire.

RECOMMENDED APPLICATIONS: Intersection and freeway control. Used in traffic signal systems.

POWER REQUIREMENTS (watts/amps): 110 VAC

POWER OPTIONS:

CLASSIFICATION ALGORITHMS:

TELEMETRY:

COMPUTER REQUIREMENTS:

DATA OUTPUT:

DATA OUTPUT FORMATS:

SUPPORTING DATA BASE MANAGEMENT SYSTEM:

EQUIPMENT AND INSTALLATION COSTS (One-lane and four-lane):

STATES CURRENTLY USING THIS EQUIPMENT:

Country/State

Contact name

Telephone number

Please contact Peek Traffic for current list of references.

MANUFACTURER AND VENDOR INFORMATION

Effective Date: 4/23/07

Manufacturer name: Peek Traffic Corp.

Sales representative name(s): Joyce Turco

Address: 2511 Corporate Way
Palmetto, Florida 34221

Address: same

Phone number: (941) 845-1200

Phone number: _____

Fax number: (941) 365-0837

Fax number: _____

e-mail address: _____

e-mail address: joyce.turco@quixotecorp.com

URL address: www.peektrafficinc.com/products

URL address: _____

PRODUCT NAME/MODEL NUMBER: 537B/MS GP7

FIRMWARE VERSION/CHIP NO.:

SOFTWARE VERSION NO.:

GENERAL DESCRIPTION OF EQUIPMENT: 4-channel inductive loop detector with loop diagnostics

SENSOR TECHNOLOGY AND CONFIGURATION: Monitors the change of inductance produced by a metal vehicle passing over a wire loop

SENSOR INSTALLATION: Shelf mount

INSTALLATION TIME (Per Lane): Minimal

INSTALLATION REQUIREMENTS: Must be connected to in-ground inductive loop

MAXIMUM NUMBER OF LANES/LOOPS MONITORED SIMULTANEOUSLY: Four

PRODUCT CAPABILITIES/FUNCTIONS: Monitors wire loop for inductive changes. Outputs on passage of vehicle over buried loop of wire.

RECOMMENDED APPLICATIONS: Intersection and freeway control. Used in traffic signal systems.

POWER REQUIREMENTS (watts/amps): 110 VAC

POWER OPTIONS:

CLASSIFICATION ALGORITHMS:

TELEMETRY:

COMPUTER REQUIREMENTS:

DATA OUTPUT:

DATA OUTPUT FORMATS:

SUPPORTING DATA BASE MANAGEMENT SYSTEM:

EQUIPMENT AND INSTALLATION COSTS (One-lane and four-lane):

STATES CURRENTLY USING THIS EQUIPMENT:

<u>Country/State</u>	<u>Contact name</u>	<u>Telephone number</u>
USA/Florida		
USA/Illinois		
USA/Wisconsin		
Canada/Ontario		

MANUFACTURER AND VENDOR INFORMATION

Effective Date: 4/23/07

Manufacturer name: Peek Traffic Corp.

Sales representative name(s): Joyce Turco

Address: 2511 Corporate Way
Palmetto, Florida 34221

Address: same

Phone number: (941) 845-1200

Phone number: _____

Fax number: (941) 365-0837

Fax number: _____

e-mail address: _____

e-mail address: joyce.turco@quixotecorp.com

URL address: www.peektrafficinc.com/products

URL address: _____

PRODUCT NAME/MODEL NUMBER: 537T/MS GP7

FIRMWARE VERSION/CHIP NO.:

SOFTWARE VERSION NO.:

GENERAL DESCRIPTION OF EQUIPMENT: 4-channel inductive loop detector. With extend and delay timers.

SENSOR TECHNOLOGY AND CONFIGURATION: Monitors the change of inductance produced by a metal vehicle passing over a wire loop

SENSOR INSTALLATION: Shelf mount

INSTALLATION TIME (Per Lane): Minimal

INSTALLATION REQUIREMENTS: Must be connected to in-ground inductive loop

MAXIMUM NUMBER OF LANES/LOOPS MONITORED SIMULTANEOUSLY: Four

PRODUCT CAPABILITIES/FUNCTIONS: Monitors wire loop for inductive changes. Outputs on passage of vehicle over buried loop of wire.

RECOMMENDED APPLICATIONS: Intersection and freeway control

POWER REQUIREMENTS (watts/amps): 110VAC

POWER OPTIONS:

CLASSIFICATION ALGORITHMS:

TELEMETRY:

COMPUTER REQUIREMENTS:

DATA OUTPUT:

DATA OUTPUT FORMATS:

SUPPORTING DATA BASE MANAGEMENT SYSTEM:

EQUIPMENT AND INSTALLATION COSTS (One-lane and four-lane):

STATES CURRENTLY USING THIS EQUIPMENT:

Country/State

Contact name

Telephone number

Please contact Peek Traffic for current list of references.

MANUFACTURER AND VENDOR INFORMATION

Effective Date: 4/10/07

Manufacturer name: _____
Truvelo Manufacturers (Pty) Ltd.

Sales representative name(s): _____
James E. Kelly
AVIAR Inc.

Address: P.O. Box 14183
Lyttelton 0140
South Africa

Address: P.O. Box 162184
Austin, TX 78716

Phone number: 011-27-11-314-1405

Phone number: (512) 295-5285

Fax number: 011-27-11-314-1409

Fax number: (512) 295-2603

e-mail address: rudi@truvelo.co.za

e-mail address: jkelly24@peoplepc.com

URL address: www.truvelo.co.za

URL address: www.aviarinc.com

PRODUCT NAME/MODEL NUMBER: Traffic Classifier/Data Logger (TCL-300)

FIRMWARE VERSION/CHIP NO.: N/A

SOFTWARE VERSION NO.: N/A

GENERAL DESCRIPTION OF EQUIPMENT: TCL-300 stores and analyzes data (outputs 9 vehicle classes) using two inductive loops per lane on up to four lanes

SENSOR TECHNOLOGY AND CONFIGURATION: 2 inductive loops/lane; up to 4 lanes monitored.

SENSOR INSTALLATION: Temporary installation on surface of pavement or permanent installation in pavement surface

INSTALLATION TIME (Per Lane): Temp: 15 min
Perm: 2 hr/lane

INSTALLATION REQUIREMENTS: N/A

MAXIMUM NUMBER OF LANES MONITORED SIMULTANEOUSLY: 4 lanes

PRODUCT CAPABILITIES/FUNCTIONS: Vehicle number, date, time, direction, vehicle class using specially developed vehicle pattern recognition algorithms, vehicle length, headway, data for 20,000 individual vehicles can be stored in 256 kB of memory. Vehicle data are

classified and placed into bins within the instrument according to a user-specified recording interval; 8,000 summarized data records can be stored in this mode.

RECOMMENDED APPLICATIONS: Vehicle classification, vehicle following distances, queuing, and lane occupancy.

POWER REQUIREMENTS (watts/amps): 6 volt internal battery (rechargeable from 12 volt battery, commercial power, or solar energy)

POWER OPTIONS: See above

CLASSIFICATION ALGORITHMS: Vehicle pattern recognition applied to light, medium, heavy or light, rigid trucks and buses, trucks and trailers, tractor and semi-trailer, multi-trailer heavy vehicles

TELEMETRY: RS232 serial port and modem

COMPUTER REQUIREMENTS: Compatible PC

DATA OUTPUT: See Product Capabilities

DATA OUTPUT FORMATS: N/A

SUPPORTING DATA BASE MANAGEMENT SYSTEM: N/A

EQUIPMENT AND INSTALLATION COSTS (One-lane and four-lane):

	Temporary		Permanent	
	1 lane	4 lane	1 lane	4 lane
Equipment	\$4,000	\$4,000	\$4,700	\$4,700
Installation costs	\$500	\$1,500	\$1,000	\$2,500

STATES CURRENTLY USING THIS EQUIPMENT:

<u>Country/State</u>	<u>Contact name</u>	<u>Telephone number</u>
USA/Michigan	Jim Kramer	(517) 322-1736

MANUFACTURER AND VENDOR INFORMATION

Effective Date: 4/10/07

Manufacturer name: _____ <u>Truvelo Manufacturers (Pty) Ltd.</u>	Sales representative name(s): _____ <u>James E. Kelly</u> <u>AVIAR Inc.</u>
Address: <u>P.O. Box 14183</u> <u>Lyttelton 0140</u> <u>South Africa</u>	Address: <u>P.O. Box 162184</u> <u>Austin, TX 78716</u>
Phone number: <u>011-27-11-314-1405</u>	Phone number: <u>(512) 295-5285</u>
Fax number: <u>011-27-11-314-1409</u>	Fax number: <u>(512) 295-2603</u>
e-mail address: <u>rudi@truvelo.co.za</u>	e-mail address: <u>jkelly24@peoplepc.com</u>
URL address: <u>www.truvelo.co.za</u>	URL address: <u>www.aviarinc.com</u>

PRODUCT NAME/MODEL NUMBER: Traffic Data Logger (TDL-500)

FIRMWARE VERSION/CHIP NO.: N/A

SOFTWARE VERSION NO.: N/A

GENERAL DESCRIPTION OF EQUIPMENT: TDL-500 is used with inductive loops and capacitive weight sensors to provide high speed Weigh-In-Motion (WIM) data.

SENSOR TECHNOLOGY AND CONFIGURATION: 2 inductive loops and 1 capacitive weight sensor per lane; up to 4 lanes monitored.

SENSOR INSTALLATION: In the portable set-up, stick-on inductive loops and the Series 8 capacitive weight sensor are placed on top of the road pavement. This method allows for a cost-effective solution to monitor axle loading on all paved roads not covered by permanent sites. Typically data for one week are collected and processed. In this way many different sites can be monitored. TRUVELO also offers the Series 9 capacitive weight sensors placed in stainless steel pans, flush mounted with the pavement, to monitor axle loading on permanent sites. The Series 9 weight sensor can be replaced by a "Dummy" and moved to another site.

INSTALLATION TIME (Per Lane): Temp: 15 min
Perm: 2 hr/lane

INSTALLATION REQUIREMENTS: N/A

MAXIMUM NUMBER OF LANES MONITORED SIMULTANEOUSLY: 4 lanes

PRODUCT CAPABILITIES/FUNCTIONS: The road sensors consist of two inductive loops and one capacitive weight sensor per lane to cover a maximum of four traffic lanes. The TDL-500 combines the sensor information into a default data string consisting of vehicle number, arrival date and time, gap time, lane number, travel direction, vehicle straddling present, trailer present, vehicle chassis height, vehicle speed, vehicle length, vehicle class, number of axles, axle weight, axle distance, equivalent standard axle load, weight violations and bridge overloading. Data are stored into battery backed-up RAM of 512 kB to 8MB, space for 34000 to 650000 individual vehicle data strings. The operator can decide which data are to be stored, in what sequence and use logical AND/OR combinations of above parameters, e.g., all class 9 vehicles exceeding a certain speed AND a certain weight AND a certain length will be stored in individual data format, directly printed or sent to the computer. Certain operator selected data can be grouped per time interval into bins to maximize available memory space. The standard vehicle classification format is the American FHWA, but like all other parameters, is operator programmable. AND/OR combinations of number of axles, axle weight, axle distance, wheel base, gross vehicle mass, vehicle length, chassis height and trailer presence can be used to create virtually any classification scheme.

RECOMMENDED APPLICATIONS: Vehicle classification.

POWER REQUIREMENTS (watts/amps): 6 volt internal battery (rechargeable from 12 volt battery, commercial power, or solar energy)

POWER OPTIONS: See above

CLASSIFICATION ALGORITHMS: Vehicle pattern recognition used to provide outputs according to American FHWA classification scheme.

TELEMETRY: RS232 serial port and modem

COMPUTER REQUIREMENTS: Compatible PC

DATA OUTPUT: See Product Capabilities

DATA OUTPUT FORMATS: N/A

SUPPORTING DATA BASE MANAGEMENT SYSTEM: N/A

EQUIPMENT AND INSTALLATION COSTS (One-lane and four-lane):

STATES CURRENTLY USING THIS EQUIPMENT:

<u>Country/State</u>	<u>Contact name</u>	<u>Telephone number</u>
----------------------	---------------------	-------------------------

MANUFACTURER AND VENDOR INFORMATION

Effective Date: 4/23/07

Manufacturer name: 3M
Intelligent Transportation Systems

Sales representative name(s): _____
Mike Lemon

Address: 3M Center, Bldg 225-4N-14
St. Paul, MN 55144-1000

Address: 3M ITS
same

Phone number: _____

Phone number: (480) 221-5716 (cell)

Fax number: _____

Fax number: _____

e-mail address: _____

e-mail address: mjlemon@mmm.com

URL address: www.mmm.com/ITS

URL address: _____

PRODUCT NAME/MODEL NUMBER: Canoga C900 Series Digital Vehicle Detectors

FIRMWARE VERSION/CHIP NO.: Various

SOFTWARE VERSION NO.: Various

GENERAL DESCRIPTION OF EQUIPMENT: Two-channel (Model C922) and four-channel (Model C924) digital vehicle detectors with delay and extension timing, vehicle counting, vehicle presence, and roadway occupancy functions

SENSOR TECHNOLOGY AND CONFIGURATION: Supports operation of conventional wire loops and 3M Canoga microloops and non-invasive microloops

SENSOR INSTALLATION: Designed for use in roadside control cabinet

INSTALLATION TIME (Per Lane): N/A

INSTALLATION REQUIREMENTS: No special requirements

MAXIMUM NUMBER OF LANES MONITORED SIMULTANEOUSLY: 4

PRODUCT CAPABILITIES/FUNCTIONS: The C900 series detectors are configured using C900 Configuration Software (C900-CS), which supports making changes to the detector's configuration, viewing binning data, monitoring traffic in real-time (including speed and length),

and viewing detector status. C900 series vehicle detectors allow remote access through serial ports on the front of the detector and back panel connector.

RECOMMENDED APPLICATIONS: All presence and passage applications

POWER REQUIREMENTS (watts/amps): 10.8 VDC to 37.8 VDC, 1.3 watts typical

POWER OPTIONS: N/A

CLASSIFICATION ALGORITHMS: Provides data for length and speed binning algorithms

TELEMETRY: RS 232 and RS 485 ports available

COMPUTER REQUIREMENTS: OS req: Windows 95/98 or NT 4.0

DATA OUTPUT: N/A

DATA OUTPUT FORMATS: N/A

SUPPORTING DATA BASE MANAGEMENT SYSTEM: N/A

EQUIPMENT AND INSTALLATION COSTS: Various

STATES CURRENTLY USING THIS EQUIPMENT:

<u>Country/State</u>	<u>Contact name</u>	<u>Telephone number</u>
----------------------	---------------------	-------------------------

Please contact 3M for current list of references.

MANUFACTURER AND VENDOR INFORMATION

Effective Date: 4/23/07

Manufacturer name: Reno A&E

Sales representative name(s): _____

Address: 4655 Aircenter Circle
Reno, Nevada 89502

Address: _____

Phone number: (775) 826-2020

Phone number: _____

Fax number: (775) 826-9191

Fax number: _____

e-mail address: sales@renoae.com

e-mail address: _____

URL address: www.renoae.com

URL address: _____

PRODUCT NAME/MODEL NUMBER: Model T-110, T-210, and T-400 series detectors

FIRMWARE VERSION/CHIP NO.: N/A

SOFTWARE VERSION NO.: N/A

GENERAL DESCRIPTION OF EQUIPMENT: The T-110 series detectors are single-channel, shelf mount, DIP switch programmable detectors with Call delay and Call extension. The T-210 series detectors are two-channel, shelf mount, DIP switch programmable detectors with Call delay and Call extension. The T-400 series detectors are four-channel, shelf mount, DIP switch programmable detectors. All three are available with both relay and solid state outputs. They offer advanced single channel detection capabilities in compact, affordable packages. Compliant or exceed NEMA TS-1 standards.

SENSOR TECHNOLOGY AND CONFIGURATION: Monitors the change of inductance produced by a metal vehicle passing over a wire loop.

SENSOR INSTALLATION: Shelf mount

INSTALLATION TIME (Per Lane): Minimal

INSTALLATION REQUIREMENTS: Used with inductive wire loops

MAXIMUM NUMBER OF LANES/LOOPS MONITORED SIMULTANEOUSLY: 1, 2, or 4

PRODUCT CAPABILITIES/FUNCTIONS: Provides output corresponding to passage or presence of vehicle over buried loops of wire. Six front panel DIP switches provide: seven levels of sensitivity plus off, presence or pulse mode operation, four loop frequencies, loop Fail Event Monitor that remembers and indicates intermittent and current loop failures. Detector is self tuning and provides complete environmental tracking. Contains dual color, high intensity LED: green indicates detect, red indicates loop fail. Complete built-in detector integrity test. Audible detect signal (buzzer) facilitates loop and/or detector troubleshooting. Call Delay and Call Extension timing. Two-channel and four-channel models sequentially scan loops to eliminate crosstalk.

RECOMMENDED APPLICATIONS: Intersection and freeway control. Used in traffic signal systems.

POWER REQUIREMENTS (watts/amps): 89 to 135 VAC, 50/60 Hz, 6 Watts max.

POWER OPTIONS: None

CLASSIFICATION ALGORITHMS: N/A

TELEMETRY:

COMPUTER REQUIREMENTS:

DATA OUTPUT:

DATA OUTPUT FORMATS:

SUPPORTING DATA BASE MANAGEMENT SYSTEM:

EQUIPMENT AND INSTALLATION COSTS (One-lane and four-lane): T110: \$107, T210: \$187, T400:\$227.

STATES CURRENTLY USING THIS EQUIPMENT:

Country/State

Contact name

Telephone number

Please contact Reno A&E for current list of references.

MANUFACTURER AND VENDOR INFORMATION

Effective Date: 4/23/07

Manufacturer name: Reno A&E

Sales representative name(s): _____

Address: 4655 Aircenter Circle
Reno, Nevada 89502

Address: _____

Phone number: (775) 826-2020

Phone number: _____

Fax number: (775) 826-9191

Fax number: _____

e-mail address: sales@renoae.com

e-mail address: _____

URL address: www.renoae.com

URL address: _____

PRODUCT NAME/MODEL NUMBER: Model Y-200-SS four-channel, 2.00-inch wide (double width) detector with Solid State outputs. Model Y/2-200-SS four-channel, 1.12-inch wide (single width) detector with solid state outputs.

FIRMWARE VERSION/CHIP NO.: N/A

SOFTWARE VERSION NO.: N/A

GENERAL DESCRIPTION OF EQUIPMENT: The Model Y detectors meet or exceed NEMA Standards TS 2-1998 for Type B detectors and are downward compatible to NEMA Standards TS 1-1989. The Model Y Detector is a four-channel, card-rack type loop detector with individual channel detect and loop fail indications provided via a dual color, high intensity LED.

SENSOR TECHNOLOGY AND CONFIGURATION: The detector automatically self tunes and is operational within two seconds after application of power or after being reset. Full sensitivity and hold time requires 30 seconds of operation. Loop inductance tuning range: 20 to 2000 microHenries with a Q factor of 5 or greater.

SENSOR INSTALLATION: Rack mount

INSTALLATION TIME (Per Lane): Minimal

INSTALLATION REQUIREMENTS: NEMA TS 2 electronics rack; used with inductive wire loops.

MAXIMUM NUMBER OF LANES/LOOPS MONITORED SIMULTANEOUSLY: 4

PRODUCT CAPABILITIES/FUNCTIONS: Meets and exceeds NEMA TS 2 specification. Six front panel DIP switches for each channel provide: seven levels of sensitivity plus off, presence or pulse mode operation, four loop frequencies. Loops are sequentially scanned to eliminate crosstalk. Channel status outputs provide individual channel status states per NEMA TS 2. Loop Fail Event Monitor remembers and indicates intermittent and current loop failures. Detector is self tuning and provides complete environmental tracking. Contains dual color, high intensity LED: green indicates detect, red indicates loop fail. Complete built-in detector integrity test. Audible detect signal (buzzer) facilitates loop and/or detector troubleshooting.

RECOMMENDED APPLICATIONS: Intersection and freeway control. Used in traffic signal systems.

POWER REQUIREMENTS (watts/amps): 10.8 to 30 VDC, Solid State output, 100 mA max, Relay output, 130 mA max.

POWER OPTIONS: None

CLASSIFICATION ALGORITHMS: N/A

TELEMETRY:

COMPUTER REQUIREMENTS:

DATA OUTPUT:

DATA OUTPUT FORMATS:

SUPPORTING DATA BASE MANAGEMENT SYSTEM:

EQUIPMENT AND INSTALLATION COSTS (One-lane and four-lane): Detector card: \$160.

STATES CURRENTLY USING THIS EQUIPMENT:

Country/State

Contact name

Telephone number

Please contact Reno A&E for current list of references.

MANUFACTURER AND VENDOR INFORMATION

Effective Date: 4/23/07

Manufacturer name: Reno A&E

Sales representative name(s): _____

Address: 4655 Aircenter Circle
Reno, Nevada 89502

Address: _____

Phone number: (775) 826-2020

Phone number: _____

Fax number: (775) 826-9191

Fax number: _____

e-mail address: sales@renoae.com

e-mail address: _____

URL address: www.renoae.com

URL address: _____

PRODUCT NAME/MODEL NUMBER: Model 222S-R two-channel detector with relay outputs. Model 222S-SS two-channel detector with solid state outputs.

FIRMWARE VERSION/CHIP NO.: N/A

SOFTWARE VERSION NO.: N/A

GENERAL DESCRIPTION OF EQUIPMENT: The Model 222S is a two channel, card rack type loop detector. It is designed for use in installations requiring a Type 332/170 detector. The Model 222S incorporates a three position Call / Test switch for each channel, which can be used to simulate a continuous or momentary CALL output. This feature is useful when troubleshooting problems related to detector outputs or controller inputs.

SENSOR TECHNOLOGY AND CONFIGURATION: The detector automatically self tunes and is operational within two seconds after application of power or after being reset. Full sensitivity and hold time requires 30 seconds of operation. Loop inductance tuning range: 20 to 2000 microHenries with a Q factor of 5 or greater.

SENSOR INSTALLATION: Plugs into Type 332/170 electronics rack

INSTALLATION TIME (Per Lane): Minimal

INSTALLATION REQUIREMENTS: Type 332/170 electronics rack; used with inductive wire loops.

MAXIMUM NUMBER OF LANES/LOOPS MONITORED SIMULTANEOUSLY: 2

PRODUCT CAPABILITIES/FUNCTIONS: Provides output corresponding to passage or presence of vehicle over buried loops of wire. Eight front panel DIP switches for each channel provide: eight levels of sensitivity, presence or pulse mode operation, four loop frequencies, fail-safe or fail-secure operation, and channel disable. Front panel mounted Call/Test switch can be used to simulate CALL output. Loops are sequentially scanned to eliminate crosstalk. Loop Fail Event Monitor remembers and indicates intermittent and current loop failures. Detector is self tuning and provides complete environmental tracking. Dual color (Red/Green), high intensity LEDs provide "Detect" and "Loop Fail" indications. Complete built-in detector integrity test. Audible detect signal (buzzer) facilitates loop and detector troubleshooting.

RECOMMENDED APPLICATIONS: Intersection and freeway control. Used in traffic signal systems.

POWER REQUIREMENTS (watts/amps): 10.8 to 30 VDC, Solid State output, 100 mA max, Relay output, 130 mA max.

POWER OPTIONS: None

CLASSIFICATION ALGORITHMS: N/A

TELEMETRY:

COMPUTER REQUIREMENTS:

DATA OUTPUT:

DATA OUTPUT FORMATS:

SUPPORTING DATA BASE MANAGEMENT SYSTEM:

EQUIPMENT AND INSTALLATION COSTS (One-lane and four-lane): Detector card: \$111.

STATES CURRENTLY USING THIS EQUIPMENT:

Country/State

Contact name

Telephone number

Please contact Reno A&E for current list of references.

MANUFACTURER AND VENDOR INFORMATION

Effective Date: June 15, 2007

Manufacturer name: Eberle Design Inc.

Sales representative name(s): Carl Zabel

Address: 3819 East La Salle Street
Phoenix, AZ 85040

Address: _____

Phone number: (480) 968-6407

Phone number: (480) 968-6407

Fax number: (602) 437-1998

Fax number: _____

e-mail address: info@editraffic.com

e-mail address: czabel@editraffic.com

URL address: www.editraffic.com

URL address: _____

PRODUCT NAME/MODEL NUMBER: LMD622 two channel NEMA TS-2 Type A loop monitor; LMD604T four channel TS-1 rack mount detector with DEFLECTOMETER™, four loop frequencies, three modes of operation, delay and extension timing; LMD222 170/2070 two channel rack mount detector with DEFLECTOMETER™, four loop frequencies, three modes of operation – Caltrans Model 222 performance with push-button DEFLECTOMETER™ user interface, relay outputs are an option. Other models and capabilities available for TS-1, TS-2, and 170/2070 applications.

FIRMWARE VERSION/CHIP NO.:

SOFTWARE VERSION NO.:

GENERAL DESCRIPTION OF EQUIPMENT:

SENSOR TECHNOLOGY AND CONFIGURATION: These units contain a DEFLECTOMETER™ call strength indicator that shows the relative strength of the call while a vehicle is in the detection zone. This provides feedback that the unit is optimally tuned to detect vehicles of all sizes and provides the technician with a one-step method for accurately setting the optimum level of sensitivity to ensure accurate vehicle detection of all vehicles, including motorcycles and high-bed trucks.

SENSOR INSTALLATION: The models either plug into racks or sit on shelves in the controller cabinet.

INSTALLATION TIME (Per Lane): Minimal

INSTALLATION REQUIREMENTS: Appropriate electronics rack or shelf.

MAXIMUM NUMBER OF LANES/LOOPS MONITORED SIMULTANEOUSLY:

Depends on model. Models available to support two channels and four channels.

PRODUCT CAPABILITIES/FUNCTIONS: Automatic tuning, lightning and surge protection, four or eight frequencies depending on model, fail safe output configuration, separate color-coded led indicators, wide loop inductance range: 20 to 2500 microHenries, relay or solid-state outputs available; 9, 15, or 20 sensitivity levels depending on model.

RECOMMENDED APPLICATIONS: Intersection and freeway control. Used in traffic signal systems.

POWER REQUIREMENTS (watts/amps): 10.8 VDC minimum to 28.8 VDC maximum, 100 mA maximum.

POWER OPTIONS: None

CLASSIFICATION ALGORITHMS: N/A

TELEMETRY:

COMPUTER REQUIREMENTS:

DATA OUTPUT:

DATA OUTPUT FORMATS:

SUPPORTING DATA BASE MANAGEMENT SYSTEM:

EQUIPMENT AND INSTALLATION COSTS (One-lane and four-lane):

STATES CURRENTLY USING THIS EQUIPMENT:

Country/State

Contact name

Telephone number

Please contact Eberle Design for current list of references.

MAGNETIC SENSORS

Principles of Operation

Magnetic sensors are passive devices that indicate the presence of a metallic object by detecting the perturbation (known as a magnetic anomaly) in the Earth's magnetic field created by the object. Figure 5 shows the magnetic anomaly produced by the magnetic dipoles, i.e., magnetic fields, on a steel vehicle when it enters the magnetometer's detection zone (Kell, 1990; Lenz, 1993; and Sampey, 1999). The upper part of the figure indicates how the vector addition of the dipole magnetic field and the Earth's quiescent magnetic field produces the magnetic anomaly. The lower portion of the figure depicts several dipoles on a vehicle and their effect on sensor output.

Figure 6 illustrates the distortion induced in the Earth's magnetic field as a vehicle enters and passes through the detection zone of a magnetic sensor. Figure 6a depicts the magnetic field as the vehicle approaches the sensor. Figure 6b shows the field lines of flux as the vehicle begins to pass through the sensor's detection zone. Figure 6c illustrates the lines of flux when the entire vehicle is over the sensor.

Application and Uses

Two types of magnetic sensors are used for traffic flow parameter measurement. The first type, two- and three-axis fluxgate magnetometers, detects changes in the vertical and horizontal components of the Earth's magnetic field produced by a ferrous metal vehicle. These sensors identify stopped and moving vehicles. The two-axis fluxgate magnetometer contains a primary winding and two secondary "sense" windings on a bobbin surrounding a high permeability soft magnetic material core. In response to the magnetic field anomaly, i.e., the magnetic signature of a vehicle, the magnetometer's electronics circuitry measures the output voltage generated by the secondary windings. The vehicle detection criterion is for the voltage to exceed a predetermined threshold. In the presence mode of operation, the detection output is maintained until the vehicle leaves the detection zone.

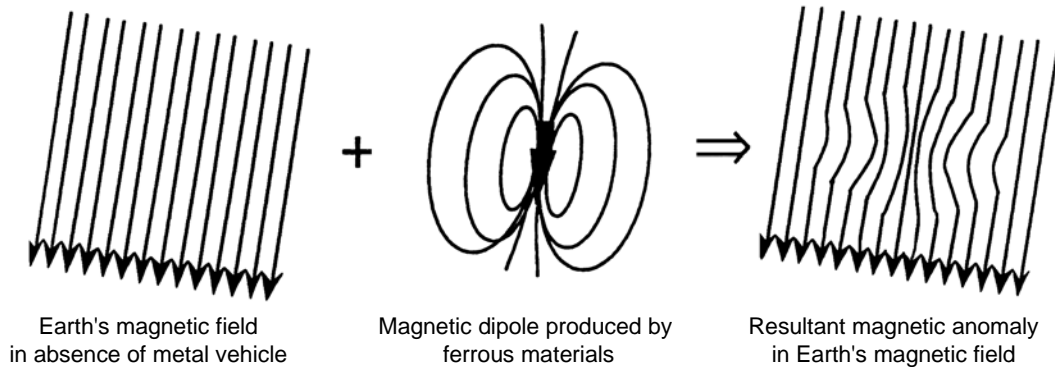

(a) Magnetic anomaly induced in the Earth's magnetic field by a magnetic dipole

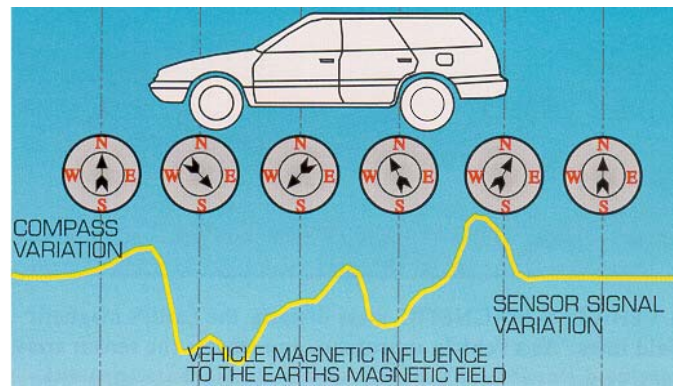

(b) Perturbation of Earth's magnetic field by a ferrous metal vehicle.
(Drawing courtesy of Nu-Metrics, Vanderbilt, PA).

Figure 5. Magnetic anomaly in the Earth's magnetic field induced by magnetic dipoles in a ferrous metal vehicle.

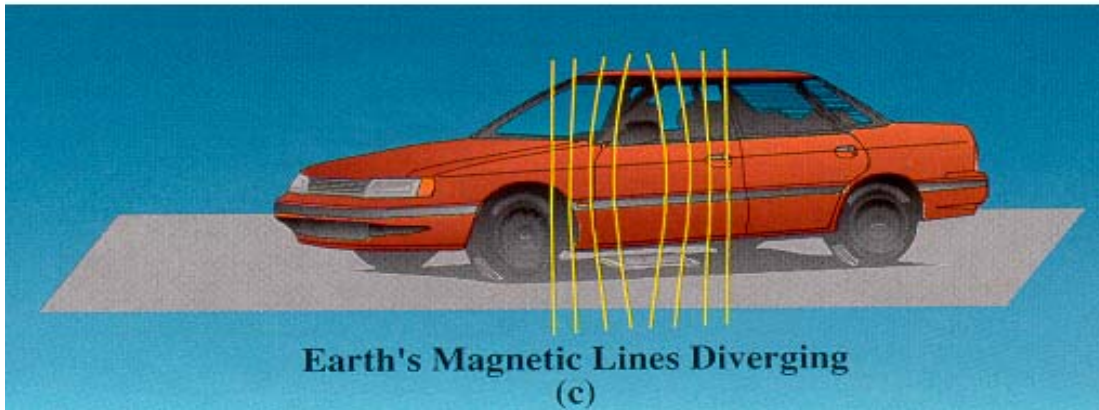
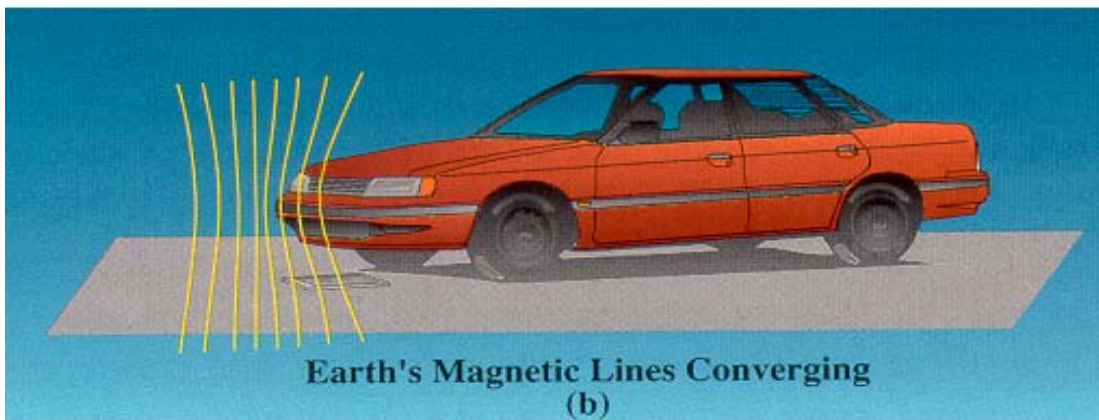
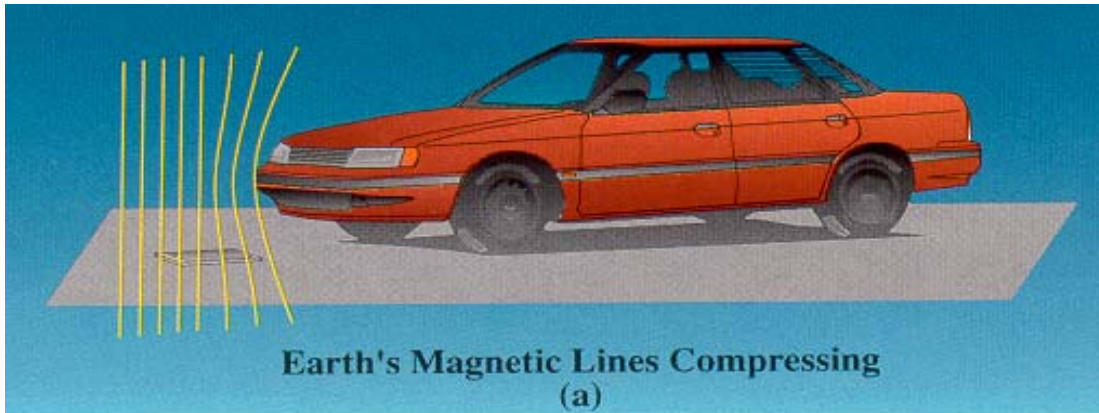

Figure 6. Distortion of Earth's magnetic field created as a vehicle enters and passes through the detection zone of a magnetic sensor. (Drawing courtesy of Nu-Metrics, Uniontown, PA).

An example of a wireless sensor that incorporates a two-axis fluxgate magnetometer is shown in Figure 7a. The G-8 series sensors fit into a 6-in diameter hole of 3¼-in depth (152.4-mm diameter × 82.6-mm depth). The sensor transmits data using the 2.45 GHz spread spectrum band to a base unit up to 300 ft (91 m) away. The base unit can be powered from batteries recharged by solar energy. The G-8 provides vehicle count, speed (up to 12 bins), length (up to 6 bins), lane occupancy, daily and annual average daily traffic (AADT), environmental monitoring of road surface temperature from –67°F to 185°F (–55°C to 85°C), road surface wet or dry condition, and chemical index. Polling intervals range from 5 to 120 minutes. The G-8 operates from 4 lithium thionyl chloride batteries for up to 5 years, typically 2 - 4 years depending on AADT and polling interval.

Figure 7b illustrates a wireless three-axis magnetometer that measures the *x*-, *y*-, and *z*-components of the Earth's magnetic field. One or more of these sensors (across the width or length of the monitored road section) are required for applications as freeway and arterial count stations, stop bar detectors, and long loop emulators. They are installed by coring a 4-in. (10-cm) diameter hole approximately 2¼ in. (6.5 cm) deep, inserting the sensor into the hole so that it is properly aligned with the direction of traffic flow, and sealing the hole with fast drying epoxy. The sensor maintains two-way wireless communication with an access point device over a range of 75 to 150 ft (23 to 46 m). The communication range may be extended another 75 to 150 ft (23 to 46 m) by installing a repeater unit between the sensor and the nearest access point device. Sensor battery life depends on the vehicle detection application, but is expected to be 10 years. This sensor is available with two mounting options: flush mount and surface mount.

Since fluxgate magnetometers are passive devices, they do not transmit an energy field and a portion of the vehicle must pass over the sensor for it to be detected. Consequently, a magnetometer can detect two vehicles separated by a distance of a foot. This potentially makes the magnetometer as accurate as or better than the inductive loop detector at counting vehicles. Conversely, the magnetometer is not a good locator of the perimeter of the vehicle. There is an uncertainty of about ±1.5 ft (45 cm). A single magnetometer is therefore seldom used for determining occupancy and speed in a traffic management application. Two closely spaced magnetometer sensors are preferred for that function.



(a) Groundhog[®] G-8 magnetometer and road-weather sensor. (Photograph courtesy of Nu-Metrics, Uniontown, PA).



(b) Sensys[™] wireless sensor. (Photograph courtesy of Sensys Networks, Berkeley, CA.)

Figure 7. Two- and three-axis fluxgate magnetometer sensors.

Previous magnetometer models were sensitive enough to detect bicycles passing across a 4-ft (1.2-m) span when the electronics unit was connected to two sensor probes buried at a depth of 6 in. (15 cm) and spaced 3 ft (0.9 m) apart. Fluxgate magnetometers can hold the presence of a vehicle for a considerable length of time and do not exhibit crosstalk interference.

The second type of magnetic sensor is the magnetic detector, more properly referred to as an induction or search coil magnetometer. It normally detects only moving vehicles by measuring the change in the magnetic lines of flux caused by a moving ferrous metal vehicle. These devices contain a single coil winding around a permeable magnetic material rod core. Similar to the fluxgate magnetometer, magnetic detectors generate a voltage when a ferromagnetic object perturbs the Earth's magnetic field. However, most magnetic detectors cannot detect stopped or slow moving (i.e., vehicles with speeds less than approximately 5 mi/h) vehicles, since they require a vehicle to be moving or otherwise changing its signature characteristics with respect to time. Examples of sensors that use the induction magnetometer principle are shown in Figure 8.

Advantages

Two- and three-axis fluxgate magnetometers are less susceptible than loops to stresses of traffic. The pavement incursion for the sensor covers a smaller area and therefore may not affect

pavement life as much as loops. Pavement cuts for data transmission to a controller are eliminated since the fluxgate magnetometers described above transmit data over wireless RF links.

The induction or search coil magnetometer is also less susceptible than loops to stresses of traffic. The induction magnetometer can be used where loops are not feasible (e.g., bridge decks) and some models can be installed under the roadway without the need for pavement cuts.

Disadvantages

Installation of magnetic sensors requires pavement cut, coring, or boring under the roadway and thus requires lane closure during installation. Magnetic detectors cannot generally detect stopped vehicles. Also, some models have small detection zones.

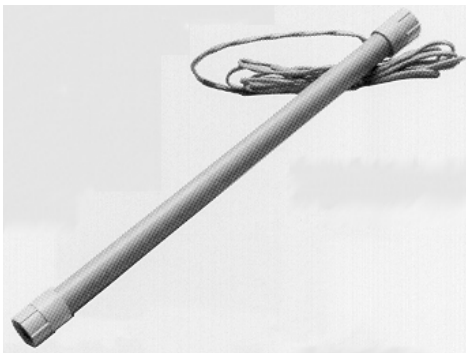

231E Detector Probe. (Photograph courtesy of Safetran Traffic Systems, Colorado Springs, Co).

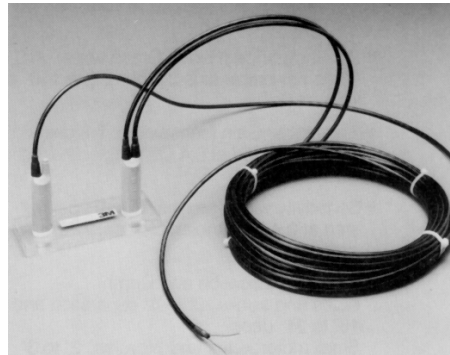

Model 701 microloop probe. (Photograph courtesy of 3M Company, St. Paul, MN)

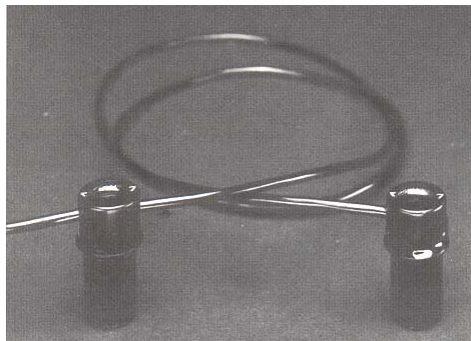

Model 702 microloop probe. (Photograph courtesy of 3M Company, St. Paul, MN)

Figure 8. Induction magnetometer sensors.

MANUFACTURER AND VENDOR INFORMATION

Effective Date: 4/23/07

Manufacturer name: 3M
Intelligent Transportation Systems

Sales representative name(s): _____
Mike Lemon

Address: 3M Center, Bldg 225-4N-14
St. Paul, MN 55144-1000

Address: 3M ITS
same

Phone number: _____

Phone number: (480) 221-5716 (cell)

Fax number: _____

Fax number: _____

e-mail address: _____

e-mail address: mjlemon@mmm.com

URL address: www.mmm.com/ITS

URL address: _____

PRODUCT NAME/MODEL NUMBER: 3M 701 Traffic Sensor

FIRMWARE VERSION/CHIP NO.: N/A

SOFTWARE VERSION NO.: N/A

GENERAL DESCRIPTION OF EQUIPMENT: 701 traffic sensors are used in single, double, or triple assemblies. In the latter two configurations, they are connected in series to extend lane coverage width. Each assembly is available with standard lead-in cable lengths.

SENSOR TECHNOLOGY AND CONFIGURATION: The 701 traffic sensor is a transducer that converts changes in the vertical component of the earth's magnetic field to changes in inductance. Vehicles containing vertical components of ferromagnetic material distort the quiescent magnetic field of the earth, increasing the magnetic field at the sensor when vehicles move over the sensor. Changes in inductance can be sensed by a traffic monitoring card or Canoga C900 series vehicle detector suitably configured for the traffic sensor. The number of sensors required per lane is determined by lane width and types of vehicles to be detected. Up to four 701 traffic sensors can be connected in series.

SENSOR INSTALLATION: The 701 traffic sensor is installed from the road surface. A 1-in. (2.5 cm) diameter hole is drilled for each 701 traffic sensor in the assembly.

INSTALLATION TIME (Per Lane): Not specified

INSTALLATION REQUIREMENTS: For autos and trucks, a single sensor centered in a lane and buried 18-24 in. (41-61 cm) deep is typical. For small motorcycles and bikes, three sensors connected in series with 3-ft (91 cm) separation and buried 16-20 in. (40-50 cm) deep is typical.

MAXIMUM NUMBER OF LANES MONITORED SIMULTANEOUSLY: N/A

PRODUCT CAPABILITIES/FUNCTIONS: Replaces inductive loops for freeway applications, and counting and intersection applications. When connected to traffic monitoring cards, 701 traffic sensors provide accurate, real-time mean speed, count, and occupancy data and vehicle speed and length classification. They detect vehicles made of ferromagnetic materials in regions where the earth's vertical magnetic field is between 0.2 and 1.0 oersted.

RECOMMENDED APPLICATIONS: All presence and passage applications

POWER REQUIREMENTS (watts/amps): N/A

POWER OPTIONS: N/A

CLASSIFICATION ALGORITHMS: N/A

TELEMETRY: N/A

COMPUTER REQUIREMENTS: N/A

DATA OUTPUT: N/A

DATA OUTPUT FORMATS: N/A

SUPPORTING DATA BASE MANAGEMENT SYSTEM: N/A

EQUIPMENT AND INSTALLATION COSTS: Various

STATES CURRENTLY USING THIS EQUIPMENT:

Country/State

Contact name

Telephone number

Please contact 3M for current list of references.

MANUFACTURER AND VENDOR INFORMATION

Effective Date: 4/23/07

Manufacturer name: 3M
Intelligent Transportation Systems

Sales representative name(s): _____
Mike Lemon

Address: 3M Center, Bldg 225-4N-14
St. Paul, MN 55144-1000

Address: 3M ITS
same

Phone number: _____

Phone number: (480) 221-5716 (cell)

Fax number: _____

Fax number: _____

e-mail address: _____

e-mail address: mjlemon@mmm.com

URL address: www.mmm.com/ITS

URL address: _____

PRODUCT NAME/MODEL NUMBER: 3M 702 Non-Invasive Traffic Sensor

FIRMWARE VERSION/CHIP NO.: N/A

SOFTWARE VERSION NO.: N/A

GENERAL DESCRIPTION OF EQUIPMENT: 702 non-invasive traffic sensors are inserted into a 3-in. (7.6 cm) plastic conduit installed 18-24 in. (46-61 cm) below the road surface. Installing the sensors in a conduit leaves the road surface intact, bypasses the effects of poor pavement conditions and inclement weather, and virtually eliminates maintenance and service requirements.

SENSOR TECHNOLOGY AND CONFIGURATION: The 702 non-invasive traffic sensor is a transducer that converts changes in the vertical component of the earth's magnetic field to changes in inductance. Vehicles containing vertical components of ferromagnetic material distort the quiescent magnetic field of the earth, increasing the magnetic field at the sensor when vehicles move over the sensor. Changes in inductance can be sensed by a traffic monitoring card or Canoga C900 series vehicle detector suitably configured for the traffic sensor. The number of sensors required per lane is determined by lane width and types of vehicles to be detected. For autos and trucks, a single sensor centered in a lane is typical. For small motorcycles and bikes, three sensors connected in series are typical.

SENSOR INSTALLATION: 702 non-invasive traffic sensors are placed into special carriers and then inserted into 3-in. (7.6 cm) Schedule 80 conduit. Horizontal directional drilling techniques or open trenching is used for placement of the conduit.

INSTALLATION TIME (Per Lane): Sensors and carriers take less than an hour for insertion into the 3-in. (7.6 cm) Schedule 80 conduit.

INSTALLATION REQUIREMENTS: Conduit is installed 21 ± 3 in. (53.3 ± 7.6 cm) below the road surface using horizontal directional drilling or open trenching techniques. Carriers hold the 702 non-invasive traffic sensors in a fixed, vertical position as they are inserted into the installed, 3-in. (7.6 cm) conduit. The carriers' interlocking mechanism maintains the alignment of the sensors within $\pm 20^\circ$ from vertical.

MAXIMUM NUMBER OF LANES MONITORED SIMULTANEOUSLY: N/A

PRODUCT CAPABILITIES/FUNCTIONS: Replaces inductive loops for freeway applications, and counting and intersection applications. When connected to traffic monitoring cards, 702 non-invasive traffic sensors provide accurate, real-time mean speed, count, and occupancy data and vehicle speed and length classification. They detect vehicles made of ferromagnetic materials in regions where the earth's vertical magnetic field is between 0.2 and 0.8 oersted.

RECOMMENDED APPLICATIONS: All presence and passage applications

POWER REQUIREMENTS (watts/amps): N/A

POWER OPTIONS: N/A

CLASSIFICATION ALGORITHMS: N/A

TELEMETRY: N/A

COMPUTER REQUIREMENTS: N/A

DATA OUTPUT: N/A

DATA OUTPUT FORMATS: N/A

SUPPORTING DATA BASE MANAGEMENT SYSTEM: N/A

EQUIPMENT AND INSTALLATION COSTS: Various

STATES CURRENTLY USING THIS EQUIPMENT:

Country/State

Contact name

Telephone number

Please contact 3M for current list of references.

MANUFACTURER AND VENDOR INFORMATION

Effective Date: 6/18/07

Manufacturer name: Sensys Networks, Inc. Sales representative name(s): _____

Address: 2560 Ninth Street, Suite 219 Address: _____
Berkeley, CA USA 94710

Phone number: +1 (510) 548-4620 Phone number: _____

Fax number: +1 (510) 548-8264 Fax number: _____

e-mail address: info@sensysnetworks.com e-mail address: _____

URL address: www.sensysnetworks.com URL address: _____

PRODUCT NAME/MODEL NUMBER: Sensys™ Wireless Vehicle Detection System

FIRMWARE VERSION/CHIP NO.:

SOFTWARE VERSION NO.:

GENERAL DESCRIPTION OF EQUIPMENT: The Sensys™ Wireless Vehicle Detection System uses pavement-mounted magnetic sensors (flush mount or surface mount) to detect the presence and movement of vehicles. The magneto-resistive sensors are wireless, transmitting their detection data in real-time via low-power radio technology to a nearby Sensys access point that relays the data to one or more local or remote traffic management controllers and systems.

A single Sensys installation consists of a number of Sensys wireless sensors installed in or on the roadway at various locations as required by the particular vehicle detection application, a Sensys access point to receive the data from the sensors and process and relay it onward, and one or more Sensys repeaters as may be needed to support sensors installed beyond the radio range of the Sensys access point.

SENSOR TECHNOLOGY AND CONFIGURATION: Each Sensys wireless sensor contains a magneto-resistive sensing device that measures the x -, y -, and z -axis components of the Earth's magnetic field at a 128 Hz sampling rate, combined with a low-power radio in a small, hardened plastic case for pavement mounting.

SENSOR INSTALLATION: In typical traffic management applications, a Sensys wireless sensor is placed in the middle of a traffic lane where it will detect the presence and passage of

vehicles. To measure vehicle speeds and length, two wireless sensors are installed in the same lane with the exact distance between them measured and configured in software upon installation. For stop bar detection applications where greater sensitivity is required and, for example, where a diagonal-slashed quadrupole (Type D) loop would be used just behind the stop bar, two Sensys wireless sensors should be installed parallel to the stop bar, each 1 ft (0.3 m) on one side or the other of the center of the traffic lane, and located 2 to 3 ft (0.6 to 0.9 m) from the stop bar where the center of the loop would have been placed. Sensor sensitivity is adjustable.

INSTALLATION TIME (Per Lane): Installation of each Sensys wireless sensor requires less than 10 minutes; two sensors are typically installed per lane for count station applications.

INSTALLATION REQUIREMENTS: For a flush-mount sensor, installation requires boring a 4-in. (10-cm) diameter hole approximately 2 ¼ in. (6.5 cm) deep at the desired sensing location, placing the sensor into the hole so that it is properly aligned with the direction of traffic, and sealing the hole with fast-drying epoxy. A hammer drill is recommended, but a core drill can alternatively be used. No lead-in cabling or long saw cuts are required, and the circular pavement hole produces the least amount of damage and stress to the roadway. Installation of a surface-mount Sensys wireless sensor is similar – orient and epoxy the sensor to its desired position in the roadway.

A Sensys access point can be installed at any roadside location that provides adequate signal coverage to the nearby Sensys wireless sensors and repeaters as long as power for the access point device is available. Generally, a Sensys access point is pole-mounted at a height of 10 ft (3 m) or more, but it can also be mounted on a retaining wall, overpass, or other structure. A Sensys repeater is installed similarly, except that it does not require power.

The maximum range between a Sensys access point or repeater and a Sensys wireless sensor is determined by site-specific variables as the local terrain, the mounting height of the access point/repeater, and whether the access point/repeater is pointed directly at the sensors. Ranges of 75 to 150 ft (3 to 46 m) are typical.

MAXIMUM NUMBER OF LANES MONITORED SIMULTANEOUSLY: 1 (each Sensys wireless sensor acts independently, although many sensors can be supported by a single Sensys access point).

PRODUCT CAPABILITIES/FUNCTIONS: Output data include vehicle counts, speed, occupancy, presence, headway, gap, direction of travel, and length classification. The system provides such capabilities as:

- Native IP communications
- Ultra-low-power consumption
- Per-vehicle or binned data collection
- Upgradeable firmware (via radio to installed sensors)

- Interfaces to standard roadside traffic controllers (Type 170, NEMA TS1, NEMA TS2, Type 2070 ATC)
- Calibration-free operation, and
- Optional GSM or CDMA cellular data modems integrated with the access point.

RECOMMENDED APPLICATIONS: Applications of the Sensys Wireless Vehicle Detection System are:

- Freeway/arterial monitoring -- count stations
- Freeway ramp management -- metering lights, queue control
- Traffic signal control (intersection management) -- stop bar detection, advance detection, adaptive traffic signal control (e.g., SCOOT, SCATS)
- Planning & asset management
- Traveler information systems
- Inductive loop replacement

POWER REQUIREMENTS (watts/amps): Sensys wireless sensors and repeaters are battery-powered. Each Sensys access point uses an external DC power input, typically provided from a nearby power pedestal, traffic controller, or solar panel. Power consumption is 1.5 W to 3.5 W, depending on the access point options.

POWER OPTIONS: Sensys access point options are available with either a 36-58 VDC isolated power input or, if solar power is used, a 9-20 VDC power input.

CLASSIFICATION ALGORITHMS:

TELEMETRY: Each Sensys installation can communicate its detection data in several ways:

- Contact closure to a roadside traffic controller;
- IP (Internet Protocol) communications over twisted pair, coaxial cable, fiber optic cable, cellular data services, or other connectivity to one or more central servers and traffic management systems, or
- Both paths, simultaneously supporting local traffic signal control as well as centralized traffic management and information systems.

COMPUTER REQUIREMENTS: Installation and configuration/control of the Sensys Wireless Vehicle Detection System is supported by Java software that runs on almost any PC operating system.

DATA OUTPUT: Per-vehicle or averaged/binning data.

DATA OUTPUT FORMATS: As required.

SUPPORTING DATA BASE MANAGEMENT SYSTEM: Optional Sensys Networks Archive, Proxy, and Statistics (SNAPS) server can archive and provide statistical analysis of detection data.

EQUIPMENT AND INSTALLATION COSTS (One-lane and four-lane): Pricing is competitive; please contact Sensys.

STATES CURRENTLY USING THIS EQUIPMENT:

<u>Country/State</u>	<u>Contact name</u>	<u>Telephone number</u>
Arizona		
California		
Colorado		
Florida		
Iowa		
Kansas		
Maryland		
Michigan		
Minnesota		
Missouri		
Nevada		
Tennessee		
Texas		
Virginia		
Canada (Winnipeg, Vancouver)		
South Africa		
Australia		

Please contact Sensys for a complete list of references.

PIEZOELECTRIC SENSORS

Piezoelectric material converts kinetic energy to electrical energy. Polymers that exhibit this property to a high degree are ideal to use in the construction of piezoelectric sensors.

Principles of Operation

Piezoelectric materials generate a voltage when subjected to mechanical impact or vibration. Electrical charges of opposite polarity appear at the inner and outer faces of the material and induce a voltage. The measured voltage is proportional to the force or weight of the vehicle. The magnitude of the piezoelectric effect depends upon the direction of the force in relation to the axes of the crystal. Since the piezoelectric effect is dynamic, i.e., charge is generated only when the forces are changing, the initial charge will decay if the force remains constant (Castle Rock Consultants, 1988).

Applications and Uses

Piezoelectric sensors are utilized to classify vehicles by axle count and axle spacing and to measure vehicle weight and speed (the latter when multiple sensors are deployed). They are frequently used as part of weigh-in-motion systems. Class I piezoelectric sensors detect and weigh axles, while Class II sensors only detect the axle. There is typically a price advantage of buying Class II sensors for non-WIM applications, although the total installed cost of some Class I sensors is only fractionally more than that of a Class II sensor for sensors of the same length (Halvorsen, 1999).

Construction

One coaxial piezoelectric tube sensor is constructed with a metal braided core element, which is surrounded by the piezoelectric material and a metal outer layer. During the manufacturing process, the sensor is subjected to an intense radial electric field, which polarizes piezoelectric material. The electrical field is applied as a corona to the cable before the outer metal jacket is

attached. The field changes the amorphous polymer into a semi-crystalline form, while retaining many of the flexible properties of the original polymer (Halvorsen, 1999).

Another type of piezoelectric sensor is Vibracoax cable, manufactured by Thermocoax. It utilizes a mineral-based powder as the piezoelectric material that forms the dielectric between the copper wire at the center of the coaxial cable and the solid copper tube that serves as the outer conductor. During manufacture, the temperature of the cable is increased to 400°C and a voltage is applied between the inner and outer conductors to polarize the powder by orienting the electrical charges on the molecules of powder. The voltage is maintained as the cable is cooled, thus stabilizing the polarized field. The cable can be supplied expoxied into an aluminum channel to ensure that it is installed without kinks as shown in Figure 9.

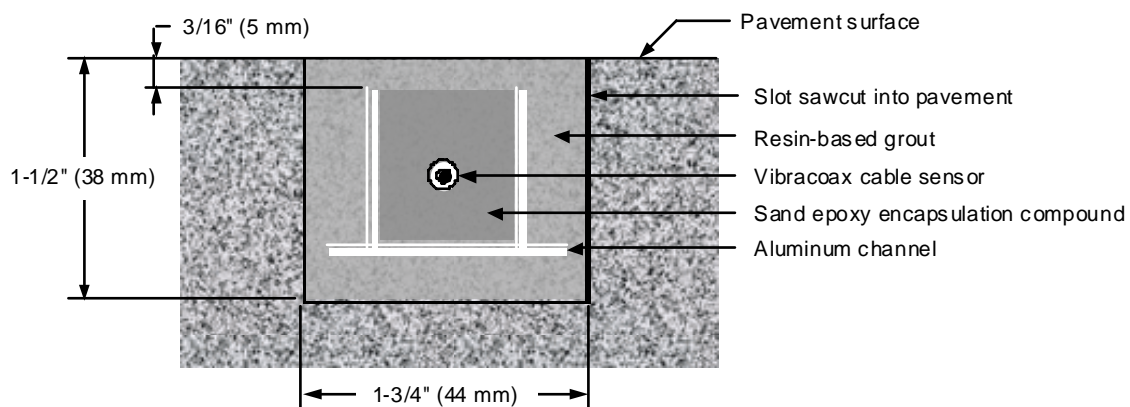

Figure 9. Vibracoax piezoelectric sensor mounted in aluminum channel as installed in a roadbed. (Drawing courtesy of IRD, Inc., Saskatoon, SK).

Vibracoax is recommended for weigh-in-motion, vehicle classification by axle count and spacing, gross vehicle and load measurement, speed measurement, and counting applications. Foam rubber is placed along the vertical sides of the sawcut when Vibracoax cable is utilized in weigh-in-motion systems manufactured by ECM, Inc. This technique enhances the vertical pressure measurement and reduces side stresses. This configuration is particularly useful for installations in concrete slabs that may contain cracks that would otherwise transfer horizontal

forces to the cable sensor. The sawcut and cable are sealed with fillers that match the mechanical properties of the road surface to produce a slightly domed surface.

Other examples of piezoelectric tube sensors include the Roadtrax BL and the BLC sensors. The Roadtrax piezoelectric sensor is manufactured with and without an aluminum channel for permanent or temporary installation in the roadbed (Roadtrax, 1995-1996). It supports Class I and Class II operations.

The BL (Brass Linguini[®]) model is installed directly into the roadbed in a slot 0.75-in (19-mm) wide by 0.75-in (19-mm) deep (typical). Polyurethane, epoxy, and acrylic grouts are available for sealing the slot.

When the BLC aluminum channel model is installed, as depicted in Figure 10, the same epoxy is used inside the channel to encapsulate the sensor and for installation in the road. This eliminates or greatly reduces temperature coefficient effects.

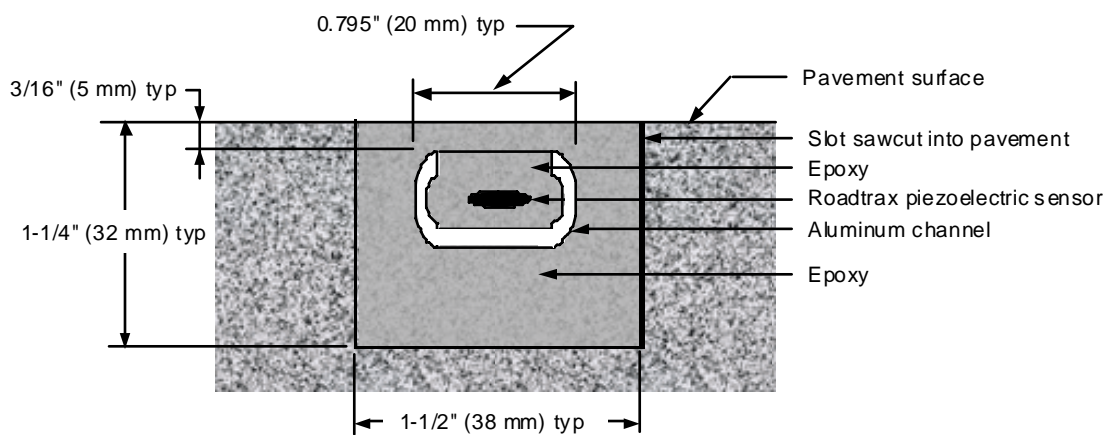

Figure 10. Roadtrax piezoelectric BLC sensor mounted in aluminum channel as installed in a roadbed (Roadtrax, 1995-1996).

Bonding Materials

A study by Fowler (Fowler, 1996) of current state practices for bonding piezoelectric sensors to pavement revealed that the bond between the piezoelectric sensor and the pavement was lost where rutting occurred. Several laboratory tests performed on the bonding material were found more relevant than others in predicting field performance of bonding agents. The most beneficial tests are listed in Table 3. Although all of these characteristics were critical, some were more indicative of desired material behavior as indicated by their rank.

Table 3.
Recommended tests for determining bonding ability of agents used with piezoelectric sensors

Recommended Test	Required Result	Importance Rank^a
Compressive strength (ASTM C 116-90)	Approx. 7 MPa	1
Storage modulus (G') component of the complex shear modulus (AASHTO TP5)	14 to 70 Mpa at 25°C, decreases with increasing temperature	2
Gel time (ASTM C881)	5 to 15 min	3
Shrinkage (DuPont method)	1.0% expansion to 0.5% shrinkage	1
Vicat set time (ASTM C 191-192)	Approx. 30 min	3
Viscosity (optional) ASTM D 2393)	20 to 40 Pa-s	1
Flexural bond strength (ASTM C 78-84)	Approx. 700 kPa to asphalt, Approx. 2100 kPa to concrete, at least 50% of failures in paving material and away from the bond	2
Field trial (ease of use)	Acceptance by installation crew	3

^a3 = most important, 1 = least important.

Advantages

Piezoelectric sensors gather information when a tire passes over the sensor, thus creating an analogue signal that is proportional to the pressure exerted on the sensor. This property of

piezoelectric sensors allows them to differentiate individual axles with high precision. In addition, on an installed cost basis, some types are only marginally more expensive than an inductive loop, but provide more information in the form of improved speed accuracy, the ability to determine the classification of the vehicle based on weight and axle spacing, and the capability to determine and monitor the weights of vehicles for WIM systems.

Disadvantages

The drawbacks to the use of piezoelectric tube or cable sensors are similar to those of inductive loop sensors in that they include disruption of traffic for installation and repair, failures associated with installations in poor road surfaces and wear, and use of substandard installation procedures. In many instances multiple detectors are required to instrument a location. In addition, resurfacing of roadways and utility repair can create the need to reinstall these types of sensors. Piezoelectric sensors have been known to be sensitive to pavement temperature and vehicle speed.

MANUFACTURER AND VENDOR INFORMATION

Effective Date: 29 March 2000

Manufacturer name: _____
Diamond Traffic.

Sales representative name(s): _____
Guy Gibson Sr., Vice President

Address: _____
P.O. Box 1455
Oakridge, OR 97463

Address: _____
P.O. Box 1455
Oakridge, OR 97463

Phone number: (541) 782-3903

Phone number: _____

Fax number: (541) 782-2053

Fax number: _____

e-mail address: Diamondtrf@aol.com

e-mail address: Diamondtrf@aol.com

URL address: www.diamondtraffic.com

URL address: _____

PRODUCT NAME/MODEL NUMBER: Phoenix Vehicle Classifier

FIRMWARE VERSION/CHIP NO.: 2.39

SOFTWARE VERSION NO.: Trafman 469

GENERAL DESCRIPTION OF EQUIPMENT: Time interval vehicle classifier and counter utilizing loops, piezo, road tube, fiber optic, and radar

SENSOR TECHNOLOGY AND CONFIGURATION: Loops, piezo, road tube, fiber optic, radar

SENSOR INSTALLATION:

INSTALLATION TIME (Per Lane): Sensors cut into pavement can require 6-10 hours

INSTALLATION REQUIREMENTS:

MAXIMUM NUMBER OF LANES MONITORED SIMULTANEOUSLY: 16 using loops for count or 8 using loops and piezo for classification

PRODUCT CAPABILITIES/FUNCTIONS: Count, classify, vehicles, incident detection and notification.

RECOMMENDED APPLICATIONS: 2 lane to multilane freeways for count and classification

POWER REQUIREMENTS (watts/amps): Range form 50 milliamps to 100 milliamps

POWER OPTIONS: 110 VAC, battery, or solar

CLASSIFICATION ALGORITHMS: FHWA 13, European

TELEMETRY: 300 to 19200. Optional 14.4K low power drew modem

COMPUTER REQUIREMENTS:

DATA OUTPUT: 28 print formats, spreadsheets

DATA OUTPUT FORMATS:

SUPPORTING DATA BASE MANAGEMENT SYSTEM: Mix of windows and DOS software, NT compatible

EQUIPMENT AND INSTALLATION COSTS (One-lane and four-lane):

One lane \$1100 to \$1500

Four lanes \$1400 to \$2000

STATES CURRENTLY USING THIS EQUIPMENT:

<u>Country/State</u>	<u>Contact name</u>	<u>Telephone number</u>
USA/Idaho	Brian Hagen	(208) 334-8250
USA/Nevada	Cecil Crandel	(775) 888-7155
USA/Washington	John Rosen	(360) 753-6100
USA/Colorado	Steve Plasten	(303) 757-9467
USA/Nebraska	Terry Guy	(402) 479-4509
USA/Connecticut	Erick Glover	(860) 594-2088
USA/Wyoming		(307) 777-4433

MANUFACTURER AND VENDOR INFORMATION

Effective Date: 2/29/00

Manufacturer name: _____ <u>Truvelo Manufacturers (Pty) Ltd.</u>	Sales representative name(s): _____ <u>James E. Kelly</u> <u>AVIAR Inc.</u>
Address: <u>P.O. Box 14183</u> <u>Lyttelton 0140</u> <u>South Africa</u>	Address: <u>P.O. Box 162184</u> <u>Austin, TX 78716</u>
Phone number: <u>011-27-11-314-1405</u>	Phone number: <u>(512) 295-5285</u>
Fax number: <u>011-27-11-314-1409</u>	Fax number: <u>(512) 295-2603</u>
e-mail address: <u>rudi@truvelo.co.za</u>	e-mail address: <u>aviar@aviarinc.com</u>
URL address: <u>www.truvelo.co.za</u>	URL address: <u>www.aviarinc.com</u>

PRODUCT NAME/MODEL NUMBER: The Combi Speed/Red Light Camera System

FIRMWARE VERSION/CHIP NO.: N/A

SOFTWARE VERSION NO.: N/A

GENERAL DESCRIPTION OF EQUIPMENT: Automatic speed and/or traffic light violation recording system for portable and/or permanent installation in one compact unit. Evidence of violation is shown on photograph.

SENSOR TECHNOLOGY AND CONFIGURATION: 3 or 4 piezo sensors for speed or 2 inductive loops/lane for presence at signalized intersection.

SENSOR INSTALLATION: Either surface mounted or cut into roadway surface

INSTALLATION TIME (Per Lane): Portable installation: 60 min. for 3 lanes
Permanent installation: 2 days

INSTALLATION REQUIREMENTS: N/A

MAXIMUM NUMBER OF LANES MONITORED SIMULTANEOUSLY: 3 lanes

PRODUCT CAPABILITIES/FUNCTIONS: Monitor traffic for speed violations or red light violations.

RECOMMENDED APPLICATIONS: Speed and red light enforcement

POWER REQUIREMENTS (watts/amps):

Portable: 12 volts D.C.

Permanent: Either 12 volts D.C. or 220-240 volts single phase A.C.

POWER OPTIONS: Either 12 volt battery or commercial source

CLASSIFICATION ALGORITHMS: N/A

TELEMETRY: N/A

COMPUTER REQUIREMENTS: Internal microprocessors

DATA OUTPUT: Photo evidence plus location code, time, date, speed, photo counter, traffic counter, statistical data (lowest/highest speed, average speed, 85 percentile speed, vehicle speed distribution)

DATA OUTPUT FORMATS: On photo or on instrument display

SUPPORTING DATA BASE MANAGEMENT SYSTEM: N/A

EQUIPMENT AND INSTALLATION COSTS (One-lane and four-lane):

Contact Truvelo for cost information.

STATES CURRENTLY USING THIS EQUIPMENT:

<u>Country/State</u>	<u>Contact name</u>	<u>Telephone number</u>
USA/Florida	Chief Tony Sparks Bartow Police Dept.	(941) 534-5034
USA/Texas	Walter Ragsdale City of Richardson	(972) 238-4273

MANUFACTURER AND VENDOR INFORMATION

Effective Date: February 2000

Manufacturer name: _____
Jamar Technologies

Sales representative name(s): _____
James E. Martin

Address: 151 Keith Valley Road
Horsham, PA 19044

Address: same

Phone number: (215) 491-4899

Phone number: same

Fax number: (215) 491-4889

Fax number: _____

e-mail address: sales@jamartech.com

e-mail address: _____

URL address: _____

URL address: _____

PRODUCT NAME/MODEL NUMBER: TRAXPRO

FIRMWARE VERSION/CHIP NO.: TRAX Type III

SOFTWARE VERSION NO.: TRAXPRO Version 1.1

GENERAL DESCRIPTION OF EQUIPMENT: Counter Classifier designed to record traffic in multiple lanes and save the data in a format that can be processed by the TRAXPRO program to give the user reports that include volumes, classification, speeds, gaps, and headways.

SENSOR TECHNOLOGY AND CONFIGURATION: Piezo and loop technology in most of the standard configurations

SENSOR INSTALLATION: Embedded in the road surface. Portable sensors due on the market in later 2000

INSTALLATION TIME (Per Lane): For permanent sites approximately 2 hours per lane, depending on configuration

INSTALLATION REQUIREMENTS: Good road surface with little or no rutting and no paving fractures

MAXIMUM NUMBER OF LANES MONITORED SIMULTANEOUSLY: Eight

PRODUCT CAPABILITIES/FUNCTIONS: Volume, speed, classifications, gaps and headways.

RECOMMENDED APPLICATIONS: Any permanent or semi-permanent site

POWER REQUIREMENTS (watts/amps): 15 mA battery powered, solar option available.
A/C power optional.

POWER OPTIONS: See above

CLASSIFICATION ALGORITHMS: FHWA and custom ones per your needs

TELEMETRY: Availability late 2000

COMPUTER REQUIREMENTS: Pentium

DATA OUTPUT: ASCII & Binary

DATA OUTPUT FORMATS: Standard

SUPPORTING DATA BASE MANAGEMENT SYSTEM: Processed data files may be exported to Excel, Quattro-Pro, Lotus programs

EQUIPMENT AND INSTALLATION COSTS (One-lane and four-lane):
One-lane – approximately \$4,000.00 and four-lane – approximately \$6,000.00

STATES CURRENTLY USING THIS EQUIPMENT:

<u>Country/State</u>	<u>Contact name</u>	<u>Telephone number</u>
USA/Vermont	Dave Gosselin	(802) 828-2694

MANUFACTURER AND VENDOR INFORMATION

Effective Date: March 22, 2000

Manufacturer name: International Road Dynamics, Inc.

Sales representative name(s): Rod Klashinsky

Address: 702 43rd Street East
Saskatoon SK, S7K 3T9 Canada

Address: _____

Phone number: 306-653-6600

Phone number: _____

Fax number: 306-242-5599

Fax number: _____

e-mail address: info@irdinc.com

e-mail address: _____

URL address: www.irdinc.com

URL address: _____

PRODUCT NAME/MODEL NUMBER: IRD Truck Advisory Safety Systems

FIRMWARE VERSION/CHIP NO.: N/A

SOFTWARE VERSION NO.: N/A

GENERAL DESCRIPTION OF EQUIPMENT: The IRD Truck Advisory Safety Systems determine truck speed, weight, height and classification (based on axle configuration). Using this information the systems are capable of displaying messages on a roadwide sign to instruct drivers to slow down prior to a sharp turn in the road or to proceed at a recommended speed prior to a steep decline in the road.

SENSOR TECHNOLOGY AND CONFIGURATION: The system typically uses an inductive loop—Class I piezo sensor—Class I piezo sensor-loop configuration.

SENSOR INSTALLATION: Sensors are saw-cut and grouted into the roadway. Sensor leads are run through conduit to a roadside cabinet.

INSTALLATION TIME (Per Lane): Depending on the application, installation of the in-road sensors, signs and associated electronics may take from 2 weeks to 1 month.

INSTALLATION REQUIREMENTS: Please see attached product information for details.

MAXIMUM NUMBER OF LANES MONITORED SIMULTANEOUSLY: Typically only a single lane of in-road equipment is required for the IRD Safety Systems.

PRODUCT CAPABILITIES/FUNCTIONS: Truck Rollover Advisory, Downhill Truck Speed Advisory, and Runaway Truck Traffic signal control.

RECOMMENDED APPLICATIONS: Truck Rollover Advisory, downhill Truck Speed Advisory, and runaway Truck Traffic Signal control.

POWER REQUIREMENTS (watts/amps): 2.5 amps/35 watts (For the WIM electronics)

POWER OPTIONS: 100-240 VAC, 50-60 Hz. (For the WIM electronics).

CLASSIFICATION ALGORITHMS: Vehicles can be classified based on axle weights, axle spacings, axle groupings and GVW.

TELEMETRY: Terminal software and standard telephone line with modem are required.

COMPUTER REQUIREMENTS: Pentium II or better, 400 MHz min., 32 Mb RAM min., Expansion slots 1 ISA, 3 PCI, 1 ISA/PCI.

DATA OUTPUT: Individual vehicle and vehicle summary data are stored on the WIM computer, which can be retrieved through a modem. Individual vehicle data can also be sent to an RS 232 port on the WIM in real-time.

DATA OUTPUT FORMATS: The vehicle information is stored on disk files in a compressed format developed by IRD. Software is available to convert the data to CSV (Comma, Sparated Value) file. Several industry standard formats are available for the WIM vehicle data transmitted through the RS 232 port.

SUPPORTING DATA BASE MANAGEMENT SYSTEM: Report generation software is available from IRD that reads the compressed vehicle data files directly. Raw data can also be exported to a file which can be read by any database system.

EQUIPMENT AND INSTALLATION COSTS (One-lane and four-lane):

1-lane: \$150,000 US and 4-lane: \$300,000 US

STATES CURRENTLY USING THIS EQUIPMENT:

<u>Country/State</u>	<u>Contact name</u>	<u>Telephone number</u>
USA/Pennsylvania (PennDot)	Jim Garling	(717) 787-3656
USA/Colorado (CDOT)	Dave Judy	(303) 512-5813

WEIGH-IN-MOTION (WIM)

Highway weigh-in-motion (WIM) systems are capable of estimating the gross vehicle weight of a vehicle and the portion of this weight carried by each wheel assembly (half-axle with one or more tires), axle, and axle group on the vehicle (ASTM E1318-02, 2002). WIM data are used by highway planners, designers, and enforcement agencies (e.g., Departments of Public Safety and state highway patrols).

Application and Uses

WIM systems increase the capacity of weigh stations and are often utilized when heavy truck traffic volumes cannot otherwise be accommodated. WIM systems provide highway planners and designers with time and date of traffic volume, speed, vehicle classification based on number and spacing of axles, and the equivalent single axle loading (ESAL) that heavy vehicles place on pavements and bridges. The heavy truck axle load data are used by motor vehicle enforcement officers to plan enforcement activities (McCall and Vodrazka, 1997). Software is frequently provided by the manufacturers to aid in system calibration and data analysis. The categories of WIM systems are listed in Table 4 along with the corresponding data each provide (ASTM E1318-02, 2002). Table 5 gives the functional performance requirements of WIM systems as defined by ASTM (ASTM E1318-02, 2002). Some states may impose more strict requirements such as those in Table 6 (McCall and Vodrazka, 1997).

The accuracy of WIM systems is a function of four principal factors:

- Vehicle dynamics;
- Pavement integrity, composition, and design;
- Variance inherent in the WIM system; and
- Calibration.

Vehicle dynamics are dependent on road surface roughness, type of vehicle suspension, vehicle dynamic balance, vehicle weight, vehicle speed, driver maneuvering, etc. Although most

agencies attempt to install WIM systems in good pavement, unexpected deterioration or structural anomalies sometimes occur. For instance, WIM measurements worsen when asphalt pavements soften in hot weather and long concrete sections rock along a central axis when a heavy truck passes over the end of the section. The inherent variance of the WIM system is a function of the technology utilized in the system to measure axle weight.

Table 4.
WIM System Categories, Applications, and Data Items

Data Item	Category			
	Type I	Type II	Type III	Type IV
Speed range	16 to 130 km/h (10 to 80 mi/h)	16 to 130 km/h (10 to 80 mi/h)	16 to 130 km/h (10 to 80 mi/h)	3 to 16 km/h (2 to 10 mi/h)
Application	Traffic data collection	Traffic data collection	Weight enforcement	Weight enforcement
Number of lanes	1 or more	1 or more	1 or more	1 or more
Bending plate	•	•	•	•
Piezoelectric	•	•		
Load cell	•	•	•	•
Wheel load	•		•	•
Axle load	•	•	•	•
Axle group load	•	•	•	•
Gross vehicle weight	•	•	•	•
Speed	•	•	•	•
Center-to-center axle spacing	•	•	•	•
Vehicle class (via axle configuration)	•	•		
Site identification code	•	•	•	•
Lane and direction of travel	•	•	•	
Date and time of passage	•	•	•	•
Sequential vehicle record number	•	•	•	•
Wheelbase (front-to-rear axle)	•	•		
Equivalent single-axle load	•	•		
Violation code	•	•	•	•
Acceleration estimate			•	•

Table 5.
ASTM performance requirements for WIM systems

Function	Tolerance for 95% Probability of Conformity				
	Type I	Type II	Type III	Type IV	
				Value \geq lb (kg) ^a	\pm lb (kg)
Wheel load	$\pm 25\%$		$\pm 20\%$	5,000 (2,300)	250 (100)
Axle load	$\pm 20\%$	$\pm 30\%$	$\pm 15\%$	12,000 (5,400)	500 (200)
Axle group load	$\pm 15\%$	$\pm 20\%$	$\pm 10\%$	25,000 (11,300)	1,200 (500)
Gross vehicle weight	$\pm 10\%$	$\pm 15\%$	$\pm 6\%$	60,000 (27,200)	2,500 (1,100)
Speed			± 1 mi/h (± 2 km/h)		
Axle spacing			± 0.5 ft (± 15 - cm)		

^a Lower values are not usually a concern in enforcement.

Source: *Standard Specification for Highway Weigh-in-Motion (WIM) Systems with User Requirements and Test Method*, Designation E 1318-02, 2005 Annual Book of ASTM Standards, Vol. 04.03, West Conshohocken, PA: ASTM.

Table 6.
California Department of Transportation (Caltrans) performance requirements for WIM systems^a

Parameter	Mean	Standard Deviation
Vehicle weight		
Single axle	$\pm 5\%$	8%
Tandem axle	$\pm 5\%$	6%
Gross weight	$\pm 5\%$	5%
Axle spacing	± 150 mm (6 in)	300 mm (12 in)
Vehicle length	± 300 mm (12 in)	460 mm (18 in)
Vehicle speed	± 1.6 km/h (1 mi/h)	3.2 km/h (2 mi/h)

^a Source: McCall, W. and W.C. Vodrazka Jr., *States' Successful Practices Weigh-In-Motion Handbook*, Center for Transportation Research and Education (CTRE), Iowa State University, Ames, IO, Dec. 15, 1997, http://www.ctre.iastate.edu/research/wim_pdf/index.htm.

Table 7 gives typical values for the inherent variance component of the system accuracy (for a ± 1 standard deviation confidence interval) for piezoelectric, bending plate, and single load cell systems. The table shows that it is common for WIM systems to be less accurate when weighing individual axle groups than when measuring gross vehicle weight. The effect of vehicle speed on total system accuracy is accounted for later in Table 8. Time out factors are sometimes programmed into WIM systems to assist in separating the weight of one vehicle from another.

Table 7.
Inherent variance component of system accuracy ^a
(1 standard deviation confidence interval)

WIM System Technology	Axle Group WIM Accuracy (%)	GVW ^b WIM Accuracy (%)
Piezoelectric cable ^c	12	10
Bending plate	3	2
Single load cell	2	1

^a Source: Bergan, A.T., C.F. Berthelot, and B. Taylor, "Effect of Weigh in Motion Accuracy on Weight Enforcement Accuracy," *Proc. of 7th Annual Meeting, ITS-America*, Washington, D.C., 1997 and IRD Bending Plate and Load Cell Weigh-in-Motion Scales Technical Specifications, Aug. 1997 and Jan. 1998.

^b Gross vehicle weight

^c By comparison, the Kistler piezoelectric quartz sensor specification for wheel load measurement accuracy is approximately ± 3 percent.

Calibration ensures that the estimation of static weight by the WIM system closely approximates the true static weight. Calibration accounts for site-specific effects such as pavement temperature, vehicle speed, and pavement condition. Calibration procedures may include an acceptance testing phase and a recalibration phase.

Acceptance testing of WIM systems as applied by Caltrans and reported in the *State's Successful Practices Weigh-in-Motion Handbook* (McCall and Vodrazka, 1997) has three stages: system component operation verification, initial calibration process, and a 72-h continuous operation verification.

Table 8.
Accuracy specifications for bending plate and load cell WIM scales^a
(1 standard deviation confidence interval)

Speed	Application	Load type	Bending Plate Accuracy	Load Cell Accuracy ^b
2 to 10 mi/h (3.2 to 16 km/h)	Low speed/slow roll just prior to static scales	Single axle Tandem axle Gross weight	± 3% of applied ± 3% of applied ± 2% of applied	± 2% of applied ± 1.5% of applied ± 1% of applied
11 to 25 mi/h (18 to 40 km/h)	Low speed ramp	Single axle Tandem axle Gross weight	± 4% of applied ± 4% of applied ± 3% of applied	± 4% of applied ± 3% of applied ± 2% of applied
26 to 45 mi/h (42 to 72 km/h)	Medium speed ramp	Single axle Tandem axle Gross weight	± 6% of applied ± 6% of applied ± 4% of applied	± 5% of applied ± 4% of applied ± 3% of applied
46 and above mi/h (74 and above km/h)	High speed ramp or mainline	Single axle Tandem axle Gross weight	± 8% of applied ± 8% of applied ± 5% of applied	± 6% of applied ± 5% of applied ± 4% of applied

^a From IRD Bending Plate and Load Cell Weigh-in Motion Scales Technical Specifications

^b Normally single load cell scales are calibrated for one of the speed ranges. If site conditions require more than one speed range, the system is calibrated for the range agreed to by the vendor and user.

- System component testing verifies the transmission of signals by the roadway sensors to the on-site controller and the conversion of the signals into the desired WIM data.
- Initial calibration consists of comparing data obtained when one or more trucks passes over the WIM sensors with measurements taken on a static scale. Several runs are made to measure weight and axle spacing in each lane equipped with WIM sensors at speeds that encompass the expected operational range. These data are utilized to compute the WIM weight factors that convert the dynamic measurements into static weights. The test vehicles make additional runs at each speed to verify the weight factor values. Weight factors can be adjusted to account for seasonal variations, changes in pavement condition, and unique vehicles.
- The 72-h calibration monitors WIM system operation to ensure continuous functioning within the required specifications. When this phase is completed, the system is ready for online operation.

Recalibration occurs throughout the design life of the WIM site. Weight factors are adjusted or repairs made to the system when problems are identified during regularly scheduled data reviews.

The four technologies used in WIM system weight measurement are bending plate, piezoelectric, load cell, and capacitance mat. Each is discussed in the following sections.

Bending Plate

Principles of Operation

Bending plate WIM systems utilize plates with strain gauges bonded to the underside. As a vehicle passes over the bending plate, as illustrated in Figure 11, the system records the strain measured by the strain gauges and calculates the dynamic load. The static load is estimated using the measured dynamic load and calibration parameters. The calibration parameters

account for factors such as vehicle speed, pavement condition, and suspension dynamics, which influence estimates of the static weight.

The accuracy of bending plate WIM systems can be expressed as a function of the vehicle speed traversed over the plates, assuming the system is installed in a sound road structure and subject to normal traffic conditions. The accuracy specifications in Table 8 apply to bending plate scales manufactured by IRD. They are based on a minimum sample of 50 vehicles loaded to within 75% of the legal allowable limit. Vehicles that traverse the scale with more than a 10% speed variation, live loads, or liquid loads are not permitted in the sample.

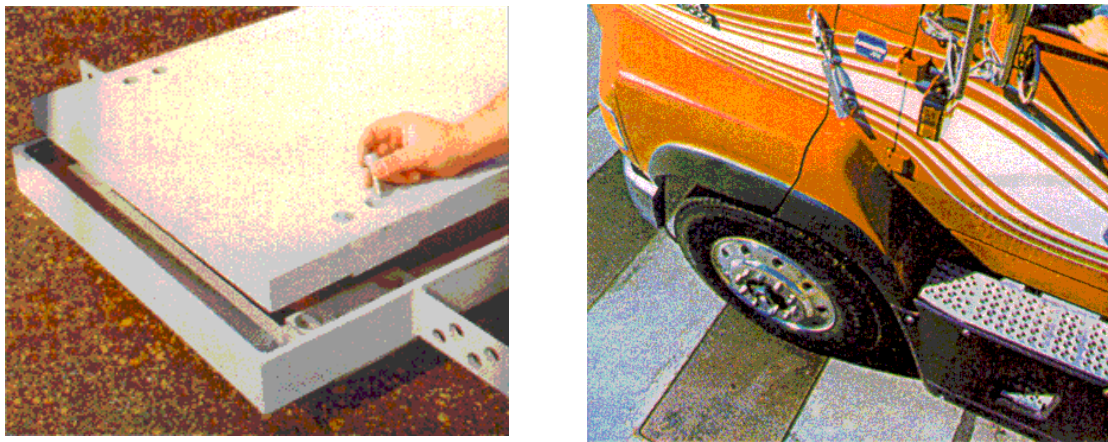

Figure 11. Bending plate sensor. (Photographs courtesy of IRD, Inc., Saskatoon, SK).

Bending plate WIM systems contain either one or two scales and two inductive loop detectors (ILDs). A typical bending plate (or load cell) installation is shown in Figure 12. The scale is placed in the travel lane perpendicular to the direction of travel. When two scales are used in one lane, one scale is placed in each wheel path of the traffic lane so that the left and right wheels are weighed individually. The pair of scales is placed in the lane side-by-side or staggered by 5 m (16 ft). Bending plate systems with one scale in the right or left wheel path are usually used in low volume lanes. The inductive loops are placed upstream and downstream of the scales. The upstream loop detects vehicles and alerts the system to an approaching vehicle.

The downstream loop determines vehicle speed based on the time it takes the vehicle to traverse the distance between the loops.

Advantages

Bending plate WIM systems can be used for traffic data collection as well as for weight enforcement purposes. The accuracy of these systems is higher than piezoelectric systems and their cost is lower than load cell systems. Bending plate WIM system maintenance does not require complete replacement of the sensor but only refurbishing after 5 years.

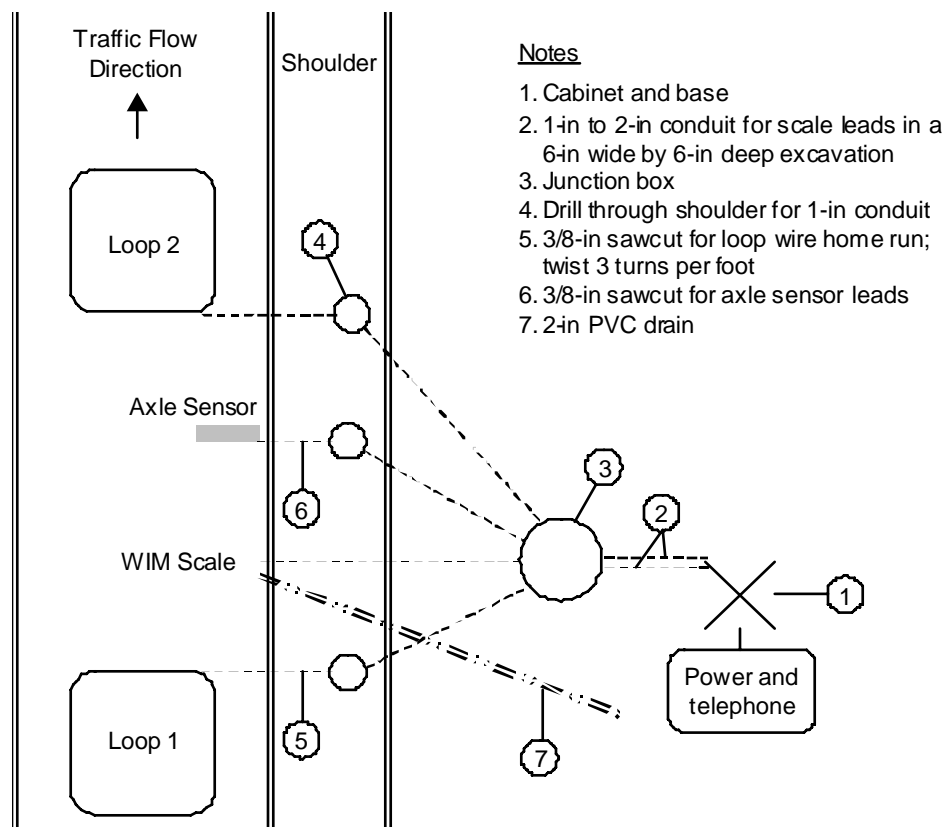

Figure 12. Bending plate or load cell WIM system (typical).

Disadvantages

Bending plate WIM systems are not as accurate as load cell systems and are considerably more expensive than piezoelectric systems.

Piezoelectric

Principles of Operation

Piezoelectric WIM systems contain one or more piezoelectric sensors that detect a change in voltage caused by pressure exerted on the sensor by an axle and thereby measure the axle's weight. As a vehicle passes over the piezoelectric sensor, the system records the sensor output voltage and calculates the dynamic load. As with bending plate systems, the dynamic load provides an estimate of the static load when the WIM system is properly calibrated.

The typical piezoelectric WIM system consists of at least one piezoelectric sensor and two ILDs. The piezoelectric sensor is placed in the travel lane perpendicular to the travel direction. The inductive loops are placed upstream and downstream of the piezoelectric sensor. The upstream loop detects vehicles and alerts the system to an approaching vehicle. The downstream loop provides data to determine vehicle speed and axle spacing based on the time it takes the vehicle to traverse the distance between the loops. Figure 13 shows a full lane-width piezoelectric WIM system installation. In this example, two piezoelectric sensors are utilized on either side of the downstream loop.

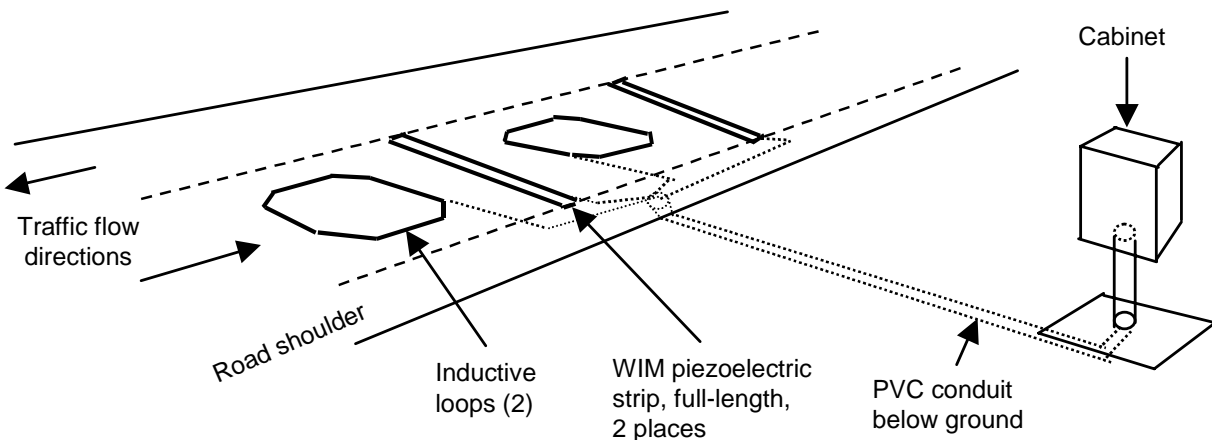

Figure 13. WIM installation with full-length piezoelectric sensors.

A newer piezoelectric WIM sensor technology is the LINEAS quartz sensor manufactured by Kistler. It contains a quartz sensing element mounted along the centerline of an aluminum core as shown in Figure 14 (Kistler, 1997 and Caldera, 1996). The sensor is installed in a slot cut into

the road surface and is grouted with a proprietary compound of epoxy and silica sand. The elastic and thermal properties of the compound closely match those of road surfaces. The sensor is isolated from side forces by an elastic material to help eliminate errors caused by a volume effect. The load bearing pad composed of a mixture of quartz sand and epoxy can be ground even with the road surface.

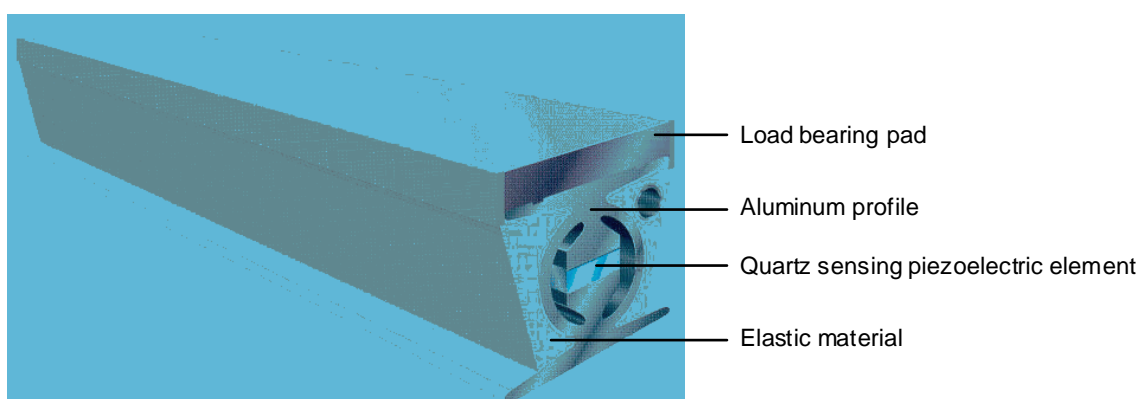

Figure 14. LINEAS quartz sensor (Drawing courtesy of Kistler Instruments AG Winterthur, Switzerland).

Advantages

Piezoelectric tube or cable sensor WIM systems are among the least expensive systems in use today in terms of initial capital costs. The LINEAS quartz sensor is more expensive, but lasts longer, reducing life cycle maintenance costs and increasing reliability. Piezoelectric WIM systems can be used at higher speed ranges (10 to 70 mi/h) than other WIM systems. Piezoelectric WIM systems can be used to monitor up to four lanes.

Quartz sensors do not generally age or fatigue. Temperature effects are negligible as the temperature coefficient of quartz is approximately $-0.02\%/K$. Since quartz crystals have no pyroelectric effect, rapid changes in temperature do not cause a drift in output signal. Wheel load measurements are to within ± 3 percent irrespective of the vehicle speed and position of the wheel along the sensor. The accuracy of these sensors makes them performance and cost competitive with the load cell WIM systems discussed in the next section.

Disadvantages

Piezoelectric tube or cable sensor WIM systems (not quartz) are less accurate than load cell and bending plate WIM systems. These piezoelectric sensors may be sensitive to temperature and speed variations. Piezoelectric tube or cable sensors for WIM systems must be replaced at least once every 3 years.

Load Cell

Principles of Operation

A typical load cell WIM system includes a single load cell, at least one ILD, and one axle sensor. The load cell has two inline scales that operate independently. Off-scale sensors are integrated into the scale assembly to sense any vehicles that are not on the weighing surface. The single load cell system manufactured by IRD contains torsion bars within the WIM system frame that transmit all forces to the load cell. This load cell has a small amount of hydraulic fluid that causes a pressure transducer to relay weight information to roadside data analysis equipment. Load cells are durable and among the most accurate WIM systems as indicated in Table 7.

The load cell is placed in the travel lane perpendicular to the direction of travel. The inductive loop is placed upstream of the load cell to detect vehicles and alert the system of an approaching vehicle. If a second inductive loop is used, it is placed downstream of the load cell to determine axle spacing and vehicle speed. The axle sensor can utilize piezoelectric technology or technology based on the change of sensor resistance with pressure.

Advantages

The load cell system is ranked among the most accurate WIM systems available. Therefore, the load cell WIM system can be utilized for traffic data collection as well as for weight enforcement purposes.

Disadvantages

The load cell is one of the most expensive WIM systems available today, in terms of initial capital costs and life cycle maintenance costs. Also, the load cell WIM system requires a complete replacement of the weighing mechanism after 5 years.

Capacitance Mat

Principles of Operation

A capacitance mat consists of a sandwich of metal steel sheets and dielectric material. In one configuration, displayed in Figure 15, a stainless steel sheet is surrounded by polyurethane dielectric material on either side. The outer surfaces of the polyurethane layers are enclosed by other stainless steel sheets. An a.c. voltage is applied across the sandwich of materials.



Figure 15. Capacitance mat sensor connected to data analysis equipment. (Photograph courtesy of LoadoMeter, Corp., Baltimore, MD).

When a vehicle passes over the mat, the spacing between the plates decreases and causes the capacitance to increase. This changes the resonant frequency of the electrical circuit of which the capacitance mat is a part. The resonant frequency, measured by the data analysis and

recording equipment, is thus proportional to the axle weight. Capacitance mats are also manufactured utilizing aluminum plates separated by a grid of insulating material and air as the dielectric.

Advantages

Capacitance mat sensors can be used for portable as well as permanent WIM applications. These systems can monitor up to four lanes simultaneously.

Disadvantages

Capacitance mat WIM systems are not as accurate as the LINEAS quartz piezoelectric, load cell, and bending plate WIM systems for estimating weights. Also, the equipment and installation costs of these types of systems, whether portable or permanent, are similar to the load cell WIM system costs, which are among the most expensive WIM systems available.

Weigh-in-Motion System Costs

WIM system costs may be expressed in terms of the life cycle cost consisting of initial capital cost (in-road WIM equipment, installation labor and materials, initial calibration, and traffic control) and life-cycle maintenance costs (labor and materials, traffic control, and system recalibration). Table 9 contains budgetary initial capital costs for piezoelectric, bending plate, and load cell technologies assuming typical road, traffic, and weather conditions. These costs may vary from manufacturer to manufacturer and with sensor model. Roadside cabinets, WIM electronics, power and communication connections, etc. are not included as these are common to all the technologies.

The life-cycle maintenance costs vary due to differences in traffic volumes and truck weights, weather, original installation procedures, roadbed condition, onsite quality control, etc. Table 10 presents WIM system life-cycle maintenance and repair costs averaged over North American installations. The costs are based on performing annual routine maintenance (e.g., road inspection and crack filling) on the roadbed surrounding the WIM system. Piezoelectric sensors

are assumed to require replacing every 3 years, bending plates refurbishing every 5 years, and single load cells replacing every 5 years. Life-cycle maintenance costs may vary with manufacturer and sensor model.

Table 9.
Budgetary initial capital costs of WIM systems^a

Capital Cost Component	Piezoelectric	Bending Plate	Single Load Cell
In-road equipment	\$4,500	\$13,000	\$34,000
Installation labor and materials	\$3,500	\$6,500	\$10,500
Traffic control	\$1,000 (1 day)	\$2,000 (2 days)	\$4,000 (4 days)
Total capital cost	\$9,000	\$21,500	\$48,000

^a *Source:* Bergan, A.T., C.F. Berthelot, and B. Taylor, “Effect of Weigh in Motion Accuracy on Weight Enforcement Accuracy,” Proceedings of 1997 Annual Meeting of ITS-America.

Table 10.
Life-cycle maintenance costs of WIM systems^a

Cost Component	Piezoelectric (3 years)	Bending Plate (5 years)	Single Load Cell (5 years)
In-road equipment	\$4,000	\$6,000	\$1,000
Labor and materials	\$4,000	\$5,500	\$500
Traffic control	\$1,500 (1 day)	\$1,500 (1 day)	\$750 (1/2 day)
Total life-cycle cost	\$9,500	\$13,000	\$2,250

^a *Source:* Bergan, A.T., C.F. Berthelot, and B. Taylor, “Effect of Weigh in Motion Accuracy on Weight Enforcement Accuracy,” Proceedings of 1997 Annual Meeting of ITS-America.

The WIM system life-cycle costs may be amortized over the life cycle. Based on the initial installation and life-cycle maintenance costs shown in Tables 9 and 10 and a discount rate of 10 percent over a 20 year WIM system life cycle, the average annual cost for each WIM technology system is:

- Piezoelectric \$3,092 per annum
- Bending plate \$4,636 per annum
- Single load cell \$5,982 per annum.

These figures show that the incremental cost for improved WIM system accuracy, durability, and reliability is relatively small when compared to the annual operating budget of a weight enforcement facility. Costs over other life-cycle intervals may be computed as required.

MANUFACTURER AND VENDOR INFORMATION

Effective Date: 4/10/07

Manufacturer name: _____ <u>Truvelo Manufacturers (Pty) Ltd.</u>	Sales representative name(s): _____ <u>James E. Kelly</u> <u>AVIAR Inc.</u>
Address: <u>P.O. Box 14183</u> <u>Lyttelton 0140</u> <u>South Africa</u>	Address: <u>P.O. Box 162184</u> <u>Austin, TX 78716</u>
Phone number: <u>011-27-11-314-1405</u>	Phone number: <u>(512) 295-5285</u>
Fax number: <u>011-27-11-314-1409</u>	Fax number: <u>(512) 295-2603</u>
e-mail address: <u>rudi@truvelo.co.za</u>	e-mail address: <u>jkelly24@peoplepc.com</u>
URL address: <u>www.truvelo.co.za</u>	URL address: <u>www.aviarinc.com</u>

PRODUCT NAME/MODEL NUMBER: Traffic Classifier/Data Logger (TCL-300)

FIRMWARE VERSION/CHIP NO.: N/A

SOFTWARE VERSION NO.: N/A

GENERAL DESCRIPTION OF EQUIPMENT: TCL-300 stores and analyzes data (outputs 9 vehicle classes) using two inductive loops per lane on up to four lanes

SENSOR TECHNOLOGY AND CONFIGURATION: 2 inductive loops/lane; up to 4 lanes monitored.

SENSOR INSTALLATION: Temporary installation on surface of pavement or permanent installation in pavement surface

INSTALLATION TIME (Per Lane): Temp: 15 min
Perm: 2 hr/lane

INSTALLATION REQUIREMENTS: N/A

MAXIMUM NUMBER OF LANES MONITORED SIMULTANEOUSLY: 4 lanes

PRODUCT CAPABILITIES/FUNCTIONS: Vehicle number, date, time, direction, vehicle class using specially developed vehicle pattern recognition algorithms, vehicle length, headway, data for 20,000 individual vehicles can be stored in 256 kB of memory. Vehicle data are

classified and placed into bins within the instrument according to a user-specified recording interval; 8,000 summarized data records can be stored in this mode.

RECOMMENDED APPLICATIONS: Vehicle classification, vehicle following distances, queuing, and lane occupancy.

POWER REQUIREMENTS (watts/amps): 6 volt internal battery (rechargeable from 12 volt battery, commercial power, or solar energy)

POWER OPTIONS: See above

CLASSIFICATION ALGORITHMS: Vehicle pattern recognition applied to light, medium, heavy or light, rigid trucks and buses, trucks and trailers, tractor and semi-trailer, multi-trailer heavy vehicles

TELEMETRY: RS-232 serial port and modem

COMPUTER REQUIREMENTS: Compatible PC

DATA OUTPUT: See Product Capabilities

DATA OUTPUT FORMATS: N/A

SUPPORTING DATA BASE MANAGEMENT SYSTEM: N/A

EQUIPMENT AND INSTALLATION COSTS (One-lane and four-lane):

	Temporary		Permanent	
	<u>1 lane</u>	<u>4 lane</u>	<u>1 lane</u>	<u>4 lane</u>
Equipment	\$4,000	\$4,000	\$4,700	\$4,700
Installation costs	\$500	\$1,500	\$1,000	\$2,500

STATES CURRENTLY USING THIS EQUIPMENT:

<u>Country/State</u>	<u>Contact name</u>	<u>Telephone number</u>
USA/Michigan	Jim Kramer	(517) 322-1736

MANUFACTURER AND VENDOR INFORMATION

Effective Date: 4/10/07

Manufacturer name: <u>Truvelo Manufacturers (Pty) Ltd.</u>	Sales representative name(s): <u>James E. Kelly</u>
	<u>AVIAR Inc.</u>
Address: <u>P.O. Box 14183</u>	Address: <u>P.O. Box 162184</u>
<u>Lyttelton 0140</u>	<u>Austin, TX 78716</u>
<u>South Africa</u>	
Phone number: <u>011-27-11-314-1405</u>	Phone number: <u>(512) 295-5285</u>
Fax number: <u>011-27-11-314-1409</u>	Fax number: <u>(512) 295-2603</u>
e-mail address: <u>rudi@truvelo.co.za</u>	e-mail address: <u>jkelly24@peoplepc.com</u>
URL address: <u>www.truvelo.co.za</u>	URL address: <u>www.aviarinc.com</u>

PRODUCT NAME/MODEL NUMBER: Traffic Data Logger (TDL-500)

FIRMWARE VERSION/CHIP NO.: N/A

SOFTWARE VERSION NO.: N/A

GENERAL DESCRIPTION OF EQUIPMENT: TDL-500 is used with inductive loops and capacitive weight sensors to provide high speed Weigh-In-Motion (WIM) data.

SENSOR TECHNOLOGY AND CONFIGURATION: 2 inductive loops and 1 capacitive weight sensor per lane; up to 4 lanes monitored.

SENSOR INSTALLATION: In the portable set-up, stick-on inductive loops and the Series 8 capacitive weight sensor are placed on top of the road pavement. This method allows for a cost-effective solution to monitor axle loading on all paved roads not covered by permanent sites. Typically data for one week are collected and processed. In this way many different sites can be monitored. TRUVELO also offers the Series 9 capacitive weight sensors placed in stainless steel pans, flush mounted with the pavement, to monitor axle loading on permanent sites. The Series 9 weight sensor can be replaced by a "Dummy" and moved to another site.

INSTALLATION TIME (Per Lane): Temp: 15 min
Perm: 2 hr/lane

INSTALLATION REQUIREMENTS: N/A

MAXIMUM NUMBER OF LANES MONITORED SIMULTANEOUSLY: 4 lanes

PRODUCT CAPABILITIES/FUNCTIONS: The road sensors consist of two inductive loops and one capacitive weight sensor per lane to cover a maximum of four traffic lanes. The TDL-500 combines the sensor information into a default data string consisting of vehicle number, arrival date and time, gap time, lane number, travel direction, vehicle straddling present, trailer present, vehicle chassis height, vehicle speed, vehicle length, vehicle class, number of axles, axle weight, axle distance, equivalent standard axle load, weight violations and bridge overloading. Data are stored into battery backed-up RAM of 512 kB to 8MB, space for 34000 to 650000 individual vehicle data strings. The operator can decide which data are to be stored, in what sequence and use logical AND/OR combinations of above parameters, e.g., all class 9 vehicles exceeding a certain speed AND a certain weight AND a certain length will be stored in individual data format, directly printed or sent to the computer. Certain operator selected data can be grouped per time interval into bins to maximize available memory space. The standard vehicle classification format is the American FHWA, but like all other parameters, is operator programmable. AND/OR combinations of number of axles, axle weight, axle distance, wheel base, gross vehicle mass, vehicle length, chassis height and trailer presence can be used to create virtually any classification scheme.

RECOMMENDED APPLICATIONS: Vehicle classification.

POWER REQUIREMENTS (watts/amps): 6 volt internal battery (rechargeable from 12 volt battery, commercial power, or solar energy)

POWER OPTIONS: See above

CLASSIFICATION ALGORITHMS: Vehicle pattern recognition used to provide outputs according to American FHWA classification scheme.

TELEMETRY: RS232 serial port and modem

COMPUTER REQUIREMENTS: Compatible PC

DATA OUTPUT: See Product Capabilities

DATA OUTPUT FORMATS: N/A

SUPPORTING DATA BASE MANAGEMENT SYSTEM: N/A

EQUIPMENT AND INSTALLATION COSTS (One-lane and four-lane):

STATES CURRENTLY USING THIS EQUIPMENT:

Country/State

Contact name

Telephone number

MANUFACTURER AND VENDOR INFORMATION

Effective Date: March 22, 2000

Manufacturer name: International Road Dynamics, Inc.

Sales representative name(s): Rod Klashinsky

Address: 702 43rd Street East
Saskatoon SK, S7K 3T9 Canada

Address: _____

Phone number: 306-653-6600

Phone number: _____

Fax number: 306-242-5599

Fax number: _____

e-mail address: info@irdinc.com

e-mail address: rod.klashinsky@ird.ca

URL address: www.irdinc.com

URL address: _____

PRODUCT NAME/MODEL NUMBER: IRD 1068 Piezoelectric WIM System

FIRMWARE VERSION/CHIP NO.: N/A

SOFTWARE VERSION NO.: N/A

GENERAL DESCRIPTION OF EQUIPMENT: The IRD 1068 Piezoelectric WIM system utilizes piezoelectric sensor technology to collect data on axle weights, vehicle classification (based on the number and spacing of axles) and vehicle speed. The system is accessible remotely using a standard telephone communication modem and PC for system monitoring, set-up and data collection.

SENSOR TECHNOLOGY AND CONFIGURATION: The system uses an inductive loop-Class I piezo sensor-Class I piezo sensor-loop configuration to collect traffic data.

SENSOR INSTALLATION: Please see attached product information for details.

INSTALLATION TIME (Per Lane): Approximately 1/2 day per lane.

INSTALLATION REQUIREMENTS: Please see attached product information for details.

MAXIMUM NUMBER OF LANES MONITORED SIMULTANEOUSLY: Eight

PRODUCT CAPABILITIES/FUNCTIONS: Vehicle WIM data collection.

RECOMMENDED APPLICATIONS: Vehicle WIM data collection.

POWER REQUIREMENTS (watts/amps): 2.5 Amps/35 Watts

POWER OPTIONS: 100-240 VAC, 50-60 Hz.

CLASSIFICATION ALGORITHMS: Vehicles can be classified based on axle weights, axle spacings, axle groupings and GVW.

TELEMETRY: Terminal software and standard

COMPUTER REQUIREMENTS: Pentium II or better, 400 MHz min., 32 Mb RAM min., Expansion slots 1 ISA, 3PCI, 1 ISA/PCI.

DATA OUTPUT: Individual vehicle and vehicle summary data are stored on the WIM computer, which can be retrieved through a modem. Individual vehicle data can also be sent to an RS 232 port on the WIM in real-time.

DATA OUTPUT FORMATS: The vehicle information is stored on disk files in a compressed format developed by IRD. Software is available to convert the data to CSV (Comma, Separated Value) file. Several industry standard formats are available for the WIM vehicle data transmitted through the RS 232 port.

SUPPORTING DATA BASE MANAGEMENT SYSTEM: Report generation software is available from IRD that reads the compressed vehicle data files directly. Raw data can also be exported to file, which can be read by any database system.

EQUIPMENT AND INSTALLATION COSTS (One-lane and four-lane):

1-lane: \$25,000 US

4-lane: \$40,000 US

STATES CURRENTLY USING THIS EQUIPMENT:

<u>Country/State</u>	<u>Contact name</u>	<u>Telephone number</u>
USA/California (CALTRANS)	Rich Quinley	(916) 645-5651
USA/New Jersey (NJ DOT)	Lou Whiteley	(609) 530-3501
USA/Indiana (IN DOT)	Don Klepinger	(317) 594-5264

MANUFACTURER AND VENDOR INFORMATION

Effective Date: March 22, 2000

Manufacturer name: International Road Dynamics, Inc.

Sales representative name(s): Rod Klashinsky

Address: 702 43rd Street East, Saskatoon SK, S7K 3T9 CANADA

Address: _____

Phone number: 306-563-6600

Phone number: _____

Fax number: 306-242-5599

Fax number: _____

e-mail address: info@ird.ca

e-mail address: rod.klashinsky@ird.ca

URL address: www.irdinc.com

URL address: _____

PRODUCT NAME/MODEL NUMBER: Model 1070 Portable WIM System

FIRMWARE VERSION/CHIP NO.: N/A

SOFTWARE VERSION NO.: WIM Data collection operation software MSDOS 6.22 operating system.

GENERAL DESCRIPTION OF EQUIPMENT: Portable Weigh-in-Motion and data collection unit.

SENSOR TECHNOLOGY AND CONFIGURATION: Uses Inductive Loops and Piezoelectric sensors. Most common configuration is Loop-Piezo-Piezo-Loop

SENSOR INSTALLATION: Portable (On road) Permanent (in-road).

INSTALLATION TIME (Per Lane): Approximately 5-6 hours in a permanent Loop-Piezo-Loop configuration. Approximately 20-30 minutes in a portable application.

INSTALLATION REQUIREMENTS: See attached installation sheet.

MAXIMUM NUMBER OF LANES MONITORED SIMULTANEOUSLY: 4 lanes for weigh-in-motion and classifying.

PRODUCT CAPABILITIES/FUNCTIONS: Collects and stores vehicle weight data including axle and gross vehicle weights.

RECOMMENDED APPLICATIONS: Weight enforcement, Traffic planning, safety, and audit.

POWER REQUIREMENTS (watts/amps): AC power for 12 volt, rechargeable battery. 24 hours operation with standard battery pack.

POWER OPTIONS: Additional battery units, solar package.

CLASSIFICATION ALGORITHMS: See attached.

TELEMETRY: RS232 port with baud rates from 300 to 19,200.

COMPUTER REQUIREMENTS: MSDOS lap top

DATA OUTPUT FORMATS: Standard Data reporting package.

SUPPORTING DATA BASE MANAGEMENT SYSTEM: Dependent on customer requirements.

EQUIPMENT AND INSTALLATION COSTS (One-lane and four-lane): Permanent one lane – approx. US \$15,000.00, 4 lanes approx. US \$25,000.00.

STATES CURRENTLY USING THIS EQUIPMENT:

<u>Country/State</u>	<u>Contact name</u>	<u>Telephone number</u>
USA/Nebraska		
USA/Colorado		
USA/North Carolina		
USA/West Virginia		
Canada/Saskatchewan		
Canada/Ontario		
Canada/New Brunswick		
Argentina		
Mexico		
Japan		
Korea		
India		

MANUFACTURER AND VENDOR INFORMATION

Effective Date: March 22, 2000

Manufacturer name: International Road Dynamics, Inc.

Sales representative name(s): Rod Klashinsky

Address: 702 43rd Street East, Saskatoon SK, S7K 3T9 CANADA

Address: _____

Phone number: 306-653-6600

Phone number: _____

Fax number: 306-242-5599

Fax number: _____

e-mail address: info@ird.ca

e-mail address: rod.klashinsky@ird.ca

URL address www.irdinc.com

URL address: _____

PRODUCT NAME/MODEL NUMBER: Model 8000 Weigh-In-Motion Mat.

FIRMWARE VERSION/CHIP NO.: N/A

SOFTWARE VERSION NO.: MS-DOS 6.2

GENERAL DESCRIPTION OF EQUIPMENT: Portable AC/DC powered vehicle weighing and screening device.

SENSOR TECHNOLOGY AND CONFIGURATION: Uses flat rectangular capacitance pads (2 per lane).

SENSOR INSTALLATION: Portable, lay flat on road.

INSTALLATION TIME (Per Lane): Set-up time-less than 10 minutes.

INSTALLATION REQUIREMENTS: Portable

MAXIMUM NUMBER OF LANES MONITORED SIMULTANEOUSLY: One lane, slow speed (0-24 km).

PRODUCT CAPABILITIES/FUNCTIONS: Weighs trucks to screen for overweight vehicles.

RECOMMENDED APPLICATIONS: Prescreening for Weigh Stations, Random Spot Checks, Mobile Weigh.

POWER REQUIREMENTS (watts/amps): AC Power or DC power (through automobile lighter)

POWER OPTIONS: AC or DC

CLASSIFICATION ALGORITHMS: See attached specifications

TELEMETRY: N/A

COMPUTER REQUIREMENTS: Laptop computer supplied with system

DATA OUTPUT FORMATS: Vehicle information stored in data files and also sent to printer.

SUPPORTING DATA BASE MANAGEMENT SYSTEM: Dependent upon customer requirements.

EQUIPMENT AND INSTALLATION COSTS (One-lane and four-lane): Equipment costs US \$18,500.00 for complete system.

STATES CURRENTLY USING THIS EQUIPMENT:

<u>Country/State</u>	<u>Contact name</u>	<u>Telephone number</u>
USA/Wisconsin		
USA/North Dakota		
Brazil		
Uruguay		
Korea		

MANUFACTURER AND VENDOR INFORMATION

Effective Date: March 22, 2000

Manufacturer name: _____
International Road Dynamics Inc.

Sales representative name(s): _____
Rod Klashinsky

Address: _____
702 43rd Street East
Saskatoon SK, S7K3T9 Canada

Address: _____

Phone number: (306) 653-6600

Phone number: _____

Fax number: (306) 242-5599

Fax number: _____

e-mail address: info@irdinc.com

e-mail address: rod.klashinsky@ird.ca

URL address: www.irdinc.com

URL address: _____

PRODUCT NAME/MODEL NUMBER: IRD 1068 Single Load Cell Scale (SLC) WIM System

FIRMWARE VERSION/CHIP NO.: N/A

SOFTWARE VERSION NO.: N/A

GENERAL DESCRIPTION OF EQUIPMENT: The IRD 1068 Single Load Cell (SLC) scale WIM system utilizes Single Load Cell (SLC) scale technology to collect data on axle weights, vehicle classification (based on the number and spacing of axles) and vehicle speed. The system is accessible remotely using a standard telephone communication modem and PC for system monitoring, set-up and data collection.

SENSOR TECHNOLOGY AND CONFIGURATION: The system uses an inductive loop Single Load Cell scale – piezo sensor loop configuration to collect traffic data.

SENSOR INSTALLATION: Please see attached product information for details

INSTALLATION TIME (Per Lane): Approximately 3 days per lane

INSTALLATION REQUIREMENTS: Please see attached product information for details

MAXIMUM NUMBER OF LANES MONITORED SIMULTANEOUSLY: 6

PRODUCT CAPABILITIES/FUNCTIONS: Vehicle WIM data collection

RECOMMENDED APPLICATIONS: Vehicle WIM data collection

POWER REQUIREMENTS (watts/amps): 2.5 amps/35 watts

POWER OPTIONS: 100-240 VAC, 50-60 Hz

CLASSIFICATION ALGORITHMS: Vehicles can be classified based on axle weights, axle spacings, axle groupings and GVW.

TELEMETRY: Terminal software and standard telephone line with modem required.

COMPUTER REQUIREMENTS: Pentium II or better, 400 MHZ min, 32 Mb RAM min, Expansion slots 1 ISA, 3PCI, 1 ISA/PCI.

DATA OUTPUT: Individual vehicle and vehicle summary data are stored on the WIM computer which can be retrieved through a modem. Individual data can also be sent to an RS 232 port on the WIM in real time.

DATA OUTPUT FORMATS: The vehicle information is stored on disk files in a compressed format developed by IRD. Software is available to convert the data to CSV (Comma, Separated Value) file. Several industry standard formats are available for the WIM vehicle data transmitted through the RS 232 port.

SUPPORTING DATA BASE MANAGEMENT SYSTEM: Report generation software is available from IRD that reads the compressed vehicle data files directly. Raw data can also be exported to file, which can be read by any database system.

EQUIPMENT COSTS (One-lane and four-lane):

1-lane: \$75,000 US

4-lane: \$215,000 US

STATES CURRENTLY USING THIS EQUIPMENT:

<u>Country/State</u>	<u>Contact name</u>	<u>Telephone number</u>
USA/Indiana (INDOT)	Don Klepinger	(317) 591-5264
USA/Minnesota (MNDOT)	Mark Novak	(651) 296-2607

MANUFACTURER AND VENDOR INFORMATION

Effective Date: 3/1/2000

Manufacturer name: Haenni/Mikros

Sales representative name(s): _____

Loadometer Corporation

3-G Nashua Court

Address: _____

Address: Baltimore, MD 21221-3133

Phone number: _____

Phone number: (800) 753-6696

Fax number: _____

Fax number: (410) 574-2856

e-mail address: _____

e-mail address: gmuhler@loadometer.com

URL address: _____

URL address: www.loadometer.com

PRODUCT NAME/MODEL NUMBER: WL110, Low Speed Portable WIM

FIRMWARE VERSION/CHIP NO.:

SOFTWARE VERSION NO.:

GENERAL DESCRIPTION OF EQUIPMENT: System consists of 2 sensors, 4 leveling mats, connecting cables and hand held monitor.

SENSOR TECHNOLOGY AND CONFIGURATION: Capacitance mat, stainless steel construction

SENSOR INSTALLATION: None, above ground

INSTALLATION TIME (Per Lane): 5 minutes

INSTALLATION REQUIREMENTS: None

MAXIMUM NUMBER OF LANES MONITORED SIMULTANEOUSLY: One

PRODUCT CAPABILITIES/FUNCTIONS: Capable of providing wheel loads, axle loads, axle group loads, gross vehicle weight and violations per set parameters

RECOMMENDED APPLICATIONS: Statistical gathering purposes and as screening device in commercial vehicle weight law enforcement

POWER REQUIREMENTS (watts/amps): Internal battery, external power supply

POWER OPTIONS: Internal battery, external power supply.

CLASSIFICATION ALGORITHMS:

TELEMETRY:

COMPUTER REQUIREMENTS:

DATA OUTPUT:

DATA OUTPUT FORMATS:

SUPPORTING DATA BASE MANAGEMENT SYSTEM:

EQUIPMENT AND INSTALLATION COSTS (One-lane and four-lane):

Installation Costs: None, portable system

Equipment Cost: \$20,000 maximum

STATES CURRENTLY USING THIS EQUIPMENT:

<u>Country/State</u>	<u>Contact name</u>	<u>Telephone number</u>
USA/Arizona	Sgt. Charles Blundell	(602) 773-3613
	Lt. Ken Barton	(602) 223-2522
USA/Exeter Township	Officer Chris Neidert	(617) 777-1490
USA/Falls Township	Lt. Charles Shaffner	(215) 949-9110
USA/Idaho DOT	Alan Frew	(208) 334-8694
USA/Kansas Hwy Patrol	Sgt. David McKee	(913) 296-7903
USA/Michigan St. Police	Lt. Jim Charles	(616) 784-8362
USA/Montana DOT	Gary Marten	(406) 444-6130
USA/Nebraska St. Patrol	Lt. Jim Doggt	(402) 471-0105
USA/NH State Police	Sgt. Wayne Peasley	(603) 271-3339
USA/PA DOT	Lance McAffe	(717) 783-8776
USA/Uwchlan Township	Cpl. Buddy Mauger	(610) 524-1135
USA/Vermont DOT	Ron Macie	(802) 828-2067
USA/West VA DOT	Jeff Davis	(304) 558-3723

MANUFACTURER AND VENDOR INFORMATION

Effective Date: March 22, 2000

Manufacturer name: International Road
Dynamics, Inc.

Sales representative name(s): Rod Klashinsky

Address: 702 43rd Street East
Saskatoon SK, S7K 3T9 Canada

Address: _____

Phone number: 306-653-6600

Phone number: _____

Fax number: 306-242-5599

Fax number: _____

e-mail address: info@irdinc.com

e-mail address: rod.klashinsky@ird.ca

URL address: www.irdinc.com

URL address: _____

PRODUCT NAME/MODEL NUMBER: IRD Dynamic Work-Zone Safety System

FIRMWARE VERSION/CHIP NO.: N/A

SOFTWARE VERSION NO.: N/A

GENERAL DESCRIPTION OF EQUIPMENT: The IRD Work-Zone Safety System is a traffic control system for construction work zones. The system utilizes traffic detection sensors to detect traffic queue length and reduce the number of vehicles in the passing lane prior to work-zone approaches.

SENSOR TECHNOLOGY AND CONFIGURATION: The IRD Dynamic work-Zone Safety System utilizes traffic sensors to detect vehicles and activate flashing lights mounted on "DO NOT PASS" panel signs prior to construction zones. Alternately, CMS or VMS signs can be used.

SENSOR INSTALLATION: Sensors are mounted on roadside panel message signs.

INSTALLATION TIME (Per Lane): The system can typically be installed in 4-5 days.

INSTALLATION REQUIREMENTS: Please see attached product information for details.

MAXIMUM NUMBER OF LANES MONITORED SIMULTANEOUSLY: Only one lane is required to be monitored for this application.

PRODUCT CAPABILITIES/FUNCTIONS: Detection of vehicles prior to a work-zone to trigger flashing lights mounted on roadway panel signs to instruct vehicles to merge into one lane. Since the signs are regulatory signs, offences are enforceable by law.

RECOMMENDED APPLICATIONS: Detection of vehicles prior to a work-zone to trigger flashing lights mounted on roadway panel signs.

POWER REQUIREMENTS (watts/amps): 12-24 AC or DC

POWER OPTIONS: AC, DC, or solar.

CLASSIFICATION ALGORITHMS: N/A

TELEMETRY: N/A

COMPUTER REQUIREMENTS: Laptop may be used to access information using serial communications software such as HyperTerminal.

DATA OUTPUT: Serial or contact Closure.

DATA OUTPUT FORMATS: ASCII

SUPPORTING DATA BASE MANAGEMENT SYSTEM: N/A

EQUIPMENT AND INSTALLATION COSTS (One-lane and four-lane):
Approximately \$60,000 US depending on the requirements (trailer and sign costs not included).

STATES CURRENTLY USING THIS EQUIPMENT:

<u>Country/State</u>	<u>Contact name</u>	<u>Telephone number</u>
USA/Indiana (IN DOT)	Dan Shamo	(317) 232-5533

Chapter 5 – Over-roadway Sensor Technologies

Over-roadway sensors are those that *do not* require the installation of the sensor directly onto, into, or below the road surface. Over-roadway sensors are mounted over the center of the roadway or to the side of the roadway. Video image processor, microwave radar, active and passive infrared, ultrasonic, and passive acoustic array are technologies applied to over-roadway sensors as discussed in the following sections.

VIDEO IMAGE PROCESSOR

Video cameras were introduced to traffic management for roadway surveillance because of their ability to transmit closed circuit television imagery to a human operator for interpretation. Present-day traffic management applications use video image processing to automatically analyze the scene of interest and extract information for traffic surveillance and control. A video image processor (VIP) system (sometimes referred to as a machine vision processor) typically consists of one or more cameras, a microprocessor-based computer for digitizing and processing the imagery, and software for interpreting the images and converting them into traffic flow data.

Principles of Operation

Video image processor systems detect vehicles by analyzing the imagery from a traffic scene to determine changes between successive frames. The image processing algorithms that analyze black and white imagery examine the variation of gray levels in groups of pixels contained in the video frames. The algorithms are designed to remove gray level variations in the image background caused by weather conditions, shadows, and daytime or nighttime artifacts and retain objects identified as automobiles, trucks, motorcycles, and bicycles. Traffic flow parameters are calculated by analyzing successive video frames. Color imagery can also be exploited to obtain traffic flow data. The improved resolution of color cameras and their ability to operate at low light levels is making this approach more viable.

Three types of data extraction approaches are available to VIPs: tripline, closed-loop tracking,

and data association tracking. Tripline systems allow the user to define a limited, but usually sufficient number of detection zones in the field of view of the video camera. When a vehicle crosses one of these zones, it is identified by noting changes in the pixels caused by the vehicle relative to the roadway in the absence of a vehicle. Surface-based and grid-based analyses are utilized to detect vehicles in tripline VIPs. The surface-based approach identifies edge features, while the grid based classifies squares on a fixed grid as containing moving vehicles, stopped vehicles, or no vehicles. Tripline systems estimate vehicle speed by measuring the time it takes an identified vehicle to travel a detection zone of known length. The speed is found as the length divided by the travel time (Klein, 2001; Klein, et al., 2006).

The advent of the VIP tracking approaches has been facilitated by low-cost, high throughput microprocessors. Closed-loop tracking systems are an extension of the tripline approach that permits vehicle detection along larger roadway sections. The closed-loop systems track vehicles continuously through the field of view of the camera. Multiple detections of the vehicle along a track are used to validate the detection. Once validated, the vehicle is counted and its speed is updated by the tracking algorithm (MacCarley, 1992). These tracking systems may provide additional traffic flow data such as lane-to-lane vehicle movements. Therefore, they have the potential to transmit information to roadside displays and radios to alert drivers to erratic behavior that can lead to an incident.

Data association tracking systems identify and track a particular vehicle or groups of vehicles as they pass through the field of view of the camera. The computer identifies vehicles by searching for unique connected areas of pixels. These areas are then tracked from frame-to-frame to produce tracking data for the selected vehicle or vehicle groups. The markers that identify the objects are based on gradients and morphology. Gradient markers utilize edges, while morphological markers utilize combinations of features and sizes that are recognized as belonging to known vehicles or groups of vehicles (Wentworth, et. al., 1994). Systems are being developed that use data association tracking to gather travel time and origin-destination pair information by identifying and tracking vehicles as they pass from one camera's field of view to another's. Figures 16 and 17 show examples of video image processors that use the tripline

approach. Some of these models also incorporate some vehicle tracking in their processing algorithms.

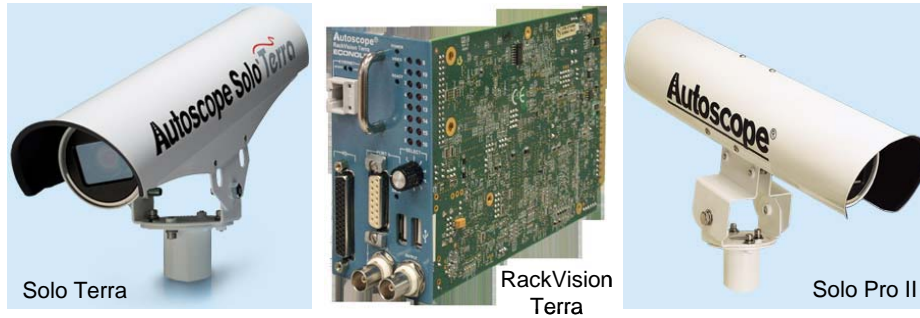

(a) Autoscope VIPs (Photograph courtesy of Econolite Control Products, Anaheim, CA)



(b) Traficon VIPs (Photograph courtesy of Traficon, Heule, Belgium)



(c) Iteris Vantage Edge2 processors (Photograph courtesy of Iteris, Anaheim, CA)

Figure 16. Video image processors (also referred to as machine vision processors).



Peek VideoTrak Plus and UniTrak (Photograph courtesy of Quixote Traffic Corp.-Peek Traffic, Palmetto, FL)

Figure 17. Video image processors (continued).

Signal Processing

Image formatting and data extraction are performed with firmware that allows image processing algorithms to run in real time. The hardware that digitizes the video imagery is commonly implemented on a single card in a personal computer architecture. Once the data are digitized and stored, spatial and temporal features are extracted from the vehicles in each detection area with a series of image processing algorithms. In the concept illustrated in Figure 18, a detection process establishes one or more thresholds that limit and segregate the data passed on to the rest of the algorithms. It is undesirable to severely limit the number of potential vehicles during detection, for once data are removed they cannot be recovered. Therefore, false vehicle detections are permitted at this stage since the declaration of actual vehicles is not made at the conclusion of the detection process. Rather, algorithms that are part of the classification, identification, and tracking processes still to come are relied on to eliminate false vehicles and retain the real ones (Klein, 1997).

Image segmentation is used to divide the image area into smaller regions (often composed of individual vehicles) where features can be better recognized. The feature extraction process examines the pixels in the regions for pre-identified characteristics, which are indicative of vehicles. When a sufficient number of these characteristics are present and recognized by the processing, a vehicle is declared present and its flow parameters are calculated.

Artificial neural networks are another form of processing used to classify and identify vehicles, measure their traffic flow parameters, and detect incidents (Chang and Kunhuang, 1993). Features are not explicitly identified and sought when this processing approach is used. Rather software or hardware systems, which emulate the processing that occurs in the human brain, are trained to recognize vehicles. The digital imagery is presented to the trained network for vehicle classification and identification.

VIPs with tracking capability use Kalman filter techniques to update vehicle position and velocity estimates. The time trace of the position estimates yields a vehicle trajectory, which can supply lane change and turning information.

A signal processing approach implemented by Computer Recognition Systems incorporates wireframe models composed of line segments to represent vehicles in the image. This approach claims to provide more unique and discriminating features than other computationally viable techniques. Alternatively, artificial neural networks can be trained to recognize and count different classes of vehicles and detect incidents (Chang & Kunhuang, 1993). The neural network approach is incorporated by Nestor Traffic Systems, Inc. in their VIP products. An advantage of the Nestor implementation is that the camera can be repositioned for data acquisition and surveillance (Nestor Corp., 1999). VIPs that utilize tracking offer the ability to warn of impending incidents due to abrupt lane changes or weaving, calculate link travel times, and determine origin-destination pairs. The tracking concept is found in the Traffic Analysis System by Computer Recognition Systems, MEDIA4 by Citilog, and IDET-2000 by Sumitomo (Klein, 2001).

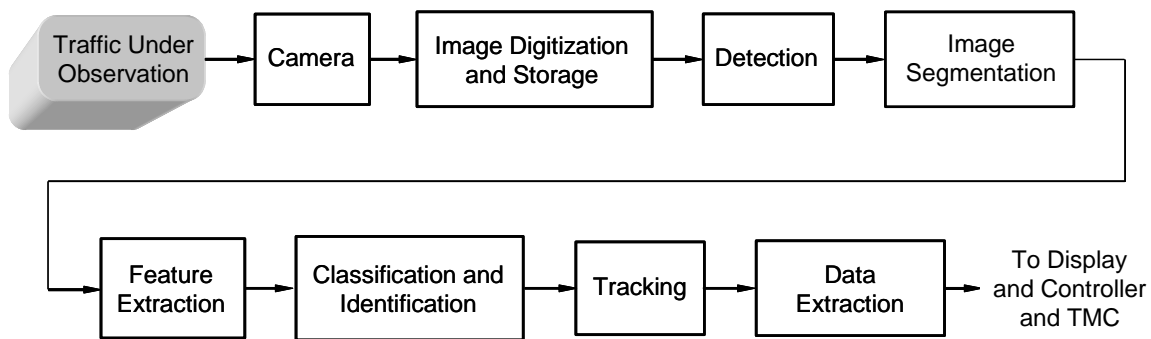

Figure 18. Conceptual image processing for vehicle detection, classification, and tracking. (Klein, 2006)

A description of vehicle tracking methods suitable for VIPs is found in Kanhere, N.K., et al., 2006. A summary of these tracking approaches appears below.

- Blob or region based tracking
 - Generates a background model for the scene
 - For each input image frame, algorithms analyze the absolute difference between the input image and the background image to extract foreground blobs that correspond to the vehicles
 - Vehicle tracking possible at region level and vehicle level

- Difficulties reported handling shadows, occlusions, and large vehicles, all of which cause multiple vehicles to appear as a single vehicle
- Active contour based tracking
 - Tracks the outside contour or boundary of an object
 - Contour initialized using a background difference image and tracked using intensity and motion boundaries
 - Occlusions are detected using depth-ordered regions associated with the objects
- Model based tracking
 - Matches detected objects with preidentified 3-D vehicle models
 - Emphasizes recovery of trajectories for a small number of vehicles with high accuracy
 - Some model-based approaches assume an aerial view of the scene, virtually eliminating all occlusions, and match wire-frame models of vehicles to edges detected in the image
- Feature based tracking
 - Tracks subfeatures in the object, represented as points, rather than tracking the entire object
 - Useful when vehicles are partially occluded
 - Tracks multiple objects by identifying groups of features based on similarity criteria, which are tracked over time
- Color based tracking
 - Color signatures (chromatic information) are used to identify and track objects
 - Vehicle detections are associated with each other by combining chromatic information with driver behavior characteristics and arrival likelihood
- Pattern based tracking
 - Vehicle detection treated as a classical pattern classification problem using support vector machines

Application and Uses

A VIP can replace several in-roadway inductive loops, provide detection of vehicles across several lanes, and perhaps lower maintenance costs. Some VIP systems process data from more

than one camera and further expand the area over which data are collected. VIPs can classify vehicles by their length and report vehicle presence, flow rate, occupancy, and speed for each class. Other potentially available traffic parameters that can be obtained by analyzing data from a series of image processors installed along a section of roadway are density, link travel time, and origin-destination pairs.

Mounting and Traffic Viewing Considerations

VIP cameras can be deployed to view upstream or downstream traffic. The primary advantage of upstream viewing is that incidents are not blocked by the resultant traffic queues as described in Table 11. However, tall vehicles such as trucks may block the line of sight and headlights may cause blooming of the imagery at night. With upstream viewing, headlight beams can be detected as vehicles in adjacent lanes on curved road sections. Downstream viewing conceals cameras mounted on overpasses so that driver behavior is not altered. Downstream viewing also makes vehicle identification easier at night through the information available in the taillights and enhances track initiation because vehicles are first detected when close to the camera.

Although some manufacturers quote a maximum surveillance range for a VIP of ten times the camera mounting height, conservative design procedures limit the range to smaller distances because of factors such as road configuration (e.g., elevation changes, curvature, and overhead or underpass structures), congestion level, vehicle mix, and inclement weather.

Other factors that affect camera installation include vertical and lateral viewing angles, number of lanes observed, stability with respect to wind and vibration, and image quality. VIP cameras can be mounted on the side of a roadway if the mounting height is high, that is 30 to 50 ft (9.1 to 15.2 m). For lower mounting heights of 20 ft (6.1 m), a centralized location over the middle of the roadway area of interest is required. However, the lower the camera mounting, the greater is the error in vehicle speed measurement, as the measurement error is proportional to the vehicle height divided by the camera mounting height. The number of lanes of imagery analyzed by the VIP becomes important when the required observation and analysis area is larger than the VIP's capability. For example, if the VIP provides data from detection zones in three lanes, but five

must be observed, that particular VIP may not be appropriate for the application. VIPs that are sensitive to large camera motion may be adversely affected by high winds as the processor may assume that the wind-produced changes in background pixels correspond to vehicle motion. Image quality and interpretation can be affected by cameras that have automatic iris and automatic gain control. In tests conducted by California Polytechnic Institute at San Luis Obispo (Cal Poly SLO), these systems were disabled (Hockaday, 1991). In follow-up tests, Cal Poly SLO found VIPs better able to compensate for light level changes when the automatic iris was set to respond slowly to variations in light entering the camera.

**Table 11.
Video image processor characteristics in upstream and downstream viewing**

Upstream Viewing	Downstream Viewing
<ul style="list-style-type: none"> • Headlight blooming, glare on wet pavement, headlight beams detected in adjacent lanes on curved road sections • More blockage from tall trucks 	<ul style="list-style-type: none"> • Camera on overpass concealed from drivers • More information from tail lights available for braking indication, vehicle classification, and turning movement identification
<ul style="list-style-type: none"> • Traffic incidents are not blocked by resulting traffic queues • With long wavelength infrared imagery, similar information is available to a tracking algorithm from headlight and tail light viewing 	<ul style="list-style-type: none"> • Easier to acquire vehicles that are closer to the camera for the tracking algorithm application • With visible imagery, more information is available to a tracking algorithm from tail light viewing

Advantages

VIP signal processing is continually improving its ability to recognize artifacts produced by shadows, illumination changes, reflections, inclement weather, and camera motion from wind or vehicle-induced vibration. However, artifacts persist and the user should evaluate VIP performance under the above conditions and other local conditions that may exist. In their 1998 report to the TRB Freeway Operations Committee, the New York State Department of Transportation (DOT) stated that one VIP model had difficulty detecting vehicles on a roadway lightly covered with snow in good visibility. Another model did not experience this problem. An example of the effect of day-to-night illumination change on VIP performance is illustrated in Figure 19. Shortly after 1900 hours, there are changes in the slopes of the vehicle count data

produced by the VIPs due to either degradation in performance of the daytime algorithm or the different performance of the nighttime algorithm (Klein, 1996).

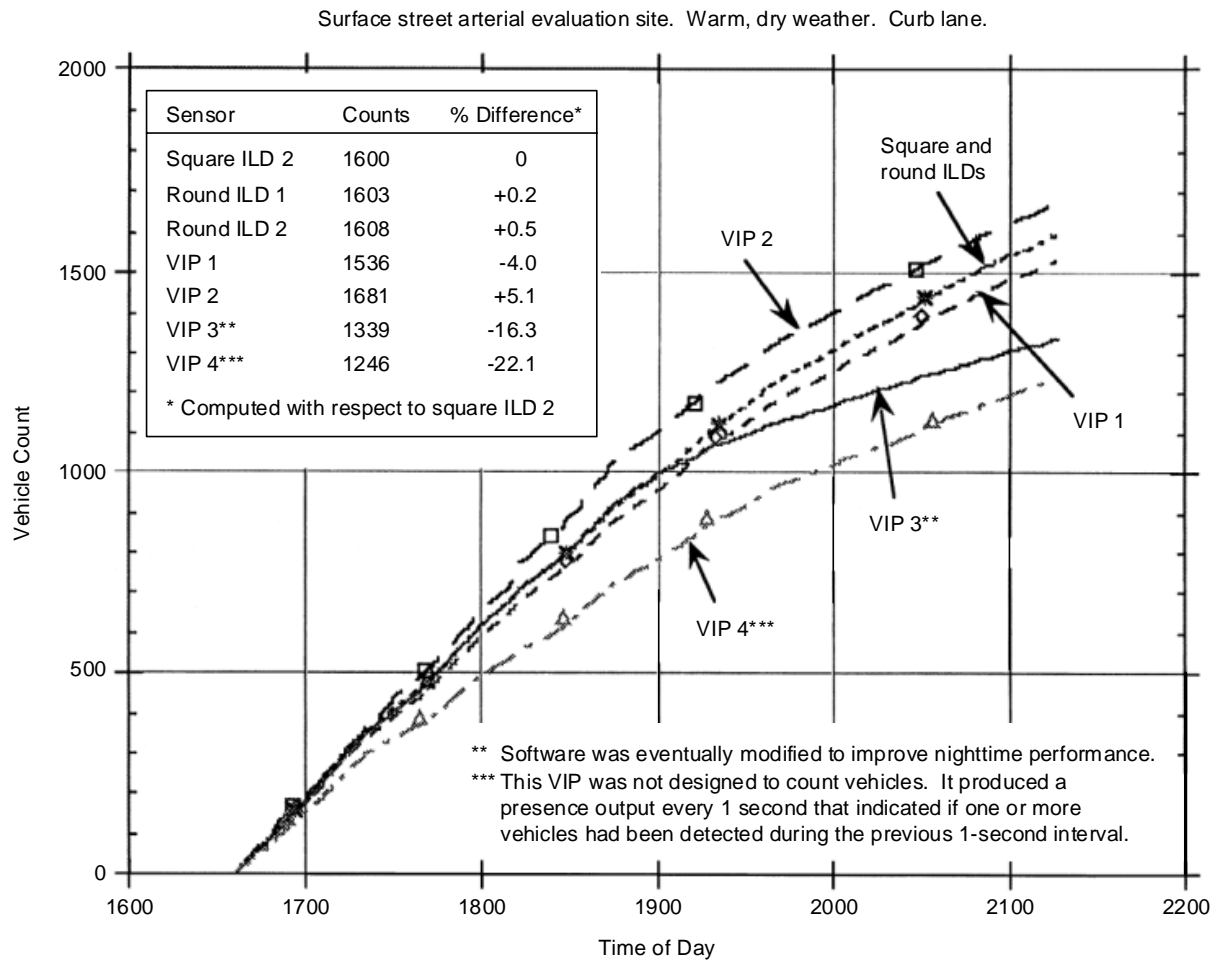

Figure 19. Vehicle count comparison from four VIPs and inductive loop detectors.

Heavy congestion that degraded early VIPs does not appear to present a problem to more modern systems. Combined results for clear and inclement weather show vehicle flow rate, speed, and occupancy measurement accuracies in excess of 95 percent using a single detection zone and a camera mounted at a sufficiently high height (Michalopoulos, et. al., 1993). VIPs with single or multiple detection zones per lane can be used to monitor traffic on a freeway. For signalized intersection control, where vehicle detection accuracies of 100 percent are desired, the number of detection zones per lane is increased to between two and four, dependent on the camera

mounting and road geometry. Even with multiple detection zones, cameras used in a side-viewing configuration that are not mounted high enough, on the order of 30 ft (9 m) rather than 50 ft (15 m)] or are not directly adjacent to the roadway can degrade the vehicle detection accuracy to 85 percent or less (Klein, 1999, vols. 1 and 2). The study that produced these results also reported that vehicle detection was sometimes sensitive to the vehicle-to-road color contrast.

Test results from other VIP performance assessments include (Kranig J., et al., 1997 and Middleton, D. and R. Parker, 2002):

- Low temperatures (near or below freezing) and snow may cause undercounting
- Peak morning traffic flows may cause undercounting, which increases to 10 to 25 percent with slower speeds of <48 to 64 km/h (<30 to 40 mi/h)
- Speed measurement accuracy is within 0 to 8 km/h (0 to 5 mi/h) during peak traffic flow periods
- Occupancy values differed from loop measurements by not more than 6 to 8 percent.

Figures 20 through 22 show VIP test results based on 5-minute averaged data from the Middleton and Parker 2002 evaluation of over-roadway sensors. Figure 20 illustrates vehicle speed as a function of ambient lighting conditions. There is some underreporting of speed by the VIPs with respect to the baseline values, but the speed measurement appears not to be sensitive to the light intensity. Figure 21 depicts the percent error in vehicle count, with respect to the baseline value, versus ambient lighting. Again there appears not to be a large effect on count as reported by the VIPs with respect to lighting changes, although there is a tendency to go from undercounting to overcounting as light intensity decreases. Figure 22 displays the percent error in vehicle count, with respect to the baseline value, as a function of vehicle speed. Peak morning traffic flows are seen to produce undercounting of 10 to 25 percent by the VIPs with respect to the baseline values.

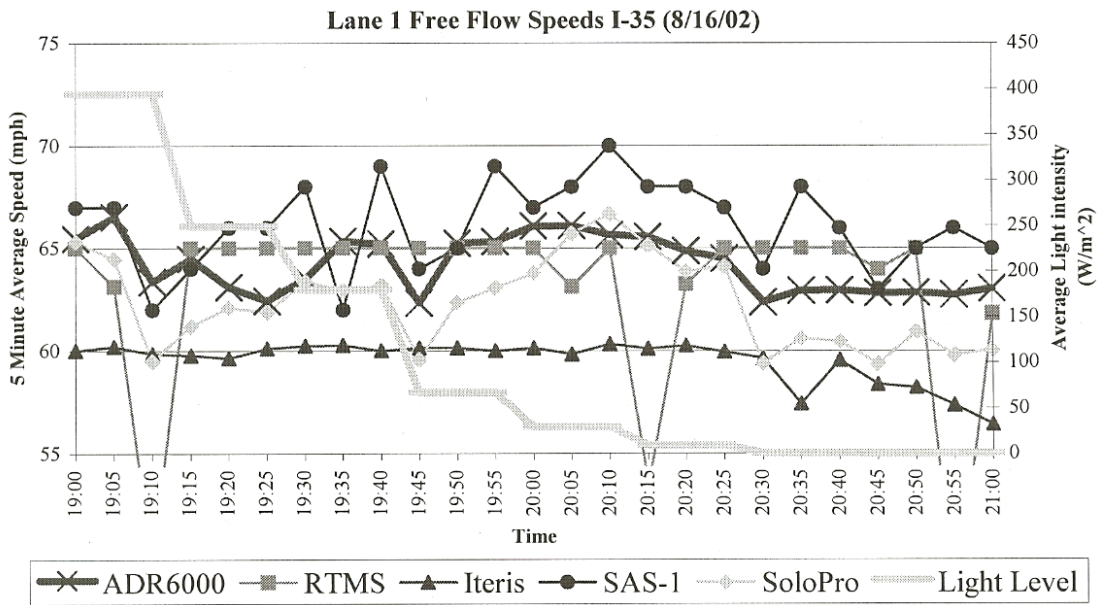

Figure 20. Vehicle speed vs. lighting VIP test results.

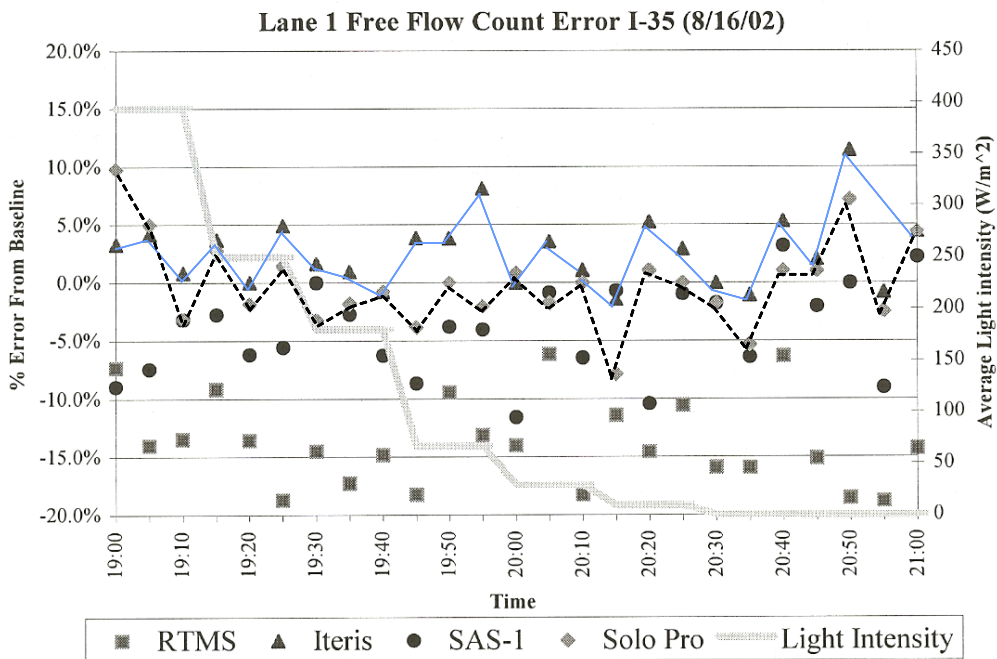

Figure 21. Vehicle count vs. lighting VIP test results.

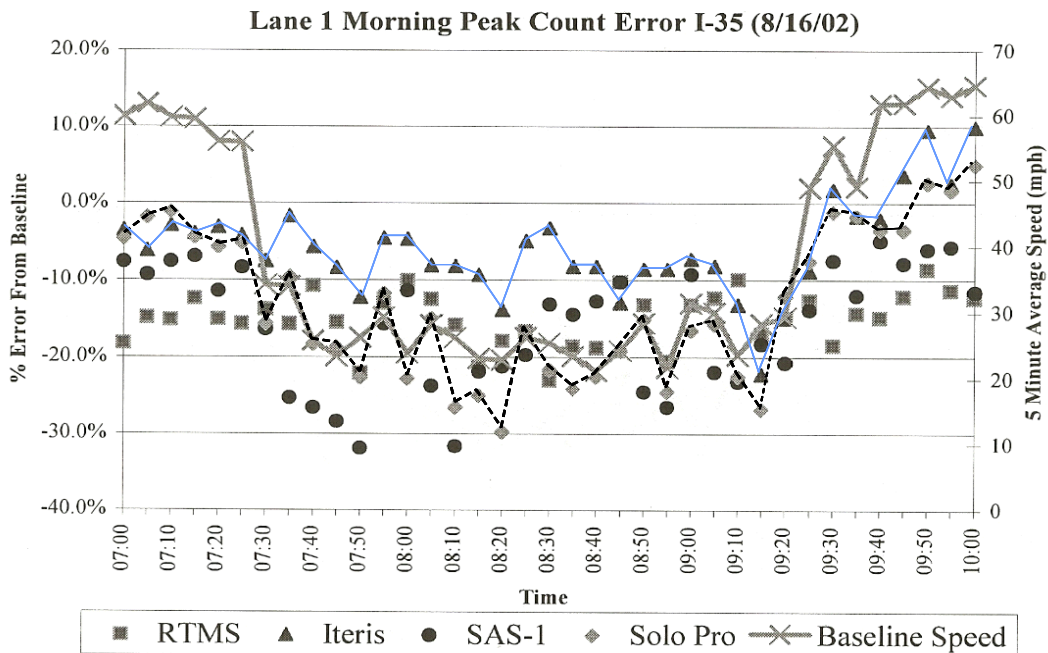

Figure 22. Vehicle count vs. speed VIP test results.

Disadvantages

Some disadvantages of the video image processor include its vulnerability to viewing obstructions; inclement weather; shadows; vehicle projection into adjacent lanes; occlusion; day-to-night transition; vehicle/road contrast; water; salt grime; icicles; and cobwebs on camera lens that can affect performance. Also, some models are susceptible to camera motion caused by strong winds. Furthermore, the installation of a video image processor may require 50 ft or greater camera mounting height (in a side mounting configuration) for optimum presence detection and speed measurement. A video image processor arrangement is generally cost effective only if many detection zones are required within the field of view of the camera.

MANUFACTURER AND VENDOR INFORMATION

Effective Date: 5/10/07

Manufacturer name: Econolite
Control Products, Inc.

Sales representative name(s): _____
Scott Robinson

Address: 3360 E. La Palma Avenue
Anaheim, California 92806-2856

Address: 3360 E. La Palma Avenue
Anaheim, California 92806-2856

Phone number: (714) 630-3700

Phone number: (714) 630-3700

Fax number: (714) 630-6349

Fax number: (714) 666-8354

e-mail address: socalsales@econolite.com

e-mail address: srobinson@econolite.com

URL address: http://www.econolite.com/products/

URL address: _____

PRODUCT NAME/MODEL NUMBER: Autoscope Solo Terra Video Detection System

FIRMWARE VERSION/CHIP NO.: Updates provided as required by the manufacturer.

SOFTWARE VERSION NO.: Updates provided as required by the manufacturer.

GENERAL DESCRIPTION OF EQUIPMENT: The Autoscope Solo Terra sensor contains a color video camera as part of this integrated detection and surveillance machine vision system. It installs with three wires and reduces maintenance with ClearVision faceplate coating. The Solo Terra sensor provides timely vehicle detection, traffic data measurement, speed, and incident detection data.

SENSOR TECHNOLOGY AND CONFIGURATION: Machine vision – video image processing, pixel tracking, and tripline technology.

SENSOR INSTALLATION: Autoscope Solo Terra unit installs on existing signal poles, mast arms, and luminaire standards.

INSTALLATION TIME (Per Lane):

INSTALLATION REQUIREMENTS: Camera and sensor are integrated into one unit. Camera mounting over center of monitored lanes provides optimum performance. Minimum camera mounting height is 30 ft. Greater heights may be required to minimize vehicle occlusion when using side-mounted cameras.

MAXIMUM NUMBER OF LANES MONITORED SIMULTANEOUSLY: Six to seven

PRODUCT CAPABILITIES/FUNCTIONS:

- Connectivity for IP-addressable broadband communications – EasyLink connectivity for simple installation into the traffic cabinet and integration into an agency's IP-based communications network. A standard CAT-5 cable connects Terra Technology products into a network providing access to video, traffic data, and the Autoscope Solo Terra vehicle detection system.
- Web server interface for easy setup
- Streaming digital MPEG-4 video output
- User-definable password protection
- Vehicle detection, traffic data measurement, speed, and incident detection
- Integrated color camera, zoom lens, and dual-core processor for advanced image processing
- Direct real-time iris and shutter speed control
- Fail-safe detector outputs with the Autoscope Terra Access Point (TAP)
- Non-volatile memory data storage
- High energy transient protection
- Technologically advanced faceplate heater and ClearVision faceplate coating
- Local language support

RECOMMENDED APPLICATIONS: Intersection detection, freeway/tollways mgt. Construction zone monitoring, railway crossings, bridges, tunnels, security areas.

POWER REQUIREMENTS (watts/amps): 15 W, 110/220 VAC, 50/60 Hz

POWER OPTIONS: None

CLASSIFICATION ALGORITHMS: User selectable by length into 5 – 6 bins.

TELEMETRY: Broadband communications up to 5MB/sec with RJ-45 connection on Terra Interface Panel (TIP).

COMPUTER REQUIREMENTS: Uses image processor hardware built into Autoscope system.

DATA OUTPUT: ASCII text format or compatible with multiple standard spreadsheet programs. Video available in NTSC and PAL formats.

DATA OUTPUT FORMATS: Per above in time slices from 10-60 seconds and 5-60 minutes.

SUPPORTING DATA BASE MANAGEMENT SYSTEM: Model dependent.

EQUIPMENT AND INSTALLATION COSTS (One-lane and four-lane):

1 lane: \$5,000

4 lane:

WARRANTY: Two years standard, option to extend to five years available.

STATES CURRENTLY USING THIS EQUIPMENT:

Country/State

Contact name

Telephone number

Please contact Econolite for current list of references.

MANUFACTURER AND VENDOR INFORMATION

Effective Date: 5/10/07

Manufacturer name: Econolite
Control Products, Inc.

Sales representative name(s): _____
Scott Robinson

Address: 3360 E. La Palma Avenue
Anaheim, California 92806-2856

Address: 3360 E. La Palma Avenue
Anaheim, California 92806-2856

Phone number: (714) 630-3700

Phone number: (714) 630-3700

Fax number: (714) 630-6349

Fax number: (714) 666-8354

e-mail address: socalsales@econolite.com

e-mail address: srobinson@econolite.com

URL address: http://www.econolite.com/products/

URL address: _____

PRODUCT NAME/MODEL NUMBER: Autoscope Solo Pro II

FIRMWARE VERSION/CHIP NO.: Updates provided as required by the manufacturer.

SOFTWARE VERSION NO.: Updates provided as required by the manufacturer.

GENERAL DESCRIPTION OF EQUIPMENT: The Autoscope Solo Pro II sensor contains an integrated color camera, zoom lens, and machine vision processor in one housing. Twisted-pair wiring to the Solo Pro II sensor eliminates need for coaxial cables. Remote connections are made with a phone line or wireless radio to bring compressed video and data back to a traffic management center.

SENSOR TECHNOLOGY AND CONFIGURATION: Machine vision – video image processing, pixel tracking, and tripline technology.

SENSOR INSTALLATION: Autoscope Solo Pro II unit installs on existing traffic signal poles, mast arms, and luminaire standards.

INSTALLATION TIME (Per Lane): 1 hour typical

INSTALLATION REQUIREMENTS: Camera mounting over center of monitored lanes provides optimum performance. Minimum camera mounting height is 30 ft. Greater heights may be required to minimize vehicle occlusion when using side-mounted cameras.

MAXIMUM NUMBER OF LANES MONITORED SIMULTANEOUSLY: Six to seven

PRODUCT CAPABILITIES/FUNCTIONS:

- Integrated color camera, zoom lens, and machine vision processor (MVP) in one housing
- 22x zoom lens and color imager
- Direct real-time iris and shutter speed control
- Unique and private IP address for Solo network
- Rugged, environmentally-sealed enclosure
- Technologically advanced faceplate heater
- Fail-safe mode sends outputs to traffic controller

RECOMMENDED APPLICATIONS: Freeway, intersection, bridge, tunnel, railroad, traffic-monitoring, and incident prevention applications. The Autoscope Communications Server Software Developer's Kit (SDK) allows a programmer to create new client applications for display, incident alarms, and traffic parameter databases.

POWER REQUIREMENTS (watts/amps): 15 W: 24 VAC, 50/60 Hz or 10 to 28 VDC.

POWER OPTIONS: See above

CLASSIFICATION ALGORITHMS: User selectable by length into 5 – 6 bins.

TELEMETRY: RS-485 interface with supervisor computer and detectors.

COMPUTER REQUIREMENTS: Uses image processor hardware built into Autoscope system.

DATA OUTPUT: ASCII text format or compatible with multiple standard spreadsheet programs. Video available in NTSC and PAL formats.

DATA OUTPUT FORMATS: Per above in time slices from 10-60 seconds and 5-60 minutes.

SUPPORTING DATA BASE MANAGEMENT SYSTEM: Model dependent.

EQUIPMENT AND INSTALLATION COSTS (One-lane and four-lane):

1 lane: \$5,000

4 lane: 14 approach intersection, \$18,200

WARRANTY: Two years standard, option to extend to five years available.

STATES CURRENTLY USING THIS EQUIPMENT:

Country/State

Contact name

Telephone number

Please contact Econolite for current list of references.

MANUFACTURER AND VENDOR INFORMATION

Effective Date: 7/10/07

Manufacturer name: Iteris, Inc.

Sales representative name(s): Michael Post

Address: 1700 Carnegie Avenue
Santa Ana, CA 92705

Address: same

Phone number: (888) 254-5487

Phone number: same

Fax number: (714) 780-7246

Fax number: same

e-mail address: vantage@iteris.com

e-mail address: mjp@iteris.com

URL address: www.iteris.com

URL address: _____

PRODUCT NAME/MODEL NUMBER: Vantage Edge2 Video Detection System

FIRMWARE VERSION/CHIP NO.: 1.12 (as of 5/2007)

SOFTWARE VERSION NO.: Not applicable

GENERAL DESCRIPTION OF EQUIPMENT: Iteris' Vantage Edge2™ is a machine vision processor consisting of a family of modules that provide 170/2070, TS-1, or TS-2 detection outputs to an intersection traffic controller for actuated operation. The modular approach allows the configuration to grow and adapt as the size and complexity of the intersection change. It is programmed using built-in menus that appear as a graphics overlay on the video image. Programming a virtual detection zone takes less than a minute, reducing installation time for both permanent and temporary installations. The image processing algorithms provide vehicle detection during most weather and lighting conditions. In addition, the Vantage Edge2™ provides failsafe operation mechanisms and motion stabilization in high wind conditions. Detection zones can be modified rapidly as needed.

SENSOR TECHNOLOGY AND CONFIGURATION: Machine vision – video image processing, pixel tracking, and trip-line technology. Cameras are analog color or monochrome CCD units – available in wired or wireless configurations.

SENSOR INSTALLATION: Camera installs on existing signal poles, mast arms, and luminaire standards.

INSTALLATION TIME (Per Lane): 15 – 30 minute average

INSTALLATION REQUIREMENTS: Camera mounting over center of monitored lanes is ideal, with minimum height of 30 ft. Greater heights may be required to minimize vehicle occlusion when using side-mounted cameras.

MAXIMUM NUMBER OF LANES MONITORED SIMULTANEOUSLY: 6 lanes

PRODUCT CAPABILITIES/FUNCTIONS:

- NEMA TS-1 and TS-2 controller compatible.
- TS-2 Bus Interface Unit (BIU) supports use in TS-2 Type 1 systems.
- 24 detector zones per camera configuration.
- Edge2 processor modules support 1, 2, or 4 video inputs.
- Extension modules support 2, 4, 24, or 32 output channel configurations.
- Detector zones are normally placed in one lane with multiple zones per lane.
- Detector zones can be AND'd or OR'd together to provide enhanced operation.
- Each detector zone holds a call for presence while vehicle remains in the zone.
- Three detector configurations can be stored for each camera and swapped according to Time of Day (TOD).
- Programming is facilitated with a pointing device using menus shown as an overlay on the displayed video.
- Communication modules provide remote programming and streaming video.
- Comprehensive set of rack configurations available to house all Vantage modules.
- All equipment is warranted for 3 years by Iteris.

RECOMMENDED APPLICATIONS: Intersection signal control, ramp metering, highway monitoring and incident detection.

POWER REQUIREMENTS (watts/amps): 115 and 240 VAC 60/50 Hz, 137 watts max.

POWER OPTIONS: See above

CLASSIFICATION ALGORITHMS:

TELEMETRY: Via RS 232 serial port or RJ45 Ethernet using eAccess communication module, which is an 802.3 compliant TCP/IP interface. The eAccess communications module contains a hardened modem that supports remote access from a PSTN line. Access to Vantage video detection processors can also be made via cable modem, DSL modem, or local area networks. Vantage eAccess Ethernet port enables MPEG-2 streaming video to be viewed on a personal computer using Internet browsers. Remote configuration and diagnostics can also be retrieved using the browser-based remote access firmware embedded within Vantage eAccess. In addition to eAccess, a wireless system utilizes the license-free 2.4 GHz band to transmit live video from the video detection CCTV camera to the controller cabinet.

COMPUTER REQUIREMENTS: None for setup or operation

DATA OUTPUT: Presence, Delay, Extend, Count, CSO (Count, Speed, and Occupancy), Pulse, Demand and Passage.

DATA OUTPUT FORMATS:

Up to 4 BNC video inputs per Edge2 module, NTSC or PAL
1 BNC video output per Edge2 module
USD female for pointing device per Edge2 or eAccess module
DB9 male for RS-232 interface per Edge2 module
DB15 female for TS-2 outputs when using TS2-IM module
DB37 female for TS-1 outputs when using IOM module

SUPPORTING DATA BASE MANAGEMENT SYSTEM: VRAS – Vantage Remote Access Software for remote access

EQUIPMENT AND INSTALLATION COSTS (One-lane and four-lane):

Approximately \$5,000.00 per approach

STATES CURRENTLY USING THIS EQUIPMENT:

Country/State

Contact name

Telephone number

Please contact Iteris for current list of references.

MANUFACTURER AND VENDOR INFORMATION

Effective Date: 5/10/07

Manufacturer name: Traficon

Sales representative name(s): _____

Traficon USA LLC

Address: Meensesteenweg 449/2
B-8501 Bissegem, Belgium

Address: 14520 Avion Parkway
Suite 305
Chantilly, Virginia 20151

Phone number: 32-56 37 22 00

Phone number: (703) 961 9617

Fax number: 32-56 37 21 96

Fax number: (703) 961 9606

e-mail address: traficon@traficon.com

e-mail address: traficon@traficonusa.com

URL address: www.traficon.com

URL address: www.traficon.com/contact/
usa_general.jsp

PRODUCT NAME/MODEL NUMBER: VIP 3D.x Video Image Processor

FIRMWARE VERSION/CHIP NO.:

SOFTWARE VERSION NO.:

GENERAL DESCRIPTION OF EQUIPMENT: The VIP3D.x Video Image Processor provides traffic data and information concerning the presence of vehicles approaching or waiting at the intersection. The input is composite video 751Vtt CCIR/EIA.

The VIP3D.x comes in two versions:

- VIP3D.1 monitors 1 camera (1 video input)
- VIP3D.2 monitors 2 cameras (2 video inputs)

In a typical installation, two VIP3D.2 units are combined with one VIEWCOM/E for remote monitoring and change of configurations.

The VIP 3D.x is a direct plug-in module for Type 170, NEMA TS-1 and TS-2 controller cabinets.

SENSOR TECHNOLOGY AND CONFIGURATION: Machine vision – video image processing, pixel tracking, and tripline technology.

SENSOR INSTALLATION: Camera installs on existing signal poles, mast arms, and luminaire standards. Machine vision processor installs in controller cabinet.

INSTALLATION TIME (Per Lane): One hour

INSTALLATION REQUIREMENTS: Bucket truck to mount camera. Camera mounting over center of monitored lanes provides optimum performance. Minimum camera mounting height is 30 ft. Greater heights may be required to minimize vehicle occlusion when using side-mounted cameras.

MAXIMUM NUMBER OF LANES MONITORED SIMULTANEOUSLY: Eight

PRODUCT CAPABILITIES/FUNCTIONS:

- VIP3D.1 provides up to 24 presence detection zones. VIP3D.2 provides up to 20 presence detection zones per camera.
- Each presence zone call can be delayed, extended or combined with an input to inhibit the call.
- Queue length measurements and directional counts on the intersection.
- Combination of outputs and inputs using Boolean functions AND, OR and NOR.
- VIP3D.1 provides eight data detection zones. The VIP3D.2 provides four data detection zones per camera.
- Detectors: *count, speed, classification, occupancy, density, headway and gap time.*
- Generation of alarm events such as: *speed alarms (four service levels), speed drop, wrong way driver, queue length threshold and quality alarm.*
- Double and single data loop simulation.
- Per zone, detection can be made direction sensitive.
- Single zones can be edited without disturbing the detection.
- Each VIP3D can control up to 24 outputs (four per board and 20 via the I/O extension boards) and 20 inputs (four for each of the five I/O extension boards).
- VIP3D stores up to four configurations per camera.
- Internal non-volatile memory database.
- VIP3D link software handles:
 - Configuration upload and download
 - Data download (database or individual data monitoring)
 - Firmware upload via RS232 port
 - Event download.

RECOMMENDED APPLICATIONS: Intersection vehicle detection for traffic signal control. Types of information available are vehicle presence; traffic data such as counts, speeds, classification, occupancy, density, headway, gap time; alarm events; wrong way driver detection; queue length; turning movement count.

POWER REQUIREMENTS (watts/amps): 10.8v to 26.5v DC

VIP3D.2 draws 200mA at 24v

VIP3D.1 draws 160mA at 24v

4 I/O draw 30mA at 24v

POWER OPTIONS: See above.

CLASSIFICATION ALGORITHMS: Available

TELEMETRY: System connection via VIEWCOM/E (Ethernet). VIP3.x Link Software via serial communication RS232. Real time video output on module.

COMPUTER REQUIREMENTS: Not mandatory

DATA OUTPUT: The VIP3D.2 provides 24 digital outputs in total using expansion output modules (available in 3 types: 2 I/O, 4 I/O or 12 I/O). Presence, volume, speed data are provided.

DATA OUTPUT FORMATS: Analog video output with overlay of system information data and detection lines, auto diagnostic LED indicators, VIP3D.2 main board contains four optically isolated open-collector outputs, expansion modules 2 I/O, 4 I/O and 12 I/O: 2, 4 or 12 digital in/outputs (with dip switches for selection of inputs and outputs)

SUPPORTING DATA BASE MANAGEMENT SYSTEM: Watts Traffic Management Software (PC-based).

EQUIPMENT AND INSTALLATION COSTS (One-lane and four-lane): Approximately \$5,000 per approach

STATES CURRENTLY USING THIS EQUIPMENT:

<u>Country/State</u>	<u>Contact name</u>	<u>Telephone number</u>
USA/Lynnwood, Washington		
USA/Tacoma, Washington		
Colorado Springs, CO		
Baltimore, MD		

MANUFACTURER AND VENDOR INFORMATION

Effective Date: 5/10/07

Manufacturer name: Traficon

Sales representative name(s): _____

Traficon USA LLC

Address: Meensesteenweg 449/2
B-8501 Bissegem, Belgium

Address: 14520 Avion Parkway
Suite 305
Chantilly, Virginia 20151

Phone number: 32-56 37 22 00

Phone number: (703) 961 9617

Fax number: 32-56 37 21 96

Fax number: (703) 961 9606

e-mail address: traficon@traficon.com

e-mail address: traficon@traficonusa.com

URL address: www.traficon.com

URL address: www.traficon.com/contact/
usa_general.jsp

PRODUCT NAME/MODEL NUMBER: TRAFICAM[®] Integrated Camera and Presence Sensor for intersection applications – 2nd Generation

FIRMWARE VERSION/CHIP NO.:

SOFTWARE VERSION NO.:

GENERAL DESCRIPTION OF EQUIPMENT: TrafiCam[®] integrates both a CMOS camera and detector in one compact box. This sensor monitors the presence of vehicles approaching or waiting at an intersection.

SENSOR TECHNOLOGY AND CONFIGURATION: Machine vision – video image processing, pixel tracking, and tripline technology.

SENSOR INSTALLATION: Camera and machine vision processor install on existing signal poles, mast arms, and luminaire standards. Wide field of view and narrow field of view lenses are available, depending on close or long range viewing, respectively.

INSTALLATION TIME (Per Lane): One hour

INSTALLATION REQUIREMENTS: Bucket truck to mount sensor. Camera mounting over center of monitored lanes provides optimum performance. Minimum camera mounting height is 30 ft. Greater heights may be required to minimize vehicle occlusion when using side-mounted cameras.

MAXIMUM NUMBER OF LANES MONITORED SIMULTANEOUSLY: Eight
PRODUCT CAPABILITIES/FUNCTIONS:

- Up to 8 detection zones
- Direction sensitive detection zones
- Real-time traffic view
- Optional: wireless communication/solar power
- Automatic trigger into safe recall mode
- MTBF > 11 years.

RECOMMENDED APPLICATIONS: Intersection vehicle detection for traffic signal control. Types of information available are vehicle presence; traffic data such as counts, speeds, classification, occupancy, density, headway, gap time; alarm events; wrong way driver detection; queue length; turning movement count.

POWER REQUIREMENTS (watts/amps): 12-26 VAC/DC, ≤78mA @ 12VDC, ≤42mA @ 24VDC

POWER OPTIONS: See above.

CLASSIFICATION ALGORITHMS: Available

TELEMETRY: Sensor configuration performed via USB connection. With a portable PC or PDA, sensor set-up is available in your native language through a user-friendly software interface. RS 485 interface is also available.

COMPUTER REQUIREMENTS: See above

DATA OUTPUT: Per Trafficam: 4 opto-isolated MOSFET outputs via clamps, normally closed (adaptable by TrafiCam[®] PC software), 4 output LEDS (green), "detection output x" and "common detection output"

DATA OUTPUT FORMATS:

SUPPORTING DATA BASE MANAGEMENT SYSTEM: Watts Traffic Management Software (PC-based).

EQUIPMENT AND INSTALLATION COSTS (One-lane and four-lane): Approximately \$5,000 per approach

STATES CURRENTLY USING THIS EQUIPMENT:

<u>Country/State</u>	<u>Contact name</u>	<u>Telephone number</u>
----------------------	---------------------	-------------------------

MANUFACTURER AND VENDOR INFORMATION

Effective Date: 5/10/07

Manufacturer name: Peek Traffic

Sales representative name(s): _____

Address: 2511 Corporate Way
Palmetto, FL 34221

Address: _____

Phone number: (866) 260-7335 or
(941) 845-1200

Phone number: _____

Fax number: (941) 365-0837

Fax number: _____

e-mail address: _____

e-mail address: _____

URL address: www.peek-traffic.com

URL address: _____

PRODUCT NAME/MODEL NUMBER: VideoTrak[®] Plus. Available in Model 905 Plus: up to 4 cameras and Model 910 Plus: up to 8 cameras.

FIRMWARE VERSION/CHIP NO.:

SOFTWARE VERSION NO.:

GENERAL DESCRIPTION OF EQUIPMENT: VideoTrak is designed for use in fully actuated vehicle detection systems for intersection control and for traffic surveillance systems. Detection features are compatible with NEMA TS-1/TS-2, Type 170/179, Type 2070 and ATC controllers. Video Processing Module supports RS-170, NTSC, CCIR or PAL format CCD cameras.

SENSOR TECHNOLOGY AND CONFIGURATION: Machine vision – video image processing, pixel tracking, and tripline technology.

SENSOR INSTALLATION: Camera installs on existing signal poles, mast arms, and luminaire standards. Machine processor installs in controller cabinet.

INSTALLATION TIME (Per Lane): Approximately one hour

INSTALLATION REQUIREMENTS: Bucket truck to mount sensor. Camera mounting over center of monitored lanes provides optimum performance. Minimum camera mounting height is 30 ft. Greater heights may be required to minimize vehicle occlusion when using side-mounted cameras.

MAXIMUM NUMBER OF LANES MONITORED SIMULTANEOUSLY: See below.

PRODUCT CAPABILITIES/FUNCTIONS:

- Available in two models, which support up to 4 or 8 cameras with as many as 32 detection zones per camera – providing up to 128 or 256 detection zones, depending on model.
- Complete intersection detection.
- Highway detection/management.
- Highway ramp control.
- Tunnel stopped-vehicle detection.
- Vehicle counting and classification.
- Automatic incident detection using features such as vehicle presence for “n” duration, vehicle speed (less than/more than speed), wrong way detection, queue length exceeded, delay exceeded, occupancy exceeded, length exceeded, red light traffic runners, vehicle stopped for “n” seconds.
- Collection of traffic statistics such as number of vehicles (volume/counts), average speed (mph/kph), lane occupancy (% time lane is occupied), density (volume/speed), headway (avg. in seconds), delay (avg. delay in sec), queue length (ft/m), vehicle length (avg. in ft/m).

RECOMMENDED APPLICATIONS: Each zone can be configured as either a normal or an incident detection zone. A normal zone provides standard presence detection, which can be programmed to operate any output, either directly or conditionally. An incident zone is used to detect particular traffic conditions or events. Typically, incident detections are forwarded to ATMS systems for instant recognition. Standard notebook/laptop computers may be used for detection zone setup and viewing of detector actuations within the traffic scene.

POWER REQUIREMENTS (watts/amps): 120 VAC/60 Hz or 240 VAC/50 Hz

POWER OPTIONS: See above.

CLASSIFICATION ALGORITHMS:

TELEMETRY:

COMPUTER REQUIREMENTS: Standard laptop or notebook computer for detection zone setup.

DATA OUTPUT: See above.

DATA OUTPUT FORMATS:

SUPPORTING DATA BASE MANAGEMENT SYSTEM:

EQUIPMENT AND INSTALLATION COSTS (One-lane and four-lane): Approximately \$5,000 per approach

STATES CURRENTLY USING THIS EQUIPMENT:

Country/State

Contact name

Telephone number

MANUFACTURER AND VENDOR INFORMATION

Effective Date: 5/10/07

Manufacturer name: Sumitomo Electric Industries

Sales representative name(s): None in USA at present

Address: 1-1-3 Shimaya
Konohana-ku, Osaka 554-0024
Japan

Address: _____

Phone number: +81 6-6461-1031

Phone number: _____

Fax number: +81 6-6466-3305

Fax number: _____

e-mail address: www@prs.sei.co.jp

e-mail address: _____

URL address: www.sei.co.jp

URL address: _____

PRODUCT NAME/MODEL NUMBER: Vehicle Imaging Vehicle Detector (VIVD)

FIRMWARE VERSION/CHIP NO.: N/A

SOFTWARE VERSION NO.: N/A

GENERAL DESCRIPTION OF EQUIPMENT: The VIVD contains an integrated camera, zoom lens, and machine vision processor in one housing. Twisted-pair wiring to the VIVD eliminates need for coaxial cables.

SENSOR TECHNOLOGY AND CONFIGURATION: Machine vision – video image processing, pixel tracking, and tripline technology.

SENSOR INSTALLATION: VIVD unit installs on existing signal poles, mast arms, and luminaire standards.

INSTALLATION TIME (Per Lane): 10 – 30 minutes after wiring is completed.

INSTALLATION REQUIREMENTS: Camera mounting over center of monitored lanes provides optimum performance. Minimum camera mounting height is 30 ft. Greater heights may be required to minimize vehicle occlusion when using side-mounted cameras.

MAXIMUM NUMBER OF LANES MONITORED SIMULTANEOUSLY: Two for presence detection applications, four for velocity measurement.

PRODUCT CAPABILITIES/FUNCTIONS: Detection signals are sent directly to a controller. Brightness of image is controlled by camera shutter speed; therefore, a lens iris is not required. Output data include vehicle count, presence for right turn and recall control, occupancy, classification (two-three), speed, stopped vehicle detection (drive lanes, shoulders), queue length measurement, inductive loop emulation, 1 still image transmission (JPEG format), incident detection (stopped vehicle, dropped object, etc.) for tunnel surveillance.

RECOMMENDED APPLICATIONS: Advanced traffic signal control, freeway monitoring, ramp control incident management, tunnel traffic flow monitoring

POWER REQUIREMENTS (watts/amps): 10 W max.; 100, 120 or 240 VAC; 50 to 60 Hz

POWER OPTIONS: See above.

CLASSIFICATION ALGORITHMS: Pattern matching for recognizing vehicle bodies, headlights, and small lamps. Vehicle velocity predicted from time of travel and distance between vehicle positions. Presence detection occurs through combining information from luminance, background subtraction, spatial differentiation, and vehicle tracking. Algorithm that eliminates most false detections from camera vibration is also included.

TELEMETRY: Telemetry available (dependent on Ethernet type in use).

COMPUTER REQUIREMENTS: PC with RS-232 for installation and adjustment

DATA OUTPUT: Count, speed, queue length, etc. for traffic signal control; loop emulation for traffic signal control; incident detection (stopped vehicle, dropped object, etc.) for tunnel surveillance.

DATA OUTPUT FORMATS: Presence: optically isolated. Speed and other parameters: serial port that currently complies with the format used in Japan.

SUPPORTING DATA BASE MANAGEMENT SYSTEM: Included in the TMC software or traffic controller software.

EQUIPMENT AND INSTALLATION COSTS (One-lane and four-lane): ≈\$3,000/camera, not including wiring.

STATES CURRENTLY USING THIS EQUIPMENT: None in US.

Country/State

Contact name

Telephone number

Japan (more than 2000 units)

MICROWAVE RADAR

Microwave radar was developed for detecting objects before and during World War II. The word radar was derived from the functions that it performs: *RA*dio *D*etection *A*nd *R*anging. The term microwave refers to the wavelength of the transmitted energy, usually between 1 and 30 cm. This corresponds to a frequency range of 1 GHz to 30 GHz, where the suffix GHz represents 10^9 Hz. Microwave sensors designed for roadside traffic data collection and monitoring in the U.S. are limited by FCC regulations to operating frequency bands near 10.5, 24.0, and 34.0 GHz. These requirements, as well as others that restrict the transmitted power, are satisfied by the sensor manufacturers. Thus, the end users are not required to possess special licenses or test equipment to verify the output frequency or power of the devices. Radars at frequencies above 30 GHz operate in the millimeter-wave spectrum since the wavelength of the transmitted energy is expressed in terms of millimeters. Most commercially available microwave radar sensors used in traffic management applications transmit electromagnetic energy at the X-band frequency of 10.525 GHz. Higher frequencies can illuminate smaller ground areas with a given size antenna and thus gather higher resolution data. Vehicle-mounted radars operating at 76 to 77 GHz support obstacle detection and automatic cruise control.

Principles of Operation

As shown in Figure 23, roadside-mounted microwave radar sensors transmit energy toward an area of the roadway from an overhead antenna. The area in which the radar energy is transmitted is controlled by the size and the distribution of energy across the aperture of the antenna. The manufacturer usually establishes the design constraints of the radar sensor. When a vehicle passes through the antenna beam, a portion of the transmitted energy is reflected back towards the antenna. The energy then enters a receiver where the detection is made and vehicle data, such as volume, speed, occupancy, and length, are calculated.

Two types of microwave radar sensors are used in traffic management applications, continuous wave (CW) Doppler radar and frequency modulated continuous wave (FMCW) radar. The traffic data they receive are dependent on the shape of the transmitted waveform. The CW

Doppler sensor transmits a signal that is constant in frequency with respect to time. According to the Doppler principle, the motion of a vehicle in the detection zone causes a shift in the frequency of the reflected signal (Klein and Kelly, 1996). This can be used to detect moving vehicles and to determine their speed. CW Doppler sensors that do not incorporate an auxiliary range measuring capability cannot detect motionless vehicles.

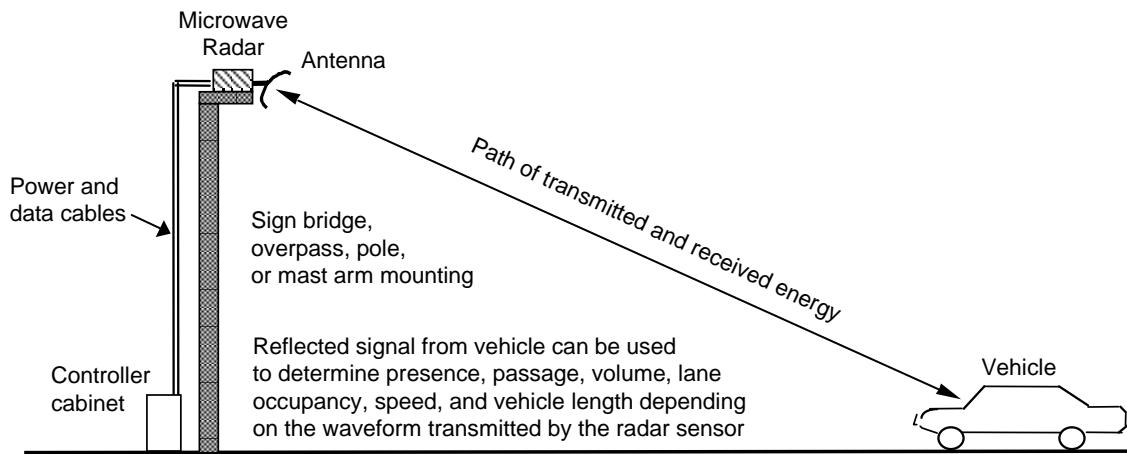

Figure 23. Microwave radar operation.

The frequency modulated continuous wave (FMCW) microwave radar sensor transmits a frequency that is constantly changing with respect to time, as illustrated in Figure 24a. The FMCW radar operates as a presence detector and can detect motionless vehicles.

The forward-looking FMCW radar measures vehicle speed in a single lane using a range binning technique that divides the field of view in the direction of vehicle travel into range bins as shown in Figure 24b. A range bin allows the reflected signal to be partitioned and identified from smaller regions on the roadway. Vehicle speed S is calculated from the time difference ΔT corresponding to the vehicle arriving at the leading edges of two range bins a known distance d apart as shown in Figure 24c. The vehicle speed is given by

$$S = \frac{d}{\Delta T}, \quad (5-1)$$

where

d = distance between leading edges of the two range bins and

ΔT = time difference corresponding to the vehicle's arrival at the leading edge of each range bin.

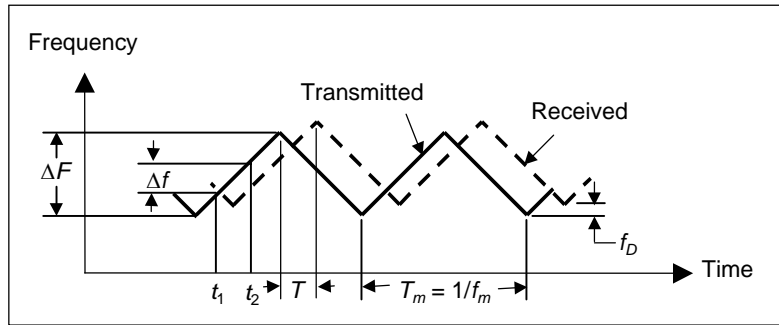

(a) Frequency modulated continuous waveform

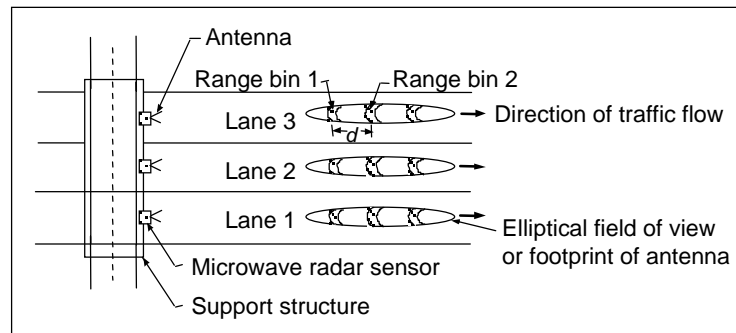

(b) Range binned footprints of radar sensors in traffic lanes

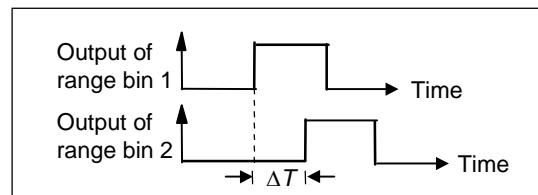

(c) Time-phased outputs of range bins

Figure 24. Speed measurement with an FMCW microwave presence-detecting radar.

Side-mounted configurations of the FMCW radar give multilane coverage as illustrated in Figure 25. Here the range bins are used to differentiate among vehicles traveling in different lanes and provide data that give their traffic flow characteristics.



Figure 25. Side-mounted configuration of an FMCW microwave presence-detecting radar illustrating multilane vehicle detection. (Photograph courtesy of EIS, Toronto, Canada)

Application and Uses

The radar sensor may be mounted over the middle of a lane to measure approaching or departing traffic flow parameters in a single lane, or at the side of a roadway to measure traffic parameters across several lanes. Forward-looking wide beamwidth radars gather data representative of traffic flow in one direction over multiple lanes. Forward-looking narrow beamwidth radars monitor a single lane of traffic flowing in one direction. Side-mounted, multiple detection zone radars project their footprint perpendicular to the traffic flow direction and provide data corresponding to several lanes of traffic, but generally not as accurately as can the same radar mounted in the forward-looking direction. Side-mounted, single detection zone radars are typically used to detect vehicle presence at signalized intersections.

The types of traffic data received by a microwave radar sensor are dependent on the waveform used to transmit the microwave energy. The CW Doppler microwave sensor detects vehicle passage or count by the presence of the Doppler frequency shift created by a moving vehicle as illustrated in Figure 26. Vehicle presence cannot be measured with the constant frequency waveform as only moving vehicles are detected.

Doppler radars can be used to measure vehicular volume and speed on city arterials and freeways, to provide direction dependent vehicle detection, and to provide data to request green

phase and extension of green phase for traffic signals. Doppler radars are operated by private companies to measure vehicle speed and subsequently provide traffic flow information to the broadcast media and public agencies. An example of such a radar is shown on the left side of Figure 27. A Doppler radar utilized to provide data for signal timing and for detection of vehicle direction is shown on the right side of the figure. Doppler radars also provide vehicle speed measurement in combination with other sensors that determine vehicle count and presence as was illustrated in the middle and right side of Figure 1.

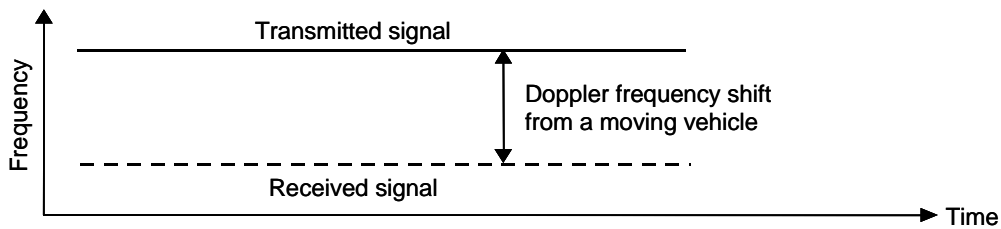
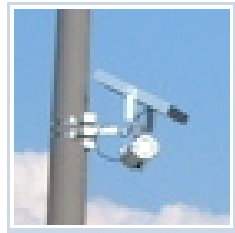

Figure 26. Constant frequency waveform.



DVSS-100 solar-powered Doppler radar.
(Photograph courtesy of SpeedInfo, San Jose, CA)



ASIM 230 series 24 GHz Doppler radars.
(Photograph courtesy of ASIM Technologies Ltd., Uznach, Switzerland)

Figure 27. Doppler microwave radar sensors.

FMCW presence-measuring radars, such as the models illustrated in Figure 28, are used to control left turn signals, provide real-time volume and occupancy data for traffic adaptive signal systems, monitor traffic queues, and collect occupancy and speed (multizone models only) data in support of freeway incident detection algorithms. Multizone microwave presence-detecting radars can measure vehicle presence and speed and are gaining acceptance in electronic toll collection and automated truck weighing applications that require vehicle identification based on vehicle length.



RTMS multizone presence-detecting microwave radars. (Photographs courtesy of Lawrence A. Klein and EIS, Toronto, Canada).



SmartSensor HD multizone presence-detecting microwave radar. (Photograph courtesy of Wavetronix, Provo, UT).



Accuwave™ LX-150 single zone presence detecting microwave radar. (Photograph courtesy of Fortran Traffic Systems Ltd., Toronto, Canada).

Figure 28. Presence-detecting microwave radar sensors.

Advantages

Advantages of microwave radar include insensitivity to inclement weather, especially over the relatively short ranges encountered in traffic management applications; direct measurement of speed; and multiple lane gathering of traffic flow data.

Disadvantages

CW Doppler radar sensors cannot detect stopped vehicles unless equipped with an auxiliary sensor. CW Doppler microwave sensors have been found to perform poorly at intersection locations as volume counters (Kranig, et al., 1997).

MANUFACTURER AND VENDOR INFORMATION

Effective Date: 14 Mar. 2000

Manufacturer name: GMH Engineering Sales representative name(s): _____

Address: 336 Mountain Way Drive Address: _____
Orem, UT 84058 _____

Phone number: (801) 225-8970 Phone number: _____

Fax number: (801) 225-9008 Fax number: _____

e-mail address: priz@gmheng.com e-mail address: _____

URL address: www.gmheng.com URL address: _____

PRODUCT NAME/MODEL NUMBER: Delta Speed Sensor, Model DRS1000

FIRMWARE VERSION/CHIP NO.:

SOFTWARE VERSION NO.:

GENERAL DESCRIPTION OF EQUIPMENT: The DRS1000 is a small, inexpensive non-contact speed sensor. The output from the sensor is a frequency pulse. Besides vehicle speed, the output can be used to determine vehicle count, distance between vehicles, and general vehicle classification.

SENSOR TECHNOLOGY AND CONFIGURATION: The Delta Speed Sensor utilizes Doppler radar technology. The sensor is mounted over the lane of traffic that you wish to monitor.

SENSOR INSTALLATION: The Delta Speed Sensor requires a 12 VDC power supply. It should be mounted over the lane of traffic one wishes to monitor. It is aimed at an angle looking up or down the road. The sensor monitors the traffic coming towards or moving away from the sensor.

INSTALLATION TIME (Per Lane): One hour

INSTALLATION REQUIREMENTS: 12 VDC and an overhead structure on which to mount the sensor (highway sign, overpass, etc).

MAXIMUM NUMBER OF LANES MONITORED SIMULTANEOUSLY: One lane per sensor.

PRODUCT CAPABILITIES/FUNCTIONS: The pulse output of the Delta Speed Sensor is proportional to both a speed measurement and a length measurement. The sensor has a frequency output directly proportional to speed. It outputs 211.6 pulses per second for every mile per hour of speed measured (131.5 pulses per second for every kilometer per hour of speed measured). Also, the total number of pulses is equal to the length of the vehicle passing under the sensor regardless of the speed of the vehicle. Every 144 pulses equal one foot of length (470 pulses equal one meter of length or 4.7 pulses are equivalent to one centimeter of length). With this information, one may determine the speed of the vehicles passing under the sensor, the length of the vehicles (as an aid to vehicle classification), the distance between vehicles, and the number of vehicles.

RECOMMENDED APPLICATIONS: Anywhere traffic habits need to be monitored inexpensively, without tearing up the roadway, and without expensive maintenance costs.

POWER REQUIREMENTS (watts/amps): 9.5 to 16.5 VDC (200 mA @ 12 VDC)

POWER OPTIONS:

CLASSIFICATION ALGORITHMS:

TELEMETRY:

COMPUTER REQUIREMENTS: If you wish to input the signal from the sensor into your computer, the computer will need to be able to accept a frequency or counter input. Or, we can provide you with a frequency counter with a RS232 output. They cost \$180.00

DATA OUTPUT: 0 to 5 V square waves, differential line driver.

DATA OUTPUT FORMATS:

SUPPORTING DATA BASE MANAGEMENT SYSTEM:

EQUIPMENT AND INSTALLATION COSTS (One-lane and four-lane):

One Lane

Cost of Delta DRS1000 Speed Sensor	\$1,595.00
Cost of installation at \$100.00/hr labor	\$100.00
TOTAL	\$1,696.00*

Four lanes

Cost of 4 Delta DRS1000 Speed Sensor	\$6,380.00
Cost of installation at \$100.00/hr labor	\$400.00
TOTAL	\$6,780.00*

*Note: The above prices do not reflect any quantity discounts.

STATES CURRENTLY USING THIS EQUIPMENT:

Country/State

Contact name

Telephone number

This product is used worldwide. Please contact us for references.

MANUFACTURER AND VENDOR INFORMATION

Effective Date: 7/17/07

Manufacturer name: ASIM Technologies AG

Sales representative name(s): Andreas Hartmann

Address: Burgerriet-Strasse 30
CH-8730 Uznach, Switzerland

Address: ASIM Technologies, Inc.
Xtralis - ASIM
700 Longwater Drive, Suite 100
Norwell, MA 02061

Phone number: +41-55-285 99 99

Phone number: 866-664-ASIM (2746) or
978-667-5207, X 111

Fax number: +41-55-285 99 00

Fax number: 978-667-8247

e-mail address: info@asim.ch

e-mail address: ahartmann@asim-technologies.com

URL address: www.asim-technologies.com

URL address: www.asim.ch/en/contact/usa.php or
www.xtralis.com

PRODUCT NAME/MODEL NUMBER: MMW 233

FIRMWARE VERSION/CHIP NO.: N/A

SOFTWARE VERSION NO.: N/A

GENERAL DESCRIPTION OF EQUIPMENT: ASIM K-Band (24 GHz) Doppler radar traffic sensors of the MW 230 series detect vehicles moving into or through their field of view over short to medium ranges. The digital output of the sensor is activated as long as objects within the field of view are moving. When the movement stops, the output resets. Correct alignment of the sensor and a stable mounting structure are mandatory for optimal performance. The detection range of the MW 233 sensor is typically 45 m (150 ft). Turn-on time is 1 s from power on.

SENSOR TECHNOLOGY AND CONFIGURATION: The MMW 233 sensor operates as a Doppler radar. The shift in frequency of the transmitted signal caused by a moving vehicle within the field of view of the sensor is used to accurately calculate the vehicle's speed and produce a vehicle passage signal.

SENSOR INSTALLATION: The sensor can be mounted overhead or on a pole on the side of the road. The recommended mounting height is 1 to 5 m (3 to 16 ft).

INSTALLATION TIME (Per Lane):

INSTALLATION REQUIREMENTS: The supplied standard mounting bracket provides an easy and stable mounting platform for all common applications.

MAXIMUM NUMBER OF LANES MONITORED SIMULTANEOUSLY: One

PRODUCT CAPABILITIES/FUNCTIONS: The operating modes and other functions of the MW 233 sensor can be selected with DIP switches. The DIP switches are accessible on the connector board. They specify sensitivity, approach direction, minimum detectable speed [4 km/h (2.5 mph) or 8 km/h (5 mph)], and timer on/off function. The timer, when on, automatically activates the output to simulate the arrival of a vehicle if the MW 233 has not changed state for a period of 2.5 minutes.

RECOMMENDED APPLICATIONS: Direction dependent vehicle detection, request of green phase, extension of green phase.

POWER REQUIREMENTS (watts/amps): 230 VAC, 115 VAC, or 48 VAC. Power consumption is typically <1 W.

POWER OPTIONS: Models 231 (responds only to approaching traffic) and 232 operate on 10.5 to 30 VDC or 24 VAC. Power consumption is typically 90 mA @ 12 VDC or 45 mA @ 24 VAC/DC.

CLASSIFICATION ALGORITHMS: N/A

TELEMETRY:

COMPUTER REQUIREMENTS: None.

DATA OUTPUT: SPDT relay, 250 VAC / 2 A / 60 W.

DATA OUTPUT FORMATS:

SUPPORTING DATA BASE MANAGEMENT SYSTEM:

EQUIPMENT AND INSTALLATION COSTS (One-lane and four-lane):

MW 231 Approach only, Vehicle Motion Detector, Radar: \$654.00 (List price/unit)

MW 232 Multi-functional, Vehicle Motion Detector, Radar: \$784.50 (List price/unit)

STATES CURRENTLY USING THIS EQUIPMENT:

Country/State

Contact name

Telephone number

Please contact manufacturer for current list of users.

MANUFACTURER AND VENDOR INFORMATION

Effective Date: 5/10/07

Manufacturer name: Electronic
Integrated Systems Inc. (EIS)

Sales representative name(s): _____
Mike Ouellette

Address: 150 Bridgeland Avenue, Suite 204
Toronto, Ontario,
Canada M6A 1Z5

Address: 150 Bridgeland Avenue, Suite 204
Toronto, Ontario,
Canada M6A 1Z5

Phone number: (800) 668-9385, (416) 785-9248

Phone number: (800) 668-9385, (416) 785-9248

Fax number: (416) 785-9332

Fax number: (416) 785-9332

e-mail address: info@rtms-by-eis.com

e-mail address: mike@rtms-by-eis.com

URL address: www.rtms-by-eis.com

URL address: www.rtms-by-eis.com

PRODUCT NAME/MODEL NUMBER: EIS Remote Traffic Microwave Sensor (RTMS)
Models X3 and G4

FIRMWARE VERSION/CHIP NO.: N/A

SOFTWARE VERSION NO.: N/A

GENERAL DESCRIPTION OF EQUIPMENT: The RTMS is a low-cost, all weather, true RADAR (Radio Detection And Ranging) device, which provides presence, multiple zone, vehicle detection. Its ranging capability is achieved by frequency-modulated continuous-wave (FMCW) operation. The RTMS is capable of detecting vehicle presence and measuring other traffic parameters in multiple zones. The X3 uses a horn antenna, while the G4 incorporates: (1) a phased-array antenna that provides improved spatial resolution and (2) a camera so that the operator can watch the traffic flow as it is detected and analyzed by the RTMS.

SENSOR TECHNOLOGY AND CONFIGURATION: The sensor transmits microwave energy and receives a portion of the energy reflected by vehicles and other objects in its path. The nominal 10.525 GHz frequency is varied continuously in a 45 MHz band. At any given time, there is a difference between the frequencies of transmitted and received signals. The difference in frequencies is proportional to the distance between the RTMS and the vehicle. The RTMS detects and measures that difference and computes range (distance) to the target. The range resolution of the RTMS is 2 m (7 ft). It detects both stationary and moving targets.

MOUNTING CONFIGURATION: The RTMS is mounted over the roadway in side-fired and forward-looking configurations.

Side-Fired: One Model X3 RTMS unit, mounted on a roadside pole and aimed at the side of the vehicles, can monitor up to 8 lanes of traffic up to 60 m (200 ft) away by mapping detection zones to lanes. The G4 can monitor up to 12 lanes of traffic in this configuration.

Forward-Looking: One RTMS unit, mounted on an overhead structure, aimed at the front or rear of the vehicles, will monitor one lane of traffic. This configuration provides higher accuracy per vehicle speed measurements

SENSOR INSTALLATION: See Installation Requirements

INSTALLATION TIME (Per Lane): Per sensor basis – 30 minutes (approx.)

INSTALLATION REQUIREMENTS: The RTMS can be mounted on light standards or poles (Side-Fired) or overhead structures (Forward-Looking). The recommended mounting height is 5 m (17 ft) above the road. Side-fired requires a setback from the first lane monitored. To include all lanes of interest within its antenna beam footprint, the RTMS is set back from the detection zones about 1 m (3 ft) for each equivalent lane monitored (with a minimum setback of 3 m).

MAXIMUM NUMBER OF LANES MONITORED SIMULTANEOUSLY: 8 for side fired and 1 for forward looking.

PRODUCT CAPABILITIES/FUNCTIONS:

- Presence detection Contact closure
- Traffic data accumulation during a programmed measurement period:
 - Volume Percent of time a vehicle was present in the detection zone
 - Speed Average speed of vehicles passing the detection zone
 - Vehicle class Number of long vehicles (i.e., semi-trailer trucks) or
Average time between vehicles (multiples of 0.1 seconds)
- Communication Serial port RS-232

RECOMMENDED APPLICATIONS:

- Multi-lane intersection control, stop-bar and advanced loop replacement
- Freeway traffic management and incident detection systems
- Ramp metering
- Off ramp queue control and signal control actuation
- Work zone and temporary intersection control
- Permanent and mobile traffic counting stations
- Enforcing of speed and red light violation

POWER REQUIREMENTS (watts/amps)/OPTIONS:

- Standard: 12 to 24 AC or DC @ 4.5 Watt derived from battery, solar, or controller
- Optional: Commercial 115 VAC

CLASSIFICATION ALGORITHMS: The RTMS statistically determines the length of an average vehicle. The Long Vehicle Count is incremented by vehicles deemed to be at least three times the average vehicle length.

TELEMETRY: Contact closures can be transmitted by optional communication systems (e.g., wireless system).

COMPUTER REQUIREMENTS:

- RTMS setup is performed using an IBM-compatible notebook PC. An intuitive, user-friendly setup program allows the user to define the operating mode, required number of zones and their locations, and to verify correct operation of the unit. During setup every vehicle within the field of view is shown on the PC screen as a "blip" at its corresponding range. The user recognizes the blip as belonging to a vehicle seen on the road at that moment, and simply moves a zone-box on the screen to surround the blip. This defines the zone's location. A zone can include one or more lanes. After a zone is defined, its corresponding contact pair closes every time a blip is contained in it. After all zones are defined, a simple observation or manual count comparison with the RTMS count completes the calibration. A wizard is included in the software to automate the setup process and assist users.
- Data collection and analysis are implemented with an IBM-compatible notebook PC.

DATA OUTPUT: Output information is provided to existing controllers via contact pairs and to computer systems via a RS-232 serial communications port.

DATA OUTPUT FORMATS: Asynchronous binary data at 9,600 BPS, 54 byte data packet

SUPPORTING DATA BASE MANAGEMENT SYSTEM: Optional data collection and analysis program can format traffic data in Paradox or Dbase.

EQUIPMENT AND INSTALLATION COSTS (One-lane and four-lane):

STATES CURRENTLY USING THIS EQUIPMENT:

<u>Country/State</u>	<u>Contact name</u>	<u>Telephone Number</u>
USA/California	TRAVINFO; Bay area	
USA/Colorado	I-25 Colorado Springs, Denver, Grand Junction	
USA/Florida	Various	
USA/Indiana	BORMAN	
USA/Kentucky	TRIMARC	
USA/Louisiana	Baton Rouge I-12	
USA/Maryland	CHART II	
USA/New Jersey	MAGIC I-80; NJ Turnpike; Garden City Parkway	
USA/New York	NY City (Intersections); Van Wyck Expressway, Long Island Expressway	
USA/North Carolina	CARAT	
USA/Missouri	Interstate – Metro St. Louis	
USA/Nebraska	Counting stations	

USA/Ohio	ARTIMIS: City of Jackson (Intersections)
USA/Pennsylvania	TOP
USA/South Carolina	Incident Detection System I 85, 77, and 26
USA/South Dakota	Various
USA/Virginia	Hampton Roads Phases II and III
USA/Wisconsin	MONITOR
USA/Washington State	Various

MANUFACTURER AND VENDOR INFORMATION

Effective Date: 5/10/07

Manufacturer name: Wavetronix LLC

Sales representative name(s): _____
Advanced Traffic Products

Address: 380 South Technology Court
Lindon, UT 84042

Address: 909 SE Everett Mall Way
Suite B280
Everett, WA 98208

Phone number: (800) 764-0277

Phone number: (800) 690-4287, (425) 347-6208

Fax number: (801) 764-0208

Fax number: (425) 347-6308

e-mail address: sales@wavetronix.com

e-mail: advancedtraffic@advancedtraffic.com

URL address: http://www.wavetronix.com

URL address: http://www.advancedtraffic.com

PRODUCT NAME/MODEL NUMBER: SmartSensor HD™ Model 125

FIRMWARE VERSION/CHIP NO.:

SOFTWARE VERSION NO.:

GENERAL DESCRIPTION OF EQUIPMENT: The SmartSensor HD™ is a frequency-modulated continuous-wave microwave radar sensor that incorporates auto-calibration and auto-configuration and operates in the above-ground forward-looking and side-firing configurations. It measures vehicle presence, volume, occupancy, and speed. Other traffic flow parameters are available.

SENSOR TECHNOLOGY AND CONFIGURATION: The sensor transmits microwave energy and receives a portion of the energy reflected by vehicles and other objects in its path. The SmartSensor HD™ operates at 24 GHz using a 250 MHz bandwidth, giving a range resolution of 2 ft (0.6 m). It detects both stationary and moving targets.

SENSOR INSTALLATION: See Installation Requirements.

INSTALLATION TIME (Per Lane):

INSTALLATION REQUIREMENTS: The SmartSensor HD™ can be mounted on light standards or poles (Side-Fired) or overhead structures (Forward-Looking). The first lane offset requirement is 6 ft (1.8 m) and the maximum detection range is 250 ft (76 m).

MAXIMUM NUMBER OF LANES MONITORED SIMULTANEOUSLY: 10

PRODUCT CAPABILITIES/FUNCTIONS: The SmartSensor HD provides vehicle-based detection, vehicle volume, vehicle presence, indicates lane-changers, per vehicle speed, average speed, 85th percentile speed, lane occupancy, four length-based vehicle classification categories, average headway, and average gap. The SmartSensor HD contains two receive antennas that are separated by a small distance. This dual-antenna design forms a radar speed trap that allows the sensor to measure the time it takes for a vehicle to pass between the two antennas to within a fraction of a millisecond. This time measurement is then used to calculate the speed of the vehicle. Traffic data and configuration settings are stored in flash memory, so the sensor can be remotely configured.

RECOMMENDED APPLICATIONS: ITS and arterial monitoring applications.

POWER REQUIREMENTS (watts/amps): 9 to 28 VDC, 8 W

POWER OPTIONS: See above

CLASSIFICATION ALGORITHMS: Vehicle length based

TELEMETRY:

COMPUTER REQUIREMENTS: Patented auto-configuration process for PC and Pocket PC[®]

DATA OUTPUT: RS 232 and RS 485 communication ports

DATA OUTPUT FORMATS:

SUPPORTING DATA BASE MANAGEMENT SYSTEM: Wavetronix Data Collector[™] integrates with most ATMS.

EQUIPMENT AND INSTALLATION COSTS (One-lane and four-lane):

STATES CURRENTLY USING THIS EQUIPMENT:

Country/State

Contact name

Telephone Number

Please contact manufacturer for current list of users.

INFRARED SENSORS

Active and *passive* infrared sensors are manufactured for traffic applications. The sensors are mounted overhead to view approaching or departing traffic or traffic from a side-looking configuration. Infrared sensors are used for signal control; volume, speed, and class measurement, as well as detecting pedestrians in crosswalks. With infrared sensors, the word detector is also used to refer to the light-sensitive element that converts the reflected or emitted energy into electrical signals. Real-time signal processing is used to analyze the received signals for the presence of a vehicle.

Active Infrared Sensor

Principles of Operation

Active infrared sensors illuminate detection zones with low power infrared energy supplied by laser diodes operating in the near infrared region of the electromagnetic spectrum at 0.85 μm . The infrared energy reflected from vehicles traveling through the detection zone is focused by an optical system onto an infrared-sensitive material mounted at the focal plane of the optics.

The active infrared laser sensor has two sets of optics. The transmitting optics split the pulsed laser diode output into two beams separated by several degrees as displayed in Figure 29. The receiving optics has a wider field of view so that it can better receive the energy scattered from the vehicles. By transmitting two or more beams, the laser radars measure vehicle speed by recording the times at which the vehicle enters the detection area of each beam

Application and Uses

Active infrared sensors provide vehicle presence at traffic signals, volume, speed measurement, length assessment, queue measurement, and classification. Multiple units can be installed at the same intersection without interference from transmitted or received signals. Modern laser sensors produce two- and three-dimensional images of vehicles suitable for vehicle classification. The laser radar illustrated in Figure 30a mounts 19.7 to 23 ft (6 to 7 m) above the road surface with an incidence angle (i.e., forward tilt) of 5 deg. Its ability to classify 11 types of

vehicles has found use on toll roads. Other models from this manufacturer mount between 5 and 16 ft (1.5 and 4.9 m) from the edge of the traffic lane above the road and classify vehicles based on the number of axles detected. Another laser radar with similar capabilities is shown in Figure 30b. This device can transmit 2 to 6 beams, which control the length of the scan over the travel lane.

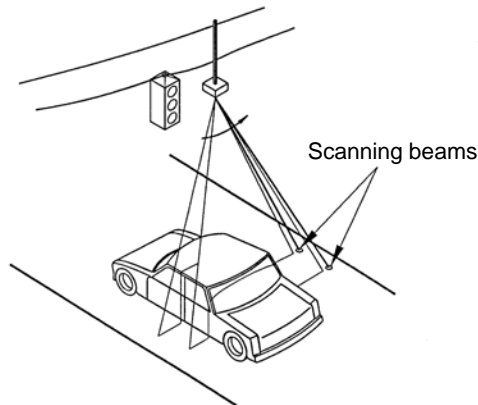

Figure 29. Laser radar beam geometry. (Drawing courtesy of OSI Laserscan, Orlando, FL).



(a) Autosense laser radar sensor.
(Photograph courtesy of OSI Laserscan, Orlando, FL).



(b) EFKON Sherlock laser radar sensor.
(Photograph from EFKON product literature).

Figure 30. Laser radar sensors.

Passive Infrared Sensors

Passive sensors detect the energy that is emitted from vehicles, road surfaces, other objects in their field of view, and from the atmosphere, but they transmit no energy of their own. Non-

imaging passive infrared sensors used in traffic management applications contain one or several (typically not more than five) energy-sensitive detector elements on the focal plane that gather energy from the entire scene. The detector in a non-imaging sensor generally has a large instantaneous field of view. The instantaneous field of view is equal to the angle, e.g., in the x-y plane, subtended by a pixel. Objects within the scene cannot be further divided into sub-objects or pixels (picture elements) with this device.

Imaging sensors, such as modern charge-coupled device (CCD) cameras, contain two-dimensional arrays of detectors, each detector having a small instantaneous field of view. The two-dimensional array gathers energy from the scene over an area corresponding to the field of view of the entire array. Imaging sensors display the pixel-resolution details found in the imaged area.

Principles of Operation

Passive infrared sensors with a single-detection zone, measure volume, lane occupancy, and passage. The source of the energy detected by passive sensors is graybody emission due to the non-zero surface temperature of emissive objects. Graybody emission occurs at all frequencies by objects not at absolute zero (-273.15°C). If the emissivity of the object is perfect, i.e., emissivity = 1, the object is called a blackbody. Most objects have emissivities less than 1 and, hence, are termed graybodies. Passive sensors can be designed to receive emitted energy at any frequency. Cost considerations make the infrared band a good choice for vehicle sensors with a limited number of pixels. Some models operate in the long-wavelength infrared band from 8 to 14 μm and, thus, minimize the effects of sun glint and changing light intensity from cloud movement. Several passive infrared sensors are illustrated in Figure 31. The Eltec 842 sensor is used for vehicle presence detection at signalized intersections for side street demand, at construction sites, and for temporary replacement of failed inductive loop detectors. The Siemens Eagle PIR-1 sensor performs vehicle counting, stopline presence detection, occupancy detection, and queue detection. The ASIM IR 250 series are multizone sensors that offer vehicle counting, speed measurement, classification by length, and presence detection.

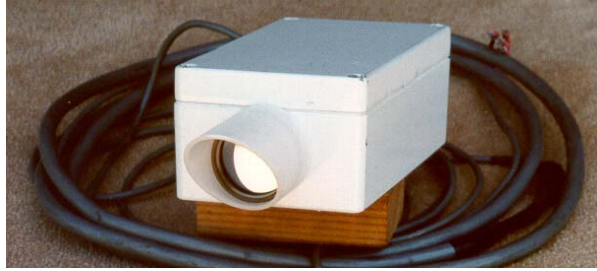

Eltec 842 passive infrared vehicle presence sensor [Photograph courtesy of L.A. Klein, *Sensor Technologies and Data Requirements for ITS* (Norwood, MA: Artech House, 2001)]



Siemens Eagle PIR-1 sensor (Photograph courtesy of Siemens ITS and Siemens Energy and Automation, Austin, TX)



ASIM IR 250 series passive infrared sensor (Photograph courtesy of ASIM Technologies, Uznach, Switzerland)

Figure 31. Passive infrared sensors.

When a vehicle enters the sensor's field of view, the change in emitted energy is used to detect the vehicle as illustrated in Figure 32. A vehicle entering the sensor's field of view generates a signal that is proportional to the product of an emissivity difference term and a temperature difference term when the surface temperatures of the vehicle and road are equal. The emissivity term is equal to the difference between the road and the vehicle emissivities. The temperature term is equal to the difference between the absolute temperature of the road surface and the temperature contributed by atmospheric, cosmic, and galactic emission. On overcast, high humidity, and rainy days, the sky temperature is larger than on clear days and the signal produced by a passing vehicle decreases. This, in itself, may not pose a problem to a properly designed passive infrared sensor operating at the longer wavelengths of the infrared spectrum, especially at the relatively short operating ranges typical of traffic management applications (Klein, 2001).

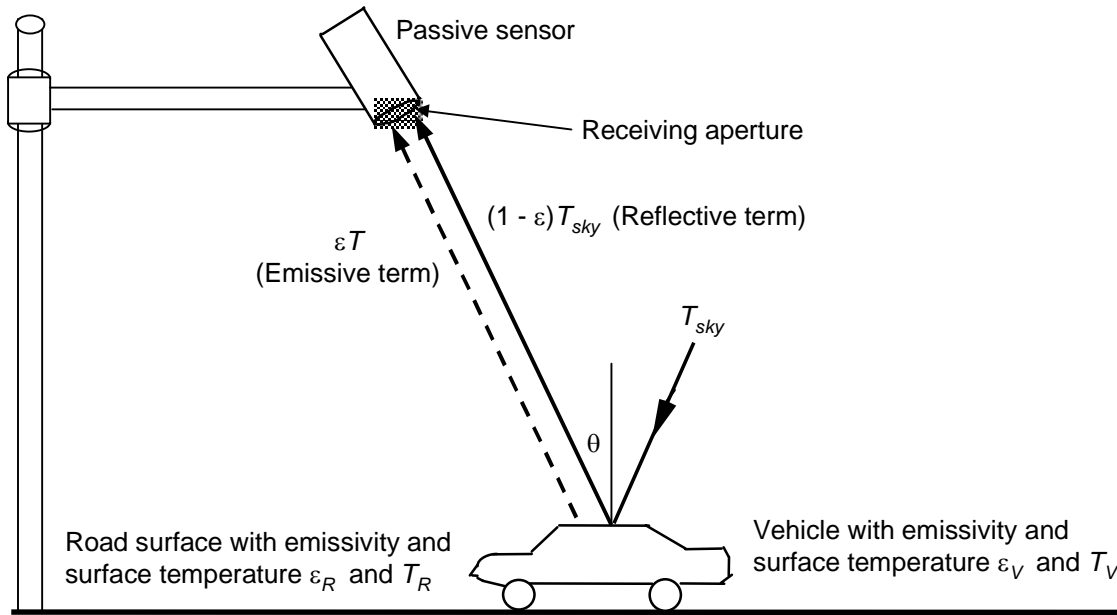

Figure 32. Emission and reflection of energy by vehicle and road surface.

Application and Uses

Multi-channel and multi-zone passive infrared sensors measure speed and vehicle length as well as the more conventional volume and lane occupancy. These models are designed with dynamic and static-thermal energy detection zones that provide the functionality of two inductive loops. Their footprint configuration is shown in Figure 33. The time delays between the signals from the three dynamic zones are used to measure speed. The vehicle presence time from the fourth zone gives the occupancy of stationary and moving vehicles.

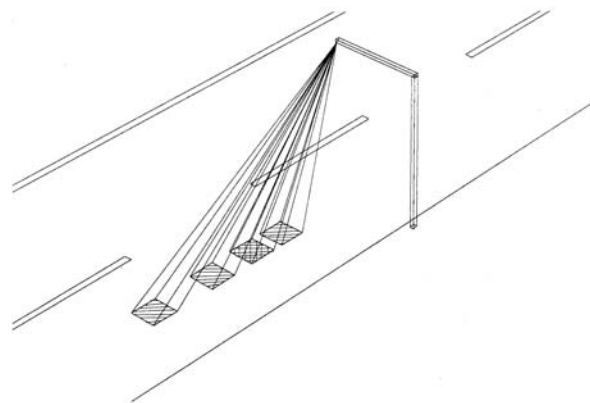

Figure 33. Multiple detection zone configuration in a passive infrared sensor.

Advantages

Installation of infrared sensors does not require an invasive pavement procedure. Some advantages of active infrared sensors are that they transmit multiple beams for accurate measurement of vehicle position, speed, and class. Also, multi-zone passive infrared sensors measure speed. Multiple lane presence detection is available in side-mounted models.

Disadvantages

Several disadvantages of infrared sensors are sometimes cited. Glint from sunlight may cause unwanted and confusing signals. Atmospheric particulates and inclement weather can scatter or absorb energy that would otherwise reach the focal plane. The scattering and absorption effects are sensitive to water concentrations in fog, haze, rain, and snow as well as to other obscuring agents such as smoke and dust. At the relatively short operating ranges encountered by infrared sensors in traffic management applications, these concerns may not be significant. However, some performance degradation in rain, freezing rain, and snow has been reported (Kranig, et al., 1997). A rule of thumb for gauging when an infrared sensor may experience difficulty detecting a vehicle in inclement weather is to note if a human observer can see the vehicle under the same circumstances. If the observer can see the vehicle, there is a high probability the infrared sensor will detect the vehicle.

MANUFACTURER AND VENDOR INFORMATION

Effective Date: 6/15/07

Manufacturer name: OSI LaserScan

Sales representative name(s): _____

Address: 300 Sunport Lane, Ste. 500
Orlando, FL 32809

Address: _____

Phone number: (407) 581-6000

Phone number: _____

Fax number: (407) 581-6038

Fax number: _____

e-mail address: sales@osi-ls.com

e-mail address: _____

URL address: http://www.osi-ls.com

URL address: _____

PRODUCT NAME/MODEL NUMBER: AutoSense 600 Overhead Vehicle Detection and Classification Sensor

FIRMWARE VERSION/CHIP NO.:

SOFTWARE VERSION NO.: N.A.

GENERAL DESCRIPTION OF EQUIPMENT: The AS600 Series AutoSense™ vehicle detection and classification sensor is a class I laser system that provides toll and traffic management authorities with vehicle detection, presence, separation and classification information. A single sensor can be mounted above a travel lane on either a gantry, pole arm or toll plaza roof structure. The AutoSense™ scans the roadway beneath the sensor, taking range measurements across the width of the road at two locations beneath the sensor. These measurements are processed to generate messages that uniquely detect and classify each vehicle, and give its speed and position in the lane. The AutoSense™ automatically initializes the vehicle detection process upon power-up and its self-calibration process eliminates the need for any field adjustments.

SENSOR TECHNOLOGY AND CONFIGURATION: Scanning infrared laser – Two beams with 10 degree separation. Each beam scans 30 degrees across lane.

SENSOR INSTALLATION: Typically mounted between 19.7 and 23 ft (6 and 7 m) centered above the traffic lane. The first beam look-down angle is 10 degrees off nadir and the second beam's look-down angle is nadir (0 degrees). These beam angles are realized by mounting the sensor with a 5-degree forward tilt.

INSTALLATION TIME (Per Lane): Approximately 20 minutes

INSTALLATION REQUIREMENTS: Requires AutoSense™ mounting plate, power cable and signal cable.

MAXIMUM NUMBER OF LANES MONITORED SIMULTANEOUSLY: One

PRODUCT CAPABILITIES/FUNCTIONS:

Vehicle Detection Accuracy	>99.9% (one vehicle in field-of-view)
Vehicle Classification Categories	Motorcycle, Motorcycle + trailer, Car, Car + trailer, Pickup/Van/Sport Utility, Pickup + trailer, Single Unit Truck/Bus, Single Unit Truck/Bus + trailer, Tractor + 1 trailer, Tractor + 2 trailers, Tractor + 3 trailers
Vehicle Classification Accuracy	>95% (into 6 vehicle classes)
Vehicle Spacing Resolution	10 ft at 125 mph (3 m at 200 kph), 4 ft at 62 mph (1.2 m at 100 kph) 1.5 ft at 10 mph (.35m @ 18.2 kph)
Trailer Tow Bar Detection	>2 in. wide, >2 ft long up to 125 mph (>5 cm wide, >60 cm long up to 200 kph)
Side-by-Side Vehicle Spacing	3 degrees minimum between vehicles
End-of-Vehicle Detection Signal	~1 ft (0.3 m) after vehicle exits 2 nd beam
Minimum Height Detection	2 ft (0.6 m)
Lane Width Coverage	12.3 ft at 23 ft mounting height (3.8 m at 7 m)
Maximum Mounting Height	25 ft (7.6 meters)
Minimum Mounting Height	19.5 ft (5.9 meters)
Vehicle Height Accuracy	± 3 in. (± 76 mm)
Vehicle Speed Accuracy	± 10%
Mean Time Between Failures	>35,000 hours

RECOMMENDED APPLICATIONS: Electronic toll collection, traffic data studies, flow measurement, traffic monitoring.

POWER REQUIREMENTS (watts/amps): 90-140 V, 50-60 Hz, 1.5 A or 200-264 V, 50-60 Hz, 1.0 A; Power consumption 35 W nominal, 157 W maximum (motor startup and heaters on).

POWER OPTIONS: See above.

CLASSIFICATION ALGORITHMS: FHWA 13 Scheme F or customer specified

TELEMETRY:

COMPUTER REQUIREMENTS: 166 MHz, 486 or better

DATA OUTPUT: RS-422 (RS-232 optional) serial interface at 19.2, 38.4 or 57.6 K baud to a 10-pin communication connector that attaches to the communication cable. This interface provides data messages in normal mode. AutoSense™ also has a high-speed (1.25 Mbps) RS-422 interface capability. The high-speed interface is used in applications requiring transmission of the sensor's raw range and intensity data.

DATA OUTPUT FORMATS: Binary data files

SUPPORTING DATA BASE MANAGEMENT SYSTEM: N/A

EQUIPMENT AND INSTALLATION COSTS (One-lane and four-lane):

STATES CURRENTLY USING THIS EQUIPMENT:

<u>Country/State</u>	<u>Contact name</u>	<u>Telephone number</u>
USA/Illinois	Bruce Hedlund	603) 505-8266
USA/New York	Jim Tate	(518) 471-4349
USA/Florida	Peter Zadarlik	(407) 481-9994
Canada/Ontario	A.J. Mohenred	(905) 265-1733
USA/Florida	Doug Martin	(805) 488-5687
USA/Colorado	Amos Pace	(609) 235-5252
USA/New York	Joe Lipari	(732) 287-8585
USA/California	Sialele Malope	(658) 646-4200
South Korea	Yang-Jong Park	011-02-531-8704
Italy	Stefano Zoppi	011-39-55-420-2322

MANUFACTURER AND VENDOR INFORMATION

Effective Date: 6/15/07

Manufacturer name: OSI LaserScan

Sales representative name(s): _____

Address: 300 Sunport Lane, Ste. 500
Orlando, FL 32809

Address: _____

Phone number: (407) 581-6000

Phone number: _____

Fax number: (407) 581-6038

Fax number: _____

e-mail address: sales@osi-ls.com

e-mail address: _____

URL address: http://www.osi-ls.com

URL address: _____

PRODUCT NAME/MODEL NUMBER: AutoSense 700 Axle-Based Vehicle Detection and Classification Sensor

FIRMWARE VERSION/CHIP NO.:

SOFTWARE VERSION NO.: A command is available to request firmware version information from the sensor.

GENERAL DESCRIPTION OF EQUIPMENT: The AS700 Series AutoSense™ vehicle detection and classification sensor is a class I laser system that provides toll authorities with timing, position, speed, length, and axle based classification of vehicles passing through its field-of-view. The AS700 Series AutoSense™ is installed on a pole arm or support structure in a toll plaza scanning side fire across the traffic lane. The AutoSense™ communicates with a roadside computer through its serial data connector, using either RS-422 (default) or RS-232 (configuration option). It provides a camera trigger signal as a discrete output through the same connector. An optional fiber optic communications interface is also available. For each vehicle passing through its field-of-view, the AutoSense™ will output five serial data messages and a camera trigger. A Vehicle ID number assigned by the unit is used to identify the passing vehicle for all five messages.

SENSOR TECHNOLOGY AND CONFIGURATION: Scanning infrared laser – Two beams with 10 degree separation. Each beam scans 30 or 40 degrees, depending on sensor model for free flow or toll barrier application.

SENSOR INSTALLATION: The AutoSense™ 700 is typically mounted between 5 and 16 ft (1.5 and 4.9 m) from the edge of the traffic lane. The recommended look down angle is 10

degrees for the first beam and 0 degrees for the second beam. These beam angles are achieved by mounting the sensor with a 5-degree forward tilt.

INSTALLATION TIME (Per Lane): Approximately 20 minutes

INSTALLATION REQUIREMENTS: Requires AutoSense™ mounting plate, power cable and signal cable.

MAXIMUM NUMBER OF LANES MONITORED SIMULTANEOUSLY: One

PRODUCT CAPABILITIES/FUNCTIONS:

Vehicle Detection Accuracy	>99.9% (one vehicle in field-of-view)
Vehicle Classification Categories	Number of axles detected
Axle Classification Accuracy	>99%
Vehicle Spacing Resolution	10 ft at 125 mph (1.2 m at 200 kph) 4 ft at 62 mph (0.6 m at 100 kph) 1.5 ft at 10 mph (0.35m @ 18.2 kph)
Trailer Tow Bar Detection	>2 in. tall, >2 ft long up to 125 mph (>5 cm tall, >60 cm long up to 200 kph)
End-of-Vehicle Detection Signal	~1 ft (0.3 m) after vehicle exits 2 nd beam
Lane Width Coverage	12.3 ft at 6 ft mounting height (3.8 m at 1.8 m)
Maximum Mounting Height	6 ft (1.8 m)
Minimum Mounting Height	4 ft (1.2 m)
Vehicle Speed Accuracy	± 10%
Mean Time Between Failures	>35,000 hours

RECOMMENDED APPLICATIONS: Electronic toll collection, traffic data studies, flow measurement, traffic monitoring.

POWER REQUIREMENTS (watts/amps): 90-140 V, 50-60 Hz, 1.5 A or 200-264 V, 50-60 Hz, 1.0 A; Power consumption 35 W nominal, 157 W maximum (motor startup and heaters on).

POWER OPTIONS: See above.

CLASSIFICATION ALGORITHMS: See table above.

TELEMETRY:

COMPUTER REQUIREMENTS: 166 MHz, 486 or better

DATA OUTPUT: RS-422 (RS-232 optional) serial interface at 19.2, 38.4 or 57.6 K baud to a 10-pin communication connector that attaches to the communication cable. This interface provides data messages in normal mode. AutoSense™ also has a high-speed (1.25 Mbps) RS-

422 interface capability. The high-speed interface is used in applications requiring transmission of the sensor's raw range and intensity data.

DATA OUTPUT FORMATS: Binary data files

SUPPORTING DATA BASE MANAGEMENT SYSTEM: N/A

EQUIPMENT AND INSTALLATION COSTS (One-lane and four-lane):

STATES CURRENTLY USING THIS EQUIPMENT:

Country/State

Contact name

Telephone number

MANUFACTURER AND VENDOR INFORMATION

Effective Date: 6/15/07

Manufacturer name: _____
OSI LaserScan

Sales representative name(s): _____

Address: 300 Sunport Lane, Ste. 500
Orlando, FL 32809

Address: _____

Phone number: (407) 581-6000

Phone number: _____

Fax number: (407) 581-6038

Fax number: _____

e-mail address: sales@osi-ls.com

e-mail address: _____

URL address: http://www.osi-ls.com

URL address: _____

PRODUCT NAME/MODEL NUMBER: Autosense™ 815

FIRMWARE VERSION/CHIP NO.:

SOFTWARE VERSION NO.: N/A

GENERAL DESCRIPTION OF EQUIPMENT: The AutoSense™ 800 series is designed to be mounted overhead to provide tolling and traffic management agencies with vehicle detection, separation, speed, and classification information for two lanes of traffic. In addition, the system can be configured to trigger enforcement cameras. The system operates by emitting two laser fields beneath the sensor to scan both the roadway and the vehicles passing through the eye-safe laser. The AS 800 Series is sensitive enough to detect tow bars and motorcycles. Classification is determined by the vehicles dimensional characteristics. Other traffic flow parameters available are speed, travel direction, lane position, left and right edge, and vehicle length, width, and height.

SENSOR TECHNOLOGY AND CONFIGURATION: Scanning infrared laser – Two beams with 10-degree separation. Each beam scans 60 degrees, covering two lanes.

SENSOR INSTALLATION: Typically mounted between 25 and 30 ft (7.6 and 9.2 m) centered above the traffic lanes. The first beam look-down angle is 10 degrees off nadir and the second beam’s look-down angle is nadir (0 degrees). These beam angles are realized by mounting the sensor with a 5-degree forward tilt.

INSTALLATION TIME (Per Lane): Approximately 1/2 hour

INSTALLATION REQUIREMENTS: Requires AutoSense™ mounting plate, power cable, signal cable.

MAXIMUM NUMBER OF LANES MONITORED SIMULTANEOUSLY: Two

PRODUCT CAPABILITIES/FUNCTIONS:

Scan rate: 720 scans/sec

Field of regard: 60 degrees

Measures per scan: 90

Scanline separation: 10 degrees

Pixel resolution: 0.67 degrees across full field of regard, both beams

Detection accuracy: >99.9% for two vehicles in field of regard

Classification accuracy: >95% into 6 vehicle classes

Vehicle speed accuracy: ±10%

Vehicle height accuracy: ± 3 in. (± 76 mm)

End-of-vehicle detection signal: ~1 ft (0.3 m) after vehicle exits second beam

Vehicle spacing resolution: 10 ft at 125 mph (3 m at 200 kph); 4 ft at 62 mph (1.2 m at 100 kph); 1.5 ft at 10 mph (0.45 m @ 16.1 kph)

Vehicle side-by-side spacing: 3 degrees minimum between vehicles

Trailer tow bar detection: >2 in. wide, >2 ft long, up to 125 mph (>5 cm wide, >60 cm long up to 200 kph)

11 standard classification categories plus 20 user-definable categories

Mean time between failures: >35,000 hours

RECOMMENDED APPLICATIONS: Two-lane, open road, free flow toll collection, traffic flow measurement, routing studies, traffic monitoring.

POWER REQUIREMENTS (watts/amps): 90-140 V, 50-60 Hz, 1.5 A or 200-264 V, 50-60 Hz, 1.0 A; Power consumption 40 W nominal, 160 W maximum (motor startup and heaters on).

POWER OPTIONS: See above.

CLASSIFICATION ALGORITHMS: Based on length, width, height and vehicle shape.

TELEMETRY:

COMPUTER REQUIREMENTS: 166 MHz, 486 or better. AutoSense™ product contains an onboard AD (Share) 21061, 32 bit, 40 MHz, DSP 120 MFLOPS with 50 MIPS.

DATA OUTPUT: RS-422 (RS-232 optional) serial interface at 19.2, 38.4 or 57.6 K baud to a 10-pin communication connector that attaches to the communication cable. This interface provides data messages in normal mode. AutoSense™ also has a high-speed (1.25 Mbps) RS-422 interface capability. The high-speed interface is used in applications requiring transmission of the sensor's raw range and intensity data.

DATA OUTPUT FORMATS:

SUPPORTING DATA BASE MANAGEMENT SYSTEM: N/A

EQUIPMENT AND INSTALLATION COSTS (One-lane and four-lane):

STATES CURRENTLY USING THIS EQUIPMENT:

<u>Country/State</u>	<u>Contact name</u>	<u>Telephone number</u>
USA/Florida	Haitham Al-Deck	(407) 823-2988
The Netherlands	Rune Lende	011-47-905-59-406

MANUFACTURER AND VENDOR INFORMATION

Effective Date: 7/3/07

Manufacturer name: EFKON AG

Sales representative name(s):
Christine Bowrey, Vice President

Address: Andritzer Reichsstrasse 66
A-8045 Graz
Austria

Address: EFKON USA
1401 Elm Street, Suite 3480
Dallas, TX 75202

Phone number: +43(316) 695 675 - 70

Phone number: (214) 453-4500

Fax number: +43(316) 695 675 - 68

Fax number: (214) 257-0432

Mobile number: +43(676)88 675 603

Mobile number: (972) 974-4556

e-mail address: dieter.berger@efkon.com

e-mail address: cbowrey@efkonusa.com

URL address: http://www.efkon.com/

URL address: www.efkonusa.com

PRODUCT NAME/MODEL NUMBER: Sherlock Laser Radar Vehicle Detector and Classifier

FIRMWARE VERSION/CHIP NO.: Firmware uploads are made available periodically.

SOFTWARE VERSION NO.:

GENERAL DESCRIPTION OF EQUIPMENT: The Sherlock sensor is an overhead-mounted traffic profiler that provides vehicle detection, classification, counting, and statistics information. The sensor incorporates class 1 near infrared laser diodes (eye-safe). It scans up to 500 times per second to perform its height-profile classification, profiling, counting, speed measuring, and driving direction indication functions. An array of 6 laser diode beams provides coverage over the entire width of the monitored lane.

SENSOR TECHNOLOGY AND CONFIGURATION: Six staring beams produced by laser diodes operating in the near infrared spectrum provide full lane coverage.

SENSOR INSTALLATION: Suggested mounting height: ~18'4" (can range from 6'6" to 21'4"). Lane width for suggested mounting height: ~11'8" (can range from 4'3" to 13'9").

INSTALLATION TIME (Per Lane):

INSTALLATION REQUIREMENTS: Mounts onto a spherical joint that serves as an adjustable mounting bracket.

MAXIMUM NUMBER OF LANES MONITORED SIMULTANEOUSLY: One

PRODUCT CAPABILITIES/FUNCTIONS: 99.899% detection accuracy (audited report of 150,000 vehicles), response time: 5 ms, vehicle speed measurement range: 0 – 155 mph, detectable vehicle separation distance: <12 in.

RECOMMENDED APPLICATIONS: Entry and exit trigger, vehicle detection, vehicle classification in up to 11 classes, vehicle separation, speed indication, driving direction, vehicle counting, toll audit systems, traffic monitoring, traffic statistics.

POWER REQUIREMENTS (watts/amps): 24 VDC, 15 W

POWER OPTIONS: None

CLASSIFICATION ALGORITHMS: Optional Softguide software running on PC; classification converter for multiple sensor scenarios.

TELEMETRY: Serial null modem cable for serial-to-Ethernet converter

COMPUTER REQUIREMENTS: See above entries.

DATA OUTPUT:

DATA OUTPUT FORMATS: Interface Converter (ICON – RS422 to RS232)

SUPPORTING DATA BASE MANAGEMENT SYSTEM:

EQUIPMENT AND INSTALLATION COSTS (One-lane and four-lane):

Equipment price 1 lane: 6200€

Equipment price 4 lanes with additional servers and converters: about 30,000€

Price excludes gantry, cabinet, racks, installation, project management, and software customizations

STATES CURRENTLY USING THIS EQUIPMENT:

<u>Country/State</u>	<u>Contact name</u>	<u>Telephone number</u>
NY/NJ	Port Authority NY-NJ	
Delaware	Delaware River Bridge Authority	

MANUFACTURER AND VENDOR INFORMATION

Effective Date: 7/3/07

Manufacturer name: _____
Eltec Instruments Inc.

Sales representative name(s): _____
Douglas S. Armstrong, Vice President,
Sales and Commercial

Address: P.O. Box 9610
Daytona Beach, FL 32120-9610

Address: _____

Phone number: (800) 874-7780

Phone number: +1 (386) 252-0411 (outside USA)

Fax number: (386) 258-3791

Fax number: _____

e-mail address: eltecinst@worldnet.att.net

e-mail address: _____

URL address: _____

URL address: _____

PRODUCT NAME/MODEL NUMBER: Model 842 Overhead Vehicle Presence Sensor

FIRMWARE VERSION/CHIP NO.: N/A

SOFTWARE VERSION NO.: N/A

GENERAL DESCRIPTION OF EQUIPMENT: A small, self-contained passive infrared (mount and aim) sensor that detects vehicles from their long wavelength infrared contrast with respect to the road surface. Vehicle presence is via a relay output.

SENSOR TECHNOLOGY AND CONFIGURATION: Thermal infrared pyroelectric detector tuned to the 8-14µm wavelength band. Housed in NEMA 4X chassis. Overhead mount (pole/mast arm) configuration.

SENSOR INSTALLATION: Mounts on overhead gantry, pole, or mast arm mount; aimed at lane to be monitored.

INSTALLATION TIME (Per Lane): Minimal – attach bracket, sensor, and run wires.

INSTALLATION REQUIREMENTS: Pole or mast arm. Mounting height is 15 to 20 ft. above road surface.

MAXIMUM NUMBER OF LANES MONITORED SIMULTANEOUSLY: One lane

PRODUCT CAPABILITIES/FUNCTIONS: Vehicle presence sensor with relay output. Responds to presence of stopped vehicle for 5 min. Multiple units at installation site will not interfere with each other; device operation cannot interfere with radios or other electronic equipment.

RECOMMENDED APPLICATIONS: Signal control at temporary construction sites, temporary replacement of failed loop detectors, side street demand only signal control.

POWER REQUIREMENTS (watts/amps): 95 to 135 VAC, 50 to 60 Hz, 10.0 watts max.

POWER OPTIONS: 190 to 270 VAC, 50 to 60 Hz.

CLASSIFICATION ALGORITHMS: N/A

TELEMETRY: N/A

COMPUTER REQUIREMENTS: N/A

DATA OUTPUT:

DATA OUTPUT FORMATS: Isolated NO or NC relay contacts. Units shipped with NO contacts unless otherwise specified.

SUPPORTING DATA BASE MANAGEMENT SYSTEM:

EQUIPMENT AND INSTALLATION COSTS (One-lane and four-lane):

STATES CURRENTLY USING THIS EQUIPMENT:

<u>Country/State</u>	<u>Contact name</u>	<u>Telephone number</u>
USA/Florida		
USA/California		
USA/North Carolina		

MANUFACTURER AND VENDOR INFORMATION

Effective Date: 7/3/07

Manufacturer name: Eltec Instruments Inc. Sales representative name(s): Douglas S. Armstrong, Vice President,

Sales and Commercial

Address: P.O. Box 9610
Daytona Beach, FL 32120-9610

Address: _____

Phone number: (800) 874-7780

Phone number: +1 (386) 252-0411 (outside USA)

Fax number: (386) 258-3791 Fax number: _____

e-mail address: eltecinst@worldnet.att.net e-mail address: _____

URL address: _____ URL address: _____

PRODUCT NAME/MODEL NUMBER: Model 864 or 864M3 (narrow field of view) Long Range Passive Infrared Telescope

FIRMWARE VERSION/CHIP NO.: N/A

SOFTWARE VERSION NO.: N/A

GENERAL DESCRIPTION OF EQUIPMENT: Long range vehicle or personnel detection up to 500 ft (152 m) in perimeter protection applications. The differences in the models occur in the vertical field of view coverage, where the wide field of view model (864) has additional downward vertical coverage. The narrow field of view model (864M3) is better suited for detection of a defined spot from a distance.

SENSOR TECHNOLOGY AND CONFIGURATION: Thermal infrared pyroelectric detector tuned to the 8-14 μ m wavelength band. Housed in a weatherproof tube.

SENSOR INSTALLATION: Overhead pole, mast arm, bridge, building wall.

INSTALLATION TIME (Per Lane): Install bracket and run wire, point to aim

INSTALLATION REQUIREMENTS: Stable (non-swaying) structure. Mounting height is 4 to 20 ft. above ground surface.

MAXIMUM NUMBER OF LANES MONITORED SIMULTANEOUSLY: N/A

PRODUCT CAPABILITIES/FUNCTIONS: Primarily designed for intrusion detection or alarm alert if vehicle or person enters forbidden zone (e.g., prior to blasting, other restricted areas).

RECOMMENDED APPLICATIONS: In a security system designed for long-range detection of people and vehicles

POWER REQUIREMENTS (watts/amps): 10.2 to 30 VDC @ 4.8 mA nominal, 5.0 mA max

POWER OPTIONS: See above.

CLASSIFICATION ALGORITHMS:

TELEMETRY:

COMPUTER REQUIREMENTS: None

DATA OUTPUT: Presence

DATA OUTPUT FORMATS: Relay and transistor outputs

SUPPORTING DATA BASE MANAGEMENT SYSTEM:

EQUIPMENT AND INSTALLATION COSTS (One-lane and four-lane):

STATES CURRENTLY USING THIS EQUIPMENT:

Country/State

Contact name

Telephone number

DEA, FBI, Secret Service, Border Patrol (US and Canada both), US Army, private roadway alarm, foreign countries from Norway to Korea, especially the Middle East.

ULTRASONIC SENSORS

Principles of Operation

Ultrasonic sensors transmit pressure waves of sound energy at frequencies between 25 and 50 KHz, which are above the human audible range. Most ultrasonic sensors, such as the model shown in Figure 34, operate with pulse waveforms and provide vehicle count, presence, and occupancy information. Pulse waveforms measure distances to the road surface and vehicle surface by detecting the portion of the transmitted energy that is reflected towards the sensor from an area defined by the transmitter's beamwidth. When a distance other than that to the background road surface is measured, the sensor interprets that measurement as the presence of a vehicle. The received ultrasonic energy is converted into electrical energy that is analyzed by signal processing electronics that is either collocated with the transducer or placed in a roadside controller. Ultrasonic sensors may be used in conjunction with other sensor technologies to enhance presence and queue detection, vehicle counting, and height and distance discrimination as shown on the left side of Figure 1.

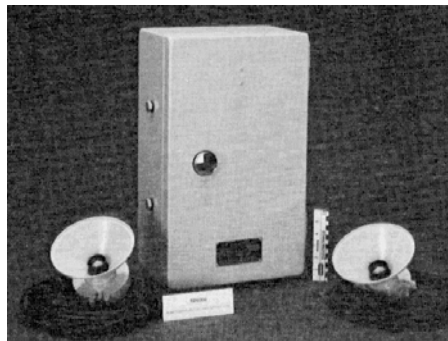

Sumitomo SDU-300 pulse ultrasonic sensor
(Photograph courtesy of Lawrence A. Klein)

Figure 34. Ultrasonic sensor.

Application and Uses

Pulse energy transmitted at two known and closely spaced incident angles allows vehicular speed to be calculated by recording the time at which the vehicle crosses each beam. Since the beams are a known distance apart, the speed is given by Eq. (5-1). Constant frequency ultrasonic sensors that measure speed using the Doppler principle are also manufactured. However, these are more expensive than pulse models.

The preferred mounting configurations for range-measuring, pulsed ultrasonic sensors are downward looking and side viewing as shown in Figure 35. The range-measuring ultrasonic sensor transmits a series of pulses of width T_p (typical values are between 0.02 and 2.5 ms) and repetition period T_0 (time between bursts of pulses), typically 33 to 170 ms. The sensor measures the time it takes for the pulse to arrive at the vehicle and return to the transmitter. The receiver is gated on and off with a user-adjustable interval that helps to differentiate between pulses reflected from the road surface and those reflected from vehicles. The detection gate is adjusted to detect an object at a distance greater than approximately 0.5 m above the road surface.

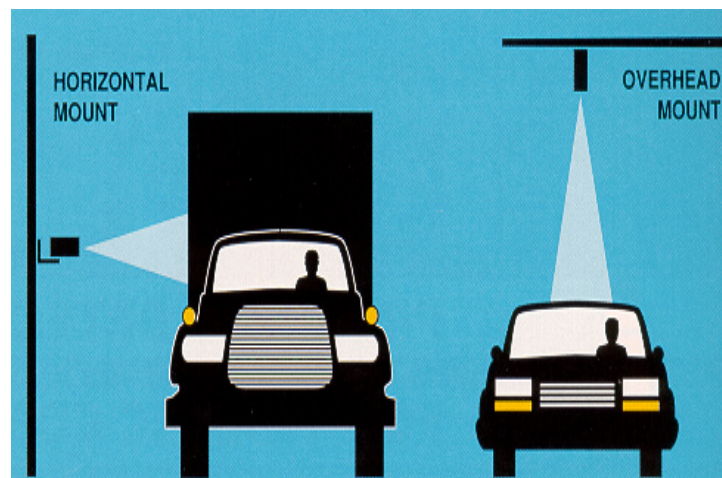

Figure 35. Mounting of ultrasonic range-measuring sensors. (Courtesy of Microwave Sensors, Ann Arbor, MI).

Automatic pulse-repetition frequency control reduces effects of multiple reflections and improves the detection of high-speed vehicles. This control is implemented by making the pulse repetition period as short as possible by transmitting the next pulse immediately after the reflected signal from the road is received (Kumagai, et al., 1992). A hold time T_h (composite values from manufacturers range from 115 ms to 10 s) is built into the sensors to enhance presence detection.

Advantages

Installation of ultrasonic sensors does not require an invasive pavement procedure. Also, some models feature multiple lane operation.

Disadvantages

Temperature change and extreme air turbulence may affect the performance of ultrasonic sensors. Temperature compensation is built into some models. Large pulse repetition periods may degrade occupancy measurement on freeways with vehicles traveling at moderate to high speeds.

MANUFACTURER AND VENDOR INFORMATION

Effective Date: 2/29/00

Manufacturer name: Sumitomo Electric Sales representative name(s): _____

Address: 1-1-3 Shimaya Address: _____
Konohana-ku, Osaka 554-0024
Japan

Phone number: +81 6-6461-1031 Phone number: _____
Fax number: +81 6-6466-3305 Fax number: _____
e-mail address: www@prs.sei.co.jp e-mail address: _____
URL address: www.sel.co.jp URL address: _____

PRODUCT NAME/MODEL NUMBER: SDU-420

FIRMWARE VERSION/CHIP NO.: N/A

SOFTWARE VERSION NO.: N/A

GENERAL DESCRIPTION OF EQUIPMENT: Ultrasonic Vehicle Detector

SENSOR TECHNOLOGY AND CONFIGURATION: Ultrasound

SENSOR INSTALLATION: Overhead

INSTALLATION TIME (Per Lane):

INSTALLATION REQUIREMENTS: Pole arm

MAXIMUM NUMBER OF LANES MONITORED SIMULTANEOUSLY: One lane/head

PRODUCT CAPABILITIES/FUNCTIONS: Presence, occupancy, classification (two)

RECOMMENDED APPLICATIONS: Advanced traffic signal control, freeway monitoring,

POWER REQUIREMENTS (watts/amps): 160 VA

POWER OPTIONS: N/A

CLASSIFICATION ALGORITHMS: Vehicle height

TELEMETRY: N/A

COMPUTER REQUIREMENTS: NO

DATA OUTPUT: NEMA TS1, custom

DATA OUTPUT FORMATS: N/A

SUPPORTING DATA BASE MANAGEMENT SYSTEM: N/A

EQUIPMENT AND INSTALLATION COSTS (One-lane and four-lane):

Approx. \$1,900/one lane & installation cost

STATES CURRENTLY USING THIS EQUIPMENT:

Country/State

Contact name

Telephone number

Japan

PASSIVE ACOUSTIC ARRAY SENSORS

Acoustic sensors measure vehicle passage, presence, and speed by detecting acoustic energy or audible sounds produced by vehicular traffic from a variety of sources within each vehicle and from the interaction of a vehicle's tires with the road. When a vehicle passes through the detection zone, an increase in sound energy is recognized by the signal-processing algorithm and a vehicle presence signal is generated. When the vehicle leaves the detection zone, the sound energy level drops below the detection threshold and the vehicle presence signal is terminated. Sounds from locations outside the detection zone are attenuated.

Principles of Operation

Two models of acoustic sensors are marketed. Both detect the sounds produced by approaching vehicles with a two-dimensional array of microphones. The SmartSonic acoustic sensor shown on the left in Figure 36 detects vehicles by measuring the time delay between the arrival of sound at the upper and lower microphones, which are arranged in a vertical and horizontal line through the center of the aperture. The time delay changes as the vehicle approaches the array. When the vehicle is inside the detection zone, the sound arrives almost instantaneously at the upper and lower microphones. When the vehicle is outside the detection zone, sound reception at the upper microphone is delayed by the intermicrophone distance. The size and shape of the detection zone are determined by the aperture size, processing frequency band, and installation geometry of the acoustic array. The SmartSonic sensor is tuned to a center frequency of 9 KHz with a 2 KHz bandwidth. Preferred mounting is at 10 to 30 degrees from nadir with a detection range of 20 to 35 ft (6 to 11 m). The speed of a detected vehicle is determined with an algorithm that assumes an average vehicle length. Vehicle presence detection is through an optically isolated semiconductor. When the optional acoustic sensor controller board is installed in a NEMA or 170 cardfile, two detection zones can be used in a speed trap mode to measure vehicle speed. The speed trap activates relay outputs that simulate two inductive loops connected to a NEMA or 170 controller.

The SAS-1 acoustic sensor on the right in Figure 36 uses a fully populated microphone array and adaptive spatial processing to form multiple zones that receive the acoustic energy from up to 5

lanes when the sensor is mounted at the side of a roadway. During setup, the detection zones are steered to positions that correspond to the monitored traffic lanes. The detection zones are self-normalized and polled for vehicles every 8 ms. Detection zones are adjustable to 6 ft (1.8 m) or 12 ft (3.6 m) in the direction of traffic flow and have user-specified values in the cross-lane direction. Acoustic frequencies between 8 and 15 kHz are processed by this sensor, which accommodates mounting heights of 20 to 40 ft (6 to 12 m).

Application and Uses

The SmartSonic is recommended for data collection applications on bridges and other roads where over-roadway sensors are required and where slow moving vehicles in stop and go traffic flow are not present.



SmartSonic acoustic sensor. (Photograph courtesy of IRD, Saskatoon, SK)



SAS-1 acoustic sensor. (Photograph courtesy of SmarTek Systems, Woodbridge, VA)

Figure 36. Acoustic array sensors.

The output data provided by the SAS-1 are volume, lane occupancy, and average speed for each monitored lane over a user-specified period (e.g., 20s, 30s, 1 min). Vehicle presence is provided by an optional relay interface.

Advantages

Installation of passive acoustic array sensors does not require an invasive pavement procedure. Acoustic sensors are insensitive to precipitation and multiple lane operation is available in some models.

Disadvantages

Cold temperatures have been reported as affecting the accuracy of the data from acoustic sensors. Also, specific models are not recommended with slow moving vehicles in stop and go traffic.

MANUFACTURER AND VENDOR INFORMATION

Effective Date: March 22, 2000

Manufacturer name: International Road Dynamics, Inc.

Sales representative name(s): Rod Klashinsky

Address: 702 43rd Street East
Saskatoon SK, S7K 3T9 Canada

Address: _____

Phone number: 306-653-6600

Phone number: _____

Fax number: 306-242-5599

Fax number: _____

e-mail address: info@irdinc.com

e-mail address: _____

URL address: www.irdinc.com

URL address: _____

PRODUCT NAME/MODEL NUMBER: IRD SmartSonic™ Vehicle Detection System

FIRMWARE VERSION/CHIP NO.: N/A

SOFTWARE VERSION NO.: N/A

GENERAL DESCRIPTION OF EQUIPMENT: The IRD Smartsonic™ Vehicle Detection System is based on acoustic-sensing and signal processing technologies. The SmartSonic™ sensors are mounted non-intrusively above or beside roadways on existing structures such as bridges, overhead traffic signs or light poles. Structures may be installed specifically to mount the sensors if required. IRD SmartSonic™ Vehicle Detection Systems are ideal for detection of vehicles on roadways where lane closure is not an option.

SENSOR TECHNOLOGY AND CONFIGURATION: SmartSonic™ detectors are acoustic-sensing technology for vehicle detection. A single detector provides vehicle detection per lane.

SENSOR INSTALLATION: Sensors may be installed above or beside roadways using existing structures or specifically installed structures.

INSTALLATION TIME (Per Lane): Typically 4 hours.

INSTALLATION REQUIREMENTS: Please see attached product information for details.

MAXIMUM NUMBER OF LANES MONITORED SIMULTANEOUSLY: Four SmartSonic™ sensors can interface to a single SmartSonic™ controller to monitor 4 lanes.

PRODUCT CAPABILITIES/FUNCTIONS: Vehicle detection, Traffic counting, Occupancy Counts per lane of Traffic.

RECOMMENDED APPLICATIONS: Vehicle detection, Traffic counting, Occupancy Counts per lane of traffic in free-flow traffic at speeds of more than 30 MPH.

POWER REQUIREMENTS (watts/amps): 12-24 VDC

POWER OPTIONS: DC or solar.

CLASSIFICATION ALGORITHMS: Up to 3 classes.

TELEMETRY: Yes

COMPUTER REQUIREMENTS: A laptop computer may be used for information retrieval with serial communication software such as HyperTerminal.

DATA OUTPUT: Serial or contact closure.

DATA OUTPUT FORMATS: ASCII

SUPPORTING DATA BASE MANAGEMENT SYSTEM: N/A

EQUIPMENT AND INSTALLATION COSTS (One-lane and four-lane):

1-lane: \$4,000 US

4-lane: \$12,000 US

STATES CURRENTLY USING THIS EQUIPMENT:

Country/State

Contact name

Telephone number

USA/Massachusetts

USA/Texas

USA/Arizona

MANUFACTURER AND VENDOR INFORMATION

Effective Date: 7/3/07

Manufacturer name: SmarTek Systems

Sales representative name(s): Greg Pieper

Address: 14710 Kogan Drive
Woodbridge, VA 22193

Address: 295 Waycross Way
Arnold, MD 21072

Phone number: (410) 315-9727

Phone number: (410) 315-9727

Fax number: (410) 384-9264

Fax number: (410) 384-9264

e-mail address: sales@smarteksys.com

e-mail address: sales@smarteksys.com

URL address: _____

URL address: www.smarteksys.com

PRODUCT NAME/MODEL NUMBER: SAS-1

FIRMWARE VERSION/CHIP NO.:

SOFTWARE VERSION NO.:

GENERAL DESCRIPTION OF EQUIPMENT: The SAS-1 is a non-intrusive, true presence vehicle detector providing traffic count, occupancy, and per vehicle speed information, and can store up to 60 days of data. It can be connected to existing traffic controllers via RS-232 serial port or opto-coupled relay. Each sensor provides up to five lanes of dual-loop, speed trap equivalence when installed from a side-fire position.

SENSOR TECHNOLOGY AND CONFIGURATION: Passive acoustic

SENSOR INSTALLATION: Side-fire mounted 25 to 40 ft (76 to 122 m) above the pavement. The horizontal distance to the first detection one is 5 to 30 ft (15 to 91 m).

INSTALLATION TIME (Per Lane): 5 minutes

INSTALLATION REQUIREMENTS: Pole mount; bucket truck

MAXIMUM NUMBER OF LANES MONITORED SIMULTANEOUSLY: Five

PRODUCT CAPABILITIES/FUNCTIONS: True presence, traffic count (volume), speed (average and per vehicle), lane occupancy, up to 60 day data storage (dependent on memory: 1, 2, or 4 Mbits).

RECOMMENDED APPLICATIONS: Traffic monitoring of highways, etc.

POWER REQUIREMENTS (watts/amps): 8-24 VDC, <2W.

POWER OPTIONS: None

CLASSIFICATION ALGORITHMS: Up to 3 levels of vehicle classification.

TELEMETRY: Wireless 2.4 GHz spread spectrum optional.

COMPUTER REQUIREMENTS:

DATA OUTPUT: See Product Capabilities/Functions

DATA OUTPUT FORMATS: RS-422 standard, RS-232 optional.

SUPPORTING DATA BASE MANAGEMENT SYSTEM:

EQUIPMENT AND INSTALLATION COSTS (One-lane and four-lane):

STATES CURRENTLY USING THIS EQUIPMENT:

<u>Country/State</u>	<u>Contact name</u>	<u>Telephone number</u>
USA/Arizona	Tim Wolf	(602) 712-6622
USA/Arizona	Glenn Jonas	(602) 712-6587
USA/Idaho	Jim Larsen	(208) 387-6197
USA/Virginia	Cyndi Ward	(804) 692-0390
USA/Virginia	Mr. Stephany Hanshaw	(757) 464-9907
USA/New York	Bill Platt	(607) 324-8412

Chapter 6 - References

1. Apogee/Hagler Bailly, *Intelligent Transportation Systems: Real World Benefits*, FHWA-JPO-98-018, January 1998.
2. ASTM E1318-02, *Standard Specification for Highway Weigh-in-Motion (WIM) with User Requirements and Test Method*, Annual Book of ASTM Standards, vol. 04.03, West Conshohocken, PA, 2005.
3. Caldera, R., *Long-Term Stable Quartz WIM Sensors*, *Proceedings – National Traffic Data Acquisition Conference, Vol. II*, NM-NATDAC'96, Albuquerque, NM, May 5-6, 1996, NM State Highway and Transportation Dept., Santa Fe, NM.
4. Castle Rock Consultants, *Automated Traffic/Truck Weight Monitoring Equipment (Weigh-in-Motion)*, FHWA-DP-88-76-006, May 1988.
5. Chang, E. C-P and H. Kunhuang, "Incident Detection Using Advanced Technologies," Paper 930943, 72nd Annual Meeting, Transportation Research Board, Washington, D.C., 1993.
6. Davis, S.C. and Diegel, S.W., *Transportation Energy Data Book: Edition 22-2002*, Table 6.5, ORNL-6967, Oak Ridge National Laboratory, Oak Ridge, TN, Sept. 2002.
7. Fowler, D. W., *Selection of Bonding Materials for Piezoelectric Sensors*, *Proceedings – National Traffic Data Acquisition Conference, Vol. II*, NM-NATDAC'96, Albuquerque, NM, May 5-6, 1996, NM State Highway and Transportation Dept., Santa Fe, NM.
8. Gordon, R.L., R.A. Reiss, H. Haenel, E.R. Case, R.L. French, A. Mohaddes, and R. Wolcott, *Traffic Control Systems Handbook*, FHWA-SA-95-032, Federal Highway Administration, U.S. Department of Transportation, Washington, D.C., Feb. 1996.
9. Halvorsen, Don, *Finger on the Pulse – Piezos on the Rise*, Traffic Technology International, June/July, 1999.
10. Hockaday, S., *Evaluation of Image Processing Technology for Applications in Highway Operations Final Report*, TR 91-2, Transportation Res. Group, California Polytechnical State University, San Luis Obispo, California, Jun. 29, 1991.
11. JAMAR Technologies, Inc., *Catalog Number 7*, Horsham, PA.
12. Kanhere, N.K., S.T. Birchfield, and W.A. Sarasua, "Vehicle Segmentation and Tracking in the Presence of Occlusions," 85th Annual TRB Meeting, Washington, DC, 2006.
13. Kell, J.H. and I.J. Fullerton, *Traffic Detector Handbook*, Second Edition, U.S. Department of Transportation, Federal Highway Administration, Washington, D.C., 1990.

14. Kistler Instrumente AG, *Weigh In Motion: The First System for Monitoring at Any Speed*, Winterthur, Switzerland, October 1997.
15. Klein L. A. and M.R. Kelley, *Detection Technology for IVHS, Vol. I: Final Report*, FHWA-RD-95-100, Federal Highway Administration, U.S. Department of Transportation, Washington, D.C., Dec. 1996.
16. Klein, L. A., *Millimeter-Wave and Infrared Multisensor Design and Signal Processing*, Artech House, Norwood, MA, 1997.
17. Klein, L. A., *Final Report: Mobile Surveillance and Wireless Communication Systems Field Operational Test - Vol. 1: Executive Summary*, California PATH Res. Rpt. UCB-ITS-PRR-99-6, University of California, Berkeley, Richmond, CA, Mar. 1999.
18. Klein, L. A., *Final Report: Mobile Surveillance and Wireless Communication Systems Field Operational Test - Vol. 2: FOT Objectives, Organization, System Design, Results, Conclusions, and Recommendations*, California PATH Res. Rpt. UCB-ITS-PRR-99-7, University of California, Berkeley, Richmond, CA, Mar. 1999.
19. Klein, L. A., *Data Requirements and Sensor Technologies for ITS*, Norwood, MA, Artech House, 2001.
20. Klein, L.A., Gibson, D., and Mills, M.K., *Traffic Detector Handbook*, FHWA-HRT-06-108, Federal Highway Administration, US Department of Transportation, Washington, DC, 2006.
21. Klein, L.A., "Machine Vision Sensors for Expressway Management: Strengths and Weaknesses Revealed," Proceedings 1st International Symposium on Freeway and Tollway Operations, Athens, Greece, June 2006.
22. Kranig J., E. Minge, and C. Jones, *Field Test of Monitoring of Urban Vehicle Operations Using Non-Intrusive Technologies*, FHWA-PL-97-018, Federal Highway Administration, U.S. Department of Transportation, Washington, D.C., May 1997.
23. Kumagai, Y., T. Yamamoto, M. Deguchi, and S. Yamaoka, *Ultrasonic Detector and New Type Sensors for Urban Traffic Control Systems*, Sumitomo Electric Industries, 1992.
24. Lenz, J.E., *FAA Demonstration of Alternate Technologies to Prevent Runway Incursions*, Final Rpt. Vol. 1, Honeywell Inc., Systems and Research Center, Minneapolis, MN, Apr. 1993.
25. McCall, William and Walt Vodrazka, *States' Successful Practices Weigh-In-Motion Handbook*, Center for Transportation Research and Education, Iowa State University, Ames, IO, Dec. 1997. http://www.ctre.iastate.edu/research/wim_pdf/index.htm

26. MacCarley, C.A., S. Hockaday, D. Need, S. Taff, "Evaluation of Video Image Processing Systems for Traffic Detection," *Transportation Research Record No. 1360*, National Research Council, Washington D.C., 1992.
27. Michalopoulos, P.G., R.D. Jacobson, C.A. Anderson, and J.C. Barbaresso, "Integration of Machine Vision and Adaptive Control in the Fast-Trac IVHS Program," 72nd Annual Meeting, Transportation Research Board, Washington, D.C., Jan. 1993.
28. Middleton, D. and R. Parker, *Vehicle Detector Evaluation*, FHWA/TX-03/2119-1, Texas Transportation Institute, College Station, TX, 2002.
29. Minnesota Department of Transportation (MnDOT), *NIT Phase II: Evaluation of Non-Intrusive Technologies for Traffic Detection*, Final Report SRF 3683, St. Paul, MN, Sept. 2002.
30. Nestor Corp. Data Sheets, Providence, R.I., 1999.
31. Proper, Allen T. and Cheslow, Melvyn D., *ITS Benefits: Continuing Successes and Operational Test Results*, FHWA-JPO-98-002, October 1997.
32. Rhodes, A., D.M. Bullock, J. Sturdevant, Z. Clark, and D.G. Candey, Jr., "Evaluation of Stop Bar Video Detection Accuracy at Signalized Intersections," 84th Annual Meeting, Transportation Research Board, Washington, D.C., 2005.
33. Roadtrax, *Roadtrax BL and BLC Piezoelectric Sensor Catalog Sheets*, Amp Inc., Valley Forge, PA, March 1995 and April 1996. Catalogs also available from Measurement Specialties, Norristown, PA, 1998.
34. Sampey, H.R., *Vehicle Magnetic Imaging*, Nu-Metrics, Vanderbilt, PA, May 1994.
35. News, Oct. 6, 1999, p.4.
36. Wentworth, J., C. Dougan, D. Green, W. Kaufman, E. Kent, T. O'Keefe, and H. Wang, *International Scanning Report on Advanced Transportation Technology*, Federal Highway Administration, FHWA-PL-95-027, Washington, D.C., Dec. 1994.

APPENDIX A:

Vendor/Manufacturer Database
Vendor Survey (Blank)
Vendor Form Letter