

CHAIN LINK FENCE

- NOTES:
1. Metal post and rails shall conform to ASTM F 761.
 2. Set all post in concrete. Set corner, end, pull posts to the dimensions shown. The minimum depth of concrete for line posts is 24 inches. Increase depth 3 inches for each additional foot inches of fence height over 4 feet.
 3. Adjust the post top elevations to provide a smooth visual fence profile. Install corner posts at horizontal breaks in the fence or 15° or more.
 4. Provide fence fabric with a 2 inch mesh, use 11 gage wire in fabric heights of 48 inches or less and 9 gage wire in fabric heights greater than 48 inches. Provide a Class D coating when zinc-coated steel fence fabric is provided. Knuckle both selvages on fabric.
 5. See Detail E619-07, sheet 2 for hardware and gate requirements.

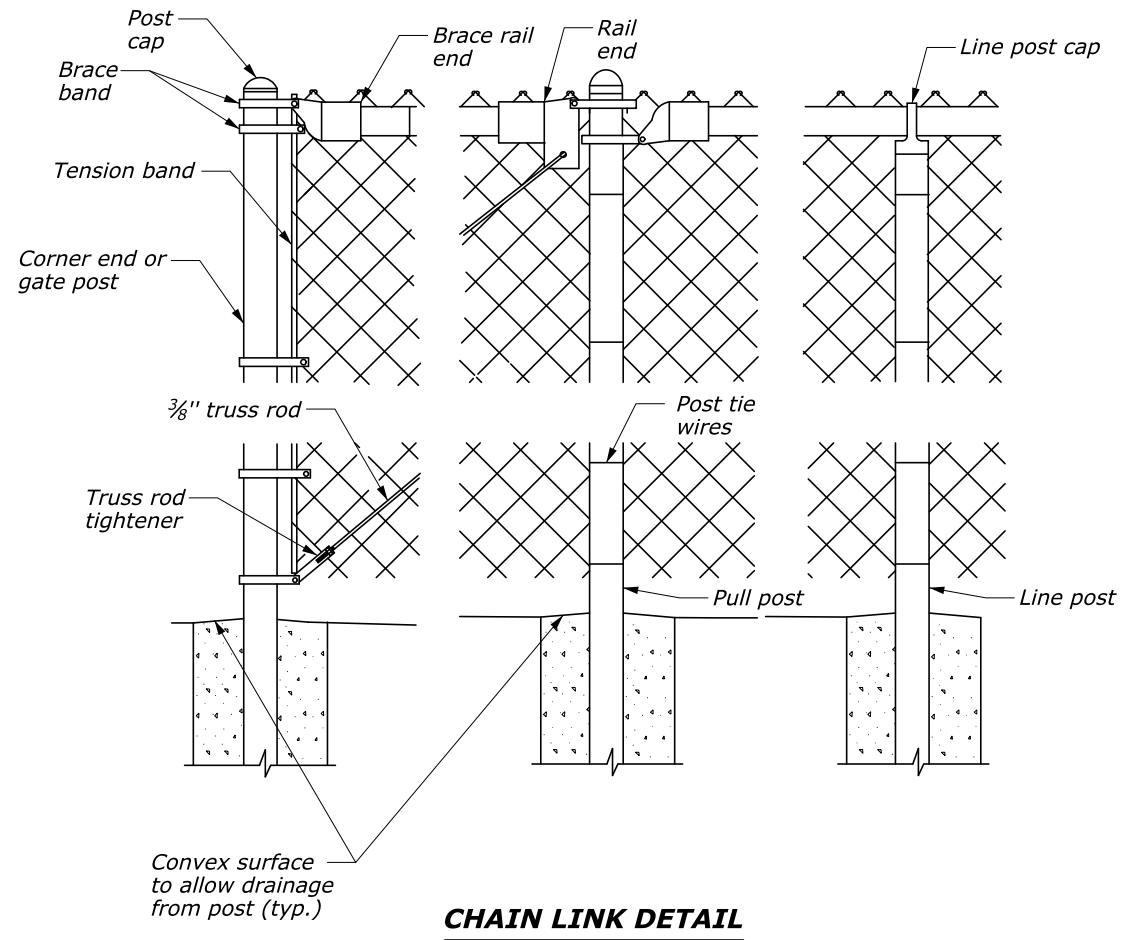

CHAIN LINK DETAIL

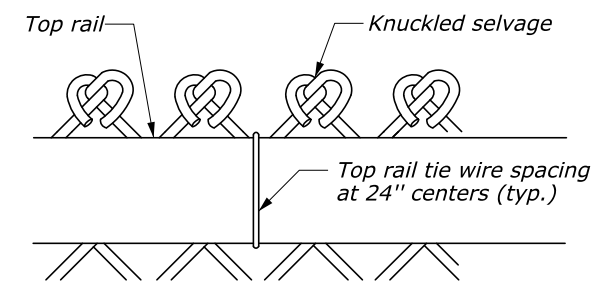

WIRE SELVAGE DETAIL

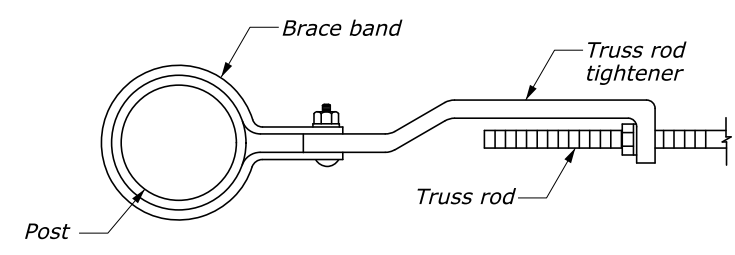

TRUSS ROD TIGHTENER DETAIL

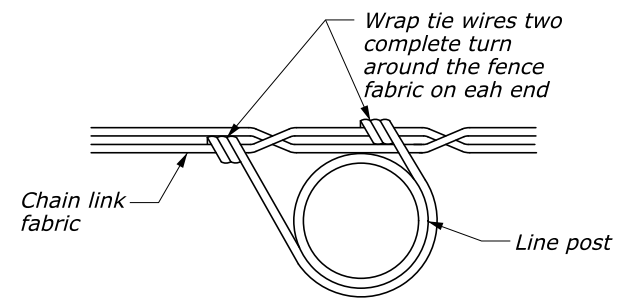

CHAIN LINK FENCE TIE DETAIL

CHAIN LINK FENCE			
POST SIZE AND WEIGHT TABLE			
DESCRIPTION	FENCE HEIGHT	ROUND PIPE	
		Yield strength 25,000 Psi (min.)	
		dia. inch	lbs/ft (min.)
Brace rail & top rail	5 feet or less	1.315	0.740
	6 feet	1.315	0.740
Line post	5 feet or less	1.660	1.107
	6 feet	1.900	1.273
End, corner & pull post	5 feet or less	1.400	1.273
	6 feet	2.375	1.603

U.S. DEPARTMENT OF TRANSPORTATION
 FEDERAL HIGHWAY ADMINISTRATION
 EASTERN FEDERAL LANDS HIGHWAY DIVISION

U.S. CUSTOMARY DETAIL

RESIDENTIAL CHAIN LINK FENCE













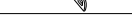

Sheet 1 of 2

DETAIL APPROVED FOR USE

APPROVED: MAY 2011
 REVISED: SEPTEMBER 2014

DETAIL E619-07

01-Dec-2014 03:04 PM \$TIME\$
 H:\Team_Folders\VIDU\VP_JA_Detail_Review\ALL_FPI4_DCH\61907_detail.dgn

HARDWARE ITEM DESCRIPTION	STANDARD REQUIREMENTS
Brace rail and top rail 	See tabel on Detail E619-09
Line post 	See tabel on Detail E619-09
Corner; end and pull posts 	See table on Detail E619-09
Post cap 	Cast non-ferrous alloy or galvanized pressed steel cap must fit snugly on post and gate topa
Line post cap 	Galvanized pressed steel minimum " 3/32" thickness or galvanized malleable ferrous alloy
Tension band 	Minimum 3/32" x 5/16" galvanized steel
Brace band 	Minimum 3/32" x 5/16" galvanized steel
Band bolt 	Minimum 5/16" x 1 1/4" galvanized carriage bolt, (Lock washer & flat washer for each band0
Rail end 	Galvanized pressed steel or galvanized malleable ferrous alloy minimum... " 3/8" thickness on back bolting appendage
Brace rail end 	Galvanized pressed steel or galvanized malleable ferrous alloy minimum " 3/8" thickness on back bolting appendage
Truss rod tightener 	Minimum 1/4" formed galvanized steel
Truss rod 	3/8" galvanized, NC threaded rod, lock washer, & flat washer with two 90° bends opposite of threaded end
Top rail sleeve 	Galvanized steel 0.051" minimum thickness by 6" minimum length
Tension bar 	Minimum 3/16" x 3/4" galvanized steel
Fence fabric 	2" diamond mesh fabric, See note no. 4 on Detail E619-07 of Sheet 1
Tie wires 	Minimum 9 gage aluminum with one hooked end
Gate latch 	Minimum 1/8" galvanized pressed steel or malleable ferrous alloy. 1 latch per each single gate with bent minimum 3/8" attachment bolt, washer & nut.
Frame hinge 	Minimum 1/8" galvanized pressed steel with 2 - 3/8" U-bolts, lockwasher & nuts per hinge. Use 2 hinges per gate leaf up to 8' in width and 3 hinges per gate leaf widths greater than 8'.
Drop rod latch & guide 	Minimum 1/8" galvanized presed steel. Drop rod guide includes 3/8" x 3" carriage bolt with lock washer & nut. Weld drop rod fork to rod & paint with an approved zinc rich paint.

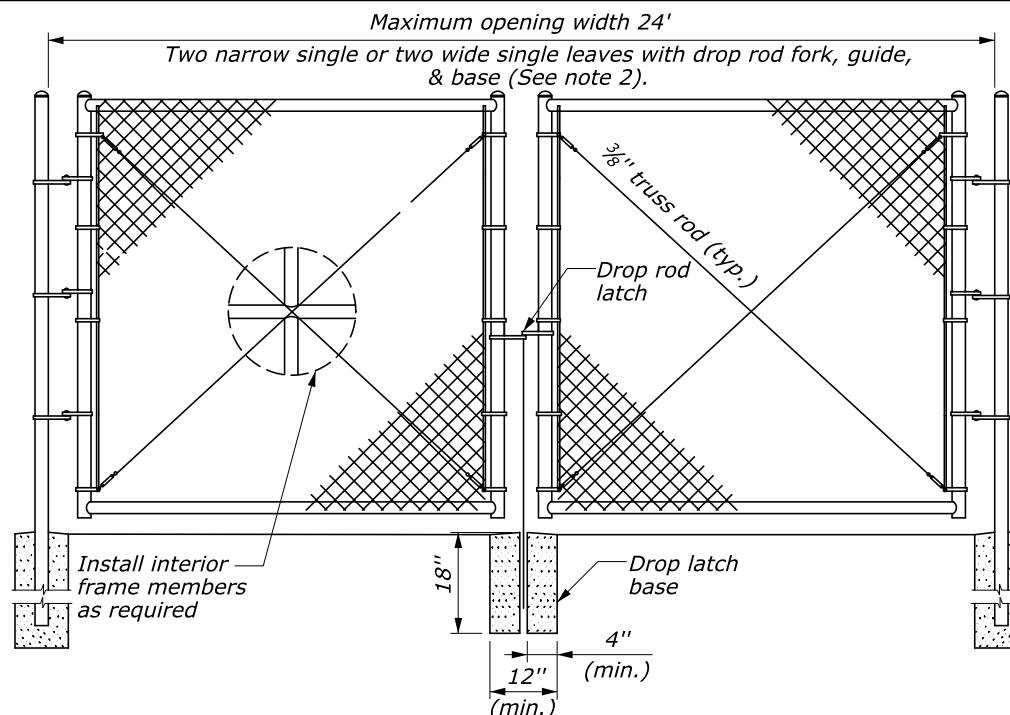

DOUBLE LEAF GATE

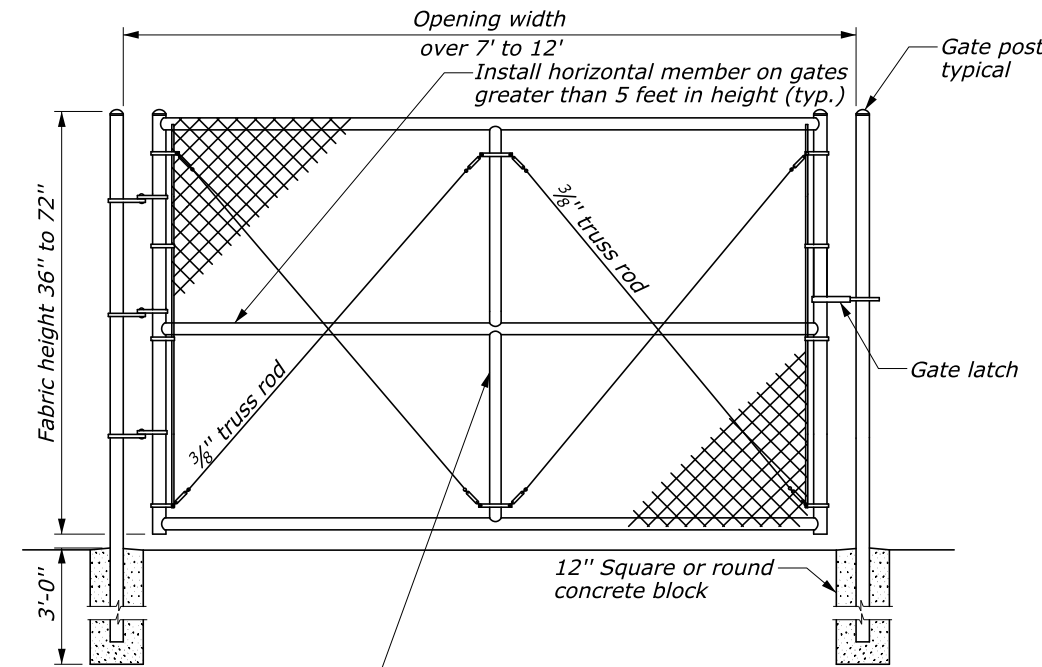

WIDE SINGLE LEAF GATE

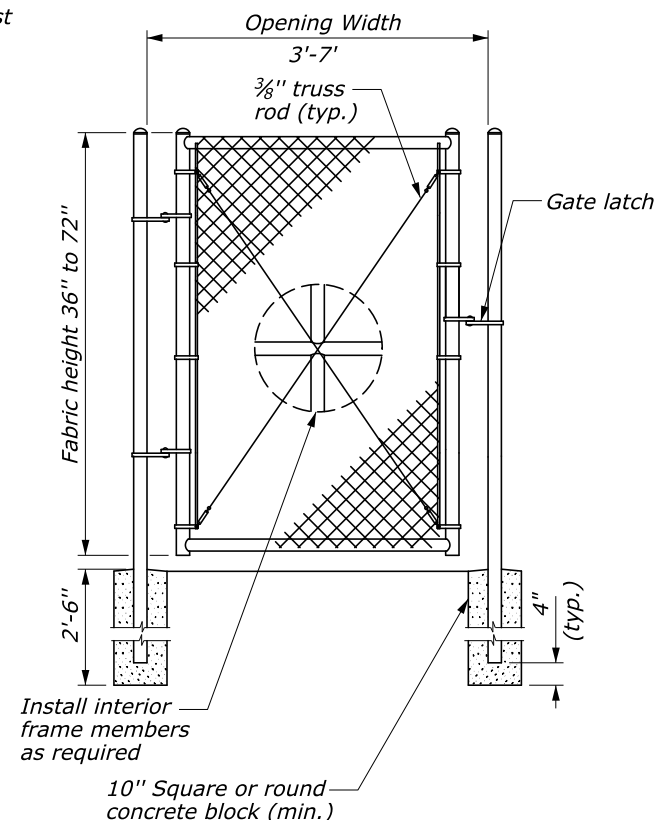

NARROW SINGLE LEAF GATE

CHAIN LINK GATE									
POST AND FRAME SIZE AND MASS TABLE									
Minimum yield strength 25,000 Psi									
GATE LEAF WIDTHS	Gate post size	ROUND TUBING				SQUARE TUBING			
		Steel		Aluminum		Steel		Aluminum	
		dia. inch	lbs/ft (min.)	dia. inch	lbs/ft (min.)	dia. inch	lbs/ft (min.)	dia. inch	lbs/ft (min.)
4 feet or less		1.90	1.257	1.90	0.866	2 x 2	2.35	2 x 2	0.94
Over 4 feet to 7 feet		2.375	2.135	2.375	1.260	2.5x2.5	2.728	2.5x2.5	1.265
Over 7 feet		2.375	3.117	2.375	2.00	2.5x2.5	3.882	2.5x2.5	2.904
Outside frame member	frame size	1.315	0.866	1.315	0.435	1.25x1.25	1.048	1.25x1.25	0.576
Interior bracing member	frame size	1.315	0.866	1.315	0.435	1.25x1.25	1.048	1.25x1.25	0.576

U.S. DEPARTMENT OF TRANSPORTATION
FEDERAL HIGHWAY ADMINISTRATION
EASTERN FEDERAL LANDS HIGHWAY DIVISION

U.S. CUSTOMARY DETAIL

**RESIDENTIAL CHAIN LINK
HARDWARE AND GATE**

Sheet 2 of 2

DETAIL APPROVED FOR USE

APPROVED: MAY 2011
REVISED: SEPTEMBER 2014

DETAIL
E619-07