

# ENDANGERMENT OF PEDESTRIANS AND BICYCLISTS AT INTERSECTIONS BY RIGHT TURNING TRUCKS

Walter Niewoehner (DEKRA)

F. Alexander Berg (DEKRA)

DEKRA Automobil GmbH

Paper Number 05-0344

## ABSTRACT

Inside urban areas some accidents are occurring between right turning trucks and bicyclists or pedestrians. The consequences are exceedingly severe if the truck runs over the vulnerable road user. This paper will help to improve the knowledge how these accidents happen. Matched to this countermeasures are shown and discussed to reduce the number and the severity of these accidents. This contribution is a compendium of the research assignment of the BASt (German Federal Highway Research Institute) given to DEKRA Accident Research named "Endangering of bicyclists and pedestrians at intersections by right turning trucks".

It includes remarks on the European regulations regarding the protection of pedestrians and bicyclists in case of collisions with trucks. This is followed by an overview of the existing standard of the knowledge documented in the literature. It includes among other things analysis of official statistics, in-depth accident analysis and description of measurements to solve the problem. The study contains the results of the in-depth analysis of 90 accidents with involved right turning trucks versus a pedestrian or bicyclist. Outcomes are coming from the pre-crash phase (e.g. kind of movement), and the impact (e.g. location of collision, speed and angle). One of the main problems is the insufficient field of view (blind spot) of the truck driver during the pre-crash phase. Results of blind spot analysis of two trucks with two different mirror systems will show possible improvements. The contribution will finish with a description of the developed safety concept concerning the analysed situation between right turning trucks and pedestrians or bicyclists.

## INTRODUCTION

The diversity of transport tasks and the mobility required of, or commercially necessary for transport users make it impossible these days to conceive of a world without road transport. Unfortunately, it is also linked with negative consequences. These

include not only the consumption of resources and pollution of the environment, but also road accidents and their resulting consequences.

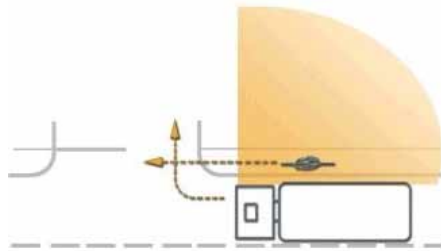
In the year 2002 38,452 people lose their life every year as a result of traffic accidents in the European Union (Figures cover the EU region before the expansion of 1st May 2004). Between 14% (in France) and 46% (in Poland) of the total number of people who died in accidents on Europe's roads were unprotected road users (cyclists and pedestrians). In Germany the figure is 21%. The conflict between a truck and a cyclist or pedestrian may not be the most common situation encountered, but it is the most dangerous. The biggest and heaviest road user comes up against the smallest and weakest. Accidents in urban environments involving a truck turning right make up an important group in this accident scenario and formed the focus of a research project commissioned by the German Federal Highway Research Institute (BASt) carried out by DEKRA.

## THE PROBLEM

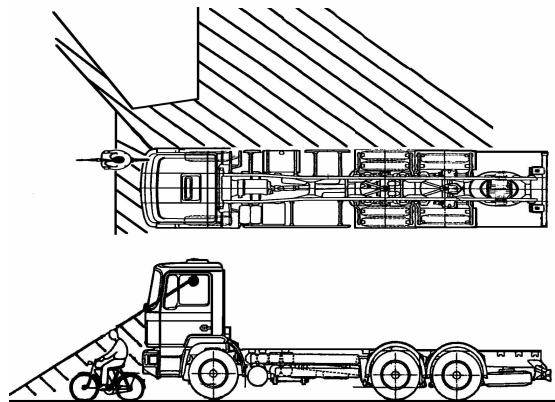
In general the truck driver and cyclist travel unaffected by each other on their own parts of the road. The paths of the two groups cross at intersections, **Fig 1**. This crossing of paths of travel entail a corresponding risk of accident that involves a correspondingly high risk of injury for the unprotected road user. This situation raises a number of questions that were to be answered as part of the research project. What happens during these accidents? What are the problems for the road users involved? How can the accident figures and their consequences be reduced? Is the side protection of the truck able to prevent the unprotected road user from run over or reduce its incidence?

Compared to the car, the blind spots of a truck, i.e. the areas where the truck driver suffers impaired field of view, are considerably greater. The truck driver's field of view problems are, however, considerably greater than other road users are generally aware of. The truck driver is seated far higher up than the car driver. This means that although the eyes of the car

driver are roughly located at the same level as the cyclist or the pedestrian, the eyes of the truck driver can be initially estimated as being 2.5 m above the road surface, the exact figure depending on the height of the truck, the seat position and the height of the seated driver. This higher position leads to numerous blind spots (dead angles) in front of, adjacent to and behind the truck. The ability of a person to be detected depends on the size of the person and his position in relation to the truck, **Fig 2**.



**Fig 1: Example of a conflict scenario involving a truck turning right /1/**



**Fig 2: Examples of blind spots impairing the direct view, in a top-down view and as side view (object size up to 1.6 m)**

The blind spots are the fundamental causes for the conflicts between the trucks and the unprotected road users analysed within this project. If the truck driver does not see the cyclist or pedestrian and turns right, a crash with the unprotected road user can be the result. The cyclists and pedestrians place their faith in the right of way laid down in the road regulations and assume that the truck driver can also see them in one of his numerous mirrors. This faith and the incorrect assumption about the truck driver's ability to see what is going on around the truck can end fatally if the accident causes the unprotected road user to end up under the truck and be rolled over by its wheels.

## GENERAL ACCIDENT STATISTICS

In 2002 there were 362,054 accidents in Germany resulting in personal injury (API), of which 233,865 in urban area (64.6%) /3/. A total of 586,180 motor vehicles were involved in all APIs, of which 364,121 took place in urban area (62.1%). 21,633 goods vehicles (GV) were involved in APIs in urban areas. Goods vehicles include delivery vans and trucks with normal and special superstructures, articulated lorries and other traction engines. Agricultural traction engines are not included. This represents 5.9% of the motor vehicles involved in urban accidents. These GVs also include vehicles with a permissible total weight (PTW) up to a maximum of 3.5t. These vehicles have a fundamentally different vehicle superstructure and thus constitute different problems in an accident. This study was interested in the heavier GVs with ladder frame chassis and a correspondingly large space between the axles. Removing GVs with a PTW of a maximum of 3.5t leaves a percentage share of heavier GVs involved in urban APIs of between 2.3% and 2.8% (A more precise figure cannot be given because the PTW was unknown for some GVs.).

In 2002 official statistics recorded a total of 47,669 turning-off crashes. This represented 13.2% of all APIs. In built-up areas there were 37,766 turning off crashes, representing 15.7% of recorded urban accidents. The remaining 84.3% of urban APIs are covered by the other accident types.

Taking altogether, goods vehicles were involved in 2,920 accidents with cyclists and 1,580 cases with pedestrians in 2002. These 4,500 cases represent 2.2% of the urban APIs involving one or two participants.

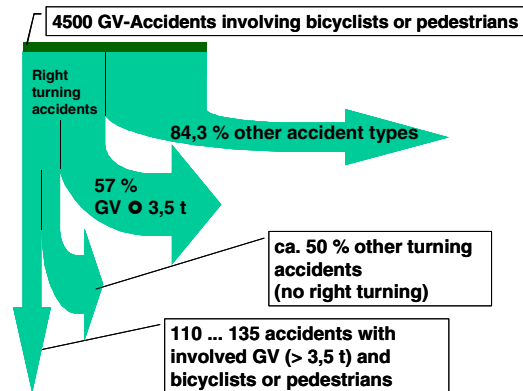
Official statistics draw no clear distinction between the number of accidents involving GVs (>3.5 t) turning right and cyclists or pedestrians. A rough estimation of the absolute figure can be made by taking the total number of accidents between GVs and cyclists or pedestrians, the percentage of urban accidents in which the vehicle was turning right and the percentage of heavier GVs (>3.5 t) of all GVs. It must be borne in mind that the recorded number of turning off accidents covers right-turning scenarios that are not pertinent to this study. This means that in general terms only half (50%) of the turning-off accidents can be included in an estimation of the absolute number of cases.

If the figures and relations described above are taken as a basis, a figure of between 110 and 135 urban APIs between right turning GV's (>3.5 t) and cyclists/pedestrians is derived in line with the estimation in Fig 3. In 2002 there were 106 fatal urban crashes involving GV's and cyclists/pedestrians. Taking as a basis the same estimation as for the APIs in Fig 3, produces a figure of ten fatal crashes involving right turning trucks and an unprotected road user. This estimation for the APIs and for the accidents involving fatalities must be viewed with a certain degree of uncertainty because there is no way of ensuring that there are no distinct deviations from the respective parent population for the particular situation of right turning trucks. This could apply to fatal crashes in particular.

Many investigations look at accidents between truck and cyclists/pedestrians in general terms. Evaluation of the publications shows that the percentage of right turning accidents, insofar as this is given at all, is relatively low (Volvo 4 % /5/, Otte with 4.1% /7/ for a special turning off situation). Individual investigations such as Appel 1977 (/5/) quote a relatively high number of fatally injured unprotected road users losing their life in a crash involving a truck. The discrepancy with the estimations based on current figures can be traced, on the one hand, to the different accident situation prevalent at the time, which involved more fatally injured persons in this field, and, on the other, to the fact that the figures given there also include crashes that are not caused by the turning off situation.

Apart from the pure incidence of accidents the sources list other interesting aspects in this field of study. A Dutch study analysed the position of the opponent and the respective field of vision of the truck driver in the pre-crash phase. In 68% of the cases studied the pedestrian/cyclist was, at the point in time of perception by the truck driver, in a position that is not covered by the statutorily defined minimum view to ground level. It was also discovered that the injuries sustained in crashes with right turning trucks are particularly serious and frequently fatal /8/.

German studies from 1977 quote the accident figures current at the time. These relate to the Federal Republic of Germany as it then was and cite about 459 fatally injured persons per year for accidents involving a truck > 3.5 t both for pedestrians as well as for cyclists /5/. Studies of 18 truck/pedestrian and 14 truck/cyclist crashes revealed that in each case four pedestrians and four cyclists were hit frontally (13% of the opponents). Seven pedestrians and cyclists (22%) collided with the side of the truck. The reason why there was no run over in all cases is due



**Fig 3: IRR figures /8/ derived estimation of the absolute figures of APIs with urban right turning GV's (> 3.5 t) and involved cyclists or pedestrians.**

to the fact that the truck performed an emergency stop immediately following the initial contact.

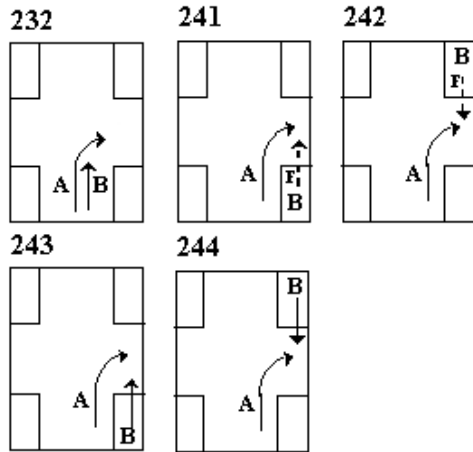
An analysis of the accident data of the Medical University of Hanover (Medizinische Hochschule Hannover (MHH)) for the years 1985 to 1994 shows that cyclists, with 9.1 %, were after cars (41.2%) and other commercial vehicles (12.7%) the third most frequent opponent of a commercial goods vehicle /6/. Pedestrians were in fourth place with 4.4%. Cyclists most frequently collided frontally into the side of a commercial vehicle (35.6%). The analysis is based on the available data of all accidents there involving a commercial vehicle, without undertaking any pre-filtering such as, for example, as regards the type of accident or the location.

In a more recent study conducted by the MHH the accident inducing situation (accident type) involving a right-turning truck colliding with a cyclist on a cycle path (accident type 243, see Fig 4) came fourth in a table of accident types with 4.1% for commercial vehicles (≥7.5 t) /7/.

### IN-DEPTH ACCIDENT ANALYSIS

The official road accident statistics /8/ can give a rough overview of the total number or the share of the accident situations of interest. In-depth data survey and analysis enable more thorough analyses. 45 individual cases involving collisions between unprotected road users and right-turning trucks were taken from a database of recorded cases held by DEKRA and the MHH, and studied in detail.

The turning trucks were nearly all involved in accidents between the period of 6 a.m. and 6 p.m. Fig 5, almost exclusively in daylight and virtually always (except for three cases) in dry weather

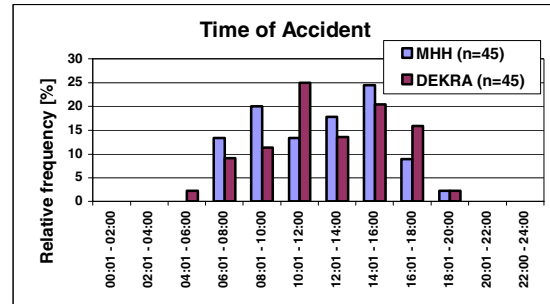


**Fig 4: Pictogram of the most common accident types involving right-turning trucks and pedestrians/cyclists from the three-digit accident type catalogue /13/**

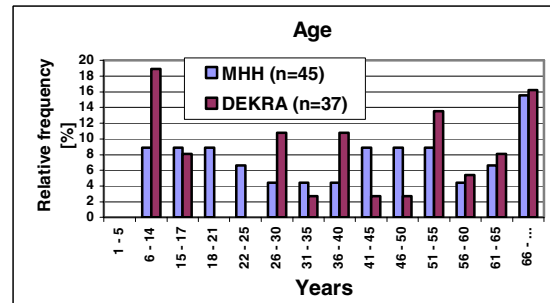
conditions. The crashes under scrutiny took place during the working days Monday to Saturday. In more than 40% of the accidents studied, one person died during or following the accident, by far the greater percentage of these crashes involving a fatally injured person coming from the DEKRA data pool.

The unprotected road users involved in the accidents studied were predominantly cyclists (78 out of 90) and came from all age groups, **Fig 6**. Females are represented far more significantly among pedestrians/cyclists than males, **Fig 7**. This distribution of about 1 : 2 (men : women) does not match the distribution of cyclists in the official statistics (about 2 : 1).

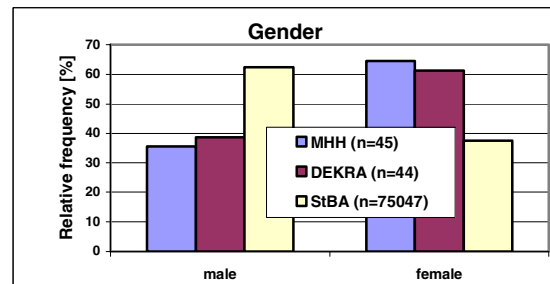
There is a range of variants corresponding to the three-digit accident type catalogue /13/ for the accident-inducing critical situation between the right-turning truck and cyclist or pedestrian. The most common incidence in the accidents studied was the conflict between the right-turning truck and the cyclist travelling in the same direction along a separate path on the right-hand side of the road surface. (accident type 243; 71 % of the 90 accidents reviewed), **Fig 8**. The corresponding situation involving a cyclist on the same lane was significantly rarer (10%). As a consequence of their relatively low share of accidents involving pedestrians in the poll of accidents studies, accident types 241 and 242 (see also Fig 4 ) are only slightly represented.



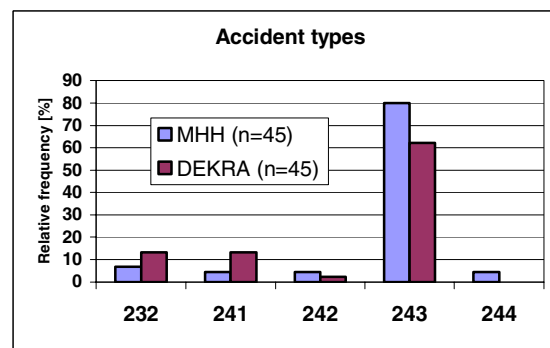
**Fig 5: Time of accident of the accidents studied involving right-turning trucks**



**Fig 6: Age of involved pedestrians and cyclists**



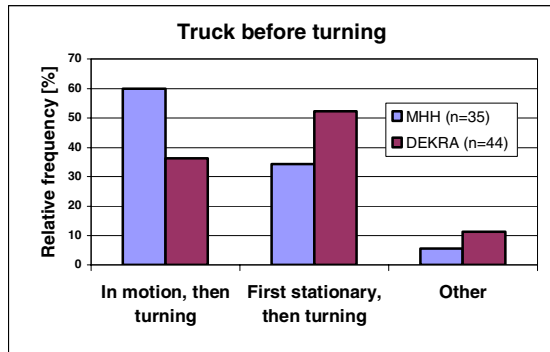
**Fig 7: Gender of the involved pedestrians and cyclists**



**Fig 8: The most frequent accident types encountered (see also Fig 4)**

Basically there are two fundamentally different behaviour patterns displayed by turning trucks before collision, **Fig 9**. One group was stationary before commencing the turning manoeuvre (at a traffic light or due to traffic conditions) in order to then accelerate

from stationary and initiate the turning manoeuvre. The other group was in motion before decelerating to the required speed to initiate the turning manoeuvre. The consequences of the accident for the cyclist are more serious in the scenario where the truck began stationary. In this instance more than half (51%, **Table 1**) suffered fatal injuries whereas the figure for the other scenario totalled merely 31% (**Table 2**). The speeds determined for the truck and cyclist involved in the accident show a similar magnitude. This means there is virtually no relative movement between cyclist and truck. This fact which can also be found in the literature is of great significance as the following will show. **Fig 10** gives the basic relative movement of the cyclist vis-à-vis the truck for the seconds of the collision /6/. The cyclist does not leave the blind spot during this time.



**Fig 9:** Movement behaviour of the truck in the accident before commencing the turning manoeuvre

|        | Slightly injured | seriously injured | killed | total |
|--------|------------------|-------------------|--------|-------|
| number | 2                | 13                | 16     | 31    |
| [%]    | 6.5              | 41.9              | 51.6   | 100.0 |

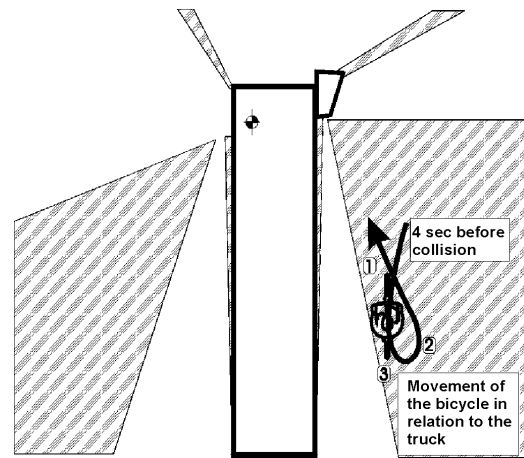
**Table 1:** Severity of cyclist injuries for a truck that is stationary before performing the turning manoeuvre, Source: DEKRA + MHH, each cover data of several years

|        | Slightly injured | seriously injured | killed | total |
|--------|------------------|-------------------|--------|-------|
| number | 7                | 17                | 11     | 35    |
| [%]    | 20.0             | 48.6              | 31.4   | 100.0 |

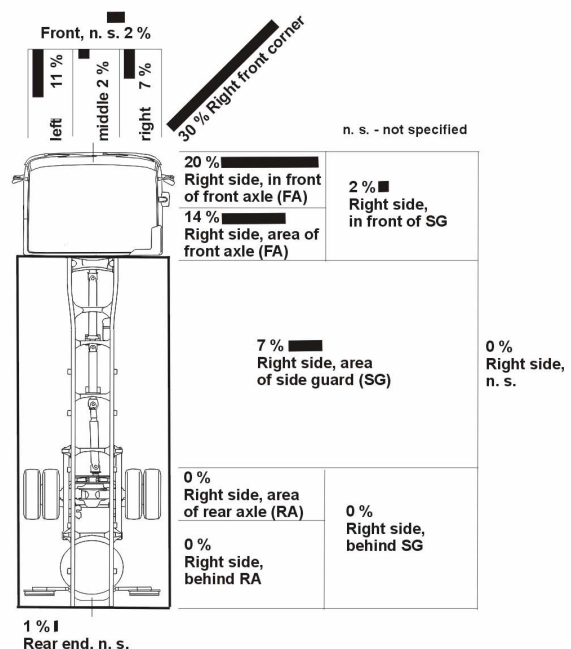
**Table 2:** Severity of cyclist injuries for a truck that is moving before performing the turning manoeuvre, Source : DEKRA + MHH, each cover data of several years

The accidents studied contain many pedestrians or cyclists that have been run over (62%). The initial impact of the cyclist/pedestrian took place for the most part in the front right-hand corner of the vehicle

(57%), **Fig 11**. This area includes the right part of the front, the front right-hand corner and the right side of the front axle. Merely 7% of the pedestrians and cyclists collided for the first time with the truck in the area of the side guard (SG). The initial collision is merely the primary contact between pedestrian/cyclist and truck. This is usually followed by a fall down and one or more additional contacts. Of particular interest is the area of the vehicle in which the pedestrian/cyclist ends up under the truck. Depending on where the initial impact took place, it is followed by a run over. A study conducted in the Netherlands /8/ discovered that 62% of initial contacts take place on the right-hand side in front of the front axle.



**Fig 10:** Principal relative movement of the cyclist in the accident in relation to the truck, /6/



**Fig 11:** Area of the initial impact on the right-turning truck



In the accidents studied the persons did not inevitably end up under the truck where the initial impact took place. Depending on the specific nature of the impact constellation, the road user who fell down only ended up under the truck at a later stage. In the accidents studied 59% of the truck opponents ended up still in front of the front axle under the truck. A further 23% ended up in the immediate area of the front axle under the vehicle. Building site and municipal vehicles were involved particularly frequently in the accidents studied (46%). In the case of the building site vehicles this is partially attributable to the greater line of sight problems occasioned by greater height of the chassis and the frame of such a truck.

The frequency of the first contact points on the right front edge of the truck wasn't expected previously. This had given a decisive influence to the following project work. Therefore the main focus changed to primary safety.

## THE PROBLEMS OF TURNING RIGHT OF TRUCKS

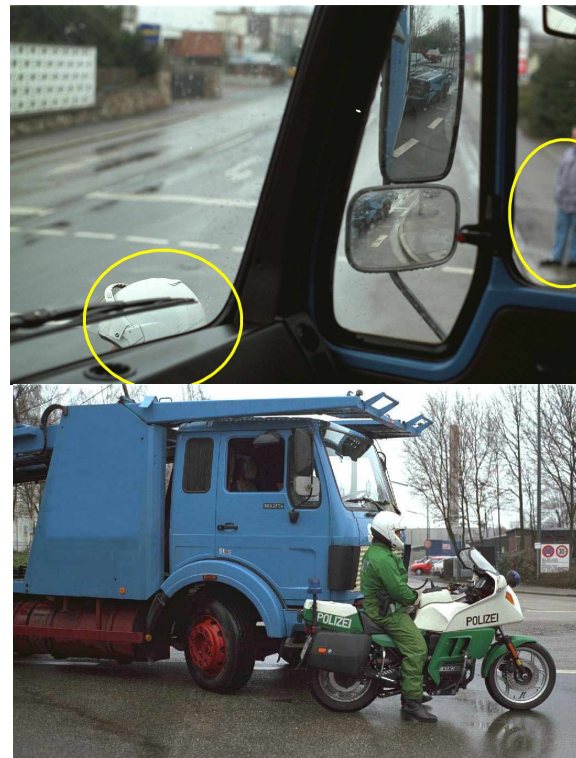
### DRIVER

Not every truck driver is aware of the dangers and problems of turning right. In many regions of a country, for example, the percentage of cyclists of private traffic is very high, while in other regions virtually no cyclists are encountered. The figure depends on the population structure and the geography. Now if a driver only comes across cyclists and pedestrians very rarely on the roads in the region he knows well, he does not reckon on encountering them on roads he does not know well even though he is, in principle, aware of the problem presented by the situation. By the same token, however, cyclists and pedestrians also reckon on what is for them the accustomed behaviour patterns of drivers. This results in a higher risk of accident. The normal behaviour patterns of road users and the state of expectation that this brings with it therefore have a considerable influence on movement in road traffic and the risks of accidents this entails.

### VEHICLE

When considering the vehicle as a factor, the risk to unprotected road users from right-turning trucks primarily derives from the very often insufficient field of vision of the truck driver. The higher sitting position is very beneficial in flowing traffic as the range of vision and the ability to see over other road users enables the driver to drive in an anticipatory manner and to detect danger in good time. It is

precisely close up, however, that this advantage turns into a significant disadvantage. The fact that the line of sight is situated higher up means that objects in the immediate vicinity of the vehicle are impossible to detect or only detectable to a degree. This particularly affects pedestrians and cyclists who quickly disappear into the blind spots due to their comparatively small and inconspicuous silhouette, **Fig 12, Fig 13.**



**Fig 12: Simulated impact scenario, helmet is just about visible (top); original conditions (below)**

The existence of a strip of grass delineates a separation between the motor vehicle traffic and the unprotected road user. Therefore a conflict between the individual truck and the cyclist or pedestrian is restricted to those areas where the used paths cross.

At the same time a correspondingly broad strip of grass also means that the truck driver is only capable of perceiving the cycle and/or foot path next to this strip of grass in the outside right mirror at a greater distance, Fig 14. This means that the standard outside mirror can supply no information on cyclists and pedestrians that are in the immediate vicinity of the intersection. The driver has to rely on the wide-angle mirror. The driver's field of view in this road traffic set-up is further restricted if trees have been planted or, as shown in **Fig 14**, advertising hoardings are located in the field of view.



**Fig 13: An example of the right-handed arrangement of mirrors on a truck (top of hair visible)**



**Fig 14: Advertising hoarding having a detrimental effect on the field of vision**

## OTHER ROAD USER

A truck is an optimised means of transport for conveying large quantities or heavy loads. These vehicles require not only more space on the road than other road users, but also move differently on account of their dimensions. An articulated lorry cannot turn on a road in the same way as a passenger car. It requires the truck to either swing out to the left beforehand, or to be first of all steered straight ahead before the turning manoeuvre is initiated and to use the entire access funnel. The other road users are often not aware of this necessity and this can lead to misinterpretations of the traffic situation. If the articulated lorry first travels straight ahead, the pedestrian only recognises the turning manoeuvre when the side wall of the trailer is already moving towards him.

## TESTS

DEKRA Accident Research has carried out tests on the subject of right-turning trucks at the DEKRA Crash Test Center by simulating the findings garnered in the accident analyses. The programme

not only included the simulation of impact scenarios but also investigations into the field of view.

## FIELD OF VIEW FROM A TRUCK

The direct and indirect field of view are the key factors for the situation involving a right-turning truck. This became clear both in the study of the literature as well as during the tests conducted as part of the project and in-depth analyses of road accidents. It is the inadequate field of view forward of the vehicle and to the right in particular that cause the truck drivers considerable problems.

The directive 71/127/EEC /11/ or the successor directive 97/2003/EC /12/ prescribes for the mirrors a field of view of the ground visible to the driver.

**Fig 15** and **Fig 16** show the blind spots as a hatched area that exists in a direct view of the ground, cross-hatched for a person 1.75m tall. The height is shown in the illustrations with 1.6 m, so that a part of the head (0.15m) remains visible to the driver. Persons smaller than 1.75 m can only be perceived outside of the cross-hatched area from the driver's position. The indicated points A and B mark the distances in relation to the centre of the outside edge of the right front wheel on the ground. The driver can only perceive a point on the road at a distance of 7.5m on the right next to the vehicle. A point at a height of 1.6m above the road surface must be at least 1.85m away from the driver's cabin ( $B_D$ ) in order for the driver to see it.

## INDIRECT VIEW

Depicting the indirect view is more difficult than the direct view. The incorporation of the field of view regions in photos has proved to be a sensible and also vivid method of depiction. The field of view depicted in the wide-angle mirror can be seen to be arranged far more rearwards on the MB 1748 (**Fig 17**) in comparison to the so-called MIM vehicle (**Fig 18**). A cycle standing at the level of the front axle would be largely visible from the MIM vehicle, whereas it cannot be seen using conventional mirror systems.

A corresponding comparison of the close-proximity mirror (**Fig 19**) with the front mirror (**Fig 20** replacement for the close-proximity mirror) on the MIM vehicle clearly shows the greater coverage of the front mirror. In spite of the improvements the driver needs to get used to the new mirror to be able to allocate the mirror image to the real surrounding. Special note should be made of the objects visible in the border regions of the mirror.

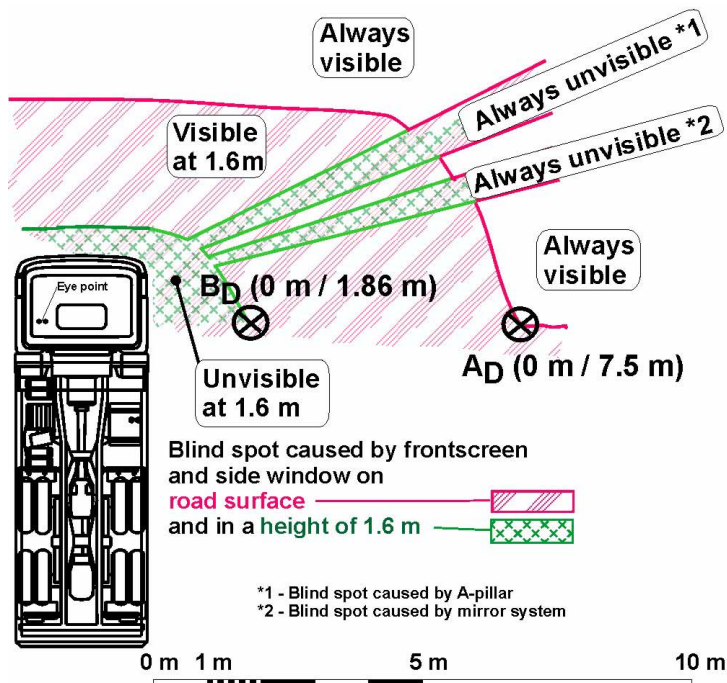


Fig 15: Diagram showing the direct field of view from a Mercedes Benz 1748 (SK-model range)

Apart from the mandatory mirror, the accessories trade offers various mirrors and lenses aimed at improving the indirect view. As part of analysing the field of view, investigations were also undertaken into whether the field of view of the driver can be perceptibly enlarged using a Fresnel lens. To this purpose a standard wide-angle lens was employed that works on the Fresnel principle. It widens the cone of the user's view. One can so-to-speak see around the corner. Conversely, the Fresnel lens reduces the size of the image of the object. It distorts the direct view of the object that, from the vision of the viewer, is behind the lens. However, it does not suffer from the blind spots a mirror has.

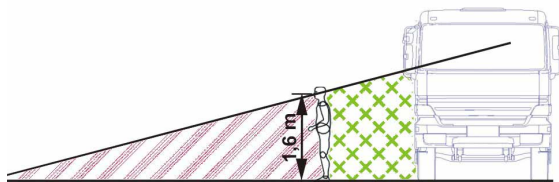


Fig 16: Explanatory picture of the field of view for Fig 15.

In front of the truck an object on the ground is visible from a distance of 3.1m. An object with a height of 1.6m is visible from a distance of 0.7m in front of the truck. On the right next to the truck the driver can only see the object on the ground at a distance of 7.5m ( $A_D$ ) away. For a height of 1.6m the minimum distance is 1.86m ( $B_D$ ) at the height of the right-hand B pillar.



Fig 17: Photo showing the indirect field of view from the driver's viewpoint (MB 1748) via the wide-angle mirror (the overlay pyramid stump marks the coverage of the wide-angle mirror; the cycle is located 2.0m away to the truck.)

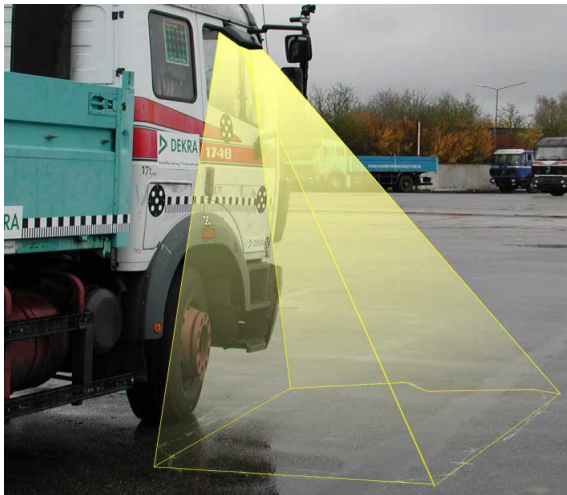
Fitting the lens close to the rear edge of the side window (Fig 21) improves view sideways and rearwards behind the B pillar of the driver's cabin. The test person was standing outside of the direct field of view and can be easily spotted in the lens. He was located on the ground directly next to the field visible in the starting mirror (see chalk markings). The commencement of the visible field on the ground



covered by the lens is documented by the three black marking plates on the ground (five-point targets). Using the lens a point on the ground by the side of the driver's cabin can already be seen at a distance of 2.95 m ( $A_L$ ) (Index L - View through the lens) (Fig 22), while without the lens the background can only be recognised at a distance of 7.5 m ( $A_D$ ) (Index D - Direct view). For a height of 1.6 m the minimum distance for recognition reduces from 1.86 m ( $B_D$ ) to 0.6 m ( $B_L$ ).



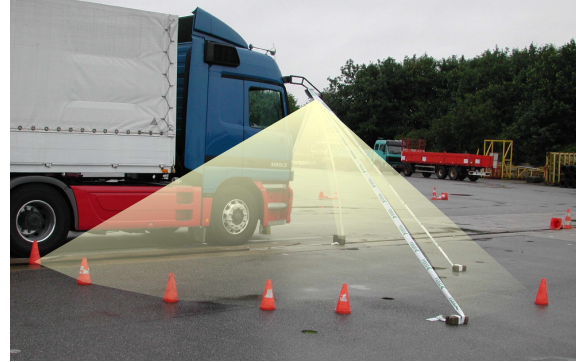
**Fig 18:** Picture showing the indirect field of view from the driver's viewpoint (Mercedes Benz MIM vehicle) via the wide-angle mirror; the marking tape defines the lower limit of coverage in the mirror and the key points of the actual field of view on the ground.



**Fig 19:** Photo showing the resulting view pyramid from the close-proximity mirror; the line running from the mirror to the marking showing the limitations of the mirror edges (Mercedes Benz 1748) Dynamic tests

The tests simulated impacts to the front right-hand side (No.1) of the corner of the driver's cabin and directly behind the driver's cabin in the area of the

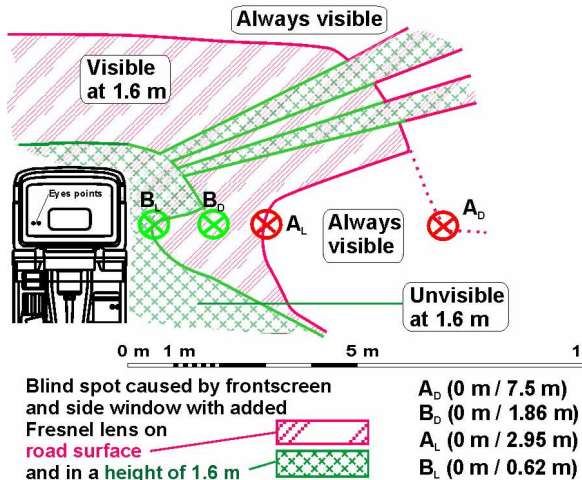
side guard (No. 2 - 5, **Fig 23**). The first three tests were impacts involving a moving cyclist; tests 4 and 5 were collisions with stationary pedestrians. Modified side protection devices were employed in tests 3 and 5.



**Fig 20:** Picture showing the resulting view cone from the front mirror (MB MIM vehicle)

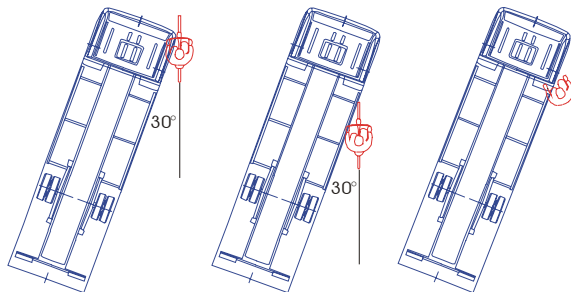


**Fig 21:** Picture of the indirect field of view (Mercedes Benz 1748) on the front right-hand side upon the fitting of a standard Fresnel lens in the rear part of the right-hand side window, person only visible with Fresnel lens, marking plates define the beginning of the field of view of the Fresnel lens on the ground.



**Fig 22:** Picture showing the combination of the direct field of view with the addition of the Fresnel lens; position at the rear or the side window

In three further tests the identical driving line as in tests 1 up to 5 was used and the field of view for the truck driver recorded in stages in order to document when the driver sees the future opponent in the mirror. A corner impact (Test 6) and an impact in the region of the side protection system (Test 7) were performed with a conventional mirror system. On the MIM vehicle merely the impact with the corner of the driver's cabin (Test 8) was performed.



**Fig 23:** Impact constellation of the tests 1 (left), 2 + 3 (centre), 4 + 5 (right)

In the corner impact involving the MB 1748 (Test 6) the truck driver was unable to see the head of the cyclist until directly before the impact in the side window, **Fig 24 + Fig 25**. This would in real life be far too late to prevent the accident. In the impact in the side protection area (Test 7) the cyclist could be seen by the truck driver in the wide-angle mirror from the moment the test was run, **Fig 26 + Fig 27**. The cyclist was so far behind in relation to the truck that he could be spotted in the wide-angle mirror. The cyclist is also visible in the main side mirror directly before the impact. In the corner impact involving the MIM vehicle the cyclist is also always visible in the

front mirror and as the test progresses in the wide-angle mirror too (**Fig 28 + Fig 29**) and then likewise in the side window, **Fig 30**.

The view tests provide a possible explanation for the relative seldom incidence of collisions between cyclists and trucks involving an initial contact in the side protection region (see Fig 11). Mirror systems that have so far been configured in accordance with 71/127/ECC put the truck driver in the position to notice a cyclist at a point in time  $x$  when he is towards the rear alongside the truck and to react before the cyclist comes into contact with the side protection system. If the cyclist is at the same point in time somewhat forward alongside the truck and the other conditions are otherwise identical he is not visible or if so only at a very late stage so that a collision in the region of the right-hand corner of the vehicle is probable.



**Fig 24:** Picture showing the driver's view from the Mercedes Benz 1748 of the (not visible) cyclist for the corner impact scenario,  $s = 17.1$  m before impact, distance of cyclist-truck  $a = 3.5$  m, Test 6



**Fig 25:** Picture showing the driver's view from the Mercedes Benz 1748 when the cyclist appears for the first time in the field of vision of the driver of the Mercedes Benz 1748,  $s = 5.9$  m before impact, Test 6





**Fig 26:** Picture showing the driver's view from the Mercedes Benz 1748 of the cyclist in the side impact scenario,  $s = 16.5$  m before impact, Test 7



**Fig 27:** Picture showing the driver's view from the Mercedes Benz 1748 of the cyclist for the side impact scenario, impact scenario Test 7



**Fig 28:** Picture showing the driver's view from the Mercedes Benz MIM vehicle of the cyclist in the corner impact scenario,  $s = 18.5$  m before impact, Test 8



**Fig 29:** Picture showing the driver's view from the Mercedes Benz MIM vehicle of the cyclist in the corner impact scenario, impact scenario, Test 8



**Fig 30:** Picture showing the driver's view from the Mercedes Benz MIM vehicle when the cyclist appears in the direct field of view of the driver of the Mercedes Benz 1748 for the first time,  $s = 5.9$  m before impact, Test 8

## ATTEMPTS TO FIND TECHNICAL SOLUTIONS

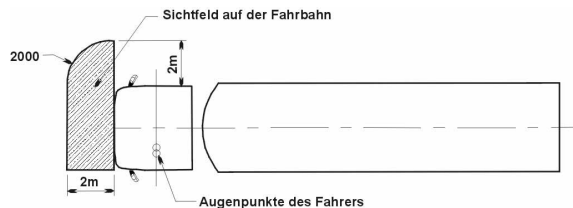
### OPTICAL SYSTEMS

Basically, the truck driver should have a direct field of view that is as good as possible. This means in detail that the vehicle should have large front and side windows that extend down as low as possible. The mirrors prescribed by the existing 71/127/ECC display clear gaps in assuring indirect view for the truck driver in particular as regards turning right as was shown in the accident analysis and the tests.

In comparison to the currently existing regulations the new mirror directive 2003/97/EC /12/ contains considerable improvements in the prescribed field of view. Apart from extending the field of view for the main outside mirror (Group 3) and the wide-angle

mirror (Group 4) the new directive also prescribes a field of view in front of the truck, **Fig 31**. These new stipulations appear at first sight to be only possible by adding at least a further mirror or camera system. The new mirror system of the MIM vehicle, altering the arrangement as well as using modified mirrors, enables the directive to be fulfilled by using three mirrors, **Fig 32**. This type of fitting is not new. It has recently become customary on coaches and this type of mirror visible through the front screen has been fitted as standard on trucks for some time now.

The mirror system fitted to the MIM vehicle more or less exhausts possible further development as far as the truck mirror is concerned. The mirror system represents the furthest development can go and additional improvements can no longer be expected here. One of the serious weak points of indirect view via mirrors is the compelling need to match it to the direct field of view of the driver. The driver must be able to see the mirror himself. This necessity does not apply to camera monitor systems as well as for sensor-based assistance systems.



**Fig 31: Field of view of the front mirror (Group VI) as foreseen by 2003/97/ECC**



**Fig 32: Field of view via the wing mirror in the DaimlerChrysler MIM vehicle /2/**

The employment of supplemental systems to improve the indirect field of view such as additional mirrors, lenses or camera monitor systems are to be considered critically as regards use and the expected distraction of the driver occasioned by consulting the systems and processing the information. The increa-

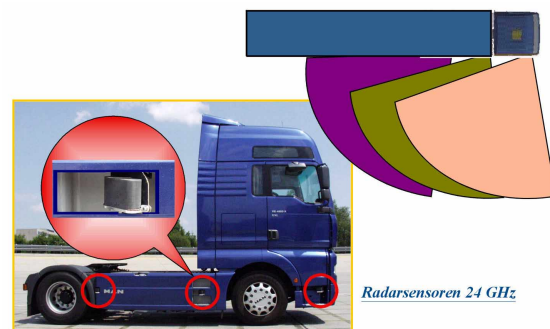
sed deployment of camera monitor systems requires more intensive research work to be done. One of the questions yet to be answered is that of determining the most optimum position of the monitor.

## DRIVER ASSISTANCE SYSTEMS

In contrast to the passive mirror and camera monitor systems mentioned so far, assistance systems function actively. The assistance systems are geared to special situations categorised as representing a problem in road traffic such as, for example, changing lane. The system lends the driver support and thus relieves him of some of his work in performing his task as driver. The assistance systems possess various levels of automation/15/. In the simplest version they inform the driver merely about an existing situation. A fully automated assistance system performs an action independently without the driver being able to intervene.

In comparison to the field of view based around the driver, the detection range of assistance systems is to be defined completely differently. The detection range is to be understood as the spatial area, also called the ROI ("Region Of Interest", /14/), that the assistance system sensors are to monitor. The detection range can be precisely delimited on sensor systems. A possible parameter for the turning manoeuvre situation could be a monitoring function that focuses on the right, alongside and front next to the vehicle spanning a range of up to 5 m to the outer contours of the vehicle.

Assistance systems are the way ahead. Currently under development are turning assistance research projects such as the version developed as part of the EU Project PROTECTOR, Fig 33.



**Fig 33: Arrangement and range of sensors on the Demonstrator with turning assistant developed as part of the EU Project PROTECTOR (Source: MAN)**



## ENVIRONMENT RELATED MEASURES

The structural design of the environment, e.g. in intersections, can influence the incidence of accidents. This also applies to vehicle-turning accidents. Structural measures must, however, be based on the local conditions. Requirements can only be implemented insofar as they are technically feasible. In densely built-up urban environments it is partially unrealistic and consequently not always practicable to implement requirements for generously apportioned intersections. Existing buildings including the front pedestrian paths restrict the options of traffic planners and building authorities.

Well-designed building measures that take into account existing restrictions can be seen in **Fig 34**. Here the stop line for cyclists is about 3 m closer to the traffic lights than for trucks. This means the cyclist is situated in the field of view of any truck driver who would like to turn right there. In addition, the lights turn green for the cyclists before they do so for motor vehicles. This allows the cyclist to start off earlier, to remain in the field of vision of the truck driver and not to end up in the blind spot. The distance of the stop lines should be at least 3 m. Any less than this would mean that the cyclist can still end up in the blind spot in unfavourable circumstances.



**Fig 34: Design of the traffic flow system and the traffic light staggering system in favour of cyclists**

## SAFETY CONCEPT

The findings garnered from the accident analysis create a completely different view on actual accident situation as expected. The impact of the unprotected road user takes place primarily around the front right-hand side of the vehicle corner. A noteworthy percentage of cyclists/pedestrians end up under the vehicle well in front of the front axle. A round table of experts examined and discussed a catalogue of possible measures to reduce or eliminate problems created by a right-turning truck. The safety concept measures also incorporate the aspects discussed during the meeting of experts.

The diverse measures affect drivers, driving schools, law givers, manufacturers, media, administrative districts, municipalities, police, schools, haulage companies, road building authorities, technical monitoring organisations and associations. They are subdivided into when they can be implemented, when they can become effective and effectiveness on the accident as well as on individual vehicle groups.

The visibility problems in the situation “a right-turning truck is in conflict with a cyclist or pedestrian” show additionally a shortcoming of information of the other road users. This shortcoming includes the possibilities of visibility and movement of a truck. There are urgent needs for campaigns to elucidate all classes of population. It is not surprising that children are not aware of all the details pertaining to trucks. It is, however, remarkable that more than a few judges that preside over the misconduct of truck drivers do not know what the view from the inside of a truck looks like. This shows that every Euro invested in a corresponding instructional campaign is money well spent. Schools could integrate relative examples into their teaching. But adults, too, must be included in this instructional work. Accompanying campaigns and events can employ printed material or suitable media for downloading in the internet or graphic video material. Real life exercises in and on the truck have much to recommend them.

The additional measures concern among other things improved mirror systems, a low bottom line of the windscreen and side window, development and adoption of driver assistance systems, optimised configuration of the signposting and the run of the road, change of the German road traffic regulations (§ 5 para. 8: a bicyclist is allowed to pass a standing truck on the right side) and also the training of the truck drivers.

## SUMMARY AND OUTLOOK

Over the course of research projects, in the literature as well as in the public the problem of the situation of "a right-turning truck and the conflict with a cyclist or pedestrian" has been discussed since the late seventies.

The in-depth accident analyses led to new findings as regards the initial contact between the truck and the unprotected road user. More than half of the cyclists and pedestrians came into initial contact around the right front of the vehicle corner. This and the resulting frequently run over by the front axle require efforts to be concentrated on the front right-hand corner. The battery of tests conducted at the DEKRA Crash Center covered both impact situations around the truck side protection area as well as the corner impact on the truck.

The literature evaluated as part of the project sees the direct and indirect field of view as the key factors for the situation involving a right-turning truck. One of the well-known reasons for the problems facing the truck driver in this situation is the insufficient view to the right and in front. A basic change is to take place in this area with the advent of the new directive 2003/97/EC.

In addition to the IRR figures, a total of 90 accidents were available for in-depth accident analyses in which a right-turning truck collided with a cyclist or pedestrian.

- The initial contact takes place in the majority of cases (57%) in the region of the front right-hand vehicle corner. This includes the front right-hand part of the vehicle, the right-hand vehicle corner and the right-hand region back to the front axle.
- Half (50%) of the unprotected road users end up in front of the front right-hand wheel or in the region around the right front wheel under the truck.
- Construction and municipal vehicles are exceedingly often involved in turning accidents.

There are basically two turning scenarios, both with their inherently different problems.

**Scenario 1:** The truck drives up to the turn off and turns right at a correspondingly reduced speed. During the turning manoeuvre both the truck and the cycle have a similar rate of speed. A cyclist located in the truck driver's blind spot during the turning manoeuvre remains hidden therein until shortly before the collision takes place.

**Scenario 2:** The truck stopped before the turning manoeuvre. This stop can be caused by traffic conditions or be due to a traffic light installation. It includes the 10% of the accidents in which the cyclist is in the same lane and intending to cycle past on the right of the stationary truck.

The investigations in the field of view comprised measurements of the direct and indirect field of view of a truck using a mirror system conforming to the current regulation (71/127/ECC) and with the addition of a field of vision aid in the form of a Fresnel lens. As a comparison, the same field of view measurements were conducted on the Daimler-Chrysler MIM vehicle.

A particularly problematical view situation exists at the pre-cash stage when the cyclist contacts the area of the front right vehicle corner. In a collision in the area of the side protection the truck driver driving a truck as currently found on the road in combination with the prescribed mirrors is always able to see the cyclist before the collision. This is not the case with an impact around the area of the front vehicle corner. This explains the more frequently encountered impact situation at the driver's cabin corner in the accident analyses.

When turning right that part of the field of view that constitutes a particular problem for the truck driver is that directly to the right next to the driver's cabin, extending to about 3 m in front of the truck. The truck driver has virtually no field of view into this zone with the previously described systems. Consequently he finds it impossible to detect any pedestrian and cyclists located there. A corresponding improvement of the field of view is urgently required. Put generally, the driver requires further information about objects located in this area.

It is precisely the investigation of the traffic situation involving "right-turning trucks coming into conflict with a cyclists or pedestrian" that reveals not only the field of view problem of the truck driver but also a considerable lack of information possessed by other road users about the viewing possibilities and the manoeuvrability behaviour of a truck. Here, instructional work aimed at the public at large is urgently required.

In the future we can expect that the introduction of different improvements will change the road traffic situation. Targeted information campaigns will bear fruit and pedestrians and cyclists will be in a position to correctly read the truck driver's manoeuvring intentions. The truck driver will encounter a host of changes. In those areas where a large blind spot still leaves uncertainty the truck driver will in future have

more information about whether another road user is located there. Indeed the advent of information and assistance systems among other things can also change the behaviour of the truck driver and the cyclist or pedestrian. The ergonomic, occupational physiological and psychological effects on the road user that this brings with it still require further interdisciplinary research. Here, in the run-up to the market launch of new systems, an attempt should be made to assess the possible effects in order to sound out the existing optimising potential and to be able to counter the negative consequences early enough. It is absolutely essential that the market launch of new types of systems be accompanied by the gathering and evaluation of relevant accident scenarios in order to record the actual changes made on real accidents and to analyse deviations to the predictions.

The MIM vehicle developed by DaimlerChrysler shows a project study with its optimised mirror configuration and positioning shows what can be achieved here. The attainable improvements in the indirect field of view have been remarkable and if systematically introduced on all trucks would not only reduce accident figures for the situation involving a right-turning vehicle. The research study developed by MAN, which incorporates turning assistants, points the way ahead in electronic driver aids. A system that warns the driver when a corresponding danger is detected is already the current state of technology. In future, a system is also conceivable that actively intervenes in a correspondingly diagnosed situation.

Further research is required into the effect of new or modified systems on the driver. It must take account of the ergonomic, occupational-physiological and psychological aspects.

## REFERENCES

- /1/ MoTiV Abschlussbericht, Teilprojekt Abbiege- und Spurwechselassistentz, Ergebniszusammenfassung May 2000.
- /2/ Stechow, R.: MIM-Multimediales Informationsmanagement, DaimlerChrysler, VDA lecture, 28th September 2000.
- /3/ StBA, Pub.: Straßenverkehrsunfälle, Verkehr, Series 8, No. 3.3, published annually by the Federal Statistical Office Germany, Wiesbaden.
- /4/ Högström, K.; Svensson, L.; Weimar, L.-A.; Thörnquist, B.: Accident investigation report 1: heavy commercial vehicles/unprotected road users, Volvo Accident Investigation, Truck Division traffic safety department, Gothenburg (Sweden) 1973, 20 pages.
- /5/ Appel, H.; Middelhave, V.; Heger, A.: Anforderungskatalog für Außenkanten an Lkw, TU Berlin, Institut für Kraftfahrzeuge, Forschungsbericht Nr. 218, February 1977.
- /6/ Otte, D.: Aspekte des Partnerschutzes bei der Nutzfahrzeugsicherheit - Probleme der Kompatibilität und gegenseitigen Erkennbarkeit, VDI conference on commercial vehicles, Ulm, June 1995, VDI report No. 1188, pages 279 - 304.
- /7/ Otte, D.: Schwerpunkte des Unfallgeschehens von Nutzfahrzeugen, VDI conference on "Innovative car occupant and partner protection", Berlin, October 2001, VDI reports No. 1234, pages 123 - 234.
- /8/ de Vries, Y.W.R.; van Oirsouw, H.: Procesverbaalanalyse van Zichtvelden en botspartner locatie bij vrachtwagenongevallen (Protocol of the analysis of fields of view and the position of the accident participants in accidents involving trucks), TNO report 01.OR.BV.003.1/YdV, January 2001, The Netherlands.
- /9/ ECE-R 46, Harmonised regulations for the approval of rear-view mirrors and vehicles relating to the attachment of rear-view mirrors, Status: May 2001.
- /10/ ECE-R 73, Harmonised regulations for the approval of goods vehicles, trailers and articulated trailers relating to their side protection, Status: October 1989.
- /11/ 71/127/ECC, Council Directive of 1st March 1971 on the approximation of the laws of the Member States relating to the rear-view mirrors of motor vehicles, Status April 1996.
- /12/ 2003/97/EG, Directive of the European Parliament and the Council of 10th November 2003 on the approximation of regulations of the Member States for the type approval of devices for the indirect view and for vehicles fitted with such devices, as well as to amend the Directive 70/156/ECC and to rescind Directive 71/127/EWG, Official Bulletin of the European Union 29.01.2004, L25/1-45.
- /13/ Forschungsgesellschaft für Straßen- und Verkehrswesen (FGSV): FGSV working paper No. 24, "Erfahrungen mit dem dreistelligen Unfalltypenkatalog", 1990.
- /14/ Gavrila, D. M.: Sensor-based Pedestrian Protection, IEEE Intelligent Systems, Vol. 16, No. 6, November/December 2001 [www.dsonline.computer.org/0108/departments/its108.htm](http://www.dsonline.computer.org/0108/departments/its108.htm), Status: June 2003.
- /15/ Enigk, H.: Ein psychologisches Vorgehensmodell zur Entwicklung von Unterstützungssystemen für Kraftfahrzeuge, Dissertation at the Humboldt-University in Berlin, October 2002.