

R1-1
STOP

*Reduce spacing 40%

A	B	C	D	E	F
18	.375	6	6 C	3	7.75
24	.625	8	8 C	4	10
C 30	.75	10	10 C	5	12.5
36	.875	12	12 C	6	15
48	1.25	16	16 C	8	20

COLORS: LEGEND — WHITE (RETROREFLECTIVE)
BACKGROUND — RED (RETROREFLECTIVE)

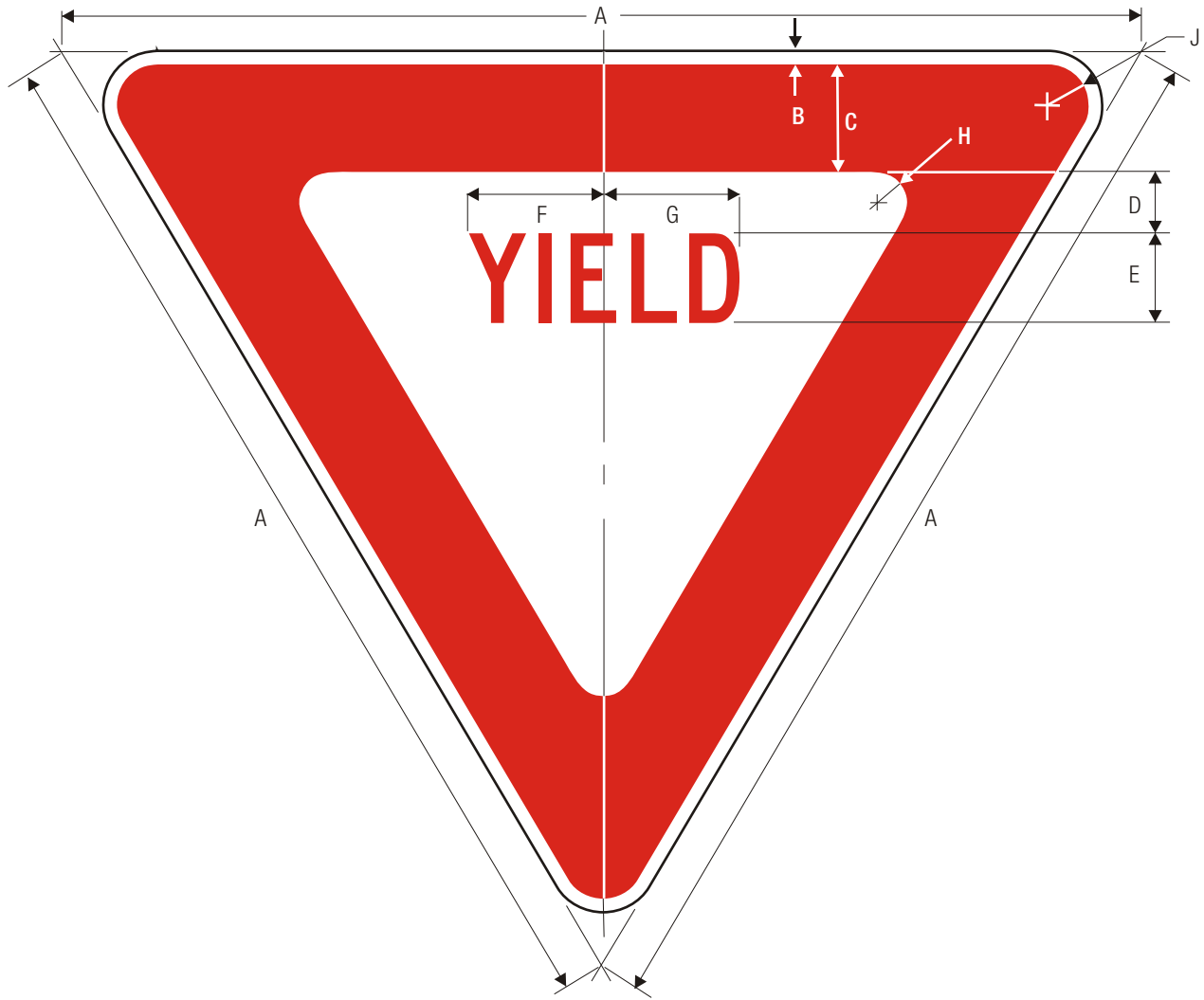

R1-2
YIELD

A	B	C	D	E	F	G	H	J
18	.375	2	1	1.5 C	2.375	2.188	.625	1.5
24	.375	3	1.375	2 C	3.25	3	.875	1.5
30	.625	4	1.75	2.5 C	3.938	3.625	.875	1.5
C 36	.75	5	2	3 C	4.688	4.375	1.25	2
48	1	6	2.75	4 C	6.25	5.875	2	3
60	1.5	8	3.5	5 C	7.875	7.25	2.5	4

COLORS: LEGEND — RED (RETROREFLECTIVE)
BACKGROUND — WHITE (RETROREFLECTIVE)

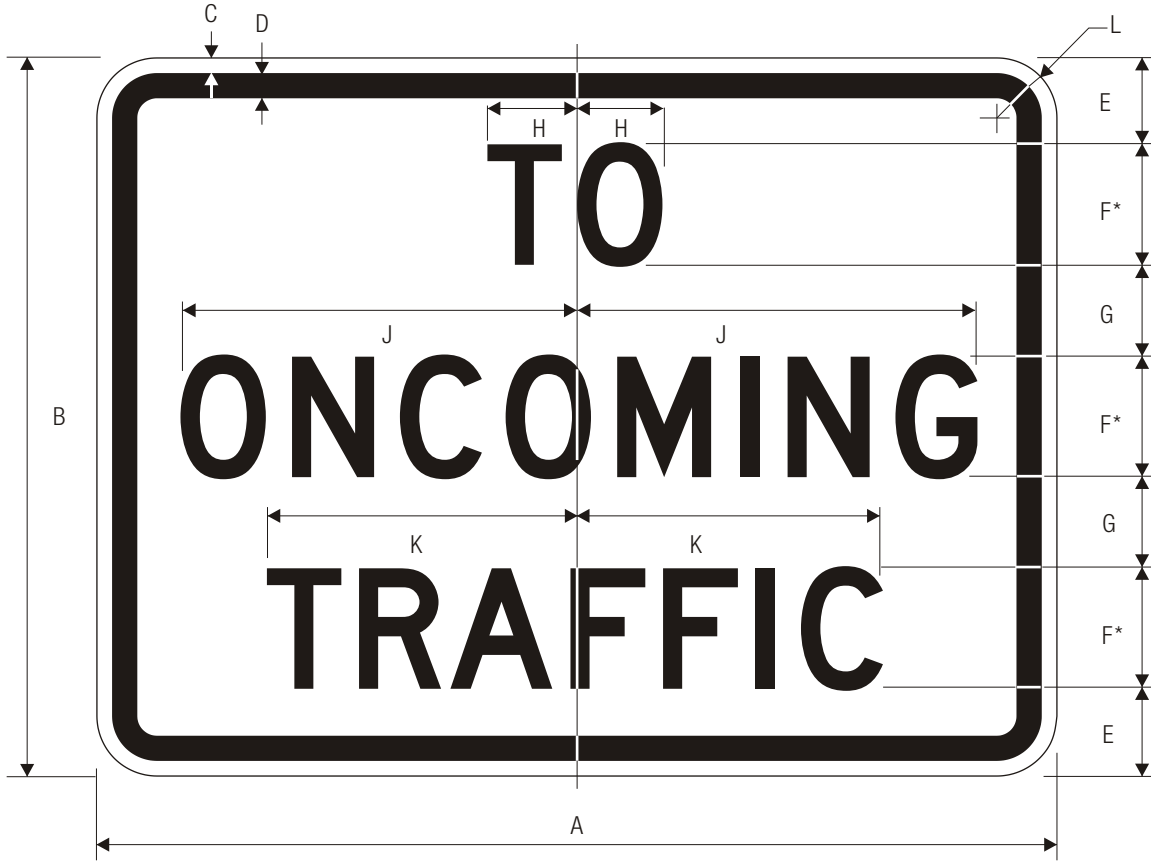

R1-2a
TO ONCOMING TRAFFIC

*Series2000 Standard Alphabets.

	A	B	C	D	E	F	G	H	J	K	L
C	24	18	.375	.625	2.5	3 D	2	2.188	10	7.75	1.5
	36	30	.625	.875	5.25	4.5 D	3	3.266	14.873	11.496	2.25
	48	36	.75	1.25	5	6 D	4	4.355	19.829	15.327	3

COLORS: LEGEND — BLACK
BACKGROUND — WHITE (RETROREFLECTIVE)

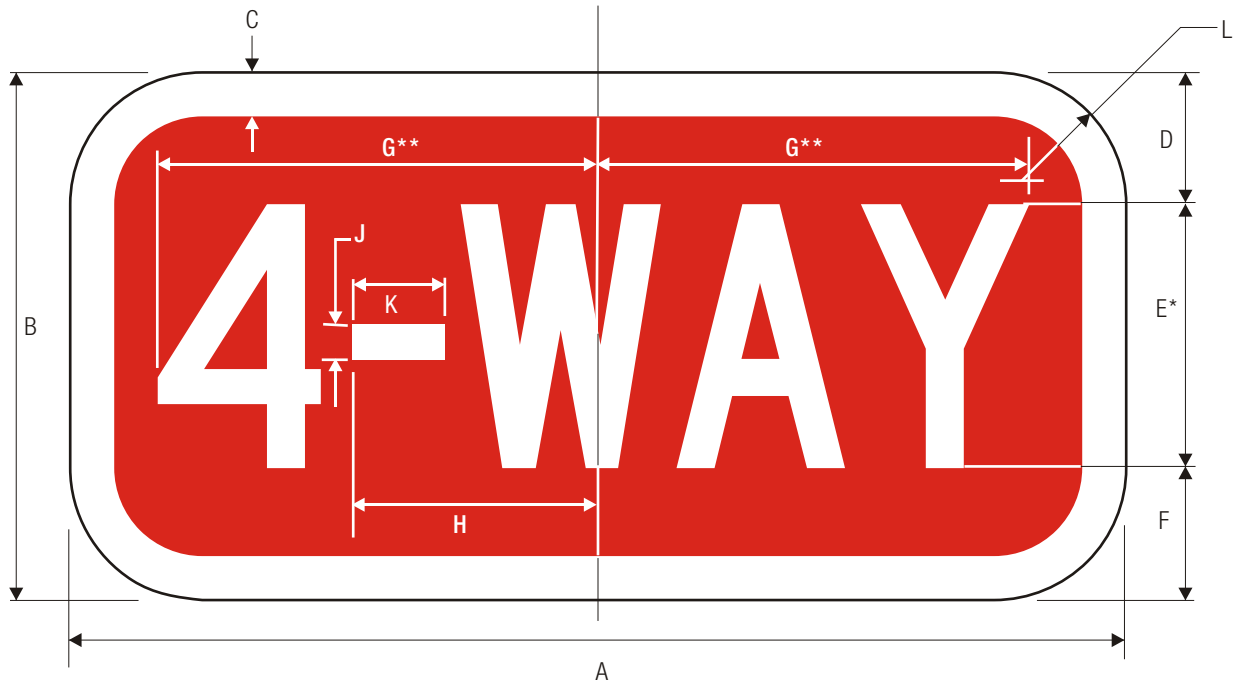

R1-3
4-WAY

*Series 2000 Standard Alphabets.
**Reduce spacing to fit.

	A	B	C	D	E	F	G	H	J	K	L
C	12	6	.5	1.5	3 C	1.5	4.875	2.75	.375	1.063	1.5
	18	9	.5	2	5 C	2	8	4.313	.687	1.75	1.5
	24	12	.5	3	6 C	3	9.562	5.188	.812	2.125	1.5
	30	15	.75	3.5	8 C	3.5	11.188	6.044	.920	2.441	1.875
	36	18	.75	4.5	9 C	4.5	14.390	7.765	1.200	3.162	2.25
	48	24	1	6	12 C	6	19.394	10.568	1.601	4.203	3

COLORS: LEGEND — WHITE (RETROREFLECTIVE)
BACKGROUND — RED (RETROREFLECTIVE)

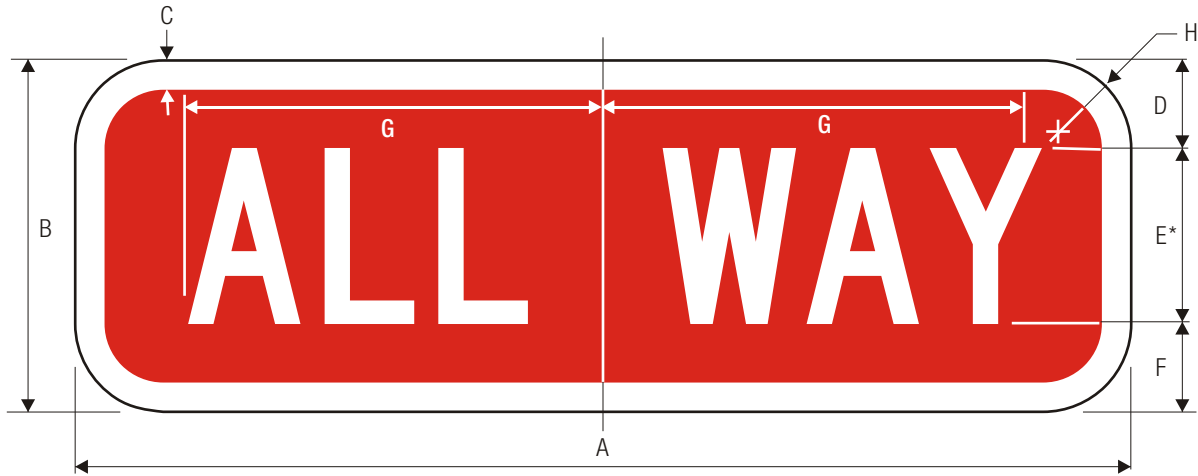

R1-4
ALL WAY

*Series 2000 Standard Alphabets.

	A	B	C	D	E	F	G	H
C	18	6	.5	1.5	3 C	1.5	7	1.5
	24	9	.5	2	5 C	2	11	1.5
	30	12	.75	3	6 C	3	13.25	1.875
	36	15	.75	4	7 C	4	15.771	2.25
	48	18	1	4.5	9 C	4.5	20.415	3

COLORS: LEGEND — WHITE (RETROREFLECTIVE)
BACKGROUND — RED (RETROREFLECTIVE)

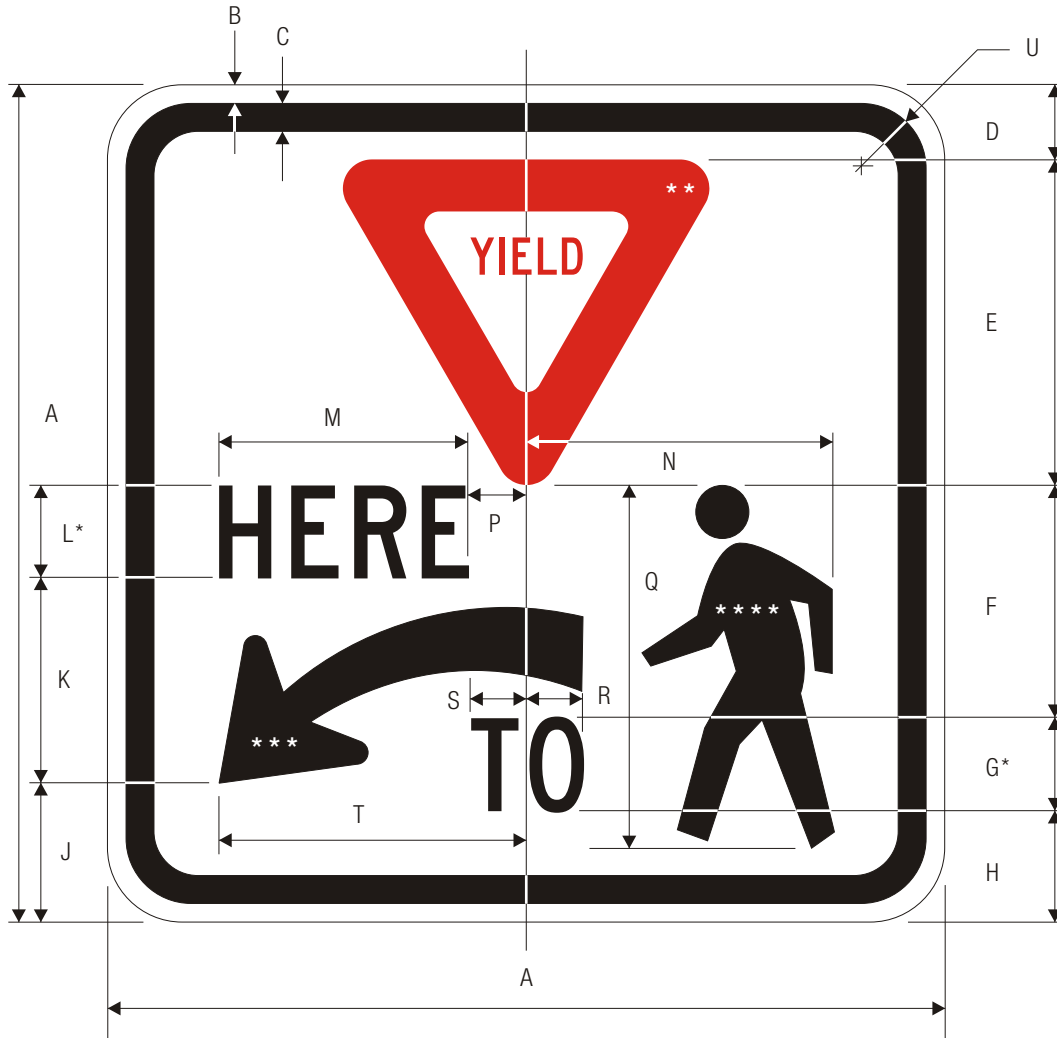

R1-5L
YIELD HERE TO PEDESTRIANS

	A	B	C	D	E	F	G	H	J	K	L
C	18	.375	.625	1.625	7	5	2 C	2.375	3	4.375	2 C
	30	.5	.75	2.75	11.5	8.5	3 C	4.25	5	7.25	3 C
	36	.625	.875	3.25	14	10	4 C	4.75	6	8.75	4 C

M	N	P	Q	R	S	T	U
5.364	6.605	1.240	7.805	1.220	1.220	6.605	1.5
8.061	11	2	13	1.820	1.820	11	1.875
10.728	13.21	2.48	15.61	2.44	2.44	13.21	2.25

*Series 2000 Standard Alphabets.
 **Insert R1-2 and size to fit.
 ***Insert R10-6a Arrow and size to fit.
 ****See 6-10 for design detail.

COLORS: LEGEND & ARROW — BLACK
 PED SYMBOL — BLACK
 BACKGROUND — WHITE (RETROREFLECTIVE)
 YIELD SYMBOL — RED (RETROREFLECTIVE)

X-XX

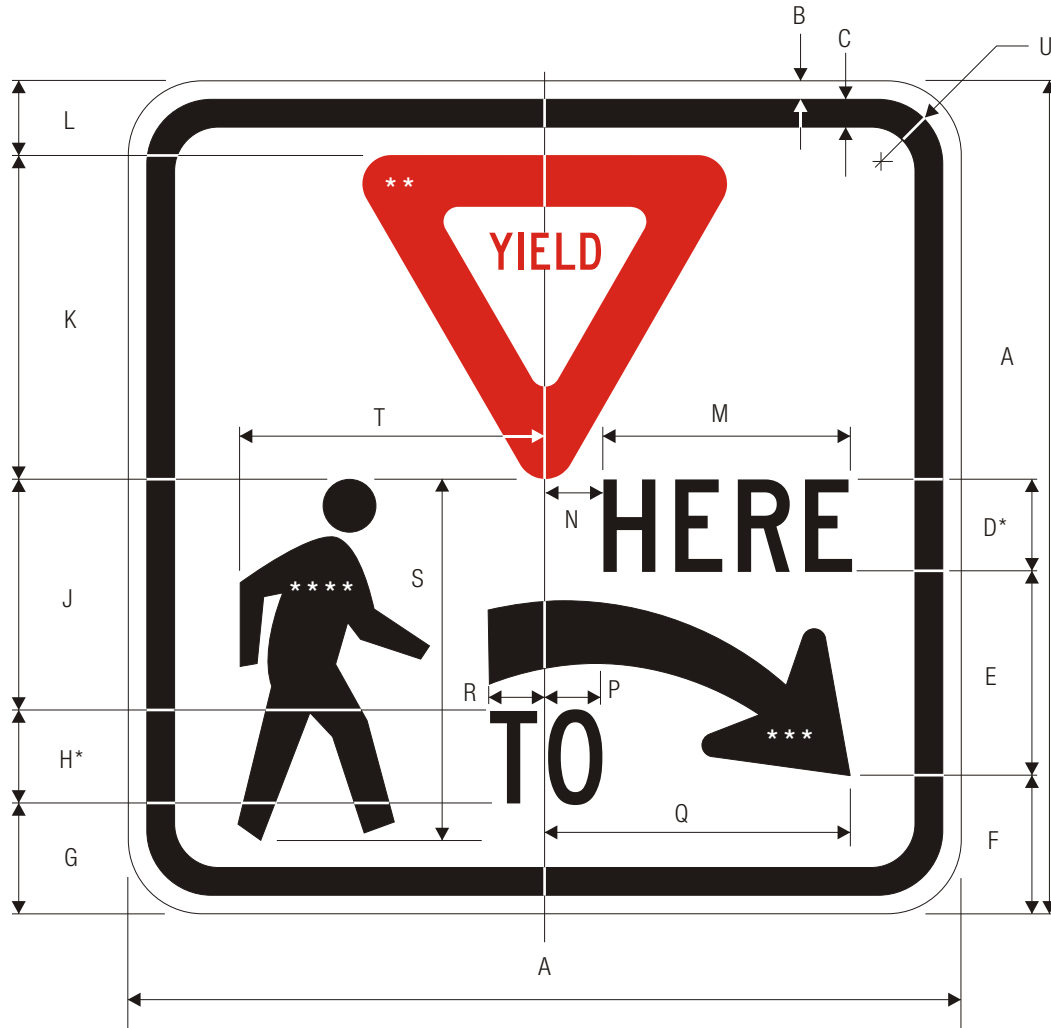

R1-5R
YIELD HERE TO PEDESTRIANS

	A	B	C	D	E	F	G	H	J	K	L
C	18	.375	.625	2 C	4.375	3	2.375	2 C	5	7	1.625
	30	.5	.75	3 C	7.25	5	4.25	3 C	8.5	11.5	2.75
	36	.625	.875	4 C	8.75	6	4.75	4 C	10	14	3.25

M	N	P	Q	R	S	T	U
5.364	1.240	1.220	6.605	1.220	7.805	6.605	1.5
8.061	2	1.820	11	1.820	13	11	1.875
10.728	2.48	2.44	13.21	2.44	15.61	13.21	2.25

*Series 2000 Standard Alphabets.
 **Insert R1-2 and size to fit.
 ***Insert R10-6a Arrow and size to fit.
 ****See 6-10 for design detail.

COLORS: LEGEND & ARROW — BLACK
 PED SYMBOL — BLACK
 BACKGROUND — WHITE (RETROREFLECTIVE)
 YIELD SYMBOL — RED (RETROREFLECTIVE)

X-XX



R1-5aL
YIELD HERE TO PEDESTRIANS

C

A	B	C	D	E	F	G	H	J	K	L
18	24	.375	.625	2	8	.75	2 C	3.625	1.250	2.375
30	42	.5	.75	5	13.5	1.25	3 C	6	2	5.25
36	48	.625	.875	4	16	1.5	4 C	7.25	2.5	4.75

M	N	P	Q	R	S	T	U
5.364	1.761	5.604	2.427	2.401	7.125	6	1.5
8.059	2.622	9.375	3.641	4.359	10.681	10	1.875
10.744	3.522	11.208	4.853	4.802	14.236	12	2.25

*Series 2000 Standard Alphabets.
**Insert R1-2 and size to fit.
***Insert R10-6a Arrow and size to fit.

COLORS: LEGEND & ARROW – BLACK
BACKGROUND – WHITE (RETROREFLECTIVE)
YIELD SYMBOL – RED (RETROREFLECTIVE)

X-XX



R1-5aR
YIELD HERE TO PEDESTRIANS

	A	B	C	D	E	F	G	H	J	K	L
C	18	24	.375	.625	6	2.375	2 C	1.250	3.625	.75	8
	30	42	.5	.75	10	5.25	3 C	2	6	1.25	13.5
	36	48	.625	.875	12	4.75	4 C	2.5	7.25	1.5	16

M	N	P	Q	R	S	T	U
2	5.364	1.761	5.604	7.125	2.401	2.427	1.5
5	8.059	2.622	9.375	10.681	4.359	3.641	1.875
4	10.744	3.522	11.208	14.236	4.802	4.853	2.25

*Series 2000 Standard Alphabets.
 **Insert R1-2 and size to fit.
 ***Insert R10-6a Arrow and reduce to fit.

COLORS: LEGEND & ARROW – BLACK
 BACKGROUND – WHITE (RETROREFLECTIVE)
 YIELD SYMBOL – RED (RETROREFLECTIVE)

X-XX

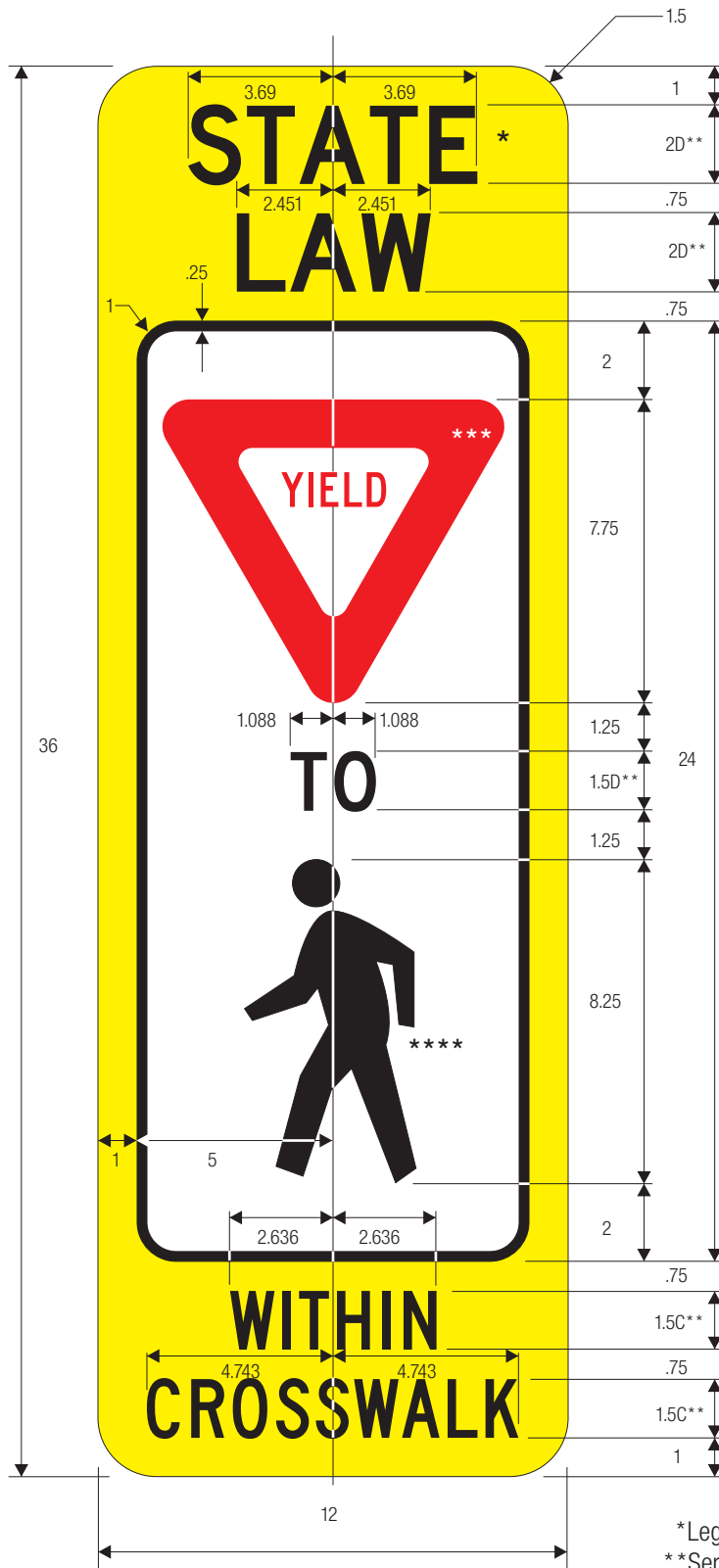

R1-6
IN-STREET PEDESTRIAN CROSSING

*Legend is optional.
 **Series 2000 Standard Alphabets.
 ***Insert R1-2 and size to fit.
 ****See 6-10 for design detail.

- COLORS:**
- LEGEND — BLACK
 - BACKGROUND — FLUORESCENT YELLOW-GREEN, OR YELLOW (RETROREFLECTIVE)
 - YIELD SYMBOL — RED (RETROREFLECTIVE) ON WHITE (RETROREFLECTIVE)
 - PED SYMBOL — BLACK ON WHITE (RETROREFLECTIVE)

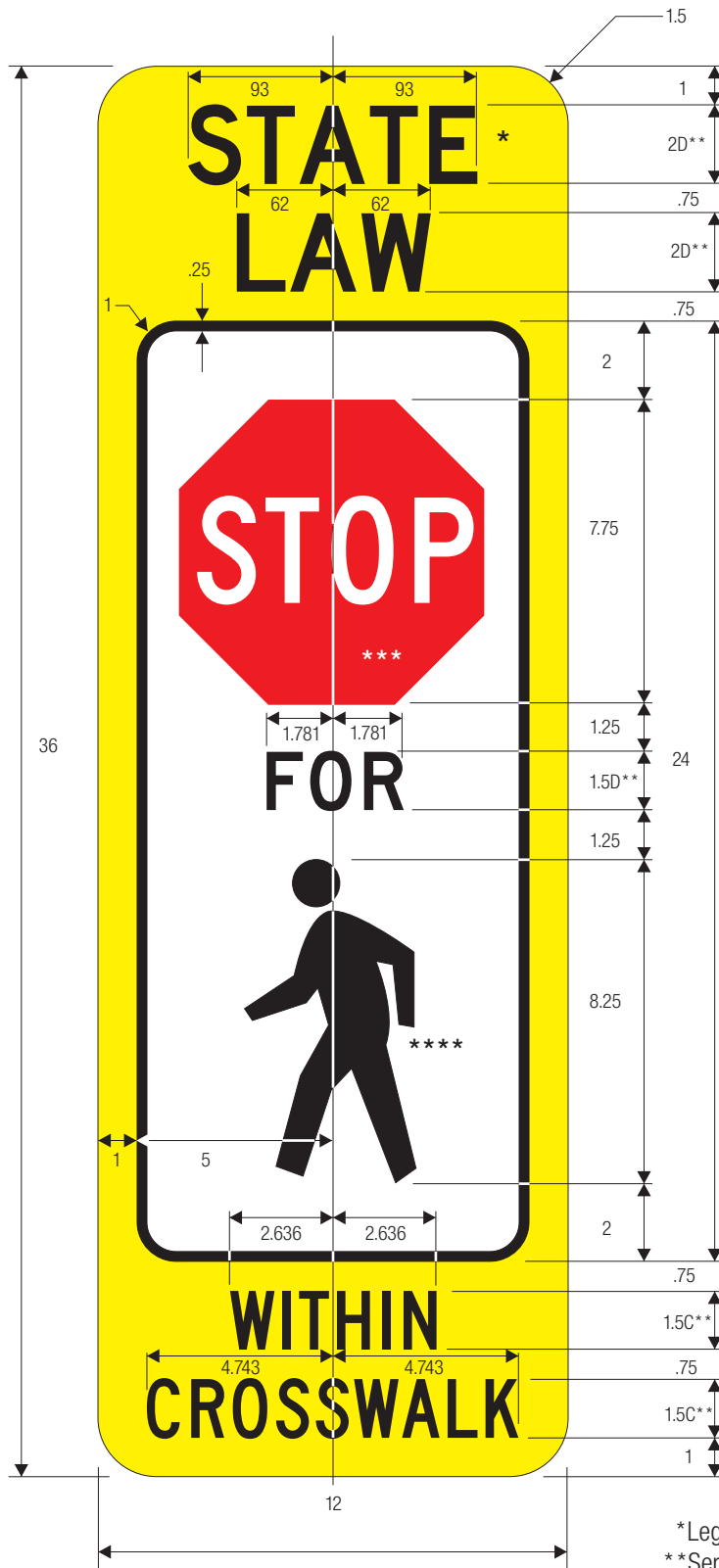

R1-6a
IN-STREET PEDESTRIAN CROSSING

*Legend is optional.
 **Series 2000 Standard Alphabets.
 ***Insert R1-1 and size to fit.
 ****See 6-10 for design detail.

- COLORS: LEGEND — BLACK
 BACKGROUND — FLOURESCENT YELLOW-GREEN, OR YELLOW (RETROREFLECTIVE)
 YIELD SYMBOL — RED (RETROREFLECTIVE) ON WHITE (RETROREFLECTIVE)
 PED SYMBOL — BLACK ON WHITE (RETROREFLECTIVE)



R2-1
SPEED LIMIT (ENGLISH)

*Optically space numerals about centerline

	A	B	C	D	E	F	G	H	J	K	L
	18	24	.375	.625	3	3 E	2	8 E	7.188	5.5	1.5
C	24	30	.375	.625	4	4 E	2	10 E	9.563	7.313	1.5
	36	48	.625	.875	6	6 E	5	14 E	14.375	11	2.25
	48	60	.75	1.25	8	8 E	6	16 E	19.125	14.625	3

COLORS: LEGEND — BLACK
BACKGROUND— WHITE (RETROREFLECTIVE)

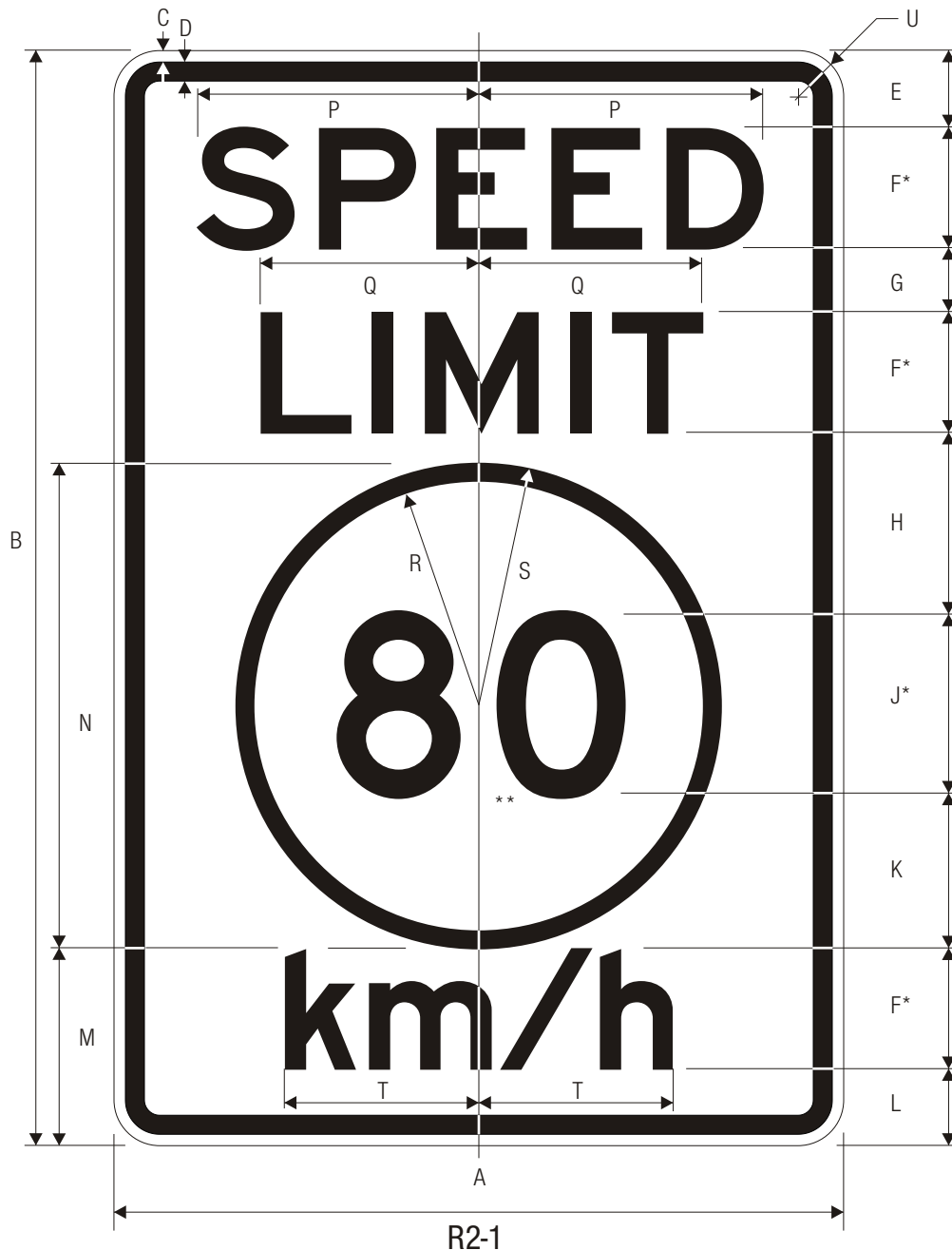

R2-1

SPEED LIMIT (METRIC)

*Series 2000 Standard Alphabets.

**Optically space numerals about centerline.

C

A	B	C	D	E	F	G	H	J	K	L
24	36	.375	.625	2.5	4 E	2	6	6 D	5	2.5
36	54	.625	.875	3.75	6 E	3	9	9 D	7.5	3.75
48	72	.75	1.25	5	8 E	4	12	12 D	10	5

M	N	P	Q	R	S	T	U
6.5	16	9.327	7.279	7.375	8	6.378	1.5
9.75	24	13.99	10.918	11.125	12	9.643	2.25
13	32	18.657	14.561	14.75	16	12.845	3

COLORS: LEGEND — BLACK
 BACKGROUND — WHITE (RETROREFLECTIVE)
 CIRCLE — BLACK



R2-2
TRUCK SPEED LIMIT

*Reduce spacing 32%.

**Optically space numerals about centerline.

	A	B	C	D	E	F	G	H	J	K	L
C	24	.375	.625	4	4 D	2.5	10 E	3.5	1.5	9.563	9.188
	36	.625	.875	6	6 D	4	14 E	6	2.25	14.313	13.813
	48	.75	1.25	8	8 D	8	16 E	8	3	19.125	18.375

COLORS: LEGEND — BLACK
BACKGROUND — WHITE (RETROREFLECTIVE)

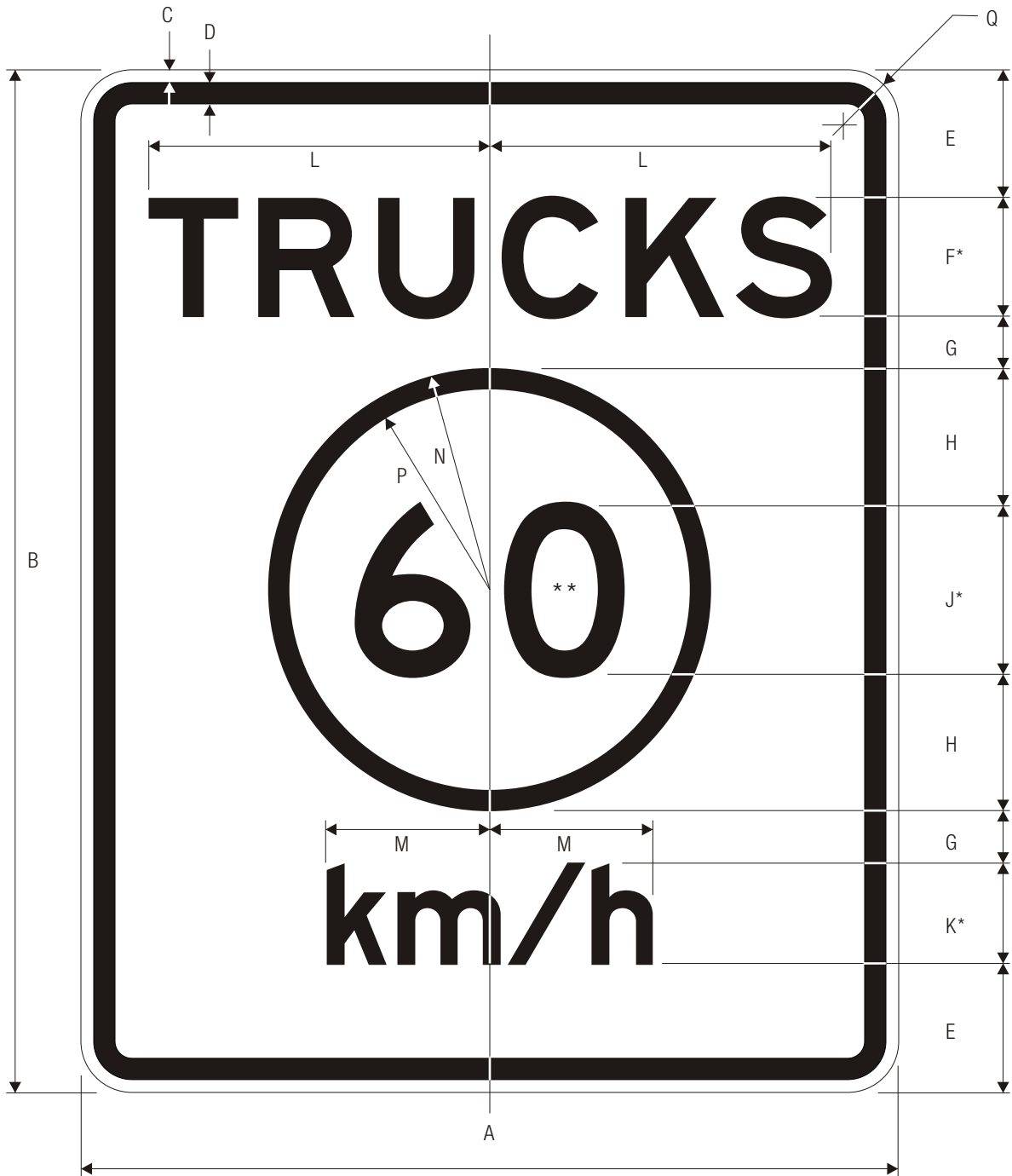

R2-2

TRUCK SPEED LIMIT (METRIC)

*Series 2000 Standard Alphabets.

**Optically space numerals about centerline.

A	B	C	D	E	F	G	H	J	K	L	M
24	30	.375	.625	3.75	3.5 E	1.5	4	5 D	3 E	10	4.783
36	48	.625	.875	6.25	5 E	2.5	6.5	8 D	4.5 E	14.323	7.175
48	60	.75	1.25	5.75	7 E	3	9	11 D	6.5 E	20	10.364

N	P	Q
6.5	5.875	1.5
10.5	9.5	2.25
14.5	13.25	3

COLORS: LEGEND — BLACK
 BACKGROUND — WHITE (RETROREFLECTIVE)
 CIRCLE — BLACK



R2-3
NIGHT SPEED LIMIT (ENGLISH)

*Increase spacing 50%
**Optically space numerals about centerline

	A	B	C	D	E	F	G	H	J
C	24	.5	4	3 F	3	10 E	7.938	8.25	1.5
	36	.75	6.5	4 F	5	14 E	10.625	11	2.25
	48	1	9	6 F	8	16 E	15.875	16.5	3

COLORS: LEGEND — WHITE (RETROREFLECTIVE)
BACKGROUND— BLACK

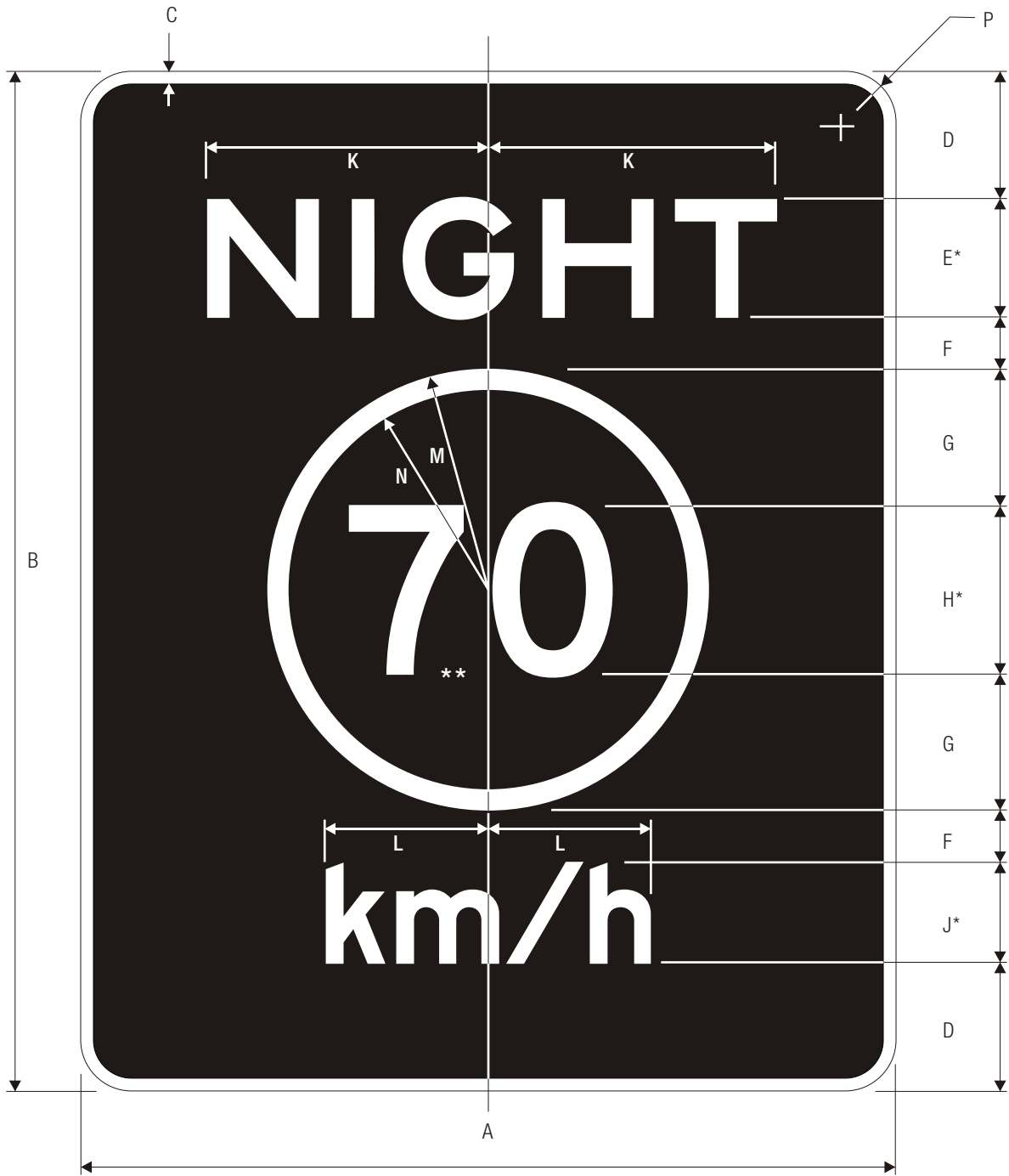

R2-3

NIGHT SPEED LIMIT (METRIC)

*Series 2000 Standard Alphabets.

**Optically space numerals about centerline.

C

A	B	C	D	E	F	G	H	J	K	L	M
24	30	.5	3.75	3.5 F	1.5	4	5 D	3 E	8.390	4.783	6.5
36	48	.75	6.25	5 F	2.5	6.5	8 D	4.5 E	11.983	7.175	10.5
48	60	1	5.75	7 F	3	9	11 D	6.5 E	16.775	10.364	14.5

N	P
5.875	1.5
9.5	2.25
13.25	3

COLORS: LEGEND — WHITE (RETROREFLECTIVE)
 BACKGROUND — BLACK
 CIRCLE — WHITE (RETROREFLECTIVE)



R2-4

MINIMUM SPEED LIMIT (ENGLISH)

*Optically space numerals about centerline

	A	B	C	D	E	F	G	H	J	K	L
C	24	30	.375	.625	4	4 C	2	10 D	9.188	6.813	1.5
	36	48	.625	.875	6	6 C	5	14 D	13.75	10.188	2.25
	48	60	.75	1.25	8	8 C	6	16 D	18.375	13.625	3

COLORS: LEGEND — BLACK
BACKGROUND — WHITE (RETROREFLECTIVE)

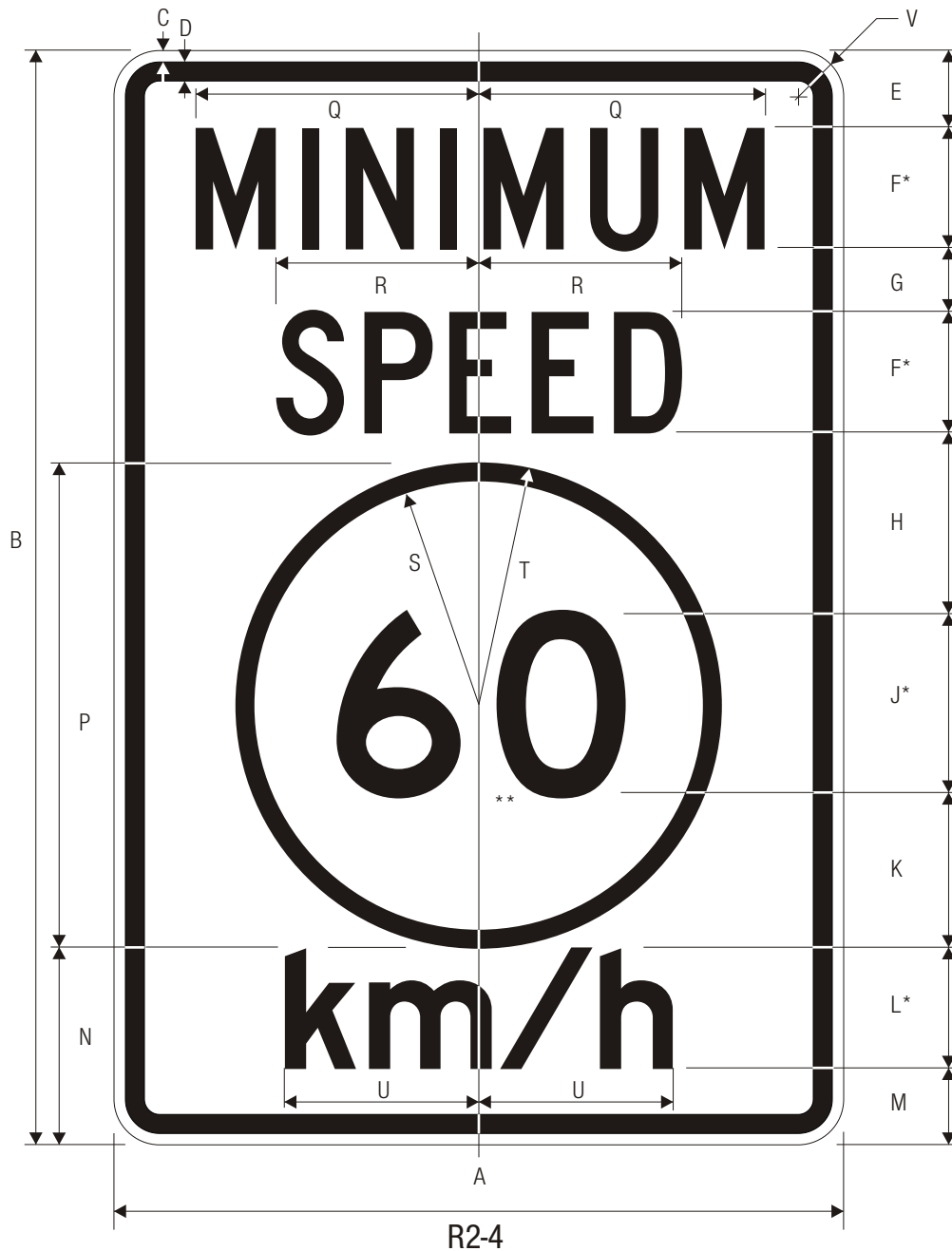

R2-4

MINIMUM SPEED LIMIT (METRIC)

*Series 2000 Standard Alphabets.

**Optically space numerals about centerline.

C

A	B	C	D	E	F	G	H	J	K	L	M
24	36	.375	.625	2.5	4 C	2	6	6 D	5	4 E	2.5
36	54	.625	.875	3.75	6 C	3	9	9 D	7.5	6 E	3.75
48	72	.75	1.25	5	8 C	4	12	12 D	10	8 E	5

N	P	Q	R	S	T	U	V
6.5	16	9.355	6.676	7.375	8	6.378	1.5
9.75	24	14.032	10.014	11.125	12	9.643	2.25
13	32	18.713	13.355	14.75	16	12.845	3

COLORS: LEGEND — BLACK
 BACKGROUND — WHITE (RETROREFLECTIVE)
 CIRCLE — BLACK

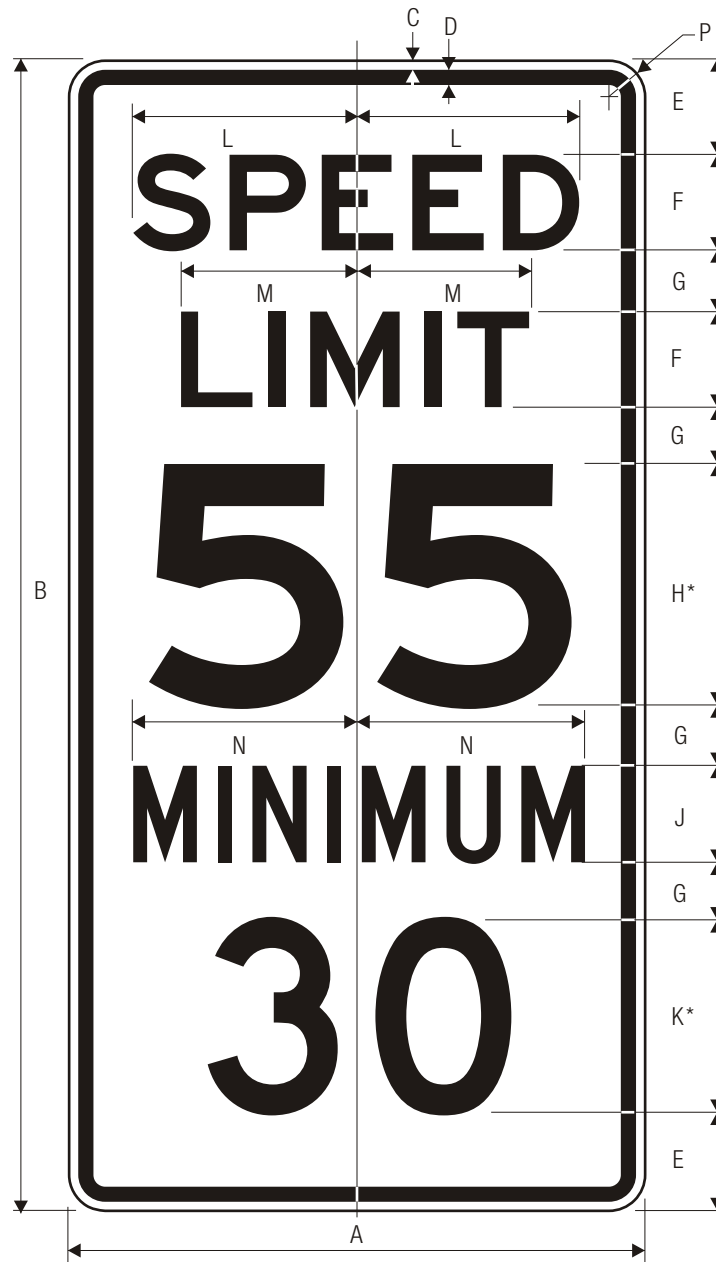

R2-4a

COMBINED SPEED LIMIT (ENGLISH)

*Optically space numerals about centerline

C

A	B	C	D	E	F	G	H	J	K	L	M
24	48	.375	.625	4	4 E	2.5	10 E	4 C	8 D	9.625	7.313
36	72	.625	.875	6	6 E	4	14 E	6 C	12 D	14.375	11
48	96	.75	1.25	8	8 E	6.5	16 E	8 C	14 D	19.25	14.625

N	P
9.188	1.5
13.75	2.25
18.375	3

COLORS: LEGEND — BLACK
BACKGROUND — WHITE (RETROREFLECTIVE)

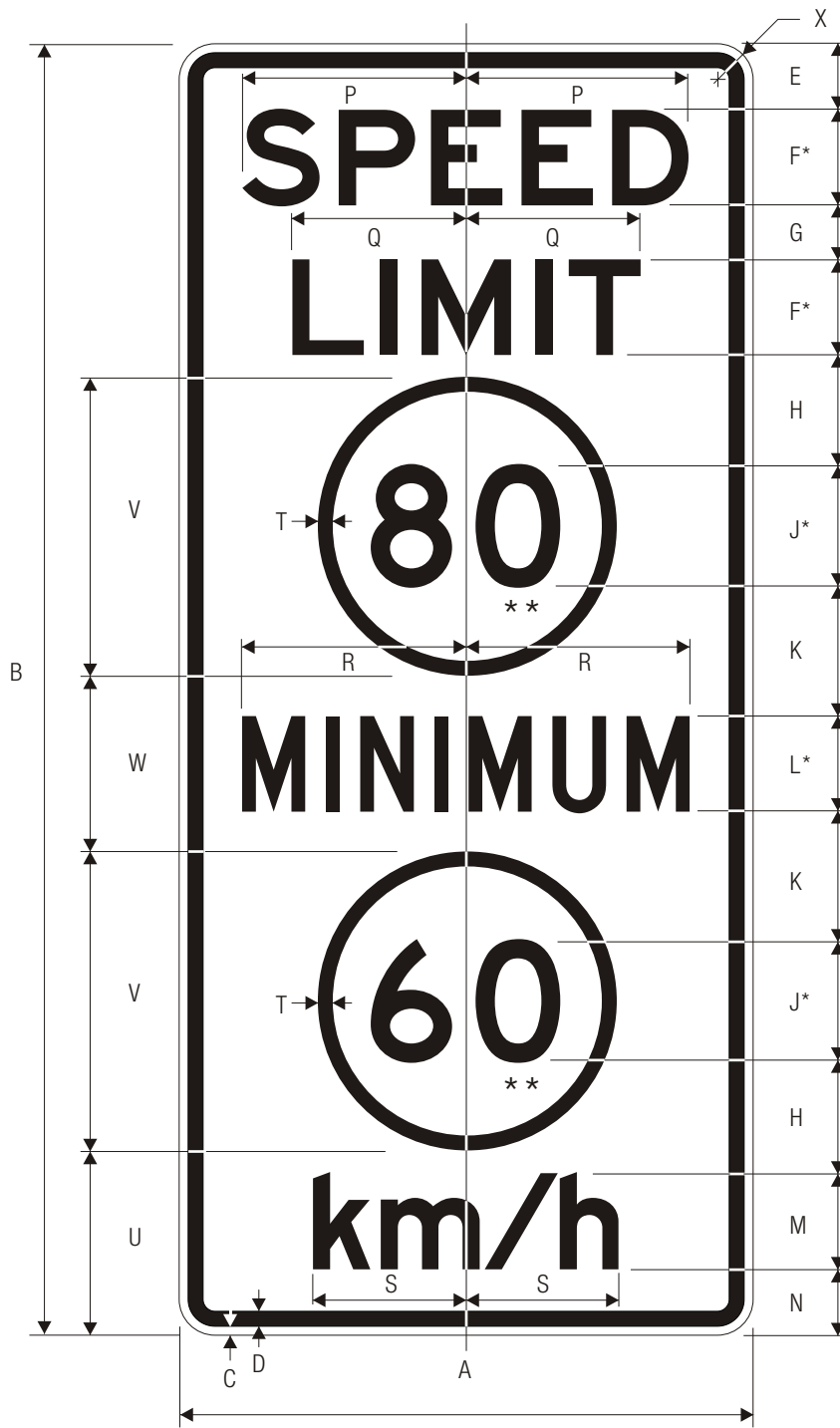

R2-4a

*Series 2000 Standard Alphabets.

COMBINED SPEED LIMIT (METRIC)

**Optically space numerals about centerline.

A	B	C	D	E	F	G	H	J	K	L	M	N	P
24	54	.375	.625	2.75	4 E	2.25	4.75	5 D	5.375	4 C	4 E	2.75	9.327
36	78	.625	.875	4	6 E	3	7.5	7 D	7	6 C	6 E	4	13.99
48	102	.75	1.25	5	8 E	4	9	9 D	10	8 C	8 E	5	18.657

C

Q	R	S	T	U	V	W	X
7.279	9.355	6.386.	.625	7.75	12.5	7.25	1.5
10.918	14.032	9.708.	.875	12	18	9	2.25
14.559	18.711	13.053	1.25	14.5	24	13	3

COLORS:
 LEGEND — BLACK
 BACKGROUND— WHITE (RETROREFLECTIVE)
 CIRCLE — BLACK



R2-6
FINES HIGHER



*Series 2000 Standard Alphabets.

	A	B	C	D	E	F	G	H	J
C	24	.375	.625	6	4 D	4	6.95	9.138	1.5
	36	.625	.875	9	6 D	6	10.425	13.707	2.25
	48	.75	1.25	12	8 D	8	13.9	18.276	3

COLORS: LEGEND — BLACK
BACKGROUND — WHITE (RETROREFLECTIVE)

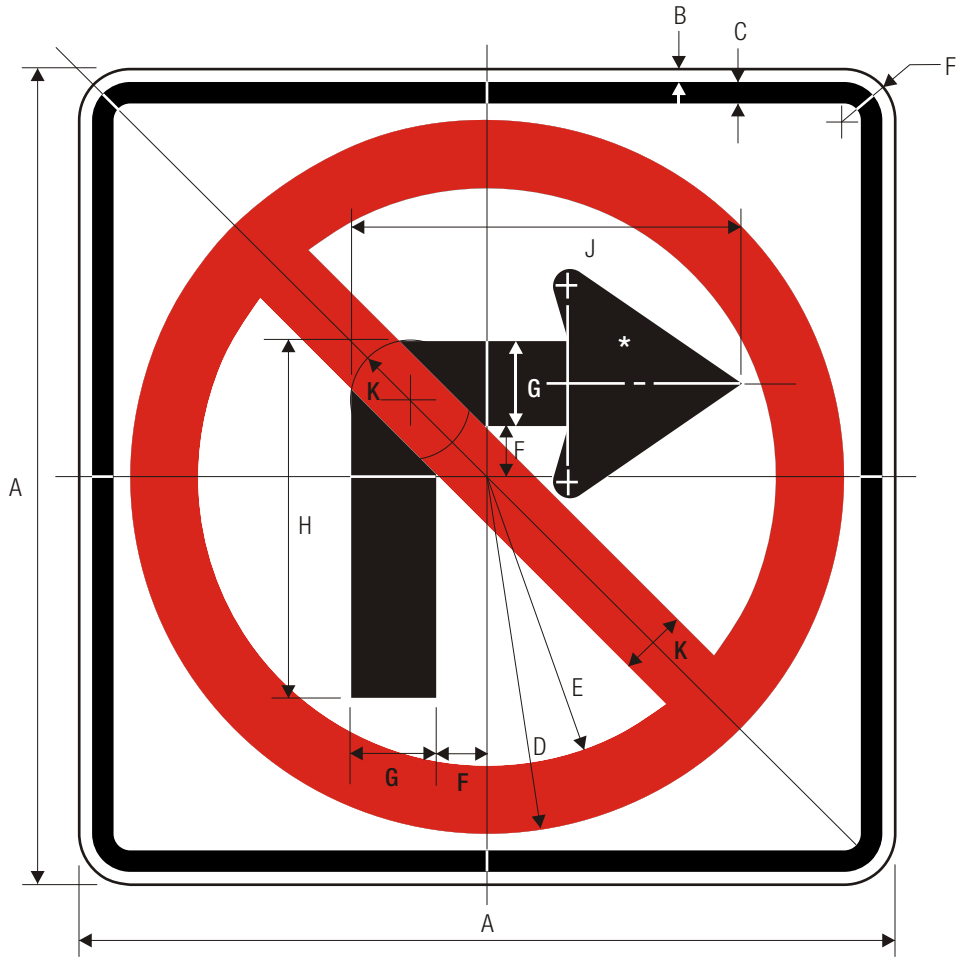

R3-1

RIGHT TURN PROHIBITION

*See page 6-2 for design details.

	A	B	C	D	E	F	G	H	J	K
C	24	.375	.625	10.5	8.5	1.5	2.5	10.5	11.5	2
	30	.5	.75	13.125	10.625	1.875	3.125	13.125	14.5	2.5
	36	.625	.875	15.75	12.75	2.25	3.75	15.75	17.25	3
	48	.75	1.25	21	17	3	5	21	23	4

COLORS: CIRCLE & DIAGONAL — RED (RETROREFLECTIVE)
 SYMBOL & BORDER — BLACK
 BACKGROUND — WHITE (RETROREFLECTIVE)

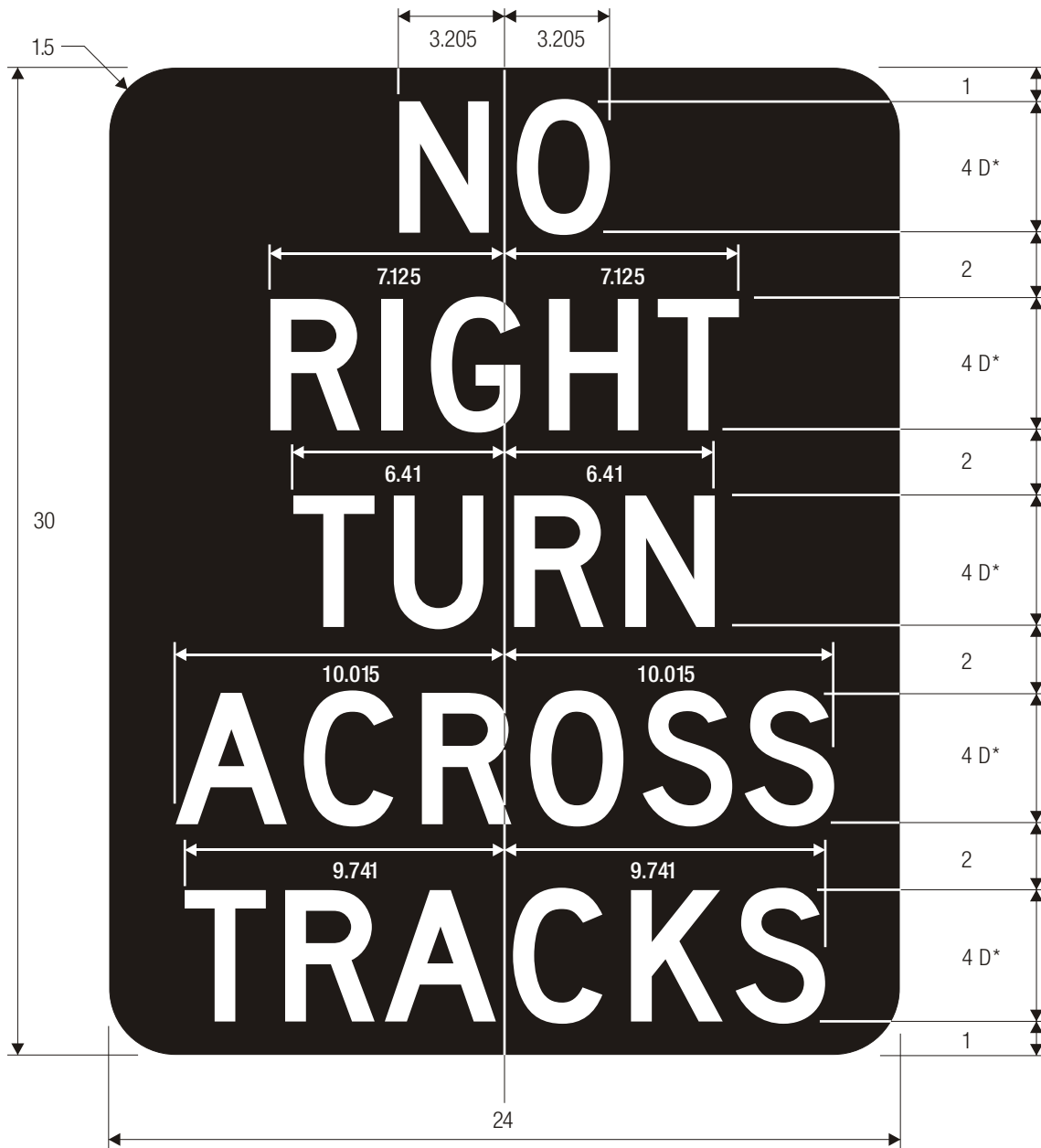

R3-1a
ACTIVATED BLANK-OUT

*Series 2000 Standard Alphabets.

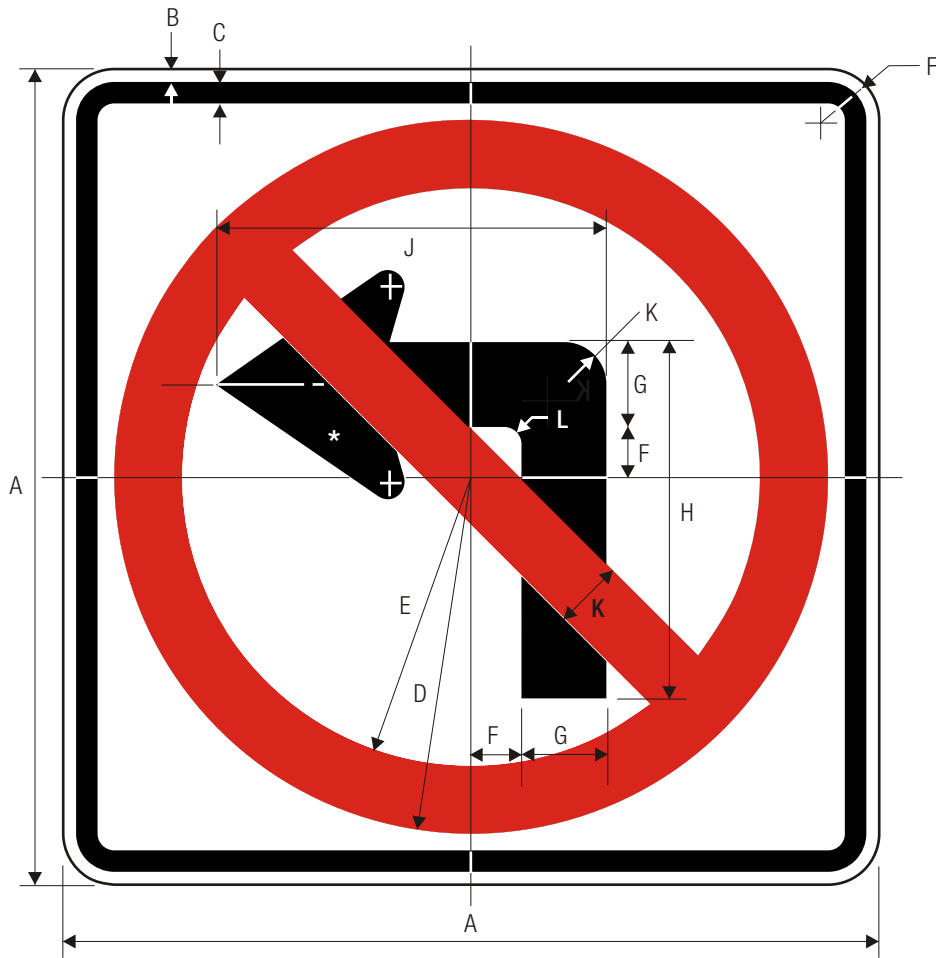

R3-2
LEFT TURN PROHIBITION

*See page 6-2 for design details.

	A	B	C	D	E	F	G	H	J	K	L
C	24	.375	.625	10.5	8.5	1.5	2.5	10.5	11.5	2	.5
	30	.5	.75	13.125	10.625	1.875	3.125	13.125	14.5	2.5	.625
	36	.625	.875	15.75	12.75	2.25	3.75	15.75	17.25	3	.75
	48	.75	1.25	21	17	3	5	21	23	4	1

COLORS: CIRCLE & DIAGONAL — RED (RETROREFLECTIVE)
 SYMBOL & BORDER — BLACK
 BACKGROUND — WHITE (RETROREFLECTIVE)

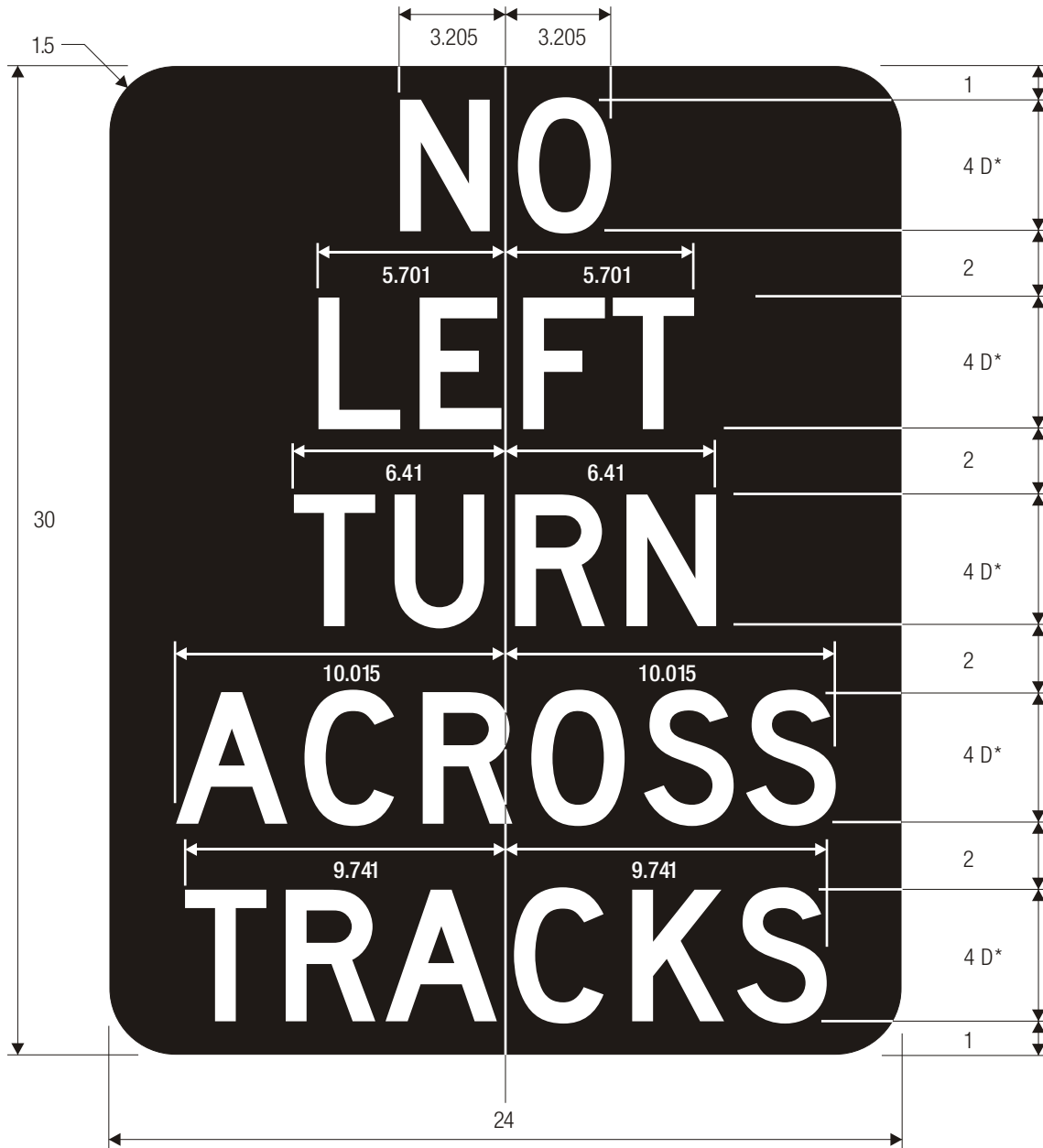

R3-2a
ACTIVATED BLANK-OUT

*Series 2000 Standard Alphabets.

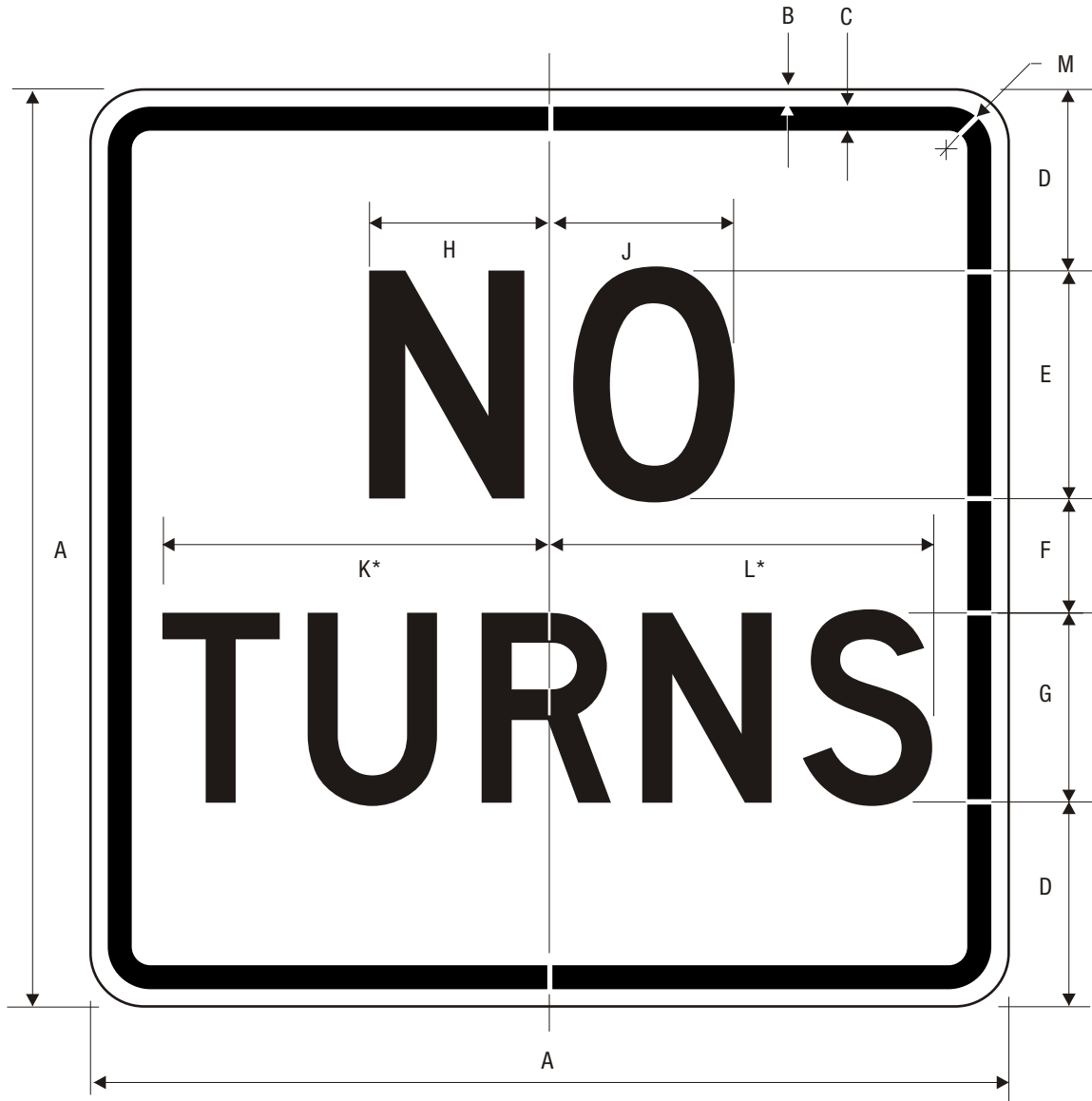

R3-3

NO TURNS

*Reduce spacing 35%.

	A	B	C	D	E	F	G	H	J	K	L	M
C	24	.375	.625	4.5	6 D	4	5 D	4.688	5	9.813	9.563	1.5
	36	.625	.875	6	10 D	6	8 D	7.75	8.313	15.688	15.313	2.25
	48	.75	1.25	9	12 D	8	10 D	9.313	10	19.625	19.125	3

COLORS: LEGEND — BLACK
 BACKGROUND— WHITE (RETROREFLECTIVE)



R3-4
U-TURN PROHIBITED

*See page 6-2 for design.

	A	B	C	D	E	F	G	H	J	K	L	M
C	24	.375	.625	10.5	8.5	2.5	2.5	6	2.25	1.5	2	5
	30	.5	.75	13.125	10.625	3.125	3.125	7.5	2.813	1.875	2.5	6.25
	36	.625	.875	15.75	12.75	3.75	3.75	9	3.375	2.25	3	7.5
	48	.75	1.25	21	17	5	5	12	4.5	3	4	10

COLORS: CIRCLE & DIAGONAL — RED (RETROREFLECTIVE)
 SYMBOL & BORDER — BLACK
 BACKGROUND — WHITE (RETROREFLECTIVE)

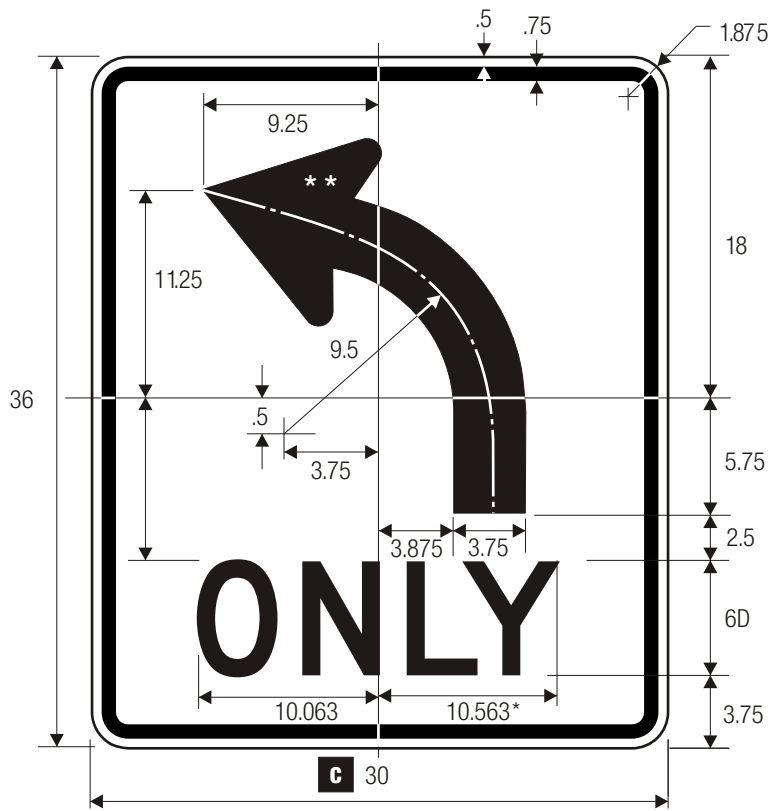

R3-5L MANDATORY MOVEMENT LANE CONTROL

*Reduce spacing to fit.
 **See page 6-2 for design details.



R3-5R

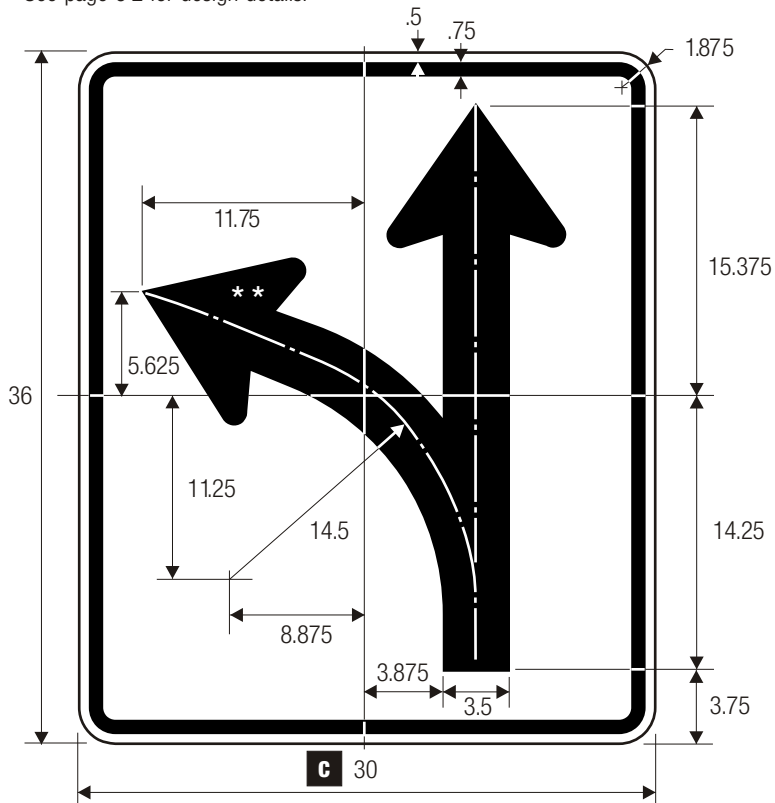

R3-6L OPTIONAL MOVEMENT LANE CONTROL

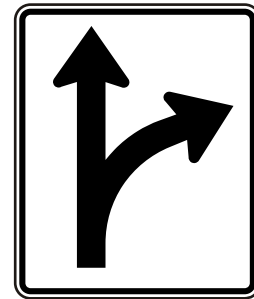

***Optional, add letters.

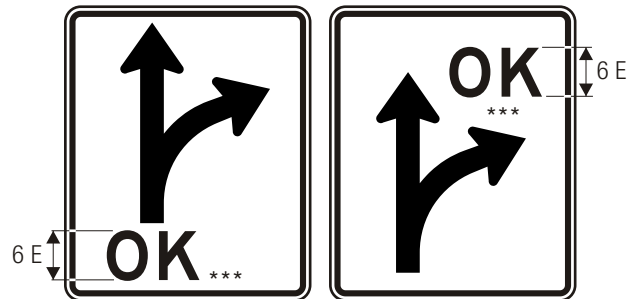

R3-6R

COLORS: LEGEND — BLACK
 BACKGROUND — WHITE (RETROREFLECTIVE)



R3-5a

MANDATORY MOVEMENT LANE CONTROL

*See page 6-2 for arrow design.

**Reduce spacing to fit.

***Series 2000 Standard Alphabets.

COLORS: LEGEND — BLACK
 BACKGROUND — WHITE (RETROREFLECTIVE)

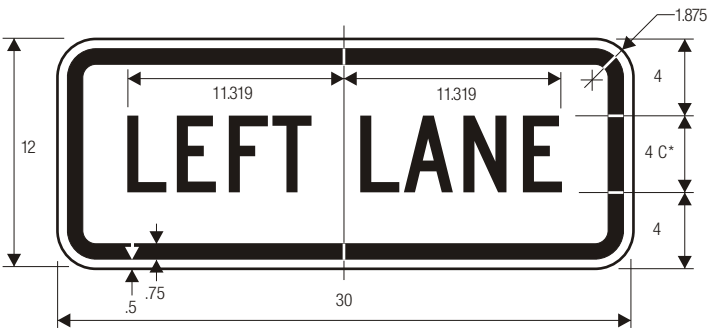

R3-5b

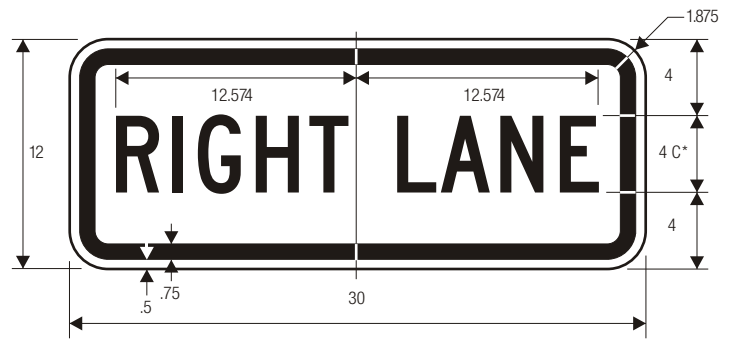

R3-5f

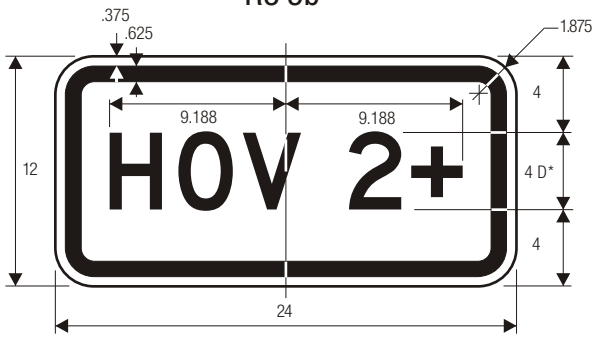

R3-5c

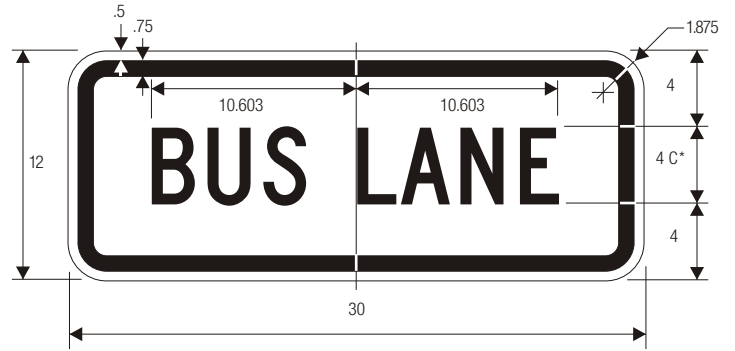

R3-5g

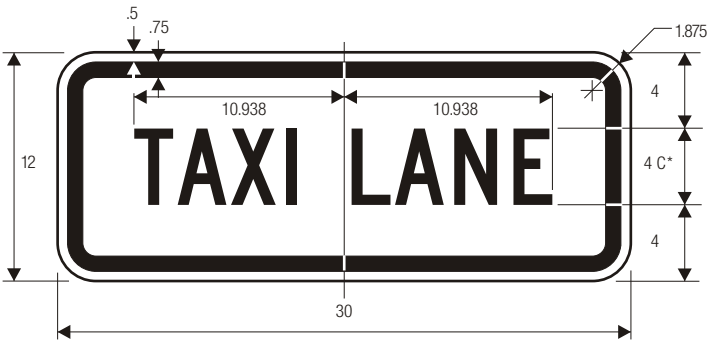

R3-5d

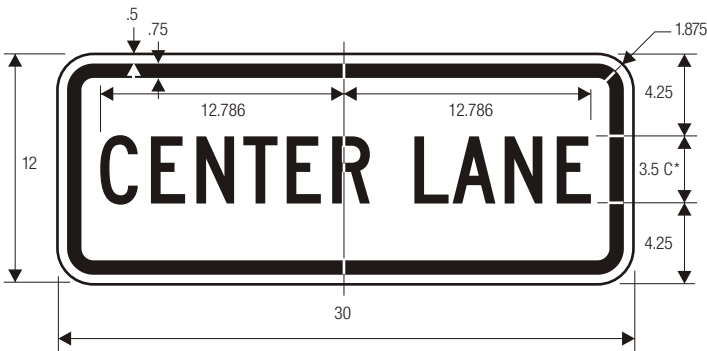

R3-5e

*Series 2000 Standard Alphabets.

LANE CONTROL PLAQUES

COLORS: LEGEND — BLACK
 BACKGROUND — WHITE (RETROREFLECTIVE)

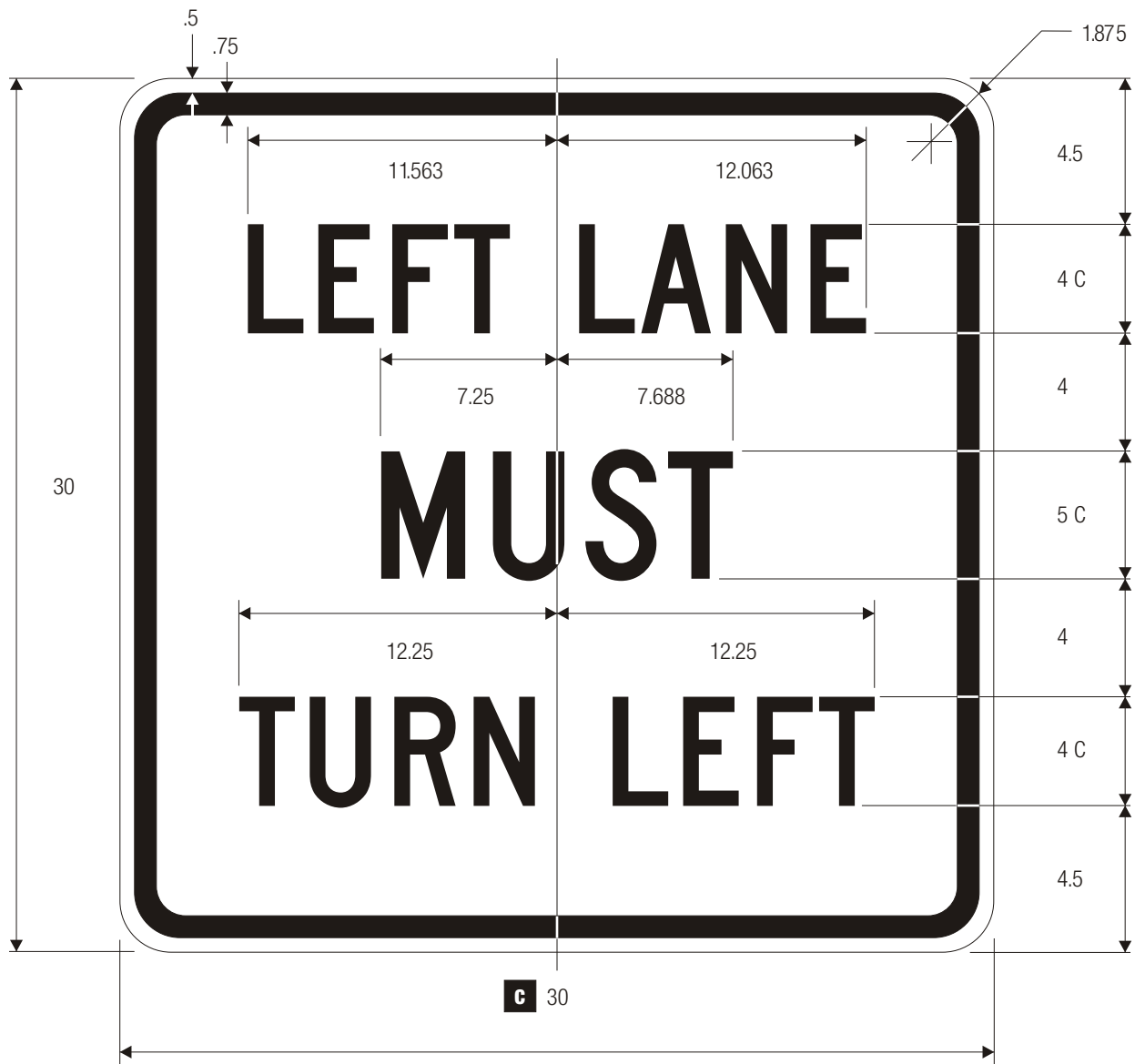

R3-7L

MANDATORY MOVEMENT LANE CONTROL

COLORS: LEGEND — BLACK
 BACKGROUND— WHITE (RETROREFLECTIVE)



R3-7R

MANDATORY MOVEMENT LANE CONTROL

COLORS: LEGEND — BLACK
 BACKGROUND— WHITE (RETROREFLECTIVE)

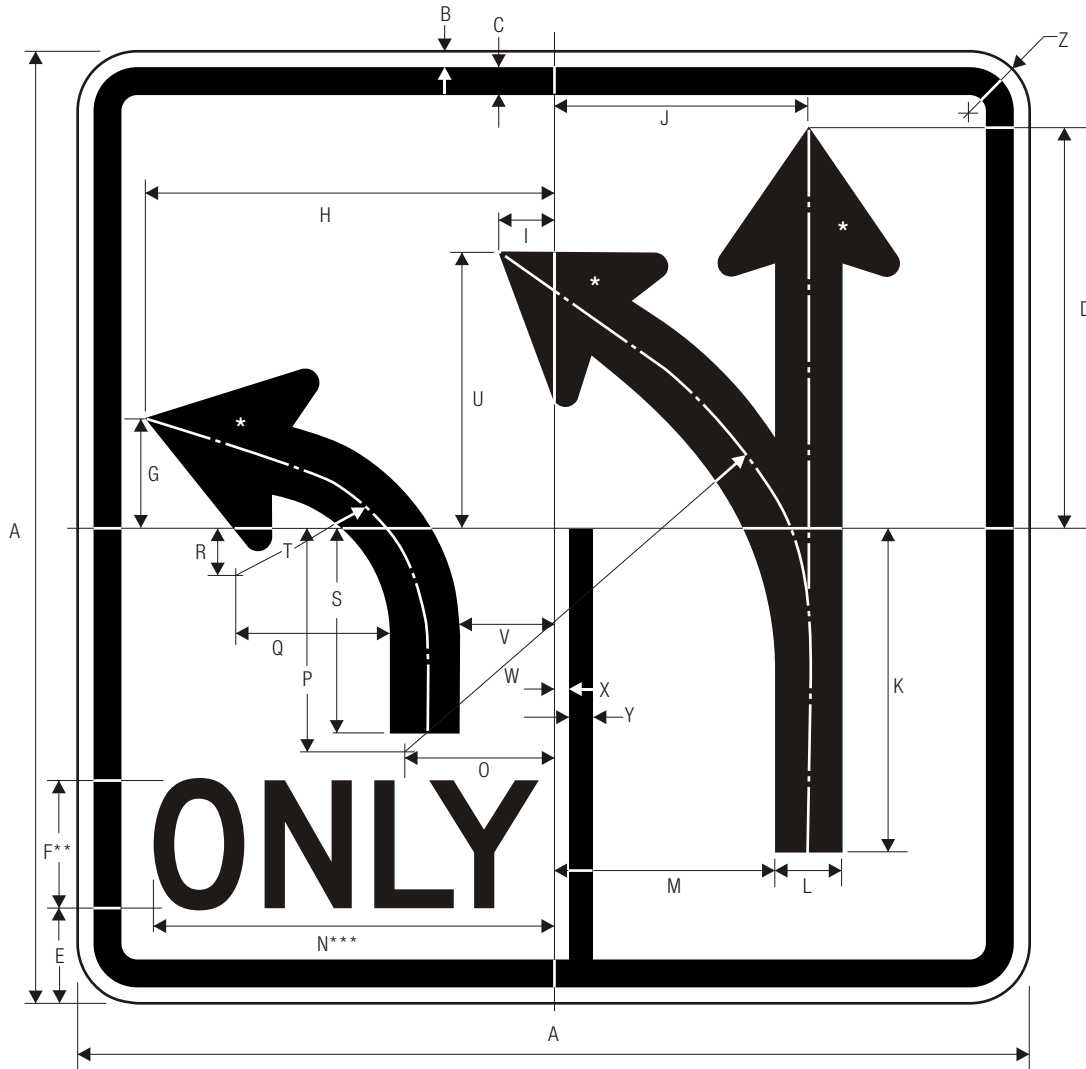

R3-8

ADVANCE INTERSECTION LANE CONTROL



- *See page 6-2 for design details.
- **Series 2000 Standard Alphabets.
- ***Reduce spacing to fit.
- ****OK is optional.

C

A	B	C	D	E	F	G	H	I	J	K	L	M
30	.5	.75	12.625	3	4 D	5	12.875	1.75	9.75	10.25	2.5	8.5
36	.625	.875	15	3.6	5 D	6	15.45	2.1	11.7	12.3	3	10.2
48	.75	1.25	20.2	4.8	6 D	8	20.6	2.8	15.6	16.4	4	13.6
N	O	P	Q	R	S	T	U	V	W	X	Y	Z
12.332	4.75	7.5	4.5	2.625	6.5	5.75	8	2.75	14.5	.5	.75	1.875
15.445	5.7	9	5.4	3.15	7.8	6.9	9.6	3.3	17.4	.6	.9	2.25
19.556	7.6	12	7.2	4.2	10.4	9.2	12.8	4.4	23.2	.8	1.2	3

COLORS: LEGEND — BLACK
 BACKGROUND— WHITE (RETROREFLECTIVE)

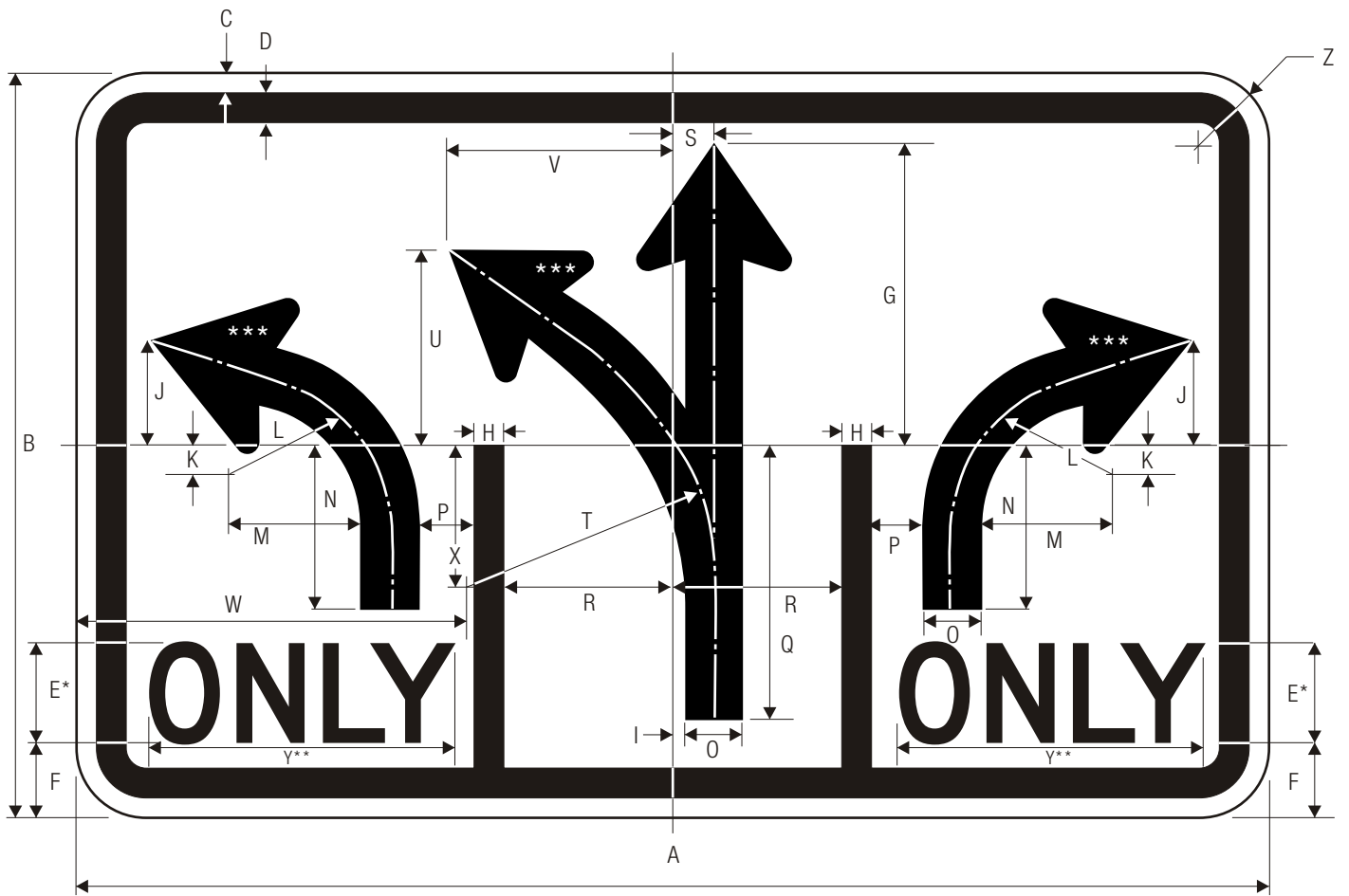

R3-8a

ADVANCE INTERSECTION LANE CONTROL

*Series 2000 Standard Alphabets.
 **Reduce spacing to fit and optically center.
 ***See page 6-2 for arrow design.

	A	B	C	D	E	F	G	H	I	J	K	L	M
C	48	30	.75	1.25	4 D	3	12.125	1.188	.438	4	3.375	5.813	4.625
	60	36	.75	1.25	5 D	3.5	14.875	1.188	.709	5.116	4.453	7.825	6.231
	N	O	P	Q	R	S	T	U	V	W	X	Y	Z
	6.625	2.5	1.688	11.063	6.813	1.688	11	7.5	9.75	14.641	6.45	12.313	3
	8.177	3	2.408	13.617	8.812	2.125	13.2	9.5	10.96	20	6.774	15.567	3

COLORS: LEGEND — BLACK
 BACKGROUND — WHITE (RETROREFLECTIVE)

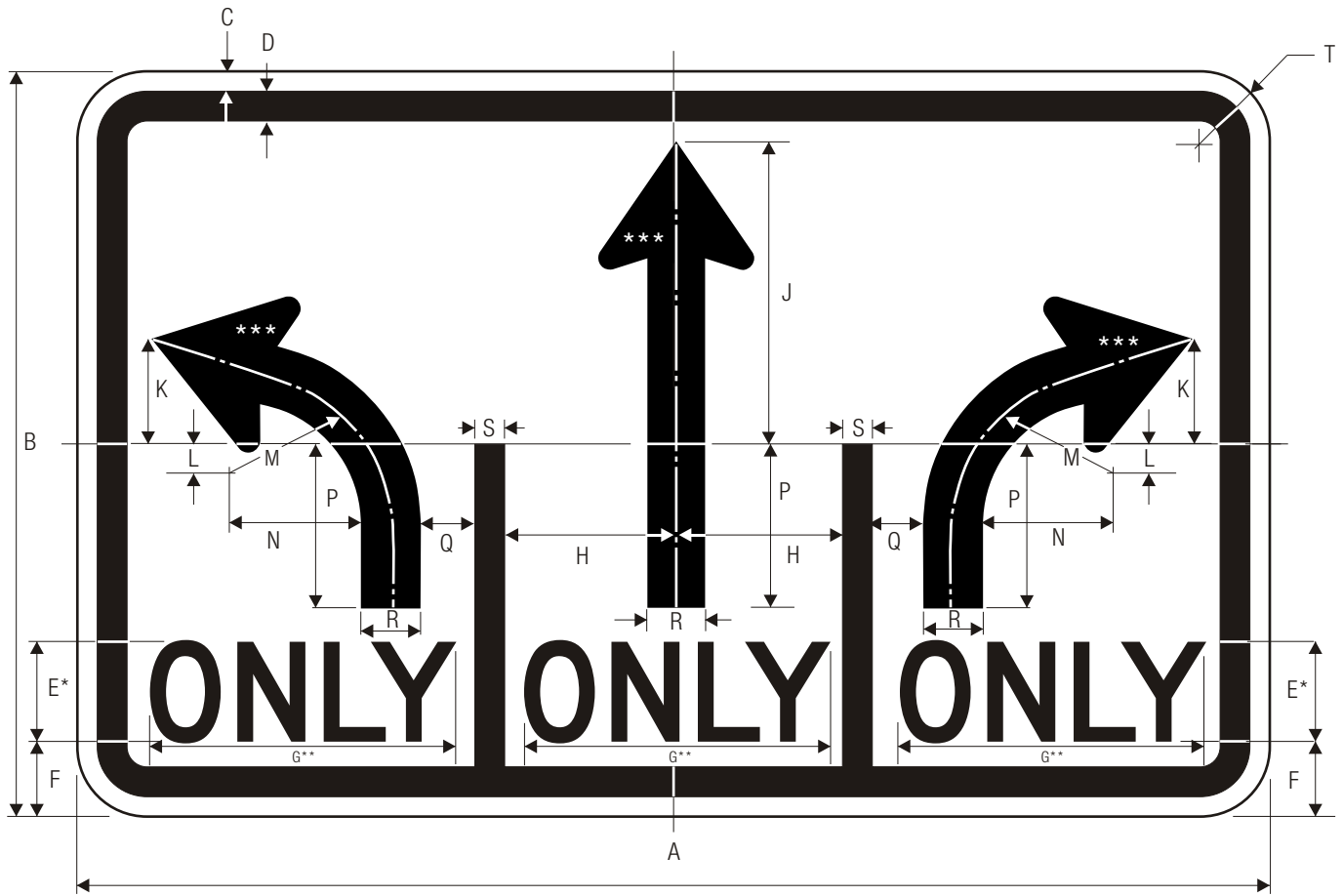

R3-8b

ADVANCE INTERSECTION LANE CONTROL

*Series 2000 Standard Alphabets.
 **Reduce spacing to fit and optically center legend.
 ***See page 6-2 for arrow design.

	A	B	C	D	E	F	G	H	J	K
C	48	30	.75	1.25	4 D	3	12.313	6.813	12.125	4
	60	36	.75	1.25	5 D	3.5	15.567	8.812	14.875	5.116
	L	M	N	P	Q	R	S	T		
	3.375	5.813	4.625	6.625	1.688	2.5	1.188	3		
	4.453	7.825	6.231	8.177	2.408	3	1.188	3		

COLORS: LEGEND — BLACK
 BACKGROUND — WHITE (RETROREFLECTIVE)

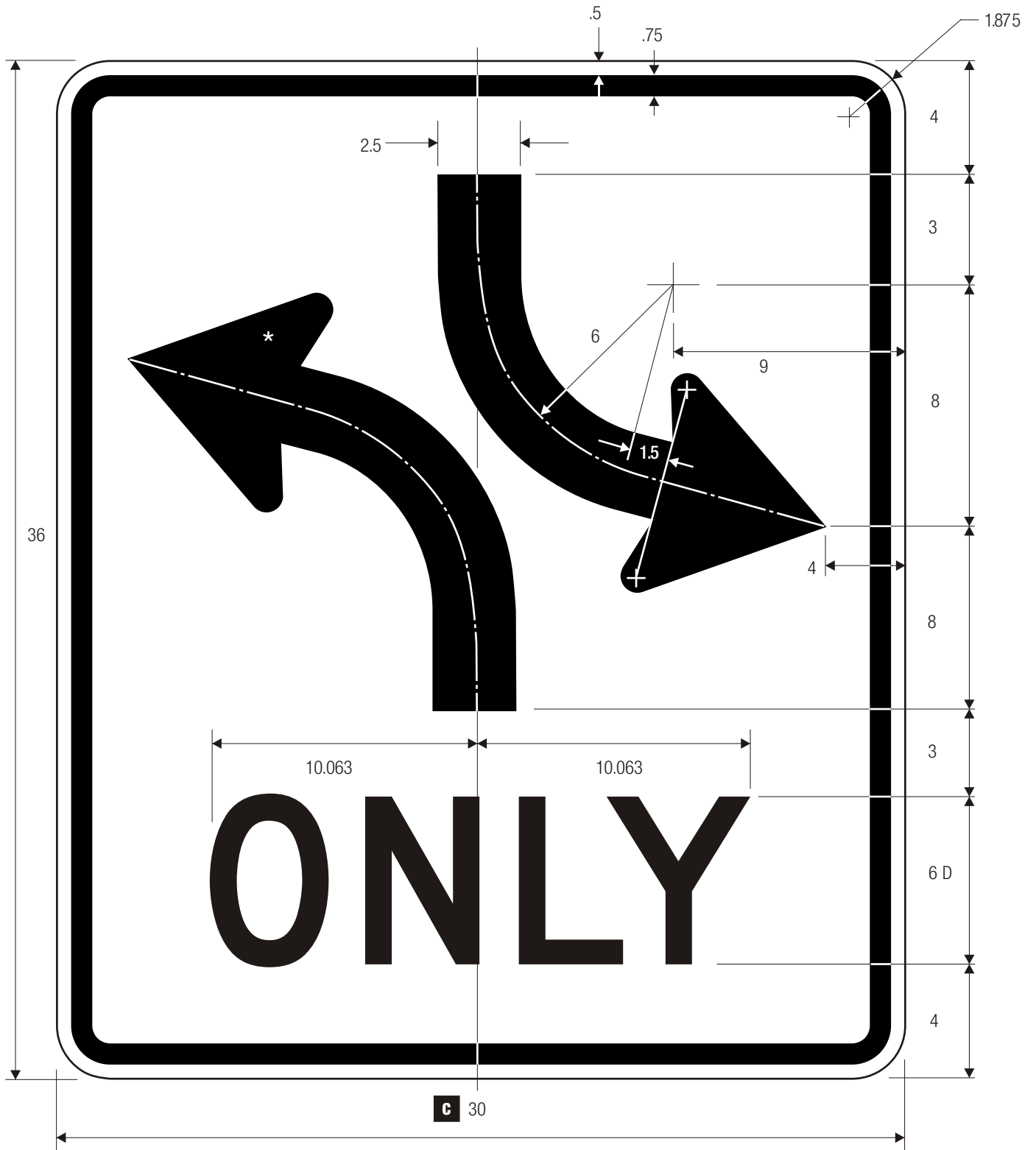

R3-9a

TWO-WAY LEFT TURN (OVERHEAD MOUNTED)

*See page 6-2 for arrow design

COLORS: LEGEND — BLACK
 BACKGROUND — WHITE (RETROREFLECTIVE)

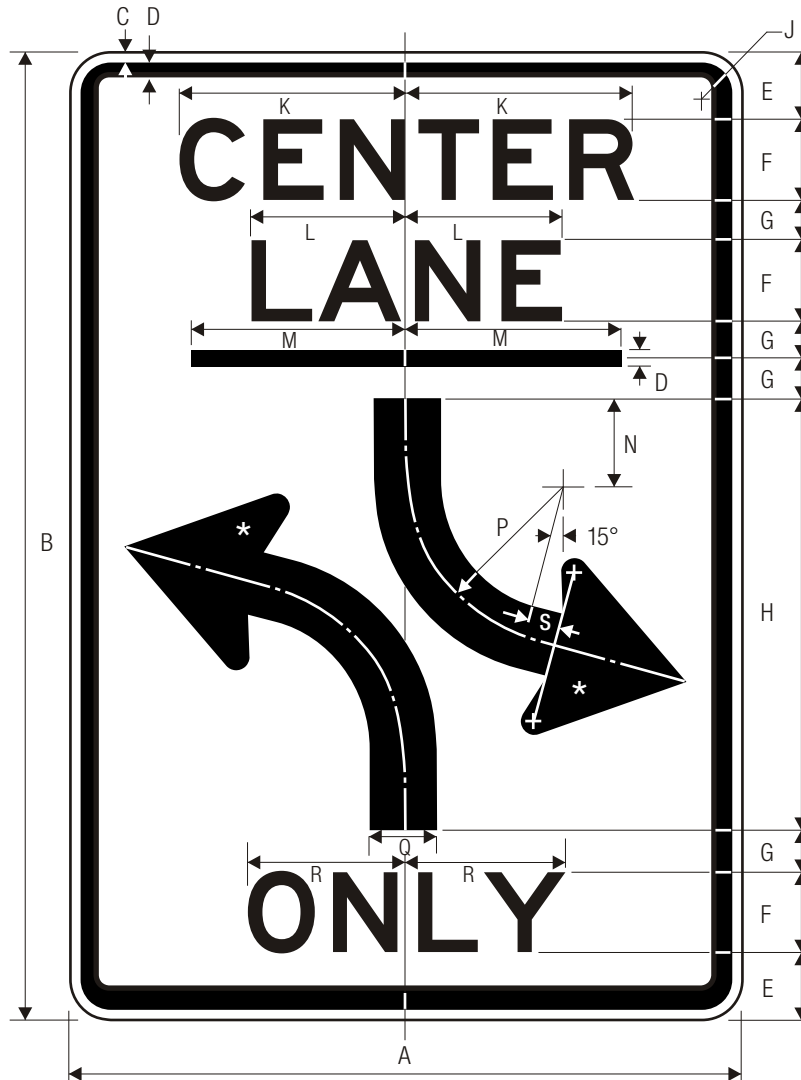

R3-9b

TWO WAY LEFT TURN ONLY (GROUND MOUNTED)

*See page 6-2 for arrow design.

C

A	B	C	D	E	F	G	H	J	K	L	M
24	36	.375	.625	2.5	3 E	1.5	16	1.5	8.438	5.75	8
36	48	.625	.875	3.5	5 E	1.5	20	2.25	14.063	9.5	12

N	P	Q	R	S
2.5	6	2	5.313	1.5
3	8	3	9.875	2

COLORS: LEGEND — BLACK
 BACKGROUND — WHITE (RETROREFLECTIVE)

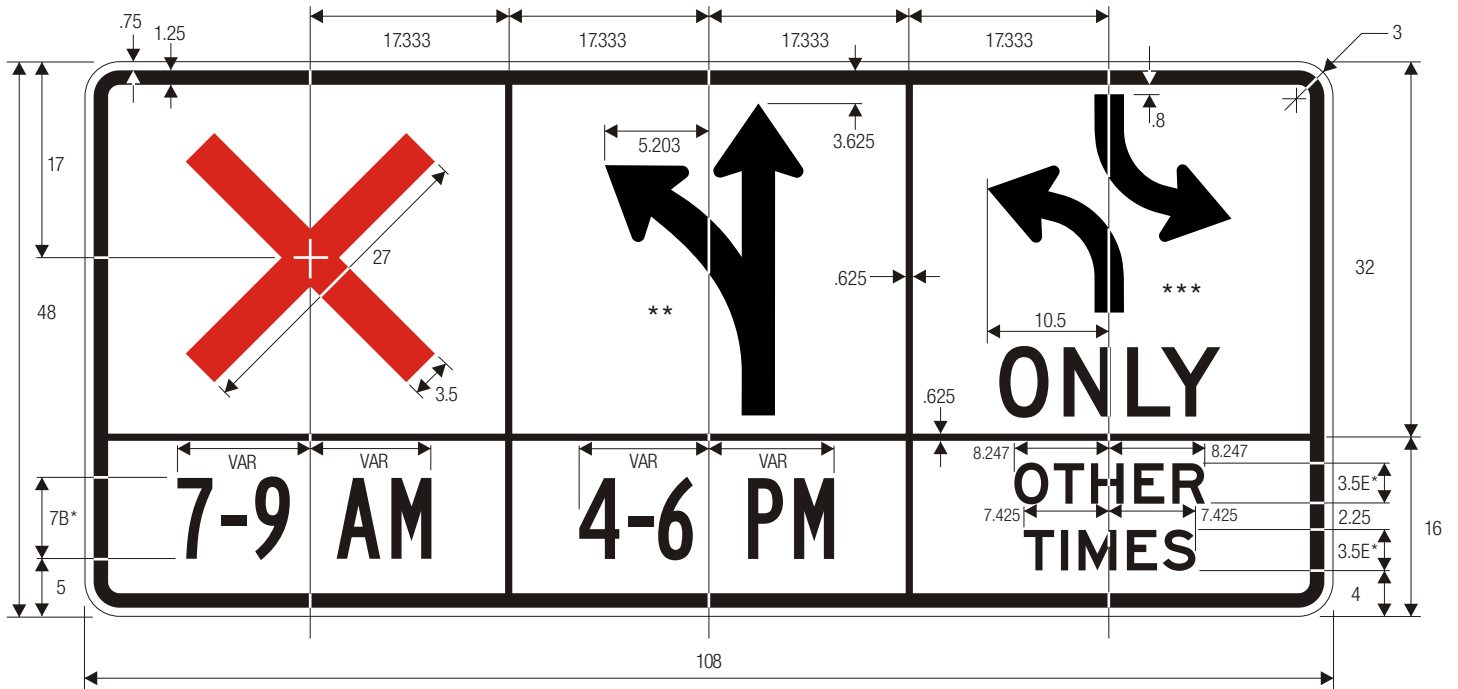

R3-9d

REVERSIBLE LANE CONTROL

*Series 2000 Standard Alphabets.
 **Insert R3-8a, increase 17% to fit.
 ***Insert R3-9a.

COLORS: LEGEND — BLACK
 SYMBOLS — BLACK
 EXCLUSION — RED (RETROREFLECTIVE)
 BACKGROUND — WHITE (RETROREFLECTIVE)



*Series 2000 Standard Alphabets.

TOP
COLORS: LEGEND — WHITE (RETROREFLECTIVE)
BACKGROUND — BLACK

BOTTOM
COLORS: LEGEND — BLACK
BACKGROUND — WHITE (RETROREFLECTIVE)

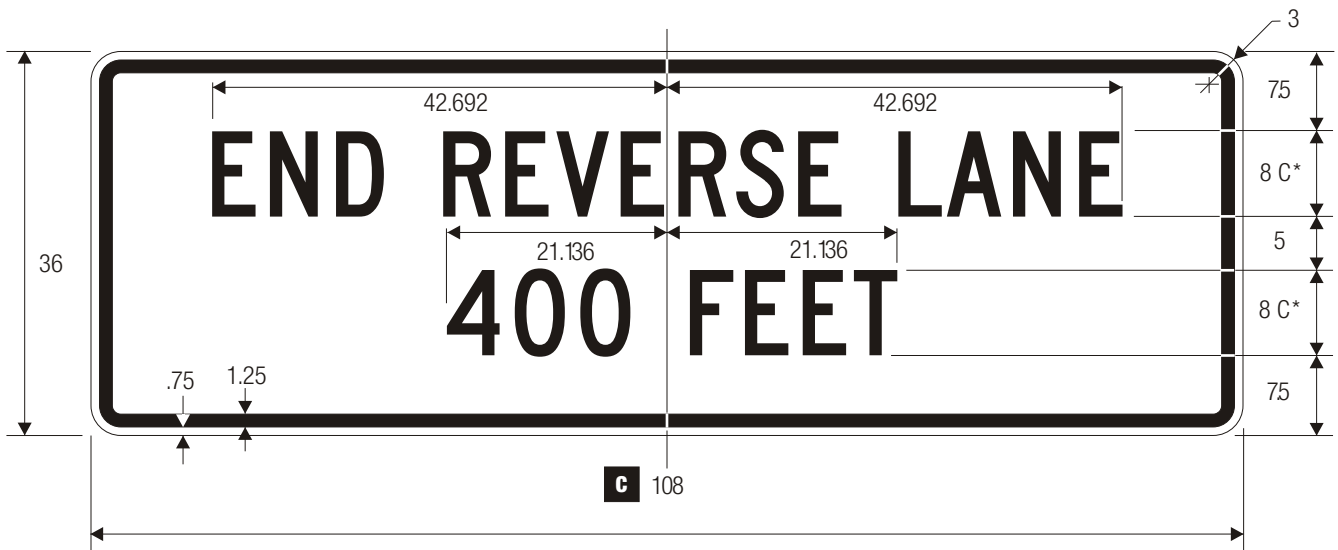

R3-9g

ADVANCE REVERSIBLE LANE CONTROL TRANSITION

* Series 2000 Standard Alphabets.

COLORS: LEGEND — BLACK
 BACKGROUND — WHITE (RETROREFLECTIVE)



*Series 2000 Standard Alphabets.

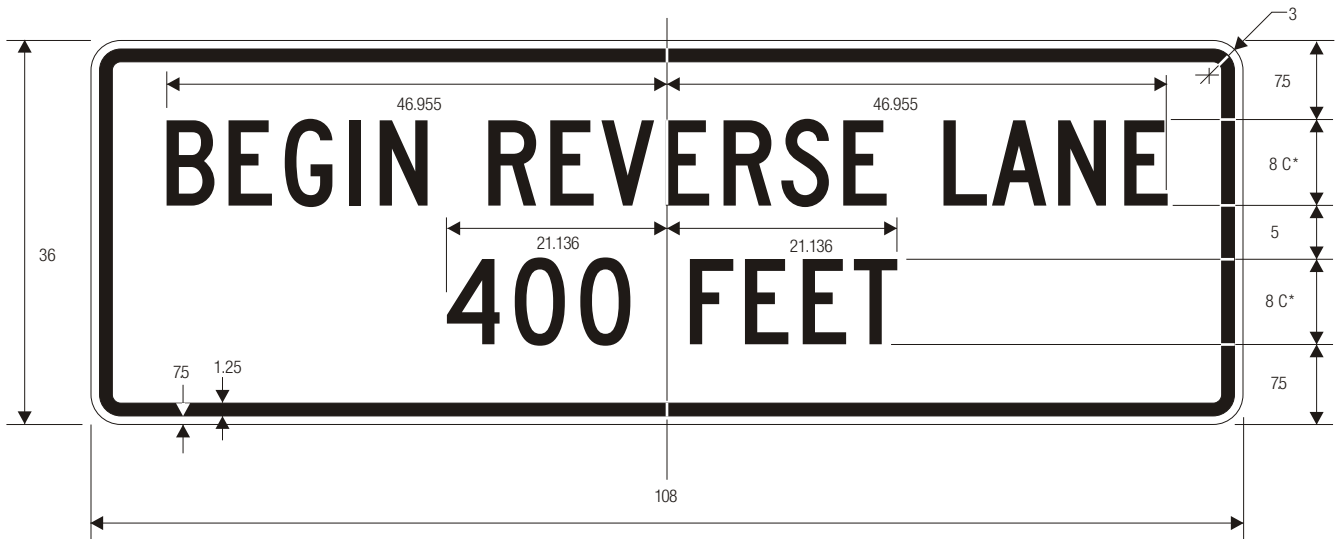

R3-9h

ADVANCE REVERSIBLE LANE CONTROL TRANSITION

COLORS: LEGEND — BLACK
 BACKGROUND — WHITE (RETROREFLECTIVE)

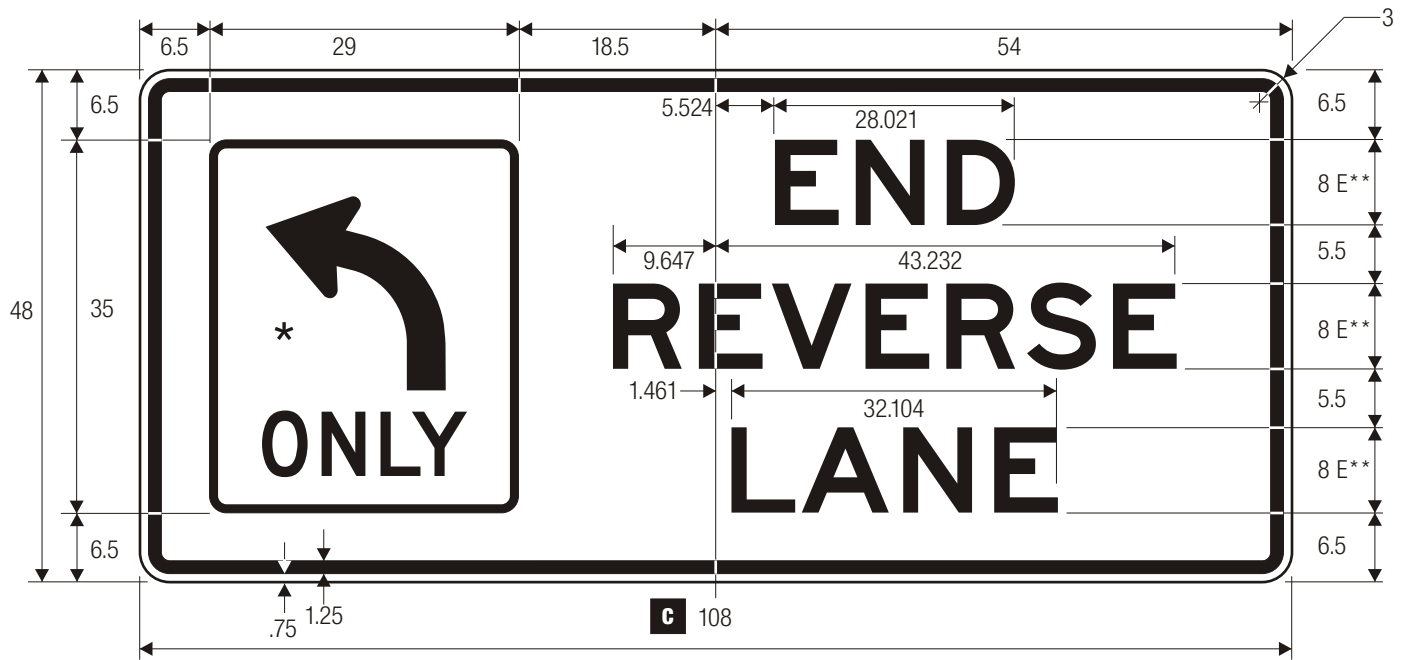

R3-9i
END REVERSE LANE

*Insert R3-5.
**Series 2000 Standard Alphabets.

COLORS: LEGEND — BLACK
BACKGROUND — WHITE (RETROREFLECTIVE)

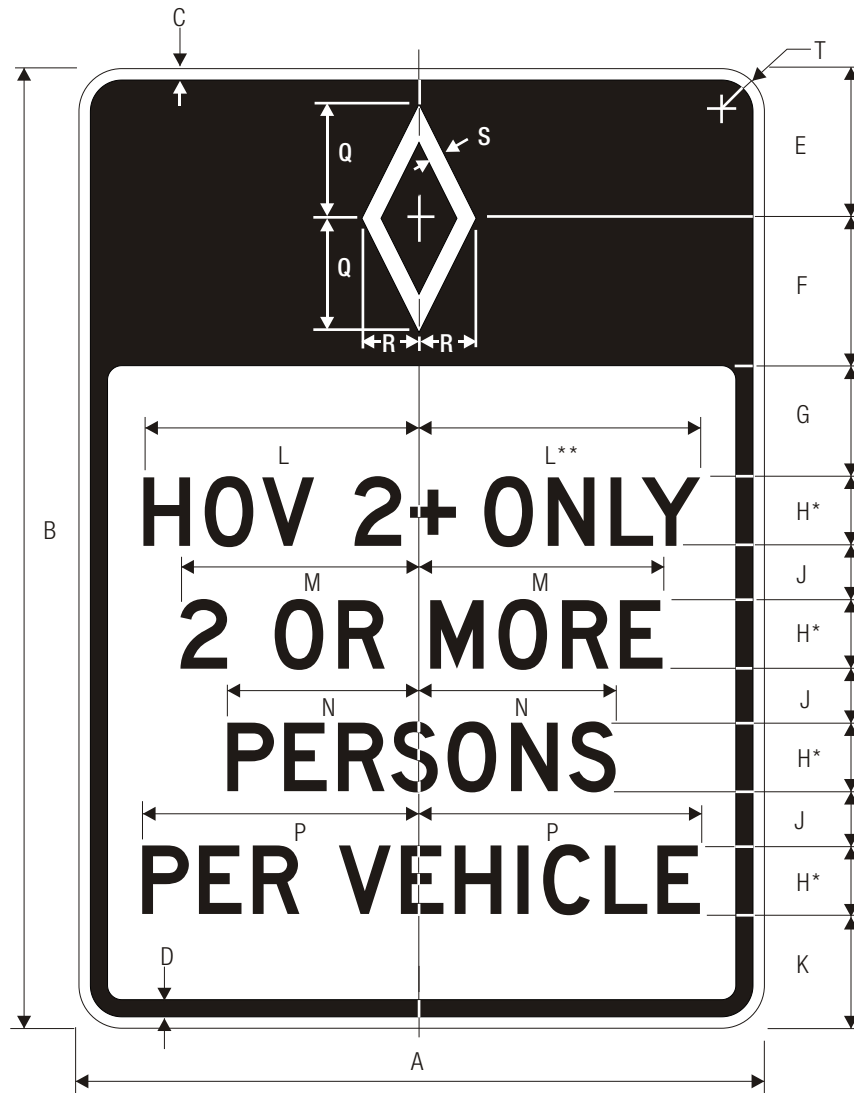

R3-10

PREFERENTIAL ONLY LANE AHEAD (GROUND MOUNTED)

*Series 2000 Standard Alphabets.
 **Reduce spacing to fit.

C

A	B	C	D	E	F	G	H	J	K	L	M
30	42	.5	.75	6.75	6.25	4.875	3 D	2.375	5	12.189	10.548
36	60	.625	.875	9.375	8.625	8.75	3.5 D	3.5	8.75	14.707	12.307
78	96	1	1.25	15.5	14.5	8	8 D	6	8	33.466	28.122

N	P	Q	R	S	T
8.506	12.209	5	2.5	.75	1.875
9.913	14.240	7	3.5	1	2.25
22.652	32.541	12.5	6.25	1.625	3

TOP
 COLORS: SYMBOL – WHITE (RETROREFLECTIVE)
 BACKGROUND – BLACK

BOTTOM
 COLORS: LEGEND – BLACK
 BACKGROUND – WHITE (RETROREFLECTIVE)

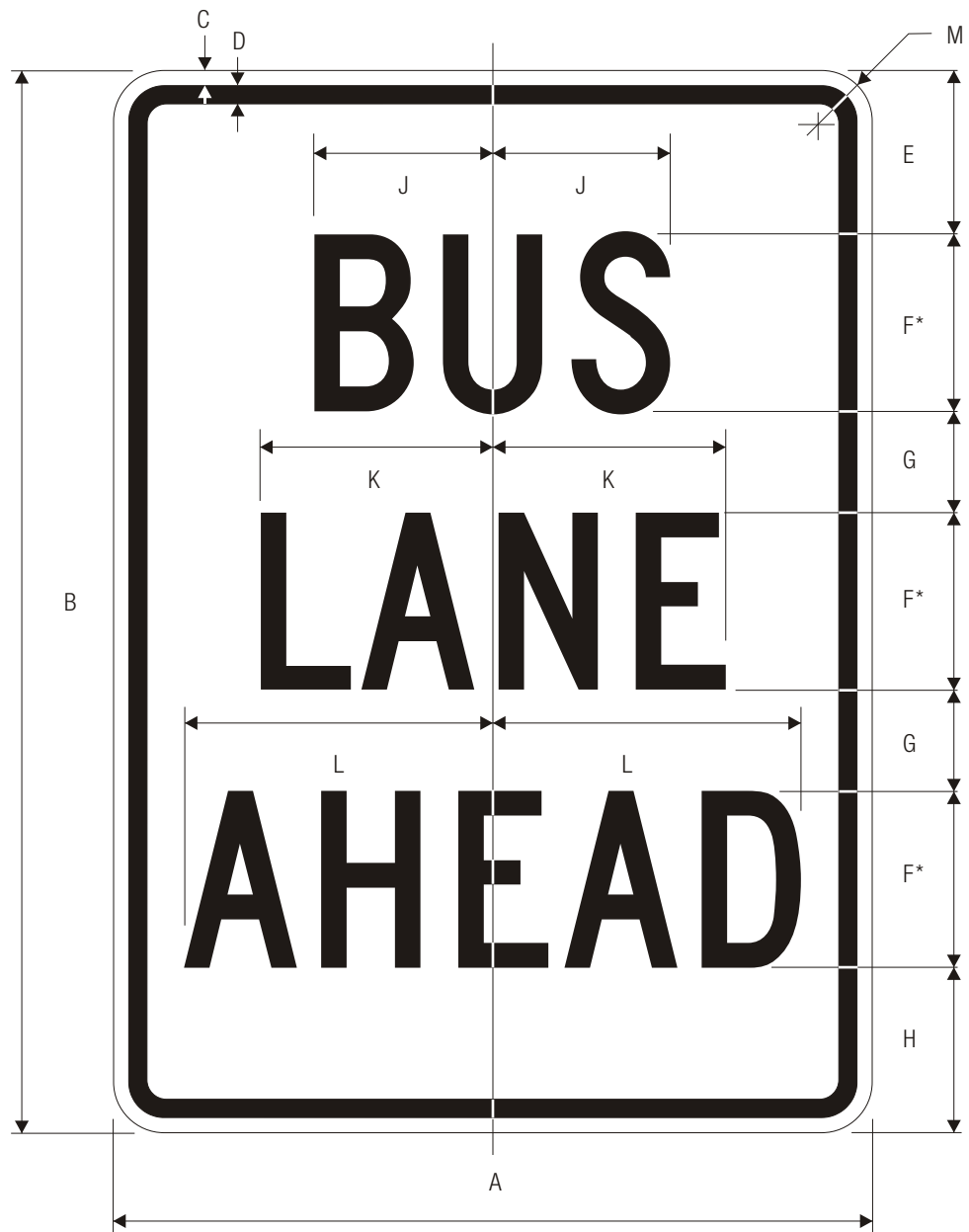

R3-10a

PREFERENTIAL ONLY LANE AHEAD (GROUND MOUNTED)

*Series 2000 Standard Alphabets.

C	A	B	C	D	E	F	G	H	J	K	L	M
	30	42	.5	.75	6.5	7 C	4	6.5	7.045	9.206	12.209	1.875
	36	60	.625	.875	10	8 C	8	10	8.038	10.5	13.944	2.25
	78	96	1	1.25	13	16 C	11	13	16.075	21.013	27.886	3

COLORS: LEGEND — BLACK
 BACKGROUND— WHITE (RETROREFLECTIVE)

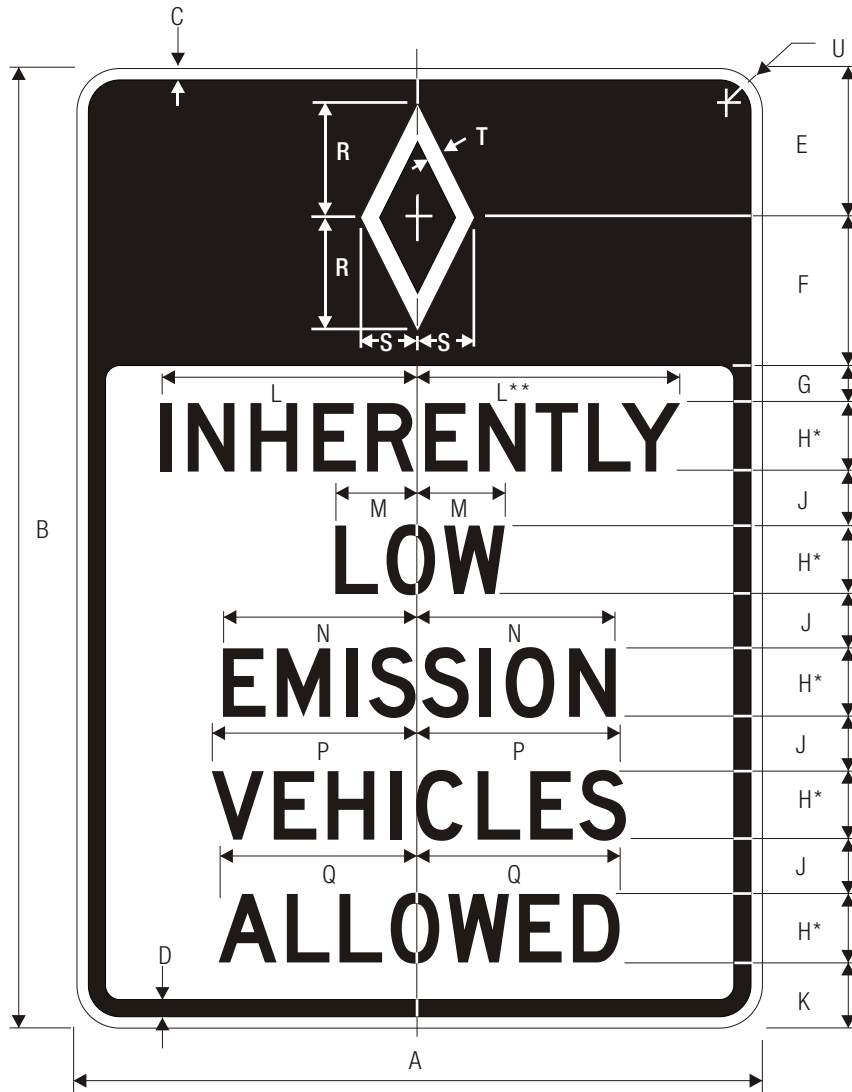

R3-10b

PREFERENTIAL ONLY LANE AHEAD (GROUND MOUNTED)

*Series 2000 Standard Alphabets.

**Reduce spacing to fit.

C

A	B	C	D	E	F	G	H	J	K	L	M
30	42	.5	.75	6.75	6.25	1.625	3 D	2.375	2.875	11.328	3.702
36	60	.625	.875	9.375	8.625	5	4 D	2.75	6	15.171	4.943
78	96	1	1.25	15.5	14.5	5.5	7 D	5	5.5	26.52	8.652

N	P	Q	R	S	T	U
8.606	9.066	8.786	5	2.5	.75	1.875
11.468	12.089	11.708	7	3.5	1	2.25
20	21.144	20.469	12.5	6.25	1.625	3

TOP
 COLORS: SYMBOL — WHITE (RETROREFLECTIVE)
 BACKGROUND — BLACK

BOTTOM
 COLORS: LEGEND — BLACK
 BACKGROUND — WHITE (RETROREFLECTIVE)

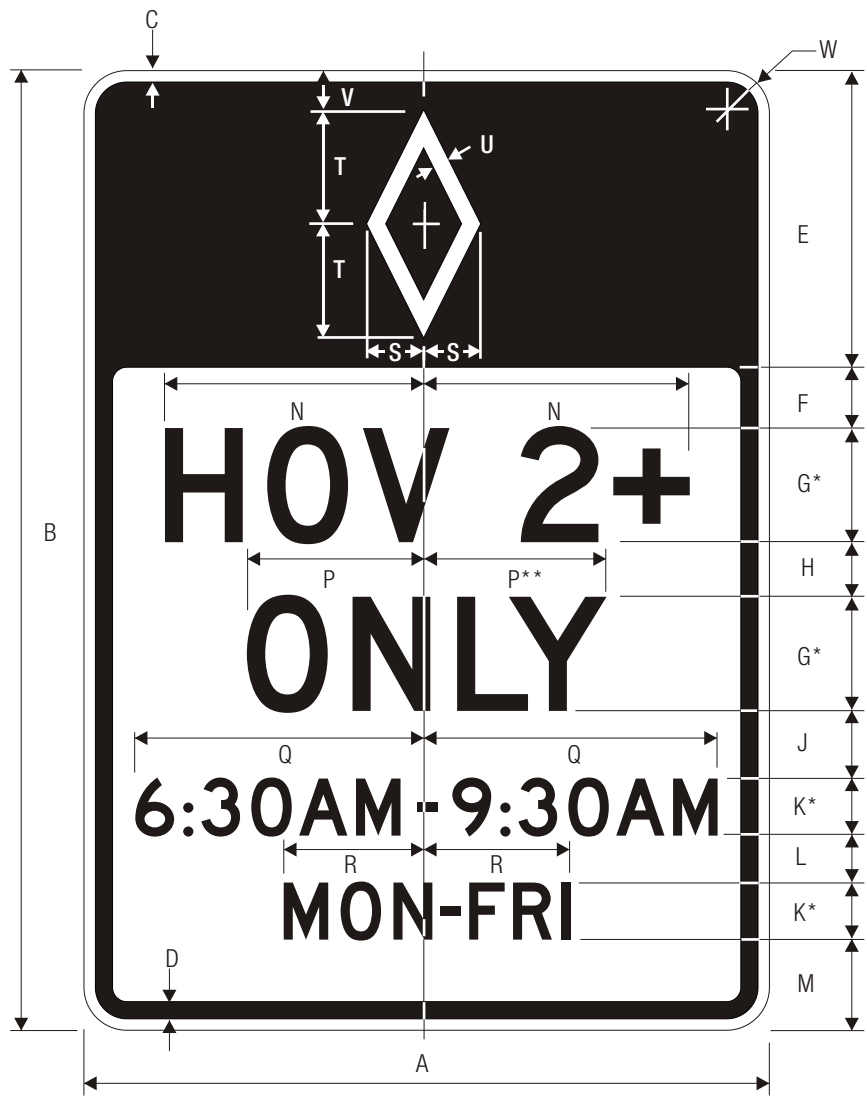

R3-11
PREFERENTIAL ONLY LANE OPERATION

*Series 2000 Standard Alphabets.
 **Reduce spacing to fit.

C

A	B	C	D	E	F	G	H	J	K	L	M
30	42	.5	.75	13	2.625	5 D	2.375	3	2.5 D	2	4
54	84	.75	1.25	26	7	8.5 D	5	7	4.5 D	5	8
78	96	1	1.25	26	6	12 D	7	8	6 D	6	7

N	P	Q	R	S	T	U	V	W
11.5	7.873	12.75	6.277	2.5	5	.75	1.7	1.875
19.5	13.681	23	11.299	5	10	1.5	3.375	3
27.576	19.236	31	15.064	5	10	1.5	3.5	3

TOP
 COLORS: LEGEND — WHITE (RETROREFLECTIVE)
 BACKGROUND — BLACK

BOTTOM
 COLORS: LEGEND — BLACK
 BACKGROUND — WHITE (RETROREFLECTIVE)

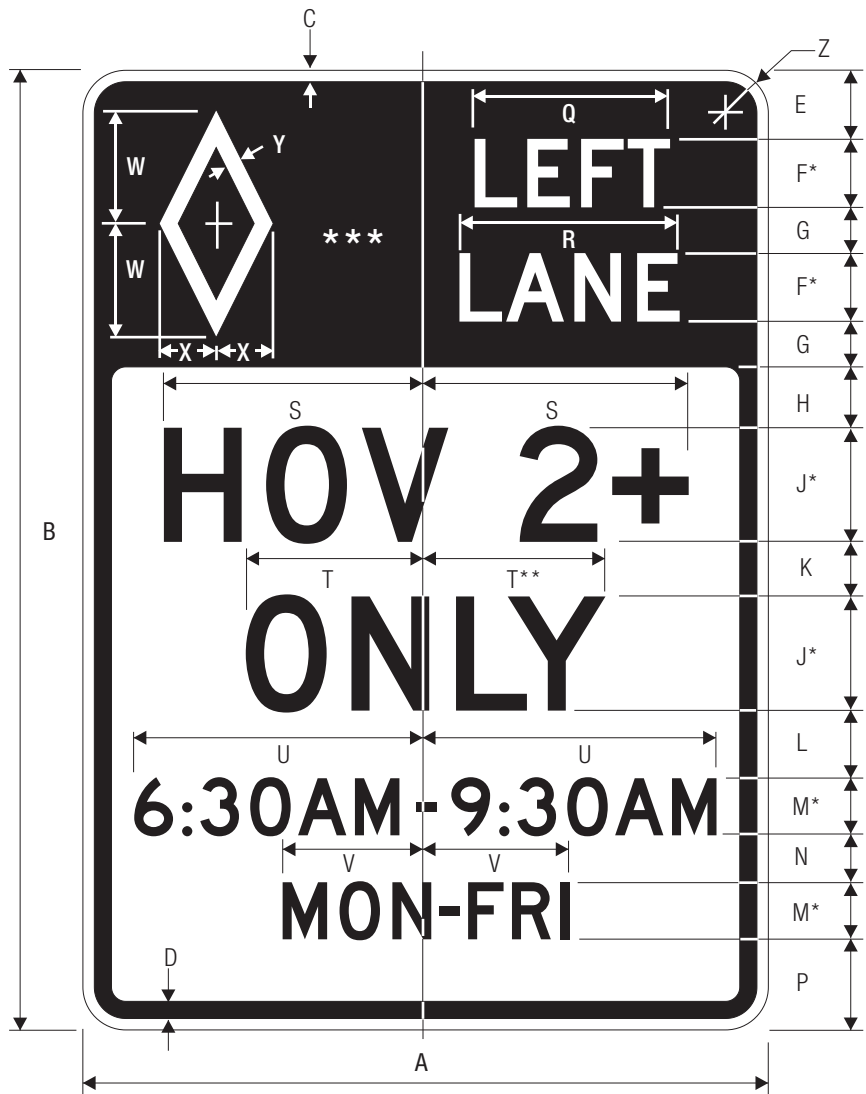
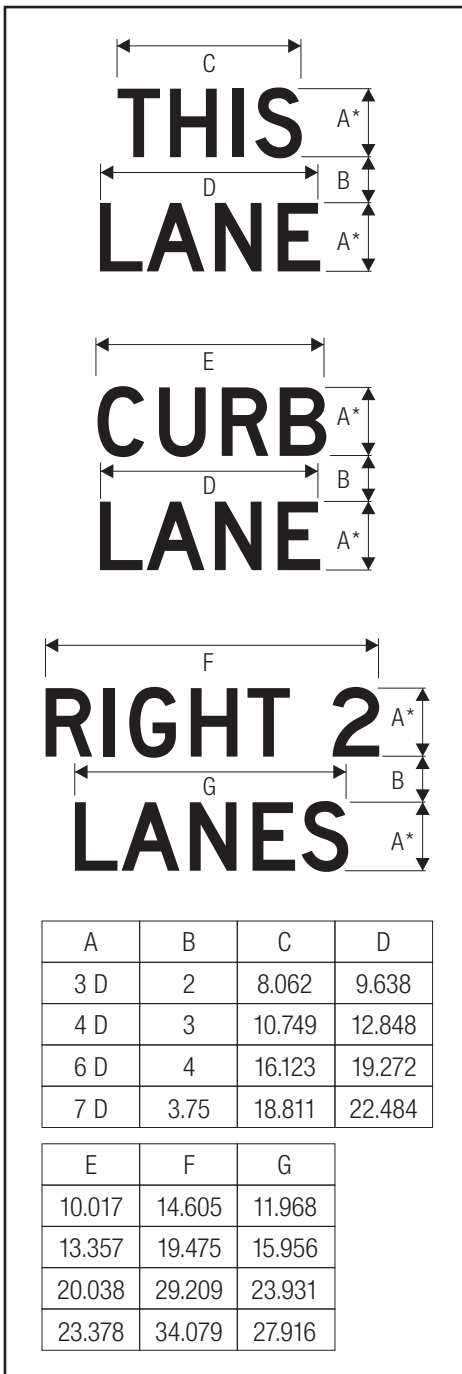

R3-11a

PREFERENTIAL ONLY LANE OPERATION (GROUND MOUNTED)

- *Series 2000 Standard Alphabets.
- **Reduce spacing to fit.
- ***Optically locate symbol and top legend.

C	A	B	C	D	E	F	G	H	J	K	L	M
	30	42	.5	.75	3	3 D	2	2.625	5 D	2.375	3	2.5 D
	42	60	.625	.875	4	4 D	3	4	7 D	4	5	3.5 D
	54	84	.75	1.25	6	6 D	4	7	8.5 D	5	7	4.5 D
	78	96	1	1.25	4.5	7 D	3.75	6	12 D	7	8	6 D
	N	P	Q	R	S	T	U	V	W	X	Y	Z
	2	4	8.554	9.638	11.5	7.873	12.75	6.277	5	2.5	.75	1.875
	3	5	11.403	12.848	16	11.022	18	8.787	7	3.5	1	2.25
	5	8	17.105	19.272	19.5	13.681	23	11.299	10	5	1.5	3
	6	7	19.955	22.484	27.576	19.236	31	15.064	10	5	1.5	3

TOP
 COLORS: LEGEND — WHITE (RETROREFLECTIVE)
 BACKGROUND — BLACK

BOTTOM
 COLORS: LEGEND — BLACK
 BACKGROUND — WHITE (RETROREFLECTIVE)



R3-11b

PREFERENTIAL ONLY LANE OPERATION (GROUND MOUNTED)

*Series 2000 Standard Alphabets.
 **Reduce spacing to fit.

A	B	C	D	E	F	G	H	J	K	L	M
30	42	.5	.75	3	3 D	2	2.625	5 D	2.375	3	2.5 D
78	96	1	1.25	4.5	7 D	3.75	6	12 D	7	8	6 D

N	P	Q	R	S	T	U	V	W
2	4	5.345	4.819	9.828	7.873	7.728	6.277	1.875
6	7	12.469	11.242	23.584	19.236	18.441	15.064	3

TOP
 COLORS: LEGEND — WHITE (RETROREFLECTIVE)
 BACKGROUND — BLACK

BOTTOM
 COLORS: LEGEND — BLACK
 BACKGROUND — WHITE (RETROREFLECTIVE)

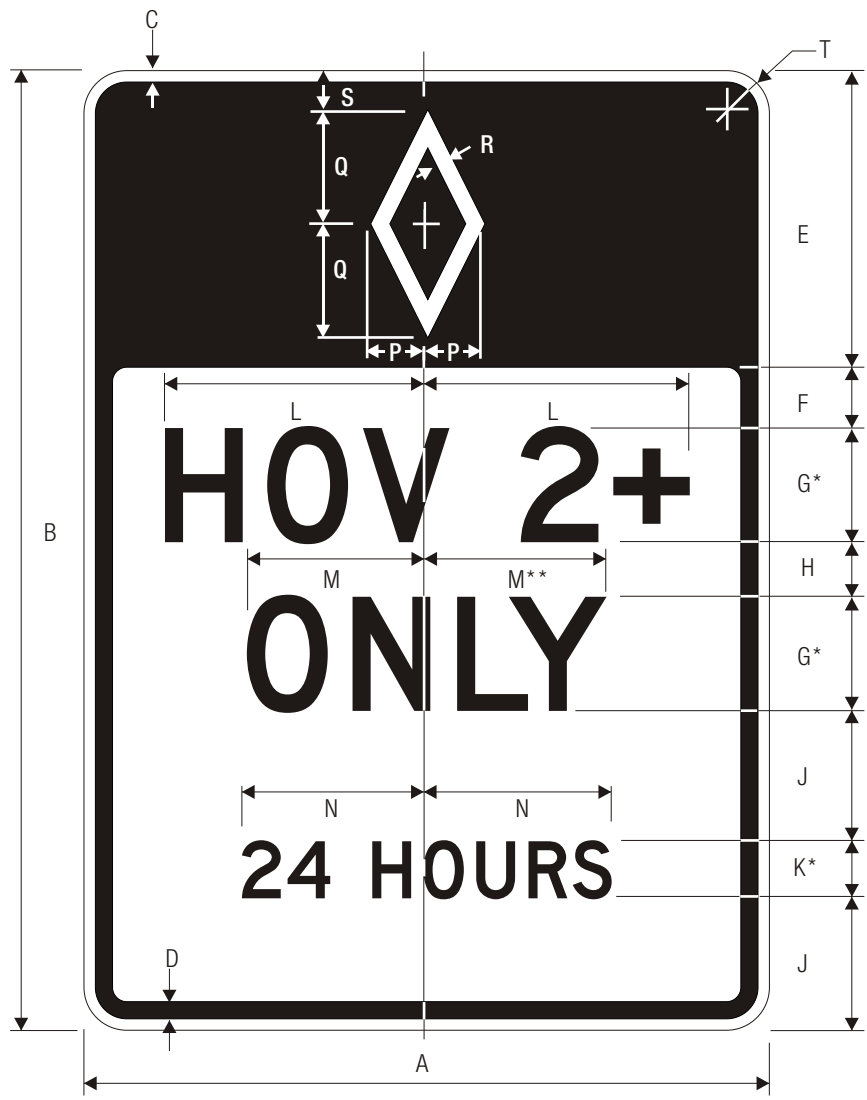

R3-11c

PREFERENTIAL ONLY LANE OPERATION (GROUND MOUNTED)

*Series 2000 Standard Alphabets.
 **Reduce spacing to fit.

A	B	C	D	E	F	G	H	J	K	L	M
30	42	.5	.75	13	2.625	5 D	2.375	5.75	2.5 D	11.5	7.873
78	96	1	1.25	26	6	12 D	7	13.5	6 D	27.575	19.236

N	P	Q	R	S	T
8.092	2.5	5	.75	1.7	1.875
19.419	5	10	1.5	3.5	3

TOP
 COLORS: LEGEND – WHITE (RETROREFLECTIVE)
 BACKGROUND – BLACK

BOTTOM
 COLORS: LEGEND – BLACK
 BACKGROUND – WHITE (RETROREFLECTIVE)

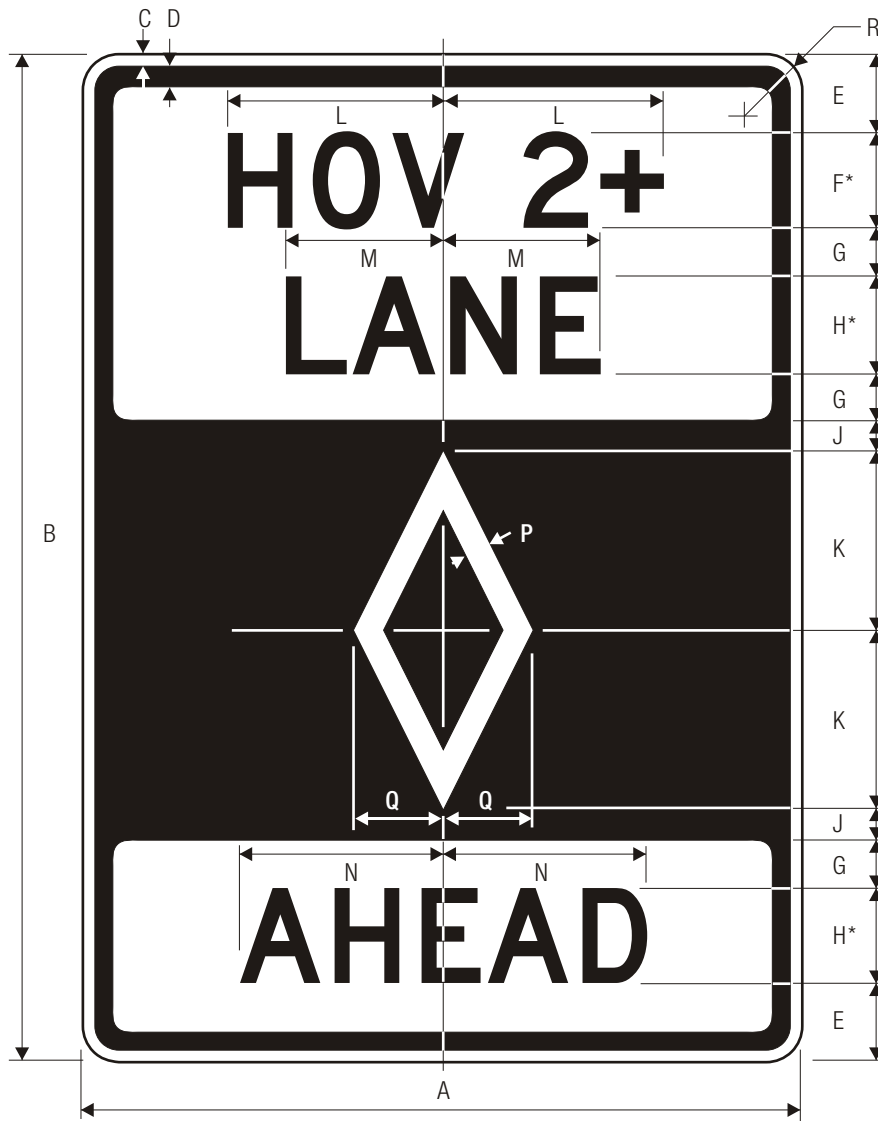

R3-12

PREFERENTIAL ONLY LANE ENDS (GROUND MOUNTED)

*Series 2000 Standard Alphabets.

C

A	B	C	D	E	F	G	H	J	K	L	M
30	42	.5	.75	3	4 D	2	4 D	1.5	7.5	9.187	6.424
36	60	.625	.875	4	6 D	3	6 D	2.5	10	13.781	9.636
48	84	.75	1.25	5	8 D	4	8 D	4	15	18.374	12.848

N	P	Q	R
8.57	1.125	3.75	1.875
12.855	1.5	5	2.25
17.14	2.25	7.5	3

COLORS: LEGEND — BLACK
 SYMBOL — WHITE (RETROREFLECTIVE) ON BLACK
 BACKGROUND — WHITE (RETROREFLECTIVE)

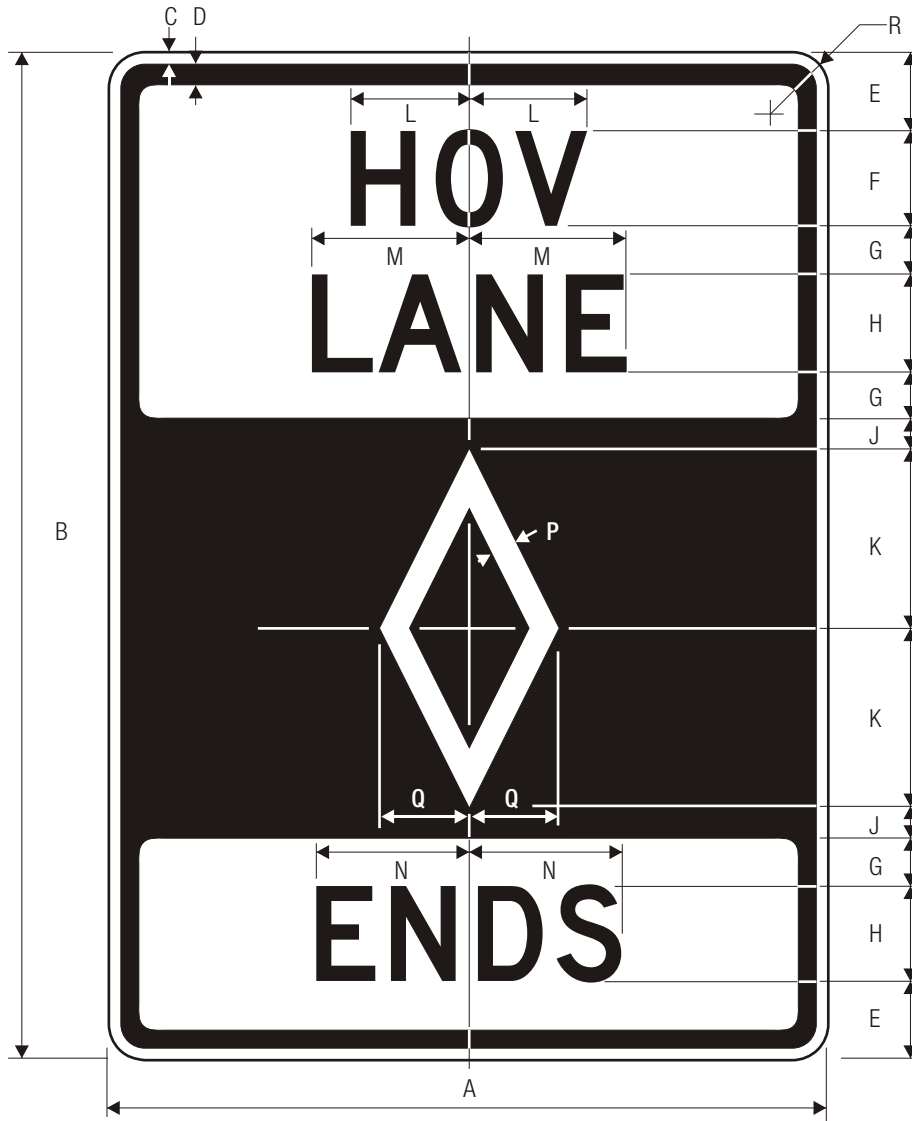

R3-12a

PREFERENTIAL ONLY LANE ENDS (GROUND MOUNTED)

*Series 2000 Standard Alphabets.

C

A	B	C	D	E	F	G	H	J	K	L	M
30	42	.5	.75	3	4 D	2	4 D	1.5	7.5	4.979	6.424
36	60	.625	.875	4	6 D	3	6 D	2.5	10	7.469	9.636
48	84	.75	1.25	5	8 D	4	8 D	4	15	9.958	12.848

N	P	Q	R
6.424	1.125	3.75	1.875
9.636	1.5	5	2.25
12.848	2.25	7.5	3

COLORS: LEGEND — BLACK
 SYMBOL — WHITE (RETROREFLECTIVE) ON BLACK
 BACKGROUND — WHITE (RETROREFLECTIVE)

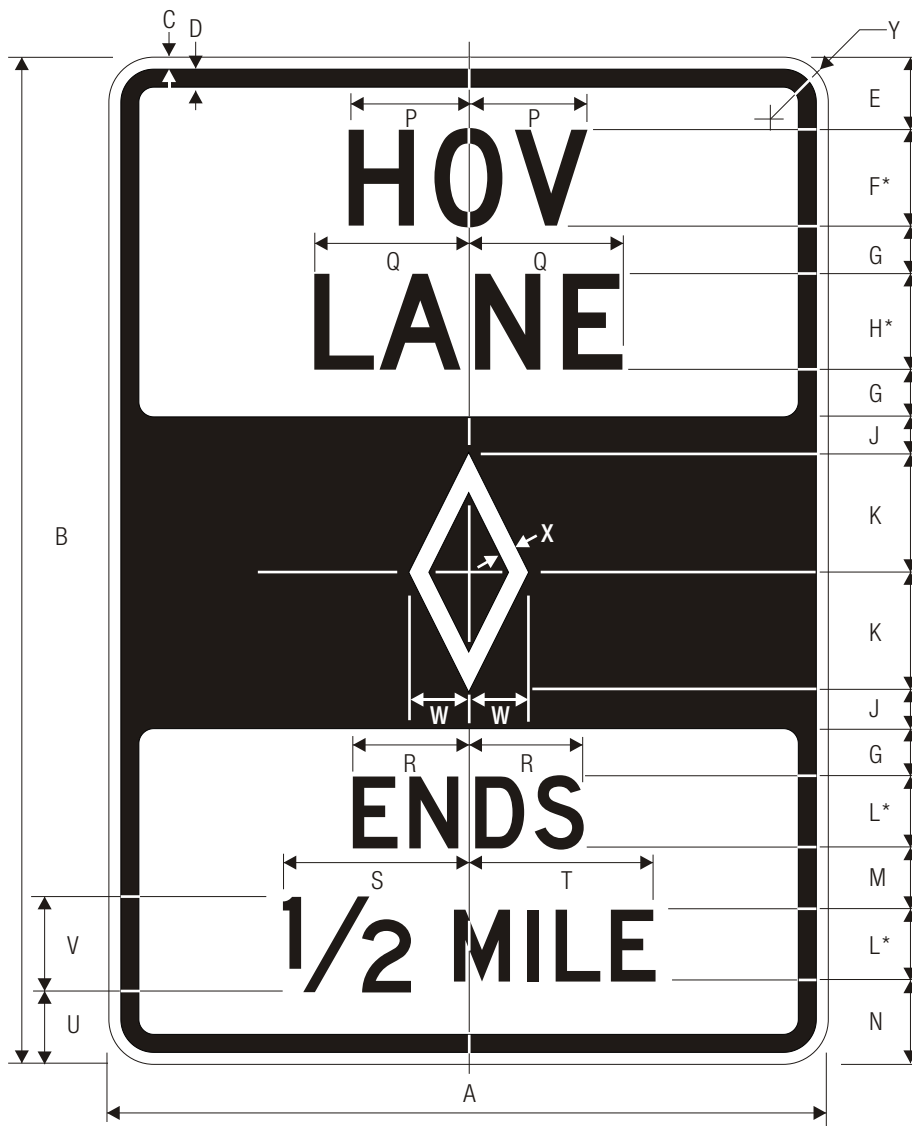

R3-12b

PREFERENTIAL ONLY LANE ENDS (GROUND MOUNTED)

*Series 2000 Standard Alphabets.

C

A	B	C	D	E	F	G	H	J	K	L	M
30	42	.5	.75	3	4 D	2	4 D	1.5	5	3 D	2.5
36	60	.625	.875	4	6 D	3	6 D	1.5	7	5 D	3.5
48	84	.75	1.25	5	8 D	4	8 D	2	11	7 D	5

N	P	Q	R	S	T	U	V	W	X	Y
3.5	4.979	6.424	4.813	7.75	7.813	3	4	2.5	.75	1.875
4.5	7.469	9.636	8.022	13	12.75	3.5	7	3.5	1	2.25
6	9.958	12.848	11.231	18	17.875	5	9	5.5	1.75	3

COLORS: LEGEND — BLACK
 SYMBOL — WHITE (RETROREFLECTIVE) ON BLACK
 BACKGROUND — WHITE (RETROREFLECTIVE)

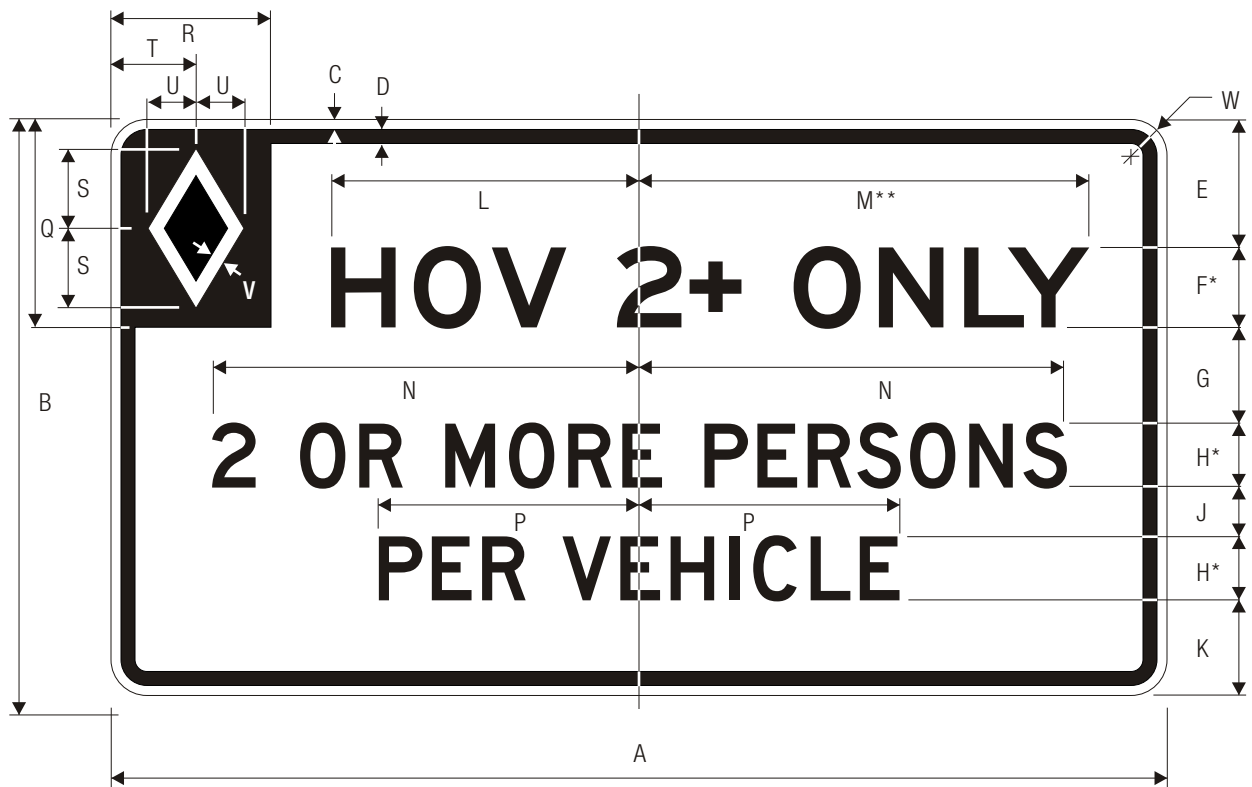

R3-13

PREFERENTIAL ONLY LANE AHEAD (OVERHEAD)

*Series 2000 Standard Alphabets.

**Reduce spacing to fit.

	A	B	C	D	E	F	G	H	J	K	L	M
C	66	36	.625	.875	8	5 E	6	4 D	3	6	19.245	28.143
	84	48	.75	1.25	11	6 E	7	5 D	4	10	22.705	33.959
	144	78	1.5	2	19	10 E	11	9 D	8	12	39.171	55.266

N	P	Q	R	S	T	U	V	W
26.705	16.270	13	10	5	5.375	3	.875	2.25
33.404	20.346	17	13	6.5	6.875	4	1	3
60.1	36.606	29	21	11	11.25	7	2	6

COLORS: LEGEND – BLACK
 BACKGROUND – WHITE (RETROREFLECTIVE)
 SYMBOL – WHITE (RETROREFLECTIVE) ON BLACK

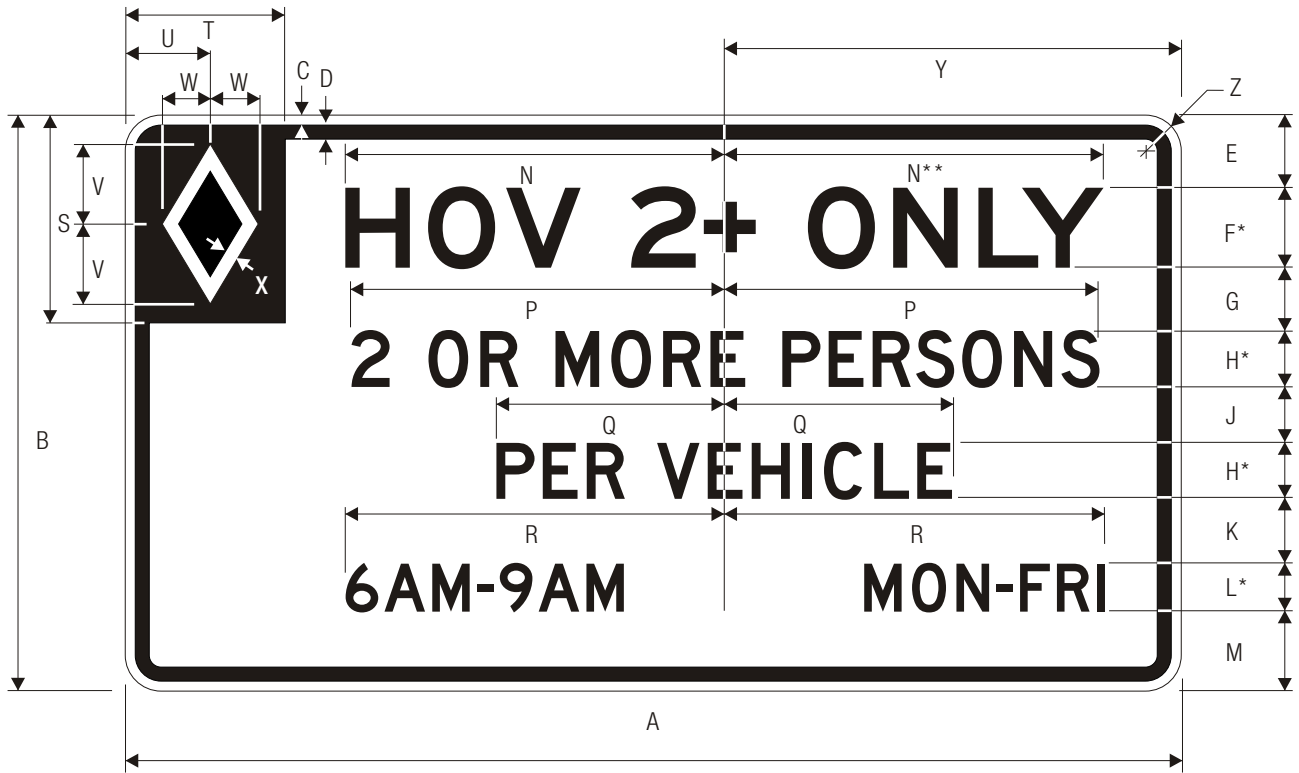

R3-13a

PREFERENTIAL ONLY LANE AHEAD (OVERHEAD)

*Series 2000 Standard Alphabets.
 **Reduce spacing to fit.

	A	B	C	D	E	F	G	H	J	K	L	M
C	66	36	.625	.875	4.5	5 E	4	3.5 D	3.5	4	3 D	5
	84	48	.75	1.25	7	6 E	5	4.5 D	4.5	5	4 D	7.5
	144	78	1.5	2	10	10 E	8.5	8 D	8	8.5	7 D	10
	N	P	Q	R	S	T	U	V	W	X	Y	Z
	23.694	23.363	14.235	23.694	13	10	5.375	5	3	.875	28.5	2.25
	28.332	30.058	18.308	28.332	17	13	6.875	6.5	4	1	36.403	3
	47.218	53.426	32.541	47.218	29	21	11.25	11	7	2	64	6

COLORS: LEGEND – BLACK
 BACKGROUND – WHITE (RETROREFLECTIVE)
 SYMBOL – WHITE (RETROREFLECTIVE) ON BLACK



R3-14

PREFERENTIAL ONLY LANE OPERATION (OVERHEAD)

*Series 2000 Standard Alphabets.
**Reduce spacing to fit.

***See page 6-3 for design.

	A	B	C	D	E	F	G	H	J	K	L	M	N
C	72	60	1	1.25	14	8 E	4	4	5 D	4	9.5	3.5	15.785
	96	72	1.25	1.5	15	9 E	6	6	7 D	6	10	4	17.819
	144	106	1.5	2	18	16 E	9	9.5	9 D	5	18	5.5	31.75

	P	Q	R	S	T	U	V	W	X	Y
	25.261	11.239	18.613	31	11	4	7.625	1	22	3
	28.356	11.871	21.395	43	15	5	10	1.5	30	4
	50.345	21.5	38.205	64	22	8	15	2	40	6

COLORS: LEGEND – BLACK
 BACKGROUND – WHITE (RETROREFLECTIVE)
 SYMBOL – WHITE (RETROREFLECTIVE ON BLACK)



R3-14a

PREFERENTIAL ONLY LANE OPERATION (OVERHEAD)

***See page 6-3 for design.

*Series 2000 Standard Alphabets.

**Reduce spacing to fit.

C

A	B	C	D	E	F	G	H	J	K	L	M	N
72	60	1	1.25	6	8 E	4	6	5 D	3	2	9.5	3.5
96	72	1.25	1.5	6	9 E	6	6	7 D	5	3	10	4
144	106	1.5	2	10	14 E	8	10.5	9 D	7	6	13	5.5

O	P	Q	R	S	T	U	V	W	X	Y	Z
15.785	25.261	11.239	18.613	26	12.555	11	4	7.625	1	22	3
17.819	28.356	11.871	21.395	35.936	17.576	15	5	10	1.5	30	4
26.715	45.174	19.464	31.984	45.559	22.598	22	8	15	2	40	6

COLORS: LEGEND – BLACK
 BACKGROUND – WHITE (RETROREFLECTIVE)
 SYMBOL – WHITE (RETROREFLECTIVE ON BLACK)



R3-14b

PREFERENTIAL ONLY LANE OPERATION (OVERHEAD)

*Series 2000 Standard Alphabets.
 **Reduce spacing to fit.
 ***See page 6-3 for design.

	A	B	C	D	E	F	G	H	J	K	L	M
C	72	60	1	1.25	12	8 E	5	10	4 D	13	31	14.645
	96	72	1.25	1.5	14	10 E	7	10	6 D	15	41	18.305
	144	106	1.5	2	20	15 E	9	18	8 D	21	61.366	27.987

	N	P	Q	R
	31	8	5.375	3
	43	10	6.25	4
	62	15	9.25	6

COLORS: LEGEND — BLACK
 BACKGROUND — WHITE (RETROREFLECTIVE)

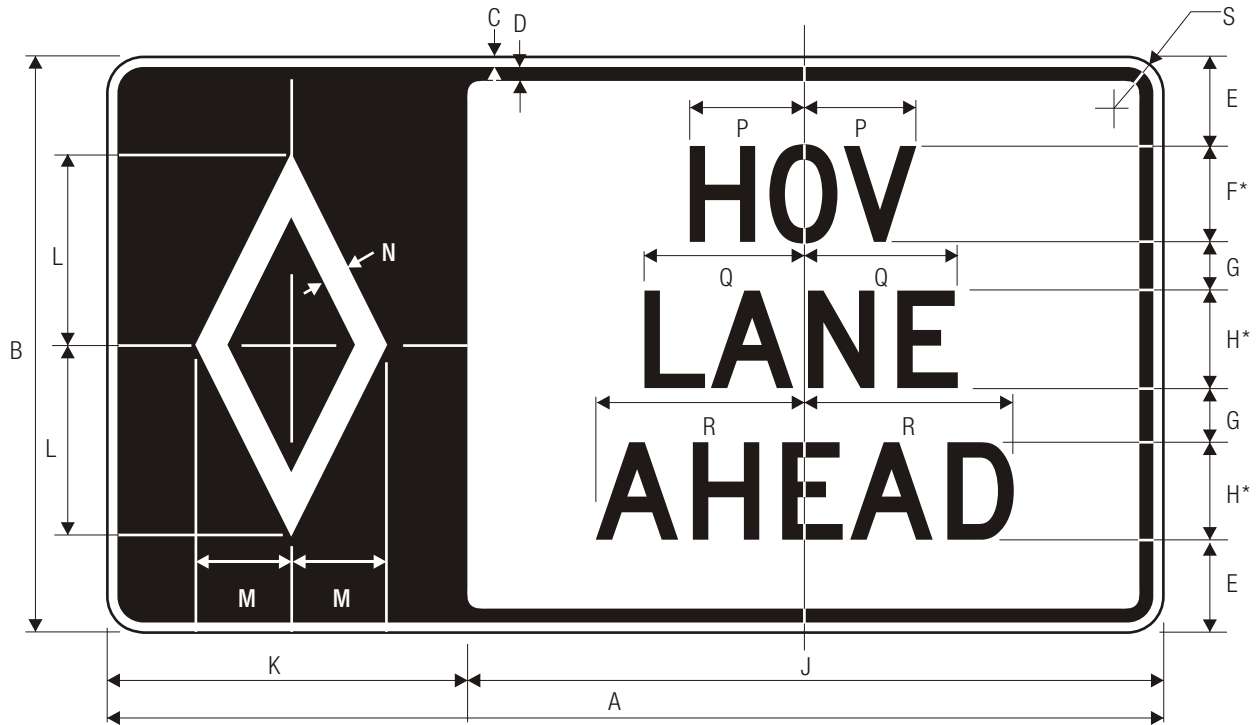

R3-15
HOV LANE AHEAD (OVERHEAD)

*Series 2000 Standard Alphabets.

C

A	B	C	D	E	F	G	H	J	K	L	M
66	36	.625	.875	6	6 D	3	6 D	42	24	12	6
84	48	.75	1.25	8	8 D	4	8 D	54	30	16	8
102	60	1	1.5	10	10 D	5	10 D	66	36	20	10

N	P	Q	R	S
1.75	7.465	9.687	12.949	2.25
2.25	9.967	12.929	17.253	3
2.75	12.449	16.092	21.476	3.75

COLORS: LEGEND – BLACK
 BACKGROUND – WHITE (RETROREFLECTIVE)
 SYMBOL – WHITE (RETROREFLECTIVE) ON BLACK

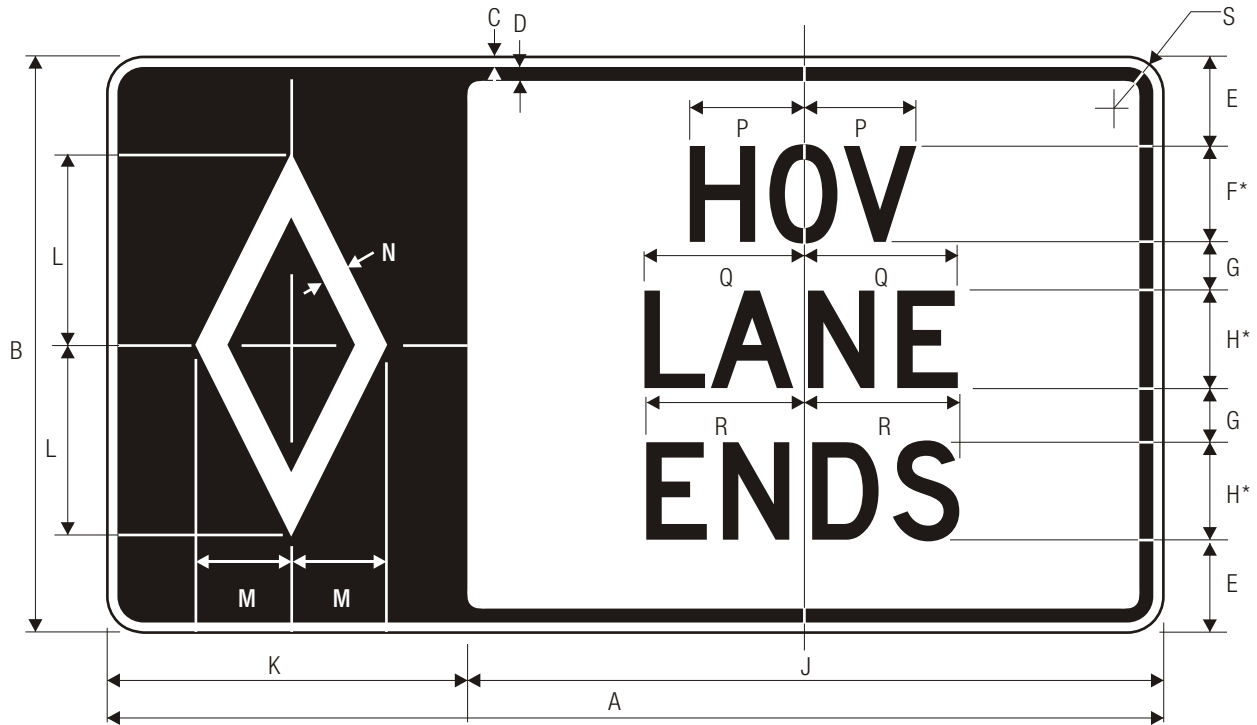

R3-15a
HOV LANE ENDS (OVERHEAD)

*Series 2000 Standard Alphabets.

C

A	B	C	D	E	F	G	H	J	K	L	M
66	36	.625	.875	6	6 D	3	6 D	42	24	12	6
84	48	.75	1.25	8	8 D	4	8 D	54	30	16	8
102	60	1	1.5	10	10 D	5	10 D	66	36	20	10

N	P	Q	R	S
1.75	7.465	9.687	9.687	2.25
2.25	9.967	12.929	12.909	3
2.75	12.449	16.092	16.072	3.75

COLORS: LEGEND — BLACK
 BACKGROUND — WHITE (RETROREFLECTIVE)
 SYMBOL — WHITE (RETROREFLECTIVE) ON BLACK

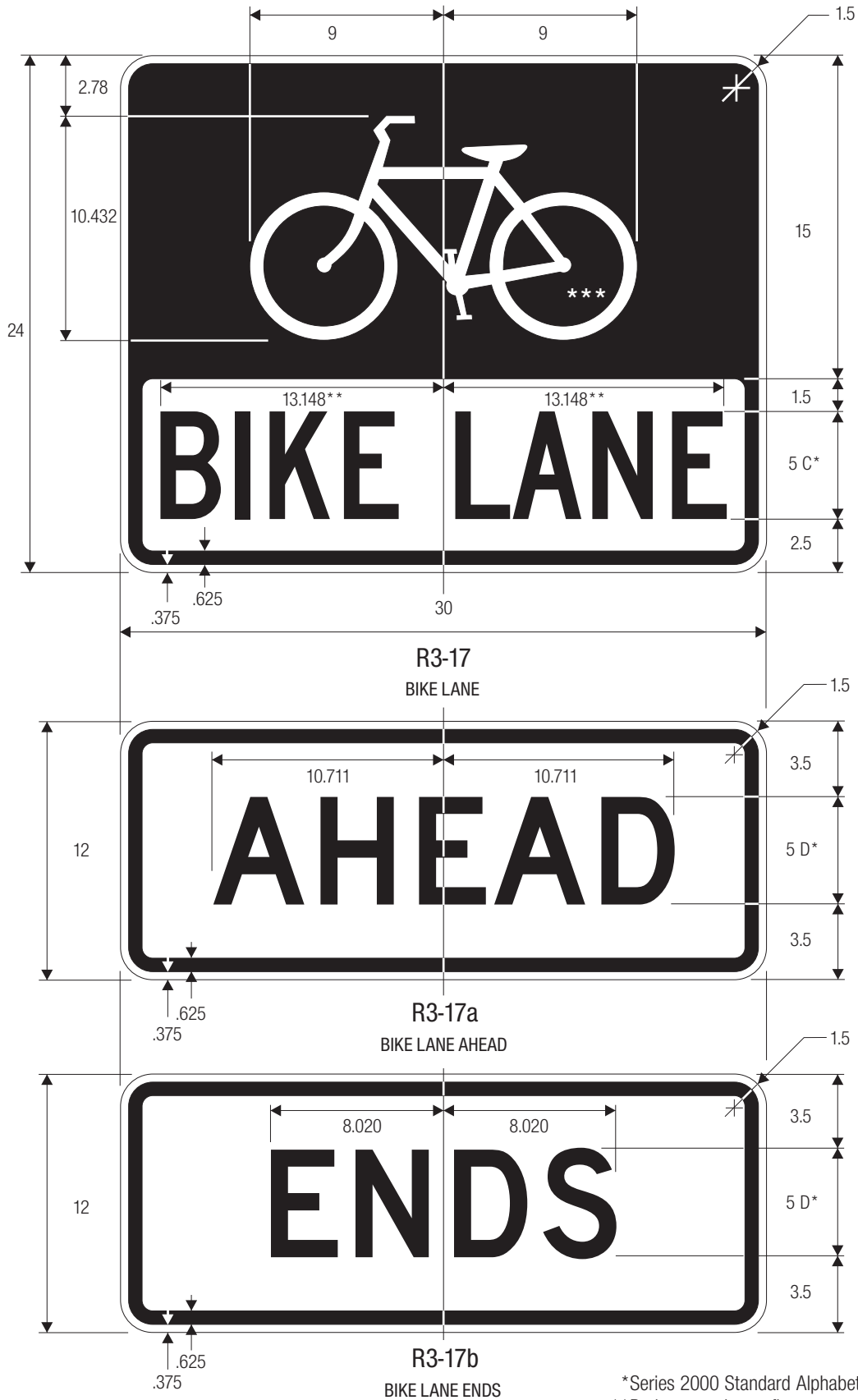

*Series 2000 Standard Alphabets.
 **Reduce spacing to fit.
 ***See page 6-7 for symbol design.

COLORS: LEGEND — BLACK
 BACKGROUND — WHITE (RETROREFLECTIVE)



R3-18

COMBINATION U-TURN & LEFT TURN PROHIBITION

*See page 6-2 for design details.

	A	B	C	D	E	F	G	H	J	K	L
C	24	.375	.625	10.407	8.566	2.081	3.682	1.841	6.805	.400	51.879
	30	.5	.75	13	10.728	2.601	4.603	2.281	8.526	.480	1.801
	36	.625	.875	15.611	12.889	3.122	5.524	2.722	10.247	.560	2.161
	48	.75	1.25	20.815	17.133	4.163	7.365	3.682	13.610	.800	2.882

	M	N	P	Q	R	S
	4.323	2.241	2.922	1.601	8.086	1.5
	5.404	2.802	3.642	2	10.087	1.875
	6.484	3.362	4.363	2.401	12.089	2.25
	8.646	4.483	5.844	3.202	16.172	3

COLORS: CIRCLE & DIAGONAL — RED (RETROREFLECTIVE)
 SYMBOL & BORDER — BLACK
 BACKGROUND — WHITE (RETROREFLECTIVE)

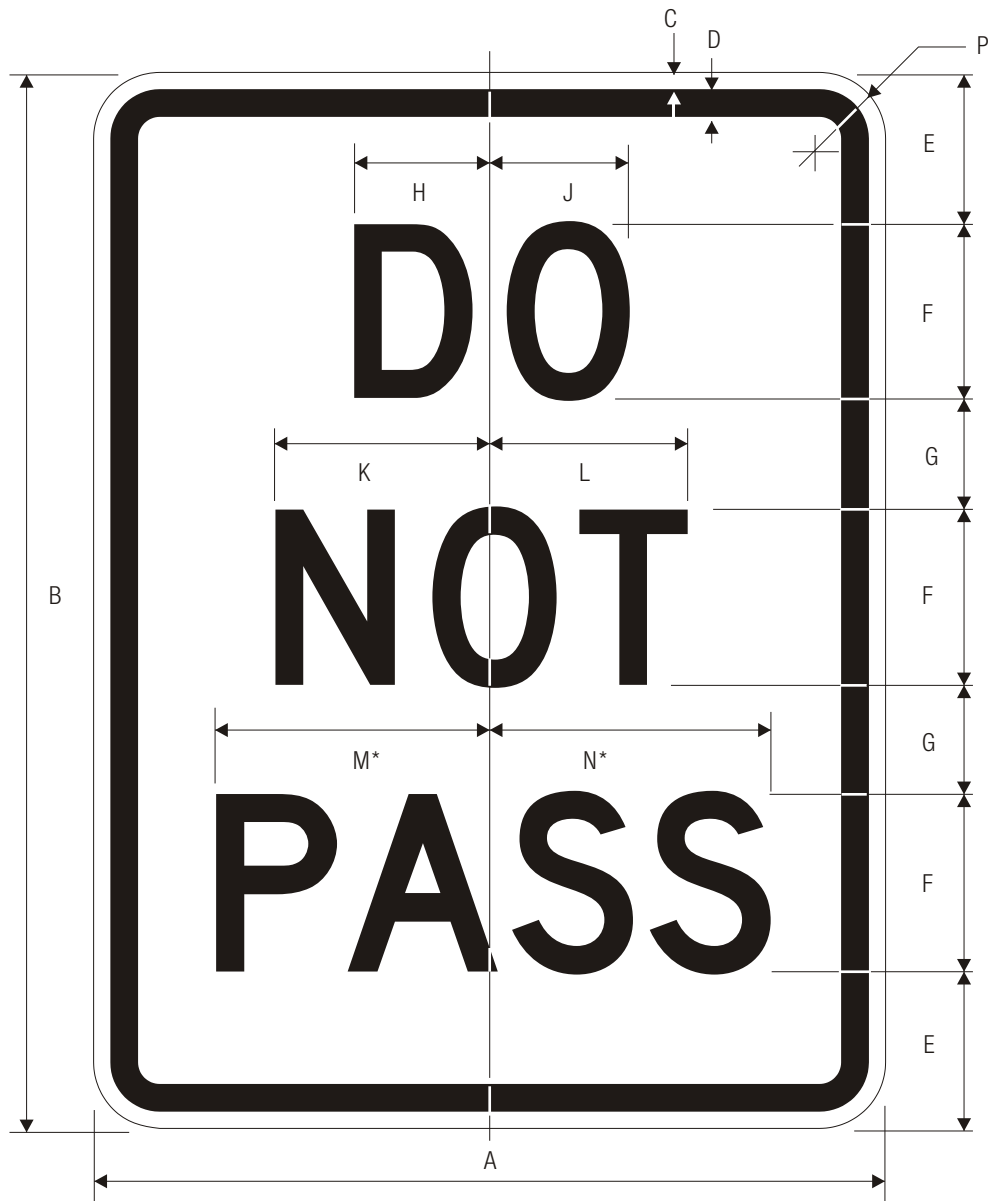

R4-1
DO NOT PASS

*Reduce spacing to fit.

C

A	B	C	D	E	F	G	H	J	K	L
12	18	.375	.438	2.875	2.75 D	2	2.125	2.188	3.188	3.438
18	24	.375	.625	3.5	4 D	2.5	3.125	3.313	4.75	4.875
24	30	.375	.625	3.5	6 D	2.5	4.688	5	7.125	7.375
36	48	.625	.875	7	8 D	5	6.25	6.625	9.5	9.75
48	60	.75	1.25	8	10 D	7	7.75	8.313	11.875	12.25

M	N	P
4.188	4.438	1.5
6.25	6.5	1.5
9.375	9.75	1.5
12.5	13	2.25
15.625	16.25	3

COLORS: LEGEND — BLACK
BACKGROUND — WHITE (RETROREFLECTIVE)



R4-2

PASS WITH CARE

C

A	B	C	D	E	F	G	H	J	K	L
12	18	.375	.438	2.5	3 C	2	3.75	4	3.75	3.375
18	24	.375	.625	3.5	4 C	2.5	5.438	5.625	5	4.75
24	30	.375	.625	3.5	6 C	2.5	8.188	8.438	7.5	7.188
36	48	.625	.875	7	8 C	5	10.875	11.25	10	9.5
48	60	.75	1.25	8	10 C	7	13.625	14.063	12.5	11.938

M	N	P
3.938	4.125	1.5
5.375	5.5	1.5
8	8.25	1.5
10.688	11	2.25
13.375	13.75	3

COLORS: LEGEND — BLACK
 BACKGROUND — WHITE (RETROREFLECTIVE)



R4-3

*Reduce spacing 25%.

SLOWER TRAFFIC KEEP RIGHT

A	B	C	D	E	F	G	H	J	K	L	M
12	18	.375	.438	3.25	1.75 D	1.5	4.313	4.5	2.625	2.813	3
18	24	.375	.625	3	3 D	2	7.313	7.5	4.563	4.875	5.25
C 24	30	.375	.625	3.625	4 D	2.25	9.75	10	6	6.563	7.125
36	48	.625	.875	6	6 D	4	14.625	15	9	9.813	10.688
48	60	.75	1.25	7.25	8 D	4.5	19.5	20	12	13.125	14.25

N	P
3.25	1.5
5.75	1.5
7.625	1.5
11.375	2.25
15.25	3

COLORS: LEGEND — BLACK
 BACKGROUND — WHITE (RETROREFLECTIVE)

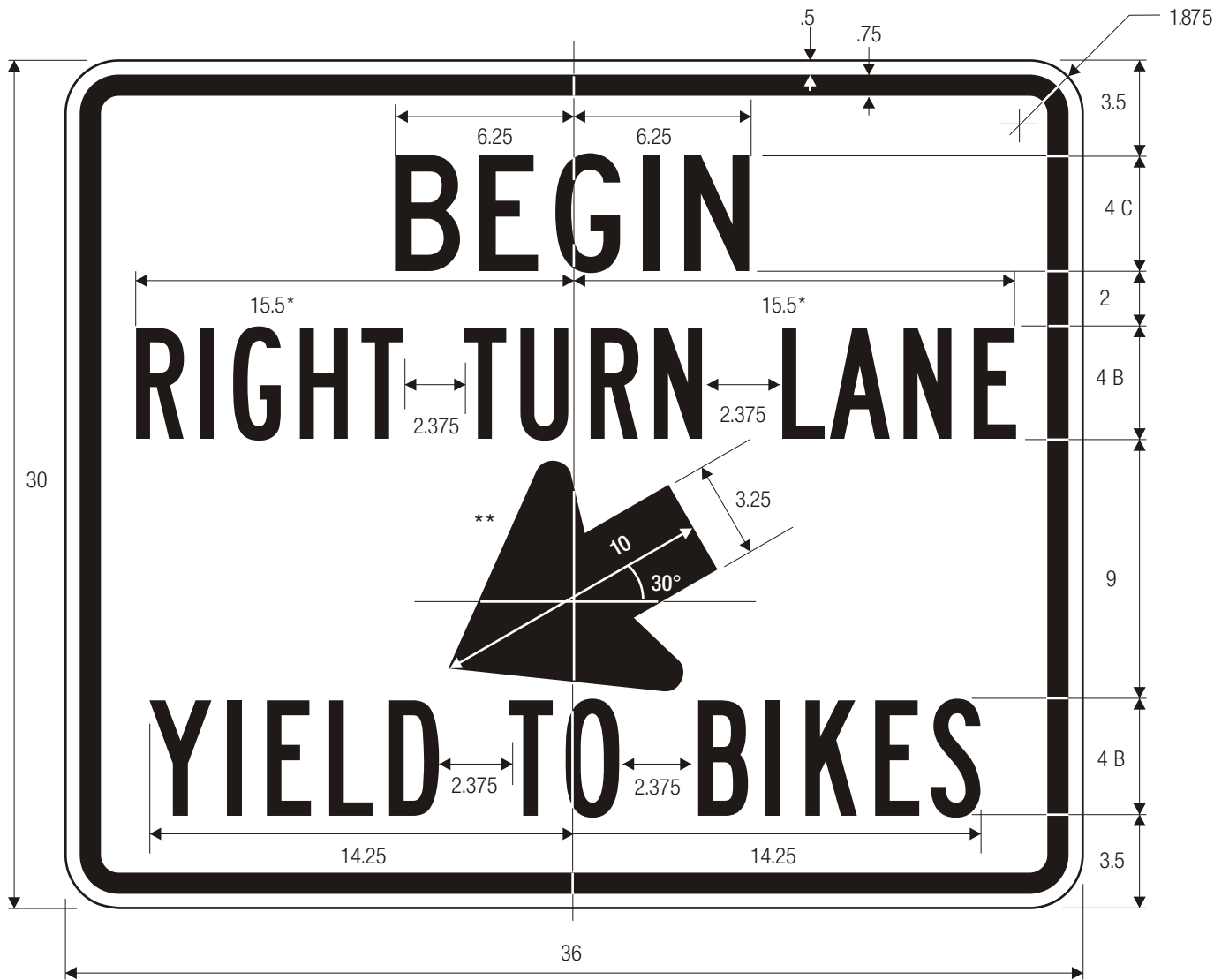

R4-4

BEGIN RIGHT TURN LANE - YIELD TO BIKES

*Reduce spacing 20%.

**Optically locate arrow, see page 6-2 for arrow design.

COLORS: LEGEND —BLACK
 BACKGROUND —WHITE (RETROREFLECTIVE)
 ARROW —BLACK

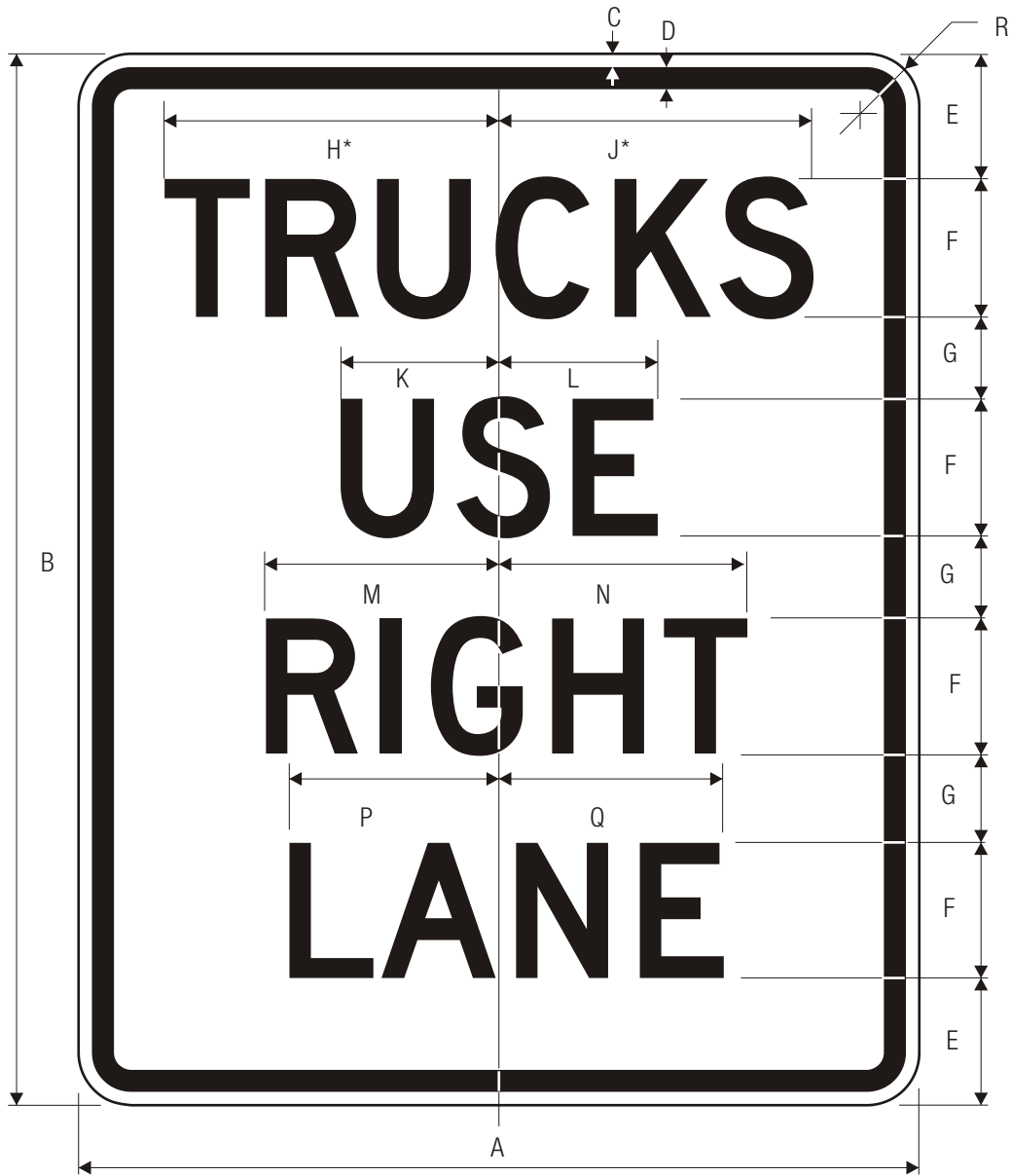

R4-5
TRUCKS USE RIGHT LANE

*Reduce spacing 32%.

C

A	B	C	D	E	F	G	H	J	K	L	M
24	30	.375	.625	3.625	4 D	2.24	9.563	9.188	4.75	5	7.125
36	48	.625	.875	6	6 D	4	14.313	13.813	7.125	7.5	10.688
48	60	.75	1.25	7.25	8 D	4.5	19.125	18.375	9.5	10	14.25

N	P	Q	R
7.625	6.25	6.625	1.5
11.375	9.375	9.938	2.25
14.25	12.5	13.25	3

COLORS: LEGEND —BLACK
BACKGROUND —WHITE (RETROREFLECTIVE)

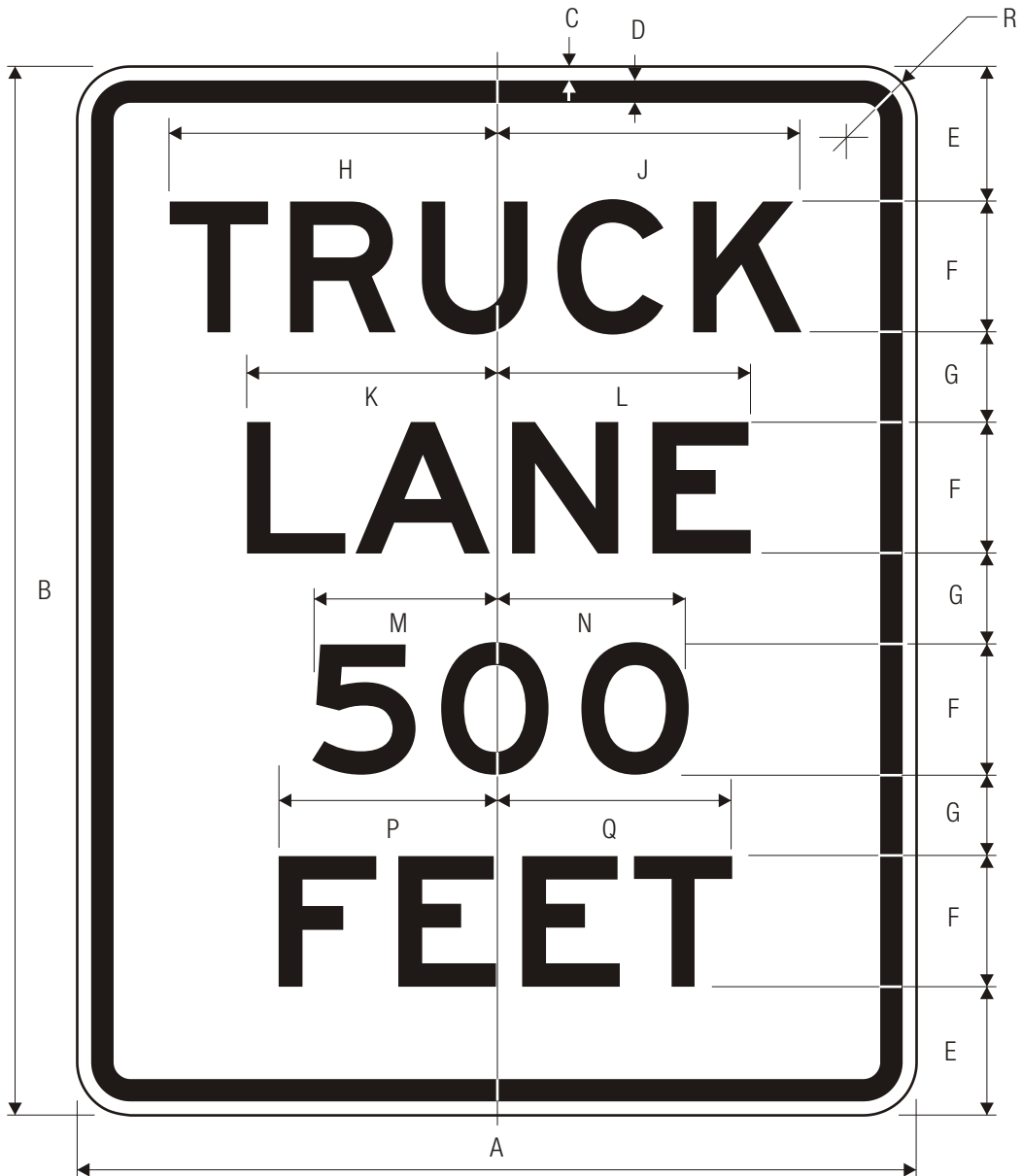

R4-6
TRUCK LANE 500 FEET

C

A	B	C	D	E	F	G	H	J	K	L	M
24	30	.375	.625	3.625	4 E	2.25	9.813	9.688	7.563	7.688	5.688
36	48	.625	.875	6	6 E	4	14.75	14.5	11.313	11.5	8.5
48	60	.75	1.25	7.25	8 E	4.25	19.625	19.375	15.125	15.375	11.375

N	P	Q	R
5.813	6.875	7.063	1.5
8.75	10.313	10.625	2.25
11.625	13.75	14.125	3

COLORS: LEGEND — BLACK
BACKGROUND — WHITE (RETROREFLECTIVE)

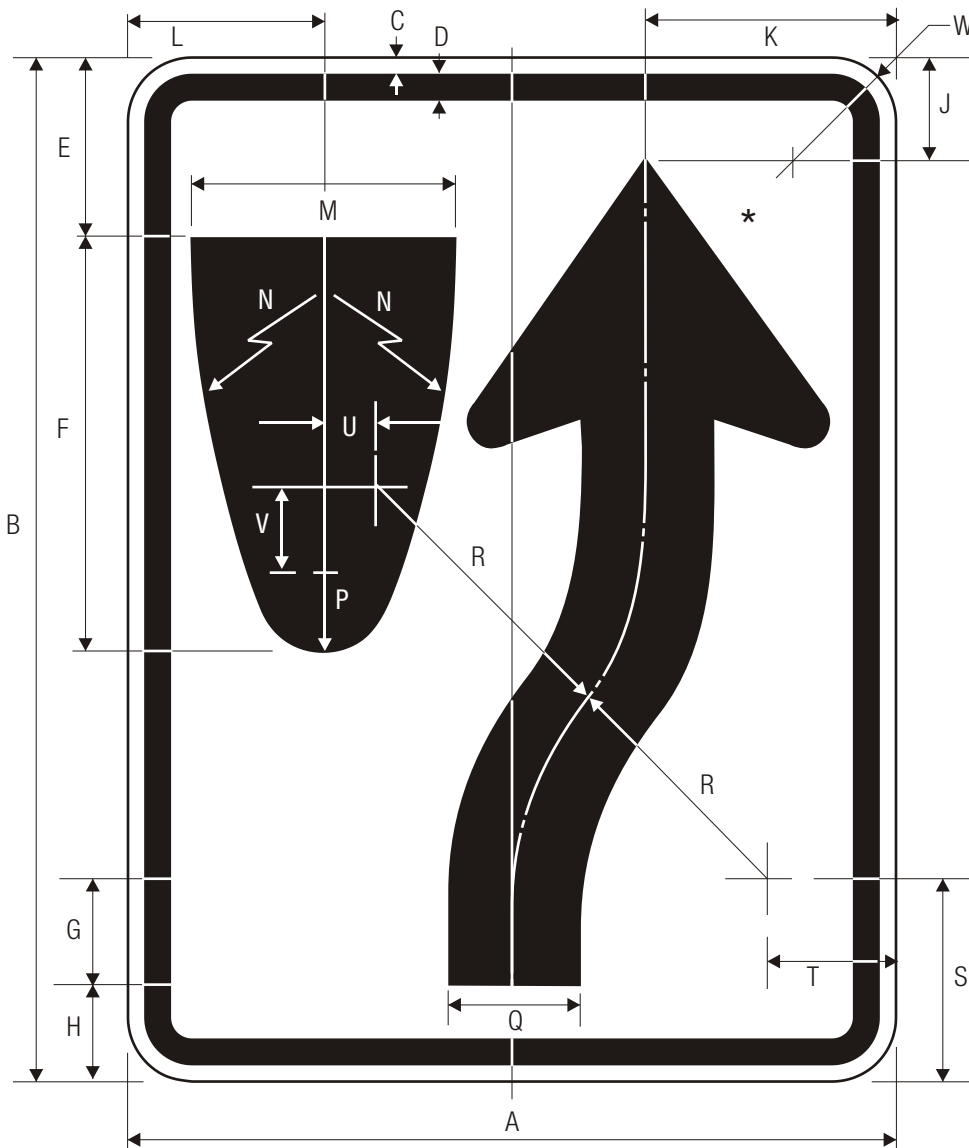

R4-7
KEEP RIGHT

*See page 6-2 for arrow design.

A	B	C	D	E	F	G	H	J	K	L	M
12	18	.375	.438	4	5.5	1.1	3.28	3.28	3.86	3.526	3.472
18	24	.375	.625	3.375	9.375	1.875	2.25	1.375	5.5	4.688	6
24	30	.375	.625	4.5	12.5	2.5	3	1.875	7.375	6.25	8
36	48	.625	.875	6.75	18.75	3.75	4.5	2.813	11.125	9.375	12
48	60	.75	1.25	9	25	5	6	3.75	14.813	12.5	16

C

N	P	Q	R	S	T	U	V	W
13	.831	1.75	4.212	4.38	1.826	.375	.5	1.5
22.5	1.5	3	6.75	4.125	2.25	1.063	.438	1.5
30	2	4	9	5.5	3	1.375	2.813	1.5
45	3	6	13.5	8.25	4.5	2	2.75	2.25
60	4	8	18	11	6	2.688	5	3

LEGEND — BLACK
BACKGROUND — WHITE (RETROREFLECTIVE)

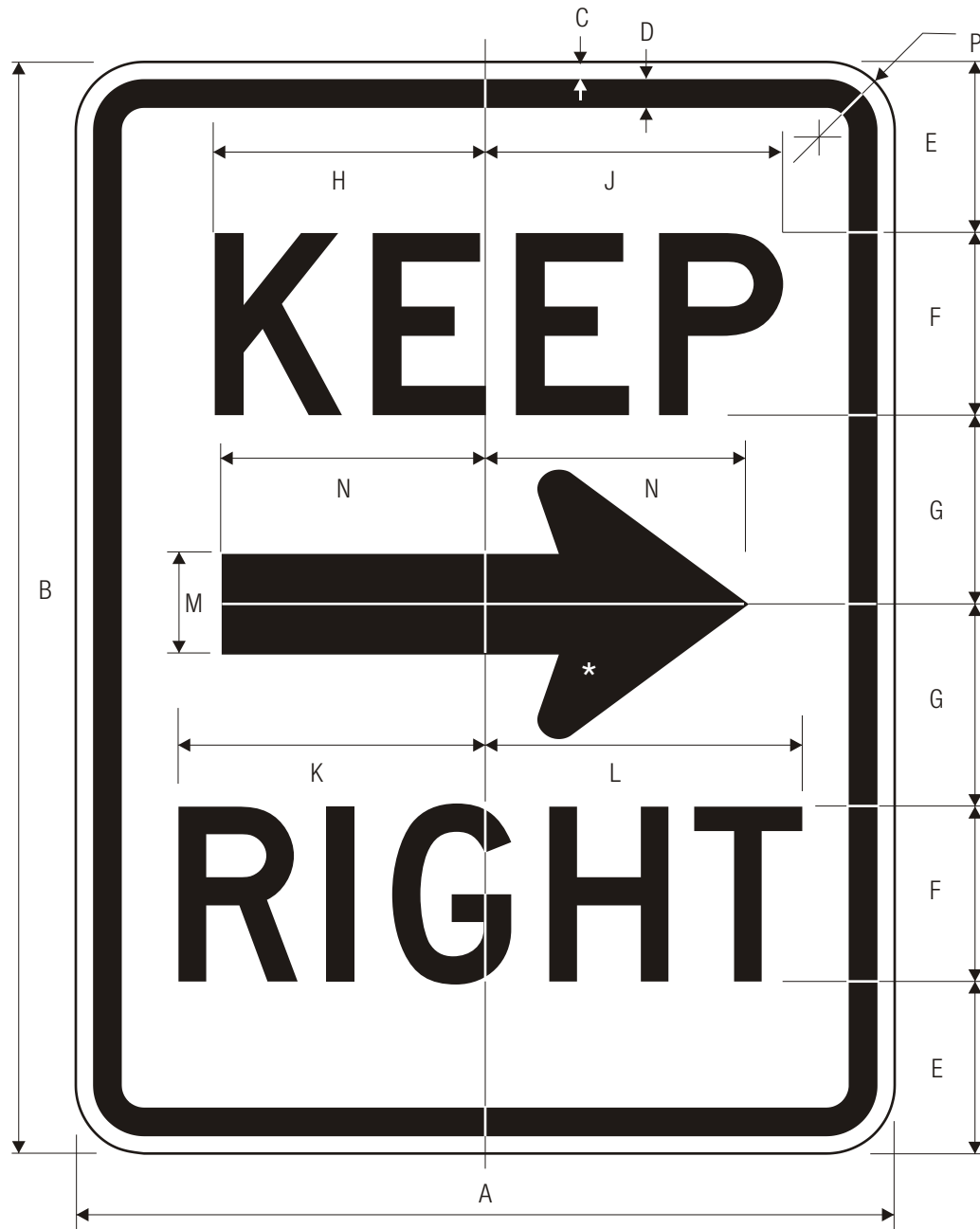

R4-7a

KEEP RIGHT

*See page 6-2 for arrow design.

C

A	B	C	D	E	F	G	H	J	K	L	M
18	24	.375	.625	3.75	4 D	4.25	6	6.563	7.125	7.625	2.25
24	30	.375	.625	4.5	5 D	5.5	7.5	8.25	8.813	9.563	2.625
36	48	.625	.875	7.5	8 D	8.5	12	13.125	14.25	15.25	4.5
48	60	.75	1.25	9	10 D	11	15	16.5	17.625	19.125	5.25

N	P
6	1.5
7.125	1.5
11.438	2.25
14.25	3

COLORS: LEGEND — BLACK
 BACKGROUND — WHITE (RETROREFLECTIVE)

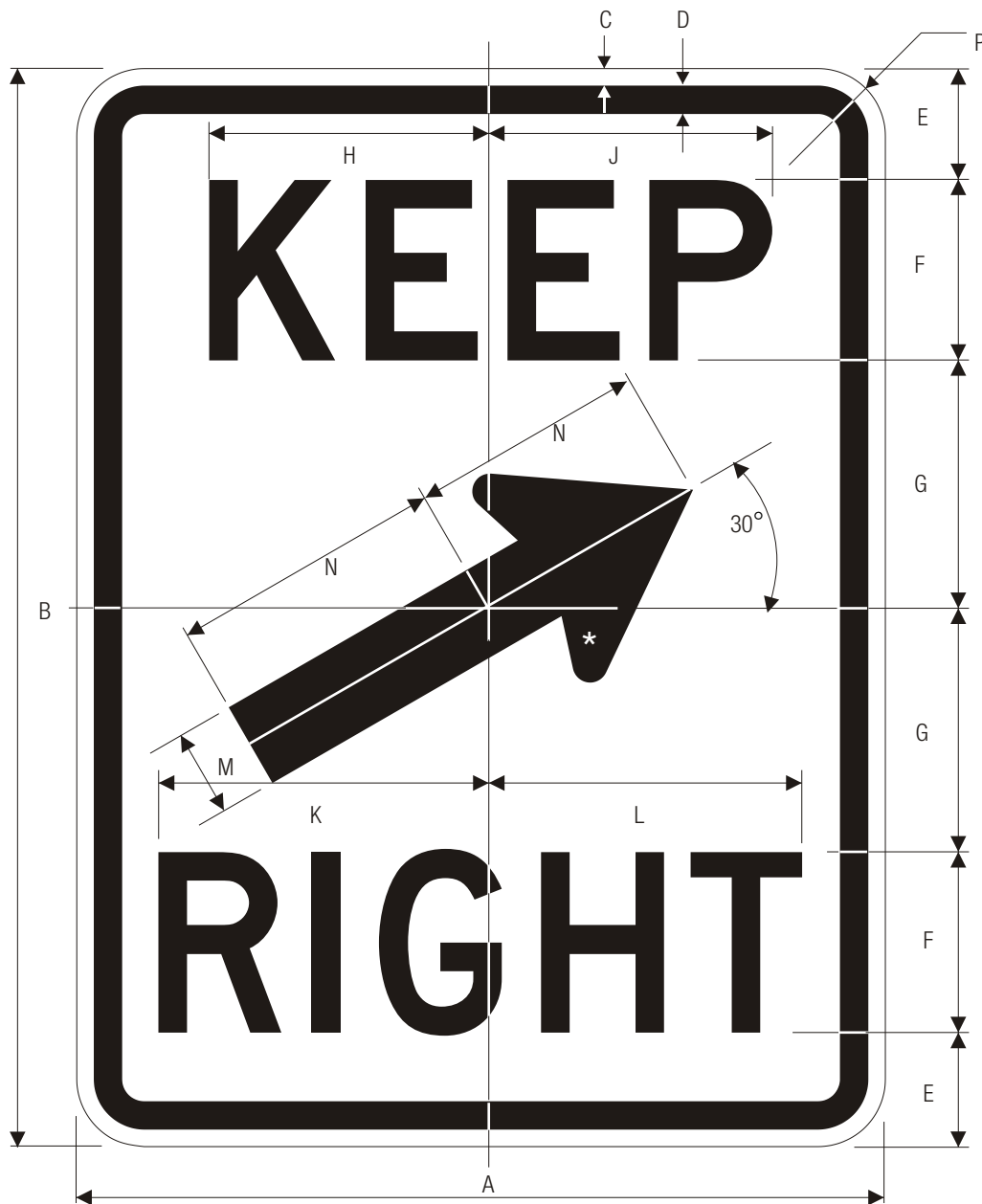

R4-7b

KEEP RIGHT

See page 6-2 for arrow design.

A	B	C	D	E	F	G	H	J	K	L	M
18	24	.375	.625	2.5	4 D	5.5	6	6.563	7.125	7.625	2.25
24	30	.375	.625	3	5 D	7	7.5	8.25	8.813	9.563	2.625
36	48	.625	.875	5	8 D	11	12	13.125	14.25	15.25	4.5
48	60	.75	1.25	6	10 D	14	15	16.5	17.625	19.125	5.25

C

N	P
6	1.5
7.125	1.5
11.438	2.25
14.25	3

COLORS: LEGEND — BLACK
 BACKGROUND — WHITE (RETROREFLECTIVE)

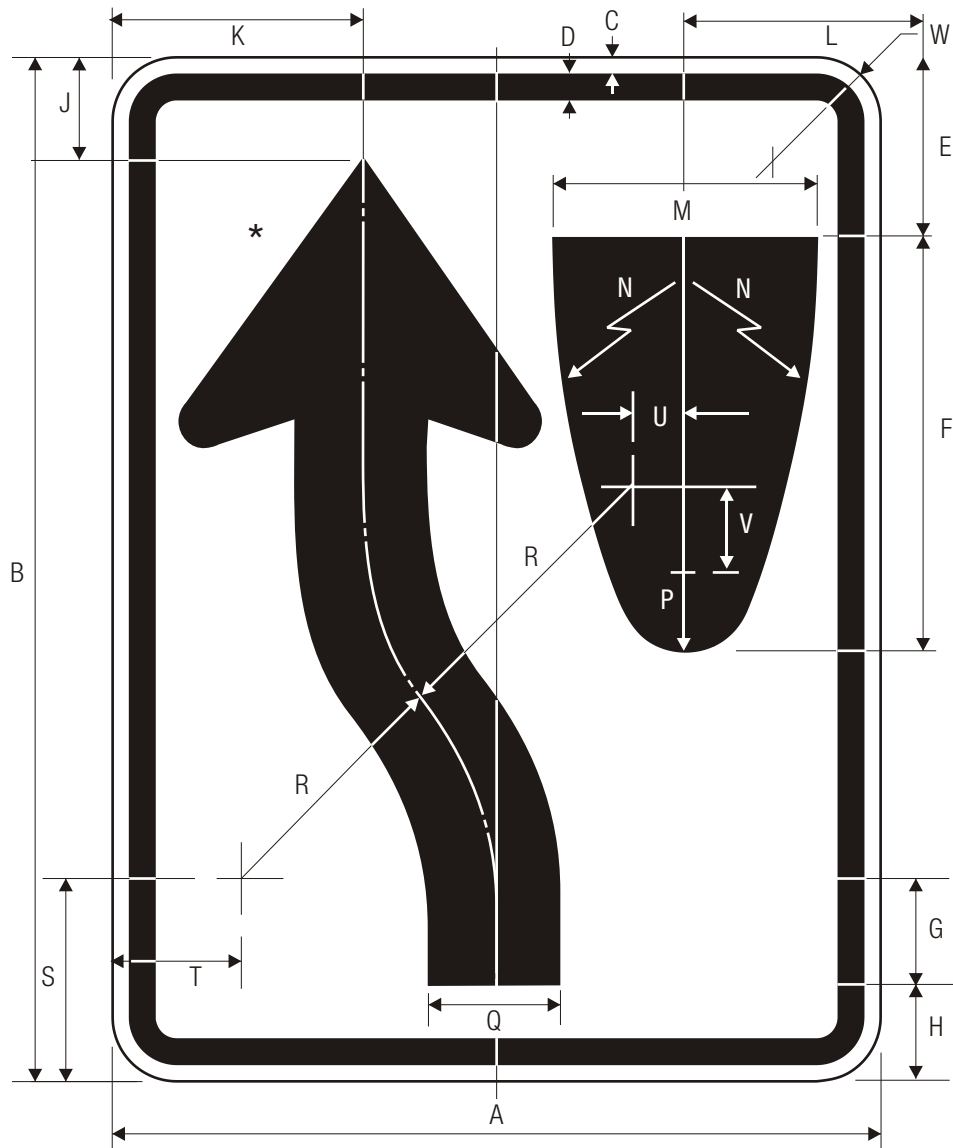

R4-8
KEEP LEFT

*See page 6-2 for design

C

A	B	C	D	E	F	G	H	J	K	L	M
18	24	.375	.625	3.375	9.375	1.875	2.25	1.375	5.5	4.688	6
24	30	.375	.625	4.5	12.5	2.5	3	1.875	7.375	6.25	8
36	48	.625	.875	6.75	18.75	3.75	4.5	2.813	11.125	9.375	12
48	60	.75	1.25	9	25	5	6	3.75	14.813	12.5	16

N	P	Q	R	S	T	U	V	W
22.5	1.5	3	6.75	4.125	2.25	1.063	.438	1.5
30	2	4	9	5.5	3	1.375	2.813	1.5
45	3	6	13.5	8.25	4.5	2	2.75	2.25
60	4	8	18	11	6	2.688	5	3

LEGEND — BLACK
BACKGROUND — WHITE (RETROREFLECTIVE)

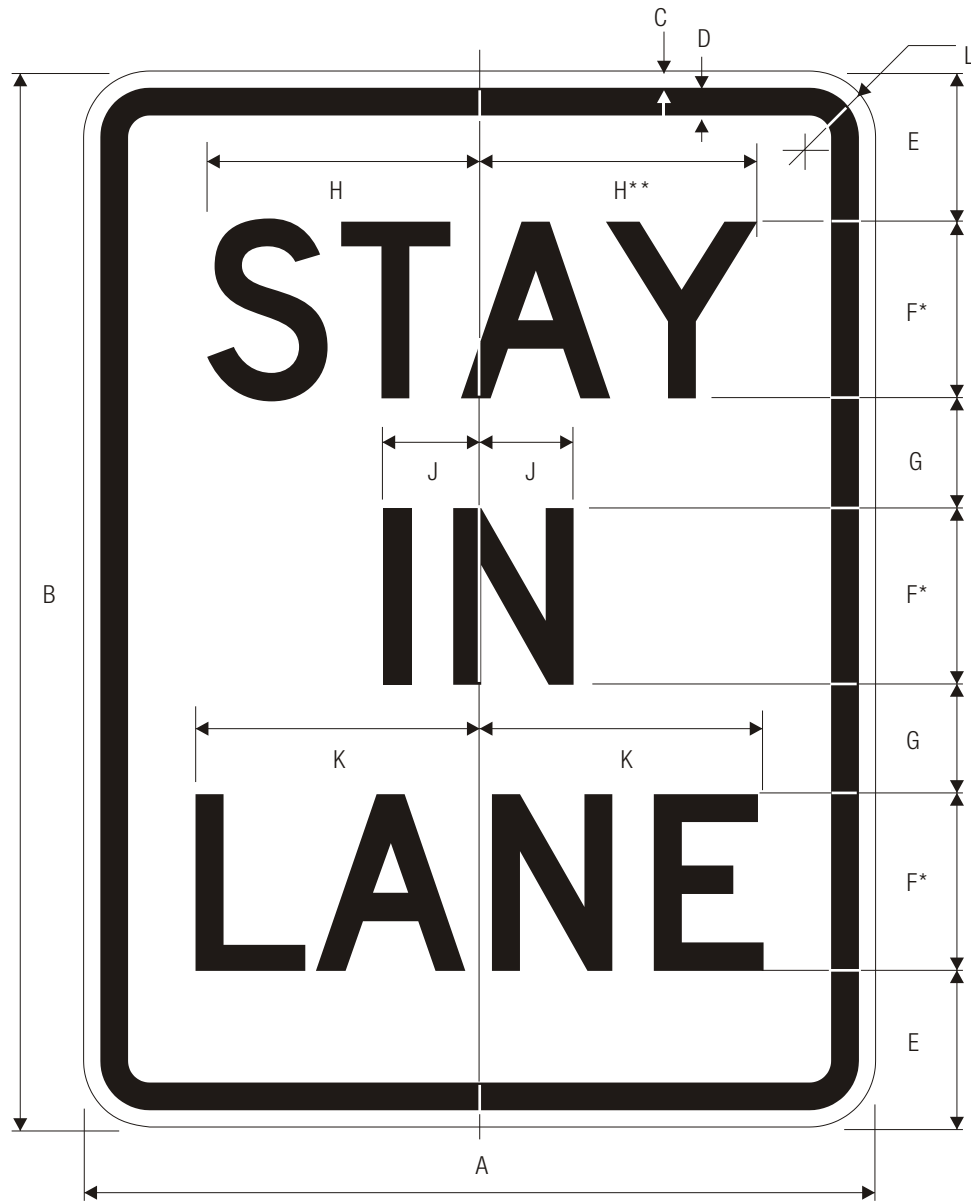

R4-9
STAY IN LANE

*Series 2000 Standard Alphabets.
**Reduce spacing to fit.

C

A	B	C	D	E	F	G	H	J	K	L
18	24	.375	.625	3	4 D	3	6.264	2.161	6.464	1.5
24	30	.375	.625	3.687	5 D	3.813	7.865	2.702	8.046	1.5
36	48	.625	.875	8.25	7 D	5.25	11	3.762	11.248	2.25
48	60	.75	1.25	7.5	10 D	7.5	15.651	5.424	16.172	3

COLORS: LEGEND — BLACK
BACKGROUND — WHITE (RETROREFLECTIVE)



C 48

R4-10
 RUNAWAY VEHICLES ONLY

*Series 2000 Standard Alphabets.
 **Reduce spacing to fit.

COLORS: LEGEND — BLACK
 BACKGROUND — WHITE (RETROREFLECTIVE)

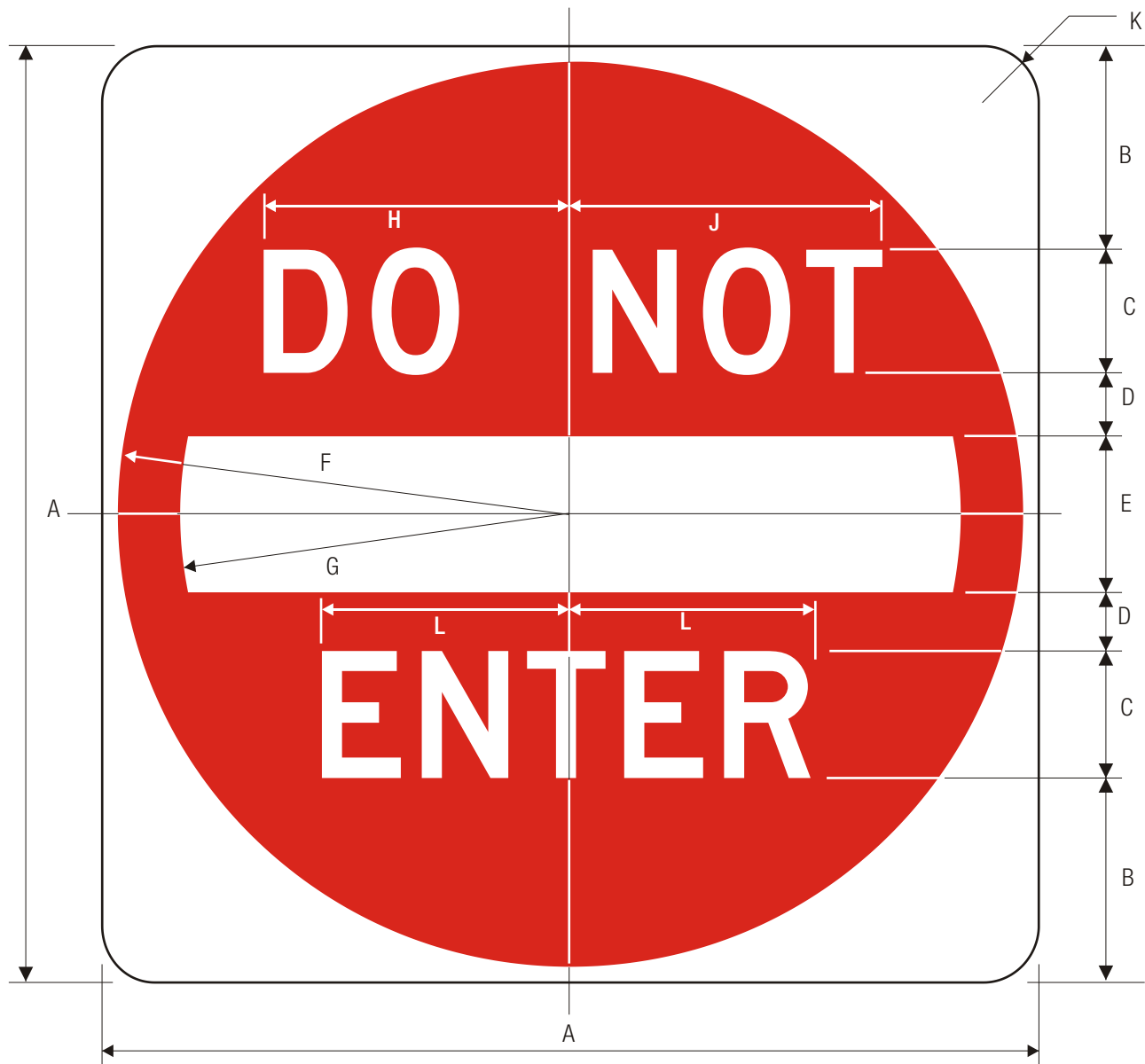

R5-1
DO NOT ENTER

	A	B	C	D	E	F	G	H	J	K	L
C	30	6.5	4 D	2	5	14.5	12.5	9.75	10	1.875	7.875
	36	7.5	5 D	2.5	6	17.5	15	12	12.375	2.25	9.813
	48	11	6 D	3	8	23.5	20	14.5	15	3	11.75

COLORS: SYMBOL — RED (RETROREFLECTIVE)
LEGEND & BACKGROUND — WHITE (RETROREFLECTIVE)

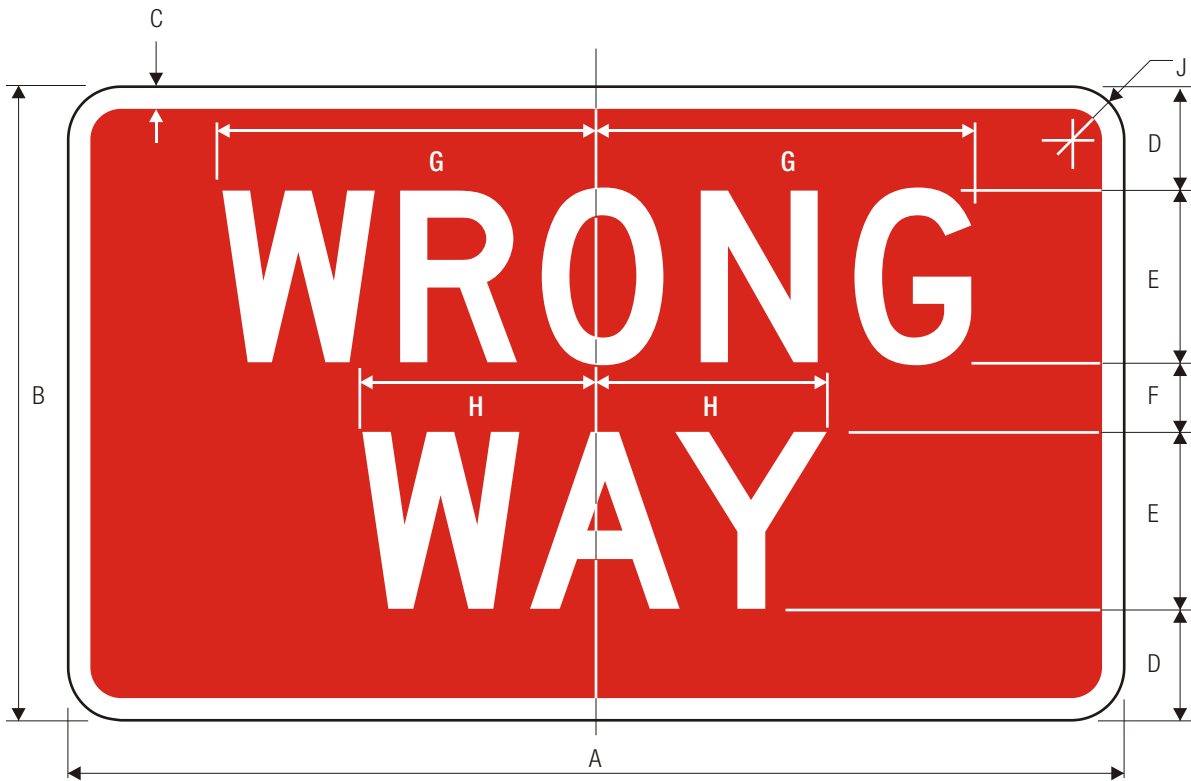

R5-1a
WRONG WAY

	A	B	C	D	E	F	G	H	J
	30	18	.625	3	5 D	2	11.063	6.688	1.5
C	36	24	.75	4.5	6 D	3	13.313	8.063	1.5
	42	30	.875	5	8 D	4	17.75	10.75	1.875

COLORS: LEGEND — WHITE (RETROREFLECTIVE)
BACKGROUND — RED (RETROREFLECTIVE)

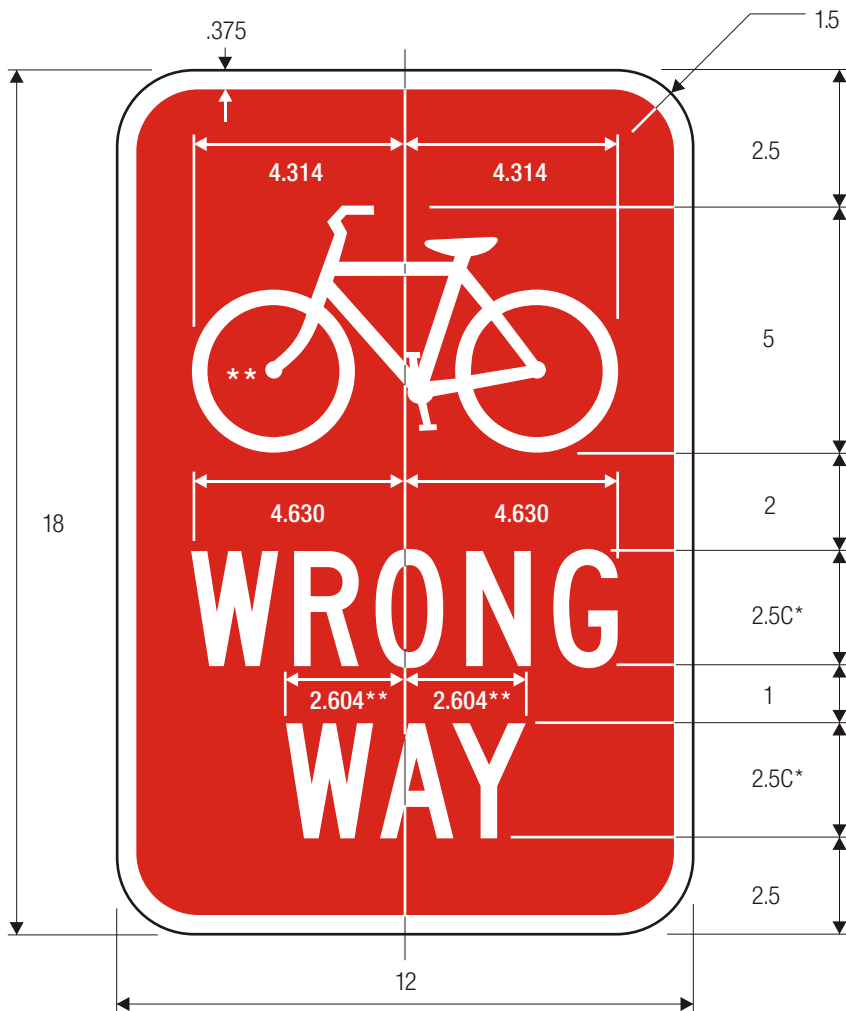

R5-1b
BICYCLE WRONG WAY

*Series 2000 Standard Alphabets.
 **Reduce spacing to fit.
 ***See page 6-7 for symbol design.

COLORS: LEGEND — WHITE (RETROREFLECTIVE)
 BACKGROUND — RED (RETROREFLECTIVE)



R5-2

NO TRUCKS

*See page 6-4 for symbol design

	A	B	C	D	E	F	G	H	J	K
C	24	.375	.625	10.5	8.5	6.5	6.875	1.375	1.5	1
	30	.5	.75	13.125	10.625	8.125	8.5	1.625	1.875	2.5
	36	.625	.875	15.75	12.75	9.75	10.25	2	2.25	3
	48	.75	1.25	21	17	13	13.625	2.625	3	4

COLORS: SYMBOL BORDER — BLACK
 CIRCLE & DIAGONAL — RED (RETROREFLECTIVE)
 BACKGROUND — WHITE (RETROREFLECTIVE)

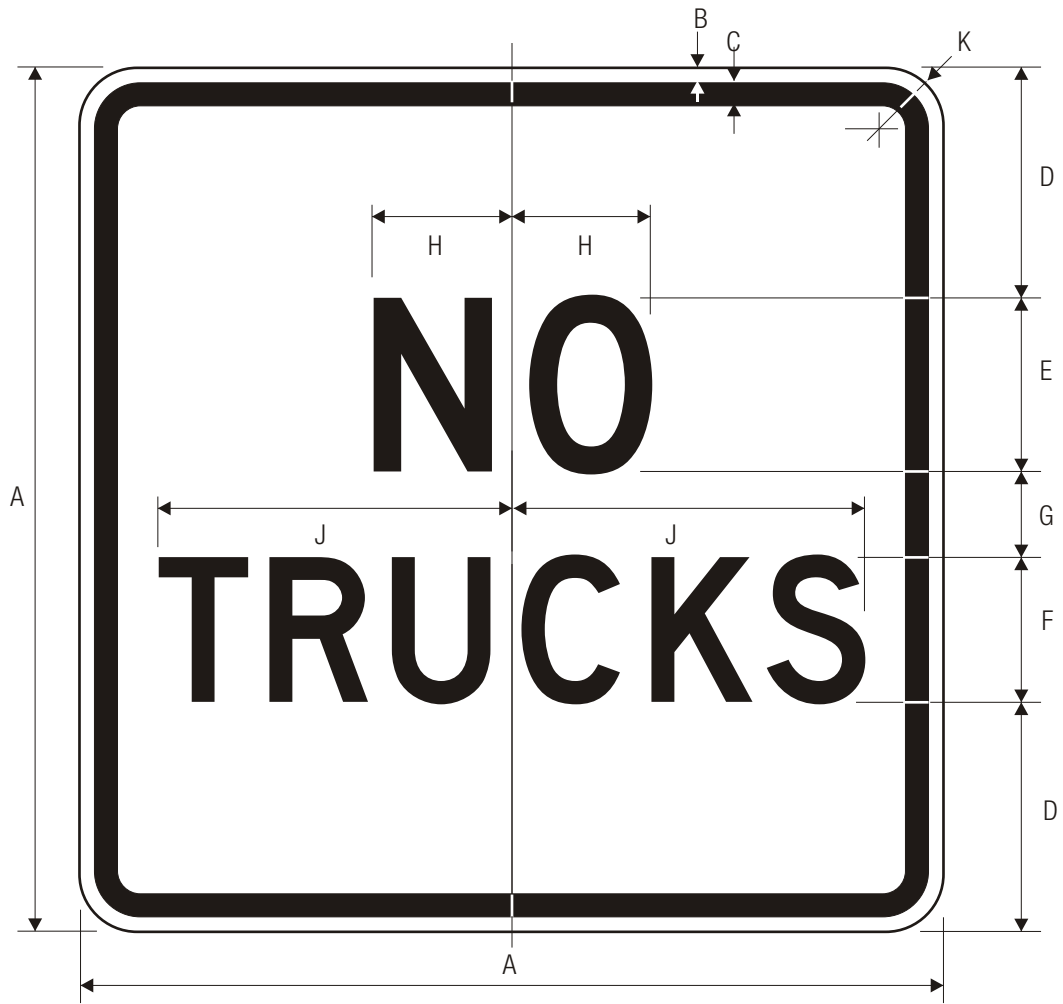

R5-2a
NO TRUCKS

	A	B	C	D	E	F	G	H	J	K
	12	.375	.375	3	2.5 D	2 D	1.5	2.003	4.877	1.5
C	24	.375	.625	6	5 D	4 D	3	4	9.767	1.5
	30	.5	.75	7.875	6 D	5 D	3.25	4.843	12.269	1.875
	36	.625	.875	9.25	7 D	6 D	4.5	5.604	14.651	2.25
	48	.75	1.25	12.5	9 D	8 D	6	7.225	19.534	3

COLORS: LEGEND — BLACK
BACKGROUND — WHITE (RETROREFLECTIVE)

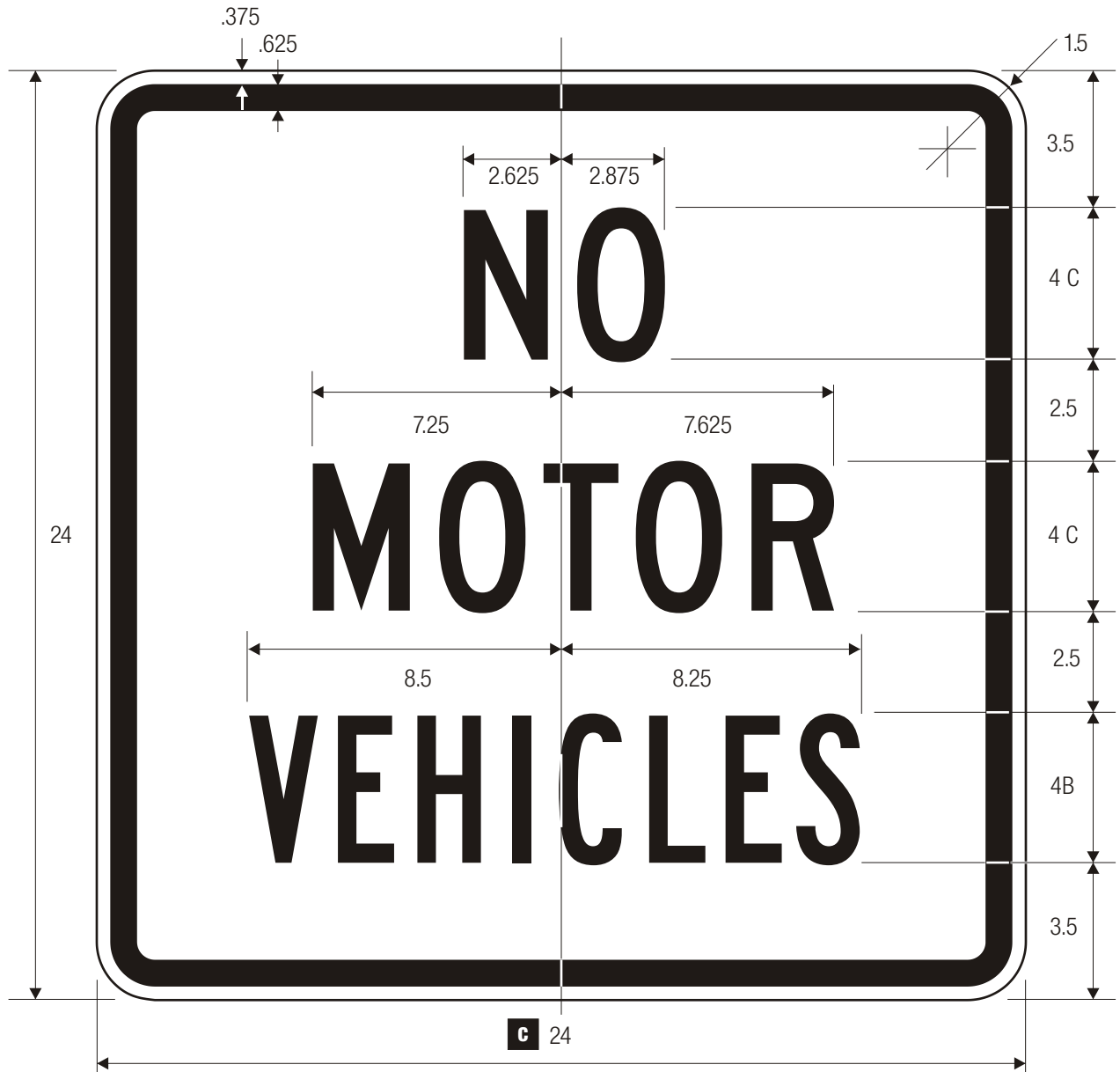

R5-3

NO MOTOR VEHICLES

COLORS: LEGEND — BLACK
 BACKGROUND — WHITE (RETROREFLECTIVE)

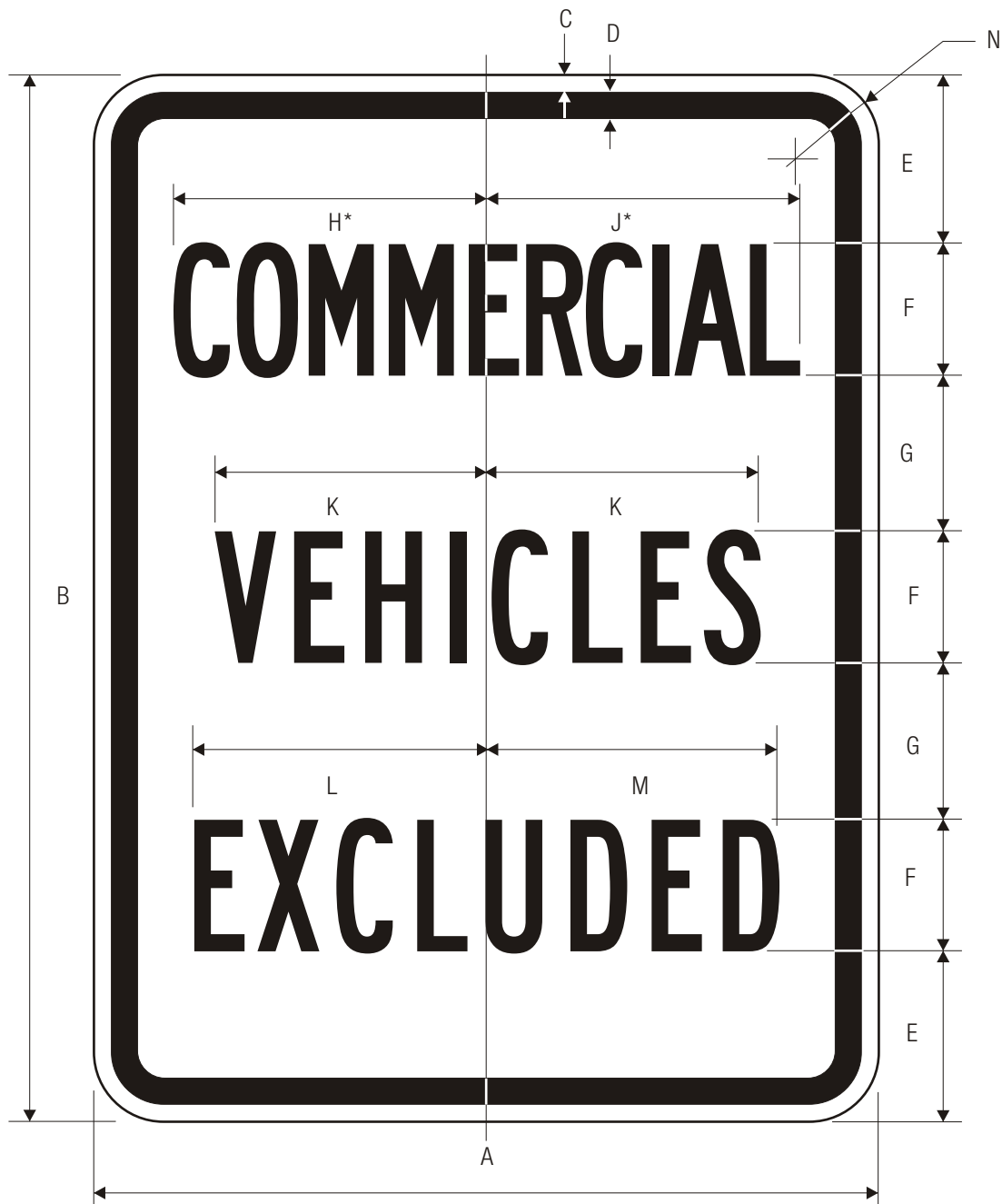

R5-4

COMMERCIAL VEHICLES EXCLUDED

*Reduce spacing 50%.

C

A	B	C	D	E	F	G	H	J	K	L
18	24	.375	.625	4.25	3 B	3.25	7.125	7.375	6.188	6.5
24	30	.375	.625	5	4 B	4	9.5	9.813	8.25	8.688
36	48	.625	.875	8.5	6 B	6.5	14.25	14.688	12.375	13
48	60	.75	1.25	10	8 B	8	19	19.625	16.5	17.375

M	N
6.688	1.5
8.938	1.5
13.375	2.25
17.875	3

COLORS: LEGEND — BLACK
 BACKGROUND — WHITE (RETROREFLECTIVE)



R5-5

VEHICLES WITH LUGS PROHIBITED

*Reduce spacing 20%.

C

A	B	C	D	E	F	G	H	J	K	L
18	24	.375	.625	4.25	3 B	3.25	6.188	7.5	7.313	7.125
24	30	.375	.625	5	4 B	4	8.25	10	9.75	9.5
36	48	.625	.875	8.5	6 B	6.5	12.375	15	15.625	14.25
48	60	.75	1.25	10	8 B	8	16.5	20	19.5	19

M	N
7.25	1.5
9.688	1.5
14.5	2.25
19.375	3

COLORS: LEGEND —BLACK
BACKGROUND —WHITE (RETROREFLECTIVE)



R5-6

NO BICYCLES

*See page 6-7 for design.

C

A	B	C	D	E	F	G	H	J	K
24	.375	.625	10.5	8.5	4.75	.75	2	3	1.5
30	.5	.75	13.125	10.625	5.875	.875	2.5	3.75	1.875
36	.625	.875	15.75	12.75	7.125	1.125	3	4.5	2.25
48	.75	1.25	21	17	9.5	1.5	4	6	3

COLORS: LEGEND — BLACK
 CIRCLE & DIAGONAL — RED (RETROREFLECTIVE)
 BACKGROUND — WHITE (RETROREFLECTIVE)



R5-7

NON-MOTORIZED TRAFFIC PROHIBITED

*Series 2000 Standard Alphabets.

	A	B	C	D	E	F	G	H	J	K	L	M
C	30	24	.5	.75	4.25	3.5 B	2.5	3.5 D	12.445	8.940	12.727	1.875
	42	24	.625	.875	3.5	4 B	2.5	4 D	14.215	10.218	14.545	2.25
	48	30	.75	1.25	4	5 B	3.5	5 D	17.769	12.772	18.181	3

COLORS: LEGEND — BLACK
 BACKGROUND— WHITE (RETROREFLECTIVE)

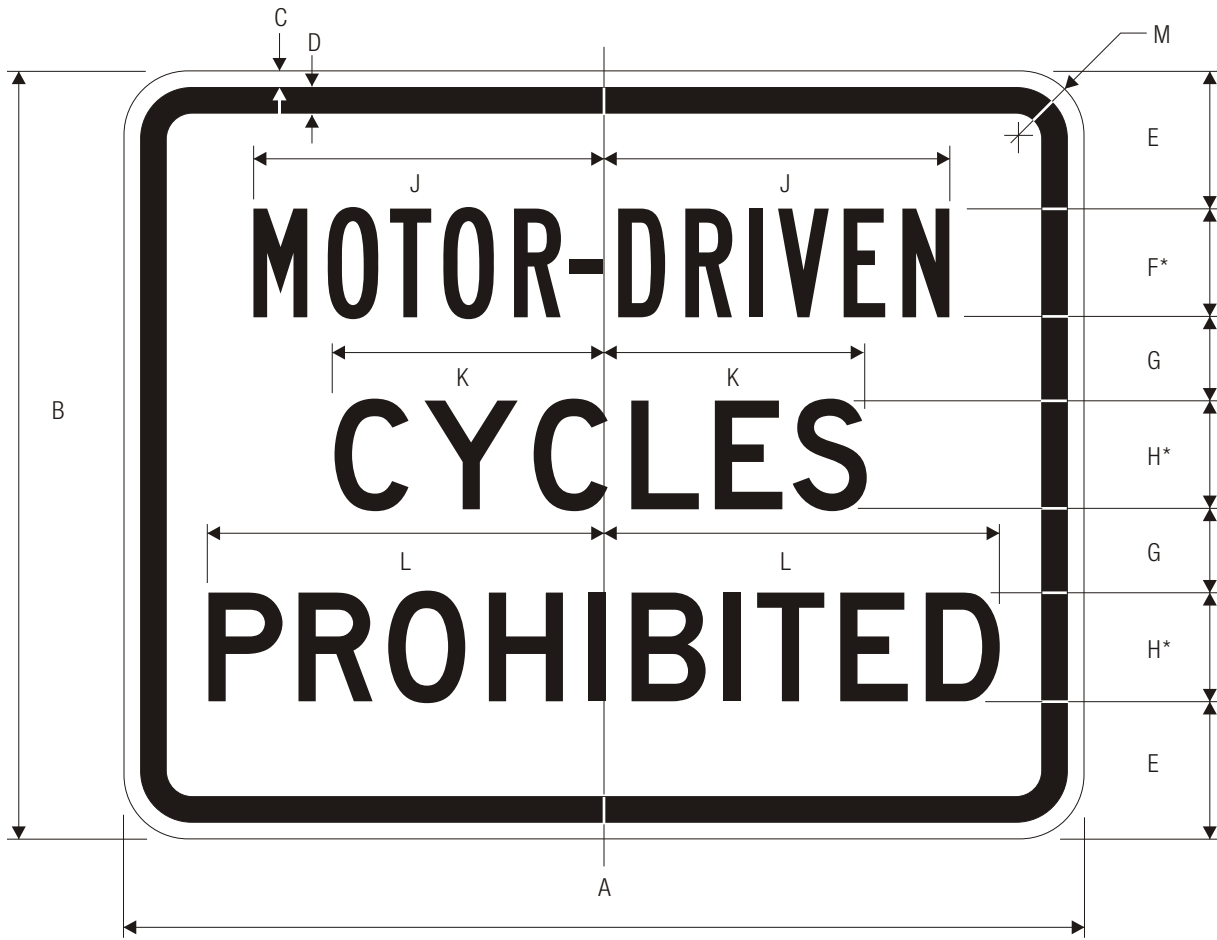

R5-8

MOTOR-DRIVEN CYCLES PROHIBITED

*Series 2000 Standard Alphabets.

C

A	B	C	D	E	F	G	H	J	K	L	M
30	24	.5	.75	4.25	3.5 B	2.5	3.5 D	11.193	8.56	12.727	1.875
42	24	.625	.875	3.5	4 B	2.5	4 D	12.791	9.783	14.545	2.25
48	30	.75	1.25	4	5 B	3.5	5 D	15.989	12.229	18.181	3

COLORS: LEGEND — BLACK
 BACKGROUND— WHITE (RETROREFLECTIVE)



R5-10a

PEDESTRIANS BICYCLES MOTOR-DRIVEN CYCLES PROHIBITED

COLORS: LEGEND — BLACK
 BACKGROUND — WHITE (RETROREFLECTIVE)



R5-10b

PEDESTRIANS AND BICYCLES PROHIBITED



R5-10c

PEDESTRIANS PROHIBITED

COLORS: LEGEND — BLACK
 BACKGROUND — WHITE (RETROREFLECTIVE)

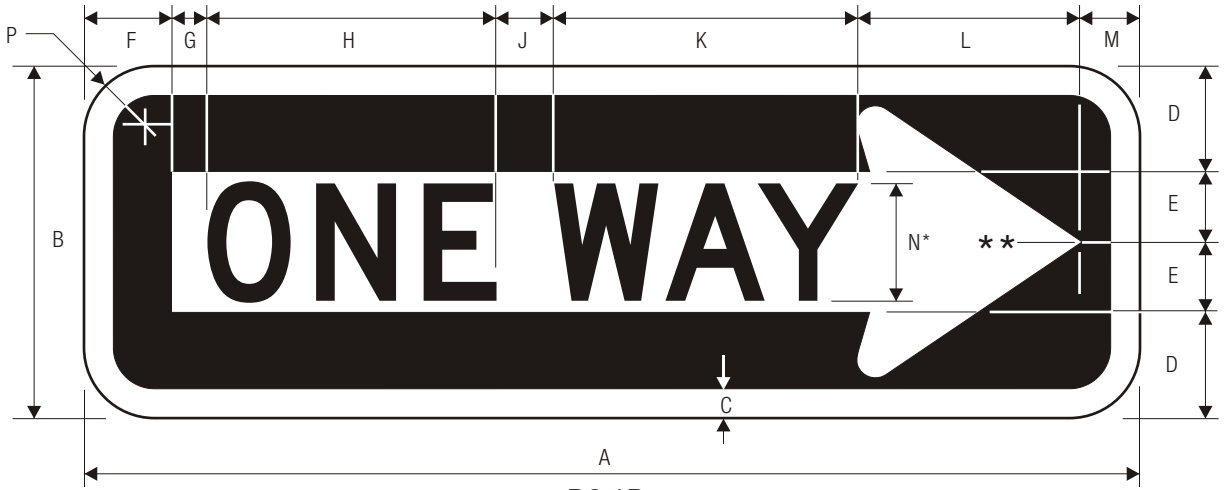

R6-1R
ONE WAY

	A	B	C	D	E	F	G	H	J	K	L	M
C	36	12	.5	3.375	2.625	3	1.25	9.125	2	9.625	9	2
	54	18	1	5.5	3.5	5	4	12.309	2.929	12.762	13	4

	N	P	Q	R	S	T	U	V
	4 D	1.5	11	9.125	2	9.625	1.25	3
	5 D	1.875	17	12.309	2.929	12.762	4	5

*Series 2000 Standard Alphabets.
**See page 6-2 for arrow design.

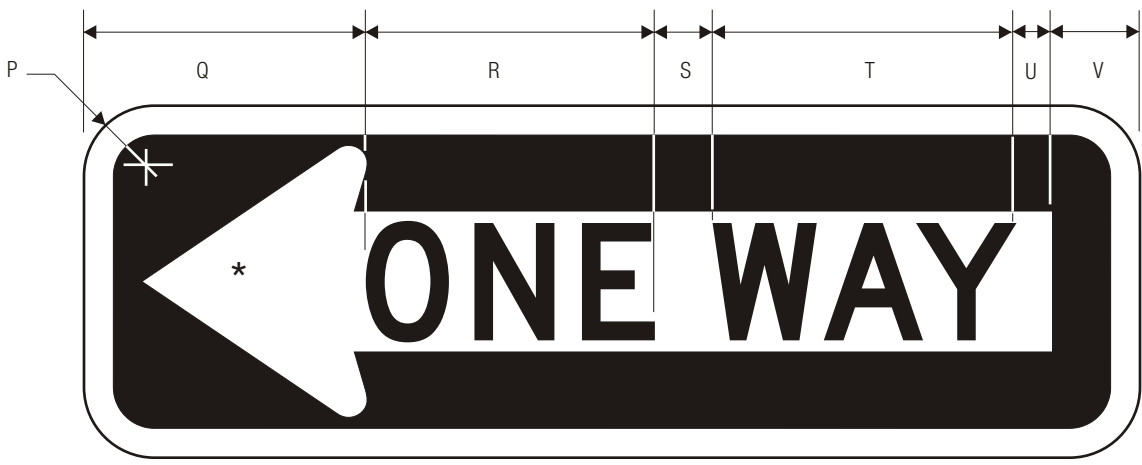

R6-1L
ONE WAY

COLORS: LEGEND — BLACK
 BACKGROUND — BLACK
 ARROW — WHITE (RETROREFLECTIVE)



R6-2R
ONE WAY

*Series 2000 Standard Alphabets.
**See page 6-2 for arrow design.

C

A	B	C	D	E	F	G	H	J	K	L	M
12	16	.375	.375	2	3 D	1.5	3	3.5	3.722	3.664	3.717
18	24	.375	.625	2.5	5 D	1.5	4.5	5.5	6.244	6.124	6.044
24	30	.375	.625	3	6 D	1.875	6.063	7.063	7.485	7.285	7.325
36	48	.625	.875	4.75	10 D	3.25	9.5	10.5	12.369	12.249	12
48	60	.75	1.25	6	12 D	4	12	14	15	14.571	14.811

N	P	Q	R	S
3.943	3.75	4	1.5	1.5
6.805	6	6.805	2.25	1.5
8.286	8.286	8.926	3	1.5
13.530	13.250	14.290	5	2.25
16.252	16.572	17.853	6	3

COLORS: LEGEND — BLACK
BACKGROUND — WHITE (RETROREFLECTIVE)

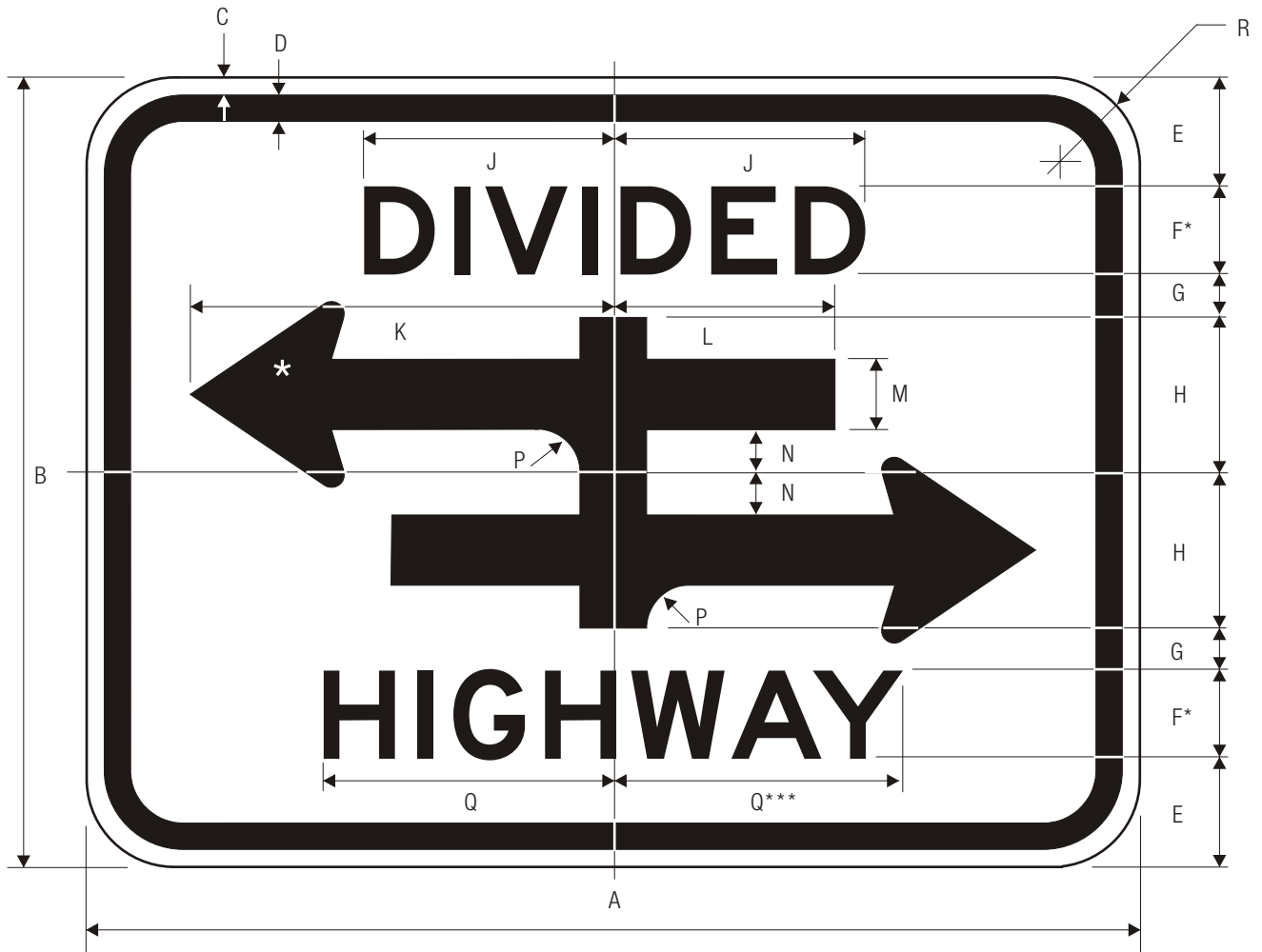

R6-3

DIVIDED HIGHWAY CROSSING

*Series 2000 Standard Alphabets.
 **See page 6-2 for arrow design.
 ***Reduce spacing to fit.

C

A	B	C	D	E	F	G	H	J	K	L	M
24	18	.375	.625	2.5	2 E	1	3.5	5.875	9.5	5	1.5
30	24	.5	.75	3	3 E	1.375	4.625	8.516	12.602	6.646	2
36	30	.625	.875	3.688	4 E	1.625	5.688	11.354	15.377	8.064	2.428

N	P	Q	R
1	1	6.608	1.5
1.327	1.327	9.842	1.875
1.62	1.62	13.051	2.25

COLORS: LEGEND — BLACK
 BACKGROUND — WHITE (RETROREFLECTIVE)

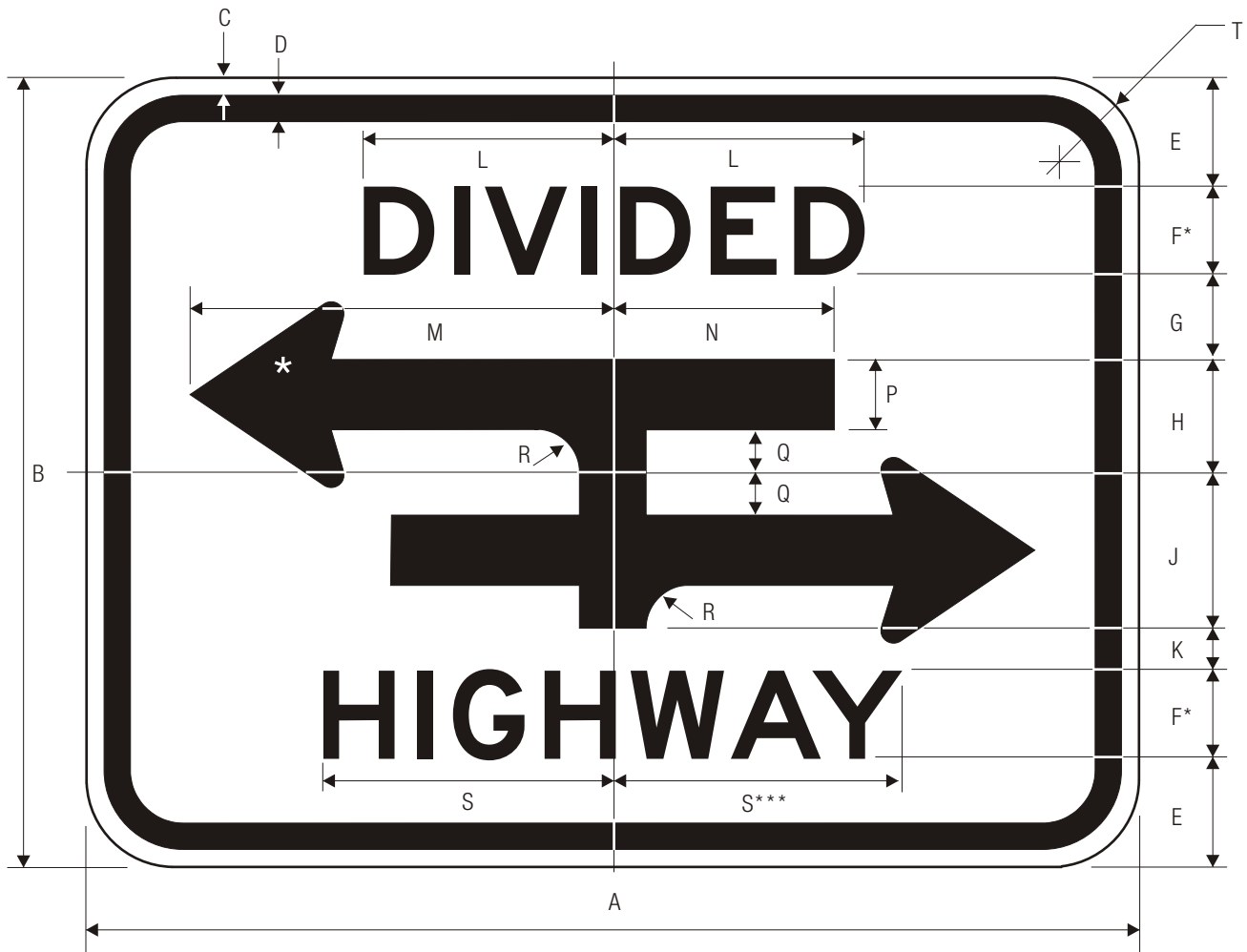

R6-3a

DIVIDED HIGHWAY CROSSING

*Series 2000 Standard Alphabets.
 **See page 6-2 for arrow design.
 ***Reduce spacing to fit.

C

A	B	C	D	E	F	G	H	J	K	L	M
24	18	.375	.625	2.5	2 E	2	2.5	3.5	1	5.875	9.5
30	24	.5	.75	3	3 E	2.625	3.375	4.625	1.375	8.516	12.643
36	30	.625	.875	3.688	4 E	3	4.133	5.867	1.625	11.354	15.851

N	P	Q	R	S	T
5	1.5	1	1	6.75	1.5
6.669	2.026	1.350	1.350	9.842	1.875
8.364	2.465	1.668	1.677	13.051	2.25

COLORS: LEGEND — BLACK
 BACKGROUND — WHITE (RETROREFLECTIVE)



R7-1 NO PARKING



R7-2 NO PARKING

COLORS: LEGEND — RED
BACKGROUND — WHITE (RETROREFLECTIVE)

*See page 6-2 for arrow design



R7-2a NO PARKING

COLORS: LEGEND, CIRCLE & DIAGONAL — RED (RETROREFLECTIVE)
BACKGROUND — WHITE (RETROREFLECTIVE)
SYMBOL — BLACK



R7-3
NO PARKING

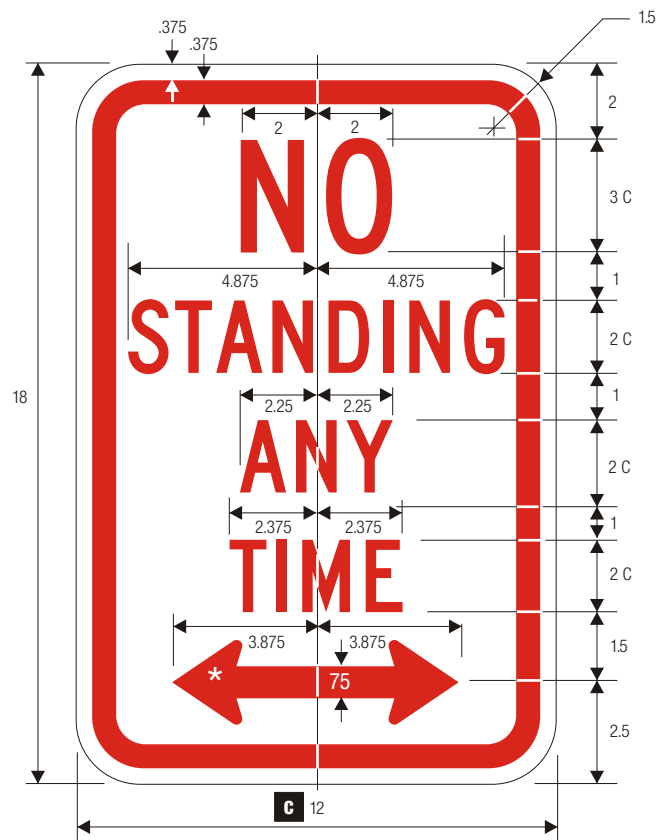

R7-4
NO PARKING

*See Page 6-2 for arrow design

COLORS: LEGEND — RED (RETROREFLECTIVE)
BACKGROUND — WHITE (RETROREFLECTIVE)



R7-5 NO PARKING

LEGEND – GREEN (RETROREFL) BACKGROUND – WHITE (RETROREFL)



R7-6 NO PARKING

LEGEND – RED (RETROREFL) BACKGROUND – WHITE (RETROREFL)



R7-7 NO PARKING

LEGEND – RED (RETROREFL) BACKGROUND – WHITE (RETROREFL)



R7-8 NO PARKING

LEGEND – GREEN (RETROREFL), WHITE SYMBOL ON BLUE (RETROREFL) BACKGROUND – WHITE (RETROREFL)

*Reduce spacing 50%.
 **See page 6-31.
 ***See page 6-2 for arrow design.

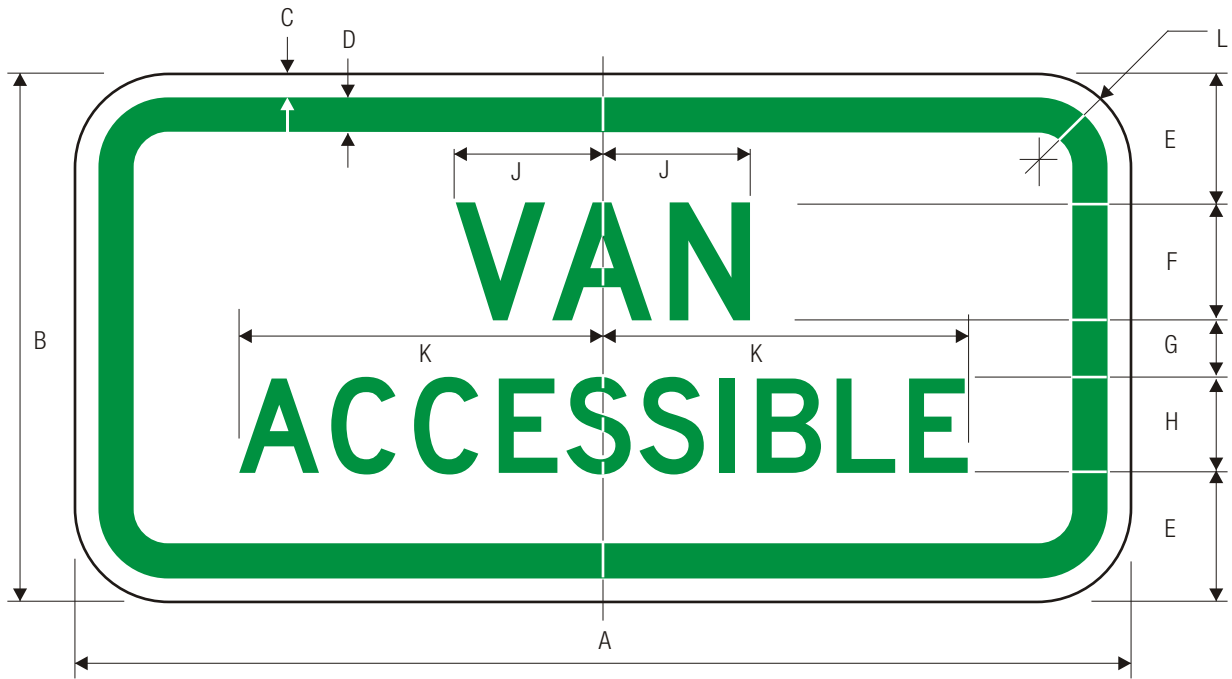

R7-8a
VAN ACCESSABLE

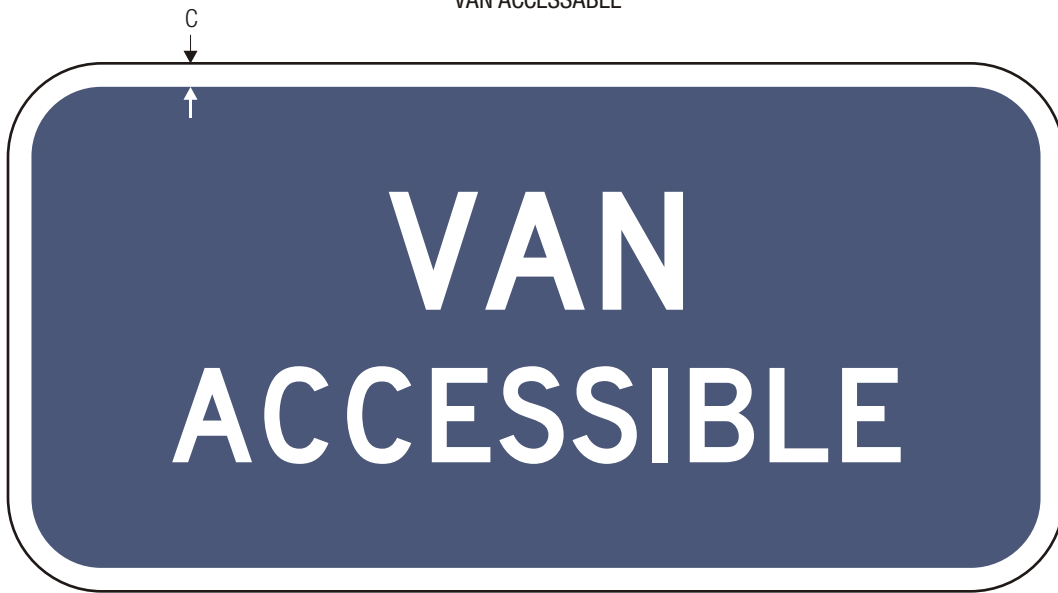

R7-8b
VAN ACCESSABLE

A	B	C	D	E	F	G	H	J	K	L
12	6	.375	.438	1.5	1.5 D	.5	1 D	1.871	3.859	1.5
18	9	.375	.438	2.25	2 D	1	1.5 D	2.493	5.784	1.5

PARKING APPLICATION

COLORS: LEGEND — GREEN (RETROREFLECTIVE) OR BLACK
BACKGROUND — WHITE (RETROREFLECTIVE)

DIRECTIONAL APPLICATION

COLORS: LEGEND — WHITE (RETROREFLECTIVE)
BACKGROUND — BLUE (RETROREFLECTIVE)



R7-9
NO PARKING, BIKE LANE

TOP LEFT
 COLORS: LEGEND — WHITE (RETROREFLECTIVE)
 BACKGROUND — RED (RETROREFLECTIVE)

*Reduce spacing 60%
 **Reduce spacing 50%

TOP RIGHT
 COLORS: LEGEND — RED (RETROREFLECTIVE)
 BACKGROUND — WHITE (RETROREFLECTIVE)

BOTTOM
 COLORS: LEGEND — RED (RETROREFLECTIVE)
 BACKGROUND — WHITE (RETROREFLECTIVE)



R7-9a

NO PARKING, BIKE LANE

COLORS: LEGEND, CIRCLE, DIAGONAL, BORDER — RED (RETROREFLECTIVE)
 SYMBOL — BLACK
 BACKGROUND — WHITE (RETROREFLECTIVE)

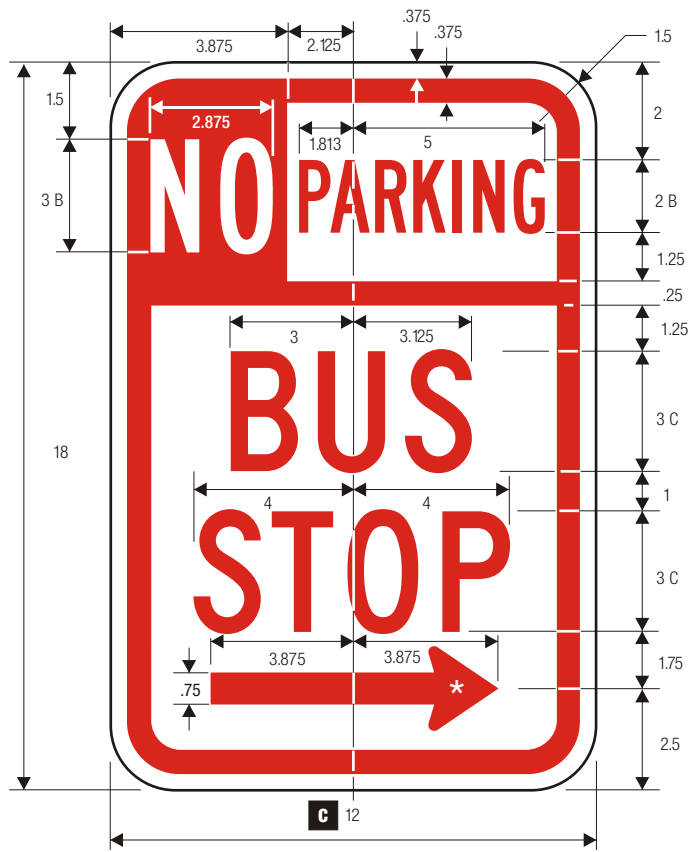

R7-107
NO PARKING



R7-107a
NO PARKING (WITH TRANSIT LOGO)

TOP LEFT
 COLORS: LEGEND — WHITE (RETROREFLECTIVE)
 BACKGROUND — RED (RETROREFLECTIVE)

TOP RIGHT
 COLORS: LEGEND — RED (RETROREFLECTIVE)
 BACKGROUND — WHITE (RETROREFLECTIVE)

BOTTOM
 COLORS: LEGEND — RED (RETROREFLECTIVE)
 BACKGROUND — WHITE (RETROREFLECTIVE)

COLORS: LEGEND, CIRCLE & DIAGONAL — RED (RETROREFLECTIVE)
 SYMBOLS, LOGO — BLACK
 ARROW — RED
 BACKGROUND — WHITE (RETROREFLECTIVE)

*See page 6-2 for arrow design
 **See page 6-33 for symbol design

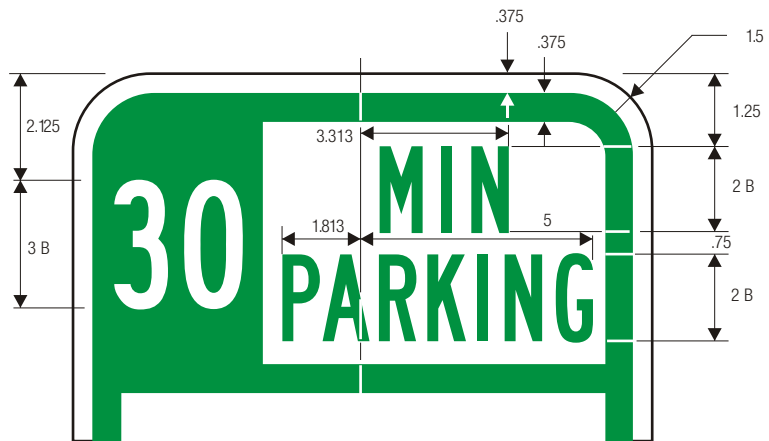

R7-108
NO PARKING-TIME

COLORS: LEGEND — GREEN (RETROREFLECTIVE)
BACKGROUND — WHITE (RETROREFLECTIVE)



C 24

R7-200

NO PARKING/RESTRICTED PARKING (COMBINED SIGN)

*See page 6-2 for arrow design

COLORS: LEGEND — RED (RETROREFLECTIVE)
BACKGROUND — WHITE (RETROREFLECTIVE)

COLORS: LEGEND — GREEN (RETROREFLECTIVE)
BACKGROUND — WHITE (RETROREFLECTIVE)

COLORS:
 LEGEND — RED (RETROREFLECTIVE)
 BACKGROUND — WHITE (RETROREFLECTIVE)

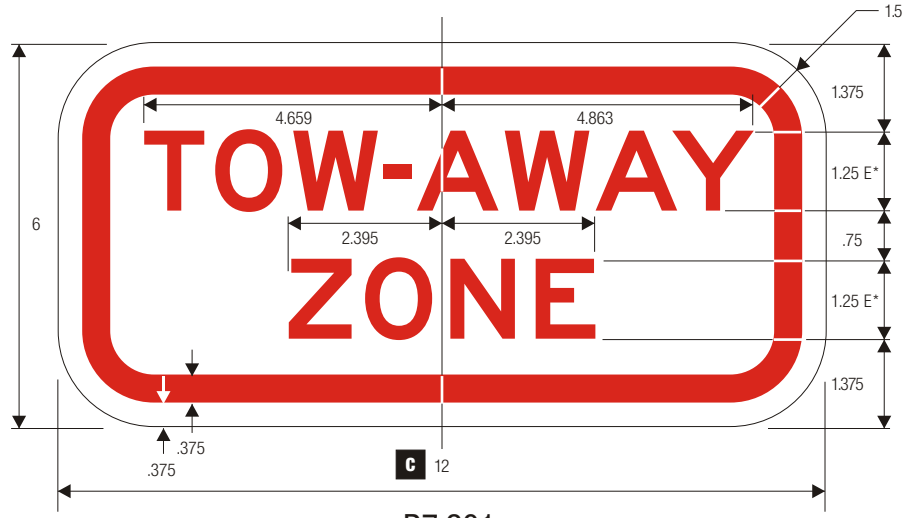

R7-201
 TOW AWAY ZONE

COLORS:
 LEGEND — BLACK
 BACKGROUND — WHITE (RETROREFLECTIVE)

**See page 6-11 for symbol design.

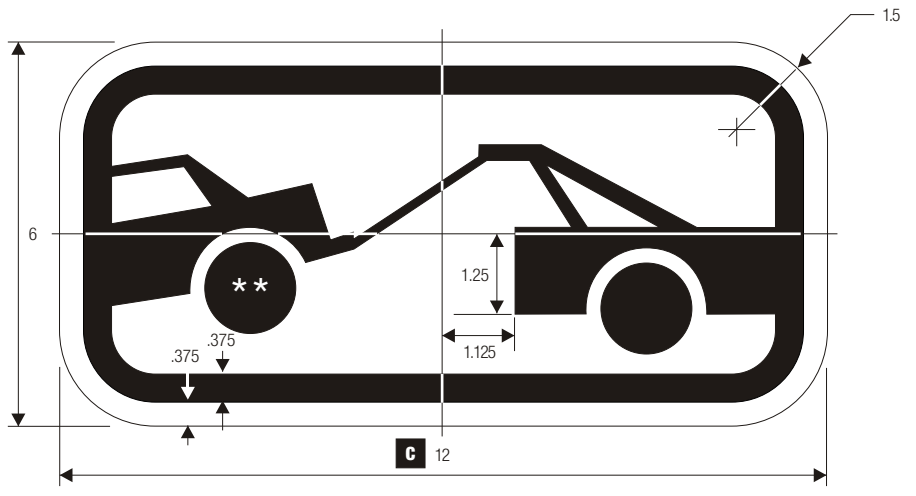

R7-201a
 TOW AWAY ZONE

COLORS:
 LEGEND — RED (RETROREFLECTIVE)
 BACKGROUND — WHITE (RETROREFLECTIVE)

*Series 2000 Standard Alphabets.

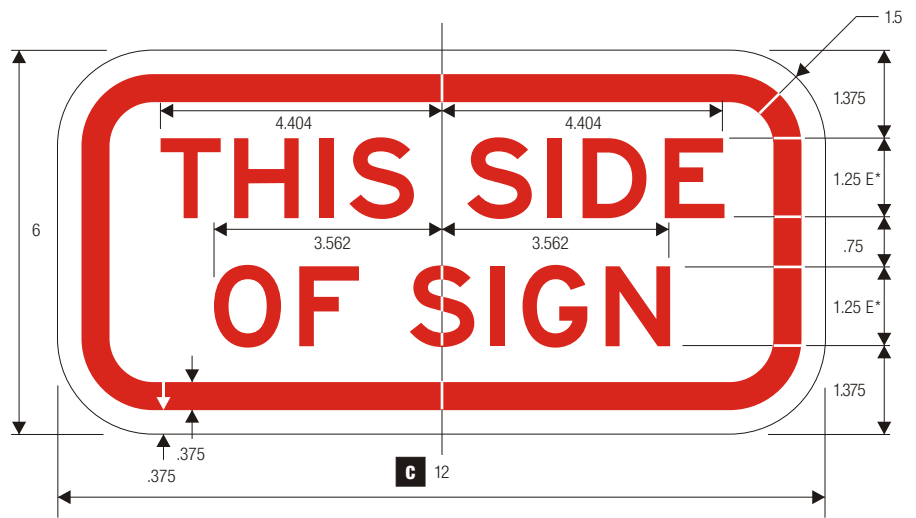

R7-202
 THIS SIDE OF SIGN



R7-203

EMERGENCY SNOW ROUTE

*Series 2000 Standard Alphabets.

C

A	B	C	D	E	F	G	H	J	K	L	M
18	24	.375	.625	9.813	2.25	2 D	1.75	3.5	2 C	3	7.685
24	30	.375	.625	12	2.75	2.5 D	2.25	4.813	2.5 C	3.187	9.591

N	P	Q	R	S
7.946	6.564	4.183	5.063	1.5
10.091	8.202	5.23	6.317	1.5

TOP COLORS: LEGEND – WHITE (RETROREFLECTIVE)
 BACKGROUND – RED (RETROREFLECTIVE)

BOTTOM COLORS: LEGEND – RED (RETROREFLECTIVE)
 BACKGROUND – WHITE (RETROREFLECTIVE)



R8-1

NO PARKING ON PAVEMENT

*Reduce spacing 50% for 24", 36" & 48" sizes.

C

A	B	C	D	E	F	G	H	J	K	L	M
18	24	.375	.625	3.5	3 D	2.5	3 C	2 D	2	2.563	6.938
24	30	.375	.625	3.625	5 D	2.25	5 C	3 D	2.25	4.313	10.125
36	48	.625	.875	6	7 D	5	7 C	4 D	4	6.063	14.25
48	60	.75	1.25	7.5	9 D	6	9 C	5 D	5	7.75	18.313

N	P	Q	R
1.625	6.688	6.875	1.5
2.438	10	10.25	1.5
3.25	13.375	13.75	2.25
4.063	16.688	17.125	3

COLORS: LEGEND — RED (RETROREFLECTIVE)
 BACKGROUND— WHITE (RETROREFLECTIVE)



R8-2

NO PARKING EXCEPT ON SHOULDER

*Reduce spacing 50% for 24", 36" & 48" sizes.

A	B	C	D	E	F	G	H	J	K	L	M
18	24	.375	.625	3.5	3 D	2.5	3 C	2 C	2	2.563	6.938
24	30	.375	.625	3.625	5 D	2.25	5 C	3 C	2.25	4.313	10.125
36	48	.625	.875	6	7 D	5	7 C	4 C	4	6.063	14.25
48	60	.75	1.25	7.5	9 D	6	9 C	5 C	5	7.75	18.313

N	P	Q
6.125	5.75	1.5
9.188	8.563	1.5
12.25	11.5	2.25
15.313	14.25	3

COLORS: LEGEND — RED (RETROREFLECTIVE)
BACKGROUND — WHITE (RETROREFLECTIVE)



R8-3

NO PARKING

*Reduce spacing 50% for 24", 36" & 48" sizes.

**Recommend square shape for 36" and 48" sizes.

	A	B	C	D	E	F	G	H	J	K	L
	18	24	.375	.625	7	4 D	3	3 C	3.5	6.938	1.5
C	24	30	.375	.625	7.25	6 D	4.5	5 C	5.188	10.125	1.5
	36	36	.625	.875	7.5	8 D	6	7 C	6.875	14.25	2.25
	48	48	.75	1.25	10.5	10 D	8	9 C	8.625	18.313	3

COLORS: LEGEND – RED (RETROREFLECTIVE)
 BACKGROUND – WHITE (RETROREFLECTIVE)



R8-3a
NO PARKING (SYMBOL)

	A	B	C	D	E	F	G	H	J
	12	.375	.375	3	6 EM	4.875	3.875	1	1.5
	18	.375	.625	4.5	9 EM	7.5	6	1.5	1.5
C	24	.375	.625	6	12 EM	10.5	8.5	2	1.5
	36	.625	.875	9	18 EM	15.75	12.75	3	2.25
	48	.75	1.25	12	24 EM	21	17	4	3

COLORS: CIRCLE & DIAGONAL – RED (RETROREFLECTIVE)
 LETTER, BORDER – BLACK
 BACKGROUND – WHITE (RETROREFLECTIVE)



R8-3b
PARKING PLAQUE

OTHER TYPICAL LEGENDS

**ON
TRACKS**

**6AM
TO 6PM**
←

**EXCEPT ON
SHOULDERS**

**LOADING
ZONE**
↔

A	B	C	D	E	F	G	H	J	K	L
12	VAR	.375	.375	VAR	VAR	VAR	VAR	VAR	VAR	1.5
24	VAR	.375	.625	VAR	VAR	VAR	VAR	VAR	VAR	1.5

COLORS: LEGEND — RED (RETROREFLECTIVE)
BACKGROUND — WHITE (RETROREFLECTIVE)



R8-3c
NO PARKING PLAQUE

*Series 2000 Standard Alphabets.
**Reduce spacing to fit for 30" size.

	A	B	C	D	E	F	G	H	J	K
	12	9	.375	.438	2.625	1.375 D	1	1.105	4.530	1.5
	18	12	.375	.625	3	2 D	2	1.606	6.585	1.5
C	24	18	.375	.625	4.75	3 D	2.5	2.409	9.88	1.5
	30	24	.5	.75	6	4 D	4	3.212	12.838	1.875

COLORS: LEGEND — RED (RETROREFLECTIVE)
BACKGROUND — WHITE (RETROREFLECTIVE)

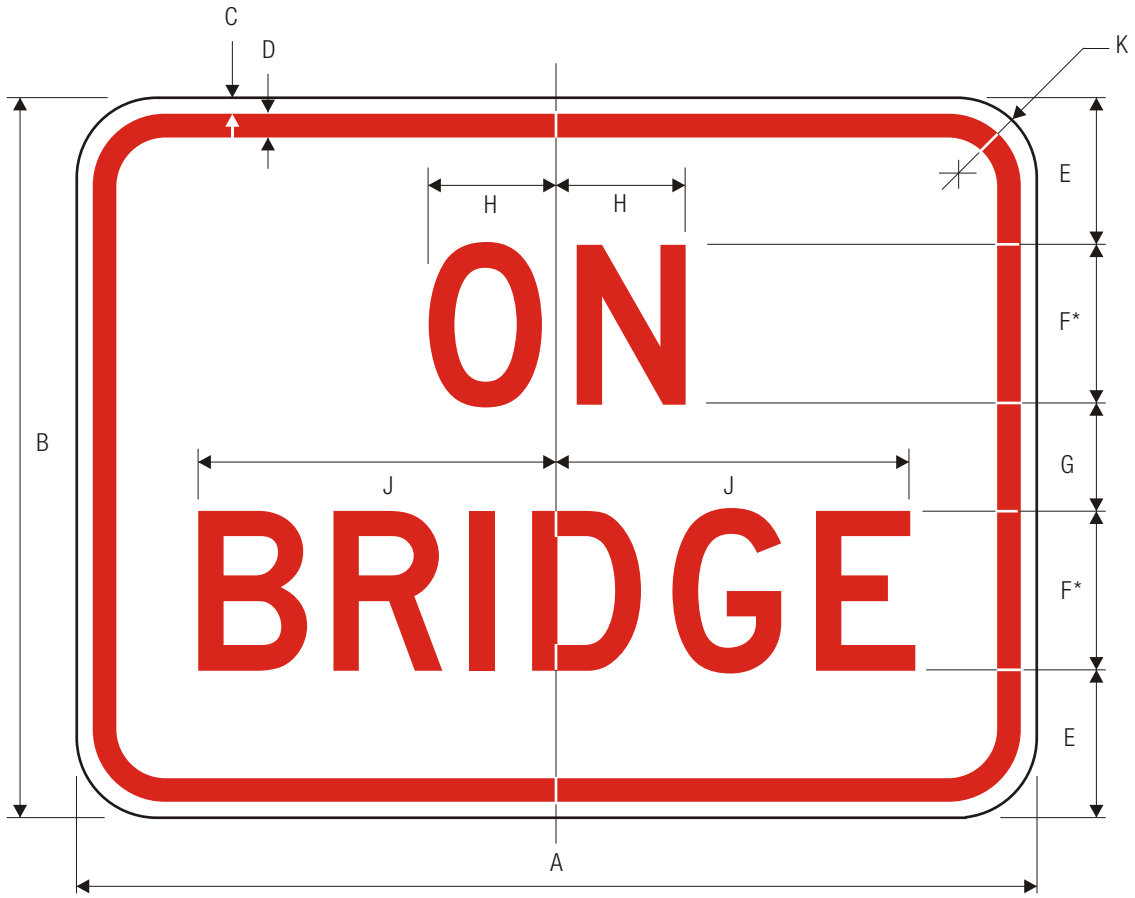

R8-3d
NO PARKING PLAQUE

*Series 2000 Standard Alphabets.

	A	B	C	D	E	F	G	H	J	K
	12	9	.375	.438	2	2 D	1	1.606	4.481	1.5
	18	12	.375	.625	2	3 D	2	2.408	6.720	1.5
C	24	18	.375	.625	3.75	4 D	2.5	3.212	8.963	1.5
	30	24	.5	.75	5	5 D	4	4.015	11.205	1.875

COLORS: LEGEND – RED (RETROREFLECTIVE)
BACKGROUND – WHITE (RETROREFLECTIVE)



R8-4
EMERGENCY PARKING ONLY

*Reduce spacing 50% for 48" size.

C

A	B	C	D	E	F	G	H	J	K	L	M
30	24	.375	.625	3.5	4 C	2.5	4 D	12.5	13	11.188	11.375
48	36	.625	.875	5	6 D	4	6 D	20.438	21.125	16.75	17

N	P	Q
6.438	7	1.5
10.063	10.563	2.25

COLORS: LEGEND — BLACK
BACKGROUND — WHITE (RETROREFLECTIVE)



R8-5

NO STOPPING ON PAVEMENT

*Reduce spacing 25%.

C

A	B	C	D	E	F	G	H	J	K	L	M
18	24	.375	.625	3.5	3 D	2.5	3 B	2 D	2	2.563	6
24	30	.375	.625	3.625	5 D	2.25	5 B	3 D	2.25	4.313	10
36	48	.625	.875	6	7 D	5	7 B	4 D	4	6.063	14
48	60	.75	1.25	7.5	9 D	6	9 B	5 D	5	7.75	18

N	P	Q	R
1.625	6.688	6.875	1.5
2.438	10	10.25	1.5
3.25	13.375	13.75	2.25
4.063	16.688	17.125	3

COLORS: LEGEND — RED (RETROREFLECTIVE)
 BACKGROUND — WHITE (RETROREFLECTIVE)

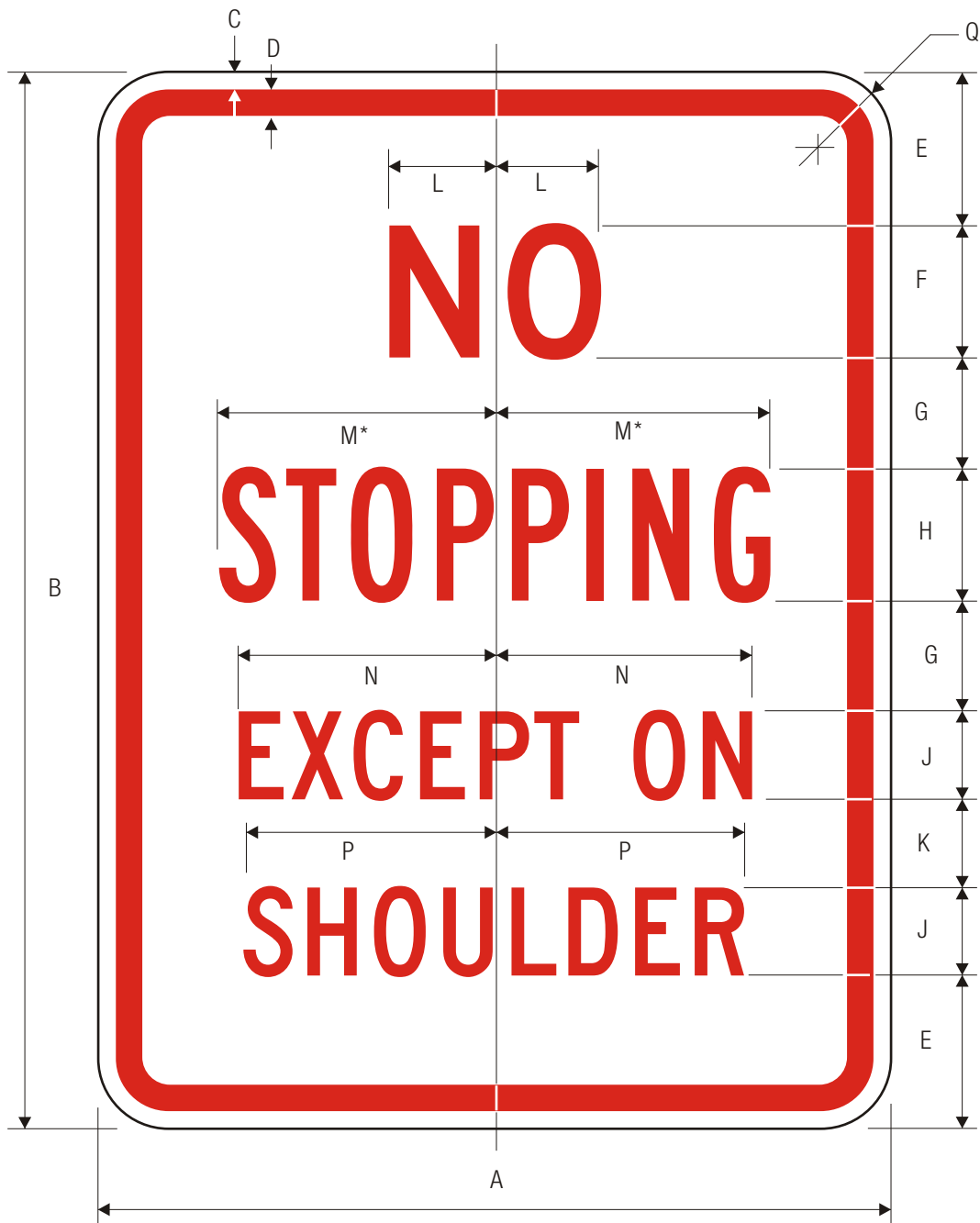

R8-6

NO STOPPING EXCEPT ON SHOULDER

*Reduce spacing 25%.

C

A	B	C	D	E	F	G	H	J	K	L	M
18	24	.375	.625	3.5	3 D	2.5	3 B	2 C	2	2.563	6
24	30	.375	.625	3.625	5 D	2.25	5 B	3 C	2.25	4.313	10
36	48	.625	.875	6	7 D	5	7 B	4 C	4	6.063	14
48	60	.75	1.25	7.5	9 D	6	9 B	5 C	5	7.75	18

N	P	Q
6.125	5.75	1.5
9.188	8.563	1.5
12.25	11.5	2.25
15.938	14.25	3

COLORS: LEGEND — RED (RETROREFLECTIVE)
BACKGROUND — WHITE (RETROREFLECTIVE)



R8-7

EMERGENCY STOPPING ONLY

*Reduce spacing 50% for 48" size.

A	B	C	D	E	F	G	H	J	K	L	M
30	24	.375	.625	3.5	4 C	2.5	4 D	12.5	13	12.75	6.438
48	36	.625	.875	5	6 D	4	6 D	20.438	21.125	19.125	10.063

N	P
7	1.5
10.563	2.25

COLORS: LEGEND — BLACK
BACKGROUND — WHITE (RETROREFLECTIVE)



R8-8
DO NOT STOP ON TRACKS

	A	B	C	D	E	F	G	H	J	K	L	M	N
C	24	30	.375	.625	3.625	4 D	2.25	9.25	9.625	6.563	3.5	10	1.5
	36	48	.625	.875	6	6 D	4	14	14.438	9.75	5.25	15	2.25
	48	60	.75	1.25	7.25	8 D	4.25	18.5	19.25	13.125	7	20	3

COLORS: LEGEND — BLACK
BACKGROUND — WHITE (RETROREFLECTIVE)

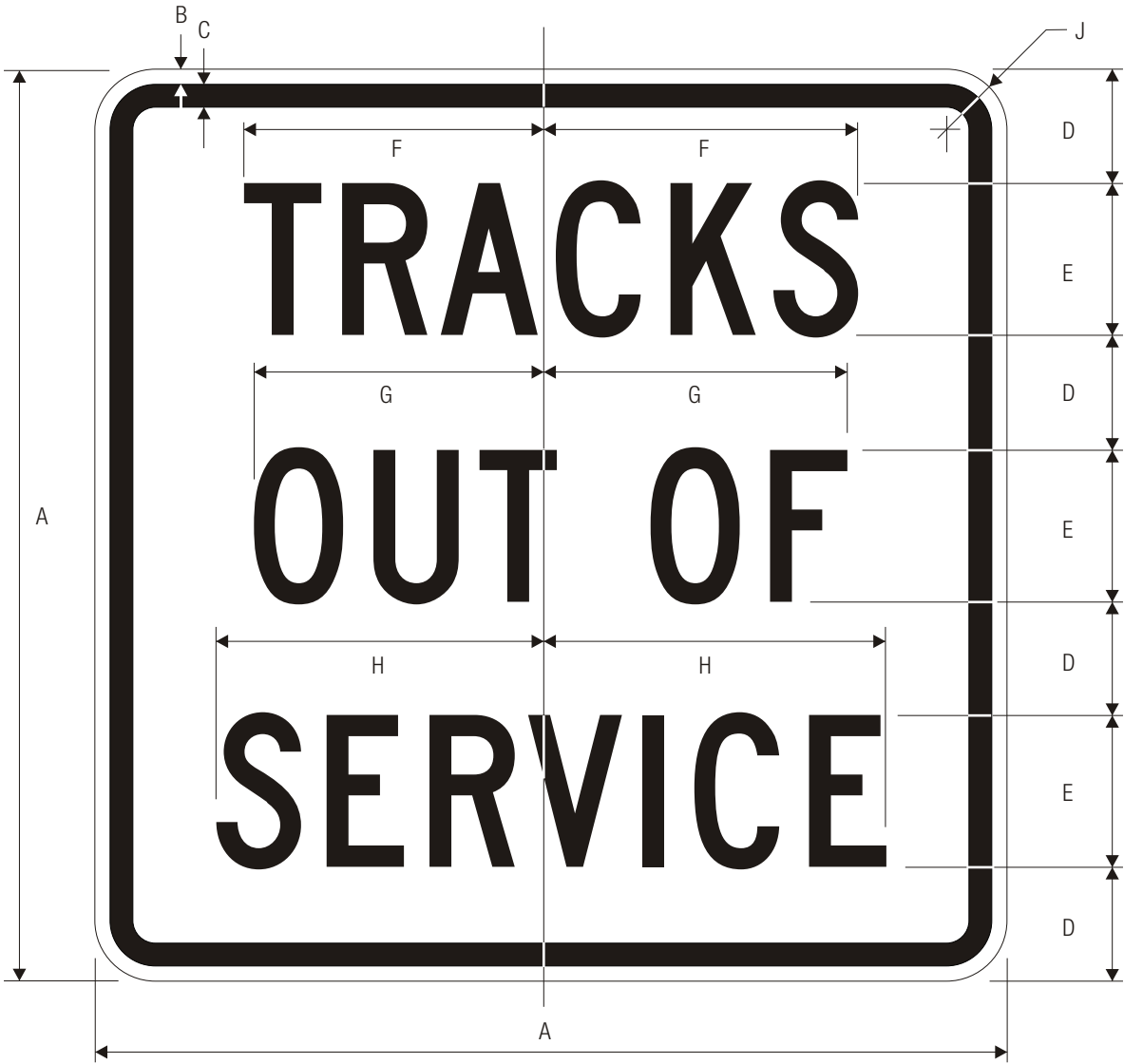

R8-9

TRACKS OUT OF SERVICE

	A	B	C	D	E	F	G	H	J
	18	.375	.625	2.25	3 C	6.061	5.856	6.614	1.5
C	24	.375	.625	3	4 C	8.086	7.805	8.826	1.5
	36	.625	.875	4.5	6 C	12.129	11.708	13.230	2.25
	48	.75	1.25	6	8 C	16.172	15.631	17.653	3

COLORS: LEGEND — BLACK
 BACKGROUND — WHITE (RETROREFLECTIVE)

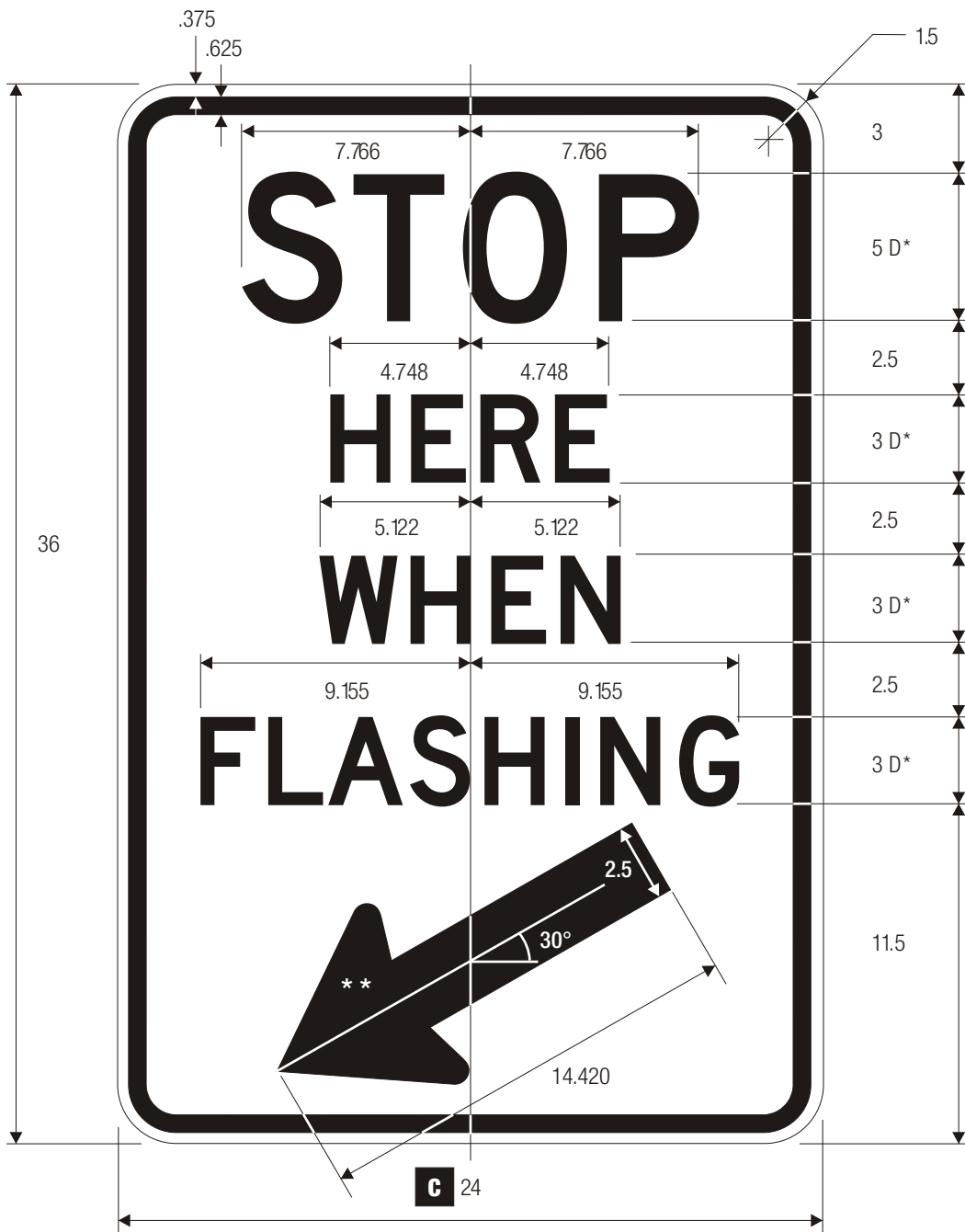

R8-10

STOP HERE WHEN FLASHING

*Series 2000 Standard Alphabets.

**See page 6-2 for design details.

COLORS: SYMBOL — BLACK
 BACKGROUND — WHITE (RETROREFLECTIVE)



R9-1 WALK ON LEFT FACING TRAFFIC



R9-2 CROSS ONLY AT CROSS WALKS

COLORS: LEGEND — BLACK
 BACKGROUND — WHITE (RETROREFLECTIVE)

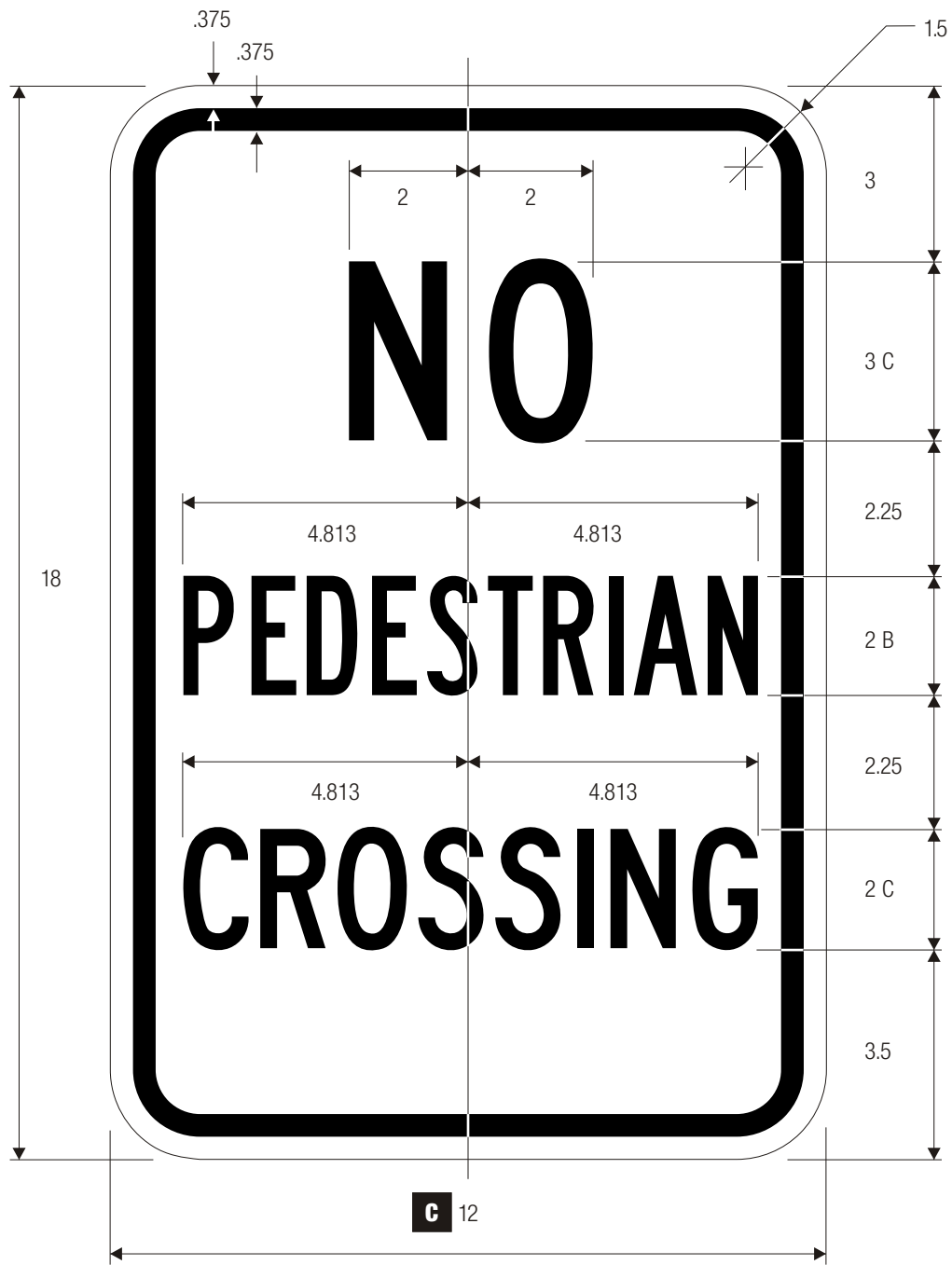

R9-3

NO PEDESTRIAN CROSSING

COLORS: LEGEND — BLACK
 BACKGROUND— WHITE (RETROREFLECTIVE)



R9-3a
NO PEDESTRIAN CROSSING

COLORS: CIRCLE & DIAGONAL — RED (RETROREFLECTIVE) *See page 6-10 for symbol design
 SYMBOL — BLACK
 BACKGROUND — WHITE (RETROREFLECTIVE)

	A	B	C	D	E	F	G	H	J
C	18	.375	.625	3.5	5.5	6.375	7.875	1.5	1.5
	24	.375	.625	4.5	7.5	8.5	10.5	2	1.5
	30	.5	.75	5.75	9.25	10.625	13.063	2.5	1.875

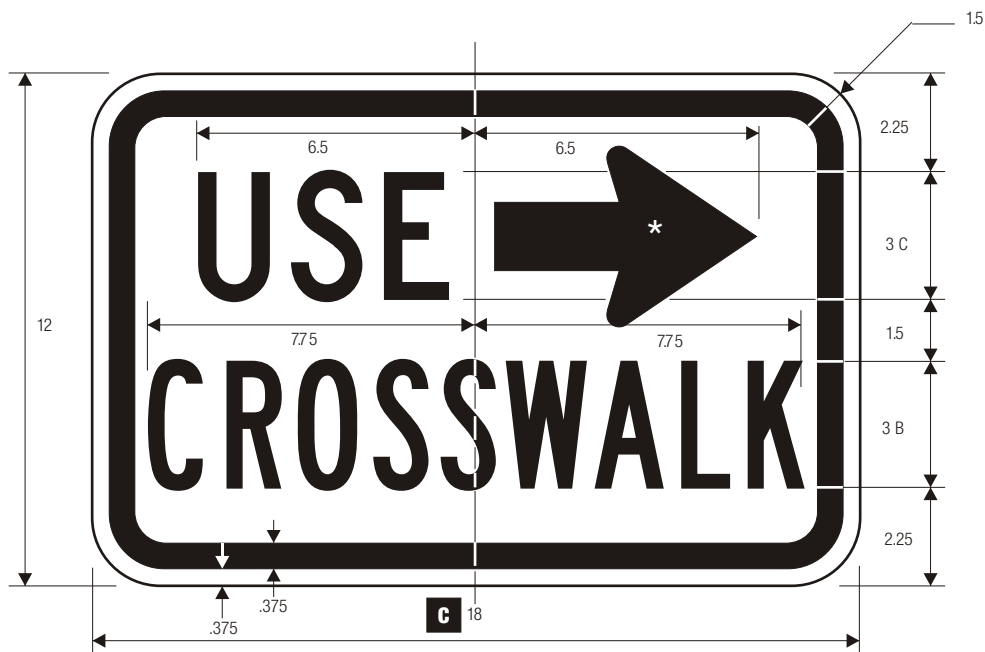

R9-3b
USE CROSSWALK

COLORS: LEGEND — BLACK
 BACKGROUND — WHITE (RETROREFLECTIVE)

*See page 6-2 for arrow design

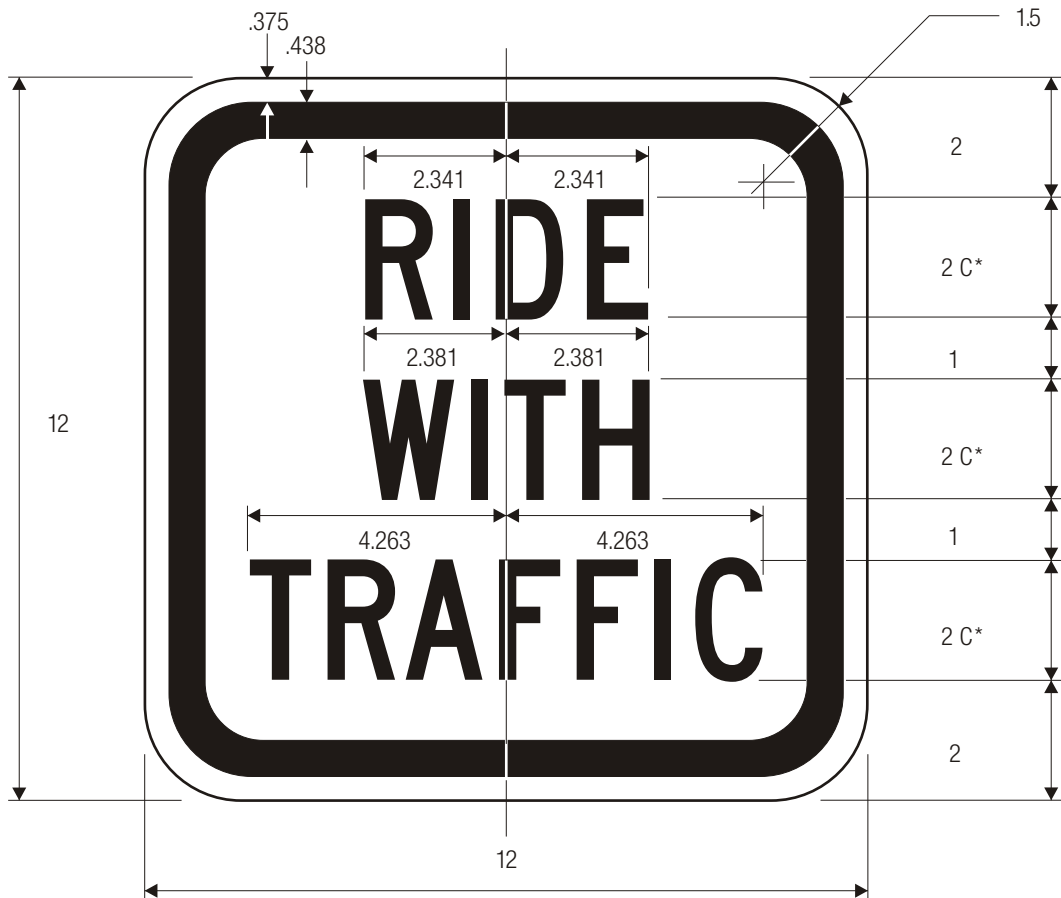

R9-3c

RIDE WITH TRAFFIC

*Series 2000 Standard Alphabets.

COLORS: LEGEND — BLACK
 BACKGROUND — WHITE (RETROREFLECTIVE)



R9-4
NO HITCH HIKING

*Series 2000 Standard Alphabets

A	B	C	D	E	F	G	H	J	K	L	M
12	18	.375	.438	2.75	4.5 C	1.5	2.5	3.022	3.747	4.413	1.5
18	24	.375	.625	3	6 C	2	4 C	4.313	6	6.75	1.5

C

COLORS: LEGEND — BLACK
BACKGROUND — WHITE (RETROREFLECTIVE)



R9-4a
HITCH HIKING PROHIBITED

*See page 6-9 for symbol design

	A	B	C	D	E	F	G	H	J
	12	.375	.438	4.75	3.845	.905	2.833	6.333	1.5
C	18	.375	.625	7.875	6.375	1.5	7.75	10.5	1.5
	24	.375	.625	10.5	8.5	2	5	14	1.5

COLORS: CIRCLE & DIAGONAL – RED (RETROREFLECTIVE)
 LEGEND – BLACK
 BACKGROUND – WHITE (RETROREFLECTIVE)

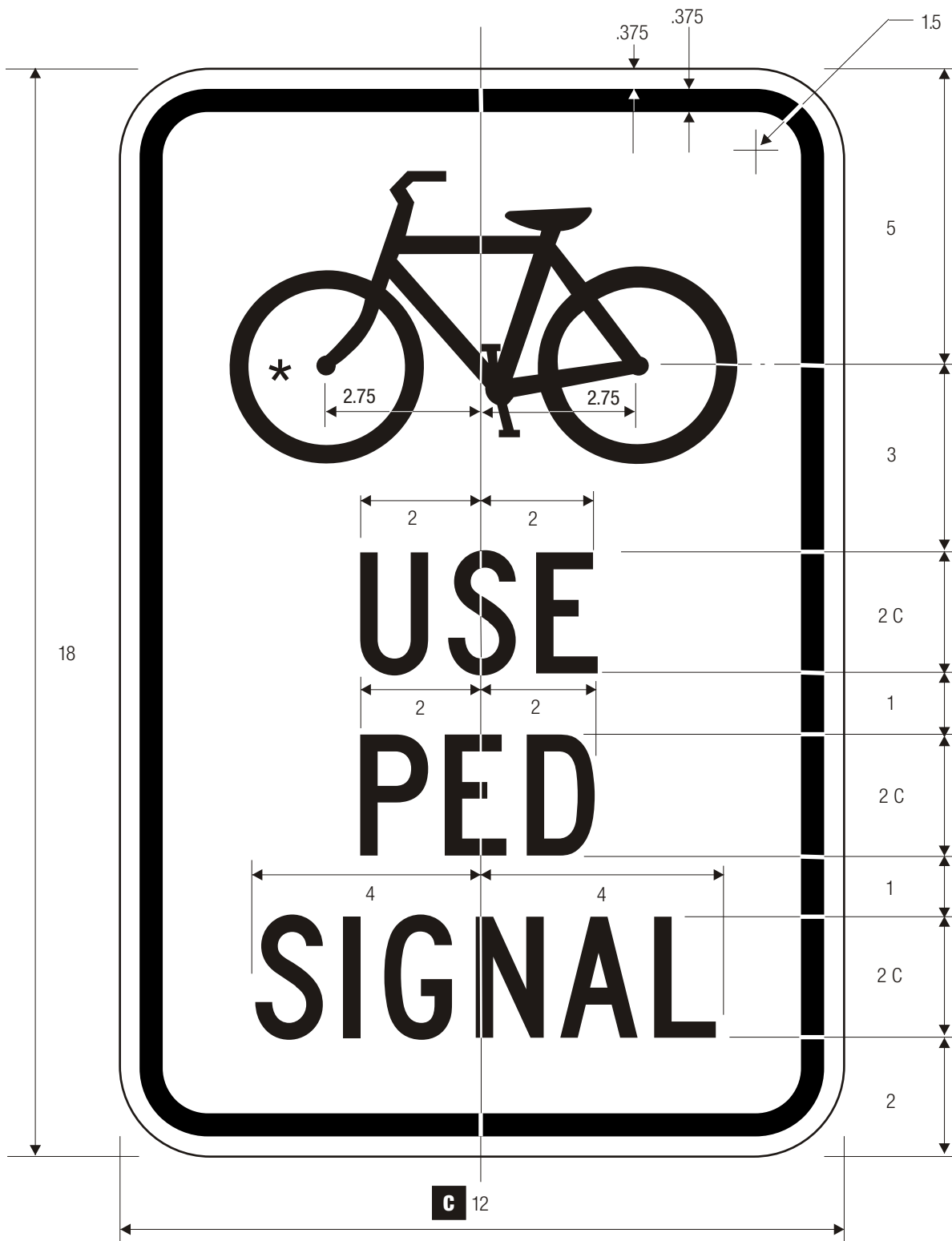

R9-5
BICYCLISTS USE PEDESTRIAN SIGNAL

*See page 6-7 for design.

COLORS: LEGEND — BLACK
BACKGROUND — WHITE (RETROREFLECTIVE)

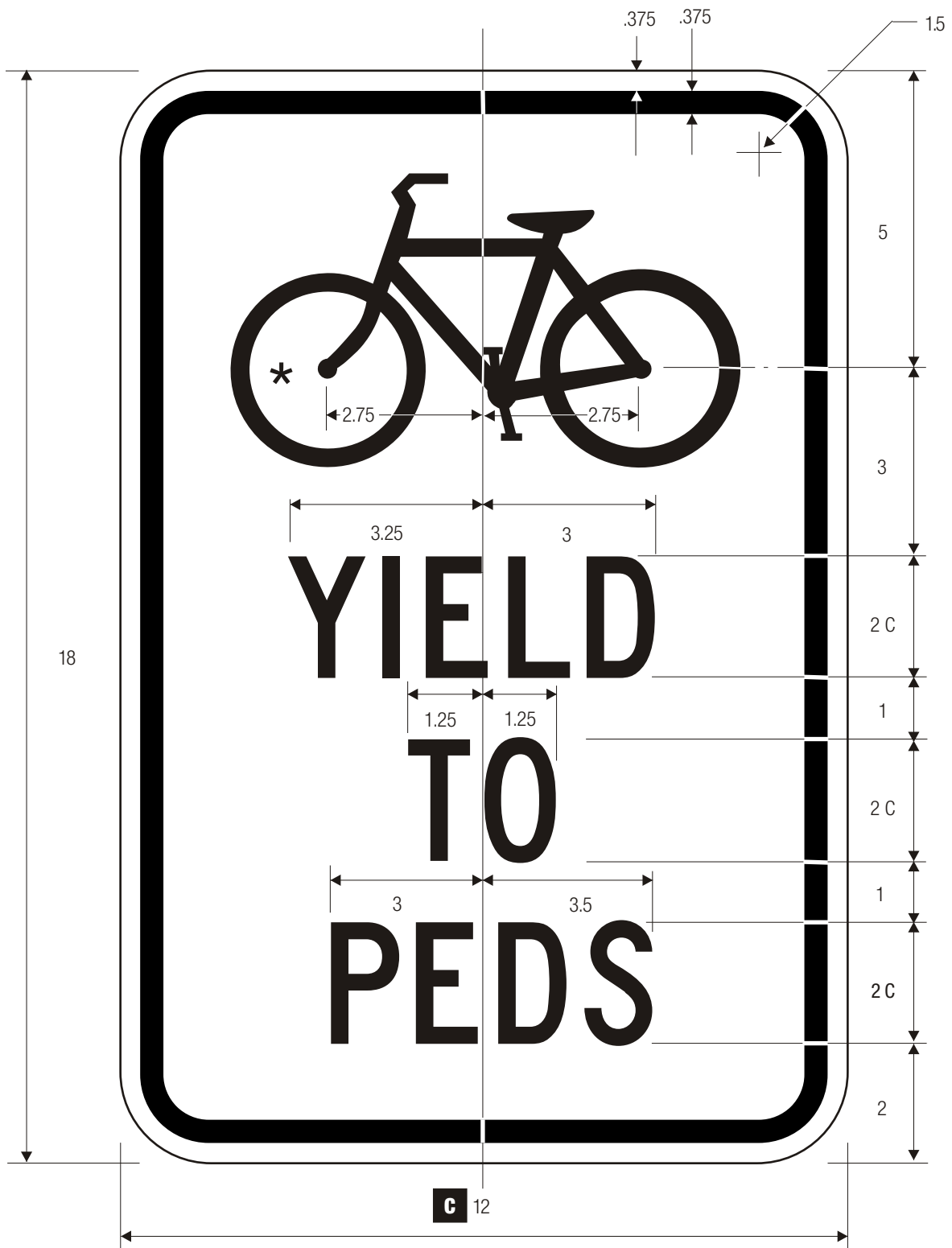

C 12

R9-6

BICYCLISTS YIELD TO PEDESTRIANS

*See page 6-7 for symbol design.

COLORS: LEGEND — BLACK
 BACKGROUND — WHITE (RETROREFLECTIVE)



*See pages 6-7 and 6-10 for symbol design.

COLORS: LEGEND — BLACK
BACKGROUND — WHITE (RETROREFLECTIVE)

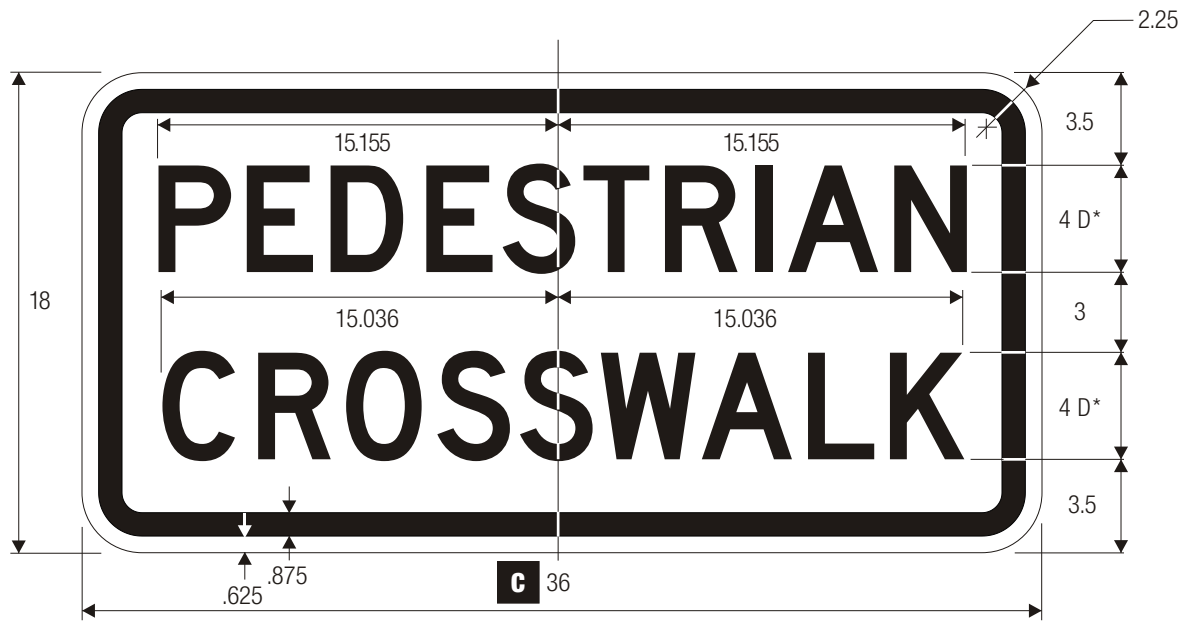

R9-8

PEDESTRIAN CROSSWALK

*Series 2000 Standard Alphabets.



R9-9

SIDEWALK CLOSED

	A	B	C	D	E	F	G	H	J	K
	24	12	.375	.625	2.125	3 D*	1.75	9.367	7.225	1.5
C	30	18	.625	.875	3.5	4 D*	3	12.490	9.622	2.25

COLORS: LEGEND — BLACK
 BACKGROUND — WHITE (RETROREFLECTIVE)

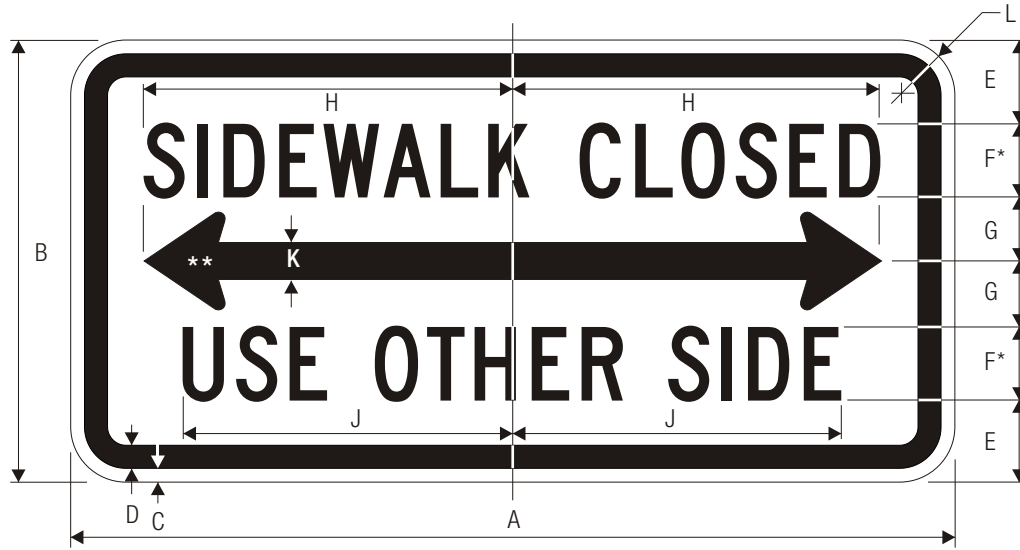

R9-10 SIDEWALK CLOSED USE OTHER SIDE

A	B	C	D	E	F	G	H	J	K	L
24	12	.375	.625	1.75	2 C	2.250	9.967	9.014	1.6	1.5
48	24	.75	1.25	4.5	4 C	3.5	20	17.882	2	3

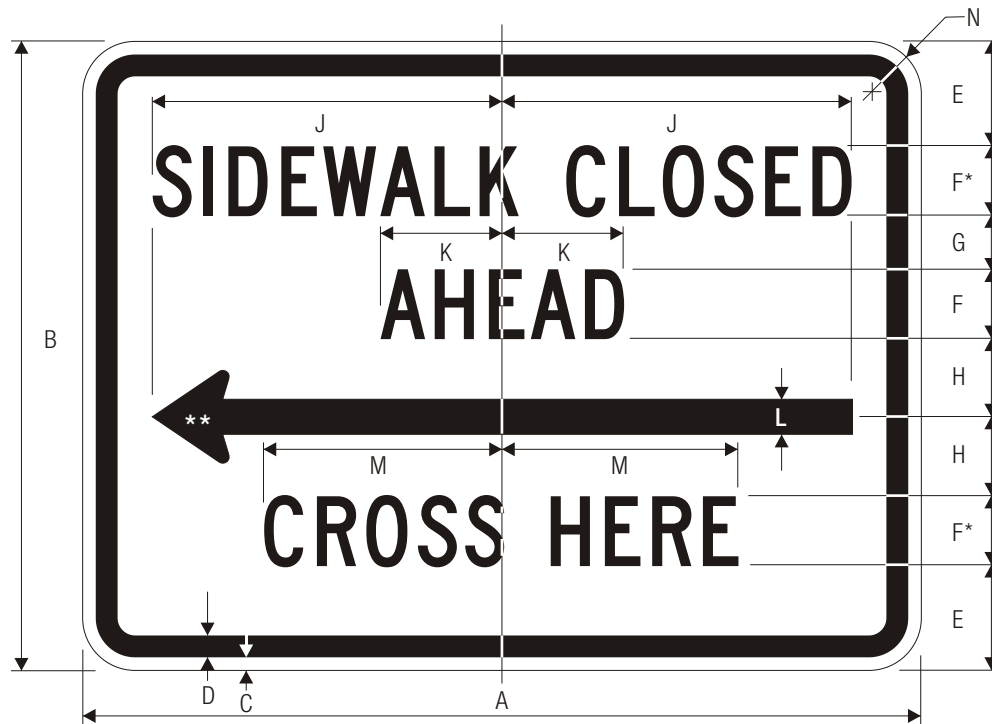

R9-11 SIDEWALK CLOSED AHEAD CROSS HERE

A	B	C	D	E	F	G	H	J	K	L	M	N
24	12	.375	.625	1.75	1.5 D	.75	1.625	9.367	3.422	.680	6.284	1.5
48	36	.75	1.25	6	4 C	3	4.5	20	6.971	2	13.570	3

COLORS: LEGEND — BLACK
 BACKGROUND — WHITE (RETROREFLECTIVE)

*Series 2000 Standard Alphabets.
 **See page 6-2 for arrow design.

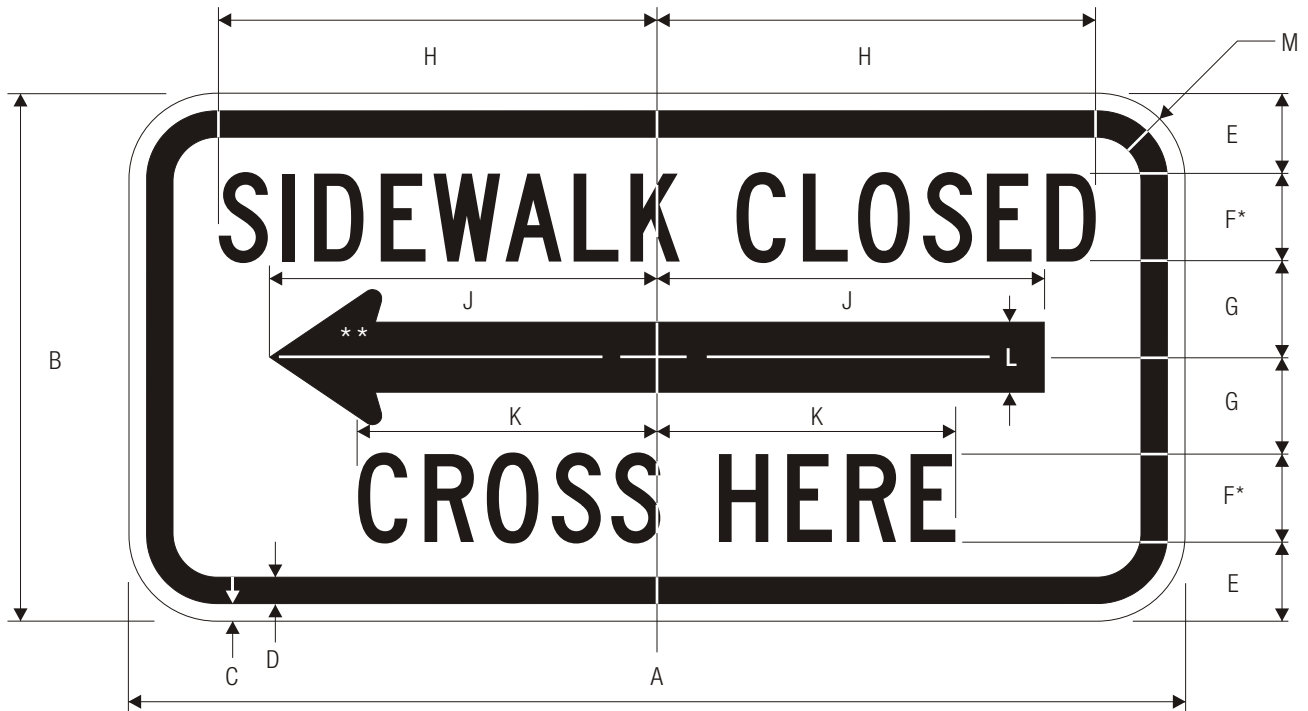

R9-11a

SIDEWALK CLOSED CROSS HERE

*Series 2000 Standard Alphabets.

**See page 6-2 for arrow design.

A	B	C	D	E	F	G	H	J	K	L	M
24	12	.375	.625	1.75	2 C	2.250	9.967	8.75	7.785	1.6	1.5
48	24	.75	1.25	4.5	4 C	3.5	20	17.882	13.5	2	3

COLORS: LEGEND — BLACK
 BACKGROUND — WHITE (RETROREFLECTIVE)

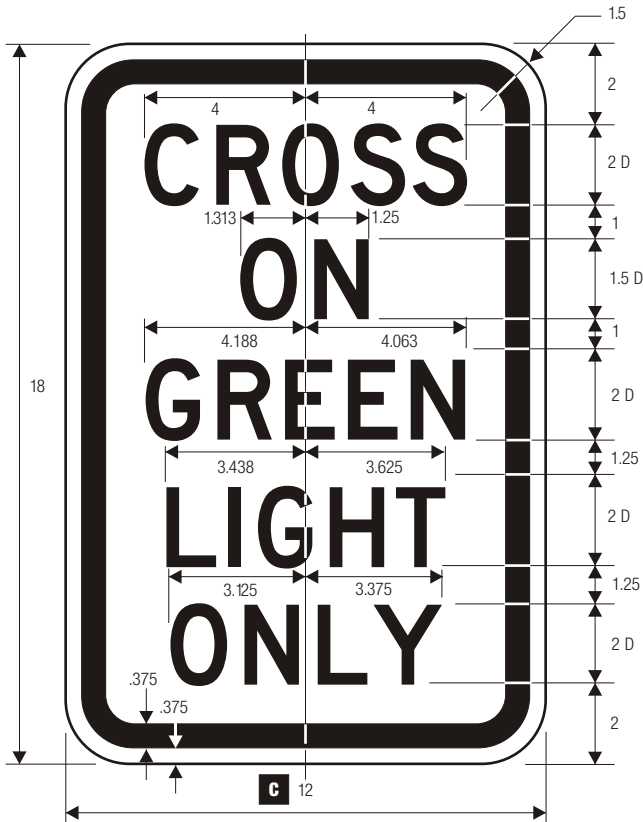

R10-1

CROSS ON GREEN LIGHT ONLY

COLORS: LEGEND — BLACK
 BACKGROUND — WHITE (RETROREFLECTIVE)

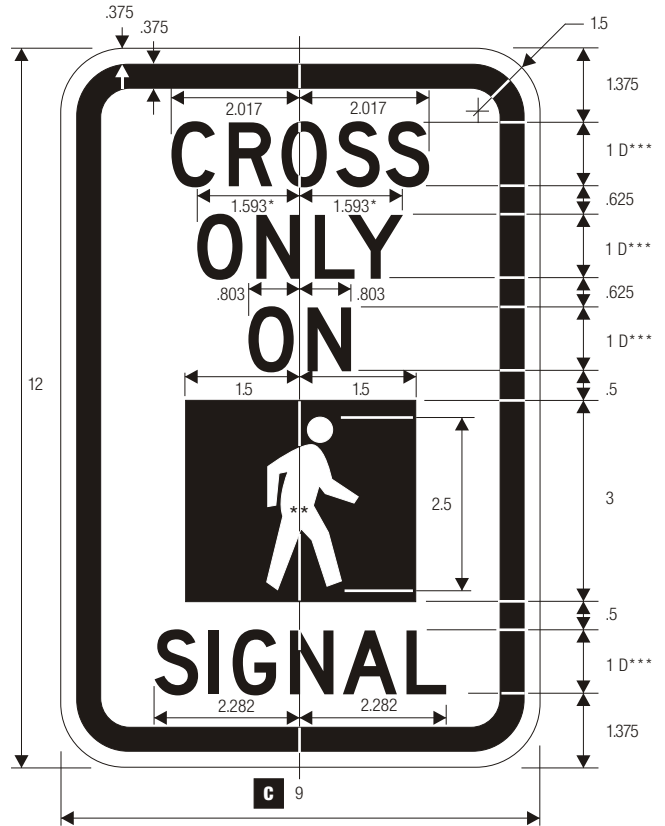

R10-2a

CROSS ONLY ON WALK SIGNAL

*Reduce spacing to fit.
 **See page 6-10 for symbol design.
 ***Series 2000 Standard Alphabets.

COLORS: LEGEND — BLACK
 SYMBOL — WHITE (RETROREFLECTIVE) ON BLACK
 BACKGROUND — WHITE (RETROREFLECTIVE)

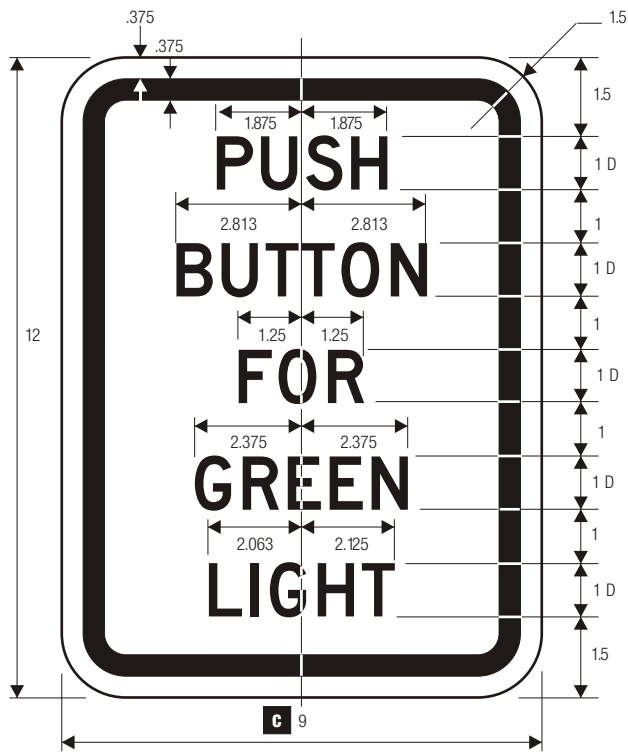

R10-3
PEDESTRIAN TRAFFIC SIGNAL

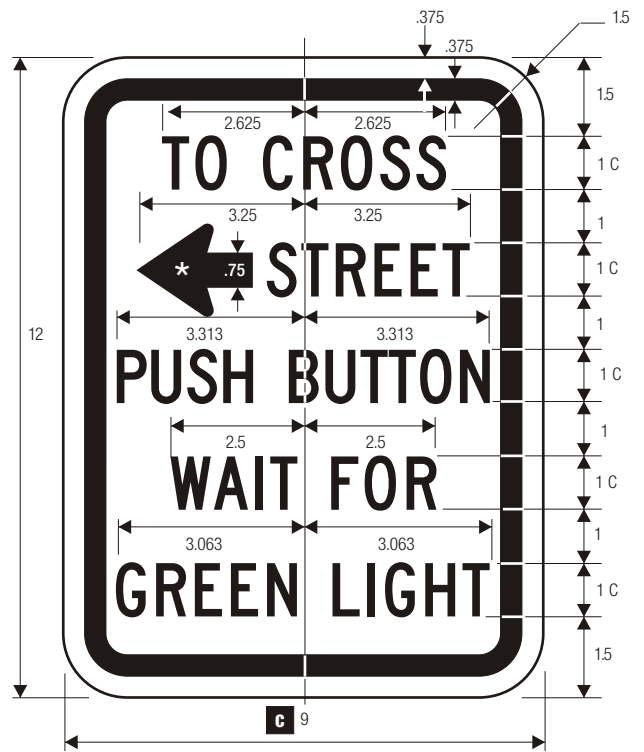

R10-3a
PEDESTRIAN TRAFFIC SIGNAL

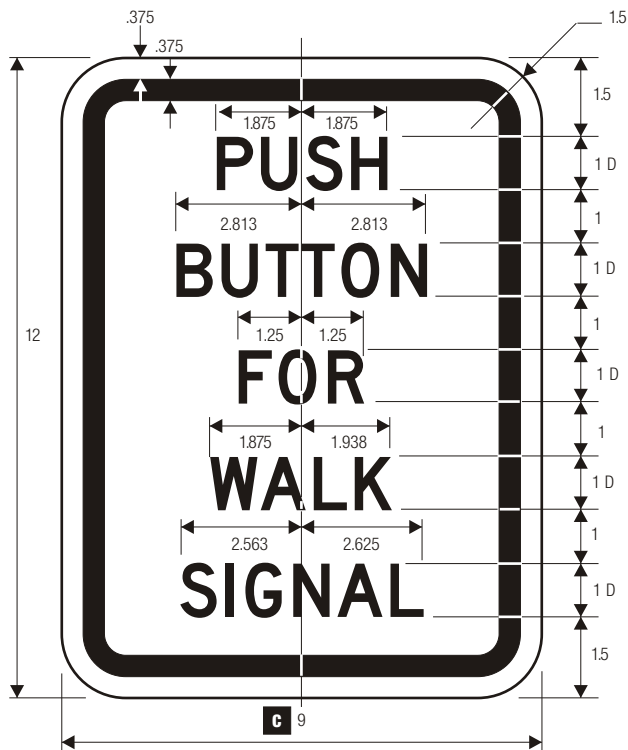

R10-4
PEDESTRIAN TRAFFIC SIGNAL

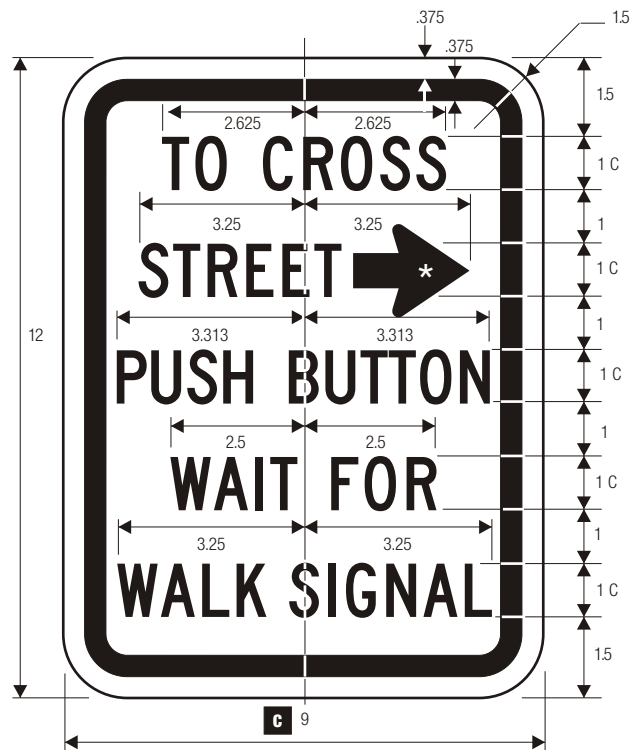

R10-4a
PEDESTRIAN TRAFFIC SIGNAL

COLORS: LEGEND & SYMBOL – BLACK
BACKGROUND – WHITE (RETROREFLECTIVE)

*See page 6-2 for arrow design

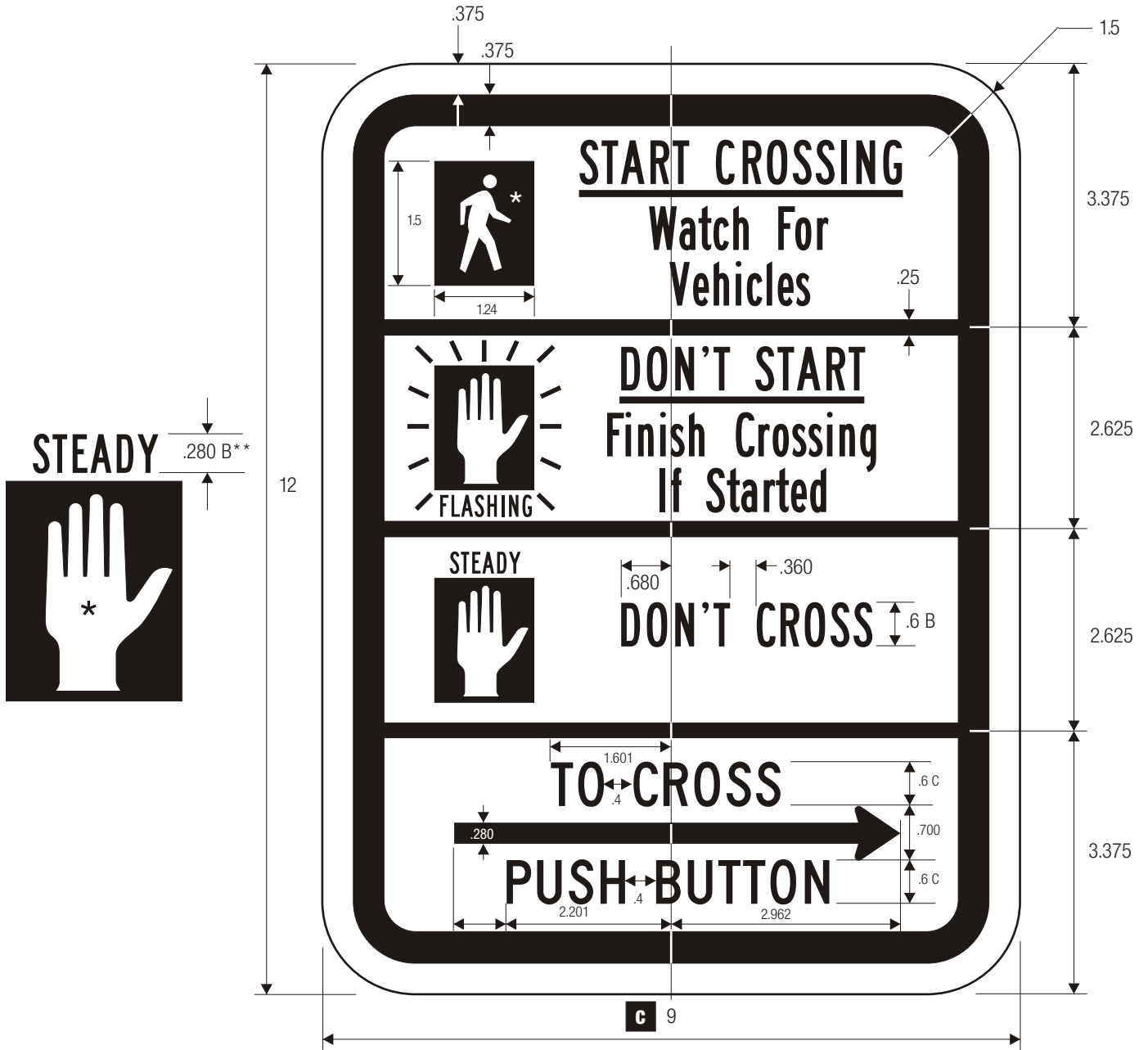

*See pages 6-8 and 6-10 for symbol designs.
 **Series 2000 Standard Alphabets.

R10-3b PEDESTRIAN TRAFFIC SIGNAL

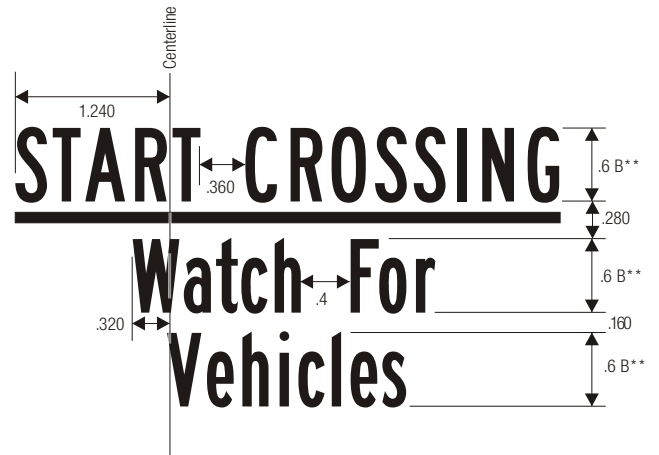

COLORS: LEGEND — BLACK
 BACKGROUND — WHITE (RETROREFLECTIVE)
 HAND SYMBOL — ORANGE (RETROREFLECTIVE)

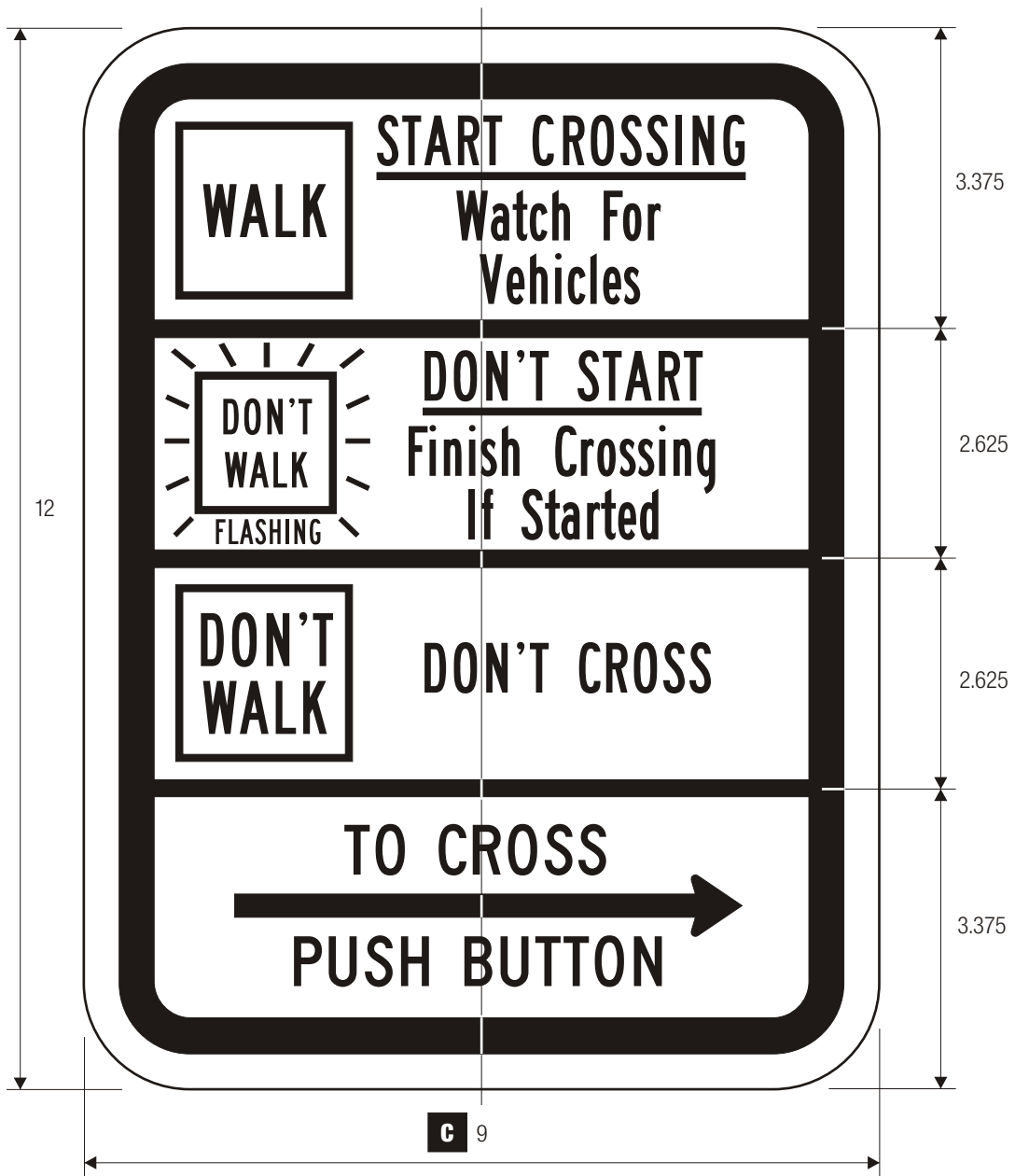

C 9

R10-3c
PEDESTRIAN TRAFFIC SIGNAL

Use Series 2000 Standard Alphabets.

COLORS: LEGEND — BLACK
 BACKGROUND — WHITE (RETROREFLECTIVE)
 DON'T WALK — ORANGE (RETROREFLECTIVE)

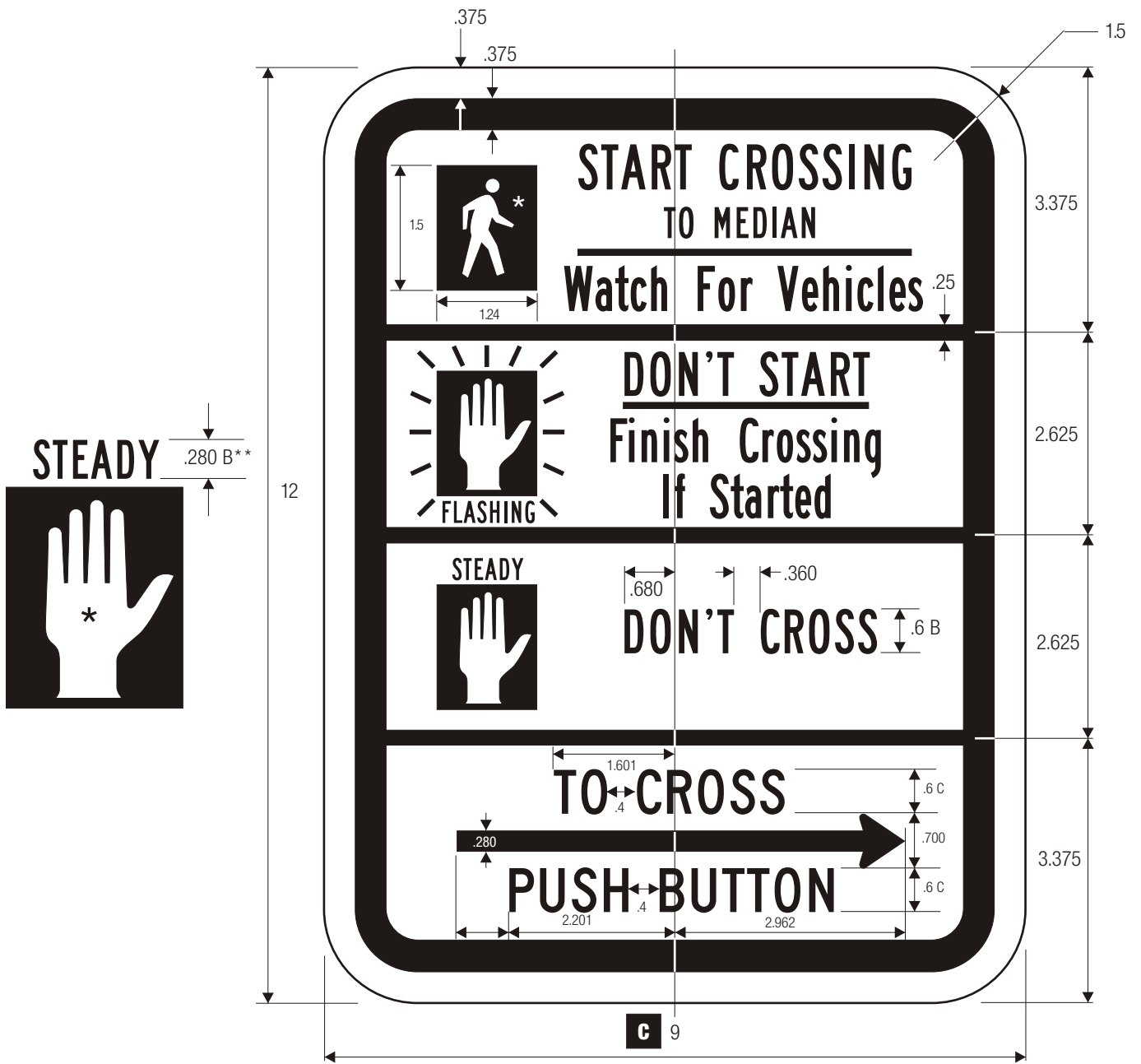

R10-3d PEDESTRIAN TRAFFIC SIGNAL

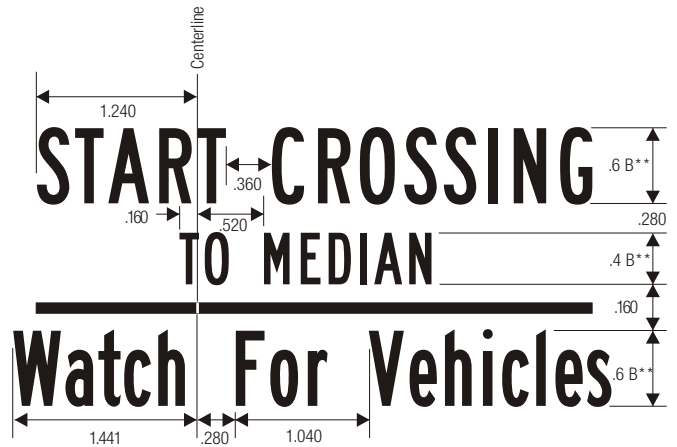
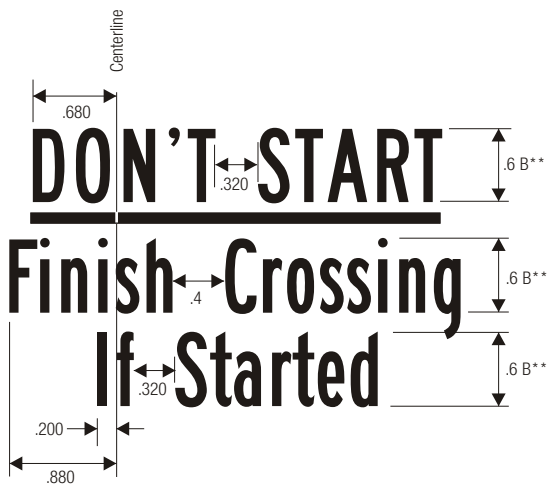

*See pages 6-8 and 6-10 for symbol designs.
 **Series 2000 Standard Alphabets.

COLORS: LEGEND — BLACK
 BACKGROUND — WHITE (RETROREFLECTIVE)
 HAND SYMBOL — ORANGE (RETROREFLECTIVE)

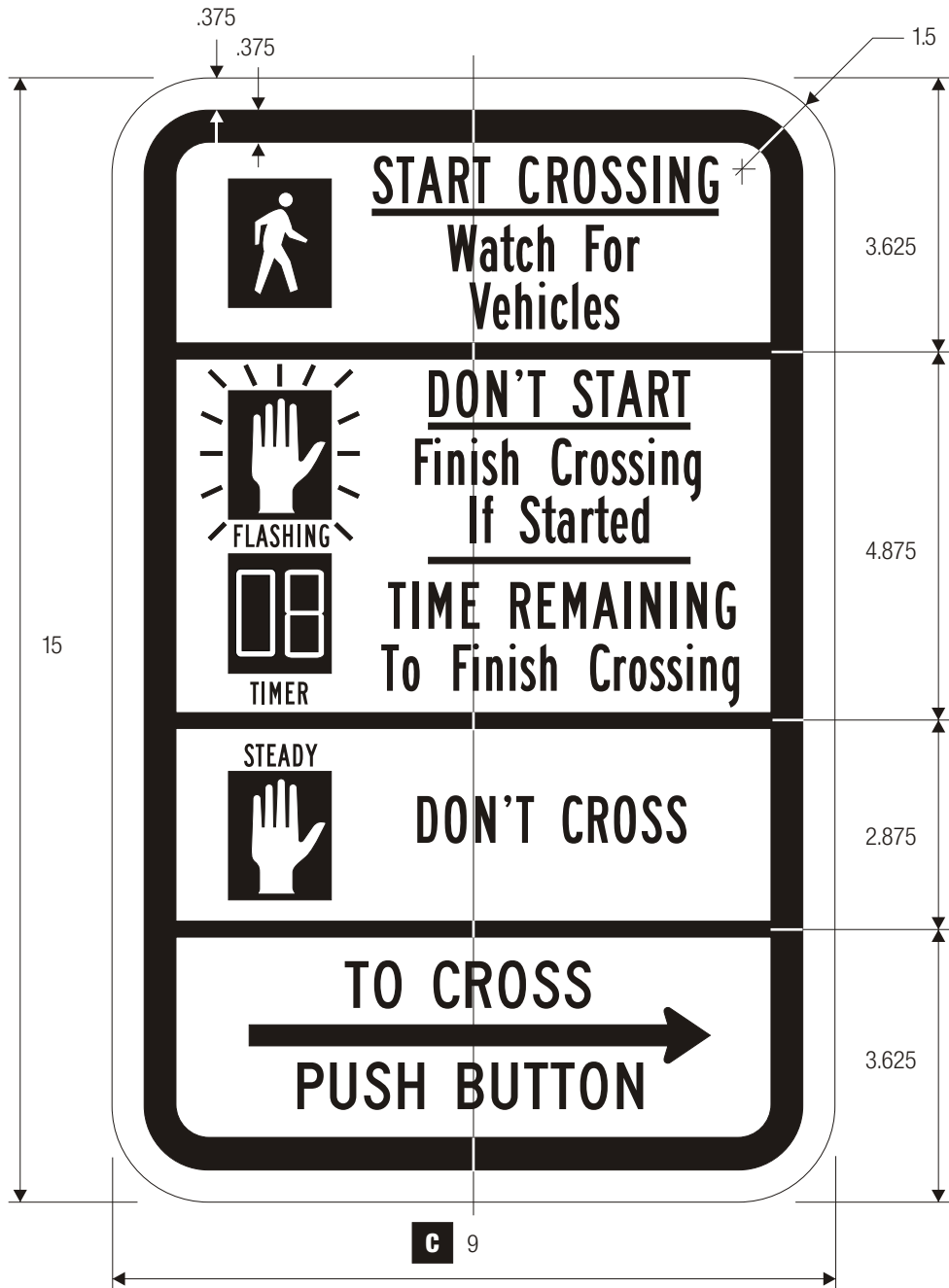

C 9

R10-3e

COUNT-DOWN PEDESTRIAN

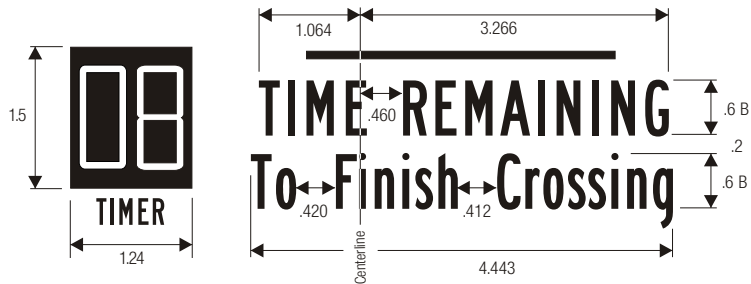

COLORS: LEGEND — BLACK
 BACKGROUND — WHITE (RETROREFLECTIVE)
 08, HAND SYMBOL — ORANGE (RETROREFLECTIVE)

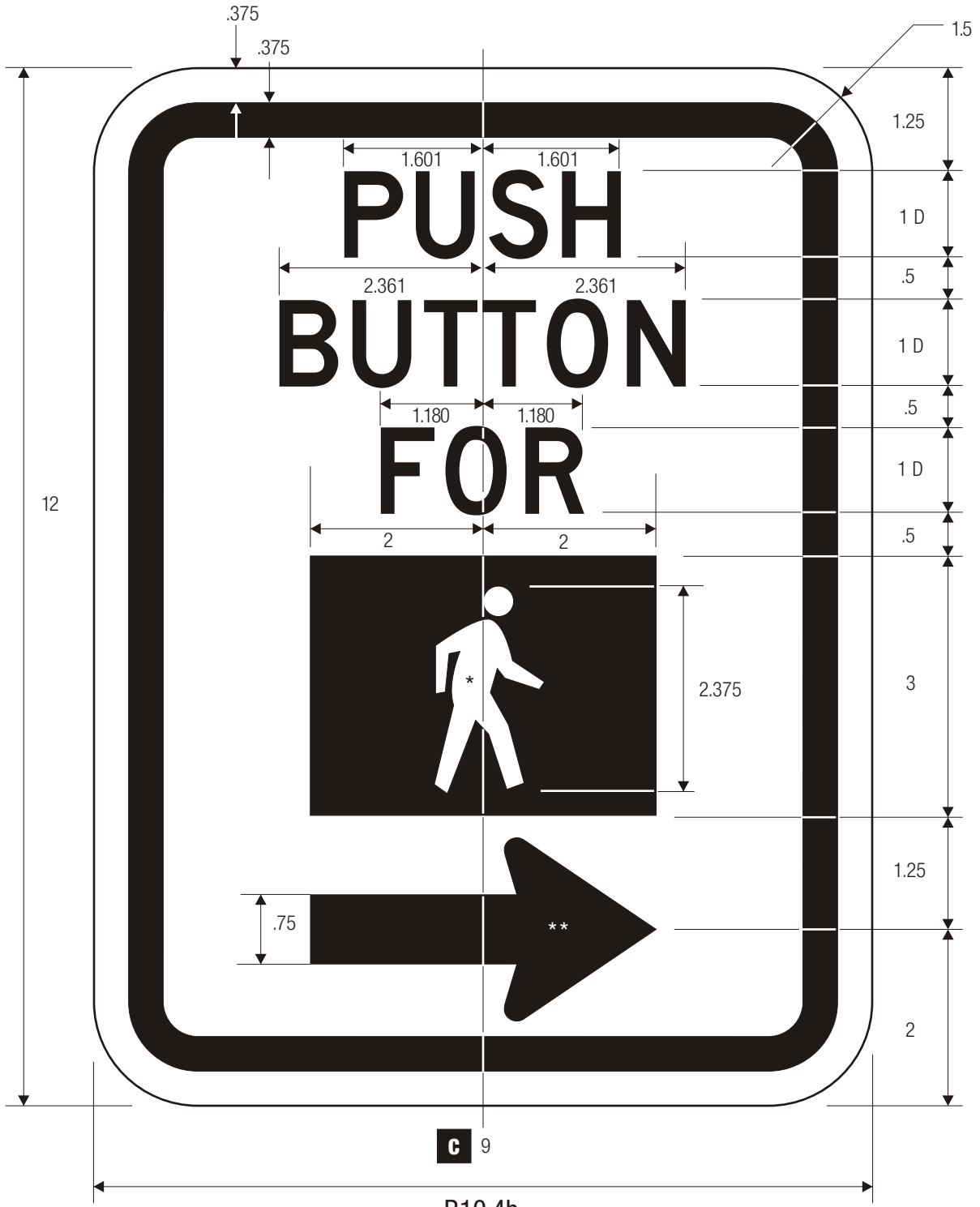

C 9

R10-4b

PEDESTRIAN TRAFFIC SIGNAL

*See page 6-10 for design.
 **See page 6-2 for design.

COLORS: LEGEND — BLACK
 SYMBOL — WHITE (RETROREFLECTIVE) ON BLACK
 BACKGROUND — WHITE (RETROREFLECTIVE)



R10-5

LEFT ON GREEN ARROW ONLY

*Reduce spacing to fit.

C

A	B	C	D	E	F	G	H	J	K	L	M
24	30	.375	.625	3.25	4 C	2.5	8.726	6.785	7.365	5.324	1.5
30	36	.5	.75	4.25	5 C	2.5	10.907	8.487	9.188	6.918	1.875
48	60	.75	1.25	6.5	8 C	5	17.452	13.58	14.702	10.508	3

COLORS: LEGEND — BLACK
 BACKGROUND— WHITE (RETROREFLECTIVE)

R10-6
STOP HERE ON RED

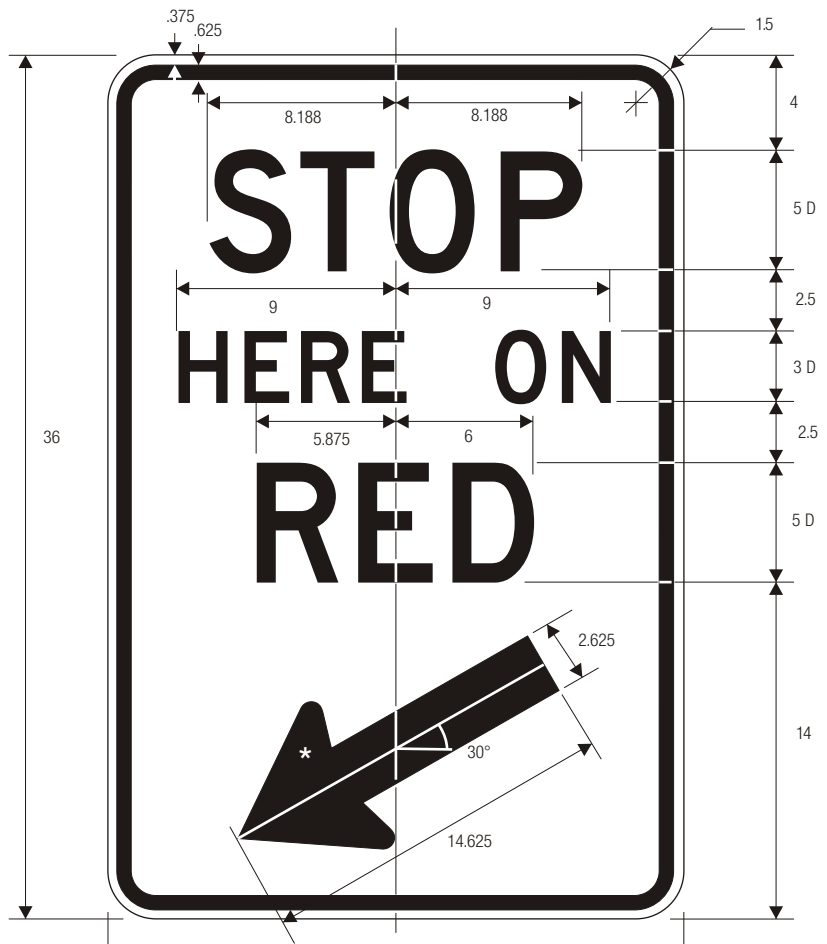

*See page 6-2 for arrow design.

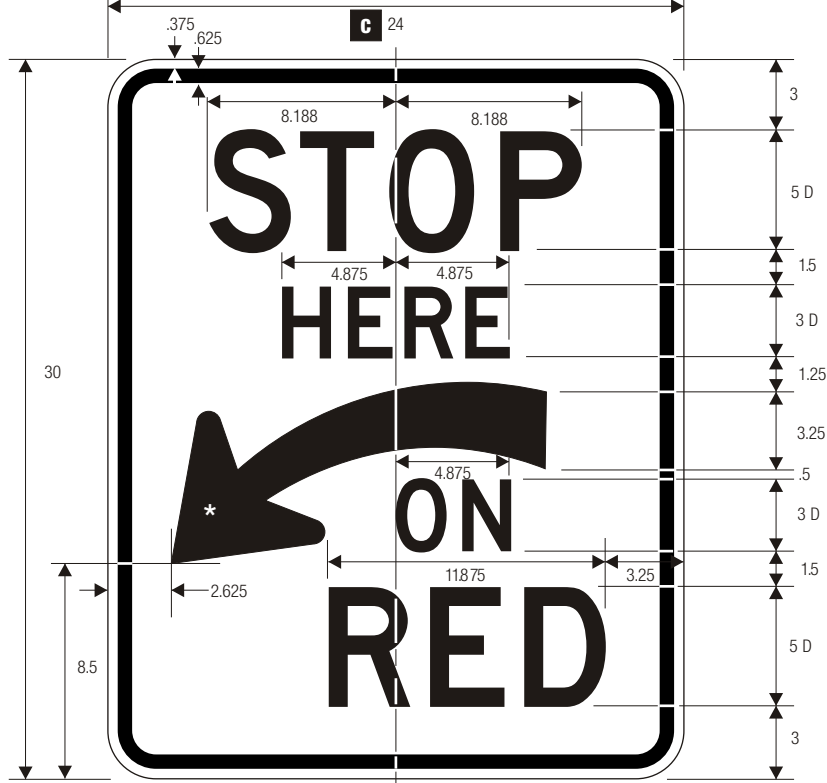
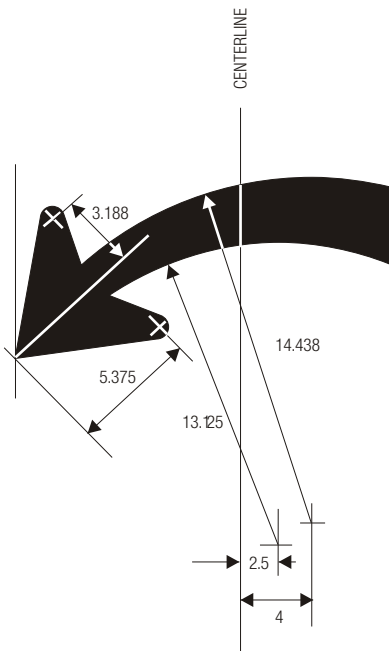

R10-6a STOP HERE ON RED

COLORS: LEGEND BLACK
BACKGROUND WHITE (RETROREFLECTIVE)

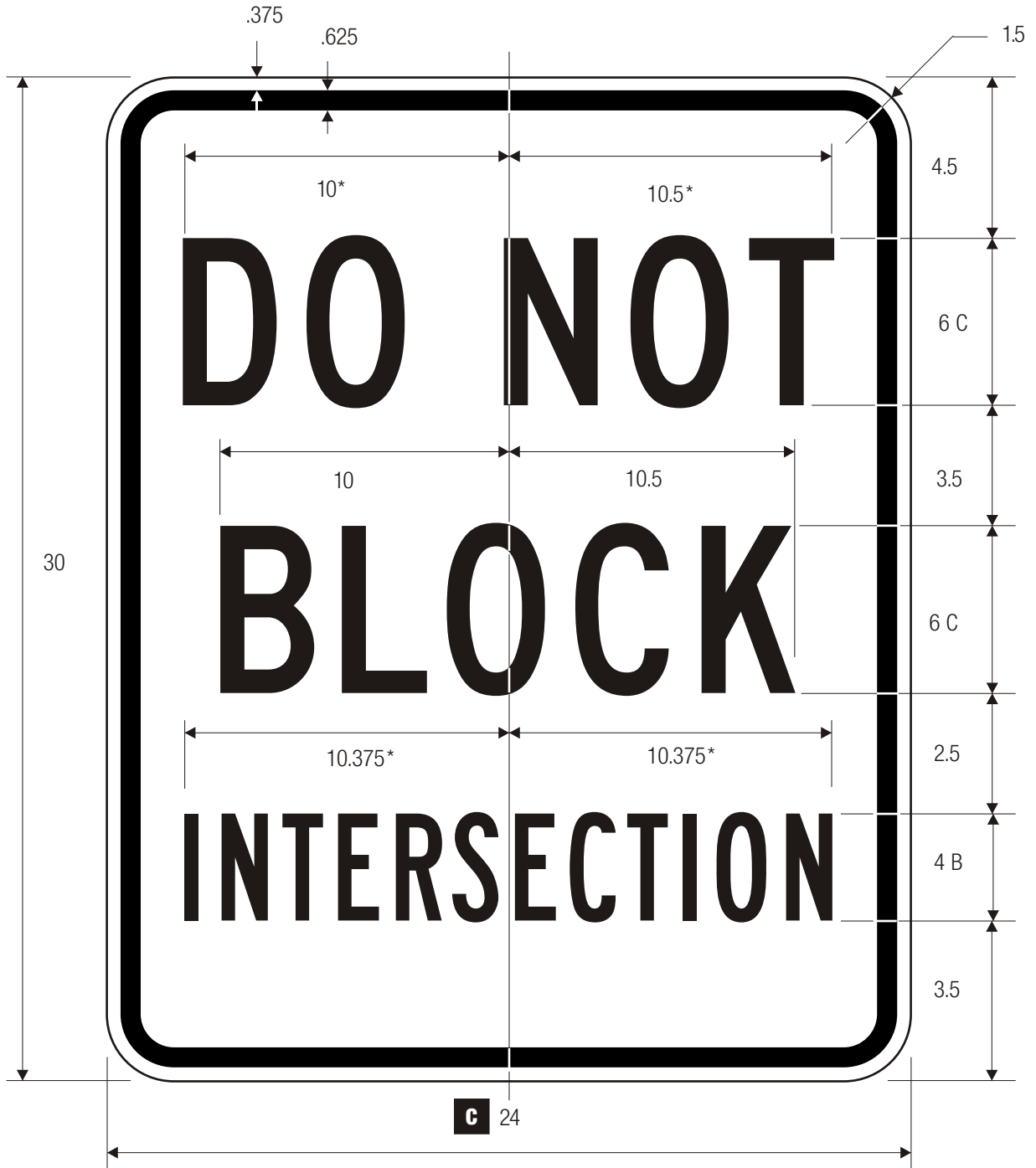

R10-7

DO NOT BLOCK INTERSECTION

*Reduce spacing 50%.

COLORS: LEGEND BLACK
 BACKGROUND WHITE (RETROREFLECTIVE)



R10-8
USE LANE WITH ARROW

*Series 2000 Standard Alphabets.

C

A	B	C	D	E	F	G	H	J	K	L	M	N
24	30	.375	.625	3	3 E	2.25	4.14	5.739	4.944	7.117	7.806	1.5
30	36	.5	.75	3	4 E	2.5	5.519	7.651	6.592	9.489	10.407	1.875
36	42	.625	.875	3.75	4.5 E	3	6.209	8.607	7.416	10.674	11.708	2.25
60	72	.75	1.25	6	8 E	5	11.04	15.304	13.186	18.98	20.817	3

COLORS: LEGEND — BLACK
BACKGROUND — WHITE (RETROREFLECTIVE)

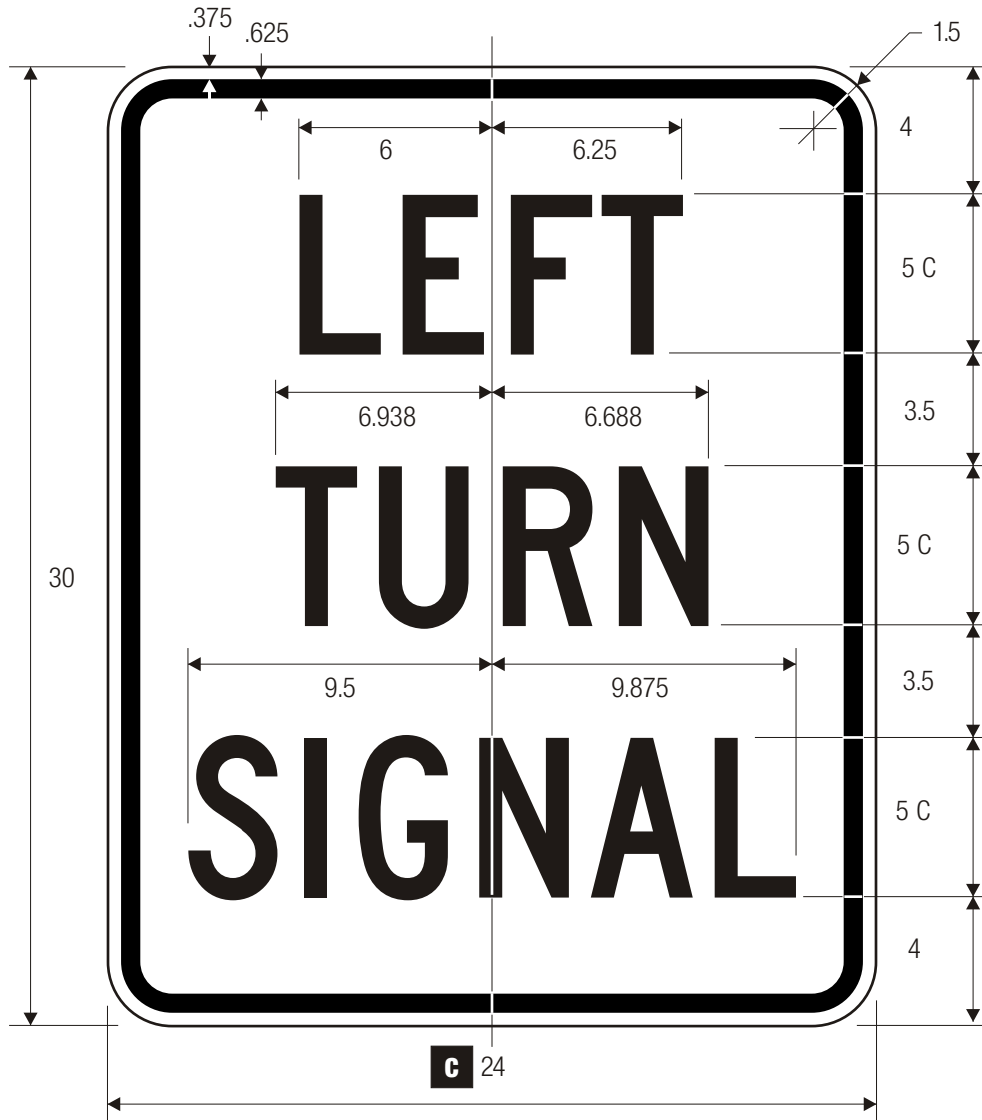

R10-10L

LEFT (RIGHT) TURN SIGNAL



R10-10R



COLORS: LEGEND — BLACK
 BACKGROUND— WHITE (RETROREFLECTIVE)

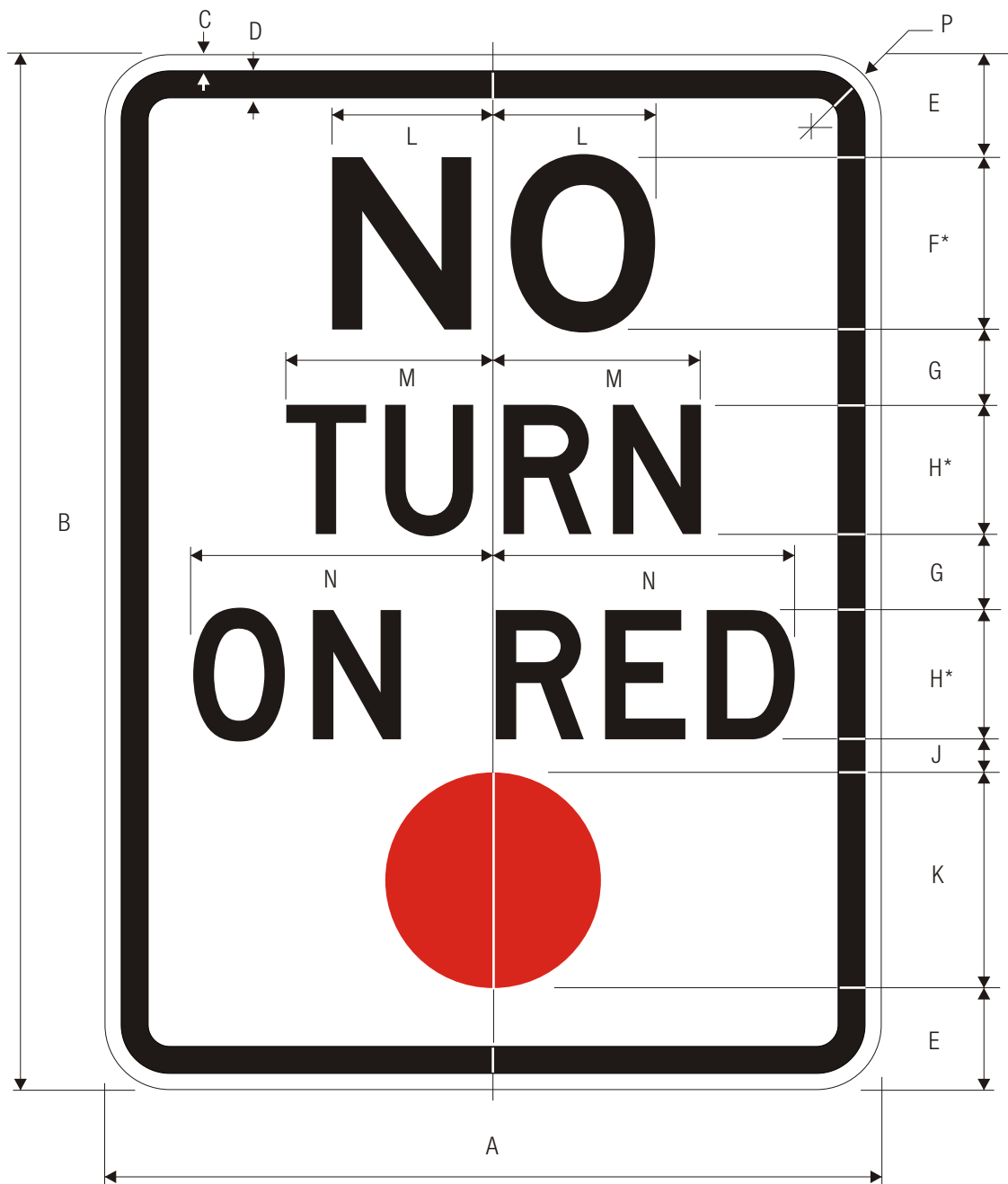

R10-11

NO TURN ON RED

*Series 2000 Standard Alphabets.

C

A	B	C	D	E	F	G	H	J	K	L
18	24	.375	.625	2.375	4 E	1.75	3 D	.75	5	3.742
24	30	.375	.625	2.75	5 E	2	4 D	1.5	6	4.681
36	48	.625	.875	4.75	8 E	3.5	6 D	1.5	10	7.491

M	N	P
4.806	6.972	1.5
6.41	9.299	1.5
9.616	13.950	2.25

COLORS: LEGEND — BLACK
 SYMBOL — RED (RETROREFLECTIVE)
 BACKGROUND — WHITE (RETROREFLECTIVE)

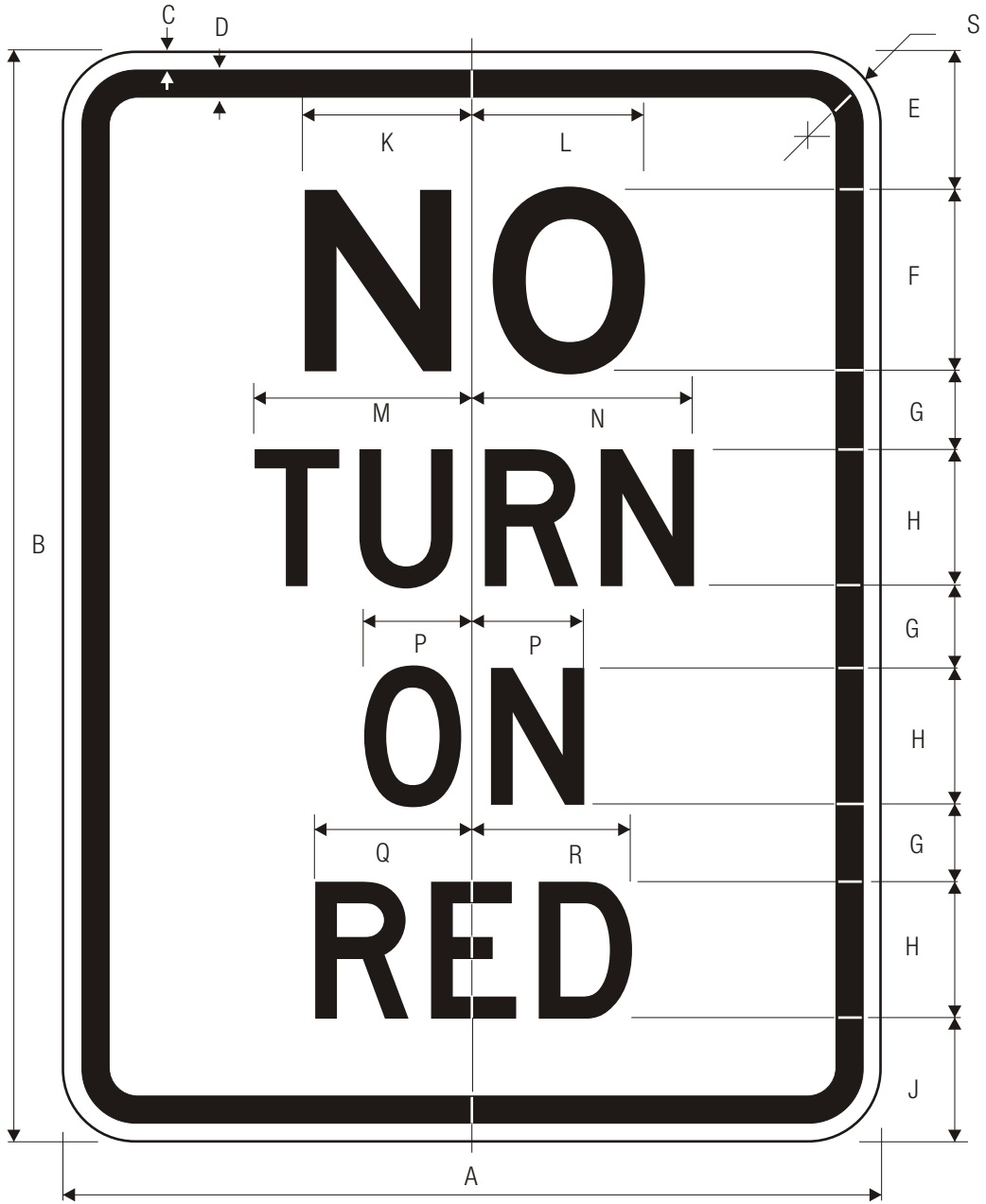

R10-11a
NO TURN ON RED

C

A	B	C	D	E	F	G	H	J	K	L	M
24	30	.375	.625	3.25	5 E	2.25	4 D	3	4.813	5.188	6.625
36	48	.625	.875	6	8 E	3.5	6 D	5.5	7.75	8.25	10

N	P	Q	R	S
6.5	3.5	4.625	4.875	1.5
9.75	5.25	6.875	7.375	2.25

COLORS: LEGEND — BLACK
BACKGROUND — WHITE (RETROREFLECTIVE)

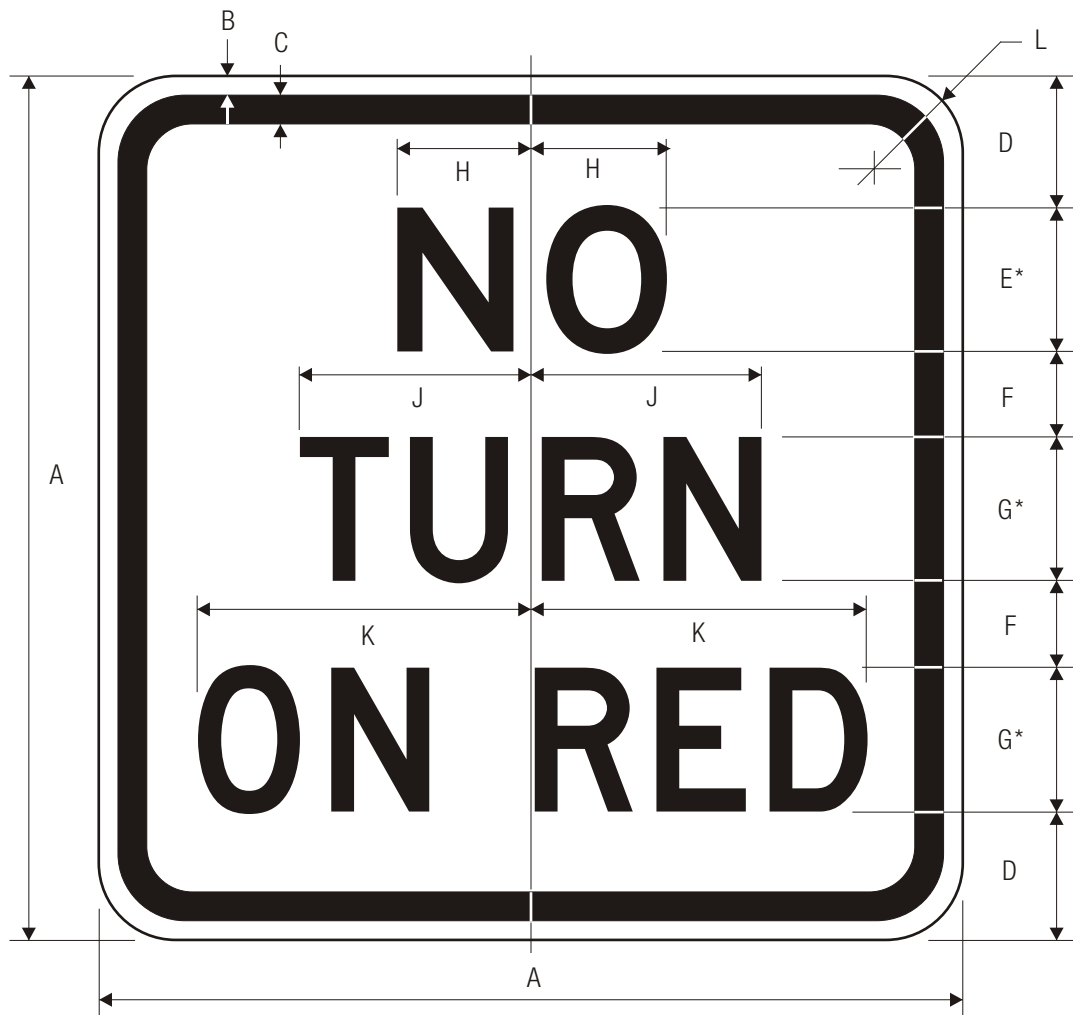

R10-11b
NO TURN ON RED

*Series 2000 Standard Alphabets.

C

A	B	C	D	E	F	G	H	J	K	L
24	.375	.625	3.5	4 E	2.5	4 D	3.745	6.41	9.299	1.5
30	.5	.75	4.5	5 E	3	5 D	4.681	8.012	11.623	1.875
36	.625	.875	5	6 E	4	6 D	5.617	9.614	13.948	2.25

COLORS: LEGEND — BLACK
BACKGROUND — WHITE (RETROREFLECTIVE)

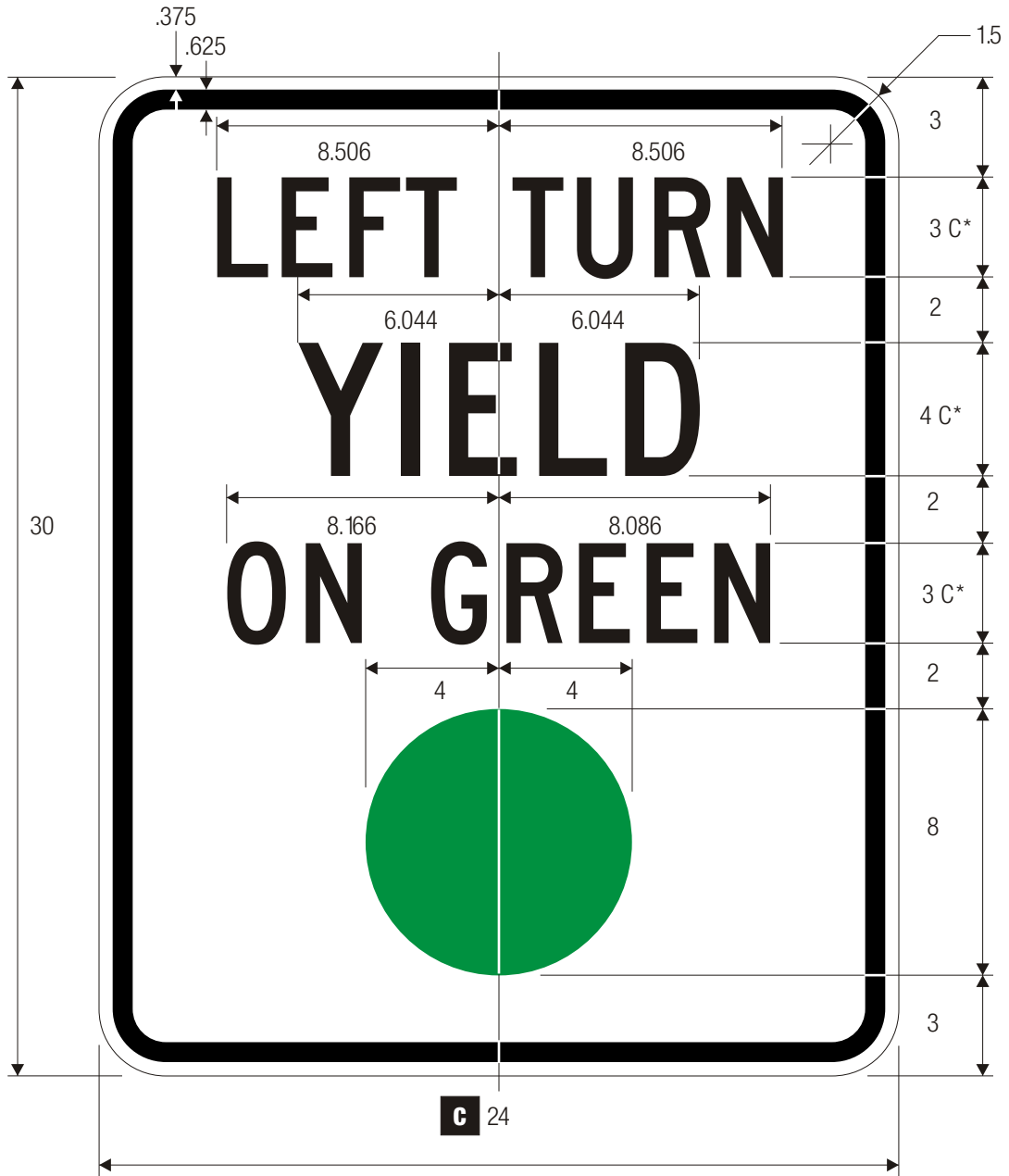

R10-12
LEFT TURN YIELD ON GREEN

*Series 2000 Standard Alphabets.

COLORS: LEGEND — BLACK
 BACKGROUND— WHITE (RETROREFLECTIVE)
 SYMBOL — GREEN (RETROREFLECTIVE)

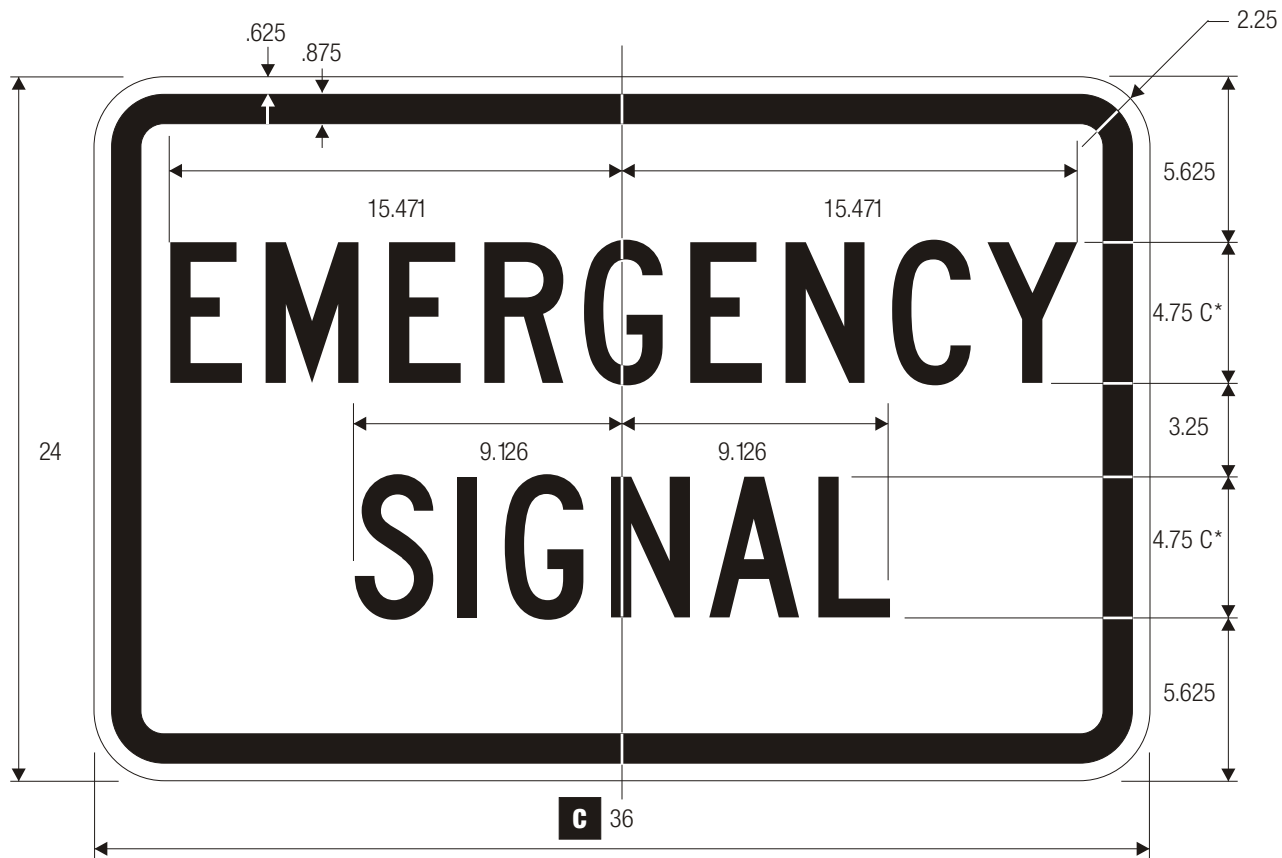

C 36

R10-13

EMERGENCY SIGNAL

*Series 2000 Standard Alphabets.

COLORS: LEGEND — BLACK
 BACKGROUND — WHITE (RETROREFLECTIVE)



R10-15

TURNING TRAFFIC MUST YIELD TO PEDESTRIANS

*Series 2000 Standard Alphabets

A	B	C	D	E	F	G	H	J	K	L	M	N	P
24	30	.375	.625	4.25	2.5 D	2	3.5 D	6.764	6.387	5.665	7.167	10.53	1.5
30	36	.5	.75	4.5	3 D	2.75	4 D	8.117	7.665	6.475	8.601	12.637	1.875
36	42	.625	.875	5.75	3.5 D	3	4.5 D	9.471	8.943	7.285	10.036	14.744	2.25

COLORS: LEGEND — BLACK
 BACKGROUND — WHITE (RETROREFLECTIVE)

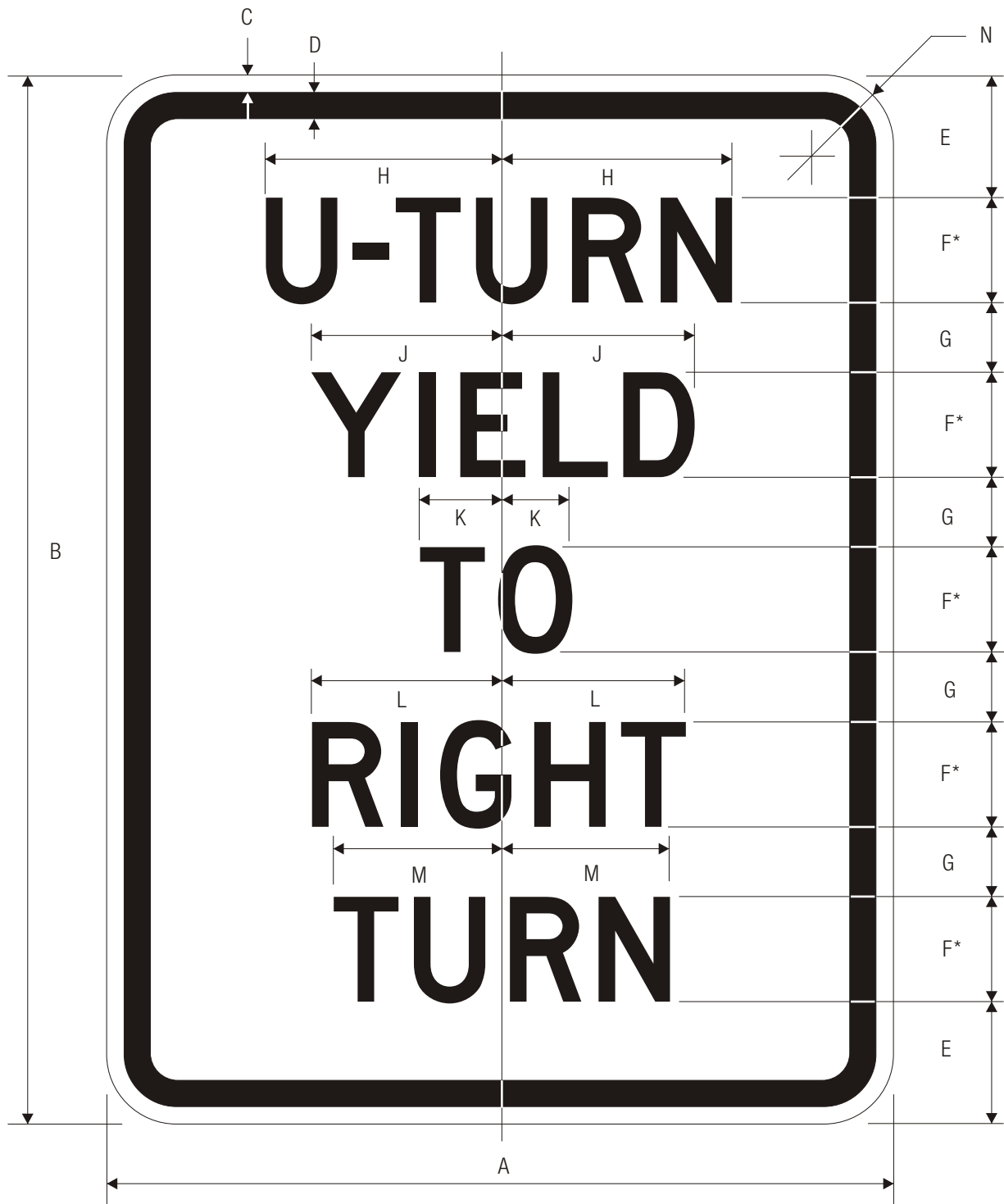

R10-16

U-TURN YIELD TO RIGHT TURN

*Series 2000 Standard Alphabets.

A	B	C	D	E	F	G	H	J	K	L	M	N
18	24	.375	.625	3	2 D	2	4.443	3.654	1.451	3.562	3.205	1.5
24	30	.375	.625	3	3 D	2.25	6.665	5.482	2.178	5.345	4.808	1.5
30	36	.5	.75	3	4 D	2.5	8.885	7.307	2.903	7.125	6.410	1.875

C

COLORS: LEGEND — BLACK
 BACKGROUND — WHITE (RETROREFLECTIVE)



R10-17a

RIGHT ON RED ARROW AFTER STOP

*Series 2000 Standard Alphabets.

	A	B	C	D	E	F	G	H	J	K	L	M	N
C	30	36	.5	.75	3.5	4 D	2.25	7.125	9.307	8.786	7.825	6.224	1.875
	36	48	.625	.875	4.5	5 D	3.5	8.906	11.628	10.988	9.767	7.765	2.25

COLORS: LEGEND — BLACK
 BACKGROUND — WHITE (RETROREFLECTIVE)



R10-18

TRAFFIC LAWS PHOTO ENFORCED

*Series 2000 Standard Alphabets.

	A	B	C	D	E	F	G	H	J	K
	24	12	.375	.625	3	2 C	2	7.665	9.707	1.5
C	36	18	.625	.875	4.5	3 C	3	11.448	14.390	2.25
	48	30	.75	1.25	8	4 C	6	15.251	19.294	3
	72	36	1	1.25	9	6 C	6	22.862	28.922	3

COLORS: LEGEND — BLACK
 BACKGROUND — WHITE (RETROREFLECTIVE)

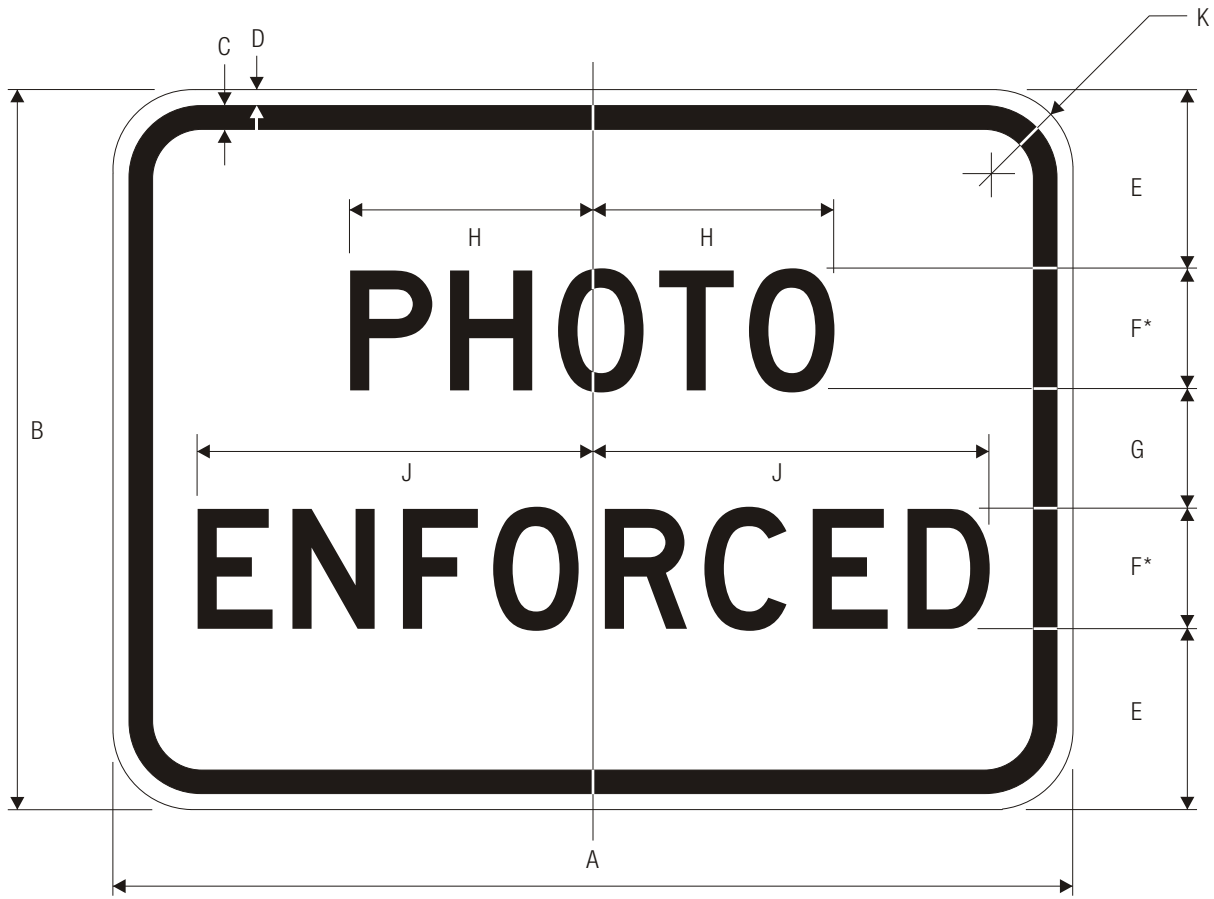

R10-19
PHOTO ENFORCED

*Series 2000 Standard Alphabets.

	A	B	C	D	E	F	G	H	J	K
C	24	18	.375	.625	4.5	3 D	3	6.018	9.843	1.5
	36	30	.625	.875	8	4 D	6	8.023	13.121	2.25
	48	36	.75	1.25	9	6 D	6	12.034	19.682	3

COLORS: LEGEND — BLACK
BACKGROUND — WHITE (RETROREFLECTIVE)

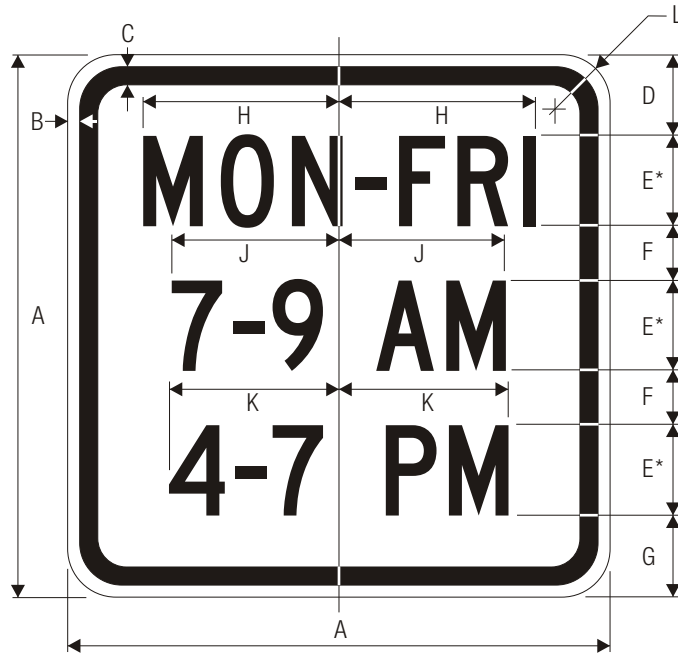

R10-20a MON-FRI (3 LINES)

C

A	B	C	D	E	F	G	H	J	K	L
24	.375	.625	3.5	4 C	2.5	3.5	8.686	7.405	7.525	1.5
30	.5	.75	4.5	5 C	3	4.5	10.853	9.240	9.389	1.875
48	.75	1.25	7	8 C	5	7	17.367	14.786	15.025	3

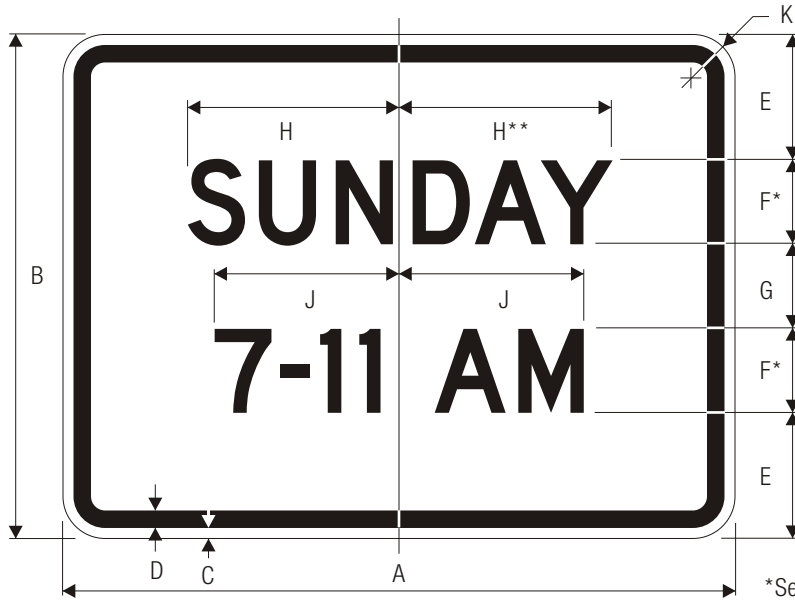

R10-20a SUNDAY (2 LINES)

*Series 2000 Standard Alphabets.
 **Reduce spacing to fit.

C

A	B	C	D	E	F	G	H	J	K
24	18	.375	.625	4.5	3 D	3	7.586	6.592	1.5
30	24	.5	.75	6	4 D	4	10.113	8.787	1.875
48	36	.75	1.25	9	6 D	6	15.8	13.181	3

COLORS: LEGEND — BLACK
 BACKGROUND — WHITE (RETROREFLECTIVE)

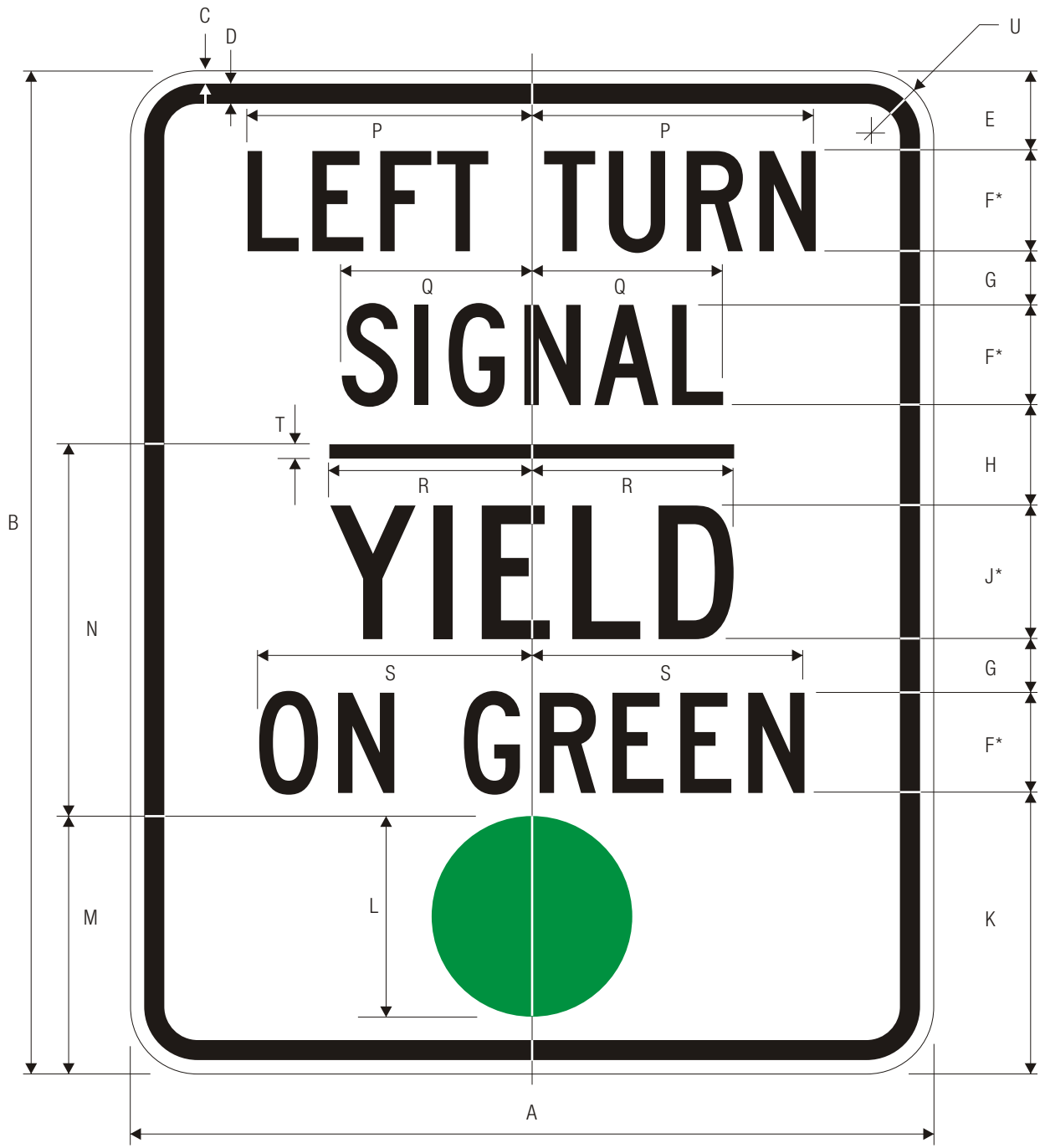

R10-21

LEFT TURN SIGNAL YIELD ON GREEN

*Series 2000 Standard Alphabets.

A	B	C	D	E	F	G	H	J	K	L
18	24	.375	.625	2	2.5 C	1	2.5	3 C	7	5
24	30	.375	.625	2.5	3 C	1.625	3	4 C	8.25	6
30	36	.5	.75	3	4 C	2	3	5 C	9	7

C

M	N	P	Q	R	S	T	U
6.5	8.438	7.081	4.75	4.525	6.796	.375	1.5
7.625	11.063	8.498	5.704	6.033	8.156	.625	1.5
8.625	13.25	11.326	7.602	7.539	10.870	.75	1.875

COLORS:
 LEGEND — BLACK
 BACKGROUND— WHITE (RETROREFLECTIVE)
 CIRCLE — GREEN (RETROREFLECTIVE)

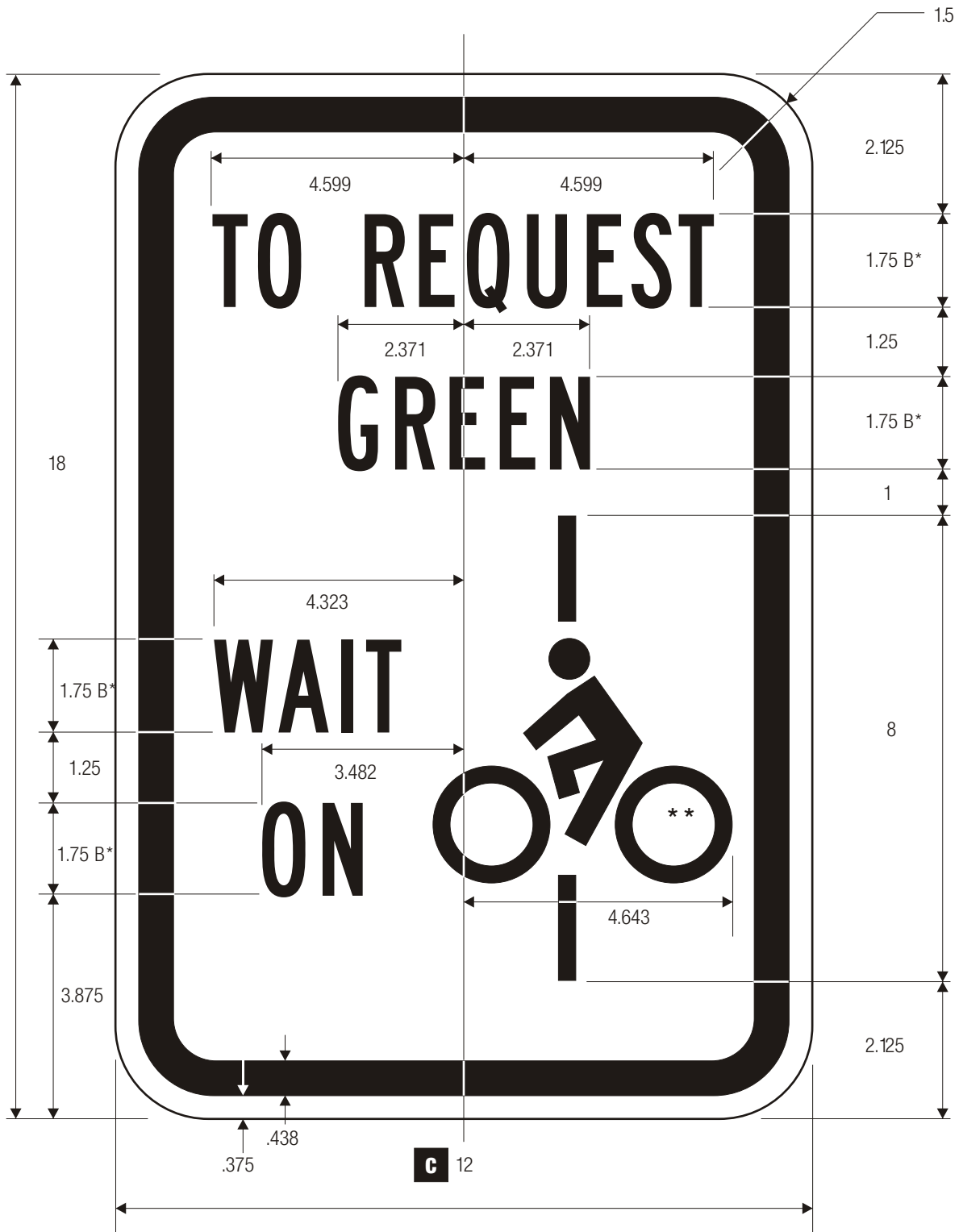

R10-22
BIKE ACTUATION

*Series 2000 Standard Alphabets.
**See pavement marking drawing for design.

COLORS: LEGEND — BLACK
BACKGROUND — WHITE (RETROREFLECTIVE)

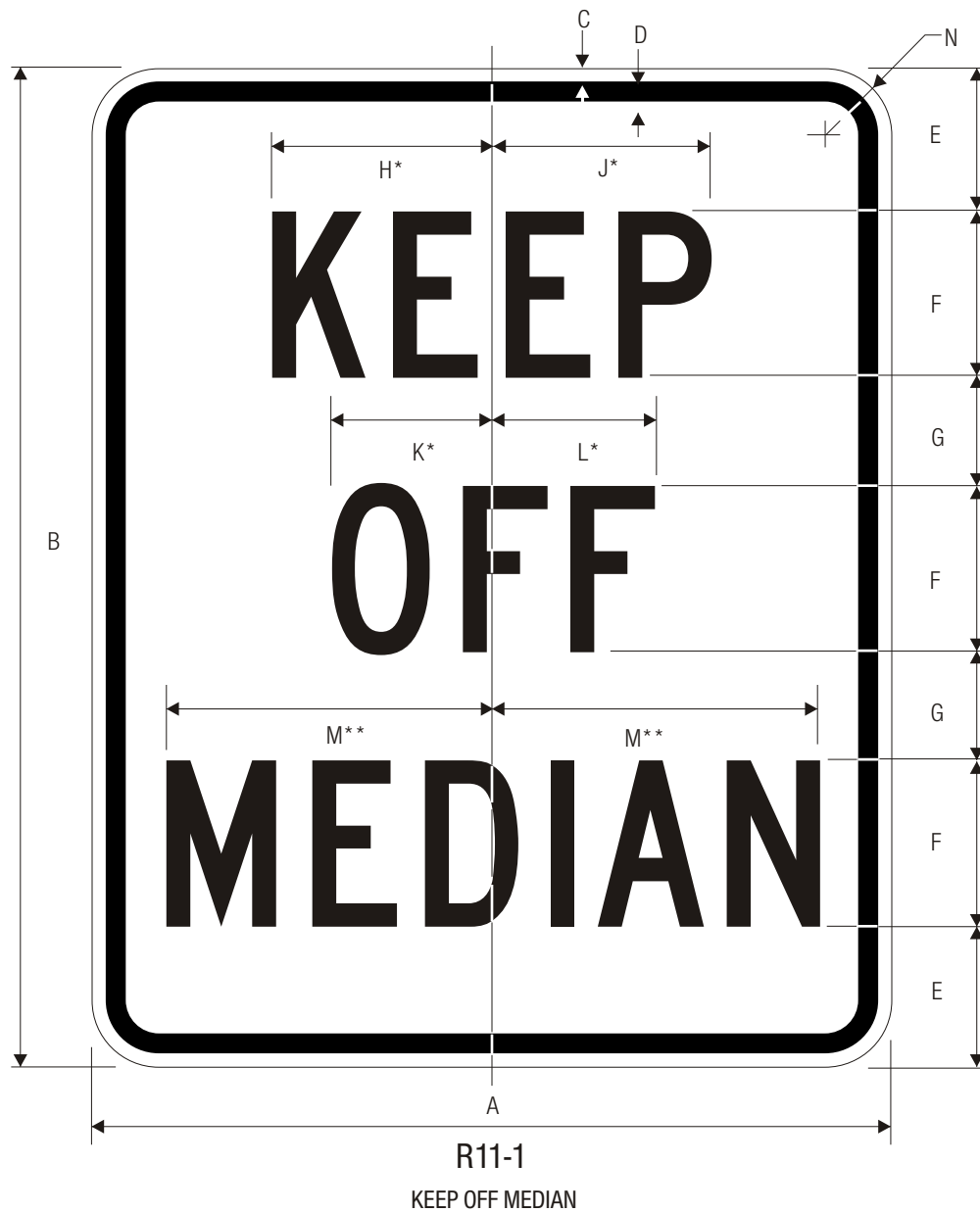

*Increase spacing 50%.
**Reduce spacing 20%.

C

A	B	C	D	E	F	G	H	J	K	L	M	N
24	30	.375	.625	4.25	5 C	3.25	6.75	7.5	4.813	5.938	9.375	1.5
36	48	.625	.875	6.75	8 C	5.25	10.813	12	8.25	8.875	15	2.25
48	60	.75	1.25	8.5	10 C	6.5	13.5	15	9.625	11.875	18.75	3

COLORS: LEGEND — BLACK
BACKGROUND— WHITE (RETROREFLECTIVE)

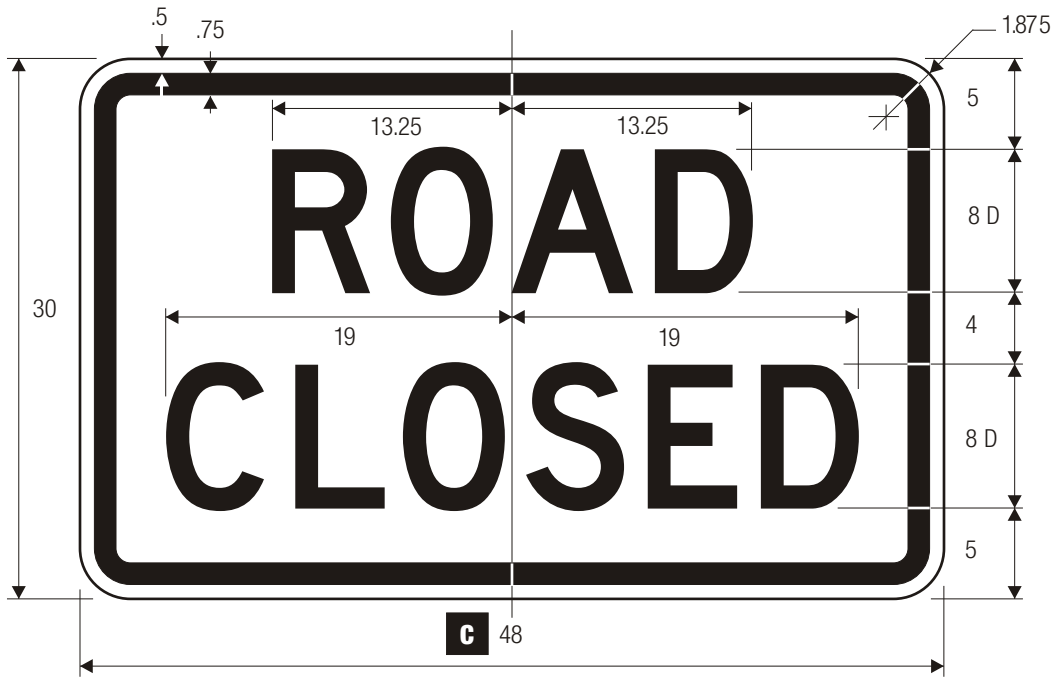

R11-2
ROAD CLOSED

COLORS: LEGEND — BLACK
BACKGROUND— WHITE (RETROREFLECTIVE)



R11-3a

ROAD CLOSED - LOCAL TRAFFIC ONLY

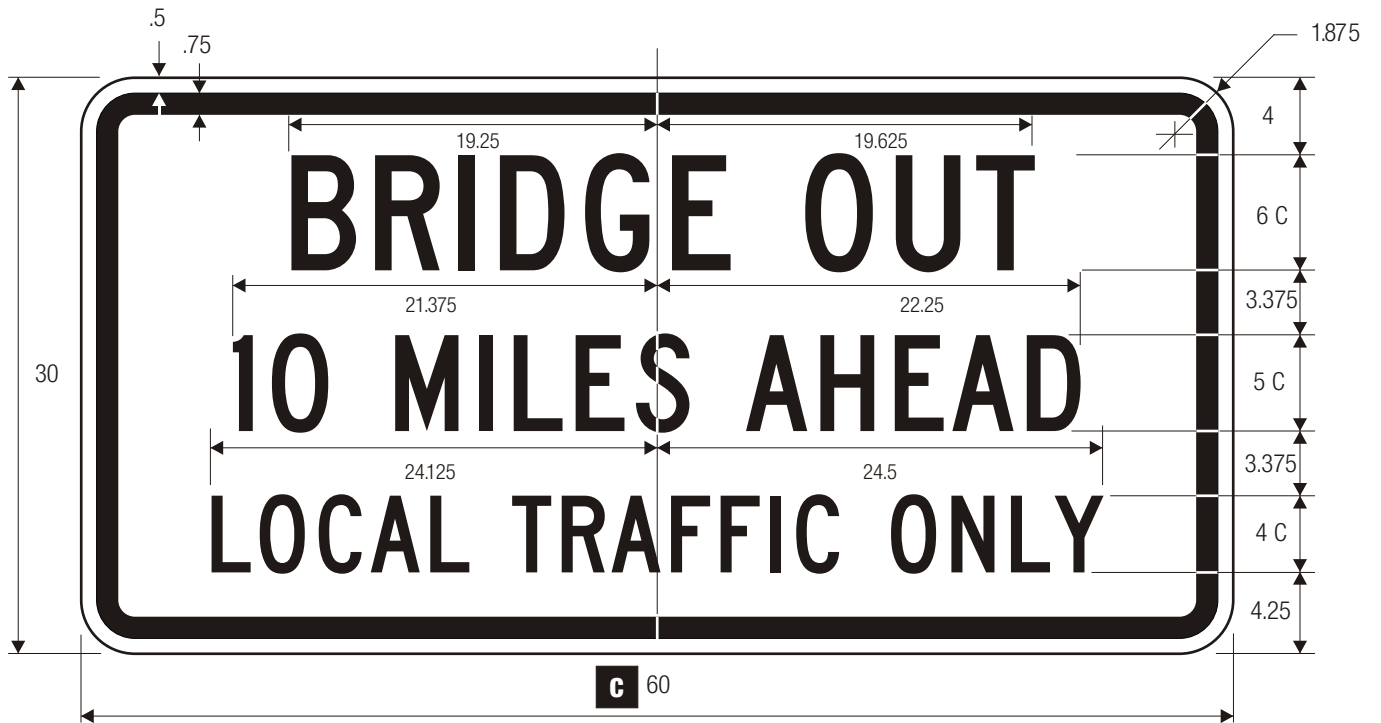

R11-3b

ROAD CLOSED - LOCAL TRAFFIC ONLY

COLORS: LEGEND — BLACK
 BACKGROUND— WHITE (RETROREFLECTIVE)

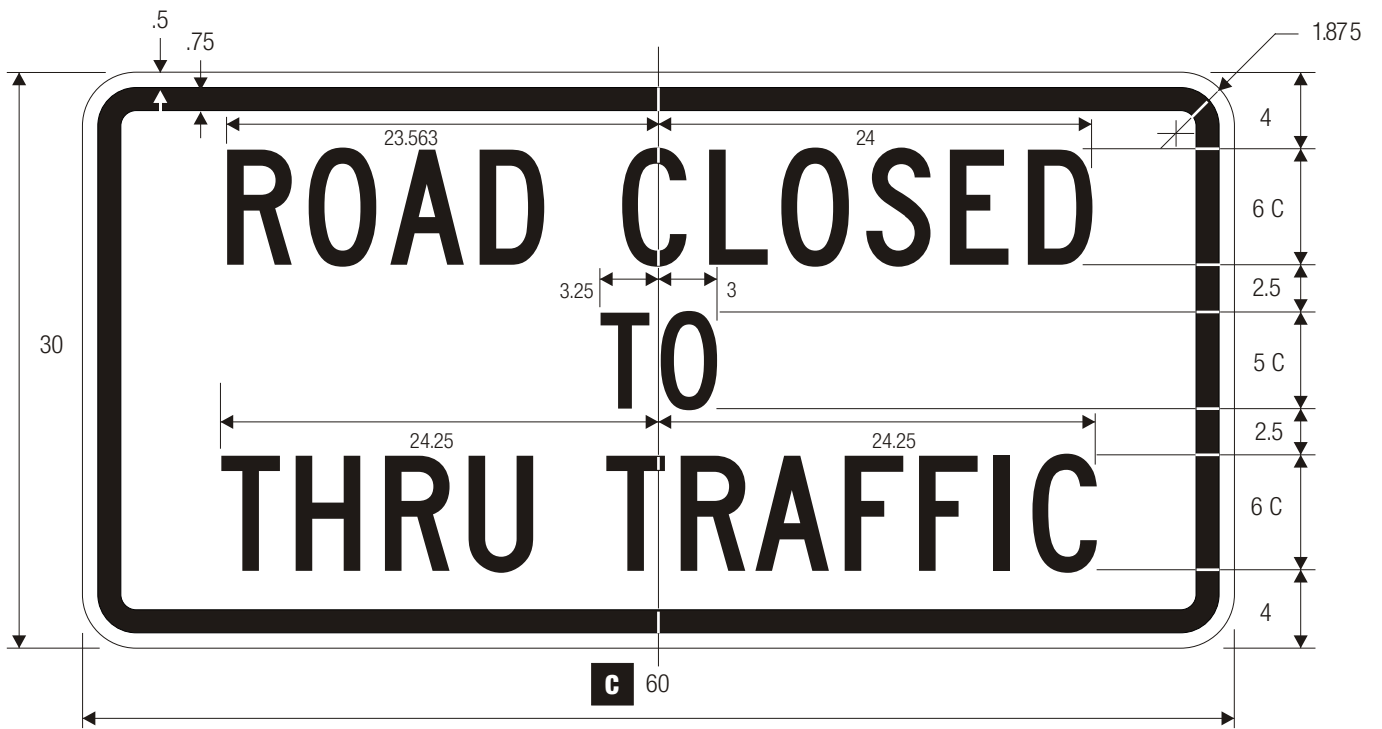

R11-4

ROAD CLOSED TO THRU TRAFFIC

COLORS: LEGEND — BLACK
 BACKGROUND— WHITE (RETROREFLECTIVE)



R12-1

WEIGHT LIMIT

*Optically space numerals about centerline.

	A	B	C	D	E	F	G	H	J	K	L
C	24	30	.375	.625	3	4 D	1.75	2.125	5 E	5D	9
	36	48	.625	.875	4.75	6 D	3	3.75	8 E	8 D	13.5

	M	N	P	Q
	9.5	6.313	8.25	1.5
	14.25	9.438	13.25	2.25

COLORS: LEGEND — BLACK
 BACKGROUND— WHITE (RETROREFLECTIVE)



R12-1

WEIGHT LIMIT (METRIC)

*Optically space numerals about centerline.
 **Series 2000 Standard Alphabets.

	A	B	C	D	E	F	G	H	J	K	L
C	24	30	.375	.625	3	4 D	2	4	10 E	9.086	6.204
	36	48	.625	.875	4.75	6 D	3	7.5	16 E	13.610	9.327

M	N
VAR	1.5
VAR	2.25

COLORS: LEGEND — BLACK
 BACKGROUND— WHITE (RETROREFLECTIVE)



R12-2

AXLE WEIGHT LIMIT

*Reduce spacing 50%.

	A	B	C	D	E	F	G	H	J	K	L
C	24	30	.375	.625	3.25	4 D	2	2.5	5 D	6.875	9
	36	48	.625	.875	5.25	6 D	3.5	4.5	8 D	10.313	13.5
	M	N	P	Q							
	9.5	6.313	10	1.5							
	14.25	9.438	15	2.25							

COLORS: LEGEND — BLACK
BACKGROUND— WHITE (RETROREFLECTIVE)



R12-2

AXLE WEIGHT LIMIT (METRIC)

*Optically position numerals about centerline.

**Series 2000 Standard Alphabets.

	A	B	C	D	E	F	G	H	J	K	L
C	24	30	.375	.625	3.25	4 D	2	2.5	5 D	6.324	9.086
	36	48	.625	.875	5.25	6 D	3.5	4.5	8 D	9.487	13.630
	M	N	P								
	6.224	VAR	1.5								
	9.327	VAR	2.25								

COLORS: LEGEND — BLACK
BACKGROUND— WHITE (RETROREFLECTIVE)

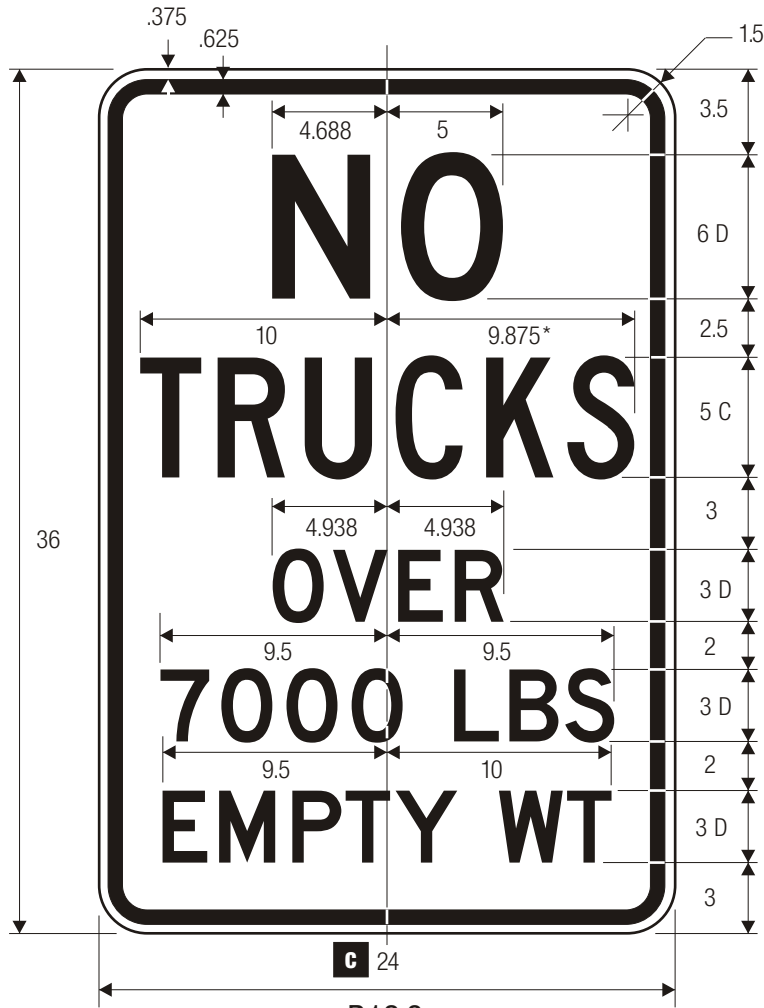

R12-3
WEIGHT LIMIT

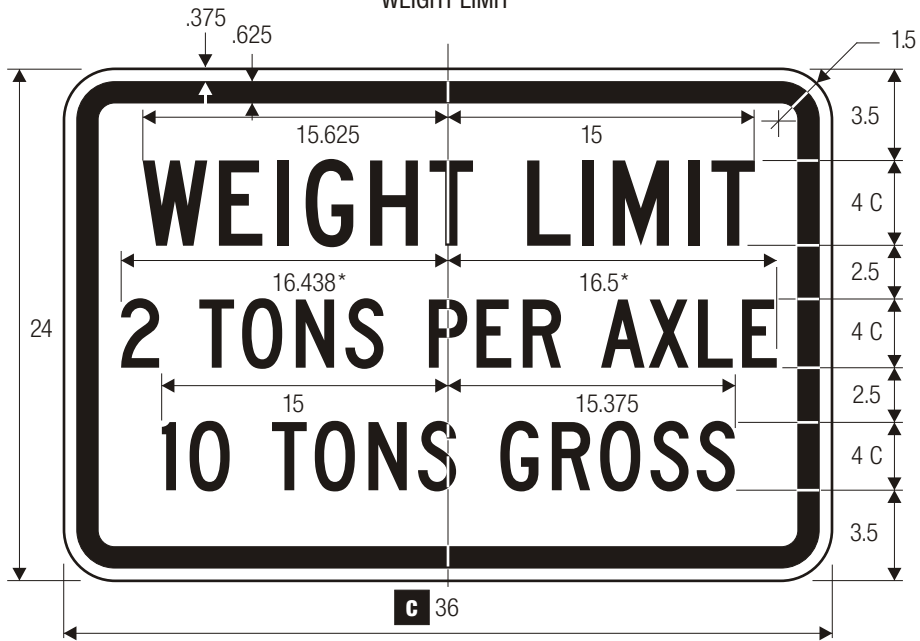

R12-4
WEIGHT LIMIT

*Reduce spacing 20%.

COLORS: LEGEND — BLACK
BACKGROUND— WHITE (RETROREFLECTIVE)



R12-3

WEIGHT LIMIT (METRIC)

*Series 2000 Standard Alphabets.

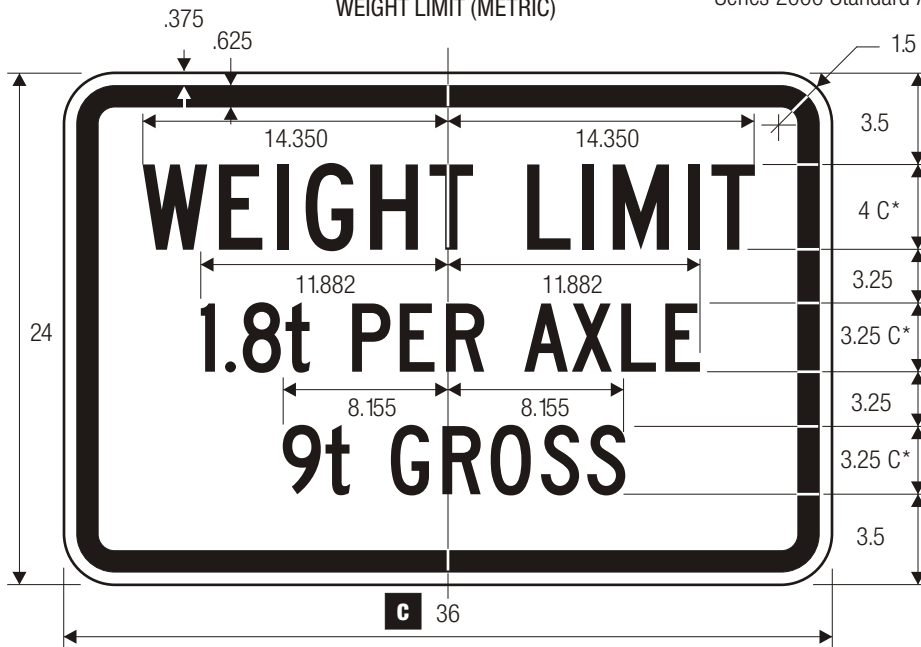

R12-4 metric

WEIGHT LIMIT (METRIC)

COLORS: LEGEND — BLACK
BACKGROUND— WHITE (RETROREFLECTIVE)

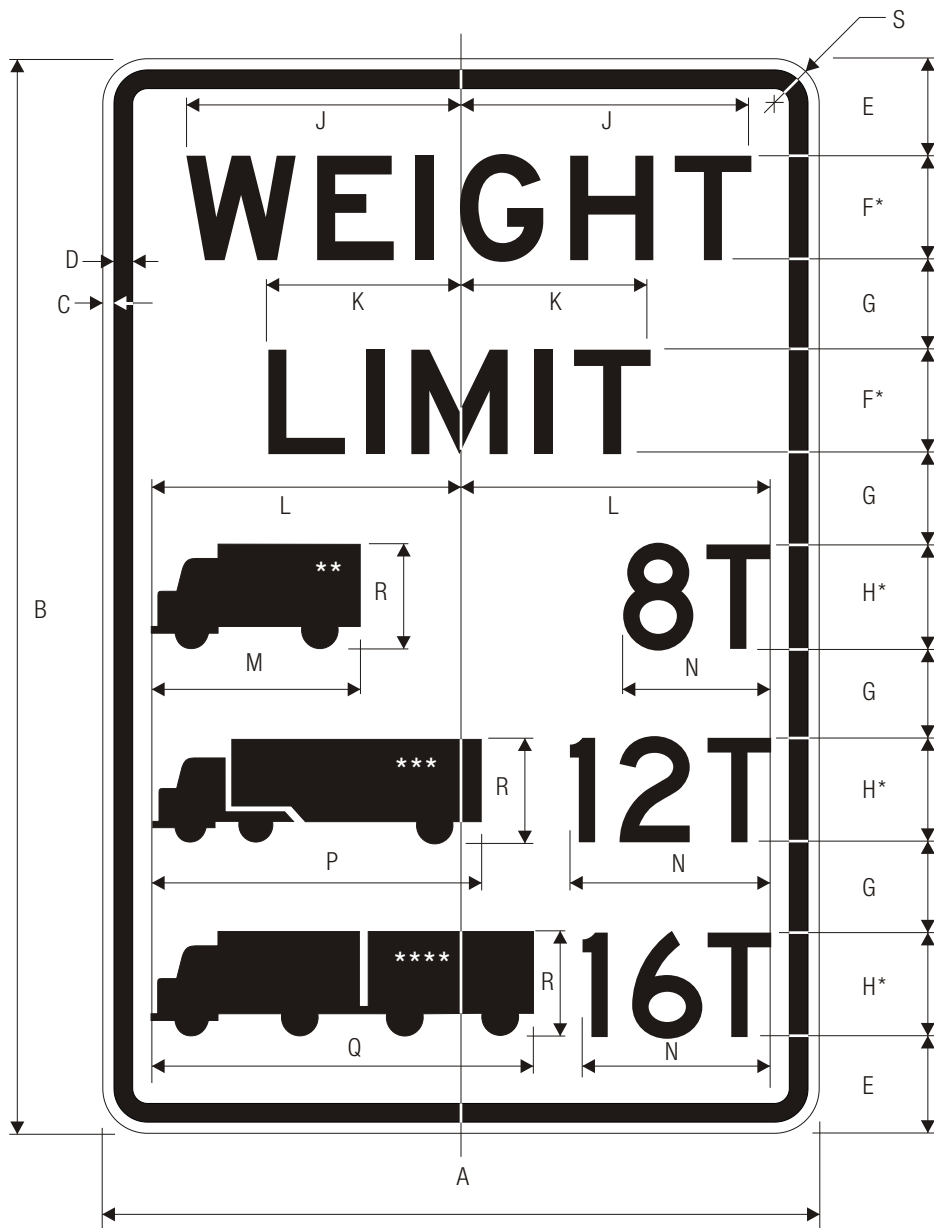

R12-5

WEIGHT LIMIT

*Series 2000 Standard Alphabets.

**See page 6-4 for design

***See page 6-5 for design

****See page 6-6 for design

C

A	B	C	D	E	F	G	H	J	K	L	M
24	36	.375	.625	3.25	3.5 E	3	3.5 D	9.465	6.403	10.375	7
30	42	.5	.75	3.75	4.5 E	3	4.5 D	12.016	8.192	13.188	9
36	48	.625	.875	5	5 E	3.25	5 D	13.350	9.099	15	10
48	60	.75	1.25	6	6 E	4.5	6 D	16.02	10.918	19	12

N	P	Q	R	S
VAR	11	12.813	3.5	1.5
VAR	13.438	16.438	4.5	1.875
VAR	15.438	18.375	5	2.25
VAR	19.688	22	6	3

COLORS: LEGEND — BLACK
BACKGROUND— WHITE (RETROREFLECTIVE)

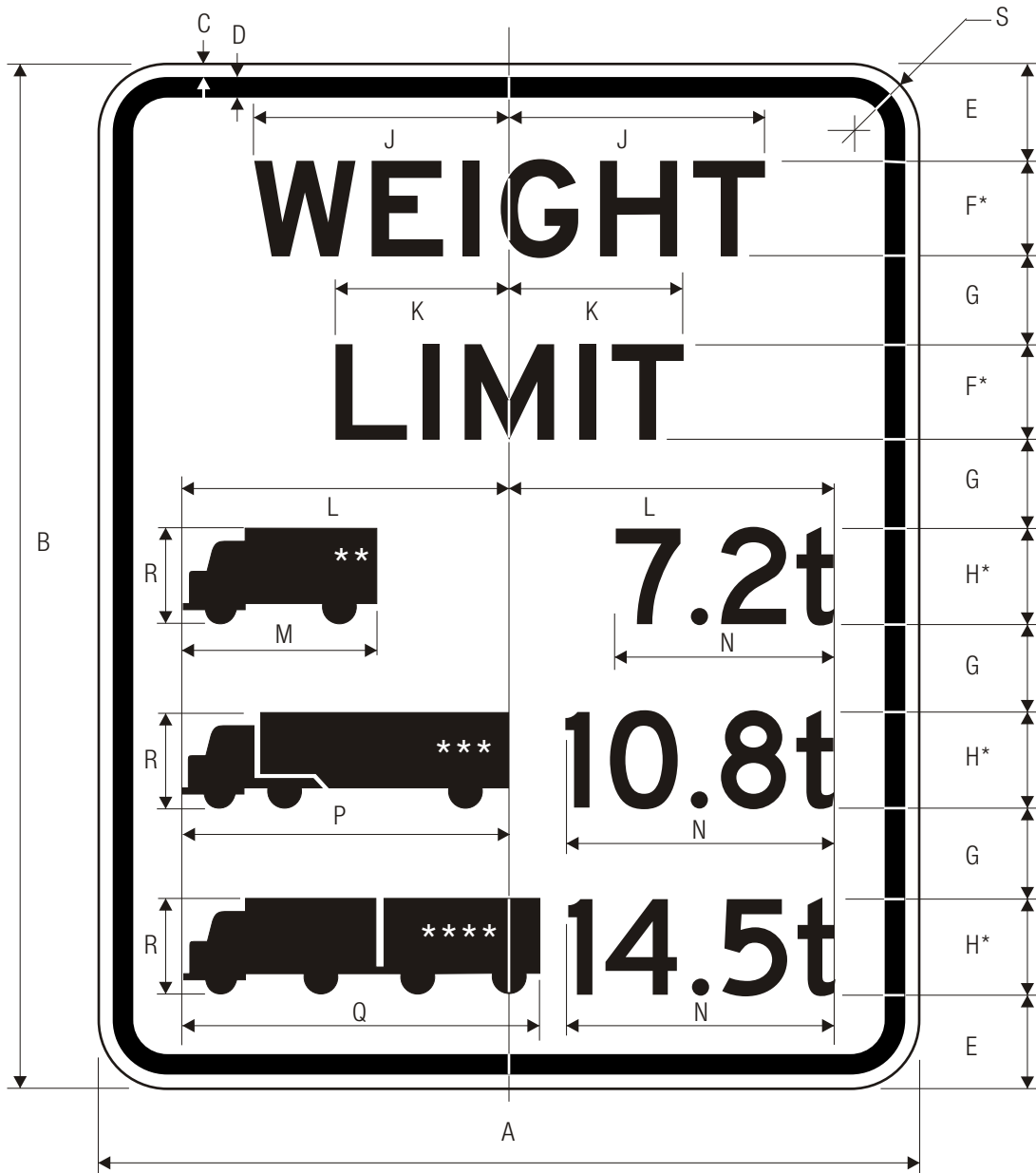

R12-5

WEIGHT LIMIT (METRIC)

*Series 2000 Standard Alphabets.
 **See page 6-4 for design.
 ***See page 6-5 for design.
 ****See page 6-6 for design.

C

A	B	C	D	E	F	G	H	J	K	L	M
24	36	.375	.625	4	3.5 E	3	3 D	9.346	6.37	9.527	6.044
30	42	.5	.75	4.5	4.5 E	3	4 D	12.015	8.189	12.329	8.126
36	48	.625	.875	5.25	5 E	3.125	5 D	13.370	9.106	15	10.127
48	60	.75	1.25	6	6 E	4.5	6 D	16.032	10.928	19.614	12.129

N	P	Q	R	S
VAR	9.527	9.967	3	1.5
VAR	10.968	12.329	4	1.875
VAR	13.450	15.491	5	2.25
VAR	16.292	19.855	6	3

COLORS: LEGEND — BLACK
 BACKGROUND— WHITE (RETROREFLECTIVE)

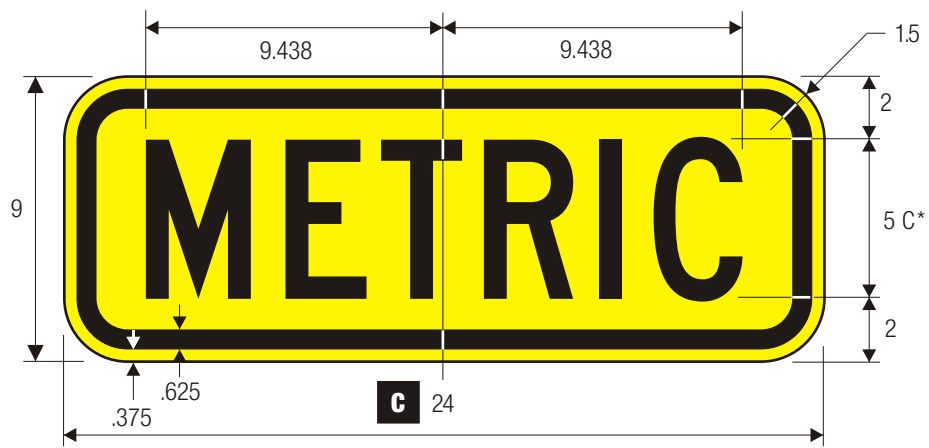

R12-6
METRIC

*Series 2000 Standard Alphabets.

COLORS: LEGEND — BLACK
BACKGROUND — YELLOW (RETROREFLECTIVE)

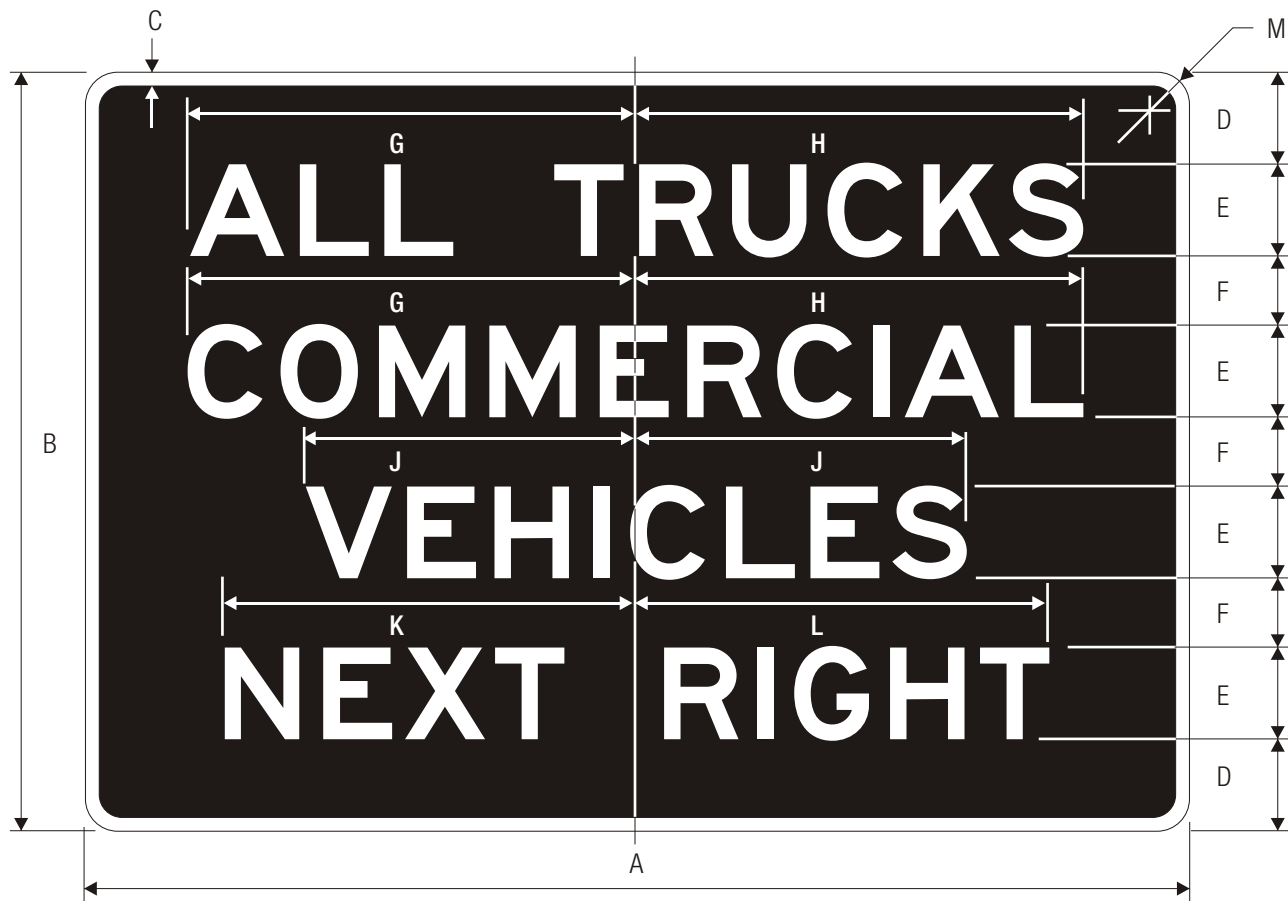

R13-1
WEIGH STATION

C

A	B	C	D	E	F	G	H	J	K	L	M
72	48	1.5	6	6 E	4	28.5	29.875	21.75	26.5	27.5	3
96	66	2	8	8 E	6	38	39.75	28.875	35.25	36.75	4
120	84	2	10	10 E	8	47.5	49.625	36.125	44	46	5

COLORS: LEGEND — WHITE (RETROREFLECTIVE)
BACKGROUND— BLACK

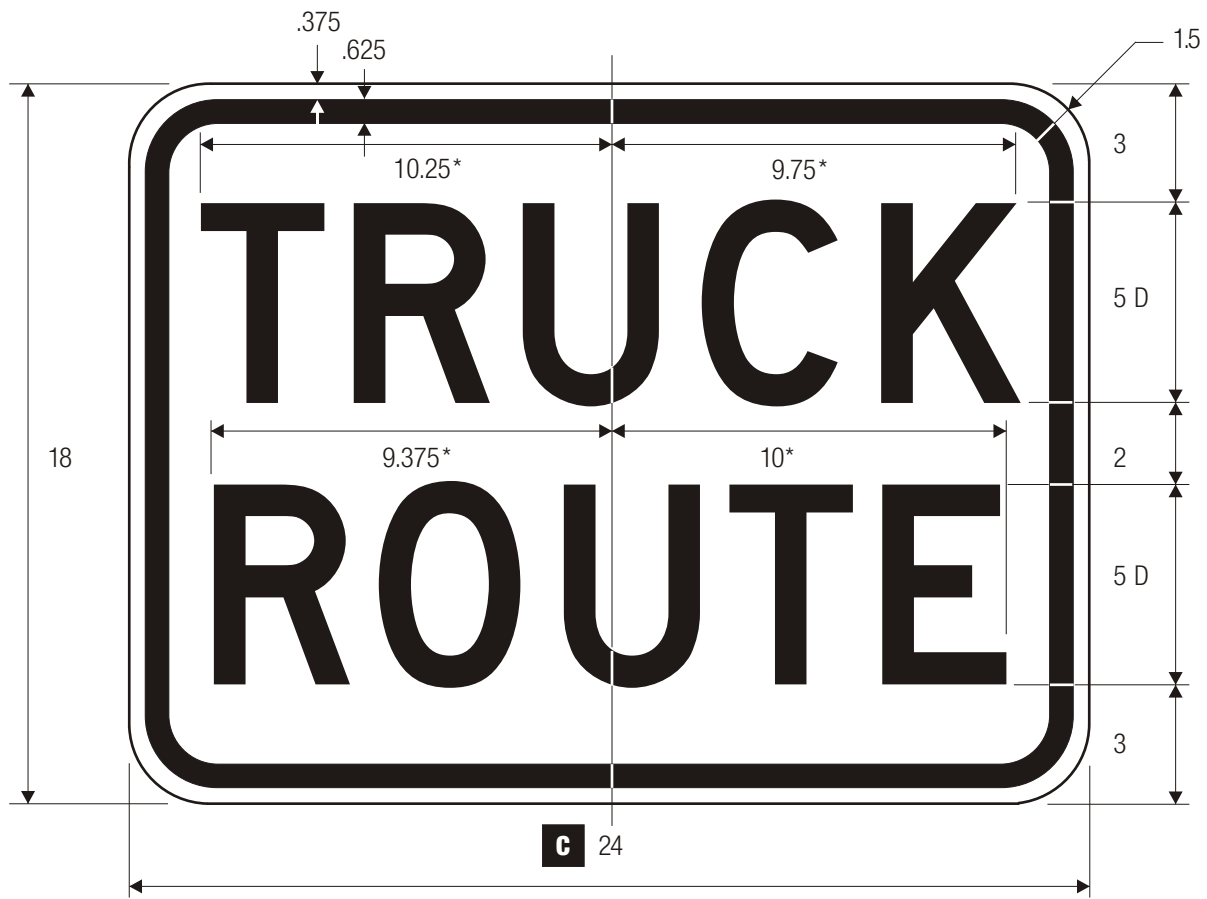

R14-1
TRUCK ROUTE

*Reduce spacing 20%.

COLORS: LEGEND — BLACK
BACKGROUND— WHITE (RETROREFLECTIVE)



R14-2
HAZARDOUS MATERIAL

*Series 2000 Standard Alphabets.

	A	B	C	D	E	F	G	H
C	24	.375	.625	7.5	9 C	8	10	1.5
	30	.5	.75	10	10 C	10	12.5	1.875
	36	.625	.875	12	12 C	12	15	2.25
	42	.625	.875	14	14 C	14	17.5	2.25

COLORS: CIRCLE — GREEN (RETROREFLECTIVE)
 LETTER, BORDER — BLACK
 BACKGROUND — WHITE (RETROREFLECTIVE)



R14-3
HAZARDOUS MATERIAL

*Series 2000 Standard Alphabets.

	A	B	C	D	E	F	G	H	J
C	24	.375	.625	7.5	9 C	8	10	2	1.5
	30	.5	.75	10	10 C	10	12.5	2.5	1.875
	36	.625	.875	12	12 C	12	15	3	2.25
	42	.625	.875	14	14 C	14	17.5	3.5	2.25

COLORS: CIRCLE & DIAGONAL — RED (RETROREFLECTIVE)
 LETTER, BORDER — BLACK
 BACKGROUND — WHITE (RETROREFLECTIVE)

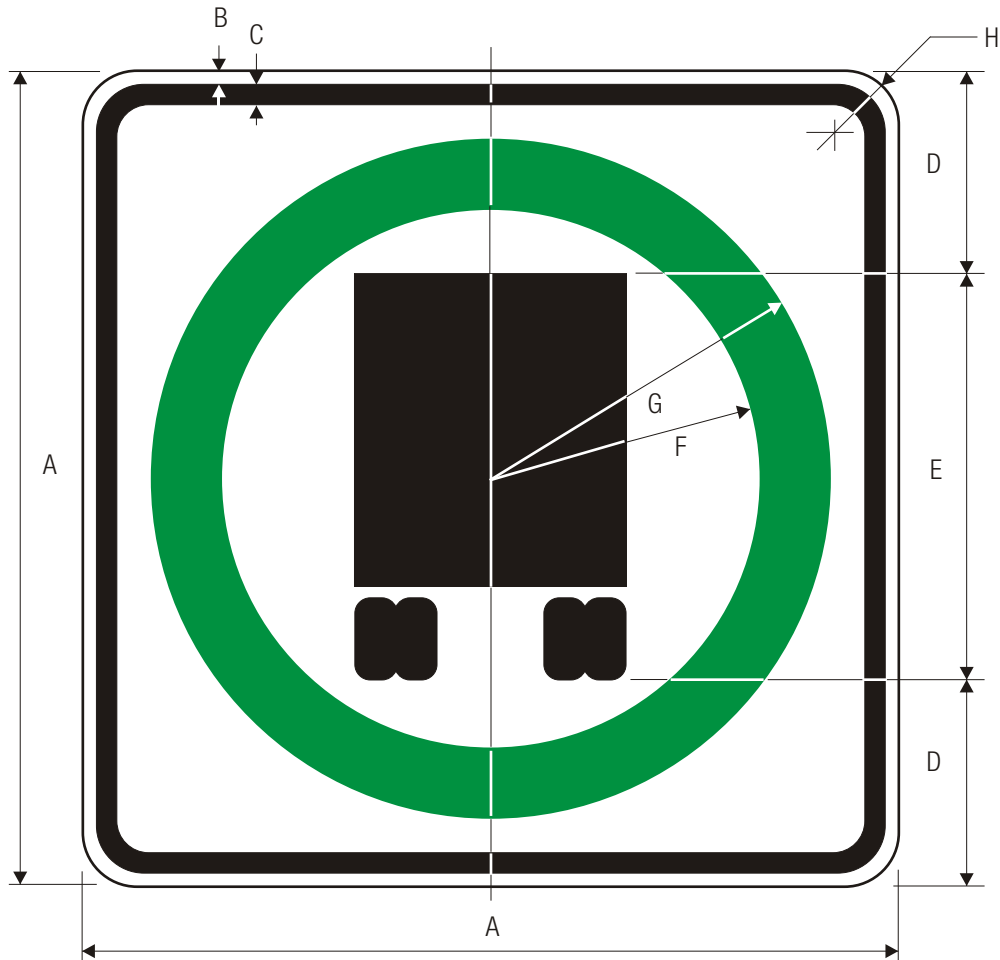

R14-4
NATIONAL NETWORK

*See page 6-62 for symbol design

	A	B	C	D	E	F	G	H
C	24	.375	.625	6	12	8	10	1.5
	30	.5	.75	7.5	15	10	12.5	1.875
	36	.625	.875	9	18	12	15	2.25
	42	.625	.875	10.5	21	14	17.5	2.25

COLORS: CIRCLE — GREEN (RETROREFLECTIVE)
 SYMBOL, BORDER — BLACK
 BACKGROUND — WHITE (RETROREFLECTIVE)



R14-5

NATIONAL NETWORK PROHIBITED

*See page 6-62 for symbol design.

	A	B	C	D	E	F	G	H	J
C	24	.375	.625	6	12	8	10	2	1.5
	30	.5	.75	7.5	15	10	12.5	2.5	1.875
	36	.625	.875	9	18	12	15	3	2.25
	42	.625	.875	10.5	21	14	17.5	3.5	2.25

COLORS: CIRCLE & DIAGONAL — RED (RETROREFLECTIVE)
 SYMBOL, BORDER — BLACK
 BACKGROUND — WHITE (RETROREFLECTIVE)

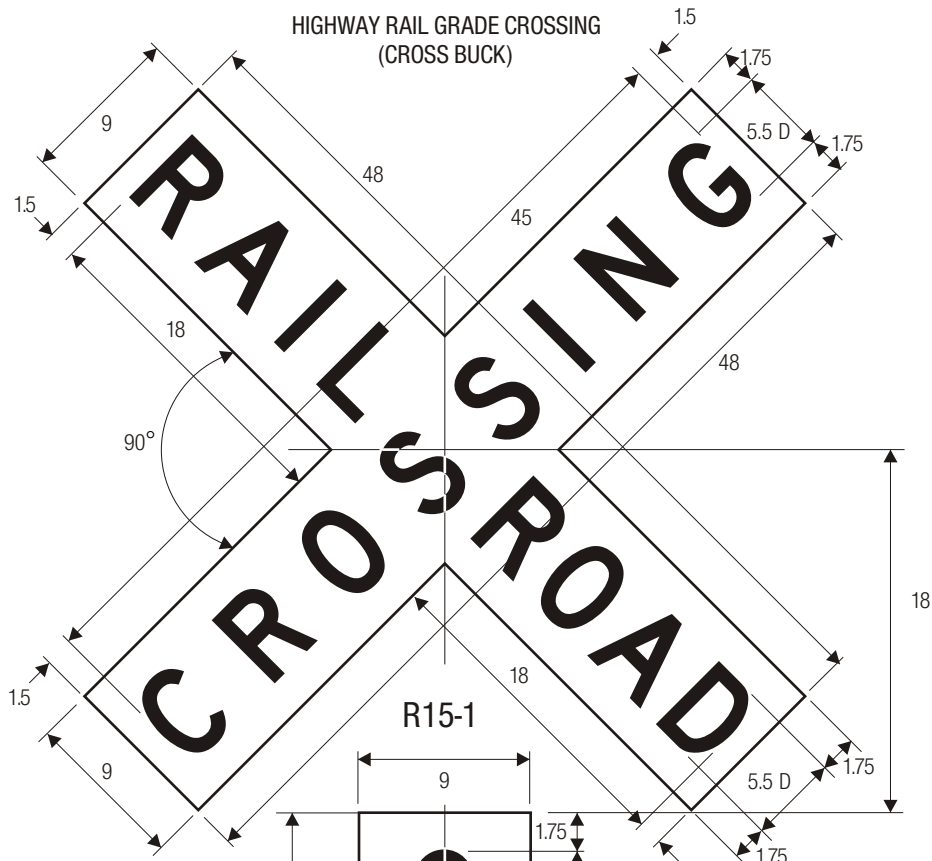

R15-1

LEGEND — BLACK
BACKGROUND — WHITE (REFLECTIVE)

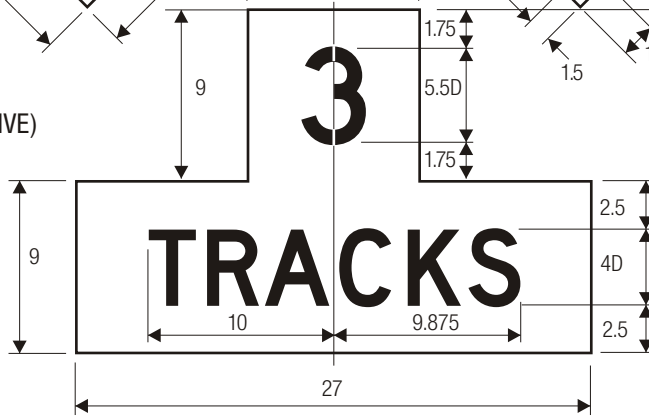

R15-2 NUMBER OF TRACKS

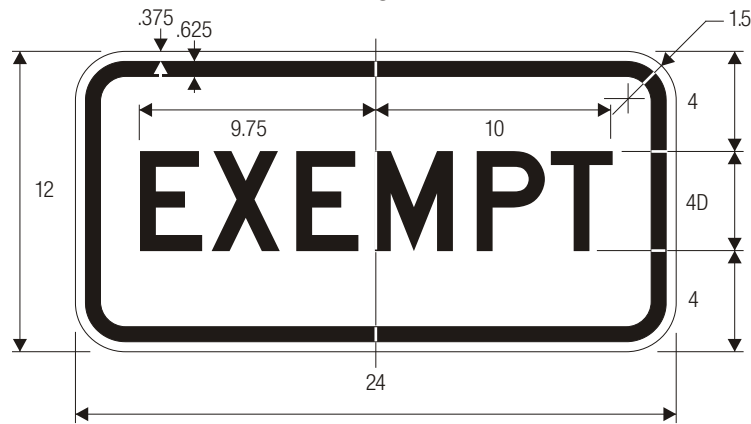

R15-3 / W10-1a EXEMPT

COLORS FOR W10-1a FOR USE WITH W10-1:
LEGEND — BLACK
BACKGROUND — YELLOW (RETROREFLECTIVE)

COLORS FOR R15-2, R15-3 FOR USE WITH R15-1:
LEGEND — BLACK
BACKGROUND — WHITE (RETROREFLECTIVE)

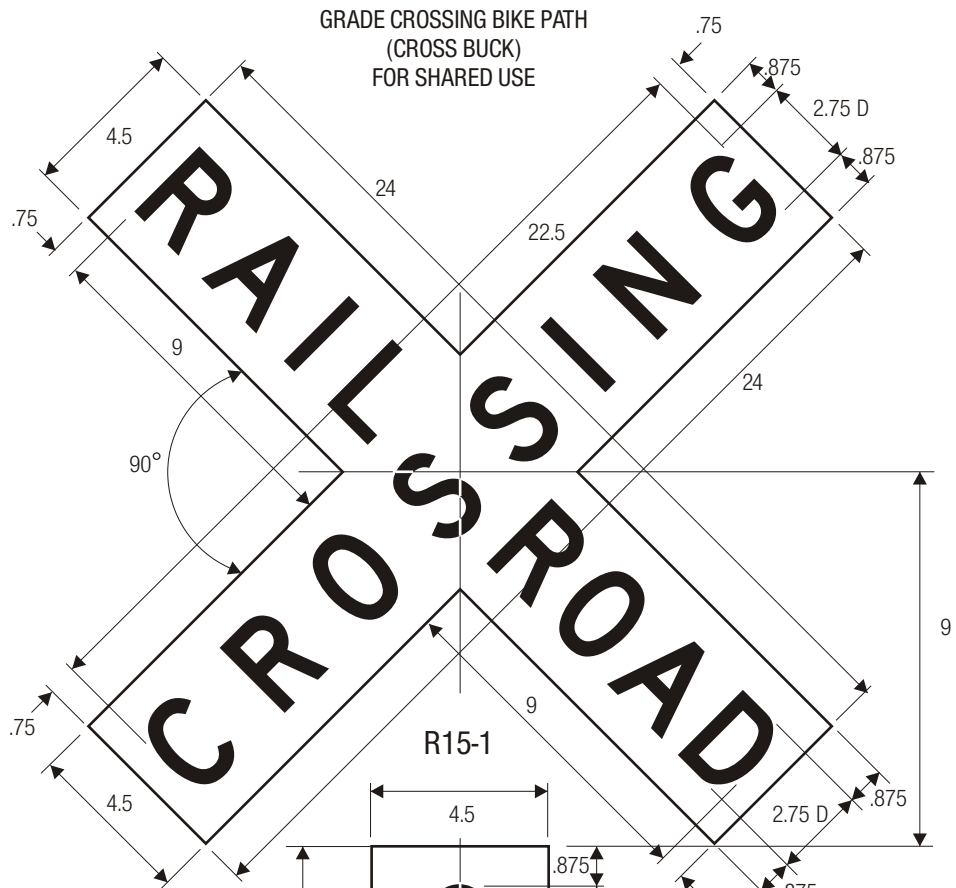

LEGEND — BLACK
BACKGROUND — WHITE (REFLECTIVE)

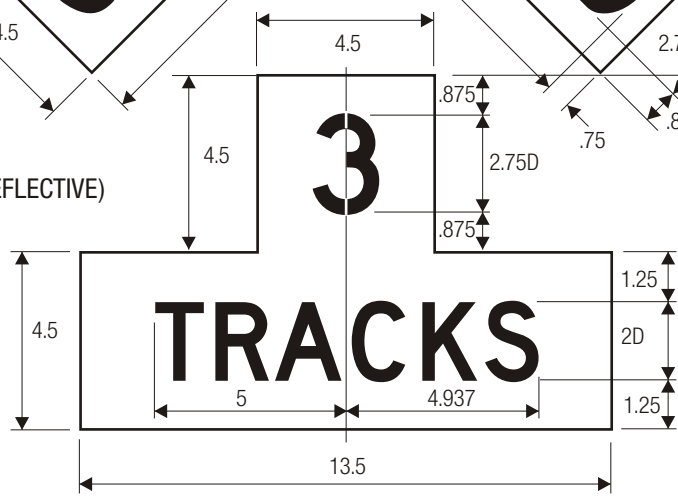

R15-2 NUMBER OF TRACKS

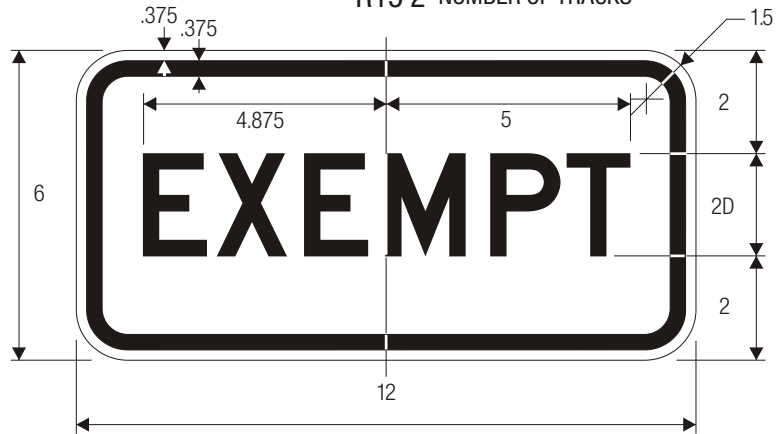

R15-3 / W10-1a EXEMPT

COLORS FOR W10-1a FOR USE WITH W10-1:
LEGEND — BLACK
BACKGROUND — YELLOW (RETROREFLECTIVE)

COLORS FOR R15-2, R15-3 FOR USE WITH R15-1:
LEGEND — BLACK
BACKGROUND — WHITE (RETROREFLECTIVE)

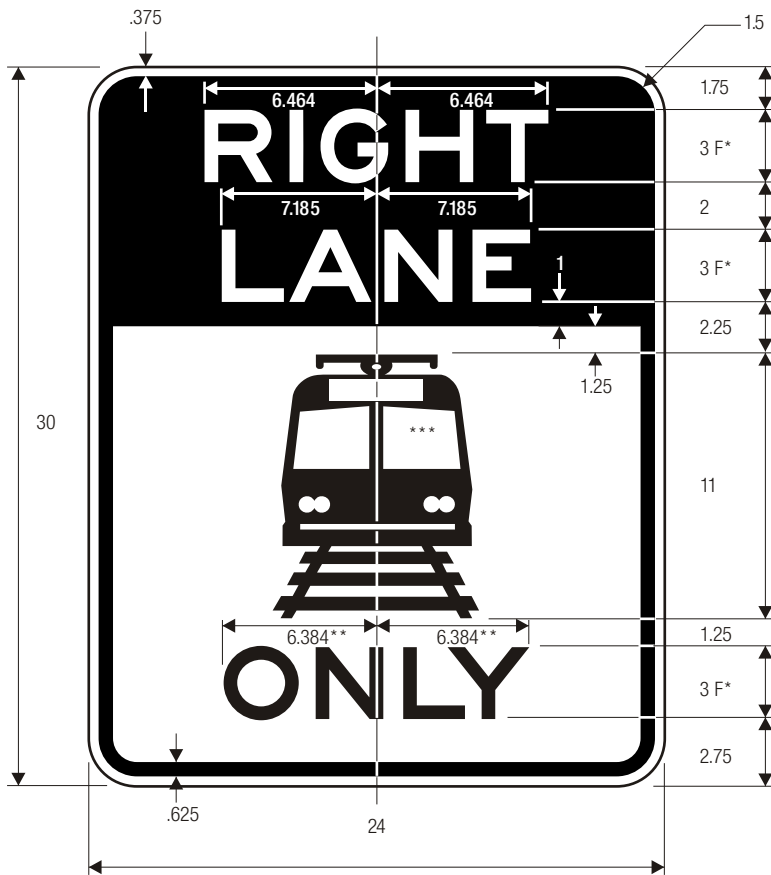

R15-4a
 LIGHT RAIL ONLY
 RIGHT LANE

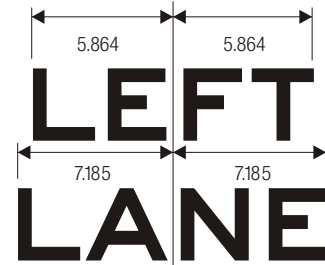

R15-4b
 LIGHT RAIL ONLY
 LEFT LANE

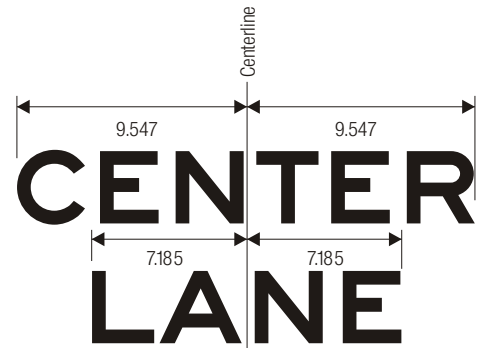

R15-4c
 LIGHT RAIL ONLY
 CENTER LANE

*Series 2000 Standard Alphabets.
 **Reduce spacing to fit.
 ***See page 6-17 for symbol design.

TOP: LEGEND — WHITE (RETROREFLECTIVE)
 BACKGROUND — BLACK

BOTTOM: SYMBOL — BLACK
 LEGEND — BLACK
 BACKGROUND — WHITE (RETROREFLECTIVE)



R15-5
LIGHT RAIL DO NOT PASS

*Series 2000 Standard Alphabets.
 **See page 6-10 for symbol design.
 ***See page 6-17 for symbol design.

COLORS: SYMBOL & LEGEND — BLACK
 BACKGROUND — WHITE (RETROREFLECTIVE)

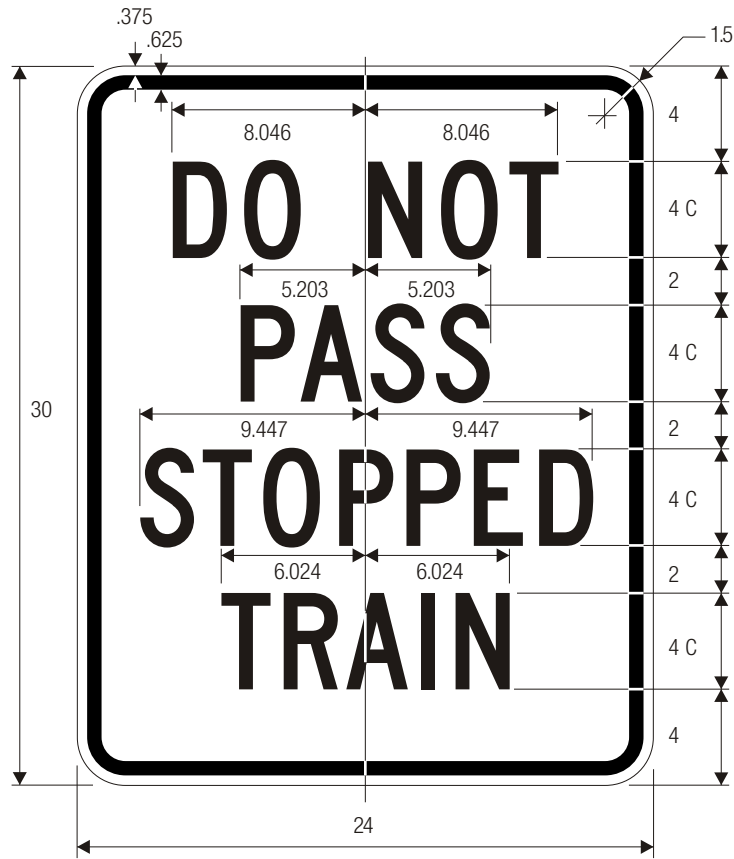

R15-5a DO NOT PASS STOPPED TRAIN



R15-6a DO NOT DRIVE ON TRACKS

COLORS: LEGEND — BLACK
 BACKGROUND— WHITE (RETROREFLECTIVE)

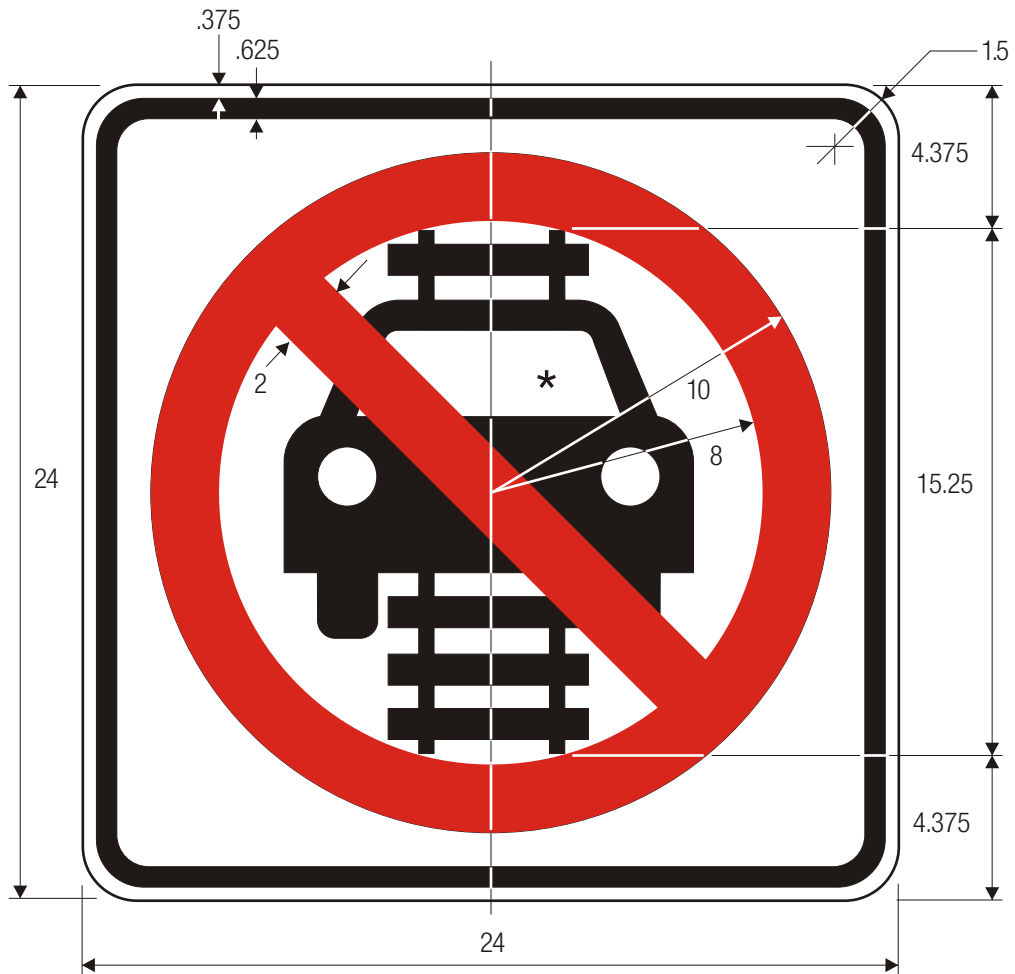

R15-6

DO NOT DRIVE ON TRACKS LIGHT RAIL SYMBOL

*See page 6-19 and 6-24 for symbol design.

COLORS: CIRCLE & DIAGONAL — RED (RETROREFLECTIVE)
 SYMBOL — BLACK
 BACKGROUND — WHITE (RETROREFLECTIVE)

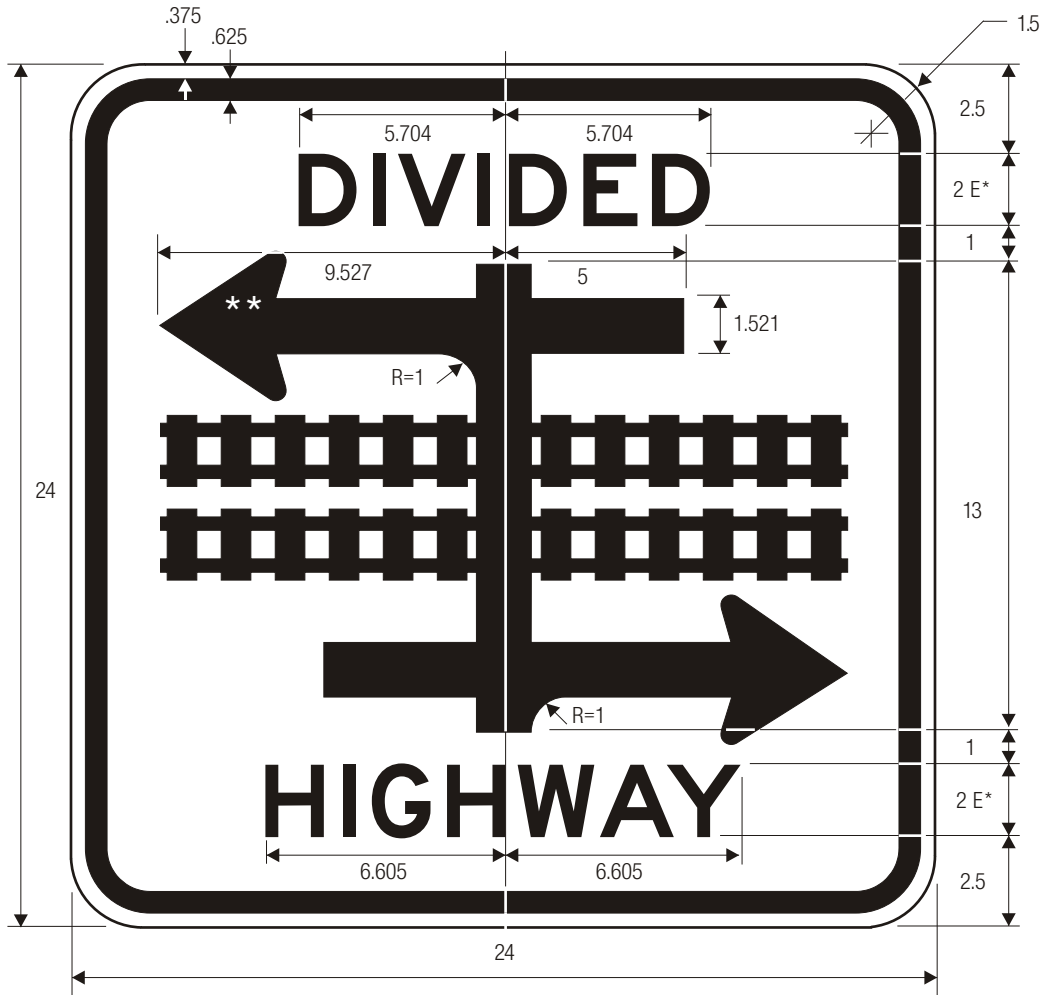

R15-7

LIGHT RAIL DIVIDED HIGHWAY SYMBOL

*Series 2000 Standard Alphabets.

**See page 6-20 for symbol design.

COLORS: LEGEND — BLACK
 BACKGROUND— WHITE (RETROREFLECTIVE)

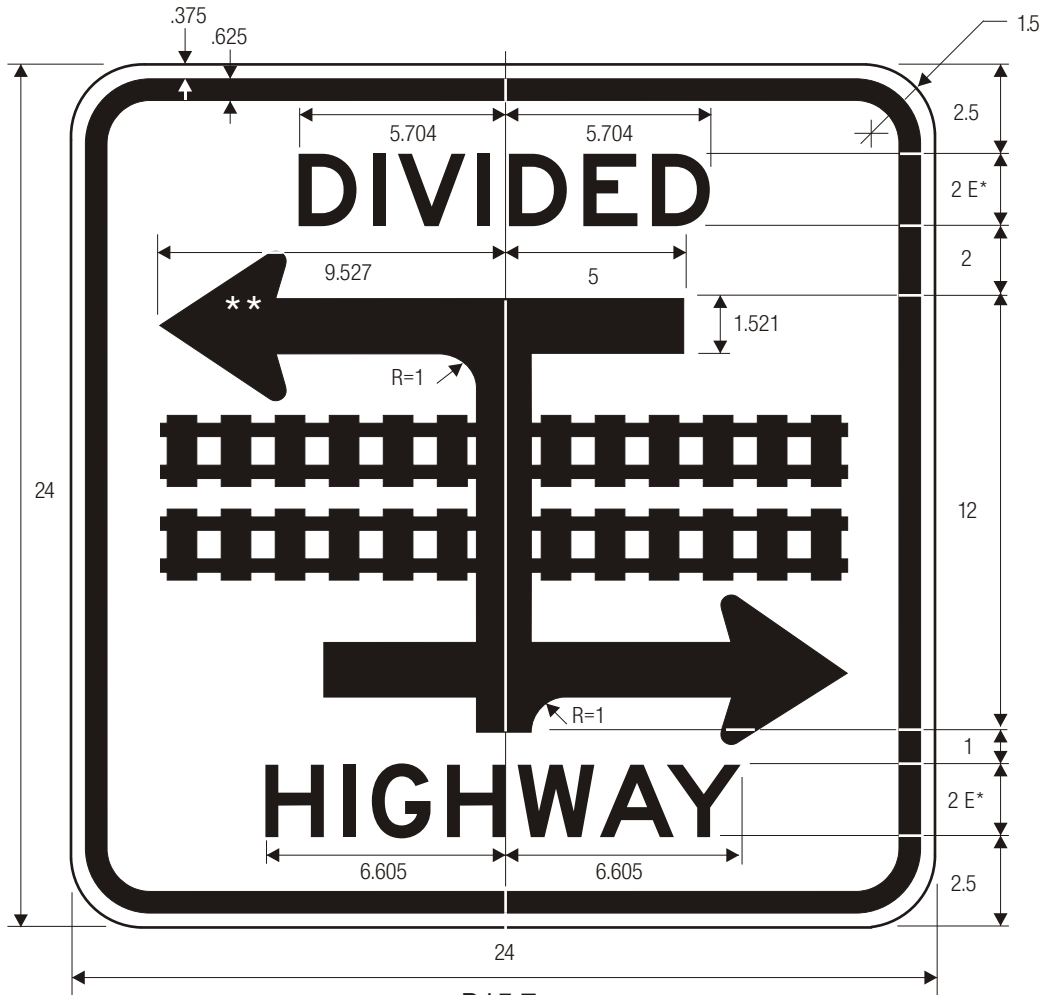

R15-7a

LIGHT RAIL DIVIDED HIGHWAY SYMBOL

*Series 2000 Standard Alphabets.
 **See page 6-20 for symbol design.

COLORS: LEGEND — BLACK
 BACKGROUND— WHITE (RETROREFLECTIVE)

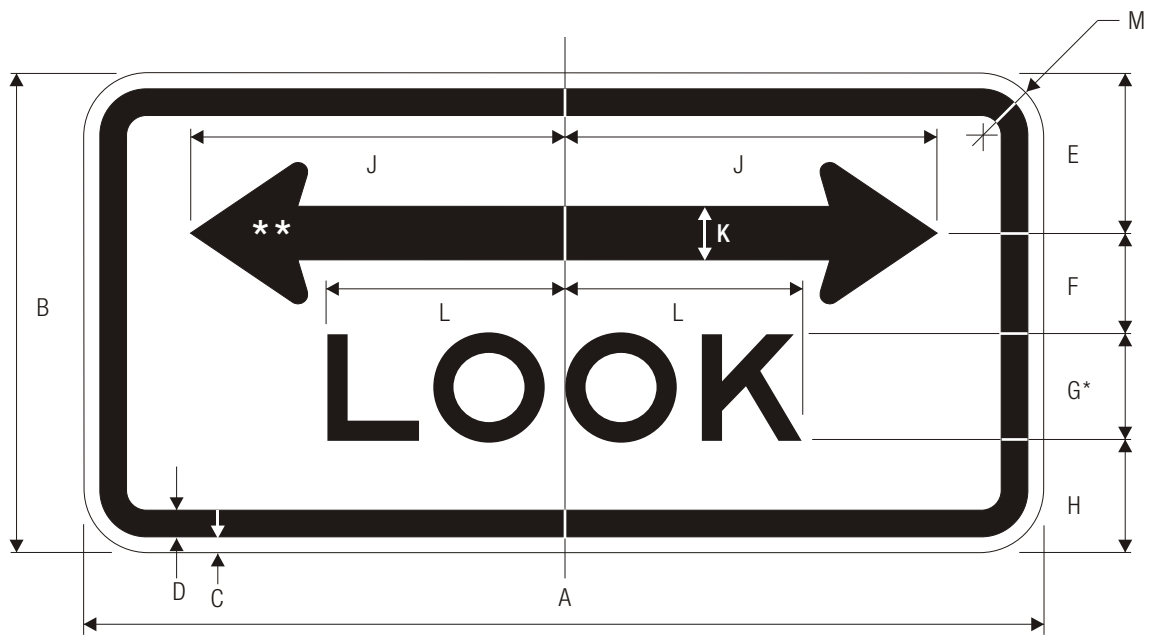

R15-8
LOOK

*Series 2000 Standard Alphabets.
**See page 6-2 for symbol design

C

A	B	C	D	E	F	G	H	J	K	L	M
36	18	.625	.875	6	3.75	4 F	4.25	14	2	8.906	2.25
48	24	.75	1.25	8	5.25	5 F	5.75	18	2.5	11.128	3

COLORS: LEGEND — BLACK
BACKGROUND— WHITE (RETROREFLECTIVE)

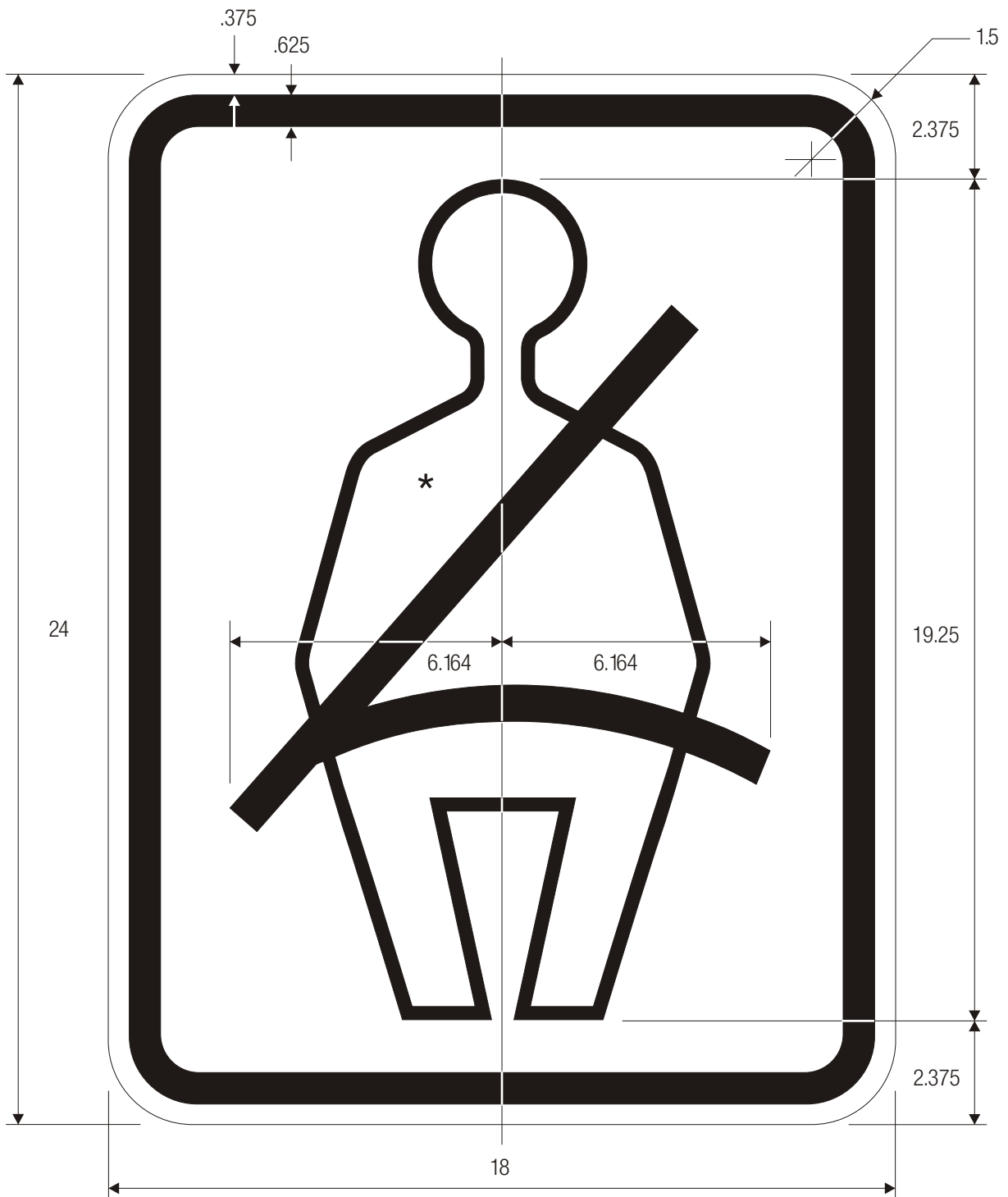

R16-1
SEATBELT

*See page 6-21 for symbol design.

COLORS: SYMBOL — BLACK
BACKGROUND— WHITE (RETROREFLECTIVE)