

# **TOXICOLOGICAL PROFILE FOR URANIUM**

U.S. DEPARTMENT OF HEALTH AND HUMAN SERVICES  
Agency for Toxic Substances and Disease Registry

February 2013

## **DISCLAIMER**

Use of trade names is for identification only and does not imply endorsement by the Agency for Toxic Substances and Disease Registry, the Public Health Service, or the U.S. Department of Health and Human Services.

## UPDATE STATEMENT

A Toxicological Profile for Uranium, Draft for Public Comment was released in May 2011. This edition supersedes any previously released draft or final profile.

Toxicological profiles are revised and republished as necessary. For information regarding the update status of previously released profiles, contact ATSDR at:

Agency for Toxic Substances and Disease Registry  
Division of Toxicology and Human Health Sciences  
Environmental Toxicology Branch  
1600 Clifton Road NE  
Mailstop F-57  
Atlanta, Georgia 30333

This page is intentionally blank.

## FOREWORD

This toxicological profile is prepared in accordance with guidelines\* developed by the Agency for Toxic Substances and Disease Registry (ATSDR) and the Environmental Protection Agency (EPA). The original guidelines were published in the *Federal Register* on April 17, 1987. Each profile will be revised and republished as necessary.

The ATSDR toxicological profile succinctly characterizes the toxicologic and adverse health effects information for the toxic substances each profile describes. Each peer-reviewed profile identifies and reviews the key literature that describes a substance's toxicologic properties. Other pertinent literature is also presented but is described in less detail than the key studies. The profile is not intended to be an exhaustive document; however, more comprehensive sources of specialty information are referenced.

The profiles focus on health and toxicologic information; therefore, each toxicological profile begins with a public health statement that describes, in nontechnical language, a substance's relevant toxicological properties. Following the public health statement is information concerning levels of significant human exposure and, where known, significant health effects. A health effects summary describes the adequacy of information to determine a substance's health effects. ATSDR identifies data needs that are significant to protection of public health.

Each profile:

- (A) Examines, summarizes, and interprets available toxicologic information and epidemiologic evaluations on a toxic substance to ascertain the levels of significant human exposure for the substance and the associated acute, subacute, and chronic health effects;
- (B) Determines whether adequate information on the health effects of each substance is available or being developed to determine levels of exposure that present a significant risk to human health of acute, subacute, and chronic health effects; and
- (C) Where appropriate, identifies toxicologic testing needed to identify the types or levels of exposure that may present significant risk of adverse health effects in humans.

The principal audiences for the toxicological profiles are federal, state, and local health professionals; interested private sector organizations and groups; and members of the public.

This profile reflects ATSDR's assessment of all relevant toxicologic testing and information that has been peer-reviewed. Staff of the Centers for Disease Control and Prevention and other federal scientists also have reviewed the profile. In addition, this profile has been peer-reviewed by a nongovernmental panel and was made available for public review. Final responsibility for the contents and views expressed in this toxicological profile resides with ATSDR.



Christopher J. Portier, Ph.D.  
Assistant Administrator

Agency for Toxic Substances and Disease Registry

### \*Legislative Background

The toxicological profiles are developed under the Comprehensive Environmental Response, Compensation, and Liability Act of 1980, as amended (CERCLA or Superfund). CERCLA section 104(i)(1) directs the Administrator of ATSDR to "...effectuate and implement the health related authorities" of the statute. This includes the preparation of toxicological profiles for hazardous substances most commonly found at facilities on the CERCLA National Priorities List and that pose the most significant potential threat to human health, as determined by ATSDR and the EPA. Section 104(i)(3) of CERCLA, as amended, directs the Administrator of ATSDR to prepare a toxicological profile for each substance on the list. In addition, ATSDR has the authority to prepare toxicological profiles for substances not found at sites on the National Priorities List, in an effort to "...establish and maintain inventory of literature, research, and studies on the health effects of toxic substances" under CERCLA Section 104(i)(1)(B), to respond to requests for consultation under section 104(i)(4), and as otherwise necessary to support the site-specific response actions conducted by ATSDR.

## QUICK REFERENCE FOR HEALTH CARE PROVIDERS

Toxicological Profiles are a unique compilation of toxicological information on a given hazardous substance. Each profile reflects a comprehensive and extensive evaluation, summary, and interpretation of available toxicologic and epidemiologic information on a substance. Health care providers treating patients potentially exposed to hazardous substances will find the following information helpful for fast answers to often-asked questions.

---

### *Primary Chapters/Sections of Interest*

**Chapter 1: Public Health Statement:** The Public Health Statement can be a useful tool for educating patients about possible exposure to a hazardous substance. It explains a substance's relevant toxicologic properties in a nontechnical, question-and-answer format, and it includes a review of the general health effects observed following exposure.

**Chapter 2: Relevance to Public Health:** The Relevance to Public Health Section evaluates, interprets, and assesses the significance of toxicity data to human health.

**Chapter 3: Health Effects:** Specific health effects of a given hazardous compound are reported by type of health effect (death, systemic, immunologic, reproductive), by route of exposure, and by length of exposure (acute, intermediate, and chronic). In addition, both human and animal studies are reported in this section.

**NOTE:** Not all health effects reported in this section are necessarily observed in the clinical setting. Please refer to the Public Health Statement to identify general health effects observed following exposure.

**Pediatrics:** Four sections in each Toxicological Profile address child health issues:

- Section 1.6**    **How Can (Chemical X) Affect Children?**
- Section 1.7**    **How Can Families Reduce the Risk of Exposure to (Chemical X)?**
- Section 3.7**    **Children's Susceptibility**
- Section 6.6**    **Exposures of Children**

**Other Sections of Interest:**

- Section 3.8**    **Biomarkers of Exposure and Effect**
  - Section 3.11**   **Methods for Reducing Toxic Effects**
- 

### *ATSDR Information Center*

**Phone:** 1-800-CDC-INFO (800-232-4636) or 1-888-232-6348 (TTY)    **Fax:** (770) 488-4178  
**E-mail:** [cdcinfo@cdc.gov](mailto:cdcinfo@cdc.gov)    **Internet:** <http://www.atsdr.cdc.gov>

The following additional material can be ordered through the ATSDR Information Center:

*Case Studies in Environmental Medicine: Taking an Exposure History*—The importance of taking an exposure history and how to conduct one are described, and an example of a thorough exposure history is provided. Other case studies of interest include *Reproductive and Developmental Hazards*; *Skin Lesions and Environmental Exposures*; *Cholinesterase-Inhibiting Pesticide Toxicity*; and numerous chemical-specific case studies.

*Managing Hazardous Materials Incidents* is a three-volume set of recommendations for on-scene (prehospital) and hospital medical management of patients exposed during a hazardous materials incident. Volumes I and II are planning guides to assist first responders and hospital emergency department personnel in planning for incidents that involve hazardous materials. Volume III—*Medical Management Guidelines for Acute Chemical Exposures*—is a guide for health care professionals treating patients exposed to hazardous materials.

*Fact Sheets (ToxFAQs)* provide answers to frequently asked questions about toxic substances.

---

### ***Other Agencies and Organizations***

*The National Center for Environmental Health (NCEH)* focuses on preventing or controlling disease, injury, and disability related to the interactions between people and their environment outside the workplace. Contact: NCEH, Mailstop F-29, 4770 Buford Highway, NE, Atlanta, GA 30341-3724 • Phone: 770-488-7000 • FAX: 770-488-7015.

*The National Institute for Occupational Safety and Health (NIOSH)* conducts research on occupational diseases and injuries, responds to requests for assistance by investigating problems of health and safety in the workplace, recommends standards to the Occupational Safety and Health Administration (OSHA) and the Mine Safety and Health Administration (MSHA), and trains professionals in occupational safety and health. Contact: NIOSH, 200 Independence Avenue, SW, Washington, DC 20201 • Phone: 800-356-4674 or NIOSH Technical Information Branch, Robert A. Taft Laboratory, Mailstop C-19, 4676 Columbia Parkway, Cincinnati, OH 45226-1998 • Phone: 800-35-NIOSH.

*The National Institute of Environmental Health Sciences (NIEHS)* is the principal federal agency for biomedical research on the effects of chemical, physical, and biologic environmental agents on human health and well-being. Contact: NIEHS, PO Box 12233, 104 T.W. Alexander Drive, Research Triangle Park, NC 27709 • Phone: 919-541-3212.

*Radiation Emergency Assistance Center/Training Site (REAC/TS)* provides support to the U.S. Department of Energy, the World Health Organization, and the International Atomic Energy Agency in the medical management of radiation accidents. A 24-hour emergency response program at the Oak Ridge Institute for Science and Education (ORISE), REAC/TS trains, consults, or assists in the response to all kinds of radiation accidents. Contact: Oak Ridge Institute for Science and Education, REAC/TS, PO Box 117, MS 39, Oak Ridge, TN 37831-0117 • Phone 865-576-3131 • FAX 865-576-9522 • 24-Hour Emergency Phone 865-576-1005 (ask for REAC/TS) • e-mail: [cooleyp@ornl.gov](mailto:cooleyp@ornl.gov) • website (including emergency medical guidance): <http://www.ornl.gov/reacts/default.htm>.

---

### ***Referrals***

*The Association of Occupational and Environmental Clinics (AOEC)* has developed a network of clinics in the United States to provide expertise in occupational and environmental issues. Contact: AOEC, 1010 Vermont Avenue, NW, #513, Washington, DC 20005 • Phone: 202-347-4976 • FAX: 202-347-4950 • e-mail: [AOEC@AOEC.ORG](mailto:AOEC@AOEC.ORG) • Web Page: <http://www.aoec.org/>.



*The American College of Occupational and Environmental Medicine (ACOEM)* is an association of physicians and other health care providers specializing in the field of occupational and environmental medicine. Contact: ACOEM, 25 Northwest Point Boulevard, Suite 700, Elk Grove Village, IL 60007-1030 • Phone: 847-818-1800 • FAX: 847-818-9266.

This page is intentionally blank.

## CONTRIBUTORS

### CHEMICAL MANAGER(S)/AUTHOR(S):

Sam Keith, M.S., CHP  
Obaid Faroon, D.V.M, Ph.D.  
Nickolette Roney, M.P.H.  
Franco Scinicariello, M.D., M.P.H.  
Sharon Wilbur, M.A.  
ATSDR, Division of Toxicology and Human Health Sciences, Atlanta, GA

Lisa Ingerman, Ph.D., DABT  
Fernando Lladós, Ph.D.  
Daneil Plewak, B.S.  
David Wohlers, Ph.D.  
Gary Diamond, Ph.D.  
SRC, Inc., North Syracuse, NY

### THE PROFILE HAS UNDERGONE THE FOLLOWING ATSDR INTERNAL REVIEWS:

1. Health Effects Review. The Health Effects Review Committee examines the health effects chapter of each profile for consistency and accuracy in interpreting health effects and classifying end points.
2. Minimal Risk Level Review. The Minimal Risk Level Workgroup considers issues relevant to substance-specific Minimal Risk Levels (MRLs), reviews the health effects database of each profile, and makes recommendations for derivation of MRLs.
3. Data Needs Review. The Environmental Toxicology Branch reviews data needs sections to assure consistency across profiles and adherence to instructions in the Guidance.
4. Green Border Review. Green Border review assures the consistency with ATSDR policy.

This page is intentionally blank.

## PEER REVIEW

A peer review panel was assembled for uranium. The panel consisted of the following members:

1. Rudolfs K. Zalups, Ph.D., Mercer University School of Medicine, Macon, Georgia;
2. Walter W. Piegorsch, Ph.D., University of Arizona, Tucson, Arizona;
3. Fletcher F. Hahn, DVM, Ph.D., DACVP, Lovelace Respiratory Research Institute, Albuquerque, New Mexico.

These experts collectively have knowledge of uranium and uranium compound's physical and chemical properties, toxicokinetics, key health end points, mechanisms of action, human and animal exposure, and quantification of risk to humans. All reviewers were selected in conformity with the conditions for peer review specified in Section 104(I)(13) of the Comprehensive Environmental Response, Compensation, and Liability Act, as amended.

Scientists from the Agency for Toxic Substances and Disease Registry (ATSDR) have reviewed the peer reviewers' comments and determined which comments will be included in the profile. A listing of the peer reviewers' comments not incorporated in the profile, with a brief explanation of the rationale for their exclusion, exists as part of the administrative record for this compound.

The citation of the peer review panel should not be understood to imply its approval of the profile's final content. The responsibility for the content of this profile lies with the ATSDR.

This page is intentionally blank.

## CONTENTS

DISCLAIMER .....	ii
UPDATE STATEMENT .....	iii
FOREWORD .....	v
QUICK REFERENCE FOR HEALTH CARE PROVIDERS .....	vii
CONTRIBUTORS .....	xi
PEER REVIEW .....	xiii
CONTENTS .....	xv
LIST OF FIGURES .....	xix
LIST OF TABLES .....	xxi
1. PUBLIC HEALTH STATEMENT FOR URANIUM .....	1
2. RELEVANCE TO PUBLIC HEALTH .....	11
2.1 BACKGROUND AND ENVIRONMENTAL EXPOSURES TO URANIUM IN THE UNITED STATES .....	11
2.2 SUMMARY OF HEALTH EFFECTS .....	13
2.3 MINIMAL RISK LEVELS (MRLs) .....	20
3. HEALTH EFFECTS .....	39
3.1 INTRODUCTION .....	39
3.2 DISCUSSION OF HEALTH EFFECTS BY ROUTE OF EXPOSURE .....	41
3.2.1 Inhalation Exposure .....	42
3.2.1.1 Death .....	43
3.2.1.2 Systemic Effects .....	46
3.2.1.3 Immunological and Lymphoreticular Effects .....	98
3.2.1.4 Neurological Effects .....	100
3.2.1.5 Reproductive Effects .....	101
3.2.1.6 Developmental Effects .....	102
3.2.1.7 Cancer .....	103
3.2.2 Oral Exposure .....	108
3.2.2.1 Death .....	109
3.2.2.2 Systemic Effects .....	110
3.2.2.3 Immunological and Lymphoreticular Effects .....	151
3.2.2.4 Neurological Effects .....	152
3.2.2.5 Reproductive Effects .....	155
3.2.2.6 Developmental Effects .....	158
3.2.2.7 Cancer .....	161
3.2.3 Dermal Exposure .....	162
3.2.3.1 Death .....	162
3.2.3.2 Systemic Effects .....	163
3.2.3.3 Immunological and Lymphoreticular Effects .....	174
3.2.3.4 Neurological Effects .....	174
3.2.3.5 Reproductive Effects .....	174
3.2.3.6 Developmental Effects .....	174
3.2.3.7 Cancer .....	175
3.2.4 Other Routes of Exposure .....	175
3.3 GENOTOXICITY .....	184
3.4 TOXICOKINETICS .....	193
3.4.1 Absorption .....	193

3.4.1.1	Inhalation Exposure .....	193
3.4.1.2	Oral Exposure .....	195
3.4.1.3	Dermal Exposure .....	197
3.4.2	Distribution .....	198
3.4.2.1	Inhalation Exposure .....	198
3.4.2.2	Oral Exposure .....	201
3.4.2.3	Dermal Exposure .....	204
3.4.2.4	Other Routes of Exposure .....	205
3.4.3	Metabolism .....	205
3.4.4	Elimination and Excretion .....	206
3.4.4.1	Inhalation Exposure .....	206
3.4.4.2	Oral Exposure .....	209
3.4.4.3	Dermal Exposure .....	210
3.4.4.4	Other Routes of Exposure .....	210
3.4.5	Physiologically Based Pharmacokinetic (PBPK)/Pharmacodynamic (PD) Models .....	210
3.5	MECHANISMS OF ACTION .....	233
3.5.1	Pharmacokinetic Mechanisms .....	233
3.5.2	Mechanisms of Toxicity .....	234
3.5.3	Animal-to-Human Extrapolations .....	236
3.6	TOXICITIES MEDIATED THROUGH THE NEUROENDOCRINE AXIS .....	237
3.7	CHILDREN'S SUSCEPTIBILITY .....	238
3.8	BIOMARKERS OF EXPOSURE AND EFFECT .....	242
3.8.1	Biomarkers Used to Identify or Quantify Exposure to Uranium .....	243
3.8.2	Biomarkers Used to Characterize Effects Caused by Uranium .....	244
3.9	INTERACTIONS WITH OTHER CHEMICALS .....	245
3.10	POPULATIONS THAT ARE UNUSUALLY SUSCEPTIBLE .....	245
3.11	METHODS FOR REDUCING TOXIC EFFECTS .....	246
3.11.1	Reducing Peak Absorption Following Exposure .....	246
3.11.2	Reducing Body Burden .....	247
3.11.3	Interfering with the Mechanism of Action for Toxic Effects .....	248
3.12	ADEQUACY OF THE DATABASE .....	248
3.12.1	Existing Information on Health Effects of Uranium .....	249
3.12.2	Identification of Data Needs .....	251
3.12.3	Ongoing Studies .....	262
4.	CHEMICAL, PHYSICAL, AND RADIOLOGICAL INFORMATION .....	263
4.1	CHEMICAL IDENTITY .....	263
4.2	PHYSICAL, CHEMICAL, AND RADIOLOGICAL PROPERTIES .....	263
5.	PRODUCTION, IMPORT/EXPORT, USE, AND DISPOSAL .....	273
5.1	PRODUCTION .....	273
5.2	IMPORT/EXPORT .....	280
5.3	USE .....	280
5.4	DISPOSAL .....	284
6.	POTENTIAL FOR HUMAN EXPOSURE .....	287
6.1	OVERVIEW .....	287
6.2	RELEASES TO THE ENVIRONMENT .....	291
6.2.1	Air .....	292
6.2.2	Water .....	296
6.2.3	Soil .....	298



6.3	ENVIRONMENTAL FATE .....	300
6.3.1	Transport and Partitioning.....	300
6.3.2	Transformation and Degradation .....	305
6.3.2.1	Air .....	305
6.3.2.2	Water.....	306
6.3.2.3	Sediment and Soil .....	306
6.4	LEVELS MONITORED OR ESTIMATED IN THE ENVIRONMENT .....	307
6.4.1	Air .....	308
6.4.2	Water.....	308
6.4.3	Sediment and Soil .....	318
6.4.4	Other Environmental Media.....	320
6.5	GENERAL POPULATION AND OCCUPATIONAL EXPOSURE .....	321
6.6	EXPOSURES OF CHILDREN.....	329
6.7	POPULATIONS WITH POTENTIALLY HIGH EXPOSURES .....	331
6.8	ADEQUACY OF THE DATABASE .....	334
6.8.1	Identification of Data Needs .....	334
6.8.2	Ongoing Studies.....	338
7.	ANALYTICAL METHODS.....	339
7.1	BIOLOGICAL MATERIALS.....	339
7.1.1	Internal Uranium Measurements.....	342
7.1.2	External Measurements.....	343
7.2	ENVIRONMENTAL SAMPLES .....	345
7.2.1	Field Measurements of Uranium.....	345
7.2.2	Collection of Environmental Samples.....	346
7.2.3	Laboratory Analysis of Environmental Samples.....	347
7.3	ADEQUACY OF THE DATABASE .....	354
7.3.1	Identification of Data Needs .....	354
7.3.2	Ongoing Studies.....	357
8.	REGULATIONS, ADVISORIES, AND GUIDELINES.....	359
9.	REFERENCES .....	371
10.	GLOSSARY .....	427
APPENDICES		
A.	ATSDR MINIMAL RISK LEVELS AND WORKSHEETS .....	A-1
B.	USER'S GUIDE.....	B-1
C.	ACRONYMS, ABBREVIATIONS, AND SYMBOLS.....	C-1
D.	OVERVIEW OF BASIC RADIATION PHYSICS, CHEMISTRY, AND BIOLOGY .....	D-1
E.	INDEX.....	E-1

This page is intentionally blank.

**LIST OF FIGURES**

3-1. Levels of Significant Exposure to Uranium – Inhalation .....	74
3-2. Levels of Significant Exposure to Uranium – Oral .....	131
3-3. Conceptual Representation of a Physiologically Based Pharmacokinetic (PBPK) Model for a Hypothetical Chemical Substance.....	212
3-4. Respiratory Tract Compartments in Which Particles May be Deposited.....	215
3-5. Environmental Pathways for Potential Human Health Effects from Uranium.....	218
3-6. The Human Respiratory Tract Model: Absorption into Blood.....	222
3-7. Structure of the Human Alimentary Tract Model (HATM) .....	224
3-8. Biokinetic Model for Uranium after Uptake to Blood.....	225
3-9. Multicompartmental Model for Uranium after Uptake to Blood.....	228
3-10. Multicompartmental Model.....	230
3-11. Existing Information on Health Effects of Uranium .....	250
5-1. Uranium Ore Processing.....	276
6-1. Frequency of NPL Sites with Uranium Contamination.....	288
6-2. Environmental Pathways for Potential Human Health Effects from Uranium.....	301
6-3. Average Uranium Concentrations in Drinking Water for States Where Concentration Exceeds 1 pCi/L .....	313

This page is intentionally blank.

## LIST OF TABLES

2-1. Renal Effects Following Intermediate-Duration Inhalation Exposure to Insoluble Uranium Compounds .....	23
2-2. Renal Effects Following Intermediate-Duration Inhalation Exposure to Soluble and Poorly Soluble Uranium Compounds.....	25
3-1. Levels of Significant Exposure to Uranium – Inhalation .....	47
3-2. Levels of Significant Exposure to Uranium – Oral .....	111
3-3. Levels of Significant Exposure to Uranium – Dermal .....	164
3-4. Summary of Significant Observations in Studies of a Cohort of Gulf War Veterans Exposed to Depleted Uranium.....	177
3-5. Genotoxicity of Uranium <i>In Vivo</i> .....	187
3-6. Genotoxicity of Uranium <i>In Vitro</i> .....	190
3-7. Reference Respiratory Values for a General Caucasian Population at Different Levels of Activity.....	216
3-8. Reference Values of Parameters for the Compartment Model to Represent Time-dependent Particle Transport from the Human Respiratory Tract.....	219
3-9. Sensitivity and Calculated Transfer Coefficients ( $d^{-1}$ ).....	231
4-1. Chemical Identity of Uranium Metal.....	264
4-2. Physical and Chemical Properties of Selected Uranium Compounds .....	265
4-3. Percent Occurrence and Radioactive Properties of Naturally Occurring Isotopes of Uranium.....	268
4-4. $^{235}\text{U}$ and $^{238}\text{U}$ Decay Series Showing Sources and Decay Products .....	269
5-1. Uranium Ores .....	274
5-2. Uranium Production in the United States by Uranium Mills and Other Sources .....	278
5-3. Uranium Mining Production, 1985–2009.....	279
5-4. Import of Uranium and Compounds (in kg) into the United States (1990–1998).....	281
5-5. Export of Uranium and Compounds (in kg) (1990–1998) .....	282
5-6. Foreign Purchases and Foreign Sales of Uranium (kg $\text{U}_3\text{O}_8$ Equivalent) by U.S. Suppliers and Owners and Operators of U.S. Civilian Nuclear Power Reactors, 1994–2009.....	283

6-1. Normalized Uranium Effluent Discharges from Uranium Mining, Milling, Conversion, Enrichment, and Fuel Fabrication.....	293
6-2. Uranium in Airborne Particles (Composites) .....	309
6-3. Uranium in Drinking Water (Composites) .....	314
6-4. Uranium Analyses of Select Precipitation Composite Samples March–May 1996 .....	315
6-5. Uranium in Rocks and Soils .....	319
6-6. Concentrations of Uranium in Some Foods.....	322
6-7. Geometric Mean and Selected Percentile of Urinary Concentrations of Uranium ( $\mu\text{g/g}$ Creatinine) for the U.S. Population from the National Health and Nutrition Examination Survey (NHANES) .....	324
6-8. Geometric Mean and Selected Percentile of Urinary Concentrations of Uranium ( $\mu\text{g/L}$ ) for the U.S. Population from the National Health and Nutrition Examination Survey (NHANES) .....	326
6-9. Urinary Levels of Uranium in Individuals Exposed through Military Use of Depleted Uranium.....	333
7-1. Analytical Methods for Determining Uranium in Biological Samples .....	340
7-2. Analytical Methods for Determining Uranium in Environmental Samples .....	348
7-3. Additional Analytical Methods for Determining Uranium in Environmental Samples .....	355
8-1. Regulations, Advisories, and Guidelines Applicable to Uranium.....	361

# 1. PUBLIC HEALTH STATEMENT FOR URANIUM

## *Overview*

We define a public health statement and show how it can help you learn about uranium.

---

### **Introduction**

A public health statement summarizes information about a hazardous substance. The information is taken from a toxicological profile developed by ATSDR's Division of Toxicology and Human Health Sciences (DTHHS). A toxicological profile is a thorough review of a hazardous substance.

This toxicological profile examines uranium. This public health statement summarizes the DTHHS findings on uranium, describes the effects of exposure to it, and describes what you can do to limit that exposure.

---

### **Uranium at hazardous waste sites**

The U.S. Environmental Protection Agency (U.S. EPA) identifies the most serious hazardous waste sites in the nation. U.S. EPA then includes these sites on the National Priorities List (NPL) and targets them for federal clean-up activities. U.S. EPA has found uranium in at least 67 of the 1,699 current or former NPL sites.

The total number of NPL sites evaluated for uranium is not known. But the possibility remains that as more sites are evaluated, the number of sites at which uranium is found may increase. This information is important; these future sites may be sources of exposure, and exposure to uranium may be harmful.

---

### **Why a uranium release can be harmful**

When a contaminant is released from a large area such as an industrial plant or from a container such as a drum or bottle, it enters the environment. But such a release does not always lead to exposure. You normally are exposed to a contaminant when you come in contact with it. That contact—and therefore that exposure—can occur when you breathe, eat, or drink the contaminant, or when it touches your skin. However, since uranium is radioactive, you can also be exposed to its radiation if you are near it.

Even if you are exposed to uranium, you might not be harmed. Whether you are harmed will depend on such factors as the dose (how much), the duration (how long), and how you happen to contact it. Harm might also depend on whether you have been exposed to any other chemicals or radioactive materials, as well as your age, sex, diet, family traits, lifestyle, and state of health.

---

## A Closer Look at Uranium

### *Overview*

This section describes uranium in detail and how you can be exposed to it.

---

#### **What is uranium?**

Uranium is a naturally occurring radioactive element. Natural uranium is a mixture of three isotopes:  $^{234}\text{U}$ ,  $^{235}\text{U}$ , and  $^{238}\text{U}$ . The most common isotope is  $^{238}\text{U}$ ; it makes up about 99% of natural uranium by mass.

All three isotopes behave the same chemically, but they have different radioactive properties.

The half-lives of uranium isotopes (the amount of time needed for half of the isotope to give off its radiation and change into a different element) are very long. The least radioactive isotope is  $^{238}\text{U}$  with a half-life of 4.5 billion years.

Depleted uranium is a mixture of the same three uranium isotopes, except that it has very little  $^{234}\text{U}$  and  $^{235}\text{U}$ . It is less radioactive than natural uranium.

Enriched uranium is another mixture of isotopes that has more  $^{234}\text{U}$  and  $^{235}\text{U}$  than natural uranium. Enriched uranium is more radioactive than natural uranium.

---

#### **How is uranium used?**

Uranium is almost as hard as steel and much denser than lead. Natural uranium is used to make enriched uranium; depleted uranium is the leftover product.

Enriched uranium is used to make fuel for nuclear power plants.

Depleted uranium is used as a counterbalance on helicopter rotors and airplane control surfaces, as a shield to protect against ionizing radiation, as a component of munitions to help them penetrate enemy armored vehicles, and as armor in some parts of military vehicles.

---



## 1. PUBLIC HEALTH STATEMENT

**Where is uranium found?**

Uranium can be released into the environment through wind and water erosion and volcanic eruptions.

Industries involved in mining, milling, and processing of uranium can also release it into the environment. Inactive uranium industries may continue to release uranium into the environment.

Possible Sources	Outcome
<b>Air:</b> In the air, uranium exists as dust.	The very small particles of uranium found in dust can fall onto water, plants, and land. Rain increases the amount of uranium in air that can settle to the ground.
<b>Water:</b> Uranium can be found in drinking water; higher levels tend to be from wells drilled in uranium-rich rock formations.	Uranium in surface water can be transported large distances. Some of the uranium in water will stick to sediment and other particles in the water.
<b>Soil:</b> Uranium is naturally present in nearly all rocks and soils.	Uranium deposited on land can mix into soil, wash into surface water, or stick to plant roots.
<b>Food:</b> Human daily intake has been estimated to range from 0.9 to 1.5 micrograms of uranium per day ( $\mu\text{g}/\text{day}$ ).	Uranium can stick to plant roots. Unwashed potatoes, radishes, and other root vegetables are a primary source of uranium in the diet.

---

## How Can You Be Exposed to Uranium

### Primary uranium exposure sources

For most people, food and drinking water are the main sources of uranium exposure.

Root crops such as potatoes, parsnips, turnips, and sweet potatoes contribute the highest amounts of uranium to the diet. The amount of uranium in these foods is directly related to the amount of uranium in the soil in which they are grown.

### Other uranium exposure sources

People who work with materials and products that contain uranium may be exposed at work. This includes workers who mine, mill, or process uranium or make items that contain uranium. People who work with phosphate fertilizers may also be exposed to higher levels of uranium.

People who live near uranium mining, processing, and manufacturing facilities could be exposed to more uranium than the general population.

People may also be exposed if they live near areas where depleted uranium weapons are used.

---

## 1. PUBLIC HEALTH STATEMENT

**Secondary uranium exposure sources**

In most areas of the United States, low levels of uranium are found in the drinking water. Higher levels may be found in areas with elevated levels of naturally occurring uranium in rocks and soil.

## How Uranium Can Affect Your Health

### Overview

This section looks at how uranium enters your body and potential uranium health effects found in human and animal studies.

### How uranium enters your body

Uranium can enter your body from the air, water, food, or from dermal contact.

Possible Sources	Possible Exposure Pathway
<b>Air</b>	Only about 0.76–5% of the uranium a person breathes will get into the bloodstream through the respiratory tract (nose, mouth, throat, lungs). Some uranium compounds are slowly cleared from the lungs.
<b>Food and water</b>	Only about 0.1–6% of the uranium a person ingests will get into the bloodstream through the gastrointestinal tract (mouth, stomach, intestines). Uranium compounds that dissolve in water enter the bloodstream more easily than uranium compounds poorly soluble in water.
<b>Dermal contact</b>	A very small amount of uranium can be absorbed through the skin; water-soluble uranium compounds are the most easily absorbed.

### How uranium leaves your body

Most of the inhaled and ingested uranium is not absorbed and leaves the body in the feces. Absorbed uranium leaves your body in the urine. Some inhaled uranium can stay in the lungs for a long time.

Uranium that is absorbed is deposited throughout the body; the highest levels are found in the bones, liver, and kidneys. Sixty-six percent of the uranium in the body is found in your bones. It can remain in the bones for a long time; the half-life of uranium in bones is 70–200 days (this is the amount of time that it takes for half of the uranium to leave the bones). Most of the uranium that is not in bones leaves the body in 1–2 weeks.

## 1. PUBLIC HEALTH STATEMENT

<b>Introduction to uranium health effects</b>	<p>Natural and depleted uranium have the identical chemical effect on your body.</p> <p>The health effects of natural and depleted uranium are due to chemical effects and not to radiation.</p> <hr/>
<b>Main uranium health effects</b>	<p>Uranium's main target is the kidneys. Kidney damage has been seen in humans and animals after inhaling or ingesting uranium compounds. However, kidney damage has not been consistently found in soldiers who have had uranium metal fragments in their bodies for several years. Ingesting water-soluble uranium compounds will result in kidney effects at lower doses than following exposure to insoluble uranium compounds.</p> <p>Workers who inhaled uranium hexafluoride have experienced respiratory irritation and accumulation of fluid in the lungs. However, these effects were attributed to the irritant hydrofluoric acid rather than the uranium.</p> <p>Inhaled insoluble uranium compounds can also damage the respiratory tract.</p> <hr/>
<b>Other uranium health effects</b>	<p>No health effects, other than kidney damage, have been consistently found in humans after inhaling or ingesting uranium compounds or in soldiers with uranium metal fragments in their bodies.</p> <p>Rats ingesting uranium over a long time had neurobehavioral changes and changes in the levels of certain chemicals in the brain.</p> <p>Uranium has been shown to decrease fertility in some studies of rats and mice; other studies have not found this effect.</p> <p>Very soluble uranium compounds on the skin caused skin irritation and mild skin damage in animals.</p> <hr/>
<b>Uranium and cancer</b>	<p>Neither the National Toxicology Program (NTP), International Agency for Research on Cancer (IARC), nor the EPA have classified natural uranium or depleted uranium with respect to carcinogenicity.</p> <hr/>

## Children and Uranium

### *Overview*

This section discusses potential health effects of uranium exposure in humans from when they are first conceived to 18 years of age, and how you might protect against such effects.

---

## 1. PUBLIC HEALTH STATEMENT

**Exposure effects for children generally** No data describe the effects of exposure to uranium on children or young animals. Although we think that children would likely show the same health effects as adults, we do not know whether children are more susceptible than adults to uranium effects.

---

**What about birth defects?** We do not know whether uranium can harm an unborn child. No scientifically strong human study that has shown birth defects due to uranium exposure has been identified.

Some studies in animals exposed to high levels of uranium during pregnancy, which caused toxicity in the mothers, have resulted in early deaths and birth defects in the young. It is not clear if this can happen in the absence of effects on the mother. Other studies have not found birth defects.

In some rat studies, enriched uranium exposure during pregnancy caused changes in brain function in the offspring. Similar studies found changes in the ovaries of the female offspring.

One study reported that giving a high amount of uranium to newborn rats altered the tooth formation.

---

## How Can You Lower Your Exposure to Uranium

**Food** Avoid eating root vegetables grown in soils with high levels of uranium. Consider washing fruits and vegetables grown in that soil and discard the outside portion of root vegetables.

---

**Drinking water** Consider having your water tested if you suspect that your drinking water might have elevated levels of uranium. If elevated levels are found, consider using bottled water.

---

**If you live near a hazardous waste site** If you live near a hazardous waste site with high amounts of uranium that are not controlled, do not let your children play outside in the dirt. Children put dirt in their mouths, and uranium is in this dirt. Also, make sure your children wash their hands often, especially before eating.

---

## 1. PUBLIC HEALTH STATEMENT

## Medical Tests to Determine Uranium Exposure

### *Overview*

Natural uranium is in your normal diet, so there will always be some level of uranium in all parts of your body. If in addition you are exposed to depleted uranium, it adds to the total uranium level in your body. We identify medical tests that can detect whether uranium is in your body, and we recommend safe toxic-substance practices.

---

#### **Uranium can be measured in blood and urine**

Uranium can be measured in blood, urine, hair, and body tissues. Normally, urinary sampling is the preferred method for assessing uranium exposure. The amount of radiation from uranium in your body can also be measured.

Most tests are for total uranium; however, expensive tests are available to estimate the amounts of both natural and depleted uranium that are present.

---

#### **What the uranium exposure tests might show**

Most uranium leaves the body within a few days. High amounts in your urine might show that you have been exposed to high amounts of uranium within the last week or so.

---

## Federal Government Recommendations to Protect Human Health

### *Overview*

One way the federal government promotes public health is by regulating toxic substances or recommending ways to handle or to avoid toxic substances.

#### **The federal government regulates toxic substances**

Regulations are enforceable by law. The U.S. EPA, the Occupational Safety and Health Administration (OSHA), the Nuclear Regulatory Commission (USNRC), and the Food and Drug Administration (FDA) are some federal agencies that develop toxic substance regulations.

---

#### **The federal government recommends safe toxic substance practices**

The Agency for Toxic Substances and Disease Registry (ATSDR) and the National Institute for Occupational Safety and Health (NIOSH) have made recommendations about toxic substances. Unlike enforceable regulations, these recommendations are advisory only.

---

## 1. PUBLIC HEALTH STATEMENT

**Toxic substance regulations** Regulations and recommendations can be expressed as “not-to-exceed” levels, that is, levels of a toxic substance in air, water, soil, or food that do not exceed a critical value usually based on levels that affect animals; levels are then adjusted to help protect humans. Sometimes, these not-to-exceed levels differ among federal organizations. Different organizations use different exposure times (an 8-hour workday or a 24-hour day), different animal studies, or emphasize some factors over others, depending on their mission.

**Check for regulation updates** Recommendations and regulations are also updated periodically as more information becomes available. For the most current information, check with the federal agency or organization that issued the regulation or recommendation.

Some regulations and recommendations for uranium include:

<b>Federal Organization</b>	<b>Regulation or Recommendation</b>
U.S. Environmental Protection Agency (EPA)	The U.S. EPA has established a maximum contaminant level of 0.03 mg/L and set a maximum contaminant level goal of no uranium in drinking water.
Occupational Safety and Health Administration (OSHA)	OSHA set a legal limit for worker exposure to uranium in workplace air of 0.05 mg uranium/m <sup>3</sup> for soluble uranium and 0.25 mg uranium/m <sup>3</sup> for insoluble uranium averaged over an 8-hour work day.
National Institute of Occupational Safety and Health (NIOSH)	NIOSH recommends that worker exposure to uranium in workplace air not exceed an exposure limit of 0.05 mg uranium/m <sup>3</sup> for soluble uranium and 0.2 mg uranium/m <sup>3</sup> for insoluble uranium averaged for up to a 10-hour work day. NIOSH also recommends that exposure to soluble uranium not exceed 0.6 mg U/m <sup>3</sup> for more than 15 minutes.
U.S. Nuclear Regulatory Commission (USNRC)	The USNRC has established derived air concentrations of 0.0005, 0.0003, and 0.00002 microcuries/m <sup>3</sup> , averaged for a working year of 2,000 hours for workers exposed to a form of uranium that is excreted at fast, medium, and slow rates, respectively.

## 1. PUBLIC HEALTH STATEMENT

## Additional Information

### *Overview*

Where to find more information about uranium.

---

**Whom to  
contact first**

If you have questions or concerns, please contact your community or state health or environmental quality department, or contact ATSDR at the address and phone number below.

---

**Additional  
information  
from ATSDR**

ATSDR can also tell you the location of occupational and environmental health clinics. These clinics specialize in recognizing, evaluating, and treating illnesses that result from exposure to hazardous substances.

---

**Where to  
obtain  
toxicological  
profile copies**

Toxicological profiles are also available online at [www.atsdr.cdc.gov](http://www.atsdr.cdc.gov) and on CD-ROM. Request a copy of the ATSDR ToxProfiles CD-ROM by

- Calling the toll-free information and technical assistance number at 1-800-CDCINFO (1-800-232-4636),
- E-mailing [cdcinfo@cdc.gov](mailto:cdcinfo@cdc.gov), or
- Writing to

Agency for Toxic Substances and Disease Registry  
Division of Toxicology and Human Health Sciences  
1600 Clifton Road NE  
Mailstop F-57  
Atlanta, GA 30333  
Fax: 1-770-488-4178

---

For-profit organizations should request final toxicological profile copies from

National Technical Information Service (NTIS)  
5285 Port Royal Road  
Springfield, VA 22161  
Phone: 1-800-553-6847 or 1-703-605-6000  
Web site: <http://www.ntis.gov/>

---

1. PUBLIC HEALTH STATEMENT

This page is intentionally blank.



## 2. RELEVANCE TO PUBLIC HEALTH

### 2.1 BACKGROUND AND ENVIRONMENTAL EXPOSURES TO URANIUM IN THE UNITED STATES

Uranium is an alpha-emitting, radioactive, heavy metal that occurs naturally in nearly all rocks and soils. Twenty-two isotopic forms of uranium have been identified, mainly associated with nuclear reactor operations or high-energy physics experiments; the most prevalent isotopes found in the environment are the three naturally-occurring isotopes:  $^{234}\text{U}$ ,  $^{235}\text{U}$ , and  $^{238}\text{U}$ . Most uranium isotopes undergo decay by alpha emission, a few undergo beta emission, and several isotopes, including  $^{238}\text{U}$ , can also undergo spontaneous fission.  $^{238}\text{U}$  decays through 16 radioactive progeny, including  $^{234}\text{U}$ , to reach stable lead-206 ( $^{206}\text{Pb}$ ), while  $^{235}\text{U}$  decays through 13 radioactive progeny to reach stable  $^{207}\text{Pb}$ . The rate of decay (or half-life) for most uranium isotopes is long; the half-lives of  $^{238}\text{U}$ ,  $^{235}\text{U}$  and  $^{234}\text{U}$  are  $4.5 \times 10^9$ ,  $7.0 \times 10^8$  and  $2.5 \times 10^5$  years, respectively. Since the activity of a given mass of uranium depends on the mass and half-life of each isotope present, the greater the relative abundance of the more rapidly decaying  $^{234}\text{U}$  and  $^{235}\text{U}$ , the higher the specific activity. Naturally occurring uranium is an isotopic mixture containing 99.284%  $^{238}\text{U}$ , 0.711%  $^{235}\text{U}$ , and 0.005%  $^{234}\text{U}$  by mass (49%  $^{238}\text{U}$ , 2%  $^{235}\text{U}$ , and 49%  $^{234}\text{U}$  by radioactivity) and has a specific activity of 0.68  $\mu\text{Ci/g}$ . The industrial process of enrichment separates natural uranium into enriched uranium (increased percentage of  $^{235}\text{U}$ ) and depleted uranium (decreased percentage of  $^{235}\text{U}$ ). The process of enrichment also increases the percentage of  $^{234}\text{U}$  (thus, enriched uranium is more reactive); depleted uranium has a decreased percentage of  $^{234}\text{U}$  and is less radioactive. Uranium enrichment for commercial nuclear energy produces uranium that contains about 3%  $^{235}\text{U}$  by activity. Uranium enrichment for other purposes, including nuclear weapons production, can produce uranium containing as much as 97.3%  $^{235}\text{U}$  and having a higher specific activity ( $\sim 50 \mu\text{Ci/g}$ ). Depleted uranium is the byproduct of the enrichment process. Depleted uranium has even less specific activity (0.33  $\mu\text{Ci/g}$ ) than natural uranium.

The average concentration of uranium in U.S. soils is about 3 ppm (2 pCi/g). Some parts of the United States, particularly the western portion, exhibit higher-than-average uranium levels due to natural geological formations. Most uranium ores contain between 0.2 and 5% uranium by weight; however, levels as high as 22% have been reported in the Athabasca Basin region of Canada. Anthropogenic sources of uranium include uranium mining and milling, uranium conversion and enrichment, uranium fuel fabrication, nuclear weapons production, production of phosphate fertilizers from phosphate rocks containing uranium, and the improper disposal of uranium mine tailings. Essentially no uranium is

## 2. RELEVANCE TO PUBLIC HEALTH

released from nuclear power plants because of the fuel assembly design and the chemical and physical nature of the uranium oxide fuel.

The general population is exposed to uranium via ingestion of food and drinking water and inhalation of air, with food being the primary contributor to body burden. The daily intake of uranium from food sources ranges from 0.6 to 1.0 pCi/day (0.9–1.5 µg/day). Uranium from soil is not taken up by plants, but rather is adsorbed onto the roots. Thus, the highest levels of uranium are found in root vegetables, primarily unwashed potatoes. Populations living near uranium mills or mines or other areas with elevated uranium in soil may be exposed to higher levels of uranium from locally grown vegetables. Uranium levels in drinking water vary widely, with a mean population-weighted average of 0.8 pCi/L. Compared to the ingestion route, the intake of uranium via inhalation is small; intakes range from 0.0007 to 0.007 pCi/day (0.001–0.01 µg/day).

Uranium is poorly absorbed following inhalation, oral, or dermal exposure and the amount absorbed is heavily dependent on the solubility of the compound. The site of deposition of inhaled particles in the respiratory tract also influences absorption. The more soluble compounds are more likely to be absorbed into the blood at the alveolar level within days. The less soluble compounds are more likely to remain in the lung tissue and associated lymph nodes either for weeks (uranium trioxide, uranium tetrafluoride) or years (uranium dioxide, triuranium octaoxide), resulting in significant pulmonary retention in inhalation-exposure toxicity and a greater dose of alpha radiation. Absorption efficiencies of 18–40 and 23% have been reported in animals exposed to uranium hexafluoride or uranium trioxide aerosols, respectively. Following oral exposure, <0.1–6% of the uranium is absorbed, depending on the solubility of the uranium compound. Following dermal application of uranyl nitrate, 0.4% of the dose was absorbed through the skin of hairless rats. Damage to the skin resulted in substantially higher absorption efficiencies. Transdermally absorbed uranium and uranium released from embedded fragments is expected to behave identically to uranium compounds absorbed through the lungs and the gastrointestinal tract. Regardless of solubility, a portion of uranium quickly reaches the systemic circulation. Uranium is usually found in compounds that can break down and recomplex to form other compounds. In body fluids, tetravalent uranium is likely to oxidize to the hexavalent form, followed by formation of the uranyl ion. Uranium generally complexes with citrate, bicarbonates, or protein in plasma. Approximately 67% of uranium in the blood is filtered in the kidneys and leaves the body in urine within 24 hours; the remainder distributes to tissues, primarily the bone, liver, and kidney. The retention half-time for uranium in bone following inhalation exposure to soluble uranium compounds is 70–200 days. The main sites of long-term retention for inhaled insoluble compounds that are deposited in the deep respiratory tract are the lungs and

## 2. RELEVANCE TO PUBLIC HEALTH

pulmonary lymph nodes. The normal adult body burden is approximately 90 µg of which 66% is found in bone, 16% is in the liver, 8% is in the kidneys, and 10% is in other tissues.

## 2.2 SUMMARY OF HEALTH EFFECTS

The following discussion of the chemical and radiological health effects of uranium is divided into the three groupings of uranium isotope mixtures (natural uranium, enriched uranium, and depleted uranium) and the various compounds in which uranium is usually found. The health effects of daughter radioactive elements (radium and radon) are addressed in other toxicological profiles (consult the ATSDR toxicological profiles for radium and radon for more information regarding these radioactive elements). The preponderance of the available toxicity data comes from animal studies of natural uranium; studies over the last 20 years have also evaluated the toxicity of enriched uranium in animals and depleted uranium in military personnel with embedded depleted uranium fragments and in animals. Comparisons across studies provide evidence that the chemical action of all isotopes and isotopic mixtures of uranium is identical, regardless of the specific activity, because chemical action depends only on chemical properties. Thus, the chemical toxicities of natural, depleted, and enriched uranium are identical. Some recent studies also suggest that exposure to enriched uranium can also result in radiotoxic effects.

***Natural Uranium.*** Current evidence from animal studies suggests that the toxicity of uranium is mainly due to its chemical damage to kidney tubular cells following exposure to soluble uranium compounds and the respiratory tract following chronic inhalation exposure to insoluble uranium compounds. Other potential targets of toxicity include the reproductive system and the developing organism. There are limited data on the renal toxicity of uranium following inhalation exposure in humans. A number of studies found no alterations in mortality due to renal disease in uranium workers. An autopsy study of long-time workers exposed to low levels of uranium did not find evidence of renal injury years after exposure termination. However, a study of uranium mill workers exposed to uranium found evidence of renal dysfunction ( $\beta$ -2-microglobulinuria, aminoaciduria); the severity and incidence of the effects appeared to be related to exposure duration. Several epidemiology studies have found associations between nonspecific parameters of renal dysfunction (e.g., urine levels of albumin,  $\beta$ <sub>2</sub>-microglobulin, glucose, and protein HC) and elevated uranium levels in drinking water. These studies did not find overt signs of toxicity and in many cases, the biomarkers of renal dysfunction were within the normal range. Although most of the epidemiology studies provided information on uranium levels in the drinking water, there was often a large range of exposure levels; thus, the human oral exposure studies do not provide reliable dose-response data.

## 2. RELEVANCE TO PUBLIC HEALTH

Renal effects have been observed in a number of animal species exposed to various uranium compounds. The observed effects have primarily involved damage to the proximal tubules and have been observed following inhalation, oral, or dermal exposures. The majority of the data on the renal toxicity of uranium come from a collection of experiments conducted in late 1940s and early 1950s. The results of these studies demonstrate compound- and species-related differences in toxicity. Soluble uranium compounds (e.g., uranyl nitrate, uranyl fluoride, uranium hexafluoride, and uranium tetrachloride) are more toxic than insoluble uranium compounds (e.g., uranium dioxide, uranium peroxide, uranium trioxide, and triuranium octaoxide). Renal effects have been observed in animals exposed to aerosols of soluble uranium compounds at concentrations of  $\geq 0.13$  mg U/m<sup>3</sup> for intermediate durations. However, no renal effects were observed in animals exposed to 1.0 mg U/m<sup>3</sup> as insoluble compounds; the lowest-observed-adverse-effect level (LOAEL) was 8.2 mg U/m<sup>3</sup>. These data suggest that soluble compounds are at least 5 times more toxic than insoluble compounds. The difference in toxicity is likely due to the more efficient absorption of soluble uranium compounds. Of the animals tested in intermediate-duration inhalation studies, dogs and rabbits are the most sensitive followed by rats, mice, and guinea pigs. The severity of renal lesions increases with increasing exposure concentrations; very slight renal tubular damage is observed at low concentrations and marked degeneration and necrosis are observed at higher concentrations. The available data on the oral and dermal toxicity of uranium are more limited than by the inhalation route. Acute-, intermediate-, and chronic-duration oral studies in laboratory animals (rats, mice, rabbits, and dogs) provide strong support for identifying the kidney as a sensitive target of uranium toxicity. Acute exposure to lethal doses of uranyl nitrate or uranyl acetate resulted in renal dysfunction in rats and mice as evidenced by increases in urine volume, plasma urea, blood urea nitrogen (BUN), and urinary total protein. Minimal histological alterations in the glomerulus, proximal tubules, and/or interstitium have been observed in rats and rabbits exposed to intermediate-duration doses of soluble uranium compounds as low as 0.05 mg U/kg/day; the severity of the renal lesions increased with dose. Additionally, a rabbit study demonstrated that renal lesions persisted up to 91 days following termination of a 91-day oral exposure. Chronic oral exposure to soluble uranium compounds resulted in minimal tubular damage at 81 mg U/kg/day and tubular atrophy at  $\geq 140$  mg U/kg/day. Due to the poor absorption of ingested insoluble uranium compounds, there are significant differences in the renal toxicity of various uranium compounds. No renal effects were observed in rats exposed to doses as high as 11,000–12,000 mg U/kg/day as uranium dioxide, uranium trioxide, uranyl octaoxide, or uranium tetrafluoride for 30 days; after 2 years of exposure to 11,000 mg U/kg/day as uranium tetrafluoride, mild tubular degeneration was observed in rats, but no adverse effects were observed in rats exposed to 12,000 mg U/kg/day as uranium dioxide for 2 years. In contrast, adverse renal effects were observed after a 30-day

## 2. RELEVANCE TO PUBLIC HEALTH

exposure to doses of 140–270 mg U/kg/day as uranyl nitrate, uranium peroxide, or uranyl fluoride and doses of 440–790 mg U/kg/day as uranium tetrachloride or uranium acetate and a 2-year exposure to 81–170 mg U/kg/day as uranyl fluoride or uranyl nitrate. Available inhalation and oral exposure studies suggest that following exposure to low levels of uranium (doses or concentrations resulting in minimal renal effects), toxicity is not strongly influenced by the duration of exposure. As with other routes of exposure, proteinuria, renal failure, and renal lesions were observed in laboratory animals following acute dermal exposure to uranyl nitrate.

General damage to pulmonary structures, usually noncancerous alveolar epithelium damage of type II cells, can occur upon inhalation of insoluble reactive chemicals such as some uranium compounds (uranium tetrafluoride, uranium dioxide, uranium trioxide, triuranium octaoxide). In acute exposures, pulmonary damage may be limited to interstitial inflammation of the alveolar epithelium leading eventually to emphysema or pulmonary fibrosis. In studies of the pulmonary effects of airborne uranium dust in uranium miners, the respiratory diseases reported were aggravated by the insoluble aerosol particles (mine dust) to which these miners were exposed because most of the noncancerous respiratory diseases reported in these studies were consistent with toxicity of inhalable dust particles other than uranium, such as crystalline silica and diesel engine exhaust particles. Respiratory effects reported in workers acutely exposed to uranium hexafluoride were caused by hydrogen fluoride, a potent lung irritant and a spontaneous byproduct of the reaction between uranium hexafluoride and water, such as in mucous membranes. A follow-up study of three of the workers did not detect uranium in the lungs or evidence of lung damage 38 years after the initial exposure. Similar to human studies, signs of respiratory irritation (rhinitis and lung edema, hemorrhage, and emphysema) have been observed in animals exposed to  $\geq 2$  mg U/m<sup>3</sup> uranium hexafluoride, uranyl fluoride, and uranium tetrafluoride. It is likely that these effects were due to co-exposure to hydrogen fluoride. Inhalation exposure to insoluble uranium compounds also results in pulmonary damage. Very slight pulmonary lesions were observed in rats and dogs exposed to 16 mg U/m<sup>3</sup> as uranium trioxide for 4 weeks; mild to severe renal tubular necrosis was also observed at this concentration. In contrast, chronic exposure to 5.1 mg U/m<sup>3</sup> as uranium dioxide for at least 3.5 years resulted in lung fibrosis in monkey and dogs; renal effects were not observed in either species.

Limited data are available regarding reproductive effects of uranium in humans. Studies of uranium miners, millers, and processors found that male uranium miners had more first-born female children than expected, suggesting that uranium's alpha radiation damaged the y-chromosomes of the miners. However, the workers were also exposed to <sup>222</sup>Rn, chlorine, hydrofluoric acid, lead sulfate, nickel, nitric acid and nitrogen oxides, silicon dioxide, sulfuric acid, tobacco smoke, and diesel exhaust. Uranium

## 2. RELEVANCE TO PUBLIC HEALTH

reduced fertility, likely due to reductions in spermatozoa counts, was observed in male mice exposed to  $\geq 5.6$  mg U/kg/day in drinking water and mated with untreated females. However, fertility was not significantly affected in another study in mice in which males and females were treated by gavage with up to 14 mg U/kg/day. These apparently discrepant results may be due to the different mode of dosing between the two studies (i.e., gavage vs. drinking water), which may have resulted in different rates of absorption. Uranium also reduced fertility in male rats dosed with 11.2 mg/kg/day and mated with untreated females; the NOAEL was 5.6 mg U/kg/day. Effects on female reproductive health have also been observed in mice orally exposed to uranium. Alterations in ovarian folliculogenesis were observed at  $\geq 1.25$  mg U/kg/day.

Developmental effects have been observed in the offspring of mice; these effects have often been observed at maternally toxic doses. Elevated uranium levels were measured in the offspring of rats exposed to uranyl acetate prior to mating and during gestation and lactation, suggesting transplacental and/or lactational transfer of uranium. The observed effects included lethality, reductions in growth, increase in visceral and skeletal abnormalities, and reproductive effects. Lethality effects consisted of reductions in viability on postnatal day 21 in offspring of mice dosed with 28 mg U/kg/day on gestation day 13 to postnatal day 21, decreases neonatal viability in the offspring of mice exposed to 5.6 mg U/kg/day prior to mating and throughout gestation and lactation, and increases in late resorptions and decreases in the number of live fetuses in the offspring of mice exposed to 14 mg U/kg/day prior to mating and during gestation. Reductions in fetal body weight were observed in the offspring of mice dosed with  $\geq 2.8$  mg U/kg/day on gestation days 6–15. This study also reported significant increases in the total number of external malformations at  $\geq 2.8$  mg U/kg/day and the total number of skeletal defects at  $\geq 14$  mg U/kg/day. Maternal toxicity may have played a role in this study since maternal weight gain during exposure was reduced by at least 33%. Alterations in ovarian folliculogenesis, similar to those described in the discussion of reproductive toxicity have been observed in the female pups of mice exposed to uranium prior to mating and/or during gestation; as discussed in the previous paragraph on reproduction toxicity, the doses tested in the study were much lower than effect levels reported in other studies, were below the detection limit, and are lower than normal background levels. In rats, doses of 22.5 or 45 mg U/kg/day administered from before mating until gestation day 14 were not fetotoxic; however, continued dosing during lactation resulted in a significant reduction in pup weight on postnatal day 21. Uranium did not affect developmental landmarks or neuromotor maturation in the pups, but the high dose altered learning and memory. Uranium was also shown to interfere with tooth eruption and development in young rats.

## 2. RELEVANCE TO PUBLIC HEALTH

Since uranium is weakly radioactive, it has been assumed to be potentially carcinogenic at occupational levels by NIOSH. The International Agency for Research on Cancer (IARC) has no classification for uranium. Although significant increases in the occurrence of respiratory tract cancer (predominantly lung cancer) have been found in numerous studies of uranium miners, radon progeny in the mines, and not the uranium, were clearly identified as the carcinogenic agents. Exposure to crystalline silica and diesel engine exhaust, known human carcinogens, may also have contributed to carcinogenicity of the mine dust and their potential contributions have not been evaluated. Studies of workers at uranium milling or nuclear facilities and residents living near uranium mining and milling facilities have not found significant increases in cancer mortality associated with uranium exposure. There are limited data on the carcinogenicity of uranium in laboratory animals and no cancer bioassays with adequate numbers of animals and multiple concentration/dose levels were identified. Chronic-duration studies have not reported increases in the incidence of malignant tumors in hamsters exposed to 19 mg U/m<sup>3</sup> as carnotite uranium ore dust for 16 months; monkeys exposed to 5.1 mg U/m<sup>3</sup> as uranium dioxide for 5 years; dogs exposed to 8–8,815 mg U/kg/day as uranyl nitrate, uranyl fluoride, uranium tetrachloride, uranium tetrafluoride, or uranium dioxide for 1 year; or rats exposed to 664–12,341 mg U/kg/day as uranyl nitrate, uranium tetrafluoride, or uranium dioxide for 1 year. The limited number of animals tested and the less-than-lifetime exposure duration makes these studies less than ideal for evaluating the carcinogenicity of uranium. Several studies have found significant associations between uranium exposure and an increased incidence of malignant tumors. Increases in the incidence of pulmonary neoplasms were observed in dogs exposed to 5.1 mg U/m<sup>3</sup> as uranium dioxide for 5 years and rats exposed to 8.4 or 22 mg U/m<sup>3</sup> as uranium ore dust for 65 weeks. As with the negative carcinogenicity studies, these studies are also limited by the small number of animals tested and the less-than-lifetime exposure. The increases in the incidence of lung tumors may have been the result of uranium chemical toxicity, radiation exposure, or both.

***Depleted Uranium.*** Like natural uranium, depleted uranium is primarily composed of <sup>238</sup>U, but has a smaller amount of <sup>235</sup>U and <sup>234</sup>U. Thus, depleted uranium is less radioactive than natural uranium. Although, the toxicity of depleted uranium has not been as well studied, the health effects associated with exposure to depleted uranium will be the same as natural uranium because the toxicity of natural uranium is primarily due to chemical toxicity to uranium rather than uranium radiotoxicity. Information on the toxicity of depleted uranium in humans comes from a series of studies of Gulf War veterans with embedded fragments containing depleted uranium. The studies examined a number of potential targets including the liver, kidney, bone, and the hematological, nervous, and reproductive systems. No significant alterations in biomarkers of liver function, bone turnover and metabolism, or hematological

## 2. RELEVANCE TO PUBLIC HEALTH

function; neuroendocrine hormone levels; or sperm parameters were observed. Alterations in biomarkers of renal function (e.g., urinary retinol binding protein and  $\beta_2$ -microglobulin levels) were observed; however, the alterations were not statistically significant, as compared to veterans with normal urinary uranium levels. Although poorer performance on neurological tests were observed in Gulf War veterans exposed to depleted uranium from embedded fragments, the effects were not consistently observed, and were found to be strongly influenced by two subjects with extremely high uranium levels and severely complex co-morbid conditions.

A small number of animal studies have examined the toxicity of depleted uranium; these studies focused on renal toxicity and neurotoxicity. As with exposure to natural uranium, alterations in renal function and histopathology (swollen glomeruli, necrosis, and fibrosis) were observed in rats exposed to depleted uranium via fragments embedded in the gastrocnemius muscle. Acute exposure to depleted uranyl acetate in drinking water resulted in increased motor activity in male rats exposed to 28 mg U/kg/day and female mice exposed to 6 mg U/kg/day. No alterations were observed in tests of spontaneous motor activity in rats implanted with up to 20 depleted uranium pellets (approximately 760 mg depleted uranium) for 150 days. The difference in the exposure routes and the lack of data on blood and/or brain uranium levels from the drinking water studies and implantation study preclude a meaningful comparison of the three studies. No effects on spatial working memory were observed in rats dosed with 2.7 mg U/kg/day as depleted uranyl nitrate for 9 months. Investigators have tried to identify biochemical and morphological substrates that, when altered, could explain the behavioral alterations. Increased motor activity showed a weak correlation with increased lipid oxidation in the brain of rats in a 2-week study. Uranium also altered the levels of neurotransmitters and their metabolites in brain areas from mice and rats. Of various brain areas examined, the hippocampus from rats exposed to natural uranium in the drinking water for 90 days had the most uranium, suggesting that this area may play an important role in the neurobehavioral alterations caused by exposure to uranium. However, alterations in the levels of oxidative stress indicators were greater in other regions of the brain with lower uranium concentrations. Implantation of depleted uranium pellets in rats resulted in measurable uranium in the brain at 6–18 months after implantation and was accompanied by electrophysiological changes in hippocampal slices from the treated animals at 6 and 12 months, but not at 18 months. The mechanism(s) by which uranium induces neurological alterations is not known.

A decrease in the number of small primary ovarian follicles was found in mice exposed to  $\geq 0.00039$  mg U/kg/day in the drinking water for 30 days prior to breeding, during the mating period, and during gestation. However, all other follicle populations including primordial, secondary/growing, healthy, and



## 2. RELEVANCE TO PUBLIC HEALTH

atretic were unchanged. It would be helpful to try to replicate these results because effects were reported at considerably lower doses than the adverse effect levels in other studies, effects were only observed in one type of follicle population, and the doses were below the detection limit and normal drinking water background levels. Uranium also showed estrogenic properties in mice at very low doses. Exposure of ovariectomized mice to depleted uranyl nitrate at 0.005 mg U/kg/day for 10 days or 0.009 mg U/kg/day for 30 days significantly increased uterine weight; an increase in the presence of cornified vaginal cells, indicative of an estrogenic effect, was also observed at 0.005 and 0.009 mg U/kg/day. However, these effects were not observed at higher doses (0.09 or 0.9 mg U/kg/day for 30 days). Again, it would be helpful to try to replicate these results observed at such low doses, particularly since the study only found effects at the lower doses tested, but not at the higher doses.

Exposure to depleted uranium did not alter the levels of serum testosterone or  $17\beta$ -estradiol or the expression of transcription factors involved in the regulation of steroidogenic genes in male rats in a 9-month drinking water study.

Information on the carcinogenicity of depleted uranium is limited to an animal study that found an increased incidence of malignant fibrous histiocytoma at the depleted uranium implantation site in rats. However, an increase in tumors was only observed in the group with the largest implant.

***Enriched Uranium.*** Enriched uranium is also primarily composed of  $^{238}\text{U}$ ,  $^{235}\text{U}$ , and  $^{234}\text{U}$ ; however, the percentage of  $^{235}\text{U}$  is increased to 2–4% (low enriched uranium) and >90% (high enriched uranium). The chemical toxicity of enriched uranium is the same as natural uranium; however, because enriched uranium is more radioactive than natural uranium, there is an increased risk of radiotoxicity. No human studies have examined the toxicity of enriched uranium and a limited number of animal studies on enriched uranium have been conducted. The chemical toxicity of uranium is identical to natural and/or depleted uranium; however, effects associated with exposure to radiation are also possible. Two studies have compared the toxicity of enriched uranium with that of depleted uranium. Enriched uranium, but not depleted uranium, increased serum testosterone and the expression of genes involved in steroidogenesis in male rats in a 9-month drinking water study. In addition, enriched uranium significantly increased the expression of transcription factors involved in the regulation of steroidogenic genes. These results suggested that the observed effects were mainly due to the radiation emitted by enriched uranium. Exposure to enriched uranium resulted in increases in the amount of paradoxical sleep and decreases in spatial working memory in rats dosed with 2.5–2.7 mg U/kg/day as enriched uranyl nitrate for 9 months. However, these effects were not observed in rats similarly exposed to depleted uranium. An additional

## 2. RELEVANCE TO PUBLIC HEALTH

study reported delayed hyperactivity and decreased spatial memory in 5- or 9-month-old offspring of rats exposed to 4.3 mg U/kg/day as enriched uranyl nitrate in drinking water during gestation. A 9-month drinking water exposure to enriched uranyl nitrate resulted in increased serum testosterone levels in male rats. In addition, enriched uranium significantly increased the expression of transcription factors involved in the regulation of steroidogenic genes. These effects were not observed in rats similarly exposed to depleted uranium, suggesting that the observed effects were mainly due to the radiation emitted by enriched uranium.

### 2.3 MINIMAL RISK LEVELS (MRLs)

Estimates of exposure levels posing minimal risk to humans (MRLs) have been made for uranium. An MRL is defined as an estimate of daily human exposure to a substance that is likely to be without an appreciable risk of adverse effects (noncarcinogenic) over a specified duration of exposure. MRLs are derived when reliable and sufficient data exist to identify the target organ(s) of effect or the most sensitive health effect(s) for a specific duration within a given route of exposure. MRLs are based on noncancerous health effects only and do not consider carcinogenic effects. MRLs can be derived for acute, intermediate, and chronic duration exposures for inhalation and oral routes. Appropriate methodology does not exist to develop MRLs for dermal exposure.

Although methods have been established to derive MRLs (Barnes and Dourson 1988; EPA 1990, 2012c), uncertainties are associated with these techniques. Furthermore, ATSDR acknowledges additional uncertainties inherent in the application of the procedures to derive less than lifetime MRLs. As an example, acute inhalation MRLs may not be protective for health effects that are delayed in development or are acquired following repeated acute insults, such as hypersensitivity reactions, asthma, or chronic bronchitis. As these kinds of health effects data become available and methods to assess levels of significant human exposure improve, these MRLs will be reevaluated.

Minimal Risk Levels (MRLs) have been derived for the effects from inhalation and oral exposure to uranium, and those values are identified in this section and their bases are detailed in Appendix A. Although most of the health effects associated with exposure to natural uranium appear to be solely chemical in nature and not radiological and the contribution of the radiation toxicity to the overall mode of action is not known, the result of any combined chemical and radiological toxicity is accounted for in the study results. The chemical toxicity of depleted uranium is the same as natural uranium; however, the radiological toxicity of depleted uranium would be lower than natural uranium due to its lower specific

## 2. RELEVANCE TO PUBLIC HEALTH

activity. Since the toxicity of natural uranium is primarily due to chemical toxicity, the MRLs calculated for natural uranium are applicable to depleted uranium. Exposure to enriched uranium is more likely to include a radiological component, but the data are limited. The toxicity of a variety of uranium compounds has been investigated in a number of animal species; the results of these studies support the findings of the available human studies. Regardless of the exposure duration or route, the animal data provide strong evidence that kidney damage is the principal toxic effect of uranium and that the toxicity varies according to solubility of the uranium compound. Other sensitive end points include the respiratory tract following chronic exposure to insoluble uranium compounds and developmental toxicity following acute oral exposure to soluble uranium compounds. The more soluble uranium compounds (uranium hexafluoride, uranium tetrachloride, uranyl fluoride, uranyl nitrate) have the highest renal toxicity, followed by the less soluble compounds (ammonium diuranate, sodium diuranate, uranium tetrafluoride) and the insoluble uranium compounds (uranium dioxide, uranium trioxide, uranium peroxide, triuranium octaoxide). The difference in toxicity is due to the easier absorption of soluble compounds from the lung or gastrointestinal tract into the blood and distribution to other tissues (Tannenbaum et al. 1951). The more insoluble uranium compounds have a greater potential for long-term respiratory toxicity due to long retention of the compound in the lung and may be due to chemical and/or radiological toxicity.

ATSDR has determined that the toxicity database for uranium justifies the derivation of separate MRLs for soluble and insoluble forms of uranium for certain durations and routes of exposure. This is based on toxicokinetic evidence that absorption of uranium (and concentration in target tissue) is significantly greater during exposure to the more water-soluble compounds. Where the database is not extensive enough to allow separate MRLs, the MRL for the soluble form should be protective for health effects due to all forms of uranium.

***Inhalation MRLs.******Acute-Duration Inhalation MRL***

There are limited data on the toxicity of uranium compounds in humans and animals following acute-duration inhalation exposure. Several case reports of individuals briefly exposed to uranium hexafluoride (Kathren and Moore 1986; USNRC 1986) or uranium tetrafluoride (Lu and Zhao 1990) are available. The observed effects included eye irritation and respiratory irritation, chemical burns, renal toxicity, and

## 2. RELEVANCE TO PUBLIC HEALTH

gastrointestinal irritation; however, some of these effects may have been caused by the rapid release of hydrogen fluoride when uranium hexafluoride reacted with water in the air and mucous membranes.

Respiratory and renal effects have been observed in acutely exposed laboratory animals. Severe alveolar septal fibrosis was observed in rats exposed to 5,051 mg U/m<sup>3</sup> as enriched uranium dioxide for 100 minutes (Morris et al. 1990) and gasping and nasal irritation were observed in mice exposed to 637 mg U/m<sup>3</sup> as uranium hexafluoride for 10 minutes (Spiegl 1949). The renal effects included proteinuria and glucosuria in rats exposed to 426 mg U/m<sup>3</sup> for 10 minutes or 1,430 mg U/m<sup>3</sup> for 2 minutes as uranium hexafluoride (Leach et al. 1984) or in guinea pigs exposed to 23,040 mg U/m<sup>3</sup> as uranium hexafluoride for 2 minutes (Leach et al. 1984).

The available data were not considered adequate for derivation of an acute-duration inhalation MRL for uranium; the human studies did not reliably report exposure levels and the animal studies involved very short (<2 hours) exposure durations. Using one of the short exposure animal studies to derive an MRL may not be protective for continuous exposure for 2 weeks; longer-term animal studies with serial sacrifices (Stokinger et al. 1953) reported renal lesions following 3 days of exposure to soluble uranium compounds. These data are poorly reported and involved very small number of animals and are not suitable for MRL derivation.

***Intermediate-Duration Inhalation MRL***

- An MRL of 0.002 mg U/m<sup>3</sup> has been derived for intermediate-duration inhalation exposure (15–364 days) to insoluble compounds of uranium.

Intermediate-duration inhalation studies in animals have examined the toxicity of various insoluble uranium compounds including uranium dioxide, uranium peroxide, uranium trioxide, and triuranium octaoxide in several animal species. The results of these studies suggest that the kidney and the respiratory tract are sensitive targets of uranium toxicity, with the kidney being the most sensitive target. A summary of the adverse effect levels for renal effects identified in reliable intermediate duration studies is presented in Table 2-1. Renal effects were observed at  $\geq 8.2$  mg U/m<sup>3</sup>; the severity of the lesions was concentration-related. Very slight tubular lesions were observed in dogs exposed to 8.2 mg U/m<sup>3</sup>, and mild to severe necrosis was observed in rats, rabbits, and dogs exposed to 16 mg U/m<sup>3</sup>. Although there are limited data to make species comparisons, data for uranium dioxide suggest that rabbits are more sensitive than rats, mice, or guinea pigs; the data do not allow for a comparison between rabbits and dogs. In addition to the renal effects observed in rats, rabbits, and dogs exposed to uranium trioxide, very slight

## 2. RELEVANCE TO PUBLIC HEALTH

**Table 2-1. Renal Effects Following Intermediate-Duration Inhalation Exposure to Insoluble Uranium Compounds**

Species	Duration	NOAEL (mg U/m <sup>3</sup> )	LOAEL (mg U/m <sup>3</sup> )	Effect	Reference
Uranium dioxide					
Rat	5 weeks	19.4			Rothstein 1949b
Mouse	5 weeks	19.4			Rothstein 1949b
Rabbit	5 weeks		19.4	Marked tubular necrosis	Rothstein 1949b
Rabbit	7 months	10			Stokinger et al. 1953
Guinea pig	5 weeks	19.4			Rothstein 1949b
Guinea pig	7 months	10			Stokinger et al. 1953
Dog	5 weeks	1.1	8.2	Very slight tubular injury	Rothstein 1949b
Uranium peroxide					
Rabbit	23 days		15.4	Moderate necrosis	Dygert 1949d
Uranium trioxide					
Rat	4 weeks		16	Mild to severe necrosis	Rothstein 1949c
Rabbit	4 weeks		16	Mild to severe necrosis	Rothstein 1949c
Dog	4 weeks		16	Mild to severe necrosis	Rothstein 1949c
Triuranium octaoxide					
Rat	26 days	14			Dygert 1949c

## 2. RELEVANCE TO PUBLIC HEALTH

pulmonary lesions were observed in dogs and rats exposed to 16 mg U/m<sup>3</sup> and severe effects were observed in rabbits dying early after exposure to 16 mg U/m<sup>3</sup> (Rothstein 1949c).

The lowest LOAEL for renal or pulmonary effects following intermediate-duration exposure to an insoluble uranium compound was 8.2 mg U/m<sup>3</sup> identified in dogs exposed to uranium dioxide for 5 weeks (Rothstein 1949b). In this study, groups of 6–19 dogs of unspecified strain and gender were exposed to 1.3, 9.3, or 10.4 mg/m<sup>3</sup> uranium dioxide (1.1, 8.2, or 9.2 mg U/m<sup>3</sup>) 6 days/week for 5 weeks, presumably for 6 hours/day. The following parameters were used to assess toxicity: mortality, body weight changes, standard hematology, clinical chemistry, urinalysis, and histopathology. No dogs died from exposure to uranium dioxide dust. Additionally, no alterations in body weight gain or hematology, serum clinical chemistry, or urinalysis parameters were noted. Histopathological alterations were limited to the kidneys; “very slight” renal tubular degeneration was observed in two of six dogs at 8.2 mg U/m<sup>3</sup>. No alterations were observed in two dogs examined from the 9.2 mg U/m<sup>3</sup> group. The results of this study are supported by the findings of slight to mild tubular degeneration in dogs exposed to 10 mg U/m<sup>3</sup> as uranium dioxide for 1 year; no effects were observed at 1 mg U/m<sup>3</sup> (Stokinger et al. 1953).

Benchmark dose (BMD) modeling was not used to estimate the point of departure due to the limited reporting of incidence data. The no-observed-adverse-effect level (NOAEL) of 1.1 mg U/m<sup>3</sup> was used to derive the MRL. This value was adjusted for intermittent exposure (6 hours/24 hours, 6 days/7 days) resulting in a NOAEL<sub>ADJ</sub> of 0.24 mg U/m<sup>3</sup>. Because regional deposited dose ratios (RDDR) are not available for dogs, dosimetric adjustments could not be made; thus, the NOAEL<sub>ADJ</sub> was used as the point of departure. The NOAEL<sub>ADJ</sub> was divided by an uncertainty factor of 100 (10 for extrapolation from animals to humans and 10 for human variability), resulting in an intermediate-duration inhalation MRL of 0.002 mg U/m<sup>3</sup> for insoluble uranium compounds.

- An MRL of 0.0001 mg U/m<sup>3</sup> has been derived for intermediate-duration inhalation exposure (15–364 days) to soluble compounds of uranium.

Intermediate-duration inhalation studies in animals have identified the kidney and lung as the most sensitive targets of toxicity following inhalation exposure to soluble or poorly soluble uranium compounds. The renal toxicity of various uranium compounds in several animal species is summarized in Table 2-2. These data demonstrate that the soluble uranium compounds are more toxic than the poorly soluble compounds, dogs, rabbits, and possibly rats are the most sensitive species tested, and guinea pigs are the least sensitive.

## 2. RELEVANCE TO PUBLIC HEALTH

**Table 2-2. Renal Effects Following Intermediate-Duration Inhalation Exposure to Soluble and Poorly Soluble Uranium Compounds**

Species	Duration	NOAEL (mg U/m <sup>3</sup> )	LOAEL (mg U/m <sup>3</sup> )	Effect	Reference
Uranium hexafluoride					
Rat	30 days	0.05	0.2	Mild tubular damage	Spiegl 1949
Mouse	30 days	2	13.3	Severe degeneration, necrosis	Spiegl 1949
Rabbit	9 months		0.2	Very mild tubular injury	Stokinger et al. 1953
Guinea pig	30 days		13.3	Severe degeneration, necrosis	Spiegl 1949
Guinea pig	9 months	0.05			Stokinger et al. 1953
Dog	30 days	0.05	0.2	Mild tubular regeneration	Spiegl 1949
Uranyl fluoride					
Rat	5 weeks	0.5	2.2	Minimal degeneration	Rothstein 1949a
Guinea pig	5 weeks	2.2	9.2	Severe degeneration	Rothstein 1949a
Dog	5 weeks		0.15	Very slight degeneration	Rothstein 1949a
Uranyl nitrate					
Rat	30 days		0.13	Slight degeneration	Roberts 1949
Rabbit	6.5 months		0.25	Mild tubular atrophy	Stokinger et al. 1953
Guinea pig	6.5 months	2			Stokinger et al. 1953
Dog	30 days		0.13	Proteinuria	Roberts 1949
Uranium tetrachloride					
Rabbit	7.5 months	0.2			Stokinger et al. 1953
Guinea pig	7.5 months	0.2			Stokinger et al. 1953
Sodium diuranate					
Rat	5 weeks		15	Moderate degeneration, necrosis	Rothermel 1949
Rabbit	5 weeks		15	Degeneration, necrosis	Rothermel 1949
Ammonium diuranate					
Rat	30 days		6.8	Minimal necrosis	Dygert 1949b
Rabbit	30 days		6.8	Severe necrosis	Dygert 1949b
Uranium tetrafluoride					
Rat	30 days	4	18	Slight azotemia	Dygert 1949a
Rabbit	9 months	3			Stokinger et al. 1953
Guinea pig	30 days	4	18	Moderate-severe necrosis	Dygert 1949a
Guinea pig	9 months	3			Stokinger et al. 1953
Dog	30 days	0.5	3	Very slight degeneration	Dygert 1949a

## 2. RELEVANCE TO PUBLIC HEALTH

In addition to the renal effects, pulmonary toxicity has been observed in animals particularly after exposure to uranium hexafluoride. Exposure to 2 mg U/m<sup>3</sup> for 30 days resulted in severe pulmonary edema in rabbits and slight pneumonia in dogs (Spiegl 1949). At higher concentrations (13.3 mg U/m<sup>3</sup>), lung edema, hemorrhage, and emphysema were observed in rats, rabbits, and guinea pigs (Spiegl 1949). Since uranium hexafluoride is readily hydrolyzed to uranyl fluoride and hydrogen fluoride and hydrogen fluoride is a strong respiratory irritant resulting in pulmonary edema, it is likely that the observed respiratory effects are due to the hydrogen fluoride exposure. Respiratory effects have also been observed in rabbits and rats exposed to 6.8 mg U/m<sup>3</sup> as ammonium diuranate (Dygert 1949b). In rabbits, ammonium diuranate exposure (6.8 mg U/m<sup>3</sup>) resulted in extensive respiratory tract irritation, evidence by nasal bleeding and pulmonary edema, hemorrhage, and necrosis. Respiratory irritation (nasal bleeding and interstitial bronchopneumonia) was also observed in rats exposed to 6.8 mg U/m<sup>3</sup>. It is possible that these effects were secondary to the release of the ammonium ion, rather than uranium toxicity. Respiratory effects have not been consistently observed following exposure to other uranium compounds.

As presented in Table 2-2, dogs are the most sensitive species to the renal toxicity of uranium compounds. The lowest LOAEL values identified in dogs are 0.13 mg U/m<sup>3</sup> as uranyl nitrate for proteinuria (Roberts 1949) and 0.15 mg U/m<sup>3</sup> as uranyl fluoride for tubular damage (Rothstein 1949a). In the Roberts (1949) study, an increase in urinary protein excretion was observed between days 9 and 12 and then returned to normal; very mild histological changes, which the investigator noted were not of sufficient severity to be of concern, were observed in the renal cortex in two dogs exposed for 10 days. Since the two LOAEL values are almost identical, the Rothstein (1949a) study was selected as the basis of the MRL because it included histological examination of dogs exposed for an intermediate duration (the one dog examined at the end of the Roberts study had severe chronic nephritis, which precluded observing any possible uranium-induced renal effects). Although the lowest LOAEL value in rats (0.13 mg U/m<sup>3</sup>) was similar to the lowest LOAEL values in dogs, the intermediate and chronic databases for soluble uranium compounds provide strong evidence that dogs are more sensitive than rats. In the Rothstein (1949a) study, groups of 2–6 dogs (strain and gender not specified) were exposed to 0.19, 2.8, or 12.2 mg/m<sup>3</sup> of uranyl fluoride dust (0.15, 2.2, or 9.2 mg U/m<sup>3</sup>) for 6 hours/day, 6 days/week for 5 weeks. Clinical signs of toxicity, mortality, body weight changes, hematology, and blood and urine chemistries were monitored. At the termination of the study, the animals were sacrificed, selected organs were histopathologically examined, and uranium levels were determined. Anorexia, rhinitis, and polydipsia were observed in the two dogs exposed to 9.2 mg U/m<sup>3</sup>; prior to death, vomiting blood, severe muscle weakness, and exhibited lassitude were observed. No deaths or clinical signs were observed at 0.15 or 2.2 mg U/m<sup>3</sup>. Severe weight loss was also observed at 9.2 mg U/m<sup>3</sup>; no alterations in body weight



## 2. RELEVANCE TO PUBLIC HEALTH

gain were observed at 0.15 or 2.2 mg U/m<sup>3</sup>. At 9.2 mg U/m<sup>3</sup>, both dogs had increased blood nonprotein nitrogen (NPN) levels with the maximum value over 200 mg%. At 2.2 mg U/m<sup>3</sup>, blood NPN and urinary amino acid levels were normal while one of three dogs had increased urinary protein levels. At 9.2 mg U/m<sup>3</sup>, severe renal damage was seen in dogs. Moderate renal damage (no additional information provided) was observed at 2.2 mg U/m<sup>3</sup> and very slight damage was observed in about 50% of the dogs at 0.15 mg U/m<sup>3</sup>.

A NOAEL/LOAEL approach was used to identify the point of departure for the MRL; BMD modeling was not used because incidence data were not available for all groups. The LOAEL of 0.15 mg U/m<sup>3</sup> for minimal renal lesions was used to derive the MRL. This value was adjusted for intermittent exposure (6 hours/24 hours, 6 days/7 days) resulting in a LOAEL<sub>ADJ</sub> of 0.032 mg U/m<sup>3</sup>. Because RDDRs are not available for dogs, dosimetric adjustments could not be made; thus, the LOAEL<sub>ADJ</sub> was used as the point of departure. The LOAEL<sub>ADJ</sub> was divided by an uncertainty factor of 300 (3 for the use of a minimal LOAEL, 10 for extrapolation from animals to humans, and 10 for human variability), resulting in an intermediate-duration inhalation MRL of 0.0001 mg U/m<sup>3</sup> for soluble uranium compounds.

***Chronic-Duration Inhalation MRL***

- An MRL of 0.0008 mg U/m<sup>3</sup> has been derived for chronic-duration inhalation exposure (365 days or more) to insoluble compounds of uranium.

There are limited data available to assess the toxicity of chronic exposure to insoluble uranium compounds. Slight to mild renal tubular degeneration was observed in dogs exposed to 10 mg U/m<sup>3</sup> as uranium dioxide for 1 year (Stokinger et al. 1953); no alterations were observed at 1 mg U/m<sup>3</sup>. Although several tissues were examined histologically, significant alterations were only noted for the kidneys. Stokinger et al. (1953) also exposed rats to 1 or 10 mg U/m<sup>3</sup> as uranium dioxide, but no uranium-related alterations were observed. In a second chronic-duration study, no adverse effects were observed in rats or dogs exposed to 5.1 mg U/m<sup>3</sup> as uranium dioxide for 1–5 years (Leach et al. 1970). However, fibrosis in the tracheobronchial lymph nodes and fibrosis and metaplasia in the lungs were observed in dogs during a 6.5-year postexposure period (Leach et al. 1973). In monkeys, exposure to 5.1 mg U/m<sup>3</sup> resulted in lung fibrosis beginning after 3.6 years of exposure (Leach et al. 1970); the severity of the fibrosis increased with exposure duration. Fibrosis was also present in the lungs and tracheobronchial lymph nodes in monkeys sacrificed during the 6.5-year postexposure period (Leach et al. 1973). The investigators noted that the fibrosis may have been a radiotoxic effect based on the magnitude of the radiation dose, the absence of renal effects, and the similarity of the lesions to those observed following exposure to

## 2. RELEVANCE TO PUBLIC HEALTH

plutonium dioxide; the alpha-radiation tissue doses were >500 rad (5 Gy) for the lungs and 7,000 rad (70 Gy) for the lymph nodes. However, it is unclear whether the damage was chemically or radiologically induced (or both); similar degenerative effects in the lungs have also been observed following prolonged exposure to diverse inorganic dusts. An elevation of blood NPN level was also observed in the monkeys during the postexposure period, but no histological alterations were observed in the kidneys (Leach et al. 1973).

Rhesus monkeys (5 males, 20 females) were exposed to 5.8 mg/m<sup>3</sup> uranium dioxide (5.1 mg U/m<sup>3</sup>) 5.4 hours/day, 5 days/week for 5 years; the mass median particle diameter was 1.03 μm with a geometric standard deviation of 2.40. Another group of one male and five female monkeys served as controls. Groups of 1–2 monkeys were sacrificed after 1 day, 4 days, 15 days, 1 month, 2 months, 3 months, 5 months, 1 year, 1.5 years, 1.8 years, 1.9 years, 3.6 years, 4.1 years, or 4.7 years; two monkeys were sacrificed at 5 years. Six monkeys were observed for 6.5 years after exposure termination; two were sacrificed after 12 months, one after 6 years, and three after 6.5 years; the results of the recovery period examinations were reported in Leach et al. (1973). The following parameters were used to assess toxicity: general health, body weight, peripheral hematology, blood NPN levels, and histopathology of major tissues and organs. No uranium dioxide-related deaths were observed. No alterations in body weight, hematological parameters, or blood NPN levels were found. Histological alterations were limited to the lungs and tracheobronchial lymph nodes. After 2–3 months of exposure, granular black pigment accumulations were found in the lungs and tracheobronchial lymph nodes. After 3.6 years of exposure, slight fibrosis was observed in the lungs and hyaline fibrosis was observed in the tracheobronchial lymph nodes; the severity of the fibrosis increased with exposure duration and was not observed in the controls. Fibrosis was still present in the lungs and tracheobronchial lymph nodes 6.5 years postexposure.

The LOAEL of 5.1 mg U/m<sup>3</sup> was selected as the point of departure for the MRL; BMD modeling was not used due to the small number of animals sacrificed at each time period. The LOAEL was adjusted for intermittent exposure (5.4 hours/24 hours, 5 days/7 days) resulting in a LOAEL<sub>ADJ</sub> of 0.82 mg U/m<sup>3</sup>. Because RDDRs are not available for monkeys, dosimetric adjustments could not be made; thus, the LOAEL<sub>ADJ</sub> was used as the point of departure. The LOAEL<sub>ADJ</sub> was divided by an uncertainty factor of 1,000 (10 for the use of a LOAEL, 10 for extrapolation from animals to humans, and 10 for human variability), resulting in a chronic-duration inhalation MRL of 0.0008 mg U/m<sup>3</sup> for insoluble uranium compounds. A full uncertainty factor of 10 was used for extrapolation from monkeys to humans because no data were available to make dosimetric adjustments (pharmacokinetic component of uncertainty factor) and there are inadequate human data to assess potential differences in sensitivity between monkeys

## 2. RELEVANCE TO PUBLIC HEALTH

and humans (pharmacodynamic component of uncertainty factor). A wide range of sensitivity has been found in animal species, but it is not known where humans would fall in the range of sensitivity.

- An MRL of 0.00004 mg U/m<sup>3</sup> has been derived for chronic-duration inhalation exposure (365 days or more) to soluble compounds of uranium.

There are limited human data on the chronic toxicity of soluble uranium. Thun et al. (1985) examined uranium mill workers exposed to yellowcake (26–86% ammonium diuranate), which was considered biologically soluble, for at least 1 year. Significant increases in urinary excretion of  $\beta_2$ -microglobulin and amino acids were observed in the uranium workers suggesting impaired renal tubular function. Clearance of  $\beta_2$ -microglobulin relative to that of creatinine was significantly associated with the length of time that the uranium workers had spent in the yellowcake area. Although urinary uranium levels were reported, atmospheric concentrations were not reported.

Stokinger et al. (1953) examined the chronic toxicity of uranium hexafluoride, uranium tetrachloride, and uranyl nitrate in dogs and rats following a 1-year exposure. Slight to mild renal tubular atrophy was observed in dogs and rats exposed to 0.2 mg U/m<sup>3</sup> as uranium hexafluoride or uranium tetrachloride; no effects were observed at 0.05 mg U/m<sup>3</sup>. Exposure to uranyl nitrate resulted in mild to moderate tubular atrophy in dogs exposed to 0.25 mg U/m<sup>3</sup> (NOAEL of 0.15 mg U/m<sup>3</sup>) and mild to marked tubular atrophy in rats exposed to 2 mg U/m<sup>3</sup> (NOAEL of 0.25 mg U/m<sup>3</sup>).

The chronic-duration inhalation MRL for soluble uranium compounds was based on a 1-year dog study involving exposure to uranium tetrachloride (Stokinger et al. 1953). In this study, dogs of both sexes (11–12 males, 9–10 females) were exposed to uranium tetrachloride in inhalation chambers for 33 hours/week for 1 year at concentrations of 0.05, and 0.20 mg U/m<sup>3</sup>. The animals were monitored for body weight alterations, clinical signs of toxicity, and biochemical alterations in the blood and urine. At the termination of the study, the animals were sacrificed and selected organs were histopathologically examined. All dogs survived the 1-year exposure period. No alterations in body weight gain, hematological parameters, or blood NPN levels were observed. Urinary protein levels were elevated, as compared to controls; however, pre-exposure levels were also elevated, precluding evaluating the clinical significance of the effect. Alterations in bromsulfalein retention test, indicating impaired liver function, were observed in the four dogs tested (0.2 mg U/m<sup>3</sup> group); no alterations in blood clotting times were observed. In the absence of histological evidence of liver damage, the change was not considered clinically significant. Renal tubular atrophy was observed in 2/16 dogs exposed to 0.05 mg U/m<sup>3</sup> (not

## 2. RELEVANCE TO PUBLIC HEALTH

statistically significant using Fisher Exact test). Slight tubular atrophy in the inner cortex was observed in 7/14 dogs exposed to 0.2 mg U/m<sup>3</sup>.

Data for the incidence of renal tubular atrophy were analyzed using all available dichotomous models in the EPA Benchmark Dose Software (BMDS, version 2.1.2) using the extra risk option; details of the BMD modeling are presented in Appendix A. The benchmark concentrations (BMCs) ranged from 0.032 to 0.082 mg U/m<sup>3</sup> and the 95% lower confidence limits on the BMCs (BMCLs) ranged from 0.019 to 0.054 mg U/m<sup>3</sup>. A BMCL<sub>10</sub> of 0.019 mg U/m<sup>3</sup> was selected as a point of departure because it was estimated from the model providing the best fit to the incidence data. The BMCL<sub>10</sub> was adjusted for intermittent exposure (33 hours/168 hours) resulting in a BMCL<sub>ADJ</sub> of 0.0037 mg U/m<sup>3</sup>. Because RDDRs are not available for dogs, dosimetric adjustments could not be made; thus, the BMCL<sub>ADJ</sub> was used as the point of departure. The BMCL<sub>ADJ</sub> was divided by an uncertainty factor of 100 (10 for extrapolation from animals to humans and 10 for human variability), resulting in a chronic-duration inhalation MRL of 0.00004 mg U/m<sup>3</sup> for soluble uranium compounds.

***Oral MRLs.******Acute-Duration Oral MRL***

- An MRL of 0.002 mg U/kg/day has been derived for acute-duration oral exposure (≤15 days) to soluble compounds of uranium.

There are limited human data on the oral toxicity of uranium. Signs of gastrointestinal irritation (nausea, vomiting, diarrhea) were observed in a subject ingesting 14.3 mg U/kg as uranyl nitrate in drinking water (Butterworth 1955); other potential targets of toxicity were not examined. Acute oral exposure studies in rats and mice have examined the lethality, systemic toxicity, neurotoxicity, and developmental toxicity of uranium. Information on the systemic toxicity is limited to two single-exposure toxicity study in rats (Domingo et al. 1987) and mice (Martinez et al. 2003) administered lethal doses and a repeated exposure study in mice (Ozmen and Yurekli 1998). In the 2 weeks following administration of a single gavage dose of 118 mg U/kg as uranyl acetate to rats, significant increases in urine volume (in the absence of changes in water consumption), plasma creatinine and urea, and urinary total protein and creatinine were observed; hyperemia and microhemorrhagic foci were also observed in the liver and kidneys at the end of the 2-week observation period (Domingo et al. 1987). In mice, administration of 166 mg U/kg as uranyl nitrate resulted in increases in blood urea and creatinine levels and proximal tubular necrosis (Martinez et al. 2003). Similarly, significant increases in BUN and creatinine levels were observed in mice exposed to

## 2. RELEVANCE TO PUBLIC HEALTH

508 mg U/kg/day as uranyl acetate in the diet for 5 days (Ozmen and Yurekli 1998); the study did not include a histological examination of the kidney or other tissues. Neurological effects consisted of increased open field activity (line crossing and/or rearing) (Briner 2009; Briner and Murray 2005) in mice administered 28 or 6 mg U/kg/day as depleted uranyl acetate in drinking water for 2 weeks; exposure to 28 mg U/kg/day also resulted in a 53% decrease in body weight gain. Gestational exposure to  $\geq 2.8$  mg U/kg/day as uranyl acetate resulted in significant decreases in fetal body weights and increases in the occurrence hematomas in the fetuses of mice exposed on gestation days 6–15 (Domingo et al. 1989c); increases in the incidence of cleft palate were observed at  $\geq 5.6$  mg U/kg/day. Decreases in maternal body weight gain were observed at  $\geq 2.8$  mg U/kg/day. Exposure of neonatal rats (1 or 7 days of age) to 42.7 mg U/kg/day as uranyl nitrate administered via gavage in water, resulted in significant reductions in bone formation, increases in bone resorption, and diminished tooth development (Pujadas Bigi et al. 2003).

The available data provide evidence that the gastrointestinal tract, kidney, and developing organisms are target of uranium toxicity following acute oral exposure. Longer duration oral studies and inhalation studies identify the kidney as the most sensitive target of toxicity. The Domingo et al. (1989c) developmental toxicity study identified the lowest LOAEL (2.8 mg U/kg/day) and was selected as the basis of acute-duration oral MRL. In this study, groups of 20 pregnant Swiss mice were administered via gavage 0, 5, 10, 25, or 50 mg/kg/day uranyl acetate dihydrate (0, 2.8, 5.6, 14, or 28 mg U/kg/day) on gestation days 6–15. Body weights, food consumption, and general appearance were monitored daily. At termination, maternal liver and kidney weights were measured and uterine contents (number of implantation sites, resorptions, dead fetuses, and live fetuses) were evaluated. Live fetuses were evaluated for body weight, body length, sex, gross morphological abnormalities, visceral malformations, visceral anomalies, and skeletal defects. Significant decreases in maternal body weight were observed in all uranium groups; during the exposure period, the dams in the 2.6, 5.6, 14, and 28 mg U/kg/day groups weighed 33, 53, 75, and 88% less than controls, respectively. Significant decreases in food intake were also observed in the dams exposed to 5.6 mg U/kg/day and higher. A significant decrease in the number of live fetuses was observed at 5.6 mg U/kg/day, but was not observed at the two higher dose levels. No significant alterations in the number of early or late resorptions, number of dead fetuses, or sex ratio were observed. Significant decreases in fetal body weight were observed at  $\geq 2.8$  mg U/kg/day and decreases in fetal length were observed at  $\geq 5.6$  mg U/kg/day. Significant increases in the incidences of external defects were observed at 2.8 mg U/kg/day. The external alterations included cleft palate (significant at  $\geq 5.6$  mg U/kg/day) and hematomas (significant at 2.8 and 28 mg U/kg/day). The total number of skeletal defects was significantly increased at 14 and 28 mg U/kg/day; skeletal defects included bipartite

## 2. RELEVANCE TO PUBLIC HEALTH

sternebrae (significant at 2.8, 14, and 28 mg U/kg/day), some metatarsal of hindlimb poorly ossified (significant at 14 and 28 mg U/kg/day), delayed ossification of skull (significant at 14 and 28 mg U/kg/day), and caudal reduced ossification (significant at 14 and 28 mg U/kg/day).

The results of the Domingo et al. (1989c) study suggest maternal body weight gain and fetal body weight and external and skeletal alterations as sensitive end points of uranium toxicity. It is possible that the developmental effects were secondary to the maternal toxicity; however, some of these effects may also be primary effects of uranium on the developing fetus. Thus, maternal and fetal end points were considered as the basis of possible points of departure for the acute-duration MRL. BMD modeling was used to identify potential points of departure for maternal and fetal effects. As described in greater detail in Appendix A, the number of litters with cleft palate, bipartite sternebrae, and total skeletal defects were analyzed using all available dichotomous models in the EPA BMDS (version 2.1.2) using the extra risk option and a benchmark response rate of 5%. The results of the BMD modeling are presented in Appendix A. The fetal body weight data and maternal body weight gain data were fit to all available continuous models in EPA's BMDS (version 2.1.2); however, none of the models provided an adequate fit to either data set.

The BMDL<sub>05</sub> values for cleft palate, bipartite sternebrae, and total skeletal defects were 0.20, 0.42, and 0.25 mg U/kg/day, respectively. The BMDL<sub>05</sub> of 0.20 mg U/kg/day for cleft palate was selected as the point of departure; this point of departure is lower than the BMDL<sub>05</sub> values for other fetal effects and is approximately 10-fold lower than the LOAEL for maternal and fetal body weight effects. Thus, it is likely to be protective of the other effects. The 0.2 mg U/kg/day point of departure was divided by an uncertainty factor of 100 (10 for extrapolation from animals to humans and 10 for human variability) resulting in an acute-duration oral MRL of 0.002 mg U/kg/day.

***Intermediate-Duration Oral MRL***

- An MRL of 0.0002 mg U/kg/day has been derived for intermediate-duration oral exposure (15–364 days) to soluble compounds of uranium.

No studies have been identified that examined the toxicity of uranium in humans following an intermediate-duration oral exposure. A number of studies have examined the intermediate-duration oral toxicity of uranium in laboratory animals. Most of these studies involved exposure to soluble uranium compounds such as uranyl nitrate and uranyl acetate; there are limited data on poorly soluble or insoluble uranium compounds. The available data suggest that the kidney is the most sensitive target of uranium

## 2. RELEVANCE TO PUBLIC HEALTH

toxicity; at higher dose levels, neurological, reproductive, and developmental effects have been reported. At lower concentrations, histological alterations have been observed in the proximal tubules, glomerulus, and/or renal interstitium in rats and mice exposed to uranyl nitrate in drinking water (Gilman et al. 1998a, 1998b, 1998c; McDonald-Taylor et al. 1992, 1997). At higher concentrations (40.38 mg U/kg/day), evidence of renal dysfunction (e.g., glycosuria, proteinuria) have also been observed (Gilman et al. 1998c). The Gilman et al. (1998a, 1998b) studies identified LOAELs of 0.06 and 0.05 mg U/kg/day for renal effects in rats and rabbits, respectively; neither study identified NOAEL values.

The LOAELs for neurological, reproductive, and developmental effects are similar and are about 50-fold higher than the LOAEL for renal effects. Neurological effects such as sleep and behavior alterations and decreased spatial memory were observed in rats exposed to 2.5–2.7 mg U/kg/day as enriched uranyl nitrate (Houpert et al. 2005, 2007b). However, no neurological effects were observed in rats similarly exposed to the same dose of depleted uranyl nitrate (Houpert et al. 2005). The investigators suggest that the observed effects may have been related to radiation toxicity. The reproductive effects consisted of decreases in male fertility in rats and mice following exposure to  $\geq 5.6$  mg U/kg/day as uranyl acetate (Linares et al. 2005; Llobet et al. 1991) and alterations in ovarian folliculogenesis in mice at  $\geq 1.25$  mg U/kg/day as uranyl nitrate (Arnault et al. 2008; Feugier et al. 2008; Kundt et al. 2009). A recent study by Raymond-Whish et al. (2007) also reported alterations in ovarian folliculogenesis in mice, but the effects were at an extremely low dose (0.00039 mg U/kg/day). Additional data are needed to support whether reproductive effects occur at this dose level and to evaluate the toxicological significance of the observed effect (reduced number of small primary follicles, but no effect on primordial, secondary/growing, healthy, or atretic follicle populations). Developmental effects have been observed in rats and mice; most effects occurred at maternally toxic doses. The observed effects included neurobehavioral effects in the offspring of rats exposed pre-mating and during gestation and lactation to 4.3 mg U/kg/day as enriched uranyl nitrate (Houpert et al. 2007a), decreases in pup body weight at  $\geq 2.8$  mg U/kg/day as uranyl acetate (Paternain et al. 1989; Sánchez et al. 2006), decreases in litter size, live fetuses, or viability at  $\geq 14$  mg U/kg/day as uranyl acetate (Domingo et al. 1989b; Paternain et al. 1989), and altered ovarian folliculogenesis in 3-month-old pups of dams exposed to 1.25 mg U/kg/day as uranyl nitrate (Arnault et al. 2008).

The LOAELs of 0.05 and 0.06 mg U/kg/day for kidney effects in rats and rabbits (Gilman et al. 1998a, 1998b) were considered as possible points of departure for an intermediate-duration oral MRL for soluble uranium compounds. Although the rabbit study identified the slightly lower LOAEL, the rat LOAEL was selected as the point of departure for the MRL due to possible subclinical infection in the rabbits. Gilman

## 2. RELEVANCE TO PUBLIC HEALTH

et al. (1998b, 1998c) conducted two 91-day studies in rabbits. The kidney uranium levels for the two studies were not comparable; rabbits in the first study (Gilman et al. 1998b) had higher kidney uranium levels than in the second study (Gilman et al. 1998c) even though the dose was lower in the first study (28.70 mg U/kg/day dose and 4.98 µg U/g kidney level in the Gilman et al. 1998b study compared to 40.98 mg U/kg/day dose and 3.48 µg U/g kidney level in the Gilman et al. 1998c study). In the Gilman et al. (1998b) study, the male rabbits were not SPF derived and four animals developed *Pasteurella multocida* infections during the study; Gilman et al. (1998c) suggested that even though the affected rabbits were removed from the study, it is possible that other animals had a subclinical infection and that this may have increased sensitivity. Thus, the rat study was selected as the basis of the MRL; the rats used in the Gilman et al. (1998a) study were SPF derived. The Raymond-Whish et al. (2007) study was not selected as the point of departure because there are no other data to support this extremely low value and the toxicological significance of this slight change in one follicle population is not known.

In the Gilman et al. (1998a) study, five groups of Sprague-Dawley rats (15/sex/dose, 60 g) were exposed to uranium as uranyl nitrate in drinking water (0, 0.96, 4.8, 24, 120, and 600 mg/L) for 91 days. Time-weighted average doses (as mg U/kg/day) calculated by the authors from fluid intake data were <0.0001 (control group), 0.06, 0.31, 1.52, 7.54, and 36.73 mg U/kg/day in males and <0.0001 (controls), 0.09, 0.42, 2.01, 9.98, and 53.56 mg U/kg/day in females. Clinical signs were monitored daily and body weights were measured weekly; fluid intake and feed consumption were also measured, but the frequency was not reported. Hematological and serum clinical chemistry parameters, organ weights, and histopathology examination of major tissues and organs were assessed at termination. Hematological and biochemical parameters were not affected in a significant exposure-related manner. Statistically significant increases in renal lesions included cytoplasmic vacuolization, tubular dilation, and lymphoid cuffing in males at  $\geq 0.06$  mg U/kg/day; capsular sclerosis, tubular anisokaryosis, and interstitial reticulin sclerosis in females at  $\geq 0.09$  mg U/kg/day; nuclear vesiculation in males and females at  $\geq 0.06/0.09$  mg U/kg/day; and glomerular adhesions and cytoplasmic degeneration in males at  $\geq 0.31$  mg U/kg/day. Lesions were also observed in the liver at all doses including anisokaryosis, vesiculation, increased portal density, perivenous vacuolation, and homogeneity; the investigators considered these adaptive and likely reversible. Thyroid lesions were observed in both sexes (multifocal reduction of follicular size, increased epithelial height in males at 0.31 mg/kg/day and females at 2.01 mg/kg/day). A decreased amount and density of colloid in the thyroid was observed in males only. Sinus hyperplasia of the spleen was observed in males and females at 36.73/53.56 mg/kg/day.



## 2. RELEVANCE TO PUBLIC HEALTH

An attempt was made to fit the incidence data to BMD models; however, none of the models provided an adequate fit. Thus, a NOAEL/LOAEL approach was used to derive the MRL. The LOAEL value of 0.06 mg U/kg/day for renal effects in rats (Gilman et al. 1998a) was divided by an uncertainty factor of 300 (3 for the use of a minimal LOAEL, 10 for animals to human extrapolation, and 10 for human variability) resulting in an intermediate-duration oral MRL of 0.0002 mg U/kg/day for soluble uranium compounds. A partial uncertainty factor was used to extrapolate from a LOAEL because the histological alterations observed at 0.06 mg U/kg/day were considered minimally adverse.

There are inadequate data to derive an MRL for insoluble uranium compounds (e.g., uranium tetrafluoride, uranium trioxide, uranium dioxide, uranium peroxide, triuranium octaoxide). The toxicity of insoluble uranium compounds were tested in a series of 30-day studies conducted by Maynard and Hodge (1949). No histological alterations were observed at the highest uranium dioxide, uranium trioxide, uranyl octaoxide, or uranium tetrafluoride doses (11,000–12,000 mg U/kg/day). By comparison, renal lesions were observed following exposure to 200 mg U/kg/day as uranyl nitrate. These data suggest that the toxicity of soluble uranium compounds are at least an order of magnitude higher than for insoluble uranium compounds.

***Chronic-Duration Oral MRL***

Available data on the chronic oral toxicity of uranium comes from several ecological studies examining the possible association between elevated levels of uranium in drinking water and alterations in kidney function (Kurttio et al. 2002, 2006a; Limson Zamora et al. 1998, 2009; Mao et al. 1995; Seldén et al. 2009). Associations between parameters of renal dysfunction (e.g., urine levels of albumin,  $\beta_2$ -microglobulin, glucose, and protein HC) and elevated uranium levels in drinking water were observed in some of the studies (Kurttio et al. 2002; Limson Zamora et al. 1998, 2009; Mao et al. 1995; Seldén et al. 2009). These studies did not find overt signs of toxicity and in many cases, the biomarkers of renal dysfunction were within the normal range. Although most of the epidemiology studies provided information on uranium levels in the drinking water, there was often a large range of exposure levels; thus, the human oral exposure studies do not provide reliable dose-response data.

Chronic-duration oral studies have been conducted in rats exposed to uranyl fluoride, uranyl nitrate, uranium dioxide, or uranium tetrafluoride in the diet for 2 years (Maynard and Hodge 1949; Maynard et al. 1953) and in dogs exposed to uranyl fluoride, uranyl nitrate, uranium tetrachloride, uranium tetrafluoride, or uranium dioxide in the diet for 1 year (Maynard and Hodge 1949; Maynard et al. 1953).

## 2. RELEVANCE TO PUBLIC HEALTH

As with shorter durations of exposure, these studies identify the kidney as the most sensitive target of uranium toxicity. In rats, minimal tubular damage primarily consisting of regeneration of tubular epithelium was observed at the lower doses of soluble uranium compounds, 81 mg U/kg/day as uranyl fluoride and 170 mg U/kg/day as uranyl nitrate. At higher doses (140 mg U/kg/day as uranyl fluoride and 330 mg U/kg/day as uranyl nitrate), tubular atrophy was observed; the severity of the atrophy and extent of the damage increased with dose. For the less soluble uranium tetrafluoride, minimal tubular degeneration was observed at the highest dose tested, 11,000 mg U/kg/day; no adverse effects were observed in rats exposed to 12,000 mg U/kg/day as uranium dioxide (Maynard and Hodge 1949; Maynard et al. 1953). In dogs, renal tubular atrophy was observed following a 1-year exposure to 7.7 mg U/kg/day as uranyl fluoride, 9.5 mg U/kg/day as uranyl nitrate, 31 mg U/kg/day as uranium tetrachloride, 150 mg U/kg/day as uranium tetrafluoride, or 900 mg U/kg/day as uranium dioxide; the uranyl fluoride study also found slight renal damage in dogs exposed to 1.9 mg U/kg/day for 1 year. As with the rat studies, the dog studies showed that the severity and extent of the renal damage increased with dose. The highest NOAELs in the dog study were 0.77 mg U/kg/day as uranyl fluoride and 6.2 mg U/kg/day as uranium tetrachloride; NOAELs were not identified in the uranyl nitrate, uranium tetrafluoride, or uranium dioxide studies.

The dog study of uranyl fluoride identified the lowest LOAEL (1.9 mg U/kg/day); however, the dog studies are not a suitable basis for an MRL because only two dogs of unknown strain and gender were tested at each dose level. The rat studies of uranyl fluoride and uranyl nitrate appear to be the most suitable basis for a chronic-duration oral MRL. A NOAEL of 0.54 mg U/kg/day and a LOAEL of 81 mg U/kg/day were identified for uranyl fluoride and a NOAEL of 33 mg U/kg/day and a LOAEL of 170 mg U/kg/day were identified for uranyl nitrate (Maynard and Hodge 1949; Maynard et al. 1953). In the uranyl fluoride study, which identified the lowest LOAEL, groups of 15–25 male and 15–25 female rats (strain not specified) were exposed to diets containing 0, 0.01, 0.05, 0.1, 0.15, 0.25, 0.5, or 0.75% uranyl fluoride (0, 5.4, 27, 54, 81, 140, 270, or 400 mg U/kg/day) for 2 years. The animals were monitored for body weight alterations, clinical signs of toxicity, hematology, and biochemical alterations in the blood and urine. At the termination of the study, the surviving animals were sacrificed and selected organs were histopathologically examined. All rats in the 400 mg U/kg/day group died within the first 2 months of the study. At 270 mg U/kg/day, increased mortality was observed, with only 50% of the animals surviving the first year of exposure. At the end of the first year, decreases in body weight gain of >10% were observed at 270 mg U/kg/day in males (30%) and females (18%); at the end of 2 years, >10% decreases in body weight gain were observed at 140 mg U/kg/day in males (11%) and females (15%) and at 270 mg U/kg/day in males (20%) and females (28%). Decreases in red blood cell counts and hemoglobin levels

## 2. RELEVANCE TO PUBLIC HEALTH

and increases in white blood cell counts were observed in males at 140 and 270 mg U/kg/day. Histopathological alterations were observed in the kidneys at doses of  $\geq 81$  mg U/kg/day. Marked renal tubular atrophy was observed at 140 and 270 mg U/kg/day, with a dose-related increase in severity of the lesions. At 81 mg U/kg/day, 2/5 rats examined showed traces of renal tubular alterations. No other uranium-related effects were noted.

Derivation of an MRL using the NOAEL of 54 mg U/kg/day identified in the 2-year uranyl fluoride rat study (Maynard and Hodge 1949; Maynard et al. 1953) as the point of departure was considered; the NOAEL/LOAEL approach was used because the lack of incidence data for most exposure groups precluded using benchmark dose analysis to identify a point of departure. Using this point of departure would result in an MRL that is higher than the intermediate-duration oral MRL for uranium; thus, a chronic-duration oral MRL has not been derived.

The results of a serial study in which rats were exposed to several doses of uranyl nitrate in the diet for up to 1 year (Maynard et al. 1953) coupled with the rat 2-year study (Maynard and Hodge 1949; Maynard et al. 1953) suggest that at low exposures, the renal tubular epithelium is regenerated and continued exposure does not result in more severe effects. However, at higher doses, the capacity to regenerate the renal tubular epithelium is exceeded and tubular atrophy is observed. In the serial study (Maynard et al. 1953), exposure to 170 mg U/kg/day as uranyl nitrate in the diet resulted in regeneration of the renal tubular epithelium after 2 weeks of exposure; there was no progression of renal damage with continued exposure and the renal tubules in rats exposed for 2 weeks were similar to those exposed for 1 year. Additionally, a 2-year exposure to 170 mg U/kg/day did not result in any further damage to the kidneys (Maynard and Hodge 1949; Maynard et al. 1953). In contrast, regeneration was observed in the first month of the exposure to 660 mg U/kg/day; however, with continued exposure, tubular atrophy was observed at 6–8 weeks. The severity of the atrophy and the areas of the kidney affected by uranium increased with duration. Given these data on the ability of the kidney to repair renal damage at low doses, the intermediate-duration oral MRL may be protective for chronic exposures.

2. RELEVANCE TO PUBLIC HEALTH

This page is intentionally blank.

### 3. HEALTH EFFECTS

#### 3.1 INTRODUCTION

The primary purpose of this chapter is to provide public health officials, physicians, toxicologists, and other interested individuals and groups with an overall perspective on the toxicology of uranium. It contains descriptions and evaluations of toxicological studies and epidemiological investigations and provides conclusions, where possible, on the relevance of toxicity and toxicokinetic data to public health.

A glossary and list of acronyms, abbreviations, and symbols can be found at the end of this profile.

The health effects associated with oral or dermal exposure to natural and depleted uranium appear to be primarily chemical in nature and not radiological, while those from inhalation exposure may also include a slight radiological component, especially if the exposure involves prolonged exposure to insoluble uranium compounds. This profile is primarily concerned with the effects of exposure to natural and depleted uranium, but does include limited discussion regarding enriched uranium, which is considered to be more of a radiological than a chemical hazard. Also, whenever the term “radiation” is used, it applies to ionizing radiation and not to non-ionizing radiation.

Although natural and depleted uranium are primarily chemical hazards, the next several paragraphs describe the radiological nature of the toxicologically-important uranium isotopes, because individual isotopes are addressed in some of the health effects studies. Uranium is a naturally occurring radioactive element and a member of the actinide series. Radioactive elements are those that undergo spontaneous transformation (decay), in which energy is released (emitted) either in the form of particles, such as alpha or beta particles, or electromagnetic radiation with energies sufficient to cause ionization, such as gamma rays or x-rays. This transformation or decay results in the formation of different elements, some of which may themselves be radioactive, in which case they will also decay. The process continues until a stable (nonradioactive) state is reached (see Appendix D for more information).

Uranium is naturally occurring or has been produced in nuclear reactors and in high energy physics experiments. It exists in a number of isotopic forms (NNDC 2011), all of which are radioactive. The most toxicologically important of the 22 currently recognized uranium isotopes are anthropogenic uranium-232 ( $^{232}\text{U}$ ) and uranium-233 ( $^{233}\text{U}$ ) and naturally occurring uranium-234 ( $^{234}\text{U}$ ), uranium-235 ( $^{235}\text{U}$ ), and uranium-238 ( $^{238}\text{U}$ ). When an atom of any of these five isotopes decays, it emits an alpha particle (the nucleus of a helium atom) and transforms into a radioactive isotope of another element. The

## 3. HEALTH EFFECTS

process continues through a series of radionuclides until reaching a stable, non-radioactive isotope of lead (or bismuth in the case of  $^{233}\text{U}$ ). The radionuclides in these transformation series (such as isotopes of radium and radon), emit alpha or beta particles, as well as gamma and x-rays, with energies and intensities that are unique to the individual radionuclide.

There are three basic categories of uranium isotope mixtures (based on the mass percentage of  $^{235}\text{U}$  relative to that of the earth's crust): natural uranium, enriched uranium, and depleted uranium. Natural uranium in the earth's crust is comprised of 99.2742%  $^{238}\text{U}$ , 0.7204%  $^{235}\text{U}$ , and 0.0054%  $^{234}\text{U}$  by mass. Combining these mass percentages with the unique half-life of each isotope converts mass into radioactivity units and shows that crustal uranium contains 48.7%  $^{234}\text{U}$ , 2.27%  $^{235}\text{U}$ , and 49.0%  $^{238}\text{U}$  by radioactivity, and has a very low specific activity of 0.69  $\mu\text{Ci/g}$  based on data compiled by the National Nuclear Data Center (NNDC 2011). Natural uranium in the environment can vary somewhat from these ratios due to physical and environmental factors, as shown by the varying ratios of natural uranium in air (EPA 2008). Enriched and depleted uranium are the products of a process, which increases (or enriches) the percentages of  $^{234}\text{U}$  and  $^{235}\text{U}$  in one portion of a uranium sample and decreases (or depletes) their percentages in the remaining portion. Enriched uranium is quantified by its  $^{235}\text{U}$  mass percentage. Uranium enrichment for nuclear energy produces uranium that typically contains 3%  $^{235}\text{U}$ . Uranium enrichment for a number of other purposes, including nuclear weapons, can produce uranium that contains as much as 97.3%  $^{235}\text{U}$  and has a higher specific activity ( $\sim 50 \mu\text{Ci/g}$ ). The residual uranium after the enrichment process is called "depleted uranium," which possesses even less radioactivity (0.36  $\mu\text{Ci/g}$ ) than natural uranium. The USNRC considers the specific activity of depleted uranium to be 0.36  $\mu\text{Ci/g}$  (10 CFR 20), but more aggressive enrichment processes can drive this value slightly lower (0.33  $\mu\text{Ci/g}$ ). In this profile, both natural and depleted uranium are referred to as "uranium," although depleted uranium is specified when this use benefits the text. The higher specific-activity mixtures and isotopes are described in the profile as "enriched uranium" or as  $^{232}\text{U}$ ,  $^{233}\text{U}$ , or  $^{234}\text{U}$ , as applicable, in the summary of the studies in which these mixtures and isotopes were used.

Uranium is a heavy metal that forms compounds and complexes of different varieties and solubilities. The chemical action of all isotopes and isotopic mixtures of uranium is identical, regardless of the specific activity (i.e., enrichment), because chemical action depends only on chemical properties. Thus, the chemical toxicity of a given amount or weight of natural, depleted, and enriched uranium is identical.

The toxicity of uranium varies according to its chemical form and route of exposure. On the basis of the toxicity of different uranium compounds in animals, it was concluded that the relatively more water-

### 3. HEALTH EFFECTS

soluble compounds (uranyl nitrate, uranium hexafluoride, uranyl fluoride, uranium tetrachloride) were the most potent systemic toxicants. The poorly water-soluble compounds (uranium tetrafluoride, sodium diuranate, ammonium diuranate) were of moderate-to-low systemic toxicity, and the insoluble compounds (uranium trioxide, uranium dioxide, uranium peroxide, triuranium octaoxide) had a much lower potential to cause systemic toxicity but could cause pulmonary toxicity when exposure was by inhalation. *The terms soluble, poorly soluble, and insoluble are often used in this profile without relisting the specific compounds.* Generally, hexavalent uranium, which tends to form relatively soluble compounds, is more likely to be a systemic toxicant than tetravalent uranium, which forms relatively insoluble compounds. Ingested uranium is less toxic than inhaled uranium, which may be partly attributable to the relatively low gastrointestinal absorption of uranium compounds.

Because natural uranium produces very little radioactivity per mass of uranium, the renal and respiratory effects from exposure of humans and animals to uranium are usually attributed to the chemical properties of uranium. However, in exposures to more radioactive uranium isotopes (e.g.,  $^{232}\text{U}$  and  $^{233}\text{U}$ , and combined  $^{234}\text{U}$  and  $^{235}\text{U}$  in enriched uranium), it has been suggested that the chemical and radiological toxicity may be additive or may potentiate in some instances. In these instances, this dual mode of uranium toxicity may not be distinguishable by end point because of the overlap of etiology and manifested effects. Although the mechanism of this interaction is as yet unclear, it is not necessary to know it in order to identify critical targets of toxicity or evaluate the dose-response relationships.

### 3.2 DISCUSSION OF HEALTH EFFECTS BY ROUTE OF EXPOSURE

To help public health professionals and others address the needs of persons living or working near hazardous waste sites, the information in this section is organized first by route of exposure (inhalation, oral, and dermal) and then by health effect (death, systemic, immunological, neurological, reproductive, developmental, genotoxic, and carcinogenic effects). These data are discussed in terms of three exposure periods: acute (14 days or less), intermediate (15–364 days), and chronic (365 days or more).

Levels of significant exposure for each route and duration are presented in tables and illustrated in figures. The points in the figures showing no-observed-adverse-effect levels (NOAELs) or lowest-observed-adverse-effect levels (LOAELs) reflect the actual doses (levels of exposure) used in the studies. LOAELs have been classified into "less serious" or "serious" effects. "Serious" effects are those that evoke failure in a biological system and can lead to morbidity or mortality (e.g., acute respiratory distress or death). "Less serious" effects are those that are not expected to cause significant dysfunction or death,

### 3. HEALTH EFFECTS

or those whose significance to the organism is not entirely clear. ATSDR acknowledges that a considerable amount of judgment may be required in establishing whether an end point should be classified as a NOAEL, "less serious" LOAEL, or "serious" LOAEL, and that in some cases, there will be insufficient data to decide whether the effect is indicative of significant dysfunction. However, the Agency has established guidelines and policies that are used to classify these end points. ATSDR believes that there is sufficient merit in this approach to warrant an attempt at distinguishing between "less serious" and "serious" effects. The distinction between "less serious" effects and "serious" effects is considered to be important because it helps the users of the profiles to identify levels of exposure at which major health effects start to appear. LOAELs or NOAELs should also help in determining whether or not the effects vary with dose and/or duration, and place into perspective the possible significance of these effects to human health.

The significance of the exposure levels shown in the Levels of Significant Exposure (LSE) tables and figures may differ depending on the user's perspective. Public health officials and others concerned with appropriate actions to take at hazardous waste sites may want information on levels of exposure associated with more subtle effects in humans or animals (LOAELs) or exposure levels below which no adverse effects (NOAELs) have been observed. Estimates of levels posing minimal risk to humans (Minimal Risk Levels or MRLs) may be of interest to health professionals and the general public alike.

Levels of exposure associated with carcinogenic effects (Cancer Effect Levels, CELs) of uranium are indicated in Table 3-1 and Figure 3-1.

A User's Guide has been provided at the end of this profile (see Appendix B). This guide should aid in the interpretation of the tables and figures for Levels of Significant Exposure and the MRLs.

#### **3.2.1 Inhalation Exposure**

The toxicity of uranium compounds to the lungs and distal organs varies when exposed by the inhalation route. In general, the more soluble compounds (uranyl fluoride,<sup>1</sup> uranium tetrachloride, uranyl nitrate hexahydrate) are less toxic to the lungs but more toxic systemically by the inhalation route due to easier absorption from the lungs into the blood and transportation to distal organs (Tannenbaum et al. 1951). A study summary of the data for inhalation toxicity (lethality) studies in mice exposed to equivalent

---

<sup>1</sup>Uranium hexafluoride is hydrolyzed to uranyl fluoride and hydrogen fluoride. Hydrogen fluoride is highly toxic in acute exposures and causes pulmonary edema, which may be immediately life-threatening.



### 3. HEALTH EFFECTS

uranium concentrations of uranium tetrafluoride, uranyl fluoride, uranium tetrachloride, uranyl nitrate hexahydrate, or triuranium octaoxide concluded that the order of decreasing systemic toxicity for these compounds may be as follows: very toxic, uranyl fluoride; toxic, uranyl nitrate hexahydrate; and nontoxic (at the levels tested in companion studies), uranium tetrachloride, uranium tetrafluoride, and triuranium octaoxide (Stokinger et al. 1953; Tannenbaum et al. 1951). Although uranium tetrachloride is highly soluble in water, it is easily hydrolyzed and oxidized into less soluble uranyl chloride and insoluble uranium dioxide. For this reason, inhaled uranium tetrachloride tends not to behave as if it is a highly soluble uranium compound. Conversely, the more common insoluble salts and oxides (uranium tetrafluoride, uranium dioxide, uranium trioxide, triuranium octaoxide) are generally more toxic to the lungs through inhalation exposure because of the longer retention time in the lung tissue but they are less toxic to distal organs.

#### **3.2.1.1 Death**

The lethal effects of inhalation exposure to uranium have been investigated in humans in epidemiological studies and in animal studies under controlled conditions. Epidemiological studies indicate that routine exposure of humans (in the workplace and the environment at large) to airborne uranium is not associated with increased mortality. Brief accidental exposures to very high concentrations of uranium hexafluoride have caused fatalities in humans, most likely due to the resulting exposure to hydrogen fluoride. Laboratory studies in animals indicate that inhalation exposure to certain uranium compounds can be fatal. These deaths are believed to result from renal failure caused by absorbed uranium. The low specific activity of uranium precludes the possibility of absorbing enough uranium to deliver a lethal dose of radiation.

No definitive evidence has been found in epidemiologic studies that links human deaths to uranium exposure. Uranium miners have higher-than-expected rates of death from lung cancer; however, this finding is attributed to the radiological effects of radon and its decay products, which are progeny of uranium and, therefore, present in uranium mines. In addition, the role of tobacco smoking was not evaluated in some of the studies (Archer et al. 1973a; Gottlieb and Husen 1982; Lundin et al. 1969; Samet et al. 1984a, 1986); additionally, the contributions of crystalline silica and diesel engine exhaust to the cancer rate ascribed to radon have not been evaluated. Epidemiologic studies of workers at uranium mill and metal processing plants (where there is little or no exposure to radon in excess of normal environmental levels) showed no significant increase in overall deaths attributable to exposure to uranium (Archer et al. 1973b; Boice et al. 2008; Checkoway et al. 1988; Cragle et al. 1988; Hadjimichael et al.

## 3. HEALTH EFFECTS

1983; NIOSH 1987; Pinkerton et al. 2004; Polednak and Frome 1981; Scott et al. 1972; Waxweiler et al. 1983). Results of several mortality assessments of populations living near uranium mining and milling operations have not demonstrated significant associations between mortality and exposure to uranium (Boice et al. 2003, 2007a, 2007b, 2010).

Deaths occurred after accidental releases of uranium hexafluoride at uranium-processing facilities in 1944 and 1986, but these deaths were not attributed to the uranium component of this compound (Kathren and Moore 1986; Moore and Kathren 1985; USNRC 1986). These releases resulted in the generation of concentrated aerosols of highly toxic hydrofluoric acid<sup>2</sup>. In the 1944 incident, exposure time was estimated to be only 17 seconds; deaths occurred in 2 of 20 workers within an hour and were attributed to severe chemical burns of the lungs. In the 1986 incident, 1 of 23 workers died from massive pulmonary edema. Estimated airborne concentrations were 20 mg uranium hexafluoride/m<sup>3</sup> for a 1-minute exposure and 120 mg uranium hexafluoride/m<sup>3</sup> for a 60-minute exposure (15.2 and 91 mg U/m<sup>3</sup>, respectively). For both accidents, the observed effects are suggestive that inhalation of hydrofluoric acid was responsible for death.

A study of U.K. Gulf War veterans (>50,000 veterans) did not find a significant increase in the risk of dying in a 13-year follow-up period, as compared to >50,000 veterans not deployed to the Gulf. Among the 7% of Gulf War veterans who self reported exposure to depleted uranium, a non-statistically significant increase in the risk of disease-related deaths was found (mortality rate ratio of 1.99, 95% confidence interval [CI] of 0.98–4.04) (Macfarlane et al. 2005).

Mortality can be induced in animals exposed to sufficiently high concentrations of pure uranium compounds. The acute-duration LC<sub>50</sub> (lethal concentration, 50% death) for uranium hexafluoride has been calculated for Long-Evans rats and Hartley guinea pigs (Leach et al. 1984). The animals were exposed to uranium hexafluoride in a nose-only exposure apparatus for periods of up to 10 minutes and then observed for 14 days. The 2-minute LC<sub>50</sub> values (95% CIs) for the rats and guinea pigs were 120,290 mg U/m<sup>3</sup> (99,270–145,750 mg U/m<sup>3</sup>) and 62,080 mg U/m<sup>3</sup> (43,380–88,830 mg U/m<sup>3</sup>), respectively. For a 5-minute inhalation exposure, the LC<sub>50</sub> in rats was estimated as 38,600 mg U/m<sup>3</sup> (26,760–55,720 mg U/m<sup>3</sup>); the LC<sub>50</sub> for a 10-minute inhalation was estimated as 12,010 mg U/m<sup>3</sup> (10,090–14,290 mg U/m<sup>3</sup>).

---

<sup>2</sup>Uranium hexafluoride rapidly dissociates into hydrofluoric acid and uranyl fluoride on contact with moisture in the air.

## 3. HEALTH EFFECTS

The animals that died showed some damage to the respiratory tract, probably due to hydrofluoric acid, but this damage was not judged to be the cause of death, at least in the animals that died more than 2 days postexposure. Urinalysis and histopathological examination indicated that renal injury was the primary cause of death (Leach et al. 1984). In other acute lethality studies, rats, mice, and guinea pigs suffered 10, 20, and 13% mortality, respectively, following a 10-minute inhalation of uranium hexafluoride corresponding to  $637 \text{ mg U/m}^3$  (Spiegl 1949).

In intermediate-duration studies, rabbits and cats were generally the most sensitive species to uranium lethality. Deaths in these studies generally occurred beginning 2 weeks after exposure started and continued to the end of the experiment. Exposure to  $2 \text{ mg U/m}^3$  (as uranium hexafluoride) 6 hours/day for 30 days caused 5, 20, and 80% mortality in guinea pigs, dogs, and rabbits, respectively (Spiegl 1949). An exposure to  $9.5 \text{ mg U/m}^3$  (as uranyl nitrate hexahydrate) for 8 hours/day, 5 days/week for 30 days caused 10% mortality in rats and guinea pigs, and 75% mortality in dogs. Exposure to  $2 \text{ mg U/m}^3$  killed all four cats tested (Roberts 1949). Exposure to  $9.2 \text{ mg U/m}^3$  (as uranyl fluoride) 6 hours/day, 5.5 days/week for 5 weeks caused 0, 100, 83, and 55% mortality in rats, mice, rabbits and guinea pigs, and deaths in two dogs and two cats tested at this concentration (Rothstein 1949a). The lowest exposure causing death with uranyl fluoride was  $0.15 \text{ mg U/m}^3$  in mice and rabbits and  $2.2 \text{ mg U/m}^3$  in guinea pigs. Exposure to  $15.4 \text{ mg U/m}^3$  (as uranium peroxide) 5 hours/day, 5 days/week for 23 days caused 10, 63, 40, 80, and 100% mortality in rats, mice, guinea pigs, rabbits, and cats, respectively, while  $9.2 \text{ mg U/m}^3$  killed all of the dogs tested (Dygert 1949d). Inhalation of air containing  $15 \text{ mg U/m}^3$  (as sodium diuranate) for 6 hours/day, 5.5 days/week for 5 weeks caused 13 and 28% mortality in guinea pigs and rabbits, respectively (Rothermel 1949).

Insoluble uranium compounds were also lethal to animals by the inhalation route, but at higher concentrations than soluble compounds. Exposure to  $15.8 \text{ mg U/m}^3$  (as uranium trioxide) 6 hours/day, 5.5 days/week for 4 weeks caused 10, 9, 17, and 67% mortality in rats, guinea pigs, dogs, and rabbits, respectively (Rothstein 1949c). Inhalation of air containing  $19.4 \text{ mg U/m}^3$  (as uranium dioxide) for 6 hours/day, 5.5 days/week for 5 weeks, caused 60% mortality in rabbits but no mortality in rats, mice, guinea pigs, or dogs (Rothstein 1949b). Inhalation of air containing  $18 \text{ mg U/m}^3$  (as uranium tetrafluoride) for 5 hours/day for 30 days caused 15, 32, 33, and 100% mortality in guinea pigs, rats, rabbits, and cats, respectively, and death in a single dog tested at this concentration. Inhalation at  $4 \text{ mg U/m}^3$  caused no deaths in a group of 18 dogs, and one death in a group of 30 rats (Dygert 1949a). A mortality of 4% was observed among rabbits given  $3 \text{ mg U/m}^3$  (Stokinger et al. 1953). Exposure to

### 3. HEALTH EFFECTS

6.8 mg U/m<sup>3</sup> (as ammonium diuranate) 6 hours/day for 30 days caused 20 and 100% mortality in guinea pigs and rabbits, respectively (Dygert 1949b).

In chronic-duration experiments, inhalation of 2 mg U/m<sup>3</sup> as uranyl nitrate hexahydrate for 6 hours/day, 5.5 days/week for 92–100 weeks resulted in 1% mortality in rats (Stokinger et al. 1953). This is not an unusual mortality rate for rats, so it is unlikely that these deaths can be attributed to uranium exposure. Dogs exposed to uranyl nitrate hexahydrate for 2 years suffered 4% mortality (Stokinger et al. 1953). Out of 25 exposed dogs, 1 dog died at 0.25 mg U/m<sup>3</sup> and another died at 2 mg U/m<sup>3</sup>. Death may or may not have been attributable to uranium, according to the study investigators.

In several other inhalation-exposure animal studies, no deaths were observed when either soluble or insoluble uranium compounds were administered. In one of these animal studies, no mortality was observed in monkeys exposed by inhalation to uranium dioxide dust at a concentration of 5 mg U/m<sup>3</sup> for 5 years. The death of Beagle dogs similarly exposed could not be attributed to uranium by the investigators (Leach et al. 1970).

The percent mortality values for each species and other LOAEL values for mortality from exposure to uranium by the inhalation route are presented in Table 3-1 and plotted in Figure 3-1.

#### **3.2.1.2 Systemic Effects**

No human studies were located regarding the cardiovascular, musculoskeletal, endocrine, metabolic, dermal, ocular, body weight, or other systemic effects of elemental uranium following acute-duration inhalation exposure. Nor were any human studies located regarding the respiratory, hematological, cardiovascular, gastrointestinal, musculoskeletal, hepatic, renal, endocrine, metabolic, dermal, ocular, body weight, or other systemic effects of uranium following intermediate-duration inhalation exposure. No studies were found regarding the cardiovascular, gastrointestinal, musculoskeletal, renal, endocrine, metabolic, dermal, ocular, body weight, or other systemic effects in humans following chronic-duration inhalation exposure. The existing human data on the respiratory and hepatic effects of uranium are limited to acute- and chronic-duration inhalation exposures, hematological effects are limited to chronic-duration inhalation exposure, and gastrointestinal and renal effects are limited to acute-duration inhalation exposure.

Table 3-1 Levels of Significant Exposure to Uranium - Inhalation

Key to Figure <sup>a</sup>	Species (Strain)	Exposure/Duration/Frequency (Route)	System	NOAEL (mg/m <sup>3</sup> )	LOAEL		Reference Chemical Form	Comments
					Less Serious (mg/m <sup>3</sup> )	Serious (mg/m <sup>3</sup> )		
<b>ACUTE EXPOSURE</b>								
<b>Death</b>								
1	Rat (Long- Evans)	5 min					18210 M (40% mortality by day 14 postexposure)	Leach et al. 1984 Uranium Hexafluoride
2	Rat (NS)	1 d 10 min					1544 (75% mortality 30 days postexposure)	Spiegl 1949 Uranium Hexafluoride
3	Mouse (NS)	1 d 10 min					637 (20% mortality 30 days post-exposure)	Spiegl 1949 Uranium Hexafluoride
4	Gn Pig (Hartley)	2 min					23040 M (2/6 died 48 hrs postexposure)	Leach et al. 1984 Uranium Hexafluoride
5	Gn Pig (NS)	1 d 10 min					637 (13% mortality 30 days post-exposure)	Spiegl 1949 Uranium Hexafluoride
<b>Systemic</b>								
6	Rat (Long- Evans)	5 min	Resp		9131		54503 M (severe nasal congestion, hemorrhage)	Leach et al. 1984 Uranium Hexafluoride
			Renal		392 M (glucosuria)			
7	Rat (Long- Evans)	10 min	Renal		426 M (proteinuria, glucosuria, and polyuria)			Leach et al. 1984 Uranium Hexafluoride

Table 3-1 Levels of Significant Exposure to Uranium - Inhalation

(continued)

Key to Figure <sup>a</sup>	Species (Strain)	Exposure/Duration/Frequency (Route)	System	NOAEL (mg/m <sup>3</sup> )	LOAEL		Reference Chemical Form	Comments
					Less Serious (mg/m <sup>3</sup> )	Serious (mg/m <sup>3</sup> )		
8	Rat (Long- Evans)	2 min	Renal	920 M	1430 M (proteinuria)		Leach et al. 1984 Uranium Hexafluoride	
9	Rat (Fischer- 344)	once 100 min	Resp			5051 M (severe alveolar fibrosis)	Morris et al. 1990 Uranium Dioxide	
10	Rat (NS)	1 d 10 min	Resp			637 (gasping in 100% of rats; severe irritation of nasal passages)	Spiegl 1949 Uranium Hexafluoride	
			Renal			637 (severe degeneration of renal cortical tubules 5-8 days post-exposure)		
			Ocular		637 (conjunctivitis)			
11	Mouse (NS)	1 d 10 min	Resp			637 (gasping in 100% of mice; severe irritation of nasal passages)	Spiegl 1949 Uranium Hexafluoride	
			Ocular		637 (conjunctivitis)			
12	Gn Pig (Hartley)	2 min	Renal		23040 M (glucosuria and polyuria)		Leach et al. 1984 Uranium Hexafluoride	
13	Gn Pig (Hartley)	2 min	Renal		23040 M (glucosuria and polyuria)		Leach et al. 1984 Uranium Hexafluoride	

Table 3-1 Levels of Significant Exposure to Uranium - Inhalation

(continued)

Key to Figure <sup>a</sup>	Species (Strain)	Exposure/Duration/Frequency (Route)	System	NOAEL (mg/m <sup>3</sup> )	LOAEL		Reference Chemical Form	Comments
					Less Serious (mg/m <sup>3</sup> )	Serious (mg/m <sup>3</sup> )		
14	Dog [Beagle]	once 0.5-1 hr	Resp	270			Morrow et al. 1982a Uranyl Fluoride	
			Renal			250 (extensive degeneration in kidney cortex and tubules)		
<b>Immuno/ Lymphoret</b>								
15	Rat (Fischer- 344)	once			44 M (increased macrophage activity)		Morris et al. 1989 Uranium Dioxide	
16	Rat (Fischer- 344)	once			132 M (increased macrophage activity)		Morris et al. 1992 Uranium Dioxide	
<b>INTERMEDIATE EXPOSURE</b>								
<b>Death</b>								
17	Rat (NS)	30 d 6 hr/d				18 (32% mortality)	Dygert 1949a Uranium Tetrafluoride	
18	Rat (NS)	30 d 6 hr/d				13.3 (75% mortality)	Spiegl 1949 Uranium Hexafluoride	
19	Mouse (NS)	23 d 5 d/wk 5 hr/d				15.4 (63% mortality)	Dygert 1949d Uranium Peroxide	
20	Mouse (NS)	30 d 6 hr/d				2 (92% mortality)	Spiegl 1949 Uranium Hexafluoride	
21	Gn Pig (NS)	30 d 6 hr/d				18 (15% mortality)	Dygert 1949a Uranium Tetrafluoride	

Table 3-1 Levels of Significant Exposure to Uranium - Inhalation

(continued)

Key to Figure <sup>a</sup>	Species (Strain)	Exposure/Duration/Frequency (Route)	System	NOAEL (mg/m <sup>3</sup> )	LOAEL		Reference Chemical Form	Comments
					Less Serious (mg/m <sup>3</sup> )	Serious (mg/m <sup>3</sup> )		
22	Gn Pig (NS)	30 d 6 hr/d				6.8 (20% mortality)	Dygert 1949b Ammonium Diuranate	
23	Gn Pig (NS)	23 d 5 d/wk 5 hr/d				15.4 (40% mortality)	Dygert 1949d Uranium Peroxide	
24	Gn Pig (NS)	5 wk 6 d/wk 6 hr/d				9.2 (55% mortality)	Rothstein 1949a Uranyl Fluoride	
25	Gn Pig (NS)	5 wk 5.5 d/wk 6 hr/d				15 (13% mortality)	Rothstein 1949d Sodium Uranate	
26	Gn Pig (NS)	30 d 6 hr/d				13.3 (45% mortality)	Spiegl 1949 Uranium Hexafluoride	
27	Dog (NS)	30 d 6 hr/d				18 (lethal dose)	Dygert 1949a Uranium Tetrafluoride	
28	Dog (NS)	30 d Cont.				9.5 (75% mortality)	Roberts 1949 Uranyl Nitrate	
29	Dog (NS)	4 wk 6 d/wk 6 hr/d				15.8 (17% mortality)	Rothstein 1949c Uranium Trioxide	
30	Dog (NS)	5 wk 6 d/wk 6 hr/d				9.2 (100% mortality)	Rothstein 1949a Uranyl Fluoride	



Table 3-1 Levels of Significant Exposure to Uranium - Inhalation

(continued)

Key to Figure <sup>a</sup>	Species (Strain)	Exposure/ Duration/ Frequency (Route)	System	NOAEL (mg/m <sup>3</sup> )	LOAEL		Reference Chemical Form	Comments
					Less Serious (mg/m <sup>3</sup> )	Serious (mg/m <sup>3</sup> )		
31	Dog (NS)	30 d 6 hr/d				13.3 (40% mortality)	Spiegl 1949 Uranium Hexafluoride	
32	Rabbit (NS)	30 d 6 hr/d				18 (33% mortality)	Dygert 1949a Uranium Tetrafluoride	
33	Rabbit (NS)	30 d 6 hr/d				6.8 (100% mortality)	Dygert 1949b Ammonium Diuranate	
34	Rabbit (NS)	23 d 5 hr/d 5 d/wk				15.4 (80% mortality)	Dygert 1949d Uranium Peroxide	
35	Rabbit (NS)	4 wk 6 d/wk 6 hr/d				15.8 (67% mortality)	Rothstein 1949c Uranium Trioxide	
36	Rabbit (NS)	5 wk 6 d/wk				19.4 (60% mortality)	Rothstein 1949b Uranium Dioxide	
37	Rabbit (NS)	5 wk 5.5 d/wk 6 hr/d				15 (28% mortality)	Rothstein 1949d Sodium Uranate	
38	Rabbit (NS)	30 d 6 hr/d				2 (80% mortality)	Spiegl 1949 Uranium Hexafluoride	
39	Cat (NS)	30 d 6 hr/d				18 (100% mortality)	Dygert 1949a Uranium Tetrafluoride	

Table 3-1 Levels of Significant Exposure to Uranium - Inhalation

(continued)

Key to Figure <sup>a</sup>	Species (Strain)	Exposure/Duration/Frequency (Route)	System	NOAEL (mg/m <sup>3</sup> )	LOAEL		Reference Chemical Form	Comments	
					Less Serious (mg/m <sup>3</sup> )	Serious (mg/m <sup>3</sup> )			
40	Cat (NS)	23 d 5 d/wk 5 hr/d				15.4	(100% mortality)	Dygert 1949d Uranium Peroxide	
41	Cat (NS)	30 d Cont.				2	(100% mortality)	Roberts 1949 Uranyl Nitrate	
<b>Systemic</b>									
42	Rat (NS)	30 d 6 hr/d	Gastro		0.4		(ulceration of cecum)	Dygert 1949a Uranium Tetrafluoride	
			Hemato	18					
			Hepatic		0.4		(focal necrosis of liver)		
			Renal	4	18		(slight azotemia)		
			Bd Wt	4		18	(26% decrease body weight)		
43	Rat (NS)	30 d 6 hr/d	Resp		6.8		(interstitial bronchopneumonia in 25% of animals; nasal irritation)	Dygert 1949b Ammonium Diuranate	
			Hemato		6.8		(decreased RBC, hemoglobin)		
			Renal		6.8		(minimal necrosis of tubular epithelium followed by regeneration)		
			Bd Wt	6.8					

Table 3-1 Levels of Significant Exposure to Uranium - Inhalation

(continued)

Key to Figure	Species (Strain)	Exposure/Duration/Frequency (Route)	System	NOAEL (mg/m <sup>3</sup> )	LOAEL		Reference Chemical Form	Comments
					Less Serious (mg/m <sup>3</sup> )	Serious (mg/m <sup>3</sup> )		
44	Rat (NS)	30 d Cont.	Hemato	2.1	9.5	(decreased RBC, hemoglobin)	Roberts 1949 Uranyl Nitrate	
			Renal		0.13	(slight renal tubular degeneration in 33% after 28 days exposure)		
			Bd Wt	2.1	9.5	(5.6-12.6% decreased body weight)		
45	Rat (NS)	4 wk 6 d/wk 6 hr/d	Resp		16	(very slight degenerative changes in the lungs)	Rothstein 1949c Uranium Trioxide	
			Hemato		16	(increased percentage of myeloblasts and lymphoid cells of bone marrow)		
			Hepatic	16				
			Renal		16	(mild to severe tubular necrosis)		
			Bd Wt	16				

Table 3-1 Levels of Significant Exposure to Uranium - Inhalation

(continued)

Key to Figure <sup>a</sup>	Species (Strain)	Exposure/Duration/Frequency (Route)	System	NOAEL (mg/m <sup>3</sup> )	LOAEL		Reference Chemical Form	Comments
					Less Serious (mg/m <sup>3</sup> )	Serious (mg/m <sup>3</sup> )		
46	Rat (NS)	5 wk 6 d/wk 6 hr/d	Hemato	9.2			Rothstein 1949a Uranyl Fluoride	
			Renal	0.5	2.2	(minimal renal tubular degeneration)		
			Bd Wt	2.2	9.2	(unspecified moderate weight loss)		
47	Rat (NS)	5 wk 6 d/wk	Resp	19.4			Rothstein 1949b Uranium Dioxide	
			Hemato	19.4				
			Renal	19.4				
48	Rat (NS)	5 wk 5.5 d/wk 6 hr/d	Hemato	15			Rothstein 1949d Sodium Uranate	
			Renal		15	(moderate renal degeneration and necrosis)		

Table 3-1 Levels of Significant Exposure to Uranium - Inhalation

(continued)

Key to Figure <sup>a</sup>	Species (Strain)	Exposure/Duration/Frequency (Route)	System	NOAEL (mg/m <sup>3</sup> )	LOAEL		Reference Chemical Form	Comments	
					Less Serious (mg/m <sup>3</sup> )	Serious (mg/m <sup>3</sup> )			
49	Rat (NS)	30 d 6 hr/d	Resp	2			13.3	(lung edema, hemorrhage, emphysema)	Spiegl 1949 Uranium Hexafluoride
			Hemato	13.3					
			Renal	0.05	0.2	(mild renal tubular damage)			
			Ocular	2	13.3	(eye irritation)			
			Bd Wt	2			13.3	(6% weight loss)	
50	Mouse (NS)	5 wk 6 d/wk	Resp	19.4					Rothstein 1949b Uranium Dioxide
			Hemato	19.4					
			Renal	19.4					
			Bd Wt	19.4					

Table 3-1 Levels of Significant Exposure to Uranium - Inhalation

(continued)

Key to Figure <sup>a</sup>	Species (Strain)	Exposure/ Duration/ Frequency (Route)	System	NOAEL (mg/m <sup>3</sup> )	LOAEL		Reference Chemical Form	Comments
					Less Serious (mg/m <sup>3</sup> )	Serious (mg/m <sup>3</sup> )		
51	Mouse (NS)	30 d 6 hr/d	Resp	2		13.3	(lung edema, hemorrhage, and emphysema; inflammation of bronchi, alveoli, and alveolar interstitices)	Spiegl 1949 Uranium Hexafluoride
			Renal	2		13.3	(severe renal-tubular degeneration followed by regeneration, and necrosis, and the presence of casts in the tubules)	
			Ocular	2	13.3	(eye irritation)		
			Bd Wt	2	13.3	(unspecified weight loss)		
52	Gn Pig (NS)	30 d 6 hr/d	Hemato	18				Dygert 1949a Uranium Tetrafluoride
			Renal	4		18	(moderate to severe necrosis of corticomedullary tubular epithelium)	
53	Gn Pig (NS)	30 d Cont.	Bd Wt	2.1		9.5	(2.9-27.9% decreased body weight)	Roberts 1949 Uranyl Nitrate

Table 3-1 Levels of Significant Exposure to Uranium - Inhalation

(continued)

Key to Figure <sup>a</sup>	Species (Strain)	Exposure/Duration/Frequency (Route)	System	NOAEL (mg/m <sup>3</sup> )	LOAEL		Reference Chemical Form	Comments
					Less Serious (mg/m <sup>3</sup> )	Serious (mg/m <sup>3</sup> )		
54	Gn Pig (NS)	5 wk 6 d/wk 6 hr/d	Renal	2.2		9.2	(severe degeneration of renal tubular epithelium)	Rothstein 1949a Uranyl Fluoride
			Bd Wt		2.2	(unspecified moderate weight loss)		
55	Gn Pig (NS)	5 wk 6 d/wk	Resp	19.4				Rothstein 1949b Uranium Dioxide
			Hemato	19.4				
			Renal	19.4				
			Bd Wt	19.4				
56	Gn Pig (NS)	30 d 6 hr/d	Resp	2		13.3	(lung edema, hemorrhage, and emphysema, acute inflammation was seen in the bronchi, alveoli, and alveolar interstitices)	Spiegel 1949 Uranium Hexafluoride
			Renal	2		13.3	(severe renal-tubular degeneration, necrosis, regeneration; casts in the tubules)	
			Bd Wt	2	13.3	(13% decreased body weight)		

Table 3-1 Levels of Significant Exposure to Uranium - Inhalation

(continued)

Key to Figure <sup>a</sup>	Species (Strain)	Exposure/Duration/Frequency (Route)	System	NOAEL (mg/m <sup>3</sup> )	LOAEL		Reference Chemical Form	Comments
					Less Serious (mg/m <sup>3</sup> )	Serious (mg/m <sup>3</sup> )		
57	Gn Pig	7.5 months 33 hr/wk	Renal	0.2			Stokinger et al. 1953 Uranium Tetrachloride	
			Bd Wt	0.2				
58	Gn Pig	9 mo 5.5 d/wk 6 hr/d	Renal	0.05			Stokinger et al. 1953 Uranium Hexafluoride	
			Bd Wt	0.05				
59	Gn Pig (NS)	7 mo 33 hrs/wk	Renal	10			Stokinger et al. 1953 Uranium Dioxide	
			Bd Wt	10				
60	Gn Pig (NS)	6.5 mo 33 hrs/wk	Hemato	2 M			Stokinger et al. 1953 Uranyl Nitrate	
			Renal	2 M				
61	Gn Pig	9 mo 5.5 d/wk 6 hr/d	Hemato	3			Stokinger et al. 1953 Uranium Tetrafluoride	
			Renal	3				
			Bd Wt	3				



Table 3-1 Levels of Significant Exposure to Uranium - Inhalation

(continued)

Key to Figure <sup>a</sup>	Species (Strain)	Exposure/Duration/Frequency (Route)	System	NOAEL (mg/m <sup>3</sup> )	LOAEL		Reference Chemical Form	Comments
					Less Serious (mg/m <sup>3</sup> )	Serious (mg/m <sup>3</sup> )		
62	Dog (NS)	30 d 6 hr/d	Gastro	4		18	(vomited blood)	Dygert 1949a Uranium Tetrafluoride
			Hemato	18				
			Renal	0.5	3	(very slight degenerative changes in tubular epithelium)		
			Ocular	4	18	(conjunctivitis)		
			Bd Wt	4			18	
63	Dog (NS)	23 d 5 d/wk 5 hr/d	Hemato	15.4				Dygert 1949d Uranium Peroxide
			Bd Wt	15.4				

Table 3-1 Levels of Significant Exposure to Uranium - Inhalation

(continued)

Key to Figure	Species (Strain)	Exposure/Duration/Frequency (Route)	System	NOAEL (mg/m <sup>3</sup> )	LOAEL		Reference Chemical Form	Comments
					Less Serious (mg/m <sup>3</sup> )	Serious (mg/m <sup>3</sup> )		
64	Dog (NS)	30 d Cont.	Resp	2.1	9.5	(rales; slight degeneration in lung epithelium)	Roberts 1949 Uranyl Nitrate	
			Gastro	2.1	9.5	(vomiting, anorexia)		
			Hemato		0.13	(slightly decreased fibrinogen)		
			Renal		0.13	(proteinuria, transient increase in bromosulfalein retention)		
			Bd Wt	2.1	9.5	(approximately 25% decreased body weight in 3/4 that died)		
		Other	2.1					
65	Dog (NS)	4 wk 6 d/wk 6 hr/d	Resp		16	(very slight pulmonary degenerative changes)	Rothstein 1949c Uranium Trioxide	
			Hemato	16				
			Hepatic	16				
			Renal		16	(mild to severe tubular necrosis)		
			Bd Wt	16				

Table 3-1 Levels of Significant Exposure to Uranium - Inhalation

(continued)

Key to Figure <sup>a</sup>	Species (Strain)	Exposure/Duration/Frequency (Route)	System	NOAEL (mg/m <sup>3</sup> )	LOAEL		Reference Chemical Form	Comments
					Less Serious (mg/m <sup>3</sup> )	Serious (mg/m <sup>3</sup> )		
66	Dog (NS)	5 wk 6 d/wk 6 hr/d	Gastro	2.2		9.2	(vomited blood)	Rothstein 1949a Uranyl Fluoride
			Hemato	9.2				
			Renal		0.15 <sup>b</sup>	(very slight renal degeneration in approximately 50% of dogs)		
			Bd Wt	2.2		9.2	(unspecified severe weight loss)	
67	Dog (NS)	5 wk 6 d/wk	Resp	9.2				Rothstein 1949b Uranium Dioxide
			Hemato	9.2				
			Renal	1.1 <sup>c</sup>	8.2	(slight renal tubular degeneration in 2/6)		
			Bd Wt	9.2				
68	Dog (NS)	30 d 6 hr/d	Resp	0.2	2	(slight pneumonia)		Spiegl 1949 Uranium Hexafluoride
			Hemato	2				
			Renal	0.05	0.2	(slight pneumonia)		
			Ocular	2	13.3	(conjunctivitis)		

Table 3-1 Levels of Significant Exposure to Uranium - Inhalation

(continued)

Key to Figure <sup>a</sup>	Species (Strain)	Exposure/Duration/Frequency (Route)	System	NOAEL (mg/m <sup>3</sup> )	LOAEL		Reference Chemical Form	Comments
					Less Serious (mg/m <sup>3</sup> )	Serious (mg/m <sup>3</sup> )		
69	Rabbit (NS)	30 d 6 hr/d	Hemato	18			Dygert 1949a Uranium Tetrafluoride	
			Renal		0.4	(increased urinary catalase and phosphatase)		
			Bd Wt	3		18		(24% decreased body weight)
70	Rabbit (NS)	30 d 6 hr/d	Resp				Dygert 1949b Ammonium Diuranate	
			Hemato		6.8	(increased neutrophils, decreased lymphocytes)		
			Renal			6.8		(severe necrosis of the tubular epithelium)

Table 3-1 Levels of Significant Exposure to Uranium - Inhalation

(continued)

Key to Figure <sup>a</sup>	Species (Strain)	Exposure/Duration/Frequency (Route)	System	NOAEL (mg/m <sup>3</sup> )	LOAEL		Reference Chemical Form	Comments	
					Less Serious (mg/m <sup>3</sup> )	Serious (mg/m <sup>3</sup> )			
71	Rabbit (NS)	23 d 5 d/wk 5 hr/d	Resp				15.4	(edematous alveoli, alveolar hemorrhage, hyperemia, and atelectasis)	Dygert 1949d Uranium Peroxide
			Hemato	15.4					
			Hepatic	15.4					
			Renal		15.4	(moderate corticomedullary tubule necrosis with regeneration of tubular cells; azotemia)			
			Bd Wt	15.4					
72	Rabbit (NS)	30 d Cont.	Resp	0.2					Roberts 1949 Uranyl Nitrate
			Hemato		0.13	(increased plasma prothrombin and fibrinogen)			
			Renal		0.13	(increased urinary catalase)			
			Bd Wt	0.13	0.2	(unspecified decrease in body weight)			

Table 3-1 Levels of Significant Exposure to Uranium - Inhalation

(continued)

Key to Figure	Species (Strain)	Exposure/Duration/Frequency (Route)	System	NOAEL (mg/m <sup>3</sup> )	LOAEL		Reference Chemical Form	Comments
					Less Serious (mg/m <sup>3</sup> )	Serious (mg/m <sup>3</sup> )		
73	Rabbit (NS)	4 wk 6 d/wk 6 hr/d	Resp				16 (hemorrhage and consolidation in lungs of animals that died)	Rothstein 1949c Uranium Trioxide
			Hemato	16				
			Hepatic		16	(moderate fatty livers in 5/8 animals that died)		
			Renal		16	(mild to severe necrosis of the tubular epithelium with degeneration and regeneration; increased NPN)		
			Bd Wt	16				
74	Rabbit (NS)	5 wk 6 d/wk	Resp	19.4				Rothstein 1949b Uranium Dioxide
			Hemato	19.4				
			Renal	9.2		19.4 (severe tubular necrosis in dying animals)		
			Bd Wt	8.2	9.2	(unspecified decreased body weight)		

Table 3-1 Levels of Significant Exposure to Uranium - Inhalation

(continued)

Key to Figure	Species (Strain)	Exposure/Duration/Frequency (Route)	System	NOAEL (mg/m <sup>3</sup> )	LOAEL		Reference Chemical Form	Comments
					Less Serious (mg/m <sup>3</sup> )	Serious (mg/m <sup>3</sup> )		
75	Rabbit (NS)	5 wk 5.5 d/wk 6 hr/d	Hepatic		15	(slight decrease in lactate)		Rothstein 1949d Sodium Uranate
			Renal		15	(progressive degeneration and necrosis followed by regeneration of tubular epithelium; increased NPN)		
			Bd Wt	15				
76	Rabbit (NS)	30 d 6 hr/d	Resp	0.2	2	(severe pulmonary edema)		Spiegl 1949 Uranium Hexafluoride
			Hemato	13				
			Renal		0.2	(mild tubular degeneration)		
			Bd Wt	0.2	2	(12% decreased body weight)		
77	Rabbit (NS)	6.5 mo 5.5 d/wk 6 hr/d	Hemato	2				Stokinger et al. 1953 Uranyl Nitrate
			Renal		0.25	mild tubular atrophy)		
			Bd Wt			2	(weight loss)	

Table 3-1 Levels of Significant Exposure to Uranium - Inhalation

(continued)

Key to Figure <sup>a</sup>	Species (Strain)	Exposure/Duration/Frequency (Route)	System	NOAEL (mg/m <sup>3</sup> )	LOAEL		Reference Chemical Form	Comments
					Less Serious (mg/m <sup>3</sup> )	Serious (mg/m <sup>3</sup> )		
78	Rabbit	9 mo 5.5 d/wk 6 hr/d	Renal		0.2	(very mild tubular injury)	Stokinger et al. 1953 Uranium Hexafluoride	
			Bd Wt	0.2				
79	Rabbit	9 mo 5.5 d/wk 6 hr/d	Hemato	3			Stokinger et al. 1953 Uranium Tetrafluoride	
			Renal	3				
			Bd Wt	3				
80	Rabbit (NS)	7 mo 33 hrs/wk	Hemato	10			Stokinger et al. 1953 Uranium Dioxide	
			Renal	10				
			Bd Wt	10				
81	Rabbit	7.5 mo 33 hr/wk	Renal	0.2			Stokinger et al. 1953 Uranium Tetrachloride	
			Bd Wt	0.2				



Table 3-1 Levels of Significant Exposure to Uranium - Inhalation

(continued)

Key to Figure <sup>a</sup>	Species (Strain)	Exposure/Duration/Frequency (Route)	System	NOAEL (mg/m <sup>3</sup> )	LOAEL		Reference Chemical Form	Comments
					Less Serious (mg/m <sup>3</sup> )	Serious (mg/m <sup>3</sup> )		
82	Cat (NS)	30 d 6 hr/d	Resp		18	(rhinitis)		Dygert 1949a Uranium Tetrafluoride
			Gastro			18	(vomited blood)	
			Hemato	18				
			Renal			18	(moderate to severe typical renal injury in 2/3 dying cats; azotemia)	
			Ocular		18	(conjunctivitis)		
		Bd Wt		18	(18% decreased body weight)			
83	Cat (NS)	23 d 5 d/wk 5 hr/d	Hemato	15.4				Dygert 1949d Uranium Peroxide
			Renal			15.4	(azotemia)	
			Bd Wt	15.4				
84	Cat (NS)	5 wk 6 d/wk 6 hr/d	Resp	2.2	9.2	(rhinitis)		Rothstein 1949a Uranyl Fluoride
			Gastro	2.2		9.2	(vomited blood prior to death)	
			Renal	2.2		9.2	(severe degeneration of renal tubular epithelium)	

Table 3-1 Levels of Significant Exposure to Uranium - Inhalation

(continued)

Key to Figure	Species (Strain)	Exposure/Duration/Frequency (Route)	System	NOAEL (mg/m <sup>3</sup> )	LOAEL		Reference Chemical Form	Comments
					Less Serious (mg/m <sup>3</sup> )	Serious (mg/m <sup>3</sup> )		
<b>Immuno/ Lymphoret</b>								
85	Rat (NS)	30 d 6 hr/d			0.4	(edematous cecal lymph nodes; focal necrosis of spleen)	Dygert 1949a Uranium Tetrafluoride	
86	Rat (NS)	30 d 6 hr/d			6.8	(rise in neutrophils, decreased lymphocytes, moderate fall in the white blood count, rise in the eosinophils)	Dygert 1949b Ammonium Diuranate	
87	Rat (NS)	30 d Cont.		2.1	9.5	(decreased absolute number of lymphocytes and neutrophils)	Roberts 1949 Uranyl Nitrate	
<b>Neurological</b>								
88	Rat (Sprague-Dawley)	3 wk 4 d/wk 0.5 hr (NS)			190 M	(increased spontaneous activity; decreased spatial working memory)	Monleau et al. 2005 Uranium Dioxide	
89	Dog (NS)	30 d 6 hr/d		4	18	(weakness and unsteady gait)	Dygert 1949a Uranium Tetrafluoride	
90	Cat (NS)	30 d 6 hr/d			18	(weakness and unsteady gait)	Dygert 1949a Uranium Tetrafluoride	

Table 3-1 Levels of Significant Exposure to Uranium - Inhalation

(continued)

Key to Figure <sup>a</sup>	Species (Strain)	Exposure/Duration/Frequency (Route)	System	NOAEL (mg/m <sup>3</sup> )	LOAEL		Reference Chemical Form	Comments
					Less Serious (mg/m <sup>3</sup> )	Serious (mg/m <sup>3</sup> )		
<b>CHRONIC EXPOSURE</b>								
<b>Death</b>								
91	Dog (Beagle)	5 yr 5 d/wk 5.4 hr/d				5 (4.5% mortality)	Leach et al. 1970, 1973 Uranium Dioxide	
<b>Systemic</b>								
92	Monkey	5 yr 5 d/wk 5.4 hr/d	Resp		5.1 <sup>d</sup>	(minimal pulmonary hyaline fibrosis)	Leach et al. 1970, 1973 Uranium Dioxide	
			Hepatic	5.1				
			Renal	5.1				
			Bd Wt	5.1				
93	Rat (NS)	1 yr 33 hrs/wk	Resp	0.2			Stokinger et al. 1953 Uranium Tetrachloride	
			Gastro	0.2				
			Hepatic	0.2				
			Renal	0.05	0.2	(slight to mild tubular injury)		
			Endocr	0.2				
			Bd Wt	0.2				
94	Rat (NS)	1 yr 33 hrs/wk	Resp	2			Stokinger et al. 1953 Uranyl Nitrate	
			Renal	0.25	2	(mild to marked renal tubular atrophy)		
			Bd Wt	2				

Table 3-1 Levels of Significant Exposure to Uranium - Inhalation

(continued)

Key to Figure <sup>a</sup>	Species (Strain)	Exposure/Duration/Frequency (Route)	System	NOAEL (mg/m <sup>3</sup> )	LOAEL		Reference Chemical Form	Comments
					Less Serious (mg/m <sup>3</sup> )	Serious (mg/m <sup>3</sup> )		
95	Rat (NS)	1 yr 5.5 d/wk 6 hr/d	Resp	0.2			Stokinger et al. 1953 Uranium Hexafluoride	
			Cardio	0.2				
			Gastro	0.2				
			Hemato	0.2				
			Hepatic	0.2				
			Renal	0.05	0.2	(very mild renal tubular lesions)		
			Endocr	0.2				
			Dermal	0.2				
			Bd Wt	0.2				
96	Rat (NS)	2 yr 5.5 d/wk 6 hr/d	Hemato	2			Stokinger et al. 1953 Uranyl Nitrate	
			Renal		2	(mild tubular atrophy)		
			Bd Wt	2				
97	Rat (NS)	1 yr 5.5 d/wk 6 hr/d	Hemato	3			Stokinger et al. 1953 Uranium Tetrafluoride	
			Renal	3				
			Bd Wt	3				

Table 3-1 Levels of Significant Exposure to Uranium - Inhalation

(continued)

Key to Figure	Species (Strain)	Exposure/Duration/Frequency (Route)	System	NOAEL (mg/m <sup>3</sup> )	LOAEL		Reference Chemical Form	Comments
					Less Serious (mg/m <sup>3</sup> )	Serious (mg/m <sup>3</sup> )		
98	Rat	1 yr 33 hrs/wk	Hemato	10			Stokinger et al. 1953 Uranium Dioxide	
			Renal	10				
			Bd Wt	10				
99	Dog (Beagle)	1-5 yr 5 d/wk 5.4 hr/d	Resp		5.1	(lung fibrosis)	Leach et al. 1970, 1973 Uranium Dioxide	
			Hemato	5.1				
			Renal	5.1				
			Bd Wt	5.1				
100	Dog (NS)	1 yr 33 hrs/wk	Hemato	0.2			Stokinger et al. 1953 Uranium Tetrachloride	
			Hepatic	0.2				
			Renal	0.05 <sup>e</sup>	0.2	(slight tubular atrophy)		
			Bd Wt	0.2				
101	Dog (NS)	1 yr 5.5 d/wk 6 hr/d	Hemato	2			Stokinger et al. 1953 Uranyl Nitrate	
			Hepatic	2				
			Renal	0.15	0.25	(mild to moderate tubular atrophy)		
			Bd Wt	2				

Table 3-1 Levels of Significant Exposure to Uranium - Inhalation

(continued)

Key to Figure <sup>a</sup>	Species (Strain)	Exposure/Duration/Frequency (Route)	System	NOAEL (mg/m <sup>3</sup> )	LOAEL		Reference Chemical Form	Comments
					Less Serious (mg/m <sup>3</sup> )	Serious (mg/m <sup>3</sup> )		
102	Dog	1 yr 33 hrs/wk	Hemato	10			Stokinger et al. 1953 Uranium Dioxide	
			Renal	1	10	(slight to mild tubular degeneration)		
			Bd Wt	10				
103	Dog	1 yr 5.5 d/wk 6 hr/d	Hemato	3			Stokinger et al. 1953 Uranium Tetrafluoride	
			Renal	0.5	3	(tubular damage)		
			Bd Wt	3				
104	Dog (NS)	1 yr 5.5 d/wk 6 hr/d	Resp	0.2			Stokinger et al. 1953 Uranium Hexafluoride	
			Hemato	0.2				
			Renal	0.05	0.2	(mild tubular injury)		
			Bd Wt	0.2				
105	Dog (NS)	2 yr 5.5 d/wk 6 hr/d	Hemato	2			Stokinger et al. 1953 Uranyl Nitrate	
			Renal		2	(moderate tubular atrophy)		

Table 3-1 Levels of Significant Exposure to Uranium - Inhalation

(continued)

Key to Figure	Species (Strain)	Exposure/ Duration/ Frequency (Route)	System	NOAEL (mg/m <sup>3</sup> )	LOAEL		Reference Chemical Form	Comments
					Less Serious (mg/m <sup>3</sup> )	Serious (mg/m <sup>3</sup> )		
<b>Immuno/ Lymphoret</b>								
106	Dog (Beagle)	5 yr 5 d/wk 5.4 hr/d			5.1 (minimal lymph node fibrosis)		Leach et al. 1970, 1973 Uranium Dioxide	
<b>Cancer</b>								
107	Rat (Sprague-Dawley)	65 wk 5 d/wk 4.2 hr/d				8.4 M (CEL: malignant lung tumors)	Mitchel et al. 1999 Uranium dust	
108	Dog (NS)	1-5 yr 5 d/wk 5.4 hr/d				5.1 (CEL: lung cancer)	Leach et al. 1973 Uranium Dioxide	

a The number corresponds to entries in Figure 3-1.

b Used to derive an intermediate-duration inhalation minimal risk level (MRL) of 0.0001 mg U/m<sup>3</sup> for soluble uranium compounds based on a LOAELADJ of 0.032 mg/m<sup>3</sup> and an uncertainty factor of 300 (3 for used of a minimal LOAEL, 10 for extrapolation from animals to humans, and 10 for human variability).

c Used to derive an intermediate-duration inhalation minimal risk level (MRL) of 0.002 mg U/m<sup>3</sup> for insoluble uranium compounds based on a NOAELADJ of 0.24 mg/m<sup>3</sup> and an uncertainty factor of 100 (10 for extrapolation from animals to humans and 10 for human variability).

d Used to derive a chronic-duration inhalation minimal risk level (MRL) of 0.0008 mg U/m<sup>3</sup> for insoluble uranium compounds based on a LOAELADJ of 0.82 mg/m<sup>3</sup> and an uncertainty factor of 1000 (10 for use of LOAEL, 10 for extrapolation from animals to humans and 10 for human variability).

e Used to derive a chronic-duration inhalation minimal risk level (MRL) of 0.00004 mg U/m<sup>3</sup> for soluble uranium compounds based on a BMCLADJ of 0.0037 mg/m<sup>3</sup> and an uncertainty factor of 100 (10 for extrapolation from animals to humans and 10 for human variability).

Bd Wt = body weight; Cardio = cardiovascular; CEL = cancer effect level; d = day(s); Endocr = endocrine; Gastro = gastrointestinal; Gn Pig = guinea pig; Hemato = hematological; hr = hour(s); LOAEL = lowest-observed-adverse-effect level; M = male; min = minute(s); NOAEL = no-observed-adverse-effect level; NS = not specified; occup = occupational; Resp = respiratory; wk = week(s); yr = year(s)

Figure 3-1 Levels of Significant Exposure to Uranium - Inhalation  
Acute (≤14 days)

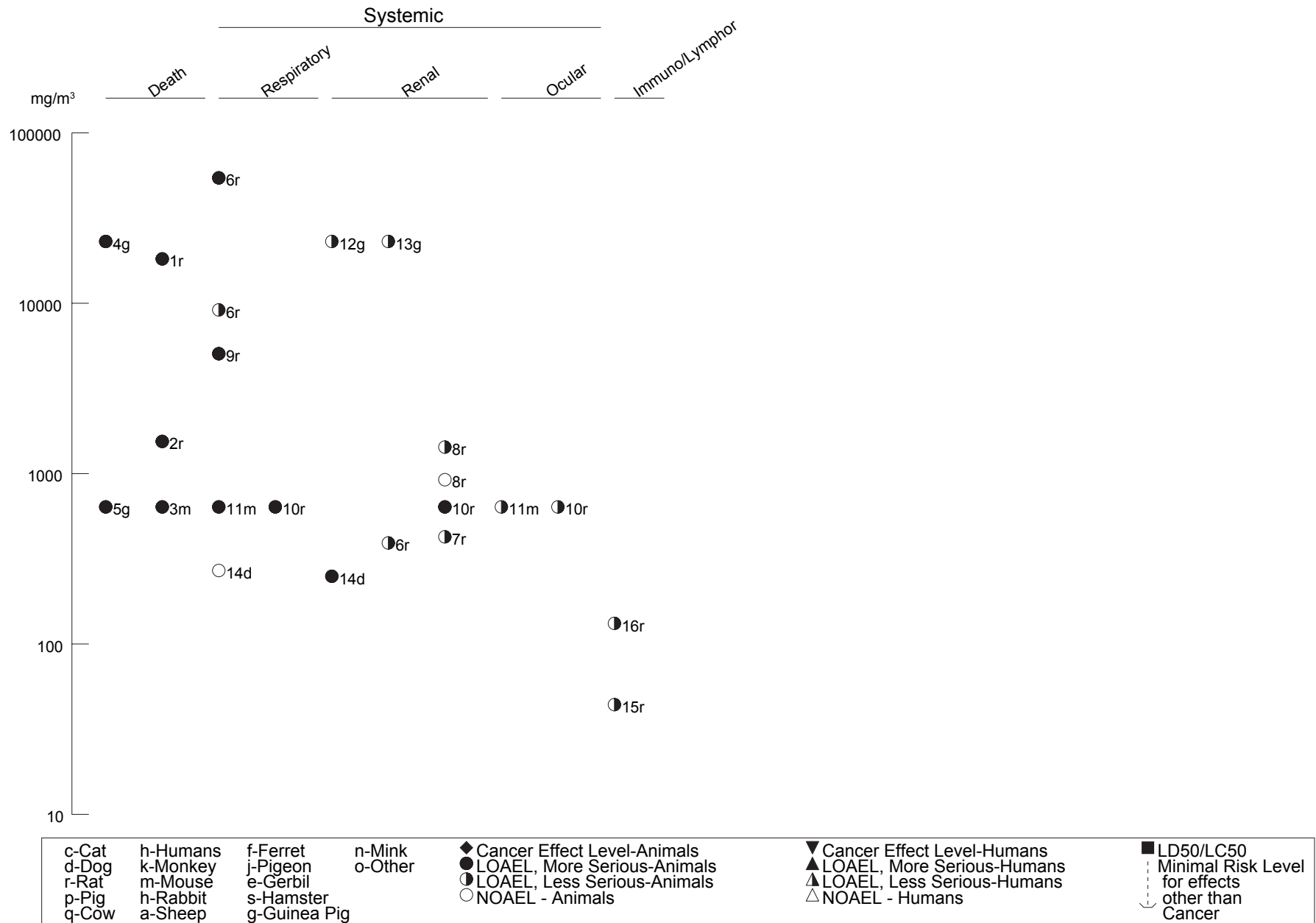



Figure 3-1 Levels of Significant Exposure to Uranium - Inhalation (Continued)

Intermediate (15-364 days)

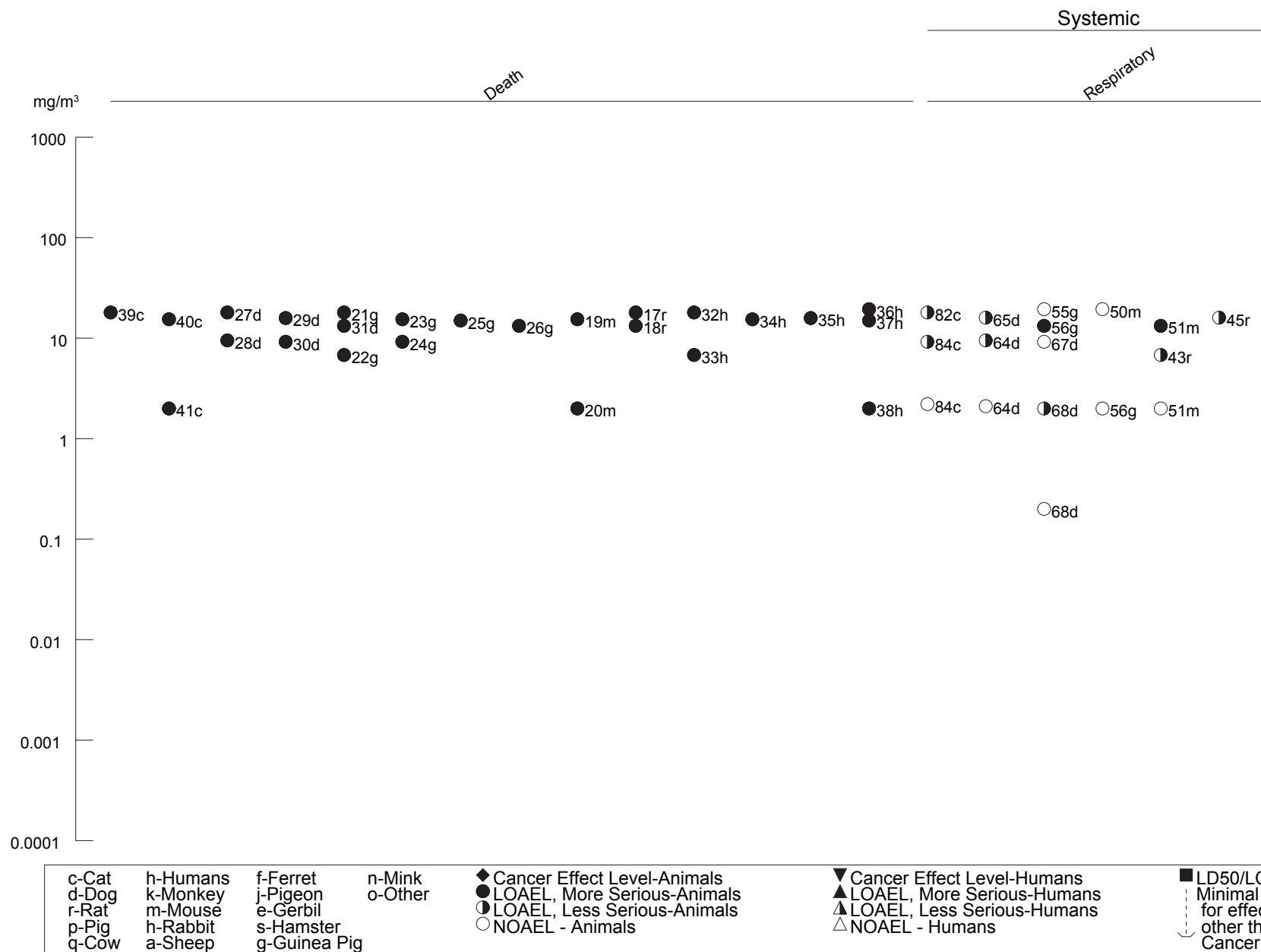

Figure 3-1 Levels of Significant Exposure to Uranium - Inhalation (Continued)

Intermediate (15-364 days)

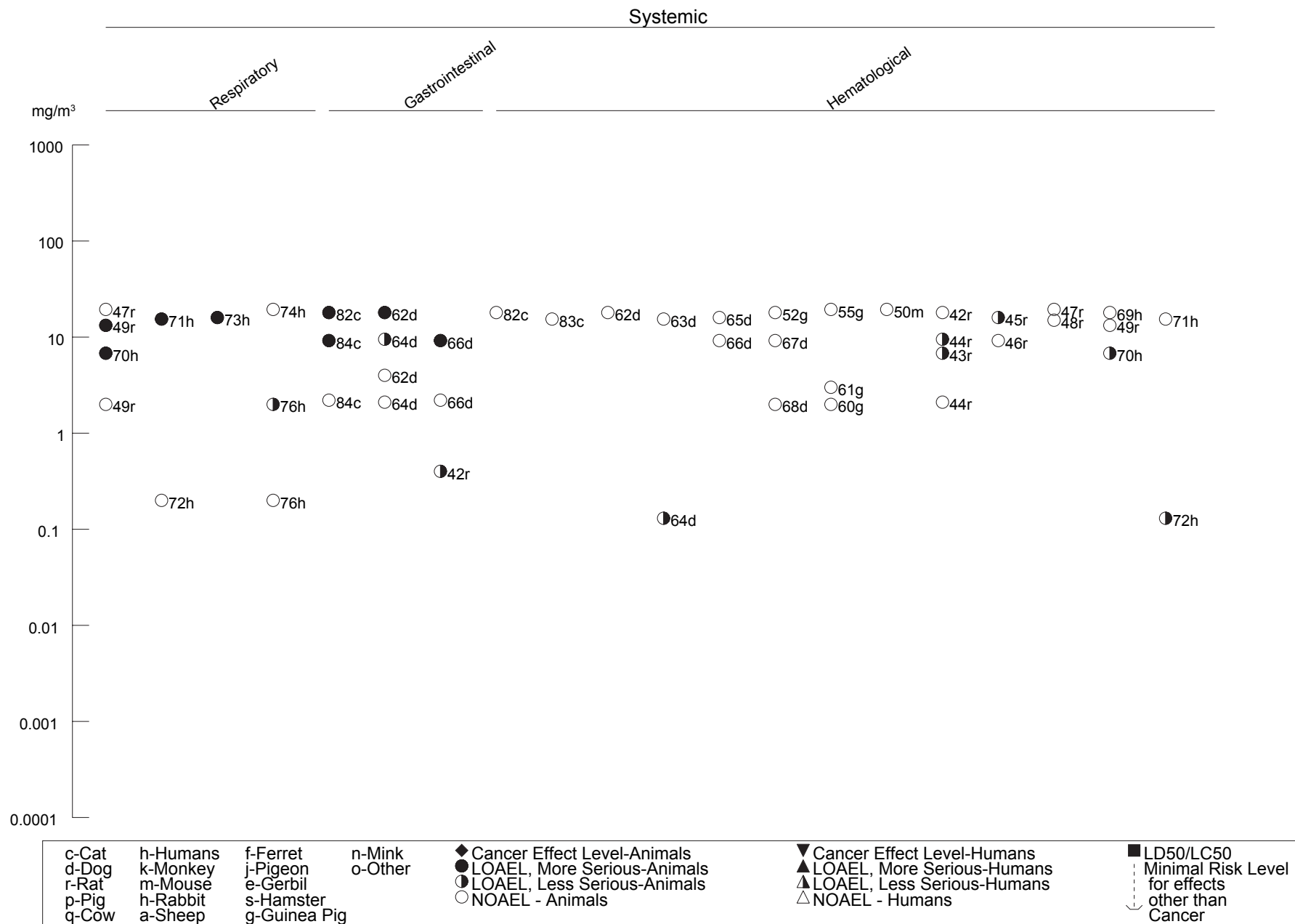

Figure 3-1 Levels of Significant Exposure to Uranium - Inhalation (Continued)

Intermediate (15-364 days)

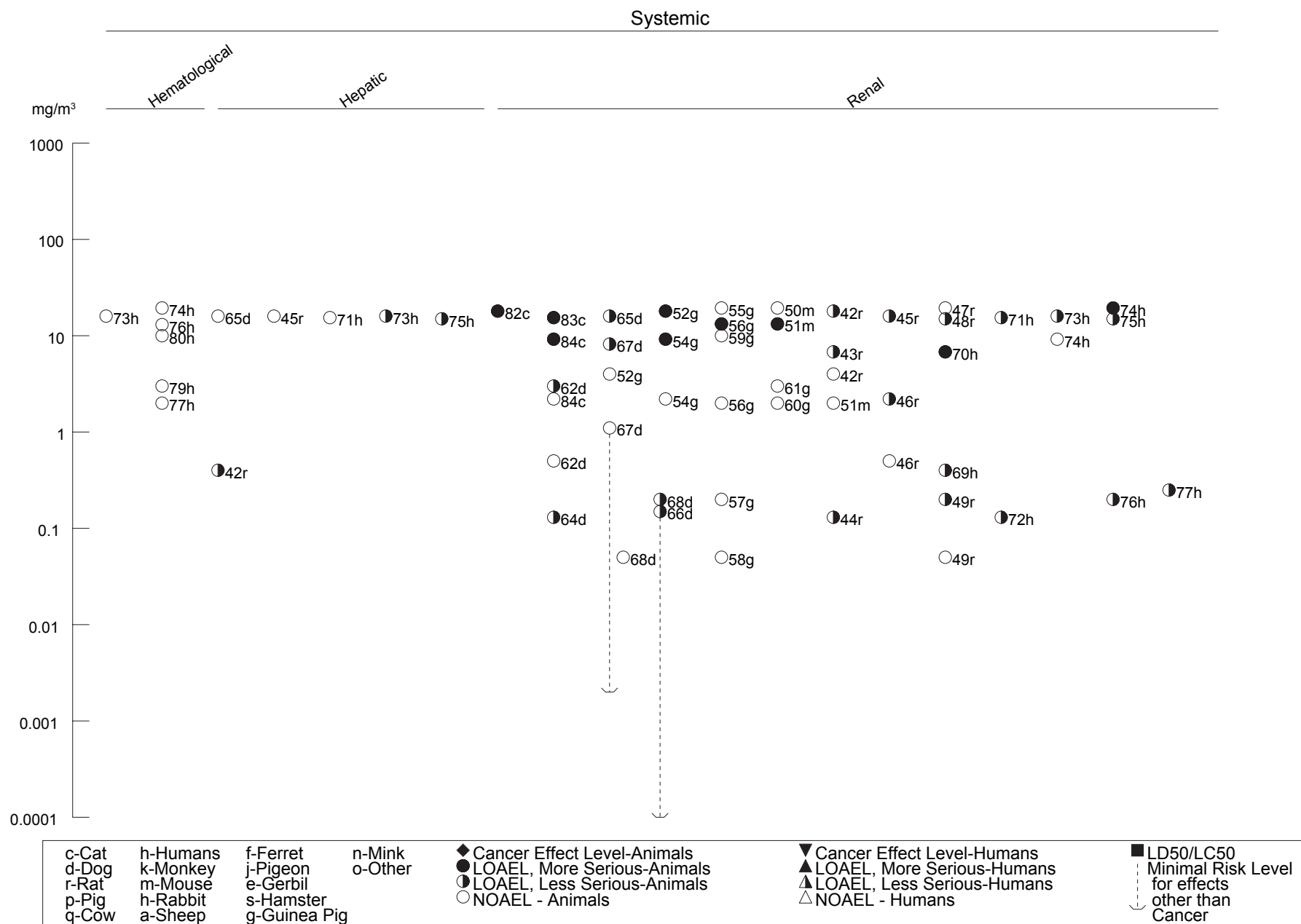

Figure 3-1 Levels of Significant Exposure to Uranium - Inhalation (Continued)

Intermediate (15-364 days)

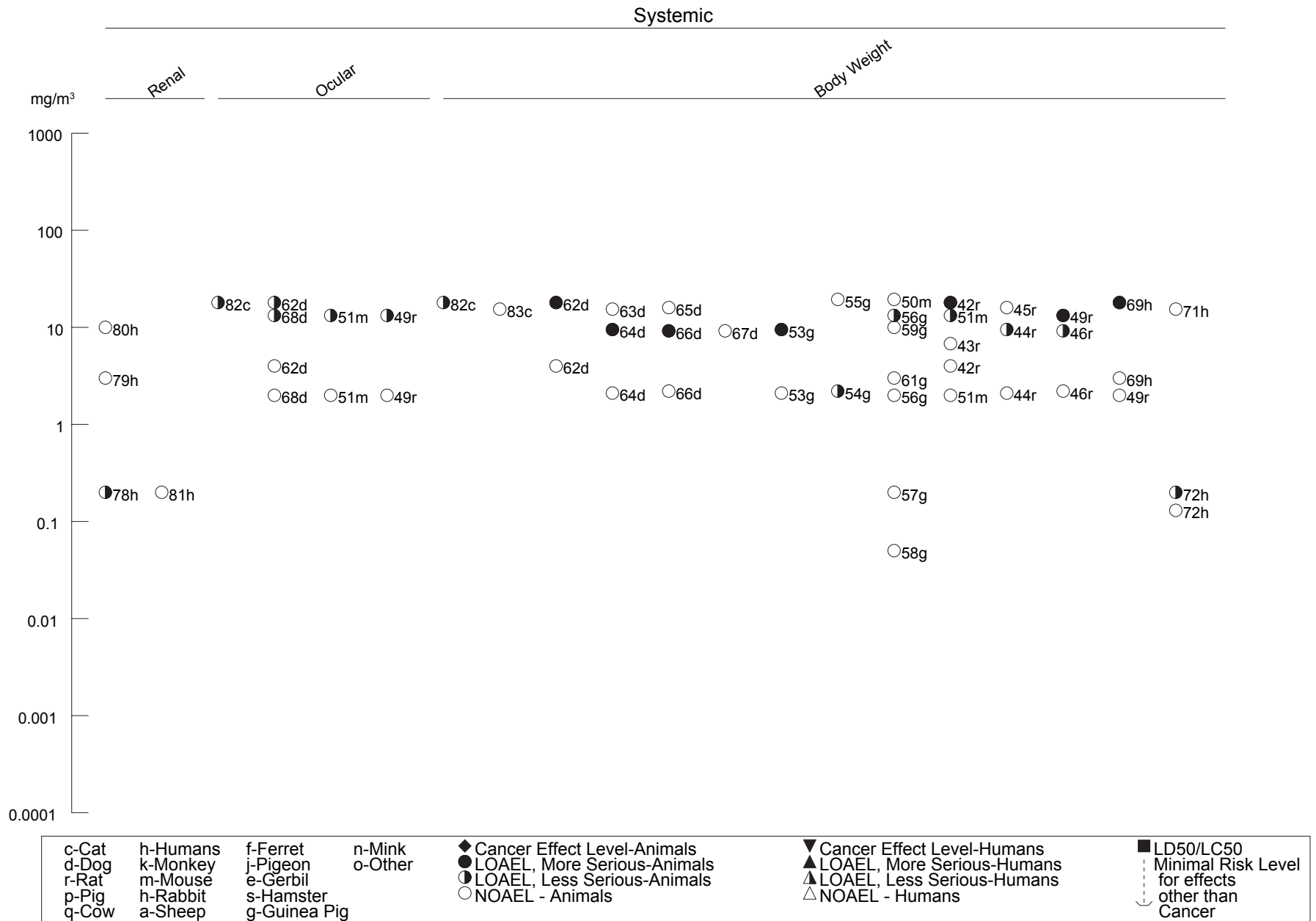

Figure 3-1 Levels of Significant Exposure to Uranium - Inhalation (Continued)

Intermediate (15-364 days)

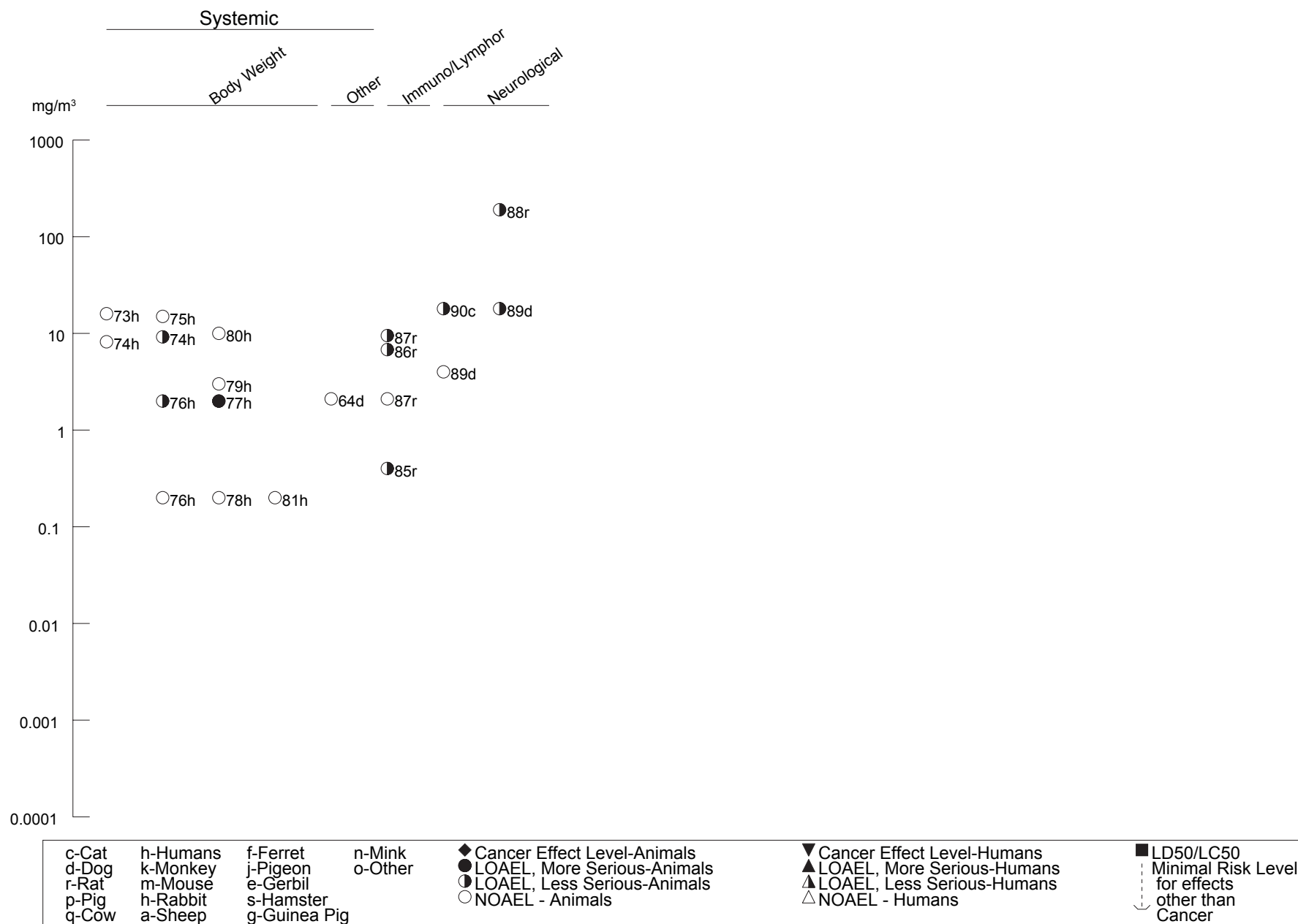

Figure 3-1 Levels of Significant Exposure to Uranium - Inhalation (Continued)

Chronic (≥365 days)

Systemic

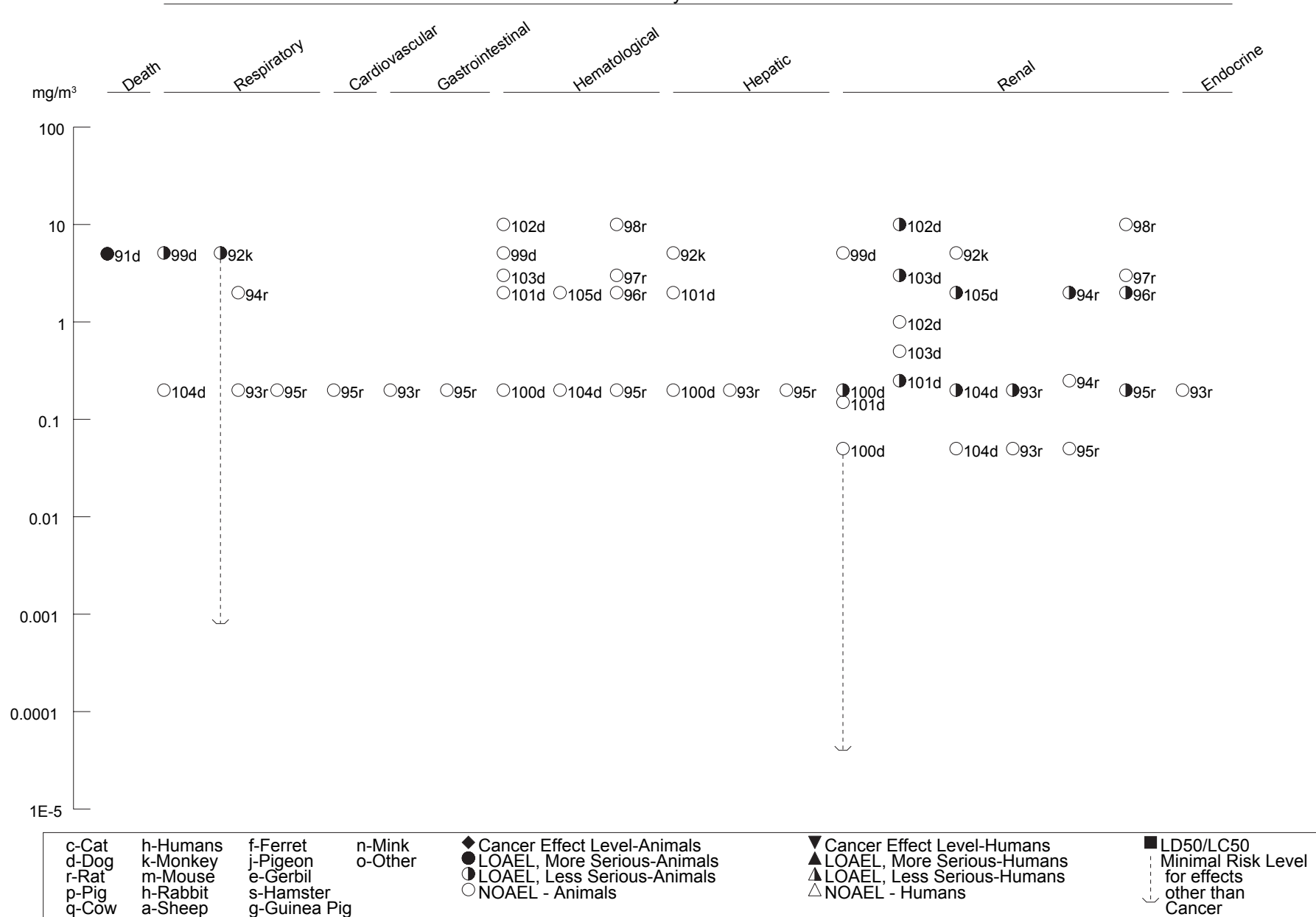
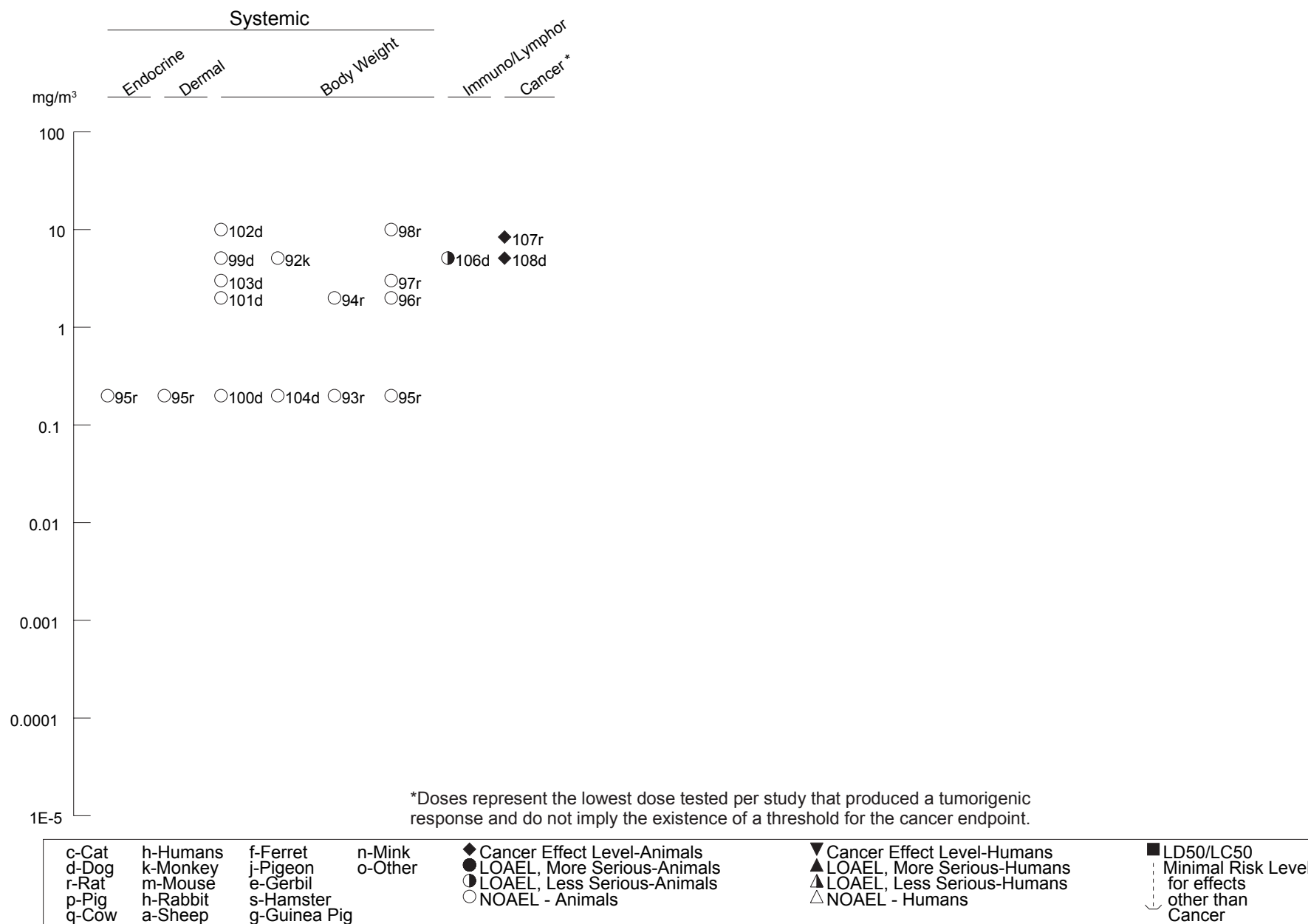

Figure 3-1 Levels of Significant Exposure to Uranium - Inhalation (Continued)

Chronic (≥365 days)



## 3. HEALTH EFFECTS

No animal studies were located regarding the endocrine, metabolic, dermal, or ocular effects of uranium in animals following acute-duration inhalation exposures to uranium. Nor were any studies located regarding the metabolic, dermal, ocular, or other systemic effects in animals following intermediate-duration inhalation exposure to uranium. There are animal data for acute-, intermediate-, and chronic-duration inhalation exposures to uranium for respiratory, hematological, cardiovascular, gastrointestinal, renal, or body weight effects. However, animal data on hepatic effects are limited to acute- and chronic-duration inhalation exposures to uranium.

The highest NOAEL values and all reliable LOAEL values in each species and duration category for systemic effects from chemical exposure to uranium by the inhalation route are presented in Table 3-1 and plotted in Figure 3-1.

**Respiratory Effects.** The hazard from inhaled uranium aerosols, or from any noxious agent, is the likelihood that the agent will reach the site of its toxic action. Two of the main factors that influence the degree of hazard from toxic airborne particles are: (1) the site of deposition in the respiratory tract of the particles and (2) the fate of the particles within the lungs. The deposition site within the lungs depends mainly on the particle size of the inhaled aerosol, while the subsequent fate of the particle depends mainly on the physical and chemical properties of the inhaled particles and the physiological status of the lungs.

Small particles (about 2 micrometers [ $\mu\text{m}$ ] or smaller in size) are primarily deposited in the alveoli. The alveoli, frequently called the “deep respiratory tract,” form the functional part of the lungs where gas exchange occurs. As the particle size increases, progressively fewer particles penetrate into the deep respiratory tract, and increasingly greater fractions of the inhaled particles are deposited in the upper respiratory tract. The respiratory tract is a system of ducts that starts at the nares and includes the pharynx, larynx, trachea, and a complex series of bronchi and bronchioles that terminate in several thousand alveoli. Three different mechanisms are involved in the removal of particles from the respiratory tract. The first is mucociliary action in the upper respiratory tract (trachea, bronchi, bronchioles, and terminal bronchioles), which sweeps particles deposited there into the throat, where they are either swallowed into the gastrointestinal tract or spat out. The two other clearance mechanisms, dissolution (which leads to absorption into the bloodstream) and phagocytosis (removal by specialized cells in the process), deal mainly with the particles deposited in the deep respiratory tract (respiratory bronchioles, alveolar ducts, and alveolar sacs) (ICRP 1994a; NCRP 1997). The less soluble uranium particles may remain in the lungs and in the regional lymph nodes for weeks (uranium trioxide, uranium tetrafluoride, uranium tetrachloride) to years (uranium dioxide, triuranium octaoxide).



## 3. HEALTH EFFECTS

Human and animal studies have shown that long-term retention in the lungs of large quantities of inhaled insoluble uranium particles (e.g., carnotite dust [4% uranium as uranium dioxide and triuranium octaoxide, 80–90% quartz, and <10% feldspar]) can lead to serious respiratory effects. However, animals exposed to high doses of purified uranium (as uranyl nitrate hexahydrate, uranium tetrachloride, uranium dioxide, uranium trioxide, uranium tetraoxide, uranium fluoride, or uranium acetate) through the inhalation or oral route in acute-, intermediate-, or chronic-duration exposures failed to develop these respiratory ailments. The lack of significant pulmonary injury in animal studies with insoluble compounds indicates that other factors, such as diverse inorganic particle abrasion or chemical reactions, may contribute to these effects.

In acute exposures, respiratory disease may be limited to interstitial inflammation of the alveolar epithelium, leading eventually to pulmonary fibrosis (Clayton and Clayton 1981; Cooper et al. 1982; Dungworth 1989; Wedeen 1992). In studies of the pulmonary effects of airborne uranium dust in uranium miners and in animals, the respiratory diseases reported are probably aggravated by the inhalable dust particles' (the form in which uranium is inhaled) toxicity. In some of these instances, additional data from the studies show that the workers were exposed to even more potent respiratory tract irritants, such as silica and vanadium pentaoxide (Waxweiler et al. 1983).

The effects of massive acute exposures to uranium in humans, as well as epidemiologic or clinical studies of uranium mine workers chronically exposed to mine atmospheres (containing other noxious agents that include silica, diesel engine exhaust, cigarette smoke, and radon and its daughters), have been investigated. Several epidemiologic studies have reported respiratory diseases in uranium mine and mill workers, who were also exposed to significant amounts of dust and other pulmonary irritants, but not in uranium-processing workers, who were not exposed to these potential aggravants.

Accidental exposure of workers to estimated airborne concentrations of 20 mg uranium hexafluoride/m<sup>3</sup> for a 1-minute exposure and 120 mg uranium hexafluoride/m<sup>3</sup> for a 60-minute exposure (15.2 and 91 mg U/m<sup>3</sup>, respectively) resulted in acute respiratory irritation, which is attributed to the hydrofluoric acid decomposition product. One worker died of pulmonary edema a few hours after the accident (USNRC 1986, 1990). In another report, 20 men who were seriously injured following accidental exposure to a stream of uranium hexafluoride when a transportation cask ruptured showed signs of pulmonary edema, which also was attributed to hydrofluoric acid. After 3 weeks, most had normal clinical findings and were considered to be in excellent health. A follow-up examination 38 years later on

## 3. HEALTH EFFECTS

three of the injured workers showed no detectable uranium deposition and no respiratory findings attributable to the exposure (Kathren and Moore 1986). No clinical signs of pulmonary toxicity were found in about 100 uranium-processing workers exposed to insoluble uranium dust at levels of 0.5–2.5 mg U/m<sup>3</sup> for about 5 years (Eisenbud and Quigley 1956). Other reports of workers in the uranium processing industry did not show increased deaths due to diseases of the respiratory system related to exposure to uranium (Cragle et al. 1988; NIOSH 1987; Polednak and Frome 1981; Scott et al. 1972).

A 30-year follow-up study (Dupree et al. 1987) in which ionizing radiation hazard was assessed for a study cohort consisting of 995 workers in a uranium-processing facility that operated between 1943 and 1949 found statistically significant increases in death from all causes. Significantly increased mortality was observed for cancer of the larynx and for pneumonia, but not for lung cancer. The workers were exposed to internal radiation from the inhaled uranium dust, with an upper limit of 1,000 mSv. The data (external radiation badge) for the last 24 months of operation indicated that the highest cumulative external gamma dose for a worker was about 20 mSv. Long-term occupational exposure was evaluated in a subcohort that received 150 mSv/year or more. Because the workers were also exposed to radon-222 (<sup>222</sup>Ra), chlorine, hydrofluoric acid, lead sulfate, nickel, nitric acid and nitrogen oxides, silicon dioxide, and sulfuric acid, the etiology of the reported laryngeal disease is uncertain (Dupree et al. 1987). An increased incidence of deaths (standard mortality ratios [SMRs]=2.29) from obstructive pulmonary disease was found in 4,106 workers in a nuclear fuels fabrication plant who were employed for >6 months from 1956 to 1978 (Hadjimichael et al. 1983). However, the overall death rate and the rate of all cancers combined were lower than expected. The association of disease with exposure to uranium was not confirmed.

Pinkerton et al. (2004) reported significantly increased mortality from nonmalignant respiratory disease (100 observed vs. 70.16 expected; SMR 1.43, 95% CI 1.16–1.73) within a cohort of 1,485 workers employed in uranium mills in the Colorado Plateau region (Arizona, Colorado, New Mexico) when worker mortality was compared to mortality within the U.S. population. The workers were employed for at least 1 year; 37% were employed for 3–9 years and 20% for ≥10 years. The latency period (time from first employment to evaluation) was at least 20 years for 86% of the cohort. Mortality rates were not significantly elevated among the mill workers when compared to Colorado Plateau regional population mortality rates. This region is noted for relatively high chronic obstructive pulmonary disease compared to other states.

## 3. HEALTH EFFECTS

Boice et al. (2008) examined mortality in a cohort of mining (1,867 males and females) and milling (759 males and females) workers at Grants, New Mexico, compared to mortality rates for the U.S. population. All workers were employed for at least 6 months; 47 and 12% of the miners were employed for 0.5–1.9 and  $\geq 10$  years and 42 and 15% of the millers were employed for 0.5–1.9 and  $\geq 10$  years. For both groups, the latency period was  $\geq 20$  years. After separating the cohort according to type of employment (mining, milling), only the group that reported having worked in underground uranium mines exhibited significant excess mortality from nonmalignant respiratory disease (55 observed vs. 33.6 expected; SMR 1.64, 95% CI 1.23–2.13); the mortality ratio for the millers was 1.07 (25 observed vs. 23.4 expected; 95% CI 0.69–1.58). The increased mortality from nonmalignant respiratory disease among the workers with uranium mining experience is attributable to exposure to mining dusts, radon decay products, diesel exhaust, and excessive tobacco use, rather than exposure to uranium.

The pulmonary toxicity of uranium compounds varies in animals. Reports of pulmonary toxicity in animals after acute-duration exposure to uranium are limited to experiments with uranium hexafluoride. Gasping and severe irritation to the nasal passages were reported after 10-minute exposures at 637 mg U/m<sup>3</sup> in rats and mice (Spiegl 1949) and nasal hemorrhage in rats after a 5-minute exposure to 54,503 mg/m<sup>3</sup> (Leach et al. 1984). Uranium hexafluoride promptly hydrolyzes on contact with water to uranyl fluoride and hydrofluoric acid. Thus, the animals were potentially exposed to hydrofluoric acid, a potent toxicant to respiratory tract epithelium, which probably contributed to pulmonary tissue destruction (Leach et al. 1984; Spiegl 1949; Stokinger et al. 1953). In addition, exposure to fluoride ions can result in hypocalcemia, hypomagnesemia, pulmonary edema, metabolic acidosis, ventricular arrhythmia, and death (Meditext 1998).

Intermediate-duration exposure to uranium compounds also caused pulmonary toxicity, particularly when exposure was to uranium hexafluoride. Exposure of rats, mice, and guinea pigs to this compound for 6 hours/day for 30 days at 13.3 mg U/m<sup>3</sup> resulted in pulmonary edema, hemorrhage, emphysema, and inflammation of the bronchi and alveoli (Spiegl 1949). Exposure to 2.0 mg U/m<sup>3</sup> resulted in pulmonary edema, hemorrhage, and emphysema in rabbits and slight pneumonia in dogs (Spiegl 1949). Milder effects were observed with other uranium compounds in a series of experiments where exposure conditions were similar to those found in the workplace (i.e., 5–6 hours/day, 5–6 days/week). For example, rhinitis was observed in cats and dogs after 30 days of exposure to 18 mg U/m<sup>3</sup> as uranium tetrafluoride (Dygert 1949a) and after 5 weeks of exposure to 9.2 mg U/m<sup>3</sup> as uranyl fluoride (Rothstein 1949a); the rhinitis was observed in animals dying early and were associated with other signs of morbidity. Histopathological evidence of toxicity was observed in several studies, including slight

## 3. HEALTH EFFECTS

degenerative changes in the lungs of rats and dogs exposed to 16 mg U/m<sup>3</sup> as uranium trioxide (Rothstein 1949c) and dogs exposed to 9.5 mg U/m<sup>3</sup> as uranyl nitrate (Roberts 1949). Uranium dioxide and triuranium octaoxide did not cause toxicity (Dygert 1949c; Rothstein 1949b). Carnotite uranium ore did not cause toxicity in mice or guinea pigs, but hemorrhagic lungs were observed in dogs (Pozzani 1949). The species differences may reflect deeper penetration of this material into the dog respiratory tract. Rabbits were more sensitive to respiratory effects of uranium compounds than other species. Severe respiratory effects (pulmonary edema, hemorrhage) were observed in this species with exposure to 6.8 mg U/m<sup>3</sup> as ammonium diuranate (Dygert 1949b), 15.4 mg U/m<sup>3</sup> as uranium peroxide (Dygert 1949d), 16 mg U/m<sup>3</sup> as uranium trioxide (Rothstein 1949c), and 22 mg U/m<sup>3</sup> as carnotite uranium ore (Pozzani 1949). Uranium dioxide at 19.4 mg U/m<sup>3</sup> did not cause respiratory effects in rabbits (Rothstein 1949b).

In chronic-duration exposure tests, a total of 3,100 test animals, including rats, rabbits, guinea pigs, and dogs were exposed to aerosols containing 0.05–10 mg U/m<sup>3</sup> of various uranium compounds for 7–13 months. No histological damage attributable to uranium exposure were observed in the lungs. There was an absence of any other type of histological damage outside the kidneys (Cross et al. 1981a, 1981b; Stokinger et al. 1953). Dogs exposed to 15 mg/m<sup>3</sup> of carnotite ore dust containing 0.6 mg U/m<sup>3</sup> with a particle size activity median aerodynamic diameter (AMAD) of 1.5–2.1 µm 4 hours/day, 5 days/week for 1–4 years showed very slightly increased pulmonary resistance, which may not have been statistically significant. Histological findings included vesicular emphysema, which was present to a lesser degree in control animals. Fibrosis was not noted at this concentration (Cross et al. 1981a, 1982). Exposure of rats to 5.1 mg U/m<sup>3</sup> as uranium dioxide dust 5.4 hours/day, 5 days/week for 1 year did not result in histological damage in the lungs (Leach et al. 1970).

Because particles containing insoluble uranium compounds can reside in the lung for years, it is likely that radiotoxicity as well as chemical toxicity can result from inhalation exposure to highly enriched uranium compounds. Radiation effects on tissues from the alveolar regions of the lungs were examined in Albino HMT (F344) male rats exposed, nose-only, for 100 minutes to an aerosol of to 92.8% <sup>235</sup>U-enriched uranium dioxide with a concentration ranging from 2,273 nCi/m<sup>3</sup> (84.1 kBq/m<sup>3</sup>) to 5,458 nCi/m<sup>3</sup> (202 kBq/m<sup>3</sup>). Increases in the sizes and numbers of lung macrophages and type II<sup>3</sup> cells and the numbers of macrophages and type I cells, and a significant increase in the size of lysosomal granules within the macrophages were reported 8 days postexposure. At 7 days postexposure, 35 of the

---

<sup>3</sup>Type I cells are alveolar lining cells that are involved with the transfer of oxygen and other substances between the alveolus and the blood. Type II cells are alveolar cells involved in production and secretion of the surfactant coating the alveolar surface.

## 3. HEALTH EFFECTS

rats were further exposed to thermal neutrons at a fluence of  $1.0 \times 10^{12}$  neutrons/cm<sup>2</sup> over 2.5 minutes in order to study the combined effects of radiation and chemical toxicity. The radiation dose due to the neutrons and the fission fragments was about 600 rad, which is about 300 times greater than the radiation dose from the uranium dioxide alpha particles. No significant difference was found between the uranium dioxide-only group and those that were subsequently irradiated with neutrons, indicating that the extra radiation exposure caused no immediate pulmonary cellular reaction above that produced by uranium dioxide alone. This finding implies that the observed acute pulmonary effects were due to the metallotoxicity of the uranium dioxide rather than to the alpha radiation from the uranium (Morris et al. 1989).

However, another study (Morris et al. 1990) reported severe alveolar fibrosis or metaplasia in the lungs of three F344 rats nose-only exposed to an aerosol of 111–220 mg/m<sup>3</sup> 92.8% enriched uranium dioxide for 100 minutes; AMAD of the particles ranged from 2.7 to 3.2 µm. The lung damage was observed only in animals sacrificed at 720 days postexposure; no effects were observed in animals examined ≤540 days postexposure. The α-particle radioactivity concentration was estimated as 1.91 kBq/g (51.6 nCi/mg) (Morris et al. 1990).

In other animal studies, changes suggestive of damage from either radiation or diverse inorganic dust (fibrosis) were reported in lungs and tracheobronchial lymph nodes in Rhesus monkeys exposed by inhalation to 5.1 mg/m<sup>3</sup> (as uranium dioxide) corresponding to a radioactivity concentration of 3.4 nCi/m<sup>3</sup> (126 Bq/m<sup>3</sup>) for periods >3 years. Estimated cumulative alpha-radiation tissue doses were >500 rad (5 Gy) for the lungs and 7,000 rad (70 Gy) for the lymph nodes. Similarly exposed dogs also developed slight interstitial and vascular fibrosis of the lungs at lung following exposure to 5.1 mg U/m<sup>3</sup> with an estimated alpha-radiation tissue dose of 760–1,280 rad (7.6–12.8 Gy) (Leach et al. 1970). The effect on the tracheobronchial lymph nodes in animals exposed for an additional 2 years ranged from involvement of a single node to complete destruction of all nodes, was dose-dependent and showed a similarity to changes seen after inhalation exposure to plutonium as <sup>238</sup>Pu or <sup>239</sup>Pu dioxide (Leach et al. 1973). Renal damage was not observed in either dogs or monkeys, but fibrosis was found in monkey lung and both necrosis and fibrosis were found in dog and monkey lymph nodes. It was not clear whether the damage was chemically or radiologically induced, but the magnitude of the radiation doses and the presence of lung and lymph node damage in the absence of renal effects was suggestive to the authors of long-term radiation damage (Leach et al. 1970). However, such degenerative changes in the lungs have also been observed following prolonged exposure to diverse inorganic dust.

### 3. HEALTH EFFECTS

For a review of the hazards associated with alpha-emitting radionuclide exposure, see Appendix D of this profile.

**Cardiovascular Effects.** No cardiovascular effects have been reported in humans after inhalation exposure to uranium. No effect on blood pressure or pulse rate was observed in a man accidentally exposed to powdered uranium tetrafluoride for 5 minutes (Lu and Zhao 1990). Air concentration and mean particle size of the powder were not determined. Electrocardiograms and chest x-rays were normal shortly after the accident and over a 7.5-year follow-up period.

No cardiovascular effects were seen in rats exposed to  $0.2 \text{ mg U/m}^3$  ( $0.13 \text{ nCi U/m}^3$ ) as uranium hexafluoride for 1 year (Stokinger et al. 1953) or in rats, mice, guinea pigs, and rabbits exposed to  $4.8 \text{ mg U/m}^3$  ( $3.2 \text{ nCi U/m}^3$ ) triuranium octaoxide for 26 days (Dygert 1949c).

**Gastrointestinal Effects.** Inhalation exposure to uranium has generally not resulted in gastrointestinal effects in humans although transient effects occurred after one accidental exposure (Lu and Zhao 1990). On the sixth day after a male worker at a uranium-enrichment plant was accidentally exposed for about 5 minutes in a closed room by inhalation to a high concentration of uranium tetrafluoride (natural uranium) powder, the patient reported nausea and loss of appetite. Air concentration and mean particle size of the powder were not determined. On postaccident day 8, the clinical findings were loss of appetite, abdominal pain, diarrhea, tenesmus, and pus and blood in the stool. On postaccident day 9, all parameters returned to normal. The study gave no indication of particle size for assessing deposition in the upper lung and no indication of whether fecal uranium analysis was undertaken to determine if the noted effects may have been mediated by the mucociliary clearance of the uranium tetrafluoride from the lung and its subsequent swallowing to the gastrointestinal tract in accordance with the current International Commission on Radiological Protection (ICRP) lung model (ICRP 1994a) or whether the signs were the result of another intestinal irritant. Gastrointestinal symptoms were not among the clinical signs reported for other workers accidentally exposed to uranium hexafluoride (Eisenbud and Quigley 1956; Moore and Kathren 1985; USNRC 1986).

Dogs, but not other species, appear susceptible to gastrointestinal effects after inhalation exposure to high concentrations of uranium compounds. Vomiting was observed during intermediate-duration exposure to  $9.5 \text{ mg U/m}^3$  uranyl nitrate (Roberts 1949),  $18 \text{ mg U/m}^3$  uranium tetrafluoride (Dygert 1949a), and  $9.2 \text{ mg U/m}^3$  uranyl fluoride (Rothstein 1949a). It is possible that irritation of the gastrointestinal tract occurred either from clearance of uranium particles from the lungs or ingestion of uranium from grooming of

## 3. HEALTH EFFECTS

uranium particulates deposited on the fur during the whole-body exposures. Histopathological examination of rat gastrointestinal tissues revealed no changes after 1-year exposures to 0.2 mg U/m<sup>3</sup> uranium hexafluoride or uranium tetrachloride (Stokinger et al. 1953).

**Hematological Effects.** Inhalation exposure to uranium compounds has generally had no effect, or only minor effects, on hematological parameters in both humans and animals. In human studies, no hematological effects were found in a man who was accidentally exposed to powdered uranium tetrafluoride for 5 minutes (Lu and Zhao 1990). Air concentration and mean particle size of the powder were not determined. Small but significant decreases in the hemoglobin concentration and the mean corpuscular hemoglobin concentration and significant increases in red blood cells counts and mean corpuscular volume were found in uranium miners who had worked for <5–20 years. All values measured were well within the normal range, such that values for individual miners could not be used as an estimate of exposure. No evidence of damage to red blood cell formation was found. The ambient concentration to which these workers had been exposed was not provided in the study (Vich and Kriklava 1970).

A study on the mortality among uranium mill workers found four deaths from lymphatic and hematopoietic tissue effects other than leukemia, while only one was statistically expected among these workers, who were occupationally exposed to uranium dust at airborne levels corresponding to a radioactivity concentration of 0.07 nCi/m<sup>3</sup> (0.1 mg/m<sup>3</sup>). However, the authors of this study suggest that this excess may be due to irradiation of the lymph nodes by thorium-230 (<sup>230</sup>Th) (Archer et al. 1973b). No changes in hematological parameters were observed in humans occupationally exposed to insoluble uranium dust at 0.5–10 mg U/m<sup>3</sup> (Eisenbud and Quigley 1956).

Some intermediate-duration animal studies observed a range of hematological changes. Rats exposed to dusts of ammonium diuranate containing 6.8 mg U/m<sup>3</sup> for 6 hours/day for 30 days showed a decrease of 1 million in red blood cell counts and a loss of 4 g of hemoglobin/100 mL of blood (Dygert 1949b). It was not stated whether exposure was for 30 consecutive days or on weekdays only. Rats exposed to airborne uranyl nitrate hexahydrate containing 9.5 mg U/m<sup>3</sup> for 8 hours/day, 5 days/week for 30 exposure days showed decreased numbers of erythrocytes and hemoglobin (measured at 24 hours postexposure and weekly thereafter) (Roberts 1949). Increased percentages of lymphoid cells and myeloblasts in bone marrow were reported at termination in rats exposed to airborne uranium peroxide containing 15.4 mg U/m<sup>3</sup> 5 hours/day 5 days/week for 23 days (Dygert 1949d). A 4-week study in rats exposed to airborne uranium as uranium trioxide at a concentration corresponding to 16 mg U/m<sup>3</sup> 6 hours/day

## 3. HEALTH EFFECTS

6 days/week reported similar findings (significant increases in myeloblasts and lymphoid cells of bone marrow) (Rothstein 1949c). Rabbits and rats exposed to airborne uranium at a level corresponding to a uranium concentration of  $0.13 \text{ mg/m}^3$  as uranyl nitrate hexahydrate for 30 days exhibited altered blood function as indicated by decreased fibrinogen during the final week of exposure (Roberts 1949).

In contrast to the above findings, most other intermediate-duration animal inhalation studies with soluble and insoluble uranium compounds found no adverse effects on the blood. In intermediate-duration inhalation studies lasting 23–40 days, exposure to various uranium compounds at the following concentrations produced no harmful effects on hematological parameters:  $22 \text{ mg U/m}^3$  as high-grade carnotite uranium ore to rats;  $2.8 \text{ mg U/m}^3$  as uranium dioxide or triuranium octaoxide to dogs;  $22 \text{ mg U/m}^3$  as uranium dioxide or triuranium octaoxide to rabbits;  $11 \text{ mg U/m}^3$  as uranium tetrachloride to rats;  $2 \text{ mg U/m}^3$  as uranium tetrachloride to rabbits;  $1 \text{ mg U/m}^3$  as uranium tetrachloride to dogs;  $13.2 \text{ mg U/m}^3$  as uranium hexafluoride to rabbits and dogs;  $0.1 \text{ mg U/m}^3$  as uranium hexafluoride to dogs;  $14.5 \text{ mg U/m}^3$  as triuranium octaoxide to mice;  $14.5 \text{ mg U/m}^3$  as uranium dioxide or triuranium octaoxide to rabbits;  $14.5 \text{ mg U/m}^3$  as triuranium octaoxide to guinea pigs and rabbits;  $15.4 \text{ mg U/m}^3$  as uranium peroxide to dogs, rabbits, and cats; or  $4.8 \text{ mg U/m}^3$  as triuranium octaoxide to rats, mice, guinea pigs, and rabbits (Dygart 1949c, 1949d; Pozzani 1949; Rothermel 1949; Spiegl 1949).

In other intermediate-duration studies, inhalation exposures to uranium dioxide dusts containing  $1 \text{ mg U/m}^3$  for 30 weeks and  $2 \text{ mg U/m}^3$  for 26 weeks in rabbits and guinea pigs, respectively (Stokinger et al. 1953),  $19.4 \text{ mg U/m}^3$  for 5 weeks in mice, and  $9.2 \text{ mg U/m}^3$  for 5 weeks in dogs and rats had no adverse effects on hematological parameters (Rothstein 1949b). Similarly, exposures to  $9.2 \text{ mg U/m}^3$  for 5 weeks to rats and dogs (Rothstein 1949a);  $16 \text{ mg U/m}^3$  for 4 weeks to rats, rabbits, cats, and dogs (Rothstein 1949c); and  $15 \text{ mg U/m}^3$  as sodium diuranate to rats had no harmful effects on hematological parameters (Rothermel 1949).

In chronic-duration exposures, dogs exposed to an airborne uranium concentration of  $0.2 \text{ mg U/m}^3$  as uranium hexafluoride for 1 year exhibited a lengthening in blood clotting time with a decrease in blood fibrinogen levels (Stokinger et al. 1953). However, hamsters exposed to airborne carnotite uranium ore dust containing  $0.7 \text{ mg U/m}^3$  for 16–27 months exhibited no adverse hematological effects (Cross et al. 1981b). Similarly, no changes in hematological parameters were observed in rats, dogs, rabbits, and monkeys exposed to airborne uranium at concentrations ranging from 1 to  $5.1 \text{ mg U/m}^3$  for 1–5 years (Leach et al. 1970, 1973; Rothstein 1949b; Stokinger et al. 1953).



## 3. HEALTH EFFECTS

**Musculoskeletal Effects.** No studies were located regarding the chemical or radiation effects of uranium on the musculoskeletal system in humans or animals following inhalation exposure for any duration.

**Hepatic Effects.** No hepatic effects were found in a man accidentally exposed to powdered uranium tetrafluoride for 5 minutes (Lu and Zhao 1990). Air concentration and mean particle size of the powder were not determined. Serum hepatic enzyme levels and liver function tests were within normal limits from the time of the incident through a 3-year follow-up period.

Data from the available studies provide equivocal evidence that exposure of animals to uranium has effects on the liver, although the etiology for this effect is not clear. Urinary catalase, a measure of hepatic injury, was significantly increased in rabbits exposed to 0.13 mg U/m<sup>3</sup> as uranyl nitrate 8 hours/day, 5 days/week for 30 days (Roberts 1949). A slight decrease in hepatic lactate content was observed in rabbits following exposure to 15 mg U/m<sup>3</sup> as sodium diuranate dust (Rothermel 1949). Rabbits exposed to 16 mg U/m<sup>3</sup> as uranium trioxide dust for 4 weeks suffered moderate fatty livers in 63% of the animals that died (Rothstein 1949c). Focal necrosis of the liver was observed in rats exposed to 0.4 mg U/m<sup>3</sup> as uranium tetrafluoride for 30 days (Dygert 1949a). In other studies, no changes were found in the liver morphology, histology, or function in the following animals: rabbits exposed to 0.15 or 2 mg U/m<sup>3</sup> as uranyl nitrate hexahydrate for 26 weeks; rats exposed to 14.5 mg U/m<sup>3</sup> as triuranium octaoxide dust for 26 days; rats exposed to 16 mg U/m<sup>3</sup> as uranium trioxide for 4 weeks; mice and guinea pigs exposed to 3 mg U/m<sup>3</sup> as high-grade uranium ore dust for 30 days; and rabbits exposed for 30 days to 22 mg U/m<sup>3</sup> as high-grade uranium ore dust (contains uranium dioxide, triuranium octaoxide, and other potentially toxic contaminants) (Dygert 1949c; Pozzani 1949; Rothstein 1949c; Stokinger et al. 1953).

In chronic-duration exposure studies with animals, an unspecified strain of dogs exposed to ambient air concentrations of 0.05–0.2 mg U/m<sup>3</sup> as uranium hexafluoride for 1 year exhibited increased and persistent bromosulfalein retention, indicative of impaired biliary function, at the 0.2 mg U/m<sup>3</sup> concentration level (Stokinger et al. 1953).

**Renal Effects.** Uranium has been identified as a nephrotoxic metal, exerting its toxic effect by chemical action mostly in the proximal tubules in humans and animals. However, it has been suggested that the renal damage from exposure to high-linear energy transfer coefficient (LET) alpha-emitting heavy metals, such as uranium, may be the complementary effect of both the chemical toxicity and the radiotoxicity of these metals (Wrenn et al. 1987).

## 3. HEALTH EFFECTS

Several epidemiologic studies found no increased mortality in uranium workers due to renal disease (Archer et al. 1973a, 1973b; Checkoway et al. 1988; NIOSH 1987; Pinkerton et al. 2004; Polednak and Frome 1981). Also, case studies showed that workers accidentally exposed to high levels of uranium did not suffer renal damage, even up to 38 years postexposure (Eisenbud and Quigley 1956; Kathren and Moore 1986), although the tests for renal damage used in these studies were not very sensitive. A comparison of kidney tissue obtained at autopsy from seven uranium workers and six referents with no known exposure to uranium showed that the groups were indistinguishable by pathologists experienced in uranium-induced renal pathology (Russell et al. 1996). Three of seven workers and four of six referents were categorized as abnormal. Uranium levels in the workers kidney tissue (estimated by alpha particle emission) ranged from 0.4 to 249  $\mu\text{g}/\text{kg}$ . As reviewed by Eisenbud and Quigley (1956), no evidence of renal toxicity was observed in workers exposed to insoluble uranium compounds; 100 workers were exposed to 0.5–2.5  $\text{mg U}/\text{m}^3$  and another 50 workers were exposed to 2.5–10  $\text{mg U}/\text{m}^3$ . Eisenbud and Quigley (1956) did not provide information on the parameters used to assess renal toxicity. A study on the kidney function of uranium mill workers chronically exposed to biologically soluble ammonium diuranate revealed renal tubular dysfunction as manifested by mild proteinuria, aminoaciduria, and a concentration-related clearance of  $\beta_2$ -microglobulin relative to that of creatinine when compared to a referent group of cement workers. Air levels of uranium dioxide were not reported; the mean (and median) urinary uranium levels were 65.2  $\mu\text{g}/\text{L}$  (20  $\mu\text{g}/\text{L}$ ) in 1975 and 7.2  $\mu\text{g}/\text{L}$  (6  $\mu\text{g}/\text{L}$ ) in 1981 after a new facility was built. The incidence and severity of these nephrotoxic signs correlated with the length of time that the uranium workers had spent in the area where yellowcake was dried and packaged in the old mill (prior to mid-1979) (Thun et al. 1985), which is typically the second dustiest area of the uranium mill following the ore crushing and grinding station. The data from this study are indicative of reduced reabsorption in the proximal renal tubules.

Delayed renal effects were observed after a male worker at a uranium enrichment plant was accidentally exposed to a high concentration of uranium tetrafluoride powder for about 5 minutes in a closed room. While renal parameters were normal during an initial 30-day observation period, the patient showed signs of nephrotoxicity beginning at postaccident day 68 as indicated by significantly elevated levels of urinary proteins, nonprotein nitrogen (NPN), and amino acid nitrogen/creatinine, and decreased phenol-sulfonphthalein excretion rate. These abnormalities persisted through day 1,065, but gradually returned to normal (Lu and Zhao 1990). The authors used uranium urinalysis data and a pharmacokinetic model (ICRP 1979) to estimate a kidney dose of 2.6  $\mu\text{g U}/\text{g}$  kidney on postaccident day 1.

## 3. HEALTH EFFECTS

Renal effects were not observed in another accidental exposure (USNRC 1990) in which 24 of 31 initially exposed workers were followed for 2 years. Estimated airborne concentrations were 20 mg uranium hexafluoride/m<sup>3</sup> for a 1-minute exposure and 120 mg uranium hexafluoride/m<sup>3</sup> for a 60-minute exposure (15.2 and 91 mg U/m<sup>3</sup>, respectively) (USNRC 1986). Initial intakes of workers involved in the accident were estimated from uranium excretion data and ranged from 470 to 24,000 µg uranium. Maximum uranium concentrations in the kidney were estimated by a kinetic model to be 0.048–2.5 µg U/g kidney tissue (Fisher et al. 1991).

The pathogenesis of the kidney damage in animals indicates that regeneration of the tubular epithelium occurs upon discontinuation of exposure to uranium (Bentley et al. 1985; Dygert 1949b; Maynard and Hodge 1949; Pozzani 1949; Rothermel 1949; Rothstein 1949b, 1949c; Spiegl 1949; Stokinger et al. 1953). The magnitude of uranium intake that causes kidney damage depends on the type of uranium compound to which the animal has been exposed, appearing to depend on its solubility and oxidation state. For example, in dogs and monkeys, exposure to 5 mg U/m<sup>3</sup> as uranium dioxide (insoluble) dust for up to 5 years produced no damage to the kidneys, even 6.5 years after the exposure ceased (Leach et al. 1970, 1973). Similarly, rats and guinea pigs were exposed to ≤10 mg U/m<sup>3</sup> as uranium dioxide for 1 year without noticeable kidney pathology (Stokinger et al. 1953). Uranium dioxide is relatively insoluble in water and is retained in the lungs longer than the other more soluble uranium compounds (uranium tetrafluoride, uranyl fluoride, uranium tetrachloride, uranium peroxide, uranyl acetate, and uranyl nitrate hexahydrate), thereby causing higher toxicity to the lungs and lower toxicity to distal organs such as the kidney. In contrast, relatively soluble uranium compounds have been shown to cause renal tubular damage in dogs, guinea pigs, rabbits, and rats (Leach et al. 1984; Morrow et al. 1982a; Roberts 1949; Stokinger et al. 1953). Apparently, the difference in effect is due to the extent of absorption of uranium deposited in the lungs and, thus, the fraction that eventually gets into the blood. Differences in species susceptibility have also been suggested to be an additional factor.

Renal effects can be produced in animals after acute-duration inhalation exposures to uranium. A 10-minute exposure to 637 mg U/m<sup>3</sup> as uranium hexafluoride produced severe degeneration of the cortical tubules 5–8 days later in rats (Spiegl 1949). These same effects were observed in dogs 1–3 days after a 1-hour exposure to 250 mg U/m<sup>3</sup> as uranyl fluoride (Morrow et al. 1982a). Proteinuria and glucosuria were also observed in rats after 2–10-minute exposures to uranium hexafluoride (Leach et al. 1984).

## 3. HEALTH EFFECTS

In intermediate-duration studies with guinea pigs, mice, rats, cats, rabbits, and dogs, inhalation exposures to a variety of uranium compounds were damaging to the kidneys. The effects were compound- and concentration-dependent and ranged from minimal microscopic lesions in tubular epithelium, increased urinary catalase, decreased diodrast (iodopyracet) clearance to severe necrosis of the tubular epithelium (for high concentrations) in several species (Dygert 1949a, 1949b, 1949c; Pozzani 1949; Roberts 1949; Rothermel 1949; Rothstein 1949a, 1949c; Spiegl 1949; Stokinger et al. 1953). Soluble uranium compounds were more toxic, as evidenced by much lower LOAEL values, than the insoluble compounds. In an intermediate-duration inhalation exposure study, mice were exposed to uranium tetrachloride dust at ambient air concentrations of 0.1, 2.1, or 11 mg U/m<sup>3</sup> for 3–7 hours/day 6 days/week for approximately 30 days. The exposure resulted in severe degeneration and necrosis of the renal-cortical tubular epithelium, as well as mortality, in the 11 mg U/m<sup>3</sup> group by the third day. At the end of the study, moderate tubular degeneration was observed in the 2.1 mg U/m<sup>3</sup> group and minimal degeneration was noted in the 0.1 mg U/m<sup>3</sup> group (Rothermel 1949). In another intermediate-duration study, rats suffered renal injury (of inconsistent severity), which became apparent on or about the 7th day and pronounced by the 25th or 26th day, following inhalation exposure to uranyl nitrate hexahydrate at 0.13, 0.2, 0.9, 2.1, or 9.5 mg U/m<sup>3</sup> daily for 8 hours/day, 5 days/week for 30 days. At 0.9 mg U/m<sup>3</sup>, the rats showed significant degenerative changes only in the renal tubules and no changes to the glomeruli. Rats exposed to 0.2 mg U/m<sup>3</sup> exhibited only slight damage to the tubular epithelium of the kidneys. At 0.13 mg U/m<sup>3</sup>, slight renal tubular degeneration was observed in one of the three animals sacrificed after 28 days of exposure. Except for the group receiving no dietary supplement, no significant difference in blood CO<sub>2</sub> values was seen at 14 days of exposure to uranium. Thirty days after the start of exposure, all groups exhibited increased blood NPN levels over 14-day values (maximum 111 mg/mL blood for the unsupplemented diet group). No clinical signs of toxicity were observed at any concentration level (Roberts 1949).

Dogs (of both sexes) exposed to 0.13 mg U/m<sup>3</sup> as uranyl nitrate hexahydrate showed mild inner cortex changes after 10 days of exposure. The dogs were given full-body exposures to aerosols with an AMAD assumed to be 1.5–2.1 µm; the average was 1.8 µm (Pozzani 1949). Severe nephritis masked any damage from uranium in one dog sacrificed after 10 days of exposure. The dogs showed a transient elevation in protein excretion between days 9 and 12 of exposure. Increased bromosulfalein retention was observed during the second and fourth weeks of exposure. No alterations to blood NPN or total blood CO<sub>2</sub> were observed. Chloride clearance values, which were initially elevated and then became depressed in one dog, returned to normal 37 days after the beginning of exposure. Catalase and protein excretion increased significantly, but returned to normal at the end of exposure. No significant changes in diodrast

## 3. HEALTH EFFECTS

clearance, inulin clearance, or blood NPN levels were observed. Dogs exposed to  $0.9 \text{ mg U/m}^3$  exhibited mild inner cortex and medullary ray degeneration and necrosis with moderate epithelial regeneration. Two of the four animals showed a steady rise in NPN from the beginning of the experiment until they were sacrificed 12 days later, at which time NPN values were 252 and 356 mg%, respectively. Urinary protein in the dogs significantly increased between the 5th and 24th days. The mean NPN level in a control study performed in the same lab was approximately 32 mg% (Sprague 1949). The dogs showed a decrease in inulin clearance during the third week of exposure, with a return toward normal values during the fifth week. There was decreased diodrast clearance throughout the observation period, indicating a severe reduction of the excretory capability for diodrast after 1 week (one dog showed a decrease of 69%). Diodrast clearances returned to normal by days 35–37. Two dogs showed a transient decrease in inulin clearance during the third week, lasting until the fifth week. All four dogs showed a drop in total blood  $\text{CO}_2$ , attaining a minimum value between the first and seventh days. The minimum value was generally less than half that of controls, indicating severe acidosis. Glucose tolerance was significantly decreased. Large quantities of protein (400–800 mg%) and sugar were excreted. The greatest excretion occurred during the first 6 days of exposure and decreased thereafter. There was also a decrease in urinary creatinine excretion during the exposure. At the  $2 \text{ mg U/m}^3$  exposure level, the dogs did not show highly elevated NPN and BUN values during exposure. There were no increases in blood NPN or BUN. All dogs exposed to  $9.5 \text{ mg U/m}^3$  had severe renal tubular damage. Four dogs showed renal injury followed by repair when they were sacrificed at the end of the exposure (Roberts 1949).

No treatment-related renal effects were seen in other studies when animals were exposed to uranium compounds by inhalation at concentrations as high as  $10 \text{ mg U/m}^3$  (as uranium dioxide) in guinea pigs for 28 weeks,  $2 \text{ mg U/m}^3$  (as uranyl nitrate hexahydrate) in guinea pigs for 26 weeks, and  $16 \text{ mg U/m}^3$  (as uranyl nitrate hexahydrate) in rats for 4 weeks (Rothstein 1949c; Stokinger et al. 1953).

The nephrotoxic effects of uranium in animals may also include damage to the glomerulus as evidenced by histopathological signs in the kidneys of rats and rabbits exposed to  $15.4 \text{ mg U/m}^3$  as uranium dioxide for 23 days (Dygert 1949d) and of dogs exposed to  $15 \text{ mg U/m}^3$  as uranyl fluoride for 5 weeks (Rothermel 1949) and to  $16 \text{ mg U/m}^3$  as uranium trioxide for 4 weeks (Rothstein 1949c).

In chronic-duration inhalation studies with rats and dogs, uranium (as uranium tetrachloride, uranium tetrafluoride, uranyl nitrate hexahydrate, or uranium dioxide) exposures as low as  $0.05 \text{ mg U/m}^3$  and as high as  $10 \text{ mg U/m}^3$  for 1–5 years were damaging to the kidneys. Nephrotoxic effects found in these animals ranged from minimal microscopic lesions in tubular epithelium (for low concentrations) to acute

## 3. HEALTH EFFECTS

tubular necrosis (for high concentrations) (Leach et al. 1970; Stokinger et al. 1953). In one of these chronic-duration studies, dogs were exposed to ambient air concentrations of 0.05 or 0.2 mg U/m<sup>3</sup> as uranium hexafluoride for 1 year for a total of 1,680 exposure hours. The UF<sub>6</sub> was rapidly hydrolyzed to HF gas and UO<sub>2</sub>F<sub>2</sub> fumes, whose AMAD was 0.1 μm. After 10 days in the study, there was evidence of mild tubular injury, which was characterized by desquamation of the epithelium and active regeneration in the proximal convoluted tubule in the inner cortex of the kidneys in 86% of animals exposed to 0.2 mg U/m<sup>3</sup>. From the 16th week to the end of the study, regeneration of the tubular epithelium was almost complete, with a few flattened atrophic tubules in the inner zone of the cortex. These mild nephrotoxic effects were also observed in 12% of the 0.05 mg U/m<sup>3</sup> exposed animals. Blood NPN levels were normal (elevated blood NPN levels indicate a decrease in renal filtration capacity, similarly to elevated BUN). Observed changes in urinary protein were inconsistent and insignificant (Stokinger et al. 1953).

In another study, dogs of both sexes (9–12 males, 9–13 females) were exposed to concentrations of 0.04, 0.15, 0.25, or 2 mg U/m<sup>3</sup> as uranyl nitrate for 6 hours/day, 5.5 days/week for 1 year. The AMAD of the aerosols was given as 2–5 μm. At the termination of the study, histological and biochemical examinations revealed minimal microscopic lesions in the renal tubules and transient increases in blood NPN in the 0.25 mg U/m<sup>3</sup> concentration-level dogs. Transient increases in blood NPN were also observed at higher concentration levels (Stokinger et al. 1953).

No treatment-related renal effects were seen in dogs exposed to uranium dioxide by inhalation at airborne concentrations as high as 5.1 mg U/m<sup>3</sup> for 1–5 years (Leach et al. 1973). In similarly exposed Rhesus monkeys, blood NPN levels were consistently elevated; however, no renal histopathology was evident (Leach et al. 1973).

**Endocrine Effects.** A single study was found that reported on possible effects of uranium on the endocrine system. In this study, no histopathology was seen in the endocrine organs (adrenal, pancreas) in rats exposed to 0.2 mg U/m<sup>3</sup> as uranium tetrachloride for 1 year (Stokinger et al. 1953).

**Dermal Effects.** No dermal effects were found in a man accidentally exposed to powdered uranium tetrafluoride for 5 minutes (Lu and Zhao 1990). Histopathologic examination of the skin was normal in rats exposed to 0.2 mg U/m<sup>3</sup> as uranium tetrachloride for 1 year (Stokinger et al. 1953).

## 3. HEALTH EFFECTS

**Ocular Effects.** Chemical burns to the eyes were reported in humans after accidental exposure to uranium hexafluoride (Kathren and Moore 1986). Conjunctivitis and eye irritation have also been reported in animals after exposure to uranium hexafluoride (Spiegel 1949) and uranium tetrachloride (Dygert 1949a). Ocular effects were due to direct contact of the eye with vapor or aerosols; because uranyl fluoride and hydrogen fluoride (a highly irritating chemical) are produced when uranium hexafluoride comes in contact with moisture, it is possible that uranium was not the causative agent for the ocular effects.

**Body Weight Effects.** In general, inhalation of insoluble uranium compounds did not significantly affect body weight in animals. Decreased body weight was observed with the more water-soluble compounds. A 30% decrease in body weight was reported for rabbits exposed to 11 mg U/m<sup>3</sup> as uranium tetrachloride dust for 35–40 days. Mice and guinea pigs experienced unspecified weight loss and 13% weight loss, respectively, following exposure to 13 mg U/m<sup>3</sup> as uranium hexafluoride for 30 days. Rabbits suffered 12% weight loss following exposure to 0.2 mg U/m<sup>3</sup> as airborne uranium hexafluoride for 30 days (Spiegel 1949). Mild to severe weight loss was observed in several species during exposure to uranyl nitrate hexahydrate (Roberts 1949). Rabbits lost 22% of their body weight during a 30-day exposure to 0.9 mg U/m<sup>3</sup>, dogs and cats lost approximately 25% of their body weight during a similar exposure to 9.5 mg U/m<sup>3</sup>. Similar effects were observed with uranium tetrafluoride (Dygert 1949a). Rabbits, rat, cats, and dogs all experienced a greater than 20% weight loss during 30 days exposure to 18 mg U/m<sup>3</sup>.

Several intermediate-duration animal inhalation studies with soluble and insoluble uranium compounds found no significant adverse effects on body weight. In short-term intermediate-duration studies lasting 23–40 days, exposure to concentrations at the following levels were without significant effects on body weight: 22 mg U/m<sup>3</sup> as high-grade or carnotite uranium ore to rats, 2.9 mg U/m<sup>3</sup> as uranium dioxide or triuranium octaoxide to dogs, 22 mg U/m<sup>3</sup> as uranium dioxide or triuranium octaoxide to rabbits, 11 mg U/m<sup>3</sup> as uranium tetrachloride to rats, 2.1 mg U/m<sup>3</sup> as uranium tetrachloride to rabbits, 1.1 mg U/m<sup>3</sup> as uranium tetrachloride to dogs, 13 mg U/m<sup>3</sup> as uranium hexafluoride to rabbits and dogs, 0.2 mg U/m<sup>3</sup> as uranium hexafluoride to dogs and guinea pigs, 14.5 mg U/m<sup>3</sup> as triuranium octaoxide to mice, and 4.8 mg U/m<sup>3</sup> as triuranium octaoxide to guinea pigs and rabbits (Dygert 1949c; Spiegel 1949); 15 mg U/m<sup>3</sup> as uranium peroxide to cats and rabbits (Dygert 1949d); 15 mg U/m<sup>3</sup> as carnotite ore (mostly uranium dioxide, triuranium octaoxide) to dogs or 22 mg U/m<sup>3</sup> as carnotite ore to rabbits for 30 days (Pozzani 1949); and 1 mg U/m<sup>3</sup> for 30 weeks to rabbits or 2 mg U/m<sup>3</sup> for 26 weeks to rabbits and guinea

### 3. HEALTH EFFECTS

pigs (Stokinger et al. 1953). Exposures of rats to 13 mg U/m<sup>3</sup> or of rabbits to 0.1 mg U/m<sup>3</sup> as uranium hexafluoride for 30 days also were without harmful effects (Spiegl 1949).

No effects on body weight were observed after several intermediate-duration dosing studies that lasted 4–5 weeks. These studies researched exposures by the inhalation route as follows: 16 mg U/m<sup>3</sup> as uranium trioxide to rats, rabbits, dogs, and cats; 19 mg U/m<sup>3</sup> as uranium dioxide to mice; 16 mg U/m<sup>3</sup> as uranium dioxide to guinea pigs; 9.2 mg U/m<sup>3</sup> as uranyl fluoride to dogs and rabbits; 2.2 mg U/m<sup>3</sup> as uranyl fluoride to rats; 9.2 mg U/m<sup>3</sup> as uranium dioxide to dogs; 19.2 mg U/m<sup>3</sup> as uranium dioxide to rabbits; 15 mg U/m<sup>3</sup> as sodium diuranate to rats and dogs; and 12 mg U/m<sup>3</sup> as ammonium diuranate to rats for 30 days (8 hours/day, 5 days/week for 6 weeks) (Rothermel 1949; Rothstein 1949a, 1949b, 1949c; Stokinger et al. 1953). Hamsters exposed to 0.8 mg U/m<sup>3</sup> as carnotite uranium ore by inhalation for 16–27 months also exhibited no adverse body weight effects (Cross et al. 1981b). Similarly, no changes in body weight were observed in rats, dogs, rabbits, and monkeys exposed to airborne uranium dioxide at 0.1–5 mg U/m<sup>3</sup> for 1–5 years (Leach et al. 1970, 1973; Stokinger et al. 1953).

In chronic-duration studies, exposure of monkeys to concentrations of 3 mg U/m<sup>3</sup> as uranium dioxide for 5 years produced no significant body weight changes (Leach et al. 1970).

**Other Systemic Effects.** Several general effects have been attributed to uranium inhalation exposure. In animal studies, dogs exposed to 13 mg U/m<sup>3</sup> as uranium hexafluoride for 30 days exhibited decreased water intake (Spiegl 1949). Reduced food intake was also observed in a 4-week study of rats and mice exposed to 16 mg U/m<sup>3</sup> as uranium trioxide (Rothstein 1949c) and in a 5-week study of rats and mice exposed to 15 mg U/m<sup>3</sup> as sodium diuranate for 6 hours/day, 5.5 days/week (Rothermel 1949).

#### 3.2.1.3 Immunological and Lymphoreticular Effects

Although no studies were located that specifically tested immunological effects in humans following inhalation exposure to uranium, none of the epidemiologic studies of workers in uranium mines and fuel fabrication plants showed increased incidence of death due to diseases of the immune system (Checkoway et al. 1988; Keane and Polednak 1983; NIOSH 1987; Polednak and Frome 1981).

Human studies that assessed damage to cellular immune components following inhalation exposure to uranium found no clear evidence of an immunotoxic potential for uranium. No association was found between the uranium exposure and the development of abnormal leukocytes in workers employed for 12–



## 3. HEALTH EFFECTS

18 years at a nuclear fuels production facility (Cragle et al. 1988). Increases in the number of fatal malignant disease of the lymphatic and hematopoietic tissue reported among uranium mill workers may have been caused by other carcinogens in the work environment such as  $^{230}\text{Th}$ . The study investigators estimated that the workers were exposed to 8–5,100 mg/m<sup>3</sup> (median 110 mg/m<sup>3</sup>) uranium mill dust, which contains  $^{230}\text{Th}$  as a natural component (Archer et al. 1973b).

In animal studies, rats exposed to dusts of ammonium diuranate containing 6.8 mg U/m<sup>3</sup> for 6 hours/day, 5 days/week for 30 days developed a rise in neutrophils, a decrease in lymphocytes, a moderate fall in the white blood cell count, and a rise in the number of eosinophils (Dygert 1949b). Rats exposed to airborne uranyl nitrate hexahydrate containing 9.5 mg U/m<sup>3</sup> 8 hours/day, 5 days/week for 30 exposure days showed an initial increase and a subsequent decrease in the absolute number of lymphocytes and neutrophils (Roberts 1949). Focal necrosis of the spleen and edematous cecal lymph nodes were observed in some rats exposed for 30 days for 6 hours/day to 0.4 and 4 mg U/m<sup>3</sup> uranium tetrafluoride (Dygert 1949a). However, these effects were not observed at 18 mg U/m<sup>3</sup>, so the significance of this finding is unclear.

No histopathological changes or accumulation of uranium were evident in the spleens of 110 dogs and 25 monkeys exposed to uranium dioxide dusts (5 mg U/m<sup>3</sup>) for 6 hours/day, 5 days/week for 1–5 years and then monitored for up to 6.5 more years. Similar results were seen for rats similarly exposed for 1 year (Leach et al. 1970, 1973). Rats, rabbits, guinea pigs, and dogs exposed to dusts of various uranium compounds for 7–12 months showed no significant histological changes in the lymph nodes and marrow (Stokinger et al. 1953).

There is some evidence from animal studies that exposure to  $\geq 90\%$  enriched uranium may affect the immune system. Increased macrophage activity, associated with localized alpha tracks in all five lobes of the lungs, was seen in F344 rats exposed to 6,825.5 nCi/m<sup>3</sup> through inhalation exposure to enriched uranium dioxide for 100 minutes (Morris et al. 1992). The radioactive material concentration of the mixture was estimated as 1.91 kBq/mg (51.6 nCi/mg); the degree of enrichment was calculated based on this specific activity. The increased activity was evident from days 1–7, 180, 360, 540, and 720 with increases in percent activity of 0.44, 2.15, 19.70, 6.54, and 37.84, respectively. The number and size of macrophage clusters in the lung increased with time postexposure.

Albino HMT (F344) male rats were exposed to 92.8% enriched uranium dioxide with a concentration ranging from 2,274.2 nCi/m<sup>3</sup> (84.1 kBq/m<sup>3</sup>) to 5,458 nCi/m<sup>3</sup> (202 kBq/m<sup>3</sup>). Increases in the sizes and

### 3. HEALTH EFFECTS

numbers of lung macrophages, with a significant increase in the size of lysosomal granules within the macrophages, were reported 8 days postexposure (Morris et al. 1989).

Dogs exposed to airborne uranium dioxide concentrations of 5.1 mg/m<sup>3</sup> for 1–5 years showed lymph node fibrosis in the lungs. Rhesus monkeys similarly exposed for 5 years showed fibrotic changes in the tracheobronchial lymph nodes. The investigators of these studies concluded that although these effects could not be extrapolated to humans because of the absence of squamous cell carcinomas in the lungs, the changes were suggestive of radiation injury (Leach et al. 1973). However, the morphological changes observed in these studies were similar to observations in humans and animals as a result of exposure to diverse inorganic dust (Dockery et al. 1993).

The highest NOAEL values and all reliable LOAEL values in each species and duration category for immunological effects from chemical exposures by the inhalation route to uranium are presented in Table 3-1 and plotted in Figure 3-1.

#### **3.2.1.4 Neurological Effects**

A limited number of studies have examined the potential of uranium to induce neurological effects in humans or animals following inhalation exposure. In the available studies, uranium has not been shown to cause damage to the nervous system of humans by metallotoxic or radiotoxic action following inhalation exposures for any duration. Although no studies were located that specifically tested neurological effects in animals following inhalation exposure to uranium, none of the available studies reported any neurological deficits, such as narcosis, ataxia, or cholinergic signs. Clinical signs in humans following acute exposure to enriched uranium included dizziness and anorexia in one man 6 days after being exposed for 5 minutes to uranium tetrafluoride by inhalation (Lu and Zhao 1990), but did not include neurological effects in others similarly exposed to uranium hexafluoride (Kathren and Moore 1986; USNRC 1986). Some of the victims were evaluated for as long as 38 years after exposure (Kathren and Moore 1986). In longer-term exposures, epidemiologic studies found no increase in deaths from brain tumors or other neurological diseases that could be attributed to uranium in workers at uranium-processing plants (Carpenter et al. 1988; Cragle et al. 1988; NIOSH 1987; Polednak and Frome 1981; Reyes et al. 1984). The autopsy reports also did not reveal any other structural pathology of the central nervous system. In a retrospective study, more deaths than expected were found from central and peripheral nervous system diseases (SMR=2.98) in employees in a nuclear fuels fabrication plant. However, the employees were also concurrently exposed to other radiological and chemical agents. The

### 3. HEALTH EFFECTS

investigators of this study concluded that there was no etiology associated with uranium for the central nervous system and peripheral nervous system diseases (Hadjimichael et al. 1983).

In intermediate-duration animal studies, neurological signs were observed in dogs and cats following inhalation exposure to uranium. On the 13th day of a 30-day study, dogs exposed to 0.5, 3, 4, or 18 mg U/m<sup>3</sup> as uranium hexafluoride gas by inhalation exhibited muscular weakness followed by instability of gait indicative of neurological dysfunction at the highest concentration tested (Dygert 1949a). Anorexia observed in dogs exposed 8 hours/day, 5 days/week for 30 days to 9.5 mg U/m<sup>3</sup> as uranyl nitrate hexahydrate may also have had its origin in neurological dysfunction (Roberts 1949). Similarly, cats exposed to 18 mg U/m<sup>3</sup> as uranium tetrafluoride exhibited unsteady gait on the seventh day in a 30-day study (Dygert 1949a). In 5-week studies (8 hours/day, 5 days/week), dogs and cats exposed to 0.15, 2.2, or 9.2 mg U/m<sup>3</sup> as uranyl fluoride suffered anorexia, severe muscle weakness, and lassitude at the highest concentration tested (Rothstein 1949a). These neurological effects were observed in animals exposed to lethal concentrations.

In 12 rats exposed to 190 mg U/m<sup>3</sup> as depleted uranium dioxide 30 minutes/day, 4 days/week for 3 weeks, a significant increase in spontaneous activity (both locomotor and rearing behaviors) was observed on day 1 postexposure, but not on day 5 postexposure (Monleau et al. 2005). This appeared to correlate with a rapid reduction in uranium concentration in the hippocampus, frontal cortex, cerebellum, and olfactory bulb; with the exception of the hippocampus, brain uranium levels reached control levels by the 3<sup>rd</sup> postexposure day. A depression of spatial working memory was also observed on day 6 postexposure, but not on day 1 postexposure; no alterations in exploratory activity were observed.

The highest NOAEL values and all reliable LOAEL values in each species and duration category for neurological effects by the inhalation route to uranium are presented in Table 3-1 and plotted in Figure 3-1.

#### **3.2.1.5 Reproductive Effects**

It is unlikely that inhalation of uranium produces a significant effect on reproductive health. Studies of one human population group (miners) were located that identified a reproductive effect associated with the inhalation exposure of mine air, but the association with uranium compounds was unclear, and the other miner studies observed no reproductive effects.

### 3. HEALTH EFFECTS

Three studies of one mining population were located that equivocally associated reproductive effects in humans following inhalation exposure to uranium. The studies reported that male uranium miners were found to have more first-born female children than expected (Muller et al. 1967; Waxweiler et al. 1981b; Wiese and Skipper 1986). In addition, it is not certain if the effect described is from exposure to uranium because the workers were also exposed to  $^{222}\text{Rn}$ , chlorine, hydrofluoric acid, lead sulfate, nickel, nitric acid and nitrogen oxides, silicon dioxide, and sulfuric acid (Dupree et al. 1987).

No animal studies were located that described reproductive effects following inhalation exposure to uranium for any duration of exposure.

#### **3.2.1.6 Developmental Effects**

No studies were located that specifically reported effects of uranium on development in humans or animals following inhalation exposures for any duration. However, the issue of teratogenicity of depleted uranium aerosols in humans was reviewed by Hindin et al. (2005). The investigators examined a series of reports that included groups of Gulf War veterans from the United States, the United Kingdom, Canada, and Australia; reports from Iraqi hospitals and clinics during and after the war; reports of birth defects in a New Mexico community living near a depleted uranium weapons testing facility; reports of birth defects in infants born in Bosnia and Herzegovina after the Bosnia War or in Kuwait after the Gulf War; and other reports. Most of the data from these reports have not been published in peer-reviewed journals; some have been published in newspapers or presented at Iraqi conferences. Lacking from all reports was documentation of individual depleted uranium exposure and other wartime-generated substances, as well as nutritional and environmental factors. Some reports lacked methodologically rigorous investigation, while in others, the incidences of birth defects between purportedly exposed and nonexposed groups were not statistically significant. Of particular interest is a report from three major maternity hospitals in Basra, Iraq, which noted a dramatic increase in the incidence of total congenital malformations since the 1991 war. However, Hindin et al. (2005) note that very low incidence reported prewar often reached baseline Western levels by 1999–2000. Of note is the case of hydrocephalus, which the report of data through 2000 indicates no diagnosed cases of hydrocephalus between 1990 and 1998. This would mean that there were no cases of hydrocephalus among about 100,000 births, which was considered implausible. Hindin et al. (2005) raised the question of whether the detection of birth defects at the Basra study was less than complete, and if so, whether the omissions could have been systematic or random. In studies of Gulf War veterans, comparisons were made between deployed versus non-deployed, not necessarily between depleted uranium-exposed and non-depleted uranium-exposed; as such, the studies

### 3. HEALTH EFFECTS

are not very informative regarding the potential role of depleted uranium in inducing congenital malformations. Hindin et al. (2005) concluded that, overall, the epidemiological evidence is consistent with increased risk of birth defects in offspring from persons exposed to depleted uranium. However, given the limitations of the data described by the reviewers and confounders that were not addressed, the conclusion regarding birth defects may have overlooked other causes for the increase and overstated the data.

Similarly, Busby et al. (2010) examined the incidence of infant mortality and alterations in sex ratio in children living in Fallujah, Iraq using data collected from questionnaires completed by 711 households with 4,843 persons. An 18% reduction in male:female ratio from the expected ratio (1,055 boys to 1,000 girls) was found among children aged 0–4 years. In older children, the ratio was close to the expected level. An infant mortality (deaths between 0 and 1 year of age) ratio of 80 deaths per 1,000 was estimated. The authors state that this is significantly higher than infant mortality ratios in Egypt, Jordan, and Kuwait. However, the investigators did not evaluate the potential exposure for depleted uranium or have a comparable reference group (i.e., Iraqi households without the potential for exposure to depleted uranium), used a questionnaire to collect information on infant mortality and birth defects without confirmation from medical records, and collected data for a 10-year period but only used the last 5 years for the analysis; additionally, the investigators did not provide demographic data to support using infant mortality data from Egypt, Jordan, and Kuwait as an appropriate reference. The limitations of this study preclude using it to establish a causal relationship between exposure to depleted uranium and developmental toxicity.

#### **3.2.1.7 Cancer**

Human and animal studies have examined the potential carcinogenicity of uranium. Because uranium emits predominantly high-LET alpha particles, current theories on gene mutation and apoptotic mechanisms of cancer promotion by high-LET alpha radiation suggest a concern for carcinogenesis from uranium's radioactivity (BEIR 1980, 1988, 1990; Otake and Schull 1984; Sanders 1986; UNSCEAR 1982, 1986, 1988) (see Appendix D for a review of the hazards associated with radionuclide exposure). As discussed below, some studies have found significant increases in the risk of lung cancer, although it is not clear whether uranium is the causative agent and whether the cancer is due to chemical toxicity or radiotoxicity. In general, human and animal studies have not found increases in the risk of cancer in other tissues, including the kidney and bone.

## 3. HEALTH EFFECTS

Increased deaths from cancers of the respiratory tract (predominantly lung cancer) have been reported in numerous studies of uranium miners (Archer et al. 1973a; Auerbach et al. 1978; Band et al. 1982; Boice et al. 2008; Chovil and Chir 1981; Gottlieb and Husen 1982; Grace et al. 1980; Hornung and Meinhardt 1987; Hornung et al. 1998; Howe and Stager 1996; Howe et al. 1986, 1987; Kusiak et al. 1993; Lundin et al. 1969; Moolgavkar et al. 1993; Saccomanno et al. 1971, 1976, 1986, 1988, 1996; Samet et al. 1984a, 1984b, 1986, 1989, 1991, 1994; Ševc et al. 1993; Tirmarche et al. 1992, 1993; Tomášek et al. 2008; Waxweiler et al. 1981a; Whittemore and McMillan 1983; Woodward et al. 1991). However, the miners were exposed to cancer-inducing agents such as radon and its decay products, silica dust, arsenic, and diesel engine exhaust fumes. As discussed in the ATSDR Toxicological Profile for Radon (Agency for Toxic Substances and Disease Registry 2012), the increased lung cancer in uranium miners is attributable to exposure to radon and the additive effect of cigarette smoking, crystalline silica, and/or diesel engine exhaust rather than exposure to uranium. No alterations in deaths from bone or kidney cancer were observed in studies of uranium miners (Boice et al. 2008; Tirmarche et al. 1993; Waxweiler et al. 1981a).

Mortality has also been assessed in uranium mill workers without reported employment in uranium mining operations. A study of 662 male uranium mill workers employed at one of six uranium mills in the Colorado Plateau states (Colorado, Utah, New Mexico, Arizona) found a significant increase in death from tumors of the lymphatic and hematopoietic tissue (other than leukemia) during the period of 1950–1967 (4 observed vs. 1.02 expected; SMR 392; 95% CI not reported); the study authors noted that none of the four men worked near the fusion furnaces where exposure to concentrated uranium dust or fume was greatest (Archer et al. 1973b). Waxweiler et al. (1983) performed a study that included 2,002 uranium millers employed at one of seven uranium mills in the Colorado Plateau states for at least 1 year after January 1, 1940; a nonsignificant excess of deaths from lymphatic malignancies other than leukemia (7 deaths vs. 5.6 expected) was reported for the period through 1977. When divided by latency period, excess risk (6 deaths vs. 2.6 expected) was only found at >20 years. No significant alterations in lung cancer risk was found. Pinkerton et al. (2004) reevaluated the cohort described by Waxweiler et al. (1983) and determined that a total of 1,484 men fit the criteria for inclusion; most of the workers were employed for <9 years, 42.7% were employed for 1–2 years. Nonsignificant excesses of mortality from lymphatic and hematopoietic malignancies other than leukemia (16 observed vs. 11.08 expected; SMR 1.44; 95% CI 0.83–2.35) and from respiratory cancers that included trachea, bronchus, and lung (78 observed vs. 68.93 expected; SMR 1.13; 95% CI 0.89–1.41) and a significant decrease in digestive systems cancers (33 observed vs. 53.18 expected; SMR 0.62; 95% CI 0.43–0.87) were reported through 1998. Mortality from these diseases did not increase with length of employment, and mortality from lung cancer was higher among workers hired prior to 1955 when exposures to uranium, silica, and vanadium

## 3. HEALTH EFFECTS

were presumably higher. Interpretation of the results of these studies of uranium mill workers is limited due to relatively small cohort sizes, inability to estimate individual exposures, and lack of smoking data.

Boice et al. (2008) conducted a cohort mortality study of workers engaged in uranium mining and milling activities near Grants, New Mexico between 1955 and 1990. Vital status was determined through 2004 and SMRs were calculated for 2,745 workers (2,500 males, 245 females) alive after 1978 who were employed for at least 6 months. No significant increases in cancer mortality were observed in 904 uranium milling workers who were not known to have worked at a mine or 106 workers whose mining experience was not known. Based on national mortality rates, mortality from respiratory cancers (bronchus, trachea, lung) was significantly higher than expected among the uranium mining and milling workers known to have been employed in an underground uranium mine ( $n=1,735$ ) (SMR 2.17; 95% CI 1.75–2.65). Therefore, the observed increased cancer mortality was considered attributable to historically high levels of radon in the mines combined with heavy use of tobacco products and co-exposure to crystalline silica and diesel exhaust. Deaths from other types of cancer were not significantly increased in the whole cohort or either subcohort.

Cancer mortality has been assessed in studies of populations living near uranium mining and milling facilities in Uravan, Colorado (Boice et al. 2007a), Montrose County, Colorado (Boice et al. 2007b), Karnes County, Texas (Boice et al. 2008), Grants, New Mexico (Boice et al. 2010), and Monticello, Utah (UDOH 2007). Compared to U.S. mortality rates, no significant increase in mortality from cancers was observed among the residents of Uravan, Colorado, or among 622 of the residents who had been employed in uranium mills. A significant increase in lung cancer (SMR 2.00; 95% CI 1.39–2.78) was found among 459 residents who had worked in underground uranium mines and was attributed to historically high levels of radon in the mines coupled with heavy use of tobacco products. Similarly, increased mortality from lung cancer was noted in males living in Montrose County, Colorado, and Grants, New Mexico, but not in females. Occupational exposure to radon and smoking among underground uranium mine workers was considered to be the cause of the increased mortality from lung cancer within the population of male residents. The female population of Grants, New Mexico exhibited a significant excess of mortality from stomach cancer (SMR 1.30; 95% CI 1.03–1.63), which declined over the 55-year observation period; the stomach cancer increase was highest before the uranium mining and milling operations began and then decreased to normal levels, indicating that these operations were not the source of the increased mortality from stomach cancer. No unusual patterns of cancer mortality were observed in residents of Karnes County, Texas from 1950 to 2001 (Boice et al. 2003). Among residents of Monticello, Utah, a significant increase in the incidence of lung and bronchial cancer was

## 3. HEALTH EFFECTS

found for three analytical periods (1973–2004, 1998–2004, and 1993–1997); the standardized incidence ratio (SIR) for the 1973–2004 period was 1.94 (95% CI 1.24–2.79) (UDOH 2007). An increase in stomach cancer risk (SIR 6.14; 95% CI 1.60–13.63) was also found for the 1998–2004 evaluation period; however, the small number of observed cases reduces the reliability of the significant SIR. Interpretation of the results of this study is limited by the small number of subjects and the lack of control for potential risk factors such as smoking and family history. In addition to potential uranium exposure, past monitoring data of on- and off-site soil samples and off-site air samples have found elevated levels of radium, radon, beryllium, chromium, lead, nickel, and thallium.

The issue of cancer risk in nuclear workers occupationally exposed to uranium has recently been reviewed by Canu et al. (2008). The authors reviewed 23 epidemiological studies: 18 cohort studies and 5 nested case-control studies published since 1980. The overall conclusion was that the epidemiological studies provide limited evidence of a relationship between site-specific cancer mortality and internal exposure to uranium and mixed fission products. The authors identified three main limitations common to almost all studies: limited statistical power, relatively low radiation doses, and inaccurate exposure assessment. A more recent study of gaseous diffusion workers (Chan et al. 2010) did not find a significant increase in deaths from all cancers or a specific type of cancer when all workers were combined. The investigators used a surrogate measure ( $\mu\text{g}/\text{year}$ ) estimated from urine data to represent cumulative dose of internally deposited radionuclides; however, since this is not a unit of measure for radiation, it is unclear what was actually measured. The workers were exposed to arsenic, beryllium, chromium, nickel, and uranium. A significant increase in the risk of non-Hodgkin's lymphoma were observed in workers with cumulative internal radiation exposures of 21–50 or 51–125  $\mu\text{g}/\text{year}$ , but not in workers with the highest cumulative exposure ( $>125 \mu\text{g}/\text{year}$ ). No significant increases in the risk of non-Hodgkin's lymphoma were found when the workers were divided by cumulative external radiation quartiles. When workers were divided by the levels of individual metal exposures, a near significant increase in lung cancer (standardized rate ratio [SRR] 1.17; 95% CI 0.99–1.38) was noted in workers with medium exposure to uranium. An increase in lung cancer risk was also observed in workers with medium exposure to nickel. Interpretation of the results of this study is limited by the lack of exposure information and due to co-exposure to other metals including arsenic, beryllium, chromium, and nickel and co-exposure to radiation. Another study of gaseous diffusion workers (Yiin et al. 2009), found a marginally increased risk of multiple myeloma among the workers (odds ratio of 1.04; 95% CIs 1.00–1.09; with adjustment for age, combined x-ray and external radiation exposures, and chemical exposures) at a radiation dose of 10  $\mu\text{Gy}$  to bone marrow estimated from uranium urinalysis measurements.



## 3. HEALTH EFFECTS

Busby et al. (2010) examined the relative risk of cancer among residents living in Fallujah, Iraq between 2005 and 2010; data were collected from questionnaire completed by 711 households with 4,843 persons. As compared to cancer rates from Egypt in 1999, significant increases in the risk of several cancers, including childhood cancers, breast cancer, leukemia, lymphoma, and brain cancer, were observed. As with the developmental toxicity portion of this study, the investigators did not provide uranium exposure level or support for the assumption that the residents were exposed to uranium. Additionally, the study did not involve a comparison between cancer incidences in Fallujah with other Iraqi populations not exposed to uranium and cancer incidences were based on self-reported data without confirmation from medical records. These limitations preclude establishing a causal relationship between increased cancer risk and uranium exposure.

A study of groups of 102 male golden Syrian hamsters exposed to carnotite uranium ore dust (AMAD=1.5–2.1  $\mu\text{m}$ ) at a concentration of 19 mg U/m<sup>3</sup> by inhalation for 16 months failed to show signs of cancer development upon examination of selected tissues including lungs, trachea, liver, kidneys, spleen, heart, and any abnormal tissue (Cross et al. 1981b). In the same study, the results of exposure of golden Syrian hamsters for 16–27 months to concentrations of radon progeny, uranium ore dust (0.5 nCi/m<sup>3</sup> [18.5 Bq/m<sup>3</sup>]), or a combination of uranium and radon progeny provided evidence that, while prolonged exposure to uranium dust causes inflammation and proliferative pulmonary changes, inhalation of radon progeny produced bronchiolar epithelial hyperplasia and changes in the alveolar epithelium in hamsters. The authors also concluded that exposure to radon progeny and development of squamous metaplasia and carcinoma were related. The animals had cumulative radon progeny exposures >8,000 WLMs. Pulmonary neoplasms occurred in the three radon-progeny-exposed hamsters and in one hamster exposed to a combination of uranium, radon, and radon progeny. Both the hamsters exposed to radon progeny and those exposed to a combination of uranium and radon progeny had a significantly greater incidence of adenomatous proliferative changes in the alveolar epithelium. No significant alterations in the incidence on nonpulmonary neoplasms were observed in any exposure group, as compared to the unexposed controls.

Pulmonary adenomas or adenocarcinomas were observed in 4/13 Beagle dogs exposed to 5.1 mg U/m<sup>3</sup> as uranium dioxide for 5 years (Leach et al. 1973). The neoplasms were observed 22–67 months after exposure termination. The lung dose was estimated as 600–700 rad (6–7 Gy). Spontaneous tumors are rarely found in dogs, and the incidence found in this study was 50–100 times higher than the expected rate of spontaneous tumors. No pulmonary neoplasms were observed in six monkeys similarly exposed to 5.1 mg U/m<sup>3</sup> as uranium dioxide for 5 years (Leach et al. 1973).

### 3. HEALTH EFFECTS

A study was conducted with uranium ore dust in male Sprague-Dawley rats (Mitchel et al. 1999). The rats were exposed nose-only to uranium ore dust that was delivered to the rats as an aerosol under positive pressure. The ore was without significant radon content. The rats were exposed to 0, 8.4, or 22 mg U/m<sup>3</sup> 4.2 hours/day, 5 days/week for 65 weeks and were allowed to live for their natural lifetime. Exposure to uranium significantly increased the incidence of malignant and nonmalignant lung tumors. The frequency of primary malignant lung tumors was 0.016, 0.175, and 0.328 and the frequency of nonmalignant lung tumors was 0.016, 0.135, and 0.131 in the control, low- and high-dose groups, respectively. The main malignant tumor was bronchioalveolar carcinoma. No bronchial lymph node tumors were detected even though the lymph node specific burdens were considerably higher than in the lung in the same animal. The average absorbed doses for the low- and high-dose groups were 0.87 and 1.64 Gy, respectively, resulting in an average risk of malignant lung tumors of about 0.20 tumors per animal per Gy in both exposed groups. Lung tumor frequency was not directly proportional to dose, but exhibited a direct linear relationship with dose rate (as measured by the lung burden at the end of dust inhalation). Mitchel et al. (1999) noted that this suggested that lung burden may be the more important determinant of lung cancer risk.

Cancer Effect Levels (CELs) for chemical and radiation inhalation exposure to uranium are shown in Table 3-1 and plotted in Figure 3-1.

#### 3.2.2 Oral Exposure

The oral toxicity of uranium compounds has been evaluated in several animal species following exposure in drinking water or via gavage. The oral exposure studies did not report baseline uranium levels in the diet or drinking water; thus, baseline exposures were not included in the estimated doses. The levels of uranium in the drinking water may vary according to the source of the water (e.g., tap water, mineral water) and some sources may have naturally high levels of uranium; if provided, the source of the drinking water was included in the discussion of individual studies. The maximal dosage just failing to be lethal for rats in a 30-day feeding test was about 0.5% uranium compound in the diet for the three soluble compounds (uranyl nitrate hexahydrate, uranyl tetrafluoride, and uranium tetrachloride) and 20% uranium compound for the three insoluble uranium compounds (uranium dioxide, uranium trioxide, and triuranium octaoxide) tested. Some of these studies sweetened the feed to make it edible. No amount of insoluble uranium compounds acceptable to the rat was lethal. Dietary levels of 1–4% soluble uranium compound produced 50% mortality in 30 days. The marked difference in the toxicity of soluble and

## 3. HEALTH EFFECTS

insoluble uranium compounds is attributable to the ease of absorption and, thus, the dose that reaches the target organs. In general, the water-soluble compounds are more toxic by the oral route because of the greater ease of absorption in the gastrointestinal tract (Domingo et al. 1987, 1989a, 1989b; Goel et al. 1980; Maynard and Hodge 1949; Paternain et al. 1989). In a summary of the oral toxicity in both rats and dogs, several uranium compounds were ordered by relative toxicity as follows: very toxic compounds included uranium tetrachloride, uranium peroxide, and uranyl fluoride; toxic compounds included uranium nitrate hexahydrate, uranyl acetate, ammonium diuranate, sodium diuranate, uranium trioxide, and high-grade uranium ore (carnotite); and practically nontoxic compounds were uranium tetrafluoride, triuranium octaoxide, and uranium dioxide (Maynard and Hodge 1949).

**3.2.2.1 Death**

There are no reports of human deaths from oral exposure to uranium compounds. However, data from animal studies demonstrate that soluble uranium compounds, at very high intake levels, can be lethal to animals through the oral route for all durations of exposure. Uranium compounds at these concentrations are not palatable to animals and require sweetening.

Oral LD<sub>50</sub> (lethal dose, 50% mortality rate) values of 114 and 136 mg U/kg have been estimated for male Sprague-Dawley rats and male Swiss-Webster mice, respectively, following single gavage administrations of uranyl acetate dihydrate (Domingo et al. 1987). Mortality occurred in pregnant Swiss mice exposed to 0.028, 0.28, 2.8, and 28 mg U/kg/day uranium as uranyl acetate dihydrate by gavage in water from gestation day 13 through postnatal day 21. Two dams in the 2.8 mg U/kg/day group and three in the 28 mg U/kg/day group died before delivery (Domingo et al. 1989b). Deaths were also reported in mice during the first 10 days of feeding studies with uranyl nitrate (8 of 25 at 925 mg U/kg/day) and with uranyl fluoride (2 of 25 at 452 mg/kg/day) (Tannenbaum et al. 1951).

In 30-day oral studies, oral LD<sub>50</sub> values for both sexes of rats of an unspecified strain given uranyl fluoride or uranyl nitrate hexahydrate have been estimated as 540 and 1,579 mg U/kg/day, respectively. Oral LD<sub>50</sub> values were 658 and 1,096 mg U/kg/day as uranium tetrachloride for male and female rats, respectively, in a similar 30-day study (Maynard and Hodge 1949). Another 30-day study, in which male and female rats of an unspecified strain were exposed to oral uranium peroxide doses, oral LD<sub>50</sub> values were estimated as 827 and 1,103 mg U/kg/day, respectively (Maynard and Hodge 1949). In other intermediate-duration feeding studies with rats, 16% mortality was reported in the animals following

### 3. HEALTH EFFECTS

dietary administration of 664 mg U/kg/day for 30 days. Most of the animals died from complications of chemically induced kidney damage (Maynard et al. 1953).

Two-year feeding studies with uranyl fluoride, uranyl nitrate hexahydrate, uranium tetrafluoride, and uranium dioxide showed that chronic intake of large amounts of uranium can lead to a decrease in lifespan. The largest daily intake that did not affect longevity in the rat was 81 mg U/kg/day as uranyl fluoride. For the other uranium compounds studied, the maximum daily intakes that did not affect longevity were 1,130 mg U/kg/day as uranyl nitrate, 1,390 mg U/kg/day as uranium tetrafluoride, and 1,630 mg U/kg/day as uranium dioxide. About 18% of the experimental rats survived for the entire 2-year duration of the study, while about 38% of the control animals survived (Maynard and Hodge 1949). Most of the deaths in the available animal studies resulted from chemically induced renal damage.

The LD<sub>50</sub> values for each species and other LOAEL values for mortality from exposure to uranium by the oral route are presented in Table 3-2 and plotted in Figure 3-2.

#### 3.2.2.2 Systemic Effects

No human studies were located regarding respiratory, endocrine, dermal, ocular, body weight, or other systemic effects in humans following acute-, intermediate-, or chronic-duration oral exposure to uranium compounds.

Animal data are lacking regarding musculoskeletal, metabolic, dermal, or ocular effects following oral exposure to uranium and its compounds for all durations. Similarly, no animal studies were located on the hematological effects of uranium in animals following acute-duration oral exposure or on the cardiovascular, endocrine, or other systemic effects following acute- or chronic-duration oral exposure. Data exist for the respiratory, renal, and body weight effects following oral exposure of animals to uranium for all durations. However, the existing data on the hematological, cardiovascular, hepatic, and other systemic effects of uranium in animals are limited to acute- or chronic-duration inhalation exposure; data on the gastrointestinal effects are limited to acute-duration exposure.

The highest NOAEL values and all reliable LOAEL values in each species and duration category for systemic effects from chemical exposures to uranium by the oral route are presented in Table 3-2 and plotted in Figure 3-2.

Table 3-2 Levels of Significant Exposure to Uranium - Oral

Key to Figure	Species <sup>a</sup> (Strain)	Exposure/Duration/Frequency (Route)	System	NOAEL (mg/kg/day)	LOAEL		Reference Chemical Form	Comments
					Less Serious (mg/kg/day)	Serious (mg/kg/day)		
<b>ACUTE EXPOSURE</b>								
<b>Death</b>								
1	Rat (Sprague-Dawley)	once (GW)				114 M (LD50)	Domingo et al. 1987 Uranyl Acetate	
2	Rat (NS)	once (F)				664 (16% mortality)	Maynard et al. 1953 Uranyl Nitrate	
3	Mouse (Swiss-Webster)	once (GW)				136 M (LD50)	Domingo et al. 1987 Uranyl Acetate	
4	Mouse (BALB/c)	once (G)				166 M (100% mortality 3 days post exposure)	Martinez et al. 2003 Uranyl Nitrate	
<b>Systemic</b>								
5	Human	once (W)	Gastro		14.3 M (nausea, vomiting, diarrhea)		Butterworth 1955 Uranyl Nitrate	
6	Rat (Long-Evans)	2 wk ad lib (W)	Bd Wt	14 M		28 M (53% reduced body weight gain)	Briner and Murray 2005 Depleted uranyl acetate	

Table 3-2 Levels of Significant Exposure to Uranium - Oral

(continued)

Key to Figure	Species (Strain)	Exposure/Duration/Frequency (Route)	System	NOAEL (mg/kg/day)	LOAEL		Reference Chemical Form	Comments
					Less Serious (mg/kg/day)	Serious (mg/kg/day)		
7	Rat (Sprague-Dawley)	once (GW)	Hepatic		118 M (microhemorrhagic foci)		Domingo et al. 1987 Uranyl Acetate	
			Renal		118 M (Increased urine volume, increased plasma creatinine and urea, increased urinary total protein and creatinine, and minimal histological lesions)			
			Bd Wt		118 M (weight loss)			
8	Rat (Sprague-Dawley)	1 or 3 d (GW)	Metab		97 M (alterations in serum 1,25(OH) <sub>2</sub> vitamin D levels)		Tissandie et al. 2006 Uranyl Nitrate	
9	Mouse (BALB/c)	once (G)	Renal		166 M (increased blood urea and creatinine levels, tubular necrosis)		Martinez et al. 2003 Uranyl Nitrate	
10	Mouse (Swiss)	5 d (F)	Renal		508 M (increased blood urea nitrogen, creatinine, and alkaline phosphatase levels)		Ozmen and Yurekli 1998 Uranyl Nitrate	
			Bd Wt	508 M				

Table 3-2 Levels of Significant Exposure to Uranium - Oral

(continued)

Key to Figure <sup>a</sup>	Species (Strain)	Exposure/Duration/Frequency (Route)	System	NOAEL (mg/kg/day)	LOAEL		Reference Chemical Form	Comments
					Less Serious (mg/kg/day)	Serious (mg/kg/day)		
<b>Neurological</b>								
11	Rat (Long-Evans)	2 wk ad lib (W)		14 M	28 M (increased open field activity)		Briner and Murray 2005 Depleted uranyl acetate	
12	Mouse (Swiss-Webster)	2 wk ad lib (W)			6 F (increased open field activity)		Briner 2009 Depleted uranyl acetate	
<b>Developmental</b>								
13	Rat (Wistar)	once (GW)			42.7 (delayed tooth eruption and development in neonatal rats)		Pujadas-Bigi et al. 2003 Uranyl Nitrate	
14	Mouse (Swiss-Webster)	Gd 6-15 (GW)			2.8 <sup>b</sup> (decreased fetal BW; increased incidence of external defects)		Domingo et al. 1989c Uranyl Acetate	
<b>INTERMEDIATE EXPOSURE</b>								
<b>Death</b>								
15	Rat (NS)	30 d (F)				827 M (LD50)	Maynard and Hodge 1949 Uranium Peroxide	
16	Rat (NS)	30 d (F)				658 M (LD50) 1096 F (LD50)	Maynard and Hodge 1949 Uranium Tetrachloride	
17	Rat (NS)	30 d (F)				541 (LD50)	Maynard and Hodge 1949 Uranyl Fluoride	

Table 3-2 Levels of Significant Exposure to Uranium - Oral

(continued)

Key to Figure <sup>a</sup>	Species (Strain)	Exposure/ Duration/ Frequency (Route)	System	NOAEL (mg/kg/day)	LOAEL		Reference Chemical Form	Comments
					Less Serious (mg/kg/day)	Serious (mg/kg/day)		
18	Rat (NS)	30 d (F)				7858 M (100% mortality) 1103 F (LD50)	Maynard and Hodge 1949 Uranyl Acetate	
19	Rat (NS)	30 d (F)				1579 (LD50)	Maynard and Hodge 1949 Uranyl Nitrate	
20	Rat (NS)	30 d (F)				664 (increased mortality)	Maynard et al. 1953 Uranyl Nitrate	
21	Mouse (Swiss- Webster)	30 d 1x/d (G)				2.8 F (10% mortality)	Domingo et al. 1989b Uranyl Acetate	
22	Mouse (dba)	48 wk ad lib (F)				452 F (8% mortality)	Tannenbaum et al. 1951 Uranyl Fluoride	
23	Mouse (dba)	48 wk ad lib (F)				925 F (24% mortality)	Tannenbaum et al. 1951 Uranyl Nitrate	
24	Dog (Beagle)	30 d 6 d/wk (F)				440 (lethal dose)	Maynard and Hodge 1949 Uranium Dioxide	
25	Dog (Beagle)	30 d 6 d/wk (F)				390 (lethal dose)	Maynard and Hodge 1949 Uranium Peroxide	



Table 3-2 Levels of Significant Exposure to Uranium - Oral

(continued)

Key to Figure <sup>a</sup>	Species (Strain)	Exposure/ Duration/ Frequency (Route)	System	NOAEL (mg/kg/day)	LOAEL		Reference Chemical Form	Comments
					Less Serious (mg/kg/day)	Serious (mg/kg/day)		
26	Dog (Beagle)	30 d 6 d/wk (F)				5653	(lethal dose)	Maynard and Hodge 1949 Triuranium Octoxide
27	Dog (Beagle)	30 d 6 d/wk (F)				63	(lethal dose)	Maynard and Hodge 1949 Uranium Tetrachloride
28	Dog (Beagle)	30 d 6 d/wk (F)				15.4	(lethal dose)	Maynard and Hodge 1949 Uranyl Fluoride
29	Dog (Beagle)	30 d 6 d/wk (F)				237	(lethal dose)	Maynard and Hodge 1949 Uranyl Nitrate
30	Dog (NS)	138 d (F)				95	(lethal dose)	Maynard and Hodge 1949 Uranyl Nitrate
31	Dog (Beagle)	30 d 6 d/wk (F)				191	(lethal dose)	Maynard and Hodge 1949 Ammonium Diuranate
32	Dog (Beagle)	30 d 6 d/wk (F)				190	(lethal dose)	Maynard and Hodge 1949 Sodium Uranate
33	Rabbit (NS)	30 d (F)				14.2	(67% mortality)	Maynard and Hodge 1949 Uranyl Nitrate

Table 3-2 Levels of Significant Exposure to Uranium - Oral

(continued)

Key to Figure <sup>a</sup>	Species (Strain)	Exposure/Duration/Frequency (Route)	System	NOAEL (mg/kg/day)	LOAEL		Reference Chemical Form	Comments
					Less Serious (mg/kg/day)	Serious (mg/kg/day)		
<b>Systemic</b>								
34	Rat (Sprague-Dawley)	1.5 mo ad lib (W)	Bd Wt	2 M			Bensoussan et al. 2009 Uranyl Nitrate	
35	Rat (Sprague-Dawley)	9 mo (W)	Hemato		2.4 M (20% decreased in erythrocyte levels)		Berradi et al. 2008 Depleted uranyl nitrate	
			Renal		2.4 M (tubulointerstitial lesions)			
36	Rat (Long-Evans)	6 mo ad lib (W)	Bd Wt	14 M		28 M (46% reduced body weight gain)	Briner and Murray 2005 Depleted uranyl acetate	
37	Rat (Sprague-Dawley)	9 mo ad lib (W)	Bd Wt		2.7 M (11% reduced final body weight)		Bussy et al. 2006 Depleted uranyl nitrate	

Table 3-2 Levels of Significant Exposure to Uranium - Oral

(continued)

Key to Figure <sup>a</sup>	Species (Strain)	Exposure/ Duration/ Frequency (Route)	System	NOAEL (mg/kg/day)	LOAEL		Reference Chemical Form	Comments
					Less Serious (mg/kg/day)	Serious (mg/kg/day)		
38	Rat (Sprague- Dawley)	28 d (W)	Resp	35.3 M			Gilman et al. 1998a Uranyl Nitrate	
			Cardio	35.3 M				
			Gastro	35.3 M				
			Hemato	35.3 M				
			Musc/skel	35.3 M				
			Hepatic	35.3 M				
			Renal	35.3 M	40 F (39% increase in serum uric acid)			
			Endocr	35.3 M				
Bd Wt	35.3 M							

Table 3-2 Levels of Significant Exposure to Uranium - Oral

(continued)

Key to Figure <sup>a</sup>	Species (Strain)	Exposure/ Duration/ Frequency (Route)	System	NOAEL (mg/kg/day)	LOAEL		Reference Chemical Form	Comments
					Less Serious (mg/kg/day)	Serious (mg/kg/day)		
39	Rat (Sprague- Dawley)	91 d (W)	Resp	36.73 M			Gilman et al. 1998a Uranyl Nitrate	
			Cardio	36.73 M				
			Gastro	36.73 M				
			Hemato	36.73 M				
			Musc/skel	36.73 M				
			Hepatic		0.06 M (anisokaryosis, vesiculation, increased portal density, perivenous vacuolation and homogeneity)			
			Renal		0.06 <sup>c</sup> M (nuclear vesiculation, cytoplasmic vacuolation, tubular dilation, interstitial lymphoid cuffing)			
			Endocr	0.06 M 0.42 F	0.31 M (multifocal reduction of follicular size, increased epithelial height in thyroid, decreased amount and density of colloid)			
					2.01 F (multifocal reduction of follicular size, increased epithelial height in thyroid, decreased amount)			
			Bd Wt	36.73 M				
Other	7.54 M	36.73 M (sinus hyperplasia in spleen)						

Table 3-2 Levels of Significant Exposure to Uranium - Oral

(continued)

Key to Figure <sup>a</sup>	Species (Strain)	Exposure/ Duration/ Frequency (Route)	System	NOAEL (mg/kg/day)	LOAEL		Reference Chemical Form	Comments
					Less Serious (mg/kg/day)	Serious (mg/kg/day)		
40	Rat (Sprague- Dawley)	3 months ad lib (W)	Bd Wt	22.5 M			Linares et al. 2005 Uranyl Acetate	
41	Rat (NS)	30 d (F)	Bd Wt			6637 (retarded growth)	Maynard et al. 1953 Uranyl Nitrate	
42	Rat (Sprague- Dawley)	4 wk (W)	Hemato	4.5 M	9 M (5.3 % increased hematocrit, 9% increased mean corpuscular hemoglobin concentration, 7% increased erythrocytes)		Ortega et al. 1989a Uranyl Acetate	
			Hepatic	2.2 M	4.5 M (28% increased blood glucose; 34% increased SGOT, 32% increased SGPT)			
			Renal		1.1 M (6% increased total plasma proteins)			
43	Rat (Sprague- Dawley)	9 mo (W)	Hepatic	1 M			Racine et al. 2010 Depleted uranyl nitrate	
			Metab		1 M (altered cholesterol catabolism)			

Table 3-2 Levels of Significant Exposure to Uranium - Oral

(continued)

Key to Figure <sup>a</sup>	Species (Strain)	Exposure/Duration/Frequency (Route)	System	NOAEL (mg/kg/day)	LOAEL		Reference Chemical Form	Comments
					Less Serious (mg/kg/day)	Serious (mg/kg/day)		
44	Rat (Sprague-Dawley)	90 months (W)	Renal	2.3 M			Rouas et al. 2011 Depleted uranyl nitrate	
45	Rat (Sprague-Dawley)	9 mo (W)	Metab		2.4 M (decreased 1,25(OH)vitamin D3 levels)		Tissandie et al. 2007 Depleted uranyl nitrate	
46	Mouse (C57BL/6N)	15 wk ad lib (W)	Bd Wt	100 F			Arnault et al. 2008 Uranyl Nitrate	
47	Mouse (B6C3F1)	30 d ad lib (W)	Bd Wt	9.3 F			Raymond-Whish et al. 2007 Depleted uranyl nitrate	
48	Mouse (dba)	48 wk ad lib (F)	Renal		452 M (nodular development on kidney surface)		Tannenbaum et al. 1951 Uranyl Fluoride	
49	Mouse (C3H)	18 wk ad lib (F)	Bd Wt	925 F			Tannenbaum et al. 1951 Uranyl Nitrate	
			Other	925 F				
50	Mouse (C3H)	48 wk ad lib (F)	Renal		452 M (nodular development on kidney surface)		Tannenbaum et al. 1951 Uranyl Fluoride	

Table 3-2 Levels of Significant Exposure to Uranium - Oral

(continued)

Key to Figure <sup>a</sup>	Species (Strain)	Exposure/Duration/Frequency (Route)	System	NOAEL (mg/kg/day)	LOAEL		Reference Chemical Form	Comments
					Less Serious (mg/kg/day)	Serious (mg/kg/day)		
51	Mouse (dba)	48 wk ad lib (F)	Bd Wt	462 F			Tannenbaum et al. 1951 Uranyl Nitrate	
			Other	462 F				
52	Rabbit (New Zealand)	91 d (W)	Resp	28.7 M			Gilman et al. 1998b Uranyl Nitrate	
			Cardio	28.7 M				
			Gastro	28.7 M				
			Hemato	28.7 M				
			Musc/skel	28.7 M				
			Hepatic	28.7 M				
			Renal		0.05 M (cytoplasmic vacuolization, anisokaryosis, nuclear vesiculation)			
					0.49 F (anisokaryosis, nuclear vesiculation, atrophy)			
Endocr	28.7 M							
Bd Wt	28.7 M							

Table 3-2 Levels of Significant Exposure to Uranium - Oral

(continued)

Key to Figure <sup>a</sup>	Species (Strain)	Exposure/Duration/Frequency (Route)	System	NOAEL (mg/kg/day)	LOAEL		Reference Chemical Form	Comments	
					Less Serious (mg/kg/day)	Serious (mg/kg/day)			
53	Rabbit (New Zealand)	91 d (W)	Resp	40.98 M			Gilman et al. 1998c Uranyl Nitrate		
			Cardio	40.98 M					
			Gastro	40.98 M					
			Hemato	40.98 M					
			Musc/skel	40.98 M					
			Hepatic		1.36 M (variation in nuclear size, nuclear pyknosis, extensive cytoplasmic vacuolization)				
			Renal	1.36 M (	40.38 M (glycosuria, proteinuria, anisokaryosis, nuclear hyperchromicity, nuclear pyknosis, tubular atrophy)				
			Endocr	40.98 M					
Bd Wt	40.98 M								
Other	40.98 M								
<b>Neurological</b>									
54	Rat (Sprague-Dawley)	3 mo ad lib (W)		22.4 M			Belles et al. 2005 Uranyl Acetate	NOAEL is for behavioral effects.	
55	Rat (Sprague-Dawley)	1.5 mo ad lib (W)			2 M (cholinergic alterations in the brain)		Bensoussan et al. 2009 Uranyl Nitrate		



Table 3-2 Levels of Significant Exposure to Uranium - Oral

(continued)

Key to Figure	Species (Strain)	Exposure/Duration/Frequency (Route)	System	NOAEL (mg/kg/day)	LOAEL		Reference Chemical Form	Comments
					Less Serious (mg/kg/day)	Serious (mg/kg/day)		
56	Rat (Long-Evans)	6 mo ad lib (W)		14 M	28 M (increased motor activity)		Briner and Murray 2005 Depleted uranyl acetate	
57	Rat (Sprague-Dawley)	9 mo ad lib (W)			2.7 M (altered neurotransmitter levels in the brain)		Bussy et al. 2006 Depleted uranyl nitrate	
58	Rat (Sprague-Dawley)	1.5 mo ad lib (W)			2.7 (sleep and behavioral alterations)		Houpert et al. 2005 Enriched Uranyl Nitrate	
59	Rat (Sprague-Dawley)	1.5 mo ad lib (W)		2.7			Houpert et al. 2005 Depleted uranyl nitrate	
60	Rat (Sprague-Dawley)	9 mo ad lib (W)			2.5 M (decreased spatial working memory)		Houpert et al. 2007b Enriched Uranyl Nitrate	
61	Rat (Sprague-Dawley)	90 days (W)			3.7 M (increase in REM sleep)		Lestaevel et al. 2005a Depleted uranyl nitrate	
62	Rat (Sprague-Dawley)	90 d ad lib (W)			5.6 M (increased oxidative stress in brain areas).		Linares et al. 2007 Uranyl Acetate	

Table 3-2 Levels of Significant Exposure to Uranium - Oral

(continued)

Key to Figure <sup>a</sup>	Species (Strain)	Exposure/ Duration/ Frequency (Route)	System	NOAEL (mg/kg/day)	LOAEL		Reference Chemical Form	Comments
					Less Serious (mg/kg/day)	Serious (mg/kg/day)		
<b>Reproductive</b>								
63	Rat (Sprague- Dawley)	28 d (W)		35.3 M 40 F			Gilman et al. 1998a Uranyl Nitrate	
64	Rat (Sprague- Dawley)	91 d (W)		36.73 M 53.56 F			Gilman et al. 1998a Uranyl Nitrate	
65	Rat (Sprague- Dawley)	9 mo ad lib (W)		1.9 M			Grignard et al. 2008 Depleted uranyl nitrate	NOAEL is for blood levels of testosterone and 17B-estradiol.
66	Rat (Sprague- Dawley)	9 mo ad lib (W)			1.9 M (3-fold increase in plasma testosterone)		Grignard et al. 2008 Enriched Uranyl Nitrate	
67	Rat (Sprague- Dawley)	3 months ad lib (W)		5.6 M	11.2 M (reduced pregnancy rate)		Linares et al. 2005 Uranyl Acetate	
68	Mouse (C57BL/6N)	15 wk ad lib (W)			1.25 F (slight disturbance in ovarian folliculogenesis)		Arnault et al. 2008 Uranyl Nitrate	

Table 3-2 Levels of Significant Exposure to Uranium - Oral

(continued)

Key to Figure <sup>a</sup>	Species (Strain)	Exposure/ Duration/ Frequency (Route)	System	NOAEL (mg/kg/day)	LOAEL		Reference Chemical Form	Comments
					Less Serious (mg/kg/day)	Serious (mg/kg/day)		
69	Mouse (Hybrid)	49 d ad lib (W)		1.9 F	3.9 F (increased proportion of morphologically abnormal oocytes)		Feugier et al. 2008 Uranyl Nitrate	
70	Mouse (Swiss- Webster)	40 d ad lib (W)			2.5 F (increased oocyte dysmorphism and micronuclei in cumulus cells)		Kundt et al. 2009 Uranyl Nitrate	
71	Mouse (Swiss- Webster)	64 d (W)			5.6 M (significantly reduced pregnancy rate)		Llobet et al. 1991 Uranyl Acetate	
72	Mouse (Swiss- Webster)	60 d (G)		14			Paternain et al. 1989 Uranyl Acetate	NOAEL is for fertility.
73	Rabbit (New Zealand)	91 d (W)		28.7 M 43.02 F			Gilman et al. 1998b Uranyl Nitrate	
<b>Developmental</b>								
74	Rat (Sprague- Dawley)	132 d (W)			4.3 F (delayed hyperactivity; decreased spatial working memory)		Houpert et al. 2007a Enriched Uranyl Nitrate	

Table 3-2 Levels of Significant Exposure to Uranium - Oral

(continued)

Key to Figure <sup>a</sup>	Species (Strain)	Exposure/Duration/Frequency (Route)	System	NOAEL (mg/kg/day)	LOAEL		Reference Chemical Form	Comments	
					Less Serious (mg/kg/day)	Serious (mg/kg/day)			
75	Rat (Sprague-Dawley)	70 d ad lib (W)			22.5	(13-16% reduction in pups weight on day 21)		Sanchez et al. 2006 Uranyl Acetate	
76	Mouse (C57BL/6N)	15 wk ad lib (W)			1.25 F	(slight disturbance in ovarian folliculogenesis)		Arnault et al. 2008 Uranyl Nitrate	
77	Mouse (Swiss-Webster)	30 d 1x/d (G)					28	(decrease in litter size on PND 21; decreased day 21 viability index)	Domingo et al. 1989b Uranyl Acetate
78	Mouse (Swiss-Webster)	27 d (G)		5.6 F			14 F	(increased late resorptions and decreased live fetuses)	Paternain et al. 1989 Uranyl Acetate
79	Mouse (Swiss-Webster)	56 d (G)			2.8 F	(reduced pup's weight on PND 21)	5.6 F	(increased neonatal death per litter)	Paternain et al. 1989 Uranyl Acetate
<b>CHRONIC EXPOSURE</b>									
<b>Death</b>									
80	Rat (NS)	2 yr (F)					270	(50% mortality within first year)	Maynard and Hodge 1949; Maynard et al. 1953 Uranyl Fluoride

Table 3-2 Levels of Significant Exposure to Uranium - Oral

(continued)

Key to Figure <sup>a</sup>	Species (Strain)	Exposure/ Duration/ Frequency (Route)	System	NOAEL (mg/kg/day)	LOAEL		Reference Chemical Form	Comments
					Less Serious (mg/kg/day)	Serious (mg/kg/day)		
81	Rat (NS)	2 yr (F)				660 M (70% mortality after 20 months)	Maynard and Hodge 1949; Maynard et al. 1953 Uranyl Nitrate	
<b>Systemic</b>								
82	Rat (NS)	2 yr (F)	Resp	660			Maynard and Hodge 1949; Maynard et al. 1953 Uranyl Nitrate	
			Cardio	660				
			Gastro	660				
			Hemato	170 F	330 F (slight decr RBCs and hemoglobin)			
			Hepatic	660				
			Renal	33	170 (minimal renal tubular damage)			
			Endocr	660				
			Bd Wt	170 M	330 M (11% decr BW gain)			

Table 3-2 Levels of Significant Exposure to Uranium - Oral

(continued)

Key to Figure <sup>a</sup>	Species (Strain)	Exposure/ Duration/ Frequency (Route)	System	NOAEL (mg/kg/day)	LOAEL		Reference Chemical Form	Comments
					Less Serious (mg/kg/day)	Serious (mg/kg/day)		
83	Rat (NS)	2 yr (F)	Resp	270			Maynard and Hodge 1949; Maynard et al. 1953 Uranyl Fluoride	
			Cardio	270				
			Gastro	270				
			Hemato	81 M	140 M	(decr RBC and hemoglobin; incr WBC)		
			Hepatic	270				
			Renal	54	81	(minimal tubular alterations)		
			Endocr	270				
			Bd Wt	81	140	(11-15% decr BW gain)		270

Table 3-2 Levels of Significant Exposure to Uranium - Oral

(continued)

Key to Figure <sup>a</sup>	Species (Strain)	Exposure/Duration/Frequency (Route)	System	NOAEL (mg/kg/day)	LOAEL		Reference Chemical Form	Comments
					Less Serious (mg/kg/day)	Serious (mg/kg/day)		
84	Rat (NS)	2 yr (F)	Resp	12000			Maynard and Hodge 1949; Maynard et al. 1953 Uranium Dioxide	
			Cardio	12000				
			Gastro	12000				
			Hemato	12000				
			Hepatic	12000				
			Renal	12000				
			Endocr	12000				
			Bd Wt	12000				
85	Rat (NS)	2 yr (F)	Resp	11000			Maynard and Hodge 1949; Maynard et al. 1953 Uranium Tetrafluoride	
			Cardio	11000				
			Gastro	11000				
			Hemato	11000				
			Hepatic	11000				
			Renal	1100	11000	(mild renal tubular degeneration)		
			Endocr	11000				

Table 3-2 Levels of Significant Exposure to Uranium - Oral

(continued)

Key to Figure <sup>a</sup>	Species (Strain)	Exposure/ Duration/ Frequency (Route)	System	NOAEL (mg/kg/day)	LOAEL		Reference Chemical Form	Comments
					Less Serious (mg/kg/day)	Serious (mg/kg/day)		

			Bd Wt	1100	11000	(10% decr BW gain after 1 year)		
--	--	--	-------	------	-------	------------------------------------	--	--

a The number corresponds to entries in Figure 3-2.

b Used to derive an acute-duration oral minimal risk level (MRL) of 0.002 mg/kg/day for soluble uranium compounds based on a BMDL0.05 of 0.20 mg/kg/day and an uncertainty factor of 100 (10 for extrapolation from animals to humans and 10 for human variability).

c Used to derive an intermediate-duration oral minimal risk level (MRL) of 0.0002 mg/kg/day for soluble uranium compounds based on a LOAEL of 0.06 mg/kg/day and an uncertainty factor of 300 (3 for use of a minimal LOAEL, 10 for extrapolation from animals to humans and 10 for human variability).

ad lib = ad libitum; Bd Wt = body weight; Cardio = cardiovascular; d = day(s); Endocr = endocrine; (F) = feed; F = Female; (G) = gavage; Gastro = gastrointestinal; Gd = gestation day; (GW) = gavage in water; Hemato = hematological; LD50 = lethal dose, 50% kill; LOAEL = lowest-observed-adverse-effect level; M = male; Metab = metabolic; mo = month(s); Musc/skel = musculoskeletal; NOAEL = no-observed-adverse-effect level; NS = not specified; PND = post-natal day; Resp = respiratory; (W) = drinking water; wk = week(s); x = time(s); yr = year(s)



Figure 3-2 Levels of Significant Exposure to Uranium - Oral  
Acute (≤14 days)

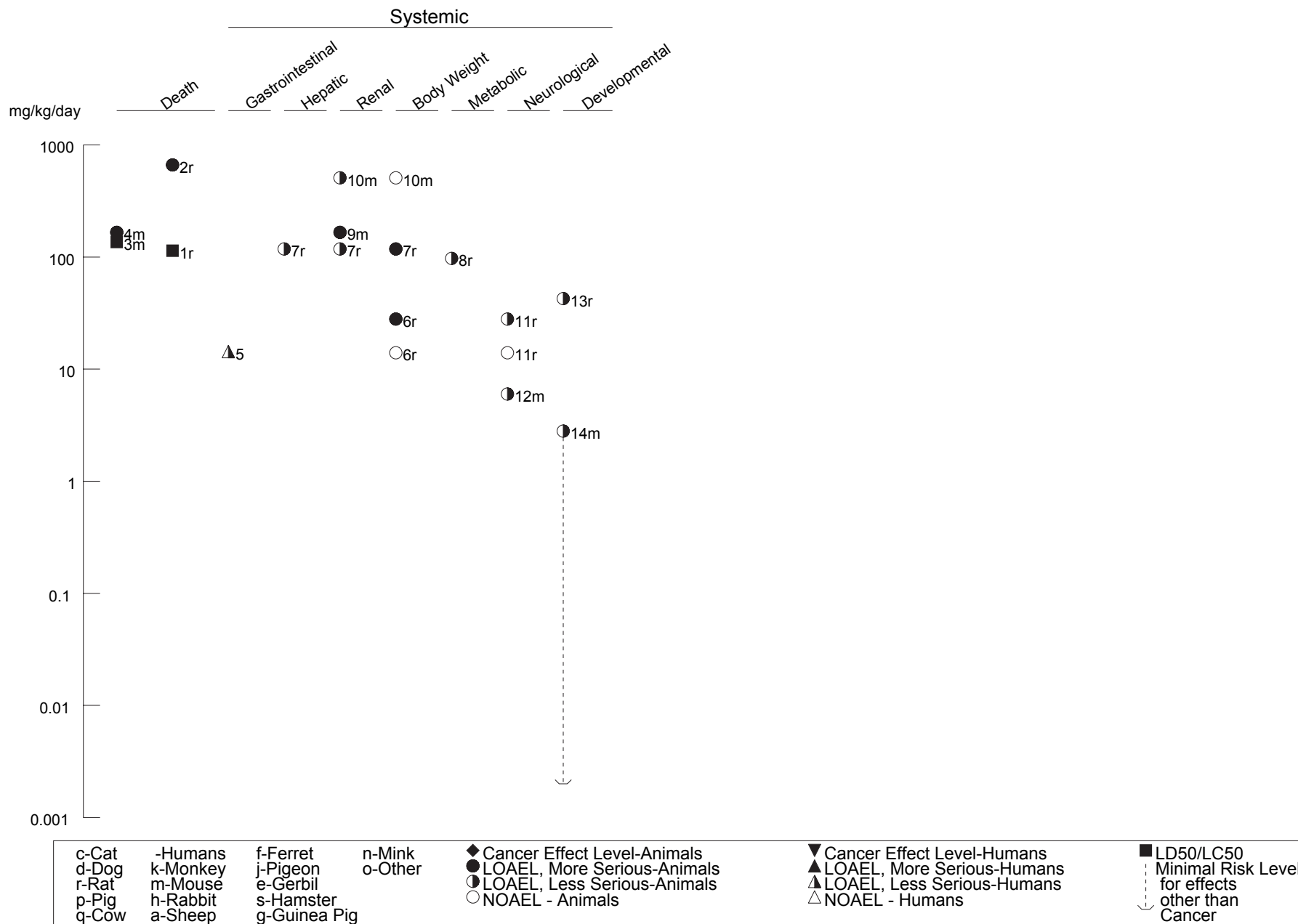

Figure 3-2 Levels of Significant Exposure to Uranium - Oral (Continued)

Intermediate (15-364 days)

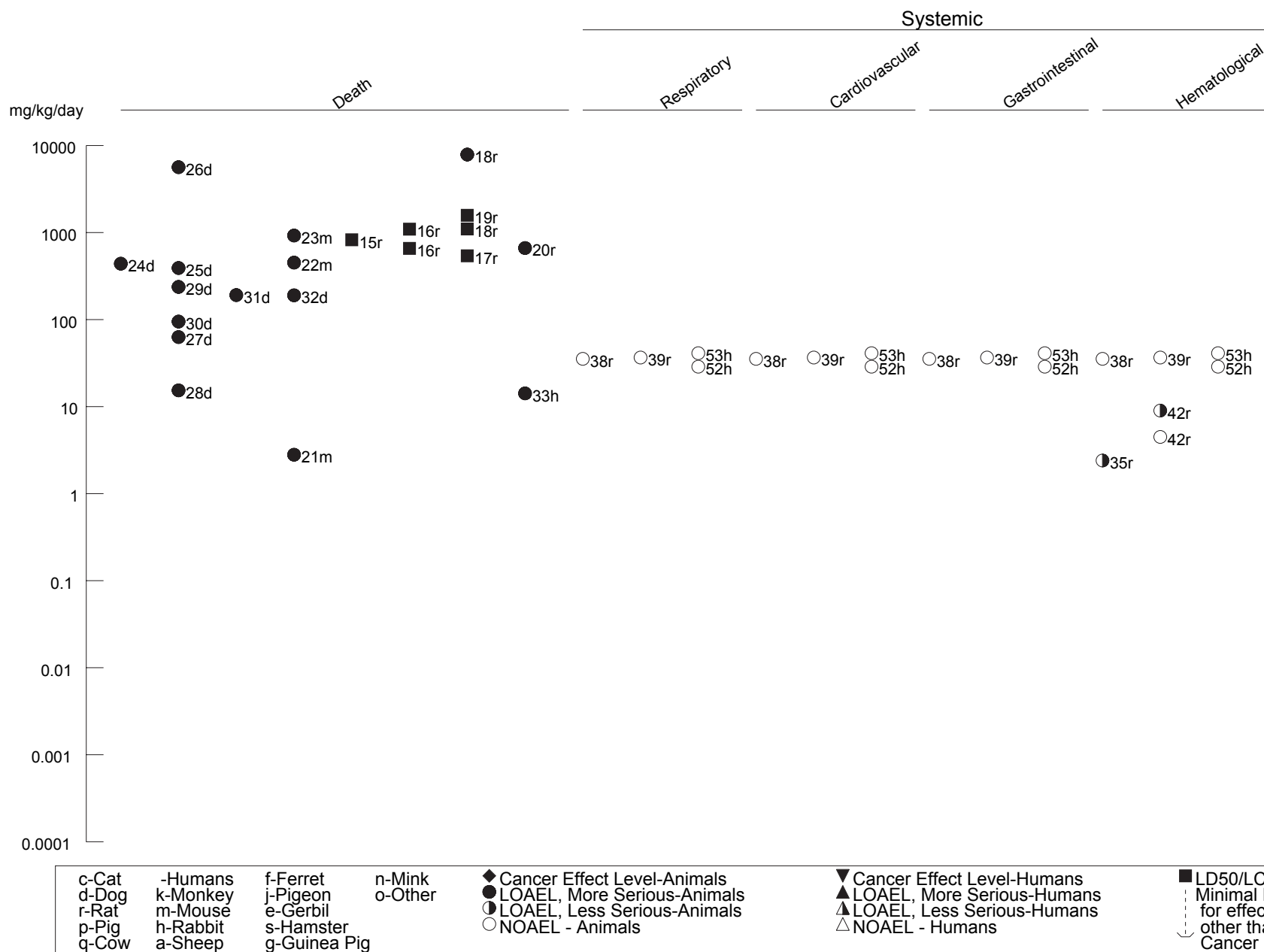

Figure 3-2 Levels of Significant Exposure to Uranium - Oral (Continued)

Intermediate (15-364 days)

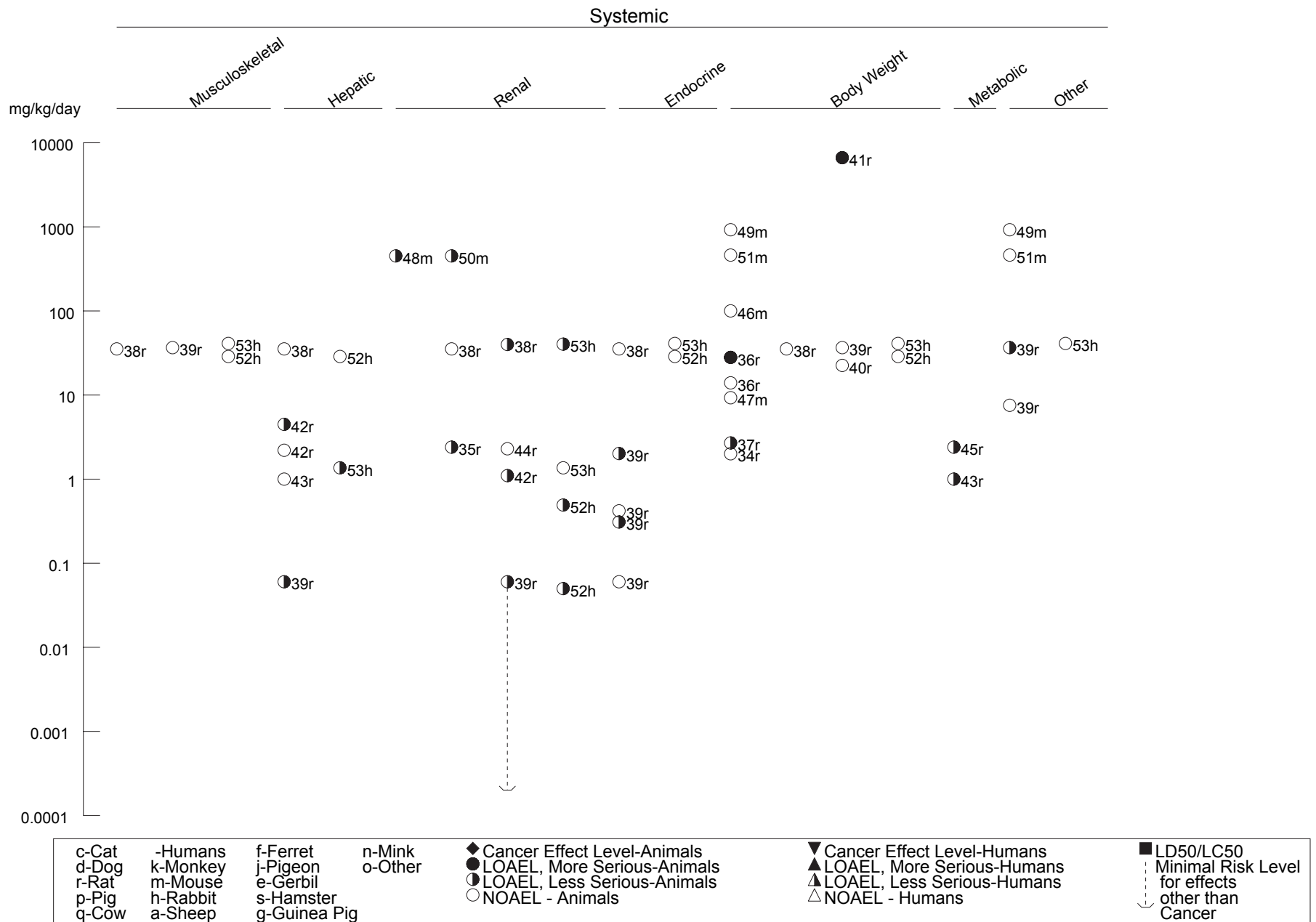

Figure 3-2 Levels of Significant Exposure to Uranium - Oral (Continued)  
Intermediate (15-364 days)

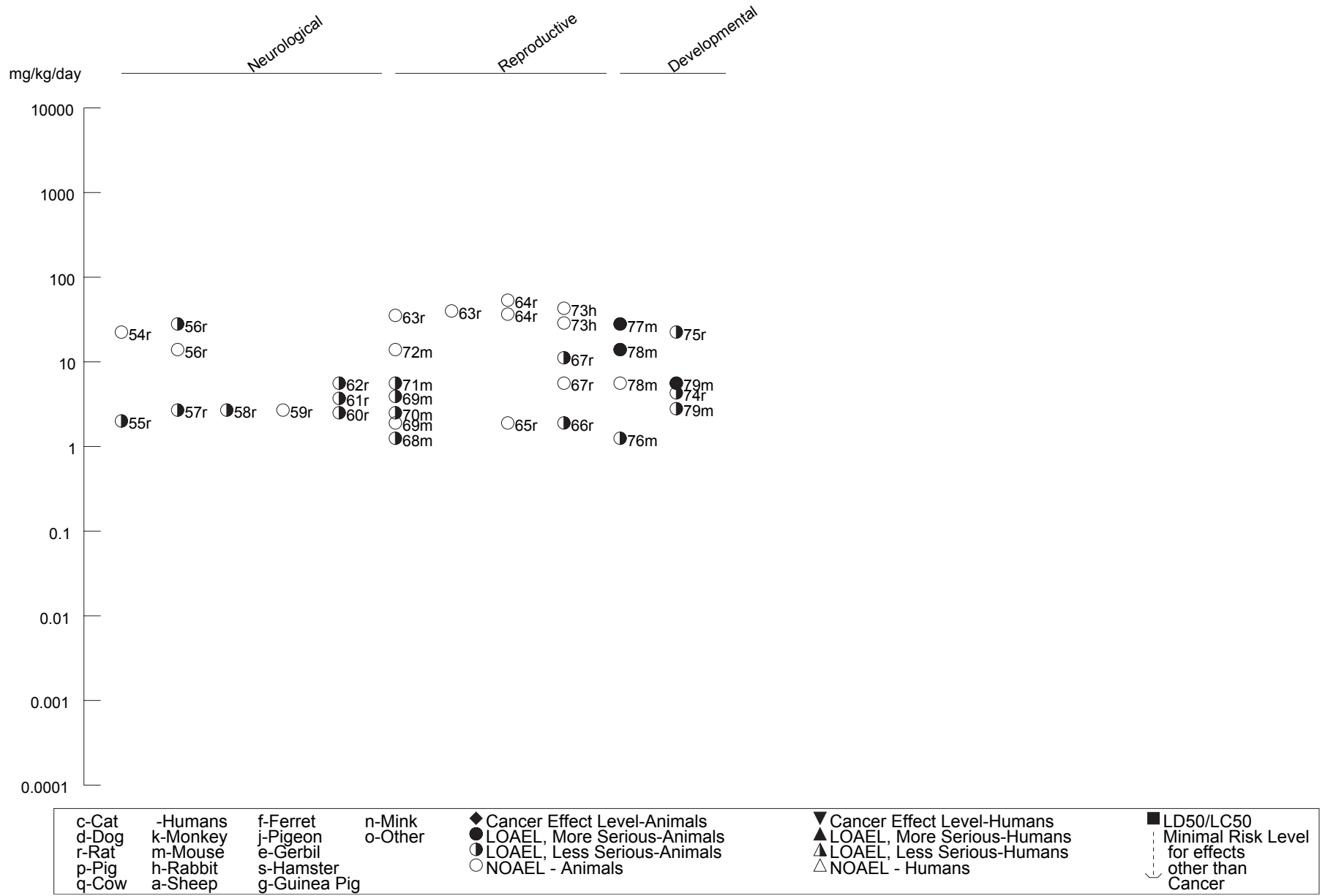
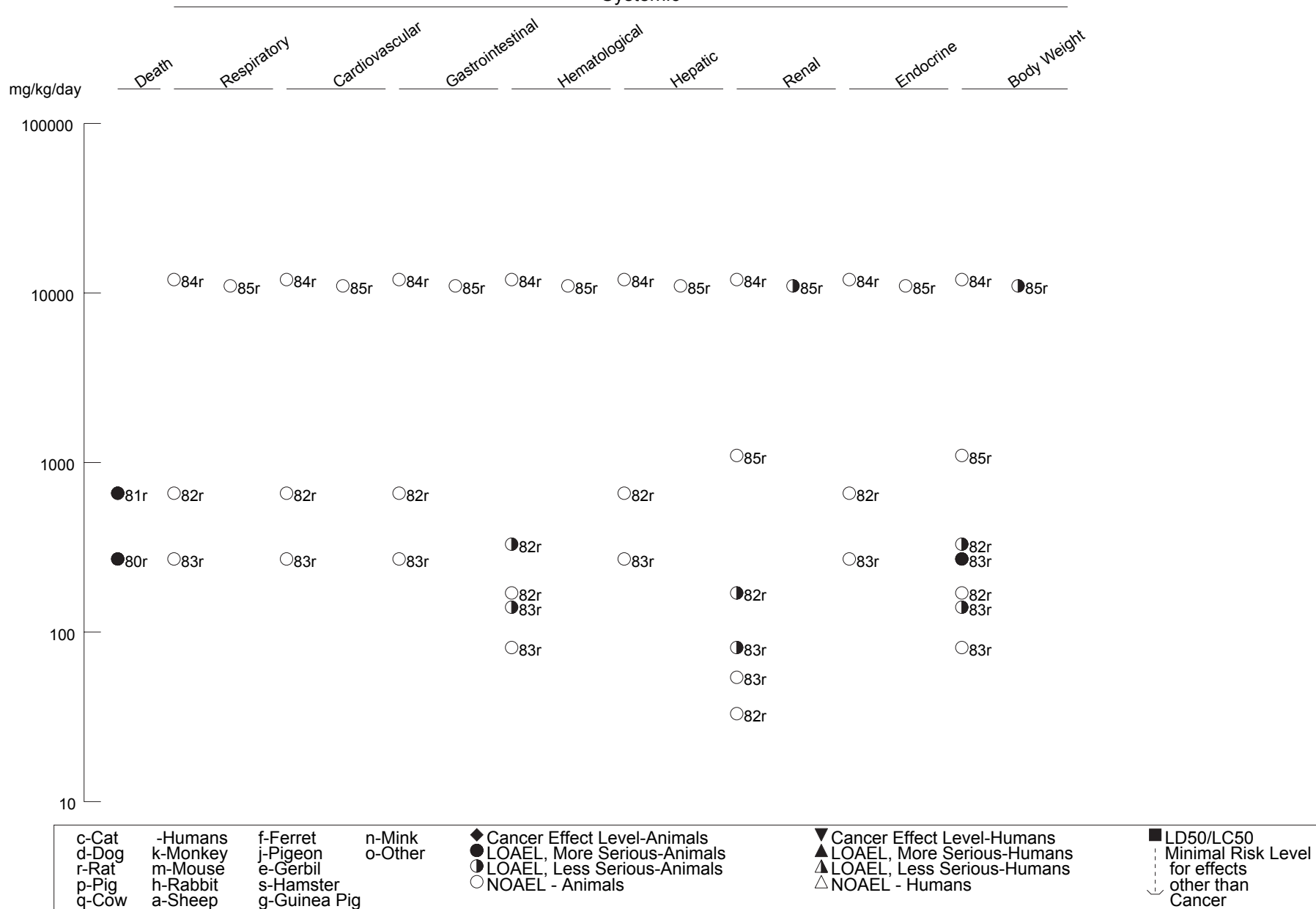

Figure 3-2 Levels of Significant Exposure to Uranium - Oral (Continued)

Chronic (≥365 days)

Systemic



## 3. HEALTH EFFECTS

**Respiratory Effects.** Respiratory effects from oral exposure to uranium are unlikely. In an acute-duration animal study, no adverse effects on the respiratory system were reported in rats given single oral doses of 118 mg uranium/kg body weight/day (U/kg/day) as uranyl acetate dihydrate (Domingo et al. 1987).

In intermediate-duration exposures, Sprague-Dawley rats (10/sex/dose) were exposed to uranium as uranyl nitrate in the drinking water (males: up to 35.3 mg/kg/day; females: up to 40.0 mg/kg/day) for 28 days and then sacrificed. No treatment-related histopathological changes were found, and no changes in lung weights were noted (Gilman et al. 1998a). In several 30-day dietary studies using much higher doses, no adverse effects on the respiratory system were reported in rats exposed to 6,637 mg U/kg/day as uranyl nitrate hexahydrate, 8,769 mg U/kg/day as uranium tetrachloride, 11,033 mg U/kg/day as uranium peroxide, 10,611 mg U/kg/day as uranium tetrafluoride, 10,818 mg U/kg/day as uranyl fluoride, 12,342 mg U/kg/day as uranium dioxide, 8.167 mg U/kg/day as uranyl acetate dihydrate, or 11,650 mg U/kg/day as uranium trioxide (Maynard and Hodge 1949; Maynard et al. 1953; Stokinger et al. 1953). Lengthening the duration of exposure to uranium failed to produce detectable lesions in lungs of laboratory animals. Sprague-Dawley rats (15/sex/dose) were exposed to uranium as uranyl nitrate in drinking water (males: up to 36.73 mg/kg/day; females: up to 53.56 mg/kg/day) for 91 days and were sacrificed. No treatment-related histopathological changes were found in the lungs, and no changes in lung weights were noted (Gilman et al. 1998a). In addition, New Zealand rabbits were exposed to uranium as uranyl nitrate in the drinking water (males: up to 28.70 mg/kg/day; females: up to 43.02 mg/kg/day) for 91 days. No treatment-related histopathological changes were found, and no changes in lung weights were noted (Gilman et al. 1998b). Male New Zealand rabbits were also exposed to uranium as uranyl nitrate in drinking water (1.36 and 40.98 mg/kg/day) for 91 days, again with no histopathological or organ weight changes found (Gilman et al. 1998c).

In chronic-duration feeding studies, no adverse effects on the respiratory system were reported in 1-year studies of dogs given oral doses of 31 mg U/kg/day as uranium tetrachloride, 3,790 mg U/kg/day as uranium hexachloride, 8 mg U/kg/day as uranyl fluoride, or 4,407 mg U/kg/day as uranium dioxide (Maynard and Hodge 1949; Maynard et al. 1953). In 2-year studies, the respiratory system was unaffected in dogs and rats given 2 mg U/kg/day as uranyl nitrate hexahydrate and in rats given 12,141 mg U/kg/day as uranium dioxide, 664 mg U/kg/day as uranyl nitrate hexahydrate, 10,611 mg U/kg/day as uranium tetrafluoride, or 405 mg U/kg/day as uranyl fluoride (Maynard and Hodge 1949; Maynard et al. 1953; Stokinger et al. 1953).

## 3. HEALTH EFFECTS

No histological alterations were observed in the lungs of rats exposed to 400 mg U/kg/day as uranyl fluoride, 660 mg U/kg/day as uranyl nitrate, 11,000 mg U/kg/day as uranium tetrafluoride, or 12,000 mg U/kg/day as uranium dioxide in the diet for 2 years (Maynard and Hodge 1949; Maynard et al. 1953).

**Cardiovascular Effects.** Cardiovascular effects following intake of uranium are unlikely. One case report documented a cardiovascular effect that was possibly related to uranium exposure in a male admitted to the hospital following deliberate ingestion of 15 g of uranyl acetate, along with an unknown quantity of benzodiazepine, in a failed suicide attempt. While body weight was not reported, the dose would be approximately 131 mg U/kg for a 70-kg reference man. Initial blood chemistry was unremarkable, and decreased cardiac output was consistent with ingestion of benzodiazepam. The patient was reported to have suffered from myocarditis resulting from the uranium ingestion, resolving 6 months after the ingestion (Pavlakakis et al. 1996).

A significant association between urinary uranium levels and increases in diastolic and systolic blood pressure were observed among adults living in households with uranium in the drinking water at levels of 0.03–1,500 µg/L (31% >100 µg/L and 55% >15 µg/L; the median daily intake was 36 µg/day) (Kurttio et al. 2006a); however, the increases in blood pressure were small and did not appear until urine uranium levels were at least 1 µg/L. A urinary uranium level of 1 µg/L is approximately 25 times higher than the 95% percentile level for the U.S. population (CDC 2012). This is consistent with the findings of Kurttio et al. (2002) that a 1 mg/L increase in uranium levels in drinking water would be associated with 7.4 and 5.0 mm Hg increases in systolic and diastolic blood pressure, respectively. Kurttio et al. (2006a) noted that the increases in blood pressure were expectedly greater in older individuals than younger individuals.

The available studies in animals have found no adverse cardiovascular effects following oral exposures for up to 30 days to uranium compounds. In one study, Sprague-Dawley rats (10/sex/dose) were exposed to uranium as uranyl nitrate in drinking water (males: up to 35.3 mg/kg/day; females: up to 40.0 mg/kg/day) for 28 days and sacrificed. No cardiac histopathological changes were found, and no changes in heart weights were noted (Gilman et al. 1998a). No changes in the heart or blood vessels were observed in rats following oral exposure to doses as high as 9,393 mg U/kg/day as uranyl nitrate hexahydrate, 8,769 mg U/kg/day as uranium tetrachloride, 11,033 mg U/kg/day as uranium peroxide, 10,611 mg U/kg/day as uranium tetrafluoride, 10,819 mg U/kg/day as uranyl fluoride, 12,342 mg U/kg/day as uranium dioxide, 11,650 mg U/kg/day as uranium trioxide, or 7,859 mg U/kg/day as uranyl acetate dihydrate (Maynard and Hodge 1949). Sprague-Dawley rats (15/sex/dose) were

## 3. HEALTH EFFECTS

exposed to uranium as uranyl nitrate in drinking water (males: up to 36.73 mg/kg/day; females: up to 53.56 mg/kg/day) for 91 days and sacrificed. No uranium-related histopathological changes were found in the heart, and no changes in heart weights were noted (Gilman et al. 1998a). In addition, New Zealand rabbits were exposed to uranium as uranyl nitrate in the drinking water (males: up to 28.70 mg/kg/day; females: up to 43.02 mg/kg/day) for 91 days. No treatment-related cardiac histopathological changes were noted, and no changes in heart weights were detected (Gilman et al. 1998b). Male New Zealand rabbits also were exposed to uranium as uranyl nitrate in drinking water (1.36 and 40.98 mg/kg/day) for 91 days, with no histopathological or organ weight changes (Gilman et al. 1998c).

No histological alterations were observed in the heart of rats exposed to 400 mg U/kg/day as uranyl fluoride, 660 mg U/kg/day as uranyl nitrate, 11,000 mg U/kg/day as uranium tetrafluoride, or 12,000 mg U/kg/day as uranium dioxide in the diet for 2 years (Maynard and Hodge 1949; Maynard et al. 1953).

**Gastrointestinal Effects.** A volunteer given a single dose of 1 g uranyl nitrate (14.3 mg/kg) and observed for clinical signs and symptoms within 24 hours after intake suffered acute nausea, vomiting, and diarrhea within a few hours of administration. All clinical signs returned to normal within 24 hours after administration of the oral uranyl nitrate dose (Butterworth 1955). Paralytic ileus was reported in a male after the deliberate ingestion of 15 g uranyl acetate (Pavlakis et al. 1996). While body weight was not reported, the dose would be approximately 131 mg U/kg for a 70-kg reference man. No other reports of gastrointestinal effects after acute-duration exposure to uranium in either humans or laboratory animals were available.

Studies of intermediate-duration exposure to uranium compounds were available for laboratory animals. In one study, Sprague-Dawley rats (10/sex/dose) were exposed to uranium as uranyl nitrate in the drinking water (males: up to 35.3 mg/kg/day; females: up to 40.0 mg/kg/day) for 28 days and sacrificed. No treatment-related histopathological changes were found, and no changes in organ weights were noted (Gilman et al. 1998a). In a study of longer duration, Sprague-Dawley rats (15/sex/dose) were exposed to uranium as uranyl nitrate in drinking water (males: up to 36.73 mg/kg/day; females: up to 53.56 mg/kg/day) for 91 days and then sacrificed. No treatment-related histopathological changes were found in the gastrointestinal tract, and no changes in stomach and intestinal weights were noted (Gilman et al. 1998a). In addition, New Zealand rabbits were exposed to uranium as uranyl nitrate in the drinking water (males: up to 28.70 mg/kg/day; females: up to 43.02 mg/kg/day) for 91 days. No treatment-related histopathological changes were found, and no changes in organ weights (i.e., colon, duodenum, stomach [gastric cardia, fundus, and pylorus]) were noted (Gilman et al. 1998b). Male New Zealand



## 3. HEALTH EFFECTS

rabbits were exposed to uranium as uranyl nitrate in drinking water (1.36 and 40.98 mg/kg/day) for 91 days, with no histopathological or organ weight changes found (Gilman et al. 1998c).

No histological alterations were observed in the stomach, small intestine, or large intestine of rats exposed to 400 mg U/kg/day as uranyl fluoride, 660 mg U/kg/day as uranyl nitrate, 11,000 mg U/kg/day as uranium tetrafluoride, or 12,000 mg U/kg/day as uranium dioxide in the diet for 2 years (Maynard and Hodge 1949; Maynard et al. 1953).

**Hematological Effects.** In one case report, a male (no age or weight given) was admitted to hospital following the deliberate ingestion of 15 g of uranyl acetate, along with an unknown quantity of benzodiazepine, in a failed suicide attempt. While body weight was not reported, the dose would be approximately 131 mg U/kg for a 70-kg reference man. Initial blood chemistry was unremarkable; however, an anemia developed and continued to progress over the next 8 weeks, along with persistent renal dysfunction (Pavlakakis et al. 1996). While the authors attributed the renal dysfunction to uranium ingestion, the etiology of the anemia was unknown. The patient also suffered from peptic ulcer disease, which may have been related to the anemia.

The majority of animal studies show no effect of uranium on hematological parameters after oral exposure. Exposure to uranium as uranyl nitrate in drinking water had no hematological effects in Sprague-Dawley rats after 28 days (up to 40 mg U/kg/day) or 91 days (up to 53 mg U/kg/day) (Gilman et al. 1998a), or in New Zealand rabbits after 91 days (up to 43 mg U/kg/day) (Gilman et al. 1998b, 1998c). Exposure to a variety of uranium compounds in feed had no effect on hematological parameters in intermediate- and chronic-duration studies (Maynard and Hodge 1949). One study reported a significant increase in the hematocrit and hemoglobin values, the mean corpuscular hemoglobin concentration, and the number of erythrocytes at 9 mg U/kg/day as uranyl acetate in drinking water for 4 weeks, but not at 4.5 mg U/kg/day and lower doses (Ortega et al. 1989a). In contrast, a 20% reduction in erythrocyte levels was observed in male Sprague-Dawley rats exposed to 2.4 mg U/kg/day as depleted uranyl nitrate hexahydrate in mineral water for 9 months (Berradi et al. 2008). The study did not find reductions in erythrocyte production in the spleen or bone marrow or evidence of alterations in spleen iron recycling. The investigators suggested that the observed hematological effect may be secondary to observed kidney damage.

In a 2-year feeding study, decreases in erythrocyte levels and/or hemoglobin levels were observed in rats exposed to  $\geq 330$  mg U/kg/day as uranyl nitrate or  $\geq 140$  mg U/kg/day as uranyl fluoride; an increase in

## 3. HEALTH EFFECTS

leukocyte levels was also observed at  $\geq 140$  mg U/kg/day as uranyl fluoride (Maynard and Hodge 1949; Maynard et al. 1953). No hematological alterations were observed in rats similarly exposed to 11,000 mg U/kg/day as uranium tetrafluoride or 12,000 mg U/kg/day as uranium dioxide (Maynard and Hodge 1949; Maynard et al. 1953).

**Musculoskeletal Effects.** In one human case report, a male (no age or weight given) was admitted to the hospital following the deliberate ingestion of 15 g of uranyl acetate, along with an unknown quantity of benzodiazepine, in a failed suicide attempt. While body weight was not reported, the dose would be approximately 131 mg U/kg for a 70-kg reference man. The patient suffered from increasing rhabdomyolysis (biochemically characterized by increased creatine kinase). At 6 months following the initial toxic insult, the rhabdomyolysis had resolved, and the subject showed no residual signs of muscle toxicity (Pavlakakis et al. 1996). The etiology of this effect is unknown.

In a study of adults (146 men and 142 women) living in an area of Finland with elevated uranium levels in drinking water (0.002–1,920  $\mu\text{g/L}$  with 27% of concentrations  $>100$   $\mu\text{g/L}$  and 59%  $>15$   $\mu\text{g/L}$ ), a significant association between elevated serum type I collagen carboxy-terminal telopeptide (CTX) levels (biomarker of bone resorption) and levels of uranium in water was observed in males (Kurttio et al. 2005). A nonsignificant association between increased osteocalcin levels (biomarker of bone formation) and uranium levels in drinking water was also observed in males. Other biomarkers of bone resorption and formation were not associated with uranium exposure. No statistically significant associations were observed in females. Daily uranium intakes ranged from 7 to 207  $\mu\text{g}$  (0.0001–0.003 mg/kg/day, using a 70-kg reference body weight) and the median intake was 36  $\mu\text{g}$  (0.0005 mg/kg/day).

There are limited data on the potential of uranium to induce bone or muscle damage following oral exposure. A significant decrease in growth cartilage width, metaphyseal bone volume, and percent metaphyseal activity in bone formation area and a significant increase in metaphyseal activity in the bone resorption area were observed in male Balb/c mice administered a single gavage dose of 170 mg U/kg as uranyl nitrate hexahydrate and sacrificed 48 hours after dosing (Bozal et al. 2005).

Histopathological examination of muscle after exposure to uranium in drinking water as uranyl nitrate showed no effects in Sprague-Dawley rats after 28 days (up to 40 mg U/kg/day) or 91 days (up to 53 mg U/kg/day) (Gilman et al. 1998a), or in New Zealand rabbits after 91 days (up to 43 mg U/kg/day) (Gilman et al. 1998b, 1998c).

## 3. HEALTH EFFECTS

**Hepatic Effects.** Few human data are available on the hepatic effects of uranium. In one case report, a male (no age or weight given) was admitted to the hospital following the deliberate ingestion of 15 g of uranyl acetate, along with an unknown quantity of benzodiazepine, in a failed suicide attempt. While body weight was not reported, the dose would be approximately 131 mg U/kg for a 70-kg reference man. The patient suffered from increasing liver dysfunction, characterized by increased serum levels of alanine aminotransferase (ALT), aspartate aminotransferase (AST), and gamma-glutamyl transpeptidase (GGT). Six months following the initial toxic insult, the patient had no residual signs of hepatic toxicity (Pavlakis et al. 1996). The etiology of this effect is unknown, although histological signs of hepatic toxicity have been observed in animals after oral exposure to uranium.

In the available animal studies, the existing data provide evidence that uranium exposure can damage the liver, although the etiology for this effect is not certain. In an acute-duration study in which Sprague-Dawley rats were given single gavage doses of 5.6 or 118 U/kg as uranyl acetate dihydrate, microhemorrhagic foci in the liver were observed at both doses tested (Domingo et al. 1987).

Ingested uranium was also hepatotoxic to dogs in studies of intermediate-duration exposure. When uranyl fluoride was tested at 7.7, 15.4, 77.3, 386.7, or 3,864 mg U/kg/day for 30 days, fatty infiltration was seen in dogs at the 15.4 mg U/kg/day dose level (Maynard and Hodge 1949). In other tests, uranium tetrachloride induced minimal hepatic lesions at a dose level of 313 mg U/kg/day; uranium peroxide induced mild degeneration at a dose level of 386 mg U/kg/day; uranium dioxide induced mild degeneration at a dose level of 441 mg U/kg/day; uranium trioxide induced slight fatty infiltration at a dose level of 416 mg U/kg/day; triuranium octaoxide induced mild fatty changes at a dose level of 5,653 mg U/kg/day; sodium diuranate induced mild degeneration at a dose level of 37.5 mg U/kg/day; uranium tetrafluoride caused degenerative fatty changes at a dose level of 15,159 mg U/kg/day; and uranyl nitrate hexahydrate induced minimal hepatic degeneration at a dose level of 237 mg U/kg/day (Maynard and Hodge 1949).

Hepatic toxicity was also found in several other studies. In one study, Sprague-Dawley rats (15/sex/dose) were exposed to uranium as uranyl nitrate in drinking water (males: up to 36.73 mg/kg/day; females: up to 53.56 mg/kg/day) for 91 days and then sacrificed. Hepatic lesions, which included anisokaryosis, vesiculation, increased portal density, perivenous vacuolation, and homogeneity, were observed in the liver at all doses (Gilman et al. 1998a), although the dose ranging portion of this study found no effects at essentially the same doses as those discussed below (Gilman et al. 1998c). However, in New Zealand rabbits exposed to uranium as uranyl nitrate in the drinking water (males: 0, 0.05, 0.20, 0.88, 4.82, and

## 3. HEALTH EFFECTS

28.70 mg/kg/day; females: 0, 0.49, 1.32, and 43.02 mg/kg/day) for 91 days, no treatment-related histopathological changes were found, and no changes in liver weights were noted (Gilman et al. 1998b). In contrast, another study by the same investigator in male New Zealand rabbits exposed to uranium as uranyl nitrate in drinking water (1.36 and 40.98 mg/kg/day) for 91 days found irregular accentuation of zonation in the liver, accompanied by increased variation in hepatocellular nuclear size, nuclear pyknosis, and extensive cytoplasmic vacuolization. These changes were found to be treatment-related but not dose-related (Gilman et al. 1998c).

In other intermediate-duration studies, no effects were seen on the liver of dogs given oral doses of 9,393 mg U/kg/day as uranyl nitrate hexahydrate or 191 mg U/kg/day as ammonium diuranate for 30 days (Maynard and Hodge 1949). Similarly, no effects were seen on the liver of rats given oral doses of 8,769 mg U/kg/day as uranium tetrachloride, 11,033 mg U/kg/day as triuranium peroxide, 10,818 mg U/kg/day as uranyl fluoride, 12,342 mg U/kg/day as uranium dioxide, 11,650 mg U/kg/day as triuranium trioxide, or 7,859 mg U/kg/day as uranium acetate dihydrate for 30 days (Maynard and Hodge 1949). Sprague-Dawley rats (10/sex/dose, 60 g) were exposed to uranium as uranyl nitrate in drinking water (males: up to 35.3 mg/kg/day; females: up to 40.0 mg/kg/day) for 28 days and then sacrificed. No treatment-related histopathological changes were found, and no changes in liver weights were noted (Gilman et al. 1998a).

Significant increases in plasma cholesterol (41%) were observed in rats exposed to approximately 2 mg U/kg/day as depleted uranyl nitrate in drinking water for 9 months (Souidi et al. 2005); the toxicological significance of this increase is not known.

No histological alterations were observed in rats exposed via the diet for 2 years to 400 mg U/kg/day as uranyl fluoride, 660 mg U/kg/day as uranyl nitrate, 11,000 mg U/kg/day as uranium tetrafluoride, or 12,000 mg U/kg/day as uranium dioxide (Maynard and Hodge 1949; Maynard et al. 1953).

**Renal Effects.** Uranium has been identified as a nephrotoxic metal, exerting its toxic effect by chemical action mostly in the renal proximal tubules of humans and animals. Few human data are available that adequately describe the dose-response toxicity of uranium after an oral exposure. In one human case report study (Pavlakis et al. 1996), acute nephrotoxicity was diagnosed in a male following the intentional ingestion of 15 g of uranyl acetate (approximately 131 mg/kg using a reference body weight of 70 kg), along with an unknown quantity of benzodiazepine, in a failed suicide attempt. Initial blood chemistry was normal; however, 16 hours after admission, his blood urea levels had doubled and

## 3. HEALTH EFFECTS

creatinine levels had increased 3.5-fold, which suggested renal damage; the patient underwent chelation therapy and dialysis. At 6 months following the initial toxic insult, the patient still suffered from an incomplete Fanconi syndrome (renal tubular acidosis). A pre-existing peptic ulcer disease in this patient may have exacerbated toxicity by increased absorption of uranium through the damaged stomach mucosal layer.

Several epidemiology studies (Kurttio et al. 2002, 2006a; Limson Zamora et al. 1998, 2009; Mao et al. 1995; Seldén et al. 2009) examined the possible association between chronic exposure to elevated levels of uranium in drinking water and alterations in kidney function. Mao et al. (1995) found a significant association between cumulative uranium exposure (product of uranium concentration in drinking water, reported average number of cups of water consumed per day, and the total years at the current residence) and urine albumin levels (expressed as mg/mmol creatinine) in adults living in households with elevated uranium levels in drinking water. The mean uranium levels in the drinking water were 19.6 and 14.7  $\mu\text{g/L}$  in the exposed group and 0.71  $\mu\text{g/L}$  in the control group. Although a significant association between cumulative uranium exposure and urinary albumin levels was found, the albumin levels were within the normal range for most subjects.

A significant association between uranium intake levels and urinary glucose,  $\beta_2$ -microglobulin, and alkaline phosphatase levels were observed in males and females living in an area of high uranium levels in the drinking water; total uranium intake ranged from 3 to 570  $\mu\text{g/kg}$  (0.00004–0.0085 mg/kg/day, assuming a reference body weight of 70 kg) (Limson Zamora et al. 1998).

In a second study by this group (Limson Zamora et al. 2009), urine uranium levels (adjusted for fluid intake) were significant positively correlated with urine volume, specific gravity,  $\gamma$ -glutamyl transferase, and  $\beta_2$ -microglobulin levels in a group of 54 residents exposed to various levels of uranium in drinking water. The estimated average uranium intake for the group was 0.00065 mg/kg/day; however, uranium intake was estimated from data for all subjects, which included eight subjects with a uranium intake of <0.000013 mg/kg/day (1.3 ng/kg/day).

No significant differences in kidney function parameters were found in 301 residents consuming drinking water from wells drilled in bedrock areas and 153 consuming municipal water (Seldén et al. 2009). When the two populations were combined, urinary uranium levels were significantly correlated with  $\beta_2$ -microglobulin, kappa immunoglobulin light chains, and protein HC levels; however, there was no dose-response relationship. Excluding 23 subjects with diabetes resulted in a tendency toward a dose-

## 3. HEALTH EFFECTS

response relationship. The median, mean, and range of uranium levels in the drinking water from wells were 6.7, 25.2, and <0.20–470 µg/L, respectively; the municipal water uranium levels were below the detection limit of 0.2 µg/L. The respective median and geometric mean urine uranium levels were 0.013 and 0.016 nmol/mmol creatinine in the well water group and 0.0019 and 0.0020 nmol/mmol creatinine in the municipal water group.

A weak significant association between urinary uranium levels and fractional excretion of calcium and phosphate were observed in 325 Finnish residents exposed to uranium in drinking water from bored wells (Kurttio et al. 2002); a tendency for increased glucose excretion was also observed. However, the lack of information on the presence of other possible contaminants in the drinking water confounds the interpretation of these results. The investigators noted that calcium, phosphate, and glucose excretion levels were within the normal range. Urinary uranium levels ranged from 1 to 5,650 µg/L (1.9–955 ng/mmol creatinine) and the mean and median levels were 424 and 78 µg/L (73 and 13 ng/mmol creatinine), respectively. The mean uranium intake was 3.2 mg/kg/day. No significant associations were found for β2-microglobulin levels or indicators of glomerular dysfunction (creatinine clearance or urinary albumin). Several years later, Kurttio et al. (2006a) examined a subset of these subjects (uranium drinking water levels ranged from 0.03 to 1,500 µg/L with 55% >15 µg/L and 31% >100 µg/L) and did not find significant associations between urinary uranium levels and calcium, phosphate, and glucose excretion. However, a significant association between cumulative uranium intake and urinary glucose levels was found.

There is sufficient information in animals with high exposures to both soluble and insoluble uranium to conclude that uranium is a renal toxicant. The pathogenesis of the kidney damage in animals indicates that regeneration of the tubular epithelium occurs in survivors upon discontinuation of exposure to uranium (Bentley et al. 1985; Dygert 1949b; Maynard and Hodge 1949; Pozzani 1949; Rothermel 1949; Rothstein 1949c; Spiegl 1949; Stokinger et al. 1953).

Two single exposure studies have reported renal damage. Marked increases in blood urea and creatinine levels and tubular necrosis were observed after 2 days in Balb-c mice administered a lethal (animals died on day 3) gavage dose of 166 mg U/kg as uranyl nitrate hexahydrate (Martinez et al. 2003). Evidence of renal dysfunction (increased urine volume, increased plasma urea and creatinine levels, and increased urinary total protein levels and creatinine clearance) and minimal microscopic lesions (moderate hyperemia and discrete microhemorrhagic foci) in the tubular epithelium were observed in male Sprague-Dawley rats exposed to a single gavage dose of 5.6 mg U/kg as uranyl acetate dihydrate (Domingo et al.

## 3. HEALTH EFFECTS

1987). In a repeated exposure acute-duration study, significant increases in BUN and serum creatinine levels were observed in Swiss albino mice exposed to 508 mg U/kg/day as uranyl acetate dihydrate in the diet for 5 days (Ozmen and Yurekli 1998).

The renal toxicity of uranium compounds following intermediate-duration exposure has been examined in rats, rabbits, and dogs (Gilman et al. 1998a, 1998b, 1998c; Maynard and Hodge 1949; McDonald-Taylor et al. 1992, 1997; Rouas et al. 2011). No histological alterations were observed in the kidneys of Sprague-Dawley rats exposed to doses as high as 35.3 mg U/kg/day (males) or 40.0 mg U/kg/day (females) as uranyl nitrate in drinking water for 28 days (Gilman et al. 1998a). The only effect observed was a significant increase in serum uric acid in females at 40 mg U/kg/day (1.64 vs. 1.18 mg/dL in controls). Similarly, no histological alterations were observed in Sprague-Dawley rats exposed to doses as high as 4.5 mg U/kg/day as uranyl acetate in drinking water for 4 weeks (Ortega et al. 1989a); small congestion of the kidney and a moderate increase in lysosomal content of the proximal convoluted tubule epithelial cells were observed at 9 mg U/kg/day. In addition, a slight, non-dose-related increase in total plasma protein levels was observed at  $\geq 1.1$  mg U/kg/day.

Extending the exposure duration to 91 days resulted in a number of kidney effects in Sprague-Dawley rats exposed to uranyl nitrate in drinking water (Gilman et al. 1998a). At the lowest dose tested in males (0.06 mg U/kg/day), histological alterations were observed in the renal tubules (nuclear vesiculation, cytoplasmic vacuolation, and tubular dilation) and interstitium (lymphoid cuffing). Exposure to  $\geq 0.31$  mg U/kg/day resulted in glomerular adhesions and tubular cytoplasmic degeneration. Although female rats were equally susceptible to the renal toxicity of uranyl nitrate, the observed histological alterations differed from the males. In the females exposed to  $\geq 0.09$  mg U/kg/day, capsular sclerosis, tubular anisokaryosis, tubular nuclear vesiculation, and interstitial reticulin sclerosis were observed. The differences in renal effects between the male and female rats do not appear to be related to uranium levels in the kidney. Although uranium levels were not measured at the lowest dose levels, exposure to 7.54 or 9.98 mg U/kg/day resulted in kidney uranium levels of 0.42 and 0.42  $\mu\text{g/g}$  in males and females, respectively.

Gender-related differences in the renal toxicity of uranium were also observed in New Zealand rabbits exposed to uranyl nitrate in the drinking water for 91 days (Gilman et al. 1998b). Histopathological alterations observed in males exposed to  $\geq 0.05$  mg U/kg/day included cytoplasmic vacuolation, anisokaryosis, and nuclear vesiculation in proximal tubular cells. At the lowest dose tested in females (0.49 mg U/kg/day), anisokaryosis, nuclear vesiculation, and atrophy were observed in the proximal

## 3. HEALTH EFFECTS

tubules. At higher doses, interstitial reticulin sclerosis (0.88 and 1.32 mg U/kg/day in males and females) and interstitial collagen sclerosis (4.82 and 43.02 mg U/kg/day in males and females) were also observed.

In contrast to the results of this study, another 91-day study conducted by Gilman et al. (1998c) did not find statistically significant increases in the incidence of histological alterations in the kidneys of New Zealand rabbits exposed to 1.36 mg U/kg/day as uranyl nitrate in the drinking water for 91 days. Exposure to 40.98 mg U/kg/day resulted in increases in the incidence of cytoplasmic vacuolation, anisokaryosis, nuclear hyperchromicity, tubular dilation, tubular atrophy, and interstitial collagen and reticulum sclerosis. Most of these histological alterations persisted throughout a 91-day recovery period. Electron micrographic examination of the glomeruli and proximal tubules were conducted by McDonald-Taylor et al. (1992, 1997). A dose-related increase in the thickness of the glomerular basement membrane was observed in the 1.36 and 40.98 mg U/kg/day groups; as compared to the control group, the glomerular basement membranes were 20 and 36% thicker in the 1.36 and 40.98 mg U/kg/day groups, respectively (McDonald-Taylor et al. 1992). Observed effects in the proximal tubules included lumens filled with debris, a reduction in the height of epithelial cells, focal loss of brush border, splitting of the basal lamina, and renal interstitial fibrosis (McDonald-Taylor et al. 1997); these alterations were more common in the 40.98 mg U/kg/day group, but were also observed in some animals in the 1.36 mg U/kg/day group (incidence not reported). At the end of the 91-day recovery period, there was an increase in the thickness of the glomerular basement membrane and an increase in the severity of the proximal tubule lesions, as compared to values in rabbits sacrificed at the end of the exposure period (McDonald-Taylor et al. 1992, 1997). The results of this study (Gilman et al. 1998c) conflict with the results of this group's previous rabbit study (Gilman et al. 1998b). The investigators suggested that there were differences in the ways that animals in the two studies handled the ingested uranium and that the animals in the Gilman et al. (1998c) study more effectively cleared the uranium resulting in lower uranium levels in the kidney and bone. In this study (Gilman et al. 1998c), the uranium levels in the kidney and bone in rabbits ingesting a total intake of 3,557.25 mg U/kg/91 days were 3.48 and 2.89 µg/g, as compared to kidney and bone levels of 4.98 and 4.04 µg/g in rabbits ingesting 2,677.87 mg U/kg/91 days (Gilman et al. 1998b). Additionally, the investigators noted that some of the rabbits in the Gilman et al. (1998b) study were infected with *Pasteurella mutocida*; although animals with known infections were excluded from the study, some of the remaining rabbits may have had subclinical infections that may have affected their response to administered uranium.

In a longer exposure study, an increased incidence of tubule-interstitial lesions were observed in the kidneys of male Sprague-Dawley rats exposed to 2.4 mg U/kg/day as depleted uranyl nitrate hexahydrate



## 3. HEALTH EFFECTS

in mineral water for 9 months (Berradi et al. 2008). However, in a similar study, no alterations in the incidence of renal lesions were observed in rats administered 2.3 mg U/kg/day as depleted uranyl nitrate hexahydrate in drinking water for 9 months (Rouas et al. 2011).

Maynard and Hodge (1949) conducted a series of 30-day dietary exposure studies in rats and dogs using various uranium compounds. Although the results were poorly reported, the rat studies provide useful information for comparing the relative renal toxicity of different uranium compounds. No histological alterations were observed in the kidneys of rats exposed to 12,000 mg U/kg/day as uranium dioxide, uranium trioxide, or uranyl octaoxide or 11,000 mg U/kg/day as uranium tetrafluoride. Mild to moderate renal lesions were found in rats exposed to 440 mg U/kg/day as uranium tetrachloride (NOAEL of 90 mg U/kg/day) or 790 mg U/kg/day as uranium acetate (NOAEL of 200 mg U/kg/day). Mild histological alterations were observed in rats exposed to 200 mg U/kg/day as uranyl nitrate (NOAEL of 40 mg U/kg/day), 270 mg U/kg/day as uranyl fluoride (NOAEL of 140 mg U/kg/day), or 140 mg U/kg/day as uranium peroxide (NOAEL of 55 mg U/kg/day). The relative toxicity of the various uranium compounds were similar in the dog studies; however, the use of one dog per dose level limits the interpretative value of this study.

The chronic toxicity of uranium compounds was evaluated in a series of dietary exposure studies conducted by Maynard and associates (Maynard and Hodge 1949; Maynard et al. 1953) involving a 1-year exposure of dogs to uranium dioxide, uranyl fluoride, uranium tetrafluoride, uranium tetrachloride, or uranyl nitrate and a 2-year exposure of rats to uranium dioxide, uranyl fluoride, uranium tetrafluoride, or uranyl nitrate. A 2-year exposure of rats to uranyl fluoride or uranyl nitrate resulted in minimal tubular alterations at 81 and 170 mg U/kg/day, respectively; at higher doses ( $\geq 140$  and  $\geq 330$  mg U/kg/day, respectively), the renal damage progressed to tubular atrophy (Maynard and Hodge 1949; Maynard et al. 1953). Exposure to the less soluble compound, uranium tetrafluoride, resulted in mild tubular degeneration at the highest dose tested (11,000 mg U/kg/day). No renal effects were observed in rats exposed to uranium dioxide at doses as high as 12,000 mg U/kg/day for 2 years. Although interpretation of the dog studies (Maynard and Hodge 1949; Maynard et al. 1953) is limited by the small number of dogs tested (typically two dogs per dose), the results are consistent with the chronic rat studies and with shorter duration studies. Soluble uranium compounds, such as uranyl nitrate and uranyl fluoride, were more toxic than less soluble or insoluble compounds. Renal tubular atrophy was observed in dogs exposed to 9.5 mg U/kg/day as uranyl nitrate, 7.7 mg U/kg/day as uranyl fluoride, 31 mg U/kg/day as uranium tetrachloride, 150 mg U/kg/day as uranium tetrafluoride, and 900 mg U/kg/day as uranium dioxide; the severity of the atrophy increased with dose.

## 3. HEALTH EFFECTS

The relationship between duration of exposure and the progression of renal lesions was evaluated in a serial exposure study in which rats were exposed to 33, 170, or 660 mg U/kg/day as uranyl nitrate hexahydrate in the diet (Maynard et al. 1953). At 660 mg U/kg/day, slight degeneration and necrosis were observed after 1 day of exposure; the extent and severity of the degeneration and necrosis continued to progress during the first week of exposure. At the end of the second week of exposure, there was less evidence of necrosis and more evidence of typical regeneration in the renal tubules. Tubular atrophy was observed in rats exposed for 6–10 weeks, which progressed in severity and extent over the next 18 weeks with a concomitant decrease in tubular regeneration. At 26 weeks, atrophy was the most prominent feature with dilation of atrophic tubules and narrowing of the cortex. At the end of the 1-year study, moderate to moderately severe tubular atrophy was observed. At the 170 mg U/kg/day dose, necrosis and degeneration were observed after 2 days of exposure and the severity continued to progress during the first week of exposure. After 2 weeks of exposure, regeneration of the tubular epithelium was the prominent effect. The severity of damage did not vary much during the first 30 weeks of exposure, with the exception of tubular atrophy detected in a small number of animals at 30 weeks. After 1 year of exposure, the renal alterations were primarily regeneration with slight atrophy in some animals. No uranium-related effects were observed in rats exposed to 33 mg U/kg/day. The results of this study suggest that at low doses, the tubular epithelium is regenerated and further exposure does not result in more severe effects. However, at higher doses, the capacity of the kidney to regenerate the damaged epithelium is exceeded, resulting in atrophy; continued exposure results in further damage to the kidney.

**Endocrine Effects.** No endocrine effects after oral intake of uranium have been reported in humans. Few endocrine effects have been reported after uranium exposure in laboratory animals. In animal studies, a dose of 0.07 mg U/kg/day as uranyl nitrate hexahydrate for 16 weeks in drinking water resulted in degenerative changes in the thyroid epithelium and altered thyroid function in Wistar rats (Malenchenko et al. 1978). Sprague-Dawley rats (10/sex/dose) were exposed to uranium as uranyl nitrate in drinking water (males: up to 35.3 mg U/kg/day; females: up to 40.0 mg U/kg/day) for 28 days and then sacrificed. No treatment-related histopathological changes were found in any of the endocrine organs studied (adrenal, pancreas, parathyroid, pituitary, thymus, thyroid), and no treatment-related changes in these organ weights were noted (Gilman et al. 1998a). In addition, New Zealand rabbits were exposed to uranium as uranyl nitrate in the drinking water (males: up to 28.70 mg U/kg/day; females: up to 43.02 mg U/kg/day) for 91 days. No treatment-related histopathological changes were found, and no weight changes in the adrenal, pancreas, parathyroid, or pituitary glands were noted (Gilman et al. 1998b). Male New Zealand rabbits exposed to uranium as uranyl nitrate in drinking water (1.36 and

## 3. HEALTH EFFECTS

40.98 mg U/kg/day) for 91 days also failed to show any treatment-related histopathological or organ weight changes (Gilman et al. 1998c). In another study, Sprague-Dawley rats (15/sex/dose) were exposed to uranium as uranyl nitrate in the drinking water (males: up to 36.73 mg U/kg/day; females: up to 53.56 mg U/kg/day) for 91 days. Thyroid lesions were observed in both sexes (multifocal reduction of follicular size, increased epithelial height in males at 0.31 mg U/kg/day and females at 2.01 mg U/kg/day). A decreased amount and density of colloid in the thyroid was observed in males only.

No histological alterations were observed in the thyroid, adrenals, or pancreas of rats exposed to 400 mg U/kg/day as uranyl fluoride, 660 mg U/kg/day as uranyl nitrate, 11,000 mg U/kg/day as uranium tetrafluoride, or 12,000 mg U/kg/day as uranium dioxide in the diet for 2 years (Maynard and Hodge 1949; Maynard et al. 1953).

**Body Weight Effects.** No body weight effects after oral intake of uranium have been reported in humans.

Oral exposure to uranium compounds has caused body weight effects in animals, but these effects are not necessarily the result of systemic toxicity. The initial loss of body weight observed in animals exposed to high doses of uranium in the diet in acute-, intermediate-, and chronic-duration studies is usually accompanied by decreased food consumption in these animals. The decreased food consumption could be due to the aversive taste of uranium compounds in food. Subsequent acclimatization of the animals to the taste would normalize food intake and, consequently, reverse the initial loss of body weight. Thus, the changes in body weight seen in such studies may be a result of reduction in food consumption due to distaste rather than of uranium-specific chemical or radiological toxicity. Similarly, uranium in drinking water may influence palatability (some investigators have added sugar to the water to increase palatability), which may result in decreased water consumption and possibly influence body weight.

In a 2-week drinking water study in rats, doses of 28 mg U/kg/day as depleted uranyl acetate dihydrate resulted in a 53% reduction in body weight gain in males; food consumption data were not provided (Briner and Murray 2005). In the same study, exposure for 6 months reduced body weight gain by approximately 46% in males and 36% in females; no significant effects were reported at 14 mg U/kg/day either in the 2-week or the 6-month experiments. In a developmental study in which rats were administered between 2.8 and 28 mg U/kg/day by gavage doses on gestation days 6–15, body weight gain during the treatment period was 33–88% lower than the control group (Domingo et al. 1989c); this was associated with significant reductions in food consumption. Body weight losses of 18, 35, 27, 20, and

## 3. HEALTH EFFECTS

29%, respectively, were observed in rats given oral doses of 886 mg U/kg/day as uranium tetrachloride, 1,081 mg U/kg/day as uranyl fluoride, or 664 mg U/kg/day as uranyl nitrate hexahydrate for 30 days (Maynard and Hodge 1949); rabbits given oral doses of 14.2 mg U/kg/day as uranyl nitrate hexahydrate for 30 days (Maynard and Hodge 1949); and rats given oral doses of 270 mg U/kg/day as uranyl fluoride for 2 years (Maynard and Hodge 1949; Maynard et al. 1953).

No harmful effects on body weight were seen in rats given 12,342 mg U/kg as uranium dioxide or 11,650 mg U/kg as uranium trioxide for 30 days (Maynard and Hodge 1949), mice given 1,100 mg U/kg as uranyl nitrate hexahydrate for 18 weeks or 462 mg U/kg as uranyl nitrate hexahydrate for 48 weeks (Tannenbaum et al. 1951), or Sprague-Dawley rats exposed to uranium as uranyl nitrate in drinking water at doses up to 35.3 mg U/kg/day (males) and 40 mg U/kg/day (females) for 28 days or up to 36.73 mg U/kg/day (males) and 53.56 mg U/kg/day (females) for 91 days (Gilman et al. 1998a). No alterations in body weights were observed in rats given 12,341 mg U/kg as uranium dioxide or 10,611 mg U/kg as uranium hexafluoride for 2 years, or dogs given 8 mg U/kg as uranyl fluoride or 95 mg U/kg as uranyl nitrate hexahydrate for 1 year (Maynard and Hodge 1949; Maynard et al. 1953). Reduced food intake was observed following a single oral dose of 5.6 mg U/kg as uranyl nitrate hexahydrate to rats (Domingo et al. 1987) and in a 48-week study in rats and mice at 1,100 mg U/kg/day as uranyl nitrate hexahydrate (Tannenbaum et al. 1951). It has been suggested that this reduced food intake is a result of loss of appetite due to the unpalatability of the uranium compounds in the animals' food (Dygert 1949e). In two more recent drinking water studies in rats, doses of approximately 2–2.7 mg U/kg/day as uranyl nitrate hexahydrate in mineral water for up to 9 months did not significantly affect body weight or food or water consumption (Bensoussan et al. 2009; Bussy et al. 2006). In mice, exposure via the drinking water to up to 100 mg U/kg/day as uranyl nitrate hexahydrate for 15 weeks had no significant effect on body weight (Arnault et al. 2008).

In series of chronic rat dietary studies (Maynard and Hodge 1949; Maynard et al. 1953), decreases in body weight gain were observed in rats exposed to 330 mg U/kg/day as uranyl nitrate, 140 mg U/kg/day as uranyl fluoride, and 11,000 mg U/kg/day as uranium tetrafluoride; no alterations in body weight gain were observed in rats exposed to 12,000 mg U/kg/day as uranium dioxide.

**Metabolic Effects.** Tissandié et al. (2006, 2007) found alterations in  $1,25(\text{OH})_2\text{D}_3$  (active form of vitamin D) levels in rats exposed to a single gavage dose of depleted uranyl nitrate or depleted uranyl nitrate in mineral water for 9 months. One day after gavage administration of 97 mg U/kg, a significant 62% increase in  $1,25(\text{OH})_2\text{D}_3$  level was observed in male Sprague-Dawley rats; 3 days after

## 3. HEALTH EFFECTS

administration, there was a significant decrease (68% compared to controls) in the level (Tissandié et al. 2006). Significant decreases in serum inorganic phosphate levels (15% at day 1 and 28% at day 3) and parathyroid hormone (day 3 only) levels (90%) were also observed. Intermediate-duration exposure to 2.4 mg U/kg/day also resulted in significant decreases in  $1,25(\text{OH})_2\text{D}_3$  levels; however, no alterations in  $25(\text{OH})\text{D}_3$  (vitamin D metabolite), plasma calcium, inorganic phosphate, parathyroid hormone, or osteocalcin levels were found (Tissandié et al. 2007). Alterations in mRNA expression levels of *cyp24a1* (encoding the enzyme that directs the catabolism of vitamin D) and vitamin D target genes involved in calcium homeostasis were also observed in the 9-month study.

**3.2.2.3 Immunological and Lymphoreticular Effects**

No information was located regarding the effects of uranium on the immune system in humans following oral exposure for any duration.

In laboratory animals, oral exposure of rats, mice, and rabbits to uranium had no significant effect on immune system function. In one study, Sprague-Dawley rats (10/sex/dose) were exposed to uranium as uranyl nitrate in drinking water (males: up to 35.3 mg U/kg/day; females: up to 40.0 mg U/kg/day) for 28 days and then sacrificed. No treatment-related effects were noted in the lymphoreticular tissues examined (bone marrow, mesenteric and mediastinal lymph nodes, spleen, and thymus) (Gilman et al. 1998a). In addition, New Zealand rabbits were exposed to uranium as uranyl nitrate in the drinking water (males: up to 28.70 mg U/kg/day; females: up to 43.02 mg U/kg/day) for 91 days. No histopathological changes were found, and no changes in the bone marrow, mesenteric and mediastinal lymph nodes, or thymus were noted (Gilman et al. 1998b). Rats exposed to oral doses of 0.07 mg U/kg as uranyl nitrate hexahydrate for 4 weeks showed an increase in spleen weight but the body weights of both the control and test animals were not provided, making it impossible to determine whether the net change in spleen weight had any toxicological significance (Malenchenko et al. 1978). Sprague-Dawley rats exposed to uranium as uranyl nitrate in drinking water (males: up to 36.73 mg U/kg/day; females: up to 53.56 mg U/kg/day) for 91 days showed sinus hyperplasia of the spleen in both sexes at the highest dose (males: 36.73 mg U/kg/day; females: 53.56 mg U/kg/day). No lesions were observed in bone marrow, mesenteric and mediastinal lymph nodes, or thymus (Gilman et al. 1998a). In other studies with mice and rats, no histological changes in the spleen, lymph nodes, or bone marrow were seen in the animals following administration of up to 5,000 mg U/kg of various uranium compounds (uranyl nitrate hexahydrate, uranyl fluoride, uranium dioxide, uranium peroxide, uranium tetrafluoride, uranium tetrachloride, triuranium octaoxide, or uranium trioxide) in the diet for 48 weeks or 2 years. No

## 3. HEALTH EFFECTS

consistent hematological changes were found in hematocrit, hemoglobin, or white blood cell counts (Maynard et al. 1953; Tannenbaum et al. 1951). No other specific immunological tests were performed.

**3.2.2.4 Neurological Effects**

No studies were located for humans regarding neurological effects following oral exposure to uranium compounds.

There is a limited number of reports of neurological effects in animals following acute oral exposure to uranium compounds. A study aimed at determining an oral LD<sub>50</sub> for uranyl acetate dihydrate in Sprague-Dawley rats given single gavage doses ranging from 11 to 717 mg U/kg reported piloerection, tremors, hypothermia, pupillary size decreases, and exophthalmos (Domingo et al. 1987). The signs became more severe as the number of days posttreatment increased; however, the study did not specify the dose levels at which the various clinical signs appeared.

Two more recent acute-duration studies focused on the neurobehavioral effects of uranium and on effects on brain neurotransmitters. Administration of 28 mg U/kg/day (depleted uranyl acetate dihydrate) to Long-Evans rats via the drinking water for 2 weeks significantly increased motor activity in males as judged by number of lines crossed and rearing frequency, no significant effect was reported at 14 mg U/kg/day (Briner and Murray 2005); similar but nonsignificant alterations in open-field behavior were observed in females. Lipid oxidation in the brain was significantly increased in males and females dosed with 28 mg U/kg/day. According to the investigators, lines crossing and rearing frequency exhibited significant correlations with brain lipid oxidation, but the correlation coefficients were only 0.21 and 0.23, respectively, indicating that only about 4% of the variance in the behavioral tests could be explained by changes in lipid oxidation. Briner and Murray (2005) also exposed rats for 6 months to 14 or 28 mg U/kg/day and found increases in line crossing and rearing behavior in males at 14 and 29 mg U/kg/day and increased line crossing in females at 29 mg U/kg/day. However, lipid oxidation did not correlate with line crossing or rearing behavior. In a 2-week study in Swiss-Webster mice that also measured neurotransmitters and their metabolites in the midbrain, exposure to 6 mg U/kg/day (depleted uranyl acetate dihydrate; only dose level tested) significantly increased open-field line crossing in females, but not in males (Briner 2009). Exposure to uranium significantly increased tyrosine and decreased 3,4-dihydroxyphenylalanine (DOPA), norepinephrine (NE), and epinephrine (E); it had no significant effect on dopamine (DA) or homovanillic acid (HVA). According to the investigator, levels of DOPA in the midbrain were inversely related to lines crossed in open field ( $r^2=0.12$ ). Exposure to uranium

## 3. HEALTH EFFECTS

significantly increased brain lipid oxidation, but lipid oxidation did not correlate with levels of tyrosine, DOPA, NE, E, or HVA.

Intermediate-duration oral studies that examined the gross and microscopic appearance of the brain of animals exposed to uranium have not reported compound-related alterations in male and female Sprague-Dawley rats exposed via drinking water to up to 40 mg U/kg/day as uranyl nitrate for 28 days or up to 54 mg U/kg/day for 91 days (Gilman et al. 1998a), and in male and female New Zealand rabbits similarly exposed to up to 43 mg U/kg/day for 91 days (Gilman et al. 1998b).

Intermediate-duration studies have also examined the effects of uranium on behavior, transmitter levels in the brain, including genes involved in neurotransmitter metabolism, and oxidative stress in the brain.

A study of neurotransmitter levels in the brain of male Sprague-Dawley rats following 1.5, 6, or 9 months of dosing with approximately 2.7 mg U/kg/day as depleted uranyl acetate dehydrate in mineral water; (only dose level tested) reported that acetylcholinesterase activity was not significantly affected in the striatum, hippocampus, or frontal cortex at any time point, but it was significantly decreased in the cerebellum at 6 months (Bussy et al. 2006). Of many biochemical measurements conducted, the only significant changes were as follows: increased dopamine in the hypothalamus at 1.5 months, decreased ratio (3,4-dihydroxyphenylacetic acid [DOPAC]+HVA)/DA in the frontal cortex at 6 months, decreased 5HIAA and the ratio 5HIAA/5HT in the frontal cortex at 9 months, and decreased DOPAC and (DOPAC+HVA)/DA in the striatum at 9 months. Uranium significantly increased in the striatum at 1.5 months and to a lesser extent at 9 months (not measured at 6 months). Bensoussan et al. (2009) examined alterations in cholinergic system in response to a 1.5- or 9-month exposure to 2 mg U/kg/day as uranyl nitrate in mineral water. After 1.5 months of exposure, there were significant decreases in acetylcholine levels and acetylcholinesterase activity in the cortex; there were no alterations in the hippocampus. At 9 months, there was a decrease in acetylcholinesterase activity in the cortex, but no changes in acetylcholine levels, and no alterations in the hippocampus. Based on alterations in gene expression, the investigators noted that exposure to uranium seemed to induce transcriptional alterations in the hippocampus aimed at preserving acetylcholine levels, whereas in the cortex, exposure led mainly to translational alterations that increased acetylcholinesterase levels after 9 months of exposure. The investigators also noted that the lack of correlation between the increase in genes expressing cortical acetylcholinesterase and the decrease in acetylcholinesterase activity in the cortex could be explained by the complex relation between mRNA and enzyme activity.

## 3. HEALTH EFFECTS

A 3-month drinking water study in male Sprague-Dawley rats dosed with up to 22.4 mg U/kg/day (uranyl acetate dihydrate) that conducted behavioral tests including open-field activity, passive avoidance, and Morris water maze reported that exposure to uranium did not significantly affect any of the behavioral tests (Belles et al. 2005). A study that compared the effects of depleted and 4% enriched uranium (2.7 mg U/kg/day in mineral water for 1.5 months) in Sprague-Dawley rats reported that whole brain of controls had comparable amounts of uranium as brains of rats exposed to depleted or enriched uranium (Houpert et al. 2005). However, uranium was 1.5–2 times higher in the hypothalamus and hippocampus from rats dosed with enriched uranium than in control rats or rats exposed to depleted uranium. No significant increases in uranium levels were observed in the cortex, striatum, brainstem, or cerebellum were observed in the enriched or depleted uranium groups. Rats exposed to enriched uranium had a significant increase in the amount of paradoxical sleep (37%) compared to controls. In addition, exposure to enriched, but not depleted, uranium significantly decreased spatial working memory capacities and increased anxiety. In an additional study by the same group of investigators, male Sprague-Dawley rats exposed to 2.5 mg U/kg/day as 5.26% enriched uranyl nitrate for 9 months via drinking water (Houpert et al. 2007b). Four neurobehavioral tests (activity in open field, a two-object recognition task, a test for spatial working memory in a Y-maze, and a forced swimming test) were conducted before dosing started and at 3, 6, and 9 months. The only test that was affected by exposure to uranium was the spatial working memory test after 3 and 9 months of exposure, but not after 6 months. The investigators suggested that the results may indicate that enriched uranium disrupts memory in a spatial task involving the hippocampus but does not affect memory in another task in which hippocampal functioning is less crucial.

In a study examining the effects of uranium on the sleep cycle, Sprague-Dawley rats were exposed to uranium in drinking water for 90 days. An increase in the amount of time spent in rapid eye movement (REM) sleep was observed in rats exposed to 3.7 mg U/kg/day as 4.92% enriched uranyl nitrate in mineral water for 30 or 60 days; a nonsignificant increase was observed after 90 days of exposure (Lestaevel et al. 2005b). This increase in REM sleep was due to the number of REM sleep episodes rather than an increase in the duration of REM episodes. The increases in the amount of REM sleep primarily occurred during the light period (normal sleeping period for rats), suggesting that the circadian rhythms were not affected by uranium exposure.

The highest NOAEL values and all reliable LOAEL values in each species and duration category for neurological effects from exposure to uranium by the oral route are presented in Table 3-2 and plotted in Figure 3-2.



## 3. HEALTH EFFECTS

**3.2.2.5 Reproductive Effects**

No human studies were located regarding reproductive effects following oral exposure to uranium compounds.

Some animal studies, mostly in rodents, have shown effects on some aspects of male and female reproductive function following exposure to uranium. For the most part, general toxicity studies that conducted gross and microscopic examination of the reproductive organs did not report adverse effects. For example, no histopathology or changes in reproductive organ weight were reported in Sprague-Dawley rats exposed to uranium as uranyl nitrate in the drinking water (males: up to 35.3 mg U/kg/day; females: up to 40.0 mg U/kg/day) for 28 days (Gilman et al. 1998a). No reproductive effects or changes in reproductive organ weights were found in the epididymis, testes, ovary, or uterus of Sprague-Dawley rats (15/sex/dose) exposed to uranium as uranyl nitrate in drinking water (males: up to 36.73 mg U/kg/day; females: up to 53.56 mg U/kg/day) for 91 days (Gilman et al. 1998a). New Zealand rabbits exposed to uranium as uranyl nitrate in the drinking water (males: up to 28.70 mg U/kg/day; females: up to 43.02 mg U/kg/day) for 91 days showed no histopathological or organ weight changes in the epididymis, ovary, testes, or uterus (Gilman et al. 1998b). In chronic-duration studies, male rats given high oral doses (331 mg U/kg/day) of uranyl nitrate hexahydrate in the diet for 2 years developed testicular degeneration (Maynard et al. 1953).

Fertility has been assessed in a few studies. Fertility was not significantly affected in a study in which male Swiss mice were given gavage doses of up to 14 mg U/kg/day as uranyl acetate dihydrate for 60 days before mating with females that had received the same doses for 14 days (Paternain et al. 1989). In a 64-day drinking-water study with Swiss-Webster mice, treatment of males with  $\geq 5.6$  mg U/kg/day (uranyl acetate) followed by mating with untreated females resulted in significant reductions in pregnancy rates, which were associated with significant reductions in spermatozoa counts and reduced epididymal weights (Llobet et al. 1991). Treatment of male Sprague-Dawley rats with 11.2 mg U/kg/day (uranyl acetate) in the drinking water for 3 months before mating with untreated females also resulted in a significant reduction in pregnancy rate; no significant effect was reported at 5.6 mg U/kg/day (Linares et al. 2005). In this study, there were no significant effects on the number of total implants/litter or number of viable and nonviable implants/litter. Neither the absolute nor relative weight of the testes and epididymis was significantly affected; a significant decrease in the number of spermatid/testis was observed at  $\geq 11.2$  mg U/kg/day. Microscopic examination of the testes showed a progressive, but not significant, loss of Sertoli cells or germinal cells with cytoplasmic vacuolization. Maynard and associates

## 3. HEALTH EFFECTS

conducted two continuous breeding studies to evaluate the effect of uranium on fertility. In the first study (Maynard and Hodge 1949), pairs of male and female rats were exposed to 2% uranyl nitrate hexahydrate in the diet for 200 days (650 and 750 mg U/kg/day in males and females, respectively) followed by 5 months on the control diet. A dramatic decrease in the number of litters produced (46%) was observed in the uranium-exposed group; a decrease in the average number of offspring per litter was also observed. Irregular estrous cycles were observed in 14/44 of the uranium-exposed rats compared to 2/45 controls. The investigators suggested that the decreased fertility and irregular estrous cycle may have resulted from the marked decrease in body weight (after 200 days of exposure, the uranium group weighed 23% less than controls) and decreased food intake (no data provided). In the second study (Maynard et al. 1953), pairs of male and female weaning rats were administered 2% uranyl nitrate hexahydrate in the diet for 24 hours (1400 mg U/kg/day) and then fed a stock diet for 1 year. A slight decrease (7%) in the total number of litters was observed in the uranium group; a 12% decrease in the total number of offspring was also observed. No alterations in body weight gain were observed. Interpretation of the study results to evaluate whether uranium affects reproduction (in the absence of marked decreases in body weight gain) is difficult because the Maynard et al. (1953) study did not conduct a statistical analysis of the data to determine whether the small decreases in number of litters and litter size were significant.

The effects of uranium on ovarian function have also been studied. Exposure of female C57Bl x CBA mice to  $\geq 1.25$  mg U/kg/day (uranyl nitrate hexahydrate) in drinking water for 15 weeks resulted in slight disturbance in ovarian folliculogenesis (Arnault et al. 2008). In a similar study, exposure of female Swiss mice to up to 10 mg U/kg/day (uranyl nitrate hexahydrate) for 40 days in drinking water did not alter the mean number of oocytes ovulated per female (Kundt et al. 2009). However, doses of  $\geq 2.5$  mg U/kg/day significantly increased (more than doubled) the percentage of dysmorphic oocytes; the increases consisted of increases in perivitaline space at  $\geq 5$  mg U/kg/day, lysed oocytes at 2.5 and 5 mg U/kg/day, fragmented oocytes at 10 mg U/kg/day, and nonspherical oocytes at  $\geq 2.5$  mg U/kg/day. Exposure to uranium also significantly increased the incidence of micronuclei in cumulus cells (oocyte-supporting cells); a strong correlation between the number of micronuclei and dose was found. The mitotic index in cumulus cells was significantly decreased in the mid- and high-dose groups in a dose-related fashion. Uranium also increased the number of metaphase plate abnormalities in oocytes arrested in metaphase II. In yet another study, exposure of hybrid female mice to up to 6.9 mg U/kg/day (uranyl nitrate hexahydrate) for 49 days in drinking water did not affect the number of ovulated oocytes (Feugier et al. 2008). Oocyte quality was not affected by the lowest dose tested (1.9 mg U/kg/day), but the proportion of healthy oocytes was reduced by half at doses  $\geq 3.9$  mg U/kg/day. Absence of the first polar body and abnormal perivitaline space were the main morphological alterations. An increase from the 3.9 to 6.9 mg U/kg/day dose did not

## 3. HEALTH EFFECTS

increase the proportion of oocytes with abnormalities, but led to a diversification in oocyte abnormalities. Both Arnault et al. (2008) and Feugier et al. (2008) measured uranium in the ovaries and reported no significant accumulation of the chemical. Effects of uranium on ovarian folliculogenesis were also studied by Raymond-Whish et al. (2007). Administration of approximately 0.08 or 0.39 mg U/kg/day as depleted uranyl nitrate hexahydrate to 28-day-old B6C3F1 mice in tap water for 30 days significantly decreased the number of large primary follicles in the ovary, whereas a larger dose of 1.9 mg U/kg/day increased secondary or growing follicles. No significant alterations were observed at 9.3 mg U/kg/day. In a different experiment, female mice were exposed to much smaller doses (0.00008–0.009 mg U/kg/day) of uranium for 30 days prior to mating with untreated males and then continued to be dosed during gestation. Necropsy of dams on postnatal day 5 showed that doses  $\geq 0.00039$  mg U/kg/day significantly reduced the number of small primary follicles; however, all other follicle populations including primordial, secondary/growing, healthy, and atretic were unchanged.

Raymond-Whish et al. (2007) also examined the potential estrogenic properties of uranium. Exposure of ovariectomized (at 28-days of age) mice to 0.009 mg U/kg/day as depleted uranyl nitrate hexahydrate for 30 days significantly increased proliferation of the epithelial cell lining of the uterus, and uterus weight increased 3-fold; however, significant effects were not observed at 0.09 or 0.9 mg U/kg/day. In addition, mice exposed to 0.005 and 0.009 mg U/kg/day had significantly increased presence of cornified vaginal cells, indicative of estrogenic effects of uranium. In a similar experiment, exposure of ovariectomized C57Bl/6J mice to 0.005 mg U/kg/day for 10 days beginning at 50 days of age significantly increased uterine weight and exposure to 0.009 mg U/kg/day significantly accelerated vaginal opening; both effects were blocked by intraperitoneal injections of an antiestrogenic drug. These effects were observed at doses that are several orders of magnitude lower than the adverse effect levels of other studies and were not observed at higher uranium doses. Additional research is needed to confirm these results; thus, the LOAEL values are not presented in Table 3-2 or plotted in Figure 3-2.

A study was conducted to distinguish chemical versus radiological effects of uranium on the metabolism of steroids in rat testes (Grignard et al. 2008). Sprague-Dawley rats were exposed to 0 or 1.9 mg depleted or 4.24% enriched U/kg/day (uranyl nitrate hexahydrate) in the drinking water for 9 months. Exposure to depleted uranium did not significantly affect blood levels of testosterone or  $17\beta$ -estradiol. Exposure to depleted uranium also did not significantly affect the levels of genes encoding proteins regulating steroid synthesis. In addition, depleted uranium did not significantly alter the expression levels of transcription factors regulating the expression of the genes that were monitored. Exposure to enriched uranium did not significantly affect blood levels of  $17\beta$ -estradiol, but significantly increased testosterone levels and the

## 3. HEALTH EFFECTS

expression of genes involved in steroidogenesis. In addition, enriched uranium significantly increased the expression of transcription factors involved in the regulation of steroidogenic genes. These results led the investigators to suggest that the adverse effects were mainly due to the radiological activity of the compounds.

The highest NOAEL values and all reliable LOAEL values in each species and duration category for reproductive effects from exposure to uranium by the oral route are presented in Table 3-2 and plotted in Figure 3-2.

**3.2.2.6 Developmental Effects**

No studies were located that reported developmental effects in humans following oral exposure to uranium for any duration. Animal studies indicate that oral exposure to uranium can cause developmental effects, but only at relatively high doses.

Pregnant Swiss mice were exposed to uranium as uranyl acetate dihydrate by gavage in water at a dose of 0.028, 0.28, 2.8, or 28 mg U/kg/day from gestation day 13 through postnatal day 21 (Domingo et al. 1989b). Treatment had no significant effects on mean litter size at birth or on day 4, but litter size was significantly decreased at postnatal day 21 at 28 mg U/kg/day (5.5 vs. 8.8 in water-only controls). The viability index (number of pups viable at day 21/number of pups born) and the lactation index (number of pups viable at day 21/number of pups retained at day 4) were significantly decreased in the 28 mg U/kg/day group. No significant differences were observed in developmental milestones (pinnae unfolding, lower incisor eruption, eye opening) or in pup weight or body length. Structural variations were not assessed in this report. Two dams in the 2.8 mg U/kg/day group and three in the 28 mg U/kg/day group died during the last period of gestation. Although the cause of death was not determined, it was attributed to the administration of uranium. Yet, the investigators stated that maternal toxicity was not evident from changes in body weight and/or food consumption.

Increased late resorptions and decreased live fetuses were reported in Swiss mice administered 14 mg U/kg/day (uranyl acetate dihydrate) by gavage for 14 days before mating with males that received the same doses for 60 days; the females were sacrificed on gestation day 13 (Paternain et al. 1989). No significant effects were reported at 5.6 mg U/kg/day. In dams that were allowed to give birth and nurse the offspring until 21 days of age (dams' exposure continued during gestation and lactation), doses of 5.6 mg U/kg/day significantly increased neonatal death per litter, and the lowest dose tested, 2.8 mg

## 3. HEALTH EFFECTS

U/kg/day, significantly reduced pup weight on postnatal day 21 (Paternain et al. 1989). No information was provided in this study regarding maternal effects. Dose-related fetotoxicity, manifested as reduced fetal body weight and length, increased incidence of stunted fetuses and external and skeletal malformations, and increased incidence of developmental variations were reported in the offspring of 20 pregnant Swiss mice given uranyl acetate dihydrate (2.8, 5.6, 14, and 28 mg U/kg/day) by gavage on gestation days 6–15 and sacrificed on gestation day 18 (Domingo et al. 1989c). A significant increase in the number of external defects was observed at  $\geq 2.8$  mg U/kg/day. The external malformations included a significant increase in the incidence of cleft palate ( $\geq 5.6$  mg U/kg/day) and hematomas (at 2.8 and 28 mg U/kg/day). A significant increase in the incidence of skeletal abnormalities (bipartite sternebrae and reduced or delayed ossification of the hindlimb, forelimb, skull, and tail) was seen in the 14 and 28 mg U/kg/day groups. Embryo lethality was not found at any of the dose levels tested. Maternal toxicity was evident in all treated groups, as a dose-related significant reduction in maternal weight gain during exposure occurred (43% reduction in the lowest dose group, 82% in the highest dose group); this may have played a role in the observed developmental effects.

More recent studies also provide information on the developmental effects of uranium. Exposure of female Sprague-Dawley rats to doses of 0, 22.5, or 45 mg U/kg/day (uranyl acetate dihydrate) in the drinking water for 4 weeks before mating with untreated males and continued dosing during gestation and lactation had no significant effect on pup developmental landmarks such as pinna detachment, incisor eruption, and eye opening (Sánchez et al. 2006). Neuromotor maturation was also not affected, but passive avoidance acquisition and retention time 24 hours after the test were significantly modified. The lowest dose tested significantly reduced pup body weight on postnatal day 21, but not on postnatal day 1. The only maternal effects reported in this study were a significant dose-related increase in body weight gain on gestation days 0–14 and a significant increase in gravid uterine weight at 45 mg U/kg/day; no data were provided regarding food consumption. Neurodevelopment was also examined by Houpert et al. (2007a) in offspring from Sprague-Dawley rats exposed to 0 or approximately 4.3 mg U/kg/day as 4.24% enriched uranyl nitrate hexahydrate in mineral water for 3 months before mating and during gestation and lactation. Behavioral tests were performed in male offspring at 2, 5, and 9 months. Rats were tested for locomotor activity and rearing indices, a spatial working memory test, and an elevated plus-maze test. At 2 months, when the tests began, exposed pups were comparable to control pups in body weight and organ weight (brain, kidneys, femur, and skull). Uranium did not accumulate in the brain. The results of the motor and behavioral tests showed that exposure to uranium induced hyperactivity in the offspring at 5 months and was more evident at 9 months; the investigators considered this to be delayed hyperactivity. This was evidenced by increased rearing indices and activity in the open field (not statistically

## 3. HEALTH EFFECTS

significant), and increased activity in the two mazes. The results also showed a reversible slight decrease in spatial working memory. The only information regarding the dams in this study was that body weight gain during gestation was comparable between treated and control groups.

Two studies reported effects on ovarian folliculogenesis in female offspring from exposed mice. Arnault et al. (2008) exposed C57Bl x CBA mice to 0, 1.25, 12.5, or 100 mg U/kg/day (uranyl nitrate hexahydrate) in the drinking water for 15 weeks. Mice were then mated to untreated males, and dams and female pups were sacrificed 3 months later. Microscopic examination of the ovaries of the female pups showed that pups from exposed dams had a significantly decreased percentage of the largest follicles. The investigators noted that the effect could be due either to a direct effect of transplacental transfer of uranium or to an indirect effect resulting from uranium-induced physiological disturbances in the dams, or both. In the other study, B6C3F1 mice were exposed via the tap water to low uranium doses ranging from approximately 0.00008 to 0.00093 mg U/kg/day as depleted uranyl nitrate hexahydrate for 30 days prior to breeding with untreated males (Raymond-Whish et al. 2007); treatment continued during gestation. In female pups, sacrificed on postnatal day 5, exposure to 0.00008 or 0.00093 mg U/kg/day significantly reduced primordial follicles. Nonsignificant decreases in primordial follicles were observed at 0.00039 and 0.00019 mg U/kg/day. The investigators noted that neonatal mouse ovaries only have oogonia and primordial follicles. These results in pups are analogous to the results in mouse dams, not-mated mice, and immature mice.

A study is available that examined the effect of a high dose of uranium on tooth eruption and development in young Wistar rats (Pujadas Bigi et al. 2003). One- or 7-day-old rats were administered a single gavage dose of 0 or approximately 42.7 mg U/kg (uranyl nitrate hexahydrate) in water and were sacrificed on days 7 or 14, respectively. Hemimandibles were resected and processed for microscopic examination. Bone formation was significantly reduced in the buccal and lingual aspects of 7-day-old treated rats. Bone resorption was significantly higher in the occlusal and lingual aspects of both 1- and 7-day-old treated rats. Tooth eruption was significantly lower in both treated groups compared with controls. Tooth development was also found to be significantly diminished in both treated groups compared with controls. The investigators suggested that the delay in tooth eruption may be due to decreased bone formation in the developing alveolar bone. They further speculated that the diminished tooth development may be caused by a toxic effect on Hertwig's sheath cells, odontoblasts, and cementoblasts. In a more recent study, the investigators showed that the delay in tooth eruption, dental development, and mandibular growth observed 7 days postdosing with uranium was no longer evident after day 27 (Pujadas Bigi and Ubios 2007).

## 3. HEALTH EFFECTS

The highest NOAEL values and all reliable LOAEL values in each species and duration category for developmental effects from exposure to uranium by the oral route are presented in Table 3-2 and plotted in Figure 3-2.

**3.2.2.7 Cancer**

No evidence linking oral exposure to uranium to human cancer has been found. Although natural, depleted, or enriched uranium and uranium compounds have not been evaluated in a cancer bioassay, there is potential for the carcinogenicity of uranium, since it emits primarily alpha radiation. Nevertheless, no evidence has been found to associate human exposure to uranium compounds and carcinogenesis. The National Academy of Sciences has determined that bone sarcoma is the most likely cancer from oral exposure to uranium; however, their report noted that this cancer has not been observed in exposed humans and concluded that exposure to natural uranium may have no measurable effect (BEIR IV).

No studies were located that provided evidence that oral exposure of humans to uranium as an alpha-emitting radiation source causes cancer. The available human data on the relative potential of ingested radium and uranium isotopes to induce cancers in humans concluded that the cumulative lifetime risk to 1 million people, each ingesting 5 pCi of a radium isotope ( $^{226}\text{Ra}$ ,  $^{228}\text{Ra}$ , and  $^{224}\text{Ra}$ ) per day, for the induction of skeletal cancers (bone sarcomas and carcinomas of the head sinuses) is 9 bone sarcomas and 12 head carcinomas for  $^{226}\text{Ra}$ , 22 bone sarcomas for  $^{228}\text{Ra}$ , and 1.6 bone sarcomas for  $^{224}\text{Ra}$ . Assuming that the risk per rad of the average skeletal dose is equal for  $^{226}\text{Ra}$  and uranium isotopes with half-lives exceeding 1,000 years, and that the equilibrium skeletal content is 25 times the daily ingestion of  $^{226}\text{Ra}$  but 11 times the daily ingestion of long-lived uranium, the cumulative lifespan risk to 1 million people, each ingesting 5 pCi/day of  $^{234}\text{U}$  (0.0008  $\mu\text{g}$ ),  $^{235}\text{U}$  (2.3  $\mu\text{g}$ ), or  $^{238}\text{U}$  (15  $\mu\text{g}$ ), is estimated to be about 1.5 bone sarcomas. However, no cancers would be expected if the incidence is found to vary with the square of the dose instead of linearly (Mays et al. 1985). The BEIR IV report came to the same conclusion, but reserved the opinion that bone sarcomas might be caused by highly enriched uranium. The report estimated a lifetime risk of excess bone sarcomas per million people of 1.5 if soluble uranium isotopes were ingested at a constant daily rate of 1 pCi/day (0.037 Bq/day). The number of bone sarcomas that occur naturally in a population of a million people is 750. However, no quantitative risk coefficient estimates for developing human exposure protection benchmarks were provided in this report. In addition, the BEIR IV analysis was presumably based on generic short-lived alpha-emitting sources,

### 3. HEALTH EFFECTS

such as radon that have a higher potential for inducing cancer, and not on radionuclides with relatively longer radioactive half-lives like  $^{238}\text{U}$ ,  $^{235}\text{U}$ , and  $^{234}\text{U}$ . Perhaps more importantly, the BEIR IV report concluded that "...exposure to natural uranium is unlikely to be a significant health risk in the population and may well have no measurable effect" (BEIR IV 1988).

There are limited data on the carcinogenicity of uranium compounds in animals. Chronic oral exposure studies in rats and dogs have not reported neoplasms following ingestion of several uranium compounds (Maynard and Hodge 1949; Maynard et al. 1953). The highest doses tested in 1-year dog studies were 95 mg U/kg/day as uranyl nitrate, 8 mg/kg/day as uranyl fluoride, 31 mg U/kg/day as uranium tetrachloride, 3,790 mg U/kg/day as uranium tetrafluoride, and 8,815 mg U/kg/day as uranium dioxide. In the rat 1-year studies, the highest doses tested were 664 mg U/kg/day as uranyl nitrate, 10,611 mg U/kg/day as uranium tetrafluoride, and 12,341 mg U/kg/day as uranium dioxide.

#### 3.2.3 Dermal Exposure

##### 3.2.3.1 Death

No deaths have been reported in humans as a result of dermal exposure to uranium.

Deaths have occurred in animals after dermal exposure to uranium compounds from both single and repeated exposures. Generally, the more water-soluble uranium compounds were the most toxic and the rabbit was the most sensitive species. Deaths were due to renal failure.

In a series of 4-hour exposures to uranium compounds followed by washing with detergent and a 30-day observation period, the lowest reported  $\text{LD}_{50}$  value was 28 mg U/kg as uranyl nitrate in an ethereal solution in New Zealand rabbits (Orcutt 1949). Calculated  $\text{LD}_{50}$  values for identical exposures to uranyl nitrate were 1,190 mg U/kg for guinea pigs and 4,286 mg U/kg for mice. Insufficient fatalities occurred to calculate an  $\text{LD}_{50}$  for rats, but the mortality curve fell between that of the rabbits and the guinea pigs. Deaths mainly occurred 5–7 days after exposure and were due to renal failure. Similar experiments with other uranium compounds in rabbits using a lanolin vehicle showed that water-soluble compounds (uranyl fluoride, uranium tetrachloride, uranium pentachloride) were the most toxic; the slightly soluble compounds (uranium trioxide, sodium diuranate, ammonium diuranate) had intermediate toxicity; and the water-insoluble compounds (uranium tetrafluoride, uranium dioxide, uranium peroxide, triuranium octoxide) caused no deaths (Orcutt 1949).



### 3. HEALTH EFFECTS

Decreased survival was observed in female Wistar rats following dermal application of 280 mg U as uranyl nitrate hexahydrate diluted in an oil-water emulsion; survival was inversely related to the duration of exposure and the application area (Lopez et al. 2000). A 24-hour application to 0.5, 1, 2, 4, 6, 8, or 16 cm<sup>2</sup> area resulted in survival rates of 80, 83, 67, 29, 33, 0, and 0%, respectively; application to 8 cm<sup>2</sup> for 1 minute, 7 minutes, 15 minutes, 30 minutes, 1 hour, 8 hours, or 24 hours resulted in survival rates of 100, 100, 100, 67, 45, 43, 10, and 0%, respectively.

Chemically induced renal failure caused 100% mortality in male Wistar rats after five daily exposures to 237 or 1,928 mg U/kg/day as uranyl nitrate hexahydrate or ammonium uranyl tricarbonate, respectively, applied in a water-Vaseline<sup>®</sup> emulsion (De Rey et al. 1983). A 60% mortality rate was also reported for other male Wistar rats that received daily applications of 1,965 mg U/kg as uranyl acetate dihydrate for 1–11 days. No deaths were reported for other Wistar rats similarly treated with 2,103 mg U/kg/day as ammonium diuranate or to an unspecified dose of uranium dioxide (De Rey et al. 1983).

Intermediate-duration dermal exposure in guinea pigs indicated that smaller repeated doses were better tolerated than a large single dose when the total exposure was the same. In a 4-week experiment where exposure was to 379 mg U/kg as uranyl nitrate for 3 days/week, 14% mortality was observed (Orcutt 1949). If the same cumulative dose (4,741 mg U/kg) had been given in a single application, 86% mortality would have been expected.

The LD<sub>50</sub> values for each species and other LOAEL values for mortality from exposure to uranium through the dermal route are presented in Table 3-3.

#### **3.2.3.2 Systemic Effects**

No studies were located regarding systemic effects in humans following dermal exposure to uranium compounds for acute, intermediate, or chronic durations.

No studies were located regarding the respiratory, cardiovascular, gastrointestinal, hematological, hepatic, or endocrine effects of uranium in animals following acute-, intermediate-, or chronic-duration exposure. The existing animal data on musculoskeletal, renal, dermal, and body weight effects are limited to acute- and intermediate-duration exposures.

Table 3-3 Levels of Significant Exposure to Uranium - Dermal

Species (Strain)	Exposure/ Duration/ Frequency/ (Route)	System	LOAEL			Reference Chemical Form	Comments
			NOAEL	Less Serious	Serious		
<b>ACUTE EXPOSURE</b>							
<b>Death</b>							
Rat (Wistar)	1-11 d 1x/d			1965 M mg/kg	(60% mortality in 11 days)	De Rey et al. 1983 Uranyl Acetate	
Rat (Wistar)	1-11 d 1x/d			1928 M mg/kg	(100% mortality in 5 days)	De Rey et al. 1983 Ammonium Uranyl Tricarbonate	
Rat (Wistar)	1-11 d 1x/d			237 M mg/kg	(100% mortality in 5 days)	De Rey et al. 1983 Uranyl Nitrate	
Rat (Wistar)	4 hr (EPICU)			101 F mg/kg	(LD50)	Orcutt 1949 Uranyl Nitrate	
Mouse (albino)	4 hr (EPICU)			4286 F mg/kg	(LD50)	Orcutt 1949 Uranyl Nitrate	
Gn Pig	4 hr (EPICU)			2520 mg/kg	(LD50)	Orcutt 1949 Uranium Tetrachloride	
Gn Pig (NS)	once (EPICU)			1190 mg/kg	(LD50)	Orcutt 1949 Uranyl Nitrate	
Rabbit (New Zealand)	4 hr (EPICU)			188 mg/kg	(50% mortality)	Orcutt 1949 Uranium Tetrachloride	

Table 3-3 Levels of Significant Exposure to Uranium - Dermal

(continued)

Species (Strain)	Exposure/Duration/Frequency (Route)	System	LOAEL			Reference Chemical Form	Comments
			NOAEL	Less Serious	Serious		
Rabbit (New Zealand white,red,chech)	4 hr (EPICU)				3091 mg/kg (83% mortality)	Orcutt 1949 Uranyl Fluoride	
Rabbit (New Zealand)	4 hr (EPICU)				28 mg/kg (LD50)	Orcutt 1949 Uranyl Nitrate	
Rabbit (New Zealand)	once 4 hr (EPICU)				198 mg/kg (33% mortality)	Orcutt 1949 Ammonium Diuranate	
Rabbit (New Zealand)	4 hr (EPICU)				344 mg/kg (67% mortality)	Orcutt 1949 UCl5	
Rabbit (New Zealand)	4 hr (EPICU)				666 mg/kg (67% mortality)	Orcutt 1949 Uranium Trioxide	
<b>Systemic</b> Rat (Wistar)	1-11 d 1x/d	Renal			237 M mg/kg (renal failure)	De Rey et al. 1983 Uranyl Nitrate	
		Dermal		237 M mg/kg (mild lesion)			

Table 3-3 Levels of Significant Exposure to Uranium - Dermal

(continued)

Species (Strain)	Exposure/ Duration/ Frequency (Route)	System	LOAEL			Reference Chemical Form	Comments
			NOAEL	Less Serious	Serious		
Rat (Wistar)	1-11 d 1x/d	Dermal	1928 M mg/kg			De Rey et al. 1983 Ammonium Uranyl Tricarbonate	
		Bd Wt		1928 M mg/kg	(slight initial weight loss)		
Rat (Wistar)	1-11 d 1x/d	Renal			1965 M (renal failure) mg/kg	De Rey et al. 1983 Uranyl Acetate	
		Dermal	3929 M mg/kg				
		Bd Wt			1965 M (70% weight loss) mg/kg		
Rat (Wistar)	1-11 d 1x/d	Renal			2670 M (renal failure) mg/kg	De Rey et al. 1983 Ammonium Diuranate	
		Dermal		2670 M (mild lesions) mg/kg			
		Bd Wt			2670 M (severe weight loss) mg/kg		

Table 3-3 Levels of Significant Exposure to Uranium - Dermal

(continued)

Species (Strain)	Exposure/Duration/Frequency (Route)	System	NOAEL	LOAEL		Reference Chemical Form	Comments
				Less Serious	Serious		
Rat (Wistar)	once (EPICU)	Renal		85 F mg/kg	(proteinuria; minimal microscopic lesions in renal tubular epithelium)	Orcutt 1949 Uranyl Nitrate	
		Bd Wt		85 F mg/kg	(unspecified decreased body weight gain)		
Mouse (albino)	4 hr (EPICU)	Renal		948 F mg/kg	(moderate tubular degeneration)	Orcutt 1949 Uranyl Nitrate	
		Bd Wt		948 mg/kg	(unspecified decreased body weight gain)		
Gn Pig (NS)	4 hr (EPICU)	Renal		660 mg/kg	(proteinurea)	Orcutt 1949 Uranium Tetrachloride	
		Bd Wt		660 mg/kg	(10-20% reduction in weight gain)		
Gn Pig (NS)	4 hr (EPICU)	Renal	450 mg/kg	616 mg/kg	(proteinuria)	Orcutt 1949 Uranyl Nitrate	
		Bd Wt	450 mg/kg	616 mg/kg	(unspecified decreased body weight gain)		

Table 3-3 Levels of Significant Exposure to Uranium - Dermal

(continued)

Species (Strain)	Exposure/ Duration/ Frequency (Route)	System	NOAEL	LOAEL		Reference Chemical Form	Comments
				Less Serious	Serious		
Gn Pig (NS)	4 hr (EPICU)	Renal		689 mg/kg	(proteinuria)	Orcutt 1949 Uranium Tetrachloride	
		Bd Wt		689 mg/kg	(10-20% decreased bod weight gain)		
Rabbit (New Zealand)	4 hr (EPICU)	Renal	410 mg/kg			Orcutt 1949 Uranium Peroxide	
		Dermal	410 mg/kg				
Rabbit (New Zealand)	4 hr (EPICU)	Renal	458 mg/kg			Orcutt 1949 Uranium Dioxide	
		Dermal	458 mg/kg				
Rabbit (New Zealand)	4 hr (EPICU)	Renal	98 mg/kg			Orcutt 1949 Uranium Tetrafluoride	
		Dermal	98 mg/kg				

Table 3-3 Levels of Significant Exposure to Uranium - Dermal

(continued)

Species (Strain)	Exposure/ Duration/ Frequency (Route)	System	LOAEL			Reference Chemical Form	Comments
			NOAEL	Less Serious	Serious		
Rabbit (New Zealand)	4 hr (EPICU)	Renal		195 mg/kg	(proteinuria)	Orcutt 1949 Sodium Uranate	
		Dermal	195 mg/kg				
Rabbit (New Zealand)	4 hr (EPICU)	Renal		666 mg/kg	(proteinuria)	Orcutt 1949 Uranium Trioxide	
		Dermal	666 mg/kg				
Rabbit (New Zealand)	4 hr (EPICU)	Renal		147 mg/kg		Orcutt 1949 Triuranium Octoxide	
		Dermal	147 mg/kg				
Rabbit (New Zealand)	4 hr (EPICU)	Renal		344.1 mg/kg	(proteinuria)	Orcutt 1949 UCI5	
		Dermal		344.1 mg/kg	(moderate skin irritation)		

Table 3-3 Levels of Significant Exposure to Uranium - Dermal

(continued)

Species (Strain)	Exposure/Duration/Frequency (Route)	System	NOAEL	LOAEL		Reference Chemical Form	Comments
				Less Serious	Serious		
Rabbit (New Zealand)	once (EPICU)	Renal		618 mg/kg	(proteinuria)	Orcutt 1949 Uranyl Fluoride	
		Dermal	618 mg/kg				
Rabbit (New Zealand)	4 hr (EPICU)	Renal		1.4 mg/kg	(proteinuria)	Orcutt 1949 Uranyl Nitrate	
		Dermal		1.4 mg/kg	(moderate erythema)		
		Bd Wt	6 mg/kg	30 mg/kg	(decreased body weight gain)		
Rabbit (New Zealand)	4 hr (EPICU)	Renal		169 mg/kg	(proteinuria)	Orcutt 1949 Ammonium Diuranate	
		Dermal	169 mg/kg				

**INTERMEDIATE EXPOSURE**

**Death**

Gn Pig (NS)	4 wk 3 d/wk			47 mg/kg	(12% mortality)	Orcutt 1949 Uranyl Nitrate	
-------------	----------------	--	--	----------	-----------------	-------------------------------	--



Table 3-3 Levels of Significant Exposure to Uranium - Dermal

(continued)

Species (Strain)	Exposure/ Duration/ Frequency (Route)	System	LOAEL			Reference Chemical Form	Comments
			NOAEL	Less Serious	Serious		
Gn Pig (NS)	4 wk 3 d/wk				379 mg/kg	(14% mortality)	Orcutt 1949 Uranyl Nitrate
<b>Systemic</b> Gn Pig (NS)	4 wk 3-6 d/wk	Renal		47 mg/kg/day		(proteinuria)	Orcutt 1949 Uranyl Nitrate
		Dermal		47 mg/kg/day		(skin irritation)	
		Bd Wt	47 mg/kg/day	161.2 mg/kg/day		(transitory weight loss)	
Rabbit (New Zealand)	5 wk 5 d/wk	Renal		2.3 mg/kg/day		(proteinuria)	Orcutt 1949 Uranyl Nitrate
		Dermal			2.3 mg/kg/day	(severe dermal ulcers)	
		Bd Wt		2.3 mg/kg/day		(temporary weight loss)	

Bd Wt = body weight; d = day(s); Gn Pig = guinea pig; hr = hour(s); LD50 = lethal dose, 50% kill; LOAEL = lowest-observed-adverse-effect level; M = male; NOAEL = no-observed-adverse-effect level; NS = not specified; wk = week(s); x = time(s)

## 3. HEALTH EFFECTS

The highest NOAEL values and all reliable LOAEL values in each species and duration category for adverse systemic effects from chemical exposure to uranium by the dermal route are presented in Table 3-3.

**Musculoskeletal Effects.** Statistically significant decreases in bone volumes were observed in female Wistar rats following an application of 280 mg U as uranyl nitrate hexahydrate diluted in an oil-water emulsion to a 1 or 2 cm<sup>2</sup> area for 24 hours or an 8 cm<sup>2</sup> area for 24 hours, but not after 30 minutes, 1 hour, or 8 hours (Lopez et al. 2000).

**Renal Effects.** Vascular congestion and vacuolization of the tubules in the corticomedullary boundary were observed in female Wistar rats following a 1–30-minute application of 280 mg U as uranyl nitrate hexahydrate diluted in an oil-water emulsion to an 8 cm<sup>2</sup> area or following 24 hours of exposure to uranyl nitrate applied to a 0.5 or 1 cm<sup>2</sup> area (Lopez et al. 2000). Application of uranyl nitrate to an 8 cm<sup>2</sup> area for 1–24 hours or to a 2–16 cm<sup>2</sup> area for 24 hours resulted in formation of hyaline bodies and necrosis. Rabbits, guinea pigs, rats, and mice dermally exposed to uranyl nitrate hexahydrate for 1 day showed proteinuria for up to 10 days, followed by recovery to control values. The degree of proteinuria did not correlate well with the applied dose of uranium. Rabbits had elevated blood NPN at doses >270 mg U/kg. The animals that died from dermal exposure to uranium had microscopic renal damage typical of uranium poisoning. The kidneys of the animals that did not die were essentially normal, which may reflect repair of acute renal injury (Orcutt 1949). Kidney lesions were also observed in female Wistar rats dermally exposed to 600 mg uranyl nitrate hexahydrate in an oil-water emulsion; the severity of the renal lesions increased with increasing exposure durations or increasing amount of exposed skin (Lopez et al. 2000). Chemically induced renal failure caused 100% mortality in male Wistar rats after five daily exposures to 237 or 1,928 mg U/kg/day as uranyl nitrate hexahydrate or ammonium uranyl tricarbonate, respectively, applied in a water-Vaseline<sup>®</sup> emulsion (De Rey et al. 1983). Deaths from renal failure were also reported in this study for male Wistar rats that received daily applications of 1,965 mg U/kg as uranyl acetate dihydrate for 1–11 days.

**Dermal Effects.** Although no human studies were located regarding the dermal effects of uranium; no dermal effects were reported in studies of uranium miners, millers, and processors exposed to airborne uranium.

## 3. HEALTH EFFECTS

In animal studies, application of 41 mg U/kg as uranium pentachloride to the shaved backs of New Zealand white rabbits resulted in mild skin irritation (Orcutt 1949). Dermally applied uranium was also damaging to the epidermis in other animal studies. Application of 56.4 mg U/kg as uranyl nitrate hexahydrate to another group of rabbits resulted in superficial coagulation necrosis and inflammation of the epidermis, while a dose of 4.2 mg U/kg as uranyl nitrate hexahydrate applied in single or multiple sites for 5 weeks resulted in severe dermal ulcers. No untreated controls were used in the 5-week study (Orcutt 1949). Moderate erythema was observed in male and female New Zealand white rabbits after single applications of 1.4 mg U/kg as uranyl nitrate hexahydrate to their uncovered clipped skins (Orcutt 1949). An applied dose of 2,670 mg U/kg as ammonium diuranate for 1–10 daily applications to the shaved backs of a group of rats resulted in mild lesions on the skin of the rats, while a dose of 237 mg U/kg as uranyl nitrate hexahydrate resulted in disrupted membranes in the cell, mitochondria, and cell nucleus, as revealed by transmission electron microscopy (TEM). Light microscopy revealed swollen and vacuolated epidermal cells and damage to hair follicles and sebaceous glands in the uranyl nitrate hexahydrate-treated animals (De Rey et al. 1983).

No dermal effects were seen following application of a single dose of 618 mg U/kg as uranyl fluoride, 666 mg U/kg as uranium trioxide, 195 mg U/kg as sodium diuranate, 198 mg U/kg as ammonium diuranate, 410 mg U/kg as uranium peroxide, 458 mg U/kg as uranium dioxide, or 147 mg U/kg as triuranium octaoxide in 50% aqueous solution to the shaved skin of New Zealand white rabbits (Orcutt 1949). No dermal effects were observed on the shaved backs of New Zealand white rabbits to which a single dose of 98 mg U/kg as a 65% concentration of the uranium tetrafluoride in lanolin was applied (Orcutt 1949). Similarly, application of 3,929 mg U/kg as uranyl acetate dihydrate or 2,103 mg U/kg as ammonium uranyl tricarbonate in water-Vaseline<sup>®</sup> emulsion to a 3 cm<sup>2</sup> shaved area of the uncovered backs of 20 male Wistar rats in 1–10 daily applications had no effect on the skin of the rats (De Rey et al. 1983).

**Body Weight Effects.** In animal studies, significant weight loss was reported in rats after the following dermal applications over a 3 cm<sup>2</sup> area: 3,948 mg U/kg as uranyl nitrate hexahydrate, 3,929 mg U/kg as uranyl acetate dihydrate, 2,103 mg U/kg as ammonium uranyl tricarbonate, or 2,670 mg U/kg as ammonium uranate to rats for 1–10 days (De Rey et al. 1983). Weight loss was also observed after single applications of 660 or 689 mg U/kg as uranium tetrachloride to guinea pigs, 616 or 948 mg U/kg as uranyl nitrate hexahydrate to mice, 85 mg U/kg as uranyl nitrate hexahydrate to rats, and 43 mg U/kg as uranyl nitrate hexahydrate to rabbits (Orcutt 1949).

### 3. HEALTH EFFECTS

Uranium (4.2 mg U/kg/day) applied as uranyl nitrate hexahydrate to the clipped backs of New Zealand white rabbits for 5 weeks also induced significant weight loss that peaked at 10–15 days after beginning treatment (Orcutt 1949). However, in several other animal studies, no changes in body weight in New Zealand white rabbits were reported following single dermal applications of 618 or 804 mg U/kg as uranyl fluoride, 344 mg U/kg as uranium pentachloride, 666 mg U/kg as uranium trioxide or uranyl fluoride, 344 mg U/kg as uranyl pentachloride, 195 mg U/kg as sodium diuranate, 198 mg U/kg as ammonium diuranate, 410 mg U/kg as uranium peroxide, 458 mg U/kg as uranium dioxide, or 147 mg U/kg as triuranium octaoxide (Orcutt 1949).

#### **3.2.3.3 Immunological and Lymphoreticular Effects**

No information was located regarding the effects of uranium on the immunological and lymphoreticular system in humans and animals following dermal exposure for any duration.

#### **3.2.3.4 Neurological Effects**

No studies were located for humans regarding neurological effects following dermal exposure to uranium compounds.

In animal studies, neurological signs including irritability, hyperactivity, upset equilibrium, limb rigidity, and respiratory arrest were observed in rabbits exposed to lethal doses of uranyl nitrate hexahydrate (Orcutt 1949); decreases in food and water intake and body weight were also observed in these animals.

#### **3.2.3.5 Reproductive Effects**

No studies were located for humans and animals that described reproductive effects following dermal exposure to uranium for any duration.

#### **3.2.3.6 Developmental Effects**

No studies were located regarding effects of uranium on development in humans or animals following dermal exposure for any duration.

## 3. HEALTH EFFECTS

**3.2.3.7 Cancer**

No information on the cancer effects in humans or animals following dermal exposure to uranium for all durations of exposure was located; however, such effects have not been observed in studies involving uranium mining, milling, and production.

**3.2.4 Other Routes of Exposure****Embedded/Implanted Uranium**

A cohort of Gulf War I veterans exposed to depleted uranium were initially examined in 1994 (Hooper et al. 1999) and re-examined every 2 years beginning in 1997 (McDiarmid et al. 2000, 2001a, 2004b, 2006, 2007, 2009, 2011b). Over the years, additional soldiers with embedded metal fragments have been added to the original cohort. The veterans were in or on armored tanks and fighting vehicles when they were fired upon by other U.S. forces using depleted uranium penetrators. These veterans may have been exposed to depleted uranium via inhalation, ingestion, fragment penetration wounds, and wound exposure to dust; some of the soldiers who were injured were left with multiple tiny fragments of uranium and other substances in muscle and/or soft tissue. However, not all of the embedded fragments contained depleted uranium (Squibb et al. 2012). In a study of excised fragments from two veterans, no fragments contained depleted uranium; the fragments were primarily composed of copper, lead, iron, and zinc (Squibb et al. 2012). Urinary uranium levels have been consistently elevated in the veterans with embedded depleted uranium fragments. Urine uranium levels in the entire cohort ranged from 0.001 to 60  $\mu\text{g/g}$  creatinine (McDiarmid et al. 2000, 2001a, 2004b, 2006, 2007, 2009, 2011b); however, urinary uranium levels in the veterans with depleted uranium fragments were typically  $>0.1$   $\mu\text{g/g}$  creatinine. In comparison, the geometric mean urine uranium levels in the U.S. males (National Health and Nutrition Examination Surveys [NHANES] sampling periods of 1999–2008) ranged from 0.005 to 0.008  $\mu\text{g/g}$  creatinine (CDC 2012) and the 95th percentile values ranged from 0.026 to 0.040  $\mu\text{g/g}$  creatinine. A number of parameters were examined to evaluate potential adverse health effects associated with exposure to depleted uranium; potential targets included renal function, liver effects, hematological alterations, neuroendocrine hormone levels, semen characteristics, bone function, neurocognitive effects, and genotoxicity. The effect of uranium exposure on these parameters was examined by dividing the veterans into two groups: low exposure (urine uranium levels of  $<0.1$   $\mu\text{g/g}$  creatinine) and high exposure (urine uranium levels of  $\geq 0.1$   $\mu\text{g/g}$  creatinine). The results of these studies for each end point are discussed in the following sections. Epidemiology studies of other war veterans exposed to depleted

## 3. HEALTH EFFECTS

uranium and animal studies involving exposure to uranium from implanted uranium are also discussed in the following sections.

**Hematological Effects.** As summarized in Table 3-4, no consistent alterations in hematological parameters were found in the Gulf War veterans (Hooper et al. 1999; McDiarmid et al. 2000, 2001a, 2004b, 2006, 2007, 2009, 2011b).

Potential hematological effects were observed in male and female Sprague-Dawley rats implanted with 20 1x2 mm pellets of depleted uranium in the gastrocnemius muscle for up to 150 days. A significant increase in the percentage of monocytes and decrease in platelet levels were observed, as compared to sham surgery controls (Arfsten et al. 2007). However, when a group of rats with implanted tantalum pellets was used as the control, no significant hematological alterations were observed.

**Musculoskeletal Effects.** The two most recent studies of the Gulf War veterans cohort (McDiarmid et al. 2009, 2011b) examined biomarkers of bone turnover and bone metabolism. A nonsignificant decrease in bone-specific serum alkaline phosphatase levels (measure of osteoblast function) was observed in the veterans with embedded fragments; however, no alteration in *N*-telopeptide levels (biomarker of collagen breakdown and bone resorption) was found (McDiarmid et al. 2009). The investigators suggested that the increase in osteoblast activity without an alteration in osteoclast activity may be a clinically insignificant uncoupling of the bone turnover process. A significant increase in 1,25-dihydroxy vitamin D levels was observed in the veterans with embedded fragments; the increased 1,25-dihydroxy vitamin D levels were within the normal range. The increase in 1,25-dihydroxy vitamin D levels, in the absence of changes in parathyroid hormone levels, may be due to an alteration in renal function rather than an alteration in bone metabolism. In the most recent study, no significant alterations in bone biomarkers were found (McDiarmid et al. 2011b).

Decreased tibia growth and impaired mandibular growth were observed in female Wistar rats administered 110 mg U/kg as uranium dioxide implanted directly into the subcutaneous tissue of dorsal skin for 30 days (Díaz Sylvester et al. 2002). The decrease in bone growth was probably related to a marked decrease in active osteoblasts, which were replaced with a large increase in bone lining cells.



## 3. HEALTH EFFECTS

**Table 3-4. Summary of Significant Observations in Studies of a Cohort of Gulf War Veterans Exposed to Depleted Uranium<sup>a</sup>**

Clinical parameter	Evaluation year							
	1994 <sup>b</sup>	1997 <sup>c</sup>	1999 <sup>d</sup>	2001 <sup>e</sup>	2003 <sup>f</sup>	2005 <sup>g</sup>	2007 <sup>h</sup>	2009 <sup>i</sup>
<b>Bone markers</b>								
Estradiol	–	–	–	–	–	–	NS	
Bone specific-alkaline phosphatase	–	–	–	–	–	–	NS	NS
1,25-Dihydroxy vitamin D	–	–	–	–	–	–	H>L	NS
25-Hydroxy vitamin D	–	–	–	–	–	–	NS	NS
Parathyroid hormone	–	–	–	–	–	–	NS	NS
Urine N-teleopeptide	–	–	–	–	–	–	NS	NS
<b>Neuroendocrine hormones</b>								
Follicle stimulating hormone	–	NS	NS	NS	NS	NS	NS	NS
Luteinizing hormone	–	NS	NS	I>h (p=0.06)	NS	NS	NS	NS
Testosterone	–	NS	NS	NS	NS	NS	NS	NS
Thyroid stimulating hormone	–	–	NS	NS	NS	NS	NS	NS
Free thyroxine	–	–	NS	L>H	NS	NS	NS	NS
<b>Semen characteristics</b>								
Semen volume	–	NS	NS	NS	NS	NS	NS	
Sperm concentration	–	H>L	h>I (p=0.09)	h>I NS	h>I NS	NS	NS	
Total sperm count	–	NS	H>L	h>I (p=0.06)	h>I NS	NS	NS	
Percent motile sperm	–	NS	NS	NS	NS	NS	NS	
Total progressive sperm	–	NS	H>L	NS	NS	NS	NS	
Percent progressive sperm	–	NS	NS	NS	NS	NS	NS	
Total rapid progressive sperm	–	NS	H>L	NS	NS	NS	NS	
Percent rapid progressive sperm	–	NS	NS	NS	NS	NS	NS	

<sup>a</sup>Table modified from Squibb and McDiarmid (2006); lower case letters indicate nonsignificant findings; upper case letters indicate significant findings (p<0.05).

<sup>b</sup>Hooper et al. 1999.

<sup>c</sup>McDiarmid et al. 2000.

<sup>d</sup>McDiarmid et al. 2001a.

<sup>e</sup>McDiarmid et al. 2004b.

<sup>f</sup>McDiarmid et al. 2006.

<sup>g</sup>McDiarmid et al. 2007.

<sup>h</sup>McDiarmid et al. 2009.

<sup>i</sup>McDiarmid et al. 2011b.

h, H = high urine uranium ( $\geq 0.1$   $\mu\text{g/g}$  creatinine); l, L = low urine uranium group ( $< 0.1$   $\mu\text{g/g}$  creatinine); NAG = *N*-acetyl- $\beta$ -glucosaminidase; NS = not significant; – not determined



## 3. HEALTH EFFECTS

**Hepatic Effects.** There are limited data on the potential hepatotoxicity of embedded depleted uranium; no consistent alterations in several clinical chemistry parameters (ALT, AST, lactate dehydrogenase, alkaline phosphatase) were found in Gulf War veterans (Hooper et al. 1999; McDiarmid et al. 2000, 2001a, 2004b, 2006, 2007, 2009, 2011b).

**Renal Effects.** In general, no significant alterations in parameters of kidney function were observed among Gulf War veterans (Hooper et al. 1999; McDiarmid et al. 2000, 2001a, 2004b, 2006, 2007, 2009, 2011b); a summary of these data are presented in Table 3-4. However, the increases in several parameters, including urinary retinol binding protein and  $\beta$ -2-microglobulin levels approached statistical significance in the veterans with embedded fragments. No alterations in *N*-acetyl- $\beta$ -glucosaminidase levels (a biomarker of renal proximal tubule cell cytotoxicity) were found (McDiarmid et al. 2009, 2011b). Of the biomarkers of renal function, only urine retinol binding protein and  $\beta$ -2-microglobulin levels were in the direction that would be indicative of renal damage (McDiarmid et al. 2009), and retinol binding protein levels were altered at several examination periods. During the period of 2001–2009, increases in retinol binding protein excretion were observed in the high exposure group at three of the four examinations. Urine retinol binding protein levels at the 2001, 2003, 2007, and 2009 examinations were 46.13, 27.33, 31.00, and 28.49  $\mu$ g/g creatinine in the low exposure group and 65.68, 80.51, 48.11, and 40.12  $\mu$ g/g creatinine in the high exposure group. The difference between the two groups did not reach statistical significance and the levels are within the normal range (<610  $\mu$ g/g creatinine, McDiarmid et al. 2009). Although the difference was not statistically significant and values were within the normal range, there is concern (Squibb and McDiarmid 2006) because retinol binding protein may be a potential sentinel marker of proximal tubular effects from uranium.

Alterations in renal function and histopathology were observed in rats 90, 180, or 360 days after 0.1, 0.2, or 0.3 g of depleted uranium fragments (each 8x2x1 mm weighing 0.1 g) were embedded in the gastrocnemius muscle (Zhu et al. 2009b). Rats in each group were implanted with 0 fragments (sham surgery controls), 1 depleted uranium and 2 tantalum fragments, 2 depleted uranium and 1 tantalum fragment, 3 depleted uranium fragments, or 3 tantalum fragments. The histological alterations included swollen glomeruli with infiltrated inflammatory cells, turgidity and epithelial necrosis in the tubules, and interstitial fibrosis (360 days after fragment implantation). Significant increases in urinary  $\beta$ -2-microglobulin levels were observed in the 0.3 g group 180 and 360 days after implantation, and an increase in urinary albumin levels was observed in the 0.3 g group after 90 days (but not after the longer exposure durations); however, there were large standard deviations for these measurements.

## 3. HEALTH EFFECTS

Additionally, significant increases in serum creatinine levels were observed in all three exposed groups at 90 days, in the 0.3 g group at 180 days, and in the 0.2 and 0.3 g groups at 360 days; BUN levels were significantly increased in the 0.3 g group at 90 days and 0.2 and 0.3 g groups at 360 days (no significant alterations were observed at 180 days). Another study by this group also found significant decreases in 1- $\alpha$ -hydroxylase activity (responsible for the hydroxylation of 25(OH)D<sub>3</sub> to 1 $\alpha$ ,25(OH)<sub>2</sub>D<sub>3</sub> the active form of vitamin D) in the kidneys of rats exposed to 0.2 or 0.3 g depleted uranium embedded in the gastrocnemius muscle for 3 months (Yan et al. 2010); no significant alterations were observed at 6 or 12 months or in the 1 g group at any time period.

**Endocrine Effects.** As summarized in Table 3-4, no consistent alterations in neuroendocrine hormone levels have been found in the Gulf War veterans with embedded uranium (Hooper et al. 1999; McDiarmid et al. 2000, 2001a, 2004b, 2006, 2007, 2009, 2011b).

**Body Weight Effects.** Significant decreases in body weight gain were observed in rats 90 days following implantation of 0.1, 0.2, or 0.3 g of depleted uranium fragments (each 8x2x1 mm weighing 0.1 g) in the gastrocnemius muscle (see discussion of study methods in Renal Effects section) (Zhu et al. 2009b); the exposed rats weighed 11–21% less than controls with 0.3 g of biologically inert tantalum (Ta) fragments embedded in the gastrocnemius. One year after implantation, decreases in body weight gain (10–11%) were only observed in the 0.2 and 0.3 g groups.

A 25% decrease body weight gain was also observed in rats following implantation of 110 mg U/kg/day as uranium dioxide into the subcutaneous tissue of the dorsal skin for 30 days (Díaz Sylvester et al. 2002).

**Neurological Effects.** The results of neurocognitive tests in the Gulf War veterans cohort have not found significant differences between the high and low exposure groups (McDiarmid et al. 2000, 2001a, 2004b, 2006, 2007, 2009, 2011b). Significant associations between urine uranium levels and accuracy scores on neurocognitive tests were observed at several examinations; however, this association was strongly influenced by two subjects with extremely high uranium levels and severely complex co-morbid conditions due to combat injuries.

An animal study examined the effects of implanted depleted uranium alloy pellets on neurobehavior in adult rats (Arfsten et al. 2007). Groups of Sprague-Dawley rats (18–84 males and 17–42 females per group) were implanted with 1x2 mm pellets of depleted uranium in the gastrocnemius muscle for up to 150 days. Males received 12 or 20 pellets and females received 4, 8, 12, or 20 pellets. Controls were

## 3. HEALTH EFFECTS

implanted with 12 or 20 tantalum pellets. Beginning on postimplantation day 150, a portion of males and females were evaluated for spontaneous locomotor activity in an open field, acoustic startle/prepulse inhibition, and conspecific social approach. The results of the behavioral testing did not show definite evidence of neurobehavioral perturbations associated with depleted uranium implantation.

In another study of rats with implanted depleted uranium pellets, 4, 10, or 20 pellets were implanted in the gastrocnemius muscle for 6, 12, or 18 months (Pellmar et al. 1999b). Neurophysiological changes (impairment of ability of the synaptic potential to elicit the population spike, EPSP/spike coupling) were detected in the hippocampus 6 or 12 months after implantation; no effects were observed after 18 months, which may have been due to the effect of aging.

**Reproductive/Developmental Effects.** In the studies of the Gulf War veterans cohort (McDiarmid et al. 2000, 2001a, 2004b, 2006, 2007, 2009), differences in semen quality have been observed at a number of examinations (data summarized in Table 3-4); however, these data suggest improved quality in the high exposure group. No significant alterations were found for follicle stimulating hormone, luteinizing hormone, or testosterone. Although prolactin levels were elevated in the 1997 cohort, no differences were found in later evaluations.

The reproductive/developmental effects of implanted depleted uranium pellets have been studied in rats (Arfsten et al. 2006, 2009). Groups of Sprague-Dawley rats (6–18/sex/group) were implanted with 0, 4, 8, 12, or 20 depleted uranium pellets (1x2 mm) in the gastrocnemius muscle. Inert implant controls were implanted with 12 or 20 Ta pellets; sham-operated controls were also used. Urine was collected from F0 rats on day 27 and 117 for uranium analysis. Rats were mated on postimplantation day 120. Body weight of pregnant females was checked throughout pregnancy. F0 males were kept until necropsy on postnatal day 200. The pups were counted and weighed immediately after birth; sex ratio was also determined; pups were also examined for gross malformations during postnatal days 1–20. F0 females that did not deliver a litter were kept until necropsy on postnatal day 200. On postnatal day 2, F0 females and their offspring underwent maternal retrieval testing. On postnatal day 4, litters were culled to eight pups (four/sex); discarded pups were killed and the whole carcasses were analyzed for uranium. The remaining pups were kept with their mothers through postnatal day 20. On postnatal day 20, two pups/sex were killed and used for whole-body uranium analysis, gross examination of all major organs, and examination of the ribcage. Subsets of F1 pups underwent neurobehavioral testing on postnatal days 4–63. These tests assess developmental markers for basic proprioceptive coordination, social bonding, social interaction, and the developmental milestone of eye opening. F0 dams were necropsied

## 3. HEALTH EFFECTS

on postnatal day 200. Survival and body weight of F1 pups were monitored until postnatal day 120. On postnatal day 120, F0 and F1 males were killed and sperm motility and concentration were examined. Major organs of males and females were examined and weighed. The F2 generation was produced by mating F1 males with F1 females on postnatal day 70. F2 pups were subjected to the same tests as F1 except the maternal retrieval test. F1 males and females were killed on postnatal day 120. One male and one female per F2 litter were killed on postnatal day 90.

No clinical signs of toxicity were seen in F0 rats during the postimplantation period. Three male and 4 female F0 rats died during the study, but necropsy did not show an obvious cause of death. Depleted uranium had no significant effect on mating index. There were no significant differences among the groups regarding gestational index, gestation duration, or gestation weight gain. Viability of F1 pups to postnatal days 4 and 20 was similar across groups. Pup body weight gain during postnatal days 4–20 also was similar across groups. In F1 pups sacrificed on postnatal day 20, there were no gross abnormalities in the major organs and no alterations in the ribcage. Results of the neurobehavioral tests showed no significant depleted uranium-related effects. Evaluation of sperm parameters in F0 males on postnatal day 200 did not show compound-related effects. Histological examination of major organs from controls and rats implanted with 20 depleted uranium pellets and 20 Ta pellets only showed tissue reactions to the foreign body; neither depleted uranium nor Ta pellet implantation sites showed evidence of proliferative or preneoplastic processes taking place in or around the site. Body weight gain and body weight of F1 pups during postnatal days 20–120 were comparable among all groups. Eight of 414 F1 rats died before necropsy on postnatal day 120 of unknown causes. No gross abnormalities were seen in the remaining F1 rats. There did not seem to be compound-related effects on F1 organ weights or in histology of kidneys, spleen, thymus, bone marrow, ovaries, and testes. An increase in mean relative heart weight was observed in the highest dose F1 females, when compared to the sham-operated controls; however, there was no change in absolute heart weight and no difference in absolute or relative heart weight when compared to the inert pellet control group. Neither sperm motility nor concentration was significantly affected by depleted uranium in male F1 rats on postnatal day 120. Overall mating success of F1 rats was lower than F0 rats, but was comparable among all groups. No significant developmental effects were reported in F2 pups at birth or during postnatal days 0–20. Gross necropsy of F2 pups on postnatal day 20 showed no significant alterations; examination of the ribcage also showed no abnormalities. Necropsy of F2 rats on postnatal day 90 did not show consistent depleted uranium-related effects on organ weights; an increase in relative heart weight was observed in the highest dosed F2 males, but there was no change in absolute heart weight. Sperm motility parameters and sperm concentration were not significantly different among F2 groups.

## 3. HEALTH EFFECTS

A study was conducted in mice to determine whether paternal exposure to uranium could result in genetic damage to the offspring (Miller et al. 2010). The authors used a transgenic mouse system that employs a  $\lambda$  shuttle vector that allows mutations to be analyzed *in vitro*. Transgenic male mice were implanted with depleted uranium pellets (two, four, or six pellets) in the gastrocnemius muscle for 7 months and were then mated with untreated non-transgenic females to produce the F1 generation. Controls received implants of biologically inert tantalum. Litters from depleted uranium-implanted fathers were smaller in a dose-dependent manner than un-implanted or tantalum-implanted fathers. Paternal exposure to depleted uranium did not result in fetal malformations and no significant increase in offspring hematopoietic malignancies in weaned offspring was observed. At the age of 4–5 months, deoxyribonucleic acid (DNA) from bone marrow cells from F1 mice was screened for mutations. A significantly higher mutation frequency relative to controls was observed in mid- and high-dose F1 mice, comparable to the frequency seen in offspring of male mice exposed to 4 Gy of  $^{60}\text{Co}$  gamma radiation delivered at 0.06 Gy/minute. Since the depleted uranium would have delivered a much lower radiation dose than the  $^{60}\text{Co}$ , the comparable results are supportive of uranium effects being primarily chemical in nature.

**Cancer.** A study of Danish military personnel deployed to the Balkans between 1992 and 2001 (most were deployed for at least 6 months) did not find significant increases in the risk of all cancers or a specific type of cancer (Storm et al. 2006).

The carcinogenicity of implanted depleted uranium was studied in rats (Hahn et al. 2002). Groups of male Wistar rats (50/group) were implanted in the thigh muscle with fragments of depleted uranium (alloyed with 0.75% titanium) of two different sizes (2.5x2.5x1 mm or 5.0x5.0x1.5 mm) or a pellet (2.0x1 mm) for life. A negative control group was implanted with Ta; a positive control group received an intramuscular injection of radioactive thorium dioxide ( $\text{ThO}_2$ ). Depleted uranium and Ta implants were encapsulated with connective tissue at the time of death. The capsules around depleted uranium were characterized histologically by fibrosis, inflammation, degeneration, and mineralization. All implants (depleted uranium,  $\text{ThO}_2$ , or Ta) had soft tissue tumors associated with the implants. The most prevalent was malignant fibrous histiocytoma, which was significantly increased in the high-dose depleted uranium fragment rats (5.0x5.0x1.5 mm) and in the positive control. There was no increase in tumors related to depleted uranium in tissues not associated with implant sites. The results showed that depleted uranium fragments of sufficient size cause localized proliferative reactions and soft tissue sarcomas that can be detected with radiography.

### 3. HEALTH EFFECTS

A significant increase in the incidence of leukemia was observed within 210 days of surgically implanting 6 depleted uranium pellets in the gastrocnemius muscle (3 pellets per leg) of DBA/2 mice, as compared to controls with or without Ta implants (Miller et al. 2005). In another experiment in which mice were implanted with 2, 6, or 8 depleted uranium pellets and 6, 2, or 0 tantalum pellets for 60 days followed by an intravenous injection of FDC-P1 hematopoietic cells, a dose-related increase in the incidence of leukemia was observed (Miller et al. 2005).

### 3.3 GENOTOXICITY

Prospective evaluations of Gulf War veterans with retained depleted uranium metal fragments have provided inconsistent results (Bakhtmutsky et al. 2011; McDiarmid et al. 2000, 2001a, 2004b, 2007, 2009, 2011a). Tests have been conducted in peripheral blood lymphocytes and included evaluations of sister chromatid exchanges (SCEs), chromosomal aberrations (traditional measures as well as those identified through fluorescent *in situ* hybridization [FISH]), micronuclei frequency, hypoxanthine-guanine phosphoribosyl transferase (HPRT) mutation frequency, and phosphatidylinositol glycan class-A (PIG-A) gene mutant frequency. No significant alterations in chromosomal aberrations were found when veterans with higher urine uranium levels were compared with veterans with lower urinary uranium levels (McDiarmid et al. 2000, 2001a, 2004b, 2006, 2007, 2009, 2011a), although a nonsignificant increase in chromosome aberrations, as measured by FISH, was found at one of the examination periods (McDiarmid et al. 2007). Assessment of SCEs yielded inconsistent results as a function of urinary uranium levels; higher levels of SCEs were found in the low uranium group at two of the examination periods (McDiarmid et al. 2000, 2004a), higher levels were found in the high uranium group at one period (McDiarmid et al. 2004b), and no differences were found at another examination period (McDiarmid et al. 2006). Nonsignificant increases in HPRT mutation frequencies were observed higher in the high uranium group at three examination periods (McDiarmid et al. 2004b, 2006, 2007); however, at the last two examinations, there were no differences between the high and low groups (McDiarmid et al. 2009, 2011a). A nonsignificant increase in PIG-A mutant frequency was observed in the high exposure group at the last examination period (McDiarmid et al. 2011a). No significant alterations in the frequency of micronuclei were found between the two groups (Bakhtmutsky et al. 2011; McDiarmid et al. 2011a). McDiarmid et al. (2009, 2011a) concluded that, overall, the body of evidence in this cohort shows relatively weak genotoxic effects from exposure to uranium.

Schröder et al. (2003) examined 16 war veteran volunteers suspected of exposures to depleted uranium. Since a control group subjected to the same multiple-agent exposures except for depleted uranium was

## 3. HEALTH EFFECTS

not available, the investigators chose subjects from their own laboratory as controls. Compared to the controls, there was a statistically significant increase in the frequency of dicentric chromosomes and centric ring chromosomes among veterans; SCEs were not increased. The results suggested previous exposure to ionizing radiation, but the different sources of exposure could not be ascertained. Four additional small studies from individuals in the former Republic of Yugoslavia who were exposed to depleted uranium either via consumption of contaminated food and/or clean-up operations reported increased frequencies of chromosomal aberrations in peripheral blood cells from the exposed subjects compared with unexposed controls (Krunić et al. 2005; Milačić 2008; Milačić and Simić 2009; Milačić et al. 2004). A cytogenetic study of men occupationally exposed to uranium in a fuel production plant and in a fuel enrichment plant found higher levels of chromosome aberrations in the exposed workers than in controls (Martin et al. 1991). However, the possible role of smoking could not be assessed with certainty.

In an early animal study, male BALB/c mice injected intraperitoneally with doses ranging from 0.05 to 1.0  $\mu\text{g U/kg}$  as 18.9% enriched uranyl fluoride showed a general tendency for an increase in chromosome breaks in sperm cells with an increasing dose of 18.9% enriched uranyl fluoride. At high dose levels, the statistically significant difference of break frequencies between treated and control mice disappeared 60 days after treatment (Hu and Zhu 1990). More recently, Monleau et al. (2006a) exposed male Sprague-Dawley rats nose-only to an aerosol of uranium dioxide at concentrations of 0, 190  $\text{mg/m}^3$  (0.5 hours), or 375  $\text{mg/m}^3$  (2 and 3 hours) and examined DNA damage in epithelial nasal cells, bronchoalveolar lavage cells (BAL), and kidney cells at various times postexposure. Groups of rats were also exposed repeatedly for 3 weeks to depleted uranium dioxide (190  $\text{mg/m}^3$ ; insoluble depleted uranium) and to uranium peroxide (116  $\text{mg/m}^3$ ; soluble depleted uranium) for 0.5 hours. No DNA damage occurred in nasal epithelial cells under any exposure scenario. BAL cells from rats exposed to 375  $\text{mg/m}^3$  uranium dioxide for 3 hours showed significant DNA damage 1 and 8, but not 3, days postexposure. A single 0.5-hour exposure to uranium peroxide did cause DNA damage in BAL cells. Repeated exposure to 190  $\text{mg/m}^3$  uranium dioxide produced DNA damage in BAL cells assessed 1, 4, 8, or 14 days postexposure. Kidney cells showed DNA damage only after repeated exposures to uranium dioxide. DNA damage consisted partly of double strand breaks, suggesting that radiation could be a contributor to the effects. These results suggested that there may be a threshold for effects of single exposure on BAL cells and that repeated inhalation exposure seemed to potentiate the effect of uranium in BAL and kidney cells. Since uranium exposure also increased the expression of cytokines involved in inflammatory responses in lung tissue and of peroxides, the investigators suggested that DNA damage may have been partly a consequence of inflammatory processes and production of reactive oxygen species. Another study from the same group of investigators reported that repeated exposure to uranium dioxide increased

## 3. HEALTH EFFECTS

the genotoxic effects of uranium peroxide inhalation in all three types of cells examined, when a single exposure to uranium peroxide had no significant effect (Monleau et al. 2006b). The investigators suggested that pre-exposure to insoluble uranium could slightly disturb the biokinetics of subsequently inhaled soluble uranium in the kidneys, gastrointestinal tract, and excreta.

In another study, groups of male and female Wistar rats were fed a diet that provided 0, 4, or 40 mg U/kg/day (depleted uranyl nitrate hexahydrate) for 4 months, at which time they were mated to produce the F1 generation (Hao et al. 2009). The offspring were treated in the same manner for 4 months. Exposure to uranium induced a statistically significant dose-related increase in the incidence of micronuclei in bone marrow from both the parental and F1 generations. It also induced DNA damage in the sperm from both generations in a dose-related manner. The effects were more pronounced in the F1 generation than in the parental groups. Analyses of uranium in urine and kidneys after the 4-month exposure period showed dose-related accumulation in the kidney, significantly higher in the F1 than in the parental generation. Hao et al. (2009) did not elaborate as to why the effects were more pronounced in the F1 generation than in the parental rats. One possible explanation could be that the F1 generation also could have been exposed during preweaning via the maternal milk.

A study was conducted in mice to determine whether paternal exposure to uranium could result in genetic damage to the offspring (Miller et al. 2010). The authors used a transgenic mouse system that employs a  $\lambda$  shuttle vector that allows mutations to be analyzed *in vitro*. Transgenic male mice were implanted with depleted uranium pellets (two, four, or six pellets) in the gastrocnemius muscle for 7 months and were then mated with untreated females to produce the F1 generation. At the age of 4–5 months, DNA from bone marrow cells from F1 mice was screened for mutations. A significantly higher mutation frequency relative to controls was observed in mid- and high-dose F1 mice, comparable to the frequency seen in offspring of male mice exposed to  $^{60}\text{Co}$  gamma radiation. To assess the role of radiation in the observed effects of depleted uranium, male mice were exposed to equal concentrations of depleted or enriched uranium in the drinking water (approximately 1 mg U/mouse) for 2 months. Exposure to either form of uranium significantly increased the frequency of mutations compared with controls and also suggested that the increase was specific-activity dependent. While this experiment showed that radiation can play a role in the observed effects of depleted uranium, the investigators noted that the mutation model used measures point mutations and cannot measure large deletions characteristic of radiation damage, the role of the chemical effects of depleted uranium may also be significant.

Table 3-5 presents results of genotoxicity tests conducted *in vivo*.



## 3. HEALTH EFFECTS

**Table 3-5. Genotoxicity of Uranium *In Vivo***

Species (test system)	End point	Exposure route	Results	Reference
Mammalian systems:				
Human peripheral lymphocytes (DU)	Chromosomal aberrations	Inhalation	+	Schröder et al. 2003
Human peripheral lymphocytes (DU)	Sister chromatid exchange	Inhalation	–	Schröder et al. 2003
Human peripheral lymphocytes (DU)	Chromosomal aberrations	Oral	+	Milačić et al. 2004
Human peripheral lymphocytes (DU)	Chromosomal aberrations	Inhalation	+	Milačić 2008
Human peripheral lymphocytes (DU)	Chromosomal aberrations	Inhalation	+	Milačić and Simić 2009
Human peripheral lymphocytes (DU)	Chromosomal aberrations	Inhalation	+	Krunić et al. 2005
Human peripheral lymphocytes (DU)	Chromosomal aberrations	Inhalation	+	Martin et al. 1991
Human peripheral lymphocytes (DU)	Sister chromatid exchange	Inhalation	+	Martin et al. 1991
Human peripheral lymphocytes (DU)	Chromosomal aberrations	Retained metal fragment	+	McDiarmid et al. 2004a
Human peripheral lymphocytes (DU)	Chromosomal aberrations	Retained metal fragment	–	McDiarmid et al. 2000, 2001a, 2006, 2007, 2009, 2011a
Human peripheral lymphocytes (DU)	Sister chromatid exchange	Retained metal fragment	+	McDiarmid et al. 2001a
Human peripheral lymphocytes (DU)	Sister chromatid exchange	Retained metal fragment	–	McDiarmid et al. 2000, 2004b, 2006
Human peripheral lymphocytes (DU)	HPRT mutation frequency	Retained metal fragment	±	McDiarmid et al. 2004a, 2006, 2007
Human peripheral lymphocytes (DU)	HPRT mutation frequency	Retained metal fragment	–	McDiarmid et al. 2009, 2011a
Human peripheral lymphocytes (DU)	Micronuclei frequency	Retained metal fragment	–	Bakhmutsky et al. 2011
Human peripheral lymphocytes (DU)	PIG-A mutant frequency	Retained metal fragment	±	McDiarmid et al. 2011a
Mouse (BALB/c) (EU)	Sperm DNA damage	Intraperitoneal	+	Hu and Zhu 1990
Rat epithelial nasal cells (DU)	DNA damage	Inhalation	–	Monleau et al. 2006a
Rat broncho-alveolar lavage (BAL) cells (DU)	DNA damage	Inhalation	+	Monleau et al. 2006a
Rat kidney cells (DU)	DNA damage <sup>a</sup>	Inhalation	–	Monleau et al. 2006a

## 3. HEALTH EFFECTS

**Table 3-5. Genotoxicity of Uranium *In Vivo***

Species (test system)	End point	Exposure route	Results	Reference
Rat kidney cells (DU)	DNA damage <sup>b</sup>	Inhalation	+	Monleau et al. 2006a
Rat bone marrow (DU)	Micronuclei	Oral	+	Hao et al. 2009
Rat sperm cells (DU)	DNA damage	Oral	+	Hao et al. 2009
Mouse bone marrow cells <sup>c</sup> (DU)	Point mutations	Oral	+	Miller et al. 2010
Mouse bone marrow cells <sup>c</sup> (EU)	Point mutations	Oral	+	Miller et al. 2010
Mouse bone marrow cells <sup>c</sup>	Point mutations	Implanted DU pellets	+	Miller et al. 2010

<sup>a</sup>Single exposure.

<sup>b</sup>Repeated exposures.

<sup>c</sup>From offspring of exposed males.

+ = positive result; - = negative result; ± = weak or inconclusive result; DU = depleted uranium; EU = enriched uranium; PIG-A = phosphatidylinositol glycan class-A

## 3. HEALTH EFFECTS

With few exceptions, studies of genotoxicity of uranium in eukaryotic cells *in vitro* have yielded positive results (Table 3-6). For example, incubation of Chinese hamster ovary (CHO) cells with uranyl nitrate hexahydrate resulted in significant dose-dependent increases in micronuclei, SCEs, and chromosomal aberrations (Lin et al. 1993). Incubation of human osteosarcoma (HOS) cells with depleted uranium for 24 hours resulted in cell transformation into a tumorigenic phenotype and in significant increases in micronuclei, SCEs, and chromosomal aberrations in the form of dicentrics (Miller et al. 2002b). The increase in dicentrics suggested that the radiological component may play a role in depleted uranium's ability to induce both DNA damage and neoplastic transformation. To further study the role of the radiological component in the genotoxicity of depleted uranium, the same group of investigators incubated HOS cells with one of three uranyl nitrate compounds ( $^{238}\text{U}$ -uranyl nitrate, specific activity 0.33  $\mu\text{Ci/g}$ ; depleted uranyl nitrate, specific activity 0.44  $\mu\text{Ci/g}$ ;  $^{235}\text{U}$ -uranyl nitrate, specific activity 2.2  $\mu\text{Ci/g}$ ) at the same concentration (50  $\mu\text{M}$ ) but varying in specific activity (Miller et al. 2002c). The results showed a statistically significant difference in transformation frequency between the three uranyl nitrates that was specific activity-dependent, indicating that radiation can play a role in the genotoxicity of depleted uranium. A subsequent report from these investigators showed that depleted uranium induced *de novo* genomic instability in HOS progeny cells, including delayed micronuclei expression and increased micronuclei frequency (Miller et al. 2003). Delayed reproductive death was evident for many generations. A similar effect was induced by nickel or gamma radiation. Depleted uranium stimulated delayed production of micronuclei up to 26 days after exposure, longer than the 12 days it took the cells to return to normal after exposure to nickel or gamma radiation. Miller et al. (2003) noted that the increase in micronuclei frequency is associated with cell lethality. Although the precise mechanism by which depleted uranium induced genomic instability is unknown, the investigators noted that it might be similar to that for gamma radiation. An additional study by Miller et al. (2002a), demonstrated that depleted uranium (15 nM), in the presence of hydrogen peroxide (2, 4, 6, 8, or 10 mM), can induce the formation of oxidative DNA damage in the absence of significant radioactive decay. The levels of hydrogen peroxide were 100 times higher than physiological levels; thus, the *in vivo* relevance of this finding is not known. A more recent study by Darolles et al. (2010) found differences between the genotoxic mechanisms of depleted and 12% enriched uranium, which is 20 times more radioactive. Significant increases in micronuclei formation were found in mouse embryo fibroblast cells exposed to depleted uranium or enriched uranium; at a given uranium concentration, there were no differences in the number of micronuclei formed after exposure to depleted uranium as compared to enriched uranium. However, the origins of the micronuclei differed between depleted uranium and enriched uranium. Following exposure to depleted uranium, the increase in micronuclei induced by depleted uranium was due to chromosome loss. In contrast, micronuclei formation following exposure to enriched uranium was

## 3. HEALTH EFFECTS

**Table 3-6. Genotoxicity of Uranium *In Vitro***

Species (test system)	End point	Results		Reference
		With activation	Without activation	
Eukaryotic cells:				
Human osteosarcoma (HOS) cells (DU)	Micronucleus test	ND	+	Miller et al. 2002b, 2002c, 2003
HOS cell line (DU)	Cell transformation	ND	+	Miller et al. 1998b, 2002b, 2002c
HOS cell line (DU)	Sister chromatid exchange	ND	+	Miller et al. 2002b
HOS cell line (DU)	DNA damage	ND	+	Miller et al. 2002b
Human bronchial fibroblasts (particulate DU)	Chromosomal aberrations	ND	+	Wise et al. 2007
Human bronchial fibroblasts (soluble DU)	Chromosomal aberrations	ND	–	Wise et al. 2007
Human bronchial epithelial cells (particulate DU)	Chromosomal aberrations	ND	+	LaCerte et al. 2010
Mouse embryo fibroblast cell line (DU)	Micronucleus test	ND	+	Darolles et al. 2010
CHO cells	Sister chromatid exchange	ND	+	Lin et al. 1993
CHO cells	Chromosomal aberrations	ND	+	Lin et al. 1993
CHO cells	Micronuclei	ND	+	Lin et al. 1993
CHO EM9 cell line (DU)	Mutation at <i>hprt</i> locus	ND	±	Stearns et al. 2005; Coryell and Stearns 2006
CHO EM9 cell line (DU)	DNA damage; DNA adducts	ND	+	Stearns et al. 2005
Rat kidney proximal cells (DU)	DNA damage	ND	+	Thiébault et al. 2007
Rat kidney proximal cells (DU)	Micronuclei	ND	–	Thiébault et al. 2007

## 3. HEALTH EFFECTS

**Table 3-6. Genotoxicity of Uranium *In Vitro***

Species (test system)	End point	Results		Reference
		With activation	Without activation	
Prokaryotic organisms:				
pBluescript SK <sup>+</sup> plasmid from <i>E. coli</i> TOP10F' (DU) <sup>a</sup>	DNA damage	ND	+	Yazzie et al. 2003
<i>Salmonella typhimurium</i> TA98 (DU)	Reverse mutation <sup>b</sup>	ND	+	Miller et al. 1998a
<i>Salmonella</i> TA7001-7006 (DU)	Reverse mutation <sup>b</sup>	ND	+	Miller et al. 1998a
<i>Salmonella</i> TA98 (DU)	Reverse mutation <sup>c</sup>	ND	–	Miller et al. 1998a
<i>Salmonella</i> TA7001-7006 (DU)	Reverse mutation <sup>c</sup>	ND	–	Miller et al. 1998a

<sup>a</sup>Incubated with ascorbate.

<sup>b</sup>Urine from rats implanted DU was tested.

<sup>c</sup>Serum from rats implanted DU was tested.

+ = positive result; ± = weakly positive; CHO = Chinese hamster ovary; DU = depleted uranium; ND = no data

## 3. HEALTH EFFECTS

primarily due to chromosome breakage. Thus, depleted uranium primarily acted as an aneugenic agent and enriched uranium as a clastogenic agent.

Studies conducted with depleted uranium trioxide partially dissolved in acetone and depleted uranyl acetate fully dissolved in water showed that while both forms were cytotoxic to human bronchial cells *in vitro*, only the partially dissolved depleted uranium trioxide induced chromosome aberrations above background levels (LaCerte et al. 2010; Wise et al. 2007). Wise et al. (2007) speculated that the different results may be related to different uptake mechanisms by the cell. Particulate depleted uranium would be able to enter the cell by phagocytosis, whereas soluble uranium would not. Wise et al. (2007) suggested that if depleted uranium were to be carcinogenic *in vivo*, it would require a high dose or involve a non-genotoxic mechanism.

In addition to causing DNA strand breaks in CHO cells, depleted uranium also produced uranium-DNA adducts. Incubation of CHO cells with depleted uranyl acetate showed the presence of DNA adducts on the order of a few uranium atoms per thousand nucleotides (Stearns et al. 2005). The formation of adducts was concentration- and time-dependent. Characterization of the uranium-induced mutation in CHO cells showed the mutation spectrum to be different from the spectra generated spontaneously or by exposure to hydrogen peroxide or alpha and beta particles (Coryell and Stearns 2006). This suggested that depleted uranyl acetate had distinct effects on cells that result in a mutagenic response. A study that assessed DNA damage in rat kidney (NRK-52<sup>E</sup>) proximal cells using several methods reported DNA damage and apoptosis occurring in a concentration-dependent manner (Thiébaud et al. 2007). Apoptosis cell death was caspase-dependent and activated via the intrinsic pathway of the cells.

Implantation of depleted uranium pellets in rats resulted in an increase in the mutagenic potential of urine towards the *Salmonella* tester strain TA98 (Miller et al. 1998a). Responses were dose- and time-dependent and strongly correlated with levels of uranium in the urine. In contrast to urine, tests conducted with rats' serum showed no significant increase in mutations, which was consistent with the low levels of uranium in blood. In support of the view that uranium in the urine and no other factor was responsible for the urine mutagenicity was the fact that the urine from controls, both non-surgical and implanted with an inert tantalum pellet, did not show an increase in mutagenic activity.

## 3. HEALTH EFFECTS

**3.4 TOXICOKINETICS**

**Overview.** Absorption of uranium is low by all exposure routes (inhalation, oral, and dermal). Absorption of inhaled uranium compounds takes place in the respiratory tract via transfer across cell membranes. The deposition of inhalable uranium dust particles in the lungs depends on the particle size, and its absorption depends on its solubility in biological fluids (ICRP 1994a, 1996). Estimates of systemic absorption from inhaled uranium-containing dusts in occupational settings based on urinary excretion of uranium range from 0.76 to 5%. A comprehensive review of the available data for a pharmacokinetic model used lung absorption factors of 2–4% for 3-month-old children and 0.2–2% for adults, based on compound absorbability (ICRP 1996). Gastrointestinal absorption of uranium can vary from <0.1 to 6%, depending on the solubility of the uranium compound. Studies in volunteers indicate that approximately 2% of the uranium from drinking water and dietary sources is absorbed in humans (Leggett and Harrison 1995; Spencer et al. 1990; Wrenn et al. 1989), while a comprehensive review indicates that the absorption is 0.2% for insoluble compounds and 2% for soluble hexavalent compounds (ICRP 1996). There are limited data on the dermal absorption of uranium. In hairless rats, dermal exposure to uranyl nitrate resulted in 0.4% of the dose being absorbed (Petitot et al. 2007a); damage to the skin resulted in higher absorption efficiencies. Once in the blood, uranium is distributed to the organs of the body. Uranium in body fluids generally exists as the uranyl ion ( $\text{UO}_2^{2+}$ ) complexed with anions such as citrate and bicarbonate. Approximately 67% of uranium in the blood is filtered in the kidneys and leaves the body in urine within 24 hours; the remainder distributes to tissues. Uranium preferentially distributes to bone, liver, and kidney. Half-times for retention of uranium are estimated to be 11 days in bone and 2–6 days in the kidney. The human body burden of uranium is approximately 90  $\mu\text{g}$ ; it is estimated that 66% of this total is in the skeleton, 16% is in the liver, 8% is in the kidneys, and 10% is in other tissues. The large majority of uranium (>95%) that enters the body is not absorbed and is eliminated from the body via the feces. Excretion of absorbed uranium is mainly via the kidney. The case of Gulf War veterans who were exposed to depleted uranium from inhalation, ingestion, and wounds, showed average urinary excretion, 7 years postexposure, of 0.08  $\mu\text{g}$  U/g creatinine, with the highest rates around 30  $\mu\text{g}/\text{g}$  (McDiarmid et al. 1999b).

**3.4.1 Absorption****3.4.1.1 Inhalation Exposure**

The deposition of inhalable uranium dust particles in the various regions of the lungs (extrathoracic, tracheobronchial, and deep pulmonary or alveolar) depends on the size of the particles. Particles >10  $\mu\text{m}$

## 3. HEALTH EFFECTS

are likely to be transported out of the tracheobronchial region by mucociliary action and swallowed. Particles that are sufficiently small to reach the alveolar region ( $\leq 10 \mu\text{m}$  AMAD) may transfer rapidly or slowly into the blood, depending on the solubility of the uranium compound. According to the ICRP (1996), a more soluble compound (uranium hexafluoride, uranyl fluoride, uranium tetrachloride, uranyl nitrate hexahydrate) is likely to be absorbed into the blood from the alveoli within days and is designated inhalation Type F (fast dissolution). A less soluble compound (uranium tetrafluoride, uranium dioxide, uranium trioxide, triuranium octaoxide) is likely to remain in the lung tissue and associated lymph glands for weeks and is designated Type M (medium dissolution). A relatively insoluble compound (uranium dioxide, triuranium octaoxide) may remain in the lungs for years and is designated Type S (slow dissolution). The dissolution parameters estimated in an *in vitro* study of uranium oxide at a fuel factory differed from the ICRP default values (Dias da Cunha et al. 2011). The rapid dissolution rate was 0.47/day and the slow dissolution rate was 0.0019/day.

Analysis of excreta of active uranium mill crushermen exposed to ore dust indicated that 1–5% of uranium entering the lungs was absorbed systemically and excreted in the urine and 95–99% was eliminated in the feces. Absorption could have taken place in the lungs or in the gastrointestinal tract from swallowed particles cleared from the lungs (Fisher et al. 1983). Uranium workers exposed to high levels of uranium dust had a very low lung burden of uranium, indicating that only a small fraction penetrates into the alveolar region (West and Scott 1969) and remains there without being cleared (or being very slowly cleared) via retrograde tracheobronchial mucus transport to the gastrointestinal tract, into lymph nodes, or dissolved into the circulating blood.

Estimates of absorption into the blood were derived from the excretion data of uranium mill workers (Wrenn et al. 1985). The authors' estimated daily mean absorption of inhaled uranium by mill workers was  $24 \mu\text{g U/day}$  ( $0.34 \mu\text{g U/kg}$  for 70-kg reference man) based on measured excretion in feces and workplace ambient air concentrations. The absorption of uranium by these workers was estimated as 0.76% (range, 0.4–1.6%). Control subjects in a study of differential metabolism of  $^{230}\text{Th}$ ,  $^{234}\text{U}$ , and  $^{238}\text{U}$  inhaled in uranium ore dust included three retired uranium mill workers (4–14 years since last employment as uranium ore crushermen), and three volunteers who lived in uranium milling communities but had no uranium work history. Two consecutive 24-hour urine and fecal collections were obtained and analyzed for  $^{234}\text{U}$  and  $^{238}\text{U}$ . The apparent total intakes of uranium of these individuals ranged from 11 to  $18 \mu\text{g U/day}$  for the controls and from 5.3 to  $71 \mu\text{g U/day}$  for the retirees. Although large compared to uranium intakes estimated for city dwellers, the uranium intakes of these individuals are not unreasonable because uranium in potable waters and locally grown foods tends to be higher in uranium mining and



## 3. HEALTH EFFECTS

milling communities. The mean uranium absorption calculated for the controls (0.82%; range, 0.6–1%) was not significantly different from that calculated for the retired uranium workers (0.94%; range, 0.55–1.6%) (Wrenn et al. 1985).

Urinary excretion data were used to estimate the absorption of uranium by workers accidentally exposed to uranium hexafluoride (USNRC 1990). Estimated airborne concentrations were 20 mg uranium hexafluoride/m<sup>3</sup> for a 1-minute exposure and 120 mg uranium hexafluoride/m<sup>3</sup> for a 60-minute exposure (15.2 and 91 mg U/m<sup>3</sup>, respectively) (USNRC 1986). Initial intakes of workers involved in the accident ranged from 470 to 24,000 µg uranium.

Higher absorption of uranium occurred in animal studies using aerosols of purified uranium compounds. In these studies, as in human studies, the solubility of the uranium compound and the size of the inhaled particles determined absorption. Reported absorption of the inhaled dose was 18–40% in rats and 20–31% in guinea pigs for uranium hexafluoride (Leach et al. 1984) and 23% for uranium trioxide in dogs (Morrow et al. 1972). One month following a single intratracheal instillation, the percentage of the dose transferred to the blood from the lungs was 73.7–74.8% for uranium peroxide (7.6 or 195 µg administered) and 38.8–43.9% for uranium tetrafluoride (32 or 301 µg administered); the percent absorbed was not influenced by the instillation concentration (Houpert et al. 1999).

In addition to the uptake of uranium from the lungs, there is some evidence from a study of rats exposed via nose-only exposure to 190 mg/m<sup>3</sup> depleted uranium dioxide 30 minutes/day, 4 days/week for 30 weeks (Houpert et al. 2007c) that uranium may be taken up by the olfactory epithelial pathway and travel along the olfactory neuron to the olfactory bulb.

#### 3.4.1.2 Oral Exposure

Experimental studies in humans consistently show that absorption of uranium by the oral route is <5%. Reported fractional absorptions include a range of 0.005–0.05 (0.5–5%) in a group of 4 males ingesting 10.8 mg uranium in a soft drink (Hursh et al. 1969), 0.001–0.06 (median of 0.009) in 50 males and females exposed to uranium in the diet and drinking water (Limson Zamora et al. 2002, 2003), 0.001–0.005 in 4 subjects ingesting a single dose of 100 mg uranium as depleted uranyl nitrate dissolved in a grapefruit drink (Karpas et al. 1998), <0.0025–0.04 in a group of 12 volunteers given drinking water high in uranium (Wrenn et al. 1989), and 0.005–0.05 in another drinking water study (Harduin et al. 1994). Measuring uranium levels in bone ash, Chen et al. (2011) estimated fractional absorption values in several

## 3. HEALTH EFFECTS

age groups. The estimated fractional absorption values were  $0.030 \pm 0.022$ ,  $0.030 \pm 0.023$ , and  $0.021 \pm 0.015$  for children aged 7–12 years, children aged 12–18 years, and adults aged 18–25 years. Similar results were obtained in dietary balance studies (Leggett and Harrison 1995; Spencer et al. 1990; Wrenn et al. 1989). A study comparing uranium absorption between subjects primarily exposed to uranium in the diet and subjects exposed to elevated levels of uranium in the drinking water (Limson Zamora et al. 2002, 2003) did not find significant differences in fractional absorption between the two subroutes. This study also found no significant differences in uranium fractional absorption related to gender or age (subjects <25 years compared to those >25 years). A review of human data conducted by the ICRP determined that a fractional absorption of 0.02 for soluble compounds and 0.002 for insoluble compounds should be used in modeling the kinetics of dietary uranium in humans (ICRP 1995). A rapid absorption rate (5–15 hours) was estimated in four individuals ingesting a single dose of depleted uranyl nitrate (Karpas et al. 1998).

In animal studies, absorption generally increases with increasing solubility of the compound, being greatest for uranium ingested as uranyl nitrate hexahydrate, uranium hexafluoride or uranyl fluoride, about half as great for uranium tetroxide or uranium trioxide, and 1–2 orders of magnitude lower for uranium tetrachloride, triuranium octaoxide, and uranium tetrafluoride (ICRP 1995). Increased absorption of uranium has been demonstrated in neonatal rats and pigs (ICRP 1995). Fractional absorption in 2-day-old rats given uranyl nitrate was estimated as 0.01–0.07, 2 orders of magnitude greater than for adults (ICRP 1995).

Evidence from several animal studies showed that the amount of uranium absorbed from the gastrointestinal tract was about 1% (Harrison and Stather 1981; Houpert et al. 2001; Larsen et al. 1984; La Touche et al. 1987; Maynard et al. 1953; Sullivan 1980a), although other studies have reported lower absorption efficiencies. Frelon et al. (2005) estimated that 0.43% of the depleted uranyl nitrate in drinking water was absorbed by rats. A range of gastrointestinal absorption rates of 0.038–0.078% has been estimated by others based on data from a 2-year study in which rats were fed diets containing 0.05–0.5% of soluble uranium compounds (uranyl fluoride or 0.5–2% of uranyl nitrate). The rate of absorption appeared to be independent of concentration of uranium in the diet (Wrenn et al. 1985). Absorption factors in rats that were exposed by gavage to doses of  $^{233}\text{U}$ -uranyl nitrate hexahydrate (where this anthropogenic radionuclide provided increased sensitivity without competition with natural isotopes) increased 3.4 times over normal in rats that were iron-deficient (Sullivan and Ruemmler 1988), doubled in rats that were fasted (Sullivan et al. 1986), and increased 3.6 times in neonates as compared to adults (Sullivan 1980b). Adult baboons (fed normally) absorbed about 0.5%, whereas fasted baboons absorbed

## 3. HEALTH EFFECTS

an average of 4.5% (Bhattacharyya et al. 1989). Consistent with the results in baboons, fed and 24-hour fasted male B6CF<sub>1</sub>/ANL mice absorbed 0.069 and 0.80%, respectively (Bhattacharyya et al. 1989).

Studies in rats suggest that the primary pathway for gastrointestinal absorption of soluble uranium as depleted uranyl nitrate is through the small intestinal epithelium (Dublineau et al. 2005, 2006) via the transcellular pathway (Dublineau et al. 2005). Uranium was not absorbed from the buccal cavity, stomach, or large intestine (Dublineau et al. 2005). *Ex vivo* experiments provide evidence that uranium is equally absorbed in all regions of the small intestine (Dublineau et al. 2005).

### 3.4.1.3 Dermal Exposure

Absorption of uranium through the skin has not been characterized in humans. Dermal absorption in animal models can be inferred from the appearance of toxicity in mice, rats, rabbits, and guinea pigs after dermal exposure to uranium compounds (Orcutt 1949).

Electron microscopy and x-ray microanalytical methods showed that uranium as uranyl nitrate hexahydrate penetrated the stratum corneum within 15 minutes and accumulated in the intracellular space between the viable epidermis and the stratum corneum (De Rey et al. 1983). As is the case with inhalation and oral absorption, water solubility is an important determinant of absorption, and no penetration was observed with the insoluble compounds uranium dioxide, uranyl acetate, or ammonium diuranate. After 48 hours, uranium applied as uranyl nitrate was no longer found in the skin and toxicity developed, indicating that the uranium had been absorbed into the blood.

A series of *in vitro* and *in vivo* studies conducted by Petitot et al. (2004, 2007a, 2007b) demonstrated that uranyl nitrate is absorbed through the skin. *In vitro*, the first transfer of uranium across hairless rat skin and pig ear skin occurred 3 or 4 hours, respectively, after application of uranyl nitrate (Petitot et al. 2004). However, uranium was transferred across excoriated skin (stratum corneum removed to simulate a wound) in 30 minutes for both rat and pig skin. Application of depleted uranium to the skin of hairless rats *in vivo* resulted in significant increases in uranium levels in muscle at the contamination site 6 hours after application to intact skin and within 30 minutes after application on excoriated skin (Petitot et al. 2007a). Twenty-four hours after application, 0.4% of the dose was absorbed through intact skin (Petitot et al. 2007a). A higher percentage of uranium was absorbed through wounded skin; 38% absorbed through excoriated skin and 2–4% through skin damaged from application of a mild acid solution. In

### 3. HEALTH EFFECTS

contrast, severely damaged skin from exposure to a strong acid or base solution, resulted in lower absorption efficiencies than intact skin.

#### 3.4.2 Distribution

Absorbed uranium is found in all human tissues, but preferentially deposits in bone and kidney, regardless of the route of exposure (ICRP 1995, 1996). Although uranium also distributes significantly to liver, this organ is not a major repository for uranium; however, for modeling purposes, tissue contents are often normalized to liver concentration because the latter is reported in almost all studies of uranium biokinetics. The normal adult body burden is considered to be approximately 90  $\mu\text{g}$ . It is estimated that about 66% of this total is in bone, 16% is in the liver, 8% is in the kidneys, and 10% is in other tissues (ICRP 1979, 1995, 1996). It is not known if maternal bone stores of uranium (like those of calcium and lead) are mobilized during pregnancy and lactation. Uranium can cross the placenta after parenteral administration in animals; no information was located on distribution of uranium in breast milk for either humans or animals.

##### 3.4.2.1 Inhalation Exposure

Autopsy data from individuals occupationally exposed to uranium indicates that bone is the primary site of long term retention of absorbed uranium (ICRP 1995). Inhalation exposure may also result in some retention of insoluble uranium particles in the lungs. An evaluation of the postmortem data from a uranium worker who had inhaled a total of 220 mg (147 pCi) uranium over a 3-year period found 11  $\mu\text{g}$  (7 pCi) uranium in the lungs 13 years after the end of exposure. The total calculated dose equivalent from the inhaled uranium was 35 rem (0.35 Sv) (Keane and Polednak 1983).

In a comprehensive study of tissues from two long-time residents of New Mexico without known occupational exposure, the skeleton was the primary depot for uranium (Kathren 1997). Approximately 80 soft tissue samples and 90 bone samples were analyzed from each subject. The mean uranium concentrations in bone were 4.8 and 5.8 ng/g wet weight for the two subjects, respectively. Highest concentrations of uranium in soft tissues were in the tracheobronchial and other pulmonary related lymph nodes indicating uranium-bearing particulate clearance from the lungs. Concentrations in pulmonary lymph nodes ranged from 16–28 ng/g in one individual to 29–259 ng/g wet weight in the other. In another comprehensive autopsy study of a worker at a facility involved in the processing and handling of radioactive material, the highest levels of uranium in soft tissues was found in the respiratory tract, particularly the tracheobronchial lymph nodes (Russell and Kathren 2004). The relative amounts of

## 3. HEALTH EFFECTS

uranium in the body were lung > skeleton > spleen > liver > kidney. Relatively high levels of uranium were also found in the urinary bladder, blood, and thyroid. A study of uranium process workers and nearby residents chronically exposed to depleted uranium aerosols detected depleted uranium levels in the urine in 2 of the 18 subjects 20 years after exposure (Parrish et al. 2008). Although the investigators suggest that this finding indicates long-term storage and distribution of depleted uranium, the small number of positive findings and the lack of monitoring data on other potential sources of depleted uranium limit the interpretation of the results.

Urinary excretion data were used in a kinetic model to estimate the maximum uranium kidney concentrations of workers accidentally exposed to uranium hexafluoride (USNRC 1990). Initial intakes of workers involved in the accident ranged from 470 to 24,000  $\mu\text{g}$  uranium. The model estimated the maximum kidney concentrations in the workers as ranging from 0.048 to 2.5  $\mu\text{g}$  U/g in kidney tissue; renal toxicity was not observed in any of the workers (USNRC 1990).

In animals, uranium that has been absorbed from the lungs leaves the blood very quickly for distribution to body tissues. Following a single intratracheal instillation, uranium was removed from the lung with retention half-times of 0.6–1.3 (63.6–71.6% absorbed) and 30–35 days (36.4–29.4% absorbed) following instillation of 32 or 301  $\mu\text{g}$  uranium tetrafluoride, and 0.5–1.2 (96.6–90.3% absorbed) and 27–38 days (3.4–9.7% absorbed) following instillation of 7.6 or 195  $\mu\text{g}$  uranium peroxide (Houpert et al. 1999). One month after instillation of either uranium compound, 11.3–20.4% of the uranium dose remained in the carcass, 1.5–4.4% was found in the kidney, and 75.9–84.3% was excreted in the urine. The amount of uranium found in the bones of dogs and rats exposed to uranium for 1 year was related to the solubility of the uranium solubility (Stokinger et al. 1953). The concentrations of uranium in bone were 2.0 and 2.7  $\mu\text{g/g}$  in rats exposed to uranyl nitrate (0.25 mg U/m<sup>3</sup>) and uranyl fluoride (0.2 mg U/m<sup>3</sup>), respectively; however, exposure to a similar concentration of uranium tetrachloride (0.2 mg U/m<sup>3</sup>) resulted in a 10-fold reduction in uranium bone levels (0.2  $\mu\text{g/g}$ ). Uranium has also been shown to accumulate in the tracheobronchial lymph nodes, lungs, bones, and kidneys of rats, dogs, and monkeys exposed to uranium dioxide at 5.1 mg U/m<sup>3</sup> for 1–5 years (Leach et al. 1970, 1973). In rats exposed to yellowcake, the U<sub>3</sub>O<sub>8</sub> portion of the yellowcake cleared from the lung with a half-time of 110–240 days (Damon et al. 1984). Mice given inhaled doses of U<sub>3</sub>O<sub>8</sub> equivalent to about 0.2 mg U/kg exhibited uranium tissue distribution (in  $\mu\text{g/g}$  tissue) as follows: lung, 6.05; liver, 0.051; spleen, 1.45; kidney, 0.536; tibia, 0.731; urine, 0.519; and feces, 2.20 (Walinder 1989). In an inhalation study using highly enriched uranium dioxide particles (92.8% <sup>235</sup>U), rat lungs were found to clear the uranium particles at a rate of 0.28% per day over a period of 720 days. At 720 days postexposure, 82% of the uranium remained in the lungs and thoracic lymph

## 3. HEALTH EFFECTS

nodes of the rats. The highest mass of extrapulmonary uranium dioxide was detected in rats sacrificed up to 11 days postexposure. This was mainly found in the intestinal tract and the carcass. The authors found that the pulmonary clearance rate of highly enriched uranium dioxide particles was about the same as the clearance rate for natural or unenriched uranium dioxide particles (Morris et al. 1990), as would be expected since they are the same chemical compound.

One site of deposition for the soluble compounds (uranyl nitrate, uranium tetrachloride, uranium hexafluoride) in animals was the skeleton, but accumulation was not seen in bone at levels below 0.25 mg U/m<sup>3</sup> over a period of 2 years in rats exposed to soluble compounds (uranyl nitrate, uranium tetrachloride, uranium hexafluoride) in one study. The insoluble compounds (uranium hexafluoride, uranium dioxide) were found to accumulate in the lungs and lymph nodes after the inhalation exposure. For uranyl nitrate exposure, no retention was found in the soft tissues. Accumulation of uranium was also found in the skeleton (Stokinger et al. 1953). The amount distributed in the skeleton has been reported to be 23–45% of the intake in dogs (Morrow et al. 1972); 28–78% in rats (Leach et al. 1984); and 34–43% in guinea pigs (Leach et al. 1984). A biological half-time of 150–200 days (Ballou et al. 1986) or 70 days (Morrow et al. 1982a) in the skeleton has been reported following inhalation exposure to soluble uranium compounds (e.g., uranium hexafluoride).

A 5-year exposure of Beagle dogs and monkeys, and a 1-year exposure of rats, to 5.8 mg uranium dioxide/m<sup>3</sup> (5.1 mg U/m<sup>3</sup>) as uranium dioxide dust (AMAD=1 µm) resulted in rapid lung buildup during the first few months, which approached maximal values of 2, 3.6, and 0.8 mg U/g in dogs, monkeys, and rats, respectively, at the end of year 1. Buildup in the tracheobronchial lymph nodes reached peak values in year 4 of 50–70 mg U/g in both dogs and monkeys. For each, the peak radiation dose rates reached 1.8 and 3.3 rad/week (0.018 and 0.033 Gy/week) to lungs and 55 and 64 rad/week (0.55 and 0.65 Gy/week) to lymph nodes, while the total radiation dose for the 5 years approached 500 and 900 rad (5 and 9 Gy) to lungs and 10,000 rad (10 Gy) to lymph nodes. A reevaluation of the study data also showed a rapid accumulation of uranium in the lungs and tracheobronchial lymph nodes during the first few months of exposure. The accumulation in these organs was highest (0.8 mg/g in lungs and 1.5 mg/g in lymph nodes) at the end of 1 year of exposure. The uranium content in the lungs decreased with a half-time of approximately 480 days. In the lymph nodes, uranium depletion showed a trend similar to the lungs in dogs exposed for 2 and 5 years and a biphasic pattern in dogs exposed for 1 year. Comparatively low levels of uranium were found in the kidney, femur, liver, and spleen, and these decreased with time (Leach et al. 1973).

## 3. HEALTH EFFECTS

In other studies, no significant accumulation was found in the spleen or liver of rats, dogs, or guinea pigs (Ballou et al. 1986; Diamond et al. 1989; Leach et al. 1973, 1984; Morrow et al. 1972; Wrenn et al. 1987). Uranium has been shown to increase in the brain following intermediate-duration inhalation exposure to depleted uranium dioxide; however, the levels rapidly decrease following exposure termination and returned to control levels within 3–8 days (Monleau et al. 2005). Uranium is unequally distributed in the brain, with the highest levels found in the olfactory bulbs, followed by the hippocampus, cortex, and cerebellum.

**3.4.2.2 Oral Exposure**

Uranium levels have been measured in tissues from humans, with no occupational exposure where the source of uranium was assumed to be dietary and environmental.

In a comprehensive study of tissues from two long-time residents of New Mexico, the skeleton was the primary depot for uranium (Kathren 1997). Approximately 80 soft tissue samples and 90 bone samples were analyzed from each subject. The mean uranium concentrations in bone were 4.8 and 5.8 ng/g wet weight for the two subjects, respectively. Highest concentrations of uranium in soft tissues were in the tracheobronchial and other pulmonary related lymph nodes, indicating uranium-bearing particulate clearance from the lungs. Concentrations in pulmonary lymph nodes ranged from 16 to 28 ng/g in one individual to 29–259 ng/g wet weight in the other. An unexpectedly high concentration was found in the thyroid of one subject. In both subjects, uranium was widely distributed among the soft tissues; liver concentrations were lower than those in the kidney (approximately 0.1 and 0.9 ng/g wet weight, respectively).

The concentrations of uranium in human blood from New York City donors averaged 0.14 mg U/kg in both whole blood and red cells, compared to values ranging from <0.04 to 86 mg U/kg globally (Fisenne and Perry 1985). The median concentrations of uranium in the lungs, liver, kidneys, and vertebra from New York City residents among all age groups were reported to be 0.33, 0.13, 0.32, and 0.29 mg U/kg, respectively (Fisenne and Welford 1986).

In an evaluation of two human skeletal tissues, it was observed that the sacrum contained the highest concentrations of  $^{238}\text{U}$  and  $^{234}\text{U}$  (4.9 mBq/g ash; 0.13 pCi/g ash; 0.20  $\mu\text{g/g}$  ash). The concentration of  $^{238}\text{U}$  was lowest (0.1 mBq/g ash; 0.0027 pCi/g ash; 0.004  $\mu\text{g/g}$  ash) in the right femur (Singh et al. 1987b). In

## 3. HEALTH EFFECTS

the United Kingdom, the mean uranium concentration in wet bone was reported to be 0.33 µg U/kg (Fisenne and Welford 1986).

Data on laboratory animals indicate that a substantial portion of uranium leaving the blood may initially distribute throughout soft tissues, but a few days after absorption or injection into the blood, most of the systemic content is found in the kidneys and skeleton (Bhattacharyya et al. 1989; ICRP 1995).

In animals, a substantial fraction of plasma uranium is associated with the ultrafilterable low-molecular-weight fraction, and the remainder is weakly associated with transferrin and other plasma proteins. Data on baboons indicate that  $\geq 50\%$  of the uranium in blood is associated with the red blood cells during the period 10–1,000 hours after injection. These data have been interpreted to mean that about 0.7% of the uranium leaving the plasma attaches to red blood cells and is returned to plasma with a half-time slightly greater than 1 day (ICRP 1995).

In animals, absorbed uranium is osteotropic, accumulating largely on the surface of all types of bone of the animals. Eventually, the uranium on the bone surface diffuses into the mineral portion of the bone. Autoradiography provides confirming evidence that, in the long-term, uranium is a bone volume seeker (Wrenn et al. 1987). Kinetic models of uranium distribution predict that, for the short-term, uranium distributes to the bone surface and bone marrow, while the deep bone is the long-term depot (Sontag 1986). These results suggest that the macro distribution of uranium in the human skeleton is not uniform.

In some ways, the skeletal behavior of uranium is quantitatively similar to that of alkaline earths. It is known that the uranyl ion ( $\text{UO}_2^{2+}$ ) exchanges with  $\text{Ca}^{2+}$  on the surfaces of bone mineral crystals, although it does not participate in crystal formation or enter existing crystals. The early distribution of uranium in different parts of the skeleton is similar to that of calcium. Uranium initially deposits on all bone surfaces but is most highly concentrated in areas of growth. Depending on the microscopic structure of the bone of each species, uranium on bone surfaces may gradually diffuse into bone volume; such diffusion has been observed in dogs but not in rats or mice. As with calcium, a substantial portion of uranium deposited in bone is lost to plasma by processes that occur more rapidly than bone resorption (see Section 3.4.5). In human subjects injected with uranium, an estimated 80–90% of the original skeletal deposition was lost from bone over the first 1.5 years (ICRP 1995).

In a study with female mice exposed orally in feed to uranyl nitrate hexahydrate at a dosage of 462 mg U/kg/day for 36–44 weeks, average uranium accumulations were 6 µg per pair of kidneys, 46 µg/g bone,



## 3. HEALTH EFFECTS

and 0–0.5 µg in whole liver, respectively. No significant organ accumulation was found for the lower dose levels (Tannenbaum et al. 1951). Maximal concentrations of 77 µg per pair of kidneys and 216 µg/g in bone were estimated at 50 weeks in male mice that were orally exposed to uranyl nitrate hexahydrate at 925 mg U/kg/day for 48 weeks. One mouse with small kidneys showed levels of 395 µg/pair of kidneys and 1,440 µg/g bone (Tannenbaum et al. 1951). Average uranium accumulations in the kidneys and bone of male mice exposed to uranyl fluoride orally at 452 mg U/kg/day for 28 weeks were 33 µg/pair of kidneys and 145 µg/g bone at 20 weeks (Tannenbaum et al. 1951). Maximal concentrations of 6 µg/pair of kidneys at 50 weeks and 29 µg/g bone at 14 weeks were found in female mice given oral uranium tetrachloride at 978 mg U/kg/day for 48 weeks (Tannenbaum et al. 1951).

Paquet et al. (2006) examined the distribution of depleted uranium in rats following chronic ingestion of 2.0–2.9 mg U/kg/day as depleted uranyl nitrate in mineral water. In addition to the elevated levels of uranium found in the kidney and bones, uranium accumulated in the teeth and brain. Uranium concentrations in teeth were higher than in the skeleton, suggesting that uranium was deposited on the enamel. Accumulation of uranium in the whole body and individual tissues followed a nonmonotonous pattern that was not predictable by biokinetic models. In the whole body, peak levels were found after 3, 10, and 19 months of exposure. Total uranium levels in the whole body were 51.0, 182, 42.2, 134, 3.8, and 200 ng/g tissue after 1, 3, 6, 10, 12, and 19 months of exposure, respectively. Different patterns of uranium accumulation were found in the lumbar vertebrae and femur (diaphysis and epiphysis regions). In the vertebrae, uranium levels did not significantly change until 570 days of exposure; in contrast, uranium levels in the femur peaked at day 95, decreased at day 186, and increased at days 312 and 570. In the kidneys, uranium levels decreased between months 1 and 12 (220 ng/g tissue to 72.4 ng/g) and then increased again (311 ng/g) at 19 months. The investigators noted that the results could not be adequately explained and that further studies should be conducted. Elevated levels of uranium in the brain were also observed in rats exposed to 3.7 mg U/kg/day as 4.92% enriched uranyl nitrate in mineral water for 90 days (Lestaevel et al. 2005b). The levels of uranium in the brain increased from 75.4 to 86.1 ng; the levels of uranium in the kidneys were also significantly increased from 101.9 to 579.0 ng.

The insoluble compounds of uranium accumulated to a lesser extent in tissues. Only small amounts of uranium were found in the kidneys (3–9 µg/pair of kidneys) of female mice that were exposed orally to uranium tetrafluoride at 4,437 mg U/kg/day for 48 weeks. No uranium was found in the bone (Tannenbaum et al. 1951). Only small amounts of uranium were found in kidney (1–3 µg/pair of kidneys) of female mice that were exposed orally to triuranium octaoxide at 1,655 mg U/kg/day for 48 weeks. No uranium was found in the bone (Tannenbaum et al. 1951).

### 3. HEALTH EFFECTS

Arruda-Neto et al. (2004a) examined the accumulation of uranium in bones as a function of uranium dose in young rats exposed to uranyl nitrate in the diet at doses of 0.1–26 mg U/kg/day for 60 days and found a biphasic relationship. The inflexion point was at approximately 6 mg/kg/day and accumulation of uranium in the bone increased linearly at doses higher than 6 mg/kg/day. Another study by this group (Arruda-Neto et al. 2004b) found that uranium was equally distributed in the bone and bone marrow in dogs following a long-term exposure to uranyl nitrate in the diet.

Oral exposure to uranyl nitrate in mineral water for 9 months resulted in significant increases in uranium concentration in the hippocampus and cortex; a 1.5-month exposure resulted in nonsignificant increases in uranium in these brain areas (Bensoussan et al. 2009). Bellés et al. (2005) also reported significant increases in brain uranium levels, as compared to controls, following a 3-month exposure to uranyl acetate; however, there was no statistical relationship between dose and brain uranium levels.

The uranium blood:tissue transfer coefficients were estimated in Wistar rats exposed to 0.5–26 mg U/kg/day as uranyl nitrate in the diet for 60 days (Arruda-Neto et al. 2001). The highest transfer coefficients were found in the kidneys and liver. A plot of the transfer coefficients for skin, brain, intestine, heart, liver, and kidneys exhibited concave shapes with the point of deflection occurring at the 5 mg U/kg/day dose level in all tissues except the intestines. The investigators suggested that this may indicate that similar mechanisms are involved in the uptake of uranium by different tissues. Additionally, the slope of the uranium tissue concentration versus dietary concentration increased gradually at the lower doses (<5 mg U/kg/day) and steeply at doses of 5–26 mg U/kg/day. This could be due to an enhanced absorption at uranium doses >20 mg U/kg/day. However, increases in occult blood levels in the urine were also observed at the higher doses, suggesting that the sharp increase in tissue uranium levels may be due to renal damage resulting in an increased concentration of uranium in blood and consequently in organs and tissues.

#### **3.4.2.3 Dermal Exposure**

No studies were located regarding distribution of uranium after dermal exposure in humans. In hairless rats dermally exposed to depleted uranium in a nitric acid solution, increased levels of uranium were detected in the kidneys and bone 6 hours after application to intact skin; the highest concentrations were found in the kidney (Petitot et al. 2007a). Application to wounded skin (via mechanical abrasion or

### 3. HEALTH EFFECTS

exposure to weak acids) resulted in significant increases in uranium levels in the kidneys and bone within 30 minutes of exposure.

#### 3.4.2.4 Other Routes of Exposure

Intravenously injected uranium is rapidly taken up by the tissues or excreted in the urine (ICRP 1995). Typically, 25% of intravenously injected uranium (as uranyl nitrate) remained in blood of human subjects after 5 minutes, 5% after 5 hours, 1% after 20 hours, and <0.5% after 100 hours although inter-subject variation was high (AEC 1948, 1957). Measurements of systemic distribution of uranium made at autopsy in one terminally ill human given a single intravenous injection of uranium indicated that the skeleton, kidneys, and other soft tissues after 2.5 hours contained about 10, 14, and 6%, respectively, of the dose. Distribution data taken from another human subject 18 hours after a single intravenous injection of uranium showed that the bones, kidneys, and other soft tissues contained about 4–13, 6, and 4%, respectively, of the amount injected. At 566 days postinjection, uranium distribution in the skeleton, kidneys, and other soft tissues declined to about 1.4, 0.3, and 0.3%, respectively.

The distribution of uranium following implantation of depleted uranium pellets into the gastrocnemius muscle has been investigated in rats (Pellmar et al. 1999a; Zhu et al. 2009a). Within 1 day of implantation, uranium was measurable in kidney and bone but not in the other tissues. At later time points, significant amounts of uranium were found in the other tissues, especially the spleen, liver, and lung; the levels were always highest in the kidney and bone. The amount of uranium in the kidney and bone was significantly correlated with the uranium dose. Tissue uranium levels peaked 90 days after implantation and gradually decreased; however, the levels were still elevated 360 days postimplantation (Zhu et al. 2009a).

#### 3.4.3 Metabolism

Uranium is usually found in compounds that can be metabolized and recomplexed to form other compounds. In body fluids, tetravalent uranium is likely to oxidize to the hexavalent form followed by formation of uranyl ion. Uranium generally complexes with citrate, bicarbonates, or protein in plasma (Cooper et al. 1982; Dounce and Flagg 1949; Stevens et al. 1980). The stability of the carbonate complex depends on the pH of the solution, which will differ in different parts of the body (BEIR IV 1988). The low-molecular-weight bicarbonate complex can be filtered at the renal glomerulus and be excreted in urine at levels dependent on the pH of the urine. The uranium bound to the protein (primarily transferrin)

## 3. HEALTH EFFECTS

is less easily filtered and is more likely to remain in blood. In the blood, the uranyl ion binds to circulating transferrin, and to proteins and phospholipids in the proximal tubule (Wedeen 1992).

### 3.4.4 Elimination and Excretion

Two-thirds of uranium, intravenously injected as uranyl nitrate in human subjects was typically excreted in urine in the first 24 hours. Approximately 10% more was excreted over a period of 5 days. Fecal excretion accounted for <1% of the excretion (ICRP 1995).

#### 3.4.4.1 Inhalation Exposure

In a study of 7,231 uranium workers, the urinary concentration of uranium ranged from 5 µg/L in 4,556 workers to >100 µg/L in 32 workers. Samples were taken weekly over a 6-year period. Among a control group of 600 non-uranium workers, none had urinary uranium concentrations that exceeded 40 µg/L. The author concluded that urinary uranium concentrations >100 µg/L are definitely indicative of recent absorption, and that pathological albuminuria is rare, except when the urinary uranium concentration exceeds 1,000 µg/L. Albuminuria, when seen, was transient, and did not persist (Butterworth 1955).

Urinary excretion in crushermen (about 0.2 nCi/day [7 Bq/day; 0.3 mg/day]) is about 1/100th of fecal excretion (about 13.5 nCi/day [500 Bq/day; 20 mg/day]). The activity of <sup>234</sup>U in urine was slightly higher than that of <sup>238</sup>U. Active crushermen excreted higher levels of <sup>234</sup>U, <sup>238</sup>U, and <sup>230</sup>Th than retired crushermen or controls (Fisher et al. 1983). Most of the inhalation doses of female employees at the Oak Ridge plant were excreted in the feces, indicating that ciliary action in the lungs, followed by fecal excretion, was an important mechanism of body clearance (West and Scott 1969).

Lu and Zhao (1990) reported on the excretion of uranium in an occupationally exposed worker. A 23-year-old man who weighed 60 kg, dressed in protective clothing, mask, and gloves, was accidentally exposed to pure uranium tetrafluoride powder for 5 minutes. The uranium tetrafluoride powder cloud was reported to contain natural uranium. Urinary excretion was reported as 112 µg/L or 156.8 µg in the first 24 hours, gradually increasing through postaccident day 60 and returning to normal at about postaccident day 1,065. The total urinary excretion of uranium through day 1,065 was calculated to be 86.7 mg. The excretion data was used to calculate total absorption and kidney content by use of a kinetic model (ICRP 1979). The kidney content on postaccident day 1 was reported as 804.2 µg or approximately 2.6 µg/g of kidney.

## 3. HEALTH EFFECTS

Depleted uranium was detected in the urine of uranium process workers and nearby residents 20 years after chronic exposure to depleted uranium aerosols (Parrish et al. 2008). The biological half-time of uranium dioxide in human lungs (occupational exposure) at German fuel fabrication facilities was estimated to be 109 days. Body burden measurements of uranium taken from 12 people who handled uranium oxides for 5–15 years were used for this determination. Twice a year for 6 years, urinalysis was conducted on workers exposed to uranium. *In vivo* lung counting was performed on the last day before and the first day after a holiday period. Levels of uranium in feces were measured during the first 3 days and the last 3 days of a holiday period and the first 3 days after the restart of work. For some employees, the levels of uranium in feces were measured during 3–4 days one-half year after the holiday period (Schieferdecker et al. 1985).

In animals, most of absorbed uranium is excreted in urine. Inhaled larger particles ( $\geq 10 \mu\text{m}$ ) are transported out of the respiratory system by mucocilliary action, then swallowed, and eliminated in the feces (Ballou et al. 1986; Downs et al. 1967; Morrow et al. 1982a). Deposition sites of inhaled aerosols, and hence the clearance kinetics, are determined in part by particle size of the inhaled particles. As the AMAD increases, the amount deposited in the upper respiratory tract increases, and the amount deposited in the deep respiratory tracts of the lungs decreases. This study used both  $^{232}\text{U}$  and  $^{233}\text{U}$  dusts. The  $^{233}\text{U}$  dust deposition in the upper respiratory tract increased from 21 to 62% of the total amount of dust deposited with increasing particle size; deposition in the deep lung decreased from 22 to 7% with increasing particle size. The  $^{232}\text{U}$  dust deposition in the upper respiratory tract increased from 10 to 32% with increasing particle size; deposition in the deep lung decreased from 23 to 9% with increasing particle size. The differences were less marked for  $^{232}\text{U}$  dust, presumably because the particle size was much more uniform than that for the  $^{233}\text{U}$  dust. A large amount of the initial lung burden was preferentially cleared via the feces following clearance from the upper respiratory tract to the gastrointestinal tract (higher fecal excretion with higher AMAD) by mucocilliary action. Urinary excretion was 25–50% of initial lung burden on day 1 and less with larger particles. By day 7, 25–80% of the uranium uptake was cleared in urine; most of the uranium was eliminated in the feces (Ballou et al. 1986). In one study with rats, most of the inhaled uranium, as uranium dioxide, was excreted in the urine. In dogs, <10% was excreted in feces (presumably cleared by mucocilliary action) (Cooper et al. 1982). About 60% of the retained uranium, as uranyl nitrate hexahydrate (Ballou et al. 1986), uranium hexafluoride (Leach et al. 1984), and uranium trioxide (Morrow et al. 1982a), was excreted in urine within 1 day in other studies with rats, dogs, and guinea pigs. Most of the retained uranium in rats exposed via intratracheal intubation with uranium dioxide or uranyl nitrate hexahydrate was excreted in the urine. Less than 10% was

## 3. HEALTH EFFECTS

excreted in feces (presumably cleared by mucocilliary action) (Cooper et al. 1982). The fraction of insoluble compounds (uranium tetrafluoride, uranium dioxide) retained in the lungs and lymph nodes was independent of the exposure concentration. More than 90% of the uranium retained at the end of the first year of exposure to uranium dioxide was cleared by the end of the second year despite continued exposure to uranyl nitrate hexahydrate. All of the uranium retained following 1 year of exposure to uranium tetrafluoride was cleared by the end of the second year. For uranyl nitrate hexahydrate exposure, no retention was found in the soft tissues (Stokinger et al. 1953).

Once deposited in the lungs, uranium compounds clear from the various biological compartments by solubility. The ICRP lung model recognizes three clearance classification types: F, M, and S. Type F compounds (uranium hexafluoride, uranyl fluoride, uranium trioxide, possibly uranium tetrafluoride, possibly triuranium octaoxide) show 100% absorption with a half-time of 10 minutes. Type M compounds (uranyl nitrate, ammonium diuranate, possibly uranium tetrafluoride, possibly triuranium octaoxide) show 10% absorption with a half-time of 10 minutes, 90% with a half-time of 140 days, and about 70% of the material in the alveoli eventually reached body fluid. Type S compounds (uranium dioxide) show 0.1% absorption with a half-time of 1 minute, 99.9% with a half-time of 7,000 days, and 10% of that deposited in the alveoli reaches body fluid (ICRP 1996). The half-time of uranium in the lungs has also been calculated to be 1–5 days for soluble compounds like uranyl nitrate hexahydrate in rats (Ballou et al. 1986), ammonium diuranate in hamsters (Stradling et al. 1984), and uranyl fluoride in dogs (Morrow et al. 1982a). It is longer for the less soluble uranium dioxide: 141–289 days in rats (Downs et al. 1967) and 480 days in dogs (Leach et al. 1973). In the kidney, uranium selectively accumulates in the proximal tubule with a biological half-time of about 1 week (Wedeen 1992). The half-time of uranyl fluoride in the kidneys has been reported to be 2–5 days in rats (Diamond et al. 1989) and 9 days in dogs. In dogs, <1% of the uranium remained in the kidneys after 30 days (Morrow et al. 1982a).

In rats receiving an intratracheal instillation of uranium tetrafluoride or uranium peroxide, urinary excretion of uranium steadily increased during the first 8 days after instillation and then remained constant until the end of the study (postexposure day 30) (Houpert et al. 1999). Two dose levels were administered for each compound, and despite signs of renal toxicity at the high dose level, there were no difference in the K/K+U ratio (K is the percent of uranium retained in the kidneys and U is the percent excreted in urine) between the groups.

## 3. HEALTH EFFECTS

**3.4.4.2 Oral Exposure**

The available evidence on the excretion of ingested uranium suggests that most ( $\geq 95\%$ ) is excreted in the feces, and the remainder in urine (Wrenn et al. 1985). Urinary uranium excretion rates from nonoccupationally exposed persons in three villages near uranium mining and refining facilities and a control village in Japan were  $<0.02$ – $0.24$  and  $<0.02$ – $0.04$  mg U/day per person, respectively (Masuda 1971). The half-time in the kidneys has been estimated to be 1–6 days for 99% of the uranium in the kidneys and 1,500 days for the remainder (ICRP 1979). Most of the uranium doses, given as 900 mL of water containing 90 pCi (3.3 Bq)  $^{234}\text{U}$  and 90 pCi (3.3 Bq)  $^{238}\text{U}$  (180 pCi or 6.6 Bq uranium) to drink over a period of 6 hours, was excreted in feces within 2 days (Singh and Wrenn 1987). Four volunteers who ingested 10.8 mg of uranium mixed with Coca-Cola excreted the uranium in both feces and urine over a 25-day period (Hursh et al. 1969). Urinary excretion after oral exposure is generally low and has been estimated as 2% of total excretion (Spencer et al. 1990).

Animal studies have shown that most ingested uranium (99%) is not absorbed in rats, but is eliminated in the feces without being cycled through the bile. In rats, most of the absorbed uranium leaves the body within a few days in urine; half is excreted in 2–6 days (Durbin and Wrenn 1975) and 98% is excreted within 7 days (Sullivan et al. 1986). About 95% of the uranium in the kidneys of rats is excreted in urine within 1 week, and very little remains in any other organ (La Touche et al. 1987; Sullivan 1980a; Sullivan et al. 1986).

Data from parenteral studies provide further indication that uranium retention in animal kidneys is described by a two-compartment exponential curve. Reported biological half-times for the compartments are 2 and 50–60 days (Diamond et al. 1989), 2 and 13 days (Bentley et al. 1985), or 3 and 103 days (DOE 1986b).

A nonmonotonous pattern of uranium excretion was observed in rats chronically exposed to 2.0–2.9 mg U/kg/day as depleted uranyl nitrate in drinking water (Paquet et al. 2006). The highest excretion levels were observed after 6 months of exposure (200 ng U/mL), after which time the levels steadily declined. At approximately 13 months of exposure, the levels remained constant at 30 ng U/mL for the last 6 months of the study.

## 3. HEALTH EFFECTS

**3.4.4.3 Dermal Exposure**

No studies were located describing the excretion of uranium following dermal exposure in humans. Application of depleted uranium or uranium in a nitric acid solution resulted in significant increases in the urinary excretion of uranium within 24 hours of exposure in hairless rats (Petitot et al. 2007a, 2007b). Application to intact skin resulted in increases in urinary uranium within 2 hours of exposure; application to wounded skin (via mechanical abrasion or exposure to low concentration of an acid solution) resulted in increases in urinary uranium within 30 minutes of exposure. In contrast, severe damage to the skin resulted in low levels of uranium in the urine, first detected 6 hours after exposure.

**3.4.4.4 Other Routes of Exposure**

One day after depleted uranium pellets were implanted in the gastrocnemius muscle of rats, increased levels of uranium were measured in the urine (Zhu et al. 2009a). Urinary excretion peaked 90 days after implantation and remained elevated 360 days after implantation.

**3.4.5 Physiologically Based Pharmacokinetic (PBPK)/Pharmacodynamic (PD) Models**

Physiologically based pharmacokinetic (PBPK) models use mathematical descriptions of the uptake and disposition of chemical substances to quantitatively describe the relationships among critical biological processes (Krishnan et al. 1994). PBPK models are also called biologically based tissue dosimetry models. PBPK models are increasingly used in risk assessments, primarily to predict the concentration of potentially toxic moieties of a chemical that will be delivered to any given target tissue following various combinations of route, dose level, and test species (Clewell and Andersen 1985). Physiologically based pharmacodynamic (PBPD) models use mathematical descriptions of the dose-response function to quantitatively describe the relationship between target tissue dose and toxic end points.

PBPK/PD models refine our understanding of complex quantitative dose behaviors by helping to delineate and characterize the relationships between: (1) the external/exposure concentration and target tissue dose of the toxic moiety, and (2) the target tissue dose and observed responses (Andersen and Krishnan 1994; Andersen et al. 1987). These models are biologically and mechanistically based and can be used to extrapolate the pharmacokinetic behavior of chemical substances from high to low dose, from route to route, between species, and between subpopulations within a species. The biological basis of PBPK models results in more meaningful extrapolations than those generated with the more conventional use of uncertainty factors.



## 3. HEALTH EFFECTS

The PBPK model for a chemical substance is developed in four interconnected steps: (1) model representation, (2) model parameterization, (3) model simulation, and (4) model validation (Krishnan and Andersen 1994). In the early 1990s, validated PBPK models were developed for a number of toxicologically important chemical substances, both volatile and nonvolatile (Krishnan and Andersen 1994; Leung 1993). PBPK models for a particular substance require estimates of the chemical substance-specific physicochemical parameters, and species-specific physiological and biological parameters. The numerical estimates of these model parameters are incorporated within a set of differential and algebraic equations that describe the pharmacokinetic processes. Solving these differential and algebraic equations provides the predictions of tissue dose. Computers then provide process simulations based on these solutions.

The structure and mathematical expressions used in PBPK models significantly simplify the true complexities of biological systems. If the uptake and disposition of the chemical substance(s) are adequately described, however, this simplification is desirable because data are often unavailable for many biological processes. A simplified scheme reduces the magnitude of cumulative uncertainty. The adequacy of the model is, therefore, of great importance, and model validation is essential to the use of PBPK models in risk assessment.

PBPK models improve the pharmacokinetic extrapolations used in risk assessments that identify the maximal (i.e., the safe) levels for human exposure to chemical substances (Andersen and Krishnan 1994). PBPK models provide a scientifically sound means to predict the target tissue dose of chemicals in humans who are exposed to environmental levels (for example, levels that might occur at hazardous waste sites) based on the results of studies where doses were higher or were administered in different species. Figures 3-3 through 3-9 show models for radionuclides in general or specifically for uranium.

If PBPK models for uranium exist, the overall results and individual models are discussed in this section in terms of their use in risk assessment, tissue dosimetry, and dose, route, and species extrapolations.

The ICRP (1994a, 1996) developed a Human Respiratory Tract Model (HRTM) for Radiological Protection, which contains respiratory tract deposition and clearance compartmental models for inhalation exposure that may be applied to uranium. The ICRP (1995) also developed a biokinetic model for human oral exposure that applies to uranium. Several more recent enhancements to the oral exposure model

## 3. HEALTH EFFECTS

**Figure 3-3. Conceptual Representation of a Physiologically Based Pharmacokinetic (PBPK) Model for a Hypothetical Chemical Substance**

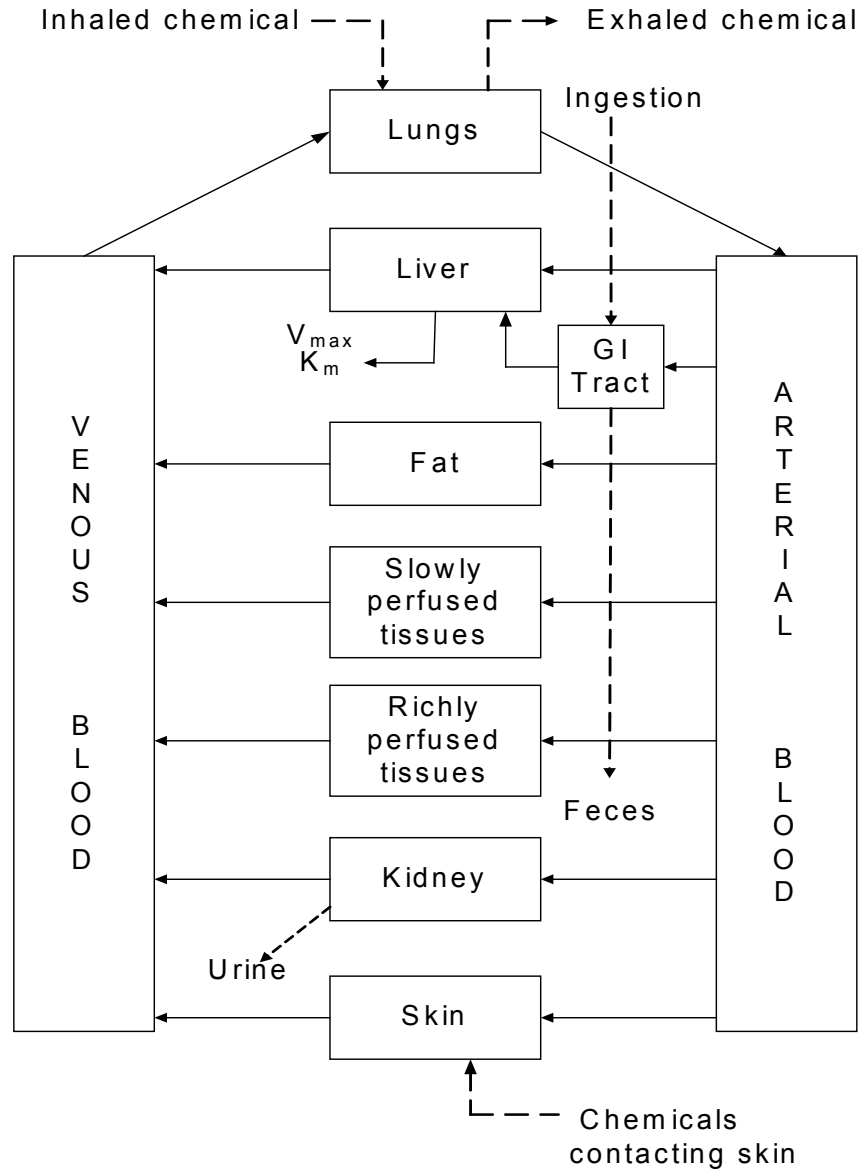

Note: This is a conceptual representation of a physiologically based pharmacokinetic (PBPK) model for a hypothetical chemical substance. The chemical substance is shown to be absorbed via the skin, by inhalation, or by ingestion, metabolized in the liver, and excreted in the urine or by exhalation.

Source: adapted from Krishnan and Andersen 1994

## 3. HEALTH EFFECTS

have been reported. A multicompartamental gastrointestinal tract model was developed to replace what was originally a single parameter model (Human Alimentary Tract Model, HATM; ICRP, 2006a). A hair compartment was developed to support biomonitoring of ingestion intakes (e.g., drinking water exposures, Li et al. 2009a). Drinking water and dietary exposure models and Bayesian approaches have been developed to improve uranium dose assessments made with the ICRP model (Little et al. 2003, 2007). A biokinetics model for embedded uranium has been developed based on studies of uranium kinetics in rats that received implants of depleted uranium pellets (Leggett and Pellmar 2002; Squibb et al. 2005). An adaptation of the ICRP human model for simulating biokinetics of inhaled uranium in rats has been reported (Monleau et al. 2006b) and the rat model was used to evaluate the general assumption of linear kinetics in the ICRP model (i.e., kinetics are independent of the dose history). Several quantitative uncertainty analyses of the ICRP model have been reported (Davesne et al. 2009; Farfan et al. 2003; Puncher et al. 2008). The ICRP model performance has been evaluated against data on urinary excretion of uranium and data on uranium levels in tissues obtained from autopsy studies (Li et al. 2005, 2006, 2009a; Russell and Kathren 2004). Several recent applications of the ICRP model to exposure and risk assessment have been reported. The model has been applied to simulate uranium body burdens and radiation doses associated with exposure scenarios of releases of depleted uranium in vehicles impacted by depleted uranium munitions (Guilmette et al. 2009). The embedded uranium model developed by Leggett and Pellmar (2002) has been extended to humans and has been applied to predicting kidney uranium burdens in military veterans who received embedded fragment wounds resulting from vehicles impacted with depleted uranium munitions (Squibb et al. 2005). A wound biokinetic model developed by NCRP (2008) has been coupled with the ICRP model to calculate predicted urinary excretion patterns and uranium kidney retention for different categories of uranium exposure (NCRP 2008). An extension of the ICRP model that includes simulation of the transfer of uranium to hair has been used to estimate uranium dose coefficients for ingestion of uranium in drinking water (Li et al. 2009a). The model has been used to predict radiation doses associated with exposures to uranium in drinking water and uranium body burdens associated with ingestion and inhalation exposures (Chen et al. 2004; Li et al. 2009b).

The NCRP has also developed a respiratory tract and biokinetics model for inhaled radionuclides (NCRP 1997). Four other compartmental models (Fisher et al. 1991; Sontag 1986; Valdés 2009; Wrenn et al. 1994) are also described below.

## 3. HEALTH EFFECTS

**Human Respiratory Tract Model for Radiological Protection (ICRP 1994a, 1996)**

**Deposition.** The ICRP has developed a deposition model for behavior of aerosols and vapors in the respiratory tract. It was developed to estimate the fractions of radioactivity in breathing air that are deposited in each anatomical region. ICRP provides inhalation dose coefficients that can be used to estimate the committed equivalent and effective doses to organs and tissues throughout the body based on a unit intake of radioactive material. The model applies to three levels of particle solubility, a wide range of particle sizes (approximately 0.0005–100  $\mu\text{m}$  in diameter), and parameter values can be adjusted for various segments of the population (e.g., sex, age, level of physical exertion). This model also allows one to evaluate the bounds of uncertainty in deposition estimates. Uncertainties arise from natural biological variability among individuals and the need to interpret some experimental evidence that remains inconclusive. It is applicable to particles containing uranium, but was developed for a wide variety of radionuclides and their chemical forms.

The ICRP deposition model estimates the amount of inhaled material that initially enters each compartment (see Figure 3-4). The model was developed with five compartments: (1) the anterior nasal passages ( $\text{ET}_1$ ); (2) all other extrathoracic airways ( $\text{ET}_2$ ) (posterior nasal passages, the naso- and oropharynx, and the larynx); (3) the bronchi (BB); (4) the bronchioles (bb); and (5) the alveolar interstitium (AI). Particles deposited in each of the regions may be removed from each region and redistributed either upward into the respiratory tree or to the lymphatic system and blood by different particle removal mechanisms.

For extrathoracic deposition, the model uses experimental data, where deposition is related to particle size and airflow parameters, and scales deposition for women and children from adult male data. Similarly to the extrathoracic region, experimental data served as the basis for lung (bronchi, bronchioles, and alveoli) aerosol transport and deposition. A theoretical model of gas transport and particle deposition was used to interpret data and to predict deposition for compartments and subpopulations other than adult males. Table 3-7 provides reference respiratory values for the general Caucasian population under several levels of activity.

3. HEALTH EFFECTS

**Figure 3-4. Respiratory Tract Compartments in Which Particles May be Deposited\***

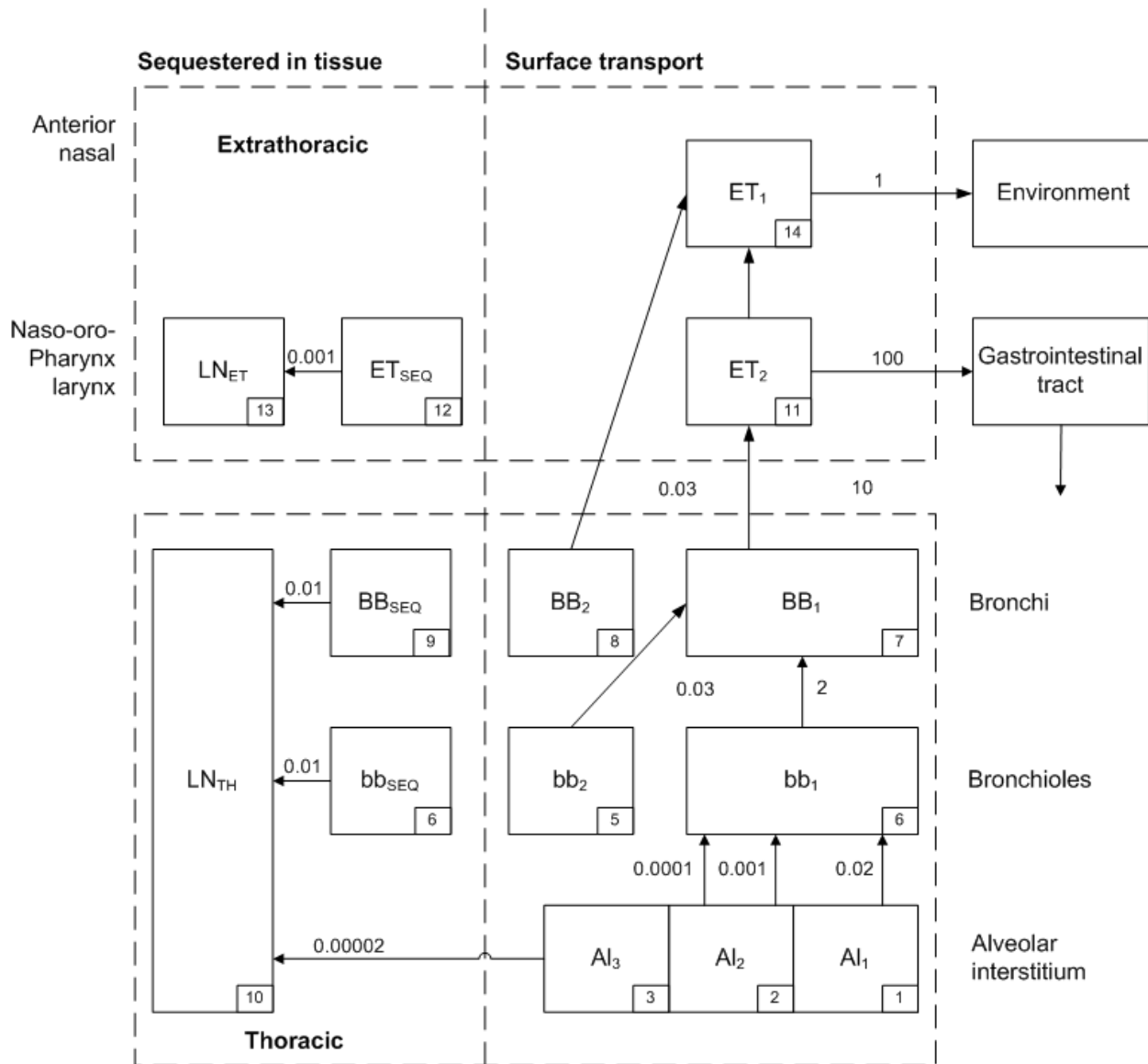

\*Compartment numbers shown in lower right corners are used to define clearance pathways. The clearance rates, half-lives, and fractions by compartment, as well as the compartment abbreviations are presented in Table 3-8.

Source: ICRP 1994a

## 3. HEALTH EFFECTS

**Table 3-7. Reference Respiratory Values for a General Caucasian Population at Different Levels of Activity**

Breathing parameters:	3 Months	1 Year	5 Years	10 Years			15 Years		Adult	
				Male	Female	Both	Male	Female	Male	Female
Resting (sleeping); maximal workload 8%										
Breathing parameters:										
$V_T$ (L)	0.04	0.07	0.17	–	–	0.3	0.500	0.417	0.625	0.444
$B$ ( $m^3$ hour $^{-1}$ )	0.09	0.15	0.24	–	–	0.31	0.42	0.35	0.45	0.32
$f_R$ (minute $^{-1}$ )	38	34	23	–	–	17	14	14	12	12
Sitting awake; maximal workload 12%										
Breathing parameters:										
$V_T$ (L)	NA	0.1	0.21	–	–	0.33	0.533	0.417	0.750	0.464
$B$ ( $m^3$ hour $^{-1}$ )	NA	0.22	0.32	–	–	0.38	0.48	0.40	0.54	0.39
$f_R$ (minute $^{-1}$ )	NA	36	25	–	–	19	15	16	12	14
Light exercise; maximal workload 32%										
Breathing parameters:										
$V_T$ (L)	0.07	0.13	0.24	–	–	0.58	1.0	0.903	1.25	0.992
$B$ ( $m^3$ hour $^{-1}$ )	0.19	0.35	0.57	–	–	1.12	1.38	1.30	1.5	1.25
$f_R$ (minute $^{-1}$ )	48	46	39	–	–	32	23	24	20	21
Heavy exercise; maximal workload 64%										
Breathing parameters:										
$V_T$ (L)	NA	NA	NA	0.841	0.667	–	1.352	1.127	1.923	1.364
$B$ ( $m^3$ hour $^{-1}$ )	NA	NA	NA	2.22	1.84	–	2.92	2.57	3.0	2.7
$f_R$ (minute $^{-1}$ )	NA	NA	NA	44	46	–	36	38	26	33

$B$  = ventilation rate;  $f_R$  = respiration frequency; NA = not applicable;  $V_T$  = tidal volume

Source: See Annex B (ICRP 1994a) for data from which these reference values were derived.

## 3. HEALTH EFFECTS

**Respiratory Tract Clearance.** This portion of the model identifies the principal clearance pathways within the respiratory tract. The model was developed to predict the retention of various radioactive materials. Figure 3-5 presents the compartmental model and is linked to the deposition model (Figure 3-4) and to reference values presented in Table 3-8. Table 3-8 provides clearance rates and deposition fractions for each compartment for insoluble particles. The table provides rates of insoluble particle transport for each of the compartments, expressed as a fraction per day and also as half-time. ICRP also developed modifying factors for some of the parameters, such as age, smoking, and disease status. Parameters of the clearance model are based on human evidence for the most part, although particle retention in airway walls is based on experimental data from animal experiments.

The clearance of particles from the respiratory tract is a dynamic process. The rate of clearance generally changes with time from each region and by each route. Following deposition of large numbers of particles (acute exposure), transport rates change as particles are cleared from the various regions. Physical and chemical properties of deposited material determine the rate of dissolution and as particles dissolve, absorption rates tend to change over time. By creating a model with compartments of different clearance rates within each region (e.g.,  $BB_1$ ,  $BB_2$ ,  $BB_{seq}$ ), the ICRP model overcomes problems associated with time-dependent functions. Each compartment clears to other compartments by constant rates for each pathway.

Particle transport from all regions is toward both the lymph nodes and the pharynx, and a majority of deposited particles end up being swallowed. In the front part of the nasal passages ( $ET_1$ ), nose blowing, sneezing, and wiping remove most of the deposited particles. Particles remain here for about a day. For particles with AMADs a few micrometers or greater, the  $ET_1$  compartment is probably the largest deposition site. A majority of particles deposited at the back of the nasal passages and in the larynx ( $ET_2$ ) are removed quickly by the fluids that cover the airways. In this region particle clearance is completed within 15 minutes.

Ciliary action removes deposited particles from both the bronchi and bronchioles. Though it is generally thought that mucocilliary action rapidly transports most particles deposited here toward the pharynx, a fraction of these particles are cleared more slowly. Evidence for this is found in human studies. For humans, retention of particles deposited in the lungs ( $BB$  and  $bb$ ) is apparently biphasic. The “slow” action of the cilia may remove as many as half of the bronchi- and bronchiole-deposited particles. In human bronchi and bronchiole regions, mucus moves more slowly the closer to the alveoli it is. For the

3. HEALTH EFFECTS

**Figure 3-5. Environmental Pathways for Potential Human Health Effects from Uranium**

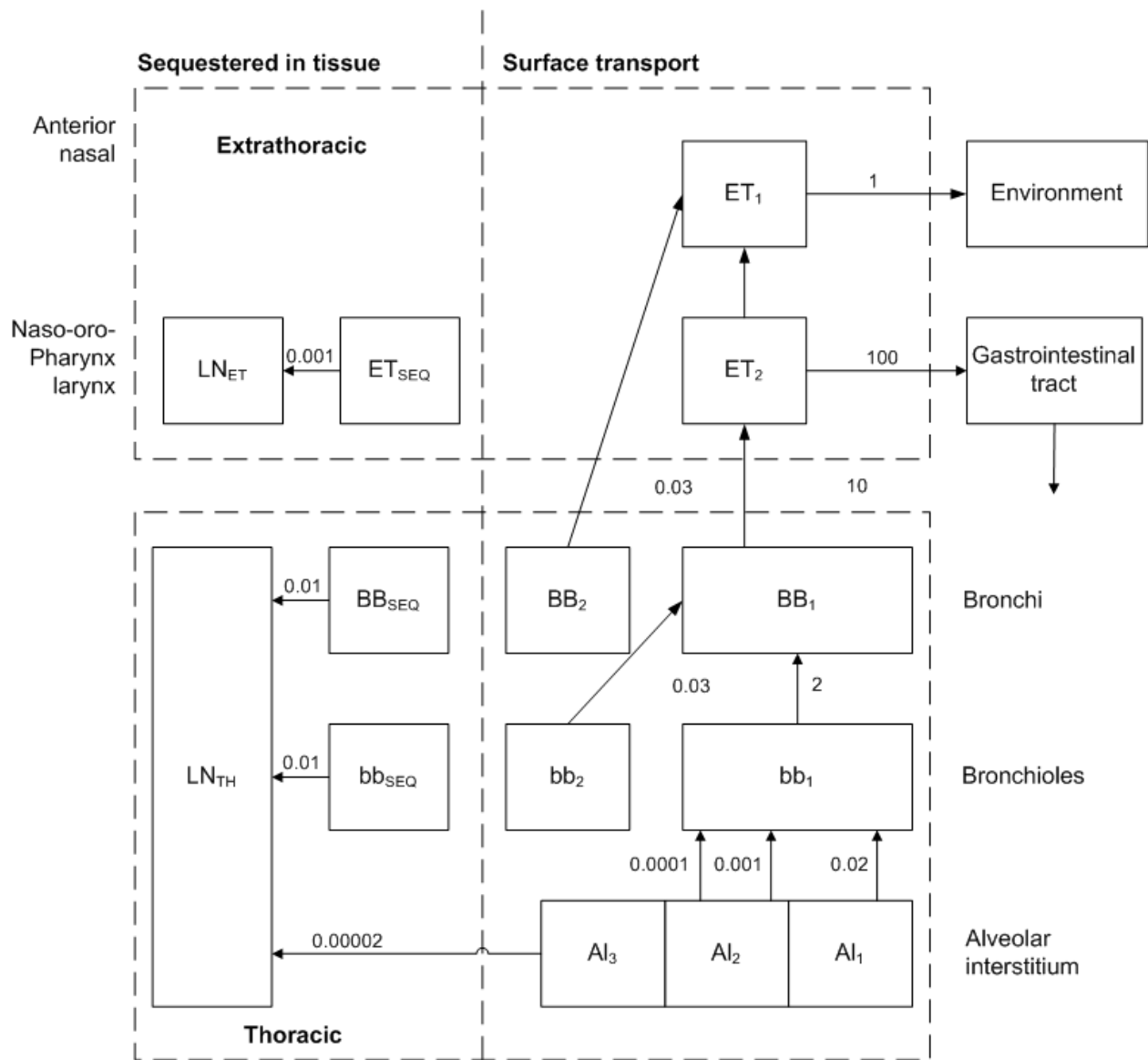

See Table 3-8 for rates, half-lives, and fractions by compartment.

Source: ICRP 1994a



## 3. HEALTH EFFECTS

**Table 3-8. Reference Values of Parameters for the Compartment Model to Represent Time-dependent Particle Transport from the Human Respiratory Tract**

**Part A**

Clearance rates for insoluble particles				
Pathway	From	To	Rate (d <sup>-1</sup> )	Half-life <sup>a</sup>
m <sub>1,4</sub>	Al <sub>1</sub>	bb <sub>1</sub>	0.02	35 days
m <sub>2,4</sub>	Al <sub>2</sub>	bb <sub>1</sub>	0.001	700 days
m <sub>3,4</sub>	Al <sub>3</sub>	bb <sub>1</sub>	1x10 <sup>-4</sup>	7,000 days
m <sub>3,10</sub>	Al <sub>3</sub>	LN <sub>TH</sub>	2x10 <sup>-5</sup>	No data
m <sub>4,7</sub>	bb <sub>1</sub>	BB <sub>1</sub>	2	8 hours
m <sub>5,7</sub>	bb <sub>2</sub>	BB <sub>1</sub>	0.03	23 days
m <sub>6,10</sub>	bb <sub>seq</sub>	LN <sub>TH</sub>	0.01	70 days
m <sub>7,11</sub>	BB <sub>1</sub>	ET <sub>2</sub>	10	100 minutes
m <sub>8,11</sub>	BB <sub>2</sub>	ET <sub>2</sub>	0.03	23 days
m <sub>9,10</sub>	BB <sub>seq</sub>	LN <sub>TH</sub>	0.01	70 days
m <sub>11,15</sub>	ET <sub>2</sub>	GI tract	100	10 minutes
m <sub>12,13</sub>	ET <sub>seq</sub>	LN <sub>ET</sub>	0.001	700 days
m <sub>14,16</sub>	ET <sub>1</sub>	Environment	1	17 hours

## 3. HEALTH EFFECTS

**Table 3-8. Reference Values of Parameters for the Compartment Model to Represent Time-dependent Particle Transport from the Human Respiratory Tract**

**Part B**

Partition of deposit in each region between compartments <sup>b</sup>		
Region or deposition site	Compartment	Fraction of deposit in region assigned to compartment <sup>c</sup>
ET <sub>2</sub>	ET <sub>2</sub>	0.9995
	ET <sub>seq</sub>	0.0005
BB	BB <sub>1</sub>	0.993-f <sub>s</sub>
	BB <sub>2</sub>	f <sub>s</sub>
	BB <sub>seq</sub>	0.007
bb	bb <sub>1</sub>	0.993-f <sub>s</sub>
	bb <sub>2</sub>	f <sub>s</sub>
	bb <sub>seq</sub>	0.007
Al	Al <sub>1</sub>	0.3
	Al <sub>2</sub>	0.6
	Al <sub>3</sub>	0.1

<sup>a</sup>The half-lives are approximate since the reference values are specified for the particle transport rates and are rounded in units of days<sup>-1</sup>. A half-life is not given for the transport rate from Al<sub>3</sub> to LN<sub>TH</sub>, since this rate was chosen to direct the required amount of material to the lymph nodes. The clearance half-life of compartment Al<sub>3</sub> is determined by the sum of the clearance rates.

<sup>b</sup>See paragraph 181, Chapter 5 (ICRP 1994a) for default values used for relating f<sub>s</sub> to d<sub>ae</sub>.

<sup>c</sup>It is assumed that f<sub>s</sub> is size-dependent. For modeling purposes, f<sub>s</sub> is taken to be:

$$f_s = 0.5 \text{ for } d_{ae} \leq 2.5\sqrt{\rho/\chi} \mu\text{m and}$$

$$f_s = 0.5e^{0.63(d_{ae}\sqrt{\chi/\rho}-2.5)} \text{ for } d_{ae} > 2.5\sqrt{\rho/\chi} \mu\text{m}$$

where

f <sub>s</sub>	=	fraction subject to slow clearance
d <sub>ae</sub>	=	aerodynamic particle diameter/(μm)
ρ	=	particle density (g/cm <sup>3</sup> )
χ	=	particle shape factor

Al = alveolar-interstitial region; BB = bronchial region; bb = bronchiolar region; BB<sub>seq</sub> = compartment representing prolonged retention in airway walls of small fraction of particles deposited in the bronchial region; bb<sub>seq</sub> = compartment representing prolonged retention in airway walls of small fraction of particles deposited in the bronchiolar region; ET = extrathoracic region; ET<sub>seq</sub> = compartment representing prolonged retention in airway tissue of small fraction of particles deposited in the nasal passages; GI = gastrointestinal; LN<sub>ET</sub> = lymphatics and lymph nodes that drain the extrathoracic region; LN<sub>TH</sub> = lymphatics and lymph nodes that drain the thoracic region

Source: ICRP 1994b

## 3. HEALTH EFFECTS

faster compartment it has been estimated that it takes about 2 days for particles to travel from the bronchioles to the bronchi and 10 days from the bronchi to the pharynx. The second (slower) compartment is assumed to have approximately equal fractions deposited between  $BB_2$  and  $bb_2$  and both with clearance half-times estimated at 20 days. Particle size is a primary determinant of the fraction deposited in this slow thoracic compartment. A small fraction of particles deposited in the BB and bb regions is retained in the airway wall for even longer periods ( $BB_{seq}$  and  $bb_{seq}$ ).

If particles reach and become deposited in the alveoli, they tend to stay imbedded in the fluid on the alveolar surface or move into the lymph nodes. The one mechanism by which particles are physically resuspended and removed from the AI region is coughing. For modeling purposes, the AI region is divided into three subcompartments to represent different clearance rates, all of which are slow.

In the alveolar-interstitial region, human lung clearance has been measured. The ICRP model uses 2 half-times to represent clearance: about 30% of the particles have a 30-day half-time and the remaining 70% are given a half-time of several hundred days. Over time, AI particle transport falls and some compounds have been found in lungs 10–50 years after exposure.

**Absorption into Blood.** The ICRP model assumes that absorption into blood occurs at equivalent rates in all parts of the respiratory tract, except in the anterior nasal passages ( $ET_1$ ), where no absorption occurs. It is essentially a two-stage process, as shown in Figure 3-6. First, there is a dissociation (dissolution) of particles; then the dissolved molecules or ions diffuse across capillary walls and are taken up by the blood. Immediately following dissolution, rapid absorption is observed. For some elements, rapid absorption does not occur because of binding to respiratory-tract components. In the absence of specific data for specific compounds, the model uses the following default absorption rate values for those specific compounds that are classified as Types F (fast), M (medium), and S (slow):

- For Type F, there is rapid 100% absorption within 10 minutes of the material deposited in the BB, bb, and AI regions, and 50% of material deposited in  $ET_2$ . Thus, for nose breathing, there is rapid absorption of approximately 25% of the deposit in ET and 50% for mouth breathing. Type F uranium compounds include uranium hexafluoride, its mixture with uranyl fluoride, uranyl nitrate (which can behave as Type M), pure uranium trioxide, and uranium tetrafluoride (which can behave at Type M).

For Type M, about 70% of the deposit in AI reaches the blood eventually. There is rapid absorption of about 10% of the deposit in BB and bb, and 5% of material deposited in  $ET_2$ . Thus, there is rapid absorption of approximately 2.5% of the deposit in ET for nose breathing, and 5% for mouth breathing. Type M compounds include unpure uranium trioxide, uranyl nitrate (which

3. HEALTH EFFECTS

**Figure 3-6. The Human Respiratory Tract Model: Absorption into Blood**

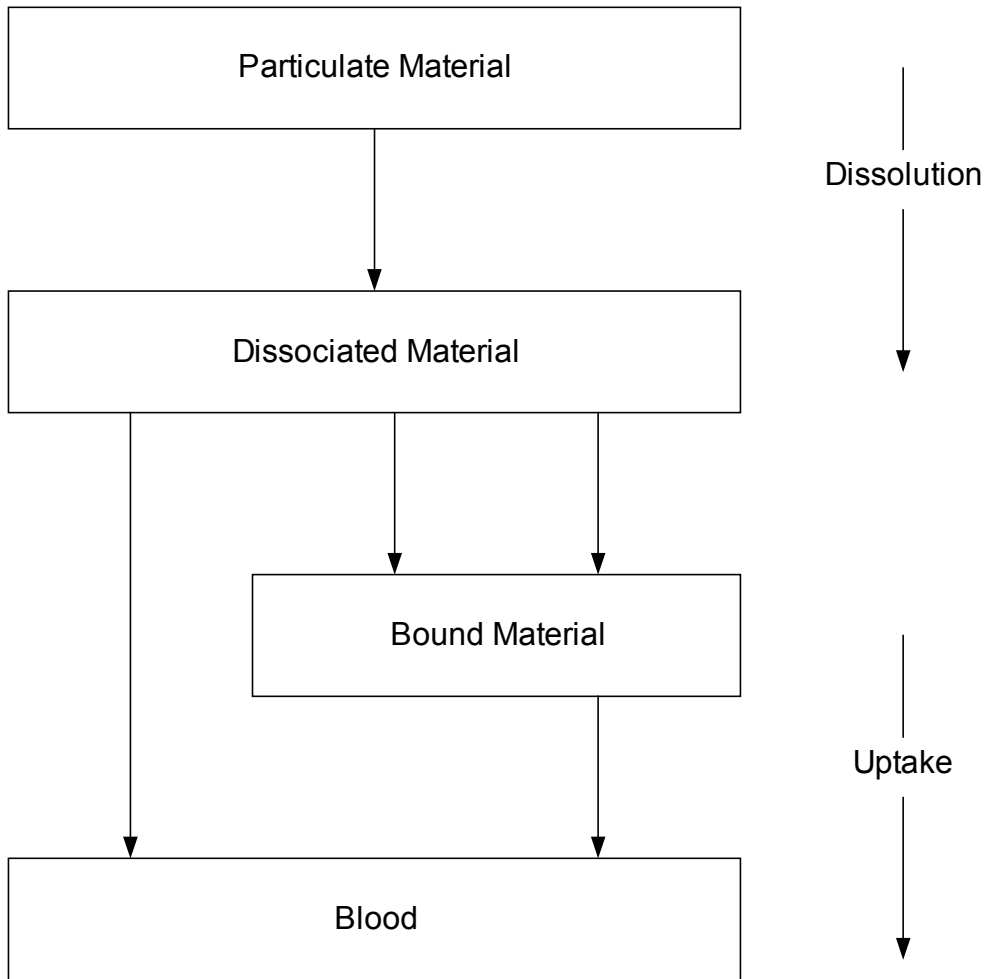

Source: ICRP 1994a

## 3. HEALTH EFFECTS

can behave as Type F), ammonium diuranate, uranium octaoxide (which can behave as Type S), and uranium tetrafluoride (which can behave as Type F).

- For Type S, 0.1% is absorbed within 10 minutes and 99.9% is absorbed within 7,000 days, so there is little absorption from ET, BB, or bb, and about 10% of the deposit in AI reaches the blood eventually. Type S compounds include uranium dioxide and uranium octaoxide (which can behave as Type M).

### Human Alimentary Tract Model for Radiological Protection (ICRP 2006a)

The ICRP HATM is a generic multicompartment gastrointestinal tract model that was developed for applications to radiation risk assessments of radionuclides. The model replaced an earlier gastrointestinal absorption model that consisted of single compartment and single parameter representation of absorption of radionuclides into the central plasma compartment from the small intestine. The structure of the multicompartment model is shown in Figure 3-7. The model simulates the following major processes that can contribute to absorption of radionuclides from the gastrointestinal tract and contact and retention radionuclides in the gastrointestinal tract tissues (i.e., which could contribute to radiation dose to these tissues):

- Entry of a radionuclide into the mouth by ingestion, or into the esophagus after mechanical clearance from the respiratory tract; sequential transfer of the radionuclide through the contents of the oral cavity, esophagus, stomach, small intestine, and segments of the colon, followed by excretion in feces.
- Deposition and retention on or between the teeth and return to the oral cavity.
- Deposition and retention in the oral mucosa or walls of the stomach and intestines.
- Transfer from the oral mucosa or walls of the stomach and intestines back into the luminal contents or into blood (absorption).
- Transfer from various secretory organs or blood into the contents of certain segments of the alimentary tract (secretion).

### Biokinetic Model for Uranium (ICRP 1995, 2006a)

The ICRP biokinetic model for uranium is based on the generic model structure for alkaline earth elements described in *Publication 67* (ICRP 1994b, 1995) linked to a generic multicompartmental alimentary tract model (HATM) described in *Publication 100* (ICRP 2006a). The structure of the model is shown in Figure 3-8. Uranium (as the  $\text{UO}_2^{2+}$  ion) is similar to calcium ( $\text{Ca}^{2+}$ ) with regard to skeletal kinetics.

3. HEALTH EFFECTS

**Figure 3-7. Structure of the Human Alimentary Tract Model (HATM)**

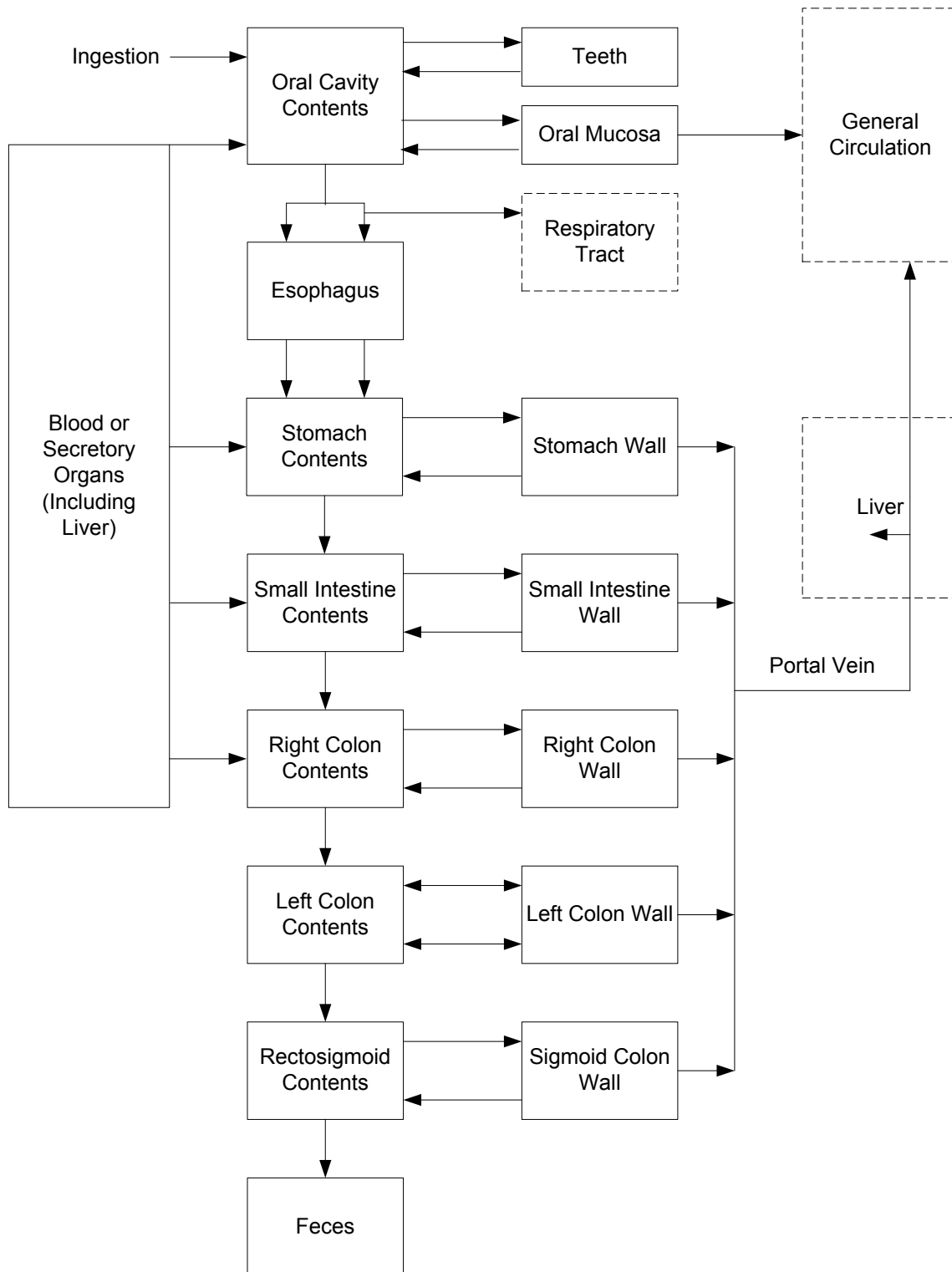

Source: ICRP 2006a

3. HEALTH EFFECTS

Figure 3-8. Biokinetic Model for Uranium after Uptake to Blood

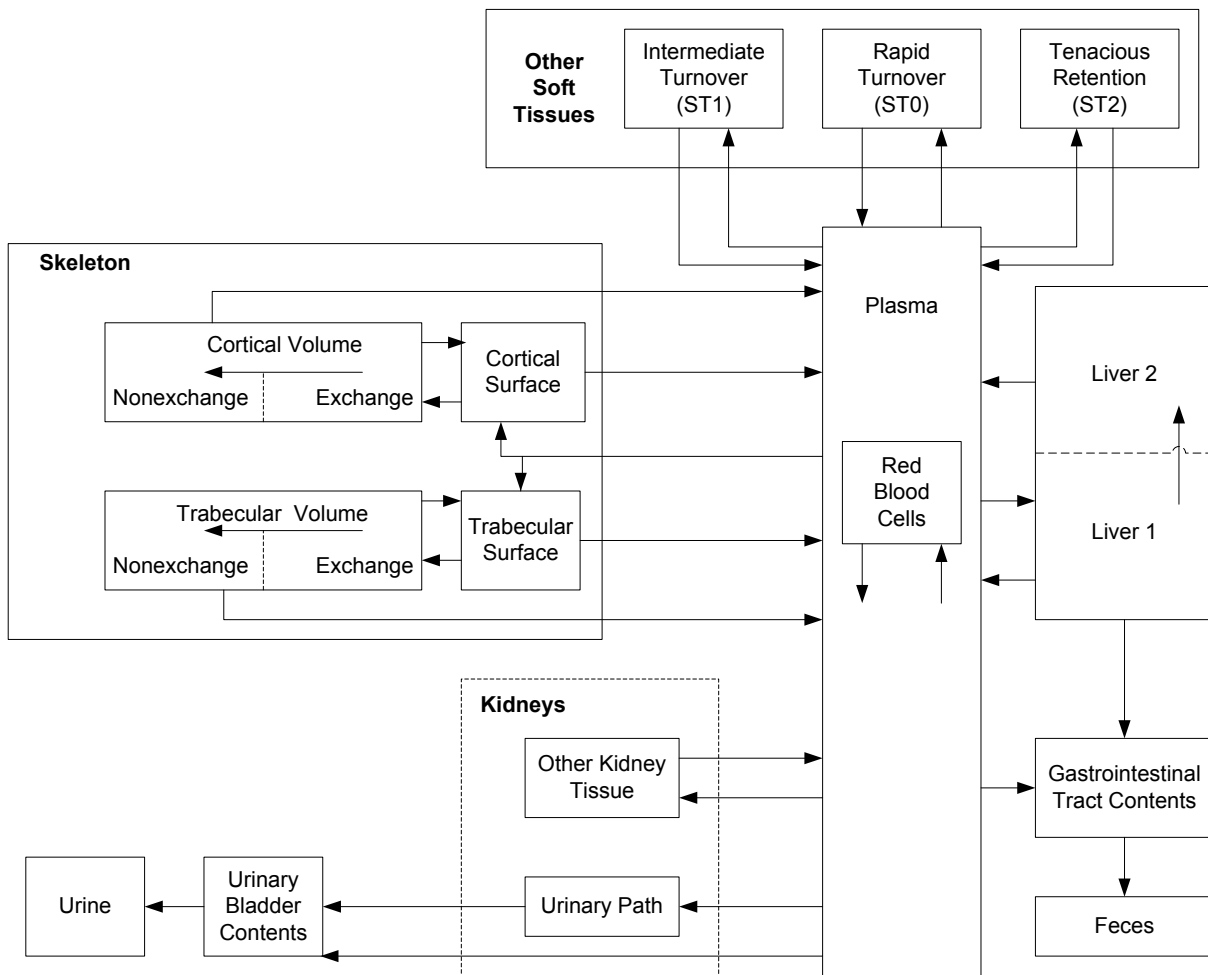

Source: ICRP 1995

### 3. HEALTH EFFECTS

Some transfer rates in the biokinetic model for uranium are equated with bone formation rates. The early behavior of uranium in human circulation is represented reasonably well by treating plasma as a uniformly mixed pool, where uranium is removed at a rate of  $35 \text{ d}^{-1}$  (ICRP 1995) and where a soft tissue compartment (ST0) is in relatively rapid exchange with plasma. Compartment ST0 is assumed to receive 30% of uranium leaving plasma and to have a removal half-time of 2 hours (from ST0 to plasma). ICRP assumed that 1% of uranium leaving the circulation (or 0.7% leaving plasma) deposits in red blood cells (ICRP 1995). The removal half-time from red blood cells to plasma is assumed to be 2 days.

Urinary excretion of uranium is assumed to arise from uranium moving directly from plasma to the urinary bladder contents. Approximately 60% of uranium leaves the blood directly to the bladder and another 12% is retained temporarily in the renal tubules before excretion. The liver is assumed to consist of two compartments: Liver 1 and Liver 2. The liver receives an estimated 1.5% of uranium leaving the blood, with over 90% returning to circulation.

Little direct information on the kinetics of uranium in children exists. Age-specific deposition of uranium in the skeleton is assumed to be proportional to the deposition of the alkaline earth elements. The rate of removal from deep bone is assumed to be the same as the age-specific bone turnover rate. Because children have higher amounts of uranium taken up by bone, deposition in soft tissues and excreta are likely lower in children than for adults.

#### **Valdés (2009) Lung Model**

A multicompartment model for predicting lung burdens of uranium resulting for exposure to depleted uranium aerosols was proposed by Valdés (2009). Clearance of uranium particles deposited in the lung is assumed to occur by mechanical clearance by the mucociliary escalator and by cellular transport of uranium particles to lymph nodes after phagocytosis by macrophages. The model assumes that phagocytosis is sufficiently rapid that essentially all absorption of uranium can be assumed to occur from macrophages after intracellular dissolution of uranium oxides to uranyl ion in macrophage lysosomes. The macrophage plasma membrane is assumed to be transparent to uranyl ion (i.e., absorption to the systemic circulation is considered to be essentially instantaneous). Therefore, the rate of absorption of uranium into the systemic circulation is determined by the dissolution rate, which is assumed to have fast and slow rate components. This representation of fast and slow dissolution kinetics and essentially instantaneous absorption of dissolved uranium is conceptually similar to the ICRP HRTM (ICRP 1995,



## 3. HEALTH EFFECTS

1996). A competing process within macrophages is precipitation of uranyl phosphates within lysosomes. Uranyl phosphate precipitates are assumed to be kinetically inert and are stored permanently in lymph nodes. Uranium absorbed into the systemic circulation is distributed and excreted according to the systemic biokinetics model based on the model developed by Wrenn et al. (1994).

The lung model is implemented as a series of first-order differential equations, the core of which are as follows. The amounts of uranium oxides in lungs (L) and lymph nodes (N) at time, t, following initial deposition in the lung of amount  $A_0$  are given by:

$$L(t) = A_0(0.0142e^{-2.1512t} + 0.3042e^{-0.00201t} + 0.0261e^{-0.2812t} + 0.0107e^{-0.0023t})$$

$$N(t) = A_0[0.0024(e^{-2.15t} - e^{-2.1512t}) + 0.0018(e^{-0.0011t} - e^{-0.0023t}) + 0.0567(e^{-0.00081t} - e^{-0.00201t}) + 0.0044(e^{-0.28t} - e^{-0.2812t})]$$

A similar set of expressions represents the amount of insoluble uranyl phosphates in lungs ( $P_L$ ) and lymph nodes ( $P_N$ ) at time, t, following initial deposition in the lung of amount  $A_0$ :

$$P_L(t) = A_0(1.460e^{-0.0012t} - 1.419e^{-0.00201t} - 0.0238e^{-2.1512t} - 0.0094e^{-0.2812t} - 0.008e^{-0.0023t})$$

$$P_N(t) = A_0(0.1015 + 2.2164 \times 10^{-6}e^{-2.1512t} + 0.1412e^{-0.00201t} + 6.6816 \times 10^{-6}e^{-0.2812t} + 0.0007e^{-0.0023t} - 0.2434e^{-0.0012t})$$

The Valdés (2009) model has been applied to estimating initial and current body burdens of uranium in military veterans who were exposed to depleted uranium aerosols, based on time history of urinary uranium measurements.

### Wrenn et al. (1994) Pharmacokinetic Model

A multicompartment model of distribution and excretion of absorbed uranium was proposed by Wrenn et al. (1994), based on data collected in studies conducted in nonhuman primates and in other animal models and data on tissue levels and urinary excretion of uranium in humans. The model includes a central compartment consisting of plasma and extracellular fluid (ECF), which exchanges uranium with the skeleton, kidney, and a lumped compartment representing all other soft tissues (see Figure 3-9). The skeleton is represented as a single compartment, unlike the ICRP model (ICRP, 1995), which subsequently adopted a multicompartment representation for the skeleton. The kidney includes slow and fast kinetics compartments, both of which contribute to urinary uranium. Uranium is also transferred to urine directly from plasma.

3. HEALTH EFFECTS

**Figure 3-9. Multicompartmental Model for Uranium after Uptake to Blood**

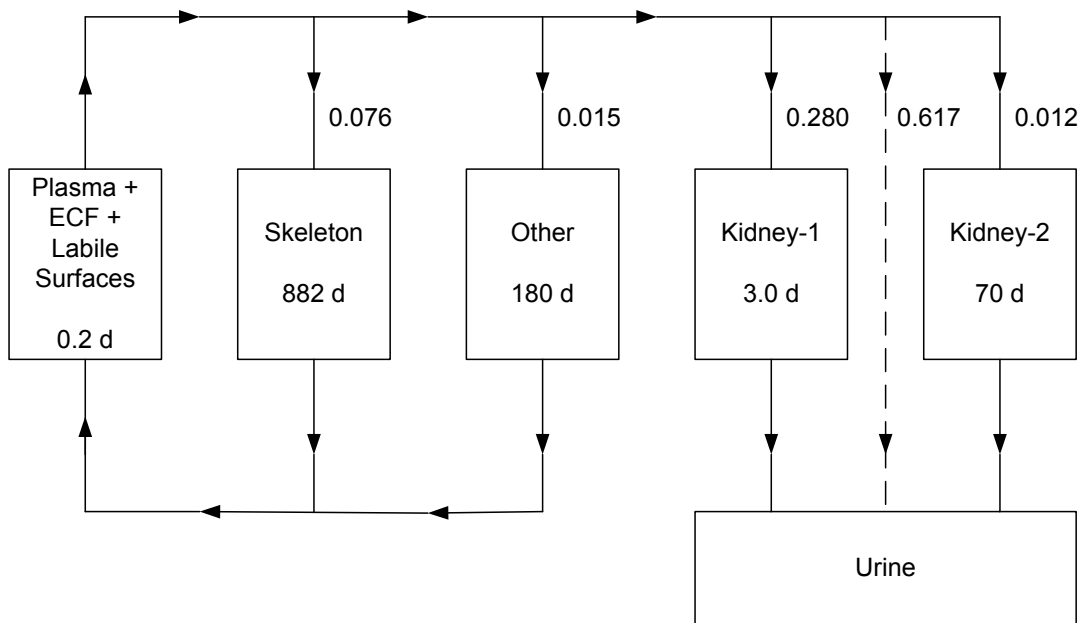

Source: Wrenn et al. 1994

## 3. HEALTH EFFECTS

**Sontag (1986) Pharmacokinetic Model**

An extended multicompartamental model (see Figure 3-10) describing the kinetic behavior of uranium (absorption, distribution, and excretion as a function of time) in the organs of male and female rats was developed using data taken from experiments performed on 13-month-old male and female Sprague-Dawley rats intravenously injected with 1.54 mCi/kg (57 kBq/kg)  $^{233}\text{U}$ -uranyl citrate and sacrificed at 7, 28, 84, 168, or 336 days after injection.

The model is composed of 10 compartments. These 10 compartments are connected by 17 linear transfer coefficients using 21 parameters. The whole system describes the flux of compounds between a central compartment (the blood) and outer compartments which connect with the central compartment only. The 10 compartments are labeled blood, bone 1, bone 2, liver 1, liver 2, kidney 1, kidney 2, residual 1, residual 2, and excretion. The organs are divided into two compartments: one compartment represents the short term and one represents the long term. For example, the short-term compartment for the bone is the bone surface and bone marrow, and the long-term compartment is the deep bone. In the liver, the short-term compartment is assumed to be the lysosomes, and the long-term compartment is assumed to be the telolysosomes. Separation of these organs into two components helps to account for the reabsorption and rapid excretion. Using the symbols BP=blood, EC=excretion, B1=bone 1, L1=liver 1, K1=kidney 1, R1=residual 1, B2=bone 2, L2=liver 2, K2=kidney, and R2=residual 2, the calculated transfer coefficients for this model are shown in Table 3-9.

Parallel evaluations produced two different values (ranges) for each of the 21 parameters. The maximum fractions of uranium in various compartments were as follows: bone, 0.0710 or 0.0735; liver, 0.0160 or 0.0146; kidney, 0.1777 or 0.4789; residual compartment, 0.0358 or 0.0481; and excretion compartment, 0.6995 or 0.3849 (if no back transfer to the blood compartment occurred). The time at which the maximum amount of the uranium in the organ is reduced to one-half is 0.0009 or 0.0013 days in the blood, 165 or 93 days in the bone, 6 or 7 days in the liver, 11 or 5 days in the kidney, and 5 or 6 days in the residual compartment. The cumulative radiation absorbed dose in the organ 365 days after injection of 56.6 kBq/kg body weight was 0.0002 or 0.0004 Gy to blood, 0.730 or 1.29 Gy to bone, 0.0268 or 0.0308 Gy to liver, 1.32 or 1.77 Gy to kidney, and 0.0061 or 0.0076 Gy to residual compartment. The ratio of single injection/continuous intake calculated for the same dose 1 year after the first injection was 0.018 or 0.003 to blood, 0.619 or 0.812 to bone, 0.422 or 0.355 to liver, 0.256 or 0.231 to kidney, 0.726 or 0.585 to residual compartment, and 1.024 or 1.023 to excretion compartment (Sontag 1986).

3. HEALTH EFFECTS

Figure 3-10. Multicompartmental Model

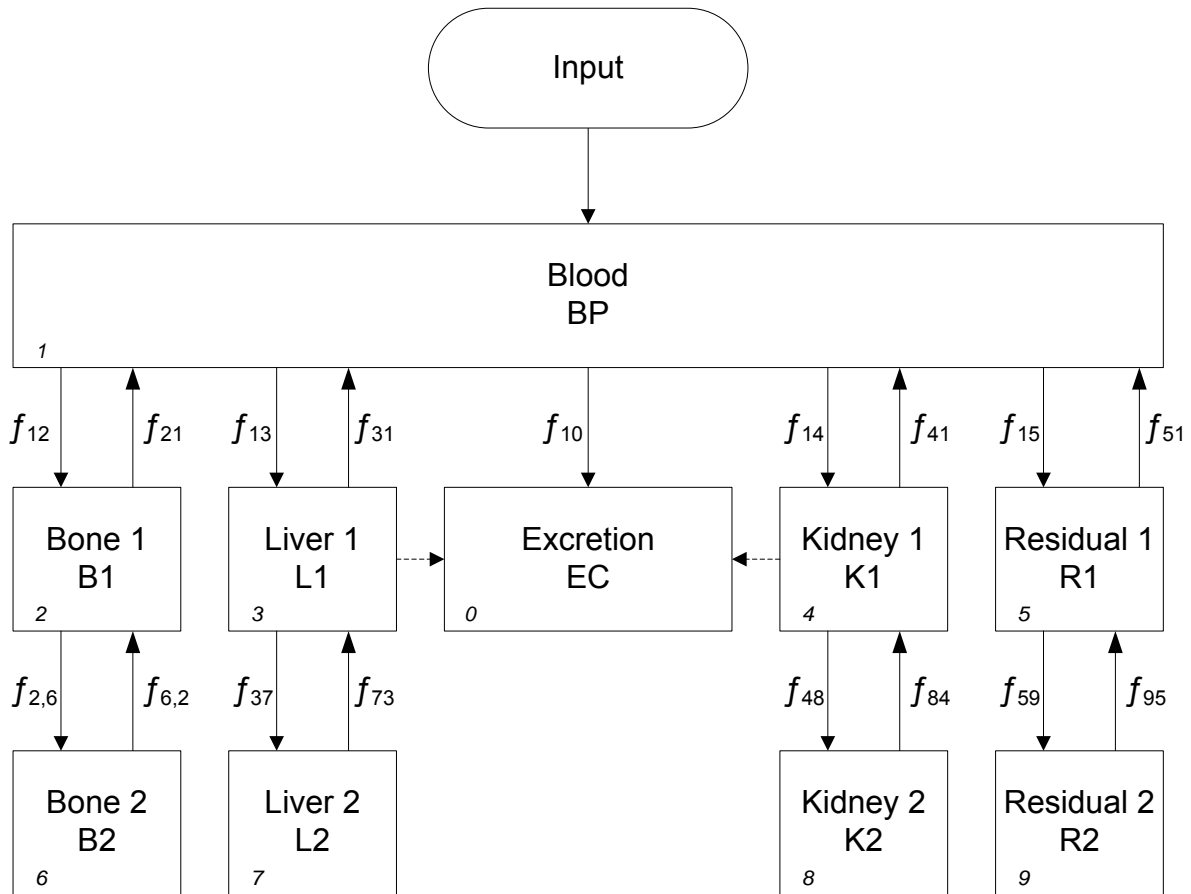

$f$  = transfer coefficient (unitless)

Source: Sontag 1986

## 3. HEALTH EFFECTS

**Table 3-9. Sensitivity and Calculated Transfer Coefficients ( $d^{-1}$ )**

Transfer from-to	Symbol	Experimental value 1	Experimental value 2	Sensitivity
BP-EC	$f_{10}$	555	209	0.2
BP-B1	$f_{12}$	56.3	39.9	5.9
BP-L1	$f_{13}$	12.7	7.94	3.3
BP-K1	$f_{14}$	141	2.60	1.5
BP-R1	$f_{15}$	28.4	26.1	17.5
B1-BP	$f_{21}$	0.00979	0.0184	1.9
L1-BP	$f_{31}$	0.187	0.270	5.6
K1-BP	$f_{41}$	0.0948	0.365	0.5
R1-BP	$f_{51}$	0.225	0.341	3.4
B1-B2	$f_{26}$	0.00565	0.00649	2.2
L1-L2	$f_{37}$	0.00863	0.00940	2.7
K1-K2	$f_{48}$	0.00114	0.00122	2.2
R1-R2	$f_{59}$	0.0103	0.00860	6.1
B2-B1	$f_{62}$	0.00261	$4.43 \times 10^{-6}$	5.0
L2-L1	$f_{73}$	0.00284	0.00349	43.7
K2-K1	$f_{84}$	0.000972	0.00122	4.8
R2-R1	$f_{95}$	0.000716	0.00138	2.3
Varinz	V	0.00663	0.00465	Not applicable

Source: Sontag 1986

## 3. HEALTH EFFECTS

**Fisher et al. (1991) Biokinetic Model**

A modified biokinetic model for uranium was developed for inhaled soluble uranium based on human data from an accidental release of uranium hexafluoride in Oklahoma. Urinary excretion data from 31 exposed workers were used to test two previously published compartmental models for inhalation exposure to uranium (ICRP 1979; Wrenn et al. 1989). Urinary uranium was measured periodically for 2 years following the accident. Statistical analysis showed that the Wrenn et al. (1989) model produced a better fit to the excretion data than the ICRP (1979) model.

Parameters of the (Wrenn et al. 1989) model were then modified to further improve the fit to the workers excretion data. Changing the retention half-time in the kidney from 15 to 6 days and the clearance half-time in the lung from 0.5 to 0.03 days optimized the fit of the model to the experimental data. The model may be summarized with the following five-term exponential equation:

$$y_u(t) = 1.5e^{-2.77t} + 0.028e^{-0.116t} + 0.0069e^{-0.0347t} + (4.8 \times 10^{-7} e^{-0.000462t}) + 3.2 \times 10^{-6} e^{-0.000139t}$$

where,  $y_u(t)$  is fractional daily uranium excretion rate at  $t$  days after intake; the excretion constants in the five exponents corresponding to compartments with retention half-times of 0.25, 6, 20, 1,500, and 5,000 days.

The model was used to estimate uranium intakes; uranium burdens in the lungs, kidneys, and bones; and effective dose equivalent for each worker in the accident. Initial intakes of workers involved in the accident ranged from 470 to 24,000  $\mu\text{g}$  uranium. The model estimated the maximum kidney concentrations in the workers as ranging from 0.048 to 2.5  $\mu\text{g}$  U/g kidney tissue; renal toxicity was not observed in any of the workers (Fisher et al. 1991; USNRC 1990).

Based on this same data base, the USNRC determined that the maximum uranium dose equivalent of workers on-site was 28 mrem (0.28 mSv). The maximum uranium dose equivalent of off-site individuals was 1.4 mrem (0.014 mSv). However, these radiological doses were small compared to the background radiation level of 106 mrem/year (1.06 mSv/year), excluding radon, in the area from which the data were collected (USNRC 1986).

## 3. HEALTH EFFECTS

**3.5 MECHANISMS OF ACTION****3.5.1 Pharmacokinetic Mechanisms**

On the average, a given amount of an ingested uranium compound appears to be less toxic than the same amount of an inhaled uranium compound (Maynard and Hodge 1949; Stokinger et al. 1953). This finding may be partly attributable to the relatively low gastrointestinal absorption of uranium compounds. Only 0.1–6% of even the more soluble uranium compounds are absorbed in the gastrointestinal tract (EPA 1988d; Harrison and Stather 1981; Hursh et al. 1969; ICRP 1979; Larsen et al. 1984; La Touche et al. 1987; Leggett and Harrison 1995; Maynard et al. 1953; Sullivan 1980a; Wrenn et al. 1985). The ICRP (1995) recommends a gastrointestinal absorption reference fraction of 0.02 for uranium ingested in relatively soluble form and 0.002 for insoluble compounds. On the basis of the toxicity of different uranium salts in animals, it was concluded that the relatively more soluble salts (uranyl nitrate hexahydrate, uranyl fluoride, uranium tetrachloride, uranium pentachloride) were most toxic, the slightly soluble compounds (uranium trioxide, sodium diuranate, ammonium diuranate) were of intermediate toxicity, and the insoluble compounds (uranium tetrafluoride, uranium dioxide, uranium tetrachloride, triuranium octaoxide) were nontoxic (Orcutt 1949).

In inhalation exposures, uranium compounds are usually inhalable aerosols. Thus, particle size plays a vital role in tissue dose. Particles  $>5 \mu\text{m}$  AMAD are likely to be transported out of the tracheobronchial region by mucociliary action and swallowed into the gastrointestinal tract, where absorption is minimal (ICRP 1979). The less soluble compounds (uranium trioxide, uranium tetrafluoride), designated Type M by the ICRP (1995), are more likely to remain in the lung tissue and associated lymph glands for weeks. The relatively insoluble compounds (uranium dioxide, triuranium octaoxide), designated Type S by the ICRP (1995), are likely to remain in the lungs for years (Eidson 1994). This retention of uranium in the lung can lead to a significant pulmonary radiation dose.

In addition, the sequestration patterns of the different uranium compounds are important determinants for the target organ chemical and radiological toxicities of these compounds. The site of deposition for the soluble uranium compounds (uranyl nitrate, uranium tetrachloride, uranium hexafluoride) is the bone, while the insoluble compounds (uranium hexafluoride, uranium dioxide) accumulate in the lungs and lymph nodes (Stokinger et al. 1953).

In an *in vitro* study by Vidaud et al. (2005), several uranium binding proteins were identified in human serum including haptoglobin, apolipoprotein A1, serum albumin,  $\alpha$ -1-antitrypsin, IgG,  $\alpha$ -1-acid

## 3. HEALTH EFFECTS

glycoprotein, holotransferrin, hemopexin, apotransferrin, complement C4, complement C3, and ceruloplasmin. Uranium was not shown to bind with retinol binding protein, transthyretin, or tropomyosin. It is not known if these proteins are involved in the distribution of uranium to other tissues.

### 3.5.2 Mechanisms of Toxicity

The dual modes of uranium chemical and radiological toxicity are not usually separately identifiable by end point. The renal and respiratory effects from exposure of humans and animals to uranium are usually attributed to the chemical properties of uranium, while the theoretically potential excess cancers are usually attributed to the radiation properties of this substance. Although the net effects on the lungs and kidneys have been suggested to be a cooperative action of the chemical and radiation properties, with a complementary mechanism of action, this relationship has not been demonstrated experimentally (Ballou et al. 1986; Dockery et al. 1993; Dungworth 1989; Filippova et al. 1978; Leach et al. 1984; Spoor and Hursh 1973; Spiegl 1949; Stokinger et al. 1953).

The most sensitive target of uranium toxicity to mammals, and perhaps humans, is the kidney. While acute, high-level exposure to uranium compounds can clearly cause nephrotoxicity in humans (Lu and Zhao 1990; Pavlakis et al. 1996), the evidence for similar toxicity as the result of long-term, lower-level occupational exposures is equivocal. Epidemiologic studies have not noted an increase in deaths from urogenital or renal diseases (Checkoway et al. 1988; Dupree et al. 1987; Lundin et al. 1969; NIOSH 1987; Polednak and Frome 1981), and follow-up studies have failed to identify significant damage to human kidneys following occupational exposure to uranium (Eisenbud and Quigley 1956; Hursh and Spoor 1973; Luessenhop et al. 1958), or after war-related exposures (McDiarmid et al. 2000, 2001a, 2004b, 2006, 2007, 2009). A comparison of autopsy kidney tissue samples revealed no differences between seven uranium workers and six referents with no known exposure to uranium (Russell et al. 1996). One epidemiologic study provided evidence of nephrotoxicity following occupational exposure to uranium. Nephrotoxicity, indicated by  $\beta_2$ -microglobulinuria and aminoaciduria due to decreased tubular reabsorption, was reported in a group of 39 male uranium mill workers exposed for >1 year to uranium concentrations exceeding the occupational standard of 3.7 Bq/m<sup>3</sup> (currently 5 Bq/m<sup>3</sup> [0.2 mg/m<sup>3</sup>]) by  $\leq$ 8-fold. Cement workers were used as controls in this study (Thun et al. 1985).

Many animal studies have shown that inhalation, oral, or dermal exposure to uranium results in kidney damage. The damage was histologically manifested as glomerular and tubular wall degeneration. Ultrastructural analysis showed damage to the endothelial cells in the glomerulus, such as loss of cell



## 3. HEALTH EFFECTS

processes, and reduction in the density of the endothelial fenestrae (Avasthi et al. 1980; Haley 1982; Haley et al. 1982; Kobayashi et al. 1984). In the terminal segments of the proximal convoluted tubules, there was a loss of the brush border, cellular vacuolization, and necrosis. Tubular reabsorption of solutes was disrupted. Functionally, this process led to a disruption of the tubular solute reabsorption and to a decrease in the filtration rate of the glomerulus, as assessed by creatinine or inulin clearance or by proteinuria (Bentley et al. 1985; Blantz 1975; Leach et al. 1973; Morrow et al. 1982a). Excessive urinary excretion of protein, glucose, amino acids, or enzymes, such as catalase or alkaline phosphatase are additional indicators of uranium-induced renal pathology (Maynard et al. 1953) by inhalation exposure (Bentley et al. 1985; Diamond et al. 1989; Haley et al. 1982; Leach et al. 1984; Maynard et al. 1953; Morrow et al. 1982a).

A mechanism involving bicarbonate activity in the kidneys has been proposed for uranium-induced renal toxicity. Uranium is usually combined with either bicarbonate or a plasma protein in the blood. In the kidneys, uranium is released from bicarbonate and is free to combine to form complexes with phosphate ligands and proteins in the tubular wall to cause damage. Uranium is not tightly bound and is released again within a few days. Within a week following exposure, uranium is largely cleared from the kidneys, and the tubules begin to regenerate. Although the regenerated epithelium has histological differences from its normal state, it is often difficult to detect histological signs of kidney damage a month after exposure because all remaining functional damage is subtle. An alternative mechanism through which uranium exerts its renal toxicity has been suggested by the results of a study conducted with rabbit kidney cells *in vitro*. In this study, uranyl nitrate hexahydrate inhibited both sodium transport-dependent and -independent ATP utilization and mitochondrial oxidative phosphorylation in the renal proximal tubule. Ouabain-insensitive adenosine triphosphatase (ATPase) activity exhibited the greatest sensitivity to uranyl nitrate hexahydrate and was significantly inhibited at submillimolar concentrations (Brady et al. 1989). Perhaps both of these activities combine to cause renal damage. In addition, because uranium is a predominantly alpha-emitting radionuclide, current theories on cellular necrosis by high-LET alpha radiation imply a contributory role to the cellular degenerative nephrotoxic changes (BEIR 1980, 1988, 1990; Filippova et al. 1978; Sanders 1986; UNSCEAR 1982, 1986, 1988).

Most studies of respiratory diseases reported for uranium involve noncancerous alveolar epithelium damage in type II cells. These changes are characterized by interstitial inflammation of the alveolar epithelium leading eventually to pulmonary fibrosis in acute exposures or to hyperplasia, hypertrophy, and transdifferentiation (metaplasia) in chronic exposures (Clayton and Clayton 1981; Cooper et al. 1982; Dungworth 1989; Wedeen 1992). However, the lack of significant pulmonary injury in most inhalation

### 3. HEALTH EFFECTS

animal studies indicates that other potentially toxic contaminants such as inhalable dust particles, radium, or radon may contribute to these effects.

Large doses of ionizing radiation have the actual or theoretical potential of being carcinogenic, teratogenic, and mutagenic. Since uranium has a low specific activity but emits high LET alpha particles that are densely ionizing along their track length, studies have been conducted to determine if uranium can produce these effects in humans and animals. The 4–8 MeV alpha particles from uranium travel through 40–70  $\mu\text{m}$  in soft tissue, incrementally transferring their kinetic energy to the series of atoms and molecules with which they interact along their short, straight paths. Consequently, only structures within this range from the site of the deposition of uranium may be affected. If a DNA molecule is intersected and damaged without resulting in cell death, a range of theoretical effects can result. DNA has been found to be the most radiosensitive biological molecule, and ionizing radiation has been observed to damage individual chromosomes. The main result from low level ionizing radiation exposure is DNA damage or fragmentation. Viable cells repair the damage, but repair errors can result which produce gene mutations or chromosomal aberrations. Such events may result in such highly rare events as carcinogenesis or teratogenesis, but there is currently no evidence for radiation mutagenesis in humans. Chromosomal aberrations following large radiation doses have been demonstrated in humans and in research animals, showing that ionizing radiation can both initiate and promote carcinogenesis, and interfere with reproduction and development.

#### **3.5.3 Animal-to-Human Extrapolations**

Kidney damage and respiratory disease are the most significant health effects in animals from the metallotoxicity of uranium. Because the biological systems through which these effects are mediated are common to both animals and humans (Brady et al. 1989; Clayton and Clayton 1981; Cooper et al. 1982; Dungworth 1989; Wedeen 1992), it is reasonable that animals are appropriate surrogates for humans in this regard. This assumption is consistent with evidence in humans for respiratory (Kathren and Moore 1986; Waxweiler et al. 1981a) and renal (AEC 1957; Fisher et al. 1991; Kathren and Moore 1986; Lu and Zhao 1990; Luessenhop et al. 1958; Thun et al. 1985; USNRC 1986; Waxweiler et al. 1981a) effects. The data from these studies support the assumption of biological similarity in the renal toxicity of uranium in animals and humans. Nevertheless, a considerable uncertainty is associated with animal-to-human extrapolation regarding the renal toxicity of uranium exposure because the renal toxicity of animals varies with species.

## 3. HEALTH EFFECTS

**3.6 TOXICITIES MEDIATED THROUGH THE NEUROENDOCRINE AXIS**

Recently, attention has focused on the potential hazardous effects of certain chemicals on the endocrine system because of the ability of these chemicals to mimic or block endogenous hormones. Chemicals with this type of activity are most commonly referred to as *endocrine disruptors*. However, appropriate terminology to describe such effects remains controversial. The terminology *endocrine disruptors*, initially used by Thomas and Colborn (1992), was also used in 1996 when Congress mandated the EPA to develop a screening program for "...certain substances [which] may have an effect produced by a naturally occurring estrogen, or other such endocrine effect[s]...". To meet this mandate, EPA convened a panel called the Endocrine Disruptors Screening and Testing Advisory Committee (EDSTAC), and in 1998, the EDSTAC completed its deliberations and made recommendations to EPA concerning *endocrine disruptors*. In 1999, the National Academy of Sciences released a report that referred to these same types of chemicals as *hormonally active agents*. The terminology *endocrine modulators* has also been used to convey the fact that effects caused by such chemicals may not necessarily be adverse. Many scientists agree that chemicals with the ability to disrupt or modulate the endocrine system are a potential threat to the health of humans, aquatic animals, and wildlife. However, others think that endocrine-active chemicals do not pose a significant health risk, particularly in view of the fact that hormone mimics exist in the natural environment. Examples of natural hormone mimics are the isoflavonoid phytoestrogens (Adlercreutz 1995; Livingston 1978; Mayr et al. 1992). These chemicals are derived from plants and are similar in structure and action to endogenous estrogen. Although the public health significance and descriptive terminology of substances capable of affecting the endocrine system remains controversial, scientists agree that these chemicals may affect the synthesis, secretion, transport, binding, action, or elimination of natural hormones in the body responsible for maintaining homeostasis, reproduction, development, and/or behavior (EPA 1997a). Stated differently, such compounds may cause toxicities that are mediated through the neuroendocrine axis. As a result, these chemicals may play a role in altering, for example, metabolic, sexual, immune, and neurobehavioral function. Such chemicals are also thought to be involved in inducing breast, testicular, and prostate cancers, as well as endometriosis (Berger 1994; Giwercman et al. 1993; Hoel et al. 1992).

Only one study was located that provided information regarding potential neuroendocrine effects of uranium (Raymond-Whish et al. 2007). In that study, 28-day-old ovariectomized female mice received doses of approximately 0.005, 0.009, 0.09, or 0.9 mg U/kg/day in tap water for 30 days. Ovariectomy was performed to remove the endogenous source of estrogen. A group of mice was also exposed to diethylstilbestrol (DES) as a positive control. Exposure to 0.009 mg U/kg/day significantly increased

### 3. HEALTH EFFECTS

uterine weight, but the higher doses were without significant effect. In addition, mice exposed to 0.005 or 0.009 mg U/kg/day had significantly increased presence of cornified vaginal cells relative to controls, which indicated an estrogenic effect of uranium. In a different experimental series, the investigators studied the dependency of the estrogen-like effects of uranium on estrogen receptor (ER) activation. Ovariectomized mice received the same doses for 10 days beginning at 50 days of age. A group of mice also received injections of an anti-estrogenic drug. Doses of 0.005 mg U/kg/day, but not higher doses, significantly increased uterine weight and the effect could be blocked by the anti-estrogenic compound. Also, exposure to 0.009 mg U/kg/day significantly accelerated vaginal opening, which was also blocked by the anti-estrogenic drug. A mechanism by which uranium evoked estrogenic responses was not defined.

No *in vitro* studies were located regarding endocrine disruption of uranium.

#### 3.7 CHILDREN'S SUSCEPTIBILITY

This section discusses potential health effects from exposures during the period from conception to maturity at 18 years of age in humans, when all biological systems will have fully developed. Potential effects on offspring resulting from exposures of parental germ cells are considered, as well as any indirect effects on the fetus and neonate resulting from maternal exposure during gestation and lactation. Relevant animal and *in vitro* models are also discussed.

Children are not small adults. They differ from adults in their exposures and may differ in their susceptibility to hazardous chemicals. Children's unique physiology and behavior can influence the extent of their exposure. Exposures of children are discussed in Section 6.6, Exposures of Children.

Children sometimes differ from adults in their susceptibility to hazardous chemicals, but whether there is a difference depends on the chemical (Guzelian et al. 1992; NRC 1993). Children may be more or less susceptible than adults to health effects, and the relationship may change with developmental age (Guzelian et al. 1992; NRC 1993). Vulnerability often depends on developmental stage. There are critical periods of structural and functional development during both prenatal and postnatal life, and a particular structure or function will be most sensitive to disruption during its critical period(s). Damage may not be evident until a later stage of development. There are often differences in pharmacokinetics and metabolism between children and adults. For example, absorption may be different in neonates because of the immaturity of their gastrointestinal tract and their larger skin surface area in proportion to

## 3. HEALTH EFFECTS

body weight (Morselli et al. 1980; NRC 1993); the gastrointestinal absorption of lead is greatest in infants and young children (Ziegler et al. 1978). Distribution of xenobiotics may be different; for example, infants have a larger proportion of their bodies as extracellular water, and their brains and livers are proportionately larger (Altman and Dittmer 1974; Fomon 1966; Fomon et al. 1982; Owen and Brozek 1966; Widdowson and Dickerson 1964). The infant also has an immature blood-brain barrier (Adinolfi 1985; Johanson 1980) and probably an immature blood-testis barrier (Setchell and Waites 1975). Many xenobiotic metabolizing enzymes have distinctive developmental patterns. At various stages of growth and development, levels of particular enzymes may be higher or lower than those of adults, and sometimes unique enzymes may exist at particular developmental stages (Komori et al. 1990; Leeder and Kearns 1997; NRC 1993; Vieira et al. 1996). Whether differences in xenobiotic metabolism make the child more or less susceptible also depends on whether the relevant enzymes are involved in activation of the parent compound to its toxic form or in detoxification. There may also be differences in excretion, particularly in newborns who all have a low glomerular filtration rate and have not developed efficient tubular secretion and resorption capacities (Altman and Dittmer 1974; NRC 1993; West et al. 1948). Children and adults may differ in their capacity to repair damage from chemical insults. Children also have a longer remaining lifetime in which to express damage from chemicals; this potential is particularly relevant to cancer.

Certain characteristics of the developing human may increase exposure or susceptibility, whereas others may decrease susceptibility to the same chemical. For example, although infants breathe more air per kilogram of body weight than adults breathe, this difference might be somewhat counterbalanced by their alveoli being less developed, which results in a disproportionately smaller surface area for alveolar absorption (NRC 1993).

Specific information is not available on whether children are more susceptible than adults to the effects of uranium. No reports were located describing toxicity in children as the result of uranium exposure. It is probable, however, that if exposure levels were high enough, signs of renal toxicity would be observed similar to those seen in adults exposed accidentally (Lu and Zhao 1990) or intentionally (Pavlakakis et al. 1996). No reports are available of studies where toxic responses of young animals to uranium were directly compared to those of adults. Three studies by Maynard et al. (1953) evaluated age-related differences in uranyl nitrate toxicity in rats aged 17 days to 6 months exposed to 2% uranyl nitrate in the diet for 30 days; in rats aged 1, 2, 3, or 6 months exposed to 2% uranyl nitrate in the diet for 24 hours followed by a 30-day observation period; and in rats aged 21 days to 6 months receiving a single intraperitoneal injection of 128 (males) or 200 (females) mg/kg uranyl nitrate hexahydrate. Both studies

## 3. HEALTH EFFECTS

found age-related increases in mortality. In the 30-day dietary exposure study, >75% of the 17- and 21-day-old animals died during the study, <10% of the 28-day-old animals died, and >50% of the 2-, 3-, 4-, 5-, and 6-month-old animals died. Insufficient body weight and food intake data were provided; thus, daily doses cannot be calculated. The 1-day dietary study found a similar pattern of mortality. Mortality increased with age; 1% (males) and 3% (females) of the 1-month-old rats died compared to 8% (males) and 16% (females) of the 6-month-old rats. Following a single intraperitoneal dose, the mortality rates were 36, 11, 8, 18, 24, and 19% males and 24, 18, 8, 23.5, 41, 22, and 52% of the females aged 21 days, 1 month, 2 months, 3 months, 4 months, 5 months, and 6 months, respectively. The differences in mortality may be due to age-related toxicokinetic differences, such as changes in absorption efficiency, skeletal development, or kidney development.

Several investigators (as reviewed by Busby et al. 2010; Hindin et al. 2005) have examined the possible association between exposure to depleted uranium and birth defects. Interpretation of these data is limited by the lack of adequate controls, monitoring data to determine whether the subjects were exposed to depleted uranium and at what level, potential exposure to other agents, and other possible confounding factors, such as poor nutrition. Animal studies have examined the developmental toxicity of uranium compounds following oral exposure or intramuscular implantation. Developmental effects (described in greater detail in Section 3.2.2.6) have been observed in rats and mice following oral exposure (gavage or drinking water administration) to soluble uranium compounds; the effects include decreases in viability or embryoletality (Domingo et al. 1989b, 1989c; Paternain et al. 1989), decreases in fetal body weight (Domingo et al. 1989c; Paternain et al. 1989), increases in the number of litters with visceral and skeletal defects (e.g., cleft palate, bipartite sternbrae, reduced ossification) (Domingo et al. 1989c), alterations in performance on neurobehavioral tests (Houpert et al. 2007a; Sánchez et al. 2006), alterations in ovarian folliculogenesis (Arnault et al. 2008; Raymond-Whish et al. 2007), and delayed tooth eruption (Pujadas Bigi and Ubios 2007; Pujadas Bigi et al. 2003). No developmental effects were observed in offspring of rats following implantation of depleted uranium pellets in the gastrocnemius muscle (Arfsten et al. 2009).

Information on the pharmacokinetics of uranium in children is very limited. Since the skeletons of children are growing (higher rate of bone formation), it is possible that a higher fraction of circulating uranium will be deposited in bone than in adults. A study of uranium content in bone from three age groups (<13, 13–20, 20–25 years old) reported somewhat higher uranium content in the youngest compared to the oldest age group (approximately 1.5–3 fold); however, there were only 2–4 subjects in each group and the differences were not statistically significant (Broadway and Strong 1983). The

## 3. HEALTH EFFECTS

fractional absorption of uranium by the oral route was higher in neonatal swine and rats than in adult animals (Sullivan 1980b; Sullivan and Gorham 1982).

Transfer of uranium across the placenta was investigated in an animal study, but no information is available for humans. In the animal study, only 0.01–0.03% of an intravenous dose of uranium to rat dams crossed the placenta (Sikov and Mahlum 1968). In contrast, another oral exposure study (Sánchez et al. 2006) found elevated uranium levels in the offspring of rats exposed to uranyl acetate prior to mating and throughout gestation and lactation, suggesting transplacental and/or lactational transfer of uranium. No studies were located regarding uranium in breast milk. Based on the chemical properties of uranium, it seems unlikely that there would be preferential distribution from the blood to this high-fat compartment. It is not known if uranium has any effect on the active transport of calcium into breast milk. Most of the adult body burden of uranium is stored in bone (ICRP 1979, 1995, 1996). It is not known if maternal bone stores of uranium (like those of calcium and lead) are mobilized during pregnancy and lactation.

Age-related differences in the pharmacokinetics of uranium have been incorporated into existing PBPK models (ICRP 1995, 1996) so that they can be applied to children. Two adjustments were made:

1. The value for the fractional absorption of ingested uranium ( $f_1$ ) was adjusted from the adult value of 0.02 (2%) to a value of 0.04 (4%) for children under the age of 1 year. This adjustment was made based on animal data (Sullivan 1980b; Sullivan and Gorham 1982) and information on postnatal changes in the human gastrointestinal tract. For ages over 1 year, the adult value for fractional absorption was used.
2. Parameters for transfer of uranium into and out of bone were assumed to be proportional to those of alkaline earth elements such as calcium (the  $\text{UO}_2^{2+}$  ion can substitute for the  $\text{Ca}^{2+}$  ion at bone surfaces). Age-specific bone turnover rates developed for a generic alkaline-earth model (ICRP 1994b) were incorporated into the uranium model to predict distribution to the tissues. As a result of this change, a greater proportion of uranium distributes to bone and a lesser proportion to soft tissues at ages under 25 years, compared to adults.

The mechanism for the renal toxicity observed in cases of adult exposure to uranium is believed to be due to the retention of uranium in the kidney. This is the result of the reabsorption of bicarbonate from the ultrafiltrate in the proximal tubule and the resulting release of the  $\text{UO}_2^{2+}$  ion from a bicarbonate complex. Newborn humans have relatively inefficient tubular secretion and reabsorption compared to older children or adults, and whether this would increase or decrease the susceptibility of newborns to uranium toxicity is not known.

## 3. HEALTH EFFECTS

**3.8 BIOMARKERS OF EXPOSURE AND EFFECT**

Biomarkers are broadly defined as indicators signaling events in biologic systems or samples. They have been classified as markers of exposure, markers of effect, and markers of susceptibility (NAS/NRC 1989).

The National Report on Human Exposure to Environmental Chemicals provides an ongoing assessment of the exposure of the U.S. population to environmental chemicals using biomonitoring. This report is available at <http://www.cdc.gov/exposurereport/>. The biomonitoring data for uranium from this report is discussed in Section 6.5. A biomarker of exposure is a xenobiotic substance or its metabolite(s) or the product of an interaction between a xenobiotic agent and some target molecule(s) or cell(s) that is measured within a compartment of an organism (NAS/NRC 1989). The preferred biomarkers of exposure are generally the substance itself, substance-specific metabolites in readily obtainable body fluid(s), or excreta. However, several factors can confound the use and interpretation of biomarkers of exposure. The body burden of a substance may be the result of exposures from more than one source. The substance being measured may be a metabolite of another xenobiotic substance (e.g., high urinary levels of phenol can result from exposure to several different aromatic compounds). Depending on the properties of the substance (e.g., biologic half-life) and environmental conditions (e.g., duration and route of exposure), the substance and all of its metabolites may have left the body by the time samples can be taken. It may be difficult to identify individuals exposed to hazardous substances that are commonly found in body tissues and fluids (e.g., essential mineral nutrients such as copper, zinc, and selenium). Biomarkers of exposure to uranium are discussed in Section 3.9.1.

Biomarkers of effect are defined as any measurable biochemical, physiologic, or other alteration within an organism that, depending on magnitude, can be recognized as an established or potential health impairment or disease (NAS/NRC 1989). This definition encompasses biochemical or cellular signals of tissue dysfunction (e.g., increased liver enzyme activity or pathologic changes in female genital epithelial cells), as well as physiologic signs of dysfunction such as increased blood pressure or decreased lung capacity. Note that these markers are not often substance specific. They also may not be directly adverse, but can indicate potential health impairment (e.g., DNA adducts). Biomarkers of effects caused by uranium are discussed in Section 3.9.2.

A biomarker of susceptibility is an indicator of an inherent or acquired limitation of an organism's ability to respond to the challenge of exposure to a specific xenobiotic substance. It can be an intrinsic genetic or



## 3. HEALTH EFFECTS

other characteristic or a preexisting disease that results in an increase in absorbed dose, a decrease in the biologically effective dose, or a target tissue response. If biomarkers of susceptibility exist, they are discussed in Section 3.11, Populations That Are Unusually Susceptible.

### 3.8.1 Biomarkers Used to Identify or Quantify Exposure to Uranium

The primary biomarker of exposure to uranium is the chemical or radiological detection of total uranium or individual uranium isotopes in the urine because uranium absorbed through the oral, dermal, and inhalation routes is excreted in urine mostly as uranyl ions (Ballou et al. 1986; Cooper et al. 1982; Downs et al. 1967; Leach et al. 1984; Morrow et al. 1982a; Stradling et al. 1984, 1987; West and Scott 1969; Wrenn et al. 1985). Uranium urinalysis data have been shown to correlate with airborne uranium exposures when averaged over a period of time when the ingested quantity is insignificant. Uranium can also be measured in feces, nails, and hair (Karpas 2001; Karpas et al. 2005a, 2005b; Muikku et al. 2009). Although elevated uranium levels could only be measured in urine and fecal samples within days of acute exposure to uranium, elevated uranium levels could be measured in hair and nail samples weeks or months after the acute exposure (Karpas 2001; Karpas et al. 2005a, 2005b). In humans chronically exposed to elevated uranium levels in drinking water, good correlations were found for daily uranium intake with hair uranium levels and with nail uranium levels (Karpas et al. 2005b). Muikku et al. (2009) noted that in areas of high uranium in drinking water, a portion of the uranium content in hair may be due to external contamination and this proportion needed to be quantified before using hair uranium levels to estimate uranium ingestion. Karpas et al. (2005a) also found that the isotopic ratio of  $^{234}\text{U}$  to  $^{238}\text{U}$  in hair and toenail samples correlated with that of drinking water (primary route of exposure for the study population) and could be used to identify the source of exposure.

Twenty-four hour urine samples, corrected per gram creatinine concentration, are considered the “gold standard” for assessing uranium body burden. To evaluate the accuracy of spot urine samples for assessing uranium body burden, McDiarmid et al. (1999b) examined 22 non-uranium exposed veterans and 29 veterans exposed to depleted uranium. In both groups, the median and mean urine uranium levels were similar in the creatinine-corrected 24-hour samples and spot samples. When both groups were combined, the 24-hour creatinine-corrected urine uranium levels were highly correlated ( $R^2=0.97$ ) with the creatinine-corrected spot urine uranium levels. However, lower correlation coefficients were found in the non-exposed group ( $R^2=0.44$ ) and in exposed veterans with 24-hour urine uranium levels of  $<0.05 \mu\text{g U/g creatinine}$  ( $R^2=0.48$ ). In contrast, the correlation coefficient was 0.99 in the veterans with 24-hour urine uranium levels of  $\geq 0.05 \mu\text{g/g creatinine}$ . Marco et al. (2008) also found that spot urine samples

### 3. HEALTH EFFECTS

normalized to creatinine concentration were representative of 24-hour uranium levels among workers at a nuclear research center.

Uranium content in soft tissue and bone could also be used as biomarkers of exposure to uranium since uranium also distributes to these tissues and other organs (Ballou et al. 1986; Diamond et al. 1989; Leach et al. 1973, 1984; Morris et al. 1990; Morrow et al. 1972; Stokinger et al. 1953; Walinder 1989; Wrenn et al. 1987). Although soft tissues and bone are the most frequently analyzed biological media after urine and feces, these tissues are usually available for analysis only at autopsy. Therefore, this method is impractical and not used for routine screening purposes.

#### 3.8.2 Biomarkers Used to Characterize Effects Caused by Uranium

Currently, there are no available biomarkers for specific exposure to the metallotoxic or radiotoxic effects of uranium.

Functional damage to the kidneys has been documented in humans (Lu and Zhao 1990; Pavlakis et al. 1996; Thun et al. 1985; Waxweiler et al. 1981a) and in animal (Leach et al. 1970, 1973, 1984; Morrow et al. 1982a; Stokinger et al. 1953) studies. Increases in the urinary excretion of several biomarkers, including  $\beta_2$  microglobulin, protein HC, and retinol binding protein, have been observed in populations consuming elevated levels of uranium in drinking water (Kurtio et al. 2002; Limson Zamora et al. 1998, 2009; Mao et al. 1995; Seldén et al. 2009). These biomarkers, although not specific to uranium, could be used to as sensitive biomarkers of renal dysfunction. In rats receiving a single intramuscular dose of depleted uranium nitrate, there was a high correlation between urinary N-acetyl- $\beta$ -D-glucosaminidase (NAG)/creatinine levels, depleted uranium concentration in the kidney, and the depleted uranium dose (Fukuda et al. 2006). The investigators suggested that urinary NAG/creatinine levels are a useful biomarker to assess kidney damage and estimate depleted uranium intake.

Toxicogenomic studies have sought to identify biomarkers that can be used to evaluate uranium-related kidney damage by examining alterations in gene or protein expression patterns in uranium-exposed renal cells and alterations in levels of urinary proteins (Malard et al. 2009; Prat et al. 2005, 2011). Prat et al. (2005) identified a “transcriptomic fingerprint” of 18 genes that form the core mRNA response to uranium in renal cells. Additionally, they identified a set of five modulated genes/proteins that could potentially be used as biomarkers of effects: actin- $\beta$ , tubulin- $\alpha$ , high mobility group protein 1 (HMGB1), protein 14-3-3, and heat shock protein (hsp) 90. A subsequent *in vitro* study by this group (Prat et al.

### 3. HEALTH EFFECTS

2011) found repression of the SPP1 gene coding for osteopontin in human kidney HK2 cells; osteopontin levels were inversely related to the uranium level. Urinary osteopontin levels were also decreased in uranium workers with urinary uranium levels  $>30 \mu\text{g/L}$  or individuals with chronic exposure to uranium in drinking water (Prat et al. 2011). The investigators cautioned that it is not known if the decreased osteopontin levels are specific to uranium toxicity and noted that interindividual variability in urinary osteopontin levels is quite high. In a study of rats injected with uranyl nitrate (Malard et al. 2009), 14 proteins were shown to be modulated by uranium exposure. A number of the proteins have been shown to be altered in response to kidney damage. These protein alterations included increases in the urinary levels of albumin,  $\alpha$ -1-antiproteinases, transthyretin, ceruloplasmin, and transferrin and decreases in urinary epidermal growth factor, contrastin-like protease inhibitor 3, and pancreatic  $\alpha$ -amylase.

Very high doses of uranium may interfere with liver function in humans (Pavlakis et al. 1996), but renal effects are far more sensitive. No specific biomarker is currently available for the liver as a target of uranium toxicity. Because uranium has no appreciable effect on the nervous system, no biomarkers of effect are needed for this end point. For more information on biomarkers for renal effects of chemicals, see *ATSDR/CDC Subcommittee Report on Biological Indicators of Organ Damage* (Agency for Toxic Substances and Disease Registry 1990). Simultaneous analysis of multiple parameters, such as urinary glucose, alkaline phosphatase, and  $\beta_2$ -microglobulin, which may be more specific to proximal tubular damage (Limson Zamora et al. 1998), should be considered for evaluating subjects in future studies.

#### 3.9 INTERACTIONS WITH OTHER CHEMICALS

Co-administration of uranium (5 mg/kg uranyl acetate dehydrate administered via subcutaneous injection) and melatonin (10 or 20 mg/kg administered via intraperitoneal injection) resulted in a decrease in uranium-induced kidney damage (Bellés et al. 2007). A significant reduction in the uranium-induced increase in urine volume and a reduction in the severity of renal tubular necrosis were observed. No information was located regarding the modulation of the toxicity of uranium by other chemicals or vice versa.

#### 3.10 POPULATIONS THAT ARE UNUSUALLY SUSCEPTIBLE

A susceptible population will exhibit a different or enhanced response to uranium than will most persons exposed to the same level of uranium in the environment. Reasons may include genetic makeup, age, health and nutritional status, and exposure to other toxic substances (e.g., cigarette smoke). These parameters result in reduced detoxification or excretion of uranium, or compromised function of organs

### 3. HEALTH EFFECTS

affected by uranium. Populations who are at greater risk due to their unusually high exposure to uranium are discussed in Section 6.7, Populations with Potentially High Exposures.

Populations susceptible to uranium toxicosis would include people with impaired renal function or renal disease. People with stomach ulcers are thought to have elevated absorption of some toxic metals and might be unusually susceptible to uranium toxicity. The potential for children's susceptibility is discussed in Section 3.6.

#### **3.11 METHODS FOR REDUCING TOXIC EFFECTS**

This section will describe clinical practice and research concerning methods for reducing toxic effects of exposure to uranium. However, because some of the treatments discussed may be experimental and unproven, this section should not be used as a guide for treatment of exposures to uranium. When specific exposures have occurred, poison control centers and medical toxicologists should be consulted for medical advice. The following texts provide specific information about treatment following exposures to uranium:

Began D. 2002. Dermatologic principles. In: Goldfrank LR, Flomenbaum NE, Lewin NA, et al., eds. Goldfrank's toxicologic emergencies. 7th ed. New York, NY: McGraw-Hill, 432-440.

Goans RE. 2007. Medical management of radiation incidents. In: Shannon MW, Borron SW, Burns MJ, eds. Haddad and Winchester's clinical management of poisoning and drug overdose. 4th ed. Philadelphia, PA: Saunders, 1467-1485.

NCRP. 2010. Management of persons contaminated with radionuclides: Handbook. NCRP Report No. 161. National Council on Radiation Protection and Measurements, 128-137, 176-236. <http://www.ncrponline.org/Publications/161press.html>. February 11, 2010.

##### **3.11.1 Reducing Peak Absorption Following Exposure**

No specific recommendations have been reported for reducing the peak absorption following acute inhalation or oral exposure to uranium. The only specific recommendation reported regarding reducing absorption of uranium following exposure is to not wash the skin with water following dermal exposure to dusts of pure uranium because it will ignite or explode when contacted by water (Began 2002). Thus, it is recommended that any residual metal should be removed with forceps, gauze, or towels and stored in mineral oil.

## 3. HEALTH EFFECTS

Houpert et al. (2001, 2004) investigated the use of chelating agents to decrease the transfer of uranium from a wound to blood. Wound contamination with uranium was simulated by an intramuscular injection of 0.66 µg U as uranyl nitrate or 63 µg U as industrial-grade uranium peroxide in the hind leg of rats (Houpert et al. 2001). Following exposure to uranium, the rats received an intramuscular or intraperitoneal injection or carballylic amido bis phosphonic acid (CAPBP). A significant increase in the amount of uranium retained at the wound site was found following the intramuscular injection of CAPBP; significant reductions in uranium levels in the kidneys, femur, carcass, and urine were also observed. Intraperitoneal administration of CAPBP did not significantly reduce uranium absorption or alter uranium tissue levels. In the second study (Houpert et al. 2004), the hind leg skin was incised and industrial-grade uranium peroxide was deposited in the underlying muscle; the wound was then covered for 1 hour with a dressing or paste composed of carboxymethylcellulose-based hydrocolloids, which are highly absorbant; in two groups, the paste was mixed with CAPBP or ethane-1-hydroxy-1,1-bisphosphonate. Although the dressing and paste were effective in decreasing the amount uranium at the wound site and uranium levels in the kidneys, adding the chelating agent to the paste did not alter its efficiency.

**3.11.2 Reducing Body Burden**

Administration of bicarbonate is applicable to reducing uranium body burdens from acute exposures. Bicarbonate ions complex with uranium and alkalize the blood, both of which enhance the excretion from the kidneys by glomerular filtration (Cooper et al. 1982) and such an application was described in a case of prophylactic treatment (Fisher et al. 1991). Experimental evidence in animals indicates that chelation therapy may reduce the body burden of uranium. Several compounds were found to enhance the urinary and fecal excretion of uranium, if administered soon after uranium exposure. When given immediately after exposure to uranium, Tiron<sup>®</sup> (sodium 4,5-dihydroxybenzene-1,3-disulphonate) resulted in the greatest reduction in renal and bone levels of uranium and acute lethal effects in animals (Domingo et al. 1992; Ortega et al. 1989a). None of the chelating agents affected bone levels of uranium when given  $\geq 24$  hours after exposure to uranium (Domingo et al. 1992). Bicarbonate treatment is also limited to very near-term exposures. Another study that tested Tiron<sup>®</sup> alone and in conjunction with either DTPA or ethylenediamine-N,N'-bis(2-hydroxyphenylacetic acid) (EDHPA) found that it reduced the uranium body burden no more than about 35%, indicating that the administration of Tiron<sup>®</sup> is of limited practical value for the treatment of uranium exposures that do not greatly exceed the permitted intake level (Stradling et al. 1991).

### 3. HEALTH EFFECTS

Other studies have reported the efficiency of other chelating agents on reducing toxicity or tissue levels of uranium. Administration of catechol-3,6-bis-(methyleneiminodiacetic acid) (CBMIDA) or ethane-1-hydroxy-1,1-bisphosphonate (EHBP) for 28 days after an intramuscular injection of 2 mg U/kg resulted in a reduction in mortality and decreases in uranium levels in the kidney, bone, and liver (Fukuda et al. 2005). Fukuda et al. (2009) also demonstrated that oral or intraperitoneal administration of CBMIDA for 6 days significantly increased excretion of uranium and decreased tissue uranium levels in rats administered 8 mg/kg depleted uranium via intraperitoneal or intramuscular injection.

Administration of bicarbonate for 3 days following an intramuscular injection of 4 mg/kg depleted uranium did not result in a significant reduction in uranium tissue levels or improvement in renal function in rats (Fukuda et al. 2008). However, co-administration of bicarbonate with the chelating agent, deferiprone, resulted in decreased uranium tissue levels and increased urinary uranium excretion compared to groups of depleted uranium exposed rats administered bicarbonate only or deferiprone only. Co-administration of bicarbonate and 4,6-dimethyl-1-hydroxyprimidin-2(1H)-one resulted in an increase in uranium excretion but did not affect tissue levels or organ function. Bicarbonate did not increase the efficiency of CBMIDA and was found to decrease the efficiency of EHBP.

Administration of a 500 mg/kg oral dose or 50 mg/kg subcutaneous dose of bisodic etidronate immediately following administration of a 170 mg U/kg dose of uranyl nitrate hexahydrate resulted in a 50% reduction in mortality and an improvement in the uranium-induced reduction in growth cartilage width, metaphyseal bone volume, and metaphyseal bone activity in male Balb/c mice (Bozal et al. 2005). Similarly, oral or subcutaneous administration of EHBP (Martinez et al. 2000, 2003) or bisodic etidronate (Martinez et al. 2003) immediately following administration of a single 170 mg U/kg as uranyl nitrate oral dose resulted in a decrease in mortality and a lessening of the severity of kidney lesions.

#### **3.11.3 Interfering with the Mechanism of Action for Toxic Effects**

No studies that examined methods for interfering with the mechanisms of action were identified.

### **3.12 ADEQUACY OF THE DATABASE**

Section 104(I)(5) of CERCLA, as amended, directs the Administrator of ATSDR (in consultation with the Administrator of EPA and agencies and programs of the Public Health Service) to assess whether adequate information on the health effects of uranium is available. Where adequate information is not available, ATSDR, in conjunction with the National Toxicology Program (NTP), is required to assure the

## 3. HEALTH EFFECTS

initiation of a program of research designed to determine the health effects (and techniques for developing methods to determine such health effects) of uranium.

The following categories of possible data needs have been identified by a joint team of scientists from ATSDR, NTP, and EPA. They are defined as substance-specific informational needs that if met would reduce the uncertainties of human health assessment. This definition should not be interpreted to mean that all data needs discussed in this section must be filled. In the future, the identified data needs will be evaluated and prioritized, and a substance-specific research agenda will be proposed.

### 3.12.1 Existing Information on Health Effects of Uranium

The existing data on health effects of inhalation, oral, and dermal exposure of humans and animals to uranium are summarized in Figure 3-11. The purpose of this figure is to illustrate the existing information concerning the health effects of uranium. Each dot in the figure indicates that one or more studies provide information associated with that particular effect. The dot does not necessarily imply anything about the quality of the study or studies, nor should missing information in this figure be interpreted as a “data need”. A data need, as defined in ATSDR’s *Decision Guide for Identifying Substance-Specific Data Needs Related to Toxicological Profiles* (Agency for Toxic Substances and Disease Registry 1989), is substance-specific information necessary to conduct comprehensive public health assessments. Generally, ATSDR defines a data gap more broadly as any substance-specific information missing from the scientific literature.

Figure 3-11 depicts the existing health effects information on uranium for a specific route and duration of exposure. There are limited data on uranium toxicity in humans following inhalation or oral exposure; no dermal exposure studies were identified. Several available studies that investigated the health effects in humans of inhalation exposure to uranium are limited to occupational settings (miners, millers, processors). The subjects of some of these studies were also concurrently exposed to other potentially toxic substances, rendering it difficult to establish the etiology for the effects reported in these studies; however, studies of processors who were not concurrently exposed to those toxicants are useful in this regard. Although three human studies presented limited evidence of reproductive effects (damage to sex chromosomes) in uranium mine workers, no empirical evidence was presented for evaluation. Oral studies are limited to several ecological studies of communities exposed to elevated uranium in drinking water. Although the studies did find significant associations, particularly for biomarkers of renal

3. HEALTH EFFECTS

**Figure 3-11. Existing Information on Health Effects of Uranium**

	Systemic									
	Death	Acute	Intermediate	Chronic	Immunologic/Lymphoretic	Neurologic	Reproductive	Developmental	Genotoxic	Cancer
Inhalation	●		●	●	●	●			●	●
Oral			●							
Dermal										

**Human**

	Systemic									
	Death	Acute	Intermediate	Chronic	Immunologic/Lymphoretic	Neurologic	Reproductive	Developmental	Genotoxic	Cancer
Inhalation	●	●	●	●	●				●	●
Oral	●	●	●	●	●	●	●		●	
Dermal	●	●	●	●	●					

**Animal**

● Existing Studies



## 3. HEALTH EFFECTS

dysfunction, the studies do not provide reliable dose-response data. Information on the systemic effects of uranium through the inhalation, oral, and dermal routes of exposure are available in a number of animal species. Several studies have examined the neurological, reproductive, and developmental toxicity of uranium following oral exposure. Reproductive and developmental end points have not been examined following inhalation or dermal exposure. Non-specific neurological symptoms have been reported in animals exposed via the inhalation or dermal routes to lethal concentrations of uranium. The carcinogenicity of uranium has been investigated in inhalation studies, but not in oral or dermal studies.

**3.12.2 Identification of Data Needs**

**Acute-Duration Exposure.** Human fatalities from acute accidental exposure to airborne uranium hexafluoride have been reported, although the deaths were attributed to the sheer force of the explosions in the accident and the highly toxic hydrofluoric acid generated from the spontaneous decomposition of uranium hexafluoride upon contact with atmospheric moisture (Kathren and Moore 1986; Moore and Kathren 1985; USNRC 1986). Two poisoning incidents, an inhalation exposure to powdered uranium tetrafluoride (Lu and Zhao 1990) and an intentional ingestion of approximately 131 mg U/kg as uranyl acetate (Pavlakis et al. 1996), resulted in renal toxicity. Acute-duration studies in animals mainly examined lethality. Inhalation acute-duration lethality studies in rats and guinea pigs are available for uranium hexafluoride for short durations (<2 hours) (Leach et al. 1984; Spiegl 1949); oral acute-duration lethality data are available for rats and rabbits (Domingo et al. 1987; Maynard and Hodge 1949; Orcutt 1949); and dermal acute-duration lethality studies in rats, mice, guinea pigs, and rabbits (De Rey et al. 1983; Orcutt 1949) are available. Additionally, there are acute oral studies examining systemic toxicity (Ozmen and Yurekli 1998), neurological effects (Briner 2009; Briner and Murray 2005), and developmental toxicity (Domingo et al. 1989c; Pujadas Bigi et al. 2003). The inhalation studies were inadequate for derivation of an MRL because the exposure durations were very short. An acute oral MRL was derived based on a developmental toxicity study (Domingo et al. 1989c). Acute-duration studies that define threshold values for renal toxicity by the inhalation and oral routes would be useful for assessment of brief exposures. Dermal exposure to uranium-contaminated soil is also possible. While dermal exposure to purified uranium compounds can cause toxicity in animals (De Rey et al. 1983; Orcutt 1949), the need for further dermal studies should be assessed after information is obtained on the bioavailability of uranium from uranium-contaminated soil.

**Intermediate-Duration Exposure.** No studies are available describing the effects of intermediate-duration exposure to uranium in humans for any route. However, an extensive animal database for this

## 3. HEALTH EFFECTS

duration for all routes demonstrates that renal toxicity is a concern for intermediate-duration human exposure. A number of animal studies have evaluated the toxicity of various uranium compounds in a number of animal species (Dygert 1949a, 1949b, 1949d; Roberts 1949; Rothstein 1949a, 1949b, 1949c; Spiegl 1949; Stokinger et al. 1953). Threshold values from these studies were used to derive inhalation MRLs for insoluble and soluble uranium compounds (see Chapter 2 and Appendix A); however, additional inhalation studies are needed to better define concentration-response relationships. The animal database for intermediate-duration oral exposure is less extensive in terms of species and compounds examined. Comprehensive studies are available for the effects of uranyl nitrate in rats and rabbits (Gilman et al. 1998a, 1998b, 1998c). The severity of histopathological alterations in the kidney increased with dose, although tests of kidney function (dye clearance, urinalysis) were normal in all dosed groups. Additionally, histopathological effects were seen in the lower dose groups without a significant increase in kidney uranium content over controls. Inconsistent results were found in the rabbit studies (Gilman et al. 1998b, 1998c), which the investigators attributed to a possible subclinical infection. No threshold for the histopathological effects was observed; the lowest dose tested in the rats was considered a minimal effect and was used to derive an oral MRL for this duration (see Chapter 2 and Appendix A). Further studies are needed to elucidate the time-course of the development of these histopathological effects; in rats, these changes were seen after 91 days, but not at 28 days, and to validate the results of the rabbit studies. No reliable studies examining the oral toxicity of insoluble uranium compounds were identified; studies providing dose-response data would be useful for establishing an MRL for insoluble compounds. Dermal exposure to uranium-contaminated soil is also possible. While dermal exposure to purified uranium compounds can cause toxicity in animals (De Rey et al. 1983; Lopez et al. 2000; Orcutt 1949), the need for further dermal studies should be assessed after information is obtained on the bioavailability of uranium from uranium-contaminated soil.

**Chronic-Duration Exposure and Cancer.** A small number of occupational exposure studies have examined renal toxicity. No evidence of renal toxicity was reported in workers exposed to relatively low concentrations of insoluble uranium compounds (Eisenbud and Quigley 1956). However, significant increases in urinary biomarkers of renal dysfunction were observed in workers exposed to ammonium diuranate (Thun et al. 1985). Future studies of uranium workers should include exposure assessments and measurement of sensitive biomarkers of renal damage. The available studies have linked respiratory diseases, fatal in some cases, in uranium miners to exposure to dust-containing uranium (and other noxious substances) (Waxweiler et al. 1981a). In several of these studies, the investigators concluded that, although uranium mining may elevate the risk for nonmalignant respiratory disease, the etiology of the excess risk is not clearly identifiable because the miners were also concurrently exposed to known

## 3. HEALTH EFFECTS

potent respiratory tract irritants such as diverse inhalable dust particles, silica, nickel oxide, cobalt oxide, and vanadium pentoxide (Waxweiler et al. 1983). Studies of underground uranium miners have not yet accounted for confounding by diesel engine exhaust or crystalline silica dust, especially freshly cracked silica dust, which was in high concentrations in mine air; and have been identified as carcinogens. A small number of studies have examined the chronic toxicity of inhaled uranium in animals. Studies involving exposure to soluble uranium compounds have identified the kidney as the most sensitive target (Stokinger et al. 1953) and were used to derive a chronic-duration MRL for soluble compounds. Data for insoluble compounds suggest that at low concentration and long exposure duration ( $\geq 3.5$  years), the lung may be a more sensitive target than the kidney (Leach et al. 1970). However, the lung effects may be due to radiotoxicity rather than chemical toxicity. Additional mechanistic studies are needed to identify the causative agent. The data were considered adequate for derivation of an MRL for insoluble uranium compounds; however, additional studies are needed to better define the concentration-response relationship for pulmonary and renal effects. Several ecological studies have examined the possible association between elevated levels of uranium in drinking water and impaired kidney function (Kurttio et al. 2002, 2006a; Limson Zamora et al. 1998, 2009; Mao et al. 1995; Seldén et al. 2009). Several studies have found significant association. A common limitation of the studies is a lack of accurate dose-response data. A series of studies in rats and dogs have examined the chronic toxicity of a variety of uranium compounds (Maynard and Hodge 1949; Maynard et al. 1953). The dog studies were not considered suitable for MRL derivation because only two dogs were exposed to each dose level. Although the rat studies tested an adequate number of animals and included histopathological examination of major tissues and organs, including the kidneys, a chronic-duration oral MRL could not be derived for uranium. Oral exposure studies examining a variety of end points, including sensitive end points of renal toxicity, are needed for soluble and insoluble uranium compounds. No chronic-duration dermal toxicity studies were identified in humans or animals.

A number of epidemiological studies are available for workers exposed to uranium (miners, millers, processors). A number of studies reported death from lung cancers from occupational inhalation exposure of mine workers (Archer et al. 1973a; Gottlieb and Husen 1982; Lundin et al. 1969; Samet et al. 1984a, 1986); however, the available studies document no lung cancers solely from inhaled uranium-bearing dust. It is generally accepted that lung cancers developed subsequent to inhalation of uranium-containing dusts were principally due to radon daughters and long-term cigarette smoking, and not to uranium metallotoxicity or uranium radioactive emissions. Existing epidemiologic studies that reported lung cancers in uranium miners, millers, and processors are inadequate for use in assessing the carcinogenic potential of uranium because the subjects were also concurrently exposed to other potential

## 3. HEALTH EFFECTS

carcinogens such as radon progeny and thorium (Archer et al. 1973a; Auerbach et al. 1978; Cookfair et al. 1983; Howe et al. 1986; Polednak et al. 1982; Saccomanno et al. 1971, 1976, 1988; Samet et al. 1986; Wrenn et al. 1983). There are limited animal data on the carcinogenicity of uranium following inhalation exposure and no oral or dermal exposure studies. Pulmonary neoplasms were observed in dogs (Leach et al. 1973) and rats (Mitchel et al. 1999).

**Genotoxicity.** Limited data exist regarding *in vivo* genotoxicity in humans following exposure to uranium. The only cases in which there were documented exposures to uranium are those of the Gulf War veterans who retained depleted uranium embedded fragments (McDiarmid et al. 2000, 2001a, 2004b, 2007, 2009). Prospective tests for clastogenicity and mutations in blood cells from this group yielded inconsistent results that led the investigators to conclude that the body of evidence in that cohort showed relatively weak genotoxic effects from uranium exposure. Future assessments are unlikely to provide key new information. Other assessments of small cohorts presumed to have been exposed to depleted uranium provided positive evidence of clastogenicity (Krunić et al. 2005; Milačić 2008; Milačić and Simić 2009; Milačić et al. 2004; Schröder et al. 2003). Studies of populations in areas with high levels of uranium in drinking water or soil would be valuable. *In vivo* studies in animals provided positive evidence of genotoxicity after inhalation and oral exposure to depleted uranium (Hao et al. 2009; Miller et al. 2010; Monleau et al. 2006a). Miller et al. (2010) also showed that implantation of depleted uranium pellets in male mice for 7 months followed by mating with untreated females resulted in transmission of genetic damage to somatic cells of offspring; the exact mechanism by which this occurred is not known, so further studies in this area are warranted. In addition, similar studies in mice exposed to uranium by routes relevant to general population exposure (contaminated drinking water or food) would be valuable. Studies of genotoxicity *in vitro*, both with mammalian cells (LaCerte et al. 2010; Lin et al. 1993; Miller et al. 2002a, 2002b, 2003; Stearns et al. 2005; Thiébaud et al. 2007; Wise et al. 2007) and prokaryotic organisms (Miller et al. 1998a; Yazzie et al. 2003) have yielded positive results. Studies with HOS cells showed that depleted uranium induced *de novo* genomic instability in the cells, which led to delayed reproductive death for many generations (Miller et al. 2003). Further studies aimed at elucidating the mechanism by which this can occur are needed. Some studies showed differences in genotoxic capacity between water-soluble and -insoluble uranium compounds (LaCerte et al. 2010; Wise et al. 2007). The investigators speculated that the difference may be related to differences in kinetics between the two types of uranium compounds; research in this area would be helpful. A study in CHO cells showed that uranium can form adducts with DNA (Stearns et al. 2005). Further research in this area can provide information regarding possible sensitive biomarkers for uranium exposure. There is an apparent knowledge gap between the positive findings of genotoxicity in *in vitro* and *in vivo* studies and the

## 3. HEALTH EFFECTS

predominantly negative findings of carcinogenicity studies. Additional studies are needed to address this data deficiency.

**Reproductive Toxicity.** Existing human data from male uranium miners, millers, and processors (Muller et al. 1967; Waxweiler et al. 1981b; Wiese and Skipper 1986) and from men exposed to depleted uranium in the Gulf War via retained metal embedded fragments (McDiarmid et al. 2000, 2001a, 2004b, 2007, 2009) have not suggested adverse uranium-induced reproductive effects. The Gulf War veterans were subjected to longitudinal analyses of sex hormone levels in blood and sperm parameters; however, no assessments of fertility have been conducted. It would be helpful to have that information, if available. Exposure to uranium reduced fertility in male mice (Llobet et al. 1991) and male rats (Linares et al. 2005) exposed via the drinking water. In the former study, reduced fertility was associated with reduced spermatozoa counts; in the latter, there were morphological alterations in Sertoli or germinal cells. Fertility was not affected in mice dosed with uranium by gavage (Paternain et al. 1989) or in a 2-generation reproductive toxicity study in rats implanted depleted uranium pellets (Arfsten et al. 2009). Differences in exposure routes may have played a role in the difference results obtained. Clearly, drinking water studies are more relevant to potential exposures of the general population than exposures by gavage or through an embedded uranium pellet. Of the four studies mentioned above (Arfsten et al. 2009; Linares et al. 2005; Llobet et al. 1991; Paternain et al. 1989), urinary uranium, as a biomarker of exposure, was only monitored by Arfsten et al. (2009). Studies are also available that reported that exposure to uranium altered ovarian folliculogenesis in mice (Arnault et al. 2008; Feugier et al. 2008; Kundt et al. 2009; Raymond-Whish et al. 2007). The study conducted by Raymond-Whish et al. (2007) reported slight alterations in ovarian folliculogenesis in mice administered doses as low as 0.39  $\mu\text{g}$  U/kg/day. These authors also reported estrogenic effects in mice treated with 5  $\mu\text{g}$  U/kg/day. Since these doses are orders of magnitude lower than those used in other studies, it would be reassuring if the findings of Raymond-Whish et al. (2007) can be replicated by other laboratories. A study in rats reported that enriched uranium, but not depleted uranium, increased serum testosterone and the expression of genes involved in steroidogenesis (Grignard et al. 2008). In addition, enriched uranium significantly increased the expression of transcription factors involved in the regulation of steroidogenic genes. This is the only study available that compared the effects of enriched versus depleted uranium on some reproductive end points. Additional studies comparing the effects of depleted and enriched uranium on other reproductive end points (i.e., fertility, sperm parameters, microscopic morphology of reproductive organs, estrogenicity, levels of sex hormones) would be valuable to distinguish between chemical and radiological activity.

## 3. HEALTH EFFECTS

**Developmental Toxicity.** There are no studies of developmental effects in humans with documented exposure to uranium. Several reports have been published regarding increased incidence of teratogenicity in populations presumed to have been exposed to depleted uranium; this subject was reviewed by Hindin et al. (2005). It should be noted that all of the reports lack documentation of individual exposure to depleted uranium, some reports lacked methodologically rigorous investigation (like exposure to other chemicals and other confounders), and in the incidences of birth defects between supposedly exposed and nonexposed groups was not statistically significant in other reports. Yet, Hindin et al. (2005) concluded that the evidence linking exposure to depleted uranium and birth defects, albeit imperfect, indicates a high probability of substantial risk. Studies could be conducted of offspring of women living in areas with documented high uranium in the drinking water or the soil to evaluate possible associations between uranium and birth defects in humans.

Maternal exposure to uranium during pregnancy has induced fetotoxicity, teratogenicity, and reduced neonatal viability in mice (Domingo et al. 1989b, 1989c; Paternain et al. 1989). An issue that is not totally clear is whether this occurs at doses not causing maternal toxicity. An additional issue that has not been explored is evaluation of the contribution of gestational exposure versus lactational exposure to the uranium-induced decreased neonatal viability. Valuable information could be collected to address this question by conducting cross-fostering studies. Gestational exposure to uranium did not affect developmental landmarks in mice (Domingo et al. 1989b) or rats (Sánchez et al. 2006). However, in rats, perinatal exposure altered the results of some neurobehavioral tests conducted in the offspring (Houpert et al. 2007a; Sánchez et al. 2006). Histological examination of different brain areas of the offspring as well as measurements of neurotransmitters could provide information regarding possible mechanisms involved in the neurobehavioral effects of perinatal exposure to uranium. In contrast with the findings of Houpert et al. (2007a) and Sánchez et al. (2006), a study in rats implanted depleted uranium pellets for 120 days before mating reported no significant alterations in neurobehavioral tests conducted on the offspring on postnatal days 4–63 (Arfsten et al. 2009). This 2-generation reproductive study also did not report significant alterations in viability of the F1 generation or in histology of selected organs or sperm parameters on postnatal day 120. Different results between studies are not totally unexpected since exposure protocols were different. Sánchez et al. (2006) exposed only females via drinking water for 4 weeks, Houpert et al. (2007a) exposed males and females via drinking water for 3 months, and Arfsten et al. (2009) implanted uranium pellets in both males and females. Information regarding uranium body burdens in the parental generation, such as urinary uranium levels, would be helpful for comparing studies with differing exposure protocols. Studies also showed that in mice, gestational exposure to uranium can alter ovarian folliculogenesis in the female offspring (Arnault et al. 2008; Raymond-Whish

## 3. HEALTH EFFECTS

et al. 2007). In one of these studies (Raymond-Whish et al. 2007), effects occurred at doses much lower than those tested in any other animal study. It would be useful to try to replicate these findings. Neonatal exposure of rats to uranium interfered with tooth eruption and development (Pujadas Bigi and Ubios 2007; Pujadas Bigi et al. 2003), but only one dose level was tested so that a NOAEL was not defined. Studies designed to define a NOAEL and to allow construction of a dose-response curve would be helpful. Recently, it was shown that paternal exposure to uranium via implantation of depleted uranium pellets resulted in transmission of genetic damage to somatic cells of unexposed offspring (Miller et al. 2010). The investigators noted that studies investigating the effects of depleted uranium exposure on germ cell mutagenesis and direct DNA damage to sperm are being completed. It would be valuable if similar studies are conducted with male mice exposed by a route more relevant to exposures of the general population such as via contaminated drinking water or food.

**Immunotoxicity.** There are limited data on the immunotoxic potential of uranium. Epidemiology studies that examined white blood cell levels or mortality from immune disease have not reported adverse effects following inhalation, oral, or dermal exposure (Archer et al. 1973b; Checkoway et al. 1988; Cragle et al. 1988; Keane and Polednak 1983; NIOSH 1987; Polednak and Frome 1981; Vich and Kriklava 1970). The available inhalation studies in animals also found no evidence of histological changes in the spleens of rats, dogs, and monkeys exposed to uranium dioxide dusts (Leach et al. 1970, 1973). Intermediate-duration exposure of rats, rabbits, guinea pigs, and dogs to dusts containing various uranium compounds for 7–12 months produced no significant histological changes in the lymph nodes, bone marrow, or spleen, and no build-up of uranium was seen in these tissues (Stokinger et al. 1953). Similarly, rats and mice exposed to oral doses of soluble or insoluble compounds of uranium for intermediate- and chronic-duration exposures suffered no immunological damage (Malenchenko et al. 1978; Maynard et al. 1953; Tannenbaum et al. 1951). No studies are available that evaluated the immunological and lymphoreticular effects in animals following acute- or intermediate-duration inhalation exposure, the oral exposure of humans for any duration, the inhalation or oral exposure of animals for acute durations, or the dermal exposure of humans and animals to uranium compounds for any duration. Additional animal studies would be useful that use current techniques to evaluate the immunological and lymphoreticular dysfunctions that may occur with exposure to uranium compounds.

**Neurotoxicity.** In general, studies of uranium workers have not provided evidence of adverse neurological effects, although tests to detect subtle neurological alterations were not conducted (Carpenter et al. 1988; Cragle et al. 1988; Hadjimichael et al. 1983; Kathren and Moore 1986; NIOSH 1987; Polednak and Frome 1981; Reyes et al. 1984; USNRC 1986). Workers were presumed to have been

## 3. HEALTH EFFECTS

exposed mainly by the inhalation and dermal routes. Longitudinal assessments of Gulf War veterans who retained depleted uranium fragments and were excreting elevated urinary levels of uranium years after the first exposure provided inconsistent results in neurobehavioral tests (McDiarmid et al. 2000, 2001a, 2004b, 2007, 2009). Surveillance of this group of subjects should continue to try to identify potentially late-appearing effects or normal aging signs that might manifest prematurely. No information was located regarding neurological effects in humans exposed orally to uranium. Early inhalation studies in animals exposed to dusts of fluoride salts of uranium reported frank neurological effects, but did not consider the possible contribution of fluoride (Dygart 1949a; Rothstein 1949a). More recent oral studies in animals have reported changes in biochemical parameters, including levels of neurotransmitters and their metabolites, in various areas of the brain following acute- and intermediate-duration exposure to uranium (Briner 2009; Briner and Murray 2005; Bussy et al. 2006). Studies also have examined neurobehavioral parameters following exposure to uranium; some reported neurobehavioral alterations (Briner 2009; Briner and Murray 2005; Houpert et al. 2005, 2007b), while others did not (Arfsten et al. 2007; Belles et al. 2005). Studies are needed that conduct morphological, electrophysiological, and biochemical evaluations in the same animals following exposure to uranium to shed light into possible mechanism(s) of action for uranium-induced neurological effects. No studies were located that examined neurological parameters in animals following chronic-duration exposure to uranium. Such studies would provide information regarding long-term, low-level exposure as could occur to populations exposed to excessive uranium in the drinking water or through consumption of food grown in areas with elevated concentrations of uranium in the soil.

**Epidemiologic and Human Dosimetry Studies.** Epidemiologic studies of uranium miners, millers, and processors are available on the health effects from exposure to airborne uranium and radon daughters (Archer et al. 1973a, 1973b; Checkoway et al. 1988; Cragle et al. 1988; Gottlieb and Husen 1982; Hadjimichael et al. 1983; Lundin et al. 1969; NIOSH 1987; Polednak and Frome 1981; Samet et al. 1984a, 1986; Scott et al. 1972; Waxweiler et al. 1983). However, some of the studies of miners and millers contain confounding factors and lack adequate quantitative exposure information compared with the studies of processors, which had fewer confounders and clearly identified an absence of toxic effects such as cancer. New studies that account for these confounding factors, such as effects of inhalable dust particles other than uranium, other sources of ionizing radiation, and other potentially pulmonary-toxic substances to which these workers are concurrently exposed, and that provide a more accurate measurement of the airborne concentrations of uranium to which these workers are exposed would be useful. Animal studies provide strong evidence that the kidney is the most sensitive target of uranium toxicity. Alterations in sensitive biomarkers of renal dysfunction have been observed in workers exposed



### 3. HEALTH EFFECTS

to airborne soluble uranium compounds (Thun et al. 1985) and in residents consuming drinking water with elevated uranium levels (Limson Zamora et al. 1998, 2009; Mao et al. 1995). However, occupational exposure studies of workers exposed to insoluble uranium (as reviewed by Eisenbud and Quigley 1956) and ecological drinking water studies (Kurtio et al. 2006a; Seldén et al. 2009) have not found significant kidney effects. Most of these studies provide limited dose-response data, and studies examining sensitive end points of renal toxicity, as well as other potential targets of toxicity, are needed to assess the relative sensitivity of humans to uranium toxicity as compared to animal species, which are used to derive MRLs for uranium. Also, simple and accurate monitoring methods should be developed for workers that would determine the relationship among atmospheric concentration, particle size, distribution, physical properties of the uranium aerosol, body burden, and excretion rates and pathways. The use of depleted uranium munitions by the military has resulted in the potential uranium exposure to military personnel and civilians; additional research regarding the health effects of acute-duration inhalation exposure to depleted uranium would be useful to assess the potential for toxicity. These studies should include toxicological end points, lung doses, metabolic fate, and techniques to detect and monitor lung exposures.

#### **Biomarkers of Exposure and Effect.**

**Exposure.** Because uranium is primarily excreted in the urine following inhalation, oral, or dermal exposure, measurement of urine uranium levels can accurately estimate uranium body burden (Ballou et al. 1986; Cooper et al. 1982; Downs et al. 1967; Leach et al. 1984; McDiarmid et al. 1999b; Morrow et al. 1982a; Stradling et al. 1984, 1987; West and Scott 1969; Wrenn et al. 1985). Several methods have been developed for chemical detection (e.g., fluorimetry and kinetic phosphorescence analysis) and radiological detection (e.g., inductively coupled plasma mass spectrometry [ICP-MS] and alpha spectroscopy). Although correlations between uranium intake and urinary levels have been reported, additional studies are needed that would allow for the development of a biokinetic model, which would allow estimation of uranium intake based on urinary uranium levels.

Uranium content in soft tissue and bone could also be used as biomarkers of exposure to uranium (Ballou et al. 1986; Diamond et al. 1989; Leach et al. 1973, 1984; Morris et al. 1990; Morrow et al. 1972; Stokinger et al. 1953; Walinder 1989; Wrenn et al. 1987). Although soft tissues and bone are the most frequently analyzed biological media after urine and feces, these tissues are usually available for analysis only at autopsy. Therefore, this method is impractical and not used for routine screening purposes.

### 3. HEALTH EFFECTS

**Effect.** Currently, there are no available biomarkers for specific exposure to the metallotoxic or radiotoxic effects of uranium. Although the kidney is the most sensitive target of uranium toxicity, biomarkers of renal dysfunction such as  $\beta_2$  microglobulin, protein HC, and retinol binding protein are not specific to uranium. Additional studies are needed to correlated these alterations with renal damage and establish dose-response relationships.

**Absorption, Distribution, Metabolism, and Excretion.** Information is needed on the comparative absorption of uranium compounds by the oral route, along with an assessment of its clearance from the skeleton. Quantitative data on the bioavailability of uranium from contaminated soil by the oral and dermal routes are also necessary to assess the risk of uranium-contaminated soil at hazardous waste sites.

**Comparative Toxicokinetics.** Numerous species (mice, rats, rabbits, guinea pigs, dogs, and monkeys) have been tested for their response to inhaled or ingested uranium. The results from these studies clearly demonstrate that there is a considerable difference in toxic responses among species. For example, rabbits appear to be unusually susceptible to the lethal effects of uranium (Maynard and Hodge 1949; Orcutt 1949; Stokinger et al. 1953), whereas dogs developed glandular neoplasms of the lungs (Leach et al. 1973), a type of lung cancer that is not observed in humans, and guinea pigs required far greater air concentrations (15x) for 2-minute exposures than did rats to produce an effect (Leach et al. 1984).

**Methods for Reducing Toxic Effects.** Most of the available research on methods for reducing the toxic effects of uranium have focused on the effectiveness of chelating agents on reducing the accumulation of uranium in the body (Bozal et al. 2005; Domingo et al. 1992; Fukuda et al. 2005, 2009; Martinez et al. 2000, 2003; Ortega et al. 1989a; Stradling et al. 1991). Several agents including Tiron, CBMIDA, EHBP, and bisodic etidronate have significantly reduced tissue uranium levels, decreased renal toxicity, and increased survival when the chelating agent was administered shortly after exposure. The effectiveness of bicarbonate in facilitating the excretion of uranium has also been investigated (Cooper et al. 1982; Fisher et al. 1991; Fukuda et al. 2008). However, few studies have investigated the effectiveness of these agents when they are administered after long-term uranium exposure and more studies are needed. No studies investigating methods for reducing peak absorption following inhalation or oral exposure were identified. Houpert et al. (2001, 2004) explored the use of dressings with or without chelating agents on decreasing the absorption of uranium from wounds. No studies researching methods for interfering with the toxic mechanisms of action were identified. Further research is needed

## 3. HEALTH EFFECTS

to validate, refute, or refine method(s) for reducing the body burden, particularly following long-term exposure, and research is needed on methods for decreasing absorption and interfering with the mechanism of toxicity.

**Children's Susceptibility.** Data needs relating to both prenatal and childhood exposures, and developmental effects expressed either prenatally or during childhood, are discussed in detail in the Developmental Toxicity subsection above.

Specific information is not available on whether children are more susceptible than adults to the effects of uranium. No reports were located describing toxicity in children as the result of uranium exposure. It is probable, however, that if exposure levels were high enough, signs of renal toxicity would be observed similar to that seen in adults exposed accidentally (Lu and Zhao 1990) or intentionally (Pavlakis et al. 1996). Because children undergo periods of rapid bone growth and remodeling and uranium is stored in bone, there is a need to examine the potential toxicity of uranium to bone. However, few studies have examined this end point and additional studies are needed.

A study by the oral route establishing a threshold for renal effects in weanling and adult rats of the same strain is needed to determine if susceptibility to uranium toxicity varies with age. Histopathological studies and urinalysis should be performed, as well as measurement of uranium in excreta for both groups. At termination in this study, uranium content should be measured in tissues, particularly bone and kidney. This will provide information on whether retention of uranium in bone is age-dependent (as assumed by analogy with calcium in PBPK models) and on whether kidney burden associated with uranium toxicity is age-related.

More information on the absorption of various forms of uranium in young animals would be useful. Also, studies are needed on whether maternally stored bone uranium is mobilized to blood during pregnancy and lactation and whether this can increase exposure to the fetus and neonate.

Child health data needs relating to exposure are discussed in Section 6.8.1, Identification of Data Needs: Exposures of Children.

## 3. HEALTH EFFECTS

**3.12.3 Ongoing Studies**

Ongoing studies are examining possible kidney toxicity in residents living near uranium mining sites, genotoxicity of depleted uranium, and adverse health outcomes in Gulf War veterans exposed to depleted uranium.

The Congressionally-mandated Navajo Uranium Assessment and Kidney Health Project is a joint Department of Energy (DOE), EPA, and ATSDR effort with three foci: (1) conducting medical monitoring; (2) completing safe water projects; and (3) studying the potential effects of heavy metals, including uranium, on pregnant women and their infants. ATSDR, in collaboration with the Indian Health Service and the Navajo Nation hospital and clinic staff, will conduct case control studies of health risks faced by individuals residing near mill sites or abandoned mine sites. The study will include a birth cohort study to address the potential association between environmental exposure to a suite of heavy metals, including uranium, and both maternal health and reproductive birth outcomes. The birth cohort study is being conducted by the University of New Mexico under a cooperative research agreement with ATSDR (EPA 2013a).

The U.S. Department of Energy's Lawrence Berkeley National Laboratory is currently developing a sequestering agent that could be administered following exposure to actinides, such as plutonium, americium, uranium, and neptunium, and result in increased excretion of the actinide contaminants.

## 4. CHEMICAL, PHYSICAL, AND RADIOLOGICAL INFORMATION

### 4.1 CHEMICAL IDENTITY

Uranium is a naturally occurring element that makes up approximately 2–4 ppm of the earth's crust. It is more plentiful than silver and about as abundant as molybdenum or arsenic. Uranium is an actinide element, and has the highest atomic mass of any naturally occurring element. In its refined state, it is a heavy, silvery-white metal that is malleable, ductile, slightly paramagnetic, and very dense, second only to tungsten. In nature, it is found in rocks and ores throughout the earth, with the greatest concentrations in the United States in the western states of Colorado, Arizona, Wyoming, Texas, Utah, and New Mexico (Lide 2008). In its natural state, crustal uranium occurs as a component of several minerals, such as carnotite, uraninite, and pitchblend, but is not found in the metallic state. The chemical information for uranium metal is listed in Table 4-1.

### 4.2 PHYSICAL, CHEMICAL, AND RADIOLOGICAL PROPERTIES

The physical properties of uranium and uranium compounds important in the nuclear fuel cycle and defense programs are listed in Table 4-2. The percent occurrence and radioactive properties of naturally occurring isotopes of uranium are listed in Table 4-3. The two decay series for the naturally occurring isotopes of uranium are shown in Table 4-4.

Metallurgically, uranium metal may exist in three allotropic forms: orthorhombic, tetragonal, or body-centered cubic (Lide 2008), and may be alloyed with other metals to alter its structural and physical properties to suit the application. Like aluminum metal powder, uranium metal powder is autopyrophoric and can burn spontaneously at room temperature in the presence of air, oxygen, and water. In the same manner, the surface of bulk metal, when first exposed to the atmosphere, rapidly oxidizes and produces a thin surface layer of  $\text{UO}_2$ , which resists oxygen penetration and protects the inner metal from oxidation. At temperatures of 200–400°C, uranium powder may self-ignite in atmospheres of  $\text{CO}_2$  and  $\text{N}_2$ . In order to prevent autoignition, uranium machining chips can be stored in open containers and under machine oil or water to prevent hydrogen gas buildup. Burning uranium may be placed under water until extinguished, which may be delayed by hydrolysis of the water, which provides some oxygen and hydrogen for continued burning. Water spray,  $\text{CO}_2$ , and halon are ineffective, and halon discharge can be explosive and produce toxic gases (DOE 2001).

## 4. CHEMICAL, PHYSICAL, AND RADIOLOGICAL INFORMATION

**Table 4-1. Chemical Identity of Uranium Metal**

	Value	Reference
Chemical name	Uranium	
Natural isotopes	Uranium-238; uranium-235; uranium-234	HSDB 2011
Synonyms	Uranium; 238U; 238U element; uranium-238; uranium-234; uranium-235; uranium, elemental; uranium, metal, pyrophoric; uranium, radioactive; uranium, natural	HSDB 2011
Trade names	No data	
Chemical formula	U	HSDB 2011
Chemical structure	Not applicable	
Identification numbers		
CAS registry	7440-61-1	HSDB 2011
NIOSH RTECS	NIOSH/YR3490000	NIOSH 2010a
EPA hazardous waste	No data	HSDB 2011
OHM/TADS	7217196	HSDB 1995
DOT/UN/NA/IMO shipping	UN2979; uranium metal, pyrophoric	HSDB 2011
HSDB	2553; 7404, uranium, radioactive	HSDB 2011
NCI	No data	HSDB 2011
STCC	4926187; uranium metal, pyrophoric (uranium metal scrap, neither irradiated nor requiring protective shielding)	HSDB 1995

CAS = Chemical Abstracts Service; DOT/UN/NA/IMCO = Department of Transportation/United Nations/North America/International Maritime Dangerous Goods Code; EPA = Environmental Protection Agency; HSDB = Hazardous Substances Data Bank; NCI = National Cancer Institute; NIOSH = National Institute for Occupational Safety and Health; OHM/TADS = Oil and Hazardous Materials/Technical Assistance Data System; RTECS = Registry of Toxic Effects of Chemical Substances; STCC = Standard Transportation Commodity Code

## 4. CHEMICAL, PHYSICAL, AND RADIOLOGICAL INFORMATION

**Table 4-2. Physical and Chemical Properties of Selected Uranium Compounds**

Property	Uranium	Uranium dioxide	Uranium trioxide	Triuranium octaoxide	Uranium tetrafluoride
Atomic/molecular weight	238.0289 <sup>a</sup>	270.028	286.027	842.08	314.023
Chemical formula	U	UO <sub>2</sub>	UO <sub>3</sub>	U <sub>3</sub> O <sub>8</sub>	UF <sub>4</sub>
Synonyms	Uranium I <sup>a</sup>	Uranium(IV) oxide	Uranyl(VI) oxide	Uranium octaoxide; uranium oxide	Uranium(IV) fluoride <sup>a</sup>
Common names		Brown oxide	Orange oxide	Yellow cake; Block oxide	Green salt <sup>a</sup>
CAS Registry No.	7440-61-1 <sup>a</sup>	1344-57-6	1344-58-7	1344-59-8	10049-14-6
Color	Silvery-white	Brown	Orange-yellow	Olive green-black	Green
Physical state	Solid <sup>a</sup>	Solid crystal	Solid crystal	Solid	Solid crystal
Odor	No data	No data	No data	No data	No data
Melting point, °C	1,135 <sup>a</sup>	2,847	Decomposes	Decomposes at 1,300	1,036
Boiling point, °C	4,131 <sup>a</sup>	~3,800°K	Not relevant	Not relevant	1,417
Autoignition temperature	20°C (cloud), 100°C <sup>a</sup> (layer) <sup>a</sup>	Not relevant	Not relevant	Not relevant	Not relevant
Solubility:					
Water	Insoluble	Insoluble	Insoluble	Insoluble	0.01 g/100 g H <sub>2</sub> O
Other solvents	Soluble in concentrated acids; insoluble in alkalis, alcohols <sup>a</sup>	Soluble in concentrated acids	Soluble in acid	Soluble in HNO <sub>3</sub> , H <sub>2</sub> SO <sub>4</sub>	Soluble in concentrated acids and alkalis
Density, g/cm <sup>3</sup>	18.06–19.1 <sup>a</sup>	10.97	~7.3	8.30	6.7
Partition coefficients	Not relevant	Not relevant	Not relevant	Not relevant	No data
Vapor pressure	0 mmHg at 20°C; 1 mmHg at 2,450°C <sup>a</sup>	0.463 atm at 2,847°C	Not relevant	Not relevant	Not relevant
Henry's law constant	Not relevant	Not relevant	Not relevant	Not relevant	Not relevant
Refractive index	No data	No data	No data	No data	No data
Flashpoint	No data	No data	No data	No data	No data
Flammability limits	Not relevant <sup>a</sup>	No data	No data	No data	No data
Conversion factor <sup>b</sup>	1 µg=0.69 pCi	1 µg=0.61 pCi	1 µg=0.57 pCi	1 µg=0.59 pCi	1 µg=0.45 pCi

## 4. CHEMICAL, PHYSICAL, AND RADIOLOGICAL INFORMATION

**Table 4-2. Physical and Chemical Properties of Selected Uranium Compounds**

Property	Uranium hexafluoride	Uranium tetrachloride	Uranyl fluoride <sup>c</sup>	Uranyl acetate, dihydrate	Uranyl nitrate hexahydrate
Atomic/molecular weight	352.019	379.841	308.0245	424.146	502.129
Chemical formula	UF <sub>6</sub>	UCl <sub>4</sub>	UO <sub>2</sub> F <sub>2</sub>	UO <sub>2</sub> (CH <sub>3</sub> COO) <sub>2</sub> •2 H <sub>2</sub> O	UO <sub>2</sub> (NO <sub>3</sub> ) <sub>2</sub> •6H <sub>2</sub> O
Synonyms	Uranium(VI) fluoride	Uranium (IV) chloride	Uranium oxyfluoride; uranium fluoride oxide	bis(Acetate-B) dioxouranium	bis(Nitrate-O) dioxouranium; hexahydrate
Common names	No data	Green salt	No data	No data	No data
CAS Registry No.	7783-81-5	10026-10-5	13536-84-0 <sup>a</sup>	6159-44-0	13520-83-7
Color	White crystalline <sup>a</sup>	Green	Yellow <sup>a</sup>	Yellow	Yellow
Physical state	Solid <sup>a</sup>	Octahedral crystal	Solid <sup>a</sup>	Solid crystal	Solid crystal
Odor	No data	No data	No data	No data	No data
Melting point, °C	64.5 at 2 atm <sup>a</sup>	590°C	Decomposes at 300	Loses 2H <sub>2</sub> O at 110	60
Boiling point, °C	56.2 sublimation point <sup>a</sup>	791	Not relevant	Decomposes at 275	Decomposes at 118
Autoignition temperature	No data	No data	No data	No data	No data
Solubility:					
Water	Reacts with H <sub>2</sub> O	Reacts with water	64.4 g/100 g at 20 °C	7.7 g/100 mL at 15 °C	127 g/100 gH <sub>2</sub> O
Other solvents	Soluble in CCl <sub>4</sub> , TCE, and chloroform <sup>a</sup>	Soluble in ethanol	Soluble in ethanol and benzene <sup>a</sup>	Soluble in ethanol	Soluble in ethanol and ether
Density g/cm <sup>3</sup>	5.09 at 20.7°C; 3.595 at 70°C	4.72	6.37	2.893 g/cm <sup>3</sup> at 15°C	2.81 g/cm <sup>3</sup> at 13°C
Partition coefficients	Not relevant	Not relevant	Not relevant	Not relevant	Not relevant
Vapor pressure	115 mmHg at 25°C <sup>c</sup>	No data	No data	No data	No data
Henry's law constant	Not relevant	Not relevant	Not relevant	Not relevant	Not relevant
Refractive index	No data	No data	No data	No data	1.4967
Flashpoint	No data	No data	No data	No data	No data
Flammability limits	No data	No data	No data	No data	No data
Conversion factor <sup>b</sup>	1 µg=0.47 pCi	1 µg=0.43 pCi	1 µg=0.53 pCi	1 µg=0.39 pCi	1 µg=0.33 pCi



## 4. CHEMICAL, PHYSICAL, AND RADIOLOGICAL INFORMATION

**Table 4-2. Physical and Chemical Properties of Selected Uranium Compounds**

Property	Uranyl nitrate (not hexahydrate)	Ammonium diuranate	Uranium peroxide	Uranyl acetate
Atomic/molecular weight	394.037	624.131	302.03 <sup>a</sup>	388.12 <sup>a</sup>
Chemical formula	(UO <sub>2</sub> )(NO <sub>3</sub> ) <sub>2</sub>	(NH <sub>4</sub> ) <sub>2</sub> U <sub>2</sub> O <sub>7</sub>	UO <sub>4</sub> <sup>a</sup>	C <sub>4</sub> H <sub>6</sub> O <sub>6</sub> U <sup>a</sup>
Synonyms	No data	Ammonium uranate(VI)	No data	No data
Common names	No data	No data	No data	No data
CAS Registry No.	10102-06-4	7783-22-4	19525-15-6 <sup>a</sup>	541-09-3 <sup>a</sup>
Color	Yellow	Reddish yellow	Pale yellow <sup>a</sup>	Yellow <sup>a</sup>
Physical state	Solid crystal	Amorphous powder	Solid	Solid crystals <sup>a</sup>
Odor	No data	No data	No data	Vinegar-like <sup>a</sup>
Melting point, °C	No data	No data	Decomposes at 90–195°C <sup>a</sup>	No data
Boiling point, °C	No data	No data	No data	Decomposes at <275 <sup>a</sup>
Autoignition temperature	Not relevant	Not relevant	Not relevant	Not relevant
Solubility:				
Water	127 g/100 g H <sub>2</sub> O	Insoluble	0.0006 g/100 cc at 20°C; 0.008 g/cc at 90°C <sup>a</sup>	7.694/100 mL at 15°C <sup>a</sup>
Other solvents	Soluble in ether	Insoluble in alkali; soluble in acids	No data	Very soluble in alcohol <sup>a</sup>
Density g/cm <sup>3</sup>	No data	No data	11.66 (calculated) <sup>a</sup>	2.893 at 15°C <sup>a</sup>
Partition coefficients	No data	No data	No data	No data
Vapor pressure	No data	No data	No data	No data
Henry's law constant	No data	No data	No data	No data
Refractive index	No data	No data	No data	No data
Flashpoint	No data	No data	No data	No data
Flammability limits	No data	No data	No data	No data
Conversion factor <sup>b</sup>	1 µg ≡ 0.42 pCi	1 µg ≡ 0.52 pCi	1 µg ≡ 0.54 pCi	1 µg ≡ 0.42 pCi

<sup>a</sup>HSDB (2011).<sup>b</sup>Calculated from National Nuclear Data Center data (NNDC 2011).<sup>c</sup>Argonne National Laboratory (2011).

Source: Lide (2008), unless annotated

## 4. CHEMICAL, PHYSICAL, AND RADIOLOGICAL INFORMATION

**Table 4-3. Percent Occurrence and Radioactive Properties of Naturally Occurring Isotopes of Uranium**

Isotope	Percent of total uranium in crustal rock		Alpha energies, keV (abundance)	Gamma energies, keV (abundance)	Half-life (years)	
	By weight	By radioactivity				
<sup>234</sup> U	0.0054	49.03	4772.4 (28.42%)	13.0 (10.0%)	2.455x10 <sup>5</sup>	
			4774.6 (71.38%)			
<sup>235</sup> U	0.7204	2.27	4214.7 (5.7%)	13.0 (37.00%)	7.038x10 <sup>8</sup>	
			4366.1 (17.0%)			93.35 (5.60%)
			4397.8 (55%)			143.76 (10.96%)
			4556.0 (4.2%)			163.33 (5.08%)
			4596.4 (5.0%)			185.715 (57.20%)
			Others (13.1%)			205.311 (5.01%)
<sup>238</sup> U	99.2742	48.70	4151 (21%)	4772.4 (28.42%)	4.468x10 <sup>9</sup>	
			4198 (79%)			4774.6 (71.38%)

Sources: NNDC 2011

4. CHEMICAL, PHYSICAL, AND RADIOLOGICAL INFORMATION

**Table 4-4. <sup>235</sup>U and <sup>238</sup>U Decay Series Showing Sources and Decay Products**

<sup>238</sup> Uranium-238 series, includes uranium-234 series							Uranium-235 series							
Np														
U	<sup>238</sup> U 4.47x 10 <sup>9</sup> y		<sup>234</sup> U 2.46x 10 <sup>5</sup> y				<sup>235</sup> U 7.04x 10 <sup>8</sup> y							
Pa	↓	<sup>234m</sup> Pa 1.16 m	↓				↓	<sup>231</sup> Pa 3.28x 10 <sup>4</sup> y						
Th	<sup>234</sup> Th 24.1 d		<sup>230</sup> Th 7.54x 10 <sup>4</sup> y				<sup>231</sup> Th 25.5 h	↓	<sup>227</sup> Th 18.7 d					
Ac			↓					<sup>227</sup> Ac 21.8 y	↓					
Ra			<sup>226</sup> Ra 1,600 y					↓	<sup>223</sup> Ra 11.4 d					
Fr			↓					<sup>223</sup> Fr 22.0 m	↓					
Rn			<sup>222</sup> Rn 3.82 d						<sup>219</sup> Rn 3.96 s					
At			↓	<sup>218</sup> At 1.5 s					↓	<sup>215</sup> At 1x10 <sup>-4</sup> s				
Po			<sup>218</sup> Po 3.10 m		<sup>214</sup> Po 1.64x 10 <sup>-4</sup> s		<sup>210</sup> Po 138 d		<sup>215</sup> Po 17.8x 10 <sup>-3</sup> s		↓	<sup>211</sup> Po 0.5 s		
Bi			↓	<sup>214</sup> Bi 19.9 m	↓	<sup>210</sup> Bi 5.01 d	↓		↓	<sup>211</sup> Bi 2.14 m	↓			
Pb			<sup>214</sup> Pb 26.8 m	↓	<sup>210</sup> Pb 22.2 y	↓	<sup>206</sup> Pb stable		<sup>211</sup> Pb 36.1 m	↓		<sup>207</sup> Pb stable		
Tl				<sup>210</sup> Tl 1.30 m		<sup>206</sup> Tl 4.20 m				<sup>207</sup> Tl 4.77 m				

↓ = alpha decay; ↘ = beta decay; half-life (d = days; h = hours; m = minutes; s = seconds; y = years)

Sources: Aieta et al. 1987; Argonne National Laboratory 2005; half-life data from NNDC 2011

## 4. CHEMICAL, PHYSICAL, AND RADIOLOGICAL INFORMATION

Uranium can exist in five oxidation states: +2, +3, +4, +5, and +6 (Lide 2008); however, only the +4 and +6 states are stable enough to be of practical importance. Tetravalent uranium is reasonably stable and forms hydroxides, hydrated fluorides, and phosphates of low solubility. Hexavalent uranium is the most stable state, and the most commonly occurring state is  $U_3O_8$ , although there are a few localized storage locations for anthropogenic uranium hexafluoride ( $UF_6$ ) in the United States (DOE 2011a). Major compounds of uranium include oxides, fluorides, carbides, nitrates, chlorides, acetates, and others. One of the characteristics of  $UO_2^{+2}$  ions is their ability to fluoresce under ultraviolet light.

Although the element uranium was discovered in 1789 by Klaproth, who named it “uranium” after the newly discovered planet Uranus, it was not until 1896 that Becquerel discovered that uranium is radioactive. There are 22 known isotopes of uranium, only 3 of which occur naturally (NNDC 2011). These three isotopes,  $^{234}U$ ,  $^{235}U$ , and  $^{238}U$ , have relative mass abundances within the earth’s undisturbed crustal rock of 0.005, 0.72, and 99.275%, respectively. One gram of natural uranium having this relative isotopic abundance has an activity of 0.69  $\mu Ci$ . Of this 0.69  $\mu Ci$ , 49.0% of the activity is attributable to  $^{234}U$ , 2.27% of the activity is attributable to  $^{235}U$ , and 48.7% of the activity is attributable to  $^{238}U$  (Agency for Toxic Substances and Disease Registry 2011). This ratio is for undisturbed crustal rock only. Although the relative mass abundance of  $^{234}U$  is only 0.005%, it accounts for approximately one-half of the total activity. The relative isotopic abundances given above can be altered to some extent by natural processes that are not fully understood, but which can cause different ratios in air, water, and soil as demonstrated in EPA reports (EPA 1994a, 2007).

$^{235}U$  is an isotope of particular interest because it is fissile (capable of being fissioned) and, consequently, can sustain a nuclear chain reaction in the presence of appropriate energy neutrons. The predominant isotope of uranium found in nature,  $^{238}U$ , is not readily fissionable, but a small portion of its transformations result in spontaneous fission rather than the typical alpha decay; these neutrons can be sufficient to initiate a chain reaction under appropriate concentration, mass, and neutron thermalization conditions. Consequently, for uranium to be used as a fuel in nuclear reactors, the ratio of  $^{235}U$  to  $^{238}U$  is increased from 0.72 to 2–4% by a process called enrichment. The enrichment process most used in the United States is called gaseous diffusion, but other enrichment processes involving thermal, centrifuge, and laser methods can be used, and other countries are actively involved in producing enriched uranium. Uranium ore is processed to uranium oxide ( $U_3O_8$ ) and then fluorinated to  $UF_6$ ; next, a stream of  $UF_6$  gas containing all three isotopic compounds is passed through a long series of diffusion stages through which the  $^{234}U$  and  $^{235}U$  pass more quickly than the  $^{238}U$ . Thus, the front end of the stream has an enhanced  $^{235}U$  concentration and is called enriched uranium hexafluoride, while the back end of the stream has a reduced

## 4. CHEMICAL, PHYSICAL, AND RADIOLOGICAL INFORMATION

$^{235}\text{U}$  concentration and is called depleted uranium hexafluoride. The percent enrichment is a measure of the mass percentage of  $^{235}\text{U}$  in the final product, and the degree of enrichment is determined by the use. Enriched  $\text{UF}_6$  is typically converted to uranium metal or oxide for power reactor fuel or to metal for weapons applications. Depleted  $\text{UF}_6$  is either converted to uranium metal for a variety of civilian and military applications or stored for future use. Low enriched uranium (2–4% enriched) is used in civilian nuclear power reactors (DOE 2000), while high enriched uranium (>90% enriched) is used in special research reactors (most of which have been removed from operation), nuclear submarine reactor cores, and nuclear weapons. Depleted uranium metal is used as radiation shielding, missile projectiles, target elements in plutonium production reactors, a gyroscope component, and counterweights or stabilizers in aircraft.

Uranium continuously undergoes transformation through the decay process whereby it releases energy to ultimately become a stable or nonradioactive element. For the uranium isotopes, this is a complex process involving the serial production of a chain of decay products, called progeny, until a final stable element is formed. The decay products of the uranium isotopes, which are also radioactive, are shown in Table 4-4.  $^{238}\text{U}$  is the parent isotope of the uranium series ( $^{234}\text{U}$  is a decay product of  $^{238}\text{U}$ ), while  $^{235}\text{U}$  is the parent isotope of the actinium decay series. All natural uranium isotopes and some of their progeny decay by emission of alpha particles; the other members of both series decay by emission of beta particles and gamma rays (NNDC 2011). Both the uranium and the actinium decay series have three features in common. Each series begins with a long-lived parent,  $^{235}\text{U}$  or  $^{238}\text{U}$ , each series contains an isotope of the noble gas radon, and each series ends with a stable isotope of lead,  $^{207}\text{Pb}$  or  $^{206}\text{Pb}$ .

The amount of time required for one-half of the atoms of a radionuclide to transform is called its radioactive half-life. The rate of decay, and thus the half-life, for each radionuclide is unique. The half-life of  $^{238}\text{U}$  is very long,  $4.5 \times 10^9$  years; the half-lives of  $^{235}\text{U}$  and  $^{234}\text{U}$  are orders of magnitude lower,  $7.0 \times 10^8$  and  $2.5 \times 10^5$  years, respectively. Since the activity of a given mass of uranium depends on the mass and half-life of each isotope present, the greater the relative abundance of the more rapidly decaying  $^{234}\text{U}$  and  $^{235}\text{U}$ , the higher the activity will be. Thus, depleted uranium is less radioactive than natural uranium and enriched uranium is more radioactive.

Uranium is unusual among the elements because it is both a chemical and a radioactive material. The hazards associated with uranium are dependent upon uranium's chemical and physical form, route of intake, and level of enrichment. The chemical form of uranium determines its solubility and, thus, transportability in body fluids as well as retention in the body and various organs. Uranium's chemical

## 4. CHEMICAL, PHYSICAL, AND RADIOLOGICAL INFORMATION

toxicity is the principal health concern, because soluble uranium compounds cause heavy metal damage to renal tissue. The radiological hazards of uranium may be a primary concern when inhaled, enriched (DOE 2001) and insoluble uranium compounds are retained long-term in the lungs and associated lymphatics.

## 5. PRODUCTION, IMPORT/EXPORT, USE, AND DISPOSAL

### 5.1 PRODUCTION

No information is available in the TRI database on facilities that manufacture or process uranium, because this chemical is not required to be reported under Section 313 of the Emergency Planning and Community Right-to-Know Act (Title III of the Superfund Amendments and Reauthorization Act of 1986) (EPA 1998a).

Uranium is present in the earth's crust at approximately 3 ppm (2 pCi/g) (Clark et al. 2006; du Preez 1989; WNA 2011). Of the more than 100 uranium ores, the primary (brannerite, carnotite, coffinite, davidite, pitchblende, thucholite, uraninite) and secondary (tobernite, autunite, tyuyamunite) are the main ores of commercial interest. The main ores are described in Table 5-1. The most economically attractive uranium ores have uranium concentrations >1,000 ppm (700 pCi/g) (Clayton and Clayton 1981; Weigel 1983; WNA 2011). In the United States, the major ore deposits are located in Colorado, Utah, Arizona, New Mexico, Wyoming, Nebraska, and Texas (EPA 1985a). The steps necessary to produce uranium for its various uses include mining, milling, conversion to uranium hexafluoride (UF<sub>6</sub>), enrichment, reduction to metal or oxidation to uranium oxide, and fabrication into the desired shape. The steps for preparing commercial reactor grade, submarine reactor grade, or weapons-grade uranium are the same, except the last two require a more aggressive enrichment process. Depleted uranium metal is produced by reducing the depleted uranium hexafluoride byproduct. Conventional fabrication methods are used to configure the uranium for specific uses, such as rectangular solid blocks for helicopter rotor counterbalances and parabolic or cylindrical solids for military depleted uranium projectiles.

**Mining.** Open-pit mining, *in situ* leaching, and underground mining are three techniques that have been used for mining uranium-containing ores (EPA 1985a; WNA 2011). Uranium is found in all soil and rock, but the higher concentrations found in phosphate rock, lignite, and monazite sands are sufficient in some areas for commercial extraction (Lide and Frederikse 1994). The choice of mining method is influenced by factors such as the size, shape, grade, depth, thickness, disaggregation, and permeability of the ore deposits and the proximity to groundwater (Grey 1993; WNA 2011). Historically, open-pit and underground mining have been most commonly used mining methods. However, most uranium in the United States is currently mined through *in situ* leaching, which results in little disturbance to the surface and generates no tailings or waste rock (Grey 1993; EIA 2010b; WNA 2011). *In situ* leaching involves leaching (or dissolving) uranium from the host rock with liquids without removing the rock from the

## 5. PRODUCTION, IMPORT/EXPORT, USE, AND DISPOSAL

**Table 5-1. Uranium Ores**

Ore	Composition	Description
<b>Primary ores</b>		
Uraninite	$UO_2 + UO_3$	A steel-, velvet-, to brownish-black in color; major ore of uranium and radium
Pitchblende	$UO_2 + UO_3$	Essentially the same as uraninite
Brannerite	$U(TiFe)_2O_2$	A black, brownish, olive greenish ore; primary mineral in granite, associated with uraninite
Coffinite	$U(SiO_4)_{1-x}(OH)_{4x}$	A black or pale-to-dark brown mineral in sandstone, associated with uraninite
Davidite	$(CeLa)U(TiFe^{3+})_{20}(O,OH)_{38}$	A black-brownish mineral in granite, associated with ilmenite and others
Thucholite	Mixture of petroleum hydrocarbons, uraninite, and sulfides	Black mixture, acronym stands for thorium, uranium, carbon, and hydrogen
Carnotite	$K_2O \cdot 2U_2O_3 \cdot V_2O_5 \cdot 3 H_2O$ (uranium potassium vanadate)	Bright-, lemon-, or greenish-yellow mineral in sandstone associated with tyuyamunite and U-V oxides
<b>Secondary ores</b>		
Autunite	$Ca (UO_2)_2 (PO_4)_2 \cdot 10 H_2O$	Yellow-to-greenish mineral produced under oxidizing conditions and associated with tormernite
Torbernite	$Cu (UO_2)_2 (PO_4)_2 \cdot 10 H_2O$	An emerald-, grassy-, to apple-green mineral formed in an oxidized zone and associated with uraninite and autunite
Tyuyamunite	$Ca(UO_2)_2 (VO_4)_2 \cdot 5-8 H_2O$ (uranium calcium vanadate)	A canary-, lemon-, to greenish-yellow mineral associated with carnotite

Sources: Amethyst Galleries 1995; Mindat 2011; MSA 2011; Stockinger 1981; Uranium Institute 1996



## 5. PRODUCTION, IMPORT/EXPORT, USE, AND DISPOSAL

ground and can only be carried out on unconsolidated sandstone uranium deposits located below the water table in a confined aquifer. A leaching solution is introduced into or below the deposit and pumped to the surface, where the uranium-pregnant liquor is processed in a conventional mill to precipitate the uranium as yellowcake ( $U_3O_8$  and other oxides) (DOE 1995b; Grey 1993; WNA 2011).

**Milling.** Ore mined in an open-pit or underground mine is crushed and leached in a uranium mill. The initial step in conventional milling involves crushing, grinding, and wet and/or dry classification of the crude ore to produce uniformly sized particles that are similar in size to beach sand (Clark et al. 2006; WNA 2011). A slurry generated in the grinding circuit is transferred to a series of tanks for leaching by either an alkaline or acid process (Clark et al. 2006; WNA 2011). Generally, leaching is a simple process whereby uranyl ions are extracted by a solvent. Uranyl ions are stripped from the extraction solvent and precipitated as yellowcake, predominantly  $U_3O_8$  (Clark et al. 2006; EPA 1995; WNA 2011). Yellowcake is pressed, dried, banded, and shipped for refinement and enrichment. The byproduct of this process is the leftover sand, known as tailings (Clark et al. 2006; WNA 2011). Thus, tailings are the original sand minus much of the uranium plus residual process chemicals. Tailings are less radioactive than the original ore; uranium metal production in a conversion facility is done postenrichment. Generalized flow charts for the alkaline and acid leaching processes for ore concentration and uranium production are shown in Figure 5-1.

**Enrichment.** Next, the  $U_3O_8$  is chemically converted to  $UF_6$ . The enrichment process increases, or enriches, the percentage of the fissionable  $^{235}U$  isotope, as well as  $^{234}U$ . Until recently, the major process used for uranium enrichment in the United States has been gaseous diffusion. The mechanism for enrichment is based on the fact that a  $UF_6$  molecule containing  $^{235}U$  or  $^{234}U$  is lighter and smaller, and has, therefore, a slightly higher thermal velocity than a  $UF_6$  molecule containing  $^{238}U$  (WNA 2011). As the  $UF_6$  passes through the series of diffusion stages, the  $^{234}UF_6$  and  $^{235}UF_6$  molecules gradually become more concentrated downstream and less concentrated upstream, while the  $^{238}UF_6$  concentrates conversely. The lead portion of the stream is collected and recycled to reach the desired enrichment. The tail portion containing a reduced  $^{235}UF_6$  content, called depleted  $UF_6$ , can be stored in the vicinity of the gaseous diffusion plant sites (DOE 1994b). There are an estimated 686,500 metric tons of depleted uranium currently in storage as  $UF_6$  (ANL 2011). A second enrichment technology, gas centrifuge separation, is now replacing gas diffusion in the United States and is expected to be the dominant enrichment process in coming years (WNA 2011). During gas centrifuge enrichment,  $UF_6$  gas is fed into centrifuge cylinders containing rotors that are spun at 50,000–70,000 rpm (WNA 2011). The heavier  $^{238}UF_6$  molecules

5. PRODUCTION, IMPORT/EXPORT, USE, AND DISPOSAL

**Figure 5-1. Uranium Ore Processing**

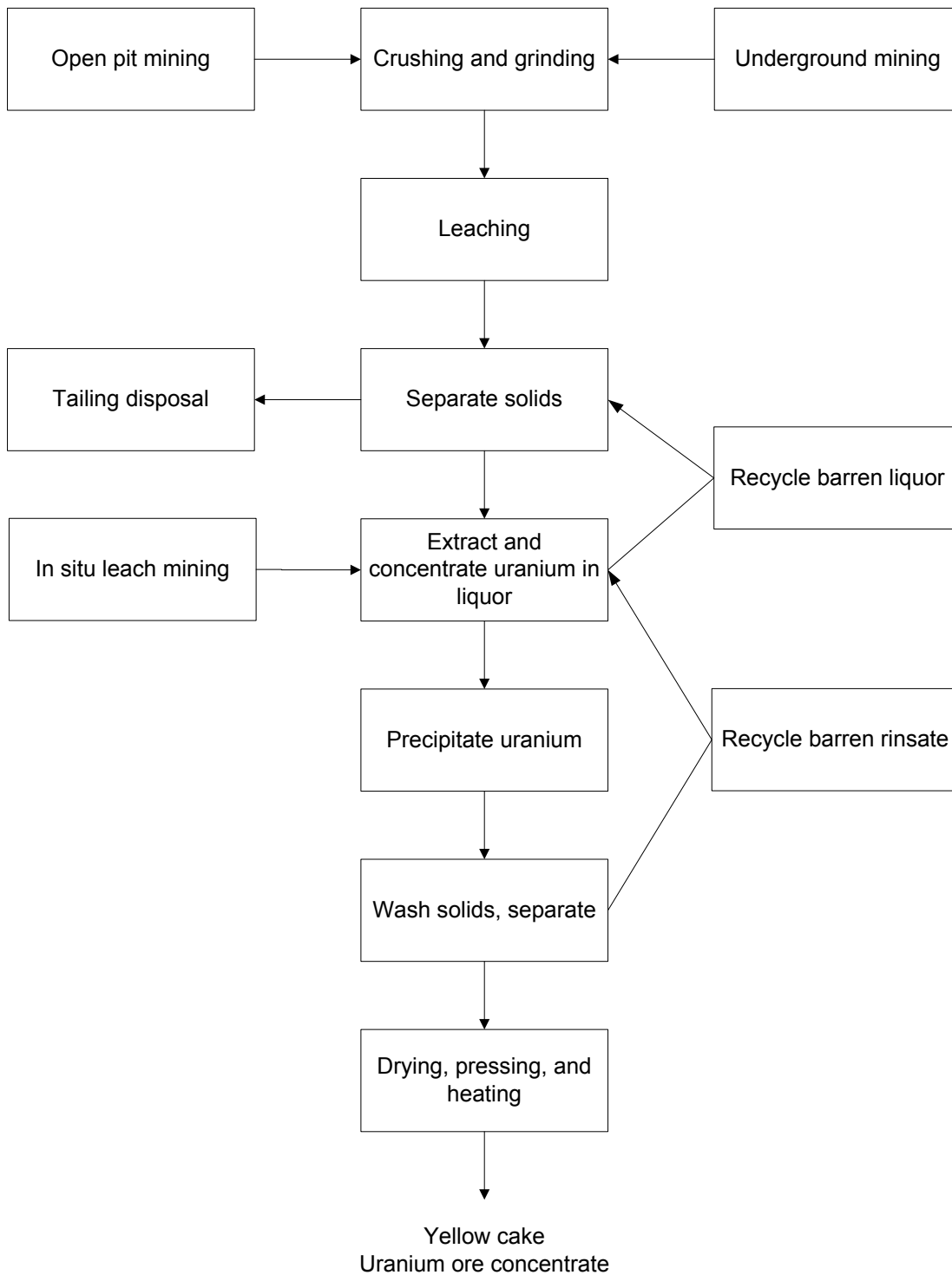

Sources: Agency for Toxic Substances and Disease Registry 1997; Uranium Institute 1996; WNA 2010

## 5. PRODUCTION, IMPORT/EXPORT, USE, AND DISPOSAL

concentrate toward the cylinder's outer edge while the lighter  $^{235}\text{UF}_6$  molecules concentrate toward the center (Clark et al. 2006; WNA 2011). At the same time, a countercurrent circulation flow along the length of the rotor creates a vertical separation of the isotopes as well allowing for them to be drawn off at separate ends (Clark et al. 2006; WNA 2011). The two major advantages of the gas centrifuge are that it is much more efficient in both its energy requirements and its ability to separate the isotopes than gas diffusion enrichment (WNA 2011). A third technology, laser separation, is currently under development (DOE 1995b; WNA 2011). A fourth technology, thermal separation, is inefficient and no longer used.

**Fuel Fabrication.** In most cases, the enriched  $\text{UF}_6$  is oxidized to uranium dioxide and formed into pellets of ceramic uranium dioxide ( $\text{UO}_2$ ). The pellets are then stacked and sealed inside metal tubes that are mounted into special fuel assemblies ready for use in a nuclear reactor (DOE 1995b; Uranium Institute 1996; WNA 2011).

**Product Fabrication.** Uranium metal has commercial and industrial uses due to its great density and strength. It is alloyed with a range of metals to meet other commercial and industrial needs (Clark et al. 2006). As with steel, uranium can be formed and fashioned by drop forging, dye casting, and machining and is often painted to minimize oxidation. Some well-known uses for these products are military armor and armor piercing munitions, helicopter rotor blade counterbalances, weights in airplane control surfaces, and radiation shields for high radioactivity sources (e.g., industrial radiography) (Parkhurst and Guilmette 2009a; WNA 2011).

**Production.** Uranium production from 1975 to 2009 is shown in Table 5-2. Peak production of uranium occurred in 1980 at 21,852 short tons ( $1.98 \times 10^7$  kg) and decreased until 1993. This was the same period when the planning and construction of new nuclear power plants ceased in the United States. Production of  $\text{U}_3\text{O}_8$  had decreased to 4,443 short tons ( $4.03 \times 10^6$  kg) in 1990 and to 1,534 short tons ( $1.39 \times 10^6$  kg) in 1993, a 65% reduction (ABMS 1994; EPA 1985a). In 1996, U.S. uranium production was 3,160 short tons ( $2.87 \times 10^6$  kg), an increase of 5% from the 1995 level and the highest level since 1991 (DOE 1996a). Underground and open-pit mining have been the two most commonly used methods of mining uranium ores. However, by 1994, uranium was produced primarily by *in situ* leaching methods. A summary of U.S. mine production from 1985 through 1996 (see Table 5-3) illustrates the shift from underground and open-pit mining to *in situ* leaching. U.S. uranium production fell to a low of 1,100 short tons in 2003 before climbing back to just over 2,000 short tons by the end of the decade (EIA 2010b).

## 5. PRODUCTION, IMPORT/EXPORT, USE, AND DISPOSAL

**Table 5-2. Uranium Production in the United States by Uranium Mills and Other Sources**

Year	Short tons <sup>a</sup> of U <sub>3</sub> O <sub>8</sub>	Kilograms of U <sub>3</sub> O <sub>8</sub>
1975	11,600	1.05x10 <sup>7</sup>
1976	12,747	1.16x10 <sup>7</sup>
1977	14,939	1.35x10 <sup>7</sup>
1978	18,486	1.68x10 <sup>7</sup>
1979	18,736	1.70x10 <sup>7</sup>
1980	21,852	1.97x10 <sup>7</sup>
1981	19,237	1.74x10 <sup>7</sup>
1982	13,434	1.22x10 <sup>7</sup>
1983	1,0579	9.60x10 <sup>6</sup>
1989	6,919	6.28x10 <sup>6</sup>
1990	4,443	4.03x10 <sup>6</sup>
1991	3,976	3.61x10 <sup>6</sup>
1992	2,823	2.56x10 <sup>6</sup>
1993	1,534	1.39x10 <sup>6</sup>
1994	1,676	1.52x10 <sup>6</sup>
1995	3,022	2.74x10 <sup>6</sup>
1996	3,160	2.87x10 <sup>6</sup>
1997	2,820	2.56x10 <sup>6</sup>
1998	2,550	2.13x10 <sup>6</sup>
1999	2,250	2.04x10 <sup>6</sup>
2000	1,550	1.41x10 <sup>6</sup>
2001	1,300	1.18x10 <sup>6</sup>
2002	1,200	1.09x10 <sup>6</sup>
2003	1,100	9.98x10 <sup>5</sup>
2004	1,250	1.13x10 <sup>6</sup>
2005	1,500	1.36x10 <sup>6</sup>
2006	2,350	2.13x10 <sup>6</sup>
2007	2,250	2.04x10 <sup>6</sup>
2008	1,950	1.77x10 <sup>6</sup>
2009	2,050	1.86x10 <sup>6</sup>

<sup>a</sup>Short ton = 2,000 lbs = 907 kg.

Sources: ABMS 1994; DOE 1996a, 1997b, 1999a; EIA 2010b; EPA 1985a

## 5. PRODUCTION, IMPORT/EXPORT, USE, AND DISPOSAL

**Table 5-3. Uranium Mining Production, 1985–2009<sup>a</sup>**

Mining method	Percentage of total													
	1985	1986	1987	1988	1990	1991	1992	1994	1996	1998	2003	2005	2006	2009
Underground	52.3	77.8	81.7	56.8	W <sup>b</sup>	W	W	0	W	W	W	W	W	W
Open-pit	23.3	W	W	W	32.0	48.8	W	0	0	0	0	0	0	0
<i>In situ</i> leaching	No data	No data	W	W	W	W	W	96.9	93.1	77.8	W	88.0	90.8	W

<sup>a</sup>Does not include uranium sources such as mine water, mill site cleanup, mill tailings, or well field restoration.

<sup>b</sup>Data withheld.

Sources: DOE 1995, 1996a, 1997b, 1999b; EIA 2010b

## 5. PRODUCTION, IMPORT/EXPORT, USE, AND DISPOSAL

Leached uranium concentrate was produced in 1996 in Wyoming, Louisiana, Nebraska, New Mexico, and Texas. At the end of 1996, two phosphate byproduct plants and five *in situ* leaching plants were in operation. In addition, seven phosphate byproduct and *in situ* leaching plants were inactive, and seven conventional uranium mills were being maintained in stand-by mode (DOE 1997b). During 2010, one conventional uranium mill and four uranium *in situ* leach plants were reported to be in operation in the United States (EIA 2010b).

## 5.2 IMPORT/EXPORT

The importation of uranium increased significantly in the 1980s (EPA 1985a). In 1983, 3,960 short tons of  $U_3O_8$  equivalent were imported into the United States (USDOC 1984), which was about 37% of the domestic production. In 1987, the amount of  $U_3O_8$  equivalent imported into the United States was 5,630 short tons (USDOC 1988). The amounts of uranium and uranium compounds imported into the United States during the period 1989–1997 are presented in Table 5-4 (USDOC 1995, 1997). The importation of uranium and uranium compounds peaked in 1990 at about 23 million kg (about 1 million tons) and has remained approximately the same, with some fluctuation, since that time. Actual uranium import values for more recent years have not been located; however, amounts of foreign-origin uranium purchased by U.S. suppliers and owners and operators of U.S. Civilian Nuclear Power Reactors are available (EIA 2010a). These data (located in Table 5-6) suggest uranium imports have remained steady over the previous two decades. Close to 27 million kg of foreign-origin uranium were purchased in 2009. Imports may be reduced as DOE sells part of its excess uranium inventory (DOE 2008).

The amount of uranium and uranium compounds exported from the United States during 1989–1993 is shown in Table 5-5. The total volume of uranium and uranium compounds exported during 1989–1993 was 2 orders of magnitude lower than the quantities imported during this same time period. Exports in 1996 were 5.2 million kg. Most of the foreign sales (Canada, France, Germany, Japan, South Korea, United Kingdom) occurred after the uranium entered the U.S. market as imports (DOE 1999b). Amounts of uranium sold to firms located outside the United States (Table 5-6) suggest exports have remained steady since the mid 1990s (EIA 2010a). Approximately 10 million kg of uranium were sold in 2009.

## 5.3 USE

Uranium has been produced for use in the commercial nuclear power industry as low-enriched metal or ceramic  $UO_2$  fuel pellets; smaller quantities of high-enriched fuel are produced for U.S. Navy ships and for weapons manufacture (Clayton and Clayton 1981; EPA 1985b; Peehs et al. 2007; WNA 2011).

## 5. PRODUCTION, IMPORT/EXPORT, USE, AND DISPOSAL

**Table 5-4. Import of Uranium and Compounds (in kg) into the United States (1990–1998)<sup>a</sup>**

Substance	Year								
	1990	1991	1992	1993	1994	1995	1996	1997	1998
U-metal (depleted)	18,343	9,673	9,008	4,458	1,735	792	1,572	36,359	508
U-alloys, dispersions, and ceramic materials	5	2,444	9	25	No data	No data	309,681	10	2
U-oxide (natural)	8,459,924	12,630,433	10,043,472	7,925,762	9,713,406	8,992,532	8,880,669	9,259,002	No data
U-oxide (enriched)	204,592	200,733	63,875	35,779	14,214	97,976	57,241	158,082	36,121
U-oxide (depleted)	886,853	19,410	608,472	495	0	0	11,253	0	0
U-fluoride (natural)	9,432,470	8,109,402	5,844,985	10,827,786	9,583,669	11,140,026	10,936,114	12,210,369	12,965,093
U-fluoride (enriched)	598,763	874,251	875,831	868,652	1,000,950	934,046	1,024,148	858,807	1,252,438
U-fluoride (depleted)	479,601	4,523	125,466	0	0	58,000	0	0	147,691
U-compounds (not otherwise stated)	42,277	191,221	847,425	1,275,137	121,439	86,935	324	446,812	253,211
U-compounds (enriched)	159,220	28,950	6	6	69,063	0	6,800	29,682	No data
U-compounds (depleted)	4,731	294	1,666	107	0	122	245	100	248
Ores and concentrates	2,763,185	1,344,927	0	0	No data	No data	0	212,434	0
Mixture (depleted)	0	0	0	4,431	No data	No data	No data	No data	No data
Spent fuel	16,401	5,033	0	115	45	0	23	306	No data

<sup>a</sup>Import data for more recent years were not located. See Table 5-6 for amounts of uranium sold to firms located outside the United States in recent years.

Sources: USDOC 1995, 1997, 1999

## 5. PRODUCTION, IMPORT/EXPORT, USE, AND DISPOSAL

**Table 5-5. Export of Uranium and Compounds (in kg) (1990–1998)<sup>a</sup>**

Substance	Year									
	1989	1990	1991	1992	1993	1994	1995	1996	1997	1998
U-oxide (natural)	6,302	318	0	96,748	6,196	690,449	351,169	192,296	250,443	0
U-oxide (enriched)	0	0	85	26,596	64	418,873	299,175	323,990	903,810	646,984
U-fluoride (natural)	85	0	20,175	186,530	4,231	No data	No data	0	688,873	53,800
U-fluoride (enriched)	15,698	39,262	0	175,445	90,459	No data	No data	No data	No data	No data
U-compounds (not otherwise stated)	0	9,801	12,596	8,019	0	No data	No data	No data	No data	No data
U-compounds (enriched)	28,221	0	6,609	3	0	0	66,893	418,447	10,506	99,456
U-compounds (depleted)	0	90	160	0	0	246,765	379,530	406,079	30,426	41,674
U-metal	No data	No data	No data	No data	No data	270	496	299,117	3,159	0
U-ores and concentrates	No data	No data	No data	No data	No data	59,461	0	0	0	0
Alloys, dispersions, ceramics <sup>b</sup>	No data	No data	No data	No data	No data	74,712	45,424	29,759	152,920	0
Spent fuel	0	21,576	0	0	0	No data	No data	No data	No data	No data

<sup>a</sup>Export data for more recent years were not located. See Table 5-6 for amounts of uranium purchased from firms located outside the United States in recent years.

<sup>b</sup>Alloys, dispersions (including cermets), ceramic products, and mixtures containing natural uranium compounds, Nesoi (SIC2819).

Sources: USDOC 1995, 1999



## 5. PRODUCTION, IMPORT/EXPORT, USE, AND DISPOSAL

**Table 5-6. Foreign Purchases and Foreign Sales of Uranium (kg U<sub>3</sub>O<sub>8</sub> Equivalent) by U.S. Suppliers and Owners and Operators of U.S. Civilian Nuclear Power Reactors, 1994–2009**

Year	Foreign purchases <sup>a</sup>	Foreign sales <sup>b</sup>
1994	1.66x10 <sup>7</sup>	8.03x10 <sup>6</sup>
1995	1.87x10 <sup>7</sup>	4.44x10 <sup>6</sup>
1996	2.06x10 <sup>7</sup>	5.22x10 <sup>6</sup>
1997	1.95x10 <sup>7</sup>	7.71x10 <sup>6</sup>
1998	1.98x10 <sup>7</sup>	6.85x10 <sup>6</sup>
1999	2.16x10 <sup>7</sup>	3.85x10 <sup>6</sup>
2000	2.04x10 <sup>7</sup>	6.17x10 <sup>6</sup>
2001	2.12x10 <sup>7</sup>	5.31x10 <sup>6</sup>
2002	2.39x10 <sup>7</sup>	6.98x10 <sup>6</sup>
2003	2.40x10 <sup>7</sup>	5.99x10 <sup>6</sup>
2004	3.00x10 <sup>7</sup>	5.99x10 <sup>6</sup>
2005	2.97x10 <sup>7</sup>	9.30x10 <sup>6</sup>
2006	2.94x10 <sup>7</sup>	8.48x10 <sup>6</sup>
2007	2.45x10 <sup>7</sup>	6.71x10 <sup>6</sup>
2008	2.59x10 <sup>7</sup>	7.80x10 <sup>6</sup>
2009	2.67x10 <sup>7</sup>	1.07x10 <sup>7</sup>

<sup>a</sup>Purchases of foreign origin uranium from a firm located outside the United States.

<sup>b</sup>Sales of uranium to a firm located outside the United States.

Sources: EIA 2010a

## 5. PRODUCTION, IMPORT/EXPORT, USE, AND DISPOSAL

Uranium fuel lasts months to years before refueling is needed, and then only a small fraction of the uranium has actually been fissioned, making fuel reprocessing an option used in other countries (WNA 2011). One pound of completely fissioned uranium produces the same amount of energy as 1,500 tons of coal (Lide and Frederikse 1994). Depleted uranium is used in the manufacture of armor-piercing ammunition for the military, in inertial guidance devices and gyro compasses, as counterbalances for helicopter rotors, as counterweights for aircraft control surfaces, as radiation shielding material, and as x-ray targets (EPA 1985b; Parkhurst and Guilmette 2009a; Peehs et al. 2007; WNA 2011). In the past, uranium salts have been used to produce colored ceramics and glasses (Clark et al. 2006). Additionally, uranium was used in dental porcelains for many years, but this practice has been discontinued (FDA 1976; WNA 2011).

#### 5.4 DISPOSAL

Radioactive waste containing uranium is usually grouped into three categories: uranium mill tailings, low-level waste, and, in the case of spent reactor fuel, high-level waste (USNRC 2002, 2007).

Uranium mill tailings are the residual sand and trace chemicals from the processing of uranium ore. About 150 tons of enriched uranium are required per year to fuel a 1,000-megawatt electric nuclear power reactor, and about 500 times that amount of ore is required to obtain the uranium. The total accumulation of uranium in licensed mill tailings piles in the United States is approximately 200 million tons (EPA 2011z; Murray 1994). Tailings from mines and mills that process other metals might also be expected to contain elevated concentrations of uranium and its progeny (El-Didamony et al. 2013; EPA 2013b; Morrison et al. 1988; Radford and Renard 1984; Vidic et al. 2011; Xuan et al. 1993), although this may not be readily recognized.

Disposal methods for processed uranium tailings have been discussed by Bearman (1979). In the late 1940s, mainly unconfined disposal systems were used. Untreated solid wastes were stored as open piles and, in some cases, were spread in urban areas where they were used as fill and as the sand in concrete used to build roads, walks, drives, and concrete block, and in brick mortar. As a result of the Animas River Survey in the United States, tailing control programs were instituted in 1959 to prevent airborne and waterborne dispersal of the wastes. Confined disposal methods were devised to reduce the exposure and dispersion of wastes and to reduce seepage of toxic materials into groundwater to the maximum extent reasonably achievable. Under the Uranium Mill Tailings Radiation Control Act (UMTRCA) of 1978, the U.S. Department of Energy (DOE) designated 24 inactive tailings piles for cleanup. These

## 5. PRODUCTION, IMPORT/EXPORT, USE, AND DISPOSAL

24 sites contained a total of about 28 million tons of tailings and covered a total of approximately 1,000 acres (EPA 1985b). Two of the sites have been withdrawn from the list and others have combined tailings piles, reducing the number of sites to 19 (USNRC 2006). According to a report by the USNRC (2006), cleanup has been completed at all but two of these locations.

In 1977, the EPA issued Environmental Radiation Protection Standards to limit the total individual radiation dose due to emissions from uranium fuel cycle facilities, including licensed uranium mills. This standard specified that the “annual dose equivalent does not exceed 25 millirem (0.25 mSv) to the whole body, 75 millirem (0.75 mSv) to the thyroid, and 25 millirem (0.25 mSv) to any other organ of any member of the public as the result of exposures of planned discharges of radioactive materials “to the general environment” (40 CFR 190). The EPA also established environmental standards for cleanup of open lands and buildings contaminated with residual radioactivity from inactive uranium processing sites (40 CFR 192).

Low-level radioactive waste (LLRW), which may contain uranium, is disposed of at DOE facilities and at commercial disposal facilities (USNRC 2002, 2007). Since 1963, seven commercial LLRW facilities have operated, but only three are currently receiving waste for disposal (USNRC 2007). A 1992 report listed the total volume of LLRW buried at six of the sites to be approximately 50 million cubic feet (Murray 1994). The current total amount of LLRW stored at the seven LLRW facilities was not located; however, the yearly total amount stored at the three operating locations was reported to be 4.01, 4.05, 2.63, and 2.09 million cubic feet in 2005, 2006, 2007, and 2008, respectively (USNRC 2011). Only a small fraction of the LLRW contains uranium. The method of disposal for commercial and DOE LLRW has been shallow land burial, in which the waste is disposed of in large trenches and covered. This method of disposal relies upon natural features to isolate the waste. Although USNRC regulations for LLRW disposal (10 CFR 61) permit shallow land burial, many states have enacted more stringent regulations that require artificial containment of the waste in addition to natural containment (Murray 1994; USNRC 2002, 2007).

High-level radioactive waste (HLRW) includes spent fuel, which is the uranium fuel rods that have been used in a nuclear reactor (USNRC 2007). When the fuel rods are removed from the reactor for refueling, they still contain most of the original unfissioned uranium. However, the hazard from the large activity of fission products and plutonium that have been produced in the fuel rods overshadows that of uranium. Approximately 47,000 metric tons of spent fuel have been removed from U.S. power reactors through 2002 (EIA 2010d). There is currently no permanent disposal facility for HLRW in the United States;

## 5. PRODUCTION, IMPORT/EXPORT, USE, AND DISPOSAL

these wastes are being stored at commercial nuclear power plants and DOE facilities where they were produced (EIA 2010d). The USNRC has issued standards for the disposal of HLRW (10 CFR 60), and the DOE is pursuing the establishment of an HLRW facility. Efforts to establish an HLRW facility, which began over 2 decades ago, have experienced many significant delays. DOE constructed the proposed U.S. HRLW facility in Yucca Mountain, Nevada contiguous to the Nevada Test Site, and EPA published the public health and environmental radiation standards for Yucca Mountain (EPA 2008).

## 6. POTENTIAL FOR HUMAN EXPOSURE

### 6.1 OVERVIEW

Uranium has been identified in at least 67 of the 1,699 hazardous waste sites that have been proposed for inclusion on the EPA National Priorities List (NPL) (HazDat 2007). However, the number of sites evaluated for uranium is not known. The frequency of these sites can be seen in Figure 6-1.

Uranium is a naturally occurring radioactive element that is present in nearly all rocks and soils; it has an average concentration in U.S. soils of about 2 pCi/g (3 ppm) (du Preez 1989; NCRP 1984a). Some parts of the United States, particularly the western portion, exhibit higher than average uranium levels due to natural geological formations. Most uranium ores contain between 0.05 and 0.2% uranium, up to 1,000 times the levels normally found in soil (Uranium Institute 1996).

Uranium can undergo oxidation-reduction reactions in the environment or microbial reactions to form complexes with organic matter (Premuzic et al. 1995). The only mechanism for decreasing the radioactivity of uranium is radioactive decay. Since all three of the naturally occurring uranium isotopes have very long half-lives ( $^{234}\text{U}$ ,  $2.4 \times 10^5$ ;  $^{235}\text{U}$ ,  $7.0 \times 10^8$ ; and  $^{238}\text{U}$ ,  $4.5 \times 10^9$  years), the rate at which the radioactivity diminishes is very slow (Clark et al. 2006; NCRP 1984a; Peehs et al. 2007). Therefore, the activity of uranium remains essentially unchanged over periods of thousands of years.

Uranium may be redistributed in the environment by both anthropogenic and natural processes. The three primary industrial processes that cause this redistribution are operations associated with the nuclear fuel cycle that include the mining, milling, and processing of uranium ores or uranium end products; the production of phosphate fertilizers for which the phosphorus is extracted from phosphate rocks containing uranium; and the improper disposal of uranium mine tailings (DOE 1981c; Hart et al. 1986; NCRP 1984a; Yang and Edwards 1984; USGS 2008, 2009, 2010c). Essentially no uranium is released from nuclear power plants because of the fuel assembly design and the chemical and physical nature of the uranium oxide fuel. Examples of uranium redistribution by natural processes include activities and processes that move soil and rock, such as resuspension of soils containing uranium through wind and water erosion, volcanic eruptions (Kuroda et al. 1984; USGS 2010a, 2010b, 2010c), operation of coal-burning power plants (coal containing significant quantities of uranium), and construction of roads and dams.

Uranium becomes airborne due to direct releases into the air from these processes. Deposition of atmospheric uranium may occur by wet (rain, sleet, or snow) or dry (gravitation or wind turbulence)

6. POTENTIAL FOR HUMAN EXPOSURE

Figure 6-1. Frequency of NPL Sites with Uranium Contamination

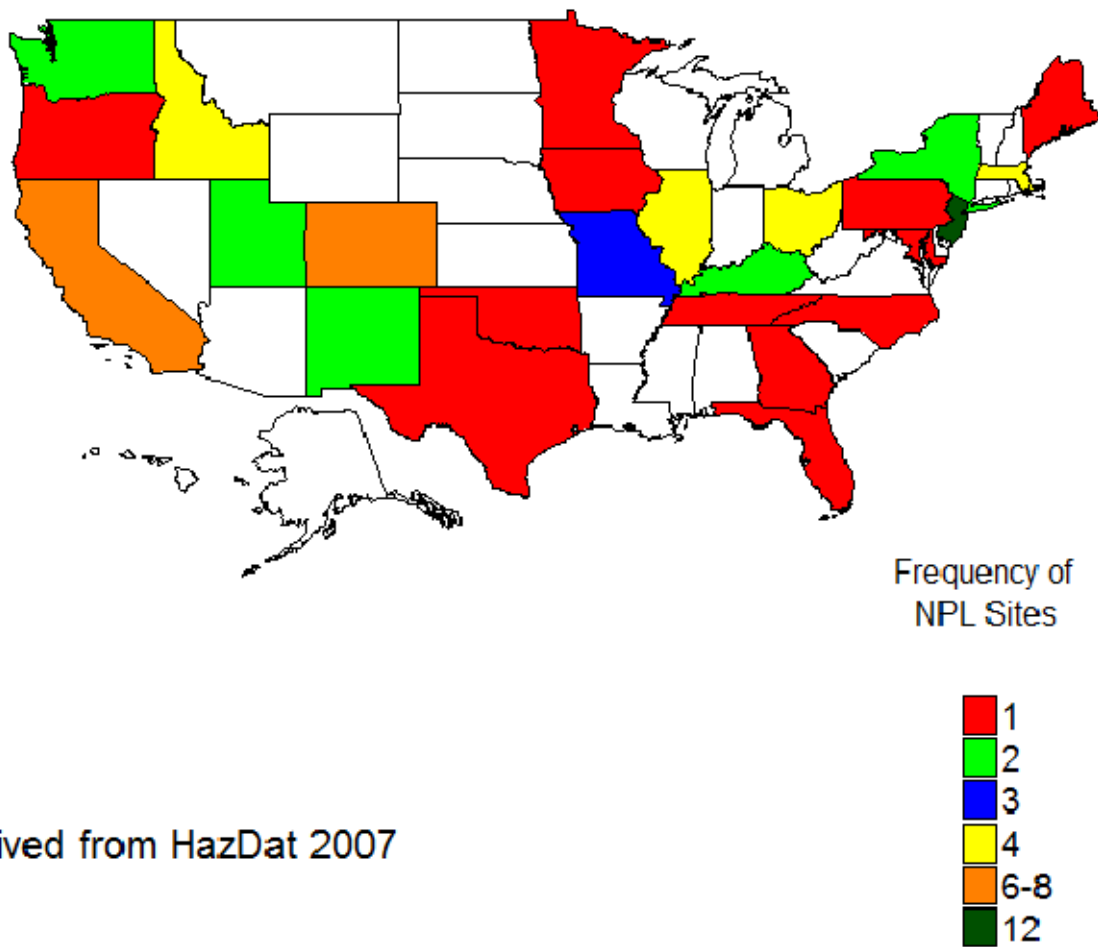

Derived from HazDat 2007

## 6. POTENTIAL FOR HUMAN EXPOSURE

processes. The rate of uranium deposition is dependent upon such factors as particle size, particle density, particle concentration, wind turbulence, and chemical form. Data are lacking on residence times of particulate uranium in the atmosphere, although UNSCEAR (1988) assumed that it behaves like atmospheric dust, for which meteorological models exist.

Uranium deposited by wet precipitation or dry deposition will be deposited on land or in surface waters. If land deposition occurs, the uranium can be reincorporated into soil, resuspended in the atmosphere (typically factors are around  $10^{-6}$ ), washed from the land into surface water, incorporated into groundwater, or deposited on or adsorbed onto plant roots (little or none enters the plant through leaves or roots). Conditions that increase the rate of formation of soluble complexes and decrease the rate of sorption of labile uranium in soil and sediment enhance the mobility of uranium. Significant reactions of uranium in soil are formation of complexes with anions and ligands (e.g.,  $\text{CO}_3^{-2}$ ,  $\text{OH}^{-1}$ ) or humic acid, and reduction of  $\text{U}^{+6}$  to  $\text{U}^{+4}$ . Other factors that control the mobility of uranium in soil are the oxidation-reduction potential, the pH, and the sorbing characteristics of the sediments and soils (Allard et al. 1979, 1982; Brunskill and Wilkinson 1987; Herczeg et al. 1988; Premuzic et al. 1995; USGS 2008).

Uranium in surface water can disperse over large distances to ponds, rivers, and oceans. The transport and dispersion of uranium in surface water and groundwater are affected by adsorption and desorption of uranium on aquatic sediments. As with soil, factors that control mobility of uranium in water include oxidation-reduction potential, pH, and sorbing characteristics of sediments and the suspended solids in the water (Brunskill and Wilkinson 1987; Swanson 1985; USGS 2008). In one study of a stream with low concentrations of inorganics, low pH, and high concentrations of dissolved organic matter, the concentration of uranium in sediments and suspended solids was several orders of magnitude higher than in the surrounding water because the uranium was adsorbed onto the surface of the sediments and suspended particles (Brunskill and Wilkinson 1987).

The levels of uranium in aquatic organisms decline with each successive trophic level because of very low assimilation efficiencies in higher trophic animals. Bioconcentration factors measured in fish were low (Mahon 1982; Poston 1982; Waite et al. 1988) and were thought to arise from the extraction of uranium from the water or simply from the accumulation of uranium on gill surfaces (Ahsanullah and Williams 1989). In plants, uptake of uranium may be restricted to the root system and may actually represent adsorption to the outer root membrane rather than incorporation into the interior of the root system (Sheppard et al. 1983). Most of this uranium may be removed by washing the vegetable surfaces; cutting away the outer membrane will essentially result in complete removal. No significant translocation

## 6. POTENTIAL FOR HUMAN EXPOSURE

of uranium from soil to the aboveground parts of plants has been observed (Van Netten and Morley 1983).

The EPA has established a nationwide network called RadNet (formerly ERAMS) for obtaining data concerning radionuclides, including natural uranium isotopes, in environmental media. Sampling locations for RadNet were selected to provide optimal population coverage (i.e., located near population centers). Airborne uranium concentrations and precipitation levels of uranium were quite low, in the attocurie/m<sup>3</sup> (10<sup>-3</sup> nanoBq/m<sup>3</sup>) and 0.006–0.098 picocurie/L (0.0002–0.004 Bq/L/m<sup>3</sup>) ranges, respectively (EPA 1994a). However, both air and water samples taken near facilities producing uranium ore or processing uranium were found to be higher, in the pCi/L range (EPA 1979a; Lapham et al. 1989; Laul 1994; NCRP 1984a; Tracy and Meyerhof 1987). The RadNet reports document <sup>234</sup>U to <sup>238</sup>U concentration ratios in drinking water that deviate from the equilibrium value of unity found in undisturbed crustal rock. Theories proposed to account for this natural phenomenon involve water contact with soil and permeable rock containing uranium. The <sup>238</sup>U atoms transform through <sup>234</sup>Th to <sup>234</sup>U, and any process that removes either of these radionuclides from the solid changes the <sup>234</sup>U to <sup>238</sup>U ratio. <sup>238</sup>U atoms at the solid-liquid interface that emit decay alpha particles inward may experience a kinetic energy recoil sufficient to either tear the <sup>234</sup>Th progeny from the solid or fracture the surficial solid layer, making the <sup>234</sup>Th more accessible for the enhanced dissolution that thorium typically experiences relative to uranium in mineral matrices. Either process can enhance the relative <sup>234</sup>U content of the liquid. Should that liquid stabilize in another location and evaporate, the localized solids could show an enhanced <sup>234</sup>U ratio.

A large drinking water study was performed in which data from the National Uranium Resource Evaluation (NURE) program plus data prepared for the EPA (DOE 1981b; USGS 2006) were compiled for a total of over 90,000 water samples. Domestic water supplies were represented by 28,000 samples and averaged 1.7 pCi/L (2.5 µg/L) uranium, with a population weighted mean value for finished waters, based on 100 measurements, of 0.8 pCi/L (1.2 µg/L). Other studies show the population-weighted average concentration of uranium in U.S. community drinking water to range from 0.3 to 2.0 pCi/L (0.4–3.0 µg/L) (Ohanian 1989), while concentrations of uranium from selected drinking water supplies analyzed by EPA laboratories were generally <1 pCi/L (1.5 µg/L) (EPA 1985c, 1997b, 2005a, 2010b).

The uranium content of food has been studied extensively; human daily intake has been estimated to range from 0.6 to 1.0 (0.9–1.5 µg/day) pCi/day of natural uranium. Uranium is adsorbed onto the roots of plants; thus, unwashed potatoes, radishes, and other root vegetables that retain their surface membrane are



## 6. POTENTIAL FOR HUMAN EXPOSURE

a primary source of uranium in the diet. Based on consumption rates, potatoes constitute the highest dietary intake of uranium (EPA 1985c). One study showed that the concentration of uranium in plant roots was proportional to the uranium concentration in the soil (NCRP 1984a), while a second study did not support a linear relationship (Mortvedt 1994).

Estimates of uranium intake for drinking water vary widely, but the mean is approximately 0.8 pCi/L uranium. Drinking water intake is in the range of 0.6–1.0 pCi/day (0.9–1.5 µg/day). Uranium intake from food and water sources is approximately equal (EPA 1991b). Compared with food and drinking water, intake of uranium by the inhalation route is small, with values reported at 0.007 pCi/day (0.010 µg/day) (Cothorn 1987) and 0.0007 pCi/day (0.0010 µg/day) (UNSCEAR 1988).

Higher rates of uranium intake have been reported for some populations. The potential for uranium intake is greater for individuals who consume foods grown in areas with elevated concentrations of uranium in the soil, and for individuals with elevated concentrations of uranium in their drinking water (EPA 1985c; NCRP 1984a). Workers engaged in the extraction and processing of uranium are occupationally exposed to uranium. Industries where uranium exposure are known to have occurred are uranium mining and milling, uranium conversion and enrichment, uranium fuel fabrication, and uranium weapons production (BEIR IV 1988; Miller 1977; NCRP 1984a; West et al. 1979). Other groups with the potential for exposure due to technologically enhanced natural background radioactivity include populations involved in producing and using phosphate fertilizers, and individuals living and working near fossil fuel plants (Jaworowski and Grzybowska 1977; NCRP 1984a; Tadmor 1986; Weissman et al. 1983).

## 6.2 RELEASES TO THE ENVIRONMENT

The Toxics Release Inventory (TRI) data should be used with caution because only certain types of facilities are required to report (EPA 2005b). This is not an exhaustive list. Manufacturing and processing facilities are required to report information to the TRI only if they employ 10 or more full-time employees; if their facility is included in Standard Industrial Classification (SIC) Codes 10 (except 1011, 1081, and 1094), 12 (except 1241), 20–39, 4911 (limited to facilities that combust coal and/or oil for the purpose of generating electricity for distribution in commerce), 4931 (limited to facilities that combust coal and/or oil for the purpose of generating electricity for distribution in commerce), 4939 (limited to facilities that combust coal and/or oil for the purpose of generating electricity for distribution in commerce), 4953 (limited to facilities regulated under RCRA Subtitle C, 42 U.S.C. section 6921 et seq.),

## 6. POTENTIAL FOR HUMAN EXPOSURE

5169, 5171, and 7389 (limited S.C. section 6921 et seq.), 5169, 5171, and 7389 (limited to facilities primarily engaged in solvents recovery services on a contract or fee basis); and if their facility produces, imports, or processes  $\geq 25,000$  pounds of any TRI chemical or otherwise uses  $>10,000$  pounds of a TRI chemical in a calendar year (EPA 2005b).

Throughout this chapter, the units used to express concentration or intake of uranium are the same units reported by the authors, and are sometimes followed by converted units obtained using a conversion factor based on the information provided about the isotopic mixture. In some cases, values are expressed in mass units, while in other cases, values are expressed as activities. In the case of natural uranium with a fixed abundance of the three isotopes in crustal rock, conversion from one unit to the other is possible using the conversion factor of 1  $\mu\text{g}$  uranium being equivalent to an activity of 0.685 pCi based on half-life, abundance, and atomic mass data from the National Nuclear Data Center (NNDC 2011). Likewise, 1 ppm is equivalent to 1  $\mu\text{g/g}$  and, therefore, to 0.69 pCi/g for natural uranium. Other conversion values have been used, such as 1  $\mu\text{g}$  of uranium being equivalent to 0.68 pCi (EPA 1991b), 0.72 pCi (EPA 1985b) and 0.67 pCi (NCRP 1984a). These different values are largely accounted for by the periodic refinement of values for uranium isotopic half-lives, atomic masses, and relative percentages in crustal rock.

### 6.2.1 Air

There is no information on releases of uranium to the atmosphere from manufacturing and processing facilities because these releases are not required to be reported (EPA 1998a).

Uranium is introduced into the atmosphere primarily by resuspension of soil, but also by the intentional or accidental release of uranium from mining and milling activities, by uranium processing facilities, or by burning coal.

Natural processes that involve the weathering of crustal rock and soil can change the crustal ratio of uranium isotopes. In some cases, human activities have also altered the normal crustal distribution of naturally occurring radioactive materials, resulting in what has been termed technologically enhanced naturally-occurring radioactive material (TNORM) (NCRP 1984a). No new radioactivity is produced by the enhancement, but uranium, its isotopes, and its progeny are redistributed in such a way that real exposure or the potential for human exposure may increase. A major localized source of enhanced natural uranium can result from mining and milling operations (Table 6-1).

## 6. POTENTIAL FOR HUMAN EXPOSURE

**Table 6-1. Normalized Uranium Effluent Discharges from Uranium Mining, Milling, Conversion, Enrichment, and Fuel Fabrication**

Uranium-238 <sup>a</sup>	Curies per GWy(e) <sup>b</sup>
Atmospheric releases	
Mining	—
Milling	$1.8 \times 10^{-2}$
Mill tailings	$1.9 \times 10^{-5}$
Conversion	$2.0 \times 10^{-3}$
Enrichment	$9.9 \times 10^{-4}$
Fabrication	$2.0 \times 10^{-5}$
Liquid releases	
Conversion	$2.2 \times 10^{-2}$
Enrichment	$9.9 \times 10^{-3}$
Fabrication	$9.9 \times 10^{-3}$

<sup>a</sup>In equilibrium with progeny through U-234.

<sup>b</sup>GWy(e) = gigawatts ( $10^9$  watts) of electricity generated for 1 year.

Source: UNSCEAR 1982

## 6. POTENTIAL FOR HUMAN EXPOSURE

Uranium ore with concentrations of uranium up to 1,000 times the average concentration normally found in soil (NCRP 1984a) is removed from its natural location during open-pit, *in-situ* leach, or underground mining operations. The primary sources of airborne releases from these sources are from the actual mining, from ore crushing and grinding, from high-temperature processes such as calcining or sintering, and from yellowcake drying and packaging at the mill. Ore stockpiles can also be a source of airborne emissions (NCRP 1993).

Production in the front end of the nuclear fuel cycle (uranium mining and milling) has undergone a significant reduction since its peak in the early 1980s (ABMS 1994; EPA 1985a). Mining and milling activities represent a source of minimal uranium release. Uranium is mined using *in situ* leaching methods and uranium is recovered as a byproduct of the processing of phosphate ore (DOE 1995). In 2010, one conventional uranium mill, which recovers uranium from ores mined from the ground, and four uranium *in situ* leach plants were in operation in the United States (EIA 2010).

As part of the nuclear fuel cycle, uranium conversion (EPA 1980b), uranium enrichment (MMES 1985), and fuel fabrication facilities also release small amounts of uranium to the atmosphere (Table 6-1). Uranium is converted to uranium hexafluoride ( $UF_6$ ) prior to enrichment. There is the potential for release of some  $UF_6$  to the atmosphere during the conversion process or from storage of the depleted  $UF_6$ . Upon release to the atmosphere, gaseous  $UF_6$  is rapidly hydrolyzed to  $UO_2F_2$  (particulate) and hydrofluoric acid (gas) (Bostick et al. 1985). Uranium is enriched in the United States by the gaseous diffusion process and ultracentrifugation, which produce appropriate enrichments for use in both commercial and government-operated facilities. A large amount of depleted uranium is the byproduct of the enrichment process; the depleted uranium is kept in storage for further potential use (DOE 1994b) or used in commercial or military applications. In one study, concentrations of uranium in the air near a uranium refinery (crude U refined to highly pure  $UO_3$ ) were found to be 200 times higher than background concentrations, which are typically low (Tracy and Meyerhof 1987).

There are numerous locations where uranium has been released to the environment from the mining, milling, and processing of ore, or from the use of uranium metal for defense purposes. These include DOE sites associated with nuclear weapons production, USNRC sites associated with uranium recovery and the nuclear fuel cycle, and Department of Defense (DOD) sites where enriched uranium nuclear and depleted uranium non-nuclear weapons have been tested or used in training (Agency for Toxic Substances and Disease Registry 2008; NNSA 2006). Regulations are in place to guide protection efforts under the Formerly Utilized Sites Remedial Action Program (FUSRAP), Uranium Mill Tailings Radiation Control

## 6. POTENTIAL FOR HUMAN EXPOSURE

Act of 1978 (UMTRCA), and Title 10 of the Code of Federal Regulations. The DOE FUSRAP sites include 87 Legacy Management (LM) sites in 29 states and territories that have been remediated and under DOE surveillance or are associated with current uranium mining (DOE 2011c), and 24 sites being evaluated and decommissioned by the U.S. Army Corps of Engineers (ACE 2013; DOE 2013). USNRC currently regulates 16 uranium recovery facilities (<http://www.nrc.gov/reading-rm/doc-collections/fact-sheets/mill-tailings.html>), as well as 24 uranium recovery sites (in Washington, Wyoming, Utah, Colorado, New Mexico, Oklahoma, and Texas (<http://www.nrc.gov/info-finder/decommissioning/uranium/>) and 2 fuel cycle facilities (in Tennessee and Illinois, <http://www.nrc.gov/info-finder/decommissioning/fuel-cycle/>) undergoing decommissioning.

Another method by which uranium may be introduced into the atmosphere is the natural process of erosion and wind activity (USGS 2010b, 2010c). In geographic areas that contain higher levels of uranium in the rocks and soil, such as the western United States, additional natural uranium is introduced into the air. Wind erosion of tailings at uranium mining and milling activities will also result in the resuspension of uranium and uranium progeny (e.g., radium-226 and radon-222) (Bigu et al. 1984; Hans et al. 1979; USGS 2010b, 2010c). Approximately 5–10% of the uranium initially present ends up in the mill tailing (Uranium Institute 1996).

Volcanic eruption is another natural phenomenon that may increase the concentration of natural uranium in the air (USGS 2010a). After the eruption of Mount St. Helens, increased levels of  $^{238}\text{U}$  were observed in rainwater at Fayetteville, Arkansas, due to precipitation of  $^{238}\text{U}$  from the atmosphere (Essien et al. 1985; Kuroda et al. 1984). Other studies indicated that long-lived natural radionuclide ( $^{232}\text{Th}$ ,  $^{226}\text{Ra}$ , and  $^{40}\text{K}$ ) content in the ash was comparable to that of crustal material (Fruchter et al. 1980).

Uranium releases occur as a result of phosphate mining for production of phosphorous, which is used in phosphoric acid and phosphate fertilizers (NCRP 1984a). Phosphate rock from Florida, Texas, and southeastern Idaho contains as much as 120 ppm (80 pCi/g) uranium, a concentration sufficiently high to be considered as a commercial source of uranium (NCRP 1975).

Coal also contains variable amounts of uranium and other elements such as sulfur. The amount discharged to the atmosphere depends on the concentration in the coal, the amount burned, the method of combustion, the plant design, and the efficiency of fly ash recovery. Approximately 90% of the coal mass is consumed during combustion. Retained uranium concentrates in the nonvolatile fraction or ash. The uranium concentration of the fly ash, which has been quantified by several investigators (Jaworowski and

## 6. POTENTIAL FOR HUMAN EXPOSURE

Grzybowska 1977; Tadmor 1986; Weissman et al. 1983), has been found to be higher than in the original coal (NCRP 1984a), indicating that <90% of the uranium is released to the atmosphere. A 550 MWe plant with a coal input of 1.5 million tons/year with a uranium content of approximately 3 tons may release 0.06–0.2 Ci (90–300 kg) of  $^{238}\text{U}$  and  $^{234}\text{U}$  per year (NCRP 1984a), indicating that modern coal power plants release more like 10% of the uranium. A nuclear power plant by comparison releases essentially no uranium.

Raw shale oil is also known to contain uranium, and retorting operations may result in the release of uranium to the environment. Studies indicate that shale oil processing operations may increase atmospheric levels of  $^{238}\text{U}$  and  $^{234}\text{U}$  by a maximum of 0.04 fCi/m<sup>3</sup> over background levels of uranium (Gogolak 1985).

Uranium has been detected in air at 25 of 67 hazardous waste sites where uranium has been identified in some environmental component (HazDat 2007).

### 6.2.2 Water

There is no information on releases of uranium to the water from manufacturing and processing facilities because these releases are not required to be reported (EPA 1998a).

The redistribution of uranium and uranium progeny to both surface water and groundwater occurs primarily from the natural erosion of rock and soil; some redistribution also comes from the mining, milling, and, to a lesser extent, conversion portions of the nuclear fuel cycle (Table 6-1). Contamination of surface water and groundwater by effluents from uranium mining, milling, and production operations has been documented (Brandvold et al. 1981; Eadie and Kaufmann 1977; Hart et al. 1986; Swanson 1985; Yang and Edwards 1984).

Uranium is discharged to surface water and/or groundwater during mining operations. If an open-pit or underground mine extends below the water table, groundwater must be removed to permit mining operations to continue. This is usually accomplished by pumping and discharging excess water into the ground or nearby bodies of water. Since mine water is generally concentrated with uranium, its introduction into surface water bodies may produce measurable increases in uranium levels.

## 6. POTENTIAL FOR HUMAN EXPOSURE

Waste waters from open-pit mines are typically one to two orders of magnitude greater in volume and radioactivity content than waters from shaft or underground mines (AEC 1974). A typical open-pit mine may discharge a million gallons of water daily, giving releases of approximately 0.5 mCi/day or 200 mCi/year, these releases consist of less uranium than other elements like radium and radon (AEC 1974).

Liquid releases from uranium mills have been implicated in contamination of surface water and nearby wells and groundwater (Table 6-1). Contamination of groundwater and surface water can also occur by water erosion of tailings piles (Goode and Wilder 1987; Veska and Eaton 1991; Waite et al. 1988). Since extraction of uranium ore during the milling process averages 90–95% recovery, the primary contaminants from uranium tailings disposal sites are uranium progeny (e.g., radium-226).

Generation of liquid waste from the uranium conversion process (see Table 6-1) is generally small and is handled by placing liquid effluent in lined ponds with sealed bottoms. The pond effluent is chemically neutralized to precipitate out uranium and uranium progeny in pond sludge. Water in the ponds is permitted to evaporate and sludge is disposed of as waste under controlled conditions (AEC 1974).

Liquid discharges containing uranium resulting from uranium enrichment and fuel fabrication are generally quite small (see Table 6-1).

In addition to processes of the nuclear fuel cycle, release of uranium has been detected in surface water adjacent to a radioactive waste disposal site in Massachusetts (DOE 1981c).  $^{238}\text{U}$  measurements indicated that surface water located adjacent to the waste disposal site had concentrations of up to 155 pCi/L. Additionally, groundwater measurements of  $^{238}\text{U}$  and  $^{235}\text{U}$  at the disposal site were 4,400 pCi/L and 2,400 pCi/L, respectively. These values were elevated compared to values obtained in a study performed for the EPA (DOE 1981b). For the EPA study, a total of 35,000 surface water samples from across the United States were analyzed; the average total uranium concentration was 1.1 pCi/L (range 0.01–582 pCi/L). Of these, 28,000 were considered samples of domestic water supplies. In this same study, 55,000 groundwater samples had a total mean uranium concentration of 3.2 pCi/L (range 0.01–635 pCi/L).

Uranium has been detected in surface water samples at 22 of 67 hazardous waste sites and in groundwater samples at 37 of 67 hazardous waste sites where uranium has been identified in some environmental component (HazDat 2007). Examples of uranium values in groundwater and surface water include the

## 6. POTENTIAL FOR HUMAN EXPOSURE

Uravan site (uranium levels ranged from 1,500 to 16,000 pCi/L) and the tailings pond of the United Nuclear site (uranium concentrations were as high as 3,900 pCi/L). A break in the tailings pond dam in 1979 sent 93 million gallons of tailings liquid into the Rio Puerco (EPA 1988b). The distribution of Superfund NPL sites is shown in Figure 6-1.

**6.2.3 Soil**

There is no information on releases of uranium to the soil from manufacturing and processing facilities because these releases are not required to be reported (EPA 1998a).

Uranium is a naturally occurring radionuclide that is present in nearly all rocks and soils (soils being derived from erosion of the rocks). The average concentration in U.S. soils is about 2 pCi/g (3 ppm); however, much higher levels are found in areas such as the Colorado Plateau and lands supporting current and previous phosphate mining in Florida, Texas, and South Carolina. Lower concentrations of uranium are found in basic rocks (e.g., basalt, 0.02–0.03 pCi/g), while acidic rocks contain higher uranium concentrations (e.g., sedimentary  $\approx 1.0$  pCi/g) (Clayton and Clayton 1981; NCRP 1984a). The uranium present in the rocks and soil as a natural constituent represents natural background levels.

Contamination of the soil can occur either from deposition of uranium originally discharged into the atmosphere, or from waste products discharged directly into or on the ground (e.g., water containing uranium from either underground or open-pit mines). Examples of industrial activities that may result in soil deposition include uranium mining and milling, uranium processing, phosphate mining, heavy metal mining, coal use, and inappropriate waste disposal.

In the process of mining uranium, when the depth of the mine is below the water table (either an open-pit or underground mine), the resulting water is pumped from the mine and often discharged directly to the ground or into surface water. For uranium milling, uranium in the ore is extracted (currently 90–95%, originally >50%) so that wastes from uranium milling contain only low levels of uranium; however, the levels of uranium progeny (e.g., radium) remain essentially unchanged. Uncontrolled erosion of these wastes from open tailings piles not protected from the weather occurred at a Shiprock, New Mexico, uranium mill site, resulting in contamination of the surrounding area (Hans et al. 1979). Uncontrolled erosion also occurred in storage areas such as the St. Louis Airport Storage Site in Missouri (DOE 1985). Increased levels of uranium, radium, radon, and other decay products of uranium have also been



## 6. POTENTIAL FOR HUMAN EXPOSURE

measured around these sites, particularly in the soil. A number of controlled disposal locations on government-owned mill sites exist, but the ones identified involved uncontrolled disposal.

At various facilities that process uranium for defense programs, uranium is released to the atmosphere under controlled conditions, resulting in deposition on the soil and surface waters. Monitoring data from the area surrounding the Fernald Environmental Management Project (formerly the Fernald Feed Materials Production Center) showed that soil contained uranium released from the facility (Stevenson and Hardy 1993).

The uranium content of phosphate rock, a source of phosphorus for fertilizers and phosphoric acid for the chemical industry, ranges from several pCi/g to 130 pCi/g (several  $\sim 200$   $\mu\text{g/g}$ ) (Boothe 1977; UNSCEAR 1977, 1982). During milling, much of the uranium content becomes concentrated in slag byproducts (Melville et al. 1981). The slag byproducts are often used for bedrock in the paving of roads, thus transferring the uranium-rich slag to the soil (DOE 1986a; Melville et al. 1981). Because of the large amounts of phosphate fertilizer produced annually (12–15 million tons), trace amounts of uranium progeny remaining in the fertilizer result in the distribution of about 120 Ci (180 metric tons) per year over U.S. agricultural lands (Kathren 1984).

Combustion of coal is a significant source of enhanced natural radioactivity (especially combustion of coal from the western United States, which contains significantly more uranium than coal from the eastern United States). When coal is burned, some of the radioactivity is released directly to the atmosphere, but a significant fraction is retained in the bottom ash. Enhanced concentrations of uranium have been found on the ground around coal-fired power plants (UNSCEAR 1982).

Unauthorized landfill disposal of uranium processing wastes (e.g., Shpack Landfill in Norton, Massachusetts, and the Middlesex Municipal Landfill in Middlesex, New Jersey) has resulted in soil contamination (DOE 1981c, 1984c). Also, elevated uranium concentrations have been measured in soil samples collected at 45 of 67 hazardous waste sites and in sediment samples at 25 of 67 hazardous waste sites (HazDat 2007). In several cases, the uranium concentrations in soils were significantly elevated. For example, uranium concentrations from the Shpack/ALI site were found to be 16,460 pCi/g (24,000  $\mu\text{g/g}$ ). At the United States Radium Corporation site (New Jersey), uranium concentrations ranged from 90 to 12,000 pCi/g (130–18,000  $\mu\text{g/g}$ ); for the Monticello site (Utah), uranium levels were reported to range from 1 to 24,000 pCi/g (1.5–36,000  $\mu\text{g/g}$ ) (HazDat 2007).

## 6. POTENTIAL FOR HUMAN EXPOSURE

The use of depleted uranium ammunition during military conflicts and training exercises will result in the localized release of depleted uranium to soil at those locations (Carvalho and Oliveira 2010; Oliver et al. 2007, 2008a, 2008b; Parrish et al. 2008; Radenkovic et al. 2008; Sansone et al. 2001).

### 6.3 ENVIRONMENTAL FATE

#### 6.3.1 Transport and Partitioning

The components of an ecosystem can be divided into several major compartments (Figure 6-2) (NCRP 1984b). None of the environmental compartments exist as separate entities; they have functional connections or interchanges between them. Figure 6-2 also shows the transport pathways between the released uranium and the environmental compartments as well as the mechanisms that lead to intakes by the population. Initial uranium deposition in a compartment, as well as exchanges between compartments (mobility), are dependent upon numerous factors such as chemical and physical form of the uranium, environmental media, organic material present, oxidation-reduction potential, nature of sorbing materials, and size and composition of sorbing particles.

Natural processes of wind and water erosion, dissolution, precipitation, and volcanic action acting on natural uranium in rock and soil redistribute far more uranium in the total environment than the industries in the nuclear fuel cycle. However, those industries may release large quantities of uranium in specific locations, mainly in the form of solids placed on tailings piles, followed by liquids released to tailings ponds and then airborne releases, both directly from the facilities and by wind erosion of the tailings piles. Although solid releases represent the largest quantity of uranium redistribution, they remain on the facility grounds and are normally inaccessible to the public. It is the airborne (direct and wind erosion on tailings piles) and liquid releases (tailings pond runoff and water erosion of tailings) that most likely represent the important pathways for public exposure (i.e., inhalation and ingestion) if pathways can be completed.

While entrained in the air, particulate uranium represents an inhalation source for humans, the extent of which is dependent upon concentration and particle size. For particulate uranium to be an inhalation hazard to humans, the particulates must be in the size range of 1–10  $\mu\text{m}$  (Bigu and Duport 1992; ICRP 1979). In some cases, the solid tailings have been removed from the site for use as fill or construction material, which can lead to external radiation exposures primarily from the uranium progeny.

6. POTENTIAL FOR HUMAN EXPOSURE

**Figure 6-2. Environmental Pathways for Potential Human Health Effects from Uranium**

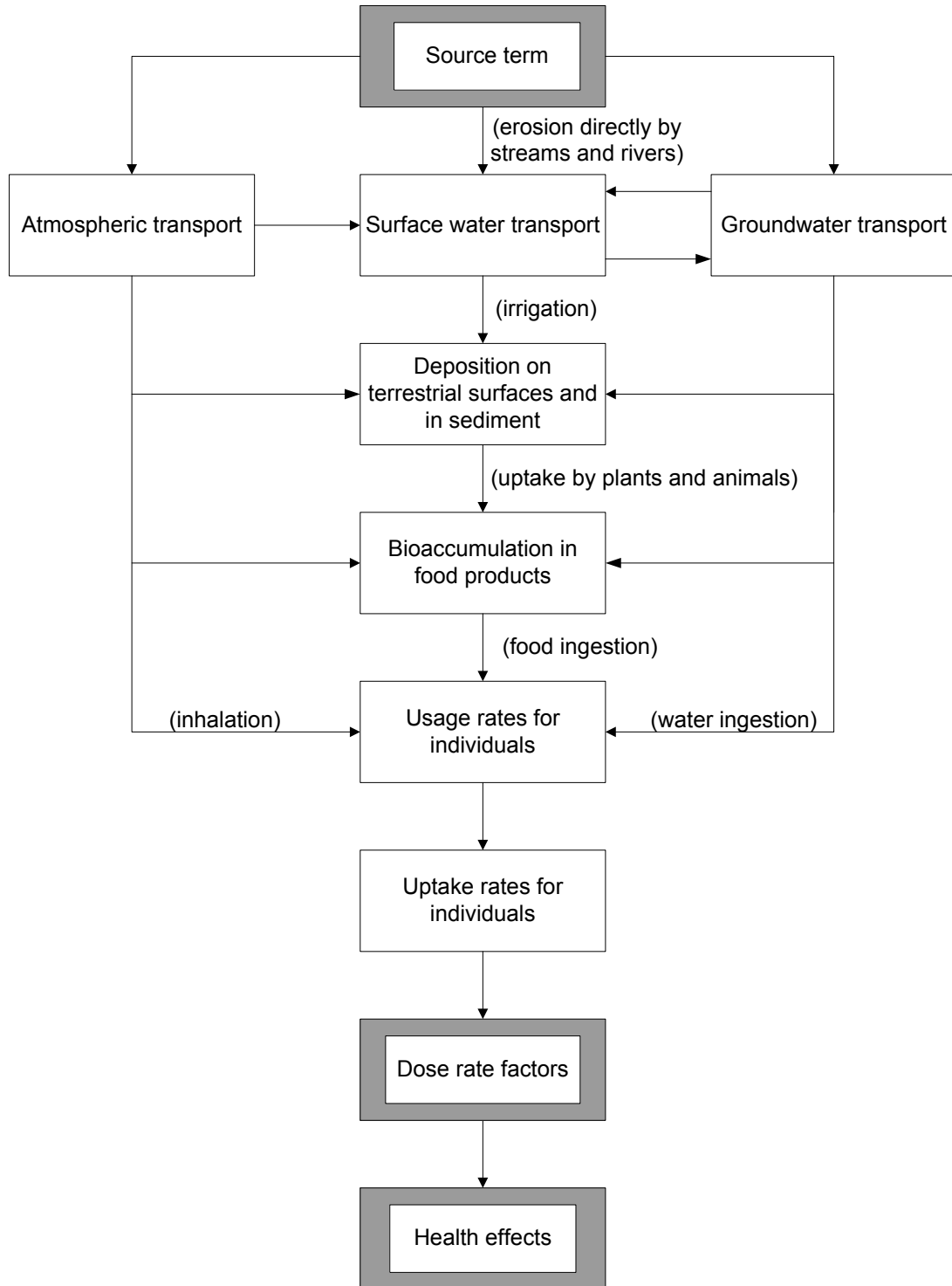

Source: NCRP 1984b

## 6. POTENTIAL FOR HUMAN EXPOSURE

Deposition of the atmospheric uranium can occur by dry deposition or wet deposition (Essien et al. 1985). Dry deposition results from gravitational settling and impaction on surfaces exposed to turbulent atmospheric flow. The rate of dry deposition is dependent upon particle size distribution, chemical form, particle density, and degree of air turbulence. Few experimental data on the particle size and residence time of uranium and uranium compounds present in ambient atmospheres are available; however, uranium particles are expected to behave like other particles for which data are available, which show that smaller uranium particles ( $<5 \mu\text{m}$ ) travel longer distances than larger particles because of their longer residence time in the atmosphere due to their low settling velocity.

The chemical form of the uranium affects the atmospheric residence time. One uranium compound for which there are data regarding residence time and particle size is uranium hexafluoride, a soluble compound, which will hydrolyze in the atmosphere to particulate  $\text{UO}_2\text{F}_2 \cdot n\text{H}_2\text{O}$  and hydrogen fluoride gas (Bostick et al. 1985). In the case of  $\text{UO}_2\text{F}_2$ , although the particles were small ( $<2.5 \mu\text{m}$ ), its atmospheric residence time was estimated to be only 35 minutes as a result of rapid hydration and agglomeration to larger particles that have faster settling velocities (Bostick et al. 1985).

In wet deposition of airborne contaminants, the uranium is washed from the atmosphere by rain, sleet, snow, or other forms of moisture. The rate of wet deposition depends upon particle size and solubility (chemical form).

Uranium thus deposited (dry or wet) will usually reside on land or be deposited on surface waters. If land deposition occurs, the uranium can incorporate into the soil or adhere to plant surfaces, be resuspended in the atmosphere as a result of wind action, or be washed from the land into surface water and groundwater. Resuspension factors are typically quite low ( $10^{-6}$ ) and protective against significant exposures, but this may not apply to windy and arid areas. Resuspension into the air can be an inhalation source even after the plume or source has disappeared.

In addition to the migration of dissolved or suspended uranium due to the movement of water in the environment, the transport and dispersion of uranium in surface water and groundwater are affected by adsorption and desorption of the uranium on surface water sediments. On the other hand, migration of uranium in soil and subsoil and uptake in vegetation are usually quite local involving distances from several centimeters to several meters.

## 6. POTENTIAL FOR HUMAN EXPOSURE

In most waters, sediments act as a sink for uranium and the uranium concentrations in sediments and suspended solids are several orders of magnitude higher than in surrounding water (Brunskill and Wilkinson 1987; Swanson 1985). Factors that control the mobility of uranium from sediment to the water phase are the oxidation-reduction potential, the pH, the characteristics of complexing agents or ligands, and the nature of sorbing materials in the water. Inorganic or organic ligands that can form soluble complexes with uranium will result in mobilization of the uranium in water. However, the stability of such complexes is dependent on the pH. For example, uranium is likely to be in solution as a carbonate complex in oxygenated water with high alkalinity (Herczeg et al. 1988); however, in acidic waters (pH < 6 containing low concentrations of inorganic ions and high concentrations of dissolved organic matter), the uranium is in solution as the soluble organic complex (Brunskill and Wilkinson 1987).

The oxidation-reduction potential of water is important in controlling the mobility of uranium. In anoxic waters where the aquatic environment is reductive, U(VI) will be reduced to U(IV) (e.g., changed from a soluble compound to an insoluble one). The U(IV) will be deposited into the sediment due to the insolubility of the resulting U(IV) salts (Allard et al. 1979; Herczeg et al. 1988). Mobilization and deposition of uranium as defined by the oxidation-reduction potential of the water has been observed by several investigators (Barnes and Cochran 1993; Shaw et al. 1994). Uranium can also be removed from solution by physical adsorption processes, such as adsorption onto oxides of iron or manganese that occur as coatings on the particles of soil and sediment (Ames et al. 1982).

The mobility of uranium in soil and its vertical transport (leaching) to groundwater depend on properties of the soil such as pH, oxidation-reduction potential, concentration of complexing anions, porosity of the soil, soil particle size, and sorption properties, as well as the amount of water available (Allard et al. 1982; Bednar et al. 2007; Crancon et al. 2010; DOE 1992; Schimmack et al. 2007). Retention of uranium by the soil may be due to adsorption, chemisorption, ion exchange, or a combination of mechanisms (Allard et al. 1982). Any soil property that alters the sorption mechanism will also alter the mobility of uranium in the soil. The sorption of uranium in most soils is such that it may not leach readily from soil surface to groundwater, particularly in soils containing clay and iron oxide (Sheppard et al. 1987), although other geological materials such as silica, shale, and granite have poor sorption characteristics (DOE 1992; Erdal et al. 1979; Silva et al. 1979; Ticknor 1994).

Sorption in most soils attains a maximum when the neutral hydroxy complex of uranium is at a maximum. However, at pH 6 and above, and in the presence of high carbonate or hydroxide concentrations, uranium may form anionic complexes such as the uranyl hydroxide anion,  $\text{UO}_2(\text{OH})_4^{-2}$ .

## 6. POTENTIAL FOR HUMAN EXPOSURE

The mobility of anionic uranium complexes in soil is dependent upon the nature of the soil. For example, the decrease in sorption in soil with little anion-exchange capacity may result in increased mobility; however, increased sorption in soil with high anion-exchange may result in decreased mobility (Allard et al. 1982; Ames et al. 1982; Brookins et al. 1993; Ho and Doern 1985; Hsi and Langmuir 1985; Ticknor 1994).

Other factors also affect the mobility of uranium in soil. A field study performed near an active carbonate leach uranium mill showed that uranium in an alkali matrix can migrate to the groundwater (Dreesen et al. 1982). Uranium mobility may also be increased due to the formation of soluble complexes with chelating agents produced by microorganisms in the soil (Premuzic et al. 1995).

Uranium may be transported to vegetation by air or by water. It can be deposited on the plants themselves by direct deposition or resuspension, or it can adhere to the outer membrane of the plant's root system with potential limited absorption. Similarly, uranium deposited on aquatic plants or water may be adsorbed or taken up from the water. The plants, aquatic or terrestrial, may be eaten directly by humans or consumed by land or aquatic animals, which provide food for humans. The uptake or bioconcentration of uranium by plants or animals is the mechanism by which uranium in soil, air, and water enters into the food chain of humans.

Numerous factors influence the bioaccumulation of uranium, such as the chemical and physical form of the uranium; the season of the year and other climatic factors such as temperature, age of the organism, specific tissue or organs involved; and the specific characteristics of the local ecosystem, such as total suspended and dissolved solids. Bioconcentration factors for uranium have been measured by several investigators in various aquatic organisms. Mahon (1982) measured bioconcentration factors of 1,576 and 459 in algae and plankton, respectively. Horikoshi et al. (1981) determined bioconcentration factors in several species of bacteria that ranged from 2,794 to 354,000. However, bioconcentration by the bacteria represented adsorption onto the cell surfaces of the bacteria rather than true biological uptake.

Low bioconcentration factors for uranium were observed in fish. The highest bioconcentration factors observed in fillet of rainbow trout (*Oncorhynchus mykiss*), white and finescale suckers (*Catostomus commersoni* and *C. catastomus*), and lake whitefish (*Coregonus clupeaformis*) did not exceed a value of 38 (Mahon 1982; Poston 1982; Swanson 1983, 1985). Ahsanullah and Williams (1989) concluded that the primary source of uranium for crab (*Pachygrapsus laevimanus*) and zebra winkle (*Austrocochlea porcata*) was from water since both fed and starved animals took up uranium at the same rate.

## 6. POTENTIAL FOR HUMAN EXPOSURE

Uranium is transported poorly from soils to plants (Dreesen et al. 1982; Moffett and Tellier 1977). As with aquatic organisms, the uptake of uranium by plants is dependent on the nature of the soils (soil texture and organic content), the pH, and the concentration of uranium in the soil. Greater plant uptake is expected to occur in soils that contain higher levels of available uranium (i.e., less sorption of uranium to soil particles or formation of soluble uranium complexes). Swiss chard grown in sandy soils contained 80 times the levels of uranium found in Swiss chard grown in peat soil (Sheppard et al. 1983). The uptake of uranium by native plants, expressed as plant/soil concentration ratio (CR), grown near a mining and milling complex was 0.8 compared to a CR of 0.09 for plants grown in soil with background levels of uranium (Ibrahim and Wicker 1988). The effect of soil and plant type on CR values has been reviewed by Mortvedt (1994).

Reported CR values for plant/soil interaction vary widely (range, 0.0025–0.81) (Garten 1978; Ibrahim and Wicker 1988; Mortvedt 1994). Although some studies indicate that CR values in plants do not vary linearly with the concentration of uranium in the soil (Mortvedt 1994), other reported studies show a linear relationship between plant content and soil content of uranium (NCRP 1984a). It has been postulated that uranium uptake by plants may be limited to the outer membrane of the root system and may not occur on the interior of the root at all (Van Netten and Morley 1983; Sheppard et al. 1983). However, other investigators have reported the transfer of uranium from soil to the stems and leaves of plants in which the CR decreased in the following order: fruit < leaf < root (Morishima et al. 1977). Because of the higher root sorption of uranium, it has been postulated that consumption of radishes and other root vegetables grown in uranium-containing soils may be a source of human exposure (Van Netten and Morley 1983). Thorough cleansing of the plant exterior, especially if performed in conjunction with removal of the outer membrane, may remove most or all of the uranium.

### 6.3.2 Transformation and Degradation

#### 6.3.2.1 Air

The presence of uranium and uranium compounds in the atmosphere results from activities associated with uranium mining, milling, processing, and use. There is limited information available regarding the abiotic transformation and degradation of uranium and uranium compounds, except for uranium hexafluoride. Uranium hexafluoride immediately hydrolyzes on contact with moisture in the air to form uranyl fluoride ( $\text{UO}_2\text{F}_2$ ) and hydrofluoric acid (HF). Uranyl fluoride is hygroscopic and will absorb moisture from the air, resulting in an increased settling velocity associated with the larger particle size.

## 6. POTENTIAL FOR HUMAN EXPOSURE

The half-life of a release of airborne UF<sub>6</sub> is about 35 minutes (Bostick et al. 1985). Uranyl fluoride is a stable oxohalide compound of uranium which is soluble in water, a factor that will increase its mobility in the environment once deposition from the air has occurred.

**6.3.2.2 Water**

The principal abiotic processes that transform uranium in water are formation of complexes and oxidation-reduction reactions that have been described in Section 6.3.1. In seawater at pH 8.2, it was shown that U(IV) exists as 100% neutral hydroxo complexes, and UO<sub>2</sub><sup>+2</sup> and U(VI) exist as 100% carbonato complexes. In freshwater at pH 6, U(IV) was shown to exist as 100% hydroxo complexes, and UO<sub>2</sub><sup>+2</sup> existed as 12% hydrated complexes, 18% hydroxo complexes, 8% fluoro complexes, and 60% carbonato complexes. In freshwater at pH 9, U(IV) exists as 100% hydroxo complexes, but UO<sub>2</sub><sup>+2</sup> exists as 100% carbonato complexes (Boniforti 1987).

Oxidation-reduction conditions are important in the geologic transport and deposition of uranium. Oxidized forms of uranium (U[VI]) are relatively soluble and can be leached from the rocks to migrate in the environment. When strong reducing conditions are encountered (e.g., presence of carbonaceous materials or H<sub>2</sub>S), precipitation of the soluble uranium will occur.

**6.3.2.3 Sediment and Soil**

The primary abiotic and biological processes that transform uranium in soil are oxidation-reduction reactions that convert U(VI) (soluble) to U(IV) (insoluble). Reduction of U(VI) to U(IV) can occur as a result of microbial action under anaerobic soil or sediment conditions, thereby reducing the mobility of uranium in its matrix (Barnes and Cochran 1993; Francis et al. 1989; Gavrilesco et al. 2009). Further abiotic and biological processes that can transform uranium in the environment are the reactions that form complexes with inorganic and organic ligands (see Section 6.3.1).

Certain microorganisms (e.g., *Thiobacillus ferrooxidans*) can facilitate the oxidation of Fe<sup>+2</sup> to Fe<sup>+3</sup>. The Fe<sup>+3</sup> ion, in turn, can convert insoluble uranium dioxide to soluble UO<sub>2</sub><sup>+2</sup> ions by the following reaction:

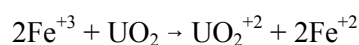

This reaction enhances the mobility of uranium in soil from mining and milling wastes (Barnes and Cochran 1993; de Sioniz et al. 1991; Scharer and Ibbotson 1982). Uranium may be removed from the



## 6. POTENTIAL FOR HUMAN EXPOSURE

pore water of sediments under sulfate reduction conditions; microbes may control this process indirectly (Barnes and Cochran 1993).

Handley-Sidhu et al. (2009) observed the oxidation of  $\text{UO}_2$  from depleted uranium penetrator surfaces in waterlogged soils resulting in the formation of mobile U(VI) species.

#### 6.4 LEVELS MONITORED OR ESTIMATED IN THE ENVIRONMENT

Reliable evaluation of the potential for human exposure to uranium depends in part on the reliability of supporting analytical data from environmental samples and biological specimens. Concentrations of uranium in unpolluted atmospheres and in pristine surface waters are often so low as to be near the limits of current analytical methods. In reviewing data on uranium levels monitored or estimated in the environment, it should also be noted that the amount of chemical identified analytically is not necessarily equivalent to the amount that is bioavailable. The analytical methods available for monitoring uranium in a variety of environmental media are detailed in Chapter 7.

In 1973, the EPA established the nationwide network RadNet (formerly called ERAMS) for obtaining data in environmental samples. RadNet consists of a network of sampling stations that provide air, surface and drinking water, and milk samples that the EPA uses to obtain environmental concentrations of radioactive material. The objective of this system is to identify trends in the accumulation of long-lived radionuclides in the environment (EPA 2007, 2010b). Sampling locations for RadNet are located near primary population centers to provide optimal population coverage.

The ratio of  $^{234}\text{U}$  to  $^{238}\text{U}$  would be expected to be unity as long as the uranium stays locked inside undisturbed crustal rock in secular equilibrium with its progeny, but measurements show that the ratio is typically different than unity (EPA 1997b, 2007). This disequilibrium occurs when the rock is disturbed by chemical or physical changes involving water. In the environment, a portion of the  $^{234}\text{U}$  separates from the  $^{238}\text{U}$  by what is theorized to be a physical process (alpha recoil ejection of the  $^{232}\text{Th}$  decay product from surfaces of soil particles) or a combination of physical and chemical processes (a  $^{238}\text{U}$  transformation at the soil particle surface fractures the surface allowing access for water to dissolve the more soluble  $^{234}\text{Th}$  product) (NCRP 1984a). These processes can change the uranium isotope ratios in air, soil, and water.

## 6. POTENTIAL FOR HUMAN EXPOSURE

**6.4.1 Air**

For airborne particles collected for the RadNet program,  $^{234}\text{U}$ ,  $^{235}\text{U}$ , and  $^{238}\text{U}$  analyses are performed on semiannually composited air filters collected from continuously operating airborne particulate samplers. Following chemical separation, the uranium is quantified by  $\alpha$ -spectroscopy.

Table 6-2 shows the results of monitoring for uranium in airborne particles for the October to December 2007 composites as published in Report 132 (EPA 2007). Results from October through December 1997 are included as well (EPA 1997b). The locations of air samples with the highest total uranium concentrations were Las Vegas, Nevada; El Paso, Texas; Ross, Ohio; Lynchburg, Virginia; and Phoenix, Arizona (listed in descending concentrations of airborne total uranium). In all cases, atmospheric levels of total uranium were low, in the attocurie/m<sup>3</sup> range. The airborne data show  $^{234}\text{U}$  to  $^{238}\text{U}$  ratios that range from 1.0 to 7.4, many of which are significantly different from the one-to-one ratio found in crustal rock.

Uranium in airborne dust appears to result from resuspension of soil and, consequently, airborne dust has the same uranium concentration as the soil particles that produce it. Airborne dust near uranium mining or milling operations would be expected to contain higher than background levels of total uranium and have an isotope ratio the same as crustal rock as long as the surface material from which it originated had not experienced significant weathering by moisture. Some examples of airborne uranium levels near mining and milling operations when the industry was actively producing uranium ore are included below for comparison with EPA values in Table 6-2. The annual average concentration of uranium in ambient air taken near the Jackpile Open Pit mine (New Mexico) was 2.4 fCi/m<sup>3</sup> (EPA 1979a), and the concentration of uranium in air measured near a Canadian refinery ranged between 1.3 and 134 fCi/m<sup>3</sup> (2–200 ng/m<sup>3</sup>) with a geometric mean of 13 fCi/m<sup>3</sup> (20 ng/m<sup>3</sup>) (Tracy and Meyerhof 1987). Air samples taken near a uranium mill tailings pile showed a uranium concentration of 1 pCi/m<sup>3</sup> (NCRP 1984a). Near the Paducah Gaseous Diffusion Plant in Kentucky, where uranium enrichment is performed, the maximum total air alpha activity in 1979 at one location was 0.7 pCi/m<sup>3</sup> (DOE 1981a).

**6.4.2 Water**

Until the early 1980s, uranium in drinking water was not often measured except when contamination was suspected. Welford and Baird (1967) found a concentration of 0.02 pCi/L in New York City tap water. UNSCEAR (1977) reported that tap water usually contains <0.03 pCi/L.

## 6. POTENTIAL FOR HUMAN EXPOSURE

**Table 6-2. Uranium in Airborne Particles (Composites)**

Location	aCi/m <sup>3</sup> ±2u					
	January–December 1997			January–December 2007		
	<sup>234</sup> U	<sup>235</sup> U	<sup>238</sup> U	<sup>234</sup> U	<sup>235</sup> U	<sup>238</sup> U
Fairbanks, Alaska	13.3±2.5	1.79±0.99	11.6±2.3	—	—	—
Birmingham, Alabama	—	—	—	44±11	2.3±2.8	29.4±8.6
Montgomery, Alabama	19.7±4.2	2.5±1.6	15.7±3.7	13.8±3.9	1.3±1.3	6.8±2.6
Little Rock, Arkansas	22.9±4.6	1.6±1.3	21.6±4.4	93±18	7.4±4.5	88±17
Phoenix, Arizona	66±12	6.3±3.9	50±10	64±18	0.7±3.3	42±14
Berkeley, California	8.7±2.3	0.64±0.71	6.3±2.0	—	—	—
Los Angeles, California	26.8±5.9	2.4±1.9	20.5±4.9	39±13	1.7±3.7	26±11
Richmond, California	—	—	—	9.6±3.2	1±1.2	4.1
San Diego, California	—	—	—	21.8±6.3	3±2.7	26.1±7
San Francisco, California	—	—	—	9.6±4.2	1.7±2.1	6.9±3.5
Denver, Colorado	35.6±5.3	3.7±1.8	31.9±4.9	18.2±3.9	3.7±1.7	16.4±3.6
Hartford, Connecticut	14±3.0	1.9±1.1	12.3±2.7	15.6±4.4	0.5±1	10.7±3.5
Washington, District of Columbia	—	—	—	13.1	0	9.9
Wilmington, Delaware	14.7±2.9	2.7±1.3	12.8±2.7	16.9±5.2	1.9±2	13.8±4.7
Jacksonville, Florida	10.5±2.1	0.56±0.50	9.7±2.0	14.5±4.4	0.8±1.4	9.6±3.5
Miami, Florida	10.1±2.4	0.78±0.81	9.2±2.2	21±6.1	0.9±1.6	17.4±5.5
Orlando, Florida	—	—	—	11.8±3.6	2.5±1.8	8.6±3
Atlanta, Georgia	—	—	—	26.3±6.4	3.1±2.2	18.4±5.2
Honolulu, Hawaii	3.01±0.91	0.47±0.40	2.33±0.78	—	—	—
Des Moines, Iowa	—	—	—	16±3.2	1.9±1.2	16±3.2
Iowa City, Iowa	19.1±3.1	2.5±1.2	14.9±2.7	18.6±4.1	2.6±1.5	16.1±3.7
Boise, Idaho	22.6±3.9	0.94±0.88	19.7±3.6	—	—	—
Idaho Falls, Idaho	16.8±3.5	1.4±1.1	19.6±3.8	—	—	—
Chicago, Illinois	—	—	—	43±11	7.2±4.6	38±10
Indianapolis, Indiana	26.8±3.7	2.5±1.1	22.8±3.4	29.5±6.3	2.5±1.9	28.1±6.1
Kansas City, Kansas	—	—	—	26.7±5.9	2.4±1.9	27.4±5.9
Topeka, Kansas	17.1±2.8	2.5±1.1	15.6±2.6	20.8±4.4	2.7±1.5	17±3.9
Boston, Massachusetts	—	—	—	8.8±2.4	0.37±0.66	5.9±1.9
Baltimore, Maryland	—	—	—	14.4±4.1	0.19±0.85	8.9±3.2
Augusta, Maine	25±4.1	2.8±1.4	22.1±3.8	—	—	—
Detroit, Michigan	—	—	—	16.7±3.8	2±1.4	19.7±4.2
Lansing, Michigan	14.7±2.5	1.25±0.82	13±2.4	12.5±2.9	0.92±0.85	11.3±2.7
Minneapolis, Minnesota	9.3±1.6	1.04±0.55	6.6±1.3	—	—	—
St. Paul, Minnesota	—	—	—	12.7±2.7	1.1±0.92	13.2±2.8

## 6. POTENTIAL FOR HUMAN EXPOSURE

**Table 6-2. Uranium in Airborne Particles (Composites)**

Location	aCi/m <sup>3</sup> 2u					
	January–December 1997			January–December 2007		
	<sup>234</sup> U	<sup>235</sup> U	<sup>238</sup> U	<sup>234</sup> U	<sup>235</sup> U	<sup>238</sup> U
Welch, Minnesota	14.5±2.2	1.75±0.82	15.5±2.3	—	—	—
Welch, Minnesota	4.25±0.79	0.24±0.23	4.22±0.79	—	—	—
St. Louis, Missouri	—	—	—	10±2.4	0.75±0.73	11.3±2.6
Jackson, Mississippi	17.9±4.5	2.9±1.9	17.1±4.4	14.5±5.1	-0.15±0.98	11.9±4.5
Charlotte, North Carolina	22.9±5.2	1.6±1.6	21.3±5.0	20.9±6.2	1.8±2	20.5±6.1
Wilmington, North Carolina	23.1±2.4	1.2±0.51	20.6±2.3	12±3.5	0±0.78	13.3±3.7
Bismarck, North Dakota	17.1±3.4	1.7±1.2	15.9±3.3	23.3±4.8	2.3±1.9	21.4±4.6
Concord, New Hampshire	9.9±2.0	1.29±0.74	9.6±2.0	10.2±2.9	1.1±1	9.2±2.7
Edison, New Jersey	—	—	—	10.7±3	0.53±0.82	9.0±2.7
Trenton, New Jersey	19.3±4.9	1.1±1.4	16±4.4	15.5±4.3	1.7±1.5	12.3±3.8
Santa Fe, New Mexico	35.2±5.1	2.2±1.3	31.5±4.8	19.4±4	0.67±0.79	18.7±3.9
Las Vegas, Nevada	44.4±7.2	2.9±1.9	32.8±6.0	55±12	4.4±3.2	36.1±3.9
Albany, New York	—	—	—	11.3±3.9	1.2±1.5	10±3.6
Lockport, New York	—	—	—	4±1.7	0.69±0.78	5.7±2
New York City, New York	13.1±2.9	0.47±0.55	14.5±3.0	18.5±5.5	1.8±2	21.4±6
Syracuse, New York	10.1±1.7	1.01±0.56	10.3±1.7	—	—	—
Yaphank, New York	6.9±1.4	0.41±0.36	5.7±1.3	7.9±2.3	0.16±0.47	3.7±1.5
Cincinnati, Ohio	—	—	—	11.5±2.5	0.54±0.54	9.2±2.2
Cleveland, Ohio	—	—	—	24.0±5	0.83±0.94	22.7±4.9
Columbus, Ohio	20.7±2.6	1.86±0.79	17.2±2.4	19.7±4.2	1.9±1.3	20.6±4.4
Painesville, Ohio	11.2±1.9	0.9±0.57	9.6±1.7	13.3±2.8	0.37±0.51	11.2±2.5
Ross, Ohio	34.4±5.0	2.3±1.4	30.7±4.7	17.8±4.3	3.1±1.8	18.1±4.3
Oklahoma City, Oklahoma	—	—	—	12.6±2.9	0.99±0.81	9.0±2.4
Portland, Oregon	—	—	—	9.1±3.8	0.4±1.2	9.2±3.8
Harrisburg, Pennsylvania	10.7±2.2	0.84±0.64	11.5±2.3	8.1±2.9	1.7±1.4	10.1±3.2
Pittsburgh, Pennsylvania	—	—	—	18.3±4.8	0.9±1.3	14.1±4.1
San Juan, Puerto Rico	—	—	—	6.2±2.8	0.32±0.94	5.6±2.7
Providence, Rhode Island	—	—	—	13.1±3.8	1.2±1.3	10.1±3.3
Barnwell, South Carolina	13.1±1.9	1.29±0.59	11.2±1.7	7.7±2.1	0.4±0.55	7.9±2.2
Columbia, South Carolina	33.4±5.4	2.5±1.5	31.9±5.3	32.0±7.9	2.7±2.5	26.3±7
Pierre, South Dakota	14.1±2.5	0.96±0.71	11.3±2.2	19.3±4.4	1.2±1.2	18.9±4.4
Knoxville, Tennessee	24.1±5.5	2.6±2.1	17.7±4.7	26.9±7.6	5.5±3.6	20.1±6.4
Memphis, Tennessee	—	—	—	20.7±6.6	3.7±3.2	21.3±6.6
Nashville, Tennessee	17.2±3.5	1.4±1.1	16.2±3.4	12.6±4.5	0.3±1.2	11.7±4.3
Oak Ridge/Bethel, Tennessee	11.5±1.9	2.14±0.85	7.4±1.5	12.3±3.3	1.1±1.1	12.4±3.4
Oak Ridge/K25, Tennessee	19.6±1.9	1.34±0.46	23.1±2.1	25.5±4.8	3.0±1.5	52.6±8.3

## 6. POTENTIAL FOR HUMAN EXPOSURE

**Table 6-2. Uranium in Airborne Particles (Composites)**

Location	aCi/m <sup>3</sup> ±2u					
	January–December 1997			January–December 2007		
	<sup>234</sup> U	<sup>235</sup> U	<sup>238</sup> U	<sup>234</sup> U	<sup>235</sup> U	<sup>238</sup> U
Oak Ridge/Melton, Tennessee	7.6±1.1	0.4±0.27	7±1.0	9.9±3.2	0.7±1	8.3±2.9
Oak Ridge/Y12 E, Tennessee	27.5±3.6	2.8±1.2	17.6±2.8	65±12	6.6±3.2	20.1±5.5
Oak Ridge/Y12 W, Tennessee	84.2±6.4	5.5±1.3	29.8±3.1	13.0±3.6	1.1±12	9.1±2.9
Austin, Texas	9.8±1.8	0.6±0.48	8.6±1.7	12.7±2.9	0.15±0.64	8.6±2.3
Austin/Concordia, Texas	—	—	—	12.2±3	0.74±0.79	12.3±3
Dallas, Texas	—	—	—	13.7±3	1.07±0.86	12.7±2.9
El Paso, Texas	57±10	2.8±2.6	48.6±9.3	66±13	4.0±3.1	48±11
Ft. Worth, Texas	—	—	—	12.2±3	1.03±0.95	13.3±3.1
Houston, Texas	—	—	—	22.4±5.2	1.1±1.2	22.6±5.1
Salt Lake City, Utah	35.4±7.1	1.8±1.6	30.1±6.4	33.5±7.6	2.3±2	27.2±6.6
Lynchburg, Virginia	86.2±8.5	4.1±1.2	10.1±1.8	47.9±8.1	1.3±1.1	9.8±2.8
Richmond, Virginia	—	—	—	15.3±3.8	0.75±0.95	13.6±3.5
Virginia Beach, Virginia	—	—	—	10.9±2.9	0.37±0.78	10.5±2.9
Olympia, Washington	3.8±1.1	0.29±0.41	2.29±0.85	—	—	—
Spokane, Washington	16.6±3.4	1.8±1.2	13.4±3.0	17.8±6.7	0.4±0.9	18.1±6.7
Madison, Wisconsin	10.7±1.6	1.03±0.5	11.9±1.7	—	—	—
Milwaukee, Wisconsin	—	—	—	11.5±3	0.48±0.75	11.5±3

aCi = attocurie, 10<sup>-18</sup> curie

Sources: EPA 1997b, 2007

## 6. POTENTIAL FOR HUMAN EXPOSURE

A large study was performed in which data from the NURE program plus data prepared for the EPA (DOE 1981b) were compiled. Over 90,000 water samples were analyzed for uranium. The total data included approximately 35,000 surface water samples that averaged 1.1 pCi/L and approximately 55,000 groundwater samples that averaged 3.2 pCi/L (NCRP 1984a). The population-weighted average concentration was 0.8 pCi/L, which was higher than the 0.03 pCi/L reported by UNSCEAR (1977).

Ohanian (1989) reported a population-weighted average concentration of uranium in U.S. community drinking water ranging from 0.3 to 2.0 pCi/L. Another study showed that the average uranium concentrations in drinking water exceeded 2 pCi/L in South Dakota, Nevada, New Mexico, California, Wyoming, Texas, Arizona, and Oklahoma. States in which the average drinking water uranium levels exceeded 1 pCi/L are shown in Figure 6-3 (Cothorn and Lappenbusch 1983; EPA 1985c). In another study based on NURE data, the mean uranium concentration in samples of more than 28,000 domestic water supplies was 1.73 pCi/L, with a median concentration range of 0.1–0.2 pCi/L (Cothorn and Lappenbusch 1983). The level of uranium in 2,228 water supplies was  $\geq 10$  pCi/L, while in 979 water supplies, the uranium concentrations were  $\geq 20$  pCi/L. Most of these water supplies were in small towns and served less than a few thousand people (Cothorn and Lappenbusch 1983; EPA 1985c).

The EPA RadNet program reports the uranium content of drinking water samples collected at selected U.S. population centers (EPA 1997b, 2005a, 2010b). The data for  $^{234}\text{U}$ ,  $^{235}\text{U}$ , and  $^{238}\text{U}$  measured during January through December 1997 and during October through December 2005 are presented in Table 6-3. The RadNet program collects drinking water samples from 78 population centers across the United States; however, analysis of uranium is only performed in samples that show elevated gross alpha radioactivity of greater than 2pCi/L (EPA 2010b). Therefore, the levels listed here represent the upper bound of uranium concentrations in all drinking water samples collected under the RadNet program. The RadNet data are in agreement with the earlier measurements reported above that the average concentration of uranium in U.S. drinking water is generally  $< 1$  pCi/L. The drinking water samples with the highest total uranium concentrations were obtained from Santa Fe, New Mexico; Lincoln, Nebraska; Las Vegas, Nevada; and Los Angeles, California (listed in descending concentration of total uranium).

Older data sets compiled by the EPA RadNet program include measurements of the uranium content of precipitation (EPA 1994a, 1996b). Precipitation samples were only collected during the months of March through May since these spring rain months usually contain the year's highest concentrations of uranium (EPA 1994a). The data for  $^{234}\text{U}$ ,  $^{235}\text{U}$ , and  $^{238}\text{U}$  for 1996 are presented in Table 6-4. In all cases, the uranium concentrations were low, confirming that the atmospheric content of airborne uranium is small.

6. POTENTIAL FOR HUMAN EXPOSURE

**Figure 6-3. Average Uranium Concentrations in Drinking Water for States Where Concentration Exceeds 1 pCi/L**

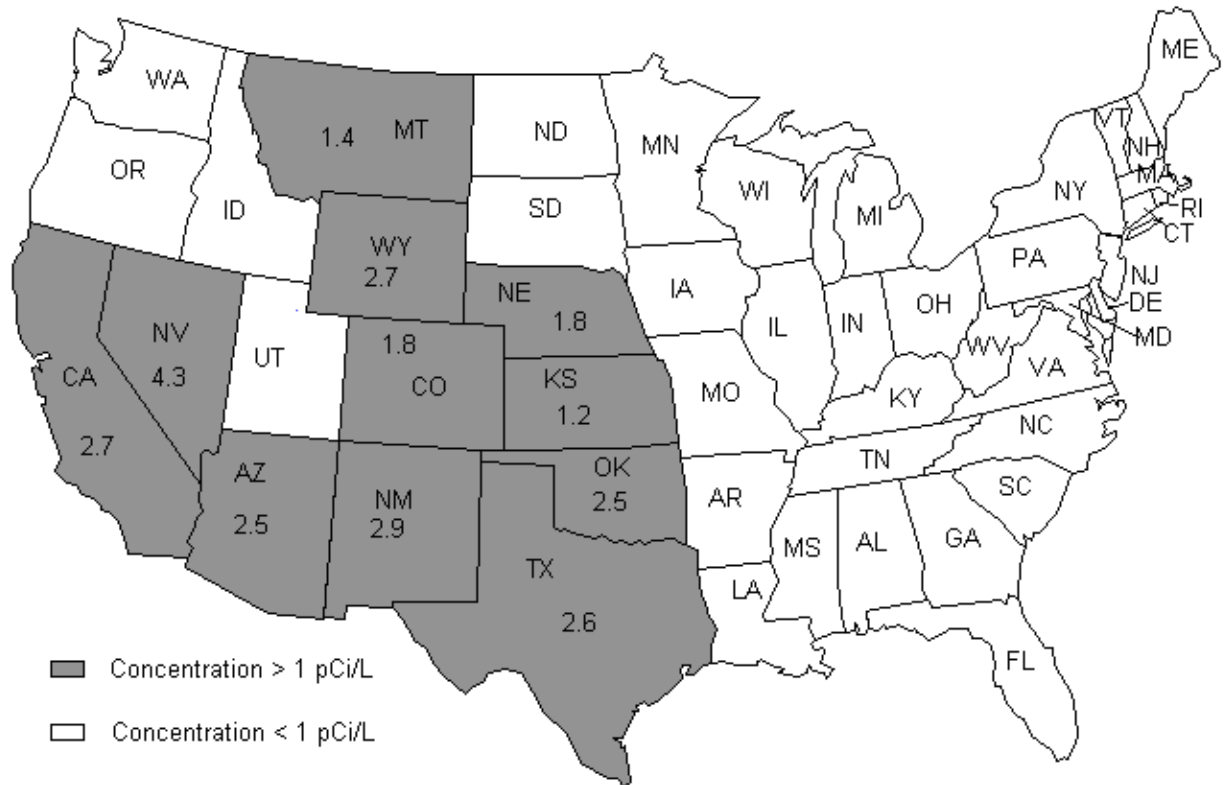

Source: NCRP 1984b

## 6. POTENTIAL FOR HUMAN EXPOSURE

**Table 6-3. Uranium in Drinking Water (Composites)**

Location	pCi/L±2 <i>u</i>					
	January–December 1997			January–December 2006*		
	<sup>234</sup> U	<sup>235</sup> U	<sup>238</sup> U	<sup>234</sup> U	<sup>235</sup> U	<sup>238</sup> U
Los Angeles, California	1.78±0.19	0.098±0.043	1.48±0.17	1.48±0.2	0.071±0.044	1.14±0.17
Tampa, Florida	—	—	—	0.174±0.061	0.009±0.024	0.134±0.052
Baxley, Georgia	0.144±0.042	0.035±0.022	0.065±0.028	0.086±0.045	0.027±0.032	0.018±0.025
Idaho Falls, Idaho	0.8±0.13	0.027±0.025	0.306±0.075	—	—	—
Morris, Illinois	0.6±0.11	0.033±0.027	0.03±0.024	0.58±0.11	0.009±0.024	0.078±0.041
W. Chicago, Illinois	1.42±0.24	0.04±0.04	0.14±0.07	0.114±0.051	0.002±0.018	0.024±0.027
New Orleans, Louisiana	—	—	—	1.05±0.16	0.052±0.041	0.69±0.13
Augusta, Maine	—	—	—	1.11±0.16	0.035±0.033	0.93±0.14
Red Wing, Minnesota	0.43±0.12	0.028±0.039	0.113±0.062	—	—	—
Port Gibson, Mississippi	—	—	—	0.131±0.049	0.010±0.018	0.044±0.032
Lincoln, Nebraska	5.11±0.46	0.358±0.099	3.26±0.33	2.96±0.32	0.097±0.05	1.98±0.24
Santa Fe, New Mexico	6.57±0.52	0.285±0.077	3.65±0.33	6.52±0.57	0.123±0.053	2.64±0.28
Las Vegas, Nevada	2.76±0.32	0.061±0.043	1.55±0.22	3.12±0.32	0.089±0.045	1.69±0.21
Jenkinsville, South Carolina	0.596±0.089	0.027±0.02	0.277±0.059	—	—	—
Genoa, Wisconsin	0.63±0.12	0.115±0.056	0.345±0.088	—	—	—
Madison, Wisconsin	1.25±0.17	0.016±0.018	0.255±0.069	—	—	—

Sources: EPA 1997b, 2006c



## 6. POTENTIAL FOR HUMAN EXPOSURE

**Table 6-4. Uranium Analyses of Select Precipitation Composite Samples March–May 1996**

Location	pCi/L±2u		
	<sup>234</sup> U	<sup>235</sup> U	<sup>238</sup> U
Montgomery, Alabama	0.0163±0.008	0.004±0.0044	0.0036±0.0042
Little Rock, Arkansas	0.0096±0.0062	0.0044±0.0044	0.0065±0.0049
Berkeley, California	0.0153±0.0074	0.0038±0.0042	0.0043±0.0048
Denver, Colorado	0.092±0.019	0.026±0.01	0.044±0.013
Hartford, Connecticut	0.0169±0.0089	0.0012±0.0038	0.0045±0.0053
Wilmington, Delaware	0.02±0.0079	0.0025±0.0032	0.0023±0.0027
Jacksonville, Florida	0.008±0.0054	0.0067±0.0051	0.0051±0.0043
Miami, Florida	0.022±0.01	0.0027±0.0038	0.0086±0.0064
Honolulu, Hawaii	0.0156±0.0086	0.0037±0.0051	0.0014±0.003
Boise, Idaho	0.0114±0.0071	0.01±0.0073	0.0057±0.005
Idaho Falls, Idaho	0.0311±0.0099	0.0111±0.0066	0.0065±0.0046
Augusta, Maine	0.023±0.011	0.0067±0.006	0.0086±0.0064
Lansing, Michigan	0.0138±0.0067	0.0016±0.0028	0.0097±0.0056
Minneapolis, Minnesota	0.0202±0.0092	0.002±0.0044	0.0132±0.0075
Welch, Minnesota	0.047±0.02	0.013±0.012	0.024±0.015
Jackson, Mississippi	0.0145±0.008	0.0134±0.0084	0.0137±0.0081
Charlotte, North Carolina	0.0101±0.0062	0.0085±0.0060	0.0151±0.0074
Wilmington, North Carolina	0.0218±0.0086	0.0047±0.0045	0.0106±0.0061
Bismarck, North Dakota	0.079±0.02	0.019±0.011	0.043±0.014
Lincoln, Nebraska	0.049±0.016	0.0129±0.0087	0.028±0.011
Concord, New Hampshire	0.0195±0.0087	0.0113±0.0074	0.024±0.0098
Trenton, New Jersey	0.0123±0.0069	0.0018±0.0031	0.0044±0.0044
Las Vegas, Nevada	0.261±0.066	0.018±0.02	0.101±0.042
Albany, New York	0.0229±0.0082	0.0043±0.0039	0.0094±0.0052
Yaphank, New York	0.0141±0.0068	0.0051±0.0048	0.0077±0.0051
Painesville, Ohio	0.0077±0.0063	0.0083±0.0071	0.0035±0.0045
Portland, Oregon	0.03±0.0095	0.0111±0.0064	0.0129±0.0063
Harrisburg, Pennsylvania	0.038±0.012	0.0103±0.0065	0.0098±0.0060
Barnwell, South Carolina	0.0153±0.0072	0.0069±0.0052	0.0085±0.0055
Columbia, South Carolina	0.0126±0.0065	0.007±0.0053	0.0039±0.0038
Knoxville, Tennessee	0.0111±0.0057	0.0043±0.0038	0.0043±0.0035
Nashville, Tennessee	0.0074±0.0068	0.0014±0.0043	0.0016±0.0044
Austin, Texas	0.0119±0.0066	0.0017±0.003	0.0061±0.0054
El Paso, Texas	0.043±0.022	0.012±0.014	0.036±0.02
Salt Lake City, Utah	0.0196±0.0078	0.0021±0.0032	0.0102±0.0056
Lynchburg, Virginia	0.05±0.013	0.0083±0.0056	0.008±0.0052
Olympia, Washington	0.0176±0.0072	0.0051±0.0042	0.0052±0.0041
Madison, Wisconsin	0.0209±0.0098	0.0039±0.0045	0.0065±0.0053

Source: EPA 1996b

## 6. POTENTIAL FOR HUMAN EXPOSURE

In some surface waters that have been contaminated by waste discharge and in groundwaters from natural uranium-bearing aquifers, the concentrations of uranium may be higher than the average natural background levels for that area. For example, higher levels of uranium have been observed in water from Ambrosia Lake in New Mexico (uranium milling and mining) (Lapham et al. 1989), the agricultural draining and evaporation pond water of the San Joaquin Valley in California (Bradford et al. 1990), groundwater from Rocky Flats, Colorado (Laul 1994), and groundwater from the Nambe region of northern New Mexico (Hakonson-Hayes et al. 2002). The concentration of uranium in creek waters that lead to the Ohio River near the Paducah Gaseous Diffusion Plant in Kentucky ranged from <0.7 to 470 pCi/L (1–700 µg/L) (DOE 1981a). Mono Lake, a natural alkaline, saline lake in California, contained 185 pCi/L <sup>238</sup>U and 222 pCi/L <sup>234</sup>U during the period 1978–1980 (Simpson et al. 1982). Analysis of water from the Colorado River and its tributaries during 1985 and 1986 showed that the levels of total uranium ranged from 3.4 to 60 pCi/L (Stewart et al. 1988).

Higher levels of uranium can be found in groundwater. Orloff et al. (2004) found elevated levels of uranium in well water in a South Carolina community (range of 1.7–5,830 pCi/L, equivalent to 1.8–7,780 mg/L, and a mean of 620 µg/L based on isotopic content). The U.S. Geological Service measured uranium concentrations above 30 µg/L in 65 out of 350 wells (19%) located in the Eastern San Joaquin Valley, California during sampling from 2004 to 2008 (Jurgens et al. 2010). Median and maximum concentrations were 18.0 and 2,500 µg/L in 98 observation wells, 8.7 and 503 µg/L, respectively, in 122 domestic wells, and 1.8 and 41.3 µg/L, respectively, in 121 public supply wells.

As part of the Navajo Uranium Assessment and Kidney Health Project, EPA (2013a) analyzed water from 240 unregulated wells on Navajo land. Uranium levels in 29 sources exceeded the MCL of 30 µg/L; the uranium concentrations in these 29 sources ranged from 31 to 700 µg/L.

Discharge of dewatering effluents from underground uranium mines and runoff from uranium mine tailings piles have contaminated surface waters and aquifers in New Mexico with elevated levels of gross alpha activity and uranium (NMHED 1989). The concentration of uranium in mine discharge water in New Mexico was 31,500 µg/L (equivalent to 22,680 pCi/L, assuming that the uranium content is natural uranium) (EPA 1985c). Groundwater from an aquifer adjacent to a uranium mill tailings pile in Falls City, Texas, was also found to have concentrations of uranium above natural background levels (DOE 1994).

## 6. POTENTIAL FOR HUMAN EXPOSURE

The concentrations of  $^{234}\text{U}$  and  $^{238}\text{U}$  in groundwater from Cambrian-Ordovician sandstone aquifers in Illinois range from  $<0.1$  to  $8.0$  pCi/L (Gilkeson and Cowart 1987). The ratio of the activity of  $^{234}\text{U}$  to  $^{238}\text{U}$  ranged from  $2.0$  to  $>40$ . The lowest ratios were found in unconfined aquifers in primary recharge zones, while ratios  $>20$  were found in the confined zones aquifer. It was suggested that glacial recharge in unconfined zones might be responsible for the high  $^{234}\text{U}$  to  $^{238}\text{U}$  ratios (Gilkeson and Cowart 1987). Fifty-five groundwater samples from the Locketong and Passaic Formation in the Newark Basin in New Jersey were analyzed during 1985–1987. These samples were found to contain  $0.1$ – $40$  pCi/L total uranium, with a median value of  $2.1$  pCi/L (Szabo and Zapecza 1987). Uranium concentrations measured in seven samples of groundwater from the Raymond Basin in California ranged from  $5.3$  to  $43.7$  pCi/L (Wiegand et al. 1987).

Water in a private well in Maine, thought to be of geologic origin, was reported to contain as much as  $403$   $\mu\text{g/L}$  uranium (approximately  $270$  pCi/L) (Lowry et al. 1987). Uranium concentrations as high as  $1,160$   $\mu\text{g/L}$  were measured in drinking water from a home in northwestern Connecticut (Magdo et al. 2007). The source of the uranium was found to be a  $500$ -foot well carrying groundwater from the Brookfield Gneiss geological formation. Hughes et al. (2005) measured elevated uranium concentrations ranging from  $44.3$  to  $5,570$   $\mu\text{g/L}$  in water from nine private wells located near Simpsonville, South Carolina. Elevated levels of uranium measured in waters from private wells in northern and northeastern Nebraska were thought to be due to the upward migration of uranium from bedrock and heavy use of phosphate fertilizers. Uranium values up to  $110$  pCi/L were measured (NEDH 1989). The concentrations of uranium in U.S. groundwaters were estimated using a conceptual model based on the geochemical and hydrological characteristics of aquifers.

The population-weighted average uranium concentration in groundwaters used as sources of drinking water in all 50 states was found to range from  $0.05$  to  $4.6$  pCi/L, with a mean value of  $0.55$  pCi/L (Longtin 1988). This mean is lower than the population-weighted uranium value for finished waters of  $0.8$  pCi/L (NCRP 1984a). Some methods that may be suitable for reducing the concentration of uranium in drinking water include lime softening, coagulation/precipitation, and filtering; however, these methods may not efficiently remove the uranium.

Concentrations of  $^{238}\text{U}$  and  $^{234}\text{U}$  measured in bottled water samples from 17 locations in Italy were generally  $<120$  mBq/kg (Forte et al. 2001). The highest reported concentrations of these isotopes were  $1,936$  and  $2,842$  mBq/kg, respectively.

## 6. POTENTIAL FOR HUMAN EXPOSURE

Jia et al. (2006) measured concentrations of 0.27–16.2 mBq/L for  $^{238}\text{U}$ , 0.41–15.6 mBq/L for  $^{234}\text{U}$ , and 0.012–0.695 mBq/L for  $^{235}\text{U}$  in water samples collected in Bosnia and Herzegovina. Two water samples were reported to contain depleted uranium. Carvalho and Oliveira (2010) reported mean uranium concentrations of 0.5 and 0.4 mg/kg measured in public drinking water supplies from Kosovo and Bosnia-Herzegovina during 2001. These levels are similar to those reported in other countries and do not reflect enhanced presence of uranium resulting from the use of depleted uranium in these areas during the 1999 military conflict (Carvalho and Oliveira 2010; Sahoo et al. 2007).

### 6.4.3 Sediment and Soil

Table 6-5 shows the average concentrations of uranium in several types of rocks and soils (NCRP 1984a). The radioactivity in soils is similar to that in the rocks, usually bedrock, from which it derives. The average soil concentration of  $^{234}\text{U}$  from Table 6-5 is 0.6 pCi/g. Since the activity of  $^{234}\text{U}$  accounts for approximately one-half of the total activity in natural uranium (see Chapter 4), the value in Table 6-5 may be multiplied by two to obtain the total uranium in soils (approximately 1.2 pCi/g).

There are wide variations from the values presented in the table, particularly in areas where uranium minerals are more concentrated. Concentrations of uranium in Louisiana soils ranged from 2.35 to 3.98  $\mu\text{g/g}$  (1.6–2.7 pCi/g) (Meriwether et al. 1988), while uranium concentrations in phosphate rock in north and central Florida ranged from 4.5 to 83.4 pCi/g (6.8–124  $\mu\text{g/g}$ ) (EPA 1985c).

Soil samples adjacent to Los Alamos, New Mexico, taken during 1974–1977 contained total uranium in the range of 0.1–5.1  $\mu\text{g/g}$  (0.067–3.4 pCi/g), with a mean concentration of 1.6 pCi/g (2.4  $\mu\text{g/g}$ ) (Purtymun et al. 1987). The concentrations of uranium in soils adjacent to the Hanford Fuel Fabrication Facility near Richland, Washington, that were collected during 1978–1981 ranged from 0.51 to 3.1 pCi/g (0.76–4.6  $\mu\text{g/g}$ ), with a median value of 1.2 pCi/g (1.8  $\mu\text{g/g}$ ). The control samples for the Hanford Fuel Fabrication Study contained uranium at concentrations of 0.21–0.86 pCi/g (0.32–1.128  $\mu\text{g/g}$ ), with a median value of 0.49 pCi/g (0.73  $\mu\text{g/g}$ ) (Price and Kinnison 1982). Uranium in the soil within the property boundary of the Paducah Gaseous Diffusion Plant in Kentucky ranged from 3.3 to 4.8 pCi/g (4.9–7.1  $\mu\text{g/g}$ ), whereas off-site samples taken as far as 12 miles away contained uranium at levels of 3.8–6.0 pCi/g (6.4–9.0  $\mu\text{g/g}$ ) (DOE 1981a). Soil monitoring data from the area surrounding the Feed Material Production Center at Fernald, Ohio, showed that the uranium concentrations within an 8-km<sup>2</sup> area were between 3 and 23 pCi/g (4.5–34  $\mu\text{g/g}$ ) compared to an mean of 2.2 pCi/g (3.3  $\mu\text{g/g}$ ) for natural background levels (Stevenson and Hardy 1993). Other investigators have detected uranium levels in

## 6. POTENTIAL FOR HUMAN EXPOSURE

**Table 6-5. Uranium in Rocks and Soils**

Material	pCi/g <sup>238</sup> U <sup>a</sup>
Igneous rocks	
Basalt (crustal average)	0.2–0.3
Mafic <sup>b</sup>	0.2–0.3
Salic <sup>b</sup>	1.3–1.6
Granite (crustal average)	1
Sedimentary rocks	
Shale	1
Sandstones	
Clean quartz	<0.3
Dirty quartz	1.0 <sup>c</sup>
Arkose	0.3–0.7 <sup>c</sup>
Beach sands (unconsolidated)	1
Carbonate rocks	0.7
Soils	0.6

<sup>a</sup>To obtain the series equilibrium radioactivity for total alpha, beta, or approximate gamma emission (excluding bremsstrahlung and x-rays), multiply by 8, 6, or 3, respectively.

<sup>b</sup>The median and mean value are given.

<sup>c</sup>Indicates that the values are not well defined.

Source: NCRP 1975

## 6. POTENTIAL FOR HUMAN EXPOSURE

surface soils at the Fernald site as high as 50 times natural background levels (Miller et al. 1994). Moon et al. (2006) measured uranium concentrations as high as 300  $\mu\text{g/g}$  at a soil depth of 6 inches at the Oak Ridge Reservation in Oak Ridge, Tennessee. The contamination was attributed to past waste disposal activities at the site.

Carvalho and Oliveira (2010) reported mean uranium concentrations of 1.8 and 3 mg/kg measured in soils from Kosovo and Bosnia-Herzegovina during 2001. Higher uranium concentrations were localized to areas impacted by depleted uranium ammunition (Carvalho and Oliveira 2010; Sansone et al. 2001).

#### 6.4.4 Other Environmental Media

Concentrations of uranium have been determined in meat and fish (Table 6-6). The uranium content measured in tissues of cattle herds grazing in pastures close to the Rocky Flats Plant in Colorado was slightly higher than in other cattle, reflecting possible contamination from this source (Smith and Black 1975). The average concentrations of uranium in game fish (surface feeders) collected from a reservoir at locations upstream and downstream from the Los Alamos National Laboratory were 2.9 ng/g dry weight (dw) (0.0019 pCi/g) and 4.9 ng/g dw (0.0033 pCi/g), respectively (Fresquez et al. 1994). The corresponding values in nongame, bottom-feeding fish were 7.9 ng/g dw (0.0058 pCi/g) and 17.7 ng/g dw (0.012 pCi/g), respectively. The concentrations of uranium in fish muscle (dw) from a Canadian lake receiving uranium mill effluents were 7–11 times higher than in fish caught in uncontaminated lakes, but this uranium may have only been attached to the gills (Swanson 1985).

The mean uranium concentration in vegetation from Ambrosia Lake, New Mexico (a site of mining and milling activities) was measured at 0.3 pCi/g dw compared to 4 fCi/g dw for vegetation from a control site (Lapham et al. 1989). Although the concentrations of uranium in muscle from exposed cattle were indistinguishable from uranium levels in muscle from control cattle, levels of uranium in liver and kidney tissues were 4 times higher in exposed cattle than in control cattle, and levels of uranium in femur samples were 13 times higher than in controls, indicating that kidney and liver slightly bioconcentrate uranium while muscle does not (Lapham et al. 1989). Thomas et al. (2005) detected uranium concentrations  $>1 \mu\text{g/g}$  in bone, liver, kidney, muscle, and rumen content samples from 14 out of 45 Saskatchewan moose and 4 out of 4 Saskatchewan cattle.

## 6. POTENTIAL FOR HUMAN EXPOSURE

**6.5 GENERAL POPULATION AND OCCUPATIONAL EXPOSURE**

General population exposure to uranium occurs by ingestion of food and drinking water and by inhalation of air. The pathways are shown in Figure 6-2.

Table 6-6 depicts uranium levels in various types of food in the United States. Measurements of normal levels of dietary  $^{234}\text{U}$  and  $^{238}\text{U}$  indicate that foods consumed contain about 0.3–0.5 pCi/day for each uranium isotope (0.6–1.0 pCi/day [0.9–1.5  $\mu\text{g}/\text{day}$ ] total uranium) (EPA 1985c; Welford and Baird 1967).

Based on consumption rates, root crops such as potatoes, parsnips, turnips, and sweet potatoes contribute approximately 38% of total dietary intake of uranium (EPA 1985c).

Ingestion of food grown in the vicinity of a uranium mill may lead to an intake up to 3 pCi/day uranium (Rayno 1983). Other investigators have estimated a dietary intake of 2.86–4.55 mg/day for individuals living near a uranium mine (Yamamoto et al. 1971).

An alternate method for estimating uranium intake is to measure the daily excretion of uranium in urine and feces. Using this method in a study of 12 subjects in Utah, it was estimated that the average dietary intake for the Salt Lake City population was  $4.4 \pm 0.6 \mu\text{g}$ , an intake that is higher than that reported for New York City, Chicago, and San Francisco residents (1.3–1.4  $\mu\text{g}$ ) (Singh et al. 1990).

Intakes of uranium in food may also increase when certain ceramic glazed dishes are used for serving or storing food (Landa and Councell 1992). Leaching occurs on contact with acidic foods or beverages. Experiments show that when a ceramic glazed plate was kept in contact with a 4% acetic acid solution for 24 hours, the concentration of uranium in the leachate was 31.8 mg/L (Landa and Councell 1992).

Uranium glazed commercial ceramic dinnerware is no longer made and sold because it was determined that the uranium is leachable by acidic foods and beverages (Landa and Councell 1992). Experiments show that when a Fiesta tableware plate was kept in contact with 20 mL of 4% acetic acid solution for 24 hours, the quantity of uranium in the leachate was 600  $\mu\text{g}$  (400 pCi). Other liquids were much less effective at leaching uranium, with water giving a value over 3 orders of magnitude lower, and other uranium glazed ceramics were much less leachable (Landa and Councell 1992).

## 6. POTENTIAL FOR HUMAN EXPOSURE

**Table 6-6. Concentrations of Uranium in Some Foods**

Type of food	Uranium concentration (ng/g raw weight)	Reference
Whole grain products	1.45	NCRP 1984a
Potatoes	2.66–2.92; 15–18	EPA 1985c; NCRP 1984a
Carrots	7.7	EPA 1985c
Root vegetables	0.94–1.20	NCRP 1984a
Cabbage	4.7	EPA 1985c
Meat	0.58–1.32; 20	EPA 1985c; NCRP 1984a
Poultry	0.14–0.42	NCRP 1984a
Beef	14	EPA 1985c
Beef liver	26	EPA 1985c
Beef kidney	70	EPA 1985c
Eggs	0.23; 9.6	EPA 1985c; NCRP 1984a
Dairy products	0.08–0.31	NCRP 1984a
Cow milk	4	EPA 1985c
Milk	1–2	EPA 1985c
Fresh fish	0.43–0.85; 11	EPA 1985c; NCRP 1984a
Shellfish	9.5–31.0	NCRP 1984a
Welsh onion	69	EPA 1985c
Flour	0.25–0.68	NCRP 1984a
Wheat bread	19	EPA 1985c
Baked products	1.32–1.5; 12	EPA 1985c; NCRP 1984a
Polished rice	1.43–6.0; 15	EPA 1985c; NCRP 1984a
Macaroni	0.4–0.63	NCRP 1984a
Tea	5	EPA 1985c
Coffee	6	EPA 1985c
Parsley	60	EPA 1985c
Red pepper	5	EPA 1985c
Mustard	0.2	EPA 1985c
Table salt	40	EPA 1985c
Canned vegetables	0.09–0.18	NCRP 1984a
Fruit juices	0.04–0.12	NCRP 1984a
Canned fruits	0.18–0.29	NCRP 1984a
Fresh fruits	0.71–1.29	NCRP 1984a
Dried beans	1.5–3.67	NCRP 1984a
Fresh vegetables	0.52–0.92	NCRP 1984a



## 6. POTENTIAL FOR HUMAN EXPOSURE

Uranium intakes from food in Japanese diets from two control areas ranged from 0.86 to 1.02  $\mu\text{g}/\text{day}$  (Yamamoto et al. 1971). Another study reported a mean value of 0.71  $\mu\text{g}/\text{day}$  for Japanese males from 31 prefectures (Shiraishi et al. 1992). Galletti et al. (2003) estimated a total dietary intake of uranium in the range of 2.9–4.8  $\mu\text{g}/\text{day}$  for the Italian population. Worldwide intake values for uranium have been reported at an average of 1 pCi/day (1.5  $\mu\text{g}/\text{day}$ ) (range 0.6–3.2 pCi/day [0.9–4.8  $\mu\text{g}/\text{day}$ ]) (Linsalata 1994).

Concentrations of uranium from selected drinking water supplies in the United States were analyzed by the EPA laboratories and found to be generally  $<1$  pCi/L (EPA 1985c, 1997b, 2005a, 2010b). Based on data obtained from the NURE program plus data prepared for the EPA (DOE 1981b; USGS 2006), a population-weighted average of 0.8 pCi/L uranium was determined. In another study, Ohanian (1989) reported population-weighted average concentrations of uranium in U.S. community drinking water ranging from 0.3 to 2.0 pCi/L. Considering an individual water intake of approximately 1.7 L/day, and an average intake of uranium from drinking water of 0.8 pCi/L as reported in the EPA study, the total intake of uranium for an individual from drinking water each day is approximately 1.4 pCi.

Uranium is also taken into the body by the inhalation route. The average daily intake of uranium from inhalation of air has been estimated to range from 0.007 pCi/day (0.010  $\mu\text{g}/\text{day}$ ) (Cothorn 1987) to 0.0007 pCi/day (0.0010  $\mu\text{g}/\text{day}$ ) (UNSCEAR 1988). This value may be somewhat higher for persons living near sources of uranium emission. Glass makers and potters who use uranium-containing enamels may be exposed to small amounts of uranium from handling the powder or from fuming operations in glass making (Rossol 1997). In general, however, exposure to uranium from inhalation is small compared to exposure from food and drinking water.

Measurements of concentrations of uranium have been made in human tissues and body fluids resulting from consumption of food and water and from natural background sources. Levels of uranium measured between 1999 and 2008 in the urine of members of the general U.S. population from the National Health and Nutrition Examination Survey (NHANES) are listed in Tables 6-7 and 6-8 (CDC 2012). The range of geometric mean values is 0.006–0.009  $\mu\text{g U/g creatinine}$  (or 0.005–0.010  $\mu\text{g U/L urine}$ ), respectively.

Two longtime residents of Los Alamos, New Mexico (one a smoker and one nonsmoker) were shown to have uranium tissue concentrations for the skeleton (average 5.8  $\mu\text{g/g wet weight}$ ) and liver (average 0.08  $\mu\text{g/kg}$ ) in closer agreement with the Reference Man (Kathren 1997; ICRP 1975) than those reported in New York City residents (Fisenne and Welford 1986). Values of uranium in whole blood measured in

6. POTENTIAL FOR HUMAN EXPOSURE

**Table 6-7. Geometric Mean and Selected Percentile of Urinary Concentrations of Uranium ( $\mu\text{g/g}$  Creatinine) for the U.S. Population from the National Health and Nutrition Examination Survey (NHANES)**

	Survey years	Geometric mean (95% confidence interval)	Selected percentiles (95% confidence interval)				Sample size
			50th	75th	90 <sup>th</sup>	95th	
<b>Total</b>	99–00	<b>0.007</b> (0.006–0.009)	<b>0.007</b> (0.006–0.009)	<b>0.013</b> (0.010–0.016)	<b>0.024</b> (0.019–0.030)	<b>0.034</b> (0.027–0.053)	2,464
	01–02	<b>0.008</b> (0.007–0.010)	<b>0.007</b> (0.006–0.009)	<b>0.014</b> (0.011–0.018)	<b>0.026</b> (0.020–0.034)	<b>0.040</b> (0.028–0.058)	2,689
	03–04	<b>0.008</b> (0.007–0.008)	<b>0.007</b> (0.006–0.008)	<b>0.012</b> (0.010–0.014)	<b>0.021</b> (0.017–0.025)	<b>0.029</b> (0.023–0.039)	2,557
	05–06	<b>0.006</b> (0.005–0.006)	<b>0.005</b> (0.005–0.006)	<b>0.009</b> (0.008–0.010)	<b>0.017</b> (0.014–0.020)	<b>0.026</b> (0.020–0.039)	2,576
	07–08	<b>0.007</b> (0.006–0.009)	<b>0.006</b> (0.005–0.008)	<b>0.012</b> (0.009–0.016)	<b>0.024</b> (0.016–0.038)	<b>0.038</b> (0.025–0.065)	2,627
<b>Age group</b> 6–11 years	99–00	<b>0.009</b> (0.007–0.012)	<b>0.008</b> (0.006–0.011)	<b>0.015</b> (0.010–0.024)	<b>0.030</b> (0.016–0.044)	<b>0.037</b> (0.030–0.077)	340
	01–02	<b>0.010</b> (0.008–0.011)	<b>0.010</b> (0.008–0.012)	<b>0.015</b> (0.013–0.019)	<b>0.027</b> (0.018–0.032)	<b>0.033</b> (0.027–0.048)	368
	03–04	<b>0.009</b> (0.008–0.010)	<b>0.008</b> (0.007–0.010)	<b>0.013</b> (0.011–0.017)	<b>0.024</b> (0.016–0.039)	<b>0.033</b> (0.022–0.050)	289
	05–06	<b>0.007</b> (0.006–0.008)	<b>0.006</b> (0.005–0.008)	<b>0.010</b> (0.008–0.014)	<b>0.018</b> (0.013–0.035)	<b>0.034</b> (0.018–0.048)	355
	07–08	<b>0.009</b> (0.007–0.011)	<b>0.008</b> (0.007–0.010)	<b>0.014</b> (0.010–0.022)	<b>0.026</b> (0.016–0.053)	<b>0.042</b> (0.023–0.065)	394
12–19 years	99–00	<b>0.007</b> (0.006–0.008)	<b>0.006</b> (0.005–0.008)	<b>0.010</b> (0.009–0.014)	<b>0.020</b> (0.014–0.030)	<b>0.030</b> (0.019–0.074)	719
	01–02	<b>0.007</b> (0.006–0.008)	<b>0.007</b> (0.006–0.008)	<b>0.012</b> (0.009–0.016)	<b>0.020</b> (0.015–0.026)	<b>0.026</b> (0.020–0.042)	762
	03–04	<b>0.007</b> (0.006–0.008)	<b>0.006</b> (0.005–0.007)	<b>0.010</b> (0.008–0.013)	<b>0.019</b> (0.015–0.027)	<b>0.034</b> (0.022–0.041)	725
	05–06	<b>0.006</b> (0.005–0.007)	<b>0.005</b> (0.005–0.006)	<b>0.009</b> (0.007–0.012)	<b>0.017</b> (0.013–0.022)	<b>0.023</b> (0.019–0.026)	701
	07–08	<b>0.007</b> (0.006–0.009)	<b>0.006</b> (0.005–0.008)	<b>0.012</b> (0.009–0.016)	<b>0.025</b> (0.013–0.050)	<b>0.033</b> (0.022–0.077)	376
$\geq 20$ years	99–00	<b>0.007</b> (0.006–0.009)	<b>0.007</b> (0.006–0.009)	<b>0.013</b> (0.010–0.016)	<b>0.024</b> (0.019–0.029)	<b>0.034</b> (0.025–0.051)	1,405
	01–02	<b>0.008</b> (0.007–0.010)	<b>0.007</b> (0.006–0.009)	<b>0.014</b> (0.011–0.019)	<b>0.027</b> (0.020–0.039)	<b>0.043</b> (0.030–0.063)	1,559
	03–04	<sup>a</sup>	<b>0.007</b> (0.006–0.008)	<b>0.012</b> (0.010–0.014)	<b>0.020</b> (0.017–0.024)	<b>0.028</b> (0.022–0.038)	1,543
	05–06	<b>0.006</b> (0.005–0.006)	<b>0.005</b> (0.005–0.006)	<b>0.009</b> (0.008–0.010)	<b>0.016</b> (0.014–0.019)	<b>0.026</b> (0.020–0.039)	1,520
	07–08	<b>0.007</b> (0.006–0.008)	<b>0.006</b> (0.005–0.008)	<b>0.012</b> (0.009–0.016)	<b>0.024</b> (0.016–0.036)	<b>0.037</b> (0.025–0.065)	1,857
<b>Gender</b> Males	99–00	<b>0.007</b> (0.006–0.009)	<b>0.006</b> (0.005–0.008)	<b>0.011</b> (0.009–0.015)	<b>0.021</b> (0.017–0.028)	<b>0.035</b> (0.024–0.056)	1,227
	01–02	<b>0.007</b> (0.006–0.008)	<b>0.007</b> (0.006–0.008)	<b>0.012</b> (0.010–0.015)	<b>0.022</b> (0.018–0.028)	<b>0.033</b> (0.025–0.047)	1,334
	03–04	<b>0.007</b> (0.006–0.008)	<b>0.006</b> (0.006–0.007)	<b>0.010</b> (0.009–0.012)	<b>0.019</b> (0.015–0.024)	<b>0.026</b> (0.019–0.039)	1,280

6. POTENTIAL FOR HUMAN EXPOSURE

**Table 6-7. Geometric Mean and Selected Percentile of Urinary Concentrations of Uranium ( $\mu\text{g/g}$  Creatinine) for the U.S. Population from the National Health and Nutrition Examination Survey (NHANES)**

	Survey years	Geometric mean (95% confidence interval)		Selected percentiles (95% confidence interval)				Sample size					
				50th	75th	90 <sup>th</sup>	95th						
Females	05–06	<b>0.005</b>	(0.005–0.005)	<b>0.005</b>	(0.004–0.005)	<b>0.008</b>	(0.007–0.009)	<b>0.014</b>	(0.013–0.016)	<b>0.021</b>	(0.016–0.031)	1,271	
	07–08	<b>0.007</b>	(0.005–0.008)	<b>0.006</b>	(0.005–0.007)	<b>0.012</b>	(0.009–0.015)	<b>0.022</b>	(0.016–0.031)	<b>0.032</b>	(0.024–0.056)	1,327	
	99–00	<b>0.008</b>	(0.007–0.010)	<b>0.007</b>	(0.006–0.010)	<b>0.013</b>	(0.010–0.017)	<b>0.025</b>	(0.019–0.033)	<b>0.034</b>	(0.027–0.054)	1,237	
	01–02	<b>0.009</b>	(0.008–0.011)	<b>0.009</b>	(0.007–0.011)	<b>0.016</b>	(0.012–0.021)	<b>0.029</b>	(0.021–0.042)	<b>0.045</b>	(0.031–0.067)	1,355	
	03–04	<sup>a</sup>		<b>0.008</b>	(0.007–0.009)	<b>0.013</b>	(0.011–0.016)	<b>0.022</b>	(0.018–0.028)	<b>0.031</b>	(0.025–0.041)	1,277	
	05–06	<b>0.006</b>	(0.006–0.007)	<b>0.006</b>	(0.005–0.006)	<b>0.010</b>	(0.009–0.011)	<b>0.019</b>	(0.015–0.024)	<b>0.035</b>	(0.022–0.041)	1,305	
Race/ethnicity	07–08	<b>0.008</b>	(0.006–0.009)	<b>0.007</b>	(0.006–0.008)	<b>0.013</b>	(0.010–0.018)	<b>0.026</b>	(0.016–0.043)	<b>0.042</b>	(0.024–0.083)	1,300	
	Mexican Americans	99–00	<b>0.015</b>	(0.011–0.022)	<b>0.015</b>	(0.011–0.020)	<b>0.029</b>	(0.016–0.058)	<b>0.059</b>	(0.027–0.146)	<b>0.100</b>	(0.042–0.270)	883
		01–02	<b>0.012</b>	(0.010–0.016)	<b>0.012</b>	(0.009–0.016)	<b>0.021</b>	(0.015–0.028)	<b>0.033</b>	(0.024–0.053)	<b>0.050</b>	(0.034–0.080)	682
		03–04	<b>0.013</b>	(0.010–0.016)	<b>0.013</b>	(0.009–0.017)	<b>0.022</b>	(0.016–0.029)	<b>0.035</b>	(0.026–0.051)	<b>0.051</b>	(0.034–0.061)	618
		05–06	<b>0.008</b>	(0.007–0.009)	<b>0.007</b>	(0.006–0.008)	<b>0.013</b>	(0.010–0.015)	<b>0.022</b>	(0.016–0.031)	<b>0.035</b>	(0.025–0.060)	652
		07–08	<b>0.009</b>	(0.008–0.012)	<b>0.009</b>	(0.007–0.011)	<b>0.017</b>	(0.014–0.021)	<b>0.031</b>	(0.021–0.048)	<b>0.042</b>	(0.027–0.097)	515
	Non-Hispanic blacks	99–00	<b>0.006</b>	(0.004–0.007)	<b>0.005</b>	(0.004–0.006)	<b>0.008</b>	(0.006–0.013)	<b>0.017</b>	(0.011–0.029)	<b>0.028</b>	(0.018–0.048)	568
		01–02	<b>0.005</b>	(0.005–0.006)	<b>0.005</b>	(0.005–0.006)	<b>0.008</b>	(0.007–0.010)	<b>0.013</b>	(0.011–0.014)	<b>0.017</b>	(0.014–0.029)	667
		03–04	<b>0.006</b>	(0.005–0.006)	<b>0.005</b>	(0.005–0.006)	<b>0.009</b>	(0.008–0.009)	<b>0.013</b>	(0.012–0.015)	<b>0.018</b>	(0.014–0.024)	722
		05–06	<b>0.004</b>	(0.004–0.005)	<b>0.004</b>	(0.003–0.005)	<b>0.006</b>	(0.006–0.007)	<b>0.011</b>	(0.009–0.015)	<b>0.017</b>	(0.012–0.021)	692
		07–08	<b>0.005</b>	(0.005–0.006)	<b>0.005</b>	(0.004–0.006)	<b>0.009</b>	(0.007–0.011)	<b>0.014</b>	(0.011–0.017)	<b>0.018</b>	(0.014–0.041)	589
	Non-Hispanic whites	99–00	<b>0.007</b>	(0.006–0.009)	<b>0.007</b>	(0.006–0.009)	<b>0.012</b>	(0.010–0.015)	<b>0.021</b>	(0.017–0.027)	<b>0.030</b>	(0.024–0.050)	822
	01–02	<b>0.008</b>	(0.007–0.009)	<b>0.007</b>	(0.006–0.009)	<b>0.013</b>	(0.011–0.016)	<b>0.025</b>	(0.018–0.032)	<b>0.034</b>	(0.025–0.051)	1,132	
	03–04	<sup>a</sup>		<b>0.007</b>	(0.006–0.008)	<b>0.011</b>	(0.010–0.013)	<b>0.019</b>	(0.015–0.024)	<b>0.027</b>	(0.020–0.040)	1,074	
	05–06	<b>0.006</b>	(0.005–0.006)	<b>0.005</b>	(0.005–0.006)	<b>0.009</b>	(0.008–0.010)	<b>0.016</b>	(0.013–0.020)	<b>0.024</b>	(0.019–0.039)	1,041	
	07–08	<b>0.007</b>	(0.006–0.009)	<b>0.006</b>	(0.005–0.008)	<b>0.012</b>	(0.009–0.019)	<b>0.025</b>	(0.015–0.043)	<b>0.039</b>	(0.024–0.081)	1,095	

<sup>a</sup>Not calculated: proportion of results below limit of detection was too high to provide a valid result.

Source: CDC 2012

## 6. POTENTIAL FOR HUMAN EXPOSURE

**Table 6-8. Geometric Mean and Selected Percentile of Urinary Concentrations of Uranium ( $\mu\text{g/L}$ ) for the U.S. Population from the National Health and Nutrition Examination Survey (NHANES)**

	Survey years	Geometric mean (95% confidence interval)	Selected percentiles (95% confidence interval)				Sample size
			50th	75th	90 <sup>th</sup>	95th	
<b>Total</b>	99–00	<b>0.008</b> (0.007–0.009)	<b>0.007</b> (0.006–0.008)	<b>0.013</b> (0.010–0.017)	<b>0.027</b> (0.021–0.038)	<b>0.046</b> (0.037–0.056)	2,464
	01–02	<b>0.009</b> (0.007–0.010)	<b>0.008</b> (0.007–0.009)	<b>0.014</b> (0.012–0.018)	<b>0.030</b> (0.023–0.039)	<b>0.046</b> (0.034–0.062)	2,690
	03–04	<b>0.008</b> (0.007–0.008)	<b>0.007</b> (0.006–0.007)	<b>0.011</b> (0.010–0.013)	<b>0.021</b> (0.017–0.026)	<b>0.031</b> (0.026–0.037)	2,557
	05–06	<b>0.006</b> (0.005–0.006)	<b>0.005</b> (0.005–0.006)	<b>0.010</b> (0.009–0.012)	<b>0.019</b> (0.016–0.022)	<b>0.033</b> (0.023–0.041)	2,576
	07–08	<b>0.007</b> (0.006–0.008)	<b>0.007</b> (0.005–0.008)	<b>0.013</b> (0.011–0.015)	<b>0.024</b> (0.018–0.033)	<b>0.039</b> (0.026–0.057)	2,627
<b>Age group</b>							
6–11 years	99–00	<b>0.009</b> (0.007–0.011)	<b>0.007</b> (0.006–0.009)	<b>0.013</b> (0.009–0.022)	<b>0.032</b> (0.019–0.048)	<b>0.048</b> (0.033–0.066)	340
	01–02	<b>0.008</b> (0.007–0.010)	<b>0.008</b> (0.006–0.010)	<b>0.014</b> (0.010–0.020)	<b>0.026</b> (0.020–0.036)	<b>0.040</b> (0.025–0.049)	368
	03–04	<b>0.008</b> (0.007–0.009)	<b>0.007</b> (0.006–0.009)	<b>0.012</b> (0.009–0.016)	<b>0.020</b> (0.016–0.026)	<b>0.028</b> (0.020–0.039)	289
	05–06	<b>0.006</b> (0.005–0.007)	<b>0.005</b> (0.004–0.007)	<b>0.010</b> (0.008–0.011)	<b>0.015</b> (0.012–0.031)	<b>0.031</b> (0.013–0.051)	355
	07–08	<b>0.007</b> (0.006–0.008)	<b>0.006</b> (0.005–0.008)	<b>0.012</b> (0.009–0.016)	<b>0.021</b> (0.016–0.027)	<b>0.030</b> (0.022–0.039)	394
12–19 years	99–00	<b>0.009</b> (0.008–0.011)	<b>0.009</b> (0.008–0.010)	<b>0.015</b> (0.012–0.018)	<b>0.026</b> (0.020–0.043)	<b>0.044</b> (0.028–0.072)	719
	01–02	<b>0.010</b> (0.008–0.012)	<b>0.010</b> (0.008–0.012)	<b>0.017</b> (0.013–0.023)	<b>0.030</b> (0.022–0.042)	<b>0.042</b> (0.027–0.088)	762
	03–04	<b>0.010</b> (0.009–0.011)	<b>0.009</b> (0.008–0.010)	<b>0.015</b> (0.012–0.018)	<b>0.028</b> (0.023–0.036)	<b>0.038</b> (0.036–0.053)	725
	05–06	<b>0.007</b> (0.006–0.008)	<b>0.007</b> (0.006–0.008)	<b>0.013</b> (0.011–0.015)	<b>0.023</b> (0.018–0.032)	<b>0.034</b> (0.027–0.045)	701
	07–08	<b>0.009</b> (0.007–0.011)	<b>0.008</b> (0.007–0.011)	<b>0.016</b> (0.014–0.020)	<b>0.029</b> (0.022–0.056)	<b>0.056</b> (0.027–0.156)	376
$\geq 20$ years	99–00	<b>0.008</b> (0.006–0.009)	<b>0.007</b> (0.005–0.008)	<b>0.013</b> (0.010–0.017)	<b>0.027</b> (0.021–0.040)	<b>0.046</b> (0.036–0.056)	1,405
	01–02	<b>0.009</b> (0.007–0.010)	<b>0.008</b> (0.007–0.009)	<b>0.014</b> (0.012–0.017)	<b>0.031</b> (0.022–0.040)	<b>0.046</b> (0.034–0.065)	1,560
	03–04	<sup>a</sup>	<b>0.006</b> (0.005–0.007)	<b>0.011</b> (0.009–0.012)	<b>0.019</b> (0.016–0.026)	<b>0.029</b> (0.024–0.038)	1,543
	05–06	<b>0.006</b> (0.005–0.006)	<b>0.005</b> (0.005–0.006)	<b>0.010</b> (0.008–0.012)	<b>0.019</b> (0.015–0.022)	<b>0.032</b> (0.022–0.041)	1,520
	07–08	<b>0.007</b> (0.005–0.008)	<b>0.006</b> (0.005–0.008)	<b>0.013</b> (0.010–0.015)	<b>0.024</b> (0.017–0.035)	<b>0.039</b> (0.026–0.052)	1,857
<b>Gender</b>							
Males	99–00	<b>0.009</b> (0.008–0.011)	<b>0.008</b> (0.007–0.010)	<b>0.015</b> (0.012–0.021)	<b>0.036</b> (0.024–0.046)	<b>0.053</b> (0.040–0.067)	1,227
	01–02	<b>0.009</b> (0.008–0.011)	<b>0.009</b> (0.007–0.010)	<b>0.015</b> (0.013–0.021)	<b>0.033</b> (0.024–0.045)	<b>0.047</b> (0.035–0.065)	1,335

6. POTENTIAL FOR HUMAN EXPOSURE

**Table 6-8. Geometric Mean and Selected Percentile of Urinary Concentrations of Uranium (µg/L) for the U.S. Population from the National Health and Nutrition Examination Survey (NHANES)**

	Survey years	Geometric mean (95% confidence interval)		Selected percentiles (95% confidence interval)				Sample size				
				50th	75th	90 <sup>th</sup>	95th					
Females	03–04	<b>0.008</b>	(0.007–0.009)	<b>0.007</b>	(0.006–0.008)	<b>0.013</b>	(0.011–0.016)	<b>0.023</b>	(0.019–0.027)	<b>0.031</b>	(0.027–0.035)	1,280
	05–06	<b>0.006</b>	(0.006–0.007)	<b>0.006</b>	(0.005–0.006)	<b>0.011</b>	(0.009–0.012)	<b>0.019</b>	(0.015–0.022)	<b>0.030</b>	(0.021–0.043)	1,271
	07–08	<b>0.007</b>	(0.006–0.009)	<b>0.007</b>	(0.006–0.009)	<b>0.014</b>	(0.013–0.016)	<b>0.026</b>	(0.021–0.037)	<b>0.046</b>	(0.030–0.056)	1,327
	99–00	<b>0.007</b>	(0.006–0.008)	<b>0.006</b>	(0.005–0.007)	<b>0.012</b>	(0.009–0.015)	<b>0.023</b>	(0.016–0.033)	<b>0.036</b>	(0.026–0.050)	1,237
	01–02	<b>0.008</b>	(0.007–0.010)	<b>0.008</b>	(0.006–0.009)	<b>0.014</b>	(0.011–0.017)	<b>0.027</b>	(0.019–0.037)	<b>0.041</b>	(0.029–0.063)	1,355
	03–04	<sup>a</sup>		<b>0.006</b>	(0.005–0.007)	<b>0.010</b>	(0.009–0.011)	<b>0.018</b>	(0.013–0.027)	<b>0.031</b>	(0.022–0.039)	1,277
	05–06	<b>0.005</b>	(0.005–0.006)	<b>0.005</b>	(0.004–0.006)	<b>0.010</b>	(0.008–0.011)	<b>0.019</b>	(0.016–0.023)	<b>0.034</b>	(0.025–0.040)	1,305
	07–08	<b>0.006</b>	(0.005–0.008)	<b>0.006</b>	(0.005–0.007)	<b>0.011</b>	(0.009–0.015)	<b>0.024</b>	(0.016–0.033)	<b>0.035</b>	(0.022–0.067)	1,300
<b>Race/ethnicity</b>												
Mexican Americans	99–00	<b>0.017</b>	(0.012–0.023)	<b>0.016</b>	(0.011–0.021)	<b>0.033</b>	(0.020–0.054)	<b>0.060</b>	(0.040–0.127)	<b>0.114</b>	(0.054–0.279)	883
	01–02	<b>0.013</b>	(0.010–0.016)	<b>0.012</b>	(0.009–0.016)	<b>0.022</b>	(0.017–0.030)	<b>0.040</b>	(0.031–0.054)	<b>0.055</b>	(0.046–0.069)	683
	03–04	<b>0.014</b>	(0.011–0.017)	<b>0.013</b>	(0.009–0.018)	<b>0.024</b>	(0.017–0.034)	<b>0.041</b>	(0.028–0.073)	<b>0.064</b>	(0.039–0.158)	618
	05–06	<b>0.008</b>	(0.007–0.009)	<b>0.009</b>	(0.007–0.010)	<b>0.014</b>	(0.013–0.017)	<b>0.025</b>	(0.021–0.033)	<b>0.042</b>	(0.028–0.051)	652
	07–08	<b>0.009</b>	(0.008–0.011)	<b>0.009</b>	(0.008–0.010)	<b>0.017</b>	(0.014–0.022)	<b>0.032</b>	(0.026–0.039)	<b>0.047</b>	(0.032–0.073)	515
	99–00	<b>0.009</b>	(0.007–0.011)	<b>0.008</b>	(0.006–0.010)	<b>0.014</b>	(0.010–0.020)	<b>0.028</b>	(0.018–0.049)	<b>0.052</b>	(0.030–0.067)	568
	01–02	<b>0.008</b>	(0.007–0.009)	<b>0.008</b>	(0.007–0.009)	<b>0.012</b>	(0.011–0.015)	<b>0.021</b>	(0.017–0.027)	<b>0.030</b>	(0.023–0.037)	667
	03–04	<b>0.008</b>	(0.008–0.009)	<b>0.007</b>	(0.007–0.008)	<b>0.012</b>	(0.011–0.013)	<b>0.021</b>	(0.017–0.027)	<b>0.031</b>	(0.023–0.045)	722
Non-Hispanic blacks	05–06	<b>0.006</b>	(0.005–0.007)	<b>0.006</b>	(0.005–0.007)	<b>0.010</b>	(0.009–0.011)	<b>0.016</b>	(0.014–0.020)	<b>0.023</b>	(0.018–0.031)	692
	07–08	<b>0.007</b>	(0.006–0.009)	<b>0.007</b>	(0.006–0.008)	<b>0.013</b>	(0.010–0.016)	<b>0.024</b>	(0.016–0.038)	<b>0.038</b>	(0.025–0.055)	589

## 6. POTENTIAL FOR HUMAN EXPOSURE

**Table 6-8. Geometric Mean and Selected Percentile of Urinary Concentrations of Uranium ( $\mu\text{g/L}$ ) for the U.S. Population from the National Health and Nutrition Examination Survey (NHANES)**

	Survey years	Geometric mean (95% confidence interval)	Selected percentiles (95% confidence interval)				Sample size
			50th	75th	90 <sup>th</sup>	95th	
Non-Hispanic whites	99–00	<b>0.007</b> (0.006–0.009)	<b>0.007</b> (0.006–0.007)	<b>0.012</b> (0.009–0.016)	<b>0.023</b> (0.017–0.037)	<b>0.043</b> (0.027–0.051)	822
	01–02	<b>0.008</b> (0.007–0.009)	<b>0.007</b> (0.006–0.009)	<b>0.013</b> (0.011–0.016)	<b>0.026</b> (0.019–0.035)	<b>0.037</b> (0.029–0.050)	1,132
	03–04	<sup>a</sup>	<b>0.006</b> (0.005–0.007)	<b>0.010</b> (0.009–0.012)	<b>0.018</b> (0.015–0.023)	<b>0.027</b> (0.020–0.036)	1,074
	05–06	<b>0.005</b> (0.005–0.006)	<b>0.005</b> (0.004–0.006)	<b>0.010</b> (0.008–0.012)	<b>0.018</b> (0.014–0.022)	<b>0.033</b> (0.021–0.043)	1,041
	07–08	<b>0.006</b> (0.005–0.008)	<b>0.006</b> (0.005–0.008)	<b>0.013</b> (0.009–0.016)	<b>0.023</b> (0.015–0.039)	<b>0.038</b> (0.022–0.086)	1,095

<sup>a</sup>Not calculated: proportion of results below limit of detection was too high to provide a valid result.

Note: Limit of detection for survey years 99–00, 01–02, 03–04, 05–06, and 07–08 are 0.004, 0.004, 0.005, 0.002, and 0.002, respectively

Source: CDC 2012

## 6. POTENTIAL FOR HUMAN EXPOSURE

New York City residents and Illinois residents averaged 0.14  $\mu\text{g}/\text{kg}$  (0.09 pCi/kg) and 0.1  $\mu\text{g}/\text{kg}$  (0.07 pCi/kg), respectively, compared to a mean value worldwide of 0.58  $\mu\text{g}/\text{kg}$  (Fisenne 1988). Mean concentrations of uranium were measured in the organs of persons representing all age groups from different parts of the United States. The uranium values for lungs, liver, kidney, and bone (vertebrae, rib, and skeleton) were 0.5–1.17  $\mu\text{g}/\text{kg}$  (0.34–0.78 pCi/kg), 0.12–0.33  $\mu\text{g}/\text{kg}$  (0.08–0.22 pCi/kg), 0.39–1.00  $\mu\text{g}/\text{kg}$  (0.26–0.67 pCi/kg), and 0.25–1.9  $\mu\text{g}/\text{kg}$  (0.17–1.3 pCi/kg), respectively (Fisenne and Welford 1986; Fisenne 1988; Singh et al. 1986b). These differences reflect dietary variations.

Workers engaged in the extraction and processing of uranium are occupationally exposed to uranium. Industries where uranium exposures are known to have occurred are uranium mining and milling, uranium conversion and enrichment, uranium fuel fabrication, and nuclear weapons production.

Epidemiologic surveys were initiated in the United States as early as 1950 to study the effects of uranium exposure on uranium millers, and similar studies were performed of workers at the Oak Ridge Gaseous Diffusion Plant in Oak Ridge, Tennessee, where uranium conversion and enrichment were performed. Those studies attributed the health decrement to radon progeny and other toxicants and not directly to the uranium (BEIR IV 1988).

Exposure to enriched uranium, used as a uranium fuel in nuclear energy production, may present a combined chemical and radiological health hazard. However, access to enriched or high specific activity uranium is strictly regulated by the USNRC and the DOE. Therefore, the potential for significant human exposure to enriched uranium should be limited to rare accidental releases in the workplace.

## 6.6 EXPOSURES OF CHILDREN

This section focuses on exposures from conception to maturity at 18 years in humans. Differences from adults in susceptibility to hazardous substances are discussed in Section 3.7, Children's Susceptibility.

Children are not small adults. A child's exposure may differ from an adult's exposure in many ways. Children drink more fluids, eat more food, breathe more air per kilogram of body weight, and have a larger skin surface in proportion to their body volume. A child's diet often differs from that of adults. The developing human's source of nutrition changes with age: from placental nourishment to breast milk or formula to the diet of older children who eat more of certain types of foods than adults. A child's behavior and lifestyle also influence exposure. Children crawl on the floor, put things in their mouths,

## 6. POTENTIAL FOR HUMAN EXPOSURE

sometimes eat inappropriate things (such as dirt or paint chips), and spend more time outdoors. Children also are closer to the ground, and they do not use the judgment of adults to avoid hazards (NRC 1993).

As for adults in the general population, small exposures occur from normal ingestion of food and drinking water and inhaling air. These exposures may be higher in areas with naturally high uranium soil levels or near uranium processing sites and hazardous waste sites containing uranium. Levels of uranium measured between 1999 and 2008 in the urine of various ages of the U.S. population from NHANES are listed in Tables 6-7 and 6-8 (CDC 2012). Concentrations measured in children aged 6–11 and 12–19 years were similar to those measured in adults aged  $\geq 20$  years, across all years.

A study of uranium content in bone from three age groups (<13, 13–20, and 20–25 years old) reported somewhat higher uranium content in the youngest compared to the oldest age group (approximately 1.5–3-fold); however, there were only 2–4 subjects in each group and the results were not statistically significant (Broadway and Strong 1983). No information on uranium levels in amniotic fluid, meconium, cord blood, neonatal blood, or breast milk was located.

At hazardous waste sites, uranium that is found in excess of natural background levels is most likely to be in soil and presents a special hazard for young children. Hand-to-mouth activity and eating contaminated dirt will result in oral exposure to uranium. The hazard in this case depends on the form of uranium present at the waste site. Soluble uranium compounds (e.g., uranyl nitrate) are absorbed by the gastrointestinal tract to a much greater degree than insoluble uranium compounds (e.g., insoluble oxides of uranium), and a large toxicity database in animals supports the higher toxicity of the soluble forms (see Chapter 3). Uranium in soil at non-hazardous waste sites is almost entirely (>99%) in the form of insoluble oxides of uranium, which have very low bioavailability.

As for adults, the potential for uranium exposure is greater for children who consume foods grown in areas with elevated concentrations of uranium in the soil and for children with elevated concentrations of uranium in their drinking water (EPA 1985c; NCRP 1984a). Other home exposures are unlikely since no household products or products used in crafts, hobbies, or cottage industries contain significant amounts of uranium, except in cases where uranium-bearing rocks are used in and around the home for decorative, collection, or construction purposes (Agency for Toxic Substances and Disease Registry 1997).

No information is available on whether children differ from adults in their weight-adjusted intake of uranium. The fractional absorption of uranium (as uranyl nitrate and uranyl citrate) by the oral route was



## 6. POTENTIAL FOR HUMAN EXPOSURE

higher in neonatal than in adult rats and swine (Sullivan 1980b; Sullivan and Gorham 1982). In a mathematical model developed by the ICRP for risk assessment, one of the assumptions is that the fractional absorption of ingested uranium is twice as high in children under the age of 1 year compared to adults.

Uranium exposure to children from parents' work clothes, skin, hair, tools, or other objects from the workplace is possible if the parent uses uranium at work. However, in a comprehensive review of incidents of home contamination by workers (NIOSH 1997), no cases of uranium contamination were described.

As a radionuclide, uranium is potentially genotoxic and thus, it is important to know if parental exposure to uranium could affect the developing fetus or germ cells. However, epidemiological studies of workers exposed to uranium show no evidence of genotoxic effects. This is most likely due to the very low specific activity, the low systemic absorption of uranium, and the lack of concentration of uranium in the germ cells. Genotoxic effects to parental germ cells or to a developing fetus are not likely at probable levels of exposure to uranium from the environment or at hazardous waste sites. Some uranium is stored in bone, but it is not known if this uranium is released during pregnancy and lactation, when it could result in exposure to the fetus or infant.

### 6.7 POPULATIONS WITH POTENTIALLY HIGH EXPOSURES

Higher rates of uranium exposure have been reported for some populations. The potential for uranium exposure is greater for individuals who consume foods grown in areas with elevated concentrations of uranium in the soil, and for individuals with elevated concentrations of uranium in their drinking water (EPA 1985c; NCRP 1984a; Orloff et al. 2004). Industries where higher exposures to uranium are known to occur include uranium mining and milling, uranium conversion and enrichment, uranium fuel fabrication, and nuclear weapons production (BEIR IV 1988; Miller 1977; NCRP 1984a; West et al. 1979). Other groups with the potentially higher exposures include persons involved in producing and using phosphate fertilizers and individuals living and working near fossil fuel plants (Jaworowski and Grzybowska 1977; NCRP 1984a; Tadmor 1986; Weissman et al. 1983). Uranium compounds were previously used in dental appliances, and individuals with dental work of this kind have potentially higher exposures (Sairenji et al. 1980).

## 6. POTENTIAL FOR HUMAN EXPOSURE

The use of depleted uranium in high-density tank armor and armor piercing munitions may result in higher exposures of military personnel who are located in, or nearby, an armored vehicle penetrated by a depleted uranium munition (kinetic energy penetrator) during combat. The primary routes of exposure to depleted uranium include inhalation of aerosols formed during the high energy collisions of depleted uranium munitions with vehicle armor, embedding of depleted uranium fragments in wounds to the body, and ingestion resulting from contact with depleted uranium residue on contaminated surfaces (Parkhurst and Guilmette 2009a; Szrom et al. 2009). The handling of coated and intact depleted uranium plates and unfired depleted uranium munitions should not result in exposure to uranium.

The Capstone Depleted Uranium Aerosol Characterization and Risk Assessment Study, begun in November 2000, was conducted to determine the level of exposure to depleted uranium aerosols resulting from perforation of armored Abrams Tanks and Bradley Fighting Vehicles with large caliber depleted uranium munitions (Guilmette and Parkhurst 2007; Parkhurst and Guilmette 2009a). Results of the Capstone study show mean depleted uranium concentrations measured inside the unventilated combat vehicles ranging from 3.0 to 16 g/m<sup>3</sup> 10 seconds after perforation and falling to 0.020–0.15 g/m<sup>3</sup> within 30 minutes (Parkhurst et al. 2009). Levels were much lower in a ventilated Abrams tank with a maximum concentration of 0.22 g/m<sup>3</sup> measured 1 minute after perforation and 0.011 g/m<sup>3</sup> after 30 minutes (Guilmette and Parkhurst 2007; Parkhurst et al. 2009). Based on the aerosol measurements, median inhalation intakes of depleted uranium were determined to be 10–280 mg for a combat vehicle crew member exiting 1 minute after perforation, 43–710 mg for a combat vehicle crew member exiting 5 minutes after perforation, and 27–200 mg for a first responder entering 5 minutes after perforation and remaining in the combat vehicle for 10 minutes (Guilmette et al. 2009; Parkhurst and Guilmette 2009b). A depleted uranium inhalation intake rate ranging from 0.447 to 14.5 mg/hour was estimated for military personnel and civilian employees located near vehicles containing depleted uranium fragments but not directly involved in the perforation incident (Szrom et al. 2009). Ingestion intake rates for these individuals were estimated to be 1.78–38.9 mg/hour resulting from hand-to-mouth transfer from contact with depleted uranium contaminated surfaces (Szrom et al. 2009).

Depleted uranium was reportedly used in the military conflicts in Iraq during 1991 and 2003, in Bosnia during 1994, and in Kosovo during 1999 (Oeh et al. 2007b). Several studies have monitored the levels of uranium in the urine of individuals with reported exposure to the depleted uranium used during these conflicts (Hooper et al. 1999; McDiarmid et al. 1999b, 2001b, 2004a; Miller et al. 2008; Oeh et al. 2007a, 2007b; Toohey 2003). Table 6-9 lists urinary concentrations measured in these studies. In general, the levels of uranium measured in the urine of individuals reporting exposure were not different than levels in

## 6. POTENTIAL FOR HUMAN EXPOSURE

**Table 6-9. Urinary Levels of Uranium in Individuals Exposed through Military Use of Depleted Uranium**

Location	Number of individuals	Concentration ( $\mu\text{g U/g creatinine}$ )			Reference
		Mean	Minimum	Maximum	
U.S. Gulf War veterans, 1993–1994					Hooper et al. 1999
Reported depleted uranium exposure without embedded fragments	10	0.03	—	—	
With embedded depleted uranium fragments	15	4.47	—	22.48	
1997					McDiarmid et al. 1999b; Toohey 2003
Non-exposed	22	0.02	0.01	0.05	
Reported depleted uranium exposure <sup>a</sup>	29	3.59	0.01	30.74 <sup>a</sup>	
1997–1999					Toohey 2003
With embedded depleted uranium fragments (30–840 mg)	7	—	0.46	24.77	
1998–1999					McDiarmid et al. 2001b
Reported depleted uranium exposure	169	0.01 <sup>b</sup>	0.001	0.432	
1998–2002					McDiarmid et al. 2004a
Reported depleted uranium exposure without embedded fragments	440	0.001	0.005 <sup>c</sup>	0.042 <sup>d</sup>	
With embedded depleted uranium fragments	6	0.083	0.008 <sup>c</sup>	2.895	
Peacekeepers and residents in Kosovo, 1999–2006					Oeh et al. 2007a, 2007b
German peacekeepers	726	0.0139	0.006	0.1715	
Kosovo residents	25	0.0251	0.00292	0.2668	
Unexposed controls from southern Germany	63	0.0128	0.0014	0.775	
British Forces					Miller et al. 2008
Military personnel not having served in Iraq	732	0.0027 <sup>b</sup>	<0.001	0.556	

<sup>a</sup>All values >1.0  $\mu\text{g U/g creatinine}$  occurred in nine veterans containing embedded fragments.

<sup>b</sup>Median value.

<sup>c</sup>10th percentile value.

<sup>d</sup>95th percentile value.

## 6. POTENTIAL FOR HUMAN EXPOSURE

non-exposed individuals. A notable exception is seen with individuals having depleted uranium-containing fragments embedded within their bodies (Hooper et al. 1999; McDiarmid et al. 1999b, 2004a; Toohey 2003). Measured urinary uranium levels in these individuals are consistently elevated, reaching as high as 30 µg U/g creatinine.

## 6.8 ADEQUACY OF THE DATABASE

Section 104(i)(5) of CERCLA, as amended, directs the Administrator of ATSDR (in consultation with the Administrator of EPA and agencies and programs of the Public Health Service) to assess whether adequate information on the health effects of uranium is available. Where adequate information is not available, ATSDR, in conjunction with NTP, is required to assure the initiation of a program of research designed to determine the health effects (and techniques for developing methods to determine such health effects) of uranium.

The following categories of possible data needs have been identified by a joint team of scientists from ATSDR, NTP, and EPA. They are defined as substance-specific informational needs that if met would reduce the uncertainties of human health assessment. This definition should not be interpreted to mean that all data needs discussed in this section must be filled. In the future, the identified data needs will be evaluated and prioritized, and a substance-specific research agenda will be proposed.

### 6.8.1 Identification of Data Needs

**Physical and Chemical Properties.** Pertinent data on the physical and chemical properties of uranium and uranium compounds are available in the literature.

**Production, Import/Export, Use, Release, and Disposal.** According to the Emergency Planning and Community Right-to-Know Act of 1986, 42 U.S.C. Section 11023, industries are required to submit substance release and off-site transfer information to the EPA. The TRI, which contains this information for 2010, became available in May of 2008. This database is updated yearly and should provide a list of industrial production facilities and emissions.

Data regarding the past and present production (ABMS 1994; EPA 1985a) and import/export volumes (USDOC 1995) for uranium are available. The uses of uranium and uranium compounds are well known (Clayton and Clayton 1981; EPA 1985c). Other than glazed ceramic foodware and decorative items (Landa and Councell 1992) and dental appliances (Sairenji et al. 1980), consumer contact with uranium

## 6. POTENTIAL FOR HUMAN EXPOSURE

products is negligible. Since uranium is not covered under SARA, Title III, manufacturers and users are not required to report releases to the EPA. There is a lack of data on the release and disposal of uranium during mining, milling, and chemical processing and its use during fuel cycle operations. The disposal of uranium is governed by the USNRC regulations (10 CFR 61), and releases of uranium to the environment are governed by USNRC and EPA regulations (10 CFR 20, Appendix B; 40 CFR 190; 40 CFR 192). Since significant amounts of depleted uranium are used on modern battlefields, it would be useful to have more information on the export of depleted uranium to other nations, the disposal of related wastes in the United States, and the mass of depleted uranium released to long-distance air transport when projectiles are used against different target types.

**Environmental Fate.** For solids, there is a need to determine uptake factors into edible portions of plants and not just adherence to the root structure. For the solid-liquid interface, a method is needed to determine a method by which  $^{234}\text{U}$  to  $^{238}\text{U}$  ratio deviates from unity such that the EPA ERAMS water sample results indicate disequilibrium. Uranium enters the atmosphere in particulate form from natural sources and from uranium mining, milling, and processing. Dry or wet deposition from the atmosphere to soil and water can occur (Essien et al. 1985). Little experimental data on the particle size and residence time of uranium and uranium compounds present in ambient atmospheres are available. Additional data regarding the measured particle size of uranium compounds in ambient air, settling velocity, and knowledge of the chemical forms and lifetime of the particles in air would be useful. Although some studies have characterized the oxidation states and chemical forms of some uranium compounds ( $\text{UO}_2$  and  $\text{UO}_3$ ) (Dodge and Francis 1994; Wersin et al. 1994), more data identifying the chemical forms of uranium in the environment are needed to better understand the fate and transport of uranium. Since significant amounts of depleted uranium are used on modern battlefields, it would be useful to have more information on the export of depleted uranium to other nations and the disposal of related wastes in the United States, as well as estimates of projectile quantities that aerosolize to a significant extent and associated downwind air contamination levels.

**Bioavailability from Environmental Media.** The absorption and distribution of uranium as a result of inhalation and ingestion exposures have been discussed in Sections 3.5.1 and 3.5.2. However, quantitative data relating to physical/chemical properties such as particle size, chemical form, and degree of absorption with the bioavailability of uranium from inhaled air particles and inhaled and/or ingested soil particles, are lacking. Such studies would be useful in assessing potential public health impact of uranium to people living near a hazardous waste site.

## 6. POTENTIAL FOR HUMAN EXPOSURE

**Food Chain Bioaccumulation.** Information about uranium bioaccumulation in fish (Mahon 1982; Poston 1982; Swanson 1983; Waite et al. 1988) is available. Data concerning levels of uranium in various foods (EPA 1985c) are also available. These data indicate that uranium does not biomagnify in the food chain (Ahsanullah and Williams 1989; Morishima et al. 1977; Swanson 1983, 1985). Data on the levels of uranium in food grown in contaminated areas are limited. Additional data are needed on whether the uptake of uranium in fish is restricted to the gills and how much actually distributes to the meat.

**Exposure Levels in Environmental Media.** Reliable monitoring data for the levels of uranium in contaminated media at hazardous waste sites are needed so that the information obtained on levels of uranium in the environment can be used in combination with the known body burden of uranium to assess the potential risk of adverse health effects in populations living in the vicinity of hazardous waste sites.

The levels of uranium in airborne particles and precipitation have been monitored since 1973 (EPA 1994). Data from several large studies of uranium in domestic water supplies are available (Cothorn and Lappenbusch 1983; DOE 1981b), as are data from studies of groundwater and surface water (NCRP 1984a). The primary source of information on the occurrence of uranium in drinking water is the National Inorganics and Radionuclides Survey (NIRS) conducted by EPA (EPA 1991b). Some monitoring data are available for uranium-contaminated soils and sediments associated with the nuclear fuel cycle. Better information on background levels in the environment and speciation of uranium in soils and sediments would be useful for determining which species lead to actual public exposure.

**Exposure Levels in Humans.** Although some data on the urinary levels of uranium in humans exposed to natural background levels (food, water, and air) are available (CDC 2012), these data are nationally representative and do not reflect high exposures, such as those experienced in the Southwest area of the United States. Biomonitoring studies are needed in areas with higher natural uranium exposure to develop a baseline for comparison. Additionally, there are limited data on the uranium content in human tissues in the general population and in populations living in areas with higher background uranium levels. The principal source of information about occupationally exposed individuals is the U.S. Transuranium and Uranium Registries (USTUR) Tissue Program and database, established to document uranium levels and distribution in human tissues for occupationally exposed workers (PNL 1981). Several major database files are available. The Radiochemical file contains information about radiochemical analysis of tissue donations from occupationally exposed individuals. The Health Physics file contains bioassay and other health physics data. These two databases are

## 6. POTENTIAL FOR HUMAN EXPOSURE

regularly updated. The Medical file contains abstracted personal, medical, and clinical data; the Pathology file contains autopsy and pathology information; and the Skeletal Estimate file contains estimated actinide concentrations for unanalyzed half skeletons from donors (USTUR 1999).

This information is necessary for assessing the need to conduct health studies on these populations.

**Exposures of Children.** Children will be exposed to uranium in the same manner as adults in the general population (i.e., ingestion of food and water and inhalation of air). Concentrations measured in the urine of children aged 6–11 and 12–19 years during the National Health and Nutrition Examination Survey (NHANES) were similar to those measured in adults aged 20 years and older (CDC 2012), across all years. A study of uranium content in bone from three age groups (<13, 13–20, and 20–25 years old) reported somewhat higher uranium content in the youngest compared to the oldest age group (approximately 1.5–3-fold); however, there were only 2–4 subjects in each group and the results were not statistically significant (Broadway and Strong 1983). Since the skeletons of children are growing (higher rate of bone formation), it is possible that a higher fraction of circulating uranium will be deposited in bone than in adults. Further information is needed on bone levels of uranium in children to determine if this is the case. Uranium is found in all soil, and at potentially higher levels at some hazardous waste sites. Since children may have oral exposure to soil through hand-to-mouth activity, bioavailability studies of uranium in soil may be useful to assess the risk of this type of exposure. There is some evidence that neonatal animals absorb uranium in the gastrointestinal tract to a greater extent than adults. Experiments to confirm this finding and to determine how long into maturation a difference exists would help refine risk assessment for uranium exposure in children.

Child health data needs relating to susceptibility are discussed in Section 3.12.2, Identification of Data Needs: Children's Susceptibility.

**Exposure Registries.** A voluntary exposure registry, the USTUR for occupationally exposed individuals, was established at Richland, Washington, in 1968 as the National Plutonium Registry for investigation of the potential hazards for occupational exposure to uranium. In 1971, additional radiochemistry support was provided by Los Alamos National Laboratory. The U.S. Uranium Registry was created as a separate entity in 1978, and the two registries operated in parallel until 1987, when a single director was given responsibility for both registries. In 1992, the management and operation of the registries was combined at Washington State University under a grant from the U.S. DOE. The primary goals are to develop information on the distribution and dose of uranium and transuranic elements in

## 6. POTENTIAL FOR HUMAN EXPOSURE

humans, providing data for verification or development of radiation protection standards, and to determine and evaluate health effects due to exposure to these radioactive elements.

### **6.8.2 Ongoing Studies**

Ongoing studies are examining the levels of potential exposure to depleted uranium used for military purposes.



## 7. ANALYTICAL METHODS

The purpose of this chapter is to describe the analytical methods that are available for detecting, measuring, and/or monitoring uranium, its metabolites, and other biomarkers of exposure and effect to uranium. The intent is not to provide an exhaustive list of analytical methods. Rather, the intention is to identify well-established methods that are used as the standard methods of analysis. Many of the analytical methods used for environmental samples are the methods approved by federal agencies and organizations such as EPA and the National Institute for Occupational Safety and Health (NIOSH). Other methods presented in this chapter are those that are approved by groups such as the Association of Official Analytical Chemists (AOAC) and the American Public Health Association (APHA). Additionally, analytical methods are included that modify previously used methods to obtain lower detection limits and/or to improve accuracy and precision.

### 7.1 BIOLOGICAL MATERIALS

Uranium can enter the human body through inhalation, ingestion, or penetration through the skin. Measurement of the quantities of uranium in the body can be performed by two primary methods, *in vivo* measurements and *in vitro* measurements. *In vivo* techniques measure the quantities of internally deposited uranium directly using a whole-body counter, while *in vitro* techniques permit estimation of internally deposited uranium by analysis of body fluids, excreta, or (in rare instances) tissues obtained through biopsy or postmortem tissue sectioning (USTUR 2011). Some of these analytical methods are summarized in Table 7-1.

The accurate and precise quantification of uranium in biological materials by either *in vivo* or *in vitro* methodologies requires that standard, certified sources with known concentrations of appropriate radionuclides be available and used appropriately on properly calibrated equipment. The U.S. national primary standards laboratories for developing and disseminating ionizing radiation standards include DOE laboratories for special nuclear materials standards and the National Institute of Standards and Technology (NIST) for the remaining standards. Also, the Health Physics Society accredits secondary standards laboratories for developing and disseminating NIST-traceable radioactive sources (HPS 2011). DOE does not produce Certified Reference Materials for biological matrices. However, NIST does produce human biological standard reference materials (SRMs) for uranium in two matrices (human lung powder [SRM4351,  $^{234}\text{U}$  and  $^{238}\text{U}$  each  $1.0 \times 10^{-4}$  Bq/g] and urine [SRM2668, two concentrations, 0.0340 or 13.37  $\mu\text{g/L}$  with 626 or 618 mg creatinine/L, respectively] (NIST 2011).

## 7. ANALYTICAL METHODS

**Table 7-1. Analytical Methods for Determining Uranium in Biological Samples**

Sample matrix	Sample preparation	Analytical method	Detection limit	Accuracy	Reference
Urine	Enrichment on an anion exchange column, solvent extraction	$\alpha$ -Counting (total uranium)	Not given	92% at 0.9 dpm spike	Hinton 1983
Urine	Spiked urine wet ashed; sample clean-up by coprecipitation, solvent extraction and electro-deposition	$\alpha$ -Spectrometry (total uranium)	0.02 dpm/L for $^{238}\text{U}^a$	78%	Singh and Wrenn 1988
Urine	Sample treated with HCl and $\text{H}_2\text{O}_2$ , clean-up on anion exchange resin column	Spectrophotometric (total uranium)	5 $\mu\text{g/L}$	87% at 11 $\mu\text{g/L}$	Kressin 1984
Urine	Sample wet ashed, enrichment on anion exchange column, purification by solvent extraction	Fluorometric (total uranium)	0.1 $\mu\text{g/L}$	75% at 0.1–100 $\mu\text{g/L}$	Dupzyk and Dupzyk 1979
Urine	Sample digestion with $\text{K}_2\text{S}_2\text{O}_8$ and dissolution in water	Laser-induced fluorometry (total uranium)	1 $\mu\text{g/L}$	86% at 7 $\mu\text{g/L}$	Hinton and White 1981
Urine	Wet-ashed; solubilized	KPA	$\sim 0.050$ $\mu\text{g/L}$	90–110%	Birkenfeld et al. 1995
Urine	Acid digestion, purification by coprecipitation and column chromatography	NAA (isotopic quantification)	<6 $\mu\text{g/L}$	80% at 2 $\mu\text{g}$ added uranium	Pleskach 1985
Urine	Sample with $^{232}\text{U}$ spike wet ashed, clean-up by anion exchange chromatography	Isotope dilution-MS (isotopic quantification)	5 pg ( $10^{-6}$ $\mu\text{g}$ ) uranium (total chemical blank)	No data	Kelly et al. 1987
Urine	Acidification; dilution	ICP-MS	3 ng/L	No data	Karpas et al. 1996
Urine	Dilution with acid, triton-X-100	ICP-MS	0.004 $\mu\text{g/L}$	3.71 RSD (%) at 0.08 $\mu\text{g/L}$	Caldwell et al. 2005
Urine	Digestion in concentrated $\text{HNO}_3$	ICP-DRC-MS (isotope quantification)	4 ng/L (total uranium); 60 ng/L ( $^{235}\text{U}/^{238}\text{U}$ ratio)	>95%	Todorov et al. 2009
Urine	Compilation from ANSI, DOE, EPA, IAEA, ICRP	Not provided	0.04–1 pCi/L (0.0007–0.07 Bq/L)	Not provided	HPS 1996

## 7. ANALYTICAL METHODS

**Table 7-1. Analytical Methods for Determining Uranium in Biological Samples**

Sample matrix	Sample preparation	Analytical method	Detection limit	Accuracy	Reference
Blood	Dilution with deionized water	ICP-DRC-MS (isotope quantification)	0.0001 µg/L (total U); 0.003 µg/L ( <sup>235</sup> U/ <sup>238</sup> U ratio)	97–99% at 0.005–0.5 µg/L	Ejnik et al. 2005
Soft tissue	Spiked tissues wet ashed; clean-up by coprecipitation, solvent extraction and electro-deposition	α-Spectrometry (total uranium)	0.03 µg/sample	85–92%	Singh and Wrenn 1988
Soft tissue	Spiked sample wet digested; purification by anion exchange; loaded into a single ion-exchange bead as a point source for MS	Isotope dilution-MS (isotopic quantification)	<5 pg/L	77%	Kelley and Fassett 1983
Bones	Spiked sample dry ashed; clean-up by coprecipitation, solvent extraction and electrodeposition	α-Spectrometry (isotopic quantification)	0.03 µg/sample	60–93%	Singh and Wrenn 1988; Singh et al. 1984
Bone ash	Spiked sample wet ashed; clean-up by solvent extraction and electrodeposition	α-Spectrometry (isotopic quantification)	0.4 µg/kg for <sup>238</sup> U	>95%	Fisenne et al. 1980
Feces	Spiked sample dry and wet ashed; clean-up by coprecipitation, solvent extraction and electro-deposition	α-Spectrometry (isotopic quantification)	0.03 µg/sample	58%	Singh and Wrenn 1988
Bone ash	Sampled dried; wet-ashed; homogenization; dissolution in acid	ICP-MS	3 ng/g	No data	Twiss et al. 1994
Feces	Sample wet or dry ashed, irradiation	<sup>3</sup> He neutron analyzer	0.04 ng/sample	No data	Gonzales et al. 1988

<sup>a</sup>This detection limit was reported by Melgard 1988.

ANSI = American National Standard Institute; DOE = Department of Energy; DRC = dynamic reaction cell; EPA = Environmental Protection Agency; IAEA = International Atomic Energy Agency; ICP = inductively coupled plasma; ICRP = International Commission on Radiological Protection; KPA = kinetic phosphorescence analysis; MS = mass spectrometry; NAA = neutron activation analysis

## 7. ANALYTICAL METHODS

Ough et al. (2006) conducted an interlaboratory comparison of analytical methods of synthetic urine samples containing natural and depleted uranium. The laboratories used ICP-sector field-MS (ICP-SF-MS), quadrupole ICP-MS (ICP-Q-MS), thermal ionization mass spectrometry (TIMS), and instrumental and delayed neutron activation analysis (I/DNAA) methods. The study showed that the ICP-SF-MS and ICP-Q-MS had the greatest accuracy and precision in measuring total uranium; the TIMS method also had a high precision, but lower accuracy. In tests of the  $^{238}\text{U}/^{235}\text{U}$  isotope ratio, the TIMS results had the lowest accuracy, but the highest precision. The ICP-SF-MS and ICP-Q-MS had high accuracy and precision in the isotope ratio tests; I/DNAA method was not analyzed for the isotope tests. The relative sensitivity of the instrument detection limits was TIMS>ICP-SF-MS>ICP-Q-MS>I/DNAA.

### 7.1.1 Internal Uranium Measurements

*In vivo* or direct measurements of uranium in the body are made with radiation detector systems and associated electronics called whole-body counters that measure radiation as it leaves the body from internally deposited uranium. *In vivo* assays are the most direct method of quantifying internally deposited radioactive materials. However, not all radionuclides emit radiations than may be detected with sufficient accuracy outside the body ( $^{234}\text{U}$  and  $^{238}\text{U}$  due to low-energy, low-intensity gamma emissions, for example) (NCRP 1978).

The most commonly used detectors for uranium *in vivo* counting are sodium iodide, phoswich (NaI and CsI sandwich), and hyperpure germanium, which measure the gamma rays emitted during uranium decay (DOE 1988, 2009). Since the gamma radiations emitted from uranium and a number of its progeny are the same as those emitted by uranium in the environment, shielded rooms are normally used to house the uranium internal monitoring equipment to ensure that background radiation is as low as possible (DOE 1999b; MARLAP 2004; Parrington et al. 1996). Although whole-body counters may be made in many configurations, a chest counter is usually used for inhaled uranium. *In vivo* analysis is widely used throughout the nuclear industry, both commercial and government, for quantifying levels of insoluble uranium in the body. *In vitro* analysis (see Section 7.1.2) is often used in conjunction with whole-body counting for monitoring workers handling uranium (DOE 2009).

*In vivo* counting systems are calibrated using tissue-equivalent phantoms. These phantoms have shapes similar to the human torso and are made of polystyrene or other tissue equivalent material. Standard uranium sources of known activity are inserted into the phantom at locations where uranium would be expected to accumulate in a human body (DOE 1988). Relationships are determined between the

## 7. ANALYTICAL METHODS

uranium activity measured by the detection system and the known activity in the phantom (DOE 1988; HPS 1996).

There are limitations associated with *in vivo* counting uranium measurements. First, soluble uranium is readily excreted, with fractions retained for varying periods in the bone and kidney, so detectability depends on factors such as intake quantity, chemical and physical form, biodistribution fraction, time since intake, background uranium contribution, analysis time, and detection system efficiency. Second, only the  $^{235}\text{U}$  isotope is typically evaluated using sodium iodide or hyperpure germanium detector systems, since  $^{234}\text{U}$  and  $^{238}\text{U}$  decay results in the emission of gamma rays of such low intensity and energy that they are difficult for these systems to quantify (NCRP 1987). In such cases, indirect *in vitro* methods can be used for measuring uranium in urine or feces (DOE 2009). Analytical equipment and procedures vary widely among laboratories and often require individual-specific input (NCRP 1987). Routine bioassay monitoring is recommended for uranium processing facility workers at high risk of incurring an intake when the quantity of uranium handled reaches 0.5 kg (320  $\mu\text{Ci}$ ), 5 kg (3,200  $\mu\text{Ci}$ ), or 50 kg (32,000  $\mu\text{Ci}$ ), respectively, when the process occurs in an open room or on a bench top with possible escape from a process vessel, in a fume hood, or in a glove box (DOE 2009). The Minimum Testing Level (amount of radioactive material a test laboratory should be able to measure in a performance test) for laboratories engaged in biomonitoring is 0.81 nCi (30 Bq) for *in vivo* lung monitoring (HPS 1996). The radiological limit is based on 50-rem to bone surfaces for class F uranium (formerly class D uranium), 5-rem to the whole body for class M uranium (formerly class W uranium), and 50-rem to the extrathoracic portion of the respiratory tract for class S uranium (formerly class Y uranium) (DOE 2009).

### 7.1.2 External Measurements

*In vitro* uranium analyses are routinely performed in support of a personnel monitoring program, or in cases where the size of an operation does not justify the cost of whole-body counter facilities. These analyses are usually done on urine samples, but other types of body materials may also be used (e.g., feces or blood). Urinalysis is effective for analysis of transportable or soluble uranium. A fraction of insoluble uranium also appears in the urine (DOE 2009).

The excretion of uranium in fecal material results primarily from intakes by ingestion, and includes uranium swallowed after inhalation. Uranium will usually appear in feces within hours after intake, thus providing a rapid means of determining whether an intake has occurred. Fecal analysis requires prechemistry preparation that includes ashing of the sample, cleaning by co-precipitation, and solvent

## 7. ANALYTICAL METHODS

extraction followed by electrodeposition. Alpha spectroscopy is then performed (Singh and Wrenn 1988). In the other methods, electrodeposition is replaced with an equipment-specific step, such as direct injection for ICP-MS and mixing with a scintillation cocktail for liquid scintillation. Urinalysis is typically favored over both fecal and blood analysis because it is generally more sensitive and less costly, and because fecal analysis provides no uptake or retention information and blood analyses is invasive.

The analysis of uranium is rarely performed in favor of modeling using biokinetic and biodynamic parameters linked to bioassay results, unless it is conducted as part of an autopsy. The U.S. Transuranium and Uranium Registries (USTUR) maintains the bodies and tissues of uranium workers who donated their bodies to scientific research. USTUR has developed methods for accepting, handling, storing, preparing, analyzing, and disposing of donated human tissues. Tissues analyzed for uranium content are prepared by ashing, anion exchange, and electrodeposition followed by alpha spectroscopy (USTUR 2011).

Several methods that do not require chemical separation are available for measuring uranium in urine (in units of total mass or total activity). These methods include spectrophotometric (total mass), fluorometric (total mass), kinetic phosphorescence analysis (KPA) (total mass), and gross alpha (total activity) analyses (DOE 2009; Elliston et al. 2001, 2005; MARLAP 2004; Wessman 1984). Photometric techniques such as fluorometry and phosphometry are not frequently used, but kinetic phosphorescence analysis is widely used. Measurements of total uranium do not provide the relative isotopic abundance of the uranium isotopes, but this may only be important when converting between activity and mass when the isotopic ratios are uncertain, or when differentiating between natural and depleted uranium (Magnoni et al. 2001; Roth et al. 2003).

If quantification of an individual uranium isotope is needed (e.g.,  $^{234}\text{U}$ ,  $^{235}\text{U}$ , or  $^{238}\text{U}$ ), the most commonly used methods require chemical separation followed by  $\alpha$ -spectrometry, or chemical separation and electrodeposition followed by  $\alpha$ -spectrometry (see Table 7-1). Mass spectrometers are more expensive, but provide sensitive, accurate, low-level analysis of uranium isotopes in much less time and with greater throughput than other methods due to greatly reduced sample preparation and analysis times (Twiss et al. 1994; MARLAP 2004; MARSSIM 2000).

The Minimum Testing Level for laboratories engaged in *in vitro* analysis of  $^{234}\text{U}$ ,  $^{235}\text{U}$ , and  $^{238}\text{U}$  in biological samples using  $\alpha$ -spectroscopy is 0.54 pCi (0.02 Bq) per liter or per sample (HPS 1996). An acceptable minimum testing level of 20  $\mu\text{g/L}$  of urine has also been established for natural uranium based on mass determination (HPS 1996).

## 7.2 ENVIRONMENTAL SAMPLES

Two types of methods are commonly used for measurement of uranium in environmental samples. The first are field surveys using portable survey instruments, and the second is analysis of samples procured in the field that are returned to the laboratory for quantification.

Accurately measuring the uranium in the field and in environmental samples requires that standard, certified radioactive sources with known concentrations of uranium, or other appropriate radionuclides, be available and used properly. The U.S. national primary standards laboratories for developing and disseminating ionizing radiation standards are the DOE (for special nuclear materials only) and the NIST for the remainder. Also, the Health Physics Society accredits secondary standards laboratories for calibrating portable radiation meters and developing and disseminating NIST-traceable radioactive sources (HPS 2011). DOE can provide environmental uranium standards for metal (natural and depleted uranium), compounds (hexafluoride, oxide, nitrate, and octaoxide), isotopic mixtures, and minerals (phosphate rock, carnotite, pitchblende, monazite, and octaoxide) (DOE 2011b). NIST produces environmental uranium standards in 4 matrices (aqueous solution [SRM3164, SRM4321c] and natural water [SRM1640a], coal [SRMs 1632c and 1635], glass [SRMs 610 and 612–617], and urban particulate matter [SRM1648]) (NIST 2011). Specifics for these include: SRM3164 (natural uranium aqueous solution; 9.994 mg/g), SRM 4321b (natural uranium aqueous solution;  $^{234}\text{U}$ ,  $^{235}\text{U}$ , and  $^{238}\text{U}$ ; 6.5, 0.3, 6.3 nCi/g; 242.0, 11.14, 233.1 Bq/g, respectively), SRM 617 (trace elements in glass, 0.02 ppm uranium), SRM1635 (trace elements in coal, uranium, 0.24 mg/kg) (NIST 2011).

### 7.2.1 Field Measurements of Uranium

Uranium measurements in the field are typically qualitative in nature in that the instruments simply respond to alpha emissions, regardless of their isotopic origin. However, the levels can be measured quantitatively if key parameters are known, such as relative abundances of all alpha-emitting isotopes present, thickness of the layer being assessed, and detection efficiency of the instrument for the type of surface being assessed. Measurements in the past have typically been made using a portable, hand-held alpha scintillation detector (e.g., ZnS) equipped with a count rate meter, which detects alpha radiation while discriminating against beta-emitters in the same area. However, the need for low detection limits in radiological remediation efforts has found a more suitable and sensitive instrument in the large-area gas-flow proportional counter. These instruments can be carried by an individual or attached to a holder for maintaining a selected surface-to-detector distance. The latter method can be integrated into a system

## 7. ANALYTICAL METHODS

which moves along a surface at a predetermined velocity recording spatially-related real-time data for later graphical imaging of absolute surface activity distributions (DOE 1988). These surveys can also be performed on people whose skin or clothing is contaminated. Survey instruments can provide a quick estimate or a measure of the level of activity that might be present. However, more accurate measurement of uranium activity may require that samples be taken for laboratory analyses. Under normal usage, the lowest level of uranium that can be reliably detected using an alpha scintillation survey meter is 200–500 disintegrations per minute/100 cm<sup>2</sup> (0.09–0.23 nCi/100 cm<sup>2</sup>) (DOE 1988); however, detection of levels several time lower is practical with gas flow proportional counters, especially when used in the integrate mode. Detection capability varies with the type of detector used, the active area of the probe, the electronics, etc.

Several limitations are associated with the measurement of uranium by portable survey instruments. First, the uranium must be present on the surface of the material being surveyed. Since uranium decays by emission of  $\alpha$  particles, which travel only short distances in materials, any uranium that is imbedded in the surface being surveyed will be partially or completely masked. Secondly, when performing surveys, it must be possible to place the detector very close to the surface being surveyed (i.e., approximately one-quarter of an inch) (DOE 1988, 1994a), and uneven surfaces that are unintentionally touched can tear the detector window, disabling the instrument. Additional information is available in MARSSIM (2000) on the use and usefulness of field survey instruments.

### 7.2.2 Collection of Environmental Samples

The Multi-Agency Radiological Laboratory Analytical Protocols Manual (MARLAP 2004) recommends that a field sampling plan be developed to provide comprehensive guidance for collecting, preparing, preserving, shipping, and tracking field samples and recording field data. The principal objective is to provide representative samples of the proper size for analysis. The design should address input and recommendations of representatives from the field sampling team, health physics professional staff, analytical laboratory, statistical and data analysts, quality assurance personnel, and end-users of data. Field organizations conduct operations according to standard operating procedures that may include but should not be limited to the following:

- Developing a technical basis for defining the size of individual samples;
- Selecting field equipment and instrumentation;
- Using proper sample containers and preservatives;



## 7. ANALYTICAL METHODS

- Using consistent container labels and sample identification codes;
- Documenting field sample conditions and exceptions;
- Documenting sample location;
- Tracking, accountability, custody, and shipment forms;
- Providing legal accountability, such as chain-of-custody record, when required;
- Selecting samples for field quality control (QC) program;
- Decontaminating equipment and avoiding sample cross-contamination;
- Specifying sample packaging, radiological surveys of samples, shipping, and tracking; and
- Documenting the health and safety plan.

The *in situ* high purity germanium (HPGe) gamma spectrometry system is used to assess concentrations of radioactive materials in undisturbed soils (MARSSIM 2000). The detector is able to discriminate among different radionuclides on the basis of characteristic gamma and x-ray energies. Another *in situ* technology, laser ablation-ICP-atomic emission spectrometry or MS (LA-ICP-AES/MS), sends a probe to various soil depths where a laser ablates a 1 m<sup>3</sup> sample (MARSSIM 2000). The material is then passed through a plasma torch where it becomes ionized and electrically excited, producing an ionic emission spectrum. As with the *in situ* HPGe system, the surface material is not consumed during the operation and results can be obtained in real-time.

### 7.2.3 Laboratory Analysis of Environmental Samples

Analytical methods for measuring uranium in environmental samples are summarized in Table 7-2. The available methods can be divided into two groups: chemical methods to determine the total mass of uranium in a sample, and radiological methods to determine amounts of individual isotopes.

Environmental media that have been tested for uranium include air filters, swipes, biota, water, soil, and others; a full range of laboratory analysis methods has been used to quantify the total uranium or its individual isotopes. The equipment and methods tend to improve over time. The radiological analysis methods include alpha counting (with ionization, proportional, scintillation, or other solid state detectors), alpha spectroscopy, beta counting (with thin-window GM, ionization, proportional, and solid state detectors), beta spectrometry, or gamma spectroscopy (with NaI or HPGe systems). The equipment and method selection depends on the results needed and the non-uranium radionuclides that may be present

## 7. ANALYTICAL METHODS

**Table 7-2. Analytical Methods for Determining Uranium in Environmental Samples**

Sample matrix	Sample preparation	Analytical method	Sample detection limit	Accuracy	Reference
Air	Air particulate collection on glass fiber filter; digestion in HNO <sub>3</sub>	ICP-MS (total uranium)	0.1 µg/L in final solution	No data	Boomer and Powell 1987
Air	Spiked air particulate dry and wet ashed; dissolution; coprecipitation with iron hydroxide and Ca oxalate, purification by solvent extraction and electrodeposition onto platinum	α-Spectrometry (isotope quantification)	0.02 dpm/L <sup>b</sup> for <sup>238</sup> U in solution	No data	Singh and Wrenn 1988
Air	Sample collection on cellulose filters; ashing; extraction with triisooctylamine; purification by anion exchange chromatography and coprecipitation.	α-Spectroscopy	0.015 pCi	No data	EPA 1984b
Air	Collection on cellulose filters	INAA	0.03 µg per filter	No data	Querol et al. 1997
Rainwater	Coprecipitation with iron hydroxide, radiochemical, ion-exchange and solvent extractive purification, and electrodeposition on steel	α-Spectrometry (isotope quantification)	0.02 dpm/L for <sup>238</sup> U in solution <sup>a</sup>	68%	Jiang et al. 1986
Drinking water	Direct analysis or concentration by coprecipitation and solvent extraction; fusion	Fluorometry (total uranium)	<20 µg/L (direct); 0.1 µg/L (cleaned)	104% (cleaned)	EPA 1980c (EPA Method 908.1)
Drinking water	Concentrated by coprecipitation; separation; clean-up by ion-exchange	Gross α-counting (total uranium)	1 pCi/L	92.6%	EPA 1980c (EPA Method 908.0)
Drinking water	Sample chelation in EDTA; addition of Fluron	Laser-induced fluorometry	0.08 µg/L	100% at 1 µg/L	EPA 1984e (EPA Method 908.2)
Natural waters	Sample concentration by cation-exchange resin, separation by ion-exchange resin and complexation with Arsenazo III	Spectrophotometry (total uranium)	0.1 µg/L	80%	Paunescu 1986

## 7. ANALYTICAL METHODS

**Table 7-2. Analytical Methods for Determining Uranium in Environmental Samples**

Sample matrix	Sample preparation	Analytical method	Sample detection limit	Accuracy	Reference
Water	Sample fusion with NaF and LiF	Fluorometry (total uranium)	5 µg/L	117.5% at 6.3 µg/L	ASTM 1986 (ASTM Method D2907-83)
Water	Coprecipitation with iron hydroxide; purification by ion-exchange chromatography and electrodeposition	α-Spectrometry (isotope quantification)	0.02 dpm/L	97.7–108% at 0.028–0.044 Bq/L	ASTM 1986 (EPA Method D3972-82)
Water	Solvent extraction; coprecipitation with BaSO <sub>4</sub> ; dissolution in HClO <sub>4</sub> ; reprecipitation with TiF <sub>3</sub> ; filtration	α-Spectrometry (isotope quantification)	0.02 dpm/L <sup>b</sup> for <sup>238</sup> U	No data	Stewart et al. 1988
Water	Preconcentration by complexation with oxine and adsorption on activated carbon	NAA (total uranium)	3 µg/L	>80%	Holzbecher and Ryan 1980
Water	Preconcentration by ion-exchange chromatography; purification by ion-exchange and solvent extraction	NAA ( <sup>235</sup> U and <sup>238</sup> U)	No data	No data	Gladney et al. 1983
Water	Extraction by ion-exchange; dissolution in low oxygen solvent; irradiation	Delayed neutron analysis (total uranium)	0.4 µg/L	No data	Zielinski and McKown 1984
Water	Wet-ashed; reaction with complexant	Pulsed-laser phosphorimetry	0.05 ppb	103% (average)	ASTM 1994 (Method 5174-91)
Water (uranyl nitrate)	Solvent extraction	Fluorescence spectroscopy	6.1–10.5 ppm	No data	ASTM 1994 (Method D4763-88)
Ground-water	Separation on resin; automated	FI-ICP-MS (isotope quantification)	0.3 ng/L for <sup>238</sup> U	±1.8%	Aldstadt et al. 1996
Ground-water	Separation and concentration on two HPLC columns; complexation with Arsenazo III	Spectrophotometry (total uranium)	1–2 µg/L	No data	Kerr et al. 1988
Water and wastes	Acid digestion; filtration (dissolved); acid digestion (total recoverable)	ICP-MS (total uranium)	0.1 µg/L	105–110%	EPA 1991a (EPA Method 200.8)

## 7. ANALYTICAL METHODS

**Table 7-2. Analytical Methods for Determining Uranium in Environmental Samples**

Sample matrix	Sample preparation	Analytical method	Sample detection limit	Accuracy	Reference
Seawater	Uranium enriched by chelation with APDC in the presence of $\text{Fe}^{+2}$ , complexation with APDC followed by adsorption on activated carbon	X-ray fluorescence (total uranium)	0.56–0.64 $\mu\text{g/L}$	No data	Nagj et al. 1986
Seawater	Oxine addition	Cathodic stripping voltametry (total uranium)	0.02–0.2 nM	No data	Van den Berg and Nimmo 1987
Sediment	Sediment dried and well-mixed; dissolution in $\text{HCl-HClO}_4\text{-HF}$ ; purification by coprecipitation, ion exchange and electrodeposition	$\alpha$ -Spectrometry (isotope quantification)	No data	No data	Anderson and Fler 1982
Soil	Soil leached with $\text{HCl-HNO}_3\text{-HF}$ ; purification by ion-exchange, and solvent extraction, and electrodeposition	$\alpha$ -Spectrometry (isotope quantification)	No data	No data	Golchert et al. 1980
Soil	Dissolution in $\text{HCl-HNO}_3\text{-HF}$ ; purification by coprecipitation, solvent extraction and electrodeposition	$\alpha$ -Spectrometry (isotope quantification)	0.03 $\mu\text{g/sample}$	67%	Singh and Wrenn 1988
Soil, sediment, and biota	Ashing; fusion with $\text{KF}$ and $\text{K}_2\text{S}_2\text{O}_7$ ; purification by extraction with triisooctylamine, anion exchange chromatography and coprecipitation.	$\alpha$ -Spectroscopy	No data	No data	EPA 1984b
Soil, sediment, and biota	Ashing; extraction into triisooctylamine, strip from triisooctylamine with $\text{HNO}_3$ and coprecipitation with lanthanum.	gross $\alpha$ -Spectroscopy or $\alpha$ -spectroscopy	No data	No data	EPA 1984b
Minerals	Dissolution in $\text{HNO}_3\text{-HF-HClO}_4$ ; purification by solvent extraction	Laser fluorometry (total uranium)	No data	No data	Veselsky et al. 1988
Low level radioactive waste	Dissolution; purification by coprecipitation, ion-exchange and electrodeposition	$\alpha$ -Spectrometry (isotope quantification)	0.03 dpm	No data	Wessman 1984

## 7. ANALYTICAL METHODS

**Table 7-2. Analytical Methods for Determining Uranium in Environmental Samples**

Sample matrix	Sample preparation	Analytical method	Sample detection limit	Accuracy	Reference
Building materials and lichen	Wet ashing with HNO <sub>3</sub> -H <sub>2</sub> O-HF; purification by coprecipitation, solvent extraction and electro-deposition	α-Spectrometry (isotope quantification)	0.03 µg/sample	54-73%	Singh and Wrenn 1988
Vegetation	Sample dried and homogenized; dry and wet ashing	ICP-MS (total uranium)	0.1 µg/L in final solution	No data	Boomer and Powell 1987
Vegetation	Sample dried and homogenized; wet ashing and purification by solvent extraction	Laser fluorometry (total uranium)	0.05 mg/kg in plant ash	No data	Harms et al. 1981
Process water	Dilution and filtration	Laser fluorometry (total soluble uranium)	0.01 µg/L <sup>b</sup>	No data	Hinton and White 1981
Process water	Direct analysis	Ion chromatography spectrophotometric detection (U <sup>6+</sup> )	0.04 mg/L	No data	Byerley et al. 1987
Field survey	None	Scintillation detector and count rate meter	200-500 dpm/100 cm <sup>2</sup> (scintillation detector)	No data	ANSI 1978 (ANSI Standard N323)

<sup>a</sup>This detection limit was reported by Melgard 1988.

<sup>b</sup>This detection limit was reported by Wessman 1984.

APDC = ammonium pyrrolidine dithiocarbamate; Bq = Becquerel and 1 pCi = 0.37 Bq; dpm = disintegration per minute and 1 pCi = 2.22 dpm; EDTA = ethylenediaminetetraacetic acid; FI = flow injection; HPLC = high performance liquid chromatography; ICP = inductively coupled plasma spectrometry; INAA = instrumental neutron activation and analysis; MS = mass spectrometry; NAA = neutron activation analysis; nM = nanomole or 10<sup>-9</sup> of a mol

## 7. ANALYTICAL METHODS

(DOE 2009). The use of high resolution  $\alpha$ -spectroscopy is common, although gamma spectroscopy is usable with great care. The chemical methods which are often used include spectrophotometry, fluorometry, and kinetic phosphorescence, with the addition of various mass spectrometer applications (ICP-MS, AES-MS, and accelerator-MS). If conversions between mass and activity are to be made accurately, prior knowledge of the relative abundance of the various uranium isotopes must be available or measured radiologically. A few media-specific methods that have been used successfully for measuring uranium concentrations in environmental samples are described below. The current trend, however, is away from prescriptive methods and toward performance-based methods which enable the user to optimize their available analytical tools.

A cornerstone of this method is the development of Data Quality Objectives and the use of Data Quality Assessment to ensure that the selected method is properly developed and the results are of the appropriate quality (DOE 2010; EPA 2000, 2006a, 2006b). Field sampling quality assurance (QA) addresses a range of practices aimed at minimizing errors and evaluating sampling performance, and is a responsibility of all individuals involved. Aspects of field QA/QC include the use of standard operating procedures for sample collection and analysis; chain-of-custody and sample-identification procedures; instrument standardization, calibration, and verification; technician and analyst training; sample preservation, handling, and decontamination; and QC samples such as field and trip blanks, duplicates, and equipment rinses (ORNL 2011).

DOE's method for analyzing environmental materials is based on the methods of Hindman (1983), Sill and Williams (1981), and Welford et al. (1960) and involves preparing vegetation, soft tissue, and water samples by concentrating or isolating uranium from the media prior to separation in an anion exchange column, followed by alpha spectrometry (DOE 2000).

In one analytical method for air filters, the air filters are ashed, silica content is volatilized with hydrogen fluoride, and uranium is extracted with triisooctylamine, purified by anion exchange chromatography and co-precipitated with lanthanum as fluoride. The precipitated uranium is collected by filtration, dried, and  $\alpha$ -spectroscopy is performed (EPA 1984b). The activities of  $^{234}\text{U}$ ,  $^{235}\text{U}$ , and  $^{238}\text{U}$  are determined based on the number of counts that appear in the  $\alpha$  energy region unique to each isotope. This method is used by the EPA National Air and Radiation Environmental Laboratory for measurement of uranium in air as part of the Environmental Radiation Ambient Monitoring System (see Chapter 6).

## 7. ANALYTICAL METHODS

Singh and Wrenn (1988) describe a method for uranium isotopic analysis of air filters. Air filters are ashed, redissolved, and co-precipitated with iron hydroxide and calcium oxalate. The uranium is further purified by solvent extraction and electrodeposition. An alpha spectroscopy detection level of 0.02 dpm/L for  $^{238}\text{U}$  in solution was reported (Singh and Wrenn 1988).

Considerable work has been done to develop methods for analysis of uranium in water. In 1980, the EPA published standardized procedures for measurement of radioactivity in drinking water, which included uranium analysis by both radiochemical and fluorometric methods (EPA 1980c), and more recently developed an ICP-MS method. An example of each is provided below.

The radiochemical method quantifies gross  $\alpha$  activity utilizing either a gas flow proportional counter or a scintillation detection system following chemical separation. In the EPA radiochemical method, the uranium is co-precipitated with ferric hydroxide, purified through anion exchange chromatography, and converted to a nitrate salt. The residue is transferred to a stainless steel planchet, dried, flamed, and counted for  $\alpha$  particle activity (EPA 1980c).

For the fluorometric method, uranium is concentrated by co-precipitation with aluminum phosphate and dissolved in diluted nitric acid containing magnesium nitrate as a salting agent, and the co-precipitated uranium is extracted into ethyl acetate and dried. The uranium is dissolved in nitric acid, sodium fluoride flux is added, and the samples are fused over a heat source (EPA 1980b).

The ICP-MS method was developed for measuring total uranium in water and wastes. The sample preparation is minimal—filtration for dissolved uranium and acid digestion for total recoverable uranium. Recovery is quantitative (near 100%) for a variety of aqueous and solid matrices and detection limits are low, 0.1  $\mu\text{g/L}$  for aqueous samples and 0.05 mg/kg for solid samples (EPA 1991a).

The EPA developed two methods for the radiochemical analysis of uranium in soils, vegetation, ores, and biota, using the equipment described above. The first is a fusion method in which the sample is ashed, the silica is volatilized, the sample is fused with potassium fluoride and pyrosulphate, a  $^{236}\text{U}$  tracer is added, and the uranium is extracted with triisooctylamine, purified on an anion exchange column, coprecipitated with lanthanum, filtered, and prepared in a planchet. Individual uranium isotopes are separately quantified by high resolution  $\alpha$ -spectroscopy and the sample concentration calculated using the  $^{236}\text{U}$  yield. The second is a nonfusion method in which the sample is ashed, the silica is volatilized, a  $^{236}\text{U}$  tracer is added, and the uranium is extracted with triisooctylamine, stripped with nitric acid, co-

## 7. ANALYTICAL METHODS

precipitated with lanthanum, transferred to a planchet, and analyzed in the same way by high resolution  $\alpha$ -spectroscopy (EPA 1984).

The detection capability of any measurement process is an important performance characteristics, along with precision and accuracy. The lower limit of detection (LLD) has been adopted to refer to the intrinsic detection capability of the measurement process (sampling through data reduction and reporting. Factors that influence the LLD include background count rate, sensitivity of detector, and, particularly, the length of time a sample and background are counted. Because of these variables, LLDs between laboratories, employing the same or similar chemical separation procedures, will vary. Additional examples of the techniques for quantification of uranium (as described above) are available, as well as examples of less frequently used techniques. These are identified in Table 7-3.

### 7.3 ADEQUACY OF THE DATABASE

Section 104(i)(5) of CERCLA, as amended, directs the Administrator of ATSDR (in consultation with the Administrator of EPA and agencies and programs of the Public Health Service) to assess whether adequate information on the health effects of uranium is available. Where adequate information is not available, ATSDR, in conjunction with NTP, is required to assure the initiation of a program of research designed to determine the health effects (and techniques for developing methods to determine such health effects) of uranium.

The following categories of possible data needs have been identified by a joint team of scientists from ATSDR, NTP, and EPA. They are defined as substance-specific informational needs that if met would reduce the uncertainties of human health assessment. This definition should not be interpreted to mean that all data needs discussed in this section must be filled. In the future, the identified data needs will be evaluated and prioritized, and a substance-specific research agenda will be proposed.

#### 7.3.1 Identification of Data Needs

**Methods for Determining Biomarkers of Exposure and Effect.** Analytical methods with satisfactory sensitivity and precision are available to determine the levels of uranium in human tissues and body fluids. However, improved methods are needed to assess the biological effects of uranium in tissues.



## 7. ANALYTICAL METHODS

**Table 7-3. Additional Analytical Methods for Determining Uranium in Environmental Samples**

Sample matrix	Preparation method	Analytical method	Sample detection limit	Percent recovery	Reference
Rocks, minerals, nuclear fission products, biological material	Solvent extraction as MHFA complex; optional purification by back-extraction	Spectrophotometric	0.0062 mg/L (with back-extraction)	99–103%	Abbassi 1989
Ore leachates	Separation as arsenazo III complex	Flow injection; spectrophotometric	6.6 µg/L	No data	Perez et al. 1990
Aqueous solutions	Complexation with o-hydroxy-propiofenone isonicotinoyl-hydrazone	Spectrophotometric	No data	No data	Ramachandraiah et al. 1993
Natural waters	Co-precipitation with Fe(OH) <sub>3</sub> ; selective separation by precipitation; determined as dibenzoyl methane complex	Laser fluorometry	5 ppb	No data	Eral 1989
Rocks, minerals, nuclear fission products and biological material	Solvent extraction as MHFA complex; optional purification by back-extraction	Atomic absorption spectrometry	<0.08 mg/L	No data	Abbassi 1989
Phosphate rock and phosphoric acid	Wet digestion; separation by extraction with trioctylphosphine oxide; destruction of complex prior to analysis	Argon plasma emission spectrometry	No data	98–100%	Woodis et al. 1980
Uranium tailings (U <sub>3</sub> O <sub>8</sub> )	Wet digestion; solvent extraction	ICP-OES	No data	101%	Feeney et al. 1983
Phosphate rock	Wet digestion; extraction with trioctylphosphine oxide; back-extraction with stripping solution	dc argon ICP	<1 ppm	99–106%	Norman et al. 1983
Ground, mine waters	Direct analysis	ICP	low ppm	No data	Greene et al. 1985
Coal ash	Acid digestion; separation with s-thenoyltrifluoric acetone; back-extraction	ICP	29 µg/L	98%	Kamata et al. 1987

## 7. ANALYTICAL METHODS

**Table 7-3. Additional Analytical Methods for Determining Uranium in Environmental Samples**

Sample matrix	Preparation method	Analytical method	Sample detection limit	Percent recovery	Reference
Seawater	Separation on chelate fiber	ICP-OES	5 µg/L	No data	Chang et al. 1990
Apatite minerals	Extraction with 3-phenyl-4-benzoyl-s-isoxazolone	ICP-AES	0.02 mg/L	No data	Fujino et al. 1994
Natural waters	Extraction with s-thenoyltrifluoric acetone and tri-n-butyl phosphate	Stripping voltametry	10 <sup>-10</sup> mol/dm <sup>3</sup>	≈90%	Mlakar and Branica 1989
Groundwater, soil	Separation as propyl gallate complex	Stripping voltametry	subnanomolar	No data	Wang et al. 1994
Surface soils	<i>in situ</i>	Gamma spectrometry	0.1 Bq/g	No data	Miller et al. 1994
Ceramic and plastic semiconductor packaging material	None	NAA with fission track counting	0.02 ppb	No data	Riley 1982
River sediments	None	Instrumental NAA	No data	≈70% (certified materials)	Labrecque et al. 1986
Air samples	Sample collection on filters	Instrumental NAA	2 ng/sample	95%	Landsberger and Wu 1993
Sediment, pore water	Dilution	ICP-MS	40 pg/mL	99%	Toole et al. 1991
Soil	None	Proton induced fluorescent x-rays	No data	No data	Lazo et al. 1991
Soil		Isotope dilution MS			Wessman 1984
Biological and environmental samples	Complexation with phosphoric acid	Laser phosphorimetry	Sensitivity 10 <sup>-12</sup> g	No data	Bushaw 1984

AES = atomic emission spectrometry; Bq = Bequerel; ICP = inductively coupled plasma (spectrometry); MHFA = N-p-methoxyphenyl-2-furylacrylohydroxamic acid; MS = mass spectrometry; NAA = neutron activation analysis; OES = optical emission spectrometry

## 7. ANALYTICAL METHODS

Uranium is in essentially all food, water, and air, so everyone is exposed to some levels. In a study reported by NIOSH (1981) and Thun et al. (1985), enhanced levels of  $\beta_2$ -microglobulin levels were observed in the urine of uranium workers. It was postulated that enhanced excretion of  $\beta_2$ -microglobulin might be used as an indication of uranium exposure; however, NIOSH (1981) and Thun et al. (1985) were unable to establish a dose-response correlation between level of exposure and excretion of the  $\beta_2$ -microglobulin. Limson Zamora et al. (1998) identified changes in several potential biomarkers of effect following exposure to uranium, in which each individual biomarker could be affected by a range of chemicals, but the results suggested that it may be possible to identify a series of biomarkers whose combined responses could serve as a single uranium-specific biomarker of effect. Development of new or combination biomarkers for high uranium exposures would be useful.

**Methods for Determining Parent Compounds and Degradation Products in Environmental Media.** Analytical methods with the required sensitivity and accuracy are available for quantification of uranium, both total and isotopic, in environmental matrices (Table 7-2). Knowledge of the levels of uranium in various environmental media, along with the appropriate modeling (see Chapters 3 and 5), can be used to evaluate potential human exposures through inhalation and ingestion pathways.

Whether in the environment or in the human body, uranium will undergo radioactive decay to form a series of radioactive nuclides that end in a stable isotope of lead (see Chapter 4). Examples of these include radioactive isotopes of the elements thorium, radium, radon, polonium, and lead. Analytical methods with the required sensitivity and accuracy are also available for quantification of these elements in the environment where large sample are normally available (EPA 1980b, 1984), but not necessarily for the levels from the decay of uranium in the body. More sensitive analytical methods are needed for accurately measuring very low levels of these radionuclides.

### 7.3.2 Ongoing Studies

No ongoing studies were identified.

## 7. ANALYTICAL METHODS

This page is intentionally blank.

## 8. REGULATIONS, ADVISORIES, AND GUIDELINES

MRLs are substance specific estimates, which are intended to serve as screening levels, are used by ATSDR health assessors and other responders to identify contaminants and potential health effects that may be of concern at hazardous waste sites.

The international and national regulations, advisories, and guidelines regarding uranium in air, water, and other media are summarized in Table 8-1.

ATSDR has derived an MRL of 0.002 mg U/m<sup>3</sup> for intermediate-duration inhalation exposure to insoluble uranium compounds based on a NOAEL of 1.1 mg U/m<sup>3</sup> and a LOAEL of 8.2 mg U/m<sup>3</sup> for renal effects in dogs exposed to uranium dioxide 6 hours/day, 6 days/week for 5 weeks (Rothstein 1949b) and an uncertainty factor of 100 (10 for extrapolation from animals to humans and 10 for human variability).

ATSDR has derived an MRL of 0.0001 mg U/m<sup>3</sup> for intermediate-duration inhalation exposure to soluble uranium compounds based on a LOAEL of 0.15 mg U/m<sup>3</sup> for renal effects in dogs exposed to uranyl fluoride 6 hours/day, 6 days/week for 5 weeks (Rothstein 1949a) and an uncertainty factor of 300 (3 for the use of a minimal LOAEL, 10 for extrapolation from animals to humans, and 10 for human variability).

ATSDR has derived an MRL of 0.0008 mg U/m<sup>3</sup> for chronic-duration inhalation exposure to insoluble uranium compounds based on a LOAEL of 5.1 mg U/m<sup>3</sup> for lung fibrosis in monkeys exposed to uranium dioxide 5.4 hours/day, 5 days/week for 5 years (Leach et al. 1970, 1973) and an uncertainty factor of 1,000 (10 for the use of a LOAEL, 10 for extrapolation from animals to humans, and 10 for human variability).

ATSDR has derived an MRL of 0.00004 mg U/m<sup>3</sup> for chronic-duration inhalation exposure to soluble uranium compounds based on a BMCL<sub>10</sub> of 0.019 mg U/m<sup>3</sup> for renal effects in dogs exposed to uranium tetrachloride 33 hours/week for 1 year (Stokinger et al. 1953) and an uncertainty factor of 100 (10 for extrapolation from animals to humans and 10 for human variability).

ATSDR has derived an MRL of 0.002 mg/kg/day for acute-duration oral exposure to soluble uranium compounds based on an average BMDL<sub>05</sub> of 0.2 mg U/kg/day for developmental effects in the offspring

## 8. REGULATIONS, ADVISORIES, AND GUIDELINES

of mice administered via gavage uranyl acetate dehydrate on gestation days 6–15 (Domingo et al. 1989c) and an uncertainty factor of 100 (10 for extrapolation from animals to humans and 10 for human variability).

ATSDR has derived an MRL of 0.0002 mg/kg/day for intermediate-duration oral exposure to soluble uranium compounds based on a LOAEL of 0.06 mg U/kg/day for renal effects in rats exposed to uranyl nitrate hexahydrate in drinking water for 91 days (Gilman et al. 1998a) and an uncertainty factor of 300 (3 for use of a minimal LOAEL, 10 for extrapolation from animals to humans, and 10 for human variability).

EPA derived a reference dose (RfD) of 0.003 mg/kg/day for uranium soluble salts based on a LOAEL of 2.8 mg/kg/day for initial weight loss and moderate nephrotoxicity in rabbits exposed to uranium in the diet for 30 days (Maynard and Hodge 1949) and an uncertainty factor of 1,000 (10 for the use of a LOAEL, 10 for intraspecies variability, and 10 for interspecies variability) (IRIS 2012). This RfD (developed in 1989) is currently under review by EPA.

IARC, the U.S. Department of Human and Health Services, and the NTP have not classified uranium as to its carcinogenicity. According to the Integrated Risk Information System (IRIS) database, the EPA withdrew its carcinogenic assessment of natural uranium in 1993 (IRIS 2012).

## 8. REGULATIONS, ADVISORIES, AND GUIDELINES

**Table 8-1. Regulations, Advisories, and Guidelines Applicable to Uranium**

Agency	Description	Information	Reference
<u>INTERNATIONAL</u>			
Guidelines:			
IARC	Carcinogenicity classification		IARC 2012
	Mixtures of uranium isotopes	Limited evidence in humans for carcinogenicity	
	<sup>233</sup> U, <sup>234</sup> U, <sup>235</sup> U, and <sup>238</sup> U (natural, enriched, and depleted uranium)	There is sufficient evidence in experimental animals for carcinogenicity	
ICRP	Recommended dose limits		ICRP 1991
	Occupational		
	Effective dose <sup>a</sup>	20 mSv per year, averaged over defined periods of 5 years	
	Annual equivalent dose		
	Lens of the eye	150 mSv	
	Skin <sup>b</sup>	500 mSv	
	Hands and feet	500 mSv	
	Public		
	Effective dose <sup>c</sup>	1 mSv in a year	
	Annual equivalent dose		
	Lens of the eye	15 mSv	
	Skin	50 mSv	
	Hands and feet	No data	
WHO	Air quality guidelines	No data	WHO 2010
	Provisional drinking water quality guidelines	0.015 mg/L <sup>d</sup>	WHO 2008
	TDI	0.6 µg/kg/day	
<u>NATIONAL</u>			
Regulations and Guidelines:			
a. Air			
ACGIH	TLV (8-hour TWA)		ACGIH 2012
	Uranium, soluble and insoluble compounds, as U	0.2 mg/m <sup>3</sup>	

## 8. REGULATIONS, ADVISORIES, AND GUIDELINES

**Table 8-1. Regulations, Advisories, and Guidelines Applicable to Uranium**

Agency	Description	Information	Reference
<u>NATIONAL</u> (cont.)			
	STEL		
	Uranium, soluble and insoluble compounds, as U	0.6 mg/m <sup>3</sup>	
AIHA	ERPGs	No data	AIHA 2011
DOE	PAC-1 <sup>e</sup>	0.6 mg/m <sup>3</sup>	DOE 2012
	PAC-2 <sup>e</sup>	0.6 mg/m <sup>3</sup>	
	PAC-3 <sup>e</sup>	30 mg/m <sup>3</sup>	
EPA	AEGLs	No data	EPA 2011a
	Hazardous air pollutant	No data	EPA 2012a 42 USC 7412
	NAAQS	No data	EPA 2010a
	National emission standards for radon-222 emissions from underground uranium mines	10 mrem/year	EPA 2011k 40 CFR 61.22, Subpart B
	National emission standards for radionuclide emissions from federal facilities other than USNRC licensees and not covered by Subpart H	10 mrem/year	EPA 2011l 40 CFR 61.102, Subpart I
	National emission standards for radon-222 emissions from the disposal of uranium mill tailings that are no longer operational	20 pCi/(m <sup>2</sup> -sec)	EPA 2011j 40 CFR 61.222, Subpart T
	National emission standards for radon-222 emissions from operating mill tailings	20 pCi/(m <sup>2</sup> -sec)	EPA 2011i 40 CFR 61.252, Subpart W
NIOSH	REL (10-hour TWA)		NIOSH 2012
	Uranium, metal and insoluble compounds, as U <sup>f</sup>	0.2 mg/m <sup>3</sup>	
	Uranium, soluble compounds, as U <sup>f</sup>	0.05 mg/m <sup>3</sup>	
	STEL		
	Uranium, metal and insoluble compounds, as U <sup>f</sup>	0.6 mg/m <sup>3</sup>	
	IDLH		
	Uranium, metal, insoluble, and soluble compounds, as U <sup>f</sup>	10 mg/m <sup>3</sup>	
USNRC	Effluent concentrations in the air <sup>g</sup>		USNRC 2012a 10 CFR 20, Appendix B



## 8. REGULATIONS, ADVISORIES, AND GUIDELINES

**Table 8-1. Regulations, Advisories, and Guidelines Applicable to Uranium**

Agency	Description	Information	Reference
<u>NATIONAL</u> (cont.)			
	<u>Isotope</u>	<u>Class</u>	<u>Concentration (<math>\mu\text{Ci/mL}</math>)</u>
	$^{230}\text{U}$	D	$8 \times 10^{-13}$
		W	$5 \times 10^{-13}$
		Y	$4 \times 10^{-13}$
	$^{231}\text{U}$	D	$1 \times 10^{-8}$
		W	$8 \times 10^{-9}$
		Y	$6 \times 10^{-9}$
	$^{232}\text{U}$	D	$6 \times 10^{-13}$
		W	$5 \times 10^{-13}$
		Y	$1 \times 10^{-14}$
	$^{233}\text{U}$	D	$3 \times 10^{-12}$
		W	$1 \times 10^{-12}$
		Y	$5 \times 10^{-14}$
USNRC	Effluent concentrations in the air <sup>9</sup>		USNRC 2012a 10 CFR 20, Appendix B
	<u>Isotope</u>	<u>Class</u>	<u>Concentration (<math>\mu\text{Ci/mL}</math>)</u>
	$^{234}\text{U}$	D	$3 \times 10^{-12}$
		W	$1 \times 10^{-12}$
		Y	$5 \times 10^{-14}$
	$^{235}\text{U}$	D	$3 \times 10^{-12}$
		W	$1 \times 10^{-12}$
		Y	$6 \times 10^{-14}$
	$^{236}\text{U}$	D	$3 \times 10^{-12}$
		W	$1 \times 10^{-12}$
		Y	$6 \times 10^{-14}$
	$^{237}\text{U}$	D	$4 \times 10^{-9}$
		W	$2 \times 10^{-9}$
		Y	$2 \times 10^{-9}$
	$^{238}\text{U}$	D	$3 \times 10^{-12}$
		W	$1 \times 10^{-12}$
		Y	$6 \times 10^{-14}$
	$^{239}\text{U}$	D	$3 \times 10^{-7}$
		W	$3 \times 10^{-7}$
		Y	$3 \times 10^{-7}$
	$^{240}\text{U}$	D	$5 \times 10^{-9}$
		W	$4 \times 10^{-9}$
		Y	$3 \times 10^{-9}$
	U (natural)	D	$3 \times 10^{-12}$
		W	$9 \times 10^{-13}$
		Y	$9 \times 10^{-14}$

## 8. REGULATIONS, ADVISORIES, AND GUIDELINES

**Table 8-1. Regulations, Advisories, and Guidelines Applicable to Uranium**

Agency	Description	Information		Reference
<u>NATIONAL</u> (cont.)				
	Occupational ALIs and DACs for inhalation <sup>9</sup>			USNRC 2012a 10 CFR 20, Appendix B
	<u>Isotope</u>	<u>Class</u>	<u>ALI (μCi)</u>	<u>DAC (μCi/mL)</u>
	<sup>230</sup> U	D	6x10 <sup>-1</sup>	2x10 <sup>-10</sup>
		W	4x10 <sup>-1</sup>	1x10 <sup>-10</sup>
		Y	3x10 <sup>-1</sup>	1x10 <sup>-10</sup>
	<sup>231</sup> U	D	8x10 <sup>-3</sup>	3x10 <sup>-6</sup>
		W	6x10 <sup>-3</sup>	2x10 <sup>-6</sup>
		Y	5x10 <sup>-3</sup>	2x10 <sup>-6</sup>
	<sup>232</sup> U	D	4x10 <sup>-1</sup>	9x10 <sup>-11</sup>
		W	4x10 <sup>-1</sup>	2x10 <sup>-10</sup>
		Y	8x10 <sup>-3</sup>	3x10 <sup>-12</sup>
	<sup>233</sup> U	D	2x10 <sup>0</sup>	5x10 <sup>-10</sup>
		W	7x10 <sup>-1</sup>	3x10 <sup>-10</sup>
		Y	4x10 <sup>-2</sup>	2x10 <sup>-11</sup>
	<sup>234</sup> U	D	2x10 <sup>0</sup>	5x10 <sup>-10</sup>
		W	7x10 <sup>-1</sup>	3x10 <sup>-10</sup>
		Y	4x10 <sup>-2</sup>	2x10 <sup>-11</sup>
	<sup>235</sup> U	D	2x10 <sup>0</sup>	6x10 <sup>-10</sup>
		W	8x10 <sup>-1</sup>	3x10 <sup>-10</sup>
		Y	4x10 <sup>-2</sup>	2x10 <sup>-11</sup>
	Occupational ALIs and DACs for inhalation <sup>9</sup>			USNRC 2012a 10 CFR 20, Appendix B
	<u>Isotope</u>	<u>Class</u>	<u>ALI (μCi)</u>	<u>DAC (μCi/mL)</u>
	<sup>236</sup> U	D	2x10 <sup>0</sup>	5x10 <sup>-10</sup>
		W	8x10 <sup>-1</sup>	3x10 <sup>-10</sup>
		Y	4x10 <sup>-2</sup>	2x10 <sup>-11</sup>
	<sup>237</sup> U	D	3x10 <sup>-3</sup>	1x10 <sup>-6</sup>
		W	2x10 <sup>-3</sup>	7x10 <sup>-7</sup>
		Y	2x10 <sup>-3</sup>	6x10 <sup>-7</sup>
	<sup>238</sup> U	D	2x10 <sup>0</sup>	6x10 <sup>-10</sup>
		W	8x10 <sup>-1</sup>	3x10 <sup>-10</sup>
		Y	4x10 <sup>-2</sup>	2x10 <sup>-11</sup>
	<sup>239</sup> U	D	2x10 <sup>5</sup>	8x10 <sup>-5</sup>
		W	2x10 <sup>5</sup>	7x10 <sup>-5</sup>
		Y	2x10 <sup>5</sup>	6x10 <sup>-5</sup>
	<sup>240</sup> U	D	4x10 <sup>3</sup>	2x10 <sup>-6</sup>
		W	3x10 <sup>3</sup>	1x10 <sup>-6</sup>
		Y	2x10 <sup>3</sup>	1x10 <sup>-6</sup>
	U (natural)	D	2x10 <sup>0</sup>	5x10 <sup>-10</sup>
		W	8x10 <sup>-1</sup>	3x10 <sup>-10</sup>
		Y	5x10 <sup>-2</sup>	2x10 <sup>-11</sup>

## 8. REGULATIONS, ADVISORIES, AND GUIDELINES

**Table 8-1. Regulations, Advisories, and Guidelines Applicable to Uranium**

Agency	Description	Information	Reference
<u>NATIONAL</u> (cont.)			
	Occupational dose limits		USNRC 2012b
	Adults	5 rems (0.05 Sv)	10 CFR 20, Subpart C
	Lens dose	15 rems (0.15 Sv)	
	Shallow-dose equivalent to the skin of the whole body or to the skin of any extremity	50 rems (0.5 Sv)	
	Minors	10% of the annual dose limits specified for adult workers	
OSHA	PEL (8-hour TWA) for general industry		OSHA 2012c
	Uranium, soluble compounds, as U	0.05 mg/m <sup>3</sup>	29 CFR 1910.1000, Table Z-1
	Uranium, insoluble compounds, as U	0.25 mg/m <sup>3</sup>	
	Each area or room in which natural uranium is used or stored shall be conspicuously posted with a sign or signs bearing the radiation caution symbol	Amount >100 times the quantity of such material specified in 10 CFR, Part 20	OSHA 2012a 29 CFR 1910.1096
	Each container in which natural uranium is transported, stored, or used shall bear a durable, clearly visible label bearing the radiation caution symbol	Quantity >10 times the quantity specified in 10 CFR, Part 20, Appendix C	OSHA 2012b 29 CFR 1910.1096
b. Water			
EPA	Designated as hazardous substances in accordance with Section 311(b)(2)(A) of the Clean Water Act	No data	EPA 2011b 40 CFR 116.4
	Drinking water contaminant candidate list	No data	EPA 1998b 63 FR 10274
	Drinking water standards and health advisories		EPA 2011c
	MCL	0.03 mg/L	
	MCLG	Zero	
	DWEL	0.02 mg/L	
	National primary drinking water standards		EPA 2009a
	MCL	0.03 mg/L	
	Potential health effects from long-term exposure above the MCL	Increased risk of cancer and kidney toxicity	

## 8. REGULATIONS, ADVISORIES, AND GUIDELINES

**Table 8-1. Regulations, Advisories, and Guidelines Applicable to Uranium**

Agency	Description	Information	Reference
<u>NATIONAL</u> (cont.)			
	Common sources of contaminant in drinking water	Erosion of natural deposits	
	Public health goal	Zero	
	National recommended water quality criteria	No data	EPA 2009b
	Reportable quantities of hazardous substances designated pursuant to Section 311 of the Clean Water Act	No data	EPA 2011p 40 CFR 117.3
USNRC	Effluent concentrations in the water		USNRC 2012a
	<u>Isotope</u>	<u>Concentration (<math>\mu\text{Ci/mL}</math>)</u>	10 CFR 20, Appendix B
	$^{230}\text{U}$	$8 \times 10^{-8}$	
	$^{231}\text{U}$	$6 \times 10^{-5}$	
	$^{232}\text{U}$	$6 \times 10^{-8}$	
	$^{233}\text{U}$	$3 \times 10^{-7}$	
	$^{234}\text{U}$	$3 \times 10^{-7}$	
	$^{235}\text{U}$	$3 \times 10^{-7}$	
	$^{236}\text{U}$	$3 \times 10^{-7}$	
	$^{237}\text{U}$	$3 \times 10^{-5}$	
	$^{238}\text{U}$	$3 \times 10^{-7}$	
	$^{239}\text{U}$	$9 \times 10^{-4}$	
	$^{240}\text{U}$	$2 \times 10^{-5}$	
	U (natural)	$3 \times 10^{-7}$	
c. Food			
FDA	Bottled water		FDA 2012a 21 CFR 165.110
	Uranium	30 $\mu\text{g/L}$	
	EAFUS <sup>h</sup>	No data	FDA 2012b
d. Other			
ACGIH	Carcinogenicity classification		ACGIH 2012
	Uranium, soluble and insoluble compounds, as U	A1 <sup>i</sup>	
	BEI		
	Uranium in urine, end of shift	200 $\mu\text{g/L}$	
EPA	Carcinogenicity classification	No data	IRIS 2012
	RfC	No data	
	RfD	0.003 mg/kg/day	
	Environmental radiation protection standards for management and disposal of spent nuclear fuel, high-level and transuranic radioactive wastes		EPA 2011d 40 CFR 191, Appendix A

## 8. REGULATIONS, ADVISORIES, AND GUIDELINES

**Table 8-1. Regulations, Advisories, and Guidelines Applicable to Uranium**

Agency	Description	Information	Reference
<u>NATIONAL</u> (cont.)			
	Release limit per 1,000 metric tons of heavy metal or other unit of waste for $^{233}\text{U}$ , $^{234}\text{U}$ , $^{235}\text{U}$ , $^{236}\text{U}$ , or $^{238}\text{U}$	100	
	Environmental standards for the uranium fuel cycle	Yes	EPA 2011e 40 CFR 190.10, Subpart B
	Identification and listing of hazardous waste	No data	EPA 2011g 40 CFR 261, Appendix VIII
	Exclusion from Identification and listing of hazardous waste		EPA 2011f 40 CFR 261.4
	Uranium	Yes	
	Inert pesticide ingredients in pesticide products	No data	EPA 2011h
	National oil and hazardous substances pollution contingency plan; Hazard ranking system		EPA 2011m 40 CFR 300, Appendix A
	Uranium	Yes	
	National priorities list		EPA 2011n 40 CFR 300, Appendix B
	Uranium	Yes	
	NPDES permit application testing requirements; hazardous substance required to be tested by existing dischargers if expected to be present		EPA 2011o 40 CFR 122, Appendix D
	Uranium	Yes	
	Master Testing List	No data	EPA 2012b
EPA	Standards for cleanup of land and buildings contaminated with residual radioactive materials from inactive uranium processing sites; listed constituents	Combined $^{234}\text{U}$ and $^{238}\text{U}$	EPA 2011q 40 CFR 192, Subpart B
	Standards for management of uranium byproduct materials pursuant to Section 84 of the Atomic Energy Act of 1954, as amended	Yes	EPA 2011r 40 CFR 192, Subpart D
	Standards for the control of residual radioactive materials from inactive uranium processing sites		EPA 2011t 40 CFR 192, Subpart A

## 8. REGULATIONS, ADVISORIES, AND GUIDELINES

**Table 8-1. Regulations, Advisories, and Guidelines Applicable to Uranium**

Agency	Description	Information	Reference
<u>NATIONAL</u> (cont.)			
	Maximum concentration of constituents for groundwater protection; combined $^{234}\text{U}$ and $^{238}\text{U}$	30 pCi/L	
	Standards for owners and operators of hazardous waste TSD facilities; groundwater monitoring list	No data	EPA 2011s 40 CFR 264, Appendix IX
	Superfund, emergency planning, and community right-to-know		
	Designated CERCLA hazardous substance and reportable quantity		EPA 2011u 40 CFR 302.4
	<u>Isotope</u>	<u>RQ (pounds)</u>	<u>Ci (Bq)</u>
	$^{230}\text{U}$	1	$3.7 \times 10^{10}$
	$^{231}\text{U}$	1,000	$3.7 \times 10^{13}$
	$^{232}\text{U}$	0.01	$3.7 \times 10^8$
	$^{233}\text{U}$	0.1	$3.7 \times 10^9$
	$^{234}\text{U}$	0.1	$3.7 \times 10^9$
	$^{235}\text{U}$	0.1	$3.7 \times 10^9$
	$^{236}\text{U}$	0.1	$3.7 \times 10^9$
	$^{237}\text{U}$	100	$3.7 \times 10^{12}$
	$^{238}\text{U}$	0.1	$3.7 \times 10^9$
	$^{239}\text{U}$	1,000	$3.7 \times 10^{13}$
	$^{240}\text{U}$	1,000	$3.7 \times 10^{13}$
	Effective date of toxic chemical release reporting	No data	EPA 2011w 40 CFR 372.65
	Extremely hazardous substances and its threshold planning quantity	No data	EPA 2011v 40 CFR 355, Appendix A
	TSCA chemical lists and reporting periods	No data	EPA 2011x 40 CFR 712.30
	TSCA health and safety data reporting	No data	EPA 2011y 40 CFR 716.120
USNRC	Releases to the sewers; monthly average concentration		USNRC 2012a 10 CFR 20, Appendix B

## 8. REGULATIONS, ADVISORIES, AND GUIDELINES

**Table 8-1. Regulations, Advisories, and Guidelines Applicable to Uranium**

Agency	Description	Information	Reference
<u>NATIONAL</u> (cont.)			
	<u>Isotope</u>	<u>Concentration (μCi/mL)</u>	
	<sup>230</sup> U	8x10 <sup>-7</sup>	
	<sup>231</sup> U	6x10 <sup>-4</sup>	
	<sup>232</sup> U	6x10 <sup>-7</sup>	
	<sup>233</sup> U	3x10 <sup>-6</sup>	
	<sup>234</sup> U	3x10 <sup>-6</sup>	
	<sup>235</sup> U	3x10 <sup>-6</sup>	
	<sup>236</sup> U	3x10 <sup>-6</sup>	
	<sup>237</sup> U	3x10 <sup>-4</sup>	
	<sup>238</sup> U	3x10 <sup>-6</sup>	
	<sup>239</sup> U	9x10 <sup>-3</sup>	
	<sup>240</sup> U	2x10 <sup>-4</sup>	
	U (natural)	3x10 <sup>-6</sup>	
	Occupational ALIs for oral ingestion		USNRC 2012a 10 CFR 20, Appendix B
	<u>Isotope</u>	<u>ALI (μCi)</u>	
	<sup>230</sup> U	4.0	
	<sup>231</sup> U	5,000	
	<sup>232</sup> U	2.0	
	<sup>233</sup> U	10	
	<sup>234</sup> U	10	
	<sup>235</sup> U	10	
	<sup>236</sup> U	10	
	<sup>237</sup> U	2,000	
	<sup>238</sup> U	10	
	<sup>239</sup> U	70,000	
	<sup>240</sup> U	1,000	
	U (natural)	10	
NTP	Carcinogenicity classification		NTP 2012 77 FR 2728
	Uranium (depleted)	Nominated to the Report on Carcinogens	

<sup>a</sup>With the further provision that the effective dose should not exceed 50 mSv in any single year. Additional restrictions apply to the occupational exposure of pregnant women.

<sup>b</sup>The guideline value is designated as provisional because of outstanding uncertainties regarding the toxicology and epidemiology of uranium as well as difficulties concerning its technical achievability in smaller supplies.

<sup>c</sup>The limitation on the effective dose provides sufficient protection for the skin against stochastic effects. An additional limit is needed for localized exposure in order to prevent deterministic effects.

<sup>d</sup>In special circumstances, a higher value of effective dose could be allowed in a single year, provided that the average over 5 years does not exceed 1 mSv per year.

<sup>e</sup>PAC-1: mild, transient health effects. PAC-2: irreversible or other serious health effects that could impair the ability to take protective action. PAC-3: life-threatening health effects.

<sup>f</sup>NIOSH potential occupational carcinogen.

<sup>g</sup>Three classes (D,W,Y) of radioactive material, which refer to their retention (approximately days, weeks, or years) in the pulmonary region of the lung. This classification applies to a range of clearance half-times of <10 days for D, for W from 10 to 100 days, and for Y >100 days.

<sup>h</sup>The EAFUS list of substances contains ingredients added directly to food that FDA has either approved as food additives or listed or affirmed as GRAS.

<sup>i</sup>A1: confirmed human carcinogen

## 8. REGULATIONS, ADVISORIES, AND GUIDELINES

**Table 8-1. Regulations, Advisories, and Guidelines Applicable to Uranium**

Agency	Description	Information	Reference
<p>ACGIH = American Conference of Governmental Industrial Hygienists; AEGL = acute exposure guideline levels; AIHA = American Industrial Hygiene Association; ALI = annual limit on intake; BEI = biological exposure indices; CERCLA = Comprehensive Environmental Response, Compensation, and Liability Act; CFR = Code of Federal Regulations; DAC = derived air concentration; DOE = Department of Energy; DWEL = drinking water equivalent level; EAFUS = Everything Added to Food in the United States; EPA = Environmental Protection Agency; ERPG = emergency response planning guidelines; FDA = Food and Drug Administration; FR = Federal Register; GRAS = Generally Recognized As Safe; IARC = International Agency for Research on Cancer; ICRP = International Commission on Radiological Protection; IDLH = immediately dangerous to life or health; IRIS = Integrated Risk Information System; MCL = maximum contaminant level; MCLG = maximum contaminant level goal; NAAQS = National Ambient Air Quality Standards; NIOSH = National Institute for Occupational Safety and Health; NTP = National Toxicology Program; OSHA = Occupational Safety and Health Administration; PAC = Protective Action Criteria; PEL = permissible exposure limit; REL = recommended exposure limit; RfC = inhalation reference concentration; RfD = oral reference dose; STEL = short-term exposure level; TDI = tolerable daily intake; TLV = threshold limit values; TSCA = Toxic Substances Control Act; TSD = treatment, storage, and disposal; TWA = time-weighted average; U = uranium; USC = United States Code; USNRC = U.S. Nuclear Regulatory Commission; WHO = World Health Organization</p>			



## 9. REFERENCES

Abbasi SA. 1989. Atomic absorption spectrometric and spectrophotometric trace analysis of uranium in environmental samples with N-p-methoxyphenyl-2-furylacrylohydroxamic acid and 4-(2-pyridylazo) resorcinol. *Int J Environ Anal Chem* 36:163-172.

ABMS. 1994. Non-ferrous metal data 1993. American Bureau of Metal Statistics Inc.

ACE. 2013. Formerly utilized sites remedial action program. U.S. Army Corps of Engineers. <http://www.usace.army.mil/Media/FactSheets/FactSheetArticleView/tabid/219/Article/816/formerly-utilized-sites-remedial-action-program.aspx>. February 21, 2013.

ACGIH. 2012. Uranium. Threshold limit values for chemical substances and physical agents and biological exposure indices. Cincinnati, OH: American Conference of Governmental Industrial Hygienists, 59, 111.

Adams N, Spoor NL. 1974. Kidney and bone retention functions in the human metabolism of uranium. *Phys Med Biol* 19:460-471.

Adinolfi M. 1985. The development of the human blood-CSF-brain barrier. *Dev Med Child Neurol* 27(4):532-537.

Adlercreutz H. 1995. Phytoestrogens: Epidemiology and a possible role in cancer protection. *Environ Health Perspect Suppl* 103(7):103-112.

AEC. 1948. The excretion of hexavalent uranium following intravenous administration. II. Studies on human subjects. Rochester, NY: U.S. Atomic Energy Commission. UR-37. <http://www.osti.gov/bridge/purl.cover.jsp?purl=/122006-Q20zHP/webviewable/>. November 23, 2010.

AEC. 1957. A study of the distribution and excretion of uranium in man. Oak Ridge, TN: U.S. Atomic Energy Commission. DE86013703.

AEC. 1974. Environmental survey of the uranium fuel cycle. U.S. Atomic Energy Commission. USAEC Report WASH-1248.

Agency for Toxic Substances and Disease Registry. 1989. Decision guide for identifying substance-specific data needs related to toxicological profiles; Notice. Agency for Toxic Substances and Disease Registry, Division of Toxicology. *Fed Regist* 54(174):37618-37634.

Agency for Toxic Substances and Disease Registry. 1990c. Biomarkers of organ damage or dysfunction for the renal, hepatobiliary, and immune systems. Subcommittee on Biomarkers of Organ Damage and Dysfunction. Atlanta, GA: Agency for Toxic Substances and Disease Registry.

Agency for Toxic Substances and Disease Registry. 1997. Public health assessment. Monticello Mill tailings (DOE) and Monticello radioactively contaminated properties (aka Monticello vicinity properties). Agency for Toxic Substances and Disease Registry, U.S. Department of Health and Human Services. <http://www.atsdr.cdc.gov/HAC/pha/PHA.asp?docid=802&pg=0>. November 15, 2010.

---

\* Not cited in text

## 9. REFERENCES

- Agency for Toxic Substances and Disease Registry. 2008. Health consultation. Depleted uranium at Hawaiian military sites; Schofield Barracks Impact Area; Makua Military Reservation, Pohakuloa Training Area on Islands of Oahu and Hawaii. Agency for Toxic Substances and Disease Registry. [http://www.atsdr.cdc.gov/HAC/pha//DepletedUraniumHawaiianMilitarySites/Depleted\\_Uranium\\_At\\_Hawaiian\\_Military\\_Sites%20\(HC%208-25-2008\)%20.pdf](http://www.atsdr.cdc.gov/HAC/pha//DepletedUraniumHawaiianMilitarySites/Depleted_Uranium_At_Hawaiian_Military_Sites%20(HC%208-25-2008)%20.pdf). February 21, 2013.
- Agency for Toxic Substances and Disease Registry. 2010. Toxicological profile for plutonium. Atlanta, GA: Agency for Toxic Substances and Disease Registry. U.S. Department of Health and Human Services. <http://www.atsdr.cdc.gov/ToxProfiles/tp143.pdf>. December 16, 2010.
- Agency for Toxic Substances and Disease Registry. 2012. Toxicological profile for radon. Atlanta, GA: Agency for Toxic Substances and Disease Registry. U.S. Department of Health and Human Services. <http://www.atsdr.cdc.gov/ToxProfiles/tp145.pdf>. July 24, 2012.
- Ahsanullah M, Williams AR. 1989. Kinetics of uranium uptake by the crab *Pachygrapsus laevimanus* and the zebra winkle *Austrocochlea constricta*. *Mar Biol* 101:323-327.
- Aieta EM, Singley JE, Trussell AR, et al. 1987. Radionuclides in drinking water: An overview. *J Am Water Works Assoc* 79:144-152.
- AIHA. 2011. Emergency response planning guidelines (ERPG). Fairfax, VA: American Industrial Hygiene Association. [http://www.aiha.org/insideaiha/GuidelineDevelopment/ERPG/Documents/2011erpgweelhandbook\\_table-only.pdf](http://www.aiha.org/insideaiha/GuidelineDevelopment/ERPG/Documents/2011erpgweelhandbook_table-only.pdf). April 25, 2012.
- Aldstadt JH, Kuo JM, Smith LL, et al. 1996. Determination of uranium by flow injection inductively coupled plasma mass spectrometry. *Anal Chim Acta* 319(1-2):135-143.
- Allard, B; Kipatsi, H; Torstenfelt, B; et al. 1979. Nuclide transport by groundwater in Swedish bedrock. In: McCarthy, GJ, ed. *Scientific Basis for Nuclear Waste Management*. NY: Plenum Press; pp. 403-410.
- Allard, B; Olofsson, U; Torstenfelt, B; et al. 1982. Sorption of actinides in well-defined oxidation states on geologic media. In: Lutze, W, ed. *Scientific basis for radioactive waste management - V*. Elsevier, pp. 775-782.
- Altman PL, Dittmer DS. 1974. *Biological handbooks: Biology data book*. Vol. III. 2nd ed. Bethesda, MD: Federation of American Societies for Experimental Biology, 1987-2008, 2041.
- Ames LL, McGarrah JE, Walker BA. 1982. Sorption of uranium and cesium by Hanford basalts and associated secondary smectite. *Chem Geol* 35:205-225.
- Amethyst Galleries. 1995. The mineral tyuyamunite. <http://mineral.galleries.com/minerals/phosphat/tyuyamun/tyuyamun.htm>.
- Andersen ME, MacNaughton MG, Clewell HJ, et al. 1987. Adjusting exposure limits for long and short exposure periods using a physiological pharmacokinetic model. *Am Ind Hyg Assoc J* 48(4):335-343.

## 9. REFERENCES

- Andersen ME, Krishnan K. 1994. Relating *in vitro* to *in vivo* exposures with physiologically based tissue dosimetry and tissue response models. In: Salem H, ed. Animal test alternatives: Refinement, reduction, replacement. New York, NY: Marcel Dekker, Inc., 9-25.
- Anderson RF, Fleer AP. 1982. Determination of natural actinides and plutonium in marine particulate material. *Anal Chem* 54:1142-1147.
- Andre S, Metivier H, Auget D, et al. 1989. Lung dissolution of uranium tetrafluoride in rats and baboons. Comparison with dissolution by alveolar macrophages in culture and chemical dissolution. *Hum Toxicol* 8:111-119.
- ANL. 2011. Depleted UF6 storage. Depleted UF6 inventory and storage locations. Argonne National Laboratory. <http://web.ead.anl.gov/uranium/mgmtuses/storage/index.cfm>. January 21, 2011.
- ANSI. 1978. American national standard radiation protection instrumentation test and calibration. American National Standard Institute, ANSI N323. New York, NY: Institute of Electrical and Electronics Engineers, Inc.
- Anthony ML, Gartland KPR, Beddell CR, et al. 1994. Studies of the biochemical toxicology of uranyl nitrate in the rat. *Arch Toxicol* 68(1):43-53.
- Archer VE, Wagoner JK, Lundin FE. 1973a. Lung cancer among uranium miners in the United States. *Health Phys* 25:351-371.
- Archer VE, Wagoner JK, Lundin FE. 1973b. Cancer mortality among uranium mill workers. *J Occup Med* 15:11-14.
- Arfsten DP, Schaeffer DJ, Johnson EW, et al. 2006. Evaluation of the effect of implanted depleted uranium on male reproductive success, sperm concentration, and sperm velocity. *Environ Res* 100(2):205-215.
- Arfsten DP, Still KR, Wilfong ER, et al. 2009. Two-generation reproductive toxicity study of implanted depleted uranium (DU) in CD rats. *J Toxicol Environ Health A* 72(6):410-427.
- Arfsten DP, Wilfong ER, Bekkedal MY, et al. 2007. Evaluation of the effect of implanted depleted uranium (DU) on adult rat behavior and toxicological endpoints. *J Toxicol Environ Health A* 70(23):1995-2010.
- Argonne National Laboratory. 2005. Natural decay series: Uranium, radium, and thorium. Human health fact sheet. <http://www.ead.anl.gov/pub/doc/natural-decay-series.pdf>. April 28, 2011.
- Arnault E, Doussau M, Pesty A, et al. 2008. Natural uranium disturbs mouse folliculogenesis *in vivo* and oocyte meiosis *in vitro*. *Toxicology* 247(2-3):80-87.
- Arruda-Neto JD, Guevara MV, Nogueira GP, et al. 2004a. Long-term accumulation of uranium in bones of Wistar rats as a function of intake dosages. *Radiat Prot Dosimetry* 112(3):385-393.
- Arruda-Neto JD, Likhachev VP, Nogueira GP, et al. 2001. Transfer coefficient measurements of uranium to the organs of Wistar rats, as a function of the uranium content in the food. *Appl Radiat Isot* 54(6):947-956.

## 9. REFERENCES

- Arruda-Neto JD, Manso Guevara MV, Nogueira GP, et al. 2004b. Long-term accumulation and microdistribution of uranium in the bone and marrow of beagle dog. *Int J Radiat Biol* 80(8):567-575.
- ASTM. 1986. Annual books of ASTM standards. Water and environmental technology, Section 11, Vol. 11.02 (water 11). Philadelphia, PA: American Society for Testing of Materials, 511-515; 516-521; 523-528.
- ASTM. 1994. Annual books of ASTM standards. Water and environmental technology. Philadelphia, PA: American Society for Testing of Materials, 449-452.
- Au WW, Lane RG, Legator MS, et al. 1995. Biomarker monitoring of a population residing near uranium mining activities. *Environ Health Perspect* 103(5):466-70.
- Auerbach O, Saccomanno G, Kuschner M, et al. 1978. Histologic findings in the tracheobronchial tree of uranium miners and non-miners with lung cancer. *Cancer* 42:483-489.
- Avasthi PS, Evan AP, Hay D. 1980. Glomerular endothelial cells in uranyl nitrate-induced acute renal failure in rats. *J Clin Invest* 65:121-127.
- Bakhtmutsky MV, Oliver MS, McDiarmid MA, et al. 2011. Long term depleted uranium exposure in Gulf War I veterans does not cause elevated numbers of micronuclei in peripheral blood lymphocytes. *Mutat Res* 720(1-2):53-57.
- Ballou JE, Gies RA, Case AC, et al. 1986. Deposition and early disposition of inhaled uranium-233 uranyl nitrate and uranium-232 uranyl nitrate in the rat. *Health Phys* 51:755-772.
- Band P, Feldstein M, Saccomanno G, et al. 1980. Potentiation of cigarette smoking and radiation: Evidence from a sputum cytology survey among uranium miners and controls. *Cancer* 45:1273-1277.
- Band P, Feldstein M, Watson L, et al. 1982. Lung cancer screening programs in Canadian uranium mines. *Recent Results Cancer Res* 82:153-158.
- Barber DS, Hancock SK, McNally AM, et al. 2007. Neurological effects of acute uranium exposure with and without stress. *Neurotoxicology* 28(6):1110-1119.
- Barnes CE, Cochran JK. 1993. Uranium geochemistry in estuarine sediments controls on removal and release processes. *Geochim Cosmochim Acta* 57:555-569.
- Barnes DG, Dourson M. 1988. Reference dose (RfD): Description and use in health risk assessments. *Regul Toxicol Pharmacol* 8(4):471-486.
- Bearman PJ. 1979. A review of the environmental problems associated with the disposal of uranium tailings. *Miner Environ* 1:64-74.
- Bednar AJ, Medina VF, Ulmer-Scholle DS, et al. 2007. Effects of organic matter on the distribution of uranium in soil and plant matrices. *Chemosphere* 70(2):237-247.
- Began D. 2002. Dermatologic principles. In: Goldfrank LR, Flomenbaum NE, Lewin NA, et al., eds. *Goldfrank's toxicologic emergencies*. 7th ed. New York, NY: McGraw-Hill, 432-440.

## 9. REFERENCES

- BEIR III. 1980. The effects on populations of exposure to low levels of ionizing radiation. Committee on the Biological Effects of Ionizing Radiations, National Research Council. Washington, DC: National Academy Press.
- BEIR IV. 1988. Uranium. In: Health risk of radon and other internally deposited alpha-emitters. Washington, DC: National Academy Press. Biological Effects of Ionizing Radiations, 276-302.
- BEIR V. 1990. Health effects of exposure to low levels of ionizing radiation. Committee on the Biological Effects of Ionizing Radiations, National Research Council. Washington, DC: National Academy Press.
- Beiter H, Gibb FR, Morrow PE. 1975. Intramuscular retention of  $UO_3$  and  $UO_2$ . *Health Phys* 29:273-277.
- Belles M, Albina ML, Linares V, et al. 2005. Combined action of uranium and stress in the rat. I. Behavioral effects. *Toxicol Lett* 158(3):176-185.
- Belles M, Linares V, Luisa Albina M, et al. 2007. Melatonin reduces uranium-induced nephrotoxicity in rats. *J Pineal Res* 43(1):87-95.
- Bensoussan H, Grancolas L, Dhieux-Lestaevél B, et al. 2009. Heavy metal uranium affects the brain cholinergic system in rat following sub-chronic and chronic exposure. *Toxicology* 261(1-2):59-67.
- Bentley KW, Stockwell DR, Britt KA, et al. 1985. Transient proteinuria and aminoaciduria in rodents following uranium intoxication. *Bull Environ Contam Toxicol* 34:407-416.
- Berard P, Quesne B, Auriol B, et al. 1994. Cutaneous contamination after a uranyl nitrate skin burn: Incident report. *Radiat Prot Dosim* 53(1-4):269-272.
- Berger GS, ed. 1994. Epidemiology of endometriosis. In: Endometriosis: Modern surgical management of endometriosis. New York, NY: Springer-Verlag, 3-7.
- Berradi H, Bertho JM, Dudoignon N, et al. 2008. Renal anemia induced by chronic ingestion of depleted uranium in rats. *Toxicol Sci* 103(2):397-408.
- Bhattacharyya RP, Larsen P, Cohen N, et al. 1989. Gastrointestinal absorption of plutonium and uranium in fed and fasted adult baboons and mice: Application to humans. *Radiat Prot Dosimetry* 26:159-165.
- Bigu J, Duport P. 1992. Characterization of long-lived radioactive dust in uranium mill operations. *Am Ind Hyg Assoc* 53:588-595.
- Bigu J, Grenier NK, Dave TP, et al. 1984. Study of radon gas concentration surface radon flux and other radiation variables from uranium mine tailings areas. *Uranium* 1:257-277.
- Birkenfeld HP, Kathren RL, Hedaya MA. 1995. A sensitive method for the determination of uranium in biological samples utilizing kinetic phosphorescence analysis (KPA). *Pharm Res* 12(9 Suppl):S48.
- Blantz RC. 1975. The mechanism of acute renal failure after uranyl nitrate. *J Clin Invest* 55:621-635.

## 9. REFERENCES

- Boice JD, Cohen SS, Mumma MT, et al. 2008. A cohort study of uranium millers and miners of Grants, New Mexico, 1979-2005. *J Radiol Prot* 28(3):303-325.
- Boice JD, Cohen SS, Mumma MT, et al. 2007a. Mortality among residents of Uravan, Colorado who lived near a uranium mill, 1936-84. *J Radiol Prot* 27(3):299-319.
- Boice JD, Mumma MT, Blot WJ. 2007b. Cancer and noncancer mortality in populations living near uranium and vanadium mining and milling operations in Montrose County, Colorado, 1950-2000. *Radiat Res* 167(6):711-726.
- Boice JD, Mumma MT, Blot WJ. 2010. Cancer incidence and mortality in populations living near uranium milling and mining operations in Grants, New Mexico, 1950-2004. *Radiat Res* 175(5):624-636.
- Boice JD, Mumma M, Schweitzer S, et al. 2003. Cancer mortality in a Texas county with prior uranium mining and milling activities, 1950-2001. *J Radiol Prot* 23(3):247-262.
- Boniforti R. 1987. Lanthanides, uranium, and thorium as possible simulators of the behavior of transuranics in the aquatic environment. *Sci Total Environ* 64:181-189.
- Boomer DW, Powell MJ. 1987. Determination of uranium in environmental samples using inductively coupled plasma mass spectrometry. *Anal Chem* 59:2810-2813.
- Boothe GF. 1977. The need for radiation controls in the phosphate and related industries. *Health Phys* 32:285.
- Bosque MA, Domingo JL, Llobet JM, et al. 1993. Embryotoxicity and teratogenicity of uranium in mice following subcutaneous administration of uranyl acetate. *Biol Trace Elem Res* 36(2):109-118.
- Bostick WD, McCulla WH, Pickrell PW. 1985. Sampling, characterization, and remote sensing of aerosols formed in the atmospheric hydrolysis of uranium hexafluoride. *J Environ Sci Health A* 20:369-393.
- Bozal CB, Martinez AB, Cabrini RL, et al. 2005. Effect of ethane-1-hydroxy-1,1-bisphosphonate (EHBP) on endochondral ossification lesions induced by a lethal oral dose of uranyl nitrate. *Arch Toxicol* 79(8):475-481.
- Bradford GR, Bakhtar D, Westcot D. 1990. Uranium vanadium and molybdenum in saline waters of California. *J Environ Qual* 19:105-108.
- Brady HR, Kone CB, Brenner RM, et al. 1989. Early effects of uranyl nitrate on respiration and K transport in rabbit proximal tubule. *Kidney Int* 36:27-34.
- Brandvold LL, Brendvold DK, Popp CJ. 1981. Effects of uranium mining and milling on surface water in New Mexico. In: *Environmental and economic considerations in energy utilization. Proceedings of the Seventh Conference on Energy and the Environment, Phoenix, Arizona.* Canton, NY: Ann Arbor Science Publishers, 467-476.
- Braunlich H, Fleck C. 1981. Urinary enzyme excretion as an indicator of nephrotoxicity in dependence on age. *Exp Pathol* 20(3):182-187.

## 9. REFERENCES

- Briner W. 2009. Effects of depleted uranium on mouse midbrain catecholamines and related behavior. *Internet Journal of Toxicology* 7(1):No pp. [http://www.ispub.com/journal/the\\_internet\\_journal\\_of\\_toxicology/volume\\_7\\_number\\_2\\_29/article/effects-of-depleted-uranium-on-mouse-midbrain-catecholamines-and-related-behavior.html](http://www.ispub.com/journal/the_internet_journal_of_toxicology/volume_7_number_2_29/article/effects-of-depleted-uranium-on-mouse-midbrain-catecholamines-and-related-behavior.html). November 5, 2010.
- Briner W, Byrd K. 2000. Effects of depleted uranium on development of the mouse. In: Collery P, Centeno JA, al., eds. *Metal ions in biology and medicine. Proceedings of the sixth International symposium on metal ions in biology and medicine, held in San Juan, Puerto Rico, USA, on May 7-10, 2000.* Vol. 6. Montrouge, France: John Libbey Eurotext, 459-461.
- Briner W, Murray J. 2005. Effects of short-term and long-term depleted uranium exposure on open-field behavior and brain lipid oxidation in rats. *Neurotoxicol Teratol* 27(1):135-144.
- Broadway JA, Strong AB. 1983. Radionuclides in human bone samples. *Health Phys* 45:765-768.
- Brookins DG, Thomson BM, Longmire PA, et al. 1993. Geochemical behavior of uranium mill tailings leachate in the subsurface. In: *Radioactive waste management and the nuclear fuel cycle.* Vol. 17 (3-4). Malaysia: Harwood Academic Publishers, 269-287.
- Brunskill GJ, Wilkinson P. 1987. Annual supply of uranium-238, uranium-234, thorium-230, radium-226, lead-210, polonium-210 and thorium-232 to lake 239 (Experimental Lakes Area, Ontario, Canada) from terrestrial and atmospheric sources. *Can J Fish Aquat Sci* 44(Suppl 1):215-230.
- Busby C, Hamdan M, Ariabi E. 2010. Cancer, infant mortality and birth sex-ratio in Fallujah, Iraq 2005-2009. *Int J Environ Res Public Health* 7(7):2828-2837.
- Bushaw BA. 1984. Advanced analytical techniques. In: *Biokinetics and analysis of uranium in man. Proceedings of a colloquium held at Richland, WA, August 8-9, 1984.* Prepared by the Hanford Environmental Health Foundation for the Department of Energy, K-1 to K-36.
- Bussy C, Lestaevel P, Dhieux B, et al. 2006. Chronic ingestion of uranyl nitrate perturbs acetylcholinesterase activity and monoamine metabolism in male rat brain. *Neurotoxicology (Amsterdam)* 27(2):245-252.
- Butterworth A. 1955. The significance and value of uranium in urine analysis. *Trans Assoc Ind Med Offrs* 5:36-43.
- Byerley JJ, Scharer JM, Atkinson GF. 1987. Determination of uranium(VI) in process liquors by ion chromatography. *Analyst* 112:41-44.
- Caldwell KL, Hartel J, Jarrett J, et al. 2005. Inductively coupled plasma mass spectrometry to measure multiple toxic elements in urine in NHANES 1999-2000. *Atom Spectrosc* 26(1):1-7.
- Canu IG, Ellis ED, Tirmarche M. 2008. Cancer risk in nuclear workers occupationally exposed to uranium-emphasis on internal exposure. *Health Phys* 94:1-17.
- Carpenter AV, Flanders WD, Frome EL, et al. 1988. Chemical exposures and central nervous system cancers: A case-control study among workers at two nuclear facilities. *Am J Ind Med* 13:351-362.
- Carvalho FP, Oliveira JM. 2010. Uranium isotopes in the Balkan's environment and foods following the use of depleted uranium in the war. *Environ Int* 36(4):352-360.

## 9. REFERENCES

- CDC. 2012. Fourth national report on human exposure to environmental chemicals and updated tables, February 2012. Atlanta, GA: Centers for Disease Control and Prevention. <http://www.cdc.gov/exposurereport/>. May 30, 2012.
- Chan C, Hughes TS, Muldoon S, et al. 2010. Mortality patterns among Paducah Gaseous Diffusion Plant workers. *J Occup Environ Med* 52(7):725-732.
- Chang X, Luo X, Zhan G, et al. 1990. Performance for PAN-3 chelate fiber for adsorbing and separating trace uranium. *Mikrochim Acta* 101-105.
- Chase GR. 1989. Correlation between airborne uranium exposure and uranium urinalysis results at Bear Creek Uranium. *Health Phys* 56(2):195-199.
- \*Checkoway H, Crawford-Brown D. 1987. Metabolic modeling of organ-specific doses to carcinogens as illustrated with alpha-radiation emitting radionuclides. *J Chronic Dis* 40(2):191S-200S.
- Checkoway H, Pearce N, Crawford-Brown DJ, et al. 1988. Radiation doses and cause-specific mortality among workers at a nuclear materials fabrication plant. *Am J Epidemiol* 127(2):255-266.
- Chen J, Lariviere D, Timmins R, et al. 2011. Estimation of uranium GI absorption fractions for children and adults. *Radiat Prot Dosimetry* 144(1-4):379-383.
- Chen J, Meyerhof DP, Tracy BL. 2004. Model results of kidney burdens from uranium intakes. *Health Phys* 86(1):3-11.
- Chovil A, Chir B. 1981. The epidemiology of primary lung cancer in uranium miners in Ontario. *J Occup Med* 23(6):417-421.
- Clark DL, Neu MP, Runde W, et al. 2006. Uranium and uranium compounds. In: Kirk-Othmer encyclopedia of chemical technology. <http://onlinelibrary.wiley.com/doi/10.1002/0471238961.2118011403120118.a01.pub3/pdf>. January 26, 2011.
- Clarke R. 1999. Control of low-level radiation exposure: Time for a change? *J Radiol Prot* 19(2):107-115.
- Clayton GD, Clayton FE. 1981. *Patty's industrial hygiene and toxicology*. Vol. 2A: Toxicology. 3rd ed. New York: John Wiley & Sons, 1995-2013.
- Clewell HJ, Andersen ME. 1985. Risk assessment extrapolations and physiological modeling. *Toxicol Ind Health* 1(4):111-131.
- Cookfair, DL; Beck, WL; Shy, C; et al. 1983. Lung cancer among workers at a uranium processing plant. *Epidemiology applied to health physics: Proceedings of the sixteenth midyear topical meeting of the Health Physics society, Albuquerque, New Mexico, January 9-13, 1983*. U.S. Department of Energy. Health Physics Society, 398-406. DE83014383.
- Cooper JR, Stradling GN, Smith H, et al. 1982. The behavior of uranium-233 oxide and uranyl-233 nitrate in rats. *Int J Radiat Biol Relat Stud Phys Chem Med* 41(4):421-433.



## 9. REFERENCES

- Coryell VH, Stearns DM. 2006. Molecular analysis of hprt mutations generated in Chinese hamster ovary EM9 cells by uranyl acetate, by hydrogen peroxide, and spontaneously. *Mol Carcinog* 45(1):60-72.
- Cothorn CR. 1987. Development of regulations for radionuclides in drinking water. In: Graves B, ed. Radon in ground water, radon, radium and other radioactivity in ground water: Hydrogeologic impact and application to indoor airborne contamination. Proceedings of the National Water Well Association conference, Somerset, NJ, April 7-9, 1987. Chelsea, MI: Lewis Publishers, Inc. 1-11.
- Cothorn CR, Lappenbusch WL. 1983. Occurrence of uranium in drinking water in the U.S. *Health Phys* 45:89-99.
- Cowart JB, Burnett WC. 1994. The distribution of uranium and thorium decay-series radionuclides in the environment-A review. *J Environ Qual* 23:651-662.
- Cragle DL, McLain RW, Qualters JR, et al. 1988. Mortality among workers at a nuclear fuels production facility. *Am J Ind Med* 14:379-401.
- Crancon P, Pili E, Charlet L. 2010. Uranium facilitated transport by water-dispersible colloids in field and soil columns. *Sci Total Environ* 408(9):2118-2128.
- Cross FT, Filipy RE, Loscutt SM, et al. 1981a. Histopathologic, morphometric and physiologic investigation of lungs of dogs exposed to uranium ore dust. In: International conference: Hazards Min Control Meas Med Aspects 228-235.
- Cross FT, Palmer RF, Busch RH, et al. 1981b. Development of lesions in Syrian golden hamsters following exposure to radon daughters and uranium ore dust. *Health Phys* 41:135-153.
- Cross FT, Palmer RF, Filipy RE, et al. 1982. Carcinogenic effects of radon daughters, uranium ore dust and cigarette smoke in Beagle dogs. *Health Phys* 42(1):33-52.
- Damon EG, Eidson AF, Hahn FF, et al. 1984. Comparison of early lung clearance of yellowcake aerosols in rats with *in vitro* dissolution and IR analysis. *Health Phys* 46:859-866.
- Darolles C, Broggio D, Feugier A, et al. 2010. Different genotoxic profiles between depleted and enriched uranium. *Toxicol Lett* 192(3):337-348.
- Davesne E, Chojnacki E, Paquet F, et al. 2009. Modeling the imprecision in prospective dosimetry of internal exposure to uranium. *Health Phys* 96(2):144-154.
- de Rey BM, Lanfranchi HE, Cabrini RL. 1983. Percutaneous absorption of uranium compounds. *Environ Res* 30:480-491.
- de Sioniz MI, Lorenzo P, Perera J. 1991. Distribution of oxidizing bacterial activities and characterization of bioleaching-related microorganisms in a uranium mineral heap. *Microbiologia* 7(2):82-89.
- \*Diamond GL. 1988. Biological monitoring of urine for exposure to toxic metals. In: Clarkson TW, Friberg L, Nordberg GF, et al., eds. Biological monitoring of toxic metals. New York, NY: Plenum Press, 515-529.

## 9. REFERENCES

- Diamond GL, Morrow PE, Panner BJ, et al. 1989. Reversible uranyl nephrotoxicity in the Long Evans rat. Govt Rep Announce Ind, Issue 01. NTIS/NUREG/CR-4951.
- Dias da Cunha KM, Lima C, Barros Leite CV, et al. 2011. Case study. Uranium oxide solubility in simulated lung fluids. *J Occup Environ Hyg* 8(6):D51-D56.
- Diaz Sylvester PL, Lopez R, Ubios AM, et al. 2002. Exposure to subcutaneously implanted uranium dioxide impairs bone formation. *Arch Environ Health* 57(4):320-325.
- Dockery DW, Arden P, Xu X. 1993. An association between air pollution and mortality in six US cities. *N Engl J Med* 329(24):1753-1759.
- Dodge CJ, Francis AJ. 1994. Photodegradation of uranium-citrate complex with uranium recovery. *Environ Sci Technol* 28:1300-1306.
- Dodge CJ, Francis AJ. 1997. Biotransformation of binary and ternary citric acid complexes of iron and uranium. *Environ Sci Technol* 31(11):3062-3067.
- DOE. 1981a. Environmental monitoring report. Paducah gaseous diffusion plant. Calendar year 1980. U.S. Department of Energy. DE81023308.
- DOE. 1981b. Uranium in U.S. surface, ground, and domestic waters. Volume 1. U.S. Department of Commerce. National Technical Information Services.
- DOE. 1981c. Radiological survey of the Shpack Landfill, Norton, Massachusetts. Washington, DC: U.S. Department of Energy. DE82004939.
- DOE. 1985. Geochemical information for sites contaminated with low-level radioactive wastes: II-St. Louis airport storage site. U.S. Department of Energy. DE85004955.
- \*DOE. 1986a. Results of radiological measurements taken in the Niagara Falls, NY area. Oak Ridge National Lab, TN: U.S. Department of Energy. DE87002963.
- DOE. 1986b. The elimination rate of uranium from the kidney of the dog. In: *Research in radiobiology. Annual report of work in progress in the Internal Irradiation Program.* U.S. Department of Energy. DEAC0276EV00119.
- DOE. 1988. Health physics manual of good practices for uranium facilities. U.S. Department of Energy, Idaho National Engineering Laboratory, EGG-2530 UC-41.
- DOE. 1992. Behavior of mercury, lead, cesium, and uranyl ions on four SRS soils (U). Aiken, SC: U.S. Department of Energy. DE93003378.
- \*DOE. 1994a. Radiological control manual. U.S. Department of Energy, DOE/EH-0256T, Revision 1, April 1994.
- DOE. 1994b. U.S. Department of Energy. Management of depleted uranium hexafluoride (UF<sub>6</sub>); request for recommendations. *Fed Regist* 56324, Washington, D.C., November 1994.

## 9. REFERENCES

- DOE. 1984c. Environment monitoring report for the former Middlesex Sampling Plant and Middlesex Municipal Landfill sites, calendar year 1984. U.S. Department of Energy. DOE/OR20722-56. DE85017886.
- DOE. 1995. Uranium Industry Annual 1994. Energy Information Administration, Office of Coal, Nuclear, Electric and Alternate Fuels, U.S. Department of Energy. Washington DC.
- DOE. 1996a. Uranium industry annual 1995. Energy Information Administration, Office of Coal, Nuclear, Electric and Alternate Fuels, U.S. Department of Energy. Washington DC.
- \*DOE. 1996b. Annual limits on intake (ALIs) and derived air concentrations (DACs) of radionuclides for occupational exposure; effluent concentrations; concentrations for release to sewerage. 10CFR20 Appendix B. U.S. Department of Energy, Washington, DC.
- DOE. 1997b. Uranium industry annual 1996. Energy Information Administration, Office of Coal, Nuclear, Electric and Alternate Fuels; U.S. Department of Energy, Washington, DC, April 1997, DOE/EIA-0478(96), Distribution Category UC-950.
- DOE. 1997a. EML procedures manual, HASL-300, 28<sup>th</sup> edition. Environmental Measurements Laboratory, U.S. Department of Energy, New York.
- DOE. 1999a. Total production of uranium concentrate in the United States. U.S. Department of Energy. [http://www.eia.doe.gov/cneaf/nuclear/page/at\\_a\\_glance/qtr\\_upd/qupd.html](http://www.eia.doe.gov/cneaf/nuclear/page/at_a_glance/qtr_upd/qupd.html)
- DOE. 1999b. Uranium industry annual 1998. Washington, DC: U.S. Department of Energy, Energy Information Administration, Office of Coal, Nuclear, and Alternate Fuels. DOE/EIA0478(98).
- DOE. 2000. Isotopic uranium in biological and environmental materials. Washington, DC: U.S. Department of Energy, Environmental Measurements Laboratory. <http://www.caslab.com/Test-Methods-Search/PDF/DOE-Method-U-02-RC.pdf>. March 23, 2011.
- DOE. 2008. Excess uranium inventory management plan. U.S. Department of Energy. [www.ne.doe.gov/pdfFiles/inventory\\_plan\\_unclassified.pdf](http://www.ne.doe.gov/pdfFiles/inventory_plan_unclassified.pdf). August 3, 2012.
- DOE. 2009. DOE Standard: Guide of good practices for occupational radiological protection in uranium facilities. Washington, DC: U.S. Department of Energy. DOE-STD-1136-2004.
- DOE. 2010. Quality assurance program document. Carlsbad, New Mexico: U.S. Department of Energy, Carlsbad Field Office. DOE/CBFO-94-1012. [www.wipp.energy.gov/library/qapd/qapd.pdf](http://www.wipp.energy.gov/library/qapd/qapd.pdf). March 23, 2011.
- DOE. 2011a. Depleted UF<sub>6</sub> Storage. U.S. Department of Energy. Office of Environmental Management. <http://web.ead.anl.gov/uranium/mgmtuses/storage/index.cfm>. March 24, 2011.
- DOE. 2011b. Certified reference materials price list (CRM listing, prices and certificates). Chicago, IL: U.S. Department of Energy. [http://www.nbl.doe.gov/htm/lists/certified\\_reference\\_materials\\_price\\_list.htm](http://www.nbl.doe.gov/htm/lists/certified_reference_materials_price_list.htm). March 23, 2011.
- DOE. 2011c. Legacy management 2011-2020 strategic plan. U.S. Department of Energy. <http://www.lm.doe.gov/WorkArea/linkit.aspx?LinkIdentifier=id&ItemID=7624>. February 22, 2013.

## 9. REFERENCES

- DOE. 2012. Protective action criteria (PAC). Oak Ridge, TN: U.S. Department of Energy and Subcommittee on Consequence Assessment and Protective Actions (SCAPA). <http://orise.orau.gov/emi/scapa/chem-pacs-teels/default.htm>. April 25, 2012.
- DOE. 2013. Formerly Utilized Sites Remedial Action Program (FUSRAP). LM and U.S. Army Corps of Engineers Sites. U.S. Department of Energy. <http://www.lm.doe.gov/default.aspx?id=2126>. February 22, 2013.
- DOI. 2010. Exclusion of certain noncoal reclamation sites. U.S. Department of the Interior. Code of Federal Regulations 30 CFR 875.16 [http://edocket.access.gpo.gov/cfr\\_2010/julqtr/pdf/30cfr875.16.pdf](http://edocket.access.gpo.gov/cfr_2010/julqtr/pdf/30cfr875.16.pdf). January 27, 2011.
- Domingo JL, Colomina MT, Llobet JM, et al. 1992. The action of chelating agents in experimental uranium intoxication in mice: Variations with structure and time of administration. *Fundam Appl Toxicol* 19:350-357.
- Domingo JL, de la Torre A, Belles M, et al. 1997. Comparative effects of the chelators sodium 4,5-dihydroxybenzene-1,3-disulfonate (Tiron) and diethylenetriaminepentaacetic acid (DTPA) on acute uranium nephrotoxicity in rats. *Toxicology* 118(1):49-59.
- Domingo JL, Llobet JM, Tomas JM, et al. 1987. Acute toxicity of uranium in rats and mice. *Bull Environ Contam Toxicol* 39:168-174.
- Domingo JL, Ortega A, Llobet JM, et al. 1989a. The effects of repeated parenteral administration of chelating agents on the distribution and excretion of uranium. *Res Commun Chem Pathol Pharmacol* 64(1):161-164.
- Domingo JL, Ortega A, Paternain JL, et al. 1989b. Evaluation of the perinatal and postnatal effects of uranium in mice upon oral administration. *Arch Environ Health* 44(6):395-398.
- Domingo JL, Paternain JL, Llobet JM, et al. 1989c. The developmental toxicity of uranium in mice. *Toxicology* 55(1-2):143-152.
- Dounce AL, Flagg JF. 1949. The chemistry of uranium compounds. In: Voegtlin C, Hodge HC, eds. *Pharmacology and toxicology of uranium compounds with a section on the pharmacology and toxicology of fluorine and hydrogen fluoride*. New York, NY: McGraw-Hill Book Co., Inc., 55, 83-84.
- Downs WL, Wilson HB, Sylvester GE, et al. 1967. Excretion of uranium by rats following inhalation of uranium dioxide. *Health Phys* 13:445-453.
- Dreesen DR, Williams MJ, Marple ML, et al. 1982. Mobility and bioavailability of uranium mill tailings contaminants. *Environ Sci Technol* 16:702-709.
- Dublineau I, Grison S, Baudelin C, et al. 2005. Absorption of uranium through the entire gastrointestinal tract of the rat. *Int J Radiat Biol* 81(6):473-482.
- Dublineau I, Grison S, Grandcolas L, et al. 2006. Absorption, accumulation and biological effects of depleted uranium in Peyer's patches of rats. *Toxicology* 227(3):227-239.

## 9. REFERENCES

- Dungworth DL. 1989. Noncarcinogenic responses of the respiratory tract to inhaled toxicants. In: McClellan RO, Henderson RF, eds. Concepts in inhalation toxicology. New York, NY: Hemisphere Publishing Corporation, 273-298.
- Dupree EA, Cragle DL, McLain RW, et al. 1987. Mortality among workers at a uranium processing facility, the Linde Air Products Company Ceramics Plant, 1943-1949. *Scand J Work Environ Health* 13(2):100-107.
- du Preez JGH. 1989. A review of the industrial process involving uranium from the ore to the reactor. *Radiat Prot Dosimetry* 26:7-13.
- Dupzyk IA, Dupzyk RJ. 1979. Separation of uranium from urine for measurement by fluorimetry of isotope-dilution mass spectrometry. *Health Phys* 36:526-529.
- Durbin PW, Wrenn ME. 1975. Metabolism and effects of uranium in animals. In: Wrenn ME, ed. Conference: Occupational health experience with uranium. Arlington, VA, April, 1975. Washington, DC: U.S. Energy Research and Development Administration. ERDA-93, 67-129.
- Dygert HP. 1949a. Uranium tetrafluoride. In: Voegtlin C, Hodge HC, eds. Pharmacology and toxicology of uranium compounds. New York, NY: McGraw-Hill Book Inc., 603-614.
- Dygert HP. 1949b. Ammonium diuranate. In: Voegtlin C, Hodge HC, eds. Pharmacology and toxicology of uranium compounds. New York, NY: McGraw-Hill Book Inc., 666-672.
- Dygert HP. 1949c. Uranium triauroxide. In: Voegtlin C, Hodge HC, eds. Pharmacology and toxicology of uranium compounds. New York, NY: McGraw-Hill Book Inc., 673-676.
- Dygert HP. 1949d. Uranium peroxide. In: Voegtlin C, Hodge HC, eds. Pharmacology and toxicology of uranium compounds. New York, NY: McGraw-Hill Book Inc., 647-652.
- Dygert HP. 1949e. Tests of respiratory protective devices in atmospheres containing uranium dust. In: Voegtlin C, Hodge HC, eds. Pharmacology and toxicology of uranium compounds. New York, NY: McGraw-Hill Book Inc., 676-700.
- Eadie GG, Kaufmann RF. 1977. Radiological evaluation of the effects of uranium mining and milling operations on selected ground water supplies in the Grants Mineral Belt, New Mexico. *Health Phys* 32:231-241.
- EIA. 2010a. Uranium marketing annual report. U.S. Energy Information Administration. <http://www.eia.doe.gov/cneaf/nuclear/umar/umar.html>. January 26, 2011.
- EIA. 2010b. Domestic uranium production report - annual. U.S. Energy Information Administration. <http://www.eia.doe.gov/cneaf/nuclear/dupr/dupr.html>. January 26, 2011.
- \*EIA. 2010c. Domestic uranium production report - quarterly U.S. Energy Information Administration. <http://www.eia.doe.gov/cneaf/nuclear/dupr/qupd.html>. January 26, 2011.
- EIA. 2010d. U.S. uranium reserves estimates. U.S. Energy Information Administration. <http://www.eia.doe.gov/cneaf/nuclear/page/reserves/ures.html>. January 26, 2011.

## 9. REFERENCES

EIA. 2010e. Domestic uranium production report - quarterly: 4th quarter 2010. Washington, DC: U.S. Energy Information Administration. <http://eia.doe.gov/cneaf/nuclear/dupr/qupd.pdf>. March 23, 2011.

Eidson AF. 1994. The effect of solubility on inhaled uranium compound clearance. *Health Phys* 67(1):1-14.

Eidson AF, Griffith WC, Jr., Hahn FF, et al. 1989. A model for scaling the results of U excretion rate studies in Beagle dogs to man. *Health Phys* 57:199-210.

Eisenbud M, Quigley JA. 1956. Industrial hygiene of uranium processing. *AMA Arch Ind Health* 14:12-22.

Ejnik JW, Todorov TI, Mullick FG, et al. 2005. Uranium analysis in urine by inductively coupled plasma dynamic reaction cell mass spectrometry. *Anal Bioanal Chem* 382(1):73-79.

El-Didamony H, Gado HS, Awwade NS, et al. 2013. Treatment of phosphogypsum waste produced from phosphate ore processing. *J Hazard Mater* 244-245:596-602.

\*Ellender M. 1987. The clearance of uranium after deposition of the nitrate and bicarbonate in different regions of the rat lung. *Human Toxicol* 6:479-482.

Ellender M, Haines JW, Harrison JD. 1995. The distribution and retention of plutonium, americium and uranium in cba/h mice. *Hum Exp Toxicol* 14(1):38-48.

Elliston JT, Glover SE, Filby RH. 2001. The determination of natural uranium in human tissues by recovery corrected kinetic phosphorescence analysis. *J Radioanal Nucl Chem* 248(2):487-491.

Elliston JT, Glover SE, Filby RH. 2005. Comparison of direct kinetic phosphorescence analysis and recovery corrected kinetic phosphorescence analysis and recovery corrected kinetic phosphorescence analysis for the determination of natural uranium in human tissues. *J Radioanal Nucl Chem* 263(2):301-306.

EPA. 1979a. Ambient airborne radioactivity measurements in the vicinity of the jackpile open pit uranium mine New Mexico. Las Vegas, NV: U.S. Environmental Protection Agency. ISS ORP/LV-79/2. PB292379.

\*EPA. 1979b. U.S. Environmental Protection Agency. Code of Federal Regulations. 40 CFR 125.

EPA. 1980a. A combined methodology for estimating dose rates and health effects for exposure to radioactive pollutants. Oak Ridge, TN: U.S. Environmental Protection Agency. EPA78DX0231. ORNL/RM-7105.

EPA. 1980b. Source category survey: Uranium refining industry. Research Triangle Park, NC: U.S. Environmental Protection Agency. EPA450380010. PB80192867.

EPA. 1980c. Prescribed procedures for measurement of radioactivity in drinking water. Cincinnati, OH: U.S. Environmental Protection Agency. EPA600480032. PB80224744.

\*EPA. 1984a. U.S. Environmental Protection Agency Code of Federal Regulations. 40 CFR 60 Subpart LL.

## 9. REFERENCES

- EPA. 1984b. U.S. Environmental Protection Agency. Radionuclides: Background information document for final rules. Vol 1. U.S. Environmental Protection Agency, Office of Radiation Program, Washington, DC. EPA 520/1-84-022-1. NTIS PB85-165751.
- EPA. 1984e. Determination of uranium in drinking water by laser induced fluorometry. EPA Method 908.2. Cincinnati, OH: Environmental Monitoring and Support Laboratory, Physical and Chemical Methods Branch, U.S. Environmental Protection Agency.
- EPA. 1985a. U.S. Environmental Protection Agency Code of Federal Regulations. 40 CFR 302.3.
- EPA. 1985b. U.S. Environmental Protection Agency Code of Federal Regulation CFR 421, Subpart AD.
- EPA. 1985c. Drinking water criteria document for uranium. Washington, DC: U.S. Environmental Protection Agency. PB86241049.
- \*EPA. 1988a. U.S. Environmental Protection Agency. Analysis of clean water act effluent guidelines pollutants: Summary of the chemicals regulated by industrial point source category. Prepared by the Industrial technology Division (WH 552), Office of Water Regulations and Standards, Office of Water, Washington, DC. 40 CFR Parts 400-475.
- EPA. 1988b. U.S. Environmental Protection Agency. Limiting values of radionuclide intake and air concentration and dose conversion factors for inhalation, submersion, and ingestion. EPA-520/1-88-020. U.S. Environmental Protection Agency. Washington, DC.
- \*EPA. 1988c. U.S. Environmental Protection Agency. Environmental radiation protection standards for nuclear power operations. 40 CFR 190.
- EPA. 1988d. Gastrointestinal absorption of soluble uranium from drinking water. Research Triangle Park, NC: U.S. Environmental Protection Agency. EPA600D88G78. PB8201231.
- EPA. 1990. Interim methods for development of inhalation reference concentrations. Washington, DC: U.S. Environmental Protection Agency, Office of Health and Environmental Assessment, Office of Research and Development, Environmental Criteria and Assessment Office. EPA600890066A.
- EPA. 1991b. U.S. Environmental Protection Agency. Radionuclides in drinking water fact sheet. National Primary Drinking Water Regulations for Radionuclides, Proposed Rule, June, 1991. EPA570991700. Washington, DC.
- EPA. 1991a. Method 200.8: Determination of trace elements in waters and wastes by inductively coupled plasma-mass spectrometry (revision 4.4). Cincinnati, OH: Environmental Monitoring Systems Laboratory, Office of Research and Development, U.S. Environmental Protection Agency.
- EPA. 1994a. Environmental radiation data. Report number 74. April-June 1993. U.S. Environmental Protection Agency. <http://www.epa.gov/narel/radnet/erd/erd74.pdf>. July 5, 2012.
- EPA. 1994b. U.S. Environmental Protection Agency. EPA requirements for quality assurance project plans for environmental data operations. EPA QA/R-5, draft interim final, Quality Assurance Management Staff, Washington, D.C.

## 9. REFERENCES

EPA. 1995. U.S. Environmental Protection Agency. Technical resource document, extraction and beneficiation of ores and minerals. EPA 530-R-94-032, NTIS PB94-2008987.

\*EPA. 1996a. U.S. Environmental Protection Agency. Guidance for data quality assessment: Practical methods for data analysis. EPA QA/G-9 QA96 Version, EPA/600/R-96/084, Quality Assurance Management Staff, Washington, D.C.

EPA. 1996b. Environmental radiation data. Report 86. U.S. Environmental Protection Agency. <http://www.epa.gov/narel/radnet/erd/erd86.pdf>. January 28, 2011.

EPA. 1997a. Special report on environmental endocrine disruption: An effects assessment and analysis. Washington, DC: U.S. Environmental Protection Agency, Risk Assessment Forum. EPA630R96012. Endocrine section

EPA. 1997b. Environmental radiation data. Report 92. U.S. Environmental Protection Agency. <http://www.epa.gov/narel/radnet/erd/erd92.pdf>. January 28, 2011.

EPA. 1998a. Automated Form R for Windows: User's guide (RY97). Washington, DC: U.S. Environmental Protection Agency, Office of Pollution Prevention and Toxics.

EPA. 1998b. The drinking water contaminant candidate list. U.S. Environmental Protection Agency. Federal Register 63 FR 10274 <http://www.gpo.gov/fdsys>. April 25, 2012.

EPA. 2000. Data quality objectives process for hazardous waste site investigations. Washington, DC: U.S. Environmental Protection Agency, Office of Environmental Information. EPA600R00007. [www.epa.gov/quality/qs-docs/g4hw-final.pdf](http://www.epa.gov/quality/qs-docs/g4hw-final.pdf). March 23, 2011.

EPA. 2005a. Environmental radiation data. Report 124. U.S. Environmental Protection Agency. <http://www.epa.gov/narel/radnet/erd/erd124.pdf>. January 28, 2011.

EPA. 2005b. Toxic chemical release inventory reporting forms and instructions: Revised 2004 version. Section 313 of the Emergency Planning and Community Right-to-Know Act (Title III of the Superfund Amendments and Reauthorization Act of 1986). U.S. Environmental Protection Agency. Office of Environmental Information. EPA260B05001.

EPA. 2006a. Data quality assessment: A reviewer's guide. Washington, DC: U.S. Environmental Protection Agency, Office of Environmental Information. EPA240B06002. [www.epa.gov/QUALITY/qs-docs/g9r-final.pdf](http://www.epa.gov/QUALITY/qs-docs/g9r-final.pdf). March 23, 2011.

EPA. 2006b. Data quality assessment: Statistical methods for practitioners. Washington, DC: U.S. Environmental Protection Agency, Office of Environmental Information. EPA240B06003. [www.epa.gov/quality/qs-docs/g9s-final.pdf](http://www.epa.gov/quality/qs-docs/g9s-final.pdf). March 23, 2011.

EPA. 2006c. Environmental radiation data. Report 128 October-December 2006. U.S. Environmental Protection Agency. <http://www.epa.gov/narel/radnet/erd/erd128.pdf>. March 22, 2011.

EPA. 2007. Environmental radiation data. Report 132. U.S. Environmental Protection Agency. <http://www.epa.gov/narel/radnet/erd/erd132.pdf>. January 28, 2011.



## 9. REFERENCES

- EPA. 2008. Public health and environmental radiation protection standards for Yucca Mountain, Nevada. U.S. Environmental Protection Agency. Fed Regist 73(200):61256-61289. [http://www.epa.gov/radiation/docs/yucca/yucca\\_mtn\\_rule\\_fed\\_reg\\_version.pdf](http://www.epa.gov/radiation/docs/yucca/yucca_mtn_rule_fed_reg_version.pdf). August 3, 2012.
- EPA. 2009a. National primary drinking water regulations. Washington, DC: Office of Ground Water and Drinking Water, U.S. Environmental Protection Agency. EPA816F090004. <http://water.epa.gov/drink/contaminants/upload/mcl-2.pdf>. April 25, 2012.
- EPA. 2009b. National recommended water quality criteria. Washington, DC: Office of Water, Office of Science and Technology, U.S. Environmental Protection Agency. <http://water.epa.gov/scitech/swguidance/standards/current/upload/nrwqc-2009.pdf>. April 25, 2012.
- EPA. 2010a. National ambient air quality standards (NAAQS). Washington, DC: Office of Air and Radiation, U.S. Environmental Protection Agency. <http://www.epa.gov/air/criteria.html>. April 25, 2012.
- EPA. 2010b. RadNet-tracking environmental radiation nationwide. U.S. Environmental Protection Agency. <http://www.epa.gov/narel/radnet/aboutus.html>. January 28, 2011.
- EPA. 2011a. Acute exposure guideline levels (AEGs). Washington, DC: Office of Pollution Prevention and Toxics, U.S. Environmental Protection Agency. [http://www.epa.gov/oppt/aegl/pubs/compiled\\_aegls\\_nov072011.pdf](http://www.epa.gov/oppt/aegl/pubs/compiled_aegls_nov072011.pdf). April 25, 2012.
- EPA. 2011b. Designated as hazardous substances in accordance with section 311(b)(2)(a) of the clean water act. U.S. Environmental Protection Agency. Code of Federal Regulations 40 CFR 116.4 <http://www.gpo.gov/fdsys>. April 25, 2012.
- EPA. 2011c. Drinking water standards and health advisories. Washington, DC: Office of Water, U.S. Environmental Protection Agency. <http://water.epa.gov/action/advisories/drinking/upload/dwstandards2011.pdf>. April 25, 2012.
- EPA. 2011d. Environmental radiation protection standards for management and disposal of spent nuclear fuel, high-level and transuranic radioactive wastes. U.S. Environmental Protection Agency. Code of Federal Regulations 40 CFR 191, Appendix A <http://www.gpo.gov/fdsys>. June 15, 2012.
- EPA. 2011e. Environmental standards for the uranium fuel cycle. U.S. Environmental Protection Agency. Code of Federal Regulations 40 CFR 190.10, Subpart B <http://www.gpo.gov/fdsys>. June 15, 2012.
- EPA. 2011f. Exclusion from Identification and listing of hazardous waste. U.S. Environmental Protection Agency. Code of Federal Regulations 40 CFR 261.4 <http://www.gpo.gov/fdsys>. June 15, 2012.
- EPA. 2011g. Identification and listing of hazardous waste. Hazardous constituents. U.S. Environmental Protection Agency. Code of Federal Regulations 40 CFR 261, Appendix VIII <http://www.gpo.gov/fdsys>. April 25, 2012.
- EPA. 2011h. Inert ingredients permitted for use in nonfood pesticide products. Washington, DC: U.S. Environmental Protection Agency. [http://www.epa.gov/opprd001/inerts/inert\\_nonfooduse.pdf](http://www.epa.gov/opprd001/inerts/inert_nonfooduse.pdf). April 25, 2012.

## 9. REFERENCES

- EPA. 2011i. National emission standards for radon-222 emissions from operating mill tailings. U.S. Environmental Protection Agency. Code of Federal Regulations 40 CFR 61.252, Subpart W <http://www.gpo.gov/fdsys>. June 15, 2012.
- EPA. 2011j. National emission standards for radon-222 emissions from the disposal of uranium mill tailings that are no longer operational. U.S. Environmental Protection Agency. Code of Federal Regulations. 40 CFR 61.222, Subpart T <http://www.gpo.gov/fdsys>. June 15, 2012.
- EPA. 2011k. National emission standards for radon-222 emissions from underground uranium mines. U.S. Environmental Protection Agency. Code of Federal Regulations 40 CFR 61.22, Subpart B <http://www.gpo.gov/fdsys>. June 15, 2012.
- EPA. 2011l. National emission standards for radionuclide emissions from federal facilities other than NRC licensees and not covered by Subpart H. U.S. Environmental Protection Agency. Code of Federal Regulations 40 CFR 61.102, Subpart I <http://www.gpo.gov/fdsys>. June 15, 2012.
- EPA. 2011m. National oil and hazardous substances pollution contingency plan. Hazard ranking system. U.S. Environmental Protection Agency. Code of Federal Regulations 40 CFR 300, Appendix A <http://www.gpo.gov/fdsys>. June 15, 2012.
- EPA. 2011n. National oil and hazardous substances pollution contingency plan. National priorities list. U.S. Environmental Protection Agency. Code of Federal Regulations 40 CFR 300, Appendix B <http://www.gpo.gov/fdsys>. June 15, 2012.
- EPA. 2011o. NPDES permit application testing requirements. U.S. Environmental Protection Agency. Code of Federal Regulations 40 CFR 122, Appendix D <http://www.gpo.gov/fdsys>. June 15, 2012.
- EPA. 2011p. Reportable quantities of hazardous substances designated pursuant to section 311 of the clean water act. U.S. Environmental Protection Agency. Code of Federal Regulations 40 CFR 117.3 <http://www.gpo.gov/fdsys>. April 25, 2012.
- EPA. 2011q. Standards for cleanup of land and buildings contaminated with residual radioactive materials from inactive uranium processing sites; listed constituents. U.S. Environmental Protection Agency. Code of Federal Regulations 40 CFR 192, Subpart B <http://www.gpo.gov/fdsys>. June 15, 2012.
- EPA. 2011r. Standards for management of uranium byproduct materials pursuant to Section 84 of the Atomic Energy Act of 1954, as amended. U.S. Environmental Protection Agency. Code of Federal Regulations 40 CFR 192, Subpart D <http://www.gpo.gov/fdsys>. June 15, 2012.
- EPA. 2011s. Standards for owners and operators of hazardous waste TSD facilities. Groundwater monitoring list. U.S. Environmental Protection Agency. Code of Federal Regulations 40 CFR 264, Appendix IX <http://www.gpo.gov/fdsys>. April 25, 2012.
- EPA. 2011t. Standards for the control of residual radioactive materials from inactive uranium processing sites. U.S. Environmental Protection Agency. Code of Federal Regulations 40 CFR 192, Subpart A <http://www.gpo.gov/fdsys>. June 15, 2012.
- EPA. 2011u. Superfund, emergency planning, and community right-to-know programs. Designation, reportable quantities, and notifications. U.S. Environmental Protection Agency. Code of Federal Regulations 40 CFR 302.4 <http://www.gpo.gov/fdsys>. April 25, 2012.

## 9. REFERENCES

- EPA. 2011v. Superfund, emergency planning, and community right-to-know programs. Extremely hazardous substances and their threshold planning quantities. U.S. Environmental Protection Agency. Code of Federal Regulations 40 CFR 355, Appendix A <http://www.gpo.gov/fdsys>. April 25, 2012.
- EPA. 2011w. Superfund, emergency planning, and community right-to-know programs. Toxic chemical release reporting. U.S. Environmental Protection Agency. Code of Federal Regulations 40 CFR 372.65 <http://www.gpo.gov/fdsys>. April 25, 2012.
- EPA. 2011x. Toxic substances control act. Chemical lists and reporting periods. U.S. Environmental Protection Agency. Code of Federal Regulations 40 CFR 712.30 <http://www.gpo.gov/fdsys>. April 25, 2012.
- EPA. 2011y. Toxic substances control act. Health and safety data reporting. U.S. Environmental Protection Agency. Code of Federal Regulations 40 CFR 716.120 <http://www.gpo.gov/fdsys>. April 25, 2012.
- EPA. 2011z. Uranium mill tailings. U.S. Environmental Protection Agency. <http://www.epa.gov/radiation/docs/radwaste/402-k-94-001-umt.html>. April 28, 2011.
- EPA. 2012a. Hazardous air pollutants. Clean air act. U.S. Environmental Protection Agency. United States Code 42 USC 7412 <http://www.epa.gov/ttn/atw/orig189.html>. April 25, 2012.
- EPA. 2012b. Master testing list. Washington, DC: Office of Pollution Prevention and Toxics, U.S. Environmental Protection Agency. <http://www.epa.gov/oppt/chemtest/pubs/index1.pdf>. April 25, 2012.
- EPA. 2012c. Benchmark dose technical guidance. U.S. Environmental Protection Agency. EPA100R12001. U.S. Environmental Protection Agency. [http://www.epa.gov/raf/publications/pdfs/benchmark\\_dose\\_guidance.pdf](http://www.epa.gov/raf/publications/pdfs/benchmark_dose_guidance.pdf). July 5, 2012.
- EPA. 2013a. Federal actions to address impacts of uranium contamination in the Navajo Nation: Five-year plan summary report. U.S. Environmental Protection Agency. <http://www.epa.gov/region9/superfund/navajo-nation/pdf/NavajoUraniumReport2013.pdf>. February 21, 2013.
- EPA. 2013b. Fertilizer and fertilizer production wastes. U.S. Environmental Protection Agency. <http://www.epa.gov/rpdweb00/tenorm/fertilizer.html>. February 21, 2013.
- Eral M. 1989. Chemical determination of uranium in natural waters with DBM by the adsorption of U(VI) on Fe(OH)<sub>3</sub>. *Spectrosc Lett* 22(4):431-440.
- Erdal BR, Daniels WR, Hoffman DC, et al. 1979. Sorption and migration of radionuclides in geologic media. In: J. MG, ed. *Scientific basis for nuclear waste management*. Vol. 1. New York: Plenum Press, 423-425.
- Essien IO, Sandoval DN, Kuroda PK. 1985. Deposition of excess amount of natural U from the atmosphere. *Health phys* 48(3):325-331.
- Fabrikant JI. 1990. The health effects of radon and other alpha emitting radionuclides: The National Academy of Sciences BEIR IV report. Elsevier Science Publishers, 9-13.

## 9. REFERENCES

Fajgelj A, Horvat D, Pucelj B. 1992. Chromosome aberrations induced in human lymphocytes by U-235 fission neutrons. Part II: Evaluation of the effect of the induced Na-24 activity on the chromosomal aberration yield. *Strahlenther Onkol* 168(7):406-411.

\*Fajgelj A, Lakoski D, Horvat I, et al. 1991. Chromosome aberrations induced in human lymphocytes by U-235 fission neutrons: 1. Irradiation of human blood samples in the "dry cell" of the TRIGA Mark II nuclear reactor. *Strahlenther. Onkol* 167:661-666.

Farfan EB, Huston TE, Bolch WE, et al. 2003. Influences of parameter uncertainties within the ICRP-66 respiratory tract model: Regional tissue doses for  $^{239}\text{PuO}_2$  and  $^{238}\text{UO}_2/^{238}\text{U}_3\text{O}_8$ . *Health Phys* 84(4):436-450.

FDA. 2012a. Bottled water. U.S. Food and Drug Administration. Code of Federal Regulations 21 CFR 165.110 <http://www.gpo.gov/fdsys>. June 15, 2012.

FDA. 2012b. Everything added to food in the United States (EAFUS). Washington, DC: U.S. Food and Drug Administration. <http://www.fda.gov/food/foodingredientspackaging/ucm115326.htm>. April 25, 2012.

FDA. 1976. Uranium in dental porcelain. Rockville, MD: U.S. Food and Drug Administration. PB259624.

Feeney CM, Anderson JW, Tindall FM. 1983. Determination of uranium in tailings by inductively coupled plasma optical emission spectrometry. *At Spectrosc* 4:108-110.

Feugier A, Frelon S, Gourmelon P, et al. 2008. Alteration of mouse oocyte quality after a subchronic exposure to depleted uranium. *Reprod Toxicol* 26(3-4):273-277.

Filippova LG, Nifativ AP, Lyubchanskii ER. 1978. Some of the long-term sequelae of giving rats enriched uranium. *Radiobiologia* 18(3):94-100.

Fisenne IM. 1988. Uranium in humans. *Radiat Prot Dosimetry* 24:127-131.

Fisenne IM, Perry PM. 1985. Isotopic U concentration in human blood from New York City donors. *Health Phys* 49:1272-1275.

Fisenne IM, Welford GA. 1986. Natural U concentrations in soft tissues and bone of New York City residents. *Health Phys* 50:739-746.

Fisenne IM, Perry PM, Welford GA. 1980. Determination of uranium (isotopes) in human bone ash. *Anal Chem* 52:777-779.

Fisher DR, Jackson PO. 1986. Reply to Singh and Wrenn regarding levels of uranium-234, -238 and thorium-230 in excreta of uranium mill crushermen. *Health Phys* 50:302-303.

Fisher DR, Jackson PO, Brodaczynski GG, et al. 1983. Levels of  $^{234}\text{U}$ ,  $^{238}\text{U}$  and  $^{230}\text{Th}$  in excreta of uranium mill crushermen. *Health Phys* 45:617-629.

Fisher DR, Kathern RL, Swint MJ. 1991. Modified biokinetic model for uranium from analysis of acute exposure of  $\text{UF}_6$ . *Health Phys* 60(3):335-342.

## 9. REFERENCES

- Fomon SJ. 1966. Body composition of the infant: Part I: The male reference infant. In: Falkner F, ed. Human development. Philadelphia, PA: WB Saunders, 239-246. Child health section
- Fomon SJ, Haschke F, Ziegler EE, et al. 1982. Body composition of reference children from birth to age 10 years. *Am J Clin Nutr* 35(Suppl 5):1169-1175. Child health section
- Forte M, Rusconi R, Margini C, et al. 2001. Determination of uranium isotopes in food and environmental samples by different techniques: A comparison. *Radiat Prot Dosimetry* 97(4):325-328.
- Francis AJ, Dodge CJ, Gillow JB, et al. 1989. Microbial transformation of uranium in wastes. 2nd International conference on chemistry and migration behavior of actinides and fission products in the geosphere held in Monterey, California, November 6-10, 1989. Washington, DC: U.S. Department of Energy. DE90004191. BNL43483.
- Frome EL, Cragle DL, McLain RW. 1990. Poisson regression analysis of the mortality among a cohort of World War II. *Radiat Res* 123:138-152.
- Fruchter JS, Robertson DE, Evans JC, et al. 1980. Reports-Mount St. Helens ash from the 18 May 1980 eruption: Chemical, physical, mineralogical, and biological properties. *Science* 209(5):1116-1125.
- Fujino O, Umetani S, Matsui M. 1994. Determination of uranium in apatite minerals by inductively coupled plasma atomic emission spectrometry after solvent extraction and separation with 3-phenyl-4-benzoyl-5-isoxazolone into diisobutyl ketone. *Anal Chim Acta* 296:63-68.
- Fukuda S, Iida H, Ikeda M, et al. 2005. Toxicity of uranium and the removal effects of CBMIDA and EHBP in simulated wounds of rats. *Health Phys* 89(1):81-88.
- Fukuda S, Ikeda M, Anzai K, et al. 2006. Radiation protection by deferiprone in animal models. *Hemoglobin* 30(2):201-208.
- Fukuda S, Ikeda M, Nakamura M, et al. 2008. The effects of bicarbonate and its combination with chelating agents used for the removal of depleted uranium in rats. *Hemoglobin* 32(1-2):191-198.
- Fukuda S, Ikeda M, Nakamura M, et al. 2009. Efficacy of oral and intraperitoneal administration of CBMIDA for removing uranium in rats after parenteral injections of depleted uranium. *Radiat Prot Dosimetry* 133(1):12-19.
- Galle P, Berry JP, Galle C. 1992. Role of alveolar macrophages in precipitation of mineral elements inhaled as soluble aerosols. *Environ Health Perspect* 97:145-147.
- Galletti M, D'Annibale L, Pinto V, et al. 2003. Uranium daily intake and urinary excretion: A preliminary study in Italy. *Health Phys* 85(2):228-235.
- Garten CT. 1978. A review of parameter values used to assess the transport of plutonium, uranium, and thorium in terrestrial food chains. *Environ Res* 17(3):437-452.
- Gavrilescu M, Pavel LV, Cretescu I. 2009. Characterization and remediation of soils contaminated with uranium. *J Hazard Mater* 163(2-3):475-510.

## 9. REFERENCES

- \*Giglio MJ, Brandan N, Leal TL, et al. 1989. The mechanism of the transient depression of the erythropoietic rate induced in the rat by a single injection of uranyl nitrate. *Toxicol Appl Pharmacol* 99(2):260-265.
- Gilkeson RH, Cowart JB. 1987. Radium radon and uranium isotopes in groundwater from Cambrian-Ordovician sandstone aquifers in Illinois USA. In: Graves B, ed. Radon in ground water, radon, radium and other radioactivity in ground water: Hydrogeologic impact and application to indoor airborne contamination: Proceedings of the National Water Well Association conference, Somerset, NJ, April 7-9, 1987. Chelsea, MI: Lewis Publishers, Inc., 403-422.
- Gilman AP, Moss MA, Villeneuve DC, et al. 1998c. Uranyl nitrate: 91-day exposure and recovery studies in the male New Zealand white rabbit. *Toxicol Sci* 41(1):138-151.
- Gilman AP, Villeneuve DC, Secours VE, et al. 1998a. Uranyl nitrate: 28-day and 91-day toxicity studies in the Sprague-Dawley rat. *Toxicol Sci* 41(1):117-128.
- Gilman AP, Villeneuve DC, Secours VE, et al. 1998b. Uranyl nitrate: 91-day toxicity studies in the New Zealand white rabbit. *Toxicol Sci* 41(1):129-137.
- Gindler JE. 1973. Physical and chemical properties of uranium. In: Hodge HC, et al., eds. Uranium, plutonium transplutonic elements. New York, NY: Springer-Verlag, 69-164.
- Giwerzman A, Carlsen E, Keiding N, et al. 1993. Evidence for increasing incidence of abnormalities of the human testis: A review. *Environ Health Perspect Suppl* 101(2):65-71.
- Gladney ES, Peters RJ, Perrin DR. 1983. Determination of uranium-235/uranium-238 ratio in natural waters by Chelex-100 ion exchange and neutron-activation analysis. *Anal Chem* 55:976-977.
- Goans RE. 2007. Medical management of radiation incidents. In: Shannon MW, Borron SW, Burns MJ, eds. Haddad and Winchester's clinical management of poisoning and drug overdose. 4th ed. Philadelphia, PA: Saunders, 1467-1485.
- Goel KA, Garg VK, Garg V. 1980. Histopathology of kidney of albino rat poisoned with uranyl nitrate. *Bull Environ Contam Toxicol* 24:9-12.
- Gogolak CV. 1985. The radiological impact of atmospheric emissions from oil shale retorts. *Environ Int* 11:57-64.
- Golchert NW, Iwami FS, Sedlet J. 1980. Determination of actinides in soil. In: Lyon WS, ed. Radioelement analysis: Progress and problems. 23rd Conference: Analytical chemistry in energy technology, Gatlinburg, TN, Oct. 9-11, 1979. Ann Arbor, MI: Ann Arbor Science Publishers, Inc., 215-222.
- Gonzales ER, Gladney ES, Boyd HA, et al. 1988. Determination of U in human tissues by delayed neutron activation analysis. *Health Phys* 55(6):927-932.
- Goode DJ, Wilder RJ. 1987. Ground-water contamination near a uranium tailings disposal site in Colorado. *Ground Water* 27:545-554.

## 9. REFERENCES

- Goodman DR. 1985. Nephrotoxicity. Toxic effects in the kidneys. In: Williams PL, Burson JL, eds. *Industrial toxicology safety and health applications in the workplace*. New York, NY: Van Nostrand Reinhold Company, 106-122.
- Gottlieb LS, Husen LA. 1982. Lung cancer among Navajo uranium miners. *Chest* 81:449-452.
- Grace M, Larson M, Hanson J. 1980. Bronchogenic carcinoma among former uranium mine workers at Port Radium, Canada. *Health Phys* 38:657-661.
- Greene B, Uranga A, Sneddon J. 1985. Observations on the determination of uranium in waters by direct current argon plasma emission spectrometry. *Spectrosc Lett* 18(6):425-436.
- Grey C. 1993. Uranium: From ore to concentrate. *The Nuclear Engineer* 34(1):3-9.
- Grignard E, Gueguen Y, Grison S, et al. 2008. Contamination with depleted or enriched uranium differently affects steroidogenesis metabolism in rat. *Int J Toxicol* 27(4):323-328.
- Guglielmotti MB, Ubios AM, Larumbe J, et al. 1989. Tetracycline in uranyl nitrate intoxication: Its action on renal damage and U retention in bone. *Health Physics* 57:403-405.
- Guilmette RA, Parkhurst MA. 2007. Dose assessment for inhalation intakes in complex, energetic environments: Experience from the US Capstone study. *Radiat Prot Dosimetry* 127(1-4):516-520.
- Guilmette RA, Miller G, Parkhurst MA. 2009. Capstone depleted uranium aerosol biokinetics, concentrations, and doses. *Health Phys* 96(3):328-342.
- Guzelian PS, Henry CJ, Olin SS, eds. 1992. *Similarities and differences between children and adults: Implications for risk assessment*. Washington, DC: International Life Sciences Institute Press.
- Hadjimichael CC, Ostfeld AM, D'Atri DA, et al. 1983. Mortality and cancer incidence experience of employees in a nuclear fuels fabrication plant. *J Occup Med* 25:48-61.
- Hahn FF. 1989. Carcinogenic responses of the lung to inhaled materials. In: McClellan RO, Henderson RF, eds. *Concepts in inhalation toxicology*. New York, NY: Hemisphere Publishing Corporation, 313-346.
- Hahn FF, Guilmette RA, Hoover MD. 2002. Implanted depleted uranium fragments cause soft tissue sarcomas in the muscles of rats. *Environ Health Perspect* 110(1):51-59.
- Hakonson-Hayes AC, Fresquez PR, Whicker FW. 2002. Assessing potential risks from exposure to natural uranium in well water. *J Environ Radioact* 59(1):29-40.
- Haley DP. 1982. Morphologic changes in uranyl nitrate-induced acute renal failure in saline- and water-drinking rats. *Lab Invest* 46:196-208.
- Haley DP, Bulger RE, Dobyan DC. 1982. The long-term effects of uranyl nitrate on the structure and function of the rat kidney. *Virchows Arch B* 41:181-192.
- Handley-Sidhu S, Worsfold PJ, Livens FR, et al. 2009. Biogeochemical controls on the corrosion of depleted uranium alloy in subsurface soils. *Environ Sci Technol* 43(16):6177-6182.

## 9. REFERENCES

Hans J, Burris E, Gorsuch T. 1979. Radioactive waste management at the former Shiprock Uranium Mill Site New-Mexico, USA. *Health Phys* 37:811.

Hao Y, Li R, Leng Y, et al. 2009. A study assessing the genotoxicity in rats after chronic oral exposure to a low dose of depleted uranium. *J Radiat Res (Tokyo)* 50(6):521-528.

Harduin JC, Cogema LH, Beaumont-Hague FP. 1994. Uptake and urinary excretion of uranium after oral administration in man. *Radiat Prot Dosimetry* 53(1-4):245-248.

\*Harley NH, Fisenne IS. 1990. Distribution and radiation dose from naturally occurring U, Th and Ra in the human skeleton. *Health Phys* 58(4):515-518.

\*Harley NH, Pasternack BS. 1981. A model for predicting lung cancer risks induced by environmental levels of radon daughters. *Health Phys* 40:307-316.

Harms TF, Ward FN, Erdman JA. 1981. Laser fluorometric analysis of plants for uranium exploration. *J Geochem Explor* 15:617-623.

Harrison JD, Stather JW. 1981. The gastrointestinal absorption of proactinium, uranium and neptunium in the hamster. *Radiat Res* 88:47-55.

Hart DR, McKee PM, Burt AJ, et al. 1986. Benthic community and sediment quality assessment of Port Hope Harbour, Lake Ontario. *J Great Lakes Res* 12:206-220.

HazDat. 2007. Uranium. HazDat Database: ATSDR's Hazardous Substance Release and Health Effects Database. Atlanta, GA: Agency for Toxic Substances and Disease Registry.

\*Heid KR, Fuqua PA. 1974. Review of uranium inhalation case. *Health Phys* 26:399-403.

\*Henge-Napoli MH, Archimbaud M, Ansoborlo E, et al. 1995. Efficacy of 3,4,3-LIHOPO for reducing the retention of uranium in rat after acute administration. *Int J Radiat Biol* 68(4):389-393.

Herczeg AL, Simpson HJ, Anderson RF, et al. 1988. Uranium and radium mobility in groundwaters and brines within the Delaware basin, southeastern New Mexico, U.S.A. *Chem Geol* 72:181-196.

Hindin R, Brugge D, Panikkar B. 2005. Teratogenicity of depleted uranium aerosols: a review from an epidemiological perspective. *Environ Health* 4:17.

Hindman FD. 1983. Neodymium fluoride mounting for alpha spectrometric determination of uranium, plutonium, and americium. *Anal Chem* 55:2460-2461.

Hinton ER. 1983. Development of a multi-purpose alpha-detection procedure for enriched uranium in urine. *Anal Lett* 16:367-380.

Hinton ER, White LE. 1981. Applications of laser-induced fluorimetry to analysis of ultra-trace levels of uranium in an industrial environment. *Anal Lett* 14:947-958.

Ho CH, Doern DC. 1985. The sorption of uranyl species on a hematite sol. *Can J Chem* 63:1100-1104.



## 9. REFERENCES

- \*Hobbs CH, McClellan RO. 1986. Toxic effects of radiation and radioactive materials. In: Doull J, Klaassen CD, Amdur MO, eds. *Casarett and Doull's Toxicology, the basic science of poisons*. 3rd ed. New York, NY: Macmillan Publishing Co., Inc., 669-705.
- Hoel DG, Davis DL, Miller AB, et al. 1992. Trends in cancer mortality in 15 industrialized countries, 1969-1986. *J Natl Cancer Inst* 84(5):313-320.
- Holzbecher J, Ryan DE. 1980. Determination of uranium by thermal- and epithermal-neutron activation in natural waters and in human urine. *Anal Chim Acta* 119:405-408.
- Hoopar FJ, Squibb KS, Siegel EL, et al. 1999. Elevated urine uranium excretion by soldiers with retained uranium shrapnel. *Health Phys* 77(5):512-519.
- \*Horikoshi T, Nakajima A, Sakaguchi T. 1981. Studies on the accumulation of heavy metal elements in biological systems. XIX. Accumulation of uranium by microorganisms. *Eur J Appl Microbiol Biotechnol* 12:90-96.
- Hornung RW, Meinhardt TJ. 1987. Quantitative risk assessment of lung cancer in USA uranium miners. *Health Phys* 52:417-430.
- Hornung RW, Deddens JA, Roscoe RJ. 1998. Modifiers of lung cancer risk in uranium miners from the Colorado Plateau. *Health Phys* 74(1):12-21.
- Houpert P, Bizot JC, Bussy C, et al. 2007b. Comparison of the effects of enriched uranium and 137-cesium on the behaviour of rats after chronic exposure. *Int J Radiat Biol* 83(2):99-104.
- Houpert P, Chazel V, Paquet F, et al. 1999. The effects of the initial lung deposit on uranium biokinetics after administration as UF<sub>4</sub> and UO<sub>4</sub>. *Int J Radiat Biol* 75(3):373-377.
- Houpert P, Chazel V, Paquet F, et al. 2001. Reduction of uranium transfer by local chelation in simulated wounds in rats. *Hum Exp Toxicol* 20(5):237-241.
- Houpert P, Chazel V, Paquet F. 2004. A local approach to reduce industrial uranium wound contamination in rats. *Can J Physiol Pharmacol* 82(2):73-78.
- Houpert P, Frelon S, Lestaevel P, et al. 2007a. Parental exposure to enriched uranium induced delayed hyperactivity in rat offspring. *Neurotoxicology* 28(1):108-113.
- Houpert P, Frelon S, Monleau M, et al. 2007c. Heterogeneous accumulation of uranium in the brain of rats. *Radiat Protect Dosimetry* 127:86-89.
- Houpert P, Lestaevel P, Bussy C, et al. 2005. Enriched but not depleted uranium affects central nervous system in long-term exposed rat. *Neurotoxicology* 26(6):1015-1020.
- Howe GR, Stager RH. 1996. Risk of lung cancer mortality after exposure to radon decay products in the Beaverlodge cohort based on revised exposure estimates. *Radiat Res* 146(1):37-42.
- Howe GR, Nair RC, Newcombe HB, et al. 1986. Lung cancer mortality (1950-1980) in relation to radon daughter exposure in a cohort of workers at the Eldorado Beaverlodge Uranium Mine (Saskatchewan, Canada). *J Natl Cancer Inst* 77:357-362.

## 9. REFERENCES

- Howe GR, Nair RC, Newcombe HB, et al. 1987. Lung cancer mortality (1950-1980) in relation to radon daughter exposure in a cohort of workers at the Eldorado Port Radium Uranium Mine: Possible modification of risk by exposure rate. *J Natl Cancer Inst* 79:1255-1260.
- HPS. 1996. Health Physics Society Standard no. N13.30-1996. Performance criteria for radiobioassay published by the Health Physics Society in 1996.
- HPS. 2011. HPS laboratory accreditation program. Atlanta, GA: Health Physics Society. <http://www.hps.org/labs/>. March 23, 2011.
- HSDB. 1995. Hazardous Substances Data Bank. National Library of Medicine, National Toxicology Program (via TOXNET), Bethesda, MD. January 1995.
- HSDB. 2011. Uranium and uranium compounds. Hazardous Substances Data Bank. National Library of Medicine. <http://toxnet.nlm.nih.gov>. June 21, 2011.
- Hsi CKD, Langmuir D. 1985. Adsorption of uranyl onto ferric oxyhydroxides: Application of the surface complexation site-binding model. *Geochim Cosmochim Acta* 49:1931-1942.
- Hu QY, Zhu SP. 1990. Detection of DNA damage in spermiogenic stages of mice and treated with enriched uranyl fluoride by alkaline elution. *Radiat Environ Biophys* 29(3):161-167.
- Hueper WC, Zuefle JH, Link AM, et al. 1952. Experimental studies in metal carcinogenesis. II. Experimental uranium cancers in rats. *J Natl Cancer Inst* 13:291-305.
- Hughes LD, Powell BA, Soreefan AM, et al. 2005. Anomalously high levels of uranium and other naturally occurring radionuclides in private wells in the piedmont region of South Carolina. *Health Phys* 88(3):248-252.
- Hursh JB, Spoor NL. 1973. Data on man. In: Hodge HC, Stannard JN, Hursh JB, eds. *Uranium-plutonium transplutonic elements*. New York, NY: Springer-Verlag, 197-239
- Hursh JB, Neuman WF, Toribara T, et al. 1969. Oral ingestion of uranium by man. *Health Phys* 17:619-621.
- IARC. 2012. IARC monographs on the evaluation of carcinogenic risks to humans. Volume 100. A review of human carcinogens. Part D: Radiation. Lyon, France: International Agency for Research on Cancer. <http://monographs.iarc.fr/ENG/Monographs/vol100D/index.php>. June 15, 2012.
- Ibrahim SA, Wicker FW. 1988. Comparative uptake of U and Th by native plants at a U production site. *Health phys* 54(4):413-419.
- \*ICRP. 1966. Depositions and retention models for internal dosimetry of the human respiratory tract. Task group on lung dynamics. International Commission for Radiation Protection. *Health Phys* 21:173-207.
- \*ICRP. 1972. The metabolism of compounds of plutonium and other actinides. ICRP Publication No. 19. New York, NY: Pergamon Press. International Commission for Radiation Protection.
- ICRP. 1975. Report of the task group on reference man. ICRP Publication No. 23. New York, NY: Pergamon Press. International Commission for Radiation Protection.

## 9. REFERENCES

ICRP. 1979. Limits for intakes of radionuclides by workers. Supplement to Part 1. Publication 30. Pergamon Press. International Commission on Radiological Protection.

\*ICRP. 1984. A compilation of the major concepts and quantities in use by ICRP. ICRP Publication 42. Oxford: Pergamon Press. International Commission for Radiation Protection.

ICRP. 1991. 1990 Recommendations of the International Commission on Radiological Protection. Oxford: International Commission on Radiological Protection. ICRP Publication 60.

ICRP. 1994a. Appendix A: Age-specific biokinetic models for the alkaline earth elements and lead. In: Age-dependent doses to members of the public from intake of radionuclides: Part 2 ingestion dose coefficients. ICRP publication 67. Tarrytown, NY: The International Commission on Radiological Protection, 95-120.

ICRP. 1994b. Human respiratory tract model for radiological protection. International Commission on Radiological Protection. Pergamon Press, Oxford.

ICRP. 1995. Age-dependent doses to members of the public from intake of radionuclides: Part 3, Ingestion dose coefficients. ICRP Publication 69. Oxford: Pergamon Press. International Commission for Radiation Protection.

ICRP. 1996. Age-dependent doses to members of the public from intake of radionuclides: Part 4, Inhalation dose coefficients. ICRP Publication 71. Oxford: Pergamon Press. International Commission for Radiation Protection.

ICRP. 2006a. Description of the model. 5.1 Overview. International Commission on Radiological Protection. 36(1-2):69-76.

ICRP. 2006b. Draft recommendations of the International Commission on Radiological Protection. International Commission on Radiological Protection.  
[http://www.icrp.org/docs/ICRP\\_Recs\\_02\\_276\\_06\\_web\\_cons\\_5\\_June.pdf](http://www.icrp.org/docs/ICRP_Recs_02_276_06_web_cons_5_June.pdf). January 28, 2011.

\*Ingersoll JG. 1983. A survey of radionuclide contents and radon emanation rates in building materials used in the U.S. Health Phys 45:363-368.

Inn KGW. 1987. The National Bureau of Standards fresh water lake sediment environmental-level radioactivity standard reference material. J Radioanal Nucl Chem 115:91-112.

IRIS. 2011. Uranium, natural and uranium, soluble salts. Integrated Risk Information System. Washington, DC: U.S. Environmental Protection Agency.  
<http://cfpub.epa.gov/ncea/iris/index.cfm?fuseaction=iris.showSubstanceList>. January 28, 2011.

IRIS. 2012. Uranium. Integrated risk information system. Washington, DC: U.S. Environmental Protection Agency. <http://www.epa.gov/iris/>. June 15, 2012.

\*James RC. 1985. Hematotoxicity: Toxic effects in the blood. In: Williams PL, Burson JL, eds. Industrial toxicology. Safety and health applications in the workplace. New York: Van Nostrand Reinhold Company, 59-78. .

## 9. REFERENCES

- Jaworowski Z, Grzybowska D. 1977. Natural radionuclides in industrial and rural soils. *Sci Total Environ* 7:45-52.
- Jefferson CW, Thomas DJ, Gandhi SS, et al. 2007. Unconformity-associated uranium deposits of the Athabasca basin, Saskatchewan and Alberta. In: Goodfellow WD, ed. *Mineral deposits of Canada: A synthesis of major deposit-types, District Metallogeny, the evolution of geological provinces, and exploration methods*. Special Publication No. 5. Geological Association of Canada, Mineral Deposits Division, 273-305.
- Jia G, Belli M, Sansone U, et al. 2006. Concentration and characteristics of depleted uranium in biological and water samples collected in Bosnia and Herzegovina. *J Environ Radioact* 89(2):172-187.
- Jiang FS, Lee SC, Bakhitiar SN, et al. 1986. Determination of thorium, uranium and plutonium isotopes in atmospheric samples. *J Radioanal Nucl Chem* 100:65-72.
- Johanson CE. 1980. Permeability and vascularity of the developing brain: Cerebellum vs cerebral cortex. *Brain Res* 190(1):3-16.
- Jurgens BC, Fram MS, Belitz K, et al. 2010. Effects of groundwater development on uranium: Central Valley, California, USA. *Ground Water* 48(6):913-928.
- Kamata E, Nakashima R, Furukawa M. 1987. Determination of trace amounts of thorium and uranium in coal ash by inductively coupled plasma atomic emission spectrometry after extraction with 2-thenoyltrifluoroacetone and back-extraction with dilute nitric acid. *J Anal Atom Spectrom* 2:321-324.
- Karpas Z. 2001. Uranium bioassay-beyond urinalysis. *Health Phys* 81(4):460-463.
- Karpas Z, Halicz L, Roiz J, et al. 1996. Inductively coupled plasma mass spectrometry as a simple, rapid, and inexpensive method for determination of uranium in urine and fresh water: Comparison with LIF. *Health Phys* 71(6):879-885.
- Karpas Z, Lorber A, Elish E, et al. 1998. Uptake of ingested uranium after low "acute intake". *Health Phys* 74(3):337-345.
- Karpas Z, Lorber A, Sela H, et al. 2005a. Measurement of the  $^{234}\text{U}/^{238}\text{U}$  ratio by MC-ICPMS in drinking water, hair, nails, and urine as an indicator of uranium exposure source. *Health Phys* 89(4):315-321.
- Karpas Z, Paz-Tal O, Lorber A, et al. 2005b. Urine, hair, and nails as indicators for ingestion of uranium in drinking water. *Health Phys* 88(3):229-242.
- Kathren RL. 1984. *Radioactivity in the environment: Sources, distribution and surveillance*. New York, NY: Harwood Academic Publishers, 75.
- Kathren RL. 1997. Uranium in the tissues of two whole body donations to the USTUR. United States Transuranium and Uranium Registries. Washington State University, Richland, WA. Annual report October 1, 1995-September 30, 1996. USTUR-0072-97.
- Kathren RL, Moore RH. 1986. Acute accidental inhalation of uranium: A 38-year follow-up. *Health Phys* 51:609-620.

## 9. REFERENCES

Keane AT, Polednak AP. 1983. Retention of uranium in the chest: Implications of findings *in vivo* and postmortem. *Health Phys* 44(Suppl 1):391-402.

Kelly WR, Fassett JD. 1983. Determination of picogram quantities of uranium in biological tissues by isotope-dilution thermal-ionization mass spectrometry with ion-counting detection. *Anal Chem* 55:1040-1044.

Kelly WR, Fassett JD, Hotes SA. 1987. Determining picogram quantities of uranium in human urine by thermal ionization mass spectrometry. *Health Phys* 52:331-336.

Kerr A, Kupferschmidt W, Atlas M. 1988. Determination of uranium in natural groundwaters using high-performance liquid chromatography. *Anal Chem* 60:2729-2733.

Kirk WS. 1980. Depleted uranium. In: *Mineral facts and problems*, 1980 edition. Washington, DC: U.S. Department of the Interior, Bureau of Mines, 1-7. Bulletin 671.

Kobayashi S, Nagase M, Honda N, et al. 1984. Glomerular alterations in uranyl acetate-induced acute renal failure in rabbits. *Kidney Int* 26:808-815.

Komori M, Nishio K, Kitada M, et al. 1990. Fetus-specific expression of a form of cytochrome P-450 in human livers. *Biochemistry* 29(18):4430-4433.

Kressin IK. 1984. Spectrophotometric method for the determination of uranium in urine. *Anal Chem* 56:2269-2277.

Krishnan K, Andersen ME. 1994. Physiologically based pharmacokinetic modeling in toxicology. In: Hayes AW, ed. *Principles and methods of toxicology*. 3rd ed. New York, NY: Raven Press, Ltd., 149-188.

Krishnan K, Andersen ME, Clewell HJ, et al. 1994. Physiologically based pharmacokinetic modeling of chemical mixtures. In: Yang RSH, ed. *Toxicology of chemical mixtures: Case studies, mechanisms, and novel approaches*. San Diego, CA: Academic Press, 399-437.

Krunić A, Haverić S, Ibrulj S. 2005. Micronuclei frequencies in peripheral blood lymphocytes of individuals exposed to depleted uranium. *Arh Hig Rada Toksikol* 56(3):227-232.

Kundt MS, Martinez-Taibo C, Muhlmann MC, et al. 2009. Uranium in drinking water: Effects on mouse oocyte quality. *Health Phys* 96(5):568-574.

Kuroda PK, Essien IO, Sandoval DN. 1984. Fallout of uranium isotopes from the 1980 eruption of Mount St. Helens. *J Radioanal Nucl Chem* 84:23-32.

Kurttio P, Auvinen A, Salonen L, et al. 2002. Renal effects of uranium in drinking water. *Environ Health Perspect* 110(4):337-342.

Kurttio P, Harmoinen A, Saha H, et al. 2006a. Kidney toxicity of ingested uranium from drinking water. *Am J Kidney Dis* 47(6):972-982.

Kurttio P, Komulainen H, Leino A, et al. 2005. Bone as a possible target of chemical toxicity of natural uranium in drinking water. *Environ Health Perspect* 113(1):68-72.

## 9. REFERENCES

- \*Kurtio P, Salonen L, Ilus T, et al. 2006b. Well water radioactivity and risk of cancers of the urinary organs. *Environ Res* 102(3):333-338.
- Kusiak RA, Ritchie AC, Muller J, et al. 1993. Mortality from lung cancer in Ontario uranium miners. *Br J Ind Med* 50:920-928.
- Labrecque JJ, Rosales PA, Mejias G. 1986. Instrumental neutron-activation analysis of river sediments from Rio Tigre (Venezuela) employing a planar germanium detector. *Appl Spectrosc* 40:1232-1235.
- LaCerte C, Xie H, Aboueissa AM, et al. 2010. Particulate depleted uranium is cytotoxic and clastogenic to human lung epithelial cells. *Mutat Res* 697(1-2):33-37.
- \*Land CE, Shimosato Y, Saccomanno G, et al. 1993. Radiation-associated lung cancer. A comparison of the histology of lung: Cancers in uranium miners and survivors of the atomic bombings on Hiroshima and Nagasaki. *Radiat Res* 134(2):234-243.
- Landa ER, Councill TB. 1992. Leaching of uranium from glass and ceramic foodware and decorative items. *Health Phys* 343-348.
- Landsberger S, Wu D. 1993. Improvement of analytical sensitivities for the determination of antimony, arsenic, cadmium, indium, iodine, molybdenum, silicon and uranium in airborne particulate matter by epithermal neutron activation analysis. *J Radioanal Nucl Chem* 167(2):219-225.
- \*Lang S, Raunemaa T. 1991. Behavior of neutro-activated uranium dioxide dust particles in the gastrointestinal tract of the rat. *Radiat Res* 26:273-279.
- \*Lang S, Kosma VM, Kumlin T, et al. 1994. Distribution and short-term effects of intratracheally instilled neutron-irradiation UO<sub>2</sub> particles in the rat. *Environ Res* 65:119-131.
- Lapham SC, Millard JB, Samet JM. 1989. Health implications of radionuclide levels in cattle raised near U mining and milling facilities in Ambrosia Lake, New Mexico. *Health Phys* 36(3):327-340.
- Larsen RP, Bhattacharyya MH, Oldham RD, et al. 1984. Gastrointestinal absorption and retention of plutonium and uranium in the baboon. Division of Biological and Medical Research. Institute of Environmental Medicine, New York University Medical Center, Tuxedo, New York, 51-60.
- La Touche YD, Willis DL, Dawydiak OI. 1987. Absorption and biokinetics of U in rats following an oral administration of uranyl nitrate solution. *Health Phys* 53(2):147-162.
- Laul JC. 1994. U-234/U-238 ratio: Qualitative estimate of groundwater flow in Rocky Flats monitoring wells. Golden, CO: Environmental Technologies.
- Lazo EN, Roessler GS, Berven BA. 1991. Determination of uranium and thorium concentrations in unprocessed soil samples. *Health phys* 61(2):231-243.
- Leach LJ, Gelein RM, Panner BJ, et al. 1984. The acute toxicity of the hydrolysis products of uranium hexafluoride (UF<sub>6</sub>) when inhaled by the rat and guinea pig. Final report. ISS K/SUB-81-9039-3. DE84011539.
- Leach LJ, Maynard EA, Hodge CH, et al. 1970. A five-year inhalation study with natural uranium dioxide dust. *Health Phys* 18:599-612.

## 9. REFERENCES

- Leach LJ, Yuile CL, Hodge HC, et al. 1973. A five-year inhalation study with natural uranium dioxide (UO<sub>2</sub>) dust. II. Postexposure retention and biologic effects in the monkey, dog and rat. *Health Phys* 25:239-258.
- Leeder JS, Kearns GL. 1997. Pharmacogenetics in pediatrics: Implications for practice. *Pediatr Clin North Am* 44(1):55-77.
- Leggett RW, Harrison JD. 1995. Fractional absorption of ingested uranium in humans. *Health Phys* 68(4):484-498.
- Leggett RW, Pellmar TC. 2002. The biokinetics of uranium migrating from embedded DU fragments. *J Environ Radioact* 64(2-3):205-225.
- \*Leifer R, Juzdan ZR, Kelly WR, et al. 1987. Detection of uranium from Cosmos-1402 in the stratosphere. *Science* 238:512-514.
- Lestaevel P, Bussy C, Paquet F, et al. 2005b. Changes in sleep-wake cycle after chronic exposure to uranium in rats. *Neurotoxicol Teratol* 27(6):835-840.
- \*Lestaevel P, Houpert P, Bussy C, et al. 2005a. The brain is a target organ after acute exposure to depleted uranium. *Toxicology* 212(2-3):219-226.
- Leung HW. 1993. Physiologically-based pharmacokinetic modelling. In: Ballentyne B, Marrs T, Turner P, eds. *General and applied toxicology*. Vol. 1. New York, NY: Stockton Press, 153-164.
- Li WB, Gerstmann UC, Hollriegel V, et al. 2009b. Radiation dose assessment of exposure to depleted uranium. *J Expo Sci Environ Epidemiol* 19(5):502-514.
- Li WB, Karpas Z, Salonen L, et al. 2009a. A compartmental model of uranium in human hair for protracted ingestion of natural uranium in drinking water. *Health Phys* 96(6):636-645.
- Li WB, Roth P, Wahl W, et al. 2005. Biokinetic modeling of uranium in man after injection and ingestion. *Radiat Environ Biophys* 44(1):29-40.
- Li WB, Salonen L, Muikku M, et al. 2006. Internal dose assessment of natural uranium from drinking water based on biokinetic modeling and individual bioassay monitoring: A study of a Finnish family. *Health Phys* 90(6):533-543.
- Lide DR, Frederikse HPR. 1994. *CRC Handbook of chemistry and physics*. Boca Raton, FL: CRC Press, 4-31 to 4-32; 11-131 to 11-31; 4-109 to 4-110.
- Limson Zamora M, Tracy BL, Zielinski JM, et al. 1998. Chronic ingestion of uranium in drinking water: A study of kidney bioeffects in humans. *Toxicol Sci* 43(1):68-77.
- Limson Zamora M, Zielinski JM, Meyerhof DP, et al. 2002. Gastrointestinal absorption of uranium in humans. *Health Phys* 83(1):35-45.
- Limson Zamora M, Zielinski JM, Meyerhof D, et al. 2003. Uranium gastrointestinal absorption: The  $f_1$  factor in humans. *Radiat Prot Dosimetry* 105(1-4):55-60.

## 9. REFERENCES

- Limson Zamora M, Zielinski JM, Moodie GB, et al. 2009. Uranium in drinking water: Renal effects of long-term ingestion by an aboriginal community. *Arch Environ Occup Health* 64(4):228-241.
- Lin RH, Wu LJ, Lee CH, et al. 1993. Cytogenetic toxicity of uranyl nitrate in Chinese hamster ovary cells. *Mutat Res* 319:197-203.
- Linares V, Albina ML, Belles M, et al. 2005. Combined action of uranium and stress in the rat. II. Effects on male reproduction. *Toxicol Lett* 158(3):186-195.
- Linares V, Sanchez DJ, Belles M, et al. 2007. Pro-oxidant effects in the brain of rats concurrently exposed to uranium and stress. *Toxicology* 236(1-2):82-91.
- Linsalata P. 1994. Uranium and thorium decay series radionuclides in human and animal foodchains. *J Environ Qual* 23:633-642.
- \*Lippmann M, Ong LDY, Harris WB. 1964. The significance of urine uranium excretion data. *Ind Hyg J* 25:43-54.
- Little TT, Miller G, Guilmette R. 2003. Internal dosimetry of uranium isotopes using Bayesian inference methods. *Radiat Prot Dosimetry* 105(1-4):413-416.
- Little T, Miller G, Guilmette R, et al. 2007. Uranium dose assessment: A Bayesian approach to the problem of dietary background. *Radiat Prot Dosimetry* 127(1-4):333-338.
- Livingston AL. 1978. Forage plant estrogens. *J Toxicol Environ Health* 4(2-3):301-324.
- Llobet JM, Sirvent JJ, Ortega A, et al. 1991. Influence of chronic exposure to uranium on male reproduction in mice. *Fundam Appl Toxicol* 16:821-829.
- Longtin JP. 1988. Occurrence of radon, radium, and uranium in groundwater. *Am Water Works Assoc J* 80:84-93.
- \*Loomis DP, Shy CM, Allen JW, et al. 1990. Micronuclei in epithelial cells from sputum of uranium workers. *Scand J Work Environ Health* 16:355-362.
- Lopez R, Diaz Sylvester PL, Ubios AM, et al. 2000. Percutaneous toxicity of uranyl nitrate: Its effect in terms of exposure area and time. *Health Phys* 78(4):434-437.
- Lowry JD, Hoxie DC, Moreau E. 1987. Extreme levels of radon-222 and uranium in a private water supply. In: Graves B, ed. *Radon in ground water, radon, radium and other radioactivity in ground water: Hydrogeologic impact and application to indoor airborne contamination: Proceedings of the National Water Well Association Conference, Somerset, NJ, April 7-9, 1987*. Chelsea, MI: Lewis Publishers, Inc., 363-376.
- Lu S, Zhao F. 1990. Nephrotoxic limit and annual limit on intake for natural U. *Health Phys* 58(5):619-623.
- \*Lubin JH, Boice JD Jr., Edling C, et al. 1995. Lung cancer in radon-exposed miners and estimation of risk from indoor exposure. *J Natl Cancer Inst* 87(11):817-827.



## 9. REFERENCES

- Luessenhop AJ, Gallimore JC, Sweet WH, et al. 1958. The toxicity in man of hexavalent uranium following intravenous administration. *Am J Roentgenol* 79:83-100.
- Lundin FE, Lloyd W, Smith EM, et al. 1969. Mortality of uranium miners in relation to radiation exposure, hard rock mining and cigarette smoking 1950 through September 1967. *Health Phys* 16:571-578.
- \*MacNider WDB. 1936a. A study of the acquired resistance of fixed tissue cells morphologically altered through processes of repair. I. The liver injury induced by uranium nitrate. A consideration of the type of epithelial repair which imparts to the liver resistance against subsequent uranium intoxications. *J Pharmacol Exp Ther* 56(3):359-372.
- \*MacNider WDB. 1936b. A study of the acquired resistance of fixed tissue cells morphologically altered through processes of repair. II. The resistance of liver epithelium altered morphologically as the result of an injury from uranium, followed by repair, to the hepatotoxic action of chloroform. *J Pharmacol Exp Ther* 56(3):373-381.
- MacFarlane GJ, Hotopf M, Maconochie N, et al. 2005. Long-term mortality amongst Gulf War Veterans: Is there a relationship with experiences during deployment and subsequent morbidity? *Int J Epidemiol* 34(6):1403-1408.
- Magdo HS, Forman J, Graber N, et al. 2007. Grand rounds: nephrotoxicity in a young child exposed to uranium from contaminated well water. *Environ Health Perspect* 115(8):1237-1241.
- Magnoni M, Bertino S, Bellotto B, et al. 2001. Variations of the isotopic ratios of uranium in environmental samples containing traces of depleted uranium: Theoretical and experimental aspects. *Radiat Prot Dosimetry* 97(4):337-340.
- Mahon DC. 1982. Uptake and translocation of naturally-occurring radionuclides of the uranium series. *Bull Environ Cont Toxicol* 29:697-703.
- Malard V, Gaillard JC, Berenguer F, et al. 2009. Urine proteomic profiling of uranium nephrotoxicity. *Biochim Biophys Acta* 1794(6):882-891.
- Malenchenko AF, Barkun NA, Guseva GF. 1978. Effect of uranium on the induction and course of experimental autoimmune orchitis and thyroiditis. *J Hyg Epidemiol Microbiol Immunol* 22:268-277.
- Mao Y, Desmeules M, Schaubel D, et al. 1995. Inorganic components of drinking water and microalbuminuria. *Environ Res* 71(2):135-140.
- Marco R, Katorza E, Gonen R, et al. 2008. Normalisation of spot urine samples to 24-h collection for assessment of exposure to uranium. *Radiat Prot Dosimetry* 130(2):213-223.
- MARLAP. 2004. Multi-agency radiological laboratory analytical protocols manual. Washington, DC: Multi-Agency Radiological Laboratory Analytical Protocols. NUREG-1576, EPA402b04001A. PB2004105421. <http://www.nrc.gov/reading-rm/doc-collections/nuregs/staff/sr1576/initial/>. March 23, 2011.
- MARSSIM. 2000. Multi-agency radiation survey and site investigation manual (MARSSIM). Washington, DC: Multi-agency radiation survey and site investigation manual. NUREG-1575, EPA402R97016, DOE/EH-0624. <http://www.epa.gov/rpdweb00/marssim/obtain.html>. March 23, 2011.

## 9. REFERENCES

- Martin F, Earl R, Tawn EJ. 1991. A cytogenetic study of men occupationally exposed to uranium. *Br J Ind Med* 48:98-102.
- Martinez AB, Cabrini RL, Ubios AM. 2000. Orally administered ethane-1-hydroxy-1,1-biphosphonate reduces the lethal effect of oral uranium poisoning. *Health Phys* 78(6):668-671.
- Martinez AB, Mandalunis PM, Bozal CB, et al. 2003. Renal function in mice poisoned with oral uranium and treated with ethane-1-hydroxy-1,1-bisphosphonate (EHBP). *Health Phys* 85(3):343-347.
- Masuda K. 1971. Intake and urinary excretion of uranium in non-occupationally exposed persons. III. Urinary excretion of uranium. *Nippon Eiseigaku Zasshi (Japan)* 26:442-446.
- Maynard EA, Hodge HC. 1949. Studies of the toxicity of various uranium compounds when fed to experimental animals. In: Voegtlin IC, Hodge HC, eds. *Pharmacology and toxicology of uranium compounds*, National Nuclear Energy Series (VI). New York, NY: McGraw-Hill, 309-376.
- Maynard EA, Down WL, Hodge HC. 1953. Oral toxicity of uranium compounds. In: Voegtlin C, Hodge HC, eds. *Pharmacology and toxicology of uranium compounds*. New York, NY: McGraw-Hill, 1221-1369.
- Mayr U, Butsch A, Schneider S. 1992. Validation of two *in vitro* test systems for estrogenic activities with zearalenone, phytoestrogens and cereal extracts. *Toxicology* 74(2-3):135-149.
- Mays CW, Rowland RE, Stehaney AF, et al. 1985. Cancer risk from the lifetime intake of Ra and U isotopes. *Health Phys* 48(5):635-647.
- McDiarmid MA, Albertini RJ, Tucker JD, et al. 2011a. Measures of genotoxicity in Gulf War I veterans exposed to depleted uranium. *Environ Mol Mutagen* 52(7):569-581.
- McDiarmid MA, Engelhardt SM, Dorsey CD, et al. 2009. Surveillance results of depleted uranium-exposed Gulf War I veterans: Sixteen years of follow-up. *J Toxicol Environ Health A* 72(1):14-29.
- McDiarmid MA, Engelhardt SM, Dorsey CD, et al. 2011b. Longitudinal health surveillance in a cohort of Gulf War veterans 18 years after first exposure to depleted uranium. *J Toxicol Environ Health A* 74(10):678-691.
- McDiarmid, MA; Engelhardt, S; Oliver, M; et al. 2004b. Health effects of depleted uranium on exposed Gulf War veterans: A 10-year follow-up. *J Toxicol Environ Health A* 67(4):277-296.
- McDiarmid MA, Engelhardt SM, Oliver M, et al. 2006. Biological monitoring and surveillance results of Gulf War I veterans exposed to depleted uranium. *Int Arch Occup Environ Health* 79(1):11-21.
- McDiarmid MA, Engelhardt SM, Oliver M, et al. 2007. Health surveillance of Gulf War I veterans exposed to depleted uranium: Updating the cohort. *Health Phys* 93(1):60-73.
- McDiarmid MA, Engelhardt SM, Oliver M. 2001b. Urinary uranium concentrations in an enlarged Gulf War veteran cohort. *Health Phys* 80(3):270-273.
- McDiarmid MA, Hooper FJ, Squibb K, et al. 1999b. The utility of spot collection for urinary uranium determinations in depleted uranium exposed Gulf War veterans. *Health Phys* 77(3):261-264.

## 9. REFERENCES

- \*McDiarmid MA, Keough JP, Hooper FJ, et al. 1999a. Health effects of depleted uranium on exposed Gulf War veterans. *J Int Neuropsychol Soc* 82(2):168-180.
- McDiarmid MA, Keough JP, Hooper FJ, et al. 2000. Health effects of depleted uranium on exposed Gulf War veterans. *Environ Res* 82(2):168-180.
- McDiarmid, MA; Squibb, K; Engelhardt, S; et al. 2001a. Surveillance of depleted uranium exposed Gulf War veterans: Health effects observed in an enlarged "friendly fire" cohort. *J Occup Environ Med* 43(12):991-1000.
- McDiarmid MA, Squibb K, Engelhardt SM. 2004a. Biologic monitoring for urinary uranium in Gulf War I veterans. *Health Phys* 87(1):51-56.
- McDonald-Taylor CK, Bhatnagar MK, Gilman A, et al. 1992. Uranyl nitrate-induced glomerular basement membrane alterations in rabbits: A quantitative analysis. *Bull Environ Contam Toxicol* 48(3):367-373.
- McDonald-Taylor C, Singh A, Gilman A, et al. 1997. Uranyl nitrate-induced proximal tubule alterations in rabbits: A quantitative analysis. *Toxicol Pathol* 25(4):381-389.
- Meditext. 1998. Medical management (uranium). Micromedex Inc. Vol. 34 (expires 10-31-97), copyright 1987-1997.
- Melgard R. 1988. In: Kathren RL, Weber JR, eds. Proceedings of the meeting on ultrasensitive techniques for measurement of uranium in biological samples and the nephrotoxicity of uranium. Washington, DC: U.S. Nuclear Regulatory Commission, 1-9.
- Melville CM, Wai CM, Collopy M, et al. 1981. Uranium dispersion along roads paved with phosphate slag. *Bull Environ Cont Toxicol* 27:470-473.
- Meriwether JR, Beck JN, Keeley DF, et al. 1988. Radionuclides in Louisiana soils. *J Environ Qual* 17:562-568.
- Milačić S. 2008. Health investigations of depleted-uranium clean-up workers. *Med Lav* 99(5):366-370.
- Milačić S, Simic J. 2009. Identification of health risks in workers staying and working on the terrains contaminated with depleted uranium. *J Radiat Res (Tokyo)* 50(3):213-222.
- Milacic S, Petrovic D, Jovicic D, et al. 2004. Examination of the health status of populations from depleted-uranium-contaminated regions. *Environ Res* 95(1):2-10.
- Miller HT. 1977. Radiation exposures associated with surface mining for uranium. *Health Phys* 32:523-527.
- Miller AC, Blakely WF, Livengood D, et al. 1998b. Transformation of human osteoblast cells to the tumorigenic phenotype by depleted uranium-uranyl chloride. *Environ Health Perspect* 106:465-471.
- Miller AC, Bonait-Pellie C, Merlot RF, et al. 2005. Leukemic transformation of hematopoietic cells in mice internally exposed to depleted uranium. *Mol Cell Biochem* 279(1-2):97-104.

## 9. REFERENCES

- Miller AC, Brooks K, Stewart M, et al. 2003. Genomic instability in human osteoblast cells after exposure to depleted uranium: Delayed lethality and micronuclei formation. *J Environ Radioact* 64(2-3):247-259.
- Miller AC, Fuciarelli AF, Jackson WE, et al. 1998a. Urinary and serum mutagenicity studies with rats implanted with depleted uranium or tantalum pellets. *Mutagenesis* 13:643-648.
- Miller AC, Stewart M, Brooks K, et al. 2002a. Depleted uranium-catalyzed oxidative DNA damage: Absence of significant alpha particle decay. *J Inorg Biochem* 91(1):246-252.
- Miller AC, Stewart M, Rivas R. 2010. Preconceptional paternal exposure to depleted uranium: Transmission of genetic damage to offspring. *Health Phys* 99(3):371-379.
- Miller AC, Xu J, Stewart M, et al. 2002b. Potential late health effects of depleted uranium and tungsten used in armor-piercing munitions: Comparison of neoplastic transformation and genotoxicity with the known carcinogen nickel. *Mil Med* 167(2 Suppl):120-122.
- Miller AC, Xu J, Stewart M, et al. 2002c. Observation of radiation-specific damage in human cells exposed to depleted uranium: dicentric frequency and neoplastic transformation as endpoints. *Radiat Prot Dosimetry* 99(1-4):275-278.
- Miller BG, Colvin AP, Hutchison PA, et al. 2008. A normative study of levels of uranium in the urine of British Forces personnel. *Occup Environ Med* 65(6):398-403.
- Miller KM, Shebell P, Kemic A. 1994. *In situ* gamma-ray spectrometry for the measurement of uranium in surface soils. *Health Phys* 67(2):140-150.
- Mindat. 2011. Thucholite. In: Ralph J, Chau I, eds. Mindat.org.<http://www.mindat.org/min-3954.html>. April 28, 2011.
- Mitchel RE, Jackson JS, Heinmiller B. 1999. Inhaled uranium ore dust and lung cancer risk in rats. *Health Phys* 76(2):145-155.
- Mlakar M, Branica M. 1989. Stripping voltammetric determination of trace levels of uranium by synergic adsorption. *Anal Chim Acta* 221:279-287.
- MMES. 1985. United States Department of Energy Paducah Gaseous Diffusion Plant: Environmental monitoring report, 1984. Report ISS KY-747. Martin Marietta Energy Systems, Inc. DE85014027.
- Moffett D, Tellier M. 1977. Uptake of radioisotopes by vegetation growing on uranium tailings. *Can J Soil Sci* 57:417-424.
- Monleau M, Bussy C, Lestaevel P, et al. 2005. Bioaccumulation and behavioural effects of depleted uranium in rats exposed to repeated inhalations. *Neurosci Lett* 390(1):31-36.
- Monleau M, De Meo M, Frelon S, et al. 2006b. Distribution and genotoxic effects after successive exposure to different uranium oxide particles inhaled by rats. *Inhal Toxicol* 18(11):885-894.
- Monleau M, De Meo M, Paquet F, et al. 2006a. Genotoxic and inflammatory effects of depleted uranium particles inhaled by rats. *Toxicol Sci* 89(1):287-295.

## 9. REFERENCES

- Moolgavkar SH, Luebeck EG, Krewski D, et al. 1993. Radon, cigarette smoke, and lung cancer a re-analysis of the Colorado Plateau Uranium Miners Data. *Epidemiology* 4:204-217.
- Moon JW, Roh Y, Phelps TJ, et al. 2006. Physicochemical and mineralogical characterization of soil-saprolite cores from a field research site, Tennessee. *J Environ Qual* 35(5):1731-1741.
- Moore RH, Kathren RL. 1985. A World War II uranium hexafluoride inhalation event with pulmonary implications for today. *J Occup Med* 27:753-756.
- Morishima H, Koga T, Kawai H, et al. 1977. Studies on the movement of distribution of uranium in the environments-distribution of uranium in agricultural products. *J Radiat Res* 18:139-150.
- Morris KJ, Barker CL, Batchelor AL, et al. 1992. Dosimetric implications of pulmonary macrophage clusters observed within lungs of rats that have inhaled enriched UO<sub>2</sub> particles. *Environ Health Perspect* 97:201-208.
- Morris KJ, Khanna P, Batchelor AL. 1990. Long-term clearance of inhaled UO<sub>2</sub> particles from the pulmonary region of the rat. *Health Phys* 58(4):477-485.
- Morris KJ, Townsend KMS, Batchelor AL. 1989. Studies of alveolar cell morphometry and mass clearance in the rat lung following inhalation of an enriched uranium dioxide aerosol. *Radiat Environ Biophys* 28:141-154.
- Morrison HI, Semenciw RM, Mao Y, et al. 1988. Cancer mortality among a group of fluor spar miners exposed to radon progeny. *Am J Epidemiol* 128(6):1266-1275.
- Morrow PE, Gelein R, Beiter H. 1982a. Inhalation and intravenous studies of UF<sub>6</sub>/UO<sub>2</sub>F<sub>2</sub> in dogs. *Health Phys* 43:859-873.
- Morrow PE, Gibb FR, Beiter HD. 1972. Inhalation studies of uranium trioxide. *Health Phys* 23:273-280.
- Morrow PE, Leach LJ, Smith FA, et al. 1982b. Metabolic fate and evaluation of injury in rats and dogs following exposure to the hydrolysis products of uranium hexafluoride. Implications for a bioassay program related to potential releases of uranium hexafluoride. *Govt Rep Announce Ind, Issue 11. NTIS/NUREG/CR-2268.*
- Morselli PL, Franco-Morselli R, Bossi L. 1980. Clinical pharmacokinetics in newborns and infants: Age-related differences and therapeutic implications. *Clin Pharmacokin* 5(6):485-527.
- Mortvedt JJ. 1994. Plant and soil relationships of uranium and thorium decay series radionuclides. *J Environ Qual* 23:643-650.
- MSA. 2011. Uranium ores. The Mineralogical Society of America. <http://www.handbookofmineralogy.org/search.html?p=all>. April 27, 2011
- Muikku M, Puhakainen M, Heikkinen T, et al. 2009. The mean concentration of uranium in drinking water, urine, and hair of the occupationally unexposed Finnish working population. *Health Phys* 96(6):646-654.

## 9. REFERENCES

- Muller C, Rozicka L, Bakstein J. 1967. The sex ratio in the offsprings of uranium miners. *Acta Univ Carol Med* 13(7):599-603.
- Murray RL. 1994. *Understanding radioactive waste*, 4th edition. Battelle Pacific Northwest Laboratories, Battelle Press.
- Nagj M, Makjanic J, Orlic I, et al. 1986. Determination of uranium in sea-water by X-ray fluorescence spectroscopy. *J Radioanal Nucl Chem* 97:373-380.
- NAS/NRC. 1989. Report of the oversight committee. In: *Biologic markers in reproductive toxicology*. Washington, DC: National Academy of Sciences, National Research Council, National Academy Press, 15-35.
- NCRP. 1975. National Council on Radiation Protection and Measurements. Natural background radiation in the United States. NCRP Report No. 45. Bethesda, MD, 4-6.
- NCRP. 1978. National Council on Radiation Protection and Measurements. Instrumentation and monitoring methods for radiation protection. NCRP Report No. 57. Washington, DC.
- NCRP. 1984a. National Council on Radiation Protection and Measurements. Exposures from the uranium series with emphasis on radon and its daughter. NCRP Report No. 77. Bethesda, MD.
- NCRP. 1984b. National Council on Radiation Protection and Measurements. Radiological assessment: Predicting the transport, bioaccumulation and uptake by man of radionuclides released to the environment. NCRP Report No. 76.
- NCRP. 1993. National Council on Radiation Protection and Measurements. Limitation of exposure to ionizing radiation. Report No. 116. Bethesda, MD.
- NCRP. 1997. Deposition, retention and dosimetry of inhaled radioactive substances. National Council on Radiation Protection and Measurement. NCRP Report No. 125. Bethesda, MD.
- NCRP. 2008. NCRP Report no. 156. Development of a biokinetic model for radionuclidecontaminated wounds and procedures for their assessment, dosimetry and treatment. Bethesda, MD: National Council on Radiation Protection and Measurements. <http://www.ncrppublications.org/Reports/156>. July 5, 2012.
- NCRP. 2010. Management of persons contaminated with radionuclides: Handbook. NCRP Report No. 161. National Council on Radiation Protection and Measurements, 128-137, 176-236. <http://www.ncrponline.org/Publications/161press.html>. February 11, 2010.
- NEDH. 1989. Nebraska Department of Health. Domestic well water sampling in Nebraska, 1987 laboratory findings and their implications. Division of Environmental Health and Housing Surveillance, Lincoln, NE.
- NIOSH. 1981. Health hazard evaluation: Cotter Corporation; Canon City, Colorado; September 1981. Cincinnati, OH: U.S. National Institute for Occupational Safety and Health. PB83127407.
- NIOSH. 1987. Mortality among uranium enrichment workers. Washington, DC: National Institute of Occupational Safety and Health. PB87188991

## 9. REFERENCES

- NIOSH. 1997. NIOSH pocket guide to chemical hazards. U.S. Department of Health and Human Services. Public Health Services. Centers for Disease Control and Prevention. National Institute for Occupational Safety and Health.
- NIOSH. 2010a. Uranium (insoluble compounds, as U). NIOSH pocket guide to chemical hazards. National Institute for Occupational Safety and Health. <http://www.cdc.gov/niosh/npg/npgd0650.html>. January 28, 2011.
- NIOSH. 2010b. Uranium (soluble compounds, as U). NIOSH pocket guide to chemical hazards. National Institute for Occupational Safety and Health. <http://www.cdc.gov/niosh/npg/npgd0651.html>. January 28, 2011.
- NIOSH. 2012. Uranium. NIOSH pocket guide to chemical hazards. Atlanta, GA: National Institute for Occupational Safety and Health, Centers for Disease Control and Prevention. <http://www.cdc.gov/niosh/npg/>. June 15, 2012.
- NIST. 1995. Standard reference materials catalog, special publication 260. Washington, DC: National Institute for Standards and Technology. U.S. Department of Commerce.
- NIST. 2011. Standard reference materials. National Institute of Standards and Technology. <http://www.nist.gov/srm/>. April 29, 2011.
- NMHED. 1989. Summary report on the Church Rock uranium mill tailings spill: A health and environment assessment. Santa Fe, NM: New Mexico Health and Environment Department.
- NNDC. 2011. Chart of Nuclides. Upton, NY: National Nuclear Data Center, Brookhaven National Laboratory. <http://www.nndc.bnl.gov/chart/>. April 28, 2011.
- NNSA. 2006. Environmental assessment for increased depleted uranium use on Target 63-10, Nevada Test and Training Range. National Nuclear Security Administration. <http://nnsa.energy.gov/sites/default/files/nnsa/inlinefiles/usaf%202006d.pdf>. February 21, 2013.
- Norman JD, Stumpe LA, Trimm J, et al. 1983. Argon-plasma emission spectrometry of uranium in phosphatic materials (e.g., fertilizers). *J Assoc Off Anal Chem* 66:949-951.
- NRC. 1993. Pesticides in the diets of infants and children. National Research Council. Washington DC: National Academy Press.
- NTP. 2012. Substances nominated to the report on carcinogens. U.S. Department of Health and Human Services, Public Health Service, National Toxicology Program. Federal Register 77 FR 2728 <http://ntp.niehs.nih.gov/?objectid=C3213BD9-F807-E389-916C16858403102B>. June 15, 2012.
- Oeh U, Li WB, Hollriegl V, et al. 2007a. Daily uranium excretion in German peacekeeping personnel serving on the Balkans compared to ICRP model prediction. *Radiat Prot Dosimetry* 127(1-4):329-332.
- Oeh U, Priest ND, Roth P, et al. 2007b. Measurements of daily urinary uranium excretion in German peacekeeping personnel and residents of the Kosovo region to assess potential intakes of depleted uranium (DU). *Sci Total Environ* 381(1-3):77-87.
- Ohanian EV. 1989. National primary drinking water regulations for radionuclides. *Safe Drinking Water Act: Amendments, Regulations and Standards*. Lewis Publishers, 45-55.

## 9. REFERENCES

- Oliver IW, Graham MC, MacKenzie AB, et al. 2007. Assessing depleted uranium (DU) contamination of soil, plants and earthworms at UK weapons testing sites. *J Environ Monit* 9(7):740-748.
- Oliver IW, Graham MC, MacKenzie AB, et al. 2008a. Depleted uranium mobility across a weapons testing site: Isotopic investigation of porewater, earthworms, and soils. *Environ Sci Technol* 42(24):9158-9164.
- Oliver IW, Graham MC, Mackenzie AB, et al. 2008b. Distribution and partitioning of depleted uranium (DU) in soils at weapons test ranges-investigations combining the BCR extraction scheme and isotopic analysis. *Chemosphere* 72(6):932-939.
- Orcutt JA. 1949. The toxicology of compounds of uranium following application to the skin. In: Voegtlin C, Hodge HC, eds. *Pharmacology and toxicology of uranium compounds*. Vols 3 and 4. New York, NY: McGraw Hill Book Co., 377-414.
- Orloff KG, Mistry K, Charp P, et al. 2004. Human exposure to uranium in groundwater. *Environ Res* 94(3):319-326.
- ORNL. 2011. Oak Ridge Reservation annual site environmental report for 1995. Oak Ridge, TN: Oak Ridge National Laboratory. [http://www.ornl.gov/sci/env\\_rpt/aser95/aser.htm](http://www.ornl.gov/sci/env_rpt/aser95/aser.htm). March 23, 2011.
- \*Ortega A, Domingo JL, Gomez M, et al. 1989b. Treatment of experimental acute uranium poisoning by chelating agents. *Pharmacol Toxicol* 64:247-251.
- Ortega A, Domingo JL, Lloket JM, et al. 1989a. Evaluation of the oral toxicity of uranium in a 4-week drinking water study in rats. *Bull Environ Contam Tox* 42:935-941.
- OSHA. 2012a. Each area or room in which natural uranium is used or stored shall be conspicuously posted with a sign or signs bearing the radiation caution symbol. Occupational Safety and Health Administration. Code of Federal Regulations 29 CFR 1910.1096 <http://www.gpo.gov/fdsys>. June 15, 2012.
- OSHA. 2012b. Each container in which natural uranium is transported, stored, or used shall bear a durable, clearly visible label bearing the radiation caution symbol. Occupational Safety and Health Administration. Code of Federal Regulations 29 CFR 1910.1096 <http://www.gpo.gov/fdsys>. June 15, 2012.
- OSHA. 2012c. Toxic and hazardous substances. Occupational safety and health standards. Occupational Safety and Health Administration. Code of Federal Regulations 29 CFR 1910.1000, Table Z-1 <http://www.osha.gov/law-regs.html>. April 25, 2012.
- Otake M, Schull W. 1984. Mental retardation in children exposed *in utero* to the atomic bombs: A reassessment. Technical Report RERF TR 1-83, Radiation Effects Research Foundation, Japan.
- Ough EA, Lewis BJ, Andrews WS, et al. 2006. Determination of natural and depleted uranium in urine at the ppt level: An interlaboratory analytical exercise. *Health Phys* 90:494-499.
- Owen GM, Brozek J. 1966. Influence of age, sex and nutrition on body composition during childhood and adolescence. In: Falkner F, ed. *Human development*. Philadelphia, PA: WB Saunders, 222-238.



## 9. REFERENCES

- Ozmen M, Yurekli M. 1998. Subacute toxicity of uranyl acetate in Swiss-Albino mice. *Environ Toxicol Pharmacol* 6(2):111-115.
- Paquet F, Houpert P, Blanchardon E, et al. 2006. Accumulation and distribution of uranium in rats after chronic exposure by ingestion. *Health Phys* 90(2):139-147.
- Parkhurst MA, Guilmette RA. 2009a. Overview of the Capstone depleted uranium study of aerosols from impact with armored vehicles: Test setup and aerosol generation, characterization, and application in assessing dose and risk. *Health Phys* 96(3):207-220.
- Parkhurst MA, Guilmette RA. 2009b. Conclusions of the Capstone depleted uranium aerosol characterization and risk assessment study. *Health Phys* 96(3):393-409.
- Parkhurst MA, Cheng YS, Kenoyer JL, et al. 2009. Physicochemical characterization of Capstone depleted uranium aerosols I: Uranium concentration in aerosols as a function of time and particle size. *Health Phys* 96(3):251-265.
- Parrington JR, Knox H, Breneman SL, et al. 1996. Nuclides and isotopes. San Jose, CA: General Electric Co. and KAPL Inc.
- Parrish RR, Horstwood M, Arnason JG, et al. 2008. Depleted uranium contamination by inhalation exposure and its detection after approximately 20 years: Implications for human health assessment. *Sci Total Environ* 390(1):58-68.
- \*Paschoa AS, Cholewa M, Jones KW, et al. 1987. PIXE-RBS (Rutherford Back-Scattering) combination to measure uranium and thorium in environmental and biological samples. *J Radioanal Nucl Chem* 115:231-240.
- Paternain JL, Domingo JL, Ortega A, et al. 1989. The effects of uranium on reproduction, gestation, and postnatal survival in mice. *Ecotoxicol Environ Saf* 17:291-296.
- Paunescu N. 1986. Determination of uranium and thorium concentration in natural waters. *J Radioanal Nucl Chem* 104:209-216.
- Pavlakakis N, Pollock CA, McLean G, et al. 1996. Deliberate overdose of uranium: Toxicity and treatment. *Nephron* 72(2):313-317.
- Peehs M, Walter T, Walter S, et al. 2007. Uranium, uranium alloys, and uranium compounds. In: *Ullmann's encyclopedia of industrial chemistry*. [http://onlinelibrary.wiley.com/doi/10.1002/14356007.a27\\_281.pub2/pdf](http://onlinelibrary.wiley.com/doi/10.1002/14356007.a27_281.pub2/pdf). January 26, 2011.
- Pellmar TC, Fuciarelli AF, Ejniak JW, et al. 1999a. Distribution of uranium in rats implanted with depleted uranium pellets. *Toxicol Sci* 49:29-39.
- Pellmar TC, Keyser DO, Emery C, et al. 1999b. Electrophysiological changes in hippocampal slices isolated from rats embedded with depleted uranium fragments. *Neurotoxicology* 20(5):785-792.
- \*Pelayo JC, Andrews PM, Coffey AK, et al. 1983. The influence of age on acute renal toxicity of uranyl nitrate in the dog. *Pediatr Res* 17(12):985-992.

## 9. REFERENCES

- Perez JLP, Cordero BM, Garcia ER, et al. 1990. Determination of uranium using a flow system with reagent injection. Application to the determination of uranium in ore leachates. *Anal Chim Acta* 230:217-220.
- Petitot F, Frelon S, Moreels AM, et al. 2007a. Incorporation and distribution of uranium in rats after a contamination on intact or wounded skin. *Health Phys* 92(5):464-474.
- Petitot F, Gautier C, Moreels AM, et al. 2007b. Percutaneous penetration of uranium in rats after a contamination on intact or wounded skin. *Radiat Prot Dosimetry* 127(1-4):125-130.
- Petitot F, Moreels AM, Paquet F. 2004. *In vitro* evaluation of percutaneous diffusion of uranyl nitrate through intact or excoriated skin of rat and pig. *Can J Physiol Pharmacol* 82(2):133-139.
- Pinkerton LE, Bloom TF, Hein MJ, et al. 2004. Mortality among a cohort of uranium mill workers: An update. *Occup Environ Med* 61(1):57-64.
- Pleskach SD. 1985. Determination of uranium and thorium in urine by neutron activation. *Health Phys* 48:303-307.
- PNL. 1981. Occupational exposures to uranium: Processes, hazards and regulations. Pacific Northwest Laboratory and Hanford Environmental Health Foundation, PNL-3341 USUR-01 UC-41.
- Polednak AP, Frome EL. 1981. Mortality among men employed between 1943 and 1947 at a uranium-processing plant. *J Occup Med* 23:169-178.
- Polednak AP, Keane AT, Beck WL. 1982. Estimation of radiation doses to the lungs of early uranium processing plant workers. *Environ Res* 28:313-328.
- Poston TM. 1982. The bioaccumulation potential of thorium and uranium in rainbow trout (*Salmo gairdneri*). *Bull Environ Cont Toxicol* 28:682-690.
- Pozzani UC. 1949. High-grade ore. In: *Pharmacology and toxicology of uranium compounds*. New York, NY: McGraw-Hill, Inc., 622-634.
- Prat O, Ansoborlo E, Sage N, et al. 2011. From cell to man: Evaluation of osteopontin as a possible biomarker of uranium exposure. *Environ Int* 37(4):657-662.
- Prat O, Berenguer F, Malard V, et al. 2005. Transcriptomic and proteomic responses of human renal HEK293 cells to uranium toxicity. *Proteomics* 5(1):297-306.
- Premuzic ET, Francis AJ, Lin M, et al. 1995. Induced formation of chelating agents by *Pseudomonas aeruginosa* grown in presence of thorium and uranium. *Arch Environ Contam Toxicol* 14:759-768.
- Price KR, Kinnison RR. 1982. Uranium and other heavy metals in soil and vegetation from the Hanford environs. Report: ISS PNL-4466. DE83003313.
- \*Priest ND, Howells GR, Green D, et al. 1982. Uranium in bone: Metabolic and autoradiographic studies in the rat. *Hum Toxicol* 1:97-114.
- Pujadas-Bigi MM, Lemlich L, Mandalunis PM, et al. 2003. Exposure to oral uranyl nitrate delays tooth eruption and development. *Health Phys* 84(2):163-169.

## 9. REFERENCES

- Pujadas Bigi MM, Ubios AM. 2007. Catch-up of delayed tooth eruption associated with uranium intoxication. *Health Phys* 92(4):345-348.
- Puncher M, Bailey MR, Harrison JD. 2008. Uncertainty analysis of doses from inhalation of depleted uranium. *Health Phys* 95(3):300-309.
- Purtymun WD, Peters RJ, Buhl TE, et al. 1987. Background concentrations of radionuclides in soils and river sediments in northern New Mexico, 1974-1986. Report: ISS LA-11134-MS. DE88001560.
- Querol X, Alastuey A, Lopez-Soler A, et al. 1997. Trace element contents in atmospheric suspended particles: Inferences from instrumental neutron activation analysis. *Fresenius J Anal Chem* 357(7):934-940.
- Racine R, Grandcolas L, Grison S, et al. 2010. Cholesterol 7 $\alpha$ -hydroxylase (CYP7A1) activity is modified after chronic ingestion of depleted uranium in the rat. *J Steroid Biochem Mol Biol* 120(1):60-66.
- Radenkovic MB, Cupac SA, Joksic JD, et al. 2008. Depleted uranium mobility and fractionation in contaminated soil (southern Serbia). *Environ Sci Pollut Res Int* 15(1):61-67.
- Radford E, Renard K. 1984. Lung cancer in Swedish iron miners exposed to low doses of radon daughters. *New Engl J Med* 310:1485-1494.
- Ramachandriah C, Vijayakumari D, Lakshminarayana K. 1993. A sensitive spectrophotometric method for the determination of trace amounts of uranium(VI) using o-hydroxypropiophenone isonicotinoyl hydrazone. *J Radioanal Nucl Chem Letters* 175(3):185-190.
- Raymond-Whish S, Mayer LP, O'Neal T, et al. 2007. Drinking water with uranium below the U.S. EPA water standard causes estrogen receptor-dependent responses in female mice. *Environ Health Perspect* 115(12):1711-1716.
- Rayno DR. 1983. Estimated dose to man from uranium milling via the beef/milk food-chain pathway. *Sci Total Environ* 31:219-241.
- Reyes M, Wilkinson GS, Tietjen G, et al. 1984. Brain tumors at a nuclear facility. *J Occup Med* 26:721-724.
- Riley JE. 1982. Ultrahigh sensitivity uranium analyses using fission track counting: Further analyses of semiconductor packaging materials. *J Radioanalytical Chem* 72(1-2):89-99.
- Roberts E. 1949. Uranyl nitrate. In: Voegtlin C, Hodge HC, eds. *Pharmacology and toxicology of uranium compounds*. New York: McGraw-Hill Book Company, Inc., 561-585.
- Rossol M. 1997. Ceramic glazes, frit metal enamels, and glass; personal communication and supporting materials. *Arts, Crafts and Theater Safety*, New York.
- Roth P, Hollriegel V, Werner E, et al. 2003. Assessment of exposure to depleted uranium. *Radiat Prot Dosimetry* 105(1-4):157-161.

## 9. REFERENCES

- Rothermel JJ. 1949. Uranium tetrachloride. In: Voegtlin C, Hodge HC, eds. Pharmacology and toxicology of uranium compounds. New York: McGraw-Hill Book Company, Inc., 588-602.
- Rothstein A. 1949a. Uranyl fluoride. Pharmacology and toxicology of uranium compounds. McGraw-Hill Book Company, Inc., 548-561.
- Rothstein A. 1949b. Uranium dioxide. In: Voegtlin C, Hodge HC, eds. Pharmacology and toxicology of uranium compounds. New York: McGraw-Hill Book Company, Inc., 614-621.
- Rothstein A. 1949c. Uranium trioxide. In: Voegtlin C, Hodge HC, eds. Pharmacology and toxicology of uranium compounds. New York: McGraw-Hill Book Company, Inc., 635-648.
- \*Rothstein A. 1949. Sodium diuranate. In: Voegtlin C, Hodge HC, eds. Pharmacology and toxicology of uranium compounds. New York: McGraw-Hill Book Company, Inc., 653-665.
- Rouas C, Stefani J, Grison S, et al. 2011. Effect of nephrotoxic treatment with gentamicin on rats chronically exposed to uranium. *Toxicology* 279(1-3):27-35.
- Russell JJ, Kathren RL. 2004. Uranium deposition and retention in a USTUR whole body case. *Health Phys* 86(3):273-284.
- Russell J, Kathren R, Dietert S. 1996. A histological kidney study of uranium and non-uranium workers. *Health phys* 70(4):466-472.
- Saccomanno G, Archer VE, Auerbach O, et al. 1971. Histologic types of lung cancer among uranium miners. *Cancer* 27:515-523.
- Saccomanno G, Archer VE, Saunders RP, et al. 1976. Early indices of cancer risk among uranium miners with reference to modifying factors. *Ann NY Acad Sciences* 271:377-383.
- Saccomanno G, Auerbach O, Kuschner M, et al. 1996. A comparison between the localization of lung tumors in uranium miners and in nonminers from 1947 to 1991. *Cancer* 77(7):1278-1283.
- Saccomanno G, Huth GC, Auerbach O, et al. 1988. Relationship of radioactive radon daughters and cigarette smoking in the genesis of lung cancer in uranium miners. *Cancer* 62:1402-1408.
- Saccomanno G, Thun MJ, Baker DB, et al. 1982. The contribution of uranium miners to lung cancer histogenesis renal toxicity in uranium mill workers. *Cancer Res* 42:43-52.
- Saccomanno G, Yale C, Dixon W, et al. 1986. An epidemiological analysis of the relationship between exposure to radon progeny, smoking and bronchogenic carcinoma in the uranium-mining population of the Colorado Plateau (USA): 1960-1980. *Health Phys* 50:605-618.
- Sahoo SK, Matsumoto M, Shiraishi K, et al. 2007. Dose effect for South Serbians due to <sup>238</sup>U in natural drinking water. *Radiat Prot Dosimetry* 127(1-4):407-10.
- Sairenji E, Moriwaki K, Shimizu M, et al. 1980. Estimation of radiation dose from porcelain teeth containing uranium compound. *J Dent Res* 59:1136-1140.
- Samet JM, Kutvirt DM, Waxweiler RJ, et al. 1984b. Uranium mining and lung cancer in Navaho men. *N Eng J Med* 310:1481-1484.

## 9. REFERENCES

- Samet JM, Morgan MV, Key CR, et al. 1986. Studies of uranium miners in New Mexico. *Ann Am Conf Gov Ind Hyg* 15:351-355.
- Samet JM, Pathak DR, Morgan MV, et al. 1989. Radon progeny exposure and lung cancer risk in New Mexico U miners: a case-control study. *Health Phys* 56(4):415-421.
- Samet JM, Pathak DR, Morgan MV, et al. 1991. Lung cancer mortality and exposure to radon progeny in a cohort of New Mexico underground uranium miners. *Health Phys* 61(6):745-752.
- Samet JM, Pathak DR, Morgan MV, et al. 1994. Silicosis and lung cancer risk in underground uranium miners. *Health Phys* 66(4):450-453.
- Samet JM, Young RA, Morgan MV, et al. 1984a. Prevalence survey of respiratory abnormalities in New Mexico uranium miners. *Health Phys* 46(2):361-370.
- Sánchez DJ, Belles M, Albina ML, et al. 2006. Exposure of pregnant rats to uranium and restraint stress: Effects on postnatal development and behavior of the offspring. *Toxicology* 228(2-3):323-332.
- Sanders CL. 1986. Radiological health. *Toxicological aspects of energy production*. Columbus, OH: Battelle Press, 253-284.
- Sansone U, Stellato L, Jia G, et al. 2001. Levels of depleted uranium in Kosovo soils. *Radiat Prot Dosimetry* 97(4):317-320.
- Scharer JM, Ibbotson B. 1982. Bacterial oxidation of inorganic compounds in mining waste. *Conserv Recycling* 5:47-53.
- Schieferdecker H, Dilger H, Doerfel H, et al. 1985. Inhalation of uranium aerosols from uranium dioxide fuel element fabrication. *Health Phys* 48:29-48.
- Schimmack W, Gerstmann U, Schultz W, et al. 2007. Long-term corrosion and leaching of depleted uranium (DU) in soil. *Radiat Environ Biophys* 46(3):221-227.
- Schröder H, Heimers A, Frentzel-Beyme R, et al. 2003. Chromosome aberration analysis in peripheral lymphocytes of Gulf War and Balkans War veterans. *Radiat Prot Dosimetry* 103(3):211-219.
- Scott LM, Bahler KW, De La Garza A, et al. 1972. Mortality experience of uranium and nonuranium workers. *Health Phys* 23:555-557.
- Seldén AI, Lundholm C, Edlund B, et al. 2009. Nephrotoxicity of uranium in drinking water from private drilled wells. *Environ Res* 109(4):486-494.
- Setchell BP, Waites GMH. 1975. The blood-testis barrier. In: Creep RO, Astwood EB, Geiger SR, eds. *Handbook of physiology: Endocrinology V*. Washington, DC: American Physiological Society, 143-172.
- Shaw TJ, Sholkovitz ER, Klinkhammer G. 1994. Redox dynamics in the Chesapeake Bay: The effect on sediment/water uranium exchange. *Geochim Cosmochim Acta* 58(14):2985-2995.

## 9. REFERENCES

- Sheppard MI, Thibault DH, Mitchell JH. 1987. Element leaching and capillary rise in sandy soil cores: Experimental results. *J Environ Qual* 16:273-284.
- Sheppard MI, Vandergraaf TT, Thibault DH, et al. 1983. Technetium and uranium: Sorption by and plant uptake from peat and sand. *Health Phys* 44:635-644.
- Shiraishi K, Igarashi Y, Takaku Y, et al. 1992. Daily intakes of <sup>232</sup>Th and <sup>238</sup>U in Japanese males. *Health Phys* 63(2):187-191.
- Sikov MR, Mahlum DD. 1968. Cross-placental transfer of selected actinides in the rat. *Health Phys* 14(3):205-208.
- Sikov MR, Rommereim DN. 1986. Evaluation of the embryotoxicity of uranium in rats. *Teratology* 33:41C.
- Silva RJ, Benson LV, Apps JA. 1979. Studies of actinide sorption on selected geologic materials. *ACS Symp Ser* 100:215-240.
- Simpson HJ, Trier RM, Toggweiler JR, et al. 1982. Radionuclides in Mono Lake, California, USA. *Science* 216:512-514.
- Singh NP, Wrenn ME. 1987. Uptake of uranium from drinking water. In: Hemphill DD, ed. *Trace substances in environmental health*. Columbia, MO: University of Missouri, 203-212.
- Singh NP, Wrenn ME. 1988. Determinations of actinides in biological and environmental samples. *Sci Total Environ* 70:187-204.
- \*Singh NP, Wrenn ME. 1989. Is the Beagle dog an appropriate experimental animal for extrapolating data to humans on organ distribution patterns of U, Th, and Pu? *Health Phys* 57:91-96.
- Singh NP, Zimmerman CJ, Lewis LL, et al. 1984. Quantitative determination of environmental levels of uranium, thorium and plutonium in bone by solvent extraction and alpha spectrometry. *Nucl Instrum Methods Phys Res* 223:558-562.
- Singh NP, Bennett DB, Wrenn ME. 1987b. Macro-distribution of naturally occurring d-emitting isotopes of U in the human skeleton. *Health Phys* 52:769-773.
- Singh NP, Burleigh DP, Ruth HM, et al. 1990. Daily U intake in Utah residents from food and drinking water. *Health Phys* 59(3):333-337.
- Singh NP, Lewis LL, Wrenn ME. 1986b. Uranium in human tissues of Colorado, Pennsylvania and Utah populations. *Health Phys* 55:583.
- Smith DD, Black SC. 1975. Actinide concentrations in tissues from cattle grazing near the Rocky Flats Plant. Report: ISS NERC-LV-539-36.
- \*Sontag W. 1983. The early distribution of plutonium-239, americium-241 and uranium-233 in the soft tissues and skeleton of old rats. A comparative study. *Hum Toxicol* 2:91-100.
- Sontag W. 1986. Multicompartment kinetic models for the metabolism of americium, plutonium and uranium in rats. *Hum Toxicol* 5:163-173.

## 9. REFERENCES

- Souidi M, Gueguen Y, Linard C, et al. 2005. *In vivo* effects of chronic contamination with depleted uranium on CYP3A and associated nuclear receptors PXR and CAR in the rat. *Toxicology* 214(1-2):113-122.
- Spencer H, Osis D, Isabel M, et al. 1990. Measured intake and excretion patterns of naturally occurring  $^{234}\text{U}$ ,  $^{238}\text{U}$ , and calcium in humans. *Radiat Res* 124:90-95.
- Spiegl, CJ. 1949. In: *Pharmacology and toxicology of uranium compounds*. New York, NY: McGraw-Hill Book Company, Inc., 532-547.
- Spoor NL, Hursh JB. 1973. Protection Criteria. I. The history of development of protection criteria for uranium in air. In: Hodge HC, Stannard JN, Hursh JB, eds. *Handbook of experimental pharmacology. Uranium plutonium transplutonic elements*. New York, NY: Springer-Verlag, 241-270.
- Sprague GF. 1949. Control studies. In: Voegtlin C, Hodge HC, eds. *Pharmacology and toxicology of uranium compounds*. New York, NY: McGraw-Hill Book Company, Inc., 525-531.
- Squibb KS, Leggett RW, McDiarmid MA. 2005. Prediction of renal concentrations of depleted uranium and radiation dose in Gulf War veterans with embedded shrapnel. *Health Phys* 89(3):267-273.
- Squibb KS, McDiarmid MA. 2006. Depleted uranium exposure and health effects in Gulf War veterans. *Philos Trans R Soc Lond B Biol Sci* 361(1468):639-648.
- Squibb KS, Gaitens JM, Engelhardt S, et al. 2012. Surveillance for long-term health effects associated with depleted uranium exposure and retained embedded fragments in US veterans. *J Occup Environ Med* 54:724-732.
- \*Sram RJ, Binkova B, Dobias L, et al. 1993. Monitoring genotoxic exposure in uranium miners. *Environ Health Perspect* 99:303-305.
- Stearns DM, Yazzie M, Bradley AS, et al. 2005. Uranyl acetate induces hprt mutations and uranium-DNA adducts in Chinese hamster ovary EM9 cells. *Mutagenesis* 20(6):417-423.
- Stevens W, Bruenger FW, Atherton DR, et al. 1980. The distribution and retention of hexavalent uranium-233 in the Beagle. *Radiat Res* 83:109-126.
- Stevenson KA, Hardy EP. 1993. Estimate of excess uranium in surface soil surrounding the feed materials production center using a requalified data base. *Health Phys* 65(3):283-287.
- Stewart BD, McKlveen JW, Glinski RL. 1988. Determination of uranium and radium concentrations in the waters of the Grand Canyon by alpha spectrometry. *J Radioanal Nucl Chem* 123:121-132.
- Stokinger HE, Baxter RC, Dygert HP, et al. 1953. Toxicity following inhalation for 1 and 2 years. In: Voegtlin C, Hodge HC, eds. *Pharmacology and toxicology of uranium compounds*. New York, NY: McGraw-Hill, 1370-1776.
- Storm HH, Jorgensen HO, Kejs AM, et al. 2006. Depleted uranium and cancer in Danish Balkan veterans deployed 1992-2001. *Eur J Cancer* 42(14):2355-2358.

## 9. REFERENCES

- \*Stradling GN, Stather JW, Gray SA, et al. 1988. The metabolism of ceramic and non-ceramic forms of uranium dioxide after deposition in the rat lung. *Human Toxicol* 7:133-139.
- \*Stradling GN, Stather JW, Gray SA, et al. 1989. The metabolic behaviour of uranium octoxide bearing residues after their deposition in the rat lung: The implications for occupational exposure. *Exp Pathol* 37(1-4):76-82.
- Stradling GN, Gray SA, Moody JC, et al. 1991. Efficacy of tiron for enhancing the excretion of uranium from the rat. *Hum Exp Toxicol* 10(3):195-198.
- Stradling GN, Smith H, Cooper JR, et al. 1984. Factors affecting the abundance of uranium isotopes in body tissues and excreta following the deposition of enriched uranium dioxide in the lungs-The radiological implications. *Health Phys* 46:434-438.
- Stradling GN, Stather JW, Gray SA, et al. 1987. Metabolism of uranium in the rat after inhalation of two industrial forms of ore concentrate: The implications for occupational exposure. *Hum Toxicol* 6:385-394.
- Stuart WI, Adams RB, Smith HE. 1979. Solubility and hemolytic activity of uranium trioxide. *Environ Res* 18:385-396.
- Sullivan MF. 1980a. Absorption of actinide elements from the gastrointestinal tract of rats, guinea pigs and dogs. *Health Phys* 38:159-171.
- Sullivan MF. 1980b. Absorption of actinide elements from the gastrointestinal tract of neonatal animals. *Health Phys* 38:173-185.
- Sullivan MF, Gorham LS. 1982. Further studies on the absorption of actinide elements from the gastrointestinal tract of neonatal animals. *Health Phys* 43(4):509-519.
- Sullivan MF, Ruemmler PS. 1988. Absorption of  $^{233}\text{U}$ ,  $^{237}\text{Np}$ ,  $^{238}\text{Pu}$ ,  $^{241}\text{Am}$  and  $^{244}\text{Cm}$  from the gastrointestinal tracts of rats fed an iron-deficient diet. *Health Phys* 54:311-316.
- Sullivan MF, Ruemmler PS, Ryan JL, et al. 1986. Influence of oxidizing or reducing agents on gastrointestinal absorption of uranium, plutonium, americium, curium, and promethium by rats. *Health Phys* 50:233-232.
- Swanson SM. 1983. Levels of  $^{236}\text{Ra}$ ,  $^{210}\text{Pb}$  and  $^{\text{total}}\text{U}$  in fish near a Saskatchewan uranium mine and mill. *Health Phys* 45(1):67-80.
- Swanson SM. 1985. Food chain transfer of U-Series radionuclides in northern Saskatchewan aquatic system. *Health Phys* 49:747-770.
- Szabo Z, Zapeca OS. 1987. Relation between natural radionuclide activities and chemical constituents in ground water in the Newark Basin New Jersey USA. In: Graves B, ed. *Radon in ground water, radon, radium and other radioactivity in ground water: Hydrogeologic impact and application to indoor airborne contamination: Proc National Water Well Association conference, Somerset, NJ, April 7-9, 1987.* Chelsea, MI: Lewis Publishers, Inc., 283-308.
- Szrom F, Falo GA, Lodde GM, et al. 2009. Inhalation and ingestion intakes with associated dose estimates for level II and level III personnel using Capstone study data. *Health Phys* 96(3):363-379.



## 9. REFERENCES

- Tadmor J. 1986. Atmospheric release of volatilized species of radioelements from coal-fired plants. *Health Phys* 50:270-273.
- Tannenbaum A, Silverstone H, Koziol J. 1951. Tracer studies of the distribution and excretion of uranium in mice, rats, and dogs. In: Tannenbaum A, ed. *Toxicology of uranium compounds*. New York, NY: McGraw-Hill, 128-181.
- Thiebault C, Carriere M, Milgram S, et al. 2007. Uranium induces apoptosis and is genotoxic to normal rat kidney (NRK-52E) proximal cells. *Toxicol Sci* 98(2):479-487.
- Thind KS. 1987. A comparison of ICRP Publication 30 lung model-based predictions with measured bioassay data for airborne natural uranium dioxide exposure. *Health Phys* 53:59-66.
- Thomas K, Colborn T. 1992. Organochlorine endocrine disruptors in human tissue. In: Colborn T, Clement C, eds. *Chemically induced alterations in sexual and functional development: The wildlife/human connection*. Princeton, NJ: Princeton Scientific Publishing, 365-394.
- Thomas P, Irvine J, Lyster J, et al. 2005. Radionuclides and trace metals in Canadian moose near uranium mines: comparison of radiation doses and food chain transfer with cattle and caribou. *Health Phys* 88(5):423-438.
- Thun MJ, Baker DB, Steenland K, et al. 1985. Renal toxicity in uranium mill workers. *Scand J Work Environ Health* 11(2):83-90.
- Ticknor KV. 1994. Uranium sorption on geological materials. *Radiochimica Acta* 64:229-236.
- Tirmarche M, Raphalen A, Allin F, et al. 1993. Mortality of a cohort of French uranium miners exposed to relatively low radon concentrations. *Br J Cancer* 67(5):1090-1097.
- Tirmarche M, Raphalen A, Chameaud J. 1992. Epidemiological study of French uranium miners. *Cancer Detect Prev* 16(3):169-172.
- Tissandie E, Gueguen Y, Lobaccaro JM, et al. 2006. Effects of depleted uranium after short-term exposure on vitamin D metabolism in rat. *Arch Toxicol* 80(8):473-480.
- Tissandie E, Gueguen Y, Lobaccaro JM, et al. 2007. *In vivo* effects of chronic contamination with depleted uranium on vitamin D<sub>3</sub> metabolism in rat. *Biochim Biophys Acta* 1770(2):266-272.
- \*Tobias CA. 1985. Failla Memorial Lecture. The future of heavy-ion science in biology and medicine. *Radiat Res* 103(1):1-33.
- Todorov TI, Xu H, Ejniak JW, et al. 2009. Depleted uranium analysis in blood by inductively coupled plasma mass spectrometry. *J Anal Atom Spectrom* 24:189-193.
- Tomasek L, Rogel A, Tirmarche M, et al. 2008. Lung cancer in French and Czech uranium miners: Radon-associated risk at low exposure rates and modifying effects of time since exposure and age at exposure. *Radiat Res* 169(2):125-37.
- Toohy RE. 2003. Excretion of depleted uranium by Gulf War veterans. *Radiat Prot Dosimetry* 105(1-4):171-174.

## 9. REFERENCES

- Toole J, McKay K, Baxter M. 1991. Determination of uranium in marine sediment pore waters by isotope dilution inductively coupled plasma mass spectrometry. *Anal Chim Acta* 245:83-88.
- Tracy BL, Meyerhof DP. 1987. Uranium concentrations in air near a Canadian uranium refinery. *Atmos Env* 21:165-172.
- \*Tracy BL, Quinn JM, Lahey J, et al. 1992. Absorption and retention of uranium from drinking water by rats and rabbits. *Health Phys* 62(1):65-73.
- Twiss P, Watling RJ, Delev D. 1994. Determination of thorium and uranium in faecal material from occupationally-exposed workers using ICP-MS. *Atom Spectrosc* 15(1):36-39.
- \*Ubios AM, Braun EM, Cabrini RL. 1994. Lethality due to uranium poisoning is prevented by ethane-1-hydroxy-1,1-biphosphonate (EHBP). *Health Phys* 66(5):540-544.
- \*Ubios AM, Guglielmotti MB, Steimetz T, et al. 1991. Uranium inhibits bone formation in physiologic Alveolar bone modeling and remodeling. *Environ Res* 54:17-23.
- UDOH. 2007. Cancer incidence study. A follow-up study of cancer incidence in Monticello City, Utah-1973-2004. Monticello City, San Juan County, Utah. Utah Department of Health. <http://health.utah.gov/search/index.html?cx=015797132617248936942%3Afl9rxjqr2j4&cof=FORID%3A10&ie=UTF-8&q=Cancer+incidence+study.++A+follow-up+study+of+cancer+incidence+in+Monticello+City%2C+Utah-1973-2004.++Monticello+City%2C+San+Juan+County%2C+Utah>. July 5, 2012.
- UNSCEAR. 1977. United Nations Scientific Committee on the Effects of Atomic Radiation. Sources and effects of ionizing radiation. United Nations Document E.77.IX.1, New York, NY.
- UNSCEAR. 1982. Ionizing radiation: Sources and biological effects. 1982 Report to the General Assembly, with annexes. United Nations Scientific Committee on the Effects of Atomic Radiation.
- UNSCEAR. 1986. Genetic and somatic effects of ionizing radiation. New York, NY: United Nations Scientific Committee on the Effects of Atomic Radiation. .
- UNSCEAR. 1988. Sources, effects and risks of ionizing radiation. Report to the General Assembly, with annexes. New York, NY: United Nations Publications. United Nations Scientific Committee on the Effects of Atomic Radiation.
- Uranium Institute. 1996. The nuclear fuel cycle. <http://www.uilondon.org/nfc.htm>. November 4, 1999.
- USDOC. 1984. U.S. General imports and imports for consumption. Schedule A, commodity by country. Washington, DC: Bureau of Census, U.S. Department of Commerce, 2-61 to 2-62.
- USDOC. 1988. U.S. General imports and imports for consumption. Schedule A, commodity by country. Washington, DC: Bureau of Census, U.S. Department of Commerce, 2-70 to 2-71; 2-149.
- USDOC. 1995. National Trade Data Bank. U.S. Department of Commerce, Bureau of the Census.
- USDOC. 1997. U.S. Merchandise import and export trade. Retrieved from National Trade Data Bank. United States Department of Commerce, Bureau of Census.

## 9. REFERENCES

- USDOC. 1999. National Trade Data Bank. U.S. Department of Commerce, Bureau of the Census.
- USGS. 2006. History of the National Uranium Resource Evaluation Hydrogeochemical and Stream Sediment Reconnaissance Program. U.S. Geological Survey. <http://pubs.usgs.gov/of/1997/ofr-97-0492/nurehist.htm>. January 26, 2011.
- USGS. 2008. Uranium in surface waters and sediments affected by historical mining in the Denver West 1:100,000 quadrangle, Colorado. Reston, VA: U.S. Geological Survey. Scientific Investigations Report 2007-5246. [http://pubs.usgs.gov/sir/2007/5246/508ZielinskiSIR07\\_5246.pdf](http://pubs.usgs.gov/sir/2007/5246/508ZielinskiSIR07_5246.pdf). January 26, 2011.
- USGS. 2009. Groundwater restoration at uranium in-situ recovery mines, South Texas Coastal Plain. Reston, VA: U.S. Geological Survey Open-File Report 2009-1143. <http://pubs.usgs.gov/of/2009/1143/pdf/OF09-1143.pdf>. January 26, 2011.
- USGS. 2010a. Volcanogenic uranium deposits: Geology, geochemical processes, and criteria for resource assessment Reston, VA: U.S. Geological Survey. Open-File Report 2010-1001 <http://pubs.usgs.gov/of/2010/1001/pdf/OF10-1001.pdf>. January 26, 2011.
- USGS. 2010b. Hydrological, geological, and biological site characterization of breccia pipe uranium deposits in Northern Arizona. Reston, VA: U.S. Geological Survey. Scientific Investigations Report 2010-5025. <http://pubs.usgs.gov/sir/2010/5025/pdf/sir2010-5025.pdf>. January 26, 2011.
- USGS. 2010c. Geology, geochemistry, and geophysics of the Fry Canyon Uranium/Copper Project Site, Southeastern Utah—Indications of contaminant migration. Reston, VA: U.S. Geological Survey. Scientific Investigations Report 2010-5075. <http://pubs.usgs.gov/sir/2010/5075/pdf/SIR10-5075.pdf>. January 26, 2011.
- USNRC. 1986. Assessment of the public health impact from the accidental release of UP6 at the Sequoyah Fuels Corporation Facility at Gore, Oklahoma. Washington, DC: U.S. Nuclear Regulatory Commission. NUREG-1189-V1.
- USNRC. 1990. Evaluation of health effects in Sequoyah Fuels Corporation workers from accidental exposure to uranium hexafluoride. Washington, DC: U.S. Nuclear Regulatory Commission. NUREG/CR-5566 PNL-7328.
- USNRC. 1999. United States Nuclear Regulatory Commission. Standards for protection against radiation, general provisions, scope. Code of Federal Regulations. 10 CFR 20.1002.
- USNRC. 2002. Radioactive waste: Production, storage, disposal. U.S. Nuclear Regulatory Commission. <http://www.nrc.gov/reading-rm/doc-collections/nuregs/brochures/br0216/r2/br0216r2.pdf>. January 26, 2011.
- USNRC. 2006. Background. Uranium mill tailings. U.S. Nuclear Regulatory Commission. [www.nrc.gov/reading-rm/doc-collections/fact-sheets/mill-tailings.pdf](http://www.nrc.gov/reading-rm/doc-collections/fact-sheets/mill-tailings.pdf). April 28, 2011.
- USNRC. 2007. Background. Radioactive waste. U.S. Nuclear Regulatory Commission. <http://www.nrc.gov/reading-rm/doc-collections/fact-sheets/radwaste.pdf>. January 26, 2011.

## 9. REFERENCES

USNRC. 2010a. Appendix B to part 20—Annual limits on intake (ALIs) and derived air concentrations (DACs) of radionuclides for occupational exposure; effluent concentrations; concentrations for release to sewerage. U.S. Nuclear Regulatory Commission. Code of Federal Regulations 10 CFR 20, Appendix B [http://edocket.access.gpo.gov/cfr\\_2010/janqtr/pdf/10cfr20AppB.pdf](http://edocket.access.gpo.gov/cfr_2010/janqtr/pdf/10cfr20AppB.pdf). January 27, 2011.

USNRC. 2010b. Appendix G to part 20—Requirements for transfers of low-level radioactive waste intended for disposal at licensed land disposal facilities and manifests. U.S. Nuclear Regulatory Commission. Code of Federal Regulations 10 CFR 20, Appendix G [http://edocket.access.gpo.gov/cfr\\_2010/janqtr/pdf/10cfr20AppG.pdf](http://edocket.access.gpo.gov/cfr_2010/janqtr/pdf/10cfr20AppG.pdf). January 27, 2011.

USNRC. 2010c. Definitions. U.S. Nuclear Regulatory Commission. Code of Federal Regulations 10 CFR 20.1003 [http://edocket.access.gpo.gov/cfr\\_2010/janqtr/pdf/10cfr20.1003.pdf](http://edocket.access.gpo.gov/cfr_2010/janqtr/pdf/10cfr20.1003.pdf). January 27, 2011.

USNRC. 2010d. Dose equivalent to an embryo/fetus. U.S. Nuclear Regulatory Commission. Code of Federal Regulations 10 CFR 20.1208 [http://edocket.access.gpo.gov/cfr\\_2010/janqtr/pdf/10cfr20.1208.pdf](http://edocket.access.gpo.gov/cfr_2010/janqtr/pdf/10cfr20.1208.pdf). January 27, 2011.

USNRC. 2010e. Dose limits for individual members of the public. U.S. Nuclear Regulatory Commission. Code of Federal Regulations 10 CFR 20.1301 [http://edocket.access.gpo.gov/cfr\\_2010/janqtr/pdf/10cfr20.1301.pdf](http://edocket.access.gpo.gov/cfr_2010/janqtr/pdf/10cfr20.1301.pdf). January 27, 2011.

USNRC. 2010f. Occupational dose limits for minors. U.S. Nuclear Regulatory Commission. Code of Federal Regulations 10 CFR 20.1207 [http://edocket.access.gpo.gov/cfr\\_2010/janqtr/pdf/10cfr20.1207.pdf](http://edocket.access.gpo.gov/cfr_2010/janqtr/pdf/10cfr20.1207.pdf). January 27, 2011.

USNRC. 2010g. Planned special exposures. U.S. Nuclear Regulatory Commission. Code of Federal Regulations 10 CFR 20.1206 [http://edocket.access.gpo.gov/cfr\\_2010/janqtr/pdf/10cfr20.1206.pdf](http://edocket.access.gpo.gov/cfr_2010/janqtr/pdf/10cfr20.1206.pdf). January 27, 2011.

USNRC. 2010h. Subpart C—Occupational dose limits. U.S. Nuclear Regulatory Commission. Code of Federal Regulations 10 CFR 20.1201, Subpart C [http://edocket.access.gpo.gov/cfr\\_2010/janqtr/pdf/10cfr20.1201.pdf](http://edocket.access.gpo.gov/cfr_2010/janqtr/pdf/10cfr20.1201.pdf). January 27, 2011.

USNRC. 2010i. Radiological criteria for license termination. U.S. Nuclear Regulatory Commission. Code of Federal Regulations 10 CFR 20 Subpart E. <http://www.gpo.gov/fdsys/pkg/CFR-2010-title10-vol11/pdf/CFR-2010-title10-vol11-part20-subpartE.pdf>. February 2, 2011.

USNRC. 2011. Low-level waste disposal statistics. U.S. Nuclear Regulatory Commission. <http://www.nrc.gov/waste/llw-disposal/licensing/statistics.html>. April 28, 2011.

USNRC. 2012a. Annual limits on intake (ALIs) and derived air concentrations (DACs) of radionuclides for occupational exposure; effluent concentrations; concentrations for release to sewerage. Nuclear Regulatory Commission. Code of Federal Regulations 10 CFR 20, Appendix B <http://www.gpo.gov/fdsys>. June 15, 2012.

USNRC. 2012b. Occupational dose limits. U.S. Nuclear Regulatory Commission. Code of Federal Regulations 10 CFR 20, Subpart C <http://www.gpo.gov/fdsys>. June 15, 2012.

USTUR. 1999. USTUR database. U.S. Transuranium and Uranium Registry. <http://www.tricity.wsu.edu/~ustur/database.html>. February 16, 1999.

## 9. REFERENCES

- USTUR. 2011. United States transuranium and uranium registries radiochemical analysis procedures manual. Pullman, WA: Washington State University, Nuclear Radiation Center, Manual # 01.
- Valdés M. 2009. Estimating the lung burden from exposure to aerosols of depleted uranium. *Radiat Prot Dosimetry* 134(1):23-29.
- van den Berg CMG, Nimmo M. 1987. Direct determination of uranium in water by cathodic stripping voltammetry. *Anal Chem* 59:924-928.
- Van Netten C, Morley DR. 1983. Uptake of uranium molybdenum copper and selenium by the radish from uranium rich soils. *Arch Env Health* 38:172-175.
- Veselsky JC, Kwiecinska B, Wehrstein E, et al. 1988. Determination of uranium in minerals by laser fluorimetry. *Analyst* 113:451-455.
- Veska E, Eaton RS. 1991. Abandoned Rayrock uranium mill tailings in the Northwest Territories: environmental conditions and radiological impact. *Health Phys* 60(3):399-409.
- Vich Z, Kriklava J. 1970. Erythrocytes of uranium miners: The red blood picture. *Br J Ind Med* 27:83-85.
- Vidic A, Ilić Z, Deljkić D, et al. 2011. Exposure of workers in Tusnica coal mine. *Radiat Prot Dosimetry* 144:672-674.
- Vieira I, Sonnier M, Cresteil T. 1996. Developmental expression of CYP2E1 in the human liver: Hypermethylation control of gene expression during the neonatal period. *Eur J Biochem* 238(2):476-483.
- Waite DT, Joshi SR, Sommerstad H. 1988. The effect of uranium mine tailings on radionuclide concentrations in Langley Bay, Saskatchewan Canada. *Arch Env Contam Tox* 17:373-380.
- Walinder G. 1989. Metabolism and sites of effects of uranium after incorporation along different routes in mice, rabbits and piglets. *Radiat Prot Dosimetry* 26(1/4):89-95.
- Wang J, Wang J, Lu J, et al. 1994. Adsorptive stripping voltammetry of trace uranium critical comparison of various chelating agents. *Anal Chim Acta* 292:91-97.
- Waxweiler, RJ; Archer, VE; Roscoe, RJ. 1983. Mortality patterns among a retrospective cohort of uranium mill workers. *Epidemiology applied to health physics: Proceedings of the sixteenth midyear topical meeting of the Health Physics society, Albuquerque, New Mexico, January 9-13, 1983.* Albuquerque, NM: U.S. Department of Energy. Health Physics Society, 428-435. DE83014383.
- Waxweiler R, Roscoe R, Archer V, et al. 1981a. Mortality follow-up through 1977 of the white underground uranium miners cohort examined by the United States Public Health Service. In: Gomez M, ed. *International conference: Radiation hazards in mining.* New York, NY: Society of Mining Engineers of American Institute of Mining, Metallurgical, and Petroleum Engineers, Inc., 823-830.
- Waxweiler RJ, Roscoe RJ, Archer VE. 1981b. Secondary sex ratio of first-born offspring of U.S. uranium miners. In: Wiese WH, ed. *Birth effects in the Four Corners area. Transcript of Meeting Held February 27, 1981.* Albuquerque, NM: University of New Mexico School of Medicine, 37-50.
- Wedeen RP. 1992. Renal diseases of occupational origin. *Occup Med* 7(3):449-463.

## 9. REFERENCES

- Weigel F. 1983. Uranium and uranium compounds. In: Grayson M, ed. Kirk-Othmer encyclopedia of chemical technology, Vol. 23, 3rd ed. New York, NY: John Wiley & Sons, 502-547.
- Weissman SH, Carpenter RL, Newton GJ. 1983. Respirable aerosols from fluidized bed coal combustion: 3. Elemental composition of fly ash. *Environ Sci Technol* 17:65-71.
- Welford GA, Baird R. 1967. Uranium levels in human diet and biological materials. *Health Phys* 13:1321-1324.
- Welford GA, Morse RS, Alercio JS. 1960. Urinary uranium levels in non-exposed individuals. *Am Ind Hyg Assoc J* 21:68-70.
- Wersin P, Hochella MF, Persson P, et al. 1994. Interaction between aqueous uranium (VI) and sulfide minerals: Spectroscopic evidence for sorption and reduction. *Geochim Cosmochim Acta* 58(13):2829-2843.
- Wessman RA. 1984. An overview of the radiochemical analysis of uranium. In: Moore RH, eds. Biokinetics and analysis of uranium in man. Proceedings of a colloquium held at Richland, Washington August 8-9, 1984. Washington, DC: United States Uranium Registry. U.S. Department of Energy. J-1 to J-57. USUR-05 HEHF-47.
- West CM, Scott LM. 1969. Uranium cases showing long chest burden retention an updating. *Health Phys* 17:781-791.
- West CM, Scott LM, Schultz NB. 1979. 16 Years of uranium personnel monitoring experience--in retrospect. *Health Phys* 36:665-669.
- West JR, Smith HW, Chasis H. 1948. Glomerular filtration rate, effective renal blood flow, and maximal tubular excretory capacity in infancy. *J Pediatr* 32:10-18.
- Whittemore AS, McMillan A. 1983. Lung cancer mortality among USA uranium miners: A reappraisal. *J Natl Cancer Inst* 71:489-499.
- WHO. 2003. Uranium in drinking-water. Summary statement. Extract from Chapter 12 - Chemical fact sheets of WHO guidelines for drinking-water quality, 3rd edition, 2004. World Health Organization. WHO/SDE/WSH/03.04/118.  
[http://www.who.int/water\\_sanitation\\_health/dwq/chemicals/uraniumsum.pdf](http://www.who.int/water_sanitation_health/dwq/chemicals/uraniumsum.pdf). January 28, 2011.
- WHO. 2004. Uranium in drinking-water. World Health Organization. WHO/SDE/WSH/03.04/118.  
[http://www.who.int/water\\_sanitation\\_health/dwq/chemicals/uraniumsum.pdf](http://www.who.int/water_sanitation_health/dwq/chemicals/uraniumsum.pdf). January 28, 2011.
- WHO. 2008. Guidelines for drinking-water quality. 3rd ed. Geneva, Switzerland: World Health Organization. [http://www.who.int/entity/water\\_sanitation\\_health/dwq/fulltext.pdf](http://www.who.int/entity/water_sanitation_health/dwq/fulltext.pdf). April 25, 2012.
- WHO. 2010. Guidelines for indoor air quality: Selected pollutants. Geneva, Switzerland: World Health Organization. [http://www.euro.who.int/\\_\\_data/assets/pdf\\_file/0009/128169/e94535.pdf](http://www.euro.who.int/__data/assets/pdf_file/0009/128169/e94535.pdf). April 25, 2012.
- Widdowson EM, Dickerson JWT. 1964. Chemical composition of the body. In: Comar CL, Bronner F, eds. Mineral metabolism: An advanced treatise. Volume II: The elements Part A. New York, NY: Academic Press, 1-247.

## 9. REFERENCES

- Wiegand J, Yamamoto G, Gaston W. 1987. Elevated levels of radioactivity in water wells in Los Angeles and Orange counties, California. In: Graves, B, eds. Radon, radium, and other radioactivity in ground water. Hydrogeologic impact and application to indoor airborne contamination. Proceedings of the NWWA Conference April 7-9, 1987. Lewis Publishers. Association of Ground Water Scientists and Engineers. U.S. Environmental Protection Agency. 71-82.
- Wiese WH, Skipper BJ. 1986. Survey of reproductive outcomes in uranium and potash mine workers: Results of first analysis. *Ann Am Conf Gov Ind Hyg* 14:187-192.
- \*Willis DL. 1985. Pharmacokinetics and chemical toxicity of uranium-238 in drinking water. Letter from David L. Willis to Lyman Condie. Submitted to the U.S. Environmental Protection Agency.
- \*Wise SS, Thompson WD, Aboueissa AM, et al. 2007. Particulate depleted uranium is cytotoxic and clastogenic to human lung cells. *Chem Res Toxicol* 20(5):815-820.
- WNA. 2010. Uranium, from mine to mill. WNA pocket guide. World Nuclear Association. <http://www.world-nuclear.org/uploadedFiles/Pocket%20Guide%202009%20Uranium.pdf>. March 23, 2011.
- WNA. 2011. WNA Public Information Service - Full List of Pages. World Nuclear Association. <http://www.world-nuclear.org/infomap.aspx>. January 26, 2011.
- Woodis TC, Trimm JR, Holmes JH, et al. 1980. Determination of uranium in phosphate rock and wet-process phosphoric acid by argon-plasma emission spectrometry. *J Assoc Off Anal Chem* 63:208-210.
- Woodward A, Roder D, McMichael AJ, et al. 1991. Radon daughter exposures at the Radium Hill uranium mine and lung cancer rates among former workers, 1982-1987. *Cancer Causes Control* 2(4):213-220.
- Wrenn ME, Bertelli L, Durbin PW, et al. 1994. A comprehensive metabolic model for uranium metabolism and dosimetry based on human and animal data. *Radiat Prot Dosimetry* 53(1-4):255-258.
- Wrenn ME, Durbin PW, Howard B. 1985. Metabolism of ingested uranium and radium. *Health Phys* 48:601-633.
- Wrenn ME, Durbin PW, Willis DL, et al. 1987. The potential toxicity of uranium in water. *Am Water Works Assoc J* 79:177-184.
- Wrenn ME, Singh NP, Ruth H, et al. 1989. Gastrointestinal absorption of soluble uranium from drinking water by man. *Radiat Prot Dosim* 26:119-122.
- Wrenn ME, Singh NP, Saccomanno G. 1983. Uranium and thorium isotopes and their state of equilibria in lungs from uranium miners. *Health Phys* 44(Suppl 1):385-389.
- Xuan XZ, Lubin JH, Li JY, et al. 1993. A cohort study in southern China of tin miners exposed to radon and radon decay products. *Health Phys* 64(2):120-131.

## 9. REFERENCES

- Yamamoto T, Masuda K, Nukada K. 1971. Studies on environmental contamination by uranium. 6. Uranium in total diet and human urine from nonoccupationally exposed persons in Okayama Prefecture (1969-1971). *J Radiation Res* 13(1):5.
- Yan M, Zhong G, Gao L, et al. 2010. The effects of depleted uranium on 1 $\alpha$ -hydroxylase in kidney of rats. *Hum Exp Toxicol* [epub ahead of print].
- Yang IC, Edwards KW. 1984. Releases of radium and uranium into Ralston Creek and Reservoir Colorado, from uranium mining. In: Barney GS, Navratil JD, Schulz W, eds. ACS Symposium Series 246. Geochemical behavior of disposed radioactive waste. Washington, DC: American Chemical Society, 271-286.
- Yazzie M, Gamble SL, Civitello ER, et al. 2003. Uranyl acetate causes DNA single strand breaks *in vitro* in the presence of ascorbate (vitamin C). *Chem Res Toxicol* 16(4):524-530.
- Yiin JH, Anderson JL, Daniels RD, et al. 2009. A nested case-control study of multiple myeloma risk and uranium exposure among workers at the Oak Ridge Gaseous Diffusion Plant. *Radiat Res* 171(6):637-645.
- \*Yu RC, Sherwood RJ. 1996. The relationships between urinary elimination, airborne concentration, and radioactive hand contamination for workers exposed to uranium. *AIHA* 57(7):615-620.
- \*Zalups RK. 1991. An evaluation of Tiron (sodium 4,5-dihydroxybenzene-1,3-disulfonate) as a rescue agent for the nephropathy induced by uranyl fluoride (UO<sub>2</sub>F<sub>2</sub>) in rats. *Res Commun Chem Pathol Pharmacol* 72(1):125-128.
- Zhu G, Tan M, Li Y, et al. 2009a. Accumulation and distribution of uranium in rats after implantation with depleted uranium fragments. *J Radiat Res (Tokyo)* 50(3):183-192.
- Zhu G, Xiang X, Chen X, et al. 2009b. Renal dysfunction induced by long-term exposure to depleted uranium in rats. *Arch Toxicol* 83(1):37-46.
- Ziegler EE, Edwards BB, Jensen RL, et al. 1978. Absorption and retention of lead by infants. *Pediatr Res* 12(1):29-34.
- Zielinski RA, McKown DM. 1984. Determination of uranium concentration in water by liquid anion-exchange-delayed-neutron analysis. *J Radioanal Nucl Chem* 84:207-212.



## 10. GLOSSARY

**Some terms in this glossary are generic and may not be used in this profile.**

**Absorbed Dose, Chemical**—The amount of a substance that is either absorbed into the body or placed in contact with the skin. For oral or inhalation routes, this is normally the product of the intake quantity and the uptake fraction divided by the body weight and, if appropriate, the time, expressed as mg/kg for a single intake or mg/kg/day for multiple intakes. For dermal exposure, this is the amount of material applied to the skin, and is normally divided by the body mass and expressed as mg/kg.

**Absorbed Dose, Radiation**—The mean energy imparted to the irradiated medium, per unit mass, by ionizing radiation. Units: rad (rad), gray (Gy).

**Absorbed Fraction**—A term used in internal dosimetry. It is that fraction of the photon energy (emitted within a specified volume of material) which is absorbed by the volume. The absorbed fraction depends on the source distribution, the photon energy, and the size, shape and composition of the volume.

**Absorption**—The process by which a chemical penetrates the exchange boundaries of an organism after contact, or the process by which radiation imparts some or all of its energy to any material through which it passes.

**Absorption Coefficient**—Fractional absorption of the energy of an unscattered beam of x- or gamma-radiation per unit thickness (linear absorption coefficient), per unit mass (mass absorption coefficient), or per atom (atomic absorption coefficient) of absorber, due to transfer of energy to the absorber. The total absorption coefficient is the sum of individual energy absorption processes (see Compton Effect, Photoelectric Effect, and Pair Production).

**Absorption Coefficient, Linear**—A factor expressing the fraction of a beam of x- or gamma radiation absorbed in a unit thickness of material. In the expression  $I = I_0 e^{-\mu x}$ ,  $I_0$  is the initial intensity,  $I$  the intensity of the beam after passage through a thickness of the material  $x$ , and  $\mu$  is the linear absorption coefficient.

**Absorption Coefficient, Mass**—The linear absorption coefficient per cm divided by the density of the absorber in grams per cubic centimeter. It is frequently expressed as  $\mu/\rho$ , where  $\mu$  is the linear absorption coefficient and  $\rho$  the absorber density.

**Absorption Ratio, Differential**—Ratio of concentration of a nuclide in a given organ or tissue to the concentration that would be obtained if the same administered quantity of this nuclide were uniformly distributed throughout the body.

**Activation**—The process of making a material radioactive by bombardment with neutrons or protons.

**Activity**—The number of radioactive nuclear transformations occurring in a material per unit time (see Curie, Becquerel). The term for activity per unit mass is specific activity.

**Activity Median Aerodynamic Diameter (AMAD)**—The diameter of a unit-density sphere with the same terminal settling velocity in air as that of the aerosol particle whose activity is the median for the entire size distribution of the aerosol.

**Acute Exposure, Chemical**—Exposure to a chemical for a duration of 14 days or less, as specified in the Toxicological Profiles.

## 10. GLOSSARY

**Acute Exposure, Radiation**—The absorption of a relatively large amount of radiation (or intake of a radioactive material) over a short period of time.

**Acute Radiation Syndrome**—The symptoms which taken together characterize a person suffering from the effects of intense radiation. The effects occur within hours or days.

**Ad libitum**—Available in excess and freely accessible.

**Adsorption Coefficient ( $K_{oc}$ )**—The ratio of the amount of a chemical adsorbed per unit surface area or per unit weight of organic carbon of a specific particle size in the soil or sediment to the concentration of the chemical in solution at equilibrium.

**Adsorption Ratio ( $K_d$ )**—See Distribution Coefficient

**Alpha Particle**—A positively charged particle ejected spontaneously from the nuclei of some radioactive elements. It is identical to a helium nucleus, i.e., 2 neutrons and two protons, with a mass number of 4 and an electrostatic charge of +2.

**Alpha Track**—The track of ionized atoms (pattern of ionization) left in a medium by an alpha particle that has traveled through the medium.

**Annihilation (Positron-Electron)**—An interaction between a positive and a negative electron in which they both disappear; their rest mass, being converted into electromagnetic radiation (called annihilation radiation) with two 0.51 MeV gamma photons emitted at an angle of 180° to each other.

**Annual Limit on Intake (ALI)**—The derived limit for the amount of radioactive material taken into the body of an adult worker by inhalation or ingestion in a year. It is the smaller value of intake of a given radionuclide in a year by the reference man that would result in a committed effective dose equivalent of 5 rem or a committed dose equivalent of 50 rem to any organ or tissue.

**Atom**—The smallest particle of an element that cannot be divided or broken up by chemical means. It consists of a central core called the *nucleus*, which contains *protons* and *neutrons* and an outer shell of *electrons*.

**Atomic Mass (u)**—The mass of a neutral atom of a nuclide, usually expressed in terms of "atomic mass units." The "atomic mass unit" is one-twelfth the mass of one neutral atom of carbon-12; equivalent to  $1.6604 \times 10^{-24}$  g.

**Atomic Mass Number**—See Mass Number.

**Atomic Number**—The number of protons in the nucleus of an atom. The "effective atomic number" is calculated from the composition and atomic numbers of a compound or mixture. An element of this atomic number would interact with photons in the same way as the compound or mixture. (Symbol: Z).

**Atomic Weight**—The weighted mean of the masses of the neutral isotopes of an element expressed in atomic mass units.

**Attenuation**—A process by which a beam from a source of radiation is reduced in intensity by absorption and scattering when passing through some material.

## 10. GLOSSARY

**Attenuation Coefficient**—The fractional reduction in the intensity of a beam of radiation as it passes through an absorbing medium. It may be expressed as reduction per unit distance, per unit mass thickness, or per atom, and is called the linear, mass, or atomic attenuation coefficient, respectively.

**Auger Effect**—The emission of an electron from the extranuclear portion of an excited atom when the atom undergoes a transition to a less excited state.

**Background Radiation**—The amount of radiation to which a member of the general population is exposed from natural sources, such as terrestrial radiation from naturally occurring radionuclides in the soil, cosmic radiation originating from outer space, and naturally occurring radionuclides deposited in the human body.

**Becquerel (Bq)**—International System of Units unit of activity and equals that quantity of radioactive material in which one transformation (disintegration) occurs per second (see Units).

**Terabecquerel (TBq)**—One trillion becquerel.

**Gigabecquerel (GBq)**—One billion becquerel.

**Megabecquerel (MBq)**—One million becquerel.

**Kilobecquerel (kBq)**—One thousand becquerel.

**Millibecquerel (mBq)**—One-thousandth of a becquerel.

**Microbecquerel ( $\mu$ Bq)**—One-millionth of a becquerel.

**Benchmark Dose (BMD)**—Usually defined as the lower confidence limit on the dose that produces a specified magnitude of changes in a specified adverse response. For example, a  $BMD_{10}$  would be the dose at the 95% lower confidence limit on a 10% response, and the benchmark response (BMR) would be 10%. The BMD is determined by modeling the dose response curve in the region of the dose response relationship where biologically observable data are feasible.

**Benchmark Dose Model**—A statistical dose-response model applied to either experimental toxicological or epidemiological data to calculate a BMD.

**Beta Particle**—An electron that is emitted from the nucleus of an atom during one type of radioactive transformation. A beta particle has a mass and charge equal in magnitude to that of the electron. The charge may be either +1 or -1. Beta particles with +1 charges are called positrons (symbolized  $\beta^+$ ), and beta particles with -1 charges are called negatrons (symbolized  $\beta^-$ ).

**Bioconcentration Factor (BCF)**—The quotient of the concentration of a chemical in aquatic organisms at a specific time or during a discrete time period of exposure divided by the concentration in the surrounding water at the same time or during the same period.

**Biologic Effectiveness of Radiation**—See Relative Biological Effectiveness.

**Biological Half-time**—The time required for a biological system, such as that of a human, to eliminate by natural process half of the amount of a substance (such as a chemical substance, either stable or radioactive) that has entered it.

**Biomagnification**—The progressive increase in the concentration of a bioaccumulated chemical in organisms as that chemical is passed from the bottom to the top of the food web.

**Biomarkers**—Broadly defined as indicators signaling events in biologic systems or samples. They have been classified as markers of exposure, markers of effect, and markers of susceptibility.

## 10. GLOSSARY

**Body Burden, Chemical**—The total amount of a chemical found in an animal or human body.

**Body Burden, Radioactivity**—The amount of radioactive material found in an animal or human body.

**Bone Seeker**—Any compound or ion which migrates in the body and preferentially deposits into bone.

**Branching**—The occurrence of two or more modes by which a radionuclide can undergo radioactive decay. For example,  $^{214}\text{Bi}$  can undergo alpha or beta minus decay,  $^{64}\text{Cu}$  can undergo beta minus, beta plus, or electron capture decay. An individual atom of a nuclide exhibiting branching disintegrates by one mode only. The fraction disintegrating by a particular mode is the "branching fraction" for that mode. The "branching ratio" is the ratio of two specified branching fractions (also called multiple disintegration).

**Bremsstrahlung**—X rays that are produced when a charged particle accelerates (speeds up, slows down, or changes direction) in the strong field of a nucleus.

**Buildup Factor**—The ratio of the radiation intensity, including both primary and scattered radiation, to the intensity of the primary (unscattered) radiation.

**Cancer Effect Level (CEL)**—The lowest dose of chemical or radiation in a study, or group of studies, that produces significant increases in the incidence of cancer (or tumors) between the exposed population and its appropriate control.

**Capture, Electron**—A mode of radioactive decay involving the capture of an orbital electron by its nucleus. Capture from a particular electron shell, e.g., K or L shells, is designated as "K-electron capture" or "L-electron capture."

**Capture, K-Electron**—Electron capture from the K shell by the nucleus of the atom. Also loosely used to designate any orbital electron capture process.

**Carcinogen**—A chemical or radiation that is capable of inducing cancer.

**Carcinoma**—Malignant neoplasm composed of epithelial cells, regardless of their derivation.

**Case-Control Study**—A type of epidemiological study which examines the relationship between a particular outcome (disease or condition) and a variety of potential causative agents (such as toxic chemicals). In a case-controlled study, a group of people with a specified and well-defined outcome is identified and compared to a similar group of people without outcome.

**Case Report**—Describes a single individual with a particular disease or exposure. These may suggest some potential topics for scientific research but are not actual research studies.

**Case Series**—Describes the experience of a small number of individuals with the same disease or exposure. These may suggest potential topics for scientific research, but are not actual research studies.

**Cataract**—A clouding of the crystalline lens of the eye which obstructs the passage of light.

**Ceiling Value**—A concentration of a substance that should not be exceeded, even temporarily.

**Charged Particle**—A nuclear particle, atom, or molecule carrying a positive or negative charge.

## 10. GLOSSARY

**Chronic Exposure**—A long-term, continuous exposure to a chemical or radioactive material. For example, exposure to a chemical for 365 days or more, as specified in the Toxicological Profiles.

**Cohort Study**—A type of epidemiological study of a specific group or groups of people who have had a common insult (e.g., exposure to an agent suspected of causing disease or a common disease) and are followed forward from exposure to outcome. At least one exposed group is compared to one unexposed group.

**Collective Dose**—The sum of the individual doses received in a given period of time by a specified population from exposure to a specified source of radiation. Collective dose is expressed in units such as man-rem and person-sievert.

**Compton Effect**—An attenuation process observed for x- or gamma radiation in which an incident photon interacts with an orbital electron of an atom to produce a recoil electron and a scattered photon whose energy is less than the incident photon.

**Containment**—The confinement of a chemical or radioactive substance in such a way that it is prevented from being dispersed from its container or into the environment, or is released only at a specified rate.

**Contamination**—Deposition of a stable or radioactive substance in any place where it is not desired.

**Cosmic Rays**—High-energy particulate and electromagnetic radiations that originate outside the earth's atmosphere and interact with the atmosphere to produce a shower of secondary cosmic rays.

**Count (Radiation Measurements)**—The external indication of a radiation-measuring device designed to enumerate ionizing events. It refers to a single detected event. The term "count rate" refers to the total number registered in a given period of time. The term is sometimes erroneously used to designate a disintegration, ionizing event, or voltage pulse.

**Counter, Gas-flow Proportional (GPC)**—An instrument for detecting beta particle radiation. Beta particles are detected by ionization of the counter gas which results in an electrical impulse at an anode wire.

**Counter, Geiger-Mueller (GM counter)**—Highly sensitive, gas-filled radiation-measuring device that detects (counts) individual photons or particulate radiation.

**Counter, Scintillation**—The combination of a crystal or phosphor, photomultiplier tube, and associated circuits for counting light emissions produced in the phosphors by ionizing radiation. Scintillation counters generally are more sensitive than GM counters for gamma radiation.

**Counting, Cerenkov**—Relatively energetic  $\beta$ -particles pass through a transparent medium of high refractive index and a highly-directional, bluish-white light ("Cerenkov" light) is emitted. This light is detected using liquid scintillation counting equipment.

**Cross-sectional Study**—A type of epidemiological study of a group or groups which examines the relationship between exposure and outcome to a chemical or to chemicals at one point in time.

**Curie (Ci)**—A unit of radioactivity. One curie equals that quantity of radioactive material in which there are  $3.7 \times 10^{10}$  nuclear transformations per second. The activity of 1 gram of radium is approximately 1 Ci.

**Attocurie (aCi)**—One-thousandth of a femtocurie ( $3.7 \times 10^{-8}$  disintegrations per second).

## 10. GLOSSARY

**Femtocurie (fCi)**—One-billionth of a microcurie ( $3.7 \times 10^{-5}$  disintegrations per second).

**Megacurie (MCi)**—One million curies ( $3.7 \times 10^{16}$  disintegrations per second).

**Microcurie ( $\mu$ Ci)**—One-millionth of a curie ( $3.7 \times 10^4$  disintegrations per second).

**Millicurie (mCi)**—One-thousandth of a curie ( $3.7 \times 10^7$  disintegrations per second).

**Nanocurie (nCi)**—One-billionth of a curie ( $3.7 \times 10^1$  disintegrations per second).

**Picocurie (pCi)**—One-millionth of a microcurie ( $3.7 \times 10^{-2}$  disintegrations per second).

**Data Needs**—Substance-specific informational needs that if met would reduce the uncertainties of human health assessment.

**Daughter Products**—See Progeny and Decay Product

**Decay Chain or Decay Series**—A sequence of radioactive decays (transformations) beginning with one nucleus. The initial nucleus, the parent, decays into a daughter or progeny nucleus that differs from the first by whatever particles were emitted during the decay. If further decays take place, the subsequent nuclei are also usually called daughters or progeny. Sometimes, to distinguish the sequence, the daughter of the first daughter is called the granddaughter, etc.

**Decay Constant ( $\lambda$ )**—The fraction of the number of atoms of a radioactive nuclide which decay in unit time (see Disintegration Constant).

**Decay Product, Daughter Product, Progeny**—A new nuclide formed as a result of radioactive decay. A nuclide resulting from the radioactive transformation of a radionuclide, formed either directly or as the result of successive transformations in a radioactive series. A decay product (daughter product or progeny) may be either radioactive or stable.

**Decay, Radioactive**—Transformation of the nucleus of an unstable nuclide by spontaneous emission of radiation, such as charged particles and/or photons (see Disintegration).

**Delta Ray**—An electron removed from an atom of a medium that is irradiated, or through which radiation passes, during the process of ionization (also called secondary electron). Delta rays cause a track of ionizations along their path.

**Derived Air Concentration (DAC)**—The concentration of radioactive material in air that, if breathed by the reference man for a working year of 2000 hours under conditions of light work (at a rate of 1.2 liters of air per hour), would result in an intake of one ALI (see Annual Limit on Intake).

**Deterministic Effect**—A health effect, the severity of which varies with the dose and for which a threshold is believed to exist (also called a non-stochastic effect).

**Developmental Toxicity**—The occurrence of adverse effects on the developing organism that may result from exposure to a chemical or radiation prior to conception (either parent), during prenatal development, or postnatally to the time of sexual maturation. Adverse developmental effects may be detected at any point in the life span of the organism.

**Disintegration Constant**—Synonymous with decay constant. The fraction of the number of atoms of a radioactive material that decays per unit time (see Decay Constant.)

**Disintegration, Nuclear**—A spontaneous nuclear transformation (radioactivity) characterized by the emission of energy and mass from the nucleus. When large numbers of nuclei are involved, the process is characterized by a definite half-life (see Transformation, Nuclear).

## 10. GLOSSARY

**Distribution Coefficient ( $K_d$ )**—Describes the distribution of a chemical between the solid and aqueous phase at thermodynamic equilibrium, is given as follows:

$$K_d = \frac{[C]_s}{[C]_w}, \text{ Units} = (\text{L solution})/(\text{kg solid}),$$

where  $[C]_s$  is the concentration of the chemical associated with the solid phase in units of (mg)/(kg solid), and  $[C]_w$  is the concentration of the chemical in the aqueous phase in units of (mg)/(L solution). As the magnitude of  $K_d$  decreases, the potential mobility of the chemical to groundwater systems increases and vice versa.

**Dose**—A general term denoting the quantity of a substance, radiation, or energy absorbed. For special purposes it must be appropriately qualified. If unqualified, it refers to radiation absorbed dose.

**Absorbed Dose**—The energy imparted to matter by ionizing radiation per unit mass of irradiated material at the place of interest. The unit of absorbed dose is the rad. One rad equals 100 ergs per gram. In SI units, the absorbed dose is the gray which is 1 J/kg (see Rad).

**Cumulative Dose (Radiation)**—The total dose resulting from repeated or continuous exposures to radiation.

**Dose Assessment**—An estimate of the radiation dose to an individual or a population group usually by means of predictive modeling techniques, sometimes supplemented by the results of measurement.

**Dose Equivalent (DE)**—A quantity used in radiation safety practice to account for the relative biological effectiveness of the several types of radiation. It expresses all radiations on a common scale for calculating the effective absorbed dose. The NRC defines it as the product of the absorbed dose, the quality factor, and all other modifying factors at the location of interest. ICRP has changed its definition to be the product of the absorbed dose and the radiation weighting factor. (The unit of dose equivalent is the rem. In SI units, the dose equivalent is the sievert, which equals 100 rem.)

**Dose, Fractionation**—A method of administering therapeutic radiation in which relatively small doses are given daily or at longer intervals.

**Dose, Protraction**—A method of administering therapeutic radiation by delivering it continuously over a relatively long period at a low dose rate.

**Dose, Radiation**—The amount of energy imparted to matter by ionizing radiation per unit mass of the matter, usually expressed as the unit rad, or in SI units, the gray. 100 rad = 1 gray (Gy) (see Absorbed Dose).

**Committed Dose Equivalent ( $H_{T,50}$ )**—The dose equivalent to organs or tissues of reference (T) that will be received from an intake of radioactive material by an individual during the 50 years following the intake.

**Committed Effective Dose Equivalent ( $H_{E,50}$ )**—The sum of the products of the weighting factors applicable to each of the body organs or tissues that are irradiated and the committed dose equivalent to those organs or tissues.

## 10. GLOSSARY

**Effective Dose**—A dose value that attempts to normalize the detriment to the body (for cancer mortality and morbidity, hereditary effects, and years of life lost) from a non-uniform exposure to that of a uniform whole body exposure. Effective dose is calculated as the sum of products of the equivalent dose and the tissue weighting factor ( $w_T$ ) for each tissue exposed. ( $E = \sum D_{T,R} w_R w_T$ ).

**Effective Dose Equivalent ( $H_E$ )**—This dose type is limited to internal exposures and is the sum of the products of the dose equivalent to the organ or tissue ( $H_T$ ) and the weighting factors ( $w_T$ ) applicable to each of the body organs or tissues that are irradiated. ( $H_E = \sum w_T H_T$ ).

**Equivalent Dose**—A dose quantity that places the biological effect of all radiation types on a common scale for calculating tissue damage. Alpha particles, for example, are considered to cause 20 times more damage than gamma rays. Equivalent dose is calculated as the sum of products of the average absorbed dose (in gray) in an organ or tissue ( $D_{T,R}$ ) from each type of radiation and the radiation weighting factor ( $w_R$ ) for that radiation ( $\sum D_{T,R} w_R$ ).

**External Dose**—That portion of the dose equivalent received from radiation sources outside the body.

**Internal Dose**—That portion of the dose equivalent received from radioactive material taken into the body.

**Limit**—A permissible upper bound on the radiation dose.

**Maximum Permissible Dose (MPD)**—The greatest dose equivalent that a person or specified part thereof shall be allowed to receive in a given period of time.

**Median Lethal Dose (MLD)**—Dose of radiation required to kill, within a specified period (usually 30 days), 50% of the individuals in a large group of animals or organisms. Also called the  $LD_{50}$ , or  $LD_{50/30}$  if for 30 days.

**Threshold Dose**—The minimum absorbed dose that will produce a detectable degree of any given effect.

**Tissue Dose**—Absorbed dose received by tissue in the region of interest, expressed in rad (see Dose, Gray, and Rad).

**Dose Rate**—The amount of radiation dose delivered per unit time. Generically, the rate at which radiation dose is delivered to any material or tissue.

**Dose-Response Relationship**—The quantitative relationship between the amount of exposure to a toxicant and the incidence of the adverse effects.

**Dosimetry**—Quantification of radiation doses to cells, tissues, organs, individuals or populations resulting from radiation exposures.

**Early Effects (of radiation exposure)**—Effects that appear within 60 days of an acute exposure.

**Electron**—A stable elementary particle having an electric charge equal to  $\pm 1.60210 \times 10^{-19}$  C (Coulombs) and a rest mass equal to  $9.1091 \times 10^{-31}$  kg. A positron is a positively charged "electron" (see Positron).



## 10. GLOSSARY

**Electron Volt**—A unit of energy equivalent to the energy gained by an electron in passing through a potential difference of one volt. Larger multiple units of the electron volt are frequently used: keV for thousand or kilo electron volts; MeV for million or mega electron volts (eV).  $1 \text{ eV} = 1.6 \times 10^{-12} \text{ erg}$ .

**Embryotoxicity and Fetotoxicity**—Any toxic effect on the conceptus as a result of prenatal exposure to a chemical; the distinguishing feature between the two terms is the stage of development during which the insult occurred. The terms, as used here, include malformations and variations, altered growth, and *in utero* death.

**Energy**—Capacity for doing work. Gravitationally, "potential energy" is the energy inherent in a mass because of its spatial relation to other masses. Chemically or radiologically, "potential energy" is the energy released when a chemical reaction or radiological transformation goes to completion. "Kinetic energy" is the energy possessed by a mass because of its motion (SI unit: joules):

**Binding Energy (Electron)**—The amount of energy that must be expended to remove an electron from an atom.

**Binding Energy (Nuclear)**—The energy represented by the difference in mass between the sum of the component parts and the actual mass of the nucleus. It represents the amount of energy that must be expended to break a nucleus into its component neutrons and protons.

**Excitation Energy**—The energy required to change a system from its ground state to an excited state. Each different excited state has a different excitation energy.

**Ionizing Energy**—The energy required to knock an electron out of an atom. The average energy lost by electrons or beta particles in producing an ion pair in air or in soft tissue is about 34 eV.

**Radiant Energy**—The energy of electromagnetic radiation, such as radio waves, visible light, x and gamma rays.

**Enrichment, Isotopic**—An isotopic separation process by which the relative abundances of the isotopes of a given element are altered, thus producing a form of the element that has been enriched in one or more isotopes and depleted in others. In uranium enrichment, the percentage of uranium-235 in natural uranium can be increased from 0.7% to >90% in a gaseous diffusion process based on the different thermal velocities of the constituents of natural uranium ( $^{234}\text{U}$ ,  $^{235}\text{U}$ ,  $^{238}\text{U}$ ) in the molecular form  $\text{UF}_6$ .

**EPA Health Advisory**—An estimate of acceptable drinking water levels for a chemical substance based on health effects information. A health advisory is not a legally enforceable federal standard, but serves as technical guidance to assist federal, state, and local officials.

**Epidemiology**—Refers to the investigation of factors that determine the frequency and distribution of disease or other health-related conditions within a defined human population during a specified period.

**Equilibrium, Radioactive**—In a radioactive series, the state which prevails when the ratios between the activities of two or more successive members of the series remains constant.

**Secular Equilibrium**—If a parent element has a very much longer half-life than the daughters (so there is not appreciable change in its amount in the time interval required for later products to attain equilibrium) then, after equilibrium is reached, equal numbers of atoms of all members of the series disintegrate in unit time. This condition is never exactly attained, but is essentially established in such a case as  $^{226}\text{Ra}$  and its transformation series to stable  $^{206}\text{Pb}$ . The half-life of

## 10. GLOSSARY

$^{226}\text{Ra}$  is about 1,600 years; of  $^{222}\text{Rn}$ , approximately 3.82 days, and of each of the subsequent members, a few minutes. After about a month, essentially the equilibrium amount of radon is present; then (and for a long time) all members of the series disintegrate the same number of atoms per unit time. At this time, the activity of the daughter is equal to the activity of the parent.

**Transient Equilibrium**—If the half-life of the parent is short enough so the quantity present decreases appreciably during the period under consideration, but is still longer than that of successive members of the series, a stage of equilibrium will be reached after which all members of the series decrease in activity exponentially with the period of the parent. At this time, the ratio of the parent activity to the daughter activity is constant.

**Equilibrium, Electron**—The condition in a radiation field where the energy of the electrons entering a volume equals the energy of the electrons leaving that volume.

**Excitation**—The addition of energy to a system, thereby transferring it from its ground state to an excited state. Excitation of a nucleus, an atom, or a molecule can result from absorption of photons or from inelastic collisions with other particles. The excited state of an atom is an unstable or metastable state and will return to ground state by radiation of the excess energy.

**Exposure (Chemical)**—Contact of an organism with a chemical or physical agent. Exposure is quantified as the amount of the agent available at the exchange boundaries of the organism (e.g., skin, lungs, gut) and available for absorption.

**Exposure (Radiation)**—Subjection to ionizing radiation or to a radioactive material. For example, exposure in air is a measure of the ionization produced in air by x or gamma radiation; the sum of the electric charges on all ions of one sign produced in air when all electrons liberated by photons in a volume of air are completely stopped in air ( $dQ$ ), divided by the mass of the air in the volume ( $dm$ ). The unit of exposure in air is the roentgen, or coulomb per kilogram (SI units). One roentgen is equal to  $2.58 \times 10^{-4}$  coulomb per kilogram (C/kg).

**Ex Vivo**—Outside of the living body.

**Fission, Nuclear**—A nuclear transformation characterized by the splitting of a nucleus into at least two other nuclei with emission of several neutrons, accompanied by the release of a relatively large amount of energy.

**Gamma Ray, Penetrating**—Short wavelength electromagnetic radiation of nuclear origin.

**Genotoxicity**—Effects of chemical and physical agents on the hereditary material (DNA) and on the genetic processes of living cells.

**Gray (Gy)**—SI unit of absorbed dose, 1 J/kg. One gray equals 100 rad (see Units).

**Half-life, Effective**—See Half-Time, Effective.

**Half-life, Radioactive**—Time required for a radioactive substance to lose 50% of its activity by decay. Each radio-nuclide has a unique physical half-life. Known also as physical half-time and symbolized as  $T_r$  or  $T_{\text{rad}}$ .

## 10. GLOSSARY

**Half-time, Biological**—Time required for an organ, tissue, or the whole body to eliminate one-half of any absorbed substance by regular processes of elimination. This is the same for both stable and radioactive isotopes of a particular element, and is sometimes referred to as half-time, symbolized as  $t_{\text{biol}}$  or  $T_b$ .

**Half-time, Effective**—Time required for a radioactive element in an organ, tissue, or the whole body to be diminished 50% as a result of the combined action of radioactive decay and biological elimination, symbolized as  $T_e$  or  $T_{\text{eff}}$ .

$$\text{Effective half-time} = \frac{\text{Biological half-time} \times \text{Radioactive half-life}}{\text{Biological half-time} + \text{Radioactive half-life}}$$

**Immediately Dangerous to Life or Health (IDLH)**—The maximum environmental concentration of a contaminant from which one could escape within 30 minutes without any escape-impairing symptoms or irreversible health effects.

**Immunologic Toxicity**—The occurrence of adverse effects on the immune system that may result from exposure to environmental agents such as chemicals.

**Immunological Effects**—Functional changes in the immune response.

**Incidence**—The ratio of individuals in a population who develop a specified condition to the total number of individuals in that population who could have developed that condition in a specified time period.

**Intensity**—Amount of energy per unit time passing through a unit area perpendicular to the line of propagation at the point in question.

**Intermediate Exposure**—Exposure to a chemical for a duration of 15–364 days, as specified in the Toxicological Profiles.

**Internal Conversion**—Process in which a gamma ray knocks an electron out of the same atom from which the gamma ray was emitted. The ratio of the number of internal conversion electrons to the number of gamma quanta emitted in the de-excitation of the nucleus is called the "conversion ratio."

**In Vitro**—Isolated from the living organism and artificially maintained, as in a test tube. Literally, "in glass."

**In Vivo**—Occurring within the living organism. Literally, "in life."

**Ion**—Atomic particle, atom or chemical radical bearing a net electrical charge, either negative or positive.

**Ion Pair**—Two particles of opposite charge, usually referring to the electron and positive atomic or molecular residue resulting after the interaction of ionizing radiation with the orbital electrons of atoms.

**Ionization**—The process by which a neutral atom or molecule acquires a positive or negative charge.

**Primary Ionization**—(1) In collision theory: the ionization produced by the primary particles as contrasted to the "total ionization" which includes the "secondary ionization" produced by delta rays. (2) In counter tubes: the total ionization produced by incident radiation without gas amplification.

## 10. GLOSSARY

**Specific Ionization**—Number of ion pairs per unit length of path of ionizing radiation in a medium; e.g., per centimeter of air or per micrometer of tissue.

**Total Ionization**—The total electric charge of one sign on the ions produced by radiation in the process of losing its kinetic energy. For a given gas, the total ionization is closely proportional to the initial ionization and is nearly independent of the nature of the ionizing radiation. It is frequently used as a measure of absorption of radiation energy.

**Ionization Density**—Number of ion pairs per unit volume.

**Ionization Path (Track)**—The trail of ion pairs produced by an ionizing particle in its passage through matter.

**Ionizing Radiation**—Any radiation capable of knocking electrons out of atoms and producing ions. Examples: alpha, beta, gamma and x rays, and neutrons.

**Isobars**—Nuclides having the same mass number but different atomic numbers.

**Isomers**—Nuclides having the same number of neutrons and protons but capable of existing, for a measurable time, in different quantum states with different energies and radioactive properties. Commonly the isomer of higher energy decays to one with lower energy by the process of isomeric transition.

**Isotopes**—Nuclides having the same number of protons in their nuclei, and hence the same atomic number, but differing in the number of neutrons, and therefore in the mass number. Identical chemical properties exist in isotopes of a particular element. The term should not be used as a synonym for nuclide because isotopes refer specifically to different nuclei of the same element.

**Stable Isotope**—A nonradioactive isotope of an element.

**Joule**—The S.I. unit for work and energy. It is equal to the work done by raising a mass of one newton through a distance of one meter ( $J = Nm$ ), which corresponds to about 0.7 ft-pound.

**Kerma (k)**—A measure of the kinetic energy transferred from gamma rays or neutrons to a unit mass of absorbing medium in the initial collision between the radiation and the absorber atoms. The SI unit is J/kg. The special name of this unit is the rad (traditional system of units) or Gray (SI).

**Labeled Compound**—A compound containing one or more radioactive atoms intentionally added to its structure. By observations of radioactivity or isotopic composition, this compound or its fragments may be followed through physical, chemical, or biological processes.

**Late Effects (of radiation exposure)**—Effects which appear 60 days or more following an acute exposure.

**LD<sub>50/30</sub>**—The dose of a chemical or radiation expected to cause 50% mortality in those exposed within 30 days. For radiation, this is about 350 rad (3.5 gray) received by humans over a short period of time.

**Lethal Concentration<sub>(L<sub>0</sub>)</sub> (LC<sub>L<sub>0</sub></sub>)**—The lowest concentration of a chemical in air that has been reported to have caused death in humans or animals.

## 10. GLOSSARY

**Lethal Concentration<sub>(50)</sub> (LC<sub>50</sub>)**—A calculated concentration of a chemical in air to which exposure for a specific length of time is expected to cause death in 50% of a defined experimental animal population within a specified time, usually 30 days.

**Lethal Dose<sub>(Lo)</sub> (LD<sub>Lo</sub>)**—The lowest dose of a chemical introduced by a route other than inhalation that is expected to have caused death in humans or animals within a specified time, usually 30 days.

**Lethal Dose<sub>(50)</sub> (LD<sub>50</sub>)**—The dose of a chemical which has been calculated to cause death in 50% of a defined experimental animal population.

**Lethal Time<sub>(50)</sub> (LT<sub>50</sub>)**—A calculated period of time within which a specific concentration of a chemical is expected to cause death in 50% of a defined experimental animal population.

**Linear Energy Transfer (LET)**—A measure of the energy that a charged particle transfers to a material per unit path length.

**Average LET**—The energy of a charged particle divided by the length of the path over which it deposits all its energy in a material. This is averaged over a number of particles.

**High-LET**—Energy transfer characteristic of heavy charged particles such as protons and alpha particles where the distance between ionizing events is small on the scale of a cellular nucleus.

**Low-LET**—Energy transfer characteristic of light charged particles such as electrons produced by x and gamma rays where the distance between ionizing events is large on the scale of a cellular nucleus.

**Lowest-Observed-Adverse-Effect Level (LOAEL)**—The lowest dose of chemical in a study, or group of studies, that produces statistically or biologically significant increases in frequency or severity of adverse effects between the exposed population and its appropriate control.

**Lung Clearance Class (fast, F; medium, M; slow, S)**—A classification scheme for inhaled material according to its rate of clearance from the pulmonary region of the lungs to the blood and the gastrointestinal tract.

**Lymphoreticular Effects**—Represent morphological effects involving lymphatic tissues such as the lymph nodes, spleen, and thymus.

**Malformations**—Permanent structural changes that may adversely affect survival, development, or function.

**Mass Numbers (A)**—The number of nucleons (protons and neutrons) in the nucleus of an atom.

**Minimal Risk Level**—An estimate of daily human exposure to a substance that is likely to be without an appreciable risk of adverse noncancerous effects over a specified duration of exposure.

**Modifying Factor (MF)**—A value (greater than zero) that is applied to the derivation of a Minimal Risk Level (MRL) to reflect additional concerns about the database that are not covered by the uncertainty factors. The default value for a MF is 1.

**Morbidity**—State of being diseased; morbidity rate is the incidence or prevalence of disease in a specific population.

## 10. GLOSSARY

**Mortality**—Death; mortality rate is a measure of the number of deaths in a population during a specified interval of time.

**Mutagen**—A substance that causes changes (mutations) in the genetic material in a cell. Mutations can lead to birth defects, miscarriages, or cancer.

**Necropsy**—The gross examination of the organs and tissues of a dead body to determine the cause of death or pathological conditions.

**Neonates**—Newborn infants.

**Neurotoxicity**—The occurrence of adverse effects on the nervous system following exposure to a substance.

**Neutrino ( $\nu$ )**—A neutral particle of infinitesimally small rest mass emitted during beta plus or beta minus decay. This particle accounts for conservation of energy in beta plus and beta minus decays. It plays no role in damage from radiation.

**No-Observed-Adverse-Effect Level (NOAEL)**—The dose of a substance at which there were no statistically or biologically significant increases in frequency or severity of adverse effects seen between the exposed population and its appropriate control. Effects may be produced at this dose, but they are not considered to be adverse.

**Nuclear Reactor**—A power plant that heats the medium (typically water) by using the energy released from the nuclear fission of uranium or plutonium isotopes instead of burning coal, oil, or natural gas. All of these sources of energy simply heat water and use the steam which is produced to turn turbines that make electricity or propel a ship.

**Nucleon**—Common name for a constituent particle of the nucleus. Applied to a proton or neutron.

**Nuclide**—A species of atom characterized by the constitution of its nucleus. The nuclear constitution is specified by the number of protons ( $Z$ ), number of neutrons ( $N$ ), and energy content; or, alternatively, by the atomic number ( $Z$ ), mass number  $A(N+Z)$ , and atomic mass. To be regarded as a distinct nuclide, the atom must be capable of existing for a measurable time. Thus, nuclear isomers are separate nuclides, whereas promptly decaying excited nuclear states and unstable intermediates in nuclear reactions are not so considered.

**Octanol-Water Partition Coefficient ( $K_{ow}$ )**—The equilibrium ratio of the concentrations of a chemical in *n*-octanol and water, in dilute solution.

**Odds Ratio (OR)**—A means of measuring the association between an exposure (such as toxic substances and a disease or condition) which represents the best estimate of relative risk (risk as a ratio of the incidence among subjects exposed to a particular risk factor divided by the incidence among subjects who were not exposed to the risk factor). An odds ratio of greater than 1 is considered to indicate greater risk of disease in the exposed group compared to the unexposed.

**Organophosphate or Organophosphorus Compound**—A phosphorus-containing organic compound and especially a pesticide that acts by inhibiting cholinesterase.

## 10. GLOSSARY

**Pair Production**—An absorption process for x- and gamma radiation in which the incident photon is absorbed in the vicinity of the nucleus of the absorbing atom, with subsequent production of an electron and positron pair (see annihilation). This reaction can only occur for incident photon energies exceeding 1.02 MeV.

**Parent**—Any radionuclide nuclide which, upon disintegration, yields a new nuclide (termed the progeny or daughter), either directly or as a later member of a radioactive series.

**Permissible Exposure Limit (PEL)**—A maximum allowable atmospheric level of a substance in workplace air averaged over an 8-hour shift.

**Pesticide**—General classification of chemicals specifically developed and produced for use in the control of agricultural and public health pests.

**Pharmacokinetic Model**—A set of equations that can be used to describe the time course of a parent chemical or metabolite in an animal system. There are two types of pharmacokinetic models: data-based and physiologically-based. A data-based model divides the animal system into a series of compartments which, in general, do not represent real, identifiable anatomic regions of the body whereas the physiologically-based model compartments represent real anatomic regions of the body.

**Pharmacokinetics**—The dynamic behavior of a material in the body, used to predict the fate (disposition) of an exogenous substance in an organism. Utilizing computational techniques, it provides the means of studying the absorption, distribution, metabolism and excretion of chemicals by the body.

**Physiologically Based Pharmacodynamic (PBPD) Model**—A type of physiologically-based dose-response model which quantitatively describes the relationship between target tissue dose and toxic end points. These models advance the importance of physiologically based models in that they clearly describe the biological effect (response) produced by the system following exposure to an exogenous substance.

**Physiologically Based Pharmacokinetic (PBPK) Model**—A model comprising a series of compartments representing organs or tissue groups with realistic weights and blood flows. These models require a variety of physiological information: tissue volumes, blood flow rates to tissues, cardiac output, alveolar ventilation rates and, possibly membrane permeabilities. The models also utilize biochemical information such as air/blood partition coefficients, and metabolic parameters. PBPK models are also called biologically based tissue dosimetry models.

**Photoelectric Effect**—An attenuation process observed for x and gamma radiation in which an incident photon interacts with a tightly bound inner orbital electron of an atom delivering all of its energy to knock the electron out of the atom. The incident photon disappears in the process.

**Photon**—A quantum of electromagnetic energy (E) whose value is the product of its frequency ( $\nu$ ) in hertz and Planck's constant (h). The equation is:  $E = h\nu$ .

**Population dose**—See Collective dose.

**Positron**—A positively charged electron.

**Potential, Ionization**—The energy expressed as electron volts (eV) necessary to separate one electron from an atom, resulting in the formation of an ion pair.

## 10. GLOSSARY

**Power, Stopping**—A measure of the ability of a material to absorb energy from an ionizing particle passing through it; the greater the stopping power, the greater the energy absorbing ability (see Linear Energy Transfer).

**Prevalence**—The number of cases of a disease or condition in a population at one point in time.

**Progeny**—The decay product or daughter products resulting after a radioactive decay or a series of radioactive decays. The progeny can also be radioactive, and the chain continues until a stable nuclide is formed.

**Prospective Study**—A type of cohort study in which the pertinent observations are made on events occurring after the start of the study. A group is followed over time.

**Proton**—Elementary nuclear particle with a positive electric charge equal numerically to the charge of the electron and a rest mass of 1.007 mass units.

**$q_1^*$** —The upper-bound estimate of the low-dose slope of the dose-response curve as determined by the multistage procedure. The  $q_1^*$  can be used to calculate an estimate of carcinogenic potency, the incremental excess cancer risk per unit of exposure (usually  $\mu\text{g/L}$  for water,  $\text{mg/kg/day}$  for food, and  $\mu\text{g/m}^3$  for air).

**Quality**—A term describing the distribution of the energy deposited by a particle along its track; radiations that produce different densities of ionization per unit intensity are said to have different "qualities."

**Quality Factor (Q)**—The linear-energy-transfer-dependent factor by which absorbed doses are multiplied to obtain (for radiation protection purposes) a quantity that expresses - on a common scale for all ionizing radiation - the approximate biological effectiveness of the absorbed dose.

Type of radiation	Quality Factor
X, gamma, or beta	1
Alpha particles	20
Neutrons of unknown energy	10
High energy protons	10

**Rad**—The traditional unit of absorbed dose equal to 100 ergs per gram, or 0.01 joule per kilogram (0.01 Gy) in any medium (see Absorbed Dose).

**Radiation**—The emission and propagation of energy through space or through a material medium in the form of waves (e.g., the emission and propagation of electromagnetic waves, or of sound and elastic waves). The term radiation or radiant energy, when unqualified, usually refers to electromagnetic radiation. Such radiation commonly is classified according to frequency, as microwaves, infrared, visible (light), ultraviolet, and x and gamma rays (see Photon.) and, by extension, corpuscular emission, such as alpha and beta radiation, neutrons, or rays of mixed or unknown type, as cosmic radiation.

**Radiation, Annihilation**—Photons produced when an electron and a positron unite and cease to exist. The annihilation of a positron-electron pair results in the production of two photons, each of 0.51 MeV energy.

**Radiation, Background**—See Background Radiation.



## 10. GLOSSARY

**Radiation, Characteristic (Discrete)**—Radiation originating from an excited atom after removal of an electron from an atom. The wavelength of the emitted radiation is specific, depending only on the element and particular energy levels involved.

**Radiation, External**—Radiation from a source outside the body.

**Radiation, Internal**—Radiation from a source within the body (as a result of deposition of radionuclides in body tissues).

**Radiation, Ionizing**—Any electromagnetic or particulate radiation capable of producing ions, directly or indirectly, in its passage through matter (see Radiation).

**Radiation, Monoenergetic**—Radiation of a given type in which all particles or photons originate with and have the same energy.

**Radiation, Scattered**—Radiation which during its passage through a substance, has been deviated in direction. It may also have been modified by a decrease in energy.

**Radiation, Secondary**—A particle or ray that is produced when the primary radiation interacts with a material, and which has sufficient energy to produce its own ionization, such as bremsstrahlung or electrons knocked from atomic orbitals with enough energy to then produce ionization (see Delta Rays).

**Radiation Weighting Factor (also called Quality Factor)**—In radiation protection, a factor (1 for x-rays, gamma rays, beta particles; 20 for alpha particles) weighting the absorbed dose of radiation of a specific type and energy for its effect on tissue.

**Radioactive Material**—Material containing radioactive atoms.

**Radioactivity**—Spontaneous nuclear transformations that result in the formation of new elements. These transformations are accomplished by emission of alpha or beta particles from the nucleus or by the capture of an orbital electron. Each of these reactions may or may not be accompanied by a gamma photon.

**Radioactivity, Artificial**—Man-made radioactivity produced by particle bombardment or nuclear fission, as opposed to naturally occurring radioactivity.

**Radioactivity, Induced**—Radioactivity produced in a substance after bombardment with neutrons or other particles. The resulting activity is "natural radioactivity" if formed by nuclear reactions occurring in nature and "artificial radioactivity" if the reactions are caused by man.

**Radioactivity, Natural**—The property of radioactivity exhibited by more than 50 naturally occurring radionuclides.

**Radioisotope**—An unstable or radioactive isotope of an element that decays or disintegrates spontaneously, emitting radiation.

**Radionuclide**—Any radioactive isotope of any element. Approximately 5,000 natural and artificial radioisotopes have been identified.

## 10. GLOSSARY

**Radiosensitivity**—Relative susceptibility of cells, tissues, organs, organisms, or any living substance to the injurious action of radiation. Radiosensitivity and its antonym, radioresistance, are used comparatively, rather than absolutely.

**Recommended Exposure Limit (REL)**—A National Institute for Occupational Safety and Health (NIOSH) time-weighted average (TWA) concentration for up to a 10-hour workday during a 40-hour workweek.

**Reference Concentration (RfC)**—An estimate (with uncertainty spanning perhaps an order of magnitude) of a continuous inhalation exposure to the human population (including sensitive subgroups) that is likely to be without an appreciable risk of deleterious noncancer health effects during a lifetime. It can be derived from a NOAEL, LOAEL, or benchmark concentration, with uncertainty factors generally applied to reflect limitations of the data used. The inhalation reference concentration is for continuous inhalation exposures and is appropriately expressed in units of mg/m<sup>3</sup> or ppm.

**Reference Dose (RfD)**—An estimate (with uncertainty spanning perhaps an order of magnitude) of a daily oral exposure to the human population (including sensitive subgroups) that is likely to be without an appreciable risk of deleterious effects during a lifetime. It can be derived from a NOAEL, LOAEL, or benchmark dose, with uncertainty factors generally applied to reflect limitations of the data used.

**Relative Biological Effectiveness (RBE)**—The RBE is a factor used to compare the biological effectiveness of absorbed radiation doses (i.e., rad) due to different types of ionizing radiation. More specifically, it is the experimentally determined ratio of an absorbed dose of a radiation in question to the absorbed dose of a reference radiation (typically <sup>60</sup>Co gamma rays or 200 kVp x rays) required to produce an identical biological effect in a particular experimental organism or tissue (see Quality Factor).

**Rem**—The traditional unit of dose equivalent that is used in the regulatory, administrative, and engineering design aspects of radiation safety practice. The dose equivalent in rem is numerically equal to the absorbed dose in rad multiplied by the quality factor (1 rem is equal to 0.01 sievert).

**Reportable Quantity (RQ)**—The quantity of a hazardous substance that is considered reportable under CERCLA. Reportable quantities are (1) 1 pound or greater or (2) for selected substances, an amount established by regulation either under CERCLA or under Sect. 311 of the Clean Water Act. Quantities are measured over a 24-hour period.

**Reproductive Toxicity**—The occurrence of adverse effects on the reproductive system that may result from exposure to a chemical. The toxicity may be directed to the reproductive organs and/or the related endocrine system. The manifestation of such toxicity may be noted as alterations in sexual behavior, fertility, pregnancy outcomes, or modifications in other functions that are dependent on the integrity of this system.

**Roentgen (R)**—A unit of exposure (in air) to ionizing radiation. It is the amount of x or gamma rays required to produce ions carrying 1 electrostatic unit of electrical charge in 1 cubic centimeter of dry air under standard conditions. Named after William Roentgen, a German scientist who discovered x rays in 1895.

**Retrospective Study**—A type of cohort study based on a group of persons known to have been exposed at some time in the past. Data are collected from routinely recorded events, up to the time the study is undertaken. Retrospective studies are limited to causal factors that can be ascertained from existing records and/or examining survivors of the cohort.

**Risk**—The possibility or chance that some adverse effect will result from a given exposure to a chemical.

## 10. GLOSSARY

**Risk Factor**—An aspect of personal behavior or lifestyle, an environmental exposure, or an inborn or inherited characteristic that is associated with an increased occurrence of disease or other health-related event or condition.

**Risk Ratio**—The ratio of the risk among persons with specific risk factors compared to the risk among persons without risk factors. A risk ratio greater than 1 indicates greater risk of disease in the exposed group compared to the unexposed group.

**Self-Absorption**—Absorption of radiation (emitted by radioactive atoms) by the material in which the atoms are located; in particular, the absorption of radiation within a sample being assayed.

**Short-Term Exposure Limit (STEL)**—The maximum concentration to which workers can be exposed for up to 15 minutes continually. No more than four excursions are allowed per day, and there must be at least 60 minutes between exposure periods. The daily TLV-TWA may not be exceeded.

**SI Units**—The International System of Units as defined by the General Conference of Weights and Measures in 1960. These units are generally based on the meter/kilogram/second units, with special quantities for radiation including the becquerel, gray, and sievert.

**Sickness, Acute Radiation (Syndrome)**—The complex symptoms and signs characterizing the condition resulting from excessive exposure of the whole body (or large part) to ionizing radiation. The earliest of these symptoms are nausea, fatigue, vomiting, and diarrhea, and may be followed by loss of hair (epilation), hemorrhage, inflammation of the mouth and throat, and general loss of energy. In severe cases, where the radiation dose is relatively high (over several hundred rad or several gray), death may occur within two to four weeks. Those who survive six weeks after exposure of a single high dose of radiation may generally be expected to recover.

**Sievert (Sv)**—The SI unit of any of the quantities expressed as dose equivalent. The dose equivalent in sieverts is equal to the absorbed dose, in gray, multiplied by the quality factor (1 sievert equals 100 rem). The sievert is also the SI unit for effective dose equivalent, which is the sum of the products of the dose equivalent to each organ or tissue and its corresponding tissue weighting factor.

**Specific-Activity**—Radioactivity per unit mass of a radionuclide, expressed, for example, as Ci/gram or Bq/kilogram.

**Specific Energy**—The actual energy per unit mass deposited per unit volume in a small target, such as the cell or cell nucleus, as the result of one or more energy-depositing events. This is a stochastic quantity as opposed to the average value over a large number of instance (i.e., the absorbed dose).

**Standardized Mortality Ratio (SMR)**—A ratio of the observed number of deaths and the expected number of deaths in a specific standard population.

**Stochastic Effect**—A health effect that occurs randomly and for which the probability of the effect occurring, rather than its severity, is assumed to be a linear function of dose without a threshold (also called a nondeterministic effect).

**Stopping Power**—The average rate of energy loss of a charged particle per unit thickness of a material or per unit mass of material traversed.

## 10. GLOSSARY

**Surface-seeking Radionuclide**—A bone-seeking internal emitter that deposits and remains on the bone surface for a long period of time, although it may eventually diffuse into the bone mineral. This contrasts with a volume seeker, which deposits more uniformly throughout the bone volume.

**Target Organ Toxicity**—This term covers a broad range of adverse effects on target organs or physiological systems (e.g., renal, cardiovascular) extending from those arising through a single limited exposure to those assumed over a lifetime of exposure to a chemical.

**Target Theory (Hit Theory)**—A theory explaining some biological effects of radiation on the basis that ionization, occurring in a discrete volume (the target) within the cell, directly causes a lesion which subsequently results in a physiological response to the damage at that location. One, two, or more "hits" (ionizing events within the target) may be necessary to elicit the response.

**Teratogen**—A chemical that causes birth defects.

**Threshold Limit Value (TLV)**—The maximum concentration of a substance to which most workers can be exposed without adverse effect. TLV is a term used exclusively by the ACGIH. Other terms used to express similar concepts are the MAC (Maximum Allowable Concentration) and PEL (Permissible Exposure Limits).

**Time-Weighted Average (TWA)**—An allowable exposure concentration averaged over a normal 8-hour workday or 40-hour workweek.

**Tissue Weighting Factor ( $W_t$ )**—Organ- or tissue-specific factor by which the equivalent dose is multiplied to give the portion of the effective dose for that organ or tissue. Recommended values of tissue weighting factors are:

Tissue/Organ	Tissue Weighting Factor
Gonads	0.70
Bone marrow (red)	0.12
Colon	0.12
Lung	0.12
Stomach	0.12
Bladder	0.05
Breast	0.05
Liver	0.05
Esophagus	0.05
Thyroid	0.05
Skin	0.01
Bone surface	0.01
Remainder (adrenals, brain, upper large intestine, small intestine, pancreas, spleen, thymus, and uterus)	0.05

**Toxic Dose ( $TD_{50}$ )**—A calculated dose of a chemical, introduced by a route other than inhalation, which is expected to cause a specific toxic effect in 50% of a defined experimental animal population.

**Toxicokinetic**—The absorption, distribution and elimination of toxic compounds in the living organism.

**Toxicosis**—A diseased condition resulting from poisoning.

## 10. GLOSSARY

**Transformation, Nuclear**—The process of radioactive decay by which a nuclide is transformed into a different nuclide by absorbing or emitting particulate or electromagnetic radiation.

**Transition, Isomeric**—The process by which a nuclide decays to an isomeric nuclide (i.e., one of the same mass number and atomic number) of lower quantum energy. Isomeric transitions (often abbreviated I.T.) proceed by gamma ray and internal conversion electron emission.

**Tritium**—The hydrogen isotope with one proton and two neutrons in the nucleus (Symbol:  $^3\text{H}$ ). It is radioactive and has a physical half-life of 12.3 years.

**Unattached Fraction**—That fraction of the radon daughters, usually  $^{218}\text{Po}$  and  $^{214}\text{Po}$ , which has not yet attached to a dust particle or to water vapor. As a free atom, it has a high probability of being exhaled and not retained within the lung. It is the attached fraction which is primarily retained.

**Uncertainty Factor (UF)**—A factor used in operationally deriving the RfD from experimental data. UFs are intended to account for (1) the variation in sensitivity among the members of the human population, (2) the uncertainty in extrapolating animal data to the case of human, (3) the uncertainty in extrapolating from data obtained in a study that is of less than lifetime exposure, and (4) the uncertainty in using LOAEL data rather than NOAEL data. Usually each of these factors is set equal to 10.

**Units, Prefixes**—Many units of measure are expressed as submultiples or multiples of the primary unit (e.g.,  $10^{-3}$  curie is 1 mCi and  $10^3$  becquerel is 1 kBq).

Factor	Prefix	Symbol	Factor	Prefix	Symbol
$10^{-18}$	atto	A	$10^3$	kilo	k
$10^{-15}$	femto	F	$10^6$	mega	M
$10^{-12}$	pico	p	$10^9$	giga	G
$10^{-9}$	nano	N	$10^{12}$	tera	T
$10^{-6}$	micro	M	$10^{15}$	peta	P
$10^{-3}$	milli	M	$10^{18}$	exa	E
$10^{-2}$	centi	C			

**Units, Radiological**—

Units	Equivalents
Becquerel* (Bq)	1 disintegration per second = $2.7 \times 10^{-11}$ Ci
Curie (Ci)	$3.7 \times 10^{10}$ disintegrations per second = $3.7 \times 10^{10}$ Bq
Gray* (Gy)	1 J/kg = 100 rad
Rad (rad)	100 erg/g = 0.01 Gy
Rem (rem)	0.01 sievert
Sievert* (Sv)	100 rem

\*International Units, designated (SI)

**Working Level (WL)**—Any combination of short-lived radon daughters in 1 liter of air that will result in the ultimate emission of  $1.3 \times 10^5$  MeV of potential alpha energy.

## 10. GLOSSARY

**Working Level Month (WLM)**—A unit of exposure to radon daughters corresponding to the product of the radon daughter concentration in Working Level (WL) and the exposure time in nominal months (1 nominal month = 170 hours). Inhalation of air with a concentration of 1 WL of radon daughters for 170 working hours results in an exposure of 1 WLM.

**Xenobiotic**—Any chemical that is foreign to the biological system.

**X rays**—Penetrating electromagnetic radiations whose wave lengths are very much shorter than those of visible light. They are usually produced by bombarding a metallic target with fast electrons in a high vacuum. X rays (called characteristic x rays) are also produced when an orbital electron falls from a high energy level to a low energy level.

**Zero-Threshold Linear Hypothesis (or No-Threshold Linear Hypothesis)**—The assumption that a dose-response curve derived from data in the high dose and high dose-rate ranges may be extrapolated through the low dose and low dose range to zero, implying that, theoretically, any amount of radiation will cause some damage.

## APPENDIX A. ATSDR MINIMAL RISK LEVELS AND WORKSHEETS

The Comprehensive Environmental Response, Compensation, and Liability Act (CERCLA) [42 U.S.C. 9601 et seq.], as amended by the Superfund Amendments and Reauthorization Act (SARA) [Pub. L. 99–499], requires that the Agency for Toxic Substances and Disease Registry (ATSDR) develop jointly with the U.S. Environmental Protection Agency (EPA), in order of priority, a list of hazardous substances most commonly found at facilities on the CERCLA National Priorities List (NPL); prepare toxicological profiles for each substance included on the priority list of hazardous substances; and assure the initiation of a research program to fill identified data needs associated with the substances.

The toxicological profiles include an examination, summary, and interpretation of available toxicological information and epidemiologic evaluations of a hazardous substance. During the development of toxicological profiles, Minimal Risk Levels (MRLs) are derived when reliable and sufficient data exist to identify the target organ(s) of effect or the most sensitive health effect(s) for a specific duration for a given route of exposure. An MRL is an estimate of the daily human exposure to a hazardous substance that is likely to be without appreciable risk of adverse noncancer health effects over a specified duration of exposure. MRLs are based on noncancer health effects only and are not based on a consideration of cancer effects. These substance-specific estimates, which are intended to serve as screening levels, are used by ATSDR health assessors to identify contaminants and potential health effects that may be of concern at hazardous waste sites. It is important to note that MRLs are not intended to define clean-up or action levels.

MRLs are derived for hazardous substances using the no-observed-adverse-effect level/uncertainty factor approach or the benchmark dose level/uncertainty factor approach. They are below levels that might cause adverse health effects in the people most sensitive to such chemical-induced effects. MRLs are derived for acute (1–14 days), intermediate (15–364 days), and chronic (365 days and longer) durations and for the oral and inhalation routes of exposure. Currently, MRLs for the dermal route of exposure are not derived because ATSDR has not yet identified a method suitable for this route of exposure. MRLs are generally based on the most sensitive chemical-induced end point considered to be of relevance to humans. Serious health effects (such as irreparable damage to the liver or kidneys, or birth defects) are not used as a basis for establishing MRLs. Exposure to a level above the MRL does not mean that adverse health effects will occur.

## APPENDIX A

MRLs are intended only to serve as a screening tool to help public health professionals decide where to look more closely. They may also be viewed as a mechanism to identify those hazardous waste sites that are not expected to cause adverse health effects. Most MRLs contain a degree of uncertainty because of the lack of precise toxicological information on the people who might be most sensitive (e.g., infants, elderly, nutritionally or immunologically compromised) to the effects of hazardous substances. ATSDR uses a conservative (i.e., protective) approach to address this uncertainty consistent with the public health principle of prevention. Although human data are preferred, MRLs often must be based on animal studies because relevant human studies are lacking. In the absence of evidence to the contrary, ATSDR assumes that humans are more sensitive to the effects of hazardous substance than animals and that certain persons may be particularly sensitive. Thus, the resulting MRL may be as much as 100-fold below levels that have been shown to be nontoxic in laboratory animals.

Proposed MRLs undergo a rigorous review process: Health Effects/MRL Workgroup reviews within the Division of Toxicology and Human Health Sciences, expert panel peer reviews, and agency-wide MRL Workgroup reviews, with participation from other federal agencies and comments from the public. They are subject to change as new information becomes available concomitant with updating the toxicological profiles. Thus, MRLs in the most recent toxicological profiles supersede previously published levels. For additional information regarding MRLs, please contact the Division of Toxicology and Human Health Sciences, Agency for Toxic Substances and Disease Registry, 1600 Clifton Road NE, Mailstop F-57, Atlanta, Georgia 30333.



## APPENDIX A

**MINIMAL RISK LEVEL (MRL) WORKSHEET**

Chemical Name: Uranium (insoluble forms)  
CAS Numbers: Multiple  
Date: July 2012  
Profile Status: Draft 2, Postpublic Comment  
Route:  Inhalation  Oral  
Duration:  Acute  Intermediate  Chronic  
Graph Key: 66  
Species: Dog

Minimal Risk Level: 0.002  mg/kg/day  ppm  mg/m<sup>3</sup>

Reference: Rothstein A. 1949b. Uranium dioxide. In: Voegtlin C, Hodge HC, eds. Pharmacology and toxicology of uranium compounds. National Nuclear Energy Series: Manhattan Project Technical Section, Division VI, Vol. 1. New York, NY: McGraw-Hill. pp. 614-621.

Experimental design: Groups of 6–19 dogs of unspecified strain and gender were exposed to 1.3, 9.3, or 10.4 mg/m<sup>3</sup> uranium dioxide (1.1, 8.2, or 9.2 mg U/m<sup>3</sup>) 6 days/week for 5 weeks. Based on other studies conducted by this investigator (Rothermel 1949; Rothstein 1949c), it is assumed that the animals were exposed for 6 hours/day. Exposure to 8.2 mg U/m<sup>3</sup> was conducted in head-only exposure units and exposure to 1.1 or 9.2 mg U/m<sup>3</sup> were performed in full-body exposure units. The median particle size was 0.4 µm with a geometric standard deviation of 2. The following parameters were used to assess toxicity: mortality, body weight changes, standard hematology (except in the 8.2 mg U/m<sup>3</sup> group), clinical chemistry (serum nonprotein nitrogen and urea nitrogen levels), urinalysis (protein, amino acid, catalase, phosphate, and ketone levels), and histopathology. Separate control studies were conducted (Sprague 1949) in which animals were exposed in control chambers by full or head-only exposure for a duration similar to study conditions. Body weight, mortality, biochemical, hematological, and histopathological data were collected. Dogs (n = 6–19; unspecified sex and strain) were exposed to uranium dioxide dust at concentrations of 1.1, 8.2, or 9.2 mg U/m<sup>3</sup> for 5 weeks, 6 days/weeks, 6 hours/day. (Doses were analytically determined, not estimated.) Studies conducted at 8.2 mg U/m<sup>3</sup> were conducted in head exposure units. Studies conducted at the other concentrations were performed in full exposure units. The AMAD for the particles is assumed to be 1.5–2.1 µm; average 1.8 µm (see Pozzani 1949). Mortality, body weight changes, standard hematology (except in the 8.2 mg U/m<sup>3</sup> group), blood and urine chemistries, pathology, and uranium distribution in tissues were measured.

Effect noted in study and corresponding doses: No dogs died from exposure to uranium dioxide dust. Additionally, no alterations in body weight gain or hematology, serum clinical chemistry, or urinalysis parameters were noted. Histopathological alterations were limited to the kidneys; “very slight” renal tubular degeneration was observed in two of six dogs at 8.2 mg U/m<sup>3</sup>; no alterations were observed in two dogs examined from the 9.2 mg U/m<sup>3</sup> group.

Dose and end point used for MRL derivation:

NOAEL  LOAEL

The study identified a NOAEL of 1.1 mg U/m<sup>3</sup> and a LOAEL of 8.2 mg/m<sup>3</sup> for minimal microscopic lesions in the renal tubules. The NOAEL of 1.1 mg U/m<sup>3</sup> was used as the point of departure for the MRL; BMD modeling was not used to estimate the point of departure due to the limited reporting of incidence data.

## APPENDIX A

Uncertainty Factors used in MRL derivation:

- 10 for use of a LOAEL
- 10 for extrapolation from animals to humans
- 10 for human variability

Was a conversion factor used from ppm in food or water to a mg/body weight dose? Not applicable.

If an inhalation study in animals, list conversion factors used in determining human equivalent concentration: Human equivalent values were not calculated because regional deposited dose ratios are not available for dogs (EPA 1994d); thus, the NOAEL<sub>ADJ</sub> was used as the point of departure with an uncertainty factor of 10 for extrapolation from animals to humans.

Was a conversion used from intermittent to continuous exposure? The NOAEL was adjusted for intermittent exposure:

$$\text{NOAEL}_{\text{ADJ}} = (1.1 \text{ mg/m}^3) * (6 \text{ hours}/24 \text{ hours}) * (6 \text{ days}/7 \text{ days}) = 0.24 \text{ mg/m}^3$$

Other additional studies or pertinent information that lend support to this MRL: Intermediate-duration inhalation studies in animals have examined the toxicity of various insoluble uranium compounds including uranium dioxide, uranium peroxide, uranium trioxide, and triuranium octaoxide in several animal species (Dygert 1949c, 1949d; Rothstein 1949b, 1949c; Stokinger et al. 1953). The results of these studies suggest that the kidney and the respiratory tract are sensitive targets of uranium toxicity, with the kidney being the most sensitive target. Very slight renal tubular damage was observed in dogs exposed to 8.2 mg U/m<sup>3</sup> as uranium dioxide for 5 weeks (Rothstein 1949b), moderate tubular necrosis was observed in rabbits exposed to 15.4 mg U/m<sup>3</sup> as uranium peroxide for 23 days (Dygert 1949d), moderate necrosis was observed in rats, rabbits, and dogs exposed to 16 mg U/m<sup>3</sup> as uranium trioxide for 4 weeks (Rothstein 1949c), and marked tubular necrosis was observed in rabbits exposed to 19.4 mg U/m<sup>3</sup> as uranium dioxide for 5 weeks (Rothstein 1949b). Although there are limited data to make species comparisons, data for uranium dioxide suggest that rabbits are more sensitive than rats, mice, or guinea pigs; the data do not allow for a comparison between rabbits and dogs. In addition to the renal effects observed in rats, rabbits, and dogs exposed to uranium trioxide, very slight pulmonary lesions were observed in dogs and rats exposed to 16 mg U/m<sup>3</sup> and severe effects were observed in rabbits dying early after exposure to 16 mg U/m<sup>3</sup> (Rothstein 1949c). Additionally, the results of the Rothstein (1949b) study which is the basis of the MRL are supported by the findings of slight to mild tubular degeneration in dogs exposed to 10 mg U/m<sup>3</sup> as uranium dioxide for 1 year; no effects were observed at 1 mg U/m<sup>3</sup> (Stokinger et al. 1953).

Agency Contacts (Chemical Managers): Sam Keith, Obaid Faroon, Nickolette Roney, Franco Scinicariello, Sharon Wilbur

## APPENDIX A

**MINIMAL RISK LEVEL (MRL) WORKSHEET**

Chemical Name: Uranium (soluble forms)  
CAS Numbers: Multiple  
Date: July 2012  
Profile Status: Draft 2, Postpublic Comment  
Route:  Inhalation  Oral  
Duration:  Acute  Intermediate  Chronic  
Graph Key: 67  
Species: Dog

Minimal Risk Level: 0.0001  mg/kg/day  ppm  mg/m<sup>3</sup>

Reference: Rothstein A. 1949a. Uranyl fluoride. In: Voegtlin C, Hodge HC, eds. Pharmacology and toxicology of uranium compounds. National Nuclear Energy Series: Manhattan Project Technical Section, Division VI, Vol 1. New York, NY: McGraw-Hill. pp. 548-560.

Experimental design: Groups of 2–6 dogs per group (strain and gender not specified) were exposed to 0.19, 2.8, or 12.2 mg/m<sup>3</sup> of uranyl fluoride dust (0.15, 2.2, or 9.2 mg U/m<sup>3</sup>) for 6 hours/day, 6 days/week for 5 weeks. (Doses were analytically determined, not estimated.) The AMAD for the particles is assumed to be 1.5–2.1 µm; average 1.8 µm (see Pozzani 1949). Separate control studies were conducted (Sprague 1949) in which animals were exposed in control chambers by full or head-only exposure for a duration similar to study conditions. Clinical signs of toxicity, mortality, body weight changes, hematology, and blood and urine chemistries were monitored. At the termination of the study, the animals were sacrificed, selected organs were histopathologically examined, and uranium levels were determined.

Effect noted in study and corresponding doses: Anorexia, rhinitis, and polydipsia were observed in the two dogs exposed to 9.2 mg U/m<sup>3</sup>; prior to death, vomiting blood, severe muscle weakness, and exhibited lassitude were observed. No deaths or clinical signs were observed at 0.15 or 2.2 mg U/m<sup>3</sup>. Severe weight loss was also observed at 9.2 mg U/m<sup>3</sup>; no alterations in body weight gain were observed at 0.15 or 2.2 mg U/m<sup>3</sup>. At 9.2 mg U/m<sup>3</sup>, both dogs had increased blood NPN levels with the maximum value over 200 mg%. At 2.2 mg U/m<sup>3</sup>, blood NPN and urinary amino acid levels were normal while one of three dogs had increased urinary protein levels. At 9.2 mg U/m<sup>3</sup>, severe renal damage was seen in dogs. Moderate renal damage (no additional information provided) was observed at 2.2 mg U/m<sup>3</sup> and very slight damage was observed in about 50% of the dogs at 0.15 mg U/m<sup>3</sup>.

Dose and end point used for MRL derivation:

NOAEL  LOAEL

The study identified a LOAEL of 0.15 mg U/m<sup>3</sup> for minimal microscopic lesions in the renal tubules; BMD modeling was not used to estimate the point of departure because incidence data were not available for all groups.

Uncertainty Factors used in MRL derivation:

- 3 for use of a minimal LOAEL
- 10 for extrapolation from animals to humans
- 10 for human variability

## APPENDIX A

Was a conversion factor used from ppm in food or water to a mg/body weight dose? Not applicable.

If an inhalation study in animals, list conversion factors used in determining human equivalent concentration: Human equivalent values were not calculated because regional deposited dose ratios are not available for dogs (EPA 1994d); thus, the LOAEL<sub>ADJ</sub> was used as the point of departure with an uncertainty factor of 10 for extrapolation from animals to humans.

Was a conversion used from intermittent to continuous exposure? The LOAEL was adjusted for intermittent exposure:

$$\text{LOAEL}_{\text{ADJ}} = (0.15 \text{ mg/m}^3) * (6 \text{ hours}/24 \text{ hours}) * (6 \text{ days}/7 \text{ days}) = 0.032 \text{ mg/m}^3$$

Other additional studies or pertinent information that lend support to this MRL: The toxicity of various soluble and poorly soluble uranium compounds has been tested in several animal species (Dygert 1949a, 1949b; Roberts 1949; Rothermel 1949; Rothstein 1949a; Spiegl 1949; Stokinger et al. 1953). These studies identify the kidney and respiratory tract as the most sensitive targets of uranium toxicity. The renal effects consisted of tubular degeneration and necrosis at concentrations of  $\geq 0.2 \text{ mg U/m}^3$ . Compound and species differences in toxicity were found. The more soluble compounds were more toxic and dogs and rabbits were more sensitive than rats, mice, and guinea pigs.

In addition to the renal effects, pulmonary toxicity has been observed in animals particularly after exposure to uranium hexafluoride. Exposure to  $2 \text{ mg U/m}^3$  for 30 days resulted in severe pulmonary edema in rabbits and slight pneumonia in dogs (Spiegl 1949). At higher concentrations ( $13.3 \text{ mg U/m}^3$ ), lung edema, hemorrhage, and emphysema were observed in rats, rabbits, and guinea pigs (Spiegl 1949). Since uranium hexafluoride is readily hydrolyzed to uranyl fluoride and hydrogen fluoride and hydrogen fluoride is a strong respiratory irritant resulting in pulmonary edema, it is likely that the observed respiratory effects are due to the hydrogen fluoride exposure. Respiratory effects have also been observed in rabbits and rats exposed to  $6.8 \text{ mg U/m}^3$  as ammonium diuranate (Dygert 1949b). In rabbits, ammonium diuranate exposure ( $6.8 \text{ mg U/m}^3$ ) resulted in extensive respiratory tract irritation, evidence by nasal bleeding and pulmonary edema, hemorrhage, and necrosis. Respiratory irritation (nasal bleeding and interstitial bronchiopneumonia) was also observed in rats exposed to  $6.8 \text{ mg U/m}^3$ . It is possible that these effects were secondary to the release of the ammonium ion, rather than uranium toxicity. Respiratory effects have not been consistently observed following exposure to other uranium compounds.

The kidney effects were observed at lower concentrations than the respiratory effects and the dogs were the most sensitive species. The lowest LOAEL values identified in dogs are  $0.13 \text{ mg U/m}^3$  as uranyl nitrate for proteinuria (Roberts 1949) and  $0.15 \text{ mg U/m}^3$  as uranyl fluoride for tubular damage (Rothstein 1949a). In the Roberts (1949) study, an increase in urinary protein excretion was observed between days 9 and 12 and then returned to normal; very mild histological changes which the investigator noted was not of sufficient severity to be of concern were observed in the renal cortex in two dogs exposed for 10 days. Since the two LOAEL values are almost identical, the Rothstein (1949a) study was selected as the basis of the MRL because it included histological examination of dogs exposed for an intermediate duration (the one dog examined at the end of the Roberts study had severe chronic nephritis, which masked an uranium-induced renal effects). Although the lowest LOAEL value in rats ( $0.13 \text{ mg U/m}^3$ ) was similar to the lowest LOAEL values in dogs, the intermediate and chronic databases for soluble uranium compounds provide strong evidence that dogs are more sensitive than rats.

Agency Contacts (Chemical Managers): Sam Keith, Obaid Faroon, Nickolette Roney, Franco Scinicariello, Sharon Wilbur

## APPENDIX A

**MINIMAL RISK LEVEL (MRL) WORKSHEET**

Chemical Name: Uranium (insoluble forms)  
CAS Numbers: Multiple  
Date: July 2012  
Profile Status: Draft 2, Postpublic Comment  
Route:  Inhalation  Oral  
Duration:  Acute  Intermediate  Chronic  
Graph Key: 92  
Species: Monkey

Minimal Risk Level: 0.0008  mg/kg/day  ppm  mg/m<sup>3</sup>

Reference: Leach LJ, Maynard EA, Hodge HC, et al. 1970. A five-year inhalation study with natural uranium dioxide (UO<sub>2</sub>) dust. I. Retention and biological effects in the monkey, dog, and rat. Health Physics 18:599-612.

Leach LJ, Yuile CL, Hodge HC, et al. 1973. A five-year inhalation study with natural uranium dioxide (UO<sub>2</sub>) dust. II. Postexposure retention and biologic effects in the monkey, dog, and rat. Health Physics 25: 239-258.

Experimental design: Rhesus monkeys (5 males, 20 females) were exposed to 5.8 mg/m<sup>3</sup> uranium dioxide (5.1 mg U/m<sup>3</sup>) 5.4 hours/day, 5 days/week for 5 years; the mass median particle diameter was 1.03 μm with a geometric standard deviation of 2.40. Another group of one male and five female monkeys served as controls. Groups of 1–2 monkeys were killed after 1 day, 4 days, 15 days, 1 month, 2 months, 3 months, 5 months, 1 year, 1.5 years, 1.8 years, 1.9 years, 3.6 years, 4.1 years, or 4.7 years; two monkeys were killed at 5 years. Six monkeys were observed for 6.5 years after exposure termination; two were killed after 12 months, one after 6 years, and three after 6.5 years; the results of the recovery period examinations were reported in Leach et al. (1973). The following parameters were used to assess toxicity: general health, body weight, peripheral hematology, blood NPN levels, and histopathology of major tissues and organs. No uranium dioxide-related deaths were observed.

Effect noted in study and corresponding doses: No alterations in body weight, hematological parameters, or blood NPN levels were found. Histological alterations were limited to the lungs and tracheobronchial lymph nodes. After 2–3 months of exposure, granular black pigment accumulations were found in the lungs and tracheobronchial lymph nodes. After 3.6 years of exposure, slight fibrosis was observed in the lungs and hyaline fibrosis was observed in the tracheobronchial lymph nodes; the severity of the fibrosis increased with exposure duration and was not observed in the controls. Fibrosis was still present in the lungs and tracheobronchial lymph nodes 6.5 years postexposure.

Dose and end point used for MRL derivation:

NOAEL  LOAEL

The study identified a LOAEL of 5.1 mg U/m<sup>3</sup> for fibrosis in the lungs and tracheobronchial lymph nodes; BMD modeling was not used due to the small number of animals sacrificed at each time period.

Uncertainty Factors used in MRL derivation:

10 for use of a LOAEL  
 10 for extrapolation from animals to humans

## APPENDIX A

[x] 10 for human variability

Was a conversion factor used from ppm in food or water to a mg/body weight dose? Not applicable.

If an inhalation study in animals, list conversion factors used in determining human equivalent concentration: Human equivalent values were not calculated because regional deposited dose ratios are not available for monkeys (EPA 1994d). The LOAEL<sub>ADJ</sub> was used as the point of departure with an uncertainty factor of 10 for extrapolation from animals to humans.

Was a conversion used from intermittent to continuous exposure? The LOAEL was adjusted for intermittent exposure:

$$\text{LOAEL}_{\text{ADJ}} = (5.1 \text{ mg U/m}^3) * (5.4 \text{ hours/24 hours}) * (5 \text{ days/7 days}) = 0.82 \text{ mg U/m}^3$$

Other additional studies or pertinent information that lend support to this MRL: There are limited data available to assess the toxicity of chronic exposure to insoluble uranium compounds. Slight to mild renal tubular degeneration was observed in dogs exposed to 10 mg U/m<sup>3</sup> as uranium dioxide for 1 year (Stokinger et al. 1953); no alterations were observed at 1 mg U/m<sup>3</sup>. Although several tissues were examined histologically, significant alterations were only noted for the kidneys. Stokinger et al. (1953) also exposed rats to 1 or 10 mg U/m<sup>3</sup> as uranium dioxide, but no uranium-related alterations were observed. In a second chronic duration study, no adverse effects were observed in rats or dogs exposed to 5.1 mg U/m<sup>3</sup> as uranium dioxide for 1–5 years (Leach et al. 1970). However, fibrosis in the tracheobronchial lymph nodes and fibrosis and metaplasia in the lungs were observed in dogs during a 6.5-year postexposure period (Leach et al. 1973). In monkeys, exposure to 5.1 mg U/m<sup>3</sup> resulted in lung fibrosis beginning after 3.6 years of exposure (Leach et al. 1970); the severity of the fibrosis increased with exposure duration. Fibrosis was also present in the lungs and tracheobronchial lymph nodes in monkeys sacrificed during the 6.5-year postexposure period (Leach et al. 1973). The investigators noted that the fibrosis may have been a radiotoxic effect based on the magnitude of the radiation dose, the absence of renal effects, and the similarity of the lesions to those observed following exposure to plutonium dioxide; the alpha-radiation tissue doses were >500 rad (5 Gy) for the lungs and 7,000 rad (70 Gy) for the lymph nodes. However, it is unclear whether the damage was chemically or radiologically induced (or both); similar degenerative effects in the lungs have also been observed following prolonged exposure to diverse inorganic dusts. An elevation of blood nonprotein nitrogen level was also observed in the monkeys during the postexposure period, but no histological alterations were observed in the kidneys (Leach et al. 1973).

Agency Contacts (Chemical Managers): Sam Keith, Obaid Faroon, Nickolette Roney, Franco Scinicariello, Sharon Wilbur

## APPENDIX A

**MINIMAL RISK LEVEL (MRL) WORKSHEET**

Chemical Name: Uranium (soluble forms)  
CAS Numbers: Multiple  
Date: July 2012  
Profile Status: Draft 2, Postpublic Comment  
Route:  Inhalation  Oral  
Duration:  Acute  Intermediate  Chronic  
Graph Key: 100  
Species: Dog

Minimal Risk Level: 0.00004  mg/kg/day  ppm  mg/m<sup>3</sup>

Reference: Stokinger HC, Baxter RC, Dygert HP, et al. 1953. Uranium Tetrachloride: Toxicity following inhalation for 1 and 2 years. In: Voegtlin C, Hodge HC, eds. Pharmacology and toxicology of uranium compounds. National Nuclear Energy Series: Manhattan Project Technical Section, Division VI, Vol 1. New York, NY: McGraw-Hill. pp. 1522-1553.

Experimental design: Dogs of both sexes (11–12 males, 9–10 females) were exposed to uranium tetrachloride in inhalation chambers for 33 hours/week for 1 year at concentrations of 0.05 and 0.20 mg U/m<sup>3</sup>. (Doses were analytically determined, not estimated.) A control group of five male and seven female dogs were similar exposed to chamber air in a separate experiment. The size-mass median particle size of uranium tetrachloride dust was 1.58 µm (range of 1.19–2.21 µm; geometric standard deviation of 2.24) for the 0.05 mg U/m<sup>3</sup> exposures and 1.83 µm (range of 1.07–3.35 µm; geometric standard deviation of 2.25) for the 0.2 mg U/m<sup>3</sup> exposures. The animals were monitored for body weight alterations, clinical signs of toxicity, and biochemical alterations in the blood and urine. At the termination of the study, the animals were sacrificed and selected organs were histopathologically examined.

Effect noted in study and corresponding doses: All dogs survived the 1-year exposure period. No alterations in body weight gain, hematological parameters, or blood NPN levels were observed. Urinary protein levels were elevated, as compared to controls; however, pre-exposure levels were also elevated, precluding evaluating the clinical significance of the effect. Alterations in bromsulfalein retention test, indicating impaired liver function, were observed in the four dogs tested (0.2 mg U/m<sup>3</sup> group); no alterations in blood clotting times were observed. In the absence of histological evidence of liver damage, the change was not considered clinically significant. Renal tubular atrophy was observed in 2/16 dogs exposed to 0.05 mg U/m<sup>3</sup> (not statistically significant using Fisher Exact test). Slight tubular atrophy in the inner cortex was observed in 7/14 dogs exposed to 0.2 mg U/m<sup>3</sup>.

Dose and end point used for MRL derivation:

NOAEL  LOAEL  BMCL<sub>10</sub> 0.019 mg U/m<sup>3</sup> for renal toxicity

Data for the incidence of renal tubular atrophy were analyzed using all available dichotomous models in the EPA BMDS (version 2.1.2) using the extra risk option. The multistage model was run for all polynomial degrees up to n-1 (where n is the number of dose groups including control). Adequate model fit was judged by three criteria: goodness-of-fit p-value (p>0.1), visual inspection of the dose-response curve, and scaled residual at the data point (except the control) closest to the predefined benchmark response (BMR). Among all of the models meeting adequate fit criteria, the BMCL from the model with the lowest Akaike Information Criteria (AIC) was chosen. BMCs and lower bounds on the BMC (BMCLs) associated with a BMR of 10% extra risk were calculated for all models and are presented in

## APPENDIX A

Table A-1. As assessed by the chi-square goodness-of-fit statistic, all of the models provided adequate fit to the data. The BMCs ranged from 0.032 to 0.082 mg U/m<sup>3</sup> and the BMCLs ranged from 0.019 to 0.054 mg U/m<sup>3</sup>. The quantal-linear and the multistage (1-degree polynomial) had the lowest AIC values; the BMCL<sub>10</sub> of 0.019 mg U/m<sup>3</sup> estimated for both models was selected as a point of departure. The fit of the quantal-linear model is presented in Figure A-1.

**Table A-1. Model Predictions for the Incidence of Renal Tubular Atrophy in Dogs Exposed to Uranium Tetrachloride for 1 Year (Stokinger et al. 1953)**

Model	$\chi^2$ Goodness-of-fit	p-value <sup>a</sup>	AIC	BMC <sub>10</sub> (mg U/m <sup>3</sup> )	BMCL <sub>10</sub> (mg U/m <sup>3</sup> )
Gamma <sup>b</sup>	35.4648	1	35.4648	0.0411568	0.0196557
Logistic	36.7375	0.3616	36.7375	0.0825225	0.054177
Log Logistic	35.4648	1	35.4648	0.0418036	0.0146656
Log Probit	35.4648	1	35.4648	0.0426877	0.00300431
<b>Multistage (1 degree polynomial)</b>	35.4648	<b>0.9485</b>	<b>33.5743</b>	<b>0.0324681</b>	<b>0.019467</b>
Multistage (2 degree polynomial)	33.5743	1	35.4648	0.0402323	0.0196557
Probit	36.5663	0.3921	36.5663	0.0756112	0.0502782
Weibull <sup>b</sup>	35.4648	1	35.4648	0.0409589	0.0196557
<b>Quantal-Linear</b>	33.5743	<b>0.9485</b>	<b>33.5743</b>	<b>0.0324681</b>	<b>0.019467</b>

<sup>a</sup>Values <0.10 fail to meet conventional goodness-of-fit criteria.

<sup>b</sup>Power restricted to  $\geq 1$ .

AIC = Akaike Information Criteria; BMC = benchmark concentration associated with the selected benchmark response of 10% extra risk; BMCL = 95% lower confidence limit on the BMC





## APPENDIX A

the uranium workers had spent in the yellowcake area. Although urinary uranium levels were reported, atmospheric concentrations were not reported.

Stokinger et al. (1953) examined the chronic toxicity of uranium hexafluoride, uranium tetrachloride, and uranyl nitrate in dogs and rats following a 1-year exposure. Slight to mild renal tubular atrophy was observed in dogs and rats exposed to 0.2 mg U/m<sup>3</sup> as uranium hexafluoride or uranium tetrachloride; no effects were observed at 0.05 mg U/m<sup>3</sup>. Exposure to uranyl nitrate resulted in mild to moderate tubular atrophy in dogs exposed to 0.25 mg U/m<sup>3</sup> (NOAEL of 0.15 mg U/m<sup>3</sup>) and mild to marked tubular atrophy in rats exposed to 2 mg U/m<sup>3</sup> (NOAEL of 0.25 mg U/m<sup>3</sup>).

Agency Contacts (Chemical Managers): Sam Keith, Obaid Faroon, Nickolette Roney, Franco Scinicariello, Sharon Wilbur

## APPENDIX A

**MINIMAL RISK LEVEL (MRL) WORKSHEET**

Chemical Name: Uranium (soluble forms)  
CAS Numbers: Multiple  
Date: July 2012  
Profile Status: Draft 2, Postpublic Comment  
Route:  Inhalation  Oral  
Duration:  Acute  Intermediate  Chronic  
Graph Key: 14  
Species: Mouse

Minimal Risk Level: 0.002  mg/kg/day  ppm  mg/m<sup>3</sup>

Reference: Domingo JL, Paternain JL, Llobet JM, et al. 1989c. The developmental toxicity of uranium in mice. Toxicology 55:143-152.

Experimental design: Groups of 20 pregnant Swiss mice were administered via gavage 0, 5, 10, 25, or 50 mg/kg/day uranyl acetate dihydrate (0, 2.8, 5.6, 14, or 28 mg U/kg/day) on gestation days 6–15. Body weights, food consumption, and general appearance were monitored daily. At termination, maternal liver and kidney weights were measured and uterine contents (number of implantation sites, resorptions, dead fetuses, and live fetuses) were evaluated. Live fetuses were evaluated for body weight, body length, sex, gross morphological abnormalities, visceral malformations, visceral anomalies (evaluated in 1/3 of fetuses), and skeletal defects (evaluated in 2/3 of fetuses).

Effect noted in study and corresponding doses: Significant decreases in maternal body weight were observed in all uranium groups; during the exposure period, the dams in the 2.6, 5.6, 14, and 28 mg U/kg/day groups weighed 33, 53, 75, and 88% less than controls, respectively. Significant decreases in food intake were also observed in the dams exposed to  $\geq 5.6$  mg U/kg/day. A significant decrease in the number of live fetuses was observed at 5.6 mg U/kg/day, but was not observed at the two higher dose levels. No significant alterations in the number of early or late resorptions, number of dead fetuses, or sex ratio were observed. Significant decreases in fetal body weight were observed at  $\geq 2.8$  mg U/kg/day and decreases in fetal length were observed at  $\geq 5.6$  mg U/kg/day. Significant increases in the incidences of external defects were observed at 2.8 mg U/kg/day. The alterations included cleft palate (significant at  $\geq 5.6$  mg U/kg/day) and hematomas (significant at 2.8 and 28 mg U/kg/day). The total number of skeletal defects was significantly increased at 14 and 28 mg U/kg/day; skeletal defects included bipartite sternbrae (significant at 2.8, 14, and 28 mg U/kg/day), some metatarsal of hindlimb poorly ossified (significant at 14 and 28 mg U/kg/day), delayed ossification of skull (significant at 14 and 28 mg U/kg/day), and caudal reduced ossification (significant at 14 and 28 mg U/kg/day).

Dose and end point used for MRL derivation:

NOAEL  LOAEL  BMDL 0.2 mg U/kg/day for developmental toxicity

The results of the Domingo et al. (1989c) study suggest maternal body weight gain and fetal body weight and external and skeletal alterations as sensitive end points of uranium toxicity. It is possible that the developmental effects were secondary to the maternal toxicity; however, some of these effects may also be primary effects of uranium on the developing fetus. BMD modeling was used to identify potential points of departure for maternal and fetal end points. The maternal end point was decreased maternal body weight gain and the fetal end points included decreased fetal body weights and external and skeletal alterations. As summarized in Table A-2, there were significant increases in the incidence of litters with a particular types of external defect or skeletal defect and increases in the total number of litters with

## APPENDIX A

external or skeletal defects. At all but the lowest dose tested, the increase in the incidence of external defects was primarily due to increases in the incidence of cleft palate. The incidence of hematomas does not appear to be dose-related. Thus, only the incidence of cleft palate was considered for BMD modeling. The skeletal defects consisted of increases in the incidence of bipartite sternebrae and reduced or delayed ossification in several locations (skull, caudal, hindlimb metatarsals, and proximal phalanges). Unfortunately, the investigators did not provide the information on the total number of litters with reduced or delayed ossification. To estimate potential points of departure for skeletal defects, the incidence data for bipartite sternebrae and the total incidence of skeletal defects were modeled.

**Table A-2. Incidence of Litters with External or Skeletal Defects**

Dose level (mg U/kg/day)	0	2.8	5.6	14	28
Number of litters	18	17	18	18	18
Cleft palate	0	2 (12%)	13 <sup>a</sup> (72%)	13 <sup>a</sup> (72%)	16 <sup>a</sup> (89%)
Hematomas (dorsal or in facial area)	0	6 <sup>b</sup> (35%)	2 (11%)	4 (22%)	8 <sup>b</sup> (44%)
Total external defects	0	8 <sup>c</sup> (47%)	14 <sup>a</sup> (78%)	14 <sup>a</sup> (78%)	17 <sup>b</sup> (94%)
Bipartite sternebrae	0	6 <sup>c</sup> (35%)	3 (17%)	9 <sup>a</sup> (50%)	13 <sup>a</sup> (72%)
Poor ossification of hindlimb metatarsal	4 (22%)	9 (53%)	15 (83%)	18 <sup>b</sup> (100%)	18 <sup>a</sup> (100%)
Poor ossification of proximal phalanges	2 (11%)	0	6 (33%)	13 <sup>b</sup> (72%)	14 <sup>b</sup> (78%)
Delayed skull ossification	0	0	3 (17%)	9 <sup>c</sup> (50%)	12 <sup>c</sup> (67%)
Reduced caudal ossification	4 (22%)	9 (53%)	12 (67%)	18 <sup>b</sup> (100%)	18 <sup>b</sup> (100%)
Total skeletal defects	4 (22%)	11 (65%)	15 (83%)	18 <sup>c</sup> (100%)	18 <sup>c</sup> (100%)

<sup>a</sup>Significantly different from controls ( $p < 0.01$ ).

<sup>b</sup>Significantly different from controls ( $p < 0.001$ ).

<sup>c</sup>Significantly different from controls ( $p < 0.05$ ).

Source: Domingo et al. 1989c

Data for the number of litters with cleft palate, bipartite sternebrae, and total skeletal defects (summarized in Table A-2) were analyzed using all available dichotomous models in the EPA BMDS (version 2.1.2) using the extra risk option. The multistage model was run for all polynomial degrees up to  $n-1$  (where  $n$  is the number of dose groups including control). Adequate model fit was judged by three criteria: goodness-of-fit  $p$ -value ( $p > 0.1$ ), visual inspection of the dose-response curve, and scaled residual at the data point (except the control) closest to the predefined BMR. For a given end point, the BMDL from the model with the lowest AIC (among all of the models meeting adequate fit criteria) was chosen. BMDs and lower bounds on the BMD (BMDLs) associated with a BMR of 5% extra risk for dichotomous data were calculated for all models and are presented in Table A-3.

## APPENDIX A

**Table A-3. Model Predictions for Developmental Effects in the Offspring of Mice Administered Uranyl Acetate via Gavage on Gestation Days 6–15 (Domingo et al. 1989c)**

Model	AIC	$\chi^2$ Goodness- of-fit	p-value <sup>a</sup>	BMD <sub>05</sub> (mg U/kg/day)	BMDL <sub>05</sub> (mg U/kg/day)
Cleft palate					
Gamma <sup>b</sup>	78.21	8.69	0.0693	ND (GF)	ND (GF)
Logistic	92.12	18.44	0.0004	ND (GF)	ND (GF)
<b>Log Logistic</b>	<b>77.98</b>	<b>6.15</b>	<b>0.1047</b>	<b>0.75</b>	<b>0.20</b>
Log Probit	76.56	7.06	0.133	ND (LSR)	ND (LSR)
Multistage (1 degree polynomial)	78.21	8.69	0.0693	ND (GF)	ND (GF)
Multistage (2 degree polynomial)	78.21	8.69	0.0693	ND (GF)	ND (GF)
Multistage (3 degree polynomial)	78.21	8.69	0.0693	ND (GF)	ND (GF)
Multistage (4 degree polynomial)	78.21	8.69	0.0693	ND (GF)	ND (GF)
Probit	92.80	18.94	0.0003	ND (GF)	ND (GF)
Weibull <sup>b</sup>	78.21	8.69	0.0693	ND (GF)	ND (GF)
Quantal-Linear	78.58	8.4	0.078	ND (GF)	ND (GF)
Total skeletal defects					
Gamma <sup>b</sup>	63.69	0.24	0.889	0.39	0.12
<b>Logistic</b>	<b>61.85</b>	<b>0.46</b>	0.9275	<b>0.37</b>	<b>0.25</b>
Log Logistic	64.42	0.77	0.6808	0.84	0.12
Log Probit	64.02	0.49	0.7828	0.85	0.30
Multistage (1 degree polynomial)	61.87	0.29	0.9617	0.17	0.12
Multistage (2 degree polynomial)	63.54	0.14	0.9326	0.23	0.12
Multistage (3 degree polynomial)	63.45	0.07	0.9653	0.20	0.12
Multistage (4 degree polynomial)	63.40	0.03	0.9848	0.19	0.12
Probit	61.86	0.49	0.9205	0.36	0.26
Weibull <sup>b</sup>	63.64	0.21	0.902	0.33	0.12
Quantal-Linear	61.87	0.29	0.9617	0.17	0.12

## APPENDIX A

**Table A-3. Model Predictions for Developmental Effects in the Offspring of Mice Administered Uranyl Acetate via Gavage on Gestation Days 6–15 (Domingo et al. 1989c)**

Model	AIC	$\chi^2$ Goodness- of-fit	p-value <sup>a</sup>	BMD <sub>05</sub> (mg U/kg/day)	BMDL <sub>05</sub> (mg U/kg/day)
Bipartite sternebrae					
Gamma <sup>b</sup>	94.61	7.49	0.0578	ND (GF)	ND (GF)
Logistic	97.86	7.44	0.0591	ND (GF)	ND (GF)
<b>Log Logistic</b>	<b>93.02</b>	<b>4.37</b>	<b>0.224</b>	<b>0.64</b>	<b>0.42</b>
Log Probit	97.82	8.65	0.0343	ND (GF)	ND (GF)
Multistage (1 degree polynomial)	94.61	7.49	0.0578	ND (GF)	ND (GF)
Multistage (2 degree polynomial)	94.61	7.49	0.0578	ND (GF)	ND (GF)
Multistage (3 degree polynomial)	94.61	7.49	0.0578	ND (GF)	ND (GF)
Multistage (4 degree polynomial)	94.61	7.49	0.0578	ND (GF)	ND (GF)
Probit	97.69	7.43	0.0595	2.80	2.11
Weibull <sup>b</sup>	94.61	7.49	0.0578	ND (GF)	ND (GF)
Quantal-Linear	94.61	7.49	0.0578	ND (GF)	ND (GF)

<sup>a</sup>Values <0.10 fail to meet conventional goodness-of-fit criteria.

<sup>b</sup>Power restricted to  $\geq 1$ .

AIC = Akaike Information Criteria; BMD = benchmark dose associated with the selected benchmark response of 5% extra risk; BMDL = 95% lower confidence limit on the BMC ND (GF) = not determined, goodness-of-fit criteria <0.10; ND (LSR) = not determined, largest scaled residual >2

The fetal body weight data and the maternal body weight gain data, summarized in Table A-4 were fit to all available continuous models in EPA's Benchmark Dose Software (BMDS, version 2.1.2). The following procedure for fitting continuous data was used: the simplest model (linear) was first applied to the data while assuming constant variance; if the data were consistent with the assumption of constant variance ( $p \geq 0.1$ ), then the fit of the linear model to the means was evaluated and the polynomial, power, and Hill models were fit to the data while assuming constant variance. Adequate model fit was judged by three criteria: goodness-of-fit p-value ( $p > 0.1$ ), visual inspection of the dose-response curve, and scaled residual at the data point (except the control) closest to the predefined BMR. Among all of the models providing adequate fit to the data, the BMDL from the model with the lowest AIC was chosen. If the test for constant variance was negative, then the linear model was run again while applying the power model integrated into the BMDS to account for nonhomogenous variance. If the nonhomogenous variance model provided an adequate fit ( $p \geq 0.1$ ) to the variance data, then the fit of the linear model to the means was evaluated and the polynomial, power, and Hill models were fit to the data and evaluated while the variance model was applied. Model fit and point of departure selection proceeded as described earlier. If the test for constant variance was negative and the nonhomogenous variance model did not provide an adequate fit to the variance data, then the data set was considered unsuitable for modeling. For all fetal body weight models, a BMR of 5% relative deviation was used; a BMR of 10% was used for all maternal body weight gain models. Although the Hill model with constant variance or nonconstant variance

## APPENDIX A

provided an adequate fit to means for the fetal body weight data, the models did not provide adequate fit to the variance and were not considered suitable for identifying a point of departure for an MRL. None of the available models provided adequate fit for the maternal body weight gain data.

**Table A-4. Maternal Body Weight Gain and Fetal Body Weights**

Dose level (mg U/kg/day)	0	2.8	5.6	14	28
Maternal body weight gain on gestation days 6-15 (g) ±standard deviation	14.5±6.6	9.7±1.8 <sup>a</sup>	6.8±9.5 <sup>a</sup>	3.6±8.4 <sup>b</sup>	1.8±6.2 <sup>c</sup>
Fetal body weight (g) ±standard deviation	1.40±0.15	1.04±0.25 <sup>a</sup>	0.93±0.24 <sup>a</sup>	0.84±0.11 <sup>a</sup>	0.77±0.17 <sup>a</sup>

<sup>a</sup>Significantly different from controls (p<0.001).

<sup>b</sup>Significantly different from controls (p<0.05).

<sup>c</sup>Significantly different from controls (p<0.01).

Source: Domingo et al. 1989c

The potential points of departure for the acute-duration oral MRL are summarized in Table A-5. The BMDL<sub>05</sub> values for external and skeletal defects ranged from 0.20 to 0.42 mg U/kg/day and the LOAEL value for the maternal and fetal body weight effects was 2.8 mg U/kg/day. The BMDL<sub>05</sub> of 0.20 mg U/kg/day for cleft palate was selected as the basis of the MRL. Because this value is lower than the other potential points of departure, it is likely to be protective for these effects. The fit of the log logistics model to the cleft palate data is presented in Figure A-2.

**Table A-5. Summary of Potential Points of Departure for an Acute-Duration Oral MRL**

Effect	Point of departure (mg U/kg/day)	Source
Cleft palate	0.20	BMDL <sub>05</sub> (log logistic model)
Total skeletal defects	0.25	BMDL <sub>05</sub> (logistic model)
Bipartite sternebrae	0.42	BMDL <sub>05</sub> (log logistic model)
Fetal body weight	0.28	LOAEL/uncertainty factor of 10
Maternal body weight gain	0.28	LOAEL/uncertainty factor of 10

## APPENDIX A

**Figure A-2. Predicted (Log Logistic Model) and Observed Incidence of Cleft Palate\***

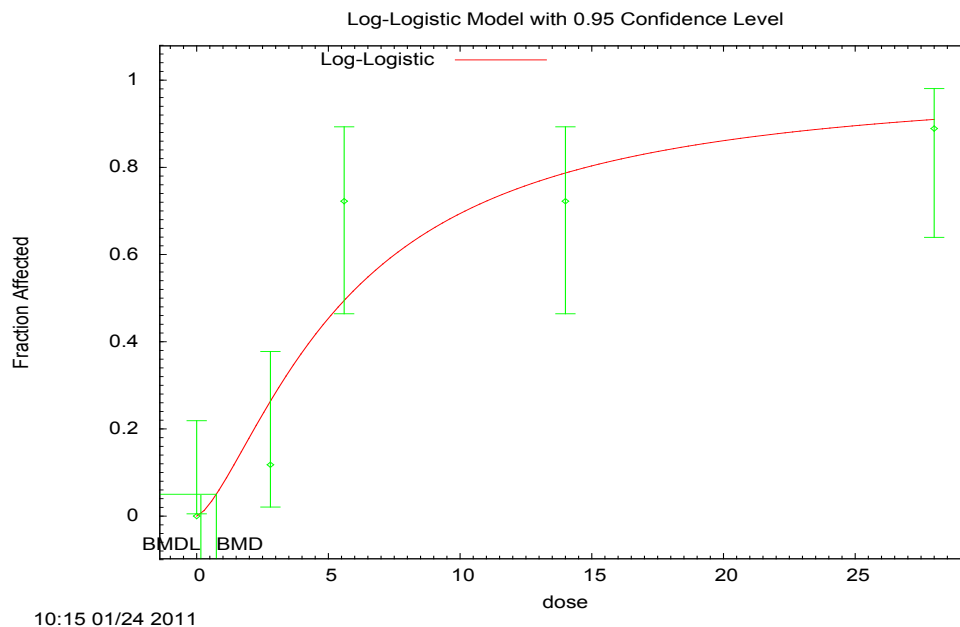

\*BMD and BMDL indicated are associated with 5% extra risk and are in units of mg U/kg/day.

Uncertainty Factors used in MRL derivation:

- [ ] 10 for use of a LOAEL
- [x] 10 for extrapolation from animals to humans
- [x] 10 for human variability

Was a conversion factor used from ppm in food or water to a mg/body weight dose? No.

If an inhalation study in animals, list conversion factors used in determining human equivalent dose: Not applicable.

Was a conversion used from intermittent to continuous exposure? Not applicable.

Other additional studies or pertinent information that lend support to this MRL: There are limited human data on the oral toxicity of uranium. Signs of gastrointestinal irritation (nausea, vomiting, diarrhea) were observed in a subject ingesting 14.3 mg U/kg as uranyl nitrate in drinking water (Butterworth 1955); other potential targets of toxicity were not examined. Acute oral exposure studies in rats and mice have examined the lethality, systemic toxicity, neurotoxicity, and developmental toxicity of uranium. Information on the systemic toxicity is limited to two single-exposure toxicity study in rats (Domingo et al. 1987) and mice (Martinez et al. 2003) administered lethal doses and a repeated exposure study in mice (Ozmen and Yurekli 1998). In the 2 weeks following administration of a single gavage dose of 118 mg U/kg as uranyl acetate to rats, significant increases in urine volume (in the absence of changes in water consumption), plasma creatinine and urea, and urinary total protein and creatinine were observed; hyperemia and microhemorrhagic foci were also observed in the liver and kidneys at the end of the 2-week observation period (Domingo et al. 1987). In mice, administration of 166 mg U/kg as uranyl nitrate resulted in increases in blood urea and creatinine levels and proximal tubular necrosis (Martinez et



## APPENDIX A

al. 2003). Similarly, significant increases in BUN and creatinine levels were observed in mice exposed to 508 mg U/kg/day as uranyl acetate in the diet for 5 days (Ozmen and Yurekli 1998); the study did not include a histological examination of the kidney or other tissues. Neurological effects consisted of increased motor activity (Briner and Murray 2005) and increased open field activity (Briner 2009) in mice administered 28 or 6 mg U/kg/day, respectively, as depleted uranyl acetate in drinking water for 2 weeks; exposure to 28 mg U/kg/day also resulted in a 53% decrease in body weight gain. Gestational exposure to  $\geq 2.8$  mg U/kg/day as uranyl acetate resulted in significant decreases in fetal body weights and increases in the occurrence hematomas in the fetuses of mice exposed on gestation days 6–15 (Domingo et al. 1989a); increases in the incidence of cleft palate were observed at  $\geq 5.6$  mg U/kg/day. Decreases in maternal body weight gain were observed at  $\geq 2.8$  mg U/kg/day. Exposure of neonatal rats (1 or 7 days of age) to 42.7 mg U/kg/day as uranyl nitrate administered via gavage in water, resulted in significant reductions in bone formation, increases in bone resorption, and diminished tooth development (Pujadas Bigi et al. 2003).

Agency Contacts (Chemical Managers): Sam Keith, Obaid Faroon, Nickolette Roney, Franco Scinicariello, Sharon Wilbur

## APPENDIX A

**MINIMAL RISK LEVEL (MRL) WORKSHEET**

Chemical Name: Uranium (soluble forms)  
CAS Numbers: Multiple  
Date: July 2012  
Profile Status: Draft 2, Postpublic Comment  
Route:  Inhalation  Oral  
Duration:  Acute  Intermediate  Chronic  
Graph Key: 39  
Species: Rat

Minimal Risk Level: 0.0002  mg/kg/day  ppm  mg/m<sup>3</sup>

Reference: Gilman AP, Villeneuve DC, Secours VE, et al. 1998a. Uranyl nitrate 28-day and 91-day toxicity studies in the Sprague-Dawley rat. *Toxicol Sci* 41(1):117-128.

Experimental design: Five groups of Sprague-Dawley rats (15/sex/dose, 60 g) were exposed to uranium as uranyl nitrate in drinking water (0, 0.96, 4.8, 24, 120, and 600 mg/L) for 91 days. Time-weighted average doses calculated by the authors from fluid intake data were <0.0001 (control group), 0.06, 0.31, 1.52, 7.54, and 36.73 mg U/kg/day in males and <0.0001 (control), 0.09, 0.42, 2.01, 9.98, and 53.56 mg U/kg/day in females. Clinical signs were monitored daily and body weights were measured weekly; fluid intake and feed consumption were also measured, but the frequency was not reported. Hematological parameters serum clinical chemistry (sodium, potassium, phosphate, bilirubin, alkaline phosphatase, aspartate aminotransferase, total protein, calcium, cholesterol, glucose, uric acid, lactate dehydrogenase, sorbitol dehydrogenase), organ weights, and histopathology (tissues examined: adrenal, brain [three sections], bone marrow, bronchi, colon, duodenum, epididymis, stomach [gastric cardia, fundus, and pylorus], heart, kidney, liver, lungs, mesenteric and mediastinal lymph nodes, ovary, pancreas, parathyroid, pituitary, salivary glands, skeletal muscle, spleen, testes, thoracic aorta, thymus, thyroid, trachea, and uterus) were assessed at termination. Uranium residues were measured in samples of brain, liver, spleen, liver, kidney, and bone in the control and two highest dose groups.

Effect noted in study and corresponding doses: Hematological and biochemical parameters were not affected in a significant exposure-related manner. Statistically significant increases in renal lesions included cytoplasmic vacuolization (0/15, 9/15, 7/15, 12/15, 9/15, 7/15), tubular dilation (0/15, 4/15, 5/15, 10/15, 4/15, 5/15), and lymphoid cuffing (0/15, 6/15, 6/15, 2/15, 7/15, 10/15) in males at  $\geq 0.06$  mg U/kg/day; capsular sclerosis (0/15, 5/15, 4/15, 3/15, 6/14, 5/14), tubular anisokaryosis (0/15, 5/15, 4/15, 3/15, 6/14, 5/14; not significant at 2.01 mg U/kg/day), and interstitial reticulin sclerosis (1/15, 9/15, 8/15, 7/15, 6/14, 5/14) in females at  $\geq 0.09$  mg U/kg/day; nuclear vesiculation in males (0/15, 6/15, 10/15, 6/15, 8/15) and females (0/15, 6/15, 6/15, 7/15, 4/14, 7/14) at  $\geq 0.06/0.09$  mg U/kg/day; and glomerular adhesions (2/15, 4/15, 10/15, 10/15, 10/15, 11/15) and cytoplasmic degeneration (0/15, 2/15, 11/15, 13/15, 7/15, 7/15) in males at  $\geq 0.31$  mg U/kg/day. Lesions were also observed in the liver at all doses including anisokaryosis, vesiculation, increased portal density, perivenous vacuolation, and homogeneity; the investigators considered these adaptive and likely reversible. Thyroid lesions were observed in both sexes (multifocal reduction of follicular size, increased epithelial height in males at 0.31 mg/kg/day and females at 2.01 mg/kg/day). A decreased amount and density of colloid in the thyroid was observed in males only. Sinus hyperplasia of the spleen was observed in males and females at 36.73/53.56 mg/kg/day.

## APPENDIX A

Dose and end point used for MRL derivation: 0.06 mg U/kg/day, renal toxicity. This is considered a minimal LOAEL.

[ ] NOAEL [X] LOAEL

Uncertainty Factors used in MRL derivation:

- [x] 3 for use of a minimal LOAEL
- [x] 10 for extrapolation from animals to humans
- [x] 10 for human variability

Was a conversion factor used from ppm in food or water to a mg/body weight dose? No, doses were calculated by the authors on the basis of measured water intake.

If an inhalation study in animals, list conversion factors used in determining human equivalent dose: Not applicable.

Was a conversion used from intermittent to continuous exposure? Not applicable.

Other additional studies or pertinent information that lend support to this MRL: No studies have been identified that examined the toxicity of uranium in humans following an intermediate-duration oral exposure. A number of studies have examined the intermediate-duration oral toxicity of uranium in laboratory animals. Most of these studies involved exposure to soluble uranium compounds such as uranyl nitrate and uranyl acetate; there are limited data on moderately soluble or insoluble uranium compounds. The available data suggest that the kidney is the most sensitive target of uranium toxicity; at higher dose levels, neurological, reproductive, and developmental effects have been reported. At lower concentrations, histological alterations have been observed in the proximal tubules, glomerulus, and/or renal interstitium in rats and mice exposed to uranyl nitrate in drinking water (Berradi et al. 2008; Gilman et al. 1998a, 1998b, 1998c; McDonald-Taylor et al. 1992, 1997). At higher concentrations (40.38 mg U/kg/day), evidence of renal dysfunction (e.g., glycosuria, proteinuria) has also been observed (Gilman et al. 1998c). The Gilman et al. (1998a, 1998b) studies identified the LOAELs of 0.06 and 0.05 mg U/kg/day for renal effects in rats and rabbits, respectively; neither study identified NOAEL values.

The LOAELs for neurological, reproductive, and developmental effects are similar and are about 50-fold higher than the LOAEL for renal effects. Neurological effects such as sleep and behavior alterations and decreased spatial memory were observed in rats exposed to 2.5–2.7 mg U/kg/day as enriched uranyl nitrate (Houpert et al. 2005, 2007b). However, no neurological effects were observed in rats similarly exposed to the same dose of depleted uranyl nitrate (Houpert et al. 2005). The investigators suggest that the observed effects may have been related to radiological activity. The reproductive effects consisted of decreases in male fertility in rats and mice following exposure to  $\geq 5.6$  mg U/kg/day as uranyl acetate (Linares et al. 2005; Llobet et al. 1991) and alterations in ovarian folliculogenesis in mice at  $\geq 1.25$  mg U/kg/day as uranyl nitrate (Arnault et al. 2008; Feugier et al. 2008; Kundt et al. 2009). A recent study by Raymond-Whish et al. (2007) also reported alterations in ovarian folliculogenesis in mice, but the effects were at an extremely low dose (0.00039 mg U/kg/day). Additional data are needed to support whether reproductive effects occur at this dose level and to evaluate the toxicological significance of the observed effect (reduced number of small primary follicles, but no effect on primordial, secondary/growing, healthy, or atretic follicle populations). Developmental effects have been observed in rats and mice; most effects occurred at maternally toxic doses. The observed effects included neurobehavioral effects in the offspring of rats exposed prenatally and during gestation and lactation to 4.3 mg U/kg/day as enriched uranyl nitrate (Houpert et al. 2007a), decreases in pup body weight at  $\geq 2.8$  mg U/kg/day as uranyl acetate (Paternain et al. 1989; Sanchez et al. 2006), decreases in litter size, live fetuses, or viability at  $\geq 14$  mg

## APPENDIX A

U/kg/day as uranyl acetate (Domingo et al. 1989b; Paternain et al. 1989), and altered ovarian folliculogenesis in 3-month-old pups of dams exposed to 1.25 mg U/kg/day as uranyl nitrate (Arnault et al. 2008).

The LOAELs of 0.05 and 0.06 mg U/kg/day for kidney effects in rats and rabbits (Gilman et al. 1998a, 1998b) were considered as possible points of departure for an intermediate-duration oral MRL for soluble uranium compounds. Although the rabbit study identified the slightly lower LOAEL, the rat LOAEL was selected as the point of departure for the MRL due to possible subclinical infection in the rabbits. Gilman et al. (1998b, 1998c) conducted two 91-day studies in rabbits. The kidney uranium levels for the two studies were not comparable; rabbits in the first study (Gilman et al. 1998b) had higher kidney uranium levels than in the second study (Gilman et al. 1998c) even though the dose was lower in the first study (28.70 mg U/kg/day dose and 4.98 µg U/g kidney level in the Gilman et al. 1998b study compared to 40.98 mg U/kg/day dose and 3.48 µg U/g kidney level in the Gilman et al. 1998c study). In the Gilman et al. (1998b) study, the male rabbits were not SPF derived and four animals developed *Pasteurella multocida* infections during the study; Gilman et al. (1998c) suggested that even though the affected rabbits were removed from the study, it is possible that other animals had a subclinical infection and that this may have increased sensitivity. Thus, the rat study was selected as the basis of the MRL; the rats used in the Gilman et al. (1998a) study were SPF derived. The Raymond-Whish et al. (2007) study was not selected as the point of departure because there are no other data to support this extremely low value and the toxicological significance of this slight change in one follicle population is not known.

#### Other Issues

The results of a serial study in which rats were exposed to several doses of uranyl nitrate in the diet for up to one year (Maynard et al. 1953) coupled with the rat 2-year study (Maynard and Hodge 1949; Maynard et al. 1953) suggest that at low exposures the renal tubular epithelium is regenerated and continued exposure does not result in more severe effects. However, at higher doses, the capacity to regenerate the renal tubular epithelium is exceeded and tubular atrophy is observed. In the serial study (Maynard et al. 1953), exposure to 170 mg U/kg/day as uranyl nitrate in the diet resulted in regeneration of the renal tubular epithelium after 2 weeks of exposure; there was no progression of renal damage with continued exposure and the renal tubules in rats exposed for 2 weeks were similar to those exposed for 1 year. Additionally, a 2 year exposure to 170 mg U/kg/day did not result in any further damage to the kidneys (Maynard and Hodge 1949; Maynard et al. 1953). In contrast, regeneration was observed in the first month of the exposure to 660 mg U/kg/day, however, with continued exposure, tubular atrophy was observed at 6–8 weeks. The severity of the atrophy and the areas of the kidney affected by uranium increased with duration. Given these data on the ability of the kidney to repair renal damage at low doses, the intermediate-duration oral MRL may be protective for chronic exposures.

Agency Contacts (Chemical Managers): Sam Keith, Obaid Faroon, Nickolette Roney, Franco Scinicariello, Sharon Wilbur

## APPENDIX B. USER'S GUIDE

### Chapter 1

#### Public Health Statement

This chapter of the profile is a health effects summary written in non-technical language. Its intended audience is the general public, especially people living in the vicinity of a hazardous waste site or chemical release. If the Public Health Statement were removed from the rest of the document, it would still communicate to the lay public essential information about the chemical.

The major headings in the Public Health Statement are useful to find specific topics of concern. The topics are written in a question and answer format. The answer to each question includes a sentence that will direct the reader to chapters in the profile that will provide more information on the given topic.

### Chapter 2

#### Relevance to Public Health

This chapter provides a health effects summary based on evaluations of existing toxicologic, epidemiologic, and toxicokinetic information. This summary is designed to present interpretive, weight-of-evidence discussions for human health end points by addressing the following questions:

1. What effects are known to occur in humans?
2. What effects observed in animals are likely to be of concern to humans?
3. What exposure conditions are likely to be of concern to humans, especially around hazardous waste sites?

The chapter covers end points in the same order that they appear within the Discussion of Health Effects by Route of Exposure section, by route (inhalation, oral, and dermal) and within route by effect. Human data are presented first, then animal data. Both are organized by duration (acute, intermediate, chronic). *In vitro* data and data from parenteral routes (intramuscular, intravenous, subcutaneous, etc.) are also considered in this chapter.

The carcinogenic potential of the profiled substance is qualitatively evaluated, when appropriate, using existing toxicokinetic, genotoxic, and carcinogenic data. ATSDR does not currently assess cancer potency or perform cancer risk assessments. Minimal Risk Levels (MRLs) for noncancer end points (if derived) and the end points from which they were derived are indicated and discussed.

Limitations to existing scientific literature that prevent a satisfactory evaluation of the relevance to public health are identified in the Chapter 3 Data Needs section.

#### Interpretation of Minimal Risk Levels

Where sufficient toxicologic information is available, ATSDR has derived MRLs for inhalation and oral routes of entry at each duration of exposure (acute, intermediate, and chronic). These MRLs are not meant to support regulatory action, but to acquaint health professionals with exposure levels at which adverse health effects are not expected to occur in humans.

## APPENDIX B

MRLs should help physicians and public health officials determine the safety of a community living near a chemical emission, given the concentration of a contaminant in air or the estimated daily dose in water. MRLs are based largely on toxicological studies in animals and on reports of human occupational exposure.

MRL users should be familiar with the toxicologic information on which the number is based. Chapter 2, "Relevance to Public Health," contains basic information known about the substance. Other sections such as Chapter 3 Section 3.9, "Interactions with Other Substances," and Section 3.10, "Populations that are Unusually Susceptible" provide important supplemental information.

MRL users should also understand the MRL derivation methodology. MRLs are derived using a modified version of the risk assessment methodology that the Environmental Protection Agency (EPA) provides (Barnes and Dourson 1988) to determine reference doses (RfDs) for lifetime exposure.

To derive an MRL, ATSDR generally selects the most sensitive end point which, in its best judgement, represents the most sensitive human health effect for a given exposure route and duration. ATSDR cannot make this judgement or derive an MRL unless information (quantitative or qualitative) is available for all potential systemic, neurological, and developmental effects. If this information and reliable quantitative data on the chosen end point are available, ATSDR derives an MRL using the most sensitive species (when information from multiple species is available) with the highest no-observed-adverse-effect level (NOAEL) that does not exceed any adverse effect levels. When a NOAEL is not available, a lowest-observed-adverse-effect level (LOAEL) can be used to derive an MRL, and an uncertainty factor (UF) of 10 must be employed. Additional uncertainty factors of 10 must be used both for human variability to protect sensitive subpopulations (people who are most susceptible to the health effects caused by the substance) and for interspecies variability (extrapolation from animals to humans). In deriving an MRL, these individual uncertainty factors are multiplied together. The product is then divided into the inhalation concentration or oral dosage selected from the study. Uncertainty factors used in developing a substance-specific MRL are provided in the footnotes of the levels of significant exposure (LSE) tables.

## **Chapter 3**

### **Health Effects**

#### **Tables and Figures for Levels of Significant Exposure (LSE)**

Tables and figures are used to summarize health effects and illustrate graphically levels of exposure associated with those effects. These levels cover health effects observed at increasing dose concentrations and durations, differences in response by species, MRLs to humans for noncancer end points, and EPA's estimated range associated with an upper-bound individual lifetime cancer risk of 1 in 10,000 to 1 in 10,000,000. Use the LSE tables and figures for a quick review of the health effects and to locate data for a specific exposure scenario. The LSE tables and figures should always be used in conjunction with the text. All entries in these tables and figures represent studies that provide reliable, quantitative estimates of NOAELs, LOAELs, or Cancer Effect Levels (CELs).

The legends presented below demonstrate the application of these tables and figures. Representative examples of LSE Table 3-1 and Figure 3-1 are shown. The numbers in the left column of the legends correspond to the numbers in the example table and figure.

## APPENDIX B

**LEGEND****See Sample LSE Table 3-1 (page B-6)**

- (1) Route of Exposure. One of the first considerations when reviewing the toxicity of a substance using these tables and figures should be the relevant and appropriate route of exposure. Typically when sufficient data exist, three LSE tables and two LSE figures are presented in the document. The three LSE tables present data on the three principal routes of exposure, i.e., inhalation, oral, and dermal (LSE Tables 3-1, 3-2, and 3-3, respectively). LSE figures are limited to the inhalation (LSE Figure 3-1) and oral (LSE Figure 3-2) routes. Not all substances will have data on each route of exposure and will not, therefore, have all five of the tables and figures.
- (2) Exposure Period. Three exposure periods—acute (less than 15 days), intermediate (15–364 days), and chronic (365 days or more)—are presented within each relevant route of exposure. In this example, an inhalation study of intermediate exposure duration is reported. For quick reference to health effects occurring from a known length of exposure, locate the applicable exposure period within the LSE table and figure.
- (3) Health Effect. The major categories of health effects included in LSE tables and figures are death, systemic, immunological, neurological, developmental, reproductive, and cancer. NOAELs and LOAELs can be reported in the tables and figures for all effects but cancer. Systemic effects are further defined in the "System" column of the LSE table (see key number 18).
- (4) Key to Figure. Each key number in the LSE table links study information to one or more data points using the same key number in the corresponding LSE figure. In this example, the study represented by key number 18 has been used to derive a NOAEL and a Less Serious LOAEL (also see the two "18r" data points in sample Figure 3-1).
- (5) Species. The test species, whether animal or human, are identified in this column. Chapter 2, "Relevance to Public Health," covers the relevance of animal data to human toxicity and Section 3.4, "Toxicokinetics," contains any available information on comparative toxicokinetics. Although NOAELs and LOAELs are species specific, the levels are extrapolated to equivalent human doses to derive an MRL.
- (6) Exposure Frequency/Duration. The duration of the study and the weekly and daily exposure regimens are provided in this column. This permits comparison of NOAELs and LOAELs from different studies. In this case (key number 18), rats were exposed to "Chemical x" via inhalation for 6 hours/day, 5 days/week, for 13 weeks. For a more complete review of the dosing regimen, refer to the appropriate sections of the text or the original reference paper (i.e., Nitschke et al. 1981).
- (7) System. This column further defines the systemic effects. These systems include respiratory, cardiovascular, gastrointestinal, hematological, musculoskeletal, hepatic, renal, and dermal/ocular. "Other" refers to any systemic effect (e.g., a decrease in body weight) not covered in these systems. In the example of key number 18, one systemic effect (respiratory) was investigated.
- (8) NOAEL. A NOAEL is the highest exposure level at which no harmful effects were seen in the organ system studied. Key number 18 reports a NOAEL of 3 ppm for the respiratory system, which was used to derive an intermediate exposure, inhalation MRL of 0.005 ppm (see footnote "b").

## APPENDIX B

- (9) LOAEL. A LOAEL is the lowest dose used in the study that caused a harmful health effect. LOAELs have been classified into "Less Serious" and "Serious" effects. These distinctions help readers identify the levels of exposure at which adverse health effects first appear and the gradation of effects with increasing dose. A brief description of the specific end point used to quantify the adverse effect accompanies the LOAEL. The respiratory effect reported in key number 18 (hyperplasia) is a Less Serious LOAEL of 10 ppm. MRLs are not derived from Serious LOAELs.
- (10) Reference. The complete reference citation is given in Chapter 9 of the profile.
- (11) CEL. A CEL is the lowest exposure level associated with the onset of carcinogenesis in experimental or epidemiologic studies. CELs are always considered serious effects. The LSE tables and figures do not contain NOAELs for cancer, but the text may report doses not causing measurable cancer increases.
- (12) Footnotes. Explanations of abbreviations or reference notes for data in the LSE tables are found in the footnotes. Footnote "b" indicates that the NOAEL of 3 ppm in key number 18 was used to derive an MRL of 0.005 ppm.

**LEGEND****See Sample Figure 3-1 (page B-7)**

LSE figures graphically illustrate the data presented in the corresponding LSE tables. Figures help the reader quickly compare health effects according to exposure concentrations for particular exposure periods.

- (13) Exposure Period. The same exposure periods appear as in the LSE table. In this example, health effects observed within the acute and intermediate exposure periods are illustrated.
- (14) Health Effect. These are the categories of health effects for which reliable quantitative data exists. The same health effects appear in the LSE table.
- (15) Levels of Exposure. Concentrations or doses for each health effect in the LSE tables are graphically displayed in the LSE figures. Exposure concentration or dose is measured on the log scale "y" axis. Inhalation exposure is reported in mg/m<sup>3</sup> or ppm and oral exposure is reported in mg/kg/day.
- (16) NOAEL. In this example, the open circle designated 18r identifies a NOAEL critical end point in the rat upon which an intermediate inhalation exposure MRL is based. The key number 18 corresponds to the entry in the LSE table. The dashed descending arrow indicates the extrapolation from the exposure level of 3 ppm (see entry 18 in the table) to the MRL of 0.005 ppm (see footnote "b" in the LSE table).
- (17) CEL. Key number 38m is one of three studies for which CELs were derived. The diamond symbol refers to a CEL for the test species-mouse. The number 38 corresponds to the entry in the LSE table.



## APPENDIX B

- (18) Estimated Upper-Bound Human Cancer Risk Levels. This is the range associated with the upper-bound for lifetime cancer risk of 1 in 10,000 to 1 in 10,000,000. These risk levels are derived from the EPA's Human Health Assessment Group's upper-bound estimates of the slope of the cancer dose response curve at low dose levels ( $q_1^*$ ).
- (19) Key to LSE Figure. The Key explains the abbreviations and symbols used in the figure.

## SAMPLE

1 →

Table 3-1. Levels of Significant Exposure to [Chemical x] – Inhalation

	Key to figure <sup>a</sup>	Species	Exposure frequency/ duration	System	NOAEL (ppm)	LOAEL (effect)		Reference
						Less serious (ppm)	Serious (ppm)	
2 →	INTERMEDIATE EXPOSURE							
		5	6	7	8	9		10
3 →	Systemic	↓	↓	↓	↓	↓		↓
4 →	18	Rat	13 wk 5 d/wk 6 hr/d	Resp	3 <sup>b</sup>	10 (hyperplasia)		Nitschke et al. 1981
	CHRONIC EXPOSURE							
	Cancer						11	
							↓	
	38	Rat	18 mo 5 d/wk 7 hr/d			20	(CEL, multiple organs)	Wong et al. 1982
	39	Rat	89–104 wk 5 d/wk 6 hr/d			10	(CEL, lung tumors, nasal tumors)	NTP 1982
	40	Mouse	79–103 wk 5 d/wk 6 hr/d			10	(CEL, lung tumors, hemangiosarcomas)	NTP 1982

12 →

<sup>a</sup> The number corresponds to entries in Figure 3-1.<sup>b</sup> Used to derive an intermediate inhalation Minimal Risk Level (MRL) of  $5 \times 10^{-3}$  ppm; dose adjusted for intermittent exposure and divided by an uncertainty factor of 100 (10 for extrapolation from animal to humans, 10 for human variability).

# SAMPLE

Figure 3-1. Levels of Significant Exposure to [Chemical X] - Inhalation

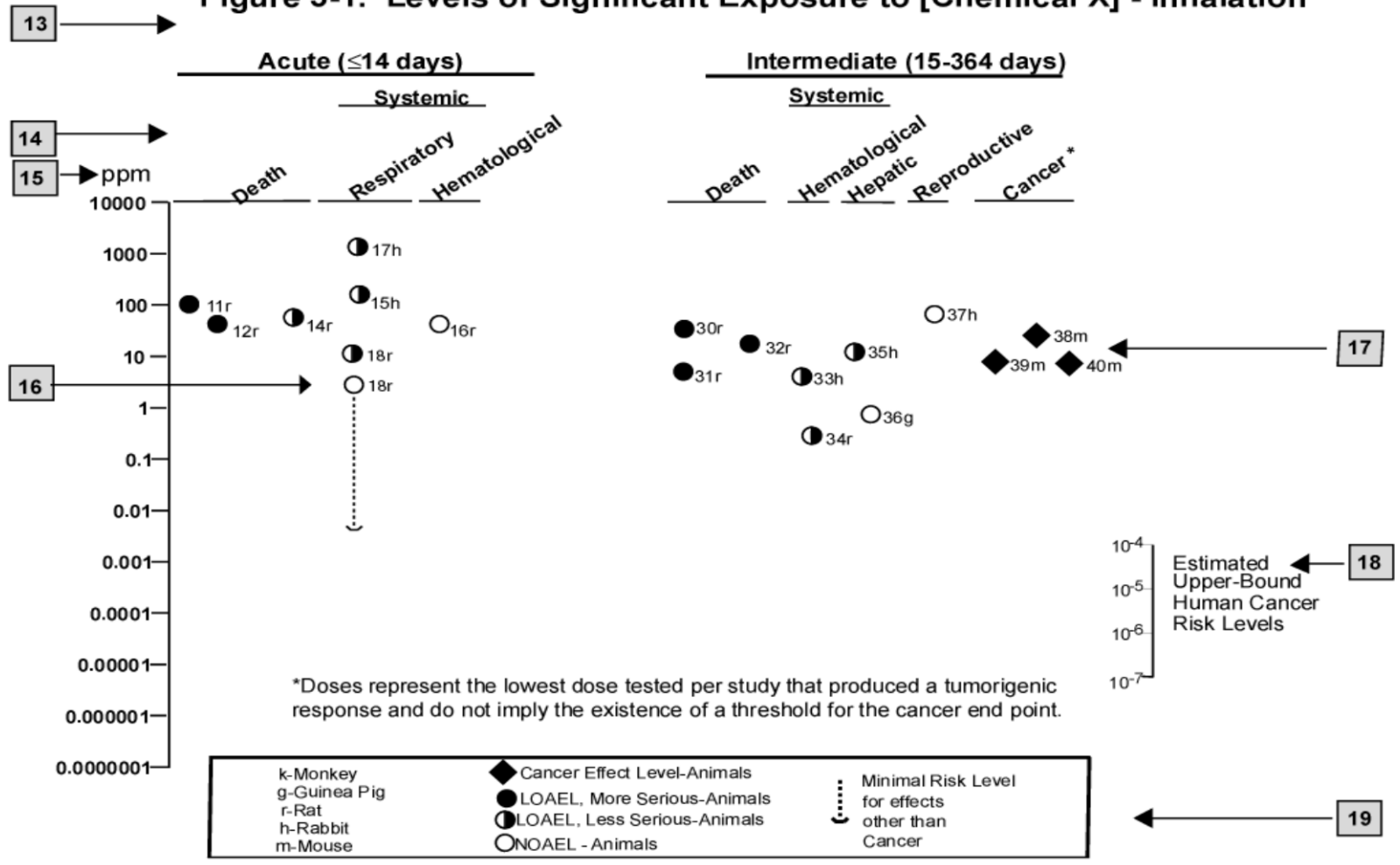

APPENDIX B

This page is intentionally blank.

## APPENDIX C. ACRONYMS, ABBREVIATIONS, AND SYMBOLS

ACGIH	American Conference of Governmental Industrial Hygienists
ACOEM	American College of Occupational and Environmental Medicine
ADI	acceptable daily intake
ADME	absorption, distribution, metabolism, and excretion
AED	atomic emission detection
AFID	alkali flame ionization detector
AFOSH	Air Force Office of Safety and Health
ALT	alanine aminotransferase
AMAD	activity median aerodynamic diameter
AML	acute myeloid leukemia
AOAC	Association of Official Analytical Chemists
AOEC	Association of Occupational and Environmental Clinics
AP	alkaline phosphatase
APHA	American Public Health Association
AST	aspartate aminotransferase
atm	atmosphere
ATSDR	Agency for Toxic Substances and Disease Registry
AWQC	Ambient Water Quality Criteria
BAT	best available technology
BCF	bioconcentration factor
BEI	Biological Exposure Index
BMC	benchmark concentration
BMCL	lower 95% confidence limit on the BMC
BMCL <sub>05</sub>	BMCL associated with a BMR of 5%
BMCL <sub>10</sub>	BMCL associated with a BMR of 10%
BMD	benchmark dose
BMDL	lower 95% confidence limit on the BMD
BMDL <sub>05</sub>	BMDCL associated with a BMR of 5%
BMDL <sub>10</sub>	BMDCL associated with a BMR of 10%
BMR	benchmark response
BSC	Board of Scientific Counselors
BUN	blood urea nitrogen
C	centigrade
CAA	Clean Air Act
CAG	Cancer Assessment Group of the U.S. Environmental Protection Agency
CAS	Chemical Abstract Services
CDC	Centers for Disease Control and Prevention
CEL	cancer effect level
CELDS	Computer-Environmental Legislative Data System
CERCLA	Comprehensive Environmental Response, Compensation, and Liability Act
CFR	Code of Federal Regulations
Ci	curie
CI	confidence interval
CL	ceiling limit value
CLP	Contract Laboratory Program
cm	centimeter
CML	chronic myeloid leukemia
CPSC	Consumer Products Safety Commission
CWA	Clean Water Act

## APPENDIX C

DHHS	Department of Health and Human Services
DNA	deoxyribonucleic acid
DOD	Department of Defense
DOE	Department of Energy
DOL	Department of Labor
DOT	Department of Transportation
DOT/UN/ NA/IMCO	Department of Transportation/United Nations/ North America/Intergovernmental Maritime Dangerous Goods Code
DWEL	drinking water exposure level
ECD	electron capture detection
ECG/EKG	electrocardiogram
EEG	electroencephalogram
EEGL	Emergency Exposure Guidance Level
EPA	Environmental Protection Agency
F	Fahrenheit
F <sub>1</sub>	first-filial generation
FAO	Food and Agricultural Organization of the United Nations
FDA	Food and Drug Administration
FEMA	Federal Emergency Management Agency
FIFRA	Federal Insecticide, Fungicide, and Rodenticide Act
FPD	flame photometric detection
fpm	feet per minute
FR	Federal Register
FSH	follicle stimulating hormone
g	gram
GC	gas chromatography
gd	gestational day
GLC	gas liquid chromatography
GPC	gel permeation chromatography
HPLC	high-performance liquid chromatography
HRGC	high resolution gas chromatography
HSDB	Hazardous Substance Data Bank
IARC	International Agency for Research on Cancer
IDLH	immediately dangerous to life and health
ILO	International Labor Organization
IRIS	Integrated Risk Information System
K <sub>d</sub>	adsorption ratio
kg	kilogram
kkg	metric ton
K <sub>oc</sub>	organic carbon partition coefficient
K <sub>ow</sub>	octanol-water partition coefficient
L	liter
LC	liquid chromatography
LC <sub>50</sub>	lethal concentration, 50% kill
LC <sub>Lo</sub>	lethal concentration, low
LD <sub>50</sub>	lethal dose, 50% kill
LD <sub>Lo</sub>	lethal dose, low
LDH	lactic dehydrogenase
LH	lutinizing hormone
LOAEL	lowest-observed-adverse-effect level
LSE	Levels of Significant Exposure

## APPENDIX C

LT <sub>50</sub>	lethal time, 50% kill
m	meter
MA	<i>trans,trans</i> -muconic acid
MAL	maximum allowable level
mCi	millicurie
MCL	maximum contaminant level
MCLG	maximum contaminant level goal
MF	modifying factor
MFO	mixed function oxidase
mg	milligram
mL	milliliter
mm	millimeter
mmHg	millimeters of mercury
mmol	millimole
mppcf	millions of particles per cubic foot
MRL	Minimal Risk Level
MS	mass spectrometry
NAAQS	National Ambient Air Quality Standard
NAS	National Academy of Science
NATICH	National Air Toxics Information Clearinghouse
NATO	North Atlantic Treaty Organization
NCE	normochromatic erythrocytes
NCEH	National Center for Environmental Health
NCI	National Cancer Institute
ND	not detected
NFPA	National Fire Protection Association
ng	nanogram
NHANES	National Health and Nutrition Examination Survey
NIEHS	National Institute of Environmental Health Sciences
NIOSH	National Institute for Occupational Safety and Health
NIOSHTIC	NIOSH's Computerized Information Retrieval System
NLM	National Library of Medicine
nm	nanometer
nmol	nanomole
NOAEL	no-observed-adverse-effect level
NOES	National Occupational Exposure Survey
NOHS	National Occupational Hazard Survey
NPD	nitrogen phosphorus detection
NPDES	National Pollutant Discharge Elimination System
NPL	National Priorities List
NPN	blood nonprotein nitrogen
NR	not reported
NRC	National Research Council
NS	not specified
NSPS	New Source Performance Standards
NTIS	National Technical Information Service
NTP	National Toxicology Program
ODW	Office of Drinking Water, EPA
OERR	Office of Emergency and Remedial Response, EPA
OHM/TADS	Oil and Hazardous Materials/Technical Assistance Data System
OPP	Office of Pesticide Programs, EPA

## APPENDIX C

OPPT	Office of Pollution Prevention and Toxics, EPA
OPPTS	Office of Prevention, Pesticides and Toxic Substances, EPA
OR	odds ratio
OSHA	Occupational Safety and Health Administration
OSW	Office of Solid Waste, EPA
OTS	Office of Toxic Substances
OW	Office of Water
OWRS	Office of Water Regulations and Standards, EPA
PAH	polycyclic aromatic hydrocarbon
PBPD	physiologically based pharmacodynamic
PBPK	physiologically based pharmacokinetic
PCE	polychromatic erythrocytes
PEL	permissible exposure limit
pg	picogram
PHS	Public Health Service
PID	photo ionization detector
pmol	picomole
PMR	proportionate mortality ratio
ppb	parts per billion
ppm	parts per million
ppt	parts per trillion
PSNS	pretreatment standards for new sources
RBC	red blood cell
REL	recommended exposure level/limit
RfC	reference concentration
RfD	reference dose
RNA	ribonucleic acid
RQ	reportable quantity
RTECS	Registry of Toxic Effects of Chemical Substances
SARA	Superfund Amendments and Reauthorization Act
SCE	sister chromatid exchange
SGOT	serum glutamic oxaloacetic transaminase
SGPT	serum glutamic pyruvic transaminase
SIC	standard industrial classification
SIM	selected ion monitoring
SMCL	secondary maximum contaminant level
SMR	standardized mortality ratio
SNARL	suggested no adverse response level
SPEGL	Short-Term Public Emergency Guidance Level
STEL	short term exposure limit
STORET	Storage and Retrieval
TD <sub>50</sub>	toxic dose, 50% specific toxic effect
TLV	threshold limit value
TOC	total organic carbon
TPQ	threshold planning quantity
TRI	Toxics Release Inventory
TSCA	Toxic Substances Control Act
TWA	time-weighted average
UF	uncertainty factor
U.S.	United States
USDA	United States Department of Agriculture



## APPENDIX C

USGS	United States Geological Survey
VOC	volatile organic compound
WBC	white blood cell
WHO	World Health Organization
>	greater than
≥	greater than or equal to
=	equal to
<	less than
≤	less than or equal to
%	percent
α	alpha
β	beta
γ	gamma
δ	delta
μm	micrometer
μg	microgram
q <sub>1</sub> *	cancer slope factor
-	negative
+	positive
(+)	weakly positive result
(-)	weakly negative result

APPENDIX C

This page is intentionally blank.

## APPENDIX D

### OVERVIEW OF BASIC RADIATION PHYSICS, CHEMISTRY, AND BIOLOGY

Understanding the basic concepts in radiation physics, chemistry, and biology is important to the evaluation and interpretation of radiation-induced adverse health effects and to the derivation of radiation protection principles. This appendix presents a brief overview of the areas of radiation physics, chemistry, and biology and is based to a large extent on the reviews of Mettler and Moseley (1985), Hobbs and McClellan (1986), Eichholz (1982), Hendeel (1973), Cember (1996, 2009), and Early et al. (1979).

#### D.1 RADIONUCLIDES AND RADIOACTIVITY

The substances we call elements are composed of atoms. Atoms in turn are made up of neutrons, protons and electrons: neutrons and protons in the nucleus and electrons in a cloud of orbits around the nucleus. Nuclide is the general term referring to any nucleus along with its orbital electrons. The nuclide is characterized by the composition of its nucleus and hence by the number of protons and neutrons in the nucleus. All atoms of an element have the same number of protons (this is given by the atomic number) but may have different numbers of neutrons (this is reflected by the atomic mass numbers or atomic weight of the element). Atoms with different atomic mass but the same atomic numbers are referred to as isotopes of an element.

The numerical combination of protons and neutrons in most nuclides is such that the nucleus is quantum mechanically stable and the atom is said to be stable, i.e., not radioactive; however, if there are too few or too many neutrons, the nucleus is unstable and the atom is said to be radioactive. Unstable nuclides undergo radioactive transformation, a process in which a neutron or proton converts into the other and a beta particle is emitted, or else an alpha particle is emitted. Each type of decay is typically accompanied by the emission of gamma rays. These unstable atoms are called radionuclides; their emissions are called ionizing radiation; and the whole property is called radioactivity. Transformation or decay results in the formation of new nuclides some of which may themselves be radionuclides, while others are stable nuclides. This series of transformations is called the decay chain of the radionuclide. The first radionuclide in the chain is called the parent; the subsequent products of the transformation are called progeny, daughters, or decay products.

In general there are two classifications of radioactivity and radionuclides: natural and artificial (man-made). Naturally-occurring radioactive material (NORM) exists in nature and no additional energy is necessary to place them in an unstable state. Natural radioactivity is the property of some naturally occurring, usually heavy elements, that are heavier than lead. Radionuclides, such as radium and uranium, primarily emit alpha particles. Some lighter elements such as carbon-14 and tritium (hydrogen-3) primarily emit beta particles as they transform to a more stable atom. Natural radioactive atoms heavier than lead cannot attain a stable nucleus heavier than lead. Everyone is exposed to background radiation from naturally-occurring radionuclides throughout life. This background radiation is the major source of radiation exposure to man and arises from several sources. The natural background exposures are frequently used as a standard of comparison for exposures to various artificial sources of ionizing radiation.

Artificial radioactive atoms are produced either as a by-product of fission of uranium or plutonium atoms in a nuclear reactor or by bombarding atoms with particles (such as neutrons, protons, or heavy nuclei) at high velocity via a particle accelerator. Goals of these efforts can include producing medical isotopes or new elements. These artificially produced radioactive elements usually decay by emission of particles, such as alpha particles, positive or negative beta particles, and one or more high energy photons (gamma rays). Unstable (radioactive) atoms of any element can be produced.

Both naturally occurring and artificial radioisotopes find application in medicine, industrial products, and consumer products. Some specific radioisotopes, called fall-out, are still found in the environment as a result of nuclear weapons use or testing, or nuclear power plant accidents (e.g., Three Mile Island Unit 2, Chernobyl, and Fukushima Dai-ichi).

## D.2 RADIOACTIVE DECAY

### D.2.1 Principles of Radioactive Decay

The stability of an atom is the result of the balance of the forces of the various components of the nucleus. An atom that is unstable (a radionuclide) will release energy (decay) in various ways and transform to stable atoms or to intermediate radioactive species called progeny or daughters, often with the release of ionizing radiation. If there are either too many or too few neutrons for a given number of protons, the resulting nucleus may undergo transformation. For some elements, a chain of progeny decay products may be produced until stable atoms are formed. Radionuclides can be characterized by the type and energy of the radiation emitted, the rate of decay, and the mode of decay. The mode of decay indicates how a parent compound undergoes transformation. Radiations considered here are primarily of nuclear origin, i.e., they arise from nuclear excitation, usually caused by the capture of charged or uncharged nucleons by a nucleus, or by the radioactive decay or transformation of an unstable nuclide. The type of radiation may be categorized as charged or uncharged particles, protons, and fission products) or electromagnetic radiation (gamma rays and x rays). Table D-1 summarizes the basic characteristics of the more common types of radiation encountered.

### D.2.2 Half-Life and Activity

For any given radionuclide, the rate of decay is a first-order process that is constant, regardless of the radioactive atoms present and is characteristic for each radionuclide. The process of decay is a series of random events; temperature, pressure, or chemical combinations do not affect the rate of decay. While it may not be possible to predict exactly which atom is going to undergo transformation at any given time, it is possible to predict, on average, the fraction of the radioactive atoms that will transform during any interval of time.

The *activity* is a measure of the quantity of radioactive material. For these radioactive materials it is customary to describe the activity as the number of disintegrations (transformations) per unit time. The unit of activity is the curie (Ci), which was originally related to the activity of one gram of radium, but is now defined as the disintegration or transformation rate occurring in a quantity of radioactive material. The definition is:

$$\begin{aligned} 1 \text{ curie (Ci)} &= 3.7 \times 10^{10} \text{ disintegrations (transformations)/second (dps) or} \\ &= 2.22 \times 10^{12} \text{ disintegrations (transformations)/minute (dpm).} \end{aligned}$$

The SI unit of activity is the becquerel (Bq); 1 Bq = that quantity of radioactive material in which there is 1 transformation/second. Since activity is proportional to the number of atoms of the radioactive material, the quantity of any radioactive material is usually expressed in curies, regardless of its purity or concentration. The transformation of radioactive nuclei is a random process, and the number of transformations is directly proportional to the number of radioactive atoms present. For any pure radioactive substance, the rate of decay is usually described by its radiological half-life,  $t_{1/2}$ , i.e., the time it takes for a specified source material to decay to half its initial activity. The specific activity is an indirect measure of the rate of decay, and is defined as the activity per unit mass or per unit volume. The higher the specific activity of a radioisotope, the faster it is decaying.

The activity of a radionuclide at time  $t$  may be calculated by:

$$A = A_0 e^{-0.693t/t_{1/2}}$$

where  $A$  = the activity in dps or curies or becquerels,

$A_0$  = the activity at time zero,

$t$  = the time at which measured, and

$t_{1/2}$  = the radiological half-life of the radionuclide ( $t_{1/2}$  and  $t$  must be in the same units of time).

The time when the activity of a sample of radioactivity becomes one-half its original value is the radioactive half-life and is expressed in any suitable unit of time.

## APPENDIX D

**Table D-1. Characteristics of Nuclear Radiations**

Radiation	Rest mass <sup>a</sup>	Charge	Typical energy range	Path length <sup>b</sup>		Comments
				Air	Solid	
Alpha ( $\alpha$ )	4.00 amu	+2	4–10 MeV	5–10 cm	25–80 $\mu$ m	Identical to ionized He nucleus
Negatron ( $\beta^-$ )	5.48x10 <sup>-4</sup> amu; 0.51 MeV	-1	0–4 MeV	0–10 m	0–1 cm	Identical to electron
Positron ( $\beta^+$ )	5.48x10 <sup>-4</sup> amu; 0.51 MeV	+1	0–4 MeV	0–10 m	0–1 cm	Identical to electron except for sign of charge
Neutron	1.00866 amu; 939.565 MeV	0	0–15 MeV	b	b	Half life: 10.183 min
X ray (e.m. photon)	–	0	5 keV–100 keV	b	b	Photon from transition of an electron between atomic orbits
Gamma ( $\gamma$ ) (e.m. photon)	–	0	10 keV–3 MeV	b	b	Photon from nuclear transformation

<sup>a</sup> The rest mass (in amu) has an energy equivalent in MeV that is obtained using the equation  $E=mc^2$ , where 1 amu = 932 MeV.

<sup>b</sup> Path lengths are not applicable to x- and gamma rays since their intensities decrease exponentially; path lengths in solid tissue are variable, depending on particle energy, electron density of material, and other factors.

amu = atomic mass unit; e.m. = electromagnetic; MeV = MegaElectron Volts

The specific activity is a measure of activity, and is defined as the activity per unit mass or per unit volume. This activity is usually expressed in curies per gram and may be calculated by

$$\text{curies/gram} = 1.3 \times 10^8 / (t_{1/2}) (\text{atomic weight}) \quad \text{or} \\ [3.577 \times 10^5 \times \text{mass(g)}] / [t_{1/2} \times \text{atomic weight}]$$

where  $t_{1/2}$  = the radiological half-life in days.

In the case of radioactive materials contained in living organisms, an additional consideration is made for the reduction in observed activity due to regular processes of elimination of the respective chemical or biochemical substance from the organism. This introduces a rate constant called the biological half-life ( $t_b$ ) which is the time required for biological processes to eliminate one-half of the activity. This time is virtually the same for both stable and radioactive isotopes of any given element.

Under such conditions the time required for a radioactive element to be halved as a result of the combined action of radioactive decay and biological elimination is the effective clearance half-time:

$$t_{\text{eff}} = (t_b \times t_{1/2}) / (t_b + t_{1/2}).$$

Table D-2 presents representative effective half-lives of particular interest.

## APPENDIX D

**Table D-2. Half-Lives of Some Radionuclides in Adult Body Organs**

Radionuclide	Critical organ	Half-life <sup>a</sup>		
		Physical	Biological	Effective
Uranium 238	Kidney	4,460,000,000 y	4 d	4 d
Hydrogen 3 <sup>b</sup> (Tritium)	Whole body	12.3 y	10 d	10 d
Iodine 131	Thyroid	8 d	80 d	7.3 d
Strontium 90	Bone	28 y	50 y	18 y
Plutonium 239	Bone surface	24,400 y	50 y	50 y
	Lung	24,400 y	500 d	500 d
Cobalt 60	Whole body	5.3 y	99.5 d	95 d
Iron 55	Spleen	2.7 y	600 d	388 d
Iron 59	Spleen	45.1 d	600 d	42 d
Manganese 54	Liver	303 d	25 d	23 d
Cesium 137	Whole body	30 y	70 d	70 d

<sup>a</sup>d = days, y = years<sup>b</sup>Mixed in body water as tritiated water

### D.2.3 Interaction of Radiation with Matter

Both ionizing and nonionizing radiation will interact with materials; that is, radiation will lose kinetic energy to any solid, liquid or gas through which it passes by a variety of mechanisms. The transfer of energy to a medium by either electromagnetic or particulate radiation may be sufficient to cause formation of ions. This process is called ionization. Compared to other types of radiation that may be absorbed, such as radio waves or microwave radiation, ionizing radiation deposits a relatively large amount of energy into a small volume.

The method by which incident radiation interacts with the medium to cause ionization may be direct or indirect. Electromagnetic radiations (x rays and gamma photons) and neutral particles (neutrons) are indirectly ionizing; that is, they give up their energy in various interactions with cellular molecules, and the energy is then utilized to produce a fast-moving charged particle such as an electron. It is the electron that then may react with and transfer energy to a target molecule. This particle is called a "primary ionizing particle. Charged particles, in contrast, strike the tissue or medium and directly react with target molecules, such as oxygen or water. These particulate radiations are directly ionizing radiations. Examples of directly ionizing particles include alpha and beta particles. Indirectly ionizing radiations are always more penetrating than directly ionizing particulate radiations.

Mass, charge, and velocity of a particle, as well as the electron density of the material with which it interacts, all affect the rate at which ionization occurs. The higher the charge of the particle and the lower the velocity, the greater the propensity to cause ionization. Heavy, highly charged particles, such as alpha particles, lose energy rapidly with distance and, therefore, do not penetrate deeply. The result of these interaction processes is a gradual slowing down of any incident particle until it is brought to rest or "stopped" at the end of its range.

### D.2.4 Characteristics of Emitted Radiation

**D.2.4.1 Alpha Emission.** In alpha emission, an alpha particle consisting of two protons and two neutrons is emitted with a resulting decrease in the atomic mass number by four and reduction of the atomic number of two, thereby changing the parent to a different element. The alpha particle is identical to a helium nucleus consisting of two neutrons and two protons. It results from the radioactive decay of some heavy elements such as uranium, plutonium, radium, thorium, and radon. All alpha particles emitted by a given radioisotope have the same energy.

## APPENDIX D

Most of the alpha particles that are likely to be found have energies in the range of about 4 to 8 MeV, depending on the isotope from which they came.

The alpha particle has an electrical charge of +2. Because of this double positive charge and their size, alpha particles have great ionizing power and, thus, lose their kinetic energy quickly. This results in very little penetrating power. In fact, an alpha particle cannot penetrate a sheet of paper. The range of an alpha particle (the distance the charged particle travels from the point of origin to its resting point) is about 4 cm in air, which decreases considerably to a few micrometers in tissue. These properties cause alpha emitters to be hazardous only if there is internal contamination (i.e., if the radionuclide is inside the body).

**D.2.4.2 Beta Emission.** A beta particle ( $\beta$ ) is a high-velocity electron ejected from a disintegrating nucleus. The particle may be either a negatively charged electron, termed a negatron ( $\beta^Z$ ) or a positively charged electron, termed a positron ( $\beta^E$ ). Although the precise definition of "beta emission" refers to both  $\beta^Z$  and  $\beta^E$ , common usage of the term generally applies only to the negative particle, as distinguished from the positron emission, which refers to the  $\beta^E$  particle.

**D.2.4.2.1 Beta Negative Emission.** Beta particle ( $\beta^Z$ ) emission is another process by which a radionuclide, with a neutron excess achieves stability. Beta particle emission decreases the number of neutrons by one and increases the number of protons by one, while the atomic mass number remains unchanged.<sup>4</sup> This transformation results in the formation of a different element. The energy spectrum of beta particle emission ranges from a certain maximum down to zero with the mean energy of the spectrum being about one-third of the maximum. The range in tissue is much less. Beta negative emitting radionuclides can cause injury to the skin and superficial body tissues, but mostly present an internal contamination hazard.

**D.2.4.2.2 Positron Emission.** In cases in which there are too many protons in the nucleus, positron emission may occur. In this case a proton may be thought of as being converted into a neutron, and a positron ( $\beta^E$ ) is emitted.<sup>1</sup> This increases the number of neutrons by one, decreases the number of protons by one, and again leaves the atomic mass number unchanged. The gamma radiation resulting from the annihilation (see glossary) of the positron makes all positron emitting isotopes more of an external radiation hazard than pure  $\beta$  emitters of equal energy.

**D.2.4.2.3 Gamma Emission.** Radioactive decay by alpha, beta, or positron emission, or electron capture often leaves some of the energy resulting from these changes in the nucleus. As a result, the nucleus is raised to an excited level. None of these excited nuclei can remain in this high-energy state. Nuclei release this energy returning to ground state or to the lowest possible stable energy level. The energy released is in the form of gamma radiation (high energy photons) and has an energy equal to the change in the energy state of the nucleus. Gamma and x rays behave similarly but differ in their origin; gamma emissions originate in the nucleus while x rays originate in the orbital electron structure or from rapidly changing the velocity of an electron (e.g., as occurs when shielding high energy beta particles or stopping the electron beam in an x ray tube).

### D.3 ESTIMATION OF ENERGY DEPOSITION IN HUMAN TISSUES

Two forms of potential radiation exposures can result: internal and external. The term exposure denotes physical interaction of the radiation emitted from the radioactive material with cells and tissues of the human body. An exposure can be "acute" or "chronic" depending on how long an individual or organ is exposed to the radiation. Internal exposures occur when radionuclides, which have entered the body (e.g., through the inhalation, ingestion, or dermal pathways), undergo radioactive decay resulting in the deposition of energy to internal organs. External exposures occur when radiation enters the body directly from sources located outside the body, such as radiation emitters from radionuclides on ground surfaces, dissolved in water, or dispersed in the air. In general, external exposures are from material emitting gamma radiation, which readily penetrate the skin and internal organs. Beta and alpha radiation from external sources are far less penetrating and deposit their energy primarily on the skin's outer layer. Consequently, their contribution to the absorbed dose of the total body dose, compared to that deposited by gamma rays, may be negligible.

---

<sup>4</sup> Neutrinos accompany negative beta particle emissions; anti-neutrinos accompany positron emissions

## APPENDIX D

Characterizing the radiation dose to persons as a result of exposure to radiation is a complex issue. It is difficult to: (1) measure internally the amount of energy actually transferred to an organic material and to correlate any observed effects with this energy deposition; and (2) account for and predict secondary processes, such as collision effects or biologically triggered effects, that are an indirect consequence of the primary interaction event. Radiation exposure (a measure of ionization density in air) is sometimes used as a surrogate for radiation dose in tissue from external radiation. Both exposure and dose are described below.

**D.3.1 Exposure (Roentgen).** The roentgen (R) is a unit of x or gamma-ray exposure and is measured by the amount of ionization caused in air by gamma or x radiation. One roentgen produces  $2.58 \times 10^{-4}$  coulomb per kilogram of air. In the case of gamma radiation, over the commonly encountered range of photon energy, the energy deposition in tissue for an exposure of 1 R is about 0.0096 joules (J)/kg of tissue. Exposure is only defined for x and gamma radiation ionization in air, and is often incorrectly interchanged with the term dose.

**D.3.2 Absorbed Dose (Gy, rad) and Absorbed Dose Rate (Gy/hr, rad/hr).** The absorbed dose is defined as the energy absorbed from the incident radiation by a unit mass of the tissue or organ (dm). The differential equation for absorbed dose is:

$$D = de/dm$$

where: D = absorbed dose  
e = mean energy deposited  
m = mass in which the energy was deposited.

The SI unit of absorbed dose in any medium is the J/kg with the special name of Gray (Gy), where  $1 \text{ J/kg} = 10,000 \text{ ergs/gram} = 1 \text{ Gy}$ . In the historical system,  $0.01 \text{ J/kg} = 100 \text{ ergs/g} = 1 \text{ rad}$ , so  $1 \text{ Gy} = 100 \text{ rad}$ . For neutrons, the absorbed dose may be estimated using the similar metric, kinetic energy released in matter (kerma). Kerma is the sum of initial kinetic energies of all charged ionizing particles liberated in a unit mass.

Absorbed dose is a measurable quantity, so there are primary national and international standards for its determination. In practice, absorbed dose is averaged over organ or tissue volumes. This allows the absorbed dose from both external and internal sources of radiation to be added. For low doses, the acceptance of the linear no threshold (LNT) theory allows the correlation of dose with degree of adverse deterministic health effects. Radiation that does not penetrate tissue well (low energy x-rays, beta particles, and alpha particles) can produce a nonuniform distribution of absorbed dose resulting in differential health effects across an organ or tissue. An example is using shielding in radiation therapy so that a kidney tumor receives a lethal dose while sparing as much health tissue as practical, thus maximizing the remaining kidney function.

Internal and external absorbed doses delivered by radiation sources are not usually instantaneous but are distributed over extended periods of time. The resulting rate of change of the absorbed dose to a small volume of mass is referred to as the absorbed dose rate, which has units of Gy/unit time or rad/unit time.

As a rough conversion, an exposure of 1 R in air results in an absorbed dose to soft tissue of approximately 0.01 J/kg.

See text below on other units of measure.

## D.4 UNITS IN RADIATION PROTECTION AND REGULATION

### D.4.1 Equivalent Dose (or Dose Equivalent)

Equivalent dose (international term) and dose equivalent (US term) are a radiation protection quantity used for setting limits that help ensure that deterministic effects (e.g. damage to a particular tissue) are kept within acceptable levels. The SI unit of equivalent dose is the J/kg, has the special name of Sievert (Sv) or rem, and is abbreviated  $H_T$ . It is a special radiation protection quantity that is used, for administrative and radiation safety purposes only, to



## APPENDIX D

express the absorbed dose in a manner which considers the difference in biological effectiveness of various kinds of ionizing radiation. The equivalent dose concept is applicable only to doses that are not great enough to produce biomedical effects.

The equivalent dose in an organ or tissue ( $H_T$ ) is determined by multiplying the absorbed dose by a radiation weighting factor and any modifying factors at the location of interest. The absorbed dose in an organ or tissue from radiation of type R ( $D_{T,R}$ ) is a measurable or estimable quantity, while the radiation weighting factor ( $\omega_R$ ) for each primary radiation type ( $\omega_R$ ) has been studied and recommendations made for their values. The formula for calculating equivalent dose is:

$$H_T = \sum_R \omega_R D_{T,R} \text{ or } \sum_R Q_R D_{T,R}$$

Where  $\omega_R$  = radiation weighting factor,  
 $D_{T,R}$  = absorbed dose to tissue T from radiation type R, and  
 $Q_R$  = quality factor.

The radiation weighting factor ( $\omega$ ) or quality factor (Q) is a dimensionless quantity that depends in part on the stopping power for charged particles, and it accounts for the differences in biological effectiveness found among the types of radiation. Originally, relative biological effectiveness (RBE) was used rather than  $\omega$  or Q to define the quantity, rem, which is of use in risk assessment. The NRC and DOE in the US, and the ICRU and ICRP in most of the remaining international community have published values for quality factors and radiation weighting factors provided in Tables D-3 and D-4.

The equivalent dose rate (or dose equivalent rate in the US) is the time rate of change of the equivalent dose (or dose equivalent) to organs and tissues and is expressed as Sv/unit time (or rem/unit time).

**Table D-3. Recommended Values of Quality Factors and Radiation Weighting Factors**

Type of Radiation	Quality Factor	Radiation Weighting Factor ( $w_R$ )
	(NRC 2011)	(ICRP 2007)
Photons (x and $\gamma$ rays)	1	1
Electrons	1	
Electrons and muons		1
High energy protons	10	
Protons and charged pions		2
Alpha particles, multiple-charged particles, fission fragments and heavy particles of unknown charge	20	
Alpha particles, fission fragments, heavy ions		20
Neutrons of unknown energy	10	
Neutrons of known energy	See Table D-4	A continuous function of neutron energy (range 2.4-21; see equation)

## APPENDIX D

---

Source:

USNRC. 2011. Standards for the protection against radiation, tables 1004(b).1 and 1004(b).2. 10 CFR 20.1004. U.S. Nuclear Regulatory Commission, Washington, D.C.

ICRP

Radiation weighting factors for neutrons are based on particle energy according to the following formulas (ICRP 2007):

$$\omega_R = \begin{cases} 2.5 + 18.2e^{-\frac{\ln(E_n^2)}{5}}, & E_n < 1 \text{ MeV} \\ 5.0 + 17.0e^{-\frac{\ln(2E_n^2)}{5}}, & 1 \text{ MeV} \leq E_n \leq 50 \text{ MeV} \\ 2.5 + 3.25e^{-\frac{\ln(0.04E_n^2)}{5}}, & E_n > 50 \text{ MeV} \end{cases}$$

**Table D-4 Mean Quality Factors, Q, and Fluence per Unit Dose Equivalent for Monoenergetic Neutrons**

	Neutron energy (MeV)	Quality factor <sup>a</sup> (Q)	Fluence per unit dose equivalent <sup>b</sup> (neutrons cm <sup>-2</sup> rem <sup>-1</sup> )
(thermal)	2.5×10 <sup>-8</sup>	2	980×10 <sup>6</sup>
	1×10 <sup>-7</sup>	2	980×10 <sup>6</sup>
	1×10 <sup>-6</sup>	2	810×10 <sup>6</sup>
	1×10 <sup>-5</sup>	2	810×10 <sup>6</sup>
	1×10 <sup>-4</sup>	2	840×10 <sup>6</sup>
	1×10 <sup>-3</sup>	2	980×10 <sup>6</sup>
	1×10 <sup>-2</sup>	2.5	1010×10 <sup>6</sup>
	1×10 <sup>-1</sup>	7.5	170×10 <sup>6</sup>
	5×10 <sup>-1</sup>	11	39×10 <sup>6</sup>
	1	11	27×10 <sup>6</sup>
	2.5	9	29×10 <sup>6</sup>
	5	8	23×10 <sup>6</sup>
	7	7	24×10 <sup>6</sup>
	10	6.5	24×10 <sup>6</sup>
	14	7.5	17×10 <sup>6</sup>
	20	8	16×10 <sup>6</sup>
	40	7	14×10 <sup>6</sup>
	60	5.5	16×10 <sup>6</sup>
	1×10 <sup>2</sup>	4	20×10 <sup>6</sup>

## APPENDIX D

	$2 \times 10^2$	3.5	$19 \times 10^6$
	$3 \times 10^2$	3.5	$16 \times 10^6$
	$4 \times 10^2$	3.5	$14 \times 10^6$

### D.4.2 Relative Biological Effectiveness

RBE is used to denote the experimentally determined ratio of the absorbed dose from one radiation type to the absorbed dose of a reference radiation required to produce an identical biological effect under the same conditions. Gamma rays from cobalt-60, cesium-137, and 200–250 keV x-rays have been used as reference standards. The term RBE has been widely used in experimental radiobiology, and the term radiation weighting factor used in calculations of dose equivalent for radiation safety purposes (ICRP 2007; NCRP 1971; UNSCEAR 1982). RBE applies only to a specific biological end point, in a specific exposure, under specific conditions to a specific species. There are no generally accepted values of RBE.

### D.4.3 Effective Dose or Effective Dose Equivalent

In an attempt to compare stochastic (e.g., cancer) detriment from absorbed dose of radiation in a limited portion of the body with the detriment from total body dose, the ICRP (1977) derived a concept of effective dose equivalent. ICRP changed this term to effective dose in 1990 (ICRP 1990) and reintroduced the term “effective dose equivalent” in 2007 (ICRP 2007). The term “effective dose equivalent” allows for the addition or direct comparison of cancer and genetic risk from various partial or whole body doses. In the U.S., the term “effective dose equivalent” is presently used by the NRC (NRC 2011) and DOE.

The effective dose (or effective dose equivalent) approach was developed to overcome limitations in using absorbed dose as a metric of the stochastic impact of ionizing radiation. The absorbed dose is usually defined as the mean absorbed dose within an organ or tissue. This represents a simplification of the actual problem. Normally when an individual ingests or inhales a radionuclide or is exposed to external radiation that enters the body (gamma), the dose is not uniform throughout the whole body.

The simplifying assumption is that the detriment will be the same whether the body is uniformly or non-uniformly irradiated. This required the development of a tissue weighting factor, which represents the estimated proportion of the stochastic risk resulting from tissue, T, to the stochastic risk when the whole body is uniformly irradiated for occupational exposures under certain conditions (ICRP 1977).

The effective dose (or effective dose equivalent) ( $H_E$ ) is weighted for both the type of radiation (R) and the type of tissue (T), and has the formula:

$$H_E = \sum_T \omega_T H_T = \sum_T \omega_T \sum_R \omega_R D_{T,R}$$

where  $H_E$  = the effective dose (or effective dose equivalent) in tissue T,  
 $\omega_T$  = the tissue weighting factor in tissue T,  
 $H_T$  = the equivalent dose (or dose equivalent dose),  
 $\omega_R$  = the radiation weighting factor, and  
 $D_{T,R}$  = the absorbed dose from radiation R to tissue T.

Tissue weighting factors for selected tissues are listed in Table D-5.

## APPENDIX D

**Table D-5. Tissue Weighting Factors for Calculating Effective Dose (or Effective Dose Equivalent) for Selected Tissues**

Tissue	Tissue Weighting factor		
	NRC (2011) /ICRP26	NCRP115 and ICRP60	ICRP103
Bladder		0.05	0.04
Bone marrow (red)	0.12	0.12	0.12
Bone surface	0.03	0.01	0.01
Brain			0.01
Breast	0.15	0.05	0.12
Colon	–	0.12	0.12
Esophagus	–	0.05	0.04
Gonads	0.25	0.20	0.08
Liver	–	0.05	0.04
Lung	0.12	0.12	0.12
Salivary glands			0.01
Skin	–	0.01	0.01
Stomach	–	0.12	0.12
Thyroid	0.03	0.05	0.04
<b>Subtotal</b>	<b>0.70</b>	<b>0.95</b>	<b>0.88</b>
<i>Remainder</i>	0.30	0.05	0.12 <sup>a</sup>
<b>Total</b>	<b>1.00</b>	<b>1.00</b>	<b>1.00</b>

ICRP60 = International Commission on Radiological Protection, 1990 Recommendations of the ICRP  
 NCRP115 = National Council on Radiation Protection and Measurements. 1993. Risk Estimates for Radiation Protection, Report 115. Bethesda, Maryland

NRC = Nuclear Regulatory Commission, Title 10, Code of Federal Regulations, Part 20

<sup>a</sup>ICRP Publication 103 remainder tissues include adrenals, extrathoracic (ET) region, gall bladder, heart, kidneys, lymphatic nodes, muscle, oral mucosa, pancreas, prostate, small intestine, spleen, thymus, uterus/cervix

The ICRU (1980), ICRP (1984), and NCRP (1985) recommended that the terms rad, roentgen, curie, and rem be replaced by the SI units: gray (Gy), Coulomb per kilogram (C/kg), Becquerel (Bq), and sievert (Sv), respectively. The relationship between the historical units and the international system of units (SI) for radiological quantities is shown in Table D-6.

**Table D-6. Comparison of Common and SI Units for Radiation Quantities**

Quantity (Abbreviation)	Historical Unit	Historical Definition	SI unit	SI Definition
Activity (A)	curie (Ci)	$3.7 \times 10^{10}$ transformations $s^{-1}$	becquerel (Bq)	$s^{-1}$
Absorbed dose (D)	rad (rad)	$10^{-2}$ Jkg <sup>-1</sup>	gray (Gy)	Jkg <sup>-1</sup>
Absorbed dose rate ( $\dot{D}$ )	rad per second (rad $s^{-1}$ )	$10^{-2}$ Jkg <sup>-1</sup> $s^{-1}$	gray per second (Gy $s^{-1}$ )	Jkg <sup>-1</sup> $s^{-1}$
Equivalent Dose (or Dose equivalent) ( $H_T$ )	rem	$10^{-2}$ Jkg <sup>-1</sup>	sievert (Sv)	Jkg <sup>-1</sup>

## APPENDIX D

Equivalent Dose Rate (or Dose equivalent rate)	rem per second (rem s <sup>-1</sup> )	10 <sup>-2</sup> Jkg <sup>-1</sup> s <sup>-1</sup>	sievert per second (Sv s <sup>-1</sup> )	Jkg <sup>-1</sup> s <sup>-1</sup>
Effective dose (or Effective Dose Equivalent) (H <sub>E</sub> )	rem	10 <sup>-2</sup> Jkg <sup>-1</sup>	sievert (Sv)	Jkg <sup>-1</sup>
Linear energy transfer (LET)	kiloelectron volts per micrometer (keV μm <sup>-1</sup> )	1.602x10 <sup>-10</sup> Jm <sup>-1</sup>	kiloelectron volts per micrometer (keV μm <sup>-1</sup> )	1.602x10 <sup>-10</sup> Jm <sup>-1</sup>

---

Jkg<sup>-1</sup> = Joules per kilogram; Jkg<sup>-1</sup>s<sup>-1</sup> = Joules per kilogram per second; Jm<sup>-1</sup> = Joules per meter; s<sup>-1</sup> = per second

**D.4.4 Working Levels and Working Level Months (for Radon Dosimetry).** Working level (WL) is a measure of the atmospheric concentration of radon and its short-lived progeny. One WL is defined as any combination of short-lived radon progeny (through polonium-214 [<sup>214</sup>Po]), per liter of air, that will result in the emission of 1.3x10<sup>5</sup> MeV of alpha energy. An activity concentration of 100 pCi <sup>222</sup>Rn/L of air, in equilibrium with its progeny, corresponds approximately to a potential alpha-energy concentration of 1 WL. The WL unit can also be used for thoron or <sup>220</sup>Rn. In this case, 1.3x10<sup>5</sup> MeV of alpha energy (1 WL) is released by 7.5 pCi <sup>220</sup>Rn/L in equilibrium with its progeny. The potential alpha energy exposure of miners is commonly expressed in the unit Working Level Month (WLM). One WLM corresponds to inhaling a concentration of 1 WL for the reference period of 170 hours, or more generally

$$\text{WLM} = \text{concentration (WL)} \times \text{exposure time (months)} / (\text{one "month"} = 170 \text{ working hours}).$$

## D.5 Dosimetry Models

Dosimetry models are used to estimate the dose from internally deposited radioactive substances. The models for internal dosimetry consider the amount of radionuclides entering the body, the factors affecting their movement or transport through the body, distribution and retention of radionuclides in the body, and the energy deposited in organs and tissues from the radiation that is emitted during spontaneous decay processes. The dose pattern for radioactive materials in the body may be strongly influenced by the route of entry of the material. For industrial workers, inhalation of radioactive particles with pulmonary deposition and puncture wounds with subcutaneous deposition have been the most frequent. The general population has been exposed via ingestion, inhalation, and external exposure to low levels of naturally occurring radionuclides as well as artificial radionuclides used in nuclear medicine procedures and released from isotope generation facilities, nuclear weapons testing, and nuclear reactor operations and accidents.

The models for external dosimetry consider only the photon doses (and neutron doses, where applicable) to organs of individuals who are immersed in air or are exposed to a contaminated object.

**D.5.1 Ingestion.** Ingestion of radioactive materials is most likely to occur from eating food or drinking water containing naturally occurring radioactive material and possibly also contaminated with artificial radionuclides. Also, a portion of inhaled radionuclides initially deposited in the lung will relocate to the throat and be swallowed. Ingestion of a sufficient amount of radioactive material may result in toxic effects as a result of either absorption of the radionuclide or irradiation of the gastrointestinal tract during passage through the tract, or a combination of both. The fraction of a radioactive material absorbed from the gastrointestinal tract is variable, depending on the specific element, the physical and chemical form of the material ingested, and the diet, as well as some other metabolic and physiological factors. The absorption of some elements is influenced by age, usually with higher absorption in the very young.

**D.5.2 Inhalation.** The nose and mouth have long been recognized as being a major portal of entry for both nonradioactive and radioactive materials. The deposition of particles within the lung is largely dependent upon the size and shape of the particles being inhaled (sometimes termed the atmospheric mean aerodynamic diameter or AMAD). After a particle is deposited, its retention will depend upon the physical and chemical properties of the dust and the physiological status of the lung. The retention of the particle in the lung depends on the location of

## APPENDIX D

deposition, in addition to the physical and chemical properties of the particles. The converse of pulmonary retention is pulmonary clearance. There are three distinct mechanisms of clearance which operate simultaneously. Ciliary clearance acts only in the upper respiratory tract. The second and third mechanisms act mainly in the deep respiratory tract. These are phagocytosis and absorption. Phagocytosis is the engulfing of foreign bodies by alveolar macrophages and their subsequent removal either up the ciliary "escalator" or by entrance into the lymphatic system. Some inhaled soluble particles are absorbed into the blood and translocated to other organs and tissues.

### D.5.3 Internal Emitters

An internal emitter is a radionuclide that is inside the body. The absorbed dose from internally deposited radioisotopes depends on the energy absorbed per unit tissue by the irradiated tissue. For a radioisotope distributed uniformly throughout an infinitely large medium, the concentration of absorbed energy must be equal to the concentration of energy emitted by the isotope. An infinitely large medium may be approximated by a tissue mass whose dimensions exceed the range of the particle. All alpha and most beta radiation will be absorbed in the organ (or tissue) of reference. Gamma-emitting isotope emissions are penetrating radiation, and a substantial fraction of gamma energy may not be absorbed in tissue. The dose to an organ or tissue is a function of the effective retention half-time, the energy released in the tissue, the amount of radioactivity initially introduced, and the mass of the organ or tissue.

## D.6 BIOLOGICAL EFFECTS OF RADIATION

When biological material is exposed to ionizing radiation, a chain of cellular events occurs as the ionizing particle passes through the biological material. A number of theories have been proposed to describe the interaction of radiation with biologically important molecules in cells and to explain the resulting damage to biological systems from those interactions. Many factors may modify the response of a living organism to a given dose of radiation. Factors related to the exposure include the dose rate, the energy of the radiation, and the temporal pattern of the exposure (e.g., protracted or fractionated exposures). Biological considerations include factors such as species, age, sex, and the portion of the body exposed. Several excellent reviews of the biological effects of radiation have been published, and the reader is referred to these for a more in-depth discussion (Brodsky 1996; Klaassen 2001; Hobbs and McClellan 1986; ICRP 1984; Mettler and Moseley 1985; Rubin and Casarett 1968).

### D.6.1 Radiation Effects at the Cellular Level

According to Mettler and Moseley (1985), at acute doses up to 10 rad (100 mGy), single strand breaks in DNA may be produced. These single strand breaks may be repaired rapidly. With doses in the range of 0.5-5 Gy (50–500 rad), irreparable double-stranded DNA breaks are likely, resulting in cellular reproductive death after one or more divisions of the irradiated parent cell. At large doses of radiation, usually greater than 5 Gy (500 rad), direct cell death before division (interphase death) may occur from the direct interaction of free-radicals with essentially cellular macromolecules. Morphological changes at the cellular level, the severity of which are dose-dependent, may also be observed.

The sensitivity of various cell types varies. According to the Bergonie-Tribondeau law, the sensitivity of cell lines is directly proportional to their mitotic rate and inversely proportional to the degree of differentiation (Mettler and Moseley 1985). Rubin and Casarett (1968) devised a classification system that categorized cells according to type, function, and mitotic activity. The categories range from the most sensitive type, "vegetative intermitotic cells," found in the stem cells of the bone marrow and the gastrointestinal tract, to the least sensitive cell type, "fixed postmitotic cells," found in striated muscles or long-lived neural tissues.

Cellular changes may result in cell death, which if extensive, may produce irreversible damage to an organ or tissue or may result in the death of the individual. If the cell recovers, altered metabolism and function may still occur, which may be repaired or may result in the manifestation of clinical symptoms. These changes may also be expressed at a later time as tumors, cellular mutations, or transformed tissue (scar tissue) which may result in abnormal tissue or compromised function.

## D.6.2 Radiation Effects at the Organ Level

In most organs and tissues the injury and the underlying mechanism for that injury are complex and may involve a combination of events. The extent and severity of this tissue injury are dependent upon the radiosensitivity of the various cell types in that organ system. Rubin and Casarett (1968) describe and schematically display the events following radiation in several organ system types. These include: a rapid renewal system, such as the gastrointestinal mucosa; a slow renewal system, such as the pulmonary epithelium; and a nonrenewal system, such as neural or muscle tissue. In the rapid renewal system, organ injury results from the direct destruction of highly radiosensitive cells, such as the stem cells in the bone marrow. Injury may also result from constriction of the microcirculation and from edema and inflammation of the basement membrane, designated as the histohematic barrier (HHB), which may progress to fibrosis. In slow renewal and nonrenewal systems, the radiation may have little effect on the parenchymal cells, but ultimate parenchymal atrophy and death over several months result from HHB fibrosis and occlusion of the microcirculation.

## D.6.3 Low Level Radiation Effects

Cancer is the major latent harmful effect produced by ionizing radiation and the one that most people exposed to radiation are concerned about. The ability of alpha, beta, and gamma radiation to produce cancer in virtually every tissue and organ in laboratory animals has been well-demonstrated, while radiogenic cancer has not been observed in some human tissues and organs. The development of cancer is not an immediate effect. In humans, radiation-induced leukemia has the shortest latent period at 2 years, thyroid cancer after Chernobyl showed up in children about four years after the accident, while other radiation induced cancers have latent periods >20 years. For the non-radiogenic cancers, it has been hypothesized either that repair mechanisms effectively protect the individual or that the latency period exceeds the current human life span (Raabe 2010). The mechanism by which cancer is induced in living cells is complex and is a topic of intense study. Exposure to ionizing radiation can produce cancer; however, some sites appear to be more common than others, such as the breast, lung, stomach, and thyroid.

DNA is a major target molecule during exposure to ionizing radiation. Other macromolecules, such as lipids and proteins, are also at risk of damage when exposed to ionizing radiation. The genotoxicity of ionizing radiation is an area of intense study, as damage to the DNA is ultimately responsible for many of the adverse toxicological effects ascribed to ionizing radiation, including cancer. Damage to genetic material is basic to developmental or teratogenic effects, as well.

There is limited evidence of non-cancer human effects at low radiation doses. Non-cancer effects that have been reported are associated with the Japanese atomic bomb survivor population and include neurological and cardiovascular effects. Neurological effects were observed in fetuses exposed to prompt radiation during the detonations while they were in gestation weeks 8–15, less so for weeks 16–25, and were not observed for other developmental time frames. Cardiovascular effects have been reported for atomic bomb survivors following 60 years of follow-up. These include a statistically significant increase in heart disease (% elevated relative risk per Gy with 95% confidence interval = 14 [6–23] %/Gy,  $p < 0.001$ ) and a non-statistically significant increase in stroke (9 [1–17]%/Gy,  $p = 0.02$ ) above a dose of 0.5 Gy. These radiation-induced circulatory effects may be increased by other factors such as smoking, microvascular damage in the kidney and associated hypertension, high serum cholesterol, diabetes, and infection.

## APPENDIX D

**REFERENCES FOR APPENDIX D**

- ATSDR. 1990a. Toxicological profile for thorium. U.S. Department of Health and Human Services. Public Health Service. Agency for Toxic Substances and Disease Registry. Atlanta, GA.
- ATSDR. 1990b. Toxicological profile for radium. U.S. Department of Health and Human Services. Public Health Service. Agency for Toxic Substances and Disease Registry. Atlanta, GA.
- ATSDR. 1990c. Toxicological profile for radon. U.S. Department of Health and Human Services. Public Health Service. Agency for Toxic Substances and Disease Registry. Atlanta, GA.
- ATSDR. 1999. Toxicological profile for uranium. U.S. Department of Health and Human Services. Public Health Service. Agency for Toxic Substances and Disease Registry. Atlanta, GA.
- BEIR III. 1980. The effects on populations of exposure to low levels of ionizing radiation. Committee on the Biological Effects of Ionizing Radiations, National Research Council. Washington, DC: National Academy Press.
- BEIR IV. 1988. Health risks of radon and other internally deposited alpha emitters. Committee on the Biological Effects of Ionizing Radiations, National Research Council. Washington, DC: National Academy Press.
- BEIR V. 1988. Health effects of exposure to low levels of ionizing radiation. Committee on the Biological Effects of Ionizing Radiations, National Research Council. Washington, DC: National Academy Press.
- Brodsky A. 1996. Review of radiation risks and uranium toxicity with application to decisions associated with decommissioning clean-up criteria. Hebron, Connecticut: RSA Publications.
- Cember H. 1996. Introduction to health physics. New York, NY: McGraw Hill.
- Cember H and Johnson T. 2007.
- Early P, Razzak M, Sodee D. 1979. Nuclear medicine technology. 2nd ed. St. Louis: C.V. Mosby Company.
- Eichholz G. 1982. Environmental aspects of nuclear power. Ann Arbor, MI: Ann Arbor Science.
- Hendee W. 1973. Radioactive isotopes in biological research. New York, NY: John Wiley and Sons.
- Hobbs C, McClellan R. 1986. Radiation and radioactive materials. In: Doull J, et al., eds. Casarett and Doull's Toxicology. 3rd ed. New York, NY: Macmillan Publishing Co., Inc., 497-530.
- ICRP. 1977. International Commission on Radiological Protection. Recommendations of the International Commission on Radiological Protection. ICRP Publication 26. Vol 1. No. 3. Oxford: Pergamon Press.
- ICRP. 1979. International Commission on Radiological Protection. Limits for intakes of radionuclides by workers. ICRP Publication 20. Vol. 3. No. 1-4. Oxford: Pergamon Press.
- ICRP. 1979. Limits for Intakes of Radionuclides by Workers. Publication 30. International Commission on Radiological Protection. Pergamon Press.
- ICRP. 1984. International Commission on Radiological Protection. A compilation of the major concepts and quantities in use by ICRP. ICRP Publication 42. Oxford: Pergamon Press.
- ICRP. 1990. International Commission on Radiological Protection 1990 Recommendations of the ICRP
- ICRP. 2007. Publication No. 103, The 2007 Recommendations of the International Commission on Radiological Protection. ICRP 37(2-4):1-332.



## APPENDIX D

- ICRU. 1980. International Commission on Radiation Units and Measurements. ICRU Report No. 33. Washington, DC.
- James A. 1987. A reconsideration of cells at risk and other key factors in radon daughter dosimetry. In: Hopke P, ed. Radon and its decay products: Occurrence, properties and health effects. ACS Symposium Series 331. Washington, DC: American Chemical Society, 400-418.
- James A, Roy M. 1987. Dosimetric lung models. In: Gerber G, et al., ed. Age-related factors in radionuclide metabolism and dosimetry. Boston: Martinus Nijhoff Publishers, 95-108.
- Kondo S. 1993. Health effects of low-level radiation. Kinki University Press, Osaka, Japan (available from Medical Physics Publishing, Madison, Wisconsin).
- Kato H, Schull W. 1982. Studies of the mortality of A-bomb survivors. Report 7 Part 8, Cancer mortality among atomic bomb survivors, 1950-78. Radiat Res 90;395-432.
- Klaassen. 2001. Casarett and Doull's toxicology: The basic science of poisons. McGraw-Hill.
- LBL. 2011. Atomic and nuclear properties of materials: Neutron (n). Lawrence Berkeley Laboratory. <http://pdg.lbl.gov/2011/AtomicNuclearProperties/neutron.html>. (December 7, 2011).
- Mettler F, Moseley R. 1985. Medical effects of ionizing radiation. New York: Grune and Stratton.
- Nakamura. Particle data group. 2012. The review of particle physics and 2011 partial update. J Phys G 37:075021. <http://pdg.lbl.gov/>. (December 7, 2011).
- NCRP. 1971. Basic radiation protection criteria. National Council on Radiation Protection and Measurements. Report No. 39. Washington, DC.
- NCRP. 1985. A handbook of radioactivity measurements procedures. 2nd ed. National Council on Radiation Protection and Measurements. Report No. 58. Bethesda, MD:
- NCRP. 1993. Risk estimates for radiation protection. National Council on Radiation Protection and Measurements. Report 115. Bethesda, Maryland
- NRC. 2012a. Electronic Code of Federal Regulations. Title 10: Energy. Part 20-Standards for protection against radon. Subpart A-General provisions. § 20.1003 Definitions. <http://ecfr.gpoaccess.gov/cgi/t/text/text-idx?c=ecfr&sid=48e22c6aa171831075552dcbea1a5939&rgn=div8&view=text&node=10:1.0.1.1.16.1.76.3&idno=10>. (January 27, 2012)
- NRC. 2012b. Electronic Code of Federal Regulations. Title 10: Energy. Part 20-Standards for protection against radon. Subpart A-General provisions. § 20.1004 Units of radiation dose. <http://ecfr.gpoaccess.gov/cgi/t/text/text-idx?c=ecfr&sid=1f508d141b96be7c2a197d0724844aa5&rgn=div5&view=text&node=10%3A1.0.1.1.16&idno=10;cc=ecfr#10:1.0.1.1.16.1.76.4>. (January 27, 2012)
- Oganessian YT, Abdullin FS, Bailey PD, et al. 2010. Synthesis of a new element with atomic number  $Z = 117$ . Phys Rev Lett 104(14):142502-1 to 142402-4
- Otake M, Schull W. 1984. Mental retardation in children exposed in utero to the atomic bombs: A reassessment. Technical Report RERF TR 1-83, Radiation Effects Research Foundation, Japan.
- Raabe OG. 2010. Concerning the health effects of internally deposited radionuclides. Health Phys 98(3):515-536.
- Rubin P, Casarett G. 1968. Clinical radiation pathology. Philadelphia: W.B. Sanders Company, 33.

## APPENDIX D

Schull WJ. 1988. Effect on intelligence test score of prenatal exposure to ionizing radiation in Hiroshima and Nagasaki: A comparison of the T65DR and DS86 dosimetry systems. Radiation Effects Research Foundation. Japan.

Shimizu Y, Kodama K, Nishi, N, et al. 2010. Radiation exposure and circulatory disease risk: Hiroshima and Nagasaki atomic bomb survivor data, 1950-2003. *Brit Med J.* 340:b5349.

Thisgaard H, Jensen M, Elema DR. 2001. Medium to large scale radioisotope production for targeted radiotherapy using a small PET cyclotron. *Appl Radiat Isot* 69(1):1-7.

UNSCEAR. 1977. United Nations Scientific Committee on the Effects of Atomic Radiation. Sources and effects of ionizing radiation. New York: United Nations.

UNSCEAR. 1982. United Nations Scientific Committee on the Effects of Atomic Radiation. Ionizing radiation: Sources and biological effects. New York: United Nations.

UNSCEAR. 1986. United Nations Scientific Committee on the Effects of Atomic Radiation. Genetic and somatic effects of ionizing radiation. New York: United Nations.

UNSCEAR. 1988. United Nations Scientific Committee on the Effects of Atomic Radiation. Sources, effects and risks of ionization radiation. New York: United Nations.

UNSCEAR. 1993. United Nations Scientific Committee on the Effects of Atomic Radiation. Sources and effects of ionizing radiation. New York: United Nations.

USNRC. 2011a. Title 10, Code of Federal Regulations Part 20.1003, U.S. Nuclear Regulatory Commission, Washington, DC. <http://ecfr.gpoaccess.gov/cgi/t/text/text-idx?c=ecfr&sid=a0927f5dead51eb92d3892fad0f1ac42&rgn=div8&view=text&node=10:1.0.1.1.16.1.76.3&idno=10>. (December 9, 2011)

USNRC. 2011. Title 10 Code of Federal Regulations Part 20, Table 1004(b).1. U.S. Nuclear Regulatory Commission, Washington, D.C. <http://ecfr.gpoaccess.gov/cgi/t/text/text-idx?c=ecfr&sid=a0927f5dead51eb92d3892fad0f1ac42&rgn=div8&view=text&node=10:1.0.1.1.16.1.76.4&idno=10>. (December 9, 2011)

## APPENDIX E. INDEX

absorbed dose.....	108, 229, 243
acetylcholine.....	153
acetylcholinesterase.....	153
active transport.....	241
adenocarcinomas.....	107
adrenals.....	149
adsorbed.....	12, 289, 290, 304
adsorption.....	289, 302, 303, 304, 349, 350
alanine aminotransferase (see ALT).....	141
ALT (see alanine aminotransferase).....	141, 179
ambient air.....	91, 94, 96, 194, 308, 335
anaerobic.....	306
anemia.....	139
antiestrogenic.....	157
aspartate aminotransferase (see AST).....	141
AST (see aspartate aminotransferase).....	141, 179
bioaccumulation.....	304, 336
bioavailability.....	251, 252, 260, 330, 335, 337
bioconcentration factor.....	304
biodistribution.....	343
biokinetic.....	186, 198, 203, 211, 213, 223, 226, 227, 232, 259, 344
biological half-time.....	200, 207, 208, 209
biomarker.....	13, 17, 35, 140, 176, 179, 242, 243, 244, 245, 249, 252, 254, 255, 258, 259, 260, 339, 357
blood cell count.....	36, 89, 99, 152
body weight effects.....	32, 82, 97, 98, 110, 149, 163, 173, 180
breast milk.....	198, 241, 329, 330
cancer.....	5, 17, 43, 84, 103, 104, 105, 106, 107, 108, 161, 175, 183, 239, 258, 260, 365
carcinogen.....	369
carcinogenic.....	17, 20, 41, 42, 192, 236, 253, 360
carcinogenicity.....	5, 17, 19, 103, 161, 162, 183, 251, 254, 255, 360, 361
carcinoma.....	100, 107, 108, 161
cardiovascular.....	46, 82, 88, 110, 137, 163
cardiovascular effects.....	88, 137
chromosomal aberrations.....	184, 185, 189, 236
clearance.....	82, 88, 92, 94, 144, 177, 198, 200, 201, 206, 207, 208, 211, 215, 217, 220, 221, 223, 226, 232, 235, 252, 260, 369
death.....	26, 41, 43, 44, 45, 46, 84, 85, 98, 104, 158, 182, 183, 189, 192, 236, 253, 254
deoxyribonucleic acid (see DNA).....	183
dermal effects.....	96, 172, 173
developmental effects.....	32, 33, 102, 158, 159, 161, 174, 181, 182, 240, 256, 261, 359
DNA (see deoxyribonucleic acid).....	183, 185, 186, 187, 188, 189, 190, 191, 192, 236, 242, 254, 257
dopamine.....	152, 153
endocrine.....	46, 82, 96, 110, 148, 163, 237, 238
endocrine effects.....	96, 148, 163, 180
erythema.....	173
estrogen receptor.....	238
estrogenic.....	19, 157, 238, 255
fetus.....	32, 238, 261, 331

## APPENDIX E

follicle stimulating hormone .....	181
fractional absorption .....	195, 241, 330
gastrointestinal effects .....	88, 110, 138
general population.....	3, 12, 254, 255, 257, 330, 336, 337
genotoxic.....	41, 184, 186, 189, 192, 254, 331
genotoxicity.....	175, 186, 189, 254, 262
germinal cell.....	155, 255
groundwater .....	273, 284, 289, 296, 297, 302, 303, 304, 312, 316, 317, 336, 368
half-life.....	2, 4, 11, 40, 220, 242, 269, 271, 292, 306
hematological effects.....	46, 89, 90, 110, 139, 176
hematopoietic.....	89, 99, 104, 183, 184
hepatic effects .....	46, 82, 91, 141, 179
hydrolysis.....	263
immune system .....	98, 99, 151
immunological .....	41, 98, 100, 152, 174, 257
immunological effects.....	98, 100
LD <sub>50</sub> .....	109, 110, 152, 162, 163
leukemia.....	89, 104, 107, 184
lymphatic .....	89, 99, 104, 214
lymphoreticular.....	151, 174, 257
metabolic effects .....	150
micronuclei .....	156, 184, 186, 189
milk .....	186, 241, 307, 322
mucociliary .....	82, 226
musculoskeletal effects .....	91, 140, 172, 176
neonatal.....	16, 31, 158, 160, 196, 241, 256, 330, 331, 337
neoplastic .....	189
neurobehavioral.....	5, 18, 33, 152, 154, 181, 182, 237, 240, 256, 258
neurological effects.....	33, 100, 101, 152, 154, 174, 180, 251, 257
neurotransmitter .....	153
non-Hodgkin's lymphoma .....	106
norepinephrine .....	152
nuclear.....	2, 11, 17, 34, 39, 40, 84, 99, 100, 106, 142, 145, 146, 244, 263, 270, 277, 280, 284, 285, 287, 294, 296, 297, 300, 329, 331, 336, 339, 342, 345, 355, 366
ocular effects.....	82, 97, 110
odds ratio.....	106
oxidative phosphorylation.....	235
pharmacodynamic .....	29, 210
pharmacokinetic.....	28, 92, 193, 210, 211, 212, 238, 240, 241
placenta .....	198, 241
pulmonary fibrosis .....	15, 83, 235
renal effects.....	14, 15, 22, 23, 25, 26, 27, 33, 35, 46, 87, 91, 92, 95, 96, 142, 145, 147, 172, 179, 180, 245, 253, 261, 359, 360
reproductive effects.....	15, 16, 33, 101, 102, 155, 158, 174, 249, 255
respiratory effects.....	26, 41, 82, 83, 86, 136, 234
retention .....	12, 21, 29, 43, 83, 91, 94, 159, 193, 198, 199, 200, 208, 209, 213, 217, 220, 223, 232, 233, 241, 261, 271, 344, 369
sarcoma .....	161
solubility .....	12, 21, 93, 193, 194, 195, 196, 197, 199, 208, 214, 270, 271, 302
spermatozoa .....	16, 155, 255
systemic effects.....	46, 82, 98, 110, 163, 172, 251

## APPENDIX E

T3 .....	47, 111, 164
thyroid .....	34, 148, 149, 199, 201, 285
thyroxine .....	178
toxicokinetic .....	21, 39, 240
tremors .....	152
tumors .....	17, 19, 100, 104, 107, 108, 183
weanling .....	261

