



**US Army Corps
of Engineers**

Hydrologic Engineering Center

Computer Models for Rainfall- Runoff and River Hydraulic Analysis

March 1973

REPORT DOCUMENTATION PAGE

Form Approved OMB No. 0704-0188

The public reporting burden for this collection of information is estimated to average 1 hour per response, including the time for reviewing instructions, searching existing data sources, gathering and maintaining the data needed, and completing and reviewing the collection of information. Send comments regarding this burden estimate or any other aspect of this collection of information, including suggestions for reducing this burden, to the Department of Defense, Executive Services and Communications Directorate (0704-0188). Respondents should be aware that notwithstanding any other provision of law, no person shall be subject to any penalty for failing to comply with a collection of information if it does not display a currently valid OMB control number.

PLEASE DO NOT RETURN YOUR FORM TO THE ABOVE ORGANIZATION.

1. REPORT DATE (DD-MM-YYYY) March 1973		2. REPORT TYPE Technical Paper		3. DATES COVERED (From - To)	
4. TITLE AND SUBTITLE Computer Models for Rainfall-Runoff and River Hydraulic Analysis			5a. CONTRACT NUMBER		
			5b. GRANT NUMBER		
			5c. PROGRAM ELEMENT NUMBER		
6. AUTHOR(S) Darryl W. Davis			5d. PROJECT NUMBER		
			5e. TASK NUMBER		
			5f. WORK UNIT NUMBER		
7. PERFORMING ORGANIZATION NAME(S) AND ADDRESS(ES) US Army Corps of Engineers Institute for Water Resources Hydrologic Engineering Center (HEC) 609 Second Street Davis, CA 95616-4687				8. PERFORMING ORGANIZATION REPORT NUMBER TP-35	
9. SPONSORING/MONITORING AGENCY NAME(S) AND ADDRESS(ES)				10. SPONSOR/ MONITOR'S ACRONYM(S)	
				11. SPONSOR/ MONITOR'S REPORT NUMBER(S)	
12. DISTRIBUTION / AVAILABILITY STATEMENT Approved for public release; distribution is unlimited.					
13. SUPPLEMENTARY NOTES Presented at the Spring 1973 Conference of the Civil Engineering Program Applications (CEPA) Conference, San Francisco, California					
14. ABSTRACT The application of computer technology to analysis of the rainfall-runoff process and the hydraulics of natural rivers has greatly expanded in the past few years. A large number of special purpose programs and a few programs designed for general application have been developed and applied to hydrologic engineering problems. The Hydrologic Engineering Center (HEC) has developed, over the past eight years, a number of generalized computer programs for use by the US Army Corps of Engineers in analyzing hydrologic engineering problems. This paper briefly describes the activities of the Hydrologic Engineering Center and discusses the capabilities of two of these programs: (1) Flood Hydrograph Package (HEC-1), and (2) Water Surface Profiles (HEC-2).					
15. SUBJECT TERMS hydrologic model, hydraulic model, river hydraulics, computer application					
16. SECURITY CLASSIFICATION OF:			17. LIMITATION OF ABSTRACT UU	18. NUMBER OF PAGES 52	19a. NAME OF RESPONSIBLE PERSON
a. REPORT U	b. ABSTRACT U	c. THIS PAGE U			19b. TELEPHONE NUMBER

Computer Models for Rainfall- Runoff and River Hydraulic Analysis

March 1973

US Army Corps of Engineers
Institute for Water Resources
Hydrologic Engineering Center
609 Second Street
Davis, CA 95616

(530) 756-1104
(530) 756-8250 FAX
www.hec.usace.army.mil

TP-35

Papers in this series have resulted from technical activities of the Hydrologic Engineering Center. Versions of some of these have been published in technical journals or in conference proceedings. The purpose of this series is to make the information available for use in the Center's training program and for distribution with the Corps of Engineers.

The findings in this report are not to be construed as an official Department of the Army position unless so designated by other authorized documents.

The contents of this report are not to be used for advertising, publication, or promotional purposes. Citation of trade names does not constitute an official endorsement or approval of the use of such commercial products.

COMPUTER MODELS FOR RAINFALL-RUNOFF
AND RIVER HYDRAULIC ANALYSIS¹

by
Darryl W. Davis²

INTRODUCTION

The application of computer technology to analysis of the rainfall-runoff process and the hydraulics of natural rivers has greatly expanded in the past few years. A large number of special purpose programs and a few programs designed for general application have been developed and applied to hydrologic engineering problems. The Hydrologic Engineering Center (HEC) has developed, over the past 8 years, a number of generalized computer programs for use by the US Army Corps of Engineers in analyzing hydrologic engineering problems. This paper briefly describes the activities of The Hydrologic Engineering Center and discusses the capabilities of two of these programs: (1) Flood Hydrograph Package (HEC-1) and (2) Water Surface Profiles (HEC-2).

THE HYDROLOGIC ENGINEERING CENTER

The Hydrologic Engineering Center, established in 1964, has three principal missions: (a) conduct research and development of hydrologic engineering techniques for use in the Corps' day-to-day work, (b) provide training for Corps of Engineers employees in traditional as well as newly

¹For presentation at the Spring 1973 Conference of the Civil Engineering Program Applications (CEPA) Conference, San Francisco, California

²Civil Engineer, The Hydrologic Engineering Center, Davis, California

developed hydrologic engineering techniques, and (c) provide assistance to Corps field offices in hydrologic engineering studies. The Center has recently been assigned responsibility in the area of planning analysis so that its capabilities in the field of systems analysis can be focused on priority components of planning problems. From the beginning, HEC concentrated on computer applications and utilization in carrying out each of these missions (reference 1).

The research and development work has resulted in the coding, testing and documentation of about 30 generalized computer programs in hydrologic engineering. The programs are generalized in that they can be applied without modification to almost any problem in their specific area of application regardless of the scope of the problem, the geographic location of the problem, or the degree of detail required in a particular solution. Five of the programs are large programs that combine a number of functions into a single package. These five programs are in the areas of flood hydrograph analysis, water surface profiles, reservoir systems analysis for flood control and conservation and monthly streamflow simulation.

The training activities conducted or sponsored by the Center are designed to improve the hydrologic engineering capabilities of the Corps of Engineers in accomplishing its civil works mission. This specialized training contributes to more efficient performance of technical studies associated with the planning, design and operation of civil works projects. The training program includes about 20 weeks per year of 1- and 2-week

courses with classroom instruction in topics of hydrologic engineering. Individual training and short seminars are also included when desirable.

The special assistance mission of the Center serves to point up the needs for training as well as for research and provides realistic problems for testing techniques and programs.

THE FLOOD HYDROGRAPH PACKAGE (HEC-1)

General Capabilities

HEC-1 can be characterized as a single storm event flood runoff simulation model. Most ordinary flood hydrograph computations associated with precipitation and runoff on a complex multisubbasin, multichannel river basin can be accomplished with the program. Because of the modelling capability of the program, a number of other routines are included that can assist in determining the appropriate parameters needed to model the runoff process and to evaluate the effect of management alternatives.

The five major types of computations that can be performed by HEC-1 are:

- Generalized precipitation, runoff, routing and combining operations to simulate the hydrologic response of a watershed and its stream network (the modelling element);
- Optimization of routing parameters (assistance in parameter derivation);
- Optimization of unit hydrograph and loss rate parameters (assistance in parameter derivation);

- Stream system computations for specified precipitation depth-area storm relationships for the entire watershed or region (application of modelling capability);
- Specialized precipitation streamflow network simulation relative to multiple floods for multiple plans of basin development and the economic analysis of flood damages (evaluation of management alternatives).

In the process of modelling a basin, the program provides several techniques for inputting and distributing the precipitation, treating the precipitation as rainfall or snowfall, computing rainfall and snow-melt losses and excess, determining subbasin outflow hydrographs from unit graph techniques, and routing hydrographs by storage routing methods. If necessary, different techniques for each process may be combined in the same job for the basin being modelled. Graphical display of intermediate or summary hydrographs and precipitation can be produced where desired.

The program may be used to optimize specified parameters of the precipitation runoff or routing processes for a stream reach or subbasin to achieve a best-fit with respect to an observed hydrograph and known precipitation or a known inflow hydrograph.

The precipitation depth-area stream system computation is designed to compute a consistent hydrograph at all desired points in a complex basin so that each corresponds to a specific depth-area relationship. The procedure operates by computing simultaneously a maximum of five base floods, each

representing average rainfall intensity corresponding to a specified area size. An interpolated hydrograph is automatically established for each concentration point based on the size of the area tributary to that point. This routine is useful in stream systems or in urban storm drainage computations where it is desired to compute a number of synthetic events (such as a 100-year flood) at a large number of locations.

The routine for evaluating reservoir and channel development plans for one or more locations includes the computation of average annual dollar benefits at each damage center for each plan of development as well as for existing conditions. This involves simultaneously computing a number of system floods for each plan, covering the entire range of floods that significantly contribute to damages. The floods may be either multiples of the runoff from a single representative storm or the runoff from multiples of a typical storm rainfall pattern. Flow-damage relations for each type of damage and flood-peak frequency relations for existing conditions must be specified for each damage center. Unit hydrograph coefficients, loss coefficients, degree of imperviousness and routing coefficients for each plan must also be specified.

Modelling Rainfall-Runoff with HEC-1

The program is designed to simulate the storm rainfall-runoff process and is composed of the appropriate mathematical relationships and constants that describe the response of the watershed to rainfall. The model accepts total storm rainfall for each subbasin, deducts losses to determine rainfall excess, transforms the excess to streamflow by the

unit hydrograph technique, and translates the streamflow through valley storage and reservoir storage by simple routing procedures.

Modelling a complex basin consists of defining its topologic structure (subbasin boundaries and areas, stream channels and the logical relationships between the subbasins and stream channels), and defining the parameters that describe the rainfall-runoff response of the subbasins and channels of the river basin. Parameters are needed to determine: (1) basin average total precipitation and its time distribution for each subbasin, (2) precipitation loss rates for selected storm events, (3) unit hydrographs for each subbasin, (4) base flow controls for each subbasin, and (5) routing criteria for each channel reach. The detailed computational algorithms can be found in reference 2. Figure 1 is a simplified flow chart of HEC-1.

Topology. The topology of the basin is described in the program essentially by the way the sequences of operations are specified. Hydrographs are computed, routed and combined with other hydrographs in accordance with the data sequence provided. In this manner any complex basin consisting of a very large number of subbasins and routing reaches can be accurately described.

Precipitation. The precipitation applied to a subarea for runoff computations may be determined by three methods. The computed precipitation will then be treated as rainfall or snowfall depending upon temperature criteria.

a. Subbasin total precipitation is computed from nonrecording station precipitation according to weights provided for each station. The subbasin total precipitation can also be computed considering longer term weighting values such as normal annual amounts that may reflect consistent

Figure 1 HEC-1 MACRO-FLOW CHART

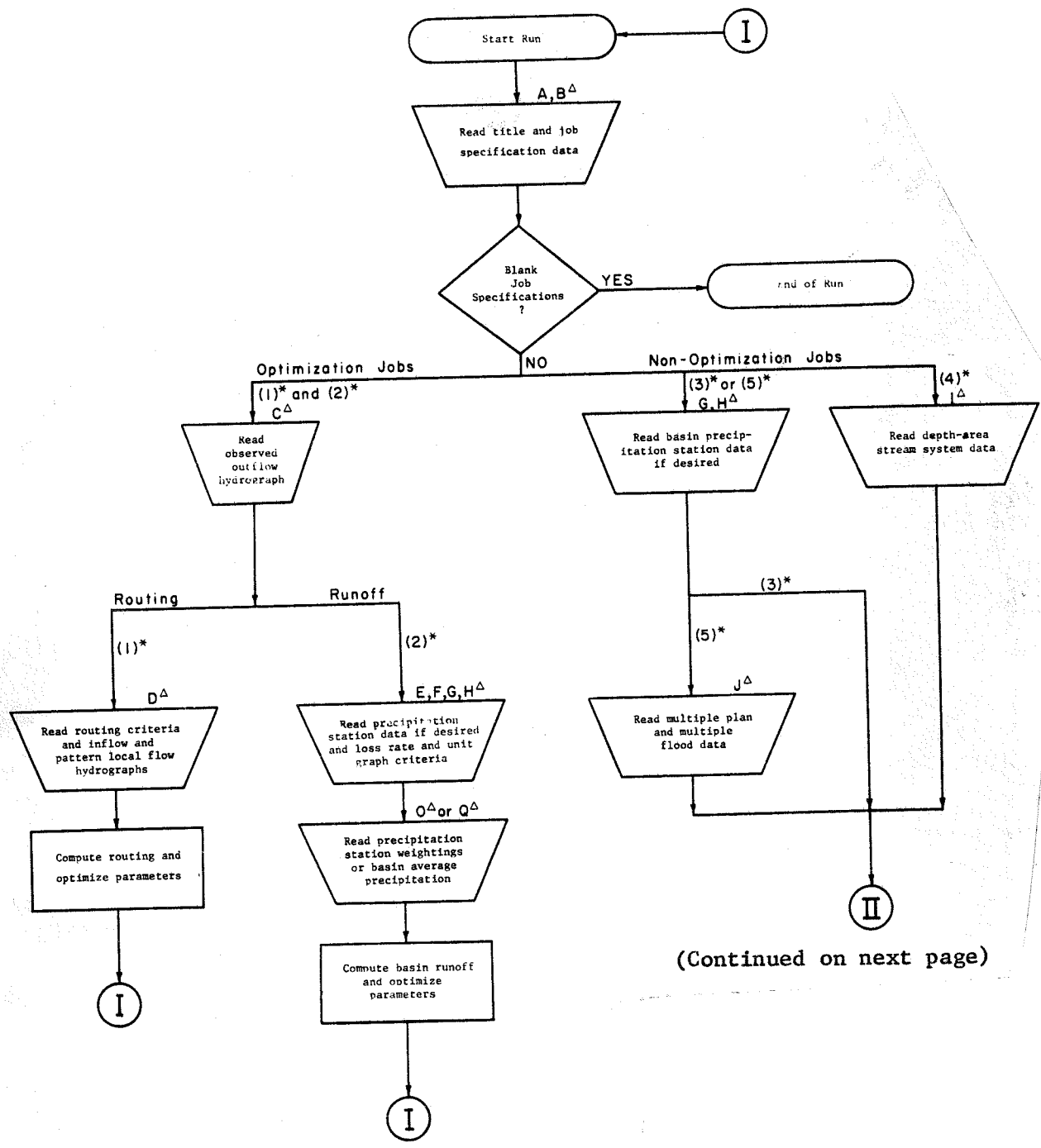

(Continued on next page)

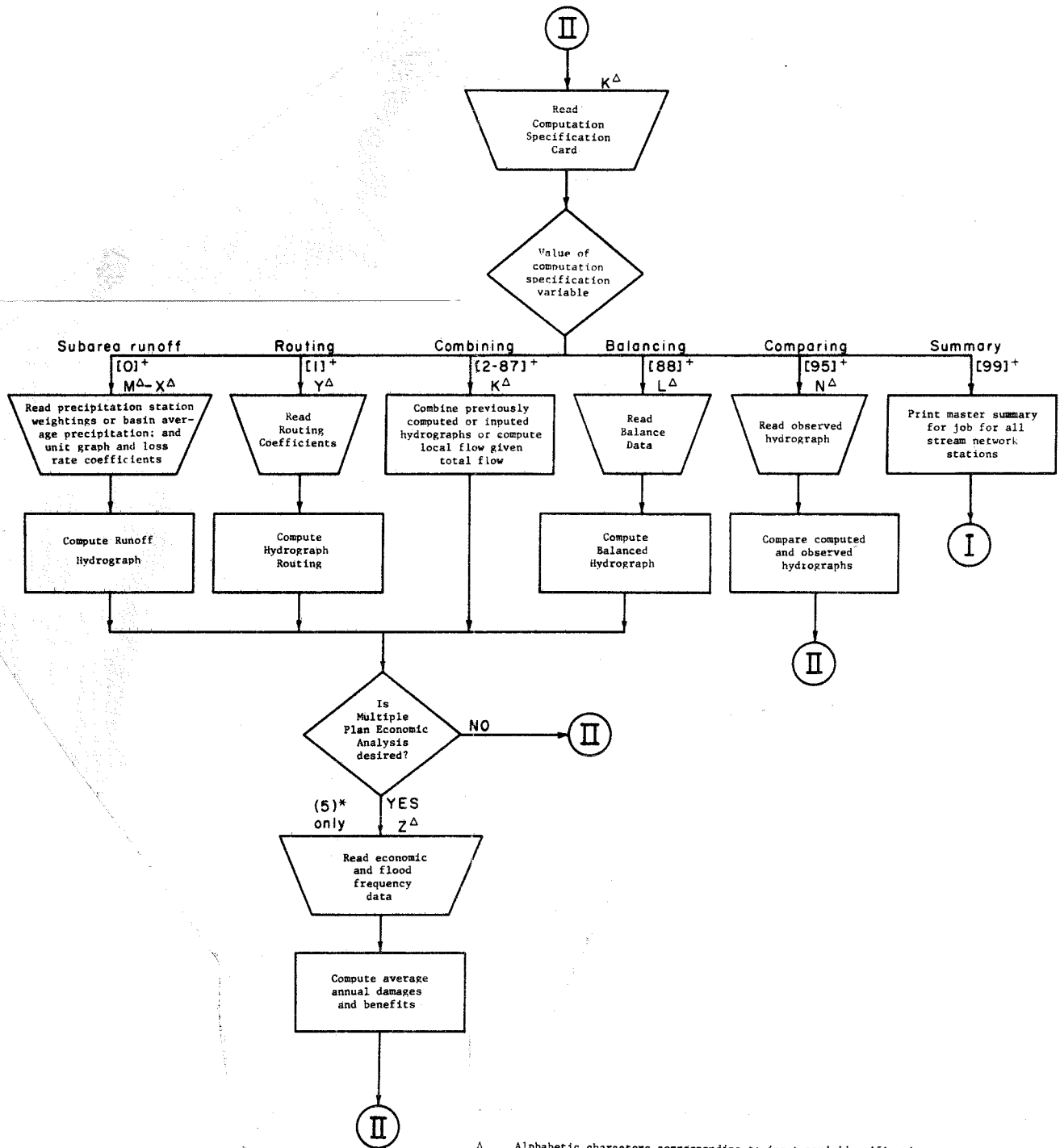

Δ Alphabetic characters corresponding to input card identification.

* Numbers in parentheses indicate the value of program variable JØPER which is used to describe the five basic types of jobs as follows:

- (1) Routing Optimization
- (2) Loss Rate and Unit Graph Optimization
- (3) Generalized Streamflow Network Computations
- (4) Depth-Area Storm Stream System Computations
- (5) Multiple Plan, Multiple Ratio Economic Computations

+ Numbers in brackets [] indicate the value of variable ICØMP on the K-card which is the key model building card describing the current operation to be undertaken.

[0] compute runoff from a subarea

[1] route hydrograph through a river reach

[2-87] combine ICØMP hydrographs at this station

[95] compare computed and observed hydrographs at this station

[99] end of job--print summary information

physiographic effects in the subbasin. The subbasin-mean recording precipitation pattern (time distribution) is computed in a similar manner with station weights as appropriate. The subbasin-mean precipitation distribution (time distribution of total storm rainfall) is then computed using the relative pattern to distribute the total subbasin rainfall.

b. Known temporal and spatial precipitation for a subbasin can be supplied directly. By this method precipitation can be supplied for each interval or as a time pattern for a given storm total. Precipitation distributions may also be specified for two differently sized areas and the program will perform a logarithmic interpolation of the two patterns for a specified area.

c. The program provides for automatic computation of standard project storm (SPS) precipitation using Corps of Engineers criteria and for probable maximum precipitation using criteria developed by the National Weather Service. For the SPS, the largest day of precipitation is preceded by the second largest and followed by the third largest. Six-hour storm amounts within each day are similarly distributed. A storm transposition coefficient can be supplied or will be computed by the program as a default option.

Where snowfall and snowmelt are considered, there is provision for separate computation in up to ten elevation zones. These zones are usually considered to be in elevation increments of 1,000 feet, but any equal increments of elevation can be used as long as the air temperature lapse

rate corresponds to the change in elevation within the zone. The input temperature data are those corresponding to the bottom of the lowest elevation zone. Temperatures are reduced by the lapse rate in degrees per increment of elevation zone. The base temperature at which melt will occur must be specified because variations from 32°F (0°C) might be warranted considering both spatial and temporal fluctuations of temperature within the zone.

Precipitation is assumed to fall as snow if the zone temperature is less than the base temperature plus 2 degrees. Melt occurs when the temperature is equal to or greater than the base temperature. Snowmelt is subtracted and snowfall is added to the snowpack in each zone. Snowmelt may be computed by the degree-day or energy-budget methods.

Precipitation Loss Rates. Loss rates can be computed using initial and uniform losses or by a function which relates loss rates to rainfall and snowmelt intensity and to accumulated loss (ground wetness). Figure 2 shows the loss rate function for a snow-free basin. The loss rate function is successively applied for each computational interval.

The loss rate parameters of figure 2 are:

DLTKR - Amount of initial accumulated rain loss during which the loss rate coefficient is increased. This parameter is considered to be a function primarily of antecedent soil moisture deficiency and is usually different for different storms.

STRKR - Starting value of loss coefficient on exponential recession curve for rain losses (snow-free ground). The starting value is considered a function of infiltration capacity and thus depends on such basin characteristics as soil type, land use and vegetal cover.

RTIOL - Ratio of rain loss coefficient on exponential loss curve to that corresponding to 10 inches more of accumulated loss. This variable may be considered a function of the ability of the surface of a basin to absorb precipitation and should be reasonably constant for large rather homogeneous areas.

ERAIN - Exponent of precipitation for rain loss function

$$ALOSS = (AK + DLTK) PRCP^{ERAIN}$$

that reflects the influence of precipitation rate on basin-average loss characteristics. It reflects the manner in which storms occur within an area and may be considered a characteristic of a particular region. Varies from 0.0 to 1.0. The terms in the equation are defined as:

$$ALOSS = \text{loss rate for particular time interval}$$

AK = loss rate coefficient at beginning of time interval, value on STRKR exponential loss curve.

PRCP = rainfall intensity in inches (mm) per hour.

DLTK = incremental increase in loss rate coefficient.

DLTK is assumed to be a parabolic function of the accumulated loss for DLTKR amount of accumulated loss. DLTK is a maximum of 0.2 DLTKR initially reducing to zero when the accumulated loss equals DLTKR.

Unit Hydrograph. The unit hydrograph corresponding to the appropriate duration of rainfall excess can be supplied directly or may be computed from coefficients of two synthetic techniques; the Clark procedure and the Snyder procedure. The Clark procedure develops a unit hydrograph from a coefficient describing the subbasin time of concentration and a coefficient describing the subbasin natural storage characteristics. A time-area diagram (sometimes termed a time delay histogram or translation hydrograph) with a base time equal to the time of concentration is routed through a linear reservoir characterized by the storage coefficient. The time-area relation may be derived from subbasin physiographic data and supplied directly or the program may be permitted to compute and use an idealized relationship that consists of a simple reverse parabola symmetrical about the center of the time base.

If a unit hydrograph that conforms to specified Snyder coefficients is desired, it is established by successive approximations for the corresponding Clark coefficients.

Base Flow and Recession. The program assumes that the flood to be computed occurs after a previous flood and therefore begins at a flow on the recession limb of the previous flood hydrograph. The recession is assumed to be described by an exponential function. The parameters required to describe the base flow and recession are the starting flow, the flow at which recession begins, and the recession constant. Figure 3 shows the base flow separation concept used by the program.

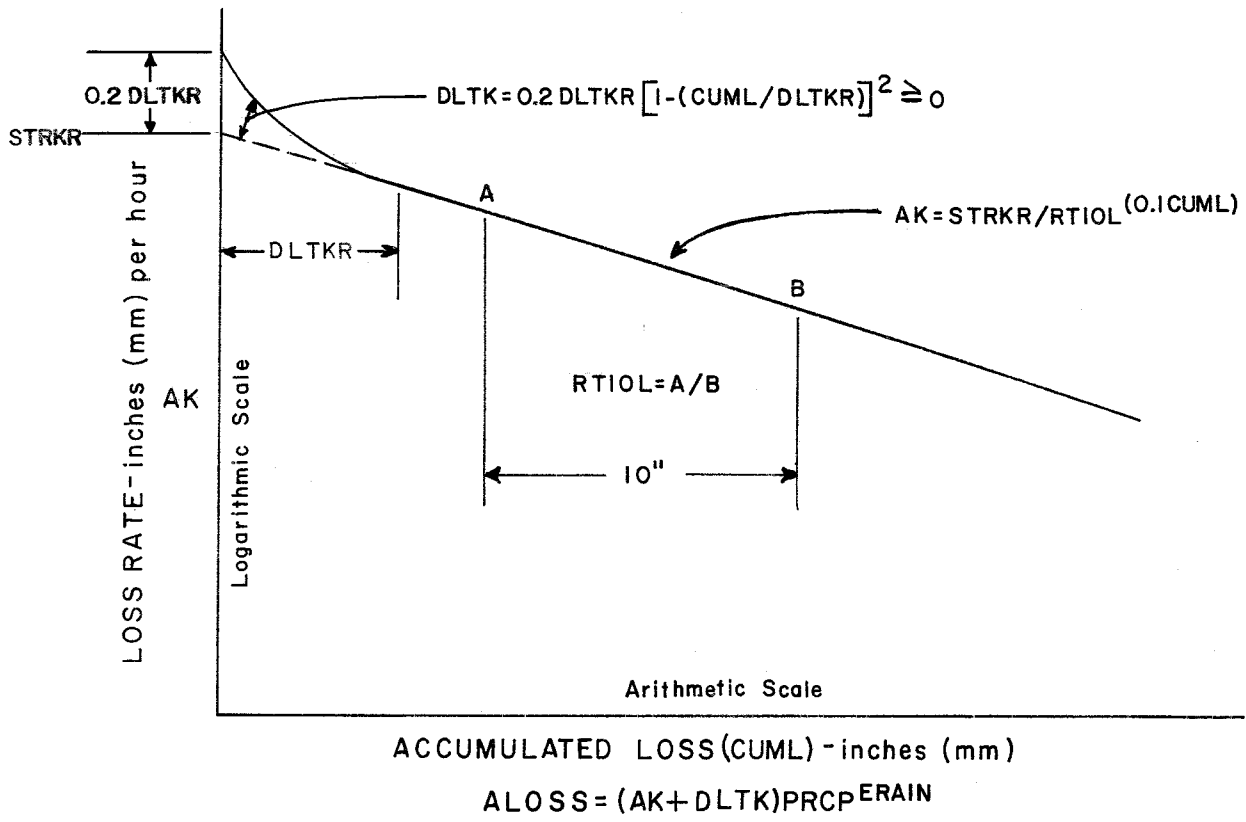

Fig. 2. General Loss Rate Function on Snow-Free Ground

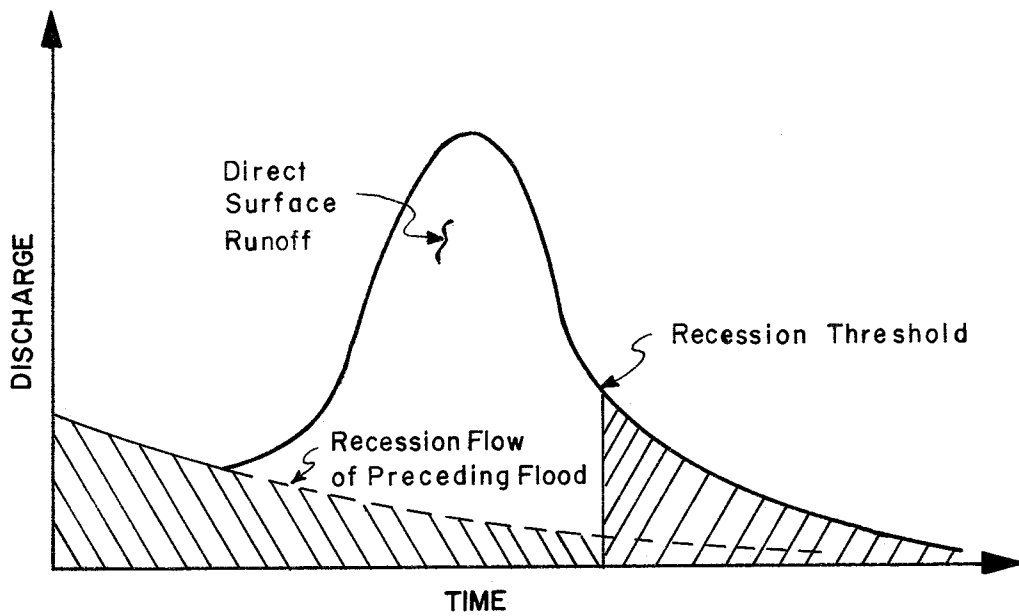

Fig. 3. Base Flow Separation

Routing. The routing procedures available in the program are the simplified storage routing procedures that neglect inertia effects. All these procedures can be used for streamflow routing and a few are useful for simple reservoir routing.

The Muskingum procedure determines reach outflow based on inflow and coefficients describing the reach travel time and attenuation characteristics. The Tatum method is a simplification of the Muskingum procedure. The modified Puls (sometimes termed storage indication) is simply a solution of the continuity equation when storage and outflow are uniquely related and is appropriate for both streamflow and simple reservoirs. The time-of-storage procedure is primarily a simple reservoir procedure and the working R and D is a combination of the Muskingum technique and the modified Puls procedure. The straddle-stagger technique, a strictly empirical procedure, is also included.

Automatic Derivation of Parameters

HEC-1 can derive loss rate and unit hydrograph coefficients or routing coefficients automatically. In order to optimize coefficients, a hydrograph of observed runoff must be supplied. In the case of routing optimization, a pattern hydrograph for intermediate runoff (between given inflow and outflow) must also be supplied. This pattern hydrograph is automatically multiplied by a ratio to make the volume of intermediate runoff equal the difference between inflow and outflow volumes.

Coefficients are derived by successive approximations to determine the optimum values of a set of variables that will result in a minimum value of an

objective function. The objective function for optimal reconstitution is the weighted root-mean-square errors between computed and observed flows. In order to improve the reproduction of peak flows, errors associated with high flows are weighted heavier than those associated with low flows. Each error square is multiplied by $(Q + \bar{Q})/2\bar{Q}$ where \bar{Q} is the average flow. A volume check is included in the hydrograph reconstruction to assure approximate correspondence in volume between the observed and computed hydrographs.

The optimization process terminates after a specified number of steps. If a reproduction is not satisfactory, considerable improvement can be made in a second run by a routine that temporarily distorts the observed hydrograph to force a better reproduction without impairing the validity of the results. For example, if a portion of a reconstituted hydrograph is too low, it can be fitted better by increasing a key flow by about double the discrepancy. These temporary adjustments to the flow are removed before the hydrograph is printed.

Hydrograph Balancing

A hydrograph balance routine is included to convert any given hydrograph to one having specified volumes within given durations. Starting with the shortest duration specified, the period of maximum flow of the given hydrograph is determined, and the sum of all flows (that have not already been used in shorter-duration computation) within each period is computed. Flows are adjusted within each period by multiplying by the ratio

required to obtain the incremental volume needed. Since the changed shape of the hydrograph can alter the location of maximum flows, this process is repeated until all volumes are within 1 percent, using the derived hydrograph as the new pattern hydrograph each iteration.

General Input Structure

HEC-1 is designed to accept input in card form that will describe the type of job to be performed, its scope and the detailed information required for processing.

A single job to be processed by HEC-1 consists of one set of A through J cards followed by repeated sets of K cards through Z cards as necessary. There are five types of jobs that can be processed by HEC-1, and these are specified by a key variable.

The values of key variables determine the data to be processed. Only the cards required for the desired process are to be used, and they must be in the proper sequence.

Cards K through Z are used to specify the data relative to the individual subarea, routing reach, or combining operations and economic analyses. The order of computing hydrographs is vital in certain respects since the most recently computed hydrographs remaining in storage are the ones that may be combined or routed.

The type of information contained on the data cards is summarized below:

<u>Card Code</u>	<u>Description</u>
A	Job title
B	Job specifications
C	Observed hydrograph to be reconstituted
D	Routing optimization criteria and observed inflow hydrograph
E, F	Unit graph and loss rate optimization criteria
G, H	Station precipitation data for all subbasins of the watershed
I	Precipitation depth-drainage area data
J	Multiflood, multiplan data
K	Computation specification for model building
L	Hydrograph balancing criteria
M-X	Subarea runoff computation data including precipitation, losses, and unit graph information
Y	Individual reach routing criteria
Z	Economic and flood frequency data

In modelling a watershed (nonoptimization jobs) the K cards, followed by the appropriate runoff or routing cards, will be repeated as many times as necessary in order to compute the runoff, routing and combining of hydrographs in a logical progression through the basin.

An example of program input and output for a subarea runoff hydrograph computation is contained on the following pages.

SUB-AREA RUNOFF COMPUTATION

MAIDEN-CREEK DAM SITE

ISTAG 0 ICOMP 0 IECON 0 ITAPE 7 JPLT 2 JPRT 0 INAME 1

IHYDR 2 IUHG 1 IAREA 161.00 SNAP .00 TRSDA .00 TRSPC .00 RATIO .000 ISNOM 0 ISAME 0 LACAL 0

NON-RECORDING STATION WEIGHTINGS (ISTN,WTN)

RECORDING STATION WEIGHTINGS (ISTR,WTR)

6, 1.00

21, 1.00

LOSS DATA

STKR DLTKR RTIOL ERAIN STRKS STRL CNSL ALSMX RTMP

TP= 7.30 CP= .40

RECESSION DATA

STRIF= 240.00 CRCSM= 400.00 RTIOR= 1.30

APPROXIMATE CLARK COEFFICIENTS FROM GIVEN SNYDER CP AND TP ARE TC= 2.58 AND R= 4.15 INTERVALS

UNIT HYDROGRAPH 24 END-OF-PERIOD ORDINATES. LAG= 7.28 HOURS, CP= .40 VOL= 1.00

END-OF-PERIOD FLOW

TIME	RAIN	EXCS	COMP
21 3 0	.00	.00	234.
21 6 0	.09	.00	228.
21 9 0	.18	.00	222.
21 12 0	.00	.00	216.
21 15 0	.26	.00	210.
21 18 0	.18	.00	205.
21 21 0	.00	.00	200.
22 3 0	1.06	.44	750.
22 6 0	.18	.00	2008.
22 9 0	.00	.00	2631.
22 12 0	.26	.00	2322.
22 15 0	3.35	2.90	5568.
22 18 0	1.67	1.22	15136.
22 21 0	.44	.00	22869.
23 3 0	.09	.00	22568.
23 6 0	.00	.00	18445.
23 9 0	.09	.00	14511.
23 12 0	.09	.00	11422.
23 15 0	.00	.00	8996.
23 18 0	.09	.00	7090.

23 15 0	.00	.00	5594.
23 14 0	.00	.00	4418.
23 21 0	.00	.00	3494.
24 3 0	.00	.00	2768.
24 3 0	.00	.00	2197.
24 6 0	.00	.00	1749.
24 9 0	.00	.00	1396.
24 12 0	.00	.00	1118.
24 15 0	.00	.00	900.
24 18 0	.00	.00	728.
24 21 0	.00	.00	592.
25 0 0	.09	.00	471.
25 3 0	.00	.00	459.
25 6 0	.00	.00	447.
25 9 0	.00	.00	435.
25 12 0	.00	.00	424.
25 15 0	.00	.00	413.
25 18 0	.00	.00	402.
26 21 0	.00	.00	392.
26 0 0	.00	.00	382.
26 3 0	.00	.00	372.
26 6 0	.00	.00	362.
26 9 0	.00	.00	353.
26 12 0	.00	.00	344.
26 15 0	.00	.00	335.
26 18 0	.00	.00	326.
26 21 0	.00	.00	318.
27 0 0	.00	.00	310.
27 3 0	.00	.00	302.
27 6 0	.00	.00	294.

SUM 8.12 4.56 168076.

PEAK	6-HOUR	24-HOUR	72-HOUR
22869.	22728.	15132.	6642.
CFS	1.31	3.50	4.61
INCHES			
AC-FT	11276.	30029.	39545.

#OVF*

STATION 89

INFLOW(I), OUTFLOW(O), AND OBSERVED FLOW(*)

	4000.	8000.	12000.	16000.	20000.	24000.						
21 3 010								0.				
21 6 010												
21 9 010												
21 12 010												
21 15 010												
21 18 010 *												
21 21 010 *												
22 0 010 *												
22 3 010 *												
22 6 010 *												
22 9 010 *												
22 12 010 *												
22 15 010 *												
22 18 010 *												
22 21 010 *												
23 0 010 *												
23 3 010 *												
23 6 010 *												
23 9 010 *												
23 12 010 *												
23 15 010 *												
23 18 010 *												
23 21 010 *												
24 0 010 *												
24 3 010 *												
24 6 010 *												
24 9 010 *												
24 12 010 *												
24 15 010 *												
24 18 010 *												
24 21 010 *												
25 0 010												
25 3 010												
25 6 010												
25 9 010												
25 12 010												
25 15 010												
25 18 010												
25 21 010												
26 0 010												
26 3 010												
26 6 010												
26 9 010												
26 12 010												
26 15 010												
26 18 010												
26 21 010												
27 0 010												
27 3 010												
27 6 010												

Hardware and Software Requirements

HEC-1 has been developed and tested primarily on the UNIVAC 1108 and the Control Data Corporation 6600 computer systems. It was then adapted for use on the GE 400 series computers. The program is written in FORTRAN IV and contains about 3,000 FORTRAN statements. Table 1 shows the hardware requirements and selected running times for the program.

Table 1. Hardware Requirements and Running Times

	FORTRAN IV Compiler Four tape and/or disk units*		
	<u>UNIVAC 1108</u>	<u>CDC 7600</u>	<u>GE 400</u>
Memory (words)	38,700	35,400	32,000
Printer (positions)	132	132	120
Compilation (CPU seconds)	30	3	--
Execution of Test 5 (CPU seconds)	11	1	--

*May only require two tapes or disks if output hydrographs are not to be saved or read in from previous jobs.

WATER SURFACE PROFILES (HEC-2)

General Capabilities

HEC-2 has been designed to perform steady gradually varied flow profile computations for natural channels. The program accommodates local obstructions such as weirs, culverts and bridges so that a continuous (uninterrupted computation) profile can be computed for either subcritical or supercritical flow. Reference 3 contains detailed information on the capabilities and data preparation requirements.

Profile computations for channel reaches are based on solution of the one-dimensional Bernoulli equation with energy loss due to friction evaluated with the Manning's equation and other losses evaluated by application of the shock-loss equation. The solution procedure used is generally referred to as the standard-step method.

The flow field at a cross section is divided into main channel and overbank areas and the overbank areas are subdivided to account for nonuniform velocity distributions. The reach distances to adjacent cross-sections may be specified for the channel and overbank areas.

Energy losses at obstructions can be accommodated by three alternative means. The loss (rating curve) may be supplied directly. The "normal" bridge routine evaluates energy losses by normal standard-step computations with corrections for flow area and wetted perimeter. The "special" bridge routine applies the principles of conservation of momentum to evaluate depths and thus, indirectly, energy loss. It observes the hydraulic control concept of critical depth in determining the flow characteristics. This routine also computes energy losses based on the weir equation when flow is over the road deck, and the orifice equation when flow is confined to the bridge opening and under pressure. Bridge characteristics are described by the natural valley cross section, the top of roadway and low chord profiles, and appropriate discharge and loss coefficients.

The program has been carefully designed to ease data handling and manipulation requirements. Many routines and options are available for describing cross sections, specifying the portion of the cross section

that is effective in passing flow, manipulating the cross section by skewing and raising and lowering as desired. Utility features permit processing many profiles during a single run, plotting output, summarizing computations and editing data. A large number of diagnostic notes are output during computations.

The program has a few special routines designed to assist in flood plain management and flood insurance studies wherein encroachments must be evaluated and floodways must be designated.

Computational Procedures for Channels

The standard-step method of computing water surface elevation at specific locations requires a trial solution of the Bernoulli equation. Figure 4 indicates a schematic of the computation procedure. The terms in the equation that require special attention in natural channels are the velocity head and the friction loss.

Velocity Head. Because the Bernoulli equation is one-dimensional, the velocity head term must be corrected to account for the kinetic energy content of the moving total fluid considering the nonuniformity of the velocity distribution. The procedure used is to subdivide the cross section at each coordinate point, compute the velocity head for each subsection and weight the incremental velocity head in accordance with the discharge in each subsection. The velocity for each subsection is computed by the Manning equation for the roughness and wetted perimeter of that subsection.

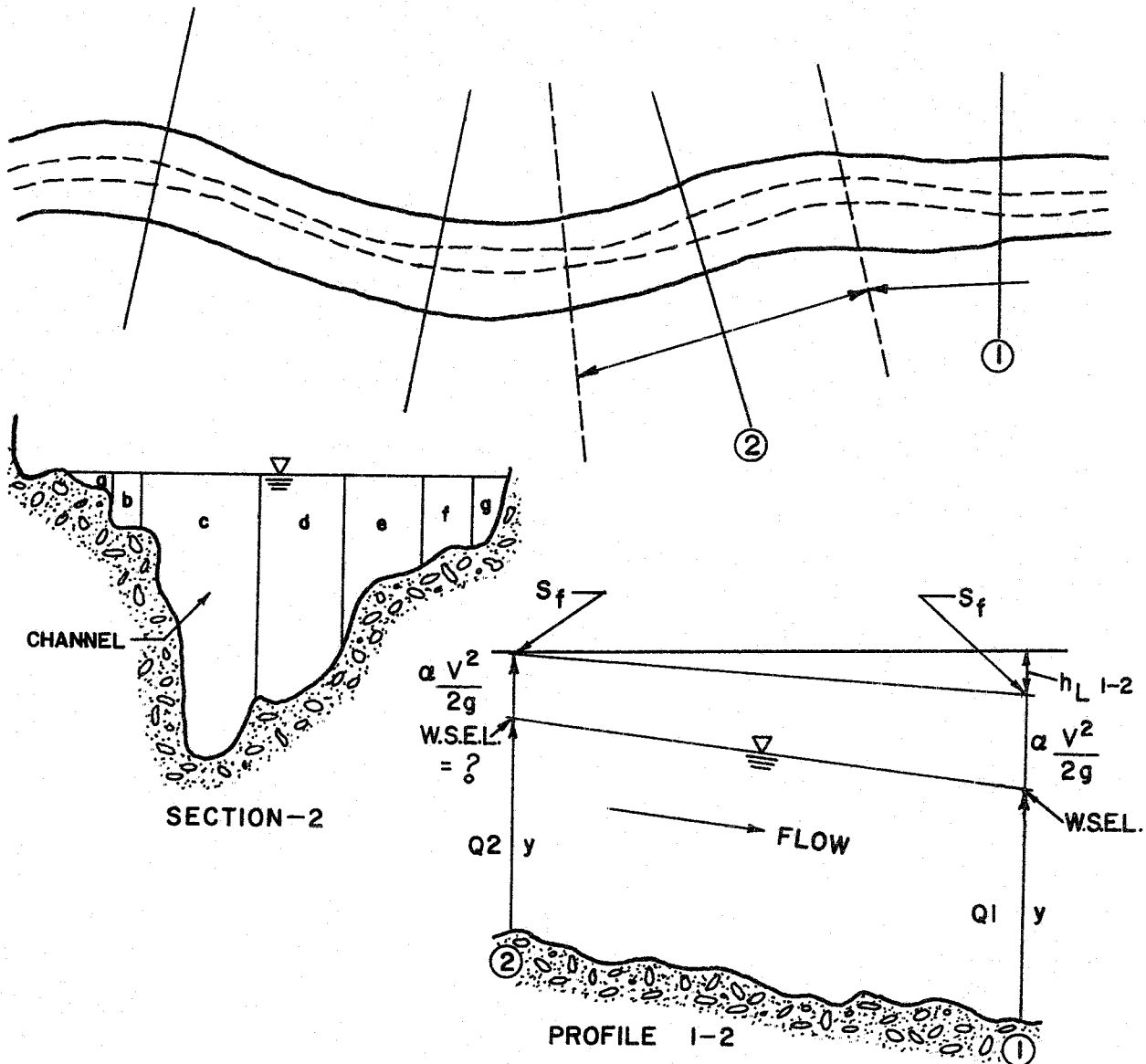

Computation Procedure

Conditions are known @ 1

- Assume water surface elevation at ② - WSEL (2)
- *** Compute conveyance-- $K(2) = \Sigma K_a + K_b + \dots + K_g$
where: $K = \frac{1.49}{n} AR^{2/3}$

- *** Compute representative rate of friction loss

$$K_{av} = \frac{K(1) + K(2)}{2} \cdot S_{av} = \frac{Q2}{K_{av}^2}$$

- Compute WSEL(2)

$$WSEL(2) = WSEL(1) + \alpha \frac{V_1^2}{2g} + S_{av} \cdot L_w + C \cdot \frac{|\Delta \alpha V^2|}{2g} - \alpha \frac{V_2^2}{2g}$$

Compare and repeat until criterion met.

Fig. 4. Schematic of Computation Procedure

Friction Loss. The friction loss between adjacent cross sections is computed as the product of the representative rate of friction loss (friction slope) and the weighted reach length. The weighted reach length is determined by weighting the channel length for each overbank area and the main channel by the discharge flowing in each of these major section elements. The representative rate of friction loss is determined by averaging the conveyances of the adjacent cross section and then computing an equivalent energy grade line slope from the Manning equation. The conveyance of each cross section is the sum of the conveyances of each subsection within the cross section. The conveyance of each subsection is computed from the geometric and hydraulic parameters of the Manning equation as indicated in figure 4.

Other Losses. The program considers other losses to be expansion and contraction losses that are generated because of changes in cross section geometry. The loss is computed as the product of the appropriate loss coefficient and the absolute value of the difference in velocity head. The loss is computed each time a new cross section is encountered, including those through bridges.

Critical Depth. The program assumes the profile being computed is either all subcritical or all supercritical. Either can be processed but must be done so separately. Critical depth therefore cannot be crossed during a profile computation. If the search procedure determines that the depth being computed lies on the other side of critical depth from the initial specification, the program assumes critical depth at that

section, prints a note and proceeds to the next section. Critical depth is calculated for every cross section for supercritical profiles but only when necessary to determine if crossing is possible for subcritical profiles. Critical depth is computed by a search procedure that seeks the depth that results in the minimum value of specific energy. The nonuniformity of velocity distribution in the cross section is considered in the computations.

Computation Controls. The solution for critical depth and for the water surface elevation at each cross section requires trial and error iterative-type computations. The number of iterations used for each computation is limited so that failure to converge would not cause profile computation to cease. In those instances where convergence does not occur, messages are generated to focus attention on problem areas. Failure to converge is not necessarily caused by errors since complex natural cross sections can give rise to inconsistencies in solution of the one-dimensional equations.

Bridge Losses

Energy losses caused by structures such as bridges and culverts are computed in two parts. First, the losses due to expansion and contraction of the cross section on the upstream and downstream sides of the structure are computed. Secondly, the loss through the structure itself is computed by either the normal bridge routine or the special bridge routine.

Normal Bridge Routine. The normal routine handles the cross section at the bridge just as it would any river cross section with the exception

that the area of the bridge below the water surface is subtracted from the total area and the wetted perimeter is increased where the water surface elevation exceeds the low chord. The bridge deck is described by entering the elevation of the top of roadway and low chord, or by specifying a table of roadway elevation and station and corresponding low chord elevations. When only top-of-roadway and low chord elevations are used, these elevations are extended horizontally until they intersect the ground line. Pier losses are accounted for by the increased wetted perimeter of the piers. The normal routine is particularly applicable for bridges without piers, bridges under high submergence, and for low flow through circular and arch culverts. Whenever flow crosses critical depth in a structure, the special bridge routine should be used. The normal bridge is automatically used by the computer, even though data was prepared for the special bridge routine, for bridges without piers and under low flow control.

Special Bridge Routine. The special bridge routine can be used for any bridge, but should be used for trapezoidal bridges with piers where low flow controls, for pressure flow through circular or arch culverts, and whenever flow passes through critical depth when going through the structure. The special bridge routine computes losses through the structure for low flow, weir flow and pressure flow or for any combination of these. The type of flow is determined by a series of comparisons as shown on figure 5 and as described below. First, the energy grade line elevations are computed assuming alternately low flow and pressure flow control. The

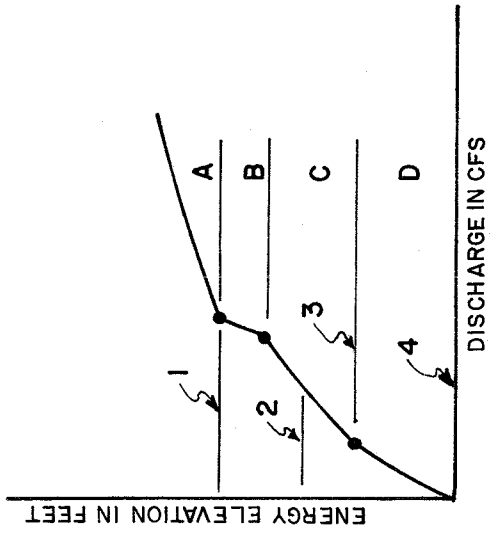

BRIDGE RATING CURVE

- FLOW CONDITION**
- A - Combined pressure under bridge, weir in over banks, weir over bridge
 - B - Combined pressure under bridge, weir in overbanks
 - C - Combined low flow under bridge, weir in overbanks
 - D - Low flow under bridge

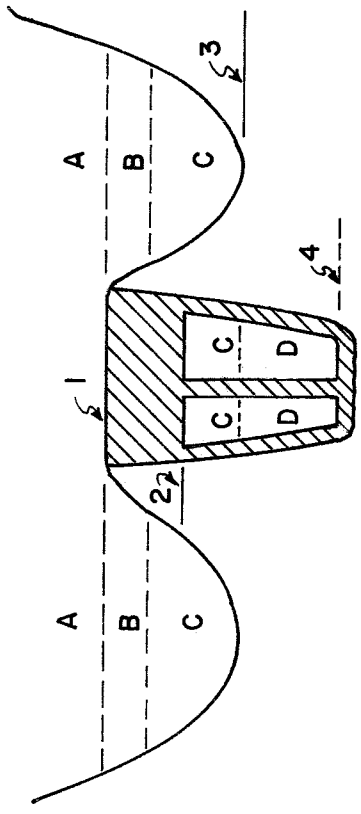

BRIDGE CROSS SECTION

- ELEVATIONS**
- 1 Top of Roadway
 - 2 Low Chord
 - 3 Roadway Approach
 - 4 Channel Invert

FIG. 5 ILLUSTRATION OF BRIDGE FLOW TYPES

higher energy grade line elevation determines the appropriate type of flow. If pressure flow appears to control and the energy grade line is above the minimum top-of-roadway elevation, then a combination of pressure flow and weir flow exists. If the energy gradient is below the minimum top of roadway, then pressure flow alone controls. If low flow appears to control, and the corresponding energy gradient elevation is above the minimum top-of-roadway elevation, then a combination of low flow under the bridge and weir flow over the roadway approach exists; if the energy elevation is below the minimum top-of-roadway, then low flow controls.

Low flow is further classified as Class A, B and C depending on whether subcritical, critical, or supercritical flow occurs between bridge piers. Class A flow (subcritical flow through bridge) is solved from Yarnell's energy equation. Class B and C flows (critical and supercritical flows, respectively) are handled by momentum relations which equate the momentum flux at adjacent locations and solve for depth. The flow class (A, B or C) is determined by comparison of the momentum flux within the constriction based on upstream and downstream conditions and the momentum flux assuming critical depth in the constriction. Weir flow is computed by the standard broad-crested weir equation. The approach velocity is included by using the energy grade line elevation in lieu of the upstream water surface elevation for computing the head, H . Where submergence by tailwater exists, the discharge coefficient is reduced by the computer program according to a specified procedure. The total flow is computed by dividing the weir flow into subsections, computing the incremental flow for each subsection and summing all subareas.

Pressure flow computations use the orifice flow equation with the head defined as the difference between the energy gradient elevation upstream and tailwater elevation downstream. The total loss coefficient K, representing losses between the cross sections immediately upstream and downstream of the bridge, is equal to the sum of loss coefficients for intake, intermediate piers, friction, exit and other minor losses.

Often combinations of these three basic types of flow occur. In these cases, a trial and error procedure is used with the equations just described to determine the amount of each type of flow. The procedure consists of assuming energy elevations and computing the total discharge until the computed discharge equals, within one percent, the discharge desired.

Program Input for Profile Computation

A major portion of the programming in HEC-2 is devoted to providing a large variety of input and data manipulation options. The program objective is quite simple--compute water surface elevations at all locations of interest for given flow values. The data needed to perform those computations include flow, starting elevation, cross section geometry and roughness, and reach lengths. The options available for providing and manipulating input are discussed in the following pages.

Flow. The river flow may be specified and altered in several ways. The starting flow is normally specified as a single value when only one flow is anticipated. If it is desired to use different flows for subsequent jobs using the same cross sections, a discharge table may be used. The flow

may also be changed at any cross section such as at a confluence with another river or stream. The flow change at any cross section becomes permanent for subsequent cross sections. The flow for the entire profile may be increased or decreased by a factor if desired. This feature can be very useful in sensitivity studies.

Starting Elevation. The water surface elevation for the beginning cross section may be specified in one of three ways: (1) as critical depth in which case it will be computed, (2) as a known elevation, (3) by the slope area method. For beginning by the slope area method, the estimated slope of the energy grade line must be provided and the initial estimate of the water surface elevation is also needed. The flows computed for the fixed slope and estimated depth are compared with the starting flow and the initial depth is adjusted until the computed flow is within 1 percent of the starting flow.

River Flow Geometry. Cross sections are required at representative locations throughout the river reach. These are locations where changes occur in slope, cross sectional area, or channel roughness; locations where levees begin or end; and at bridges. In general, for rivers of flat slope and fairly uniform section (drop of 3 or 4 feet per mile) cross sections should be taken at least every mile. For steeper slopes and very irregular cross sections, four or five cross sections per mile may be necessary. Where an abrupt change occurs in the cross section, several cross sections should be used to describe the change regardless of the distance. Every effort should be made to obtain cross sections that

accurately represent the river geometry.

Each cross section in the reach is described by coordinates that give a station number corresponding to the horizontal distance from the first point on the left and the corresponding elevation of the ground surface. Cross sections may be oriented looking either upstream or downstream since the program considers the left side to be the lowest station number and the right side the highest. The left and right stations separating the channel from the overbank areas must be specified. End points of a cross section that are too low (below the computed water surface elevation) will automatically be extended vertically by the program, if needed, and a message giving the vertical distance extended will be printed.

There are times when the user wishes to use the previous cross section as the current one (for uniform channels), with or without a modification, or to modify the current cross section (perhaps the surveyed cross section is moved upstream or downstream). The horizontal dimensions of the previous or current cross section can be increased or decreased by a factor and all the elevations of the previous or current cross sections can be raised or lowered by a constant.

The existing cross section can be modified due to the excavation of a trapezoidal channel. The coordinate points are modified due to the excavation, but no fill is used. The bank elevations and stations are modified if the channel daylights outside the original bank stations. If the alignment of the excavated channel is such that two separate

channels exist, the division between overbank and channel will be based on the excavated channel, and the old channel will be considered as overbank (no fill). It may be necessary to change the reach lengths for this case.

Levees require special consideration in computing water surface profiles because of possible overflow into areas outside the main channel. Normally the computations are based on the assumption that all area below the water surface elevation is effective in passing the discharge. However, if the water surface elevation is less than the top-of-levee elevation, and if the water cannot enter the overbanks upstream or downstream of that cross section, then all flow area in these overbanks should not be used in the computations. By setting a code, the program will consider only flow confined by the levees, unless the water surface elevation is above the top of one or both sides of the levee, in which case flow area or areas outside the levee will be included. It is important for the user to study carefully the flow pattern of the river where levees exist to determine such items as if a levee were open at both ends and flow could pass behind the levee without overtopping it. Also, assumptions regarding effective flow areas may change with changes in flow magnitude. Where cross section elevations outside the levee are considerably lower than the channel bottom, it may be necessary to confine the flow to the channel.

Sometimes it is necessary to insert cross sections between those specified because the change flow in characteristics between cross sections

is too great to accurately determine the energy losses. Up to three interpolated cross sections will be generated between given cross sections under certain conditions. It is possible to suppress program generated interpolated cross sections, and they should be omitted when computing several profiles on the same stream in order to use exactly the same cross sections. The distance between cross sections used in the computation can be specified for the left overbank, right overbank, and channel, respectively. There are conditions where they will differ, such as at river bends, or where the channel meanders considerably and the overbanks are straight.

Channel Roughness. Since Manning's coefficient of roughness, n , depends on such factors as type and amount of vegetation, channel configuration and stage, several options are available to vary n . The normal situation is when three n values are sufficient to describe the channel and overbank roughness. Any of the n values may be permanently changed at any cross section. Often three values are not enough to adequately describe the lateral roughness variation in the overbanks in which case up to 19 n values and corresponding cross section stations are provided. The n values thus specified apply only to the overbanks, while the value used for the channel is as normally entered.

Data indicating the variation of Manning's n with river stage may be used in the program. This option applies only to the channel area.

It is possible for subsequent runs of the same job to multiply the n values specified by a multiplier. The desired multiplier is simply entered for each job. This feature may be useful in calibration and sensitivity studies.

Manning's n can be computed from known high water marks along the river reach if the discharge, relative ratios of the n values for the channel and overbanks and the water surface elevations at each cross section are known. The "best estimate" of n for the first cross section must be provided since it is not possible to compute an n value for this cross section. The relative ratio of n between channel and overbank is set by the first cross section and will be used for all subsequent cross sections unless changed. The n values required to match the high water marks are then computed provided an adverse slope in energy grade line is not encountered, in which case computations restart using n values from the previous section.

Utility Features and Output

Several profiles may be computed using the same cross section data. A summary printout will provide a concise listing of the key results for all profiles for each cross section. The user may select a number of the variables to be retained for the summary printout.

Multiple Stream Profiles. The water surface profile computations may be extended up both forks of a river or throughout a whole river basin for single or multiple profiles in a single computer run. The profile is first computed for reach 1 from the most downstream point to the end of one tributary. The data for a second tributary (reach 2), whose starting water surface elevation was determined when reach 1 was calculated, follows the data for reach 1. When a negative section number is encountered, the program will search its memory for the computed water

surface elevation that corresponds to the negative section number. It will then start computing the profile for reach 2 with the previously determined water surface elevation.

Storage-Outflow Data. Punched cards can be obtained from HEC-2 for stream routing by the modified Puls method using the program HEC-1. This option can be used only if multiple profiles are computed from the same cross sectional data. It may not be wise to use interpolated cross sections since a different number of cross sections might be interpolated between two given cross sections for different magnitudes of discharge which could cause inconsistencies in the incremental storage volumes.

Encroachment Options. Four methods of specifying encroachments for floodway studies can be used. Stations and elevations of the left and/or right encroachment can be specified for individual cross sections as desired. Stations can also be specified differently for each profile. A fixed topwidth can be specified which will be used for all cross sections until changed. The left and right encroachment stations are made equidistant from the centerline of the channel, which is half-way between the left and right bank stations. Different topwidths may be specified for each profile of a multiple profile run. Encroachments can be specified by percentages which indicate the desired proportional reduction in the natural (first profile) discharge carrying capacity (conveyance) of each cross section. For example, input could specify that for the second profile 5 percent of the flow-carrying capacity based on the first profile, will be eliminated on each side of the main channel as long as

the encroachments do not fall within the main channel. If one side cannot carry the 5 percent reduction, a reduction of more than 5 percent will be attempted on the other side. The first profile is for natural conditions; different sets of ratios can be specified for all subsequent profiles.

Encroachments can be determined so that each modified cross section will have the same discharge carrying capacity (at some higher elevation) as the natural cross section. This higher elevation is specified as a fixed amount above the natural (e.g., 100-year) profile. The encroachments are determined so that an equal loss of conveyance (at the higher elevation) occurs on each side of the channel, if possible, as before.

The horizontal distribution of area, velocity and discharge can be requested for the overbank areas. If the number of subsections carrying flow in the overbanks is less than 11, the distribution using all subsections will be printed. Otherwise, the distribution will be based on subsections that carry more than 3 percent of the flow.

Cross Section Plot. Plots on the printer of any or all of the river cross sections to any scale may be requested. Vertical and horizontal scales of the plot may be specified constant for all cross sections in the job.

Profile Plot. This plot includes the water surface elevation, the critical water surface elevation, energy grade line, channel invert, left and right bank elevations, and the maximum elevation of the cross section for which hydraulic properties can be computed. The vertical

scale of the profile may be determined by the user or by the computer. Profiles are plotted automatically for jobs using more than five cross sections, but may be suppressed if desired.

Example

The following pages contain input for a sample profile computation and normal output, a summary printout and a profile plot.

T1 TEST J SECOND PROFILE USING CHANNEL IMPROVEMENT (IBW=0,BW=10)
 T2 SUMMARY PRINTOUT FOR MULTIPLE PROFILES(J2.1)
 T3 CATALPA CREEK

J1 ICHECK INQ NINV IDIR START METRIC HVINS Q WSEL FQ
 -0. 12. -0. -0. -0.00000 -0.00 -1.0 -0. 168.100 -0.000
 J2 NPROF IPLOT PRFVS XSECV XSECH FN ALLDC IBW CHNIM ITRACE
 15.000 -0.000 -1.000 -0.000 -0.000 -0.000 -0.000 30.000 -0.000

CCHV= .100 CEHV= .300

3265 DIVIDED FLOW

SECNO	DEPTH	CWSEL	CRIMS	WSELK	EG	HV	HL	OLOSS	BANK ELEV
Q	QLOB	QCH	QROB	ALOB	ACH	AROAB	VOL	TWA	LEFT/RIGHT
TIME	VLOB	VCH	VROB	XNL	XNCH	XNR	WTN	ELMIN	SSTA
SLOPE	XLOBL	XLCH	XLOBR	ITRIAL	IDC	ICONT	CORAR	TOPWID	ENDST
1.05	24.15	168.10	.00	168.10	168.64	.54	.00	.00	164.15
25000.	2194.	22806.	0.	3747.	3682.	0.	0.	0.	166.15
.000901	.59	6.19	.11	.120	.037	.120	.000	143.95	14421.00
	-0.	-0.	-0.	0	0	1	.00	2194.54	18448.34

CHIMP CLSTA= 18300.00 CELCH= 147.09 BW= 10.00 STCHL= 18150.00 STCHR= 18448.00
 2136 NH VALUES .120 18120.001 .025 18478.000 .120 20600.010

3265 DIVIDED FLOW

1.55	23.37	170.46	.00	.00	171.15	.70	2.46	.05	167.29
25000.	1221.	23768.	11.	2471.	3460.	44.	388.	74.	169.29
.15	.49	6.87	.26	.098	.025	.093	.026	147.09	14436.67
.000548	1200.	3684.	1300.	2	0	1	.00	1904.17	18547.27

CHIMP CLSTA= 18299.00 CELCH= 148.79 BW= 10.00 STCHL= 18150.00 STCHR= 18448.00
 2136 NH VALUES .098 18120.001 .025 18478.000 .093 20600.010

3265 DIVIDED FLOW

1.82	22.47	171.26	.00	.00	172.13	.87	.92	.05	168.99
25000.	739.	24260.	0.	1287.	3197.	2.	560.	127.	170.99
.21	.57	7.59	.14	.079	.025	.077	.026	148.79	14454.65
.000744	1400.	1450.	1250.	2	0	1	.00	1420.16	18493.90

CHIMP CLSTA= 18299.00 CELCH= 150.55 BW= 10.00 STCHL= 18150.00 STCHR= 18448.00
 2136 NH VALUES .079 18120.001 .025 18478.000 .077 20600.010

3265 DIVIDED FLOW

2.10	21.81	172.36	.00	.00	173.38	1.02	1.21	.05	170.75
25000.	425.	24575.	0.	660.	3000.	0.	695.	168.	172.75
.26	.64	8.19	.00	.064	.025	.077	.025	150.55	14467.87
.000942	1400.	1450.	1250.	2	0	1	.00	1089.33	18447.87

SUMMARY PRINTOUT FOR MULTIPLE PROFILES

CATALPA CREEK

SECTION NUMBER	CHANNEL LENGTH	MIN EL OF ROADWAY	MAX EL OF LOW CHORD	MIN EL OF GROUND	DISCHARGE (CFS)	CWSEL	CRINS	TOPWID	TIME	VOL	QCH	K*ANCH
1.05	.00	.00	.00	143.95	25000.00	168.10	.00	2194.54	.00	.00	22806.34	37.00
1.05	.00	.00	.00	143.95	25000.00	168.10	.00	2194.54	.00	.00	22806.34	37.00
1.55	3684.00	.00	.00	147.09	25000.00	171.23	.00	2187.47	.17	414.03	22822.25	37.00
1.55	3684.00	.00	.00	147.09	25000.00	170.46	.00	1904.17	.15	388.32	23767.64	25.00
1.82	1450.00	.00	.00	148.79	25000.00	172.58	.00	2023.04	.23	644.33	23181.32	37.00
1.82	1450.00	.00	.00	148.79	25000.00	171.26	.00	1420.16	.21	560.18	24260.43	25.00
2.10	1450.00	.00	.00	150.55	25000.00	174.10	.00	1907.81	.30	855.36	23419.54	37.00
2.10	1450.00	.00	.00	150.55	25000.00	172.36	.00	1089.33	.26	694.63	24574.69	25.00

SECTION NUMBER	DISCHARGE CFS	CWSEL	CWSEL DIFF EACH Q	CWSEL DIFF EACH SECTION	CWSEL-WSELK	TOPWID	T.W. DIFF	LENGTH
1.050	25000.000	168.100	.000	.000	.000	2194.545	-.000	-.000
1.050	25000.000	168.100	.000	.000	.000	2194.545	-.000	-.000
1.550	25000.000	171.231	.000	3.131	.000	2187.471	-.000	3684.000
1.550	25000.000	170.458	-.773	2.358	.000	1904.174	283.296	3684.000
1.820	25000.000	172.583	.000	1.352	.000	2023.043	-.000	1450.000
1.820	25000.000	171.258	-1.325	.800	.000	1420.157	602.886	1450.000
2.100	25000.000	174.103	.000	1.520	.000	1907.809	-.000	1450.000
2.100	25000.000	172.356	-1.746	1.099	.000	1089.328	818.481	1450.000

DATA FOR LAST CROSS SECTION

PROFILE	TYPE	ENC	TARGET	TOP WIDTH AREA-ACRES	TOP WIDTH AREA-DIFF
1		.000	.000	208.865	.000
2		.000	.000	167.779	-41.085

PROFILE FOR RIVER UPPER RIO HONDO RIVER

PLOTTED POINTS (BY PRIORITY)-E-ENERGY GRADIENT,W-WATER SURFACE,I-INVERT,C-CRITICAL W.S.,L-LEFT BANK,R-RIGHT BANK,M-MAX.

ELEVATION-FT	-5.	0.	5.	10.	15.	20.	25.	30.	35.	40.	45.
70936.00			I		W	C	E				
	0.		I		W	C	E				
	5.		I		W	C	E				
	10.		I		W	C	E				
	15.		I		W	C	E				
	20.		I		W	C	E				
	25.		I		W	C	E				
	30.		I		W	C	E				
	35.		I		W	C	E				
	40.		I		W	C	E				
	45.		I		W	C	E				
	50.		I		W	C	E				
	55.		I		W	C	E				
	60.		I		W	C	E				
	65.		I		W	C	E				
	70.		I		W	C	E				
	75.		I		W	C	E				
	80.		I		W	C	E				
	85.		I		W	C	E				
	90.		I		W	C	E				
70850.00			I		W	C	E				
	95.		I		W	C	E				
	100.		I		W	C	E				
	105.		I		W	C	E				
	110.		I		W	C	E				
	115.		I		W	C	E				
	120.		I		W	C	E				
	125.		I		W	C	E				
	130.		I		W	C	E				
	135.		I		W	C	E				
	140.		I		W	C	E				
70800.00			I		W	C	E				
	145.		I		W	C	E				
	150.		I		W	C	E				
	155.		I		W	C	E				
	160.		I		W	C	E				
	165.		I		W	C	E				
	170.		I		W	C	E				
	175.		I		W	C	E				
	180.		I		W	C	E				
	185.		I		W	C	E				
	190.		I		W	C	E				
70750.00			I		W	C	E				
	195.		I		W	C	E				
	200.		I		W	C	E				
	205.		I		W	C	E				
	210.		I		W	C	E				
	215.		I		W	C	E				
	220.		I		W	C	E				
	225.		I		W	C	E				
	230.		I		W	C	E				
	235.		I		W	C	E				

Hardware and Software Requirements

HEC-2 has been developed and tested primarily on the UNIVAC 1108 and the Control Data Corporation 6600 computer systems. It has subsequently been adapted for other machines. The program is written in FORTRAN II and IV, and includes about 7,000 FORTRAN statements. The following table shows an approximate comparison of memory requirements and execution speeds for a number of computers.

Computer	Memory Requirement Words	Speeds	
		Compile	Test
CDC 6600	63,000	59 sec	15 sec
UNIVAC 1108	52,000	60 sec	50 sec
GE 437	29,000	10 min	5 min
IBM 360/50	70,000 (280,000 bytes)	14.5 min	1.7 min
CDC 7600	56,000	8 sec	2 sec

ACKNOWLEDGMENTS

The computer programs described herein have been developed over a number of years by personnel of The Hydrologic Engineering Center. HEC-1 was developed primarily by Leo R. Beard, recently retired Director of the HEC. HEC-2 was developed by Bill S. Eichert, Director of the HEC.

LIST OF REFERENCES

1. U. S. Army Corps of Engineers, The Hydrologic Engineering Center, "1972 Annual Report," U. S. Army Engineer District, Sacramento, 1972.
2. U. S. Army Corps of Engineers, The Hydrologic Engineering Center, "HEC-1, Flood Hydrograph Package Users Manual," U. S. Army Engineer District, Sacramento, January 1973.
3. U. S. Army Corps of Engineers, The Hydrologic Engineering Center, "HEC-2, Water Surface Profiles Users Manual," U. S. Army Engineer District, Sacramento, February 1972.

Technical Paper Series

TP-1	Use of Interrelated Records to Simulate Streamflow	TP-39	A Method for Analyzing Effects of Dam Failures in Design Studies
TP-2	Optimization Techniques for Hydrologic Engineering	TP-40	Storm Drainage and Urban Region Flood Control Planning
TP-3	Methods of Determination of Safe Yield and Compensation Water from Storage Reservoirs	TP-41	HEC-5C, A Simulation Model for System Formulation and Evaluation
TP-4	Functional Evaluation of a Water Resources System	TP-42	Optimal Sizing of Urban Flood Control Systems
TP-5	Streamflow Synthesis for Ungaged Rivers	TP-43	Hydrologic and Economic Simulation of Flood Control Aspects of Water Resources Systems
TP-6	Simulation of Daily Streamflow	TP-44	Sizing Flood Control Reservoir Systems by System Analysis
TP-7	Pilot Study for Storage Requirements for Low Flow Augmentation	TP-45	Techniques for Real-Time Operation of Flood Control Reservoirs in the Merrimack River Basin
TP-8	Worth of Streamflow Data for Project Design - A Pilot Study	TP-46	Spatial Data Analysis of Nonstructural Measures
TP-9	Economic Evaluation of Reservoir System Accomplishments	TP-47	Comprehensive Flood Plain Studies Using Spatial Data Management Techniques
TP-10	Hydrologic Simulation in Water-Yield Analysis	TP-48	Direct Runoff Hydrograph Parameters Versus Urbanization
TP-11	Survey of Programs for Water Surface Profiles	TP-49	Experience of HEC in Disseminating Information on Hydrological Models
TP-12	Hypothetical Flood Computation for a Stream System	TP-50	Effects of Dam Removal: An Approach to Sedimentation
TP-13	Maximum Utilization of Scarce Data in Hydrologic Design	TP-51	Design of Flood Control Improvements by Systems Analysis: A Case Study
TP-14	Techniques for Evaluating Long-Term Reservoir Yields	TP-52	Potential Use of Digital Computer Ground Water Models
TP-15	Hydrostatistics - Principles of Application	TP-53	Development of Generalized Free Surface Flow Models Using Finite Element Techniques
TP-16	A Hydrologic Water Resource System Modeling Techniques	TP-54	Adjustment of Peak Discharge Rates for Urbanization
TP-17	Hydrologic Engineering Techniques for Regional Water Resources Planning	TP-55	The Development and Servicing of Spatial Data Management Techniques in the Corps of Engineers
TP-18	Estimating Monthly Streamflows Within a Region	TP-56	Experiences of the Hydrologic Engineering Center in Maintaining Widely Used Hydrologic and Water Resource Computer Models
TP-19	Suspended Sediment Discharge in Streams	TP-57	Flood Damage Assessments Using Spatial Data Management Techniques
TP-20	Computer Determination of Flow Through Bridges	TP-58	A Model for Evaluating Runoff-Quality in Metropolitan Master Planning
TP-21	An Approach to Reservoir Temperature Analysis	TP-59	Testing of Several Runoff Models on an Urban Watershed
TP-22	A Finite Difference Methods of Analyzing Liquid Flow in Variably Saturated Porous Media	TP-60	Operational Simulation of a Reservoir System with Pumped Storage
TP-23	Uses of Simulation in River Basin Planning	TP-61	Technical Factors in Small Hydropower Planning
TP-24	Hydroelectric Power Analysis in Reservoir Systems	TP-62	Flood Hydrograph and Peak Flow Frequency Analysis
TP-25	Status of Water Resource System Analysis	TP-63	HEC Contribution to Reservoir System Operation
TP-26	System Relationships for Panama Canal Water Supply	TP-64	Determining Peak-Discharge Frequencies in an Urbanizing Watershed: A Case Study
TP-27	System Analysis of the Panama Canal Water Supply	TP-65	Feasibility Analysis in Small Hydropower Planning
TP-28	Digital Simulation of an Existing Water Resources System	TP-66	Reservoir Storage Determination by Computer Simulation of Flood Control and Conservation Systems
TP-29	Computer Application in Continuing Education	TP-67	Hydrologic Land Use Classification Using LANDSAT
TP-30	Drought Severity and Water Supply Dependability	TP-68	Interactive Nonstructural Flood-Control Planning
TP-31	Development of System Operation Rules for an Existing System by Simulation	TP-69	Critical Water Surface by Minimum Specific Energy Using the Parabolic Method
TP-32	Alternative Approaches to Water Resources System Simulation		
TP-33	System Simulation of Integrated Use of Hydroelectric and Thermal Power Generation		
TP-34	Optimizing flood Control Allocation for a Multipurpose Reservoir		
TP-35	Computer Models for Rainfall-Runoff and River Hydraulic Analysis		
TP-36	Evaluation of Drought Effects at Lake Atitlan		
TP-37	Downstream Effects of the Levee Overtopping at Wilkes-Barre, PA, During Tropical Storm Agnes		
TP-38	Water Quality Evaluation of Aquatic Systems		

- TP-70 Corps of Engineers Experience with Automatic Calibration of a Precipitation-Runoff Model
- TP-71 Determination of Land Use from Satellite Imagery for Input to Hydrologic Models
- TP-72 Application of the Finite Element Method to Vertically Stratified Hydrodynamic Flow and Water Quality
- TP-73 Flood Mitigation Planning Using HEC-SAM
- TP-74 Hydrographs by Single Linear Reservoir Model
- TP-75 HEC Activities in Reservoir Analysis
- TP-76 Institutional Support of Water Resource Models
- TP-77 Investigation of Soil Conservation Service Urban Hydrology Techniques
- TP-78 Potential for Increasing the Output of Existing Hydroelectric Plants
- TP-79 Potential Energy and Capacity Gains from Flood Control Storage Reallocation at Existing U.S. Hydropower Reservoirs
- TP-80 Use of Non-Sequential Techniques in the Analysis of Power Potential at Storage Projects
- TP-81 Data Management Systems of Water Resources Planning
- TP-82 The New HEC-1 Flood Hydrograph Package
- TP-83 River and Reservoir Systems Water Quality Modeling Capability
- TP-84 Generalized Real-Time Flood Control System Model
- TP-85 Operation Policy Analysis: Sam Rayburn Reservoir
- TP-86 Training the Practitioner: The Hydrologic Engineering Center Program
- TP-87 Documentation Needs for Water Resources Models
- TP-88 Reservoir System Regulation for Water Quality Control
- TP-89 A Software System to Aid in Making Real-Time Water Control Decisions
- TP-90 Calibration, Verification and Application of a Two-Dimensional Flow Model
- TP-91 HEC Software Development and Support
- TP-92 Hydrologic Engineering Center Planning Models
- TP-93 Flood Routing Through a Flat, Complex Flood Plain Using a One-Dimensional Unsteady Flow Computer Program
- TP-94 Dredged-Material Disposal Management Model
- TP-95 Infiltration and Soil Moisture Redistribution in HEC-1
- TP-96 The Hydrologic Engineering Center Experience in Nonstructural Planning
- TP-97 Prediction of the Effects of a Flood Control Project on a Meandering Stream
- TP-98 Evolution in Computer Programs Causes Evolution in Training Needs: The Hydrologic Engineering Center Experience
- TP-99 Reservoir System Analysis for Water Quality
- TP-100 Probable Maximum Flood Estimation - Eastern United States
- TP-101 Use of Computer Program HEC-5 for Water Supply Analysis
- TP-102 Role of Calibration in the Application of HEC-6
- TP-103 Engineering and Economic Considerations in Formulating
- TP-104 Modeling Water Resources Systems for Water Quality
- TP-105 Use of a Two-Dimensional Flow Model to Quantify Aquatic Habitat
- TP-106 Flood-Runoff Forecasting with HEC-1F
- TP-107 Dredged-Material Disposal System Capacity Expansion
- TP-108 Role of Small Computers in Two-Dimensional Flow Modeling
- TP-109 One-Dimensional Model for Mud Flows
- TP-110 Subdivision Froude Number
- TP-111 HEC-5Q: System Water Quality Modeling
- TP-112 New Developments in HEC Programs for Flood Control
- TP-113 Modeling and Managing Water Resource Systems for Water Quality
- TP-114 Accuracy of Computer Water Surface Profiles - Executive Summary
- TP-115 Application of Spatial-Data Management Techniques in Corps Planning
- TP-116 The HEC's Activities in Watershed Modeling
- TP-117 HEC-1 and HEC-2 Applications on the Microcomputer
- TP-118 Real-Time Snow Simulation Model for the Monongahela River Basin
- TP-119 Multi-Purpose, Multi-Reservoir Simulation on a PC
- TP-120 Technology Transfer of Corps' Hydrologic Models
- TP-121 Development, Calibration and Application of Runoff Forecasting Models for the Allegheny River Basin
- TP-122 The Estimation of Rainfall for Flood Forecasting Using Radar and Rain Gage Data
- TP-123 Developing and Managing a Comprehensive Reservoir Analysis Model
- TP-124 Review of U.S. Army corps of Engineering Involvement With Alluvial Fan Flooding Problems
- TP-125 An Integrated Software Package for Flood Damage Analysis
- TP-126 The Value and Depreciation of Existing Facilities: The Case of Reservoirs
- TP-127 Floodplain-Management Plan Enumeration
- TP-128 Two-Dimensional Floodplain Modeling
- TP-129 Status and New Capabilities of Computer Program HEC-6: "Scour and Deposition in Rivers and Reservoirs"
- TP-130 Estimating Sediment Delivery and Yield on Alluvial Fans
- TP-131 Hydrologic Aspects of Flood Warning - Preparedness Programs
- TP-132 Twenty-five Years of Developing, Distributing, and Supporting Hydrologic Engineering Computer Programs
- TP-133 Predicting Deposition Patterns in Small Basins
- TP-134 Annual Extreme Lake Elevations by Total Probability Theorem
- TP-135 A Muskingum-Cunge Channel Flow Routing Method for Drainage Networks
- TP-136 Prescriptive Reservoir System Analysis Model - Missouri River System Application
- TP-137 A Generalized Simulation Model for Reservoir System Analysis
- TP-138 The HEC NexGen Software Development Project
- TP-139 Issues for Applications Developers
- TP-140 HEC-2 Water Surface Profiles Program
- TP-141 HEC Models for Urban Hydrologic Analysis

- TP-142 Systems Analysis Applications at the Hydrologic Engineering Center
- TP-143 Runoff Prediction Uncertainty for Ungauged Agricultural Watersheds
- TP-144 Review of GIS Applications in Hydrologic Modeling
- TP-145 Application of Rainfall-Runoff Simulation for Flood Forecasting
- TP-146 Application of the HEC Prescriptive Reservoir Model in the Columbia River Systems
- TP-147 HEC River Analysis System (HEC-RAS)
- TP-148 HEC-6: Reservoir Sediment Control Applications
- TP-149 The Hydrologic Modeling System (HEC-HMS): Design and Development Issues
- TP-150 The HEC Hydrologic Modeling System
- TP-151 Bridge Hydraulic Analysis with HEC-RAS
- TP-152 Use of Land Surface Erosion Techniques with Stream Channel Sediment Models
- TP-153 Risk-Based Analysis for Corps Flood Project Studies - A Status Report
- TP-154 Modeling Water-Resource Systems for Water Quality Management
- TP-155 Runoff simulation Using Radar Rainfall Data
- TP-156 Status of HEC Next Generation Software Development
- TP-157 Unsteady Flow Model for Forecasting Missouri and Mississippi Rivers
- TP-158 Corps Water Management System (CWMS)
- TP-159 Some History and Hydrology of the Panama Canal
- TP-160 Application of Risk-Based Analysis to Planning Reservoir and Levee Flood Damage Reduction Systems
- TP-161 Corps Water Management System - Capabilities and Implementation Status

