



**US Army Corps
of Engineers**

Hydrologic Engineering Center

Proceedings of a Seminar on

Two-Dimensional Flow Modeling

7 - 9 July 1981
Davis, CA

REPORT DOCUMENTATION PAGE

Form Approved OMB No. 0704-0188

The public reporting burden for this collection of information is estimated to average 1 hour per response, including the time for reviewing instructions, searching existing data sources, gathering and maintaining the data needed, and completing and reviewing the collection of information. Send comments regarding this burden estimate or any other aspect of this collection of information, including suggestions for reducing this burden, to the Department of Defense, Executive Services and Communications Directorate (0704-0188). Respondents should be aware that notwithstanding any other provision of law, no person shall be subject to any penalty for failing to comply with a collection of information if it does not display a currently valid OMB control number.

PLEASE DO NOT RETURN YOUR FORM TO THE ABOVE ORGANIZATION.

1. REPORT DATE (DD-MM-YYYY) 7 - 9 July 1981		2. REPORT TYPE Seminar Proceedings		3. DATES COVERED (From - To)	
4. TITLE AND SUBTITLE Two-Dimensional Flow Modeling			5a. CONTRACT NUMBER		
			5b. GRANT NUMBER		
			5c. PROGRAM ELEMENT NUMBER		
6. AUTHOR(S) CEIWR-HEC			5d. PROJECT NUMBER		
			5e. TASK NUMBER		
			5f. WORK UNIT NUMBER		
7. PERFORMING ORGANIZATION NAME(S) AND ADDRESS(ES) US Army Corps of Engineers Institute for Water Resources Hydrologic Engineering Center (HEC) 609 Second Street Davis, CA 95616-4687				8. PERFORMING ORGANIZATION REPORT NUMBER SP-13	
9. SPONSORING/MONITORING AGENCY NAME(S) AND ADDRESS(ES)				10. SPONSOR/ MONITOR'S ACRONYM(S)	
				11. SPONSOR/ MONITOR'S REPORT NUMBER(S)	
12. DISTRIBUTION / AVAILABILITY STATEMENT Approved for public release; distribution is unlimited.					
13. SUPPLEMENTARY NOTES Collection of papers presented at a seminar held at the Hydrologic Engineering Center, Davis, CA on 7 - 9 July 1981					
14. ABSTRACT A seminar on Two-Dimensional Flow Modeling was held on 7 - 9 July 1981 at the Hydrologic Engineering Center, Davis, CA. The seminar emphasized two-dimensional homogeneous flows such as occur in rivers and well-mixed bays and estuaries. Papers focused on model applications, features, performance, and utility rather than recent research advances. The objectives were (1) to bring together developers, users, and potential users of two-dimensional mathematical models to develop a continuing dialogue concerning applications experience, problem identification, research goals, model evaluation, operational problems and model limitations; (2) to make researchers working in the areas of riverine and flood plain simulation aware of recent advances in coastal and estuarine modeling; and, (3) to examine mechanisms for transferring technology to field offices and field needs to research programs.					
15. SUBJECT TERMS two-dimensional flow modeling, hydrodynamics, turbulent flow simulation, computer modeling of rivers, estuaries, reservoirs, coastal circulation, complex floodplain circulations, finite difference, finite element, link-node, characteristics methods, numerical models, computational hydraulics					
16. SECURITY CLASSIFICATION OF:			17. LIMITATION OF ABSTRACT UU	18. NUMBER OF PAGES 290	19a. NAME OF RESPONSIBLE PERSON
a. REPORT U	b. ABSTRACT U	c. THIS PAGE U			19b. TELEPHONE NUMBER

Proceedings of a Seminar on

Two-Dimensional Flow Modeling

7 - 9 July 1981

Attendees:

Corps of Engineers
J.E. Eddinger Associates, Inc.
Tetra Tech, Inc.
U.S. Geological Survey
National Weather Service, NOAA
Resource Management Associates
University of California, Davis
The RAND Corporation
Energy, Inc.
Camp Dresser & McKee, Inc.
Tennessee Valley Authority

Sponsored By:

US Army Corps of Engineers
20 Massachusetts Avenue, NW
Washington, DC 20314-1000

Co-Sponsored By:

US Army Corps of Engineers
Institute for Water Resources
Hydrologic Engineering Center
609 Second Street
Davis, CA 95616

(530) 756-1104

(530) 756-8250 FAX

www.hec.usace.army.mil

SP-13

CONTENTS

	<u>Page</u>
PREFACE	vii
ACKNOWLEDGEMENTS	ix
DEDICATION	xi
AGENDA	xiii
AUTHORS	xvi
PHOTOGRAPH OF PARTICIPANTS.	xxi
EXECUTIVE SUMMARY	1
INTRODUCTORY COMMENTS by OCE, "Two-Dimensional Flow Modeling for the Corps of Engineers," by Ming T. Tseng	4
PAPERS AND DISCUSSIONS - DAY ONE	7
"Two-Dimensional Flow Modeling for Riverine Forecasting by the National Weather Service," by Danny L. Fread	9
"Finite Difference Numerical Model for Long-Period Wave Behavior: With Emphasis on Storm Surge Modeling," by H. Lee Butler	23
"A Two-Dimensional Flood Routing Calculation," by Charles Noble and Robert E. Narum	41
"Two-Dimensional Vertically Homogeneous Hydrodynamic Models: Application to Estuarine Cooling Water Discharges and Intakes," by John Eric Edinger, Edward M. Buchak, and Vicky P. Binetti	59
"The TVA Model for Hydrodynamics of Vertically Well-Mixed Rivers and Reservoirs," by William R. Waldrop	80
"Two-Dimensional Turbulent Flow Simulation," by Bruce E. Larock.	83
PAPERS AND DISCUSSIONS - DAY TWO	95
"Evaluation and Application of the Generalized Finite Element Hydrodynamic Model, RMA-2," by D. Michael Gee and Robert C. MacArthur	97
"Hydrodynamic and Water Quality Simulation in San Pablo Bay - A Case Study," by William R. Norton and Ian P. King	114
"Computer Simulation of Water Motions in Riverine Systems," by Bernie R. Bodine	128

CONTENTS (cont'd)

	<u>Page</u>
"An Approach to Hydraulic Simulation of Complex Floodplains," by Joseph E. Gurule	147
"Experiences With the Application of the Finite Element Method to the Solution of the Shallow Water Equations," by Roy A. Walters	158
"Modeling of Tidal and Residual Circulation in San Francisco Bay," by Ralph T. Cheng	172
"Numerical Models for the Prediction of Wind and Tide Driven Coastal Circulation and Water Level," by Jon M. Hubertz	187
"A Storm Surge Model," by Michael H. Chen, David J. Divoky and Li-San Hwang	205
"SIMSYS2D: A Two-Dimensional Flow and Water Quality Simulation System," by Jan J. Leendertse	218
PAPER PRESENTATIONS AND DISCUSSIONS - DAY THREE	239
"Chesapeake Bay Modeling," by Robert P. Shubinski and Raymond Walton	241
"Application of a Two-Dimensional Finite Element Model for Shallow Water Computations," by Allen M. Teeter and William H. McAnally	253
"The Ohio River Division's Experience with Two-Dimensional Flow Modeling," by Glenn Drummond	266
"Practical 2-D Applications for River Engineers," by Alfred Harrison (paper not available at time of publication)	

PREFACE

This is the Proceedings of the first Two-Dimensional Flow Modeling Seminar sponsored by the Corps of Engineers. The seminar was held at the Hydrologic Engineering Center in Davis, California on 7, 8, 9 July 1981. The seminar also served as an experiment to evaluate the merits for possible future national meetings on multidimensional flow modeling.

The objectives of the seminar were: (1) to bring together developers, users, and potential users of two-dimensional mathematical models to develop a continuing dialogue concerning applications experience, problem identification, research goals, model evaluation, operational problems and model limitations; (2) to make researchers working in the areas of riverine and flood plain simulation aware of recent advances in coastal and estuarine modeling; and, (3) to examine mechanisms for transferring technology to field offices and field needs to research programs.

The seminar emphasized two-dimensional homogeneous flows in the horizontal plane such as occur in rivers and well-mixed bays and estuaries. Papers focused on model application, features, performance and utility rather than recent research advances. Participants included representatives from several Corps of Engineers District and Division offices, along with representatives from several other federal agencies such as the Tennessee Valley Authority and the U.S. Geological Survey, and a few private engineering companies.

Selection of participants was a difficult task. We regret that we could not include more and wish to thank everyone who helped to make the seminar a success. As a pilot seminar, it successfully provided scientists and engineers with a forum for reviewing the state of the art in multidimensional flow modeling and for sharing ideas and experiences in the application of different kinds of two-dimensional flow models. Special appreciation is due to the distinguished engineers who accepted our invitation to deliver lectures and lead discussions.

Please note that a few of the papers were submitted too late to be included in this proceedings. All of the papers included herein have been reproduced directly from material submitted by the authors, who are solely responsible for their content. Following each paper is a brief section which presents questions, answers and discussion of the paper that had been presented.

ACKNOWLEDGEMENTS

The seminar organizing committee gratefully acknowledges the Office of the Chief, U.S. Army Corps of Engineers, Washington, D.C., for sponsoring the Seminar.

We are also grateful for the assistance and cooperation offered by the following organizations and sister agencies:

National Oceanic and Atmospheric Administration, National Weather Service

Tennessee Valley Authority

University of California, Davis

U.S. Geological Survey

U.S. Army Corps of Engineers, Waterways Experiment Station

U.S. Army Corps of Engineers, Jacksonville District

U.S. Army Corps of Engineers, Ohio River Division

U.S. Army Corps of Engineers, Southwestern Division

U.S. Army Corps of Engineers, Missouri River Division

U.S. Army Corps of Engineers, South Pacific Division

U.S. Army Corps of Engineers, Office, Chief of Engineers

U.S. Army Corps of Engineers, Hydrologic Engineering Center

U.S. Army Corps of Engineers, Coastal Engineering Research Center

Camp Dresser & McKee, Inc.

J. E. Edinger Associates, Inc.

Energy, Inc.

Resource Management Associates

Tetra Tech, Inc.

The RAND Corporation

DEDICATION



ROBERT PARKER SHUBINSKI, Ph.D., P.E.

Robert P. Shubinski, a speaker and participant during the Two-Dimensional Flow Modeling Seminar, died in the Air Florida plane crash in Washington, D.C., on January 13, 1982. Dr. Shubinski, 46, was a Vice President and Eastern Regional Manager for the Water Resources Division of Camp Dresser & McKee. Originally from Dallas, Texas, Dr. Shubinski lived in Northern Virginia with his wife, Eleanor, and two daughters, Barbara and Carol, until his death.

Dr. Shubinski has been a pioneer in water resources engineering and a respected leader in the engineering community. After receiving B.A., B.S., and M.S. degrees in civil engineering while in Texas, he completed his Ph.D. in civil engineering at the University of California at Berkeley in 1965. Dr. Shubinski was a registered professional engineer in several states and an active member in numerous professional engineering and honor societies. He was a nationally recognized expert in the areas of water resources management, stormwater drainage, water pollution control and estuarial modeling.

We will all miss our friend and highly respected colleague. These proceedings are dedicated to Dr. Shubinski.

AGENDA FOR A SEMINAR ON TWO-DIMENSIONAL FLOW MODELING

held at

The Hydrologic Engineering Center
609 Second Street
Davis, California 95616

7-9 July 1981

<u>Tuesday, 7 July</u>		<u>Office</u>	<u>Speaker</u>
8:00 a.m.	Introduction to HEC	HEC	Eichert
8:30	Introductory OCE comments	OCE	Tseng
9:30	Break		
9:50	Two-Dimensional Flow Modeling for Riverine Forecasting by the National Weather Service	NWS	Fread
10:40	Break		
11:00	Finite Difference Numerical Model for Long-Period Wave Behavior: With Emphasis on Storm Surge Modeling	WES	Butler
11:50	Lunch		
1:00 p.m.	A Two-Dimensional Finite Difference Flood Routing Calculation	Energy, Inc.	Narum
1:50	Break		
2:00	Two-Dimensional Vertically Homogeneous Hydrodynamic Models: Application to Estuarine Cooling Water Discharges and Intakes	Edinger Assoc.	Edinger
2:50	Break		
3:10	The TVA Model for Hydrodynamics of Vertically Well-Mixed Rivers and Reservoirs	TVA	Waldrop
4:00	Break		
4:10	Two-Dimensional Turbulent Flow Simulation	UCD	Larock
5:00	Adjourn		
6:30	Icebreaker Dinner		

<u>Wednesday, 8 July</u>		<u>Office</u>	<u>Speaker</u>
8:00 a.m.	Evaluation and Application of the Generalized Finite Element Hydrodynamic Model, RMA-2	HEC	Gee
8:50	Break		
9:00	Mathematical Modeling of San Pablo Bay	RMA	Norton
9:50	Break		
10:10	Computer Simulation of Water Motions in Riverine Systems	SWD	Bodine
11:00	Break		
11:10	An Approach to Hydraulic Simulation of Complex Floodplains	JAX	Gurule
12:00	Lunch		
1:00 p.m.	Modeling of Tidal and Residual Circulation in San Francisco Bay	USGS	Walters
1:50	Break		
2:00	Numerical Models for the Prediction of Wind and Tide Driven Coastal Circulation and Water Level	CERC	Hubertz
2:50	Break		
3:10	A Storm Surge Model	Tetra Tech	Chen
4:00	Break		
4:10	SIMSYS2D: A Two-Dimensional Flow Water Quality Simulation Model	Rand	Leendertse
5:00	Adjourn		
6:30	Dinner Banquet		

Thursday, 9 July

		<u>Office</u>	<u>Speaker</u>
8:00 a.m.	Chesapeake Bay Modeling	CDM	Shubinski
8:50	Break		
9:00	A Two-Dimensional Finite Element Model for Shallow Water Computations	WES	Teeter
9:50	Break		
10:10	2-D Modeling or the Trials and Tribulations of a Field Office	ORD	Drummond
11:00	Break		
11:10	Practical 2-D Applications for River Engineers	MRD	Harrison
12:00	Lunch		
1:00 p.m.	Summary and comments		
	Definition of Corps' research needs		
	Closure		

AUTHORS

BINETTI, VICKY P.
J. E. Eddinger Associates, Inc.
37 West Avenue
Wayne, PA 19087

BODINE, BERNIE R.
Hydrologic Engineering Section, Water Management Branch
U.S. Army Engineer Division, Southwestern
1114 Commerce Street
Dallas, TX 75242

BUCHAK, EDWARD M.
J. E. Edinger Associates, Inc.
37 West Avenue
Wayne, PA 19087

BUTLER, H. L.
Wave Dynamics Division
U.S. Army Engineer Waterways Experiment Station
P.O. Box 631
Vicksburg, MS 39180

CHEN, MICHAEL H.
Tetra Tech, Inc.
630 N. Rosemead Boulevard
Pasadena, CA 91107

CHENG, RALPH T.
U.S. Geological Survey
Water Resources Division
345 Middlefield Road, MS 96
Menlo Park, CA 94025

DIVOKY, DAVID J.
Tetra Tech, Inc.
630 N. Rosemead Boulevard
Pasadena, CA 91107

DRUMMOND, GLENN
U.S. Army Engineer Division, Ohio River
P.O. Box 1159
Cincinnati, OH 45201

EDINGER, JOHN E.
J. E. Edinger Associates, Inc.
37 West Avenue
Wayne, PA 19087

AUTHORS (Cont'd)

FREAD, DANNY
Senior Research Hydrologist
Hydrologic Research Lab, W23
National Weather Service, NOAA
8060 13th Street, Room 530
Silver Spring, MD 20910

GEE, D. MICHAEL
U.S. Army Corps of Engineers
Hydrologic Engineering Center
Research Branch
609 Second Street
Davis, CA 95616

GURULE, JOSEPH E.
Hydrology-Hydraulic Branch
U.S. Army Engineer District, Jacksonville
P.O. Box 4970
Jacksonville, FL 32201

HARRISON, ALFRED S.
U.S. Army Engineer Division, Missouri River
P.O. Box 103
Downtown Station
Omaha, NE 68101

HUBERTZ, JON M.
Coastal Engineering Research Center
Kingman Building
Fort Belvoir, VA 22060

HWANG, LI-SAN
Tetra Tech, Inc.
630 Rosemead Boulevard
Pasadena, CA 91107

KING, IAN P.
Resource Management Associates
3738 Mt. Diablo Boulevard, Suite 200
Lafayette, CA 94549

LAROCK, BRUCE E.
Civil Engineering Department
University of California, Davis
Davis, CA 95616

LEENDERTSE, JAN J.
The RAND Corporation
1700 Main Street
Santa Monica, CA 90406

AUTHORS (Cont'd)

MACARTHUR, ROBERT C.
U.S. Army Corps of Engineers
Hydrologic Engineering Center
Research Branch
609 Second Street
Davis, CA 95616

MCANALLY, WILLIAM H.
U.S. Army Engineer Waterways Experiment Station
Hydraulics Laboratory, Estuaries Division
P.O. Box 631
Vicksburg, MS 39180

NARUM, ROBERT E.
Energy, Inc.
One Energy Drive
P.O. Box 736
Idaho Falls, ID 83401

NOBLE, CHARLES
Energy, Inc.
One Energy Drive
P.O. Box 736
Idaho Falls, ID 83401

NORTON, WILLIAM R.
Resource Management Associates
3738 Mt. Diablo Boulevard, Suite 200
Lafayette, CA 94549

SHUBINSKI, ROBERT P.
Camp Dresser & McKee, Inc.
7620 Little River Turnpike
Annandale, VA 22003

TEETER, ALLEN M.
U.S. Army Engineer Waterways Experiment Station
Hydraulic Laboratory, Estuaries Division
P.O. Box 631
Vicksburg, MS 39180

TSENG, MING
U.S. Army Corps of Engineers
Office of the Chief of Engineers
HQDA (DAEN-CWE-HW)
Washington, DC 20314

AUTHORS (Cont'd)

WALDROP, WILLIAM R.
Tennessee Valley Authority
Water Systems Development Branch
P.O. Drawer E
Norris, TN 37828

WALTERS, ROY A.
U.S. Geological Survey
Water Resources Division
345 Middlefield Road, MS 96
Menlo Park, CA 94025

WALTON, RAYMOND
Camp Dresser & McKee, Inc.
7620 Little River Turnpike, Suite 300
Annandale, VA 22003

**PARTICIPANTS AT THE TWO-DIMENSIONAL
FLOW MODELING SEMINAR, 7-9 JULY 1981**

held at

**The Hydrologic Engineering Center
US Army Corps of Engineers
609 Second Street, Davis, CA 95616**



TOP ROW (left to right)

Jon Hubertz (CERC), Arlen Feldman (HEC), George Niederauer (Energy, Inc.),
Lee Butler (WES), Danny Fread (NOAA), Theodor Strelkoff (Hydraulic Engineering),
Robert MacArthur (HEC), Warren Mellema (MRD), Jaime Merino (SPD), Michael Gee (HEC),
Glenn Drummond (ORD), John Edinger (J. E. Edinger Assoc., Inc.), Al Harrison (MRD)

FRONT ROW (left to right)

Allen Teeter (WES), Roy Walters (USGS), Bob Shubinski (Camp Dresser & McKee),
Robert Narum (Energy, Inc.), Ray Bodine (SWD), Bill Waldrop (TVA), Ming Tseng (OCE),
Michael Chen (Tetra Tech, Inc.), Bruce Larock (U.C. Davis), Jan Leendertse (Rand Corp.),
Joe Gurule (SAJ)

EXECUTIVE SUMMARY

by

The Hydrologic Engineering Center

Increasing demands for flood control, hydroelectric power, navigation, water supply, and aquatic recreation facilities have made the management of our nation's waterways a complex and difficult task. Management decisions are often predicated on the combined hydrodynamic and environmental characteristics of rivers, reservoirs, and estuaries. The goal to maintain the most desirable features of water resources projects has focused on the need for a clearer understanding within the engineering community of existing methods for predicting hydrodynamic and water quality characteristics of rivers, lakes, and estuaries.

The Office of the Chief, U.S. Army Corps of Engineers, Washington, D.C., and the Hydrologic Engineering Center (HEC), Davis, California, coordinated and conducted a three-day seminar on two-dimensional mathematical flow modeling. It was held in Davis, California, on 7, 8, 9 July 1981 at the Hydrologic Engineering Center. The seminar provided a forum for evaluating and predicting the characteristics of two-dimensional flows in the horizontal plane.

Papers and discussions emphasized model applications, features, performance and utility rather than recent research advances. Participants included representatives from several Corps of Engineers District and Division Offices, along with other federal agencies and a few private engineering companies and universities.

Presentations and open discussions of a wide variety of two-dimensional modeling methods were made. Often, comparisons were made between the merits and features of one- versus two-dimensional models. It was generally agreed that one-dimensional modeling had definite advantages as far as being less costly and requiring less initial information or data to perform an application. However, it was concluded by all that there are many situations where one-dimensional methods are inadequate and that the more detailed two-dimensional methods should be employed. Depending on the detail required and on the individual complexity of certain flow problems, it was thought that perhaps even three-dimensional methods may be required. Few fully three-dimensional models exist, and it was agreed that these methods will need much more development and verification before they can be considered as practical tools.

Two-dimensional flow modeling has advanced considerably within the last decade in part due to tremendous improvements that continue to occur in the computer industry. Computers are faster, capable of handling larger amounts of information, and are becoming more economical to operate. Therefore, two-dimensional methods of analyzing hydraulic problems are now feasible for problems that require greater detail and sophistication than a one-dimensional approach can provide.

Every complex flow problem will have some unique characteristics; however, current two-dimensional models have become sufficiently perfected and documented that even difficult flow situations can be adequately evaluated. Seminar discussions indicated that the central need now is for more "applications testing" of the various models. The more the models are used the better they will become. This was true several years ago with the first one-dimensional codes. Today, such codes as HEC-2 have become a standard procedure for conducting certain hydraulic evaluations. As two-dimensional codes improve, and as people begin to use them more frequently, people will become increasingly confident of the capabilities and benefits that multidimensional methods can provide.

Two-dimensional flow models have been applied to a wide variety of hydrodynamic and water quality problems. The papers presented during this seminar exemplify that wide variety of applications experience. River forecasting and flood routing problems were addressed by Bodine, Fread, Gurule and Narum. Applications to storm surge and coastal circulation problems were discussed by Butler, Chen and Hubertz. Cheng, Edinger, King, Leendertse, Shubinski, Teeter, and Walters discussed a multiplicity of problems, applications and methods for evaluating estuarial circulation and water quality problems. Waldrop and Gee presented several examples of river and reservoir situations where two-dimensional modeling methods proved to be beneficial. Larock discussed the latest methods for representing fully turbulent two-dimensional flows which necessitate additional model specialization. A variety of problems and applications experienced by the Corps of Engineers was discussed by Butler, Drummond, Gee, Gurule, Harrison and MacArthur.

During the seminar, finite difference, finite element, link-node, and characteristic methods of solution were discussed with respect to their overall practicality and economy. Many case studies and practical applications to engineering field projects were presented. Speakers and guests were encouraged to discuss the content of each paper with respect to its potential benefit to the engineering community. These discussions have been summarized and are included after each paper in the proceedings. Collectively, the papers represent a comprehensive report on the current state-of-the-technology of two-dimensional flow modeling.

One of the most important points emphasized during the seminar was that current multidimensional models require users with specialized training and experience in hydrodynamics and mathematical modeling. Users should always be cautious with their results and not accept computed solutions just because "the program ran." This "magic box trap" can cause difficulties even for experienced users if they are not careful to check their results with theory and observed data. As more users obtain the experience necessary to use these tools, the better the tools will become. Improved model documentation, enhanced diagnostics within the codes, and computer-aided graphical display capabilities are all essential areas where more work needs to be done in order to make two-dimensional modeling methods more practical for generalized engineering applications.

With all of these important issues in mind, the Hydrologic Engineering Center and the Corps of Engineers will continue to encourage improvement of two-dimensional modeling methods. Technology transfer through seminars such as this will help to improve our current capabilities to serve the engineering community in the areas of complex flow hydraulics and water quality management.

The Steering Committee
The Hydrologic Engineering Center
Davis, California

TWO-DIMENSIONAL FLOW MODELING FOR THE CORPS OF ENGINEERS

by

Ming T. Tseng¹

Hydrologic and hydraulic analyses are of paramount importance in the planning, design and operation of water resources projects. These analyses are needed to assure functional adequacy of the project, determine economic effects, prescribe operational requirements and provide bases for assessing potential project impacts. The quality and accuracy of hydrologic and hydraulic analyses can govern the project feasibility and engineering design to a great extent.

The most common hydraulic parameters of interest to engineers are the temporal and spatial distribution of depth and velocity of various discharges. Methods for determining these parameters vary considerably depending on the complexity of the flow pattern, time and budget limitations, data availability, application of results, available equipment, etc. General practice within the Corps has been to use one-dimensional steady state algorithms for fluvial streams and two-dimensional unsteady state models for lakes, reservoirs and coastal projects.

The diversity of Corps projects provides engineers with a wide range of challenging hydrodynamic problems. Problems such as flood routing in rivers, flood plain hydraulics, urban storm drainage, circulation in lakes and reservoirs, tidal hydraulics in estuaries and near seas, coastal storm surges and river and delta potomology must be dealt with. While all of these are basically three-dimensional flow problems, some of them may be approximated adequately either by one-dimensional or two-dimensional mathematical models. Heretofore, most Corps offices have used one-dimensional models to analyze their flow problems because of the lack of dependable and affordable multi-dimensional tools.

Among the one-dimensional models, HEC-2 has been used predominantly by Corps offices. Although HEC-2 is a one-dimensional steady state model, it has yielded satisfactory results for project analysis and assessment of flood risks for the Federal Insurance Administration in most fluvial streams. Like any numerical model, HEC-2 has certain applicational limitations that must be observed by model users. For example, flood flows over wide flood plains without readily identifiable flow paths, which are prevalent along coastal plains are neither one-dimensional nor steady state. The application of one-dimensional models to simulate such flow conditions is obviously difficult and generally inadequate. Other cases where one-dimensional models do not apply are flow patterns around locks and dams, confluence of streams, flow around islands, and flows over alluvial fans.

¹Systems Modeling, Water Control/Quality Section, Office of the Chief of Engineers, Washington, D.C.

Lately a number of Corps offices have applied one-dimensional flow models to analyze flood control projects having complex flow characteristics. Some of these analyses showed unrealistic results in delineating flood plain boundaries of various flow frequencies. The use of this information for economic analysis could have serious impact on project justification. Discussions with engineers in field offices indicated that they are either unaware of the existence of two-dimensional models or hesitate to use such models due to difficulty of model verification and costs. With the recent advance in two-dimensional modeling techniques, such concern should obviously be diminished.

More definite OCE guidance on 2-D modeling is needed. Hopefully, this seminar will help us develop useful guidance for Corps field offices. As most of us realize, the state-of-the-art in 2-D modeling has progressed rapidly in coastal and estuarine applications. Within the Corps, both WES and CERC have developed 2-D flow modeling capabilities to study storm surges in the open seas and embayments. WES and HEC are also engaged in reservoir water quality modeling. HEC has been active in Finite Element 2-D modeling. We shall see some of the impressive capabilities of these models during this seminar.

Despite the proven capabilities of 2-D models in coastal applications, there has been only limited application of 2-D techniques to riverine studies. It would be beneficial for our coastal modelers to establish a dialogue with our riverine modelers. Contributions from outside the Corps are extremely important, of course. The sharing of ideas and techniques is the first purpose of this seminar. The second purpose is to provide the Corps field offices with an opportunity to express their problems and needs and to become informed on the state-of-the-art in 2-D modeling.

It should be noted that OCE has no intention of replacing the existing one-dimensional flow models by 2-D flow models. Corps offices are continuously encouraged to use the approved, category A, one-dimensional flow models for planning, design, and operation of Corps projects, and for other purposes, as long as the limitations of these models are observed. However, when hydrologic and hydraulic analyses of Corps projects are limited by one-dimensional modeling capabilities, hydraulic analyses by 2-D flow models should be considered. Pending the publication of guidance in 2-D modeling, Corps offices are encouraged to consult with experts at OCE, HEC, WES or CERC for proper selection and use of 2-D models.

We in OCE would like to thank HEC for putting this seminar together. We would particularly like to welcome the non-Corps model experts attending this seminar. We look forward to your contributions.

PAPER PRESENTATIONS
AND
DISCUSSIONS

DAY ONE

TWO-DIMENSIONAL FLOW MODELING FOR
RIVERINE FORECASTING BY THE NATIONAL WEATHER SERVICE

by

D. L. Fread¹

INTRODUCTION

Real-time riverine forecasting by the National Weather Service (NWS) is disseminated to the public via Weather Service Offices (WSO's) located in all states within the Nation. The WSO offices are assisted in the preparation of the riverine forecasts by regional offices called River Forecast Centers (RFC) and by the National Hurricane Center (NHC) in Miami. Riverine forecasts are primarily concerned with the prediction of water surface elevations at principal locations (river forecast points) along most of the major and many of the lesser rivers in times of flood, and at many locations on a daily frequency. The floods and lesser rises of the rivers may result from rainfall and/or snowmelt runoff, reservoir release flows, hurricane storm surges, and dam failures. In addition to water surface elevations, forecasts are often provided for flow discharges and velocities. Such forecasts are used for a multitude of purposes, e.g., water supply, navigation, irrigation, power, reservoir operation, recreation, and water quality interests.

Most forecasts are associated with the runoff emanating from precipitation or snowmelt. Conceptual hydrologic mathematical models are used to predict the quantity and temporal distribution of the runoff as it accumulates in well-defined channels (streams or rivers). The resulting flood wave propagates through the channel; and its magnitude, shape, and movement are predicted by other mathematical models known as flood routing models. These are based on the one-dimensional equations of unsteady flow. Most of these models are substantial simplifications of the complete equations. Propagation of waves due to storm surges or dam failures are predicted using the complete one-dimensional equations. Currently, NWS is slowly extending this type of flood routing prediction to those floods which propagate through large navigable rivers and estuaries of very mild hydraulic gradient (less than 2 ft/mi) which are subject to backwater effects due to large tributary inflows or tides.

The use of mathematical models based on two-dimensional flow equations is currently limited to the forecasting of coastal flooding due to hurricane-produced storm surges. The NHC utilizes a two-dimensional model, SPLASH, (Jelesnianski, 1972) for this purpose. In a few locations, the RFC's are prepared to use the forecasted storm surge to predict subsequent upstream flooding along coastal rivers.

¹Senior Research Hydrologist, Hydrologic Research Laboratory, National Weather Service, NOAA, 8060 13th Street, Silver Spring, Maryland 20910

This paper briefly describes the current procedure for river forecasting of hurricane storm surge flooding. Also, considerations for possible future use of other two-dimensional flow models are discussed with respect to: a) two-dimensional porous media flow in aquifers which significantly interact with adjacent rivers, b) two-dimensional surface flow associated with dam-break floods propagating in wide, flat flood plains, and c) two-dimensional surface flow in complex channel networks associated with estuaries.

RIVERINE FORECASTING OF HURRICANE STORM SURGES

Real-time forecasting of river flooding due to hurricane-produced storm surges is presently in operation for the lower portions of the Mississippi, Sabine, and Neches Rivers as shown in Figures 1 and 2. Work is on-going to gradually extend this service to other Gulf Coast rivers in Texas. As indicated in the figures, two numerical hydrodynamic models are used to forecast this type of flooding. The hurricane-generated storm surge is predicted using the SPLASH model (Jelesnianski, 1967, 1972, 1976) and the subsequent upstream propagation of the surge within the confines of a coastal river is predicted using the DWOPER model (Fread, 1978, 1981).

SPLASH is a two-dimensional, vertically integrated hydrodynamic model. Externally specified meteorological parameters are utilized to generate the hurricane wind field. These parameters are (a) the radial distance and pressure drop from the storm center to its periphery, and (b) the forward speed of the storm. The wind field submodel empirically computes the maximum wind speed in a stationary storm and generates the wind field by dynamically balancing the computed wind speed, pressure gradient, and inflow angle fields. The computed wind field is then incorporated into the two-dimensional hydrodynamic equation through the wind stress term which drives the model, i.e., causes the development of the storm surge.

The governing partial differential hydrodynamic equations of SPLASH are numerically solved using an explicit finite difference technique. Terms relating to the water depth are linearized such that the computed surge height is not added to the undisturbed depth during the computations. Bottom friction is treated using the Ekman principle. The computational grid size is approximately 4 miles and computed results are presented 8 miles apart along the coast. The computational grid network is centered at a specified coastal location. The network width (along the coast) is 600 miles, and it extends seaward either 72 miles or the width of the continental shelf (whichever is larger). The boundary conditions consist of a vertical wall condition along the coast, a barometric pressure effect along the seaward boundary, and zero transport normal to the lateral open boundaries. The most recently published version of SPLASH (Jelesnianski, 1976) uses a sheared and stretched coordinate system along a mildly curved coastline with grid distances that vary from shore to deep water. At this time work is nearly completed in the development of the SLOSH model, which is an expanded version of SPLASH having the capability to treat overtopping of finite barrier heights to allow coastal flooding.

DWOPER is a one-dimensional hydrodynamic model. It is a general purpose river routing model. One of its capabilities is to propagate a storm surge (introduced at the downstream boundary as a time history of water surface elevations) upstream along the river. The governing partial differential hydrodynamic equations are numerically solved using a weighted nonlinear implicit finite difference technique. Newton-Raphson iteration, combined with an optimally efficient quad-diagonal matrix solution algorithm, allow DWOPER to be very computationally efficient. The model can be used on branched river channels, either dendritic (tree-type) or bifurcated networks. It treats levee overtopping and failure, lateral inflows, irregular channel geometry, space and depth-dependent boundary friction (Manning type), and variable grid spacing. Nonlinear numerical stability is enhanced with an internal time step reduction algorithm.

The SPLASH model predicts the time history of the water surface elevation due to the storm surge at the mouth of the river. DWOPER uses this as its downstream boundary condition and a specified discharge hydrograph as its upstream boundary. The upstream boundary is located considerably beyond the last point of interest where it is assumed the surge has insignificant effect on the specified discharge. The coupling between SPLASH and DWOPER is external in the sense that the surge propagation into the river is not treated during the SPLASH computations. Although it is recognized that such external coupling of the two models is not ideal, it is nevertheless considered the practical choice due to such factors as (a) dampening of the coupling effect as the surge propagates further upstream; (b) the models were developed and are maintained and operationally used by three separate divisions of NWS; and (c) the real-time use of the models.

COUPLED STREAMFLOW-POROUS MEDIA FLOW MODEL

Work is proceeding at the NWS Hydrologic Research Laboratory (HRL) to develop a two-dimensional porous media flow model which will be internally coupled to the DWOPER model. The combined model will be used to improve streamflow forecasts where flow exchanges occur between the river and the adjacent groundwater aquifer. Where the river is bounded by highly permeable alluvium, the flow interactions can be of sufficient magnitude to significantly affect the river flow by attenuating the peak flow, reducing the wave peak celerity, and extending the recession limb of the river discharge hydrograph. The river flow exchanges with the surrounding aquifer via saturated flow through the bed and banks of the river (Pinder and Sauer, 1971) and via unsaturated-saturated infiltration through the inundated river flood plain (Freeze, 1971).

The flow within the aquifer is modeled by combining the one-dimensional saturated porous media flow equations (flow is assumed to occur only in the direction perpendicular to the river axis) with the one-dimensional unsaturated porous media flow equations for flow occurring in the vertical direction. The resulting two-dimensional nonhomogenous, anisotropic porous media flow equations will be numerically solved using a weighted, nonlinear implicit finite difference technique with variable grid spacing. The model will utilize Newton-Raphson iteration and a specialized, highly efficient matrix solution algorithm.

The coupling of the two-dimensional porous media flow model with the one-dimensional DWOPER streamflow model will be internal according to the following scheme (Freeze, 1971): (1) At each time step solve the porous media model using the stream water surface elevation from the previous time step as the specified head condition at the boundary of the subsurface flow system. (2) Use subsurface flow computed at the boundary by the porous media model as lateral inflow/outflow for the stream at that time step and solve the DWOPER model for new water surface elevations. (3) Use the new water surface elevations as the specified head condition for computing the subsurface flow using the porous media model. (4) Continue this alternating cycle until successive water surface elevations differ by less than an acceptable tolerance, then proceed to the next time step. Computational efficiency will be enhanced by extrapolating the stream water surface elevations computed at previous time steps for use in step (1), and by using different size time steps for the two models based upon the individual flow response of each flow system; coupling of the two models will occur only when the smaller time step advances that model's computations to the same point in time that the larger time step has caused the other model to reach.

Data requirements for the DWOPER model consist of cross-sectional top widths and Manning's n roughness coefficients; the porous media model requires the hydraulic conductivity and the moisture content parameters. Since the porous media model parameters are generally not directly available, it is anticipated that practical implementation of the coupled model will be based on the determination of these parameters via model calibration using observed streamflow hydrographs.

DAM-BREAK FLOOD FORECASTING IN WIDE FLOOD PLAINS

Real-time forecasting and pre-computation of possible or imminent dam-break floods is accomplished by the NWS DAMBRK model (Fread, 1980, 1981). This model predicts the time-dependent outflow from a reservoir due to spillway flows, overtopping flows, and discharge through a time-dependent, variable-geometry dam breach whose characteristics are supplied by the model user. The outflow is then routed through the downstream channel-valley using the complete one-dimensional equations of unsteady flow, which are solved by the same weighted nonlinear implicit finite difference technique used in the DWOPER model. The model is capable of including downstream dams or bridge-road embankments and lateral inflows. The flows may be either completely subcritical or supercritical for all times and locations during the simulation. The treatment of channel-valley cross-sections may be either as composite sections with dead storage areas or as separate channel, left flood plain, and right flood plain sections. The latter technique, although still a one-dimensional approach, allows for better treatment of the variance between flood plain flow and the meandering river channel flow. Computational efficiency, wide applicability, and user convenience are design features of the DAMBRK model which make it suitable for real-time flood forecasting.

Work is proceeding within HRL to combine all of the capabilities of the DAMBRK and DWOPER models into a new one-dimensional model (FLDWAV). Of the

several flood-modeling improvements which will result from combining the features of DWOPER and DAMBRK, one such improvement will be in the treatment of dam-break floods spreading onto a wide flood plain as shown in Fig. 3. The FLDWAV model will be able to simulate the spreading of the flow onto the flood plain via a network of flow paths selected by the user according to the flood plain topography. Also, the use of the left flood plain, right flood plain, and channel routing option will provide additional descriptive capabilities for modeling the spreading flow. When used in this manner, the FLDWAV model, although one-dimensional, will provide a pseudo two-dimensional modeling capability while retaining the computational efficiency possible with an implicit one-dimensional model.

Consideration is being given to the need for using two-dimensional hydrodynamic equations for modeling dam-break floods spreading onto wide, flat flood plains where the topography does not aid the user in selecting particular flow paths. Some two-dimensional models for dam-break flows have been reported in the literature; e.g., Xanthopoulos and Koutitas, 1976; Richert, 1977; and Katapodes and Strelkoff, 1979. Some considerations in the use of the two-dimensional unsteady flow equations involve the following considerations: (1) A significant increase in computational requirements. (2) An inability for real-time forecasting due to data input complexities and computational requirements. (3) The additional expected accuracy may not be consistent with the present dam-break modeling capabilities in which considerable error in the predicted dam-break outflow hydrograph exists due to the state of the art in predicting the formation of the breach in a concrete, earthen, or rock-fill dam. (4) The inherent lack of precision in two-dimensional modeling of flows spreading onto dry areas. (5) The development effort to make the two-dimensional model as versatile as the existing DAMBRK model. (6) The relatively few instances where a two-dimensional approach is clearly needed.

FORECASTING IN ESTUARINE NETWORKS

At the present, NWS provides very limited real-time flow forecasting in complex estuarine networks such as shown in Fig. 4. This is accomplished using the one-dimensional DWOPER model and is generally satisfactory for predicting water surface elevations and the average velocities along the major flow axes. However, for possible future real-time forecasting of chemical or oil spill emergencies occurring in such complex waterways, improvement of such forecasts could be possible by using the two-dimensional hydrodynamic equations. A review of many two-dimensional hydrodynamic models was reported by Hinwood and Wallis, 1975. For real-time applications where computational efficiency is desirable, the implicit type finite difference solutions of the two-dimensional equations, e.g., Grubert, 1976, and Niemeyer, 1979, would be preferable.

SUMMARY

The use of two-dimensional flow models for riverine forecasting by NWS is very limited at the present time. The two-dimensional hurricane surge

model (SPLASH) is used to generate the surge at the mouth of some Gulf Coast rivers where the riverine forecasting of the surge propagation upstream is then accomplished with a one-dimensional routing model (DWOPER). Development is under way to use a two-dimensional porous media flow model internally coupled to DWOPER for real-time forecasting of rivers significantly affected by flow exchanges with the adjacent groundwater aquifer. Possible future use of the two-dimensional hydrodynamic equations includes (a) spreading of dam-break floods onto wide, flat flood plains, and (b) chemical-oil spill forecasting in complex estuarine networks.

REFERENCES

- Fread, D.L., "NWS Operational Dynamic Wave Model," Verification of Mathematical and Physical Models in Hydraulic Engineering, Proceedings, 26th Annual Hydraulic Division Specialty Conference, ASCE, Univ. Maryland, College Park, Md., Aug. 9-11, 1978, pp. 455-464.
- Fread, D.L., "Capabilities of NWS Model to Forecast Flash Floods Caused by Dam Failures," Preprint Volume, Second Conference on Flash Floods, March 18-20, 1980, American Meteorological Society, Boston, Mass., pp. 171-178.
- Fread, D.L., "Numerical Hydrodynamic Modelling of Rivers for Flood Forecasting by the National Weather Service," Proceedings, International Conference on Numerical Modelling of River, Channel, and Overland Flow for Water Resources and Environmental Applications, May 3-7, 1981, Bratislava, Czechoslovakia.
- Freeze, R.A., "Three-Dimensional, Transient, Saturated-Unsaturated Flow in a Groundwater Basin," Water Resource Research, Vol. 7, No. 2, 1971, pp. 347-366.
- Grubert, J.P., "Numerical Computation of Two-Dimensional Flows," Journal of the Waterways, Harbors, and Coastal Engineering Division, ASCE, Vol. 102, No. WW1, Feb. 1976., pp. 1-12.
- Hinwood, J.B., and Wallis, I.G., "Review of Models of Tidal Waters," Journal of the Hydraulics Division, ASCE, Vol. 101, No. HY11, Nov. 1975, pp. 1405-1421.
- Jelesnianski, C.P., "Numerical Computations of Storm Surges with Bottom Stress," Monthly Weather Review, Vol. 95, Nov. 1967, pp. 740-756.
- Jelesnianski, C.P., "SPLASH (Special Program to List Amplitudes of Surges and Hurricanes) 1. Landfall Storms," NOAA Technical Memorandum NWS TDL-46, 1972.
- Jelesnianski, C.P., "A Sheared Coordinate System for Storm Surge Equations of Motion with a Mildly Curved Coast," NOAA Technical Memorandum NWS TDL-61, July 1976.

Katapodes, N., and Strelkoff, T., "Two-Dimensional Shallow Water-Wave Models," Journal of the Engineering Mechanics Division, ASCE, Vol. 105, No. EM2, April 1979, pp. 317-334.

Niemeyer, G., "Long Wave Model Independent of Stability Criteria," Journal of the Waterway, Port, Coastal, and Ocean Division, ASCE, Vol. 105, No. WW1, Feb. 1979, pp. 51-65.

Pinder, G.F., and Sauer, S.P., "Numerical Simulation of Flood Wave Modification Due to Bank Storage Effects," Water Resources Research, Vol. 7, No. 1, 1971, pp. 63-70.

Richert, K.D., "A Numerical Model for Multidimensional Unconstrained Flow Over Irregular Terrain," Proceedings, Dam-Break Flood Routing Model Workshop, Bethesda, Md., Oct. 18-20, 1977, pp. 346-353.

Xanthopoulos, T., and Koutitas, C., "Numerical Simulation of a Two-Dimensional Flood Wave Propagation Due to Dam Failure," Journal of Hydraulic Research, Vol. 14, No. 4, 1976, pp. 321-331.

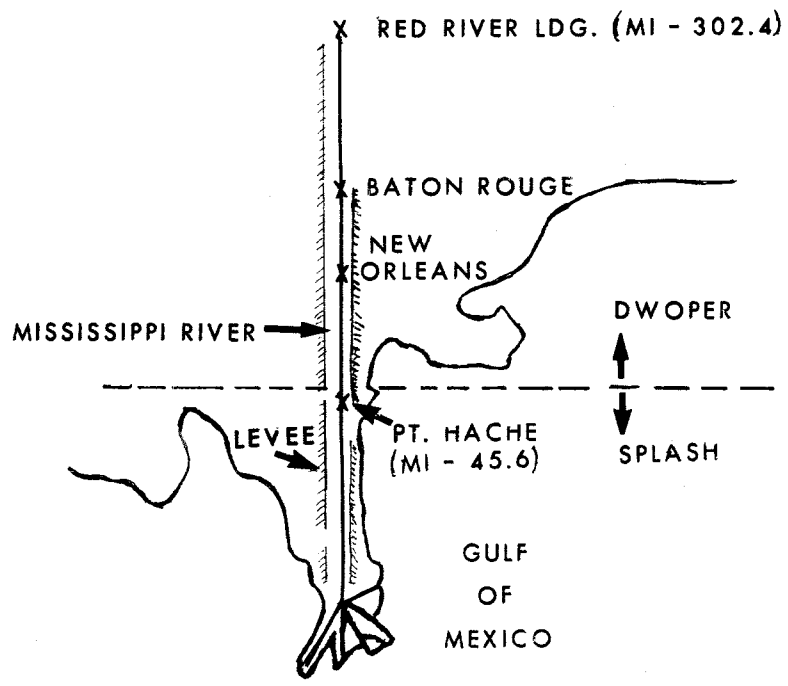

FIG. 1— HURRICANE STORM SURGE FORECASTING OF LOWER MISSISSIPPI RIVER

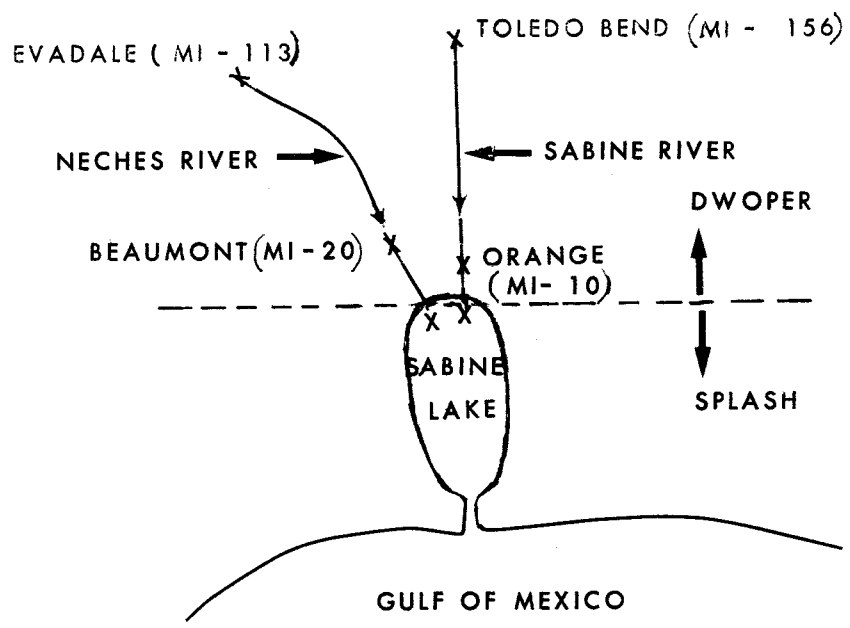

FIG. 2— HURRICANE STORM SURGE FORECASTING OF SABINE AND NECHES RIVERS

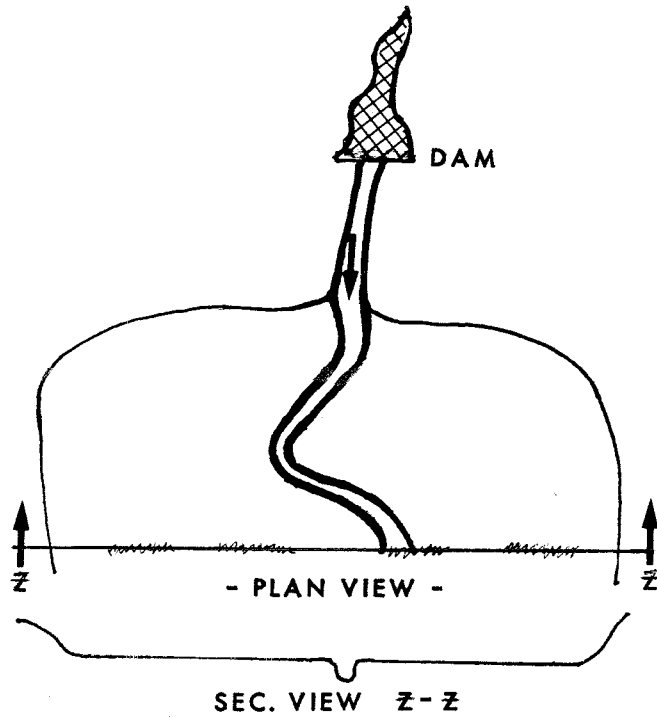

FIG. 3 - DAM-BREAK FLOOD ONTO A VERY WIDE, FLAT FLOOD PLAIN

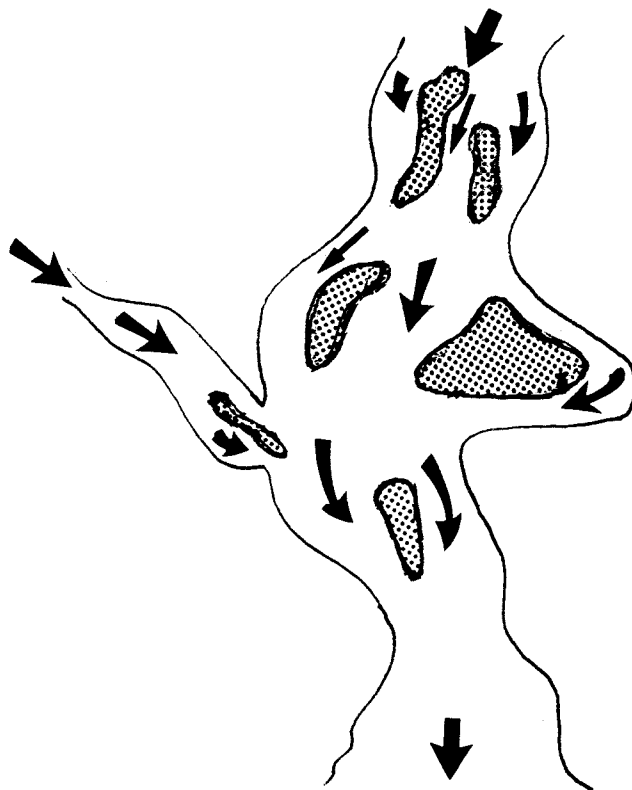

FIG. 4 - COMPLEX FLOWS IN RIVERINE - ESTUARINE NETWORKS

PAPER DISCUSSION

TWO-DIMENSIONAL FLOW MODELING FOR
RIVERINE FORECASTING BY THE NATIONAL WEATHER SERVICE

by
Danny L. Fread

Question: When will the new one-dimensional combined model (FLDWAV) be available?

Dr. Fread: The FLDWAV model is not yet operational; however, all the components have been developed and tested in other models (DWOPER and DAMBRK). They have been re-written in a completely new code which has taken the last several months to develop; currently, we are in the process of debugging the new code and hope to have it available by next spring.

Question: Could you explain more about the numbering system you use for modeling flow networks with the FLDWAV model? You talked about maintaining computational efficiency with the implicit formulation, and I would like to know more about it.

Dr. Fread: The network solution scheme used in FLDWAV is not a completely general network solution; however, I think it will treat almost all practical riverine networks. It will treat any order of dendritic (tree-type) network and/or bifurcations around islands with either zero, one, or two bypasses; the dendritic system can join any portion of the bifurcated branches; and a dendritic network associated with river delta formations can also be treated. Each type of flow junction is given a special code number by the user. This code allows the three conservation equations at each junction to be assembled in the general coefficient matrix of simultaneous equations for the entire river system in such a way as to minimize the creation of off-diagonal elements and to minimize the creation of new off-diagonal elements during the elimination phase of the matrix solution algorithm. Also, the way in which the cross-sections are assigned sequential numbers within the river system is most important in effecting the desired minimization. The numbering scheme is as follows: numbers run consecutively in the downstream direction until a dendritic-type junction is reached; then the most upstream section of the dendritic branch is given the next consecutive number and the numbers increase in the downstream direction along this branch until another junction is reached; then the most upstream section of that dendritic branch is numbered next and the numbers increase in the downstream direction along that branch until a new junction is reached; this is repeated until all sections have been numbered down to the very first dendritic-type junction; then the numbers continue to

increase along the downstream branch of this junction; bifurcations are numbered in a similar manner. The computational efficiency is achieved by use of a specially developed matrix solution technique of the Gauss elimination type which only operates on non-zero elements in the matrix through use of the user-specified code number which was assigned to each junction in the river system.

Question: How do you treat deltas as dendritic branches?

Dr. Fread: The numbering scheme is the same, but the model treats the flows which are directed in the downstream direction as negative flows.

Question: We have had situations using the DAMBRK model where the flow was supercritical in the channel and subcritical in the overbank. How can you use the model in this situation?

Dr. Fread: Within the present limitations of the DAMBRK model, perhaps you could increase the roughness associated with the in-bank flows to force this flow into the subcritical regime. This could be done if the in-bank flows were only a small portion of the total flow which is generally the case in modeling dam-break floods.

Question: What about supercritical flow in the FLDWAV model?

Dr. Fread: The FLDWAV model can simulate either subcritical or supercritical flow but not a mixture of the two types of flow in space or in time. One of our research efforts is to develop an algorithm to enable an implicit model to simulate mixed subcritical-supercritical flows.

Question: In your research concerning subcritical-supercritical flows, do you think the following scheme would work? At any given time determine where subcritical and supercritical flows are, then for the next time step use as a downstream boundary condition for any subcritical reach a critical flow rating curve and solve that part of the system separately. Then the four-point implicit scheme becomes a two-point scheme, and starting at the upstream end of the supercritical reach, solve section-by-section in the downstream direction; the final solution in the supercritical reach provides an upstream boundary condition for the next subcritical reach, and so on.

Dr. Fread: I think that scheme is a feasible approach although it is not the only one I am investigating. I am also trying to treat the entire system simultaneously by using internal boundaries where flows change from one regime to the other. At the internal boundaries, the appropriate transition

equations such as critical flow or sequent depth are substituted for the momentum equation.

Question: How do you handle obstructions such as bridges in the FLDWAV network system?

Dr. Fread: Bridges are treated in the FLDWAV model the same way they are in the DAMBRK model, i.e., as internal boundaries which may be located anywhere in the flow system. The flow through the bridge is modeled as orifice-type flow and flow which overtops the bridge embankment is treated as broad-crested weir flow. Other internal boundaries could be used for sections having (1) a specified rating curve, (2) critical flow as at a waterfall, or (3) a dam where the flow could be any combination of spillway, overtopping, and/or breach flows. At internal boundaries the continuity and momentum equations are replaced with the appropriate flow equation and a simple continuity equation ($Q_i = Q_{i+1}$). The internal boundary equations are then solved simultaneously along with the upstream and downstream boundaries and the one-dimensional continuity and momentum equations of unsteady flow.

Question: How does the DWOPER model handle levee overtopping such as in the lower Mississippi River application?

Dr. Fread: Levee overtopping is an inherent capability of the DWOPER model; however, this has not been implemented by our field office for storm surge forecasting of the lower Mississippi River. They have chosen not to use this capability since they are primarily concerned with predicting stages below the levee crests and simply determining if the levees will be overtopped. The levee overtopping feature has been used in other applications, e.g., the lower St. Johns River in New Brunswick, Canada, and the Susquehanna River. The Corps district office in Baltimore took only a few days to calibrate by trial-error the DWOPER model for the Hurricane Agnes flood of 1972. Calibration consisted of adjusting the Manning n and the weir discharge coefficients.

Question: What about submergence effects in levee overtopping?

Dr. Fread: In both the DWOPER and FLDWAV models, the standard relationships for broad-crested weir submergence are used. This is possible since flows and depths are simulated on both sides of the levee.

Question: Do you iterate during the levee overtopping computations?

Dr. Fread: Yes, iteration is used since the flow in each river (main river and a river representing the flood plain flow) are

solved through an iteration process. The main river is first solved; then the flood-plain river is solved. If the flow conditions at the junction of the two rivers are compatible within specified tolerance, the solutions are accepted and the computations are advanced in time. Thus, the feedback between the water levels on each side of the levee is accomplished via the iteration process. Also, reverse flows across the levee can be treated, e.g., if the river level falls much faster than the level in the flood plain, reverse flow could occur if the flood-plain level remained above the levee crest. If flow reverses its original direction due to a reversal of the relative water surface elevations in the river and in the flood plain, the computed broad-crested weir flow corrected for submergence is assigned a negative sign. Flows in this range are limited in their accuracy since the submergence relationship is least reliable when the differential head is small. Also, relatively large flow changes can occur for small changes in water levels for flows in this range. This can necessitate the use of smaller computational time steps to maintain numerical stability. This is accomplished automatically within the models.

Question: Can you model erosion (overtopping) failures of the levee?

Dr. Fread: Yes, the DWOPER and FLDWAV models have this capability; however, the user must specify the length of the levee failure (crevasse) and the elapsed time for its complete formation.

Question: What is the nature of the automatic time step adjustments in the DAMBRK, DWOPER, and FLDWAV models?

Dr. Fread: These models have an automatic procedure contained within the finite difference solution algorithm to increase the robust nature of the four-point implicit method. Rapidly rising hydrographs and non-linear properties of the cross-sections due to variations in the vertical and/or along the x-axis may cause computational problems which are manifested by non-convergence in the Newton-Raphson iteration or by erroneously low computed depths at the leading edge of steep-fronted waves. When either of these manifestations are sensed, an automatic procedure consisting of two parts is implemented. The first reduces the current time step (Δt) by a factor of 1/2 and repeats the computations. If the same problem persists, Δt is again halved and the computations repeated. This continues until a successful solution is obtained or the time step has been reduced to 1/16 of the original size. If a successful solution is obtained, the computational process proceeds to the next time level using the original Δt . If the solution using $\Delta t/16$ is unsuccessful, the \emptyset weighting factor is increased by 0.1 and a time step of $\Delta t/2$ is used. Upon

achieving a successful solution, \emptyset and the time step are restored to their original values. Unsuccessful solutions are treated by increasing \emptyset and repeating the computation until $\emptyset = 1.0$, whereupon the automatic procedure terminates, and the solution with $\emptyset = 1$ and $t/2$ is used to advance the solution forward in time now using the original \emptyset and t values. Often, computational problems can be overcome via one or two reductions in the time step.

Question: In a developed, urbanized area where there is a lot of housing, how do you handle the friction in the flood plains?

Dr. Fread: The models allow the Manning n to be a specified function of water surface elevation. Thus the n value assigned to the water elevations within the flood plain, where the houses affect the flow resistance, would account for the fractional effects occurring at that time. Trial-error adjustments of the n values during successive model runs could be used to determine the appropriate n values if observed stages and discharges are available. When observed flood-plain flows are not available, which is generally the case when modeling most dam-break floods and storm-surge floods, the Darcy formula can be used as an objective method to determine the proper Manning n to be used in the model. As in the Colebrook-White friction formula, the Darcy f is thought to be composed of two types of friction: (1) submerged friction expressed via a Nikuradse type roughness relation, and (2) partially submerged friction using density and spacing of the partially submerged obstructions along with their appropriate drag coefficients. Then the Manning n can be hand-computed from the Darcy f .

Question: What about the status of the streamflow-aquifer model?

Dr. Fread: Primary development of the aquifer component is just getting started. I would estimate that it will be two years before it will be available.

Question: Will you have enough data to calibrate the streamflow-aquifer model?

Dr. Fread: When testing the streamflow-aquifer model our intent is to use data sets that have cross-sections, observed streamflow stage and discharge hydrographs, and, if possible, some groundwater levels. For general field implementation of the model, it is anticipated that the groundwater levels will not be available. Since our intent in developing the stream-aquifer model is to improve the streamflow prediction, we think we can simply calibrate the parameters in the aquifer model to best reproduce observed streamflow stages and discharges.

Finite Difference Numerical Model
for Long-Period Wave Behavior: With
Emphasis on Storm Surge Modeling

By

H. L. Butler

ABSTRACT:

A two-dimensional numerical hydrodynamic model is presented including its applications to a variety of problems for which long-wave theory is valid. To achieve a solution of the governing equations, finite difference techniques are employed on a stretched rectilinear grid system. The most recent version of the model permits a selection of solution schemes. Choices include both implicit and explicit formulations written in terms of velocity or transport dependent variables. The model predicts vertically integrated flow patterns as well as the distribution of water surface elevations. Code features include the treatment of regions which are inundated during a part of the computational cycle, subgrid barrier effects, variable grid, and a variety of permissible boundary conditions and external forcing functions.

Applicability of the model is demonstrated through a presentation of various ocean-estuarine system problems for which the model was applied. Emphasis is placed on storm surge modeling by including discussion of model sensitivity to user decisions on limiting the model region, choice of timestep, and idealizing bottom topography.

* Wave Dynamics Division, Hydraulics Laboratory, Waterways Experiment Station,
Vicksburg, Mississippi 39180

FINITE DIFFERENCE NUMERICAL MODEL FOR LONG-PERIOD
WAVE BEHAVIOR: WITH EMPHASIS ON STORM SURGE MODELING

By

H. Lee Butler¹

INTRODUCTION

Numerical modeling of water-wave behavior has progressed rapidly in the last decade and is now generally recognized as a useful tool capable of providing solutions to many coastal problems. The Corps of Engineers has had to address the problem of providing reliable estimates of estuarine circulation and coastal flooding from tides and hurricane surges in order to make sound engineering decisions regarding the design, operation, and maintenance of various coastal projects. This paper reports on a two-dimensional finite difference model developed and improved over recent years and applied in a variety of Corps of Engineers studies.

The model described herein, known as the Waterways Experiment Station (WES) Implicit Flooding Model (WIFM), was first devised for application in simulating tidal hydrodynamics of Great Egg Harbor and Corson Inlets, New Jersey (Butler, 1978). Popular approaches for solving the governing equations of fluid flow have included explicit and implicit finite difference techniques as well as finite element schemes. A series of papers by Hinwood and Wallis (1975, 1976) and follow-up discussions by Abbott (1976) and Abraham and Karelse (1976) have classified or reviewed many of these models.

Program WIFM originally employed an implicit solution scheme similar to that developed by Leendertse (1970) and has been applied in numerous studies where tidal, storm surge, and tsunami inundation phenomena were simulated. Basic features of the model include inundation simulation of low-lying terrain, treatment of subgrid barrier effects, and a variable grid option. Included in the model are actual bathymetry and topography, time and spatially variable bottom roughness, inertial forces due to advective and coriolis accelerations, rainfall, and spatial and time-dependent wind fields. Horizontal diffusion terms in the momentum equations are optionally present and can be used, if desired, for aiding stability of the numerical solution. Current model versions permit a selection of solution schemes. Choices include both implicit and explicit formulations written in terms of velocity or transport dependent variables.

¹Wave Dynamics Division, Hydraulics Laboratory, Waterways Experiment Station, Vicksburg, MS 39180.

Future model developments will include subgrid-scale channels which may laterally interact with the two-dimensional model, addition of the salt conservation equation for determining horizontal salinity gradients, and eventually a baroclinic mode of operation to treat three-dimensional fluid flow problems.

HYDRODYNAMIC EQUATIONS

The equations of fluid flow used in WIFM are derived from the classical Navier-Stokes equations in a Cartesian coordinate system. By assuming vertical accelerations are small and the fluid is homogeneous and integrating the flow from sea bottom to water surface, the usual two-dimensional form of the equations of momentum and continuity are obtained. A major advantage of WIFM is the capability of applying a smoothly varying grid to a given study region permitting simulation of a complex landscape by locally increasing grid resolution and/or aligning coordinates along physical boundaries. For each direction, a piecewise reversible transformation which takes the form

$$x = a + b\alpha_1^c \quad (1)$$

where a , b , and c are arbitrary constants, is independently used to map prototype or real space into computational space. Many stability problems commonly associated with variable grid schemes are eliminated via the continuity of the transformation procedure. The resulting equation of motion in α -space can be written as

Momentum:

$$\begin{aligned} & u_t + \frac{1}{\mu_1} uu_{\alpha_1} + \frac{1}{\mu_2} vu_{\alpha_2} - fv \\ & + \frac{g}{\mu_1} (\eta - \eta_a)_{\alpha_1} + \frac{gu}{C_d^2} (u^2 + v^2)^{1/2} \\ & - \varepsilon \left(\left(\frac{1}{\mu_1} \right)^2 u_{\alpha_1 \alpha_1} + \frac{1}{\mu_1} \left(\frac{1}{\mu_1} \right)_{\alpha_1} u_{\alpha_1} + \left(\frac{1}{\mu_2} \right)^2 u_{\alpha_2 \alpha_2} \right. \\ & \left. + \frac{1}{\mu_2} \left(\frac{1}{\mu_2} \right)_{\alpha_2} u_{\alpha_2} \right) = F_{\alpha_1} \end{aligned} \quad (2)$$

$$\begin{aligned}
v_t + \frac{1}{\mu_1} uv_{\alpha_1} + \frac{1}{\mu_2} vv_{\alpha_2} + fu + \frac{g}{\mu_2} (\eta - \eta_a)_{\alpha_2} \\
+ \frac{gv}{C^2 d} (u^2 + v^2)^{1/2} - \varepsilon \left(\frac{1}{\mu_1} \right)^2 v_{\alpha_1 \alpha_1} + \frac{1}{\mu_1} \left(\frac{1}{\mu_1} \right)_{\alpha_1} v_{\alpha_1} \\
+ \left(\frac{1}{\mu_2} \right)^2 v_{\alpha_2 \alpha_2} + \frac{1}{\mu_2} \left(\frac{1}{\mu_2} \right)_{\alpha_2} v_{\alpha_2} = F_{\alpha_2}
\end{aligned} \tag{3}$$

Continuity:

$$\eta_t + \frac{1}{\mu_1} (du)_{\alpha_1} + \frac{1}{\mu_2} (dv)_{\alpha_2} = R \tag{4}$$

where

$$\mu_1 = \frac{\partial x}{\partial \alpha_1} \quad \text{and} \quad \mu_2 = \frac{\partial y}{\partial \alpha_2}$$

and η is the water-surface elevation; η_a is the hydrostatic elevation corresponding to the atmospheric pressure anomaly; u and v are the vertically integrated velocities at time t in the α_1 and α_2 directions, respectively; $d = \eta - h$ is the total water depth; h is the still-water elevation; f is the Coriolis parameter; C is the Chezy frictional coefficient; g is the acceleration of gravity; ε is a generalized eddy viscosity coefficient; R represents the rate at which additional water is introduced into or taken from the system (for example, through rainfall and evaporation); and F_{α_1} and F_{α_2} are terms representing external forcing functions such as wind stress in the α_1 and α_2 directions. Quantities μ_1 and μ_2 define the stretching of the regular-spaced computational grid in α -space to approximate a study region in real space. Directions α_1 and α_2 correspond to x and y , respectively.

FINITE DIFFERENCE FORMULATION

The differential equations (Eqs. 2-4) are to be approximated by difference equations. Various solution schemes, including implicit and explicit formulations, could be employed. WIFM permits a selection of difference formulations, but this paper will concentrate on alternating direction techniques. To illustrate how various implicit schemes can be derived consider the simplified linearized matrix equation

$$U_t + AU_x + BU_y = 0 \tag{5}$$

where

$$U = \begin{pmatrix} \eta \\ u \\ v \end{pmatrix}, \quad A = \begin{pmatrix} 0 & d & 0 \\ g & 0 & 0 \\ 0 & 0 & 0 \end{pmatrix}, \quad B = \begin{pmatrix} 0 & 0 & d \\ 0 & 0 & 0 \\ g & 0 & 0 \end{pmatrix}$$

A standard method for developing an implicit scheme is to apply the Crank-Nicolson technique to Equation 5 to obtain

$$\frac{1}{\Delta t} (U^{n+1} - U^n) + \frac{1}{2} \left(\frac{A}{\Delta x} \delta_x + \frac{B}{\Delta y} \delta_y \right) (U^{n+1} + U^n) = 0 \quad (6)$$

where δ_x and δ_y are centered difference operators. Equation 6 can be simplified further to read

$$(1 + \lambda_x + \lambda_y) U^{n+1} = (1 - \lambda_x - \lambda_y) U^n \quad (7)$$

where

$$\lambda_x = \frac{1}{2} \frac{\Delta t}{\Delta x} A \delta_x \quad \text{and} \quad \lambda_y = \frac{1}{2} \frac{\Delta t}{\Delta y} B \delta_y$$

By adding the quantity $\lambda_x \lambda_y (U^{n+1} - U^n)$ of order $(\Delta x^2, \Delta t^2)$ to permit factorization, the following relation is obtained

$$(1 + \lambda_x) (1 + \lambda_y) U^{n+1} = (1 - \lambda_x) (1 - \lambda_y) U^n \quad (8)$$

By introducing an intermediate value, U^* , Equation 8 can be split into a two-step operation in a variety of ways:

Standard Alternating Direction Implicit (ADI) Scheme:

$$(1 + \lambda_x) U^* = (1 - \lambda_y) U^n \quad (9)$$

$$(1 + \lambda_y) U^{n+1} = (1 - \lambda_x) U^* \quad (10)$$

Approximate Factorization Scheme:

$$(1 + \lambda_x) U^* = (1 - \lambda_x) (1 - \lambda_y) U^n \quad (11)$$

$$(1 + \lambda_y) U^{n+1} = U^* \quad (12)$$

Stabilizing Correction (SC) Scheme:

$$(1 + \lambda_x) U^* = (1 - \lambda_x - 2\lambda_y) U^n \quad (13)$$

$$(1 + \lambda_y) U^{n+1} = U^* + \lambda_y U^n \quad (14)$$

The first step in each procedure is carried out by sweeping the grid in the x direction, and the second step is computed by sweeping in the y direction. Completing both sweeps constitutes a full time step, advancing the solution from the nth time level to the (n+1) time level. A more complete description of these methods can be found in a paper by Weare (1980).

The SC scheme can be developed for a fully implicit approach or for any multi-time level approach. The approach currently used in WIFM is a three time level, leapfrog scheme applied on a variable rectilinear mesh. The appropriate variables are defined on each grid cell in a space-staggered fashion as depicted in Figure 1.

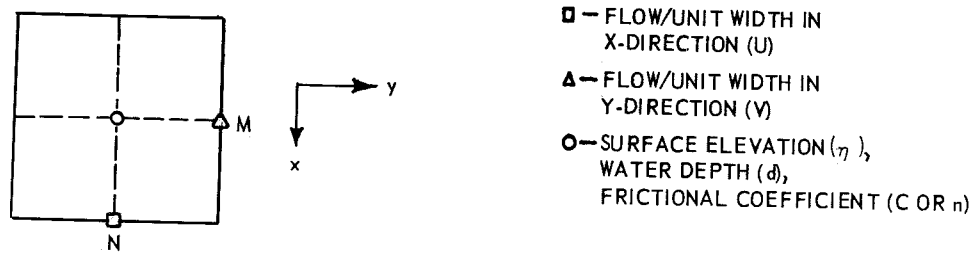

Figure 1. Computational Cell Definition

To illustrate the actual formulation, difference equations for the x-sweep are given by

$$\begin{aligned} \frac{1}{2\Delta t} (\eta^* - \eta^{k-1}) + \frac{1}{2\mu_1 \Delta \alpha_1} [\delta_\alpha (u^* \bar{d}^k + u^{k-1} \bar{d}^k)] \\ + \frac{1}{\mu_2 \Delta \alpha_2} \delta_{\alpha_2} (v^{k-1} \bar{d}^k) = R \text{ at } (n, m) \end{aligned} \quad (15)$$

$$\frac{1}{2\Delta t} (u^* - u^{k-1}) + \frac{1}{2\mu_1 \Delta \alpha_1} u^k \delta_{2\alpha_1} (u^k) + \frac{1}{2\mu_2 \Delta \alpha_2} \bar{v}^k \delta_{2\alpha_2} (u^k)$$

$$\begin{aligned}
& -\bar{f}_v^k + \frac{g}{2\mu_1 \Delta\alpha_1} [\delta_{\alpha_1} (\eta^* + \eta^{k-1} - 2\eta_a^k)] \\
& + \frac{g}{(\bar{C}^2 \bar{d})^k} u^* [(u^{k-1})^2 + (v^{k-1})^2]^{1/2} - \varepsilon \left[\frac{1}{(\mu_1 \Delta\alpha_1)^2} \delta_{\alpha_1 \alpha_1} (u^k) \right. \\
& + \frac{1}{(\mu_2 \Delta\alpha_2)^2} \delta_{\alpha_2 \alpha_2} (u^k) + \frac{1}{2\mu_1 \Delta\alpha_1} \delta_{\alpha_1} \left(\frac{1}{\mu_1} \right) \delta_{2\alpha_1} (u^k) \\
& \left. + \frac{1}{2\mu_2 \Delta\alpha_2} \delta_{\alpha_2} \left(\frac{1}{\mu_2} \right) \delta_{2\alpha_2} (u^k) \right] = F_{\alpha_1}^k \quad (n, m + \frac{1}{2}) \quad (16)
\end{aligned}$$

In these expressions, a single bar represents a two-point average and a double bar a four-point average. The subscripts m and n correspond to spatial locations and superscript k to time levels. Equations for the y -sweep are written in an analogous manner.

Implicit methods are characterized by a property of unconditional stability in the linear sense. The stabilizing correction scheme used in WIFM is limited by a weak condition, namely,

$$\Delta t \leq \frac{\min(\Delta x, \Delta y)}{(u^2 + v^2)^{1/2}} \quad (17)$$

It has been shown that the stability of implicit difference schemes can be improved by time-centering of the nonlinear terms (Weare, 1976). For this reason the difference scheme outlined above employs three full time levels permitting such time centering of the appropriate terms. Optional use of the horizontal diffusion terms is permitted to aid in stabilizing the solution method. Secondary flow effects have been studied by Vreugdenhil (1973) and Kuipers and Vreugdenhil (1973). Although inclusion of these diffusion terms does not constitute proper closure of the model (Flokstra, 1977), it does aid in stabilizing the procedure.

BOUNDARY CONDITIONS

A variety of boundary conditions are employed throughout the computational grid. These include prescribing water levels, velocities, or flow rates, fixed or movable land-water boundaries, and subgrid barrier conditions.

a. Open Boundaries: Water levels, velocities, or flow rates are prescribed as functions of location and time and are given as tabular input to the code or in tidal constituent form.

b. Water-land Boundaries: These conditions relate the normal component of flow at the boundary to the state of the water level at the boundary. Hence, water-land boundaries are prescribed along cell faces. Fixed land boundaries are treated by specifying $u = 0$ or $v = 0$ at the appropriate cell face. Low-lying terrain may alternately dry and flood within a tidal cycle or surge history. Inundation is simulated by making the location of the land-water boundary a function of local water depth. By checking water levels in adjacent cells, a determination is made as to the possibility of inundation. Initial movement of water onto dry cells is controlled by using a broad crested weir formula (Reid and Bodine, 1968). Once the water level on the dry cell exceeds some small prescribed value, the boundary face is treated as open and computations for η , u , and v are made for that cell. The drying of cells is the inverse process. Mass conservation is maintained within these procedures.

c. Sub-Grid Barriers: Such barriers are defined along cell faces and are of three types: exposed, submerged, and overtopping. Exposed barriers are handled by simply specifying no-flow conditions across the appropriately flagged cell faces. Submerged barriers are simulated by controlling flow across cell faces with the use of a time-dependent friction coefficient. The term "overtopping barrier" is used to distinguish barriers which can be submerged during one phase of the simulation and totally exposed during another. Actual overtopping is treated by using a broad-crested weir formula to specify the proper flow rate across the barrier. Water is transferred from the high to low side according to this rate. Once the barrier is submerged (or conversely exposed), procedures as described for submerged barriers (or exposed) are followed.

APPLICATIONS

Program WIFM has been used successfully in many applications conducted at WES. These include tidal circulation studies for Masonboro Inlet, North Carolina (Butler and Raney, 1976), Corson and Great Egg Harbor Inlets, New Jersey (Butler, 1978), Coos Bay Inlet - South Slough, Oregon (Butler, 1978); storm surge applications for Hurricane Eloise, Panama City, Florida (Butler and Wanstrath, 1976), Hurricane Carla, Galveston, Texas (Butler, 1978), and Hurricanes Betsy and Camille, Lake Pontchartrain, Louisiana (WES Technical Report to be published); tsunami inundation simulations for Crescent City, California (Houston and Butler, 1979) and the Hawaiian Islands (Houston, et al., 1977). A recent paper (Butler, 1979) summarizes these applications and details will not be repeated herein.

General requirements for a model simulation study are outlined as follows:

- a. Large computer (WIFM is currently installed on the CRAY 1).

b. Field data - sources include:

- (1) Maps, nautical charts, 7-1/2' quad maps, boat charts.
- (2) Tides, currents, wind - National Weather Service, Corps of Engineer Districts.
- (3) LANDSAT/NIMBUS satellite data - NASA.
- (4) Undertake a prototype data acquisition effort for additional data.

c. Field data analysis - editing, filtering, harmonic and residual analysis.

d. Model definition - included are:

- (1) Model limits, grid resolution, and bathymetry.
- (2) Boundary conditions and surface stress.
- (3) Friction and barrier characteristics.
- (4) Grid sensitivity tests (optional).

e. Verification includes:

- (1) Calibration to reproduce an observed event.
- (2) Simulation of additional observed events to verify model.

f. Impact of changes to existing conditions includes:

- (1) Simulating addition of jetties, breakwater, dredging, etc.
- (2) Comparison with/without modification for tidal prism, water elevations, current magnitude and circulation, etc.

g. Statical analysis (for stage/frequency curves) of hindcasted historical events or hypothetical events for use in a joint probability method approach.

To exemplify use of the model a brief description of computational sensitivity to modeling assumptions for a Louisiana coastal storm surge investigation is presented. As part of a study of a hurricane barrier protection plan for Lake Pontchartrain, a northern boundary for the city of New Orleans, Louisiana, an open-coast storm surge model of the pertinent coastal region was developed. Figure 2 displays the computational grid used in the investigation. Still water depths reach 3,000 m in the south-eastern corner of the grid.

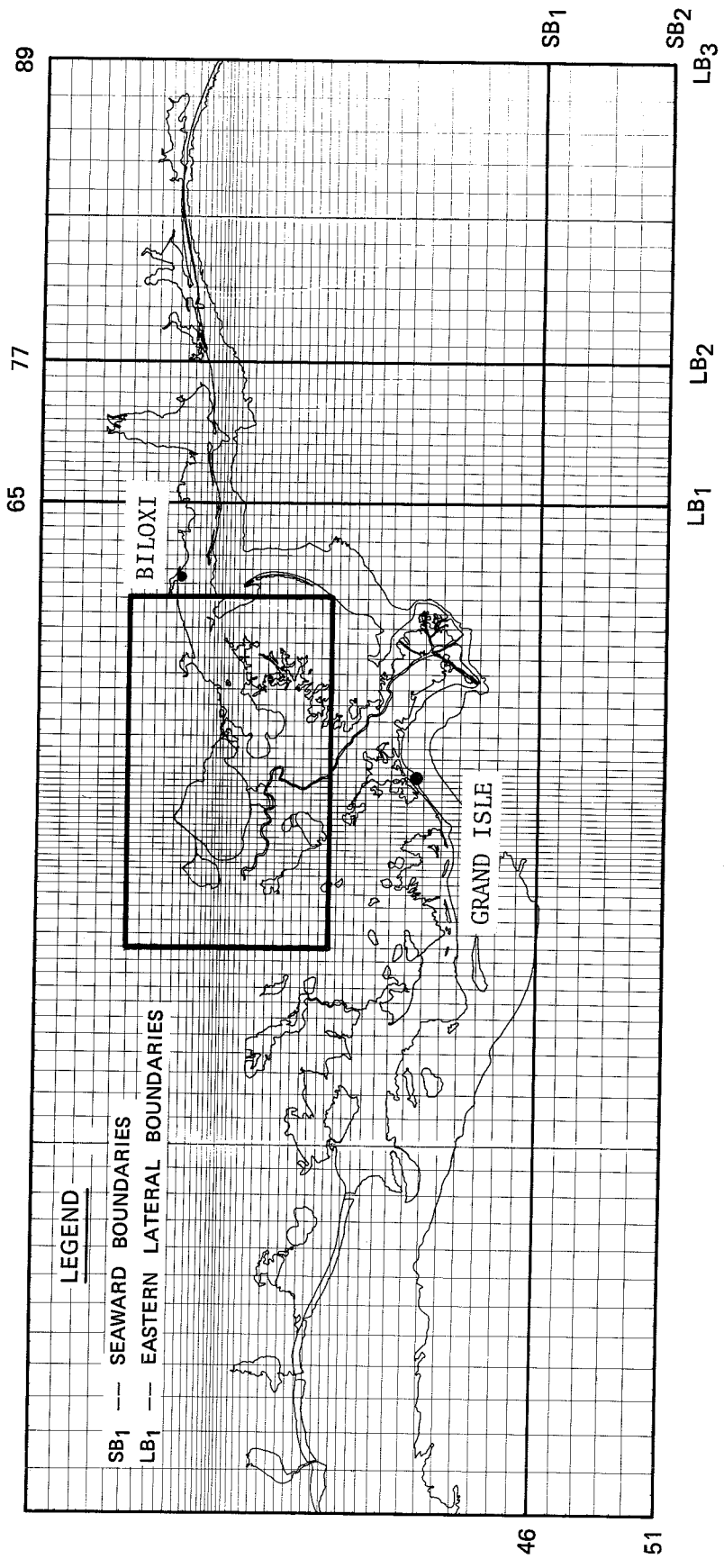

Figure 2. Computational grid for hurricane surge simulation in the vicinity of Lake Pontchartrain, LA

To insure the efficacy of all model assumptions tests were made with varying grid limits, time steps, and still-water depth limitations (usually made when running explicit formulated models to relax stability criterion restrictions on the computational time step). Six grids were formed by considering two seaward boundaries and three eastern lateral boundaries noted in Figure 2. Five separate cutoff depths were selected: 90, 240, 400, 550, and 3,000 m. The full set of runs was thus thirty in number. Various time steps were selected for a limited set of runs and the only effect noted was the typical erosion of numerical accuracy with increasing timestep. Table 1 displays peak surge elevation results for eighteen runs and two selected gages (location shown on Figure 2). Hydrograph comparison (observed vs largest grid/actual topography and smallest grid/90 m cutoff depth) for a gage at Biloxi, MS, is shown in Figure 3. Coastline peak surge behavior for largest grid/actual topography, largest grid/90 m cutoff depth and smallest grid/90 m cutoff depth is compared in Figure 4.

These results are essentially self-explanatory. What is demonstrated is that model users must insure themselves that assumptions made in model formulation are not effecting the numerical results. The deep shelf southeast of the Mississippi River Delta must be properly simulated as well as selection of the model region. Inclusion of deep water in the topography suggests the appropriateness of an implicit model, particularly if fine resolution is required.

SUMMARY

This paper presents the development of a two-dimensional finite-difference long-period wave model. The variable grid characteristic of WIFM permits the capability to obtain finer resolution in important local areas without sacrificing economical application of the model. Other features (treatment of flooding, subgrid-scale representations, selection of solution scheme, and so forth) make the model quite general. WIFM has been extensively tested and shown to be of practical value as a tool for addressing problems associated with various types of coastal projects. References are given for specific investigations along with an outline of general model study requirements. An example of model sensitivity to parameterization is described.

TABLE 1. PEAK SURGE IN METERS FOR MODEL GAGES AT BILOXI, MS AND GRAND ISLE, LA

DEPTH LIMITATION (m) (1)	GRID DIMENSIONS					
	89,51 (2)	89,46 (3)	77,51 (4)	77,46 (5)	65,51 (6)	65,46 (7)
(a) BILOXI, MS						
90	2.7	2.7	2.3	2.3	1.8	1.8
240	2.5	2.5	2.3	2.3	1.8	1.8
3000	2.4	2.4	2.3	2.3	1.8	1.8
(b) GRAND ISLE, MS						
90	2.4	1.9	2.3	1.9	2.1	1.8
240	2.2	1.8	2.1	1.8	2.0	1.8
3000	1.9	1.8	1.9	2.0	1.9	1.8

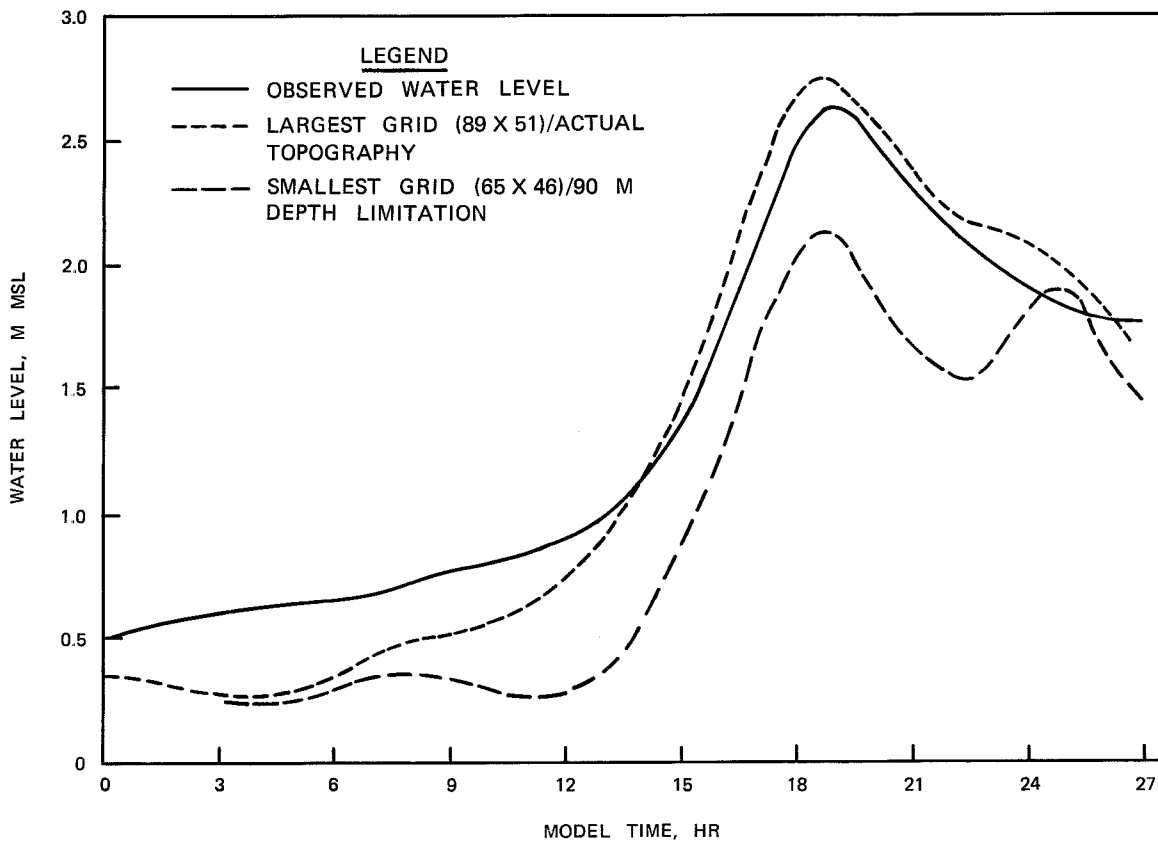

Figure 3. Comparison of computed water levels at Biloxi, MS vs observed levels

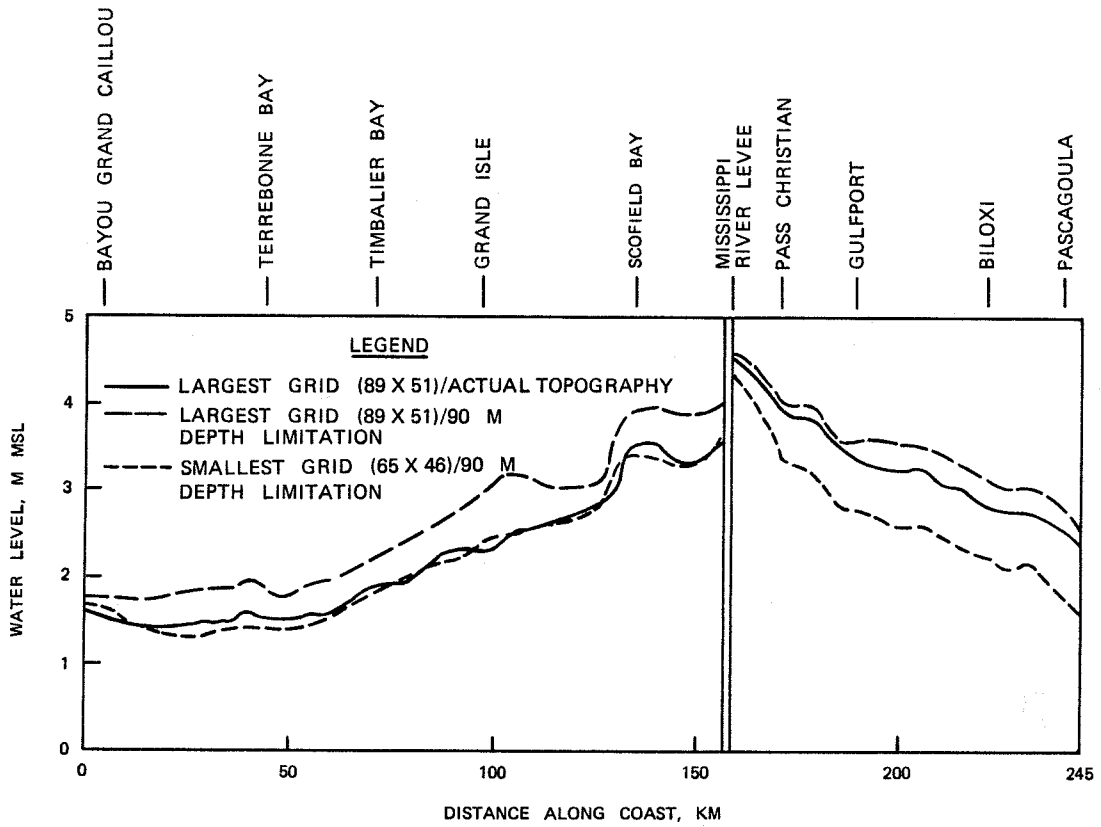

Figure 4. Comparison of computed peak water levels at the coast for various grid dimensions and depth limitations

REFERENCES

1. Abbott, M. B., discussion of "Review of Models of Tidal Waters," by J. B. Hinwood and I. G. Wallis, Journal of the Hydraulics Division, ASCE, Vol. 102, No. HY8, Proc. Paper 12280, Aug 76, pp. 1145-1148.
2. Abraham, G. and Karelse, M., discussion of "Classification of Models of Tidal Waters and Review of Models of Tidal Waters," by J. B. Hinwood and I. G. Wallis, Journal of the Hydraulics Division, ASCE, Vol. 102, No. HY6, Proc. Paper 12164, June 76, pp 808-811.
3. Butler, H. L., "Numerical Simulation of Tidal Hydrodynamics: Great Egg Harbor and Corson Inlets, New Jersey," Technical Report H-78-11, U. S. Army Waterways Experiment Station, CE, Vicksburg, MS, Jun 1978.
4. Butler, H. Lee, "Numerical Simulation of the Coos Bay-South Slough Complex," Technical Report H-78-22, U. S. Army Engineer Waterways Experiment Station, CE, Vicksburg, MS, Dec 1978.
5. Butler, H. Lee, "Coastal Flood Simulation in Stretched Coordinates," 16th International Conference on Coastal Engineering, Proc. to be published, ASCE, Hamburg, Germany, 27 Aug-1 Sep 1978.
6. Butler, H. L. and Raney, D. C., "Finite Difference Schemes for Simulating Flow in an Inlet-Wetlands System," Proceedings of the Army Numerical Analysis and Computers Conference, The Army Mathematics Steering Committee, Durham, NC, Mar 1976.
7. Butler, H. Lee and Wanstrath, J. J., "Hurricane Surge and Tidal Dynamic Simulation of Ocean Estuarine Systems," ASCE 1976 Hydraulics Division Specialty Conference, Purdue University, Indiana, 4-6 Aug 1976.
8. Butler, H. Lee, "Evolution of a Numerical Model for Simulating Long-Period Wave Behavior in Ocean-Estuarine Systems," Estuarine and Wetland Processes with Emphasis on Modeling, Marine Science Series, Vol. II, Plenum Press, New York, 1980.
9. Flokstra, C., "The Closure Problem for Depth-Averaged Two-dimensional Flow," Paper A 106, 17th International Association for Hydraulic Research Congress, Baden-Baden, Germany, 1977, pp. 247-256.
10. Hinwood, J. B., and Wallis, I. G., "Classification of Models of Tidal Waters," Journal of the Hydraulics Division, ASCE, Vol. 101, No. HY 10, Proc. Paper 11643, Oct 1975, pp. 1315-1331.
11. Hinwood, J. B. and Wallis, I. G., "Review of Models of Tidal Waters," Journal of the Hydraulics Division, Vol. 101, No. HY11, Proc. Paper 11693, Nov 1975, pp. 1405-1421.

12. Hinwood, J. B. and Wallis, I. G., Closure to "Classification of Models of Tidal Waters," Journal of the Hydraulics Division, ASCE, Vol. 102, No. HY12, Proc. Paper 12586, Dec 1976, pp. 1776-1777.
13. Houston, J. R., Carver, R. D., and Markle, D. G., "Tsunami-Wave Elevation Frequency of Occurrence for the Hawaiian Islands," Technical Report H-77-16, U. S. Army Engineer Waterways Experiment Station, CE, Vicksburg, MS, 1977.
14. Houston, James R. and Butler, H. Lee, "A Numerical Model for Tsunami Inundation," Technical Report HL-79-2, U. S. Army Engineer Waterways Experiment Station, CE, Vicksburg, MS, Feb 1979.
15. Kuipers, J. and Vreugdenhil, C. B., "Calculations of Two-Dimensional Horizontal Flow," Report No. S163, Part 1, Delft Hydraulics Laboratory, Delft, The Netherlands, Oct 1973.
16. Leendertse, J. J., "A Water-Quality Simulation Model for Well-Mixed Estuaries and Coastal Seas, Vol. 1, Principals of Computation," RM-6230-rc, Rand Corp., Santa Monica, CA, Feb 1970.
17. Reid, R. O., and Bodine, B. R., "Numerical Model for Storm Surges in Galveston Bay," Journal of Waterways and Harbors Division, ASCE, Vol. 94, No. WW1, Proc. Paper 5805, Feb 1968, pp. 33-57.
18. Vreugdenhil, C. B., "Secondary-Flow Computations," Delft Hydraulics Laboratory, Publication No. 114, Nov 1973.
19. Weare, T. John, "Instability in Tidal Flow Computational Schemes," Journal of the Hydraulics Division, ASCE, Vol. 102, No. HY5, Proc. paper 12100, May 1976, pp. 569-580.
20. Weare, T. John, "Errors Arising from Irregular Boundaries in ADI Solutions of the Shallow-Water Equations," International Journal for Numerical Methods in Engineering, Vol. 14, pp. 921-931, 1979.

PAPER DISCUSSION

FINITE DIFFERENCE NUMERICAL MODEL FOR LONG-PERIOD WAVE BEHAVIOR: WITH EMPHASIS ON STORM SURGE MODELING

by
H. Lee Butler

- Questions:
- 1) How do you create the wind field in your model?
 - 2) Please elaborate on how your models are coupled together.
 - 3) How can riverine modelers adapt your techniques to solve their problems?

Dr. Butler: We are using a number of wind field models. The one discussed this morning was the standard project hurricane model that has a fetch-limited capability of introducing land effects on the wind field. It does not dynamically include the physics of the problem in the computation but gives a steady state picture of the wind field. Other models are available to the code such as one developed by Dr. Chester Jelesniski. We are also testing and verifying a planetary boundary layer (PBL) model. We have obtained fairly good agreement with observed wind data in our testing program but model currently develops lower surges than observed. The drag law is built into the PBL model and this is where we are looking to correct this problem. Therefore, this PBL model is still considered as a research model.

As for coupling, we saw in the Atchafalaya Bay model that simulations are performed on a single global grid with enough accuracy to pick up the channel and their interactions with large bays. Some flood plain cells are modeled for storage capacity only and the surge is routed to these areas through channels resolved with sufficient accuracy. We will not worry about how the water is ultimately distributed on these areas. Our main interest is the computation of surge currents in the bays. This method of computation permits sufficient open coast area for storm development, along with sufficient inland resolution to describe channel-bay-flood plain interaction.

For our Lake Pontchartrain problem we had to look at the open coast over a large expanse and thus could not introduce enough resolution to consider surges in the lake and changes that would be introduced as a result of the proposed barrier plan. Therefore, we had to construct a subgrid, or embedded model. By taking boundaries far enough away from the actual barrier plan itself, with the barrier plan still represented in the bigger grid, the interior grid can be forced with boundary conditions recorded in the global solution around the embedded model grid. This essentially describes the

one-way coupling used in this particular problem. We do not attempt to dynamically couple the embedded grid with the open coast grid.

By using models such as these, we can then produce boundary conditions which in turn can be fed into riverine models such as Danny Fread's DWOPER model to simulate surge effects upstream from the estuary.

Question: Could you please discuss how your model equations are linearized and how this linearization may effect nonlinear stability, etc.?

Dr. Butler: In any of these models, at some point, you have to linearize certain terms. If you include nonlinear terms in an implicit model, like udu/dx terms, you usually have to evaluate components of these terms at different time levels. Some models consider the nonlinear terms in a passive sense by centering these terms at the mid level of a three-time level scheme. Such a procedure is used in WIFM.

Question: For a variable grid such as you use, how do you use spatially centered du/dx terms?

Dr. Butler: We do it through the variable grid transformation.

Question: What would happen if you expanded your grid to consider the entire Gulf of Mexico?

Dr. Butler: We have done this. Professor Reid at Texas A&M has developed a Gulf-Tide Model that we now use in conjunction with WIFM.

Question: Have you done sensitivity studies for grids this large?

Dr. Butler: No. That is an area where we hope to be doing future research. We would like to move a storm from the straights into the Gulf and through the Gulf to see if we can develop the so called pre-surge anomaly for the rise in water level usually experienced prior to arrival of storm related effects.

Question: What kinds of costs are associated with running your storm surge models?

Dr. Butler: If you wanted to run a full day's simulation with about a minute time step, you would compute for about 1500 time steps. The cost for this kind of a run would depend on what detail you wanted and on the physical size of the system being modeled, but it would probably cost around \$200.00 at a commercial computer rate for a 7000 point grid.

Question: Danny Fread, would you please state your estimated costs to run your one-dimensional flow model?

Mr. Fread: Yes. The figure I stated was 0.005 CPU seconds per Δx per Δt on an IBM 360/195 machine. This amount of time is good for either the DAMBRK or DWOPER programs, which are one-dimensional implicit models.

Question: How many iterations?

Mr. Fread: We iterate as much as we need to, but on the average it is usually one to two iterations per time stop.

Discussion: Lee Butler: For the Hurricane Carla storm surge simulations, we ran the model for 74 hours prototype time. Including a wind field computation, the run cost about \$75.

Question: How many grid points did you have?

Dr. Butler: About 4000.

Question: Perhaps one of the important aspects to consider when modeling complex systems is, how much does it cost to get the data necessary to perform the simulation? The modeling itself may not be that expensive compared to the data collection phase.

Dr. Butler: There is a multi-fiscal year project underway in the Corps, as a joint effort with CERC, WES, NOAA and several private concerns, to collect hurricane data. These data are needed for model verification. We are trying to establish gages all around the Gulf and the south Atlantic coasts of the U.S. to obtain these data. We are currently in the second year of this effort and it is very expensive! Very expensive compared to the actual model applications, but also very necessary. These data are being taken and eventually will be available for model verification.

A TWO-DIMENSIONAL FLOOD ROUTING CALCULATION

by
Charles Noble
Robert E. Narum⁽¹⁾

1.0 INTRODUCTION

The desirability of accurately predicting the extent and duration of flooding resulting from the partial or total breach of a dam has been emphasized recently. The most practical way to meet this need is the development and use of good computer-based models.

In order to predict the routing of floods, several hydrograph routing and one-dimensional models have recently been developed. Among the better known models are those employed in the code DAMBRK, Fread (1980) and in HEC-1 (1973). These models have proved to be quite good in predicting the flooding in those cases which have been amenable to a one-dimensional treatment. The accuracy of these models in situations which are clearly two-dimensional in nature is suspect, however. This was pointed out by Druffel (1979) in their one-dimensional analysis of a hypothetical failure of the Mackay Dam.

"...The accuracy of the peak water-surface elevations, arrival times, and peak discharges below the diversion was very poor....The reach below the diversion is characterized by shallow depths with several extreme expansions and contractions and several reaches with widths in excess of 7,315 m. These conditions are poorly simulated by a one-dimensional model..."

It is thus desirable to develop two-dimensional flood routing models to properly handle those situations in which the one-dimensional models are inadequate. Energy Incorporated (EI) has developed a computer code, FLOOD, that describe the two-dimensional motion of a flood. An analysis of the hypothetical Mackay Dam failure was performed using FLOOD. In this paper are given the equations used by EI, the numerical algorithm used for their solution, and the results of the Mackay Dam analysis.

2.0 MATHEMATICAL MODEL

2.1 The Flow Equations

The flow of an incompressible fluid in three dimensions is described by the Navier-Stokes equations plus the equation of continuity (incompressibility condition). In Cartesian coordinates the three-dimensional equations can be written as:

(1) Energy Incorporated, Idaho Falls, ID 83402.

Continuity Equation,

$$\frac{\partial u}{\partial x} + \frac{\partial v}{\partial y} + \frac{\partial w}{\partial z} = 0 \quad \text{Equation 1}$$

x - Momentum Equation,

$$\frac{\partial u}{\partial t} + \frac{\partial u^2}{\partial x} + \frac{\partial uv}{\partial y} + \frac{\partial uw}{\partial z} = \frac{1}{\rho} \frac{\partial P}{\partial x} + f|u|u + g_x \quad \text{Equation 2}$$

y - Momentum Equation,

$$\frac{\partial v}{\partial t} + \frac{\partial vu}{\partial x} = \frac{\partial v^2}{\partial y} + \frac{\partial vw}{\partial z} = \frac{1}{\rho} \frac{\partial P}{\partial y} + f|v|v + g_y \quad \text{Equation 3}$$

z - Momentum Equation,

$$\frac{\partial w}{\partial t} + \frac{\partial uw}{\partial x} + \frac{\partial vw}{\partial y} + \frac{\partial w^2}{\partial z} = \frac{1}{\rho} \frac{\partial P}{\partial z} + f|w|w + g_z \quad \text{Equation 4}$$

in which u , v , and w are the velocity components in the x , y , and z directions, respectively, ρ is the fluid density, P is the pressure, f is a friction factor, and g_x , g_y , and g_z represent the body force in the x , y , and z coordinate directions, respectively.

If it is assumed that the fluid is bounded at the lower and upper surfaces by functions independent of z , let

$$\begin{aligned} \text{Lower surface} &= a(x,y,t) \\ \text{Upper surface} &= b(x,y,t) \end{aligned}$$

Whenever the surfaces $a(x,y,t)$ and $b(x,y,t)$ are sufficiently smooth and nearly parallel, then the Navier-Stokes equations can be approximated by the following set of vertically integrated equations.

Continuity Equation,

$$\frac{\partial(b-a)}{\partial t} + \frac{\partial(b-a)u}{\partial x} + \frac{\partial(b-a)v}{\partial y} = 0 \quad \text{Equation 5}$$

x - Momentum Equation,

$$\frac{\partial(b-a)u}{\partial t} + \frac{\partial(b-a)u^2}{\partial x} + \frac{\partial(b-a)uv}{\partial y} = -g_z(b-a) \frac{\partial b}{\partial x} + (b-a) f|u|u + g_x(b-a) \quad \text{Equation 6}$$

y - Momentum Equation,

$$\frac{\partial(b-a)v}{\partial t} + \frac{\partial(b-a)uv}{\partial x} + \frac{\partial(b-a)v^2}{\partial y} = -g_z(b-a) \frac{\partial b}{\partial y} + (b-a) f|v|v + g_y(b-a)$$

Equation 7

These equations, Equation 5 through Equation 7, are finite differenced and the resulting difference equations are used in the FLOOD Code.

2.2 Finite Difference Equations

The manner in which the equations, Equation 5 through Equation 7, are finite-differenced is shown below. Assume a two-dimensional grid

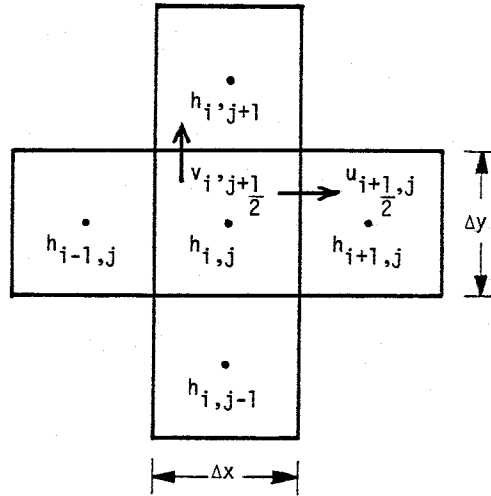

where the heights, $h = (b-a)$, are computed by finite difference equations at cell centers, and velocities are computed by finite difference equations at cell boundaries. The height at a cell boundary is computed as the average of the two adjacent heights, and velocities at cell centers as the average of the two adjacent velocities. Equation 6 can be rewritten as:

$$\frac{\partial u}{\partial t} + \frac{u \partial u}{\partial x} + \frac{\partial uv}{\partial y} + \frac{u \partial v}{\partial y} = -g_z \frac{\partial b}{\partial x} + f|u|u$$

Equation 8

The finite difference equation used in the FLOOD code is

$$U_{i+1,j}^{n+1} = \bar{U}_{i+1,j}^n - g_z \left(\frac{\Delta t}{\Delta x} \right) \left(b_{i+1,j}^{n+1} - b_{i,j}^{n+1} \right)$$

Equation 9

where

$$\bar{U}_{i+1,j}^n = U_{i+1,j}^n - U_{i+1,j}^{n+1} \left(\frac{\Delta t}{\Delta x} \right) \left(U_{i+1,j}^n - U_{i,j}^n \right)$$

$$\begin{aligned}
& - U_{i+1,j}^n \left(\frac{1}{2} \right) \left(\frac{\Delta t}{\Delta x} \right) \left[\left(v_{i,j+1}^n + v_{i+1,j+1}^n \right) - \left(v_{i,j-1}^n + v_{i+1,j-1}^n \right) \right] \\
& - \left(\frac{\Delta t}{\Delta y} \right) \left(\frac{1}{4} \right) \left[\left(U_{i+1,j}^n + U_{i+1,j+1}^n \right) \left(v_{i,j+1}^n + v_{i+1,j-1}^n \right) \right. \\
& \left. - \left(U_{i+1,j}^n + U_{i+1,j-1}^n \right) \left(v_{i,j-1}^n + v_{i+1,j-1}^n \right) \right] + f | U_{i+1,j}^n | U_{i+1,j}^n .
\end{aligned}$$

Equation 10

A similar expression is used for the y-momentum equation, and the continuity equation is finite differenced as

$$\begin{aligned}
h_{ij}^{n+1} - h_{i,j}^n + \left(\frac{\Delta t}{\Delta x} \right) \left(\frac{1}{2} \right) \left(h_{i+1,j}^{n+1} + h_{i,j}^{n+1} \right) U_{i+1,j}^{n+1} \\
- \left(\frac{\Delta t}{\Delta x} \right) \left(\frac{1}{2} \right) \left(h_{i-1,j}^{n+1} + h_{i,j}^{n+1} \right) U_{i-1,j}^{n+1} \\
+ \left(\frac{\Delta t}{\Delta y} \right) \left(\frac{1}{2} \right) \left(h_{i,j+1}^{n+1} + h_{i,j}^{n+1} \right) v_{i,j+1}^{n+1} \\
- \left(\frac{\Delta t}{\Delta y} \right) \left(\frac{1}{2} \right) \left(h_{i,j-1}^{n+1} + h_{i,j}^{n+1} \right) v_{i,j-1}^{n+1} = 0 .
\end{aligned}$$

Equation 11

The algorithm for solving the above nonlinear equations is an extension to two dimensions of a method developed by Narum (1976) based on techniques first proposed by Harlow (1971). The momentum equations are combined with the continuity equation to obtain the equation solved for h.

$$\begin{aligned}
h_{i,j}^{n+1} \left[1 + \frac{1}{2} \left(\frac{\Delta t}{\Delta x} \right) \left(\tilde{U}_{i+1/2,j} - \tilde{U}_{i-1/2,j} \right) + \frac{1}{2} \left(\frac{\Delta t}{\Delta y} \right) \left(\tilde{V}_{i,j+1/2} - \tilde{V}_{i,j-1/2} \right) \right. \\
- \frac{1}{2} g \left(\frac{\Delta t}{\Delta x} \right)^2 \left(b_{i+1,j}^{n+1} - 2b_{i,j}^{n+1} + b_{i-1,j}^{n+1} \right) \\
\left. - \frac{1}{2} g \left(\frac{\Delta t}{\Delta y} \right)^2 \left(b_{i,j+1}^{n+1} - 2b_{i,j}^{n+1} + b_{i,j-1}^{n+1} \right) \right] \\
= h_{i,j}^n - \frac{1}{2} \left(\frac{\Delta t}{\Delta x} \right) \left(h_{i+1,j}^{n+1} \tilde{U}_{i+1/2,j} - h_{i-1,j}^{n+1} \tilde{U}_{i-1/2,j} \right)
\end{aligned}$$

$$\begin{aligned}
& - \frac{1}{2} \left(\frac{\Delta t}{\Delta y} \right) (h_{i,j+1}^{n+1} \tilde{v}_{i,j+\frac{1}{2}} - h_{i,j-1}^{n+1} \tilde{v}_{i,j-\frac{1}{2}}) \\
& + \frac{1}{2} g \left(\frac{\Delta t}{\Delta x} \right)^2 h_{i+1,j}^{n+1} (b_{i+1,j}^{n+1} - b_{i,j}^{n+1}) \\
& - \frac{1}{2} g \left(\frac{\Delta t}{\Delta x} \right)^2 h_{i-1,j}^{n+1} (b_{i,j}^{n+1} - b_{i-1,j}^{n+1}) \\
& + \frac{1}{2} g \left(\frac{\Delta t}{\Delta y} \right)^2 h_{i,j+1}^{n+1} (b_{i,j+1}^{n+1} - b_{i,j}^{n+1}) \\
& - \frac{1}{2} g \left(\frac{\Delta t}{\Delta y} \right)^2 h_{i,j-1}^{n+1} (b_{i,j}^{n+1} - b_{i,j-1}^{n+1}) .
\end{aligned}
\tag{Equation 12}$$

Equation 12 replaces the continuity equation. Since the difference equations are implicit they are solved iteratively.

2.3 Boundary Conditions

There are two types of exterior boundaries currently available in the FLOOD code. These are the boundary cell types normally called continuous outflow and free slip, respectively. The finite difference mesh is bordered by a single layer of fictitious cells on each boundary. If a boundary cell is a continuous outflow cell, then the fluid flows through the cell in an unrestricted fashion. That is, the normal component of velocity of fluid leaving the cell is set equal to that for the velocity node last preceding it in the interior of the mesh. If a boundary cell is flagged as a free slip boundary cell, then the normal velocity component is set to zero and the tangential component is set equal to that in the last preceding cell in the mesh interior.

In addition there are checks in the code to test for various internal boundary conditions caused by the inundation of dry cells and the drying up of cells due to flood recession. Three of the most common situations are illustrated in Figure 1. In the first case the water in the cell on the left is below the height of the water in the cell on the right. In this case the component of the velocity from left to right is set to zero. That is, $U_{i+1/2,j}^{n+1} = 0$. In the second case the water level on the left has just

reached a height sufficient to allow flooding onto the cell on the right. In this case the component of velocity from left to right is determined by solving the usual momentum equation. In the third case the water must "fall" from the cell on the left to the lower cell on the right. In this case the velocity component is given by

$$u_{i+\frac{1}{2},j}^{n+1} = C_0 (g_z h_{i,j}^{n+1})^{1/2} . \quad \text{Equation 13}$$

Similar conventions are used in the other coordinate directions.

3.0 THE ANALYSIS OF A HYPOTHETICAL DAM BREACH

3.1 Problem Description

Mackay Dam is an earthfill irrigation reservoir located on the Big Lost River in southeastern Idaho approximately 7.2 km from Mackay, Idaho. The Idaho National Engineering Laboratory (INEL) is located in an area which includes the downstream end of the Big Lost River. The western boundary of the INEL site is approximately 72 km downstream of the reservoir. The INEL site contains a Radioactive Waste Management Complex (RWMC) which is used for the storage of nuclear waste material.

Because of the concern by residents in the several small communities located between the dam and the INEL, and the desirability of showing the consequences at the RWMC of a breach of the dam, a one-dimensional analysis of a breach of the dam was conducted by the U.S. Geological Survey, Druffel (1979). Their report concluded that the one-dimensional analysis was inadequate for much of the area downstream of Box Canyon outlet. The analysis presented in this section is a two-dimensional computation, using the FLOOD code, of the area downstream of Box Canyon. A map of the study area is shown in Figure 2.

3.2 Input Model

The inflow boundary was at the outlet of Box Canyon, and the RWMC was an area of interest. Therefore, the rectangular region nodalized for FLOOD input included each of these areas, Box Canyon, and the RWMC. A rectangle approximately four miles by eight miles that includes the designated areas was modeled for this demonstration analysis. The mesh space in both x-direction and the y-direction was chosen to be 161 meters. This corresponds to a grid spacing of 0.25 inch on 7.5-minute topographic maps. This nodalization is fine enough so that the elevation of the finite-difference cells can be approximated by inspection.

The specified inflow hydrograph as an inflow boundary condition was taken from Druffel (1979). The objective of this work was to calculate and route the flood wave resulting from a hypothetical failure of Mackay Dam. Results were given at several geographic locations, in particular, at Box Canyon and above the INEL diversion. The hydrograph for Box Canyon that assumes a full breach of Mackay Dam was used in this analysis as the inflow hydrograph. The inflow hydrograph was defined by the points indicated in Figure 3, points in between were obtained by linear interpolation.

3.3 Calculated Results

The FLOOD predictions of the flood behavior for the region below Box Canyon, as modeled in the Input Section, follow. The results presented

were calculated using a friction factor of 0.03 for each discrete cell. The current version of the FLOOD code does not allow different friction values for sub-regions. However, the work of Druffel (1979) indicated for their model that many important parameters such as arrival time of the leading edge and maximum water depth were not overly sensitive to friction within expected values. No parametric studies for sensitivity to input were attempted in this study.

The boundary and initial conditions were chosen as follows:

- (1) A set of boundary cells were adjoined internal to the computer code and the water depth was fixed at zero in the boundary cells.
- (2) The region analyzed was chosen so that it was bounded by high enough elevations south of Box Canyon and along the mountains to the east and west of the Big Lost River so that no water flowed orthogonal to the boundary.
- (3) For the initial state, it was assumed that each cell was empty except for the cell at the outlet of Box Canyon. At the outlet of Box Canyon, the water depth as a function of time was specified as shown in Figure 3. Figures 4 through 10 show the time-dependent water depth and water velocities at selected sites. The transients shown were calculated for 15 hours of flooding. From these figures, arrival times and maximum depths can be determined.

The results in Figures 4 through 10 cannot be compared to any experimental data and must be viewed as a best estimate demonstration calculation. However, the FLOOD calculations seem to sensibly predict the correct flood behavior for the following reasons:

- (1) The calculations show that in about 100 minutes a disturbance at Box Canyon is propagated to the INEL Diversion Area, location "B" on Figure 2.
- (2) The maximum water depth in the flat region near the Diversion Area - west of the railroad tracks and south of the hills near the RWMC - location "C" on Figure 1 - is 1.82 meters, Figure 7.
- (3) The RWMC, location "D" on Figure 1, is flanked by high areas on both the east and the west and the near zero velocity in the east-west directions would be expected. The spike that occurs when the water first enters the RWMC would also be expected (Figure 5).

The time calculated to propagate a disturbance from Box Canyon to the INEL Diversion Area and the depths near the Diversion Area agree reasonably well with similar calculations by Druffel (1979).

4.0 SUMMARY

The FLOOD computer code has been used to predict a two-dimensional flood plane development below Box Canyon. A fixed, known hydrograph was chosen as an inlet boundary condition; water depths, and water velocities were calculated at several geographic locations, including the RWMC. The computed results are considered good in that there was reasonable agreement with a previous, one-dimensional calculation in areas where comparisons were possible. A combination of friction factor and boundary conditions could possibly be chosen that would give a different water depth within the RWMC complex.

However, the 1.82 meter maximum water depth calculated in the flat area south of the RWMC would be less sensitive to boundary assumptions, considering disturbance propagation time and the distance to the boundary. Also, a previous one-dimensional calculation was not highly sensitive to friction. Therefore, the depth calculated south of the hills bordering the RWMC provides a good estimate of the maximum depth to be expected at that point when infiltration is not accounted for.

5.0 CONCLUSIONS

The results presented in this paper demonstrate the ability of the FLOOD code to predict the two-dimensional aspects of flooding. It is clear that with a few improvements the FLOOD code will be an accurate and efficient tool for the analysis of floodplains.

Several improvements in the code will be required to make it an efficient, user-oriented code. These include:

- (1) The ability to use variable meshes. The code is currently limited to a single value for each grid increment.
- (2) Time step control. The code is currently restricted to run at the smallest step required to obtain accurate solutions at all times during the transient.
- (3) An efficient sweep method for the mesh. The code currently does computations in all cells even if it is known a priori that no water will enter some mesh cells.
- (4) User-oriented output. The current code has only rudimentary output formats.

6.0 REFERENCES

1. L. Druffel et al., "Probable Hydrologic Effects of a Hypothetical Failure of Mackay Dam on the Big Lost River Valley from Mackay, Idaho, to the Idaho National Engineering Laboratory", U.S. Geological Survey, Water Resources Investigation 79-99, (September 1979).

2. D. L. Fread, "DAMBRK: The NWS Dam-Break Flood Forecasting Model", Office of Hydrology, National Weather Service, (September 1980).
3. F. H. Harlow and A. A. Ansdan, "A Numerical Fluid Dynamics Calculation Method for All Flow Speeds", Journal of Computational Physics 8, No. 2 (October 1971) pp. 197-213.
4. R. E. Narum et al., "Numerical Methods for Solving the Governing Equations for a Seriated Continuum", Aerojet Nuclear Company, ANCR-1340 (September 1976).
5. C. Noble, "A Two-Dimensional Analysis of Flooding of the Big Lost River Below Box Canyon Outlet", Energy Incorporated, EI-80-2 (January 1980).
6. K. D. Richert, "A Numerical Model for Multi-Dimensional Unconstrained Flow Over Irregular Terrain", Proceedings of Dam-Break Flood Routing Model Workshop Held in Bethesda, Maryland, (October 1977).
7. "HEC-1 Flood Hydrograph Package, Users Manual", The Hydrologic Engineering Center, U.S. Army corps of Engineers, (January 1973).

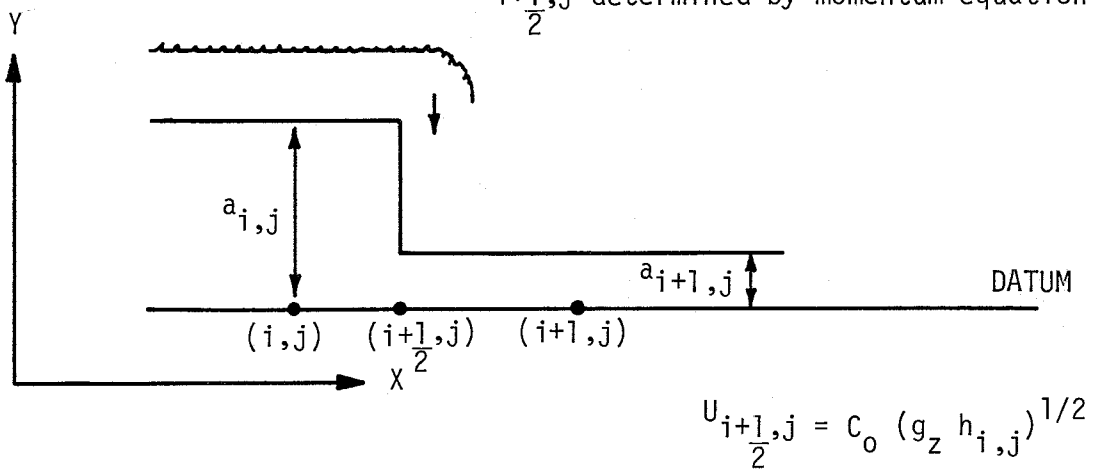
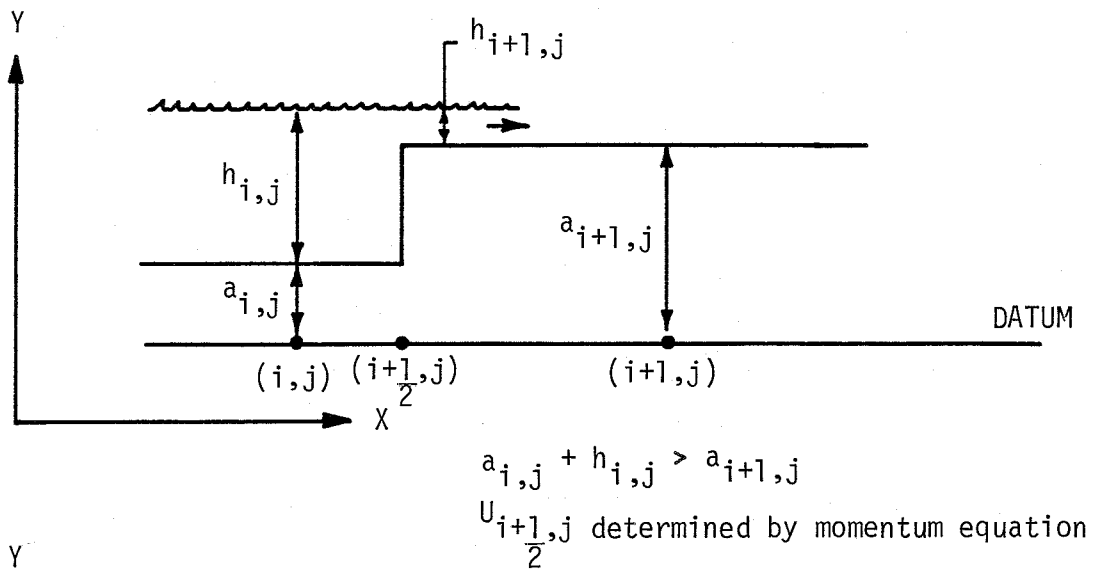
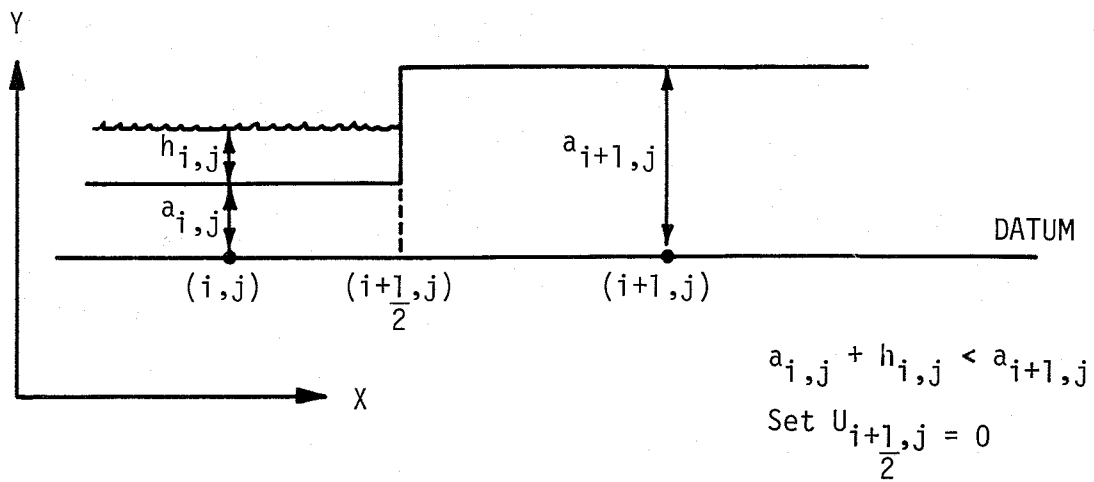
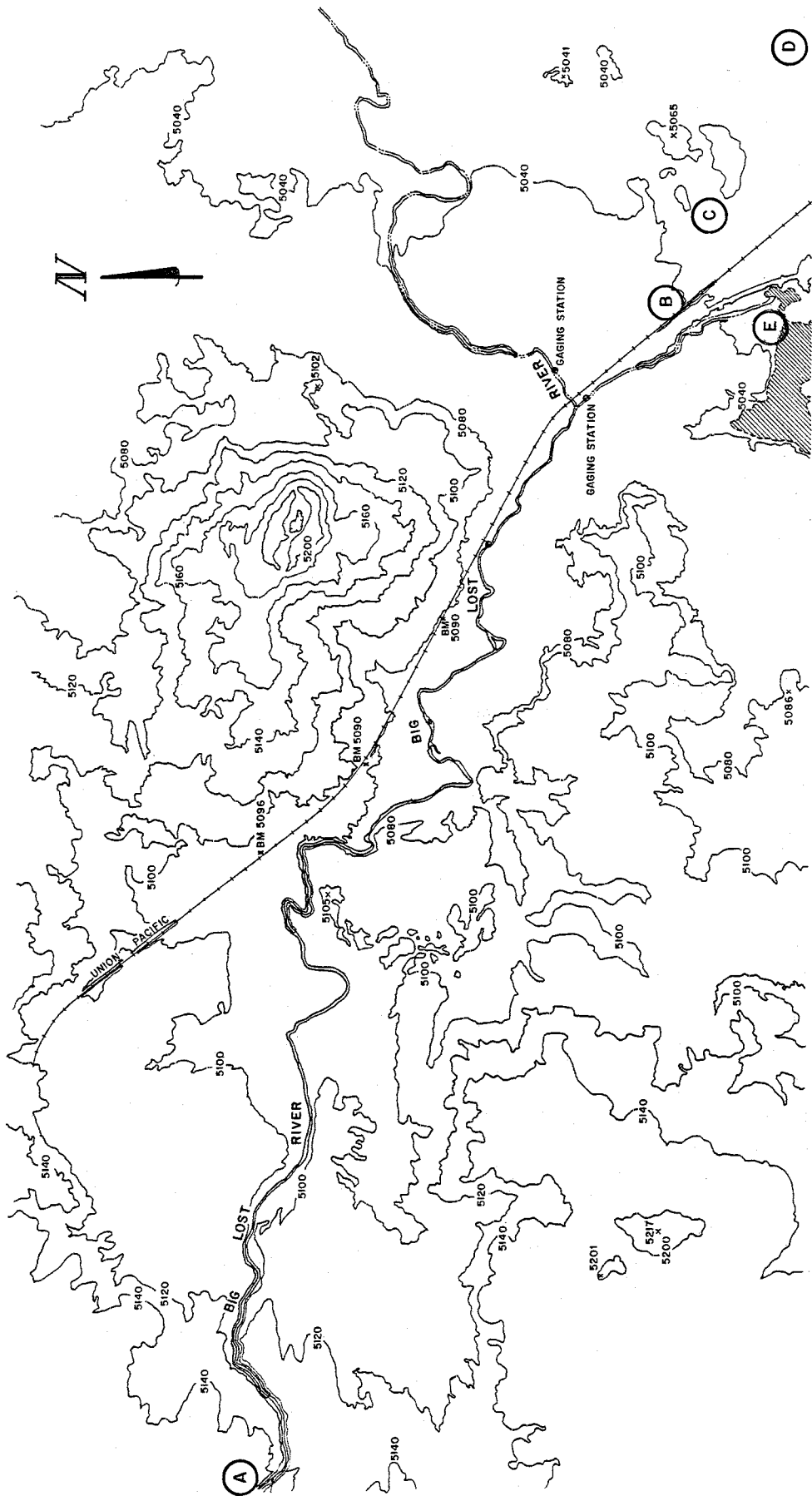

Figure 1. Internal Boundaries



A - BOX CANYON OUTLET
 B - INEL DIVERSION
 C - CALCULATED VALUES PRESENTED AT C
 D - RWMC
 E - SPREADING AREA

Figure 2. Study Area

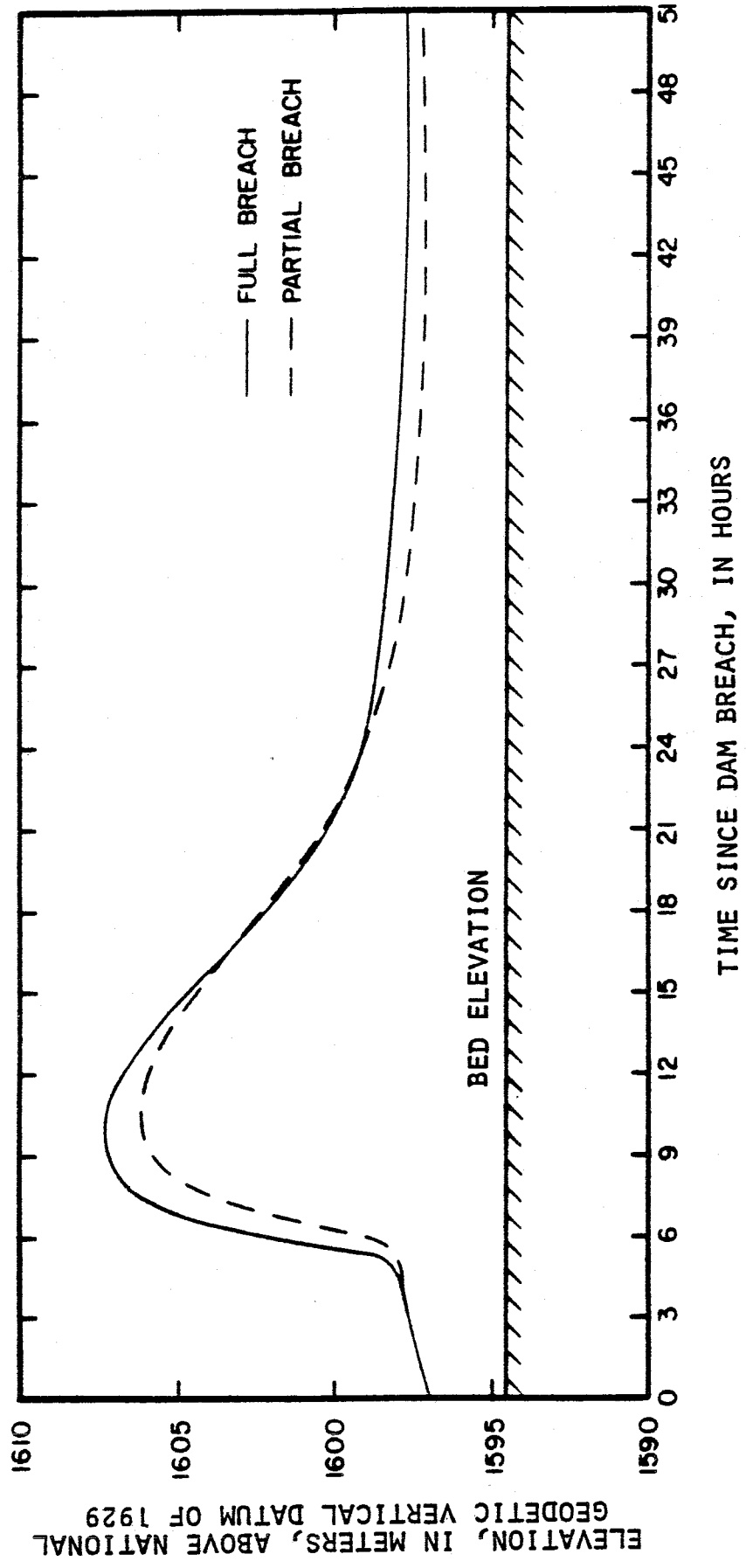

Figure 3. Inflow Hydrograph

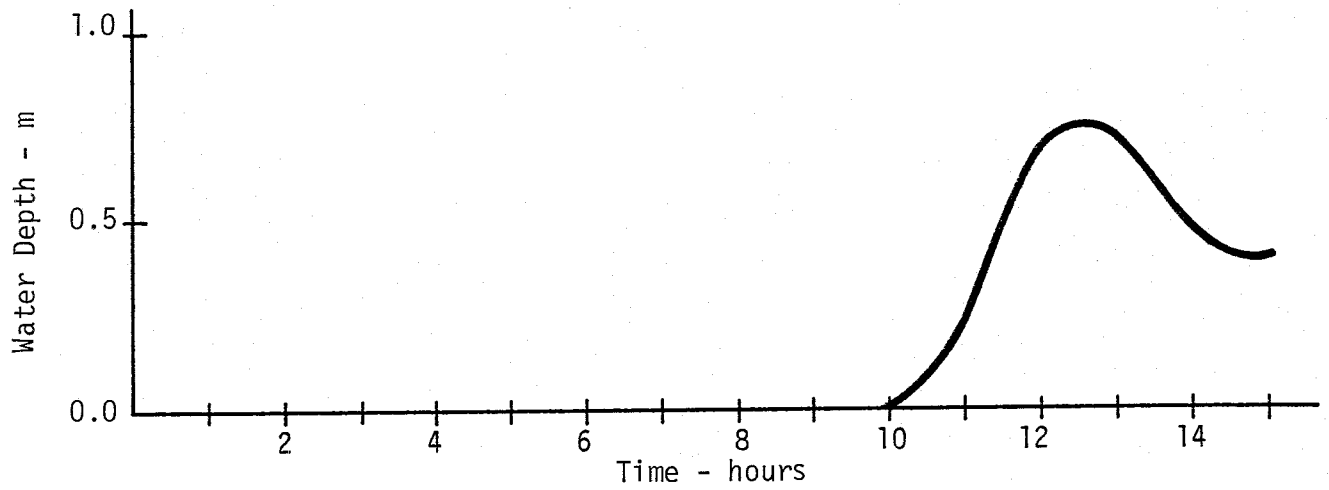

Figure 4. Water Depth at RWMC, Location D

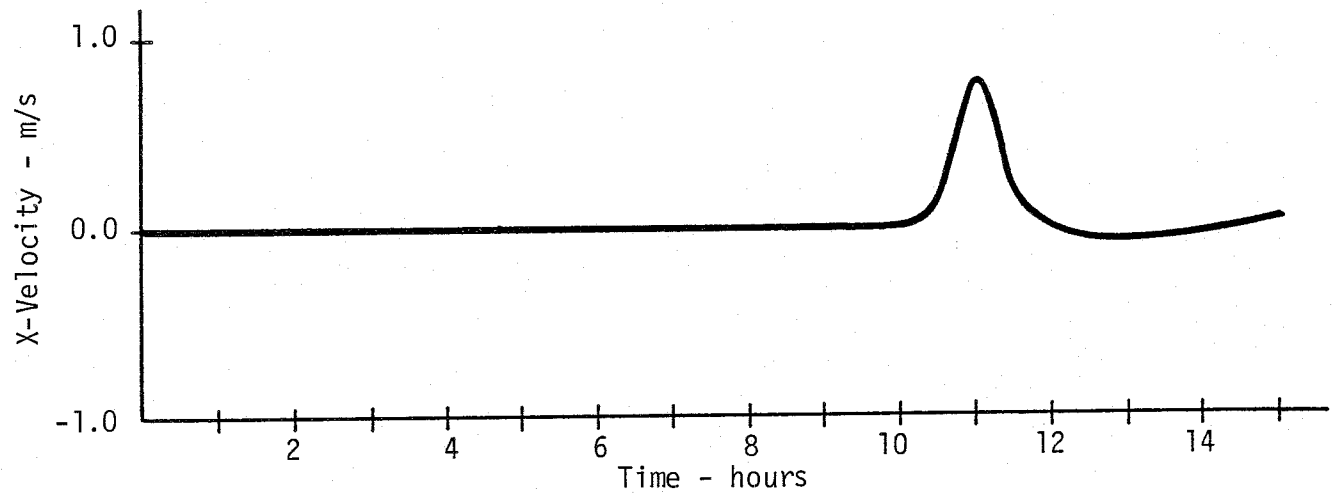

Figure 5. X-Velocity Component at RWMC, Location D

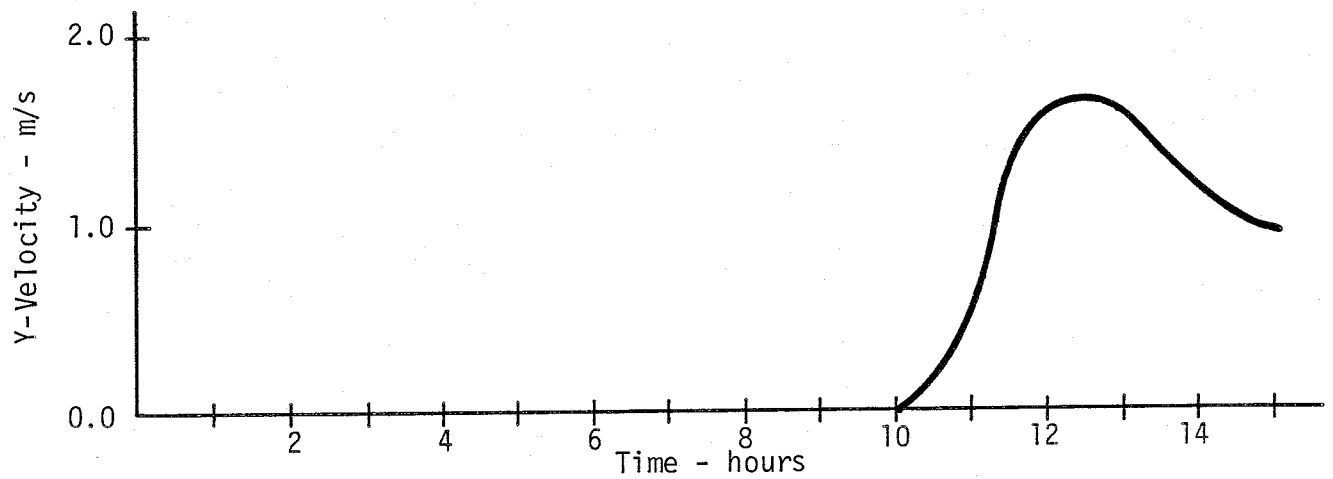

Figure 6. Y-Velocity Component at RWMC, Location D

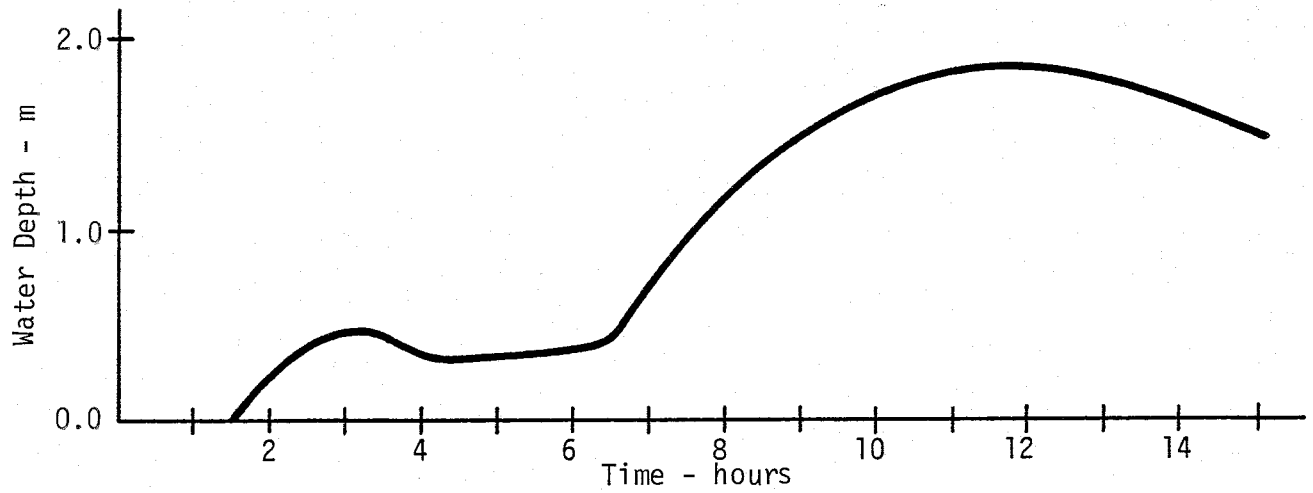

Figure 7. Water Depth Near Diversion Area, Location C

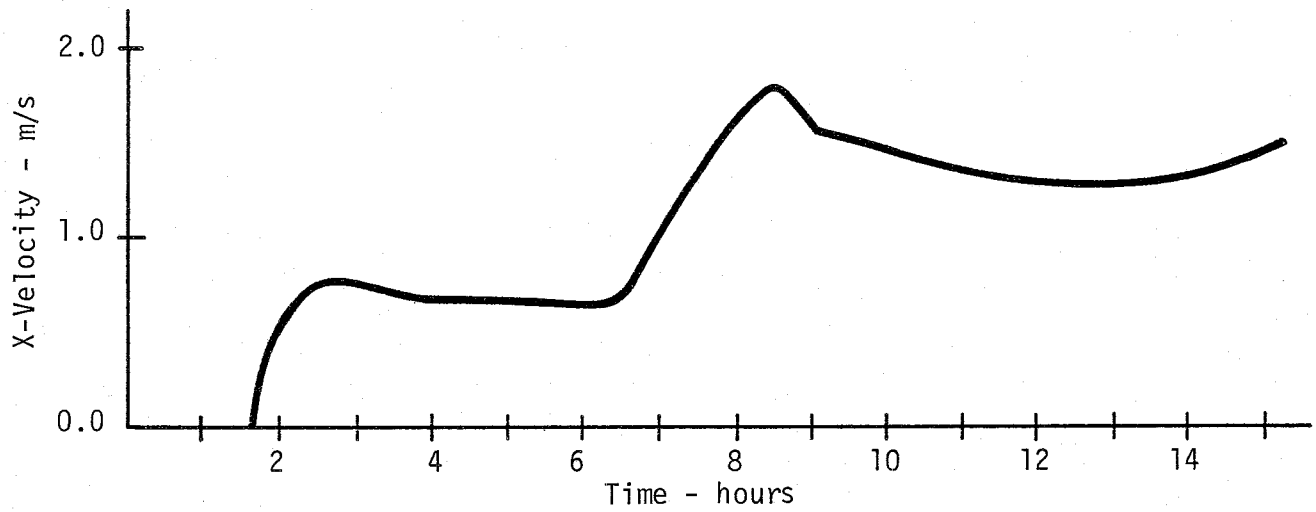

Figure 8. X-Velocity Component Near Diversion Area, Location C

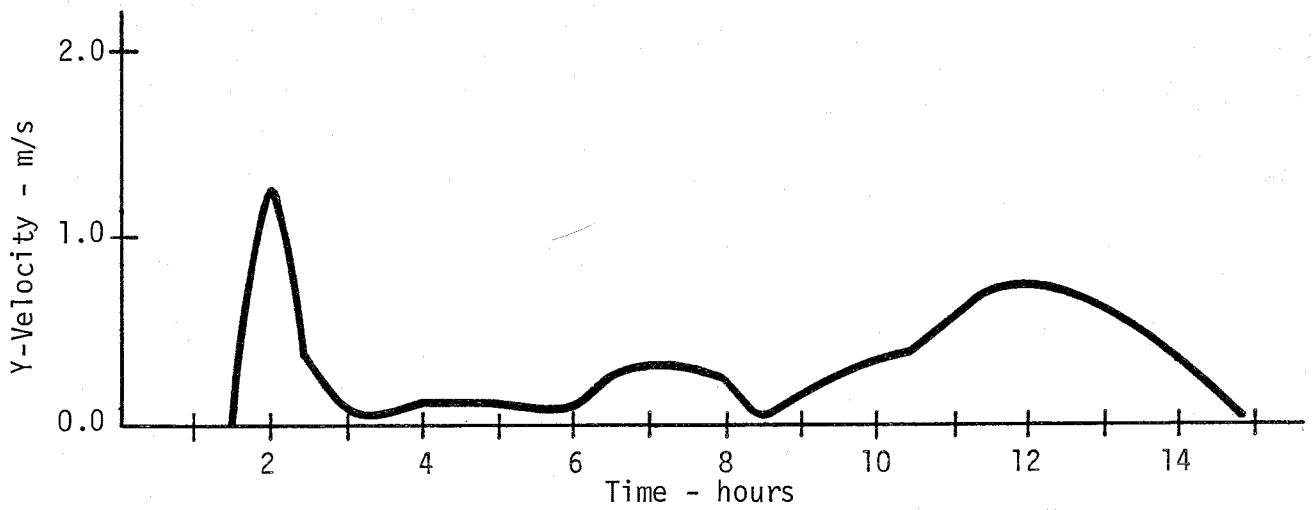

Figure 9. Y-Velocity Component Near Diversion Area, Location C

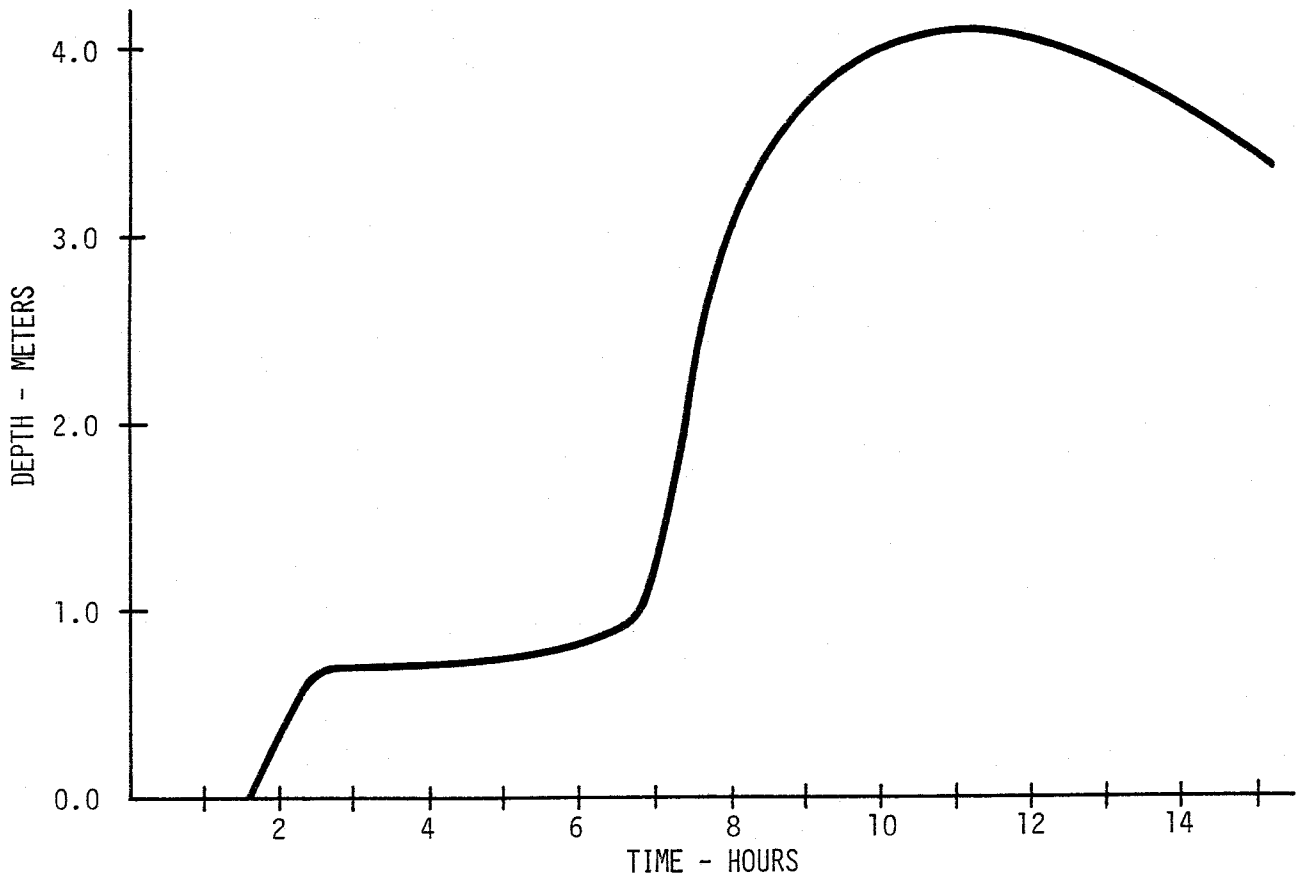

Figure 10. Water Depth at Spreading Area A, Location E

PAPER DISCUSSION

A TWO-DIMENSIONAL FLOOD ROUTING CALCULATION

by
Charles Noble
Robert E. Narum

Question: In looking at your scheme, I notice that you are using a forward differencing method; have you investigated wave damping and wave propagation tendencies? These kinds of schemes do damp quite severely the propagation of waves.

Mr. Narum: Yes, we realize these potential problems but we have not had the time or financial ability to study these effects thoroughly.

Question: Is your model explicit and therefore dependent upon the Courant stability requirements?

Mr. Narum: No, the model is implicit. We have done a linearized stability analysis on the scheme, and in a local sense, it is stable. Whether or not it is really stable if one exceeds the Courant limit, I don't know. We haven't studied that thoroughly yet. There may be nonlinear effects that have not been noticed at this stage.

Question: What do you think is the effect of the fact that you cannot calibrate this type of dam break problem? Observed data needed for calibration is obviously not available for most standing structures and hydrologic areas.

Mr. Narum: Obviously there are no historical data available for this case to be used for calibration.

Question: How confident should a person feel with the results from this kind of simulation?

Mr. Narum: I would say that in their one-dimensional analysis USGS was fairly confident about the arrival times. We were able to match those arrival times very well in the portions of the study reach which were amendable to a one-dimensional treatment. We feel fairly confident about the model's accuracy. Looking at the scale of the problem and the answers we got, they look reasonable to us.

Question: It seems like in your model, that the main unknown is the roughness coefficient; you have the topography in and the idea of getting the flow going in different directions. Did you run any sensitivity tests on the roughness coefficient with your 2-D model?

Mr. Narum: Not a lot. The roughness coefficient we used was essentially the same one that had been used for the one-dimensional analysis of the same area. There had been several runs made for the 1-D tests to determine an appropriate coefficient to use. In this particular problem, the sensitivity of the one-dimensional results to the roughness was quite low. Probably infiltration losses would be more important here.

Comment: Dr. Fread: In the 1-D model testing that the National Weather Service has done for problems such as this where you can expect tremendous overbank flows, if you look at just a rating curve, the curve will be very flat in those areas. This means you can miss your discharge an awful lot but not affect the stage much. This means that Manning's n will cause you to get different discharges if you aren't sure of what value to use. There won't be much error in stage though.

Mr. Narum: That's a good point.

Question: Do you take your friction computations at time ? When in your scheme do you compute friction?

Mr. Narum: Friction is computed the old time. It is not implicit. The roughness coefficient was also constant throughout time.

Question: Did this give you any stability problems?

Mr. Narum: It has been our experience that friction generally stabilizes the scheme. In two-level difference schemes computing the friction at the old time level generally gives no problems.

Question: Is your code available to the public?

Mr. Narum: No. It is currently a proprietary code.

Comment: When using your 1-D model at the outlet of the box canyon, it seems that you may need to supply at least a dentritic description in the basin so that flows can be better distributed over the valley plain.

Mr. Narum: The 1-D analysis did go beyond the mouth of box canyon and I think the results were fairly reasonable until the flow reached the area where it really spreads out.

Question: What techniques are used to solve your equations? Because it is implicit, how do you account for initial and boundary conditions, etc.?

Mr. Narum: The scheme we use is an off-shoot of a scheme initially developed at Los Alamos in that we do some combining of our equations to come up with an equation we solve for height (stage) for which we need to iterate. We currently use a straight iteration method that seems to converge quite well.

Question: Are you suggesting that you are using the Marker and Cell (MAC) method?

Mr. Narum: Yes, it is derived from the old MAC technique. Yes, that's where it started.

Question: That's why it is so expensive to run?

Mr. Narum: The costs of these runs are directly related to the fact that our code is still quite primitive and is a "proof of principle" code. We need a time step control in order to get more efficient computations. I'm sure we can make it much more efficient with more work.

Question: In applying the 2-D model to the broad flood plain area here, shouldn't you consider some sink terms to account for the losses of flow due to detention losses and infiltration? Those terms may be of the same order of magnitude or have the same effect as the accuracy lost by only using a 1-D approach. Putting sink terms into your equations may be complex though.

Mr. Narum: I agree; that could be a difficult task. As mentioned previously, the infiltration losses are probably quite significant in this problem.

Question: Can the model handle supercritical flow?

Mr. Narum: Some. It can handle "waterfall" type conditions. Like water spilling over a waterfall. There are currently no checks in the code to see if the bed slope is at a critical angle or something like that though.

TWO-DIMENSIONAL VERTICALLY HOMOGENEOUS
HYDRODYNAMIC MODELS: APPLICATION TO ESTUARINE
COOLING WATER DISCHARGES AND INTAKES

by

John Eric Edinger¹
Edward M. Buchak¹
Vicky P. Binetti²

INTRODUCTION

Two-dimensional vertically homogeneous hydrodynamic computations have been available for practical application since the work of Reid and Bodine (1968). Basically, the time and space dependent variables are the horizontal x and y fluxes or velocity components, U and V, and the water column depth H or surface elevation. These are computed from the horizontal x and y momentum balances and continuity. Various developments of two-dimensional hydrodynamics differ in formulation of the momentum balances and the numerical forms of the equations for finite difference evaluation.

The most straight forward formulations are explicit computations of U, V, and H, forward in time from the local time changes in momentum and continuity where each variable is computed one at a time over all grid points. All terms except local time changes are lagged at least one time step. The explicit computations have the disadvantages that the time steps are limited by the Courant wave speed condition ($\Delta x/\Delta t, \Delta y/\Delta t > \sqrt{gH_{max}}$), that computational instabilities often arise from time lagged terms, that in transient situations computational waves arise in establishing initial water surface elevations, and that it is necessary to carry all variables for at least two time levels. The first and last limitation, short time steps, and computational storage, is not a problem if computer costs and storage are of no consideration. The limitations of instabilities and waves are no problem to the analyst familiar with the computational properties of the scheme being used.

An alternative to explicit computation of U, V, and H is a spatially implicit computation where the three variables are computed simultaneously over space at each time step. Implicit computation eliminates the Courant limitation, allowing larger computational Δt , and reduces machine storage making practical the use of desk top computers for moderate sized problems. Earlier implicit schemes attempted to compute U, V, and H simultaneously from the basic equations in one large array (Codell, 1974). These lead to very large space matrix inversions or inaccurate iterative procedures for solutions on each time step. An implicit solution technique has since been developed that utilizes the free surface longwave equation as derived from the basic momentum and continuity balances that eliminates many of the limitations of implicit computational procedures.

¹J. E. Edinger Associates, Inc., 37 West Avenue, Wayne, PA 19087.

²Academy of Natural Sciences of Philadelphia, 19th and the Parkway
Philadelphia, PA 19103.

THE COMPUTATIONAL BASIS

The basic two-dimensional vertically homogeneous relationships can be developed from the three-dimensional primitive equations of fluid motion (Edinger and Buchak, 1980). The vertically integrated hydrodynamic relationships are:

x momentum:

$$\frac{\partial U}{\partial t} + gH \frac{\partial H}{\partial x} = g\beta \frac{H^2}{2} \frac{\partial T}{\partial x} - \frac{\partial (U/H)U}{\partial x} - \frac{\partial (V/H)U}{\partial y} + gHS_x - \tau_{bx} + \tau_{sx} \quad (1)$$

y momentum:

$$\frac{\partial V}{\partial t} + gH \frac{\partial H}{\partial y} = g\beta \frac{H^2}{2} \frac{\partial T}{\partial y} - \frac{\partial (U/H)V}{\partial x} - \frac{\partial (V/H)V}{\partial y} + gHS_y - \tau_{by} + \tau_{sy} \quad (2)$$

continuity:

$$\frac{\partial H}{\partial t} + \frac{\partial U}{\partial x} + \frac{\partial V}{\partial y} = q \quad (3)$$

constituent transport:

$$\frac{\partial HT}{\partial t} + \frac{\partial UT}{\partial x} + \frac{\partial VT}{\partial y} - \frac{\partial HD_x \partial T / \partial x}{\partial x} - \frac{\partial HD_y \partial T / \partial y}{\partial y} = Hn \quad (4)$$

where:

U = x component flow/width (vertically integrated velocity component),
m²/s

V = y component flow/width (vertically integrated velocity component),
m²/s

H = water column, depth, m

T = constituent concentration or temperature, C

g = acceleration of gravity, ms⁻¹

β = density constituent concentration slope, c⁻¹

s_x, s_y = x and y component bottom slope

τ_{bx}, τ_{by} = x and y component bottom friction, $m^2 s^{-2}$

τ_{sx}, τ_{sy} = x and y component surface shear (wind), $m^2 s^{-2}$

D_x, D_y = x and y horizontal dispersion coefficients, $m^2 s^{-1}$

q = in/outflow per unit surface area, $m^3 s^{-1} m^{-2}$

H_n = constituent sources/sinks, $cm^3 s^{-1} m^{-2}$

The momentum relationships are written with local acceleration and surface slope on the left hand side to illustrate the terms which are carried forward in time along with continuity to form the implicit longwave equation. The longwave equation is formed by differentiating the x and y momentum equations by $\partial/\partial x$ and $\partial/\partial y$ respectively and continuity by $\partial/\partial t$. Substitution of the former relationships into the latter gives:

$$\frac{\partial^2 H}{\partial t^2} - g \frac{\partial H \partial H / \partial x}{\partial x^2} - g \frac{\partial H \partial H / \partial y}{\partial y^2} = - (\partial F_x / \partial x + \partial F_y / \partial y) + \partial q / \partial t \quad (5)$$

where F_x and F_y are the right hand terms of Equation 1 and Equation 2, respectively.

The longwave equation is arrived at by algebraic simultaneous solution of momentum and continuity rather than numerical simultaneous solution. The numerical scheme is to solve spatially implicitly for the the water depth, then, since H is known for the new time step to solve directly from local acceleration for U and V using Equations 1 and 2.

There are three methods for solving Equation 5 implicitly for H . They are matrix inversion, iteration by successive over relation (SOR), and alternating direction implicit (ADI). All three have been used and each has advantages and disadvantages in setting up the numerical schemes. Matrix inversion gets unwieldy for large grid sizes because of machine storage and loss of accuracy. SOR is the most direct computation but requires extensive testing for accuracy. Often the number of SOR iterations approaches the computational step of an explicit scheme. The ADI technique is more difficult to program but is rapid because of the efficient Thomas algorithm. ADI is presently being utilized.

The scheme has been programed for a rectangular grid using a space staggered grid. Upwind transport is used on all the advective terms including the momentum terms. Dispersion processes are defined at cell interfaces as are the velocities which simplifies specification of transport boundary conditions. The constituent transport, Equation 4, is solved using ADI so that the full set of equations for H , U , V , and T can be evaluated on each

alternation. The computation of H in each direction is performed simultaneously in one tri-diagonal array rather than line by line. The scheme is limited in time by the Torrence condition on advection for which $\Delta x/\Delta t > U/H$ or $\Delta y/\Delta t > V/H$.

Since the implicit scheme allows a long Δt , has highly dampened initialization, and reduced storage, it can be utilized on a desk top computer for moderate size problems. The application to be presented was made on a Tektronix 4052 Graphics Computer with 32k memory programed in BASIC.

APPLICATION

There have been many applications of the implicit two-dimensional vertically homogeneous computation. In many cases it is used to iterate to a steady state flow field, as through a shallow cooling lake, for constituent transport. With the implicit scheme, a steady state flow field is attained in the simulated time of two gravity wave passes along the longest axis.

The application examined here is a section of tidal estuary containing a power plant intake and discharge for which the two-dimensional flow field is important to determine the configuration of the tidally varying discharge plume, recirculation, and entrainment of passive organisms. The application is unique because of the availability of dye tracer data and velocity data for verification of the computations.

The estuarine segment and rectangular computational grid is shown in Figure 1. The segment is on the Patuxent River estuary and is 21 miles up-estuary from the Chesapeake Bay. The segment is in a shallow portion of the estuary a few miles from the region of two-layered haline circulation. The grid was chosen such that a continuous line of cells followed the main channel and over bank volumes were reproduced.

Velocities were measured at the upestuary and downestuary boundaries as well as at intermediate cross section. The time series of downestuary boundary velocities are shown in Figure 2. Proceeding across the estuary, the west bank velocities have a stronger flood tide than ebb tide, and the pattern is reversed for the east bank velocities. At the boundary, therefore, there is a net upestuary current along the west boundary and a net downestuary current along the east boundary. A simple tide height boundary condition at the downestuary boundary would not represent the complex boundary circulation which is due to estuarine geometry effects outside the region of computation. Therefore, velocity boundary conditions were specified for the lower and upper boundaries based on the observations.

The computations were carried out for a 15-minute time step. An explicit computation would have been limited to less than a 30-second time step. An implicit time step longer than 15 minutes could have been used without exceeding Torrence stability, however, accuracy would have been lost. The

internal flow field can be resolved only to the detail of the boundary conditions and specification of the tidal velocities at longer time intervals would have been too coarse. Test computations at 10 and 5 minutes confirmed the accuracy of the 15-minute time step. At the 15-minute time step, a full tidal cycle of 12.5 hours (50 iterations) could be computed in 5 minutes on the Tektronix 4052.

The first verifications were for internal velocities. It is relatively easy to reproduce tide heights with a two-dimensional model. Velocities for transport are more demanding particularly for a two-dimensional flow field as complex as that indicated by the boundary data. A comparison of the internal observed and computed velocities is given in Table 1. The internal computed velocities were found to be sensitive only to the relative phase shifts between the upper and lower boundary velocities. All other effects such as bottom friction or geometry changes were secondary.

Transport in the application was verified from dye studies. The dye studies were a continuous release in the discharge canal. Intake concentrations were measured at the intake to determine recirculation. A comparison of the observed and computed intake dye is shown in Figure 3. The intake of dye is a gross measurement of circulation integrated over many days and over a large portion of the waterbody and is a good measure of overall model performance. Comparisons of individual transects of dye concentration were also made for specific periods of time.

The dye tests essentially represent the discharge plume. The intake draws from different portions of the estuary by different amounts. The biologist is interested in knowing the fraction of passive organisms (fish eggs and larvae, zooplankton, etc.) sampled at a given location that will pass into the intake. The instantaneous net and tow sampling used by the biologist is a measure of standing crop or densities at a particular location at a particular instant. The organisms measured at a point at one instant are transported to other points at succeeding times. In order to determine the fraction of these organisms that enter the intake, the sampling was simulated by making an instantaneous release in one computational cell of a known amount and then determining how much of that release is withdrawn at the intake over many tidal cycles. The ratio of the total withdrawn to the total released is the fractional entrainment for that cell.

The "map" of fractional entrainment is given in Figure 4. It basically shows that the intake has a plume representing successively lower intake fractions from the intake outward and shows the extent of the influence of the intake over the estuary.

CONCLUSIONS

A viable and efficient spatially implicit computational scheme for two-dimensional vertically homogeneous flows can be formulated from the two-dimensional longwave relationship. Use of the scheme has been illustrated

for an estuarine transport problem. As in any two-dimensional problem, the accuracy of solutions is highly dependent on adequate representation of boundary conditions. In the illustration, it would have been impossible to measure cross-sectional boundary tide height and phase differences representative of the observed boundary circulation. Simulation success was therefore highly dependent on adequate field measurements at the boundary.

References

1. Codell, R. (1974), personal communications.
2. Edinger, J.E. and E.M. Buchak (1980), "Numerical Hydrodynamics of Estuaries," in ESTUARINE AND WETLAND PROCESSES with Emphasis on Modeling, edited by Peter Hamilton and Keith B. Macdonald, Marine Science, Volume 11, Plenum Press, New York, pages 115-146.
3. Reid, R.O. and B.R. Bodine (1968), "Numerical Model for Storm Surges in Galveston Bay," JOURNAL OF THE WATERWAY PORT COASTAL AND OCEAN DIVISION, ASCE, proceedings, February 1968.

FIGURE 1

Spatial grid representing Patuxent River estuary from Holland Cliff to Long Point.

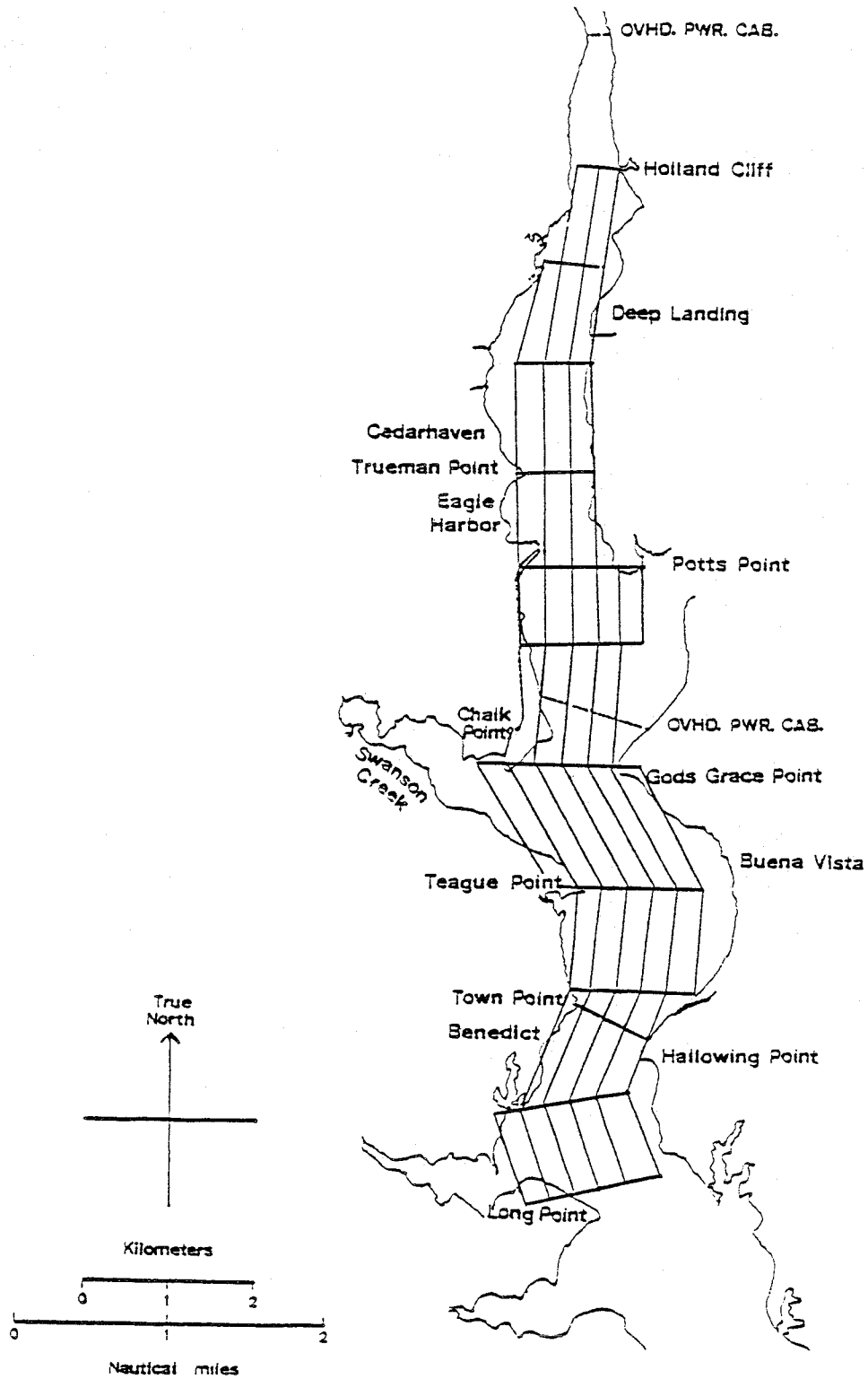

FIGURE 2

Time-varying velocities at Long Point
cross section showing lateral variations.

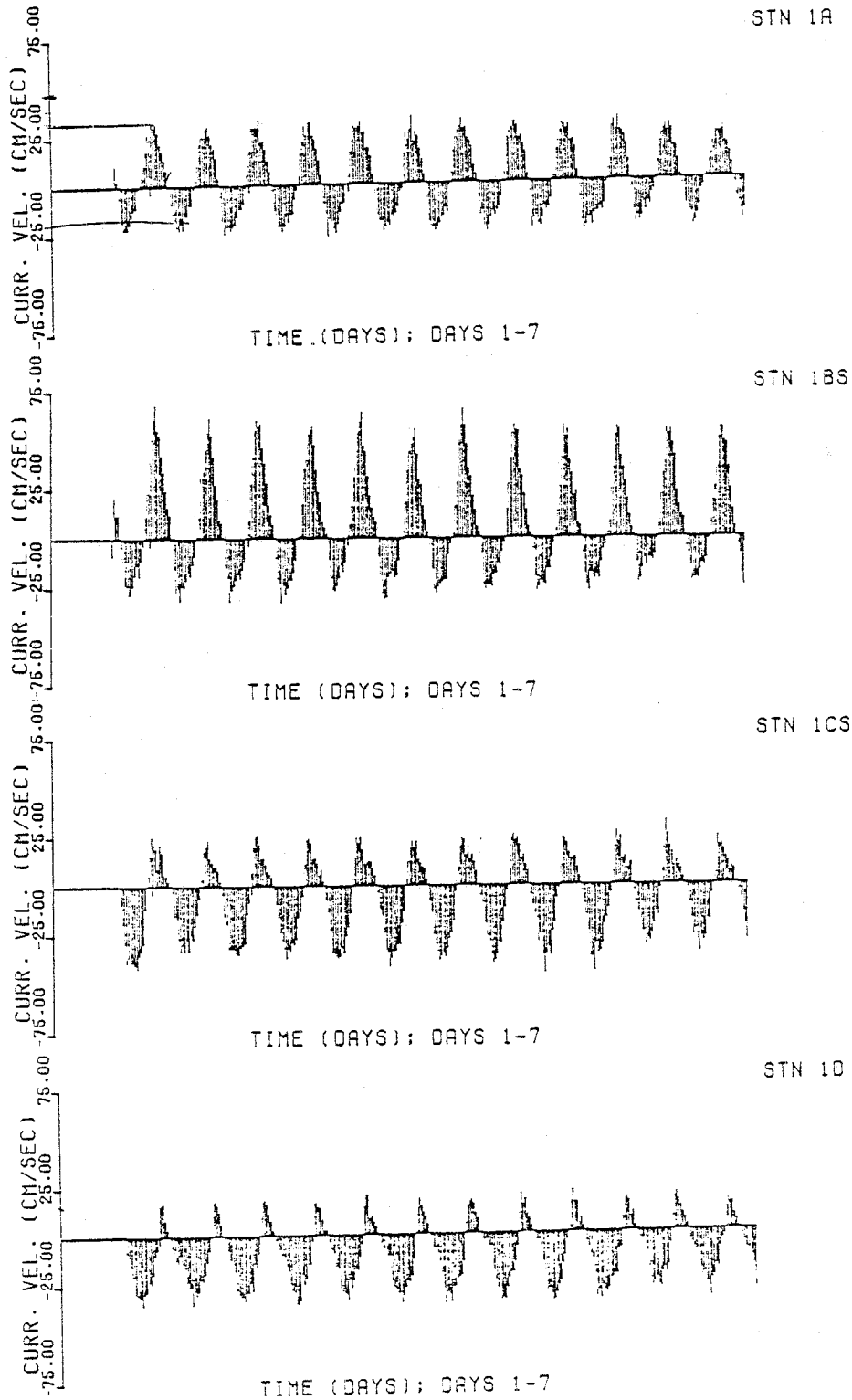

TABLE 1

Comparison of vertically-integrated fluxes
(flow/width, m^2/sec) observed during 1978
ANSP current meter surveys and computed
from survey data. (WB=west bank, EB=east
bank, Mid=mid-channel.)

Station Location		Maximum Ebb (m^2/sec)		Maximum Flood (m^2/sec)	
		Observed	Computed	Observed	Computed
Trueman Point	WB	1.17	0.51	1.16	0.53
	EB	0.52	0.42	0.45	0.44
Chalk Point	WB	1.30	0.70	1.40	0.62
	Mid	0.89	1.00	0.81	0.86
	EB	0.28	0.24	0.21	0.23
Benedict	WB	0.22	0.44	0.25	0.45
	W Mid	1.33	1.20	1.94	1.18
	E Mid	1.06	0.59	0.57	0.60
	EB	0.39	0.44	0.18	0.48

FIGURE 3

Comparison of computed dye withdrawal at the intake of the Chalk Point Generating Station to measured dye withdrawal during AI dye study, dye build-up period (12-26 July 1979).

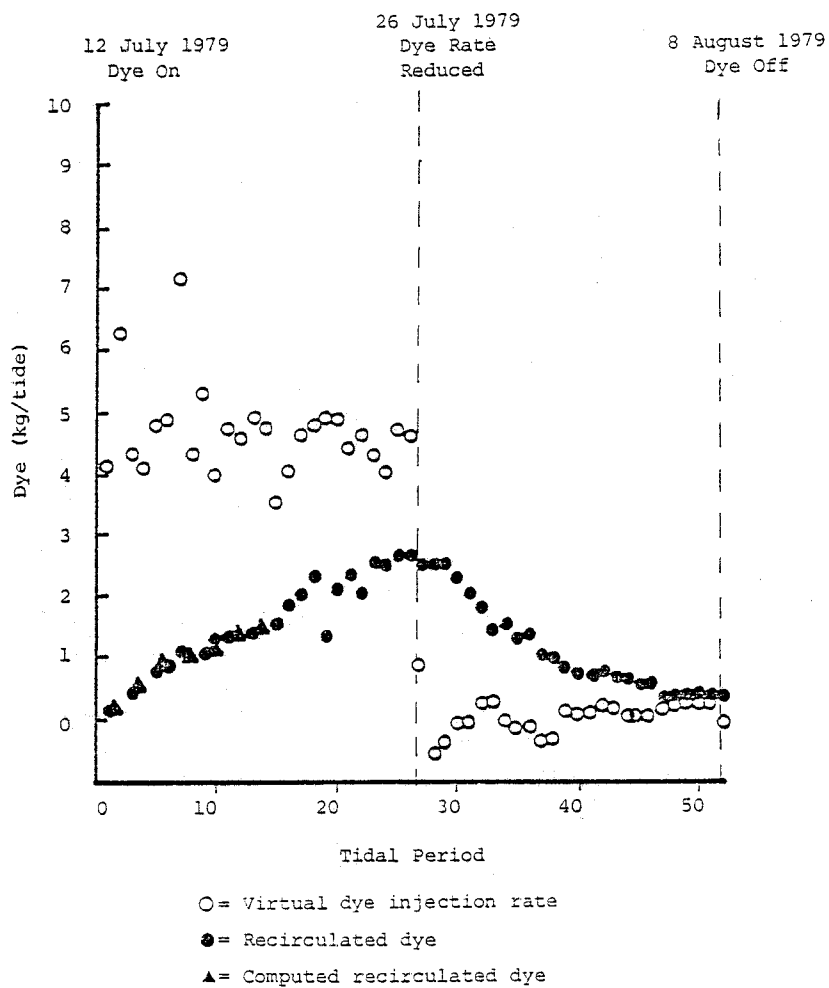
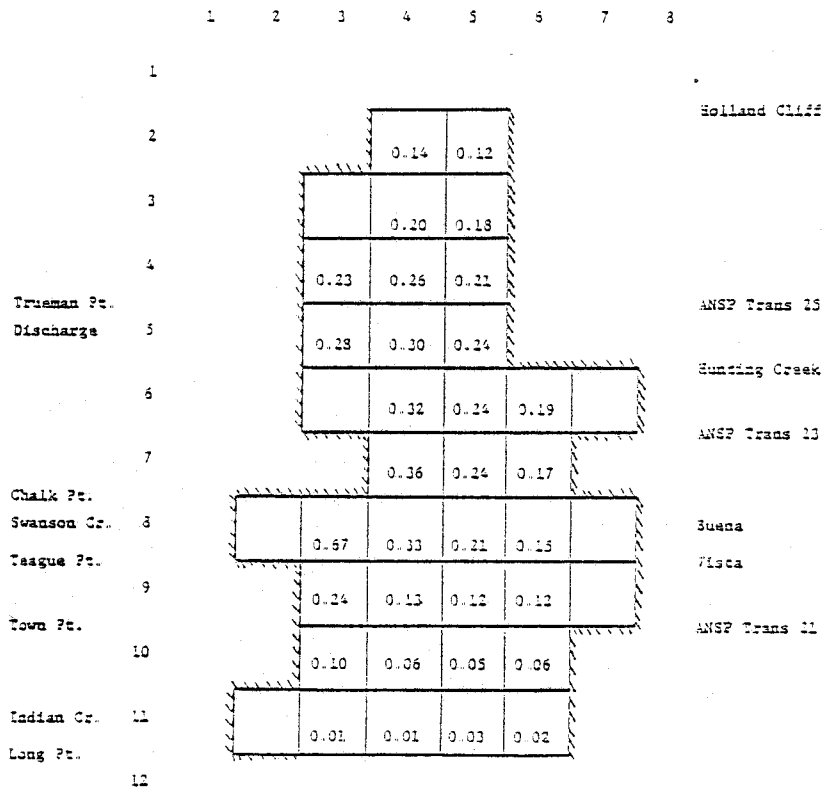

FIGURE 4

Fractional entrainment estimates for study reach of Patuxent River estuary between Holland Cliff and Long Point under summer flow conditions ($Q_r=5m^3/sec$) and maximum plant pumping rate ($Q_p=45m^3/sec$).



PAPER DISCUSSION

TWO-DIMENSIONAL VERTICALLY HOMOGENEOUS HYDRODYNAMIC MODELS:
APPLICATION TO ESTUARINE COOLING WATER DISCHARGES AND INTAKES

by
John Eric Edinger
Edward M. Buchak
Vicky P. Binetti

Question: John, what affect do you think wind would have on an estuary application like that? You can account for wind, can't you?

Dr. Edinger: You have to be careful with wind because if you simply specify a surface wind shear on the model without specifying what is occurring along your boundaries due to wind, etc., you get poor results. You get closed circulation of one kind or another. During the time of the year we were looking at, the winds were fairly low, and we determined that wind-induced circulation would drive the whole boundary and the whole estuary. Therefore, in the 2-D models with wind, you have to be very careful to include the effects of wind in your height and flow boundaries, otherwise your model will develop meaningless gyres.

Question: Did you consider these effects fixed?

Dr. Edinger: No, we looked at a wide variety of flows and conditions to see how variable they were. Interestingly, because the system is so dominated by tidal effects, the fresh water inflow had little effect on the results. Primary agents were the tides and plant pumping rates and timing of pumping.

Question: Was there a constant flow of fresh water through there?

Dr. Edinger: Yes, we're simulating relatively low flow periods when the velocity measurements had been made. We then went back and looked at some high flow periods and tried to construct what the velocity and boundary records would have looked like. You need to have high Spring runoff conditions in this system before you can begin to push the salt out.

Question: How did you determine D_x and D_y , the dispersion coefficients?

Dr. Edinger: We basically took them as a function of velocity as referenced in some of our sighted references. We cranked these values up and down by factors of ten and saw little or no effect on the solution. The reason is because for this system advection is the dominant mode of transport so we didn't need to worry much about them.

The TVA Model for Hydrodynamics of Vertically Well-Mixed Rivers and Reservoirs

by William R. Waldrop¹

INTRODUCTION

An unsteady two-dimensional vertically homogeneous hydrodynamic computer model of rivers and unstratified reservoirs is described. The model, named HOMER for Hydrodynamics of Meandering Rivers, provides a better definition of flow patterns near power generating plants or other industries which may be intaking water or discharging into the river. The objective of this model is to provide hydrodynamic information in an easily understood format which can contribute to an evaluation of existing intakes and discharges. For the case of proposed industrial plants, the model can be used to assist in the evaluation of alternative intake and discharge sites. The model provides such quantitative information as the source of water at various intake sites by tracing the time history of water passing over each potential intake location. The downstream regions affected by discharges from the plant can also be assessed by tracing the path and dispersion of releases.

Development of the model was initiated in 1977. The model was developed primarily through the contractual services of Frank Tatom of Engineering Analysis, Inc., of Huntsville, Alabama, with program direction provided by the author. This model utilizes the vertically-integrated differential equations in curvilinear coordinates, derived from the three-dimensional curvilinear equations governing flow in a river bend, as developed by Waldrop and Tatom (1976). The basic approach is similar to that used by Leendertse (1970) in the formulation of the corresponding vertically-integrated equations in cartesian coordinates. After publishing initial results from the model (Tatom and Waldrop, 1978), model development was effectively suspended because of a curtailment in TVA siting activities. However, in late 1980, interest in completing the development was revived by requests for sediment transport and sedimentation rates and distribution near both operational plants and those under construction.

In addition to these power plant related applications, the generality built into the model makes it potentially valuable for addressing a variety of hydrodynamic related problems of rivers and weakly stratified reservoirs.

FEATURES OF THE MODEL

Typical operation of the hydroelectric plants of TVA often produces unsteady flow throughout the reservoirs. As a result, a pseudo-tidal effect of alternating upstream and downstream flow in a reservoir may occur even though the daily net flow is downstream. Unsteady capability was incorporated into the model to simulate the transient nature of the hydro operation.

¹Water Systems Development Branch, TVA Division of Water Resources

The model was designed to analyze rivers or run-of-the-river reservoirs. Slight density gradients due to temperature, turbidity, etc., may exist, but not to an extent that they induce secondary currents. Underwater topography is incorporated by integrating the conservation equations from the surface to the riverbed. The effect of an assumed velocity profile in the vertical direction (i.e., logarithmic) is retained through a momentum coefficient which accounts for greater momentum at the surface than near the bed. Wind shear at the surface and roughness of the bed are also included. Lateral shear was considered negligible for momentum computations.

The vertically integrated conservation equations are formulated in curvilinear coordinates to properly account for centrifugal and Coriolis forces of bends in the meandering river. A transformation is included to place the grid system along the banks of a variable-width river. As a result of this approach, the unsteady conservation equations are expressed in a nonorthogonal, depth-averaged, boundary-fitted coordinate system.

Hydrodynamics of lateral embayments are incorporated through the addition of grid regions adjacent to the main river grid system. Simultaneous computation of these grid points with those of the main river permit mutual exchange of flows into or out of the embayment.

Islands, river banks, flow obstructions (i.e., dikes), or any other dry regions of the grid system are simulated with image points to assure conservation of mass and momentum. For the class of problems for which the model was developed, flooding of additional regions was of no concern. Consequently, the model does not currently have the capability to automatically adjust the number of wet grid points. Modification of the program to incorporate this feature would be straightforward.

The different types of boundary conditions available for this hydrodynamic model are denoted in Figure 1 and summarized individually as follows:

1. The upstream boundary may be specified as a constant or by a time series. The flow rate at this location may also be computed simultaneously as the downstream boundary condition for a one-dimensional flow routing model.
2. Lateral inflow or outflow may be specified at numerous locations.
3. Flow through the hydroelectric plant, flood gates, or locks is simulated by specifying the flow rate at the appropriate positions. A time series is often useful. When it is not convenient to use a dam site as a downstream boundary, a one-dimensional model may be used as a downstream boundary. When neither of these options is practical, downstream conditions may be estimated through extrapolation using surface slope and bed friction considerations.
4. Flow into and from embayments is technically a boundary condition for each region, but once the boundary regions are initially defined, the computation is performed internal to the program.
5. Solid boundaries are simulated as image points to assure no external exchange of mass or momentum.

Conditions along the entire boundary of each region are defined prior to initiation of the program.

The model is designed to be easily implemented and interpreted. Lateral boundaries may be digitized directly from a map or aerial photograph. All transformations are invisible to the user since all input and graphical output appear in map coordinates. The program automatically positions the specified number of grid points in the lateral and longitudinal direction. After inspection by the user, additional grid regions required to better define the topography of lateral embayments may be added, or grid rows may be deleted where less resolution is required. Underwater topography is used to define depths at each grid point. Once the computation has been completed in this nonuniform grid network, the computed velocities can be displayed in the form of vector plots which precisely conform to the reservoir shape.

Hydrodynamic results stored in a data file are used to compute the transport of passive species such as turbidity or trace chemicals which do not influence the flow patterns. A time history of a slug of water from any specified time and position can be traced either forward or backward in time using a trajectory program. This feature is useful for evaluating alternative locations for industrial intakes and discharges.

SOLUTION OF THE CONSERVATION EQUATIONS

The derivation of these unsteady vertically-integrated conservation of mass and momentum equations in the boundary-fitted coordinate system was originally presented by Tatom and Waldrop (1978). Additional details, along with more generality for three-dimensional cases, were presented by Tatom, Waldrop, and Smith (1980). The coordinate system is defined in Figure 1. The form of the equations used in this model are:

Conservation of Mass

$$\frac{\partial \zeta}{\partial t} = - \frac{R}{R+BY} \left[\frac{\partial(Hu)}{\partial x} - \frac{Y}{B} \frac{dB}{dx} \frac{\partial(Hu)}{\partial Y} \right] - \frac{1}{R+BY} \frac{\partial}{\partial Y} [(R+BY)Hv] \quad (1)$$

Conservation of Momentum in x-Direction

$$\begin{aligned} \frac{\partial(Hu)}{\partial t} = & - \left\{ \frac{R}{R+BY} \left[\frac{\partial(\beta Hu^2)}{\partial x} - \frac{Y}{B} \frac{dB}{dx} \frac{\partial(\beta Hu^2)}{\partial Y} \right] \right. \\ & + \frac{1}{B} \frac{\partial(\beta Huv)}{\partial Y} + \frac{2\beta Huv}{R+BY} + \frac{gHR}{R+BY} \left[\frac{\partial \zeta}{\partial x} - \frac{Y}{B} \frac{dB}{dx} \frac{\partial \zeta}{\partial Y} \right] \left. \right\} \\ & + \frac{1}{\rho} \{ \tau_{wx} - \tau_{bx} \} \end{aligned} \quad (2)$$

Conservation of Momentum in the y-Direction

$$\begin{aligned} \frac{\partial(Hv)}{\partial t} = & - \left\{ \frac{R}{R+BY} \left[\frac{\partial(\beta Huv)}{\partial x} - \frac{Y}{B} \frac{dB}{dx} \frac{\partial(\beta Huv)}{\partial Y} \right] \right. \\ & + \frac{1}{B} \frac{\partial(\beta Hv^2)}{\partial Y} + \frac{\beta H(v^2-u^2)}{R+BY} + \frac{gH}{B} \frac{\partial \zeta}{\partial Y} \left. \right\} + \frac{1}{\rho} \{ \tau_{wy} - \tau_{by} \} \end{aligned} \quad (3)$$

NOTE : NUMBERS REFER TO THE FIVE
 TYPES OF BOUNDARY CONDITIONS
 DISCUSSED IN THE TEXT

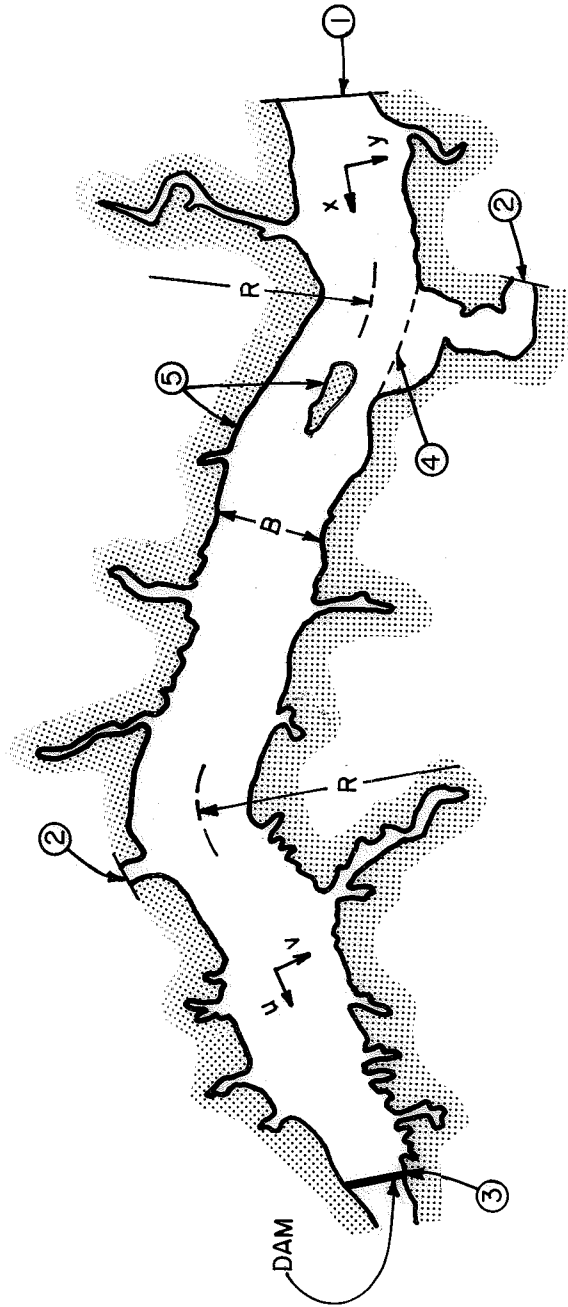
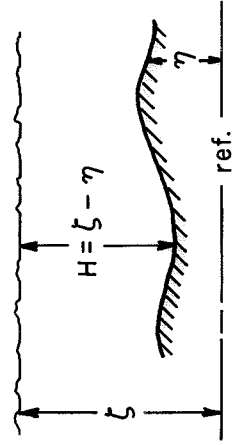

Figure 1 : Definition of Boundary Conditions and Nomenclature

The notation for these equations (see Figure 1) is defined as follows:

B = river width
 g = gravity
 H = depth of water, $\zeta - \eta$
 R = radius of curvature of the centerline of the channel
 t = time
 u = depth-averaged x-component of velocity
 v = depth-averaged y-component of velocity
 x = longitudinal coordinate
 y = transverse coordinate
 Y = transformed transverse coordinate; $Y \equiv y/B = Y(x,y)$
 β = momentum coefficient
 ζ = surface elevation
 η = bottom elevation
 ρ = density of water
 τ_{wx}, τ_{wy} = shear stress of wind in x, y directions, respectively
 τ_{bx}, τ_{by} = shear stress of bottom friction in x, y directions, respectively

This set of equations is solved by using a two-dimensional version of the explicit one-dimensional finite difference scheme first presented by MacCormack (1969) for gasdynamic applications. An adaptation for unsteady river flow, described in Ferrick and Waldrop (1977), is now used extensively by TVA. As demonstrated for the dummy variable, f, conditions at time t_0 are used to compute provisional values, \bar{f} , at time t_1 ($t_1 = t_0 + \Delta t$), by

$$\bar{f}^{t_1} = f^{t_0} + \left(\frac{\partial f}{\partial t} \right)^{t_0} \Delta t + 0(\Delta t)^2 \quad (4)$$

where Equations 1, 2, and 3 are substituted for the time derivative in Equation 4. Once provisional values have been computed for the dependent variables ζ , (Hu), and (Hv) throughout the grid network, final values are computed at time t_1 by using the second step of the two-step process. This second step is based upon the second order expansion

$$f^{t_1} = f^{t_0} + \left(\frac{\partial f}{\partial t} \right)^{t_0} \Delta t + \left(\frac{\partial^2 f}{\partial t^2} \right)^{t_0} \frac{(\Delta t)^2}{2} + 0(\Delta t)^3 \quad (5)$$

which, after manipulation explained by Ferrick and Waldrop (1977), can be combined with Equation (4) to give

$$f^{t_1} = \frac{1}{2} [f^{t_0} + \bar{f}^{t_1} + \left(\frac{\partial \bar{f}}{\partial t} \right)^{t_1} \Delta t] + 0(\Delta t)^3 \quad (6)$$

A second order difference scheme is used for spatial differencing.

SAMPLE APPLICATION

Although the model is new and currently undergoing refinements and verification, it is operational and has been used to define flow patterns in reservoirs adjacent to TVA's Browns Ferry and Sequoyah Nuclear Plants. Some computed velocity vectors in Chickamauga Reservoir near Sequoyah Nuclear Plant are shown in Figure 2. Underwater topography of this reservoir is very

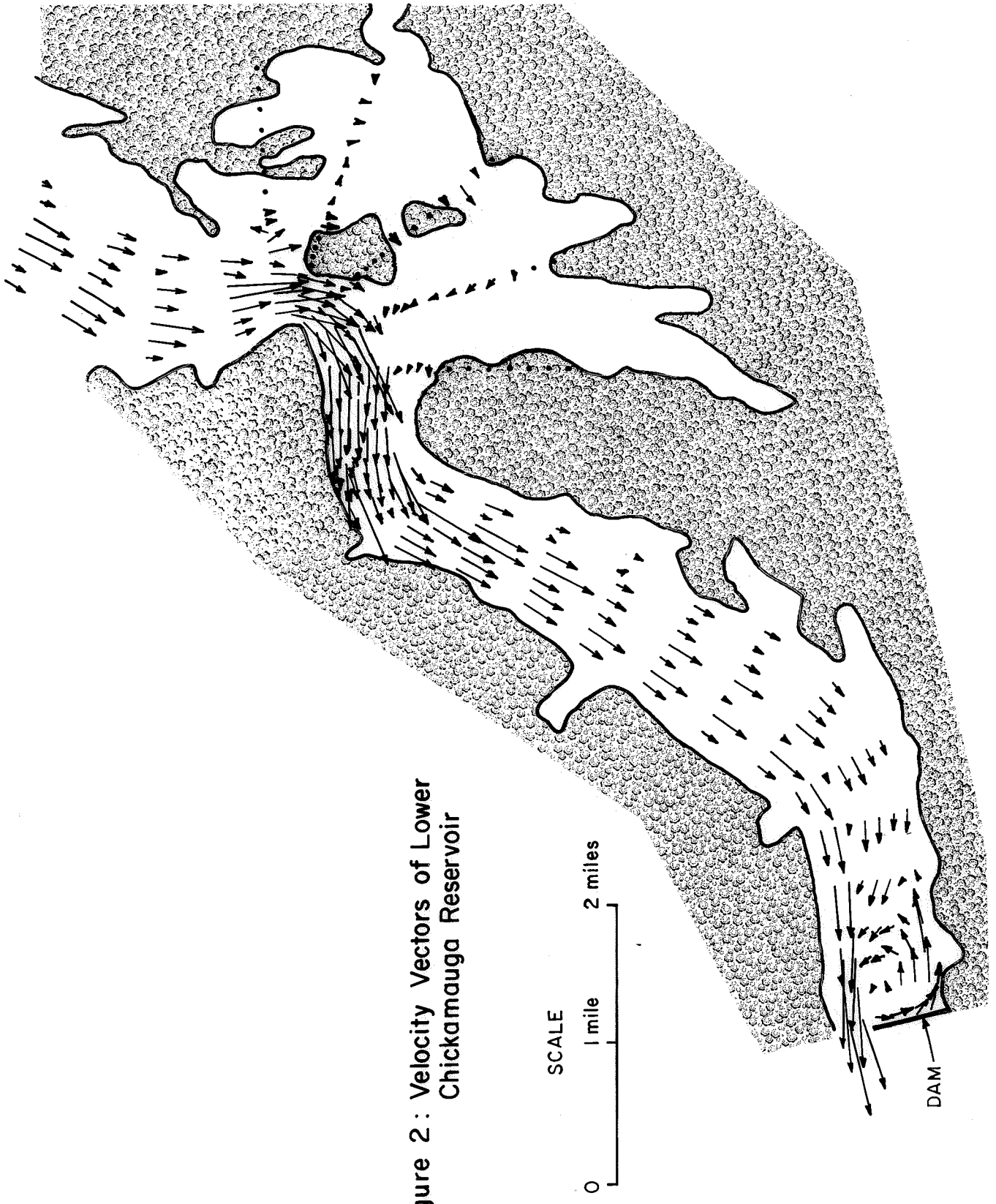

Figure 2 : Velocity Vectors of Lower Chickamauga Reservoir

irregular. Depths of the main channel are of the order of 50 feet, whereas depths of overbank regions and submerged islands are typically 10 feet or less. The option of neglecting wind shear was used for this computation. For this simulation of 20 miles of Chickamauga Reservoir, 631 grid points were used.

Figure 3 demonstrates how the computed flow field can be used to compute the path of a mass of water moving with mean velocity. This satellite calculation, discussed in Tatom and Waldrop (1978), is useful for estimating the source or time history of water at a given location. Techniques for mating the calculated flow field with the transport and dispersion of chemical species and turbidity are currently under development.

SUMMARY

The TVA Water Systems Development Branch, through the contractual services of Engineering Analysis, Inc., has developed a model for computing hydrodynamics of weakly stratified or unstratified run-of-the-river reservoirs. The model was primarily designed for environmental assessments of intakes and discharges of TVA power plants. Unsteady capabilities were included since temporal variations in TVA hydroelectric generation often produce a pseudo tidal effect even though the net daily flow is downstream.

The vertically integrated conservation equations are formulated in curvilinear boundary-fitted coordinates to efficiently match meandering river banks and to properly account for centrifugal and Coriolis forces of river bends. Wind shear is specified at the surface and bed shear at the bottom. The effect of a nonlinear velocity profile in the vertical direction is included. Solid boundaries and islands are simulated with image points to assure conservation of mass and momentum. Lateral inflows and hydroelectric generation are specified as time series. Upstream or downstream boundaries can be mated to an unsteady flow routing model.

The program is user-oriented for both geometric data input and computed hydrodynamic results. Lateral boundaries are digitized directly from a map. The program then automatically positions a specified number of grid points in the lateral and longitudinal direction, and computes the geometric parameters of the transformed coordinates. Additional grid regions required to better include the topography of lateral embayments may then be added, or grid rows may be deleted where less resolution is required. Once depths are defined at each grid point and boundary conditions are specified, the non-orthogonal set of equations is solved in the nonuniform grid system with an explicit finite difference scheme. Computed velocity vectors are transformed back into cartesian coordinates for graphical display.

Hydrodynamic results stored in a data file are used to compute the transport of passive species such as turbidity or trace chemicals which do not influence the flow patterns. A time history of a mass of water from any specified time and position can be traced either forward or backward in time using a trajectory program. This feature is useful for evaluating alternative locations for industrial intakes and discharges.

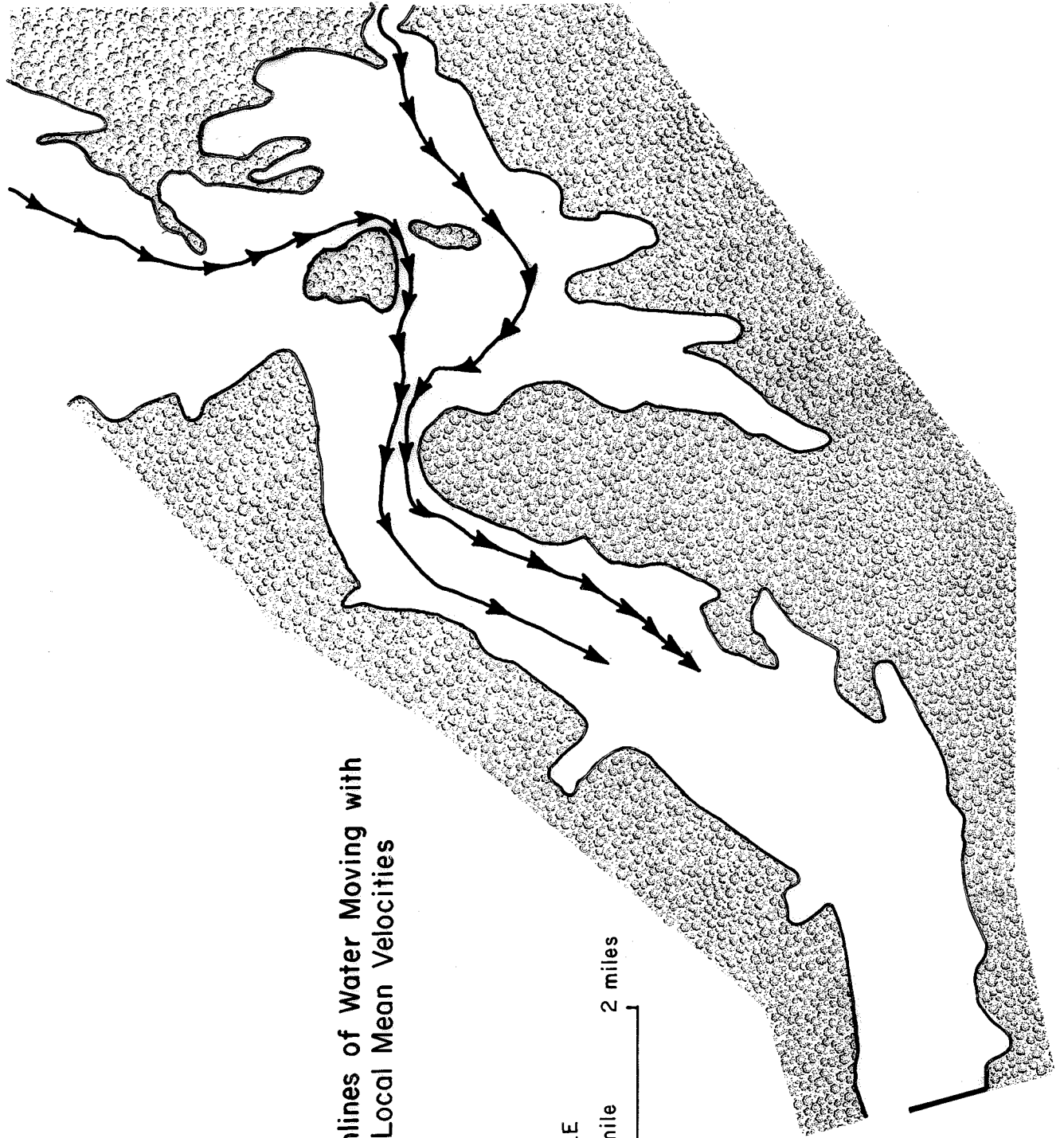

Figure 3: Pathlines of Water Moving with the Local Mean Velocities

REFERENCES

- Ferrick, M. G., and W. R. Waldrop (1977), "Two Techniques for Flow Routing with Application to Wheeler Reservoir," TVA Water Systems Development Branch Report No. 3-519, Norris, TN.
- Leendertse, J. (1970), "A Water-Quality Simulation Model for Well-Mixed Estuaries and Coastal Seas: Volume 1, Principles of Computation," RM-6230-RC, The Rand Corporation, Santa Monica, CA.
- MacCormack, R. W. (1969), "The Effect of Viscosity in Hypervelocity Impact Cratering," AIAA Paper No. 69-354.
- Tatom, F. B., and W. R. Waldrop (1978), "Curvilinear Unsteady Two-Dimensional Depth-Averaged Hydrodynamic Model," Proceeding of the International Symposium on Environmental Effects of Hydraulic Engineering Works, E. E. Driver and W. O. Wunderlich, ed., TVA, Knoxville, TN.
- Tatom, F. B., W. R. Waldrop, and S. R. Smith (1980), "Curvilinear Grids for Sinuous River Channels," Presented at the Workshop on Numerical Grid Generation Techniques for Partial Differential Equations, NASA Langley Research Center, Hampton, VA.
- Waldrop, W. R., and F. B. Tatom (1976), "Analysis of the Thermal Effluent from the Gallatin Steam Plant During Low Flows," TVA Water Systems Development Branch, Norris, TN.

PAPER DISCUSSION

THE TVA MODEL FOR HYDRODYNAMICS OF VERTICALLY
WELL-MIXED RIVERS AND RESERVOIRS

by
William R. Waldrop

Question: How do you carry out your transformations?

Dr. Waldrop: It starts with the Cartesian coordinates and knowing the river paths then you compute the radius of curvature and change in radius of curvature which allows you to go to the curvilinear coordinate system. Then the transformation from curvilinear coordinates to boundary fitted coordinates is done by the simple transformation shown in the paper. Then, stretching the coordinates to form an irregular grid, is done by weighting function between grid points. So, you are essentially computing in a square or rectangular grid, but we've gone through about four processes to get there. The results come back out on a regular x-y plot.

Question: Are you tracking a particle of water in your model; is that what your're showing there?

Dr. Waldrop: In this particular work I wanted to track a slug of water. Normally, this slug of water would probably not stay intact but we assume it will move with the mean flow. Of course, the further you go back, the less integrity that slug of water has.

Question: That was my question. What procedure do you use to follow that slug and avoid dispersion effects?

Dr. Waldrop: We have built in a distribution probability function which might be described in terms of a lateral dispersion coefficient.

Question: How would you expand the model so it could handle flooding situations? Also, can you tell us what you did to calibrate the model?

Dr. Waldrop: We are currently involved in obtaining the velocity data and other data so we can calibrate the model. Therefore, the model is basically not calibrated yet. We'll be doing this in the next few months.

To be able to handle flooding, we would need to build in the logic to check water heights and include a tangential region in the grid that would include any of the areas that would

be potentially flooded. Then specify those grid points as dry points and build the logic in the program to sample to see if they were continuing to stay dry as you move forward in time. This has not been built into yet, but it could be done I'm sure. The boundary condition for the two kinds of regions (wet and dry) are handled simultaneous because it is explicit. You are not biasing the calculation of the flow for either.

Question: Is your variable B a function of flow and location, e.g., time and location?

Dr. Waldrop: B is the width of the main river itself. It varies with location, but not with time.

Question: Do you assume that it stays constant at each particular cross section? Therefore, when the water surface rises significantly, you would see no change in B?

Dr. Waldrop: B refers to the width of the main channel and does not change with time, but the wetted cross-section could be modified by a program change. The current model does allow water surface height to change, but we now assume that the wetted cross-section won't change much.

Question: Wouldn't the continuity suffer in the broad inbayments as a result of this?

Dr. Waldrop: We would need to look at those carefully, but continuity is continuously computed throughout.

Comment: Al Harrison, MRD: We have a data set we would like to try this on if you would like to take a look at it.

Question: What were your water depths for the Brown's Ferry application?

Dr. Waldrop: Water depths varied from about 40 feet in the main channel, the old river bed, to half of a foot in the shallow areas. For the Sequoyah case, water depths were 50-60 in the main channel.

Question: Did you have any vertical stratification problems?

Dr. Waldrop: No. Even though there are temperature differences, they are not large enough to be significant or cause density currents. That was one of our basic assumptions. We would not apply a model like this to a deep storage reservoir where you would have significant vertical temperature gradients.

Question: What is that other term (Beta) in your equation of motion?

Dr. Waldrop: That is a momentum coefficient. This term allows us to include the effect of a nonuniform vertical distribution of velocity from the surface to the bed. The coefficient handles the effect of the nonuniformity in the velocity profile when you vertically integrate from the surface to the bed. If Beta is equal to one, then velocity is vertically homogeneous. If you have like a logarithmic velocity profile, Beta takes a value greater than 1.

TWO-DIMENSIONAL TURBULENT FLOW SIMULATION

by

Bruce E. Larock¹

INTRODUCTION

Nearly all practical hydrologic flow problems are turbulent and, strictly speaking, three-dimensional. However, it is often an acceptable approximation for any of a variety of reasons (preliminary investigation; limits on expense, time or computing ability; prior knowledge; etc.) to reduce the dimensionality and/or the complexity of the flow representation. This article addresses the question of representing hydrologic flows as two-dimensional flows involving significant turbulent flow processes.

Turbulent transport processes are most often important in near-field regions, e.g., in domains near the point where one fluid stream enters another and possibly transports salt, heat or sediment with it. Farther from these points simpler diffusion models, or even potential flows in some instances, may be adequate to characterize the flow processes. In near-field regions the selection and use of an appropriate turbulence representation may be the difference between a successful and an inadequate study of the local flow behavior. The remarks to follow apply primarily to near-field flow simulation.

In subsequent sections this article first presents the governing equations for turbulent steady-mean hydrologic flow simulation. The closure of this equation set by adoption of an eddy viscosity model will be discussed, with emphasis on the relatively complete and versatile k- ϵ model. Application of this model to a two-dimensional flow involving significant recirculation then follows. The article concludes by presenting an approach to the computation of the behavior of two-dimensional turbulent horizontal flows, including problems of model adaptation, interpretation and practical application.

GOVERNING EQUATIONS

The governing equations for the time-steady turbulent mean flow of an incompressible fluid are

$$\frac{\partial U_i}{\partial x_i} = 0 \quad (1)$$

$$U_j \frac{\partial U_i}{\partial x_j} = - \frac{1}{\rho} \frac{\partial P}{\partial x_i} + g_i - \frac{\partial}{\partial x_j} (\overline{u_i u_j}) \quad (2)$$

¹Professor, Civil Engineering Department, University of California, Davis

which express conservation of mass and linear momentum, respectively. Here x_i = cartesian coordinate component, and the Einstein convention of summing over a repeated subscript is used. In equation 2, called the Reynolds equation, the laminar viscous stress term has already been omitted in recognition that the turbulent stress (per unit mass) terms $\overline{u_i u_j}$ dominate the laminar terms.

These equations are the result of decomposing the instantaneous velocity \tilde{u}_i and pressure \tilde{p} into time-averaged means U_i and P and fluctuations u_i and p ; i.e. $\tilde{u}_i = U_i + u_i$, $\tilde{p} = P + p$. The gravity term g_i is known, but the creation of the turbulent stress terms by the averaging process has created a closure problem which can only be resolved by approximate modeling.

The exact differential transport equation (Launder et al., 1975) for $\overline{u_i u_j}$ in steady mean flow is

$$U_\ell \frac{\partial \overline{u_i u_j}}{\partial x_\ell} = P_{ij} + \epsilon_{ij} + D_{ij} + \phi_{ij} \quad (3)$$

The convective transport of $\overline{u_i u_j}$ by the mean-flow velocity components U_ℓ is controlled by four processes: The production rate P_{ij} of $\overline{u_i u_j}$ by straining of the mean flow is

$$P_{ij} = - \overline{u_i u_\ell} \left[\frac{\partial U_j}{\partial x_\ell} + \frac{\partial U_i}{\partial x_\ell} \right] \quad (4)$$

The viscous dissipation of $\overline{u_i u_j}$ at the small scales of turbulent motion is given by

$$\epsilon_{ij} = - 2\nu \overline{\frac{\partial u_i}{\partial x_\ell} \frac{\partial u_j}{\partial x_\ell}} \quad (5)$$

where ν = molecular kinematic viscosity;

$$D_{ij} = - \frac{\partial}{\partial x_\ell} \left[\overline{u_i u_j u_\ell} - \nu \frac{\partial}{\partial x_\ell} (\overline{u_i u_j}) + \frac{1}{\rho} \left(\delta_{i\ell} \overline{p u_j} + \delta_{j\ell} \overline{p u_i} \right) \right] \quad (6)$$

is the transport by diffusion of $\overline{u_i u_j}$ by the action of turbulent velocity fluctuations, viscosity and the turbulent pressure fluctuations p (δ_{ij} = Kronecker delta), and

$$\phi_{ij} = \frac{p}{\rho} \left(\frac{\partial u_i}{\partial x_j} + \frac{\partial u_j}{\partial x_i} \right) \quad (7)$$

is the important pressure-strain interaction term which promotes the redistribution of turbulence energy among components. The appearance of higher-order correlations in this transport equation is a clear indicator of the need to model this equation approximately to achieve closure of the equation set.

EDDY VISCOSITY MODELS

Modeling of $\overline{u_i u_j}$ began nearly a century ago when Boussinesq proposed to represent these terms via an analogy to laminar flow; this idea is now usually written as

$$-\overline{u_i u_j} = \nu_t \left(\frac{\partial U_i}{\partial x_j} + \frac{\partial U_j}{\partial x_i} \right) - \frac{2}{3} \delta_{ij} k \quad (8)$$

with the turbulence kinetic energy term $k = \overline{u_i u_i}/2$ being appended to make it tensorially correct under contraction of indices. In equation 8 all modeling uncertainties reside in the kinematic eddy viscosity ν_t , and it is worth a moment to consider the modeling options for this factor.

The simplest, and probably the most common, approach to hydraulic flows is to choose

$$\nu_t = \text{Constant} \quad (9)$$

although it is well known that ν_t must in principle vary with the local structure of the turbulence. Computations using equation 9 are relatively easy to perform, and this approach becomes even more attractive whenever the true variation of ν_t is unknown, but it really is equivalent to ignoring the entire modeling problem.

In the turbulent boundary layer and some similar flows, such as jet and pipe flows, ν_t can be modeled successfully by an algebraic mixing length expression, but for more complex flows this concept usually fails because the variation of the mixing length is then unknown. In some cases ν_t can be obtained from experimental data (e.g. Young et al., 1976), although this is often impractical. Finally, it is possible to derive a single differential equation for mixing length behavior, but Launder and Spalding (1972) conclude that this procedure is only marginally better than the use of algebraic length-scale models.

Reynolds (1976) and Dunn et al. (1975), among others, have reviewed many, more complex turbulence models that have been proposed to avoid the prescription of a length scale when flows are not mainly unidirectional. To date (1981) the most attractive of these models, on the bases of being relatively thoroughly tested and yet relatively simple, seems to be the turbulence kinetic energy and dissipation model, or k - ϵ model.

THE k - ϵ MODEL

The k - ϵ model assumes that

$$\nu_t = c_\mu k^2/\epsilon \quad (10)$$

based on dimensional reasoning alone ($c_\mu = 0.09$ is a constant). The isotropic dissipation ϵ of turbulence energy by the small-scale fluid motion is related to the dissipation expression in equation 5 in the following way:

$$\epsilon_{ij} = -\frac{2}{3} \delta_{ij} \epsilon \quad (11)$$

The distribution of k and ϵ throughout the flow is found from the solution of a separate differential transport equation for each quantity (Launder and Spalding, 1974). The equation for k can be obtained directly by contracting equation 3 (set $i = j$), and an equation analogous to equation 3 can be derived for ϵ ; all processes except the production term itself require approximate modeling to make the final equations tractable, however. The transport equation for k is

$$U_j \frac{\partial k}{\partial x_j} = P_r - \epsilon + \frac{\partial}{\partial x_j} \left[\frac{c_\mu}{\sigma_k} \frac{k^2}{\epsilon} \frac{\partial k}{\partial x_j} \right] \quad (12)$$

in which the scalar production is $P_r = P_{ii}/2$. The transport equation for ϵ is often written as

$$U_j \frac{\partial \epsilon}{\partial x_j} = c_{\epsilon 1} \frac{P_r \epsilon}{k} - c_{\epsilon 2} \frac{\epsilon^2}{k} + \frac{\partial}{\partial x_j} \left[\frac{c_\mu}{\sigma_\epsilon} \frac{k^2}{\epsilon} \frac{\partial \epsilon}{\partial x_j} \right] \quad (13)$$

The terms on the right act respectively as a source and a sink for ϵ , and as a diffusive transport term. In equations 12 and 13 σ_k and σ_ϵ are Prandtl numbers related to k and ϵ . The constants in this model have been chosen by reference (Launder and Spalding, 1974) to data from experiments which were carefully chosen to isolate individual physical processes. Recommended values for the constants for application in the next section are $c_{\epsilon 1} = 1.45$, $c_{\epsilon 2} = 1.90$, $\sigma_k = 1.0$, and $\sigma_\epsilon = 1.3$.

The complete set of equations to simulate a turbulent flow with the k - ϵ turbulence model therefore consists of equations 1 and 2 for the mean flow and equations 10, 12 and 13 for the turbulence closure.

APPLICATION TO A RECIRCULATING FLOW

The k - ϵ model has recently been used in computing the properties of turbulent flow at the longitudinal median section of a rectangular sedimentation basin (Schamber and Larock, 1981). Although almost all previous applications of the k - ϵ model have used finite difference techniques, the Galerkin finite element method of analysis was employed for this application. It allows one to use a nonuniform computational mesh, to apply boundary conditions in a direct fashion along the domain boundaries, and, if desired, to consider geometrically complex nonpolygonal domains.

The example basin is 40 feet long and 15 feet wide with inlet and exit depths of 10 and 9 feet, respectively; it was loaded at 1500 gpd/ft² to simulate operation of an overloaded primary sedimentation unit. Schematic diagrams of the unit and its finite element discretization are presented in Figures 1 and 2. The computational mesh in Figure 2 is restricted to the turbulent flow domain; it does not extend to the wall.

A relatively detailed description of the development of the discrete equation system, application of boundary conditions and solution of the final nonlinear algebraic sets (two) of 995 and 778 equations can be found in Schamber and Larock (1981).

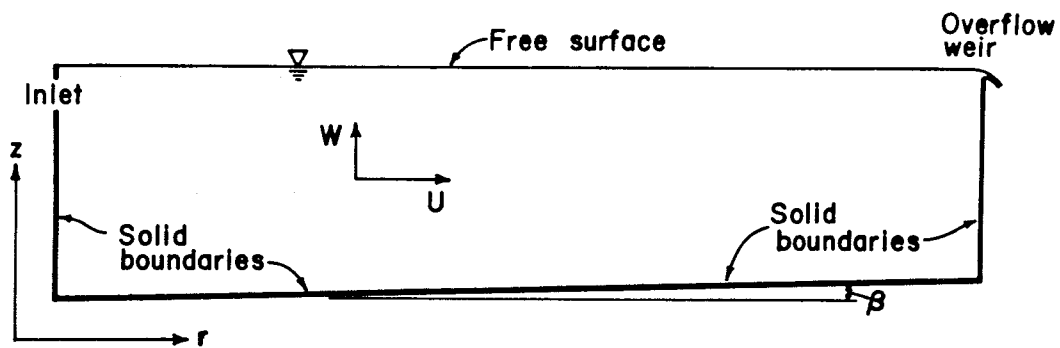

Fig. 1. — Schematic tank configuration

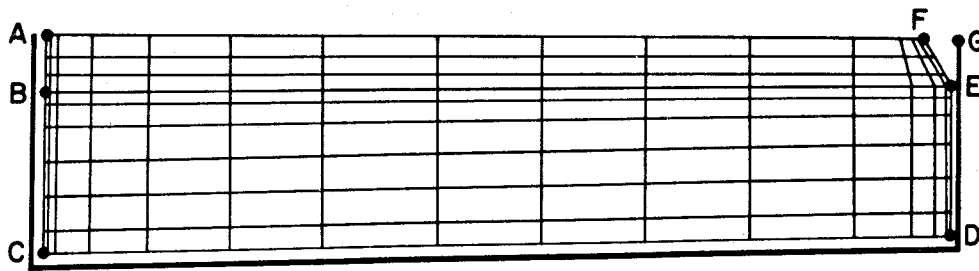

Fig. 2. — Finite element discretization of tank domain

Figure 3 is a vector plot of the computed velocity field in the basin; lengths and velocities in this figure are nondimensionalized on $h_o = 10$ ft. and $U_o = 0.1$ ft/sec. The jet of fluid at the inlet (Section AB in Figure 2) expands to full basin depth approximately two-thirds of the way through the basin. Below the jet is a substantial recirculation zone.

A contour plot of the nondimensional kinematic eddy viscosity $\nu_t/(U_o h_o)$ is presented in Figure 4; it is clearly far from uniform. The most pronounced changes in ν_t occur near the inlet and outlet, and ν_t diminishes near walls due to the damping of turbulent fluctuations by the walls. Clearly this distribution of ν_t would be very difficult to specify a priori. It is worth noting (Schamber and Larock, 1980) that use of a constant average value $\nu_t/(U_o h_o) = 0.01$ in the mean-flow equations alone (without use of the k and ϵ equations) reproduced most of the major features of this flow at roughly 10% of the computing cost for the full-model solution. However, there appears to be no good way to select the appropriate constant ν_t -value without knowledge of the complete solution or recourse to experience. Moreover, if one misses the proper value by only a factor of two (i.e. one picks 0.2 or 0.005 for this flow), then substantially different velocity fields are the result. These observations are the basis for the proposed computational scenario at the end of this article.

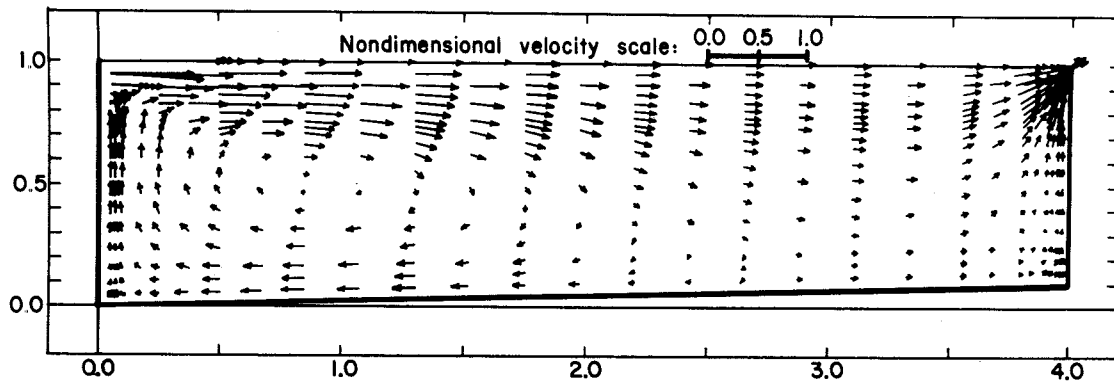

FIG. 3.—Vector Plot of Computed Velocity Field

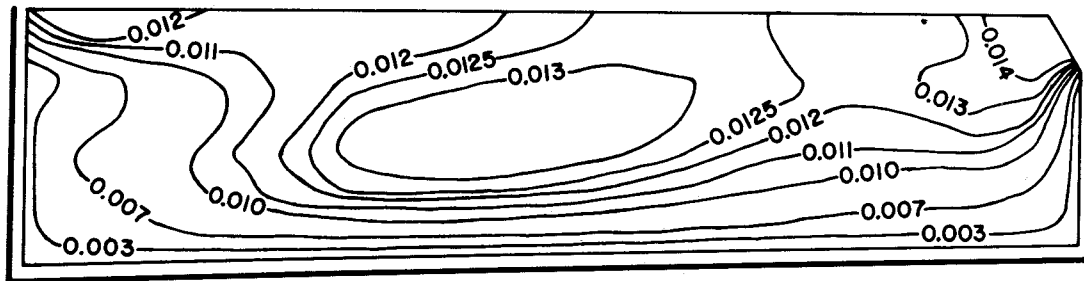

FIG. 4.—Contour Plot of Dimensionless Turbulent Kinematic Viscosity

TWO-DIMENSIONAL TURBULENT HORIZONTAL FLOWS

If one integrates the mass and momentum conservation equations over the depth, as Rastogi and Rodi (1978) and Rodi (1980) discuss more fully, one obtains equations of the form

$$\frac{\partial h}{\partial t} + \frac{\partial}{\partial x_i} (h \bar{U}_i) = 0 \quad (14)$$

and

$$\begin{aligned} \frac{\partial \bar{U}_i}{\partial t} + \bar{U}_j \frac{\partial \bar{U}_i}{\partial x_j} = & -g \frac{\partial}{\partial x_i} (h + z_b) + \frac{1}{\rho h} \frac{\partial}{\partial x_j} (h \bar{\tau}_{ij}) \\ & + \frac{1}{\rho h} (\tau_{si} - \tau_{bi}) + \frac{1}{\rho h} \frac{\partial}{\partial x_j} \int_{z_b}^{z_b+h} \rho (U_i - \bar{U}_i)(U_j - \bar{U}_j) dz \end{aligned} \quad (15)$$

when a hydrostatic pressure distribution is assumed. For the depth-averaged concentration of a scalar quantity (e.g. temperature or sediment), the conservation relation is

$$\frac{\partial \bar{C}}{\partial t} + \bar{U}_j \frac{\partial \bar{C}}{\partial x_j} = \frac{1}{\rho h} \frac{\partial}{\partial x_j} (h \bar{J}_j) + \frac{1}{\rho h} \frac{\partial}{\partial x_j} \int_{z_b}^{z_b+h} \rho (U_j - \bar{U}_j) (C - \bar{C}) dz \quad (16)$$

In these equations an overbar denotes a depth-averaged quantity, the local water depth is h and z_b is the local elevation of the channel or lake bottom. The depth averaged turbulent stresses are $\bar{\tau}_{ij}$; τ_{si} and τ_{bi} are the water surface and bottom shear stress terms created by the depth-integration. The term \bar{J}_j is a turbulent scalar flux component. The last term in each of equations 15 and 16 is a dispersion term created by vertical nonuniformities in mean-flow quantities and is not related to turbulent flow processes. If one momentarily neglects the turbulence and dispersion terms, one sees that the convection of momentum is also driven by the gravitational term; since no analogous term appears in equation 16 to drive the convective transport of \bar{C} , the turbulence and dispersion terms are essential to scalar transport and must be retained, although these same terms are not necessarily always important in equations 15. However, it usually is not possible to separate turbulence and dispersion effects in measurements of depth-averaged quantities; hence the use of such data to select turbulence model coefficients usually also accounts partly for dispersion.

The k - ϵ turbulence model must also be depth-averaged. Rastogi and Rodi (1978) present the model modifications required by the averaging process. In addition to the two-dimensional counterpart of the production term in equations 12 and 13, now additional source or production terms also exist due to the non-uniformity of vertical profiles, especially near the bottom.

Rodi and his colleagues have been the primary developers and users of these equations for two-dimensional horizontal flows; they have applied finite difference formulations of these models to studies of waste heat and sewage discharges into some German Rivers. They have been able to simplify the equations in different ways for some of their applications. When the river flow under study is known to be largely unidirectional without significant recirculation, the equations can be converted from their original elliptic form to parabolic form so that efficient solution techniques may be used; this step assumes that downstream events do not affect upstream regions, except perhaps for a backwater effect on water level. Over short reaches of rivers a "rigid-lid" simplification of the free-surface boundary conditions may also be utilized. Rastogi and Rodi (1978) present a relatively detailed comparison of some results from two- and three-dimensional versions of the k - ϵ model, as applied to selected river discharges; under proper circumstances the two-dimensional version represents the flow well, but it can not be expected to perform well when buoyancy, stratification, cross-sectional secondary currents or vertically non-uniform flow profiles are significant. In this work the k - ϵ model coefficients were taken directly from published literature without "tuning," and good predictions were achieved when the channel bed was rough for all densimetric Froude numbers, and for a smooth channel bed for densimetric Froude numbers over 10.

Can the $k-\epsilon$ turbulence modeling procedures be routinely applied to near-field regions in two-dimensional horizontal flows? Rodi and colleagues have shown that efficient finite difference procedures can be economically used to apply these models to flows in the absence of significant recirculation; with additional expense and effort recirculation zones can also be handled by their procedures. In fact, this writer knows that Rodi can incorporate locally three-dimensional effects into mostly two-dimensional computations, if necessary. To date (1981) no one has shown a similar capability via finite element methods; this writer believes such computations can be successfully accomplished, but cost and reliability of the scheme may initially be discouraging.

This article will conclude by outlining one possible finite element scenario which would allow the application of the $k-\epsilon$ turbulence model to simulate flows in non-simple geometric domains at a reasonable overall cost. The investigator would first pick one flow, or preferably several flows which span the anticipated flow spectrum, for the region of interest; these few flows would be solved (possibly with significant expense and difficulty at first) by using the full $k-\epsilon$ model in conjunction with the mean-flow equations, and the distribution of v_{\dagger} would be examined. This study of v_{\dagger} should allow the investigators to select appropriate, approximate v_{\dagger} -distributions for use in the more numerous computer "production" runs that could now begin. These computations would use only the mean flow equations and an assumed approximate distribution for v_{\dagger} , and each individual run could probably be completed for roughly 10% of the cost of a run with the complete model.

In conclusion, computations involving the use of the $k-\epsilon$ or other two-equation turbulence models for two-dimensional horizontal flows now are technically feasible. Additional development work would be required before the computational procedures could be called robust, however, and solution of the full model may be expensive for some time.

ACKNOWLEDGEMENT

The sedimentation basin flow example was developed as part of the work sponsored by the National Science Foundation under Grant No. ENG7618846.

REFERENCES

1. Dunn, W.E., Policastro, A.J. and Paddock, R.A., "Surface thermal plumes: Evaluation of mathematical models for the near and complete field," Argonne National Laboratory Report ANL/WR-75-3, 2 parts, 1975.
2. Launder, B.E., Reece, G.J. and Rodi, W., "Progress in the development of a Reynolds-stress turbulence closure," Journal of Fluid Mechanics, 68, 1975, pp. 537-566.
3. Launder, B.E. and Spalding, D.B., Lectures in mathematical models of turbulence, Academic Press, New York, 1972.
4. Launder, B.E. and Spalding, D.B., "The numerical computation of turbulent flows," Computer Methods in Applied Mechanics and Engineering, 3, 1974, pp. 269-289.
5. Rastogi, A.K. and Rodi, W., "Predictions of heat and mass transfer in open channels," Journal of the Hydraulics Division, ASCE, 104, HY3, Mar., 1978, pp. 397-420.
6. Reynolds, W.C., "Computation of turbulent flows," Annual Reviews of Fluid Mechanics, M. Van Dyke et al., ed., Annual Reviews, Inc., Palo Alto, California, 1976, pp. 183-208.

7. Rodi, W., Turbulence models and their application in hydraulics, IAHR, Delft, The Netherlands, 1980.
8. Schamber, D.R. and Larock, B.E., "Constant and variable eddy viscosity flow simulations in settling tanks," Computer and Physical Modeling in Hydraulic Engineering, G. Ashton, ed., ASCE, New York, 1980, pp. 345-355.
9. Schamber, D.R. and Larock, B.E., "Numerical analysis of flow in sedimentation basins," Journal of the Hydraulics Division, ASCE, 107, HY5, May, 1981, pp. 575-591.
10. Young, D.-L., Liggett, J.A. and Gallagher, R.H., "Steady stratified circulation in a cavity," Journal of the Engineering Mechanics Division, ASCE, 102, EM1, Feb., 1976, pp. 1-17.

PAPER DISCUSSION

TWO-DIMENSIONAL TURBULENT FLOW SIMULATION

by
Bruce E. Larock

Question: Is your solution sensitive to eddy viscosity?

Dr. Larock: In my problem, yes. This question is related to the scale of the problem you are working on. I've shown you an intermediate scale problem where I believe the turbulent transport terms are important. The scale has a great deal to do with this question.

Question: We have used RMA-2 to investigate flows through bridge constructions. When we were using the model we found that after a little experience we could specify the magnitude of the eddy viscosity terms by relating them to the anticipated sizes of eddies we would see near the bridge. How does this relate to what you've done?

Dr. Larock: You have developed via numerical experience the knowledge you need to have to pick these coefficients reasonably. I might comment as on aside that I did not present an experimental verification of this settling basin problem. That is not because we are not aware of this need; in fact, there was a project that was begun at the same time we started our computational work (about 3 years ago) that was to measure the detailed flow in the tank. The experimental equipment is impressive to me, but the experimenters have not yet been able to collect the data we need for verification. So when looked at this problem from the standpoint of cost effectiveness, the numerical model becomes more appropriate.

Question: Is it possible for you to use your approach and methods for general applications now?

Dr. Larock: My approach and methods are not yet ready for general use. Right now the solution techniques for the full variable-eddy-viscosity model must be made more robust, that is, more dependable and less prone to numerical failures, then they now are before the model is ready for routine use. Toward the end of my presentation I suggested a computational strategy that would allow the user to benefit from the power of the full model and yet reduce cost and increase reliability on production runs; I advocate serious consideration of this approach for general applications in the future.

- Question: You talked about both vertical & horizontal problems; you mentioned that you might be dealing with turbulence terms in a horizontal solution that are vertical in origin. How can you get that effect in here?
- Dr. Larock: Turbulence production occurs in the vertical plane due to mean velocity gradients which cause shear stresses; this effect can be large near the bottom, especially a rough bottom. When the equations are integrated over the depth, this effect appears in a depth-averaged turbulence production term in the k-e model. Rodi has written on this effect in his 1980 IAHR monograph Turbulence Models and their Application in Hydraulics, pp. 31-2, and in the ASCE J. Hyd. Div., March 1978, pp. 406-7.
- Comment: Jan Leendertse: May I comment on that? We have run some cases on that where we have taken the energy out of the main system and put it back as a subgrid scale energy so we are actually capable of using a subgrid scale energy model with our program. We have found that in the three dimensional code, this can be extended to the other dimension without much difficulty or computational effort.
- Dr. Larock: Rodi, Spalding, Launder and others have shown in a finite difference context that they have a much more robust solution technique than we have developed using finite elements. They are the leaders and we are the followers and it'll probably remain that way for a while.
- Dr. Leendertse: I think there is still a difference in what they do and the application in this field. I think they are looking more at isotropic turbulence and they are looking at transfers in the horizontal sense.
- Dr. Larock: They have a simpler geometry than we have normally. Which is why we like to use finite elements with complex boundary shapes. Of course, there are those who have developed methods of using boundary fitted coordinates for finite difference approaches. This may be a possible avenue to take with finite differences.
- Dr. Leendertse: There is an additional problem with this; if you try to work in three dimensions you always need to account for density differences as well. Then you open up a whole new ball game with the suppression of turbulence through mixing.
- Dr. Larock: I and two doctoral students are currently looking into the mathematical modeling of density-stratified, fully-developed channel flows; the stratification is due to the presence of a non-dilute suspension of sediment in the flow. With some success in this area we then intend in the future to progress to two-dimensional, but not three-dimensional, flows with sediment-induced stratification in a vertical plane.

I might comment on one additional aspect of turbulence modeling that has not received all the attention it might: turbulence gains its energy from the large-scale mean motion and, via the energy cascade, eventually dissipates this energy at the smallest (molecular) scales of motion. Associated with this cascade is a frequency spectrum. It has been observed that the turbulence energy decay rate vs. frequency is not the same for "two-dimensional" turbulence as for three-dimensional turbulence. This physical observation ought to be replicated by the appropriate turbulence models. My current impression is that some models can do this and others cannot, and more attention should probably be devoted to this aspect of model behavior.

PAPER PRESENTATIONS
AND
DISCUSSIONS

DAY TWO

EVALUATION AND APPLICATION OF THE GENERALIZED
FINITE ELEMENT HYDRODYNAMIC MODEL, RMA-2

D. Michael Gee and Robert C. MacArthur¹

INTRODUCTION

The Corps of Engineers' Hydrologic Engineering Center is involved in the development, evaluation, and application of mathematical models. Two finite element hydrodynamic models, one for two-dimensional free surface flow in the horizontal plane and one for the vertical plane are being evaluated and applied. Although the models are formulated to solve dynamic flow problems, all work to date has been with steady state solutions. Recent research has focused on mass continuity performance of the models, proper boundary condition specification, comparison with finite difference techniques, and production applications. The objective of this research is to develop generalized mathematical models for routine use by the engineering community. This paper presents recent results of evaluation and application of the horizontal flow model. Information concerning the vertical model can be found in Gee and MacArthur (1978) and MacArthur and Norton (1980).

THE MODEL FOR TWO-DIMENSIONAL FREE SURFACE FLOW IN THE HORIZONTAL PLANE

The model for two-dimensional free surface flow in the horizontal plane solves the governing equations in the following form:

Continuity

$$\frac{\partial h}{\partial t} + \frac{\partial}{\partial x} (uh) + \frac{\partial}{\partial y} (vh) = 0 \quad (1)$$

Momentum

$$\begin{aligned} \frac{\partial u}{\partial t} + u \frac{\partial u}{\partial x} + v \frac{\partial u}{\partial y} + g \frac{\partial h}{\partial x} + g \frac{\partial a_0}{\partial x} - \frac{\epsilon_{xx}}{\rho} \frac{\partial^2 u}{\partial x^2} - \frac{\epsilon_{xy}}{\rho} \frac{\partial^2 u}{\partial y^2} - 2\omega v \sin \phi \\ + \frac{gu}{C^2 h} (u^2 + v^2)^{1/2} - \frac{\zeta}{h} V_a^2 \cos \psi = 0 \end{aligned} \quad (2)$$

$$\begin{aligned} \frac{\partial v}{\partial t} + u \frac{\partial v}{\partial x} + v \frac{\partial v}{\partial y} + g \frac{\partial h}{\partial y} + g \frac{\partial a_0}{\partial y} - \frac{\epsilon_{yx}}{\rho} \frac{\partial^2 v}{\partial x^2} - \frac{\epsilon_{yy}}{\rho} \frac{\partial^2 v}{\partial y^2} + 2\omega u \sin \phi \\ + \frac{gv}{C^2 h} (u^2 + v^2)^{1/2} - \frac{\zeta}{h} V_a^2 \sin \psi = 0 \end{aligned} \quad (3)$$

¹The Hydrologic Engineering Center, U.S. Army Corps of Engineers, Davis, California

where

u, v = x and y velocity components respectively
 t = time
 h = depth
 a_0 = bed elevation
 ϵ = turbulent exchange coefficients
 g = gravitational acceleration
 ω = rate of earth's angular rotation
 ϕ = latitude
 C = Chezy roughness coefficient
 ζ = empirical wind stress coefficient
 V_a = wind speed
 ψ = angle between wind direction and x - axis
 ρ = fluid density

Before solution, the equations are recast with flow (velocity times depth) and depth as the dependent variables. A linear shape function is used for depth and a quadratic function for flow. The Galerkin method of weighted residuals is used and the resulting nonlinear system of equations solved with the Newton-Raphson scheme. Details of the solution have been published previously by Norton, et al. (1973) and King, et al. (1975). General discussions of finite element techniques have been published by Zienkiewicz (1971), Hubner (1975), and Strang and Fix (1973).

Evaluation of Continuity Errors

The finite element method yields a numerical solution which approximates the true solution to the governing partial differential equations. The approximate nature of this solution becomes evident when mass continuity is checked at various locations in the solution domain for a steady state simulation. Although overall continuity is maintained (inflow equals outflow over the boundary), calculated flows across internal sections deviate somewhat from the inflow/outflow values. A study was made to evaluate errors in continuity as a function of network density. Poor continuity approximation is important of itself if water quality simulation is the goal. In the present applications, however, water surface elevations and velocities are the variables of interest. Therefore, the impact of continuity errors on these parameters was also investigated.

Flows on the Rio Grande de Loiza flood plain in Puerto Rico were simulated using several networks. This flood plain was selected because of its complex flow field and a prior study by the U.S. Army Corps of Engineers (1976) had made the data readily available. Model performance had previously been evaluated for simple hypothetical and laboratory flows by Norton et al. (1973) and King et al. (1975). The Loiza flood plain is about 10 by 10 km (6 by 6 miles) in extent and is characterized by variable bottom topography, one inlet and two outlets, and several islands. Three of the networks used in the study are shown in Figs. 1 to 3 illustrating progressive increase in network detail.

The solution was considered acceptable if flow at all continuity check lines deviated from inflow by less than $\pm 5\%$. Continuity is checked by integrating the normal component of velocity times depth along lines specified by the modeler. The lines coincide with element boundaries. The continuity check lines used in this study are indicated by dark lines on Fig. 1 to 3. Note that, because the flow divides around the islands, in some cases the sum of flows across two check lines (such as 5 and 6) should be compared with inflow. Various parameters of the problem are summarized in Table 1. No attempt was made to calibrate the coefficients used.

The continuity approximation improved with increasing network detail, as expected. Flow at the worst check line in the coarsest network (7 + 8) improved from 79.3% to 98.2% of inflow as network detail was increased. Network characteristics, computer execution times, and results of the simulations with these three networks are summarized in Table 2. Average depths and velocities along the continuity check lines are given in Table 3. The check line numbers in Tables 2 and 3 refer to the lines indicated on Figs. 1-3.

Table 1 Data for Loiza Flood Plain Simulation

1. Boundary conditions:
 - a. Inflow (line 1) = 8200 cms (290,000 cfs)
 - b. Outlets (lines 11 & 12), water surface elevation = 2.5 m (8 ft) MSL
 - c. All other boundaries; either tangential flow or stagnation points
2. Bed roughness: Chezy, C spatially varied from 5.5 to 22 $m^{1/2}/sec$ (10 to 40 $ft^{1/2}/sec$)
3. Turbulent exchange coefficients: varied with element size from 24 to 48 m^2/sec (260 to 500 ft^2/sec)

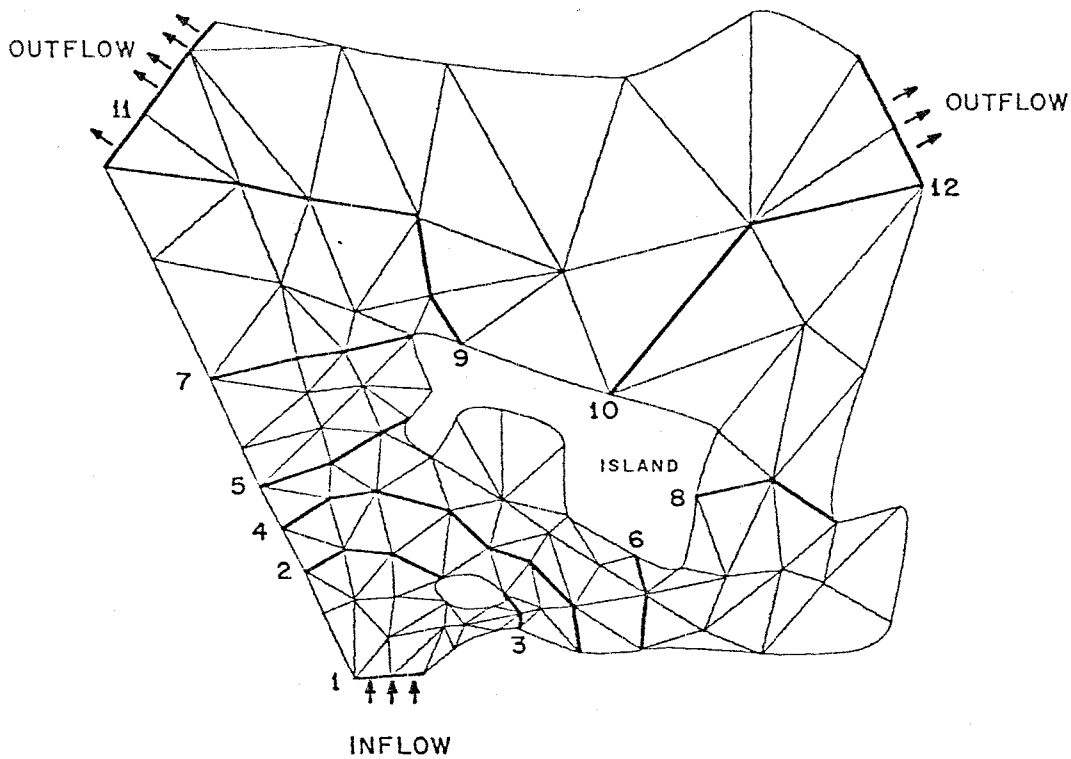

Figure 1 Continuity Check Network 3.1
(Dark Lines Indicate Continuity Check Lines)

Table 2 Continuity Performance of the Networks

Network	3.1	3.3	3.5
No. of Nodes	310	375	432
No. of Elements	131	162	189
CDC 7600 Execution Time (sec)	22	31	45
Check Line	Percent of Inflow		
1 (inflow)	100.0	100.0	100.0
2 + 3	89.2	90.8	96.2
4	114.9	106.8	104.9
5 + 6	87.5	92.0	96.4
7 + 8	79.3	90.1	98.2
9 + 10	99.8	99.4	98.7
11 + 12 (outflow)	100.0	100.0	100.0

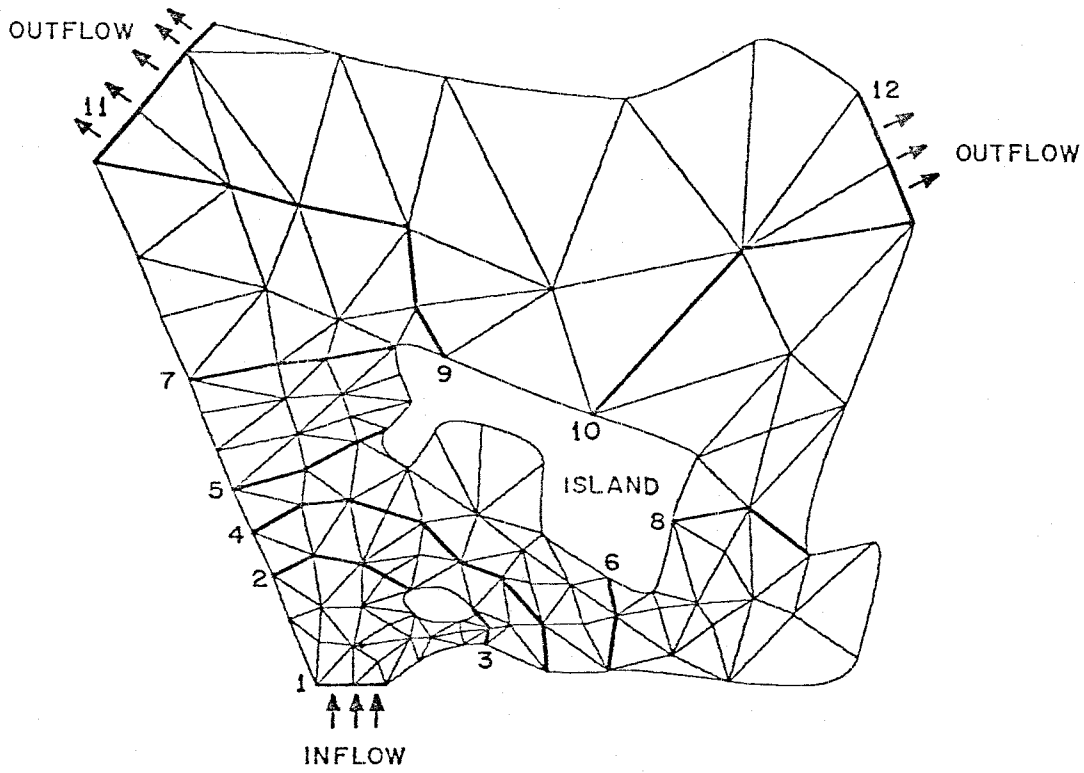

Figure 2 Continuity Check Network 3.3

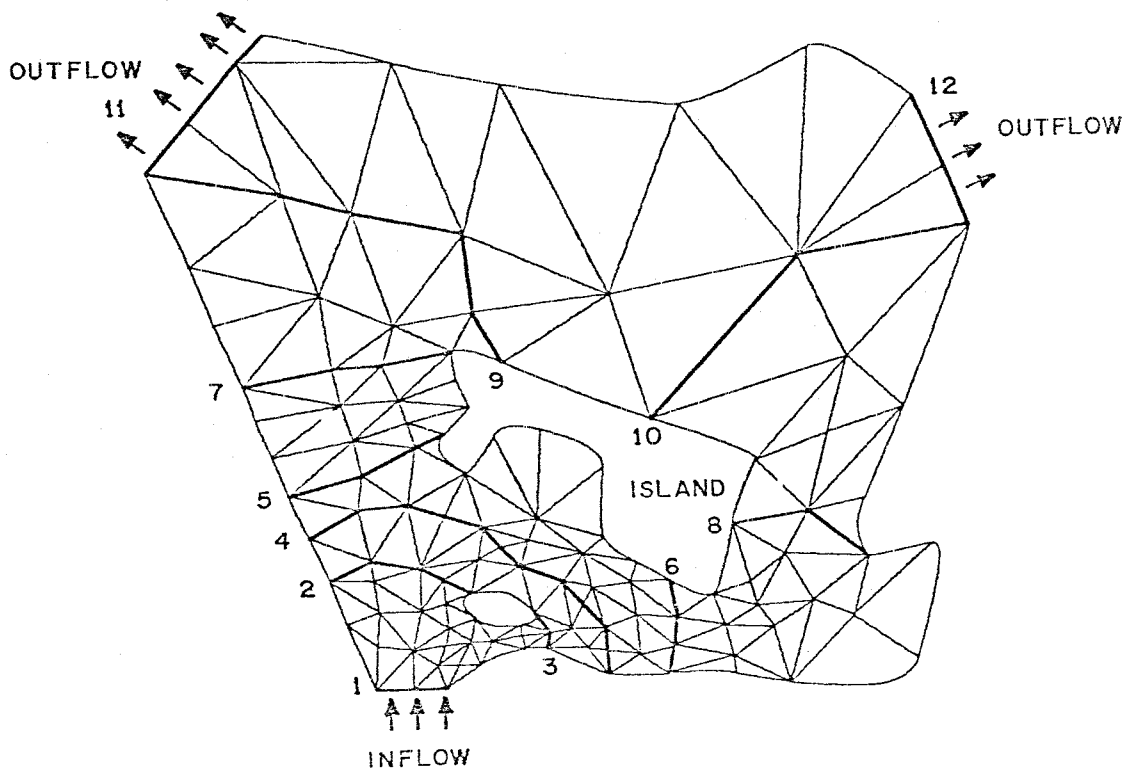

Figure 3 Continuity Check Network 3.5

Table 3 Flows (as percent of inflow), depth, and velocities for the networks

NETWORK		3.1	3.3	3.5
Line				
1	%	100	100	100
	Y(ft)	16.71	17.53	17.60
	V(fps)	6.31	6.02	5.99
2	%	50.4	50.1	53.7
	Y(ft)	9.92	9.31	9.41
	V(fps)	2.29	2.43	2.58
3	%	38.8	40.7	42.5
	Y(ft)	8.15	8.25	8.62
	V(fps)	8.28	8.59	8.57
4	%	114.9	106.8	104.9
	Y(ft)	9.56	9.12	9.13
	V(fps)	2.18	2.12	2.08
5	%	36.0	37.9	39.7
	Y(ft)	6.26	6.51	6.63
	V(fps)	2.46	2.49	2.56
6	%	51.5	54.1	56.7
	Y(ft)	12.52	12.78	12.32
	V(fps)	2.96	3.04	3.31
7	%	36.8	37.9	40.9
	Y(ft)	6.09	6.16	6.28
	V(fps)	2.03	2.07	2.19
8	%	42.5	52.2	57.3
	Y(ft)	7.41	7.77	7.79
	V(fps)	2.63	3.08	3.37
9	%	42.1	41.0	42.6
	Y(ft)	8.15	8.13	8.21
	V(fps)	0.78	0.76	0.78
10	%	57.7	58.4	56.1
	Y(ft)	10.14	10.06	10.00
	V(fps)	1.01	1.03	0.99
11	%	45.8	46.0	47.0
	Y(ft)	7.75	7.76	7.79
	V(fps)	2.21	2.22	2.26
12	%	54.2	54.0	53.0
	Y(ft)	7.58	7.58	7.54
	V(fps)	3.48	3.47	3.43

For most of the check lines, the improvement in continuity obtained with increasing network detail was associated with changes in both velocity and depth. In two cases, lines 6 and 8, the velocity changes were substantial. This region of the flow field is characterized by a rapid change of direction. The results reinforce the caveat that increased network detail is important in such regions. Furthermore, it appears that depth is somewhat less sensitive to errors in continuity than is velocity. Therefore, if one is interested in water surface elevations only, a less stringent continuity performance criterion could be accepted than if velocities are of interest.

Application to McNary Dam Second Powerhouse Study

An example of a "production" type application of the horizontal flow model is the second powerhouse site selection study for McNary lock and dam on the Columbia River. Flow fields downstream of the dam were simulated for several possible locations of the second powerhouse. Of interest were velocities, both magnitudes and directions, in the vicinity of the approach channel to the navigation lock. The study area and several of the possible second powerhouse locations are shown on Fig. 4. Finite element networks for the existing condition and for the south shore powerhouse with excavated discharge channel are shown in Figs. 5 and 6. Data are summarized in Table 4. The roughness coefficient was calibrated to reproduce an observed condition.

This study was greatly facilitated by an automatic reordering algorithm (Collins (1973)) which has been incorporated into the model. This algorithm makes modification of a network (compare Figs. 5 and 6) straightforward in that the entire network need not be renumbered. The existing numbering scheme is utilized for input/output and the system of equations internally reordered to reduce storage.

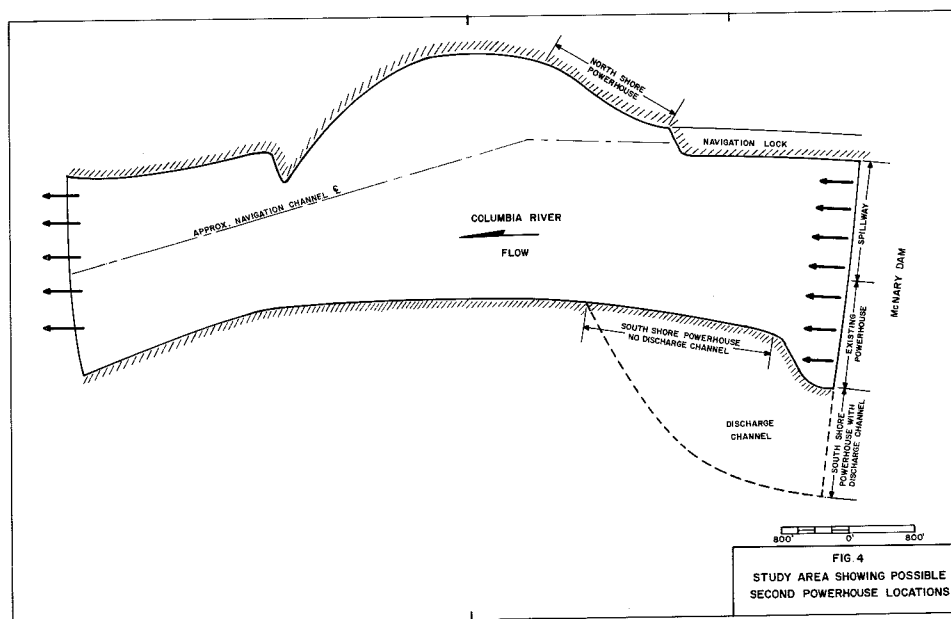

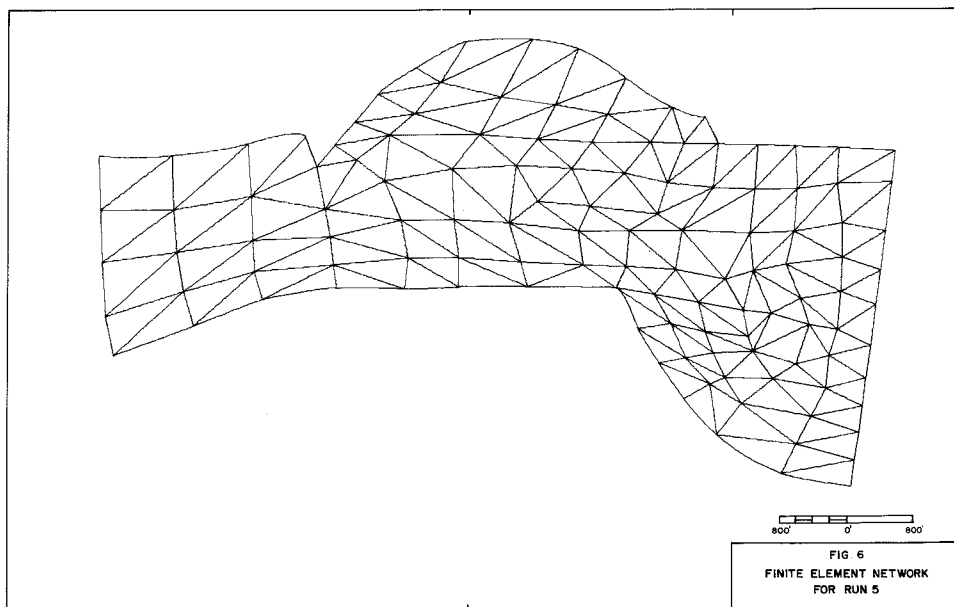
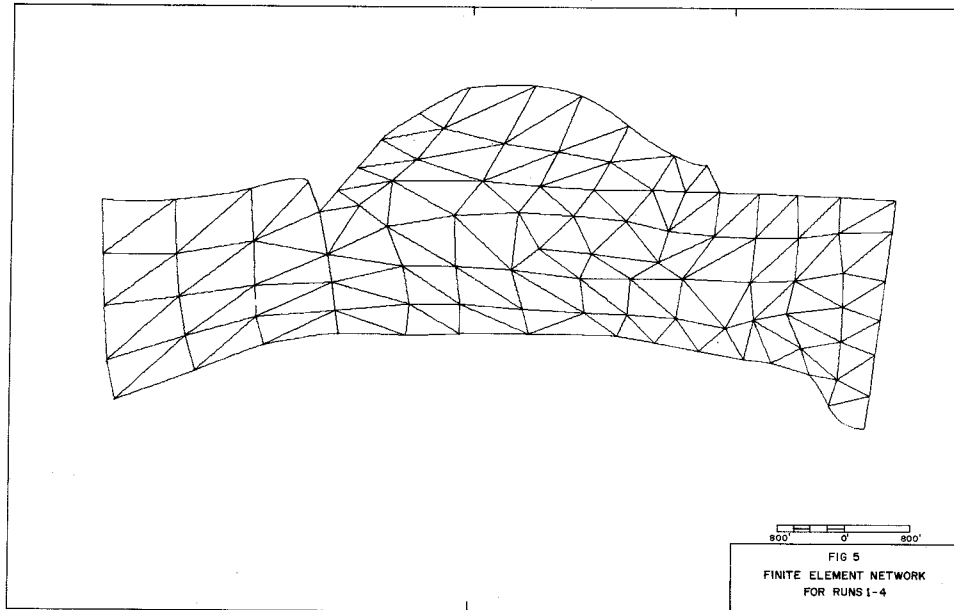

Table 4 Data for McNary Second Powerhouse Study

1. Upstream boundary condition:
 - a. Spillway: $Q = 7000$ cms (250,000 cfs) for calibration runs
 $Q = 0$ for production runs
 - b. Existing powerhouse: $Q = 6500$ cms (230,000 cfs)
 - c. Second powerhouse: $Q = 7000$ cms (250,000 cfs)
2. Downstream boundary condition: Water surface elevation = 82.4 m (270.3 ft) MSL*
3. All other boundaries: Either tangential flow or stagnation points
4. Roughness: Chezy $C = 55$ m^{1/2}/sec (100 ft^{1/2}/sec)
5. Turbulent exchange coefficients: Varied with element size from 4.8 to 14.4 m²/sec (50 to 150 ft²/sec)

*For production runs in which total river discharge was 13600 cms (480,000 cfs). This elevation was varied according to a known stage-discharge relationship for other discharges.

A vector plotting routine was used to display simulated flow fields. Two such plots are shown on Figs. 7 and 8. Plots of this type are considered essential for interpreting and analyzing complex flow fields.

Continuity errors were generally less than $\pm 5\%$ with the exception of the constriction near the downstream boundary where errors were on the order of -15% . If future detailed studies are made, and velocities in that area become important, more network detail will be provided.

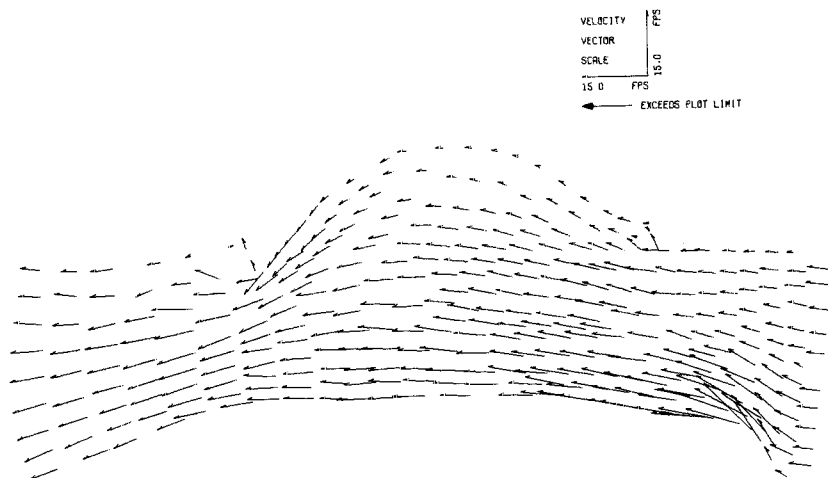

Figure 7 Velocities for Spillway $Q = 7000$ cms (250,000 cfs), Existing Powerhouse $Q = 6500$ cms (230,000 cfs), Slip Boundary Conditions

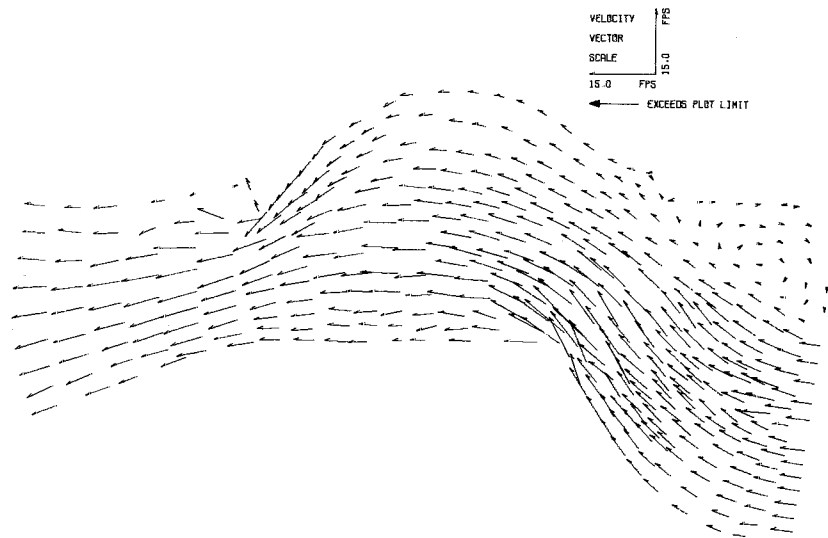

Figure 8 Velocities for Spillway $Q = 0$, Existing Powerhouse $Q = 6500$ cms (230,000 cfs), Second Powerhouse $Q = 7000$ cms (250,000 cfs), Slip Boundary Conditions

The model allows two valid types of boundary conditions at boundaries where no flow enters or leaves the system. One is the stagnation point where both components of velocity are zero; the other is the slip boundary condition where the velocity on the boundary is tangential to the boundary. The slip condition requires use of curved-sided elements on the boundaries. Use of curved boundaries with tangential flow is favored. Use of stagnation points along the boundaries results in a substantially different solution as shown in Fig. 9. Not only is the velocity distribution altered, but calculated head loss in the reach is about 0.21 m (0.7 ft.) greater than with the slip boundary condition. Continuity performance for the two simulations was similar, though in other problems analyzed by Resource Management Associates (1977), the slip condition was superior. Use of different boundary conditions should be investigated in an attempt to identify under what conditions the modeler should choose slip or stagnation point boundaries.

It is encouraging to note that the McNary study required no code changes to the model.

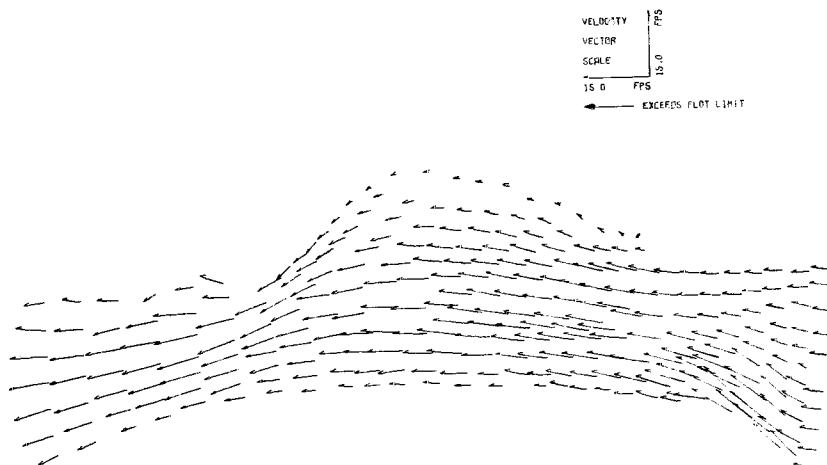

Figure 9 Velocities for Spillway $Q = 7000$ cms (250,000 cfs), Existing Powerhouse $Q = 6500$ cms (230,000 cfs), Stagnation Point Boundary Conditions

DISCUSSION

The applications to date indicate that the model and support codes (graphics, etc.) have evolved sufficiently to be used reliably on a variety of problems. The model can be used on relatively low-budget studies, such as the McNary study, to provide quick visualizations of flow fields near structures. It is anticipated that future work with RMA-2 will involve both project applications and general research. One potential research area is the detailed study of flow near bridges to improve the bridge loss computations in traditional one-dimensional models.

SUMMARY

The work to date with the horizontal flow model indicates the following:

- (1) Internal continuity errors can be reduced to acceptable levels by increasing network detail, particularly in areas of large curvature of the velocity field.
- (2) Errors in continuity tend to be reflected more strongly in the velocity than the depth.
- (3) Improvements to the solution algorithm have produced a computationally efficient model that can be applied to general steady state simulations at present.

Indicated areas of further work are:

- (1) Verification of the model's performance when an adequate data set becomes available.
- (2) Development of guidance on selection of turbulent exchange coefficients, relationship to flow properties, etc.
- (3) Investigate the model's behavior for dynamic simulations.
- (4) Evaluate use of stagnation vs. slip boundary conditions.

ACKNOWLEDGEMENTS

The evaluation of the mass continuity performance was funded by the U.S. Federal Highway Administration. The Walla Walla District, U.S. Army Corps of Engineers funded the McNary second powerhouse study. Continued advice of the finite element model developers: Ian King and Bill Norton of Resource Management Associates, is gratefully acknowledged.

REFERENCES

- Collins, R. J. (1973) "Bandwidth Reduction by Automatic Renumbering," International Journal for Numerical Methods in Engineering, Vol. 6, 345-356.
- Gee, D. M. and MacArthur, R. C. (1978) "Development of Generalized Free Surface Flow Models using Finite Element Techniques," Finite Elements in Water Resources, Proceedings of the Second International Conference on Finite Elements in Water Resources held at Imperial College, London, July 1978, Pentech Press.
- Huebner, K. (1975) The Finite Element Method for Engineers, John Wiley & Sons.
- King, I.P., Norton, W. R., and Iceman, K. R. (1975) "A Finite Element Solution for Two-Dimensional Stratified Flow Problems," in Finite Elements in Fluids, Vol. 1, John Wiley & Sons.
- MacArthur, R. C. and Norton, W. R. (1980) "Application of the Finite Element Method to Vertically Stratified Hydrodynamic Flow and Water Quality," Finite Elements in Water Resources, Proceedings of the Third International Conference on Finite Elements, The University of Mississippi, 1980.
- Norton, W. R., King, I. P., and Orlob, G. T. (1973) "A Finite Element Model for Lower Granite Reservoir," Report to U. S. Army Corps of Engineers, Walla Walla District.
- Resource Management Associates (1977) "Case Studies of Continuity Satisfaction with an Improved 2-D Hydrodynamic Model," Report to the U. S. Army Corps of Engineers, Hydrologic Engineering Center.
- Strang, G. and Fix, G. (1973) An Analysis of the Finite Element Method, Prentice-Hall.
- U. S. Army Corps of Engineers, Jacksonville District (1976) "Flood Hazard Information (Technical Appendix), Rio Grande de Loiza, Puerto Rico."
- Zienkiewicz, O. C. (1971) The Finite Element Method in Engineering Science, McGraw Hill.

PAPER DISCUSSION

EVALUATION AND APPLICATION OF THE GENERALIZED FINITE ELEMENT
HYDRODYNAMIC MODEL, RMA-2

by
D. Michael Gee
Robert C. MacArthur

- Question: How is friction described in this model?
- Dr. GEE The model uses the Chezy Law and it has the ability to change the friction coefficient by element. The model can handle up to 9 or 10 different Chezy C's or element types. The Waterways Experiment Station has done some work on that so that they can input Manning n- values and merely convert the n- value into a Chezy C.
- Comment: Mr. Harrison: Because of the degree of complexity that these models have, the advanced training the users need to apply them and the amounts of data required to make applications, I wonder if these models are really practical engineering tools.
- Dr. Gee: That was a question that we tried to pose in the beginning of the seminar and hopefully we can focus on this more throughout the seminar. We need to get everyone's opinion on this topic.
- Question: Can we ever let one of these models loose to the public for their everyday application?
- Dr. Gee: I'm not sure we need to address that at this time, however that's one of the important issues of this seminar. Perhaps we can come to grips with that by the end of the seminar. If we agree that you are right, then that's an important conclusion to be drawn from this meeting today.
- Comment: Dr. Walters: In the formulation of the equations we notice that you have eddy viscosity, but in the finite difference models that were discussed yesterday they seemed to neglect eddy viscosity. Our experience shows that when you don't add something like eddy viscosity and make it the dominant term, when the convective terms are significant then our solution never converged. Now, if we quickly look at a order of magnitude on the terms in this equation and look at u partial with respect to x , I get a rough order of magnitude of about 10 to the minus 2 and at the same time you have an eddy viscosity with the magnitude of about 500.

- Question: Have you done any kind of order of magnitude analysis on these terms to see if you have added terms which are normally neglected, and are you making them dominant?
- Dr. Gee: That's a very good question. The answer is no, we have not done that here at the HEC. Perhaps Dr. King would like to respond to that question.
- Comment: Ian King: We have, but I can't remember the particular application we were looking at. The answer to your question really is that what we have done is reduce the eddy coefficients as low as we could consistent predominantly with network size. We view the eddy viscosity as associated with the sub grid scale eddies that occur due to turbulence that we are not modeling. We have found that the size of the coefficient is dominated very much by the size of the grid. That is as we make the grid finer then we go to lower coefficients. We also find that the model results are relatively insensitive to the value of it, once we get down to these values. And in relatively convective situations, as in some of the results I'll present in a few minutes, associated with San Francisco Bay, we get good verification of velocity and head distributions. I think predominately we look toward verification in the field, of how field measurements in complex situation can be modeled. We feel confident you can get those kind of results.
- Question: Have you tried dropping the convective terms?
- Dr. King: I don't think I've ever tried dropping a convective term.
- Question: What I'm saying is that it looks like from an order of magnitude analysis that the advective terms are being overwhelmed by the diffusive terms and eddy viscosity. What do you think about this?
- Dr. King: I can not answer that directly because the convection term produces the nonlinearity in the model.
- Comment: Dr. Waldrop: That's what gave us problems too.
- Dr. King: Our results from the first iteration and for the final iteration are dramatically different. Perhaps that answers the question. In other words, the velocity distribution you get from our initial linear solution is primarily the eddy viscosity dominating term. It's entirely a different set of distributions that you get out with the convection terms.
- Question: Wouldn't you also have to look to see if the friction terms were dominating and controlling the situation when you're making an application?

Dr. King: In the Loiza application some of the difficulties you had in getting a solution were associated with the large roughness elements associated with mangrove forests and sugar cane fields. So head losses were rather unusual for that study.

Question: When are eddy viscosity terms needed for numerical stability and when are they needed to describe the physics of the problem? Are we really talking about two different things?

Comment: Dr. Walters: This is dependent upon a numerical scheme that one chooses to use and very dependent upon the physics of the problem. In the numerical schemes it's related to the overall equation set that one is using as well as the kinds of elements and shapes of those elements that they might incorporate into their numerical scheme. When I discuss the work that the U.S. Geological Survey has been doing, I hope to address this issue at greater length.

Question: Have you considered using a law of the wall relationship rather than your current slip boundary condition approach?

Dr. King: This would be an attractive approach; but for the scale of problems that we deal with in rivers and reservoirs, would that be significant?

Comment: Larock: It would bear investigation I think.

Comment: Dr. Walters: For the particular problem you are solving the natural boundary condition would be the stress on the side, and you can have a stress that is proportional to the velocity along the boundary. This will allow you to introduce a stress on the boundary without discriminating a boundary layer. The problem is you want to use large elements but yet you don't like the results because you want to add the boundary layer effects which would require small elements. Therefore, you can't get both features simultaneously. You need to make a decision about the amount of detail and refinement you want or need for a particular application.

Comment: Dr. Tseng: Dr. Ming Tseng discussed his experiences with applying RMA-2 to harbors and rivers where bridges are located and the river is constricted by the bridge approach. He described his applications and the need to have more elements and smaller elements in the area of the constriction and the nice features that curved-sided elements allow. Dr. Ming Tseng also discussed the fact that he had great success in using the published values for eddy viscosity suggested by Ian King, Bill Norton and Jerry Orlob in the literature. There are published values available for eddy viscosities in several directions. By using these

published values he said that the model could be applied fairly easily and that calibration of those and adjustment of those values can be made if measured data are available.

Question: What is the status of the flooding boundary version of the RMA-2 code?

Dr. Gee: I understand there is a version of the RMA-2 finite element model that can handle flooding boundaries and the Waterways Experiment Station is applying it. It might be best to contact Bill Norton or Ian King at RMA or Tony Thomas at WES.

HYDRODYNAMIC AND WATER QUALITY SIMULATION IN SAN PABLO BAY - A CASE STUDY

by

William R. Norton¹
Ian P. King¹

INTRODUCTION

Over the past several decades the nation has undertaken a massive program of improving its water resources. While this program has many facets, one of its major aspects has been to improve and upgrade the collection and treatment of sanitary sewage. Much of this upgrading has been done in an effort to minimize the environmental impact of the treatment plant effluent. This has been done by improving the quality of the effluent and developing creative plans for use and disposal of the effluent.

A case in point occurs along the western edge of San Pablo Bay just north of San Francisco (see Figure 1). Wastewater management plans for municipalities in the area, known as the East Marin-South Sonoma (EMSS) dischargers, have been in preparation for several years.

Among the several plans suggested were both deep and shallow water outfalls as well as intermittent discharge with onshore storage lagoons. It was the objective of this work to provide input to the final assessment of EMSS wastewater management plans in regard to their impact on receiving water quality and to describe the methods and techniques used in connection with the mathematical modeling of San Pablo Bay.

The technical objectives of this work can be summarized in two main areas. The first entails calibration and verification of the mathematical models used to simulate the hydrodynamic and water quality of San Pablo Bay. This activity required acquisition of all relevant environmental and hydrologic data for the period of a dye study conducted in 1978 (i.e., wind strength, tidal range, freshwater discharges, etc.) and interpretation of the results from the dye study in a format comparable to information produced by the mathematical models. A series of model runs were then made and appropriate model parameters and coefficients (i.e., eddy diffusion coefficients, etc.) adjusted until satisfactory agreement was achieved between model and prototype.

The second activity was to evaluate the effects of wastewater outfalls on the water quality of San Pablo Bay. To meet this objective, a series of computer runs were made simulating the aggregate impact of all discharges (i.e., Novato, Las Gallinas, Marin Bay, the Petaluma River, etc.) as well as the impact from the individual discharges.

¹ Associates, Resource Management Associates, Lafayette, California

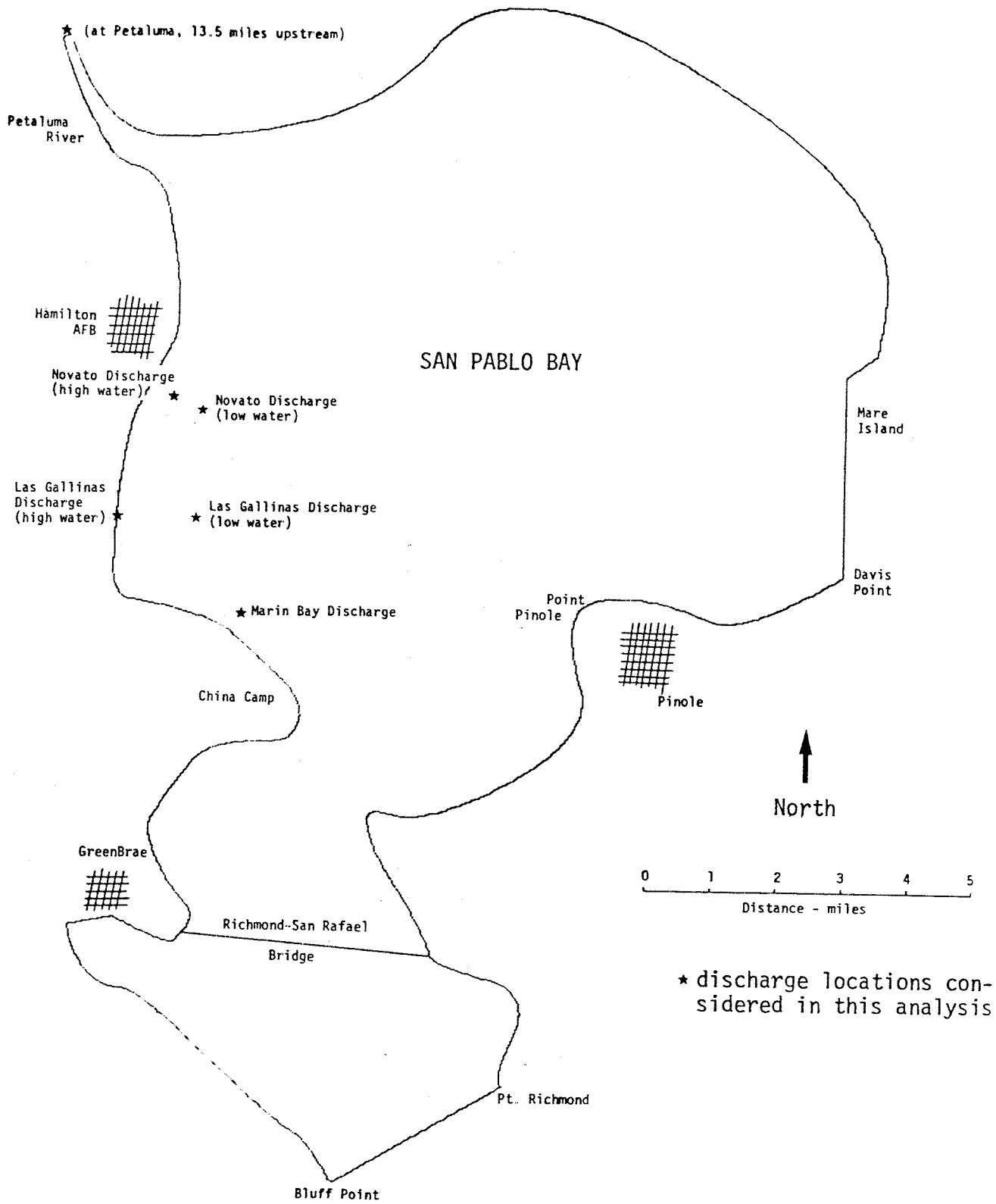

FIGURE 1
 LOCATION MAP
 SAN PABLO BAY

MODELING APPROACH

To simulate two dimensional hydrodynamic and water quality problems of the type described above, RMA has developed two similar computer programs, RMA-2 and RMA-4. RMA-2 is a generalized free surface hydrodynamics program used to calculate the temporal and spatial velocity and depth. RMA-4 is a generalized two dimensional water quality model, and uses the results from RMA-2 for its description of the flow field.

The governing differential equations used by RMA-2 can be written in the form:

$$\begin{aligned} \frac{\partial u}{\partial t} + u \frac{\partial u}{\partial x} + v \frac{\partial u}{\partial y} + g \frac{\partial h}{\partial x} + \frac{\partial a_0}{\partial x} - \epsilon_{xx} \frac{\partial^2 u}{\partial x^2} - \epsilon_{xy} \frac{\partial^2 u}{\partial y^2} \\ - 2 \omega v \sin \phi + \frac{gu}{C^2 h} (u^2 + v^2)^{1/2} - \frac{\zeta}{h} V_a^2 \cos \psi = 0 \end{aligned} \quad (1)$$

$$\begin{aligned} \frac{\partial v}{\partial t} + u \frac{\partial v}{\partial x} + v \frac{\partial v}{\partial y} + g \frac{\partial h}{\partial y} + \frac{\partial a_0}{\partial y} - \epsilon_{yx} \frac{\partial^2 v}{\partial x^2} - \epsilon_{yy} \frac{\partial^2 v}{\partial y^2} \\ + 2 \omega u \sin \phi + \frac{gv}{C^2 h} (u^2 + v^2)^{1/2} - \frac{\zeta}{H} V_a^2 \sin \psi = 0 \end{aligned} \quad (2)$$

$$\frac{\partial h}{\partial t} + \frac{\partial}{\partial x} (uh) + \frac{\partial}{\partial y} (vh) = 0 \quad (3)$$

where u, v = fluid velocity in the X and Y directions, respectively

t = time

$\epsilon_{xx}, \epsilon_{xy}, \epsilon_{yx}, \epsilon_{yy}$ = eddy viscosity coefficients in the X and Y directions

g = the gravitational constant

C = the Chezy coefficient

- h = the local water depth
- ζ = an empirical coefficient for wind shear
- V_a = the local wind velocity
- ψ = the angle between the wind direction and the X axis
- ω = the rate of the earth's angular rotation
- ϕ = the local latitude
- a_0 = the bottom surface elevation

The governing equation for RMA-4 is derived from a statement of conservation of mass and takes the form:

$$\frac{\partial c}{\partial t} + u \frac{\partial c}{\partial x} + v \frac{\partial c}{\partial y} + \frac{\partial}{\partial x} (D_x h \frac{\partial c}{\partial x}) + \frac{\partial}{\partial y} (D_y h \frac{\partial c}{\partial y}) \pm \phi = 0 \quad (4)$$

- where
- c = the concentration of the material in transport
 - u,v = the fluid velocities in the X and Y directions, respectively
 - h = the water depth
 - D_x, D_y = eddy diffusion coefficients
 - ϕ = an external source or sink of the material in transport

Both the models RMA-2 and RMA-4 are written in a generalized format and each may be applied to any appropriate problem by definition of problem specific data. Each is coded for numerical solution by the finite element method using Galerkin's method of weighted residuals. As the equations used to describe RMA-2 are nonlinear, a fully implicit, iterative, Newton-Raphson solution technique is used to obtain a numerical solution. Each model is coded in the FORTRAN programming language for solution by digital computer, and each model is capable of operating in either steady state or dynamic mode.

MODEL IMPLEMENTATION

The implementation of the finite element models took place in the five steps outlined below.

- 1) Construction of a finite element grid which could be used for both calibration and application. Construction of the grid was guided by the physical variability of the problem and the necessity to be able to specify flow and quality boundary conditions at the systems extremities.
- 2) Preparation of boundary conditions for flow and quality. For the hydrodynamic simulations this was done with the aid of the one dimensional link-node mathematical model of the entire Bay-Delta system. Quality boundary conditions are assumed at a concentration of zero on inflow and are allowed to be free on outflow.
- 3) Operation of RMA-2 to estimate velocities and depths throughout San Pablo Bay. As no direct measurements of either velocity or depth was available, acceptance of the flow simulation was subjective.
- 4) Operation of the water quality model, RMA-4, on the same schedule of dye inputs as were used in the field study and to adjust its coefficients to match observations.
- 5) Presentation of the results and an evaluation of the accuracy of the modeling approach.

The finite element network constructed for this problem is shown in Figure 2. This network contains 490 nodes and 198 elements and was developed primarily from information contained in the National Ocean Survey Chart 18654. The overall limits of the network were determined by two criteria. First, due to the difficulty of estimating inflow concentration boundary conditions if wastewater or dye leave the system, the network needed to be large enough so that inflow concentrations could reasonably be assumed to be zero under all tidal conditions. The second criterion is to extend the network to points where the hydraulic boundary conditions can be specified. This criterion is met by extending the network to points where head and flow can be reasonably approximated, and where inevitable errors in such specifications will have insignificant effects.

Finally, it was known that large mudflat areas are exposed in San Pablo Bay at low tide. To accommodate this situation, the San Pablo Bay network was given the ability to automatically delete mudflat areas at low tide conditions. The location of the waterline at lower low water was also determined from Ocean Survey Chart 18654, and the mudflat areas defined as indicated in Figure 2.

Next, the link-node model was run on the entire Bay-Delta system to a repeating dynamic condition with the average tidal, local runoff and net delta outflow conditions which occurred during the dye survey. Head and flow values extracted at Point Richmond and Mare Island were used as input to the finite element model.

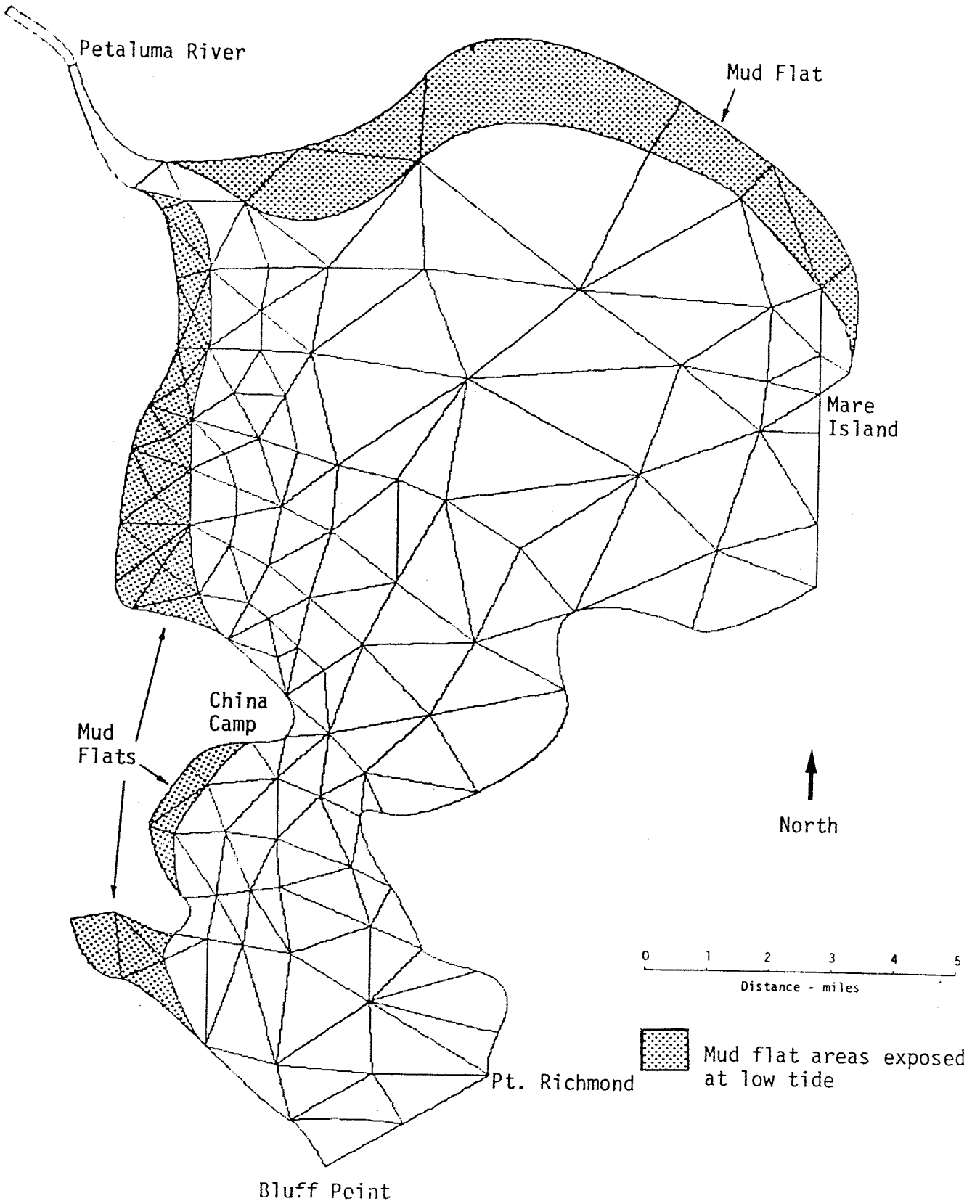

FIGURE 2
FINITE ELEMENT NETWORK FOR SAN PABLO BAY
WITH MUDFLATS SHOWN

Next, RMA-2 was run with one hour time steps for three complete tidal cycles. After about 1.5 tidal cycles the results began to reproduce themselves, and the third cycle was saved for input to RMA-4.

Plots of typical velocity vectors are shown in Figure 3. In these simulations the effects of wind were considered to be negligible, and the eddy viscosity coefficients were set at nominal, equal, values. As no direct measurements of Bay velocities were available, these results are subjectively deemed to be acceptable.

The next task was to simulate the release of dye into San Pablo Bay for the purposes of comparing simulated and observed receiving water concentrations. The dye prototype release operation can be summarized as follows. A known quantity of dye was injected into the Novato discharge for a six hour period for each of the six days from March 20-25, 1978. In this period a total of 43.446 kg of Rhodamine WT was injected into the Novato Sanitary District outfall and was released into the bay with the sewage effluent. The dye was injected at a constant rate for six hours a day for each of six consecutive days by personnel of the sanitary district. The daylight high tide period provided sufficient depth over the diffuser to permit dye release for three hours before and after high slack water. The dye injection rate was not flow proportioned and the mass of dye injected per unit time was a constant.

RMA-4 was programmed to simulate the dye release schedule. For the purposes of the model, the dye was assumed to be released at a constant average rate of 0.3352 gm/sec over the six hour period. The dye was input to the model at the location of the Novato outfall; this location was always submerged at the time of the dye release.

The model was run for eleven days of simulation. For the first six days, dye was injected at the above rate; for the final five days the previously input dye was simply allowed to dissipate within San Pablo Bay. The model simulation was concluded at the end of eleven days due to the low concentrations found in both the model and the prototype.

The model's coefficients were adjusted by comparison of simulated and observed dye concentrations for the first four days of simulation without regard to the final seven days of data. The only coefficients adjusted were the eddy diffusion coefficients (see Equation 4).

Field surveys of dye concentrations were conducted on five of the eleven days simulated. Dye samples were collected from a helicopter in the daylight hours for each of the days sampled. Typical comparisons of observed and simulated dye concentrations are shown in Figure 4. In this plot the observed values are shown as the individual star points, while the results of the model are presented as the continuous line. Values are shown for each of five sampling transects after four days of discharge. From the information on these plots, and by other statistical measures the model was judged to be sufficiently accurate to conduct the required water quality analyses.

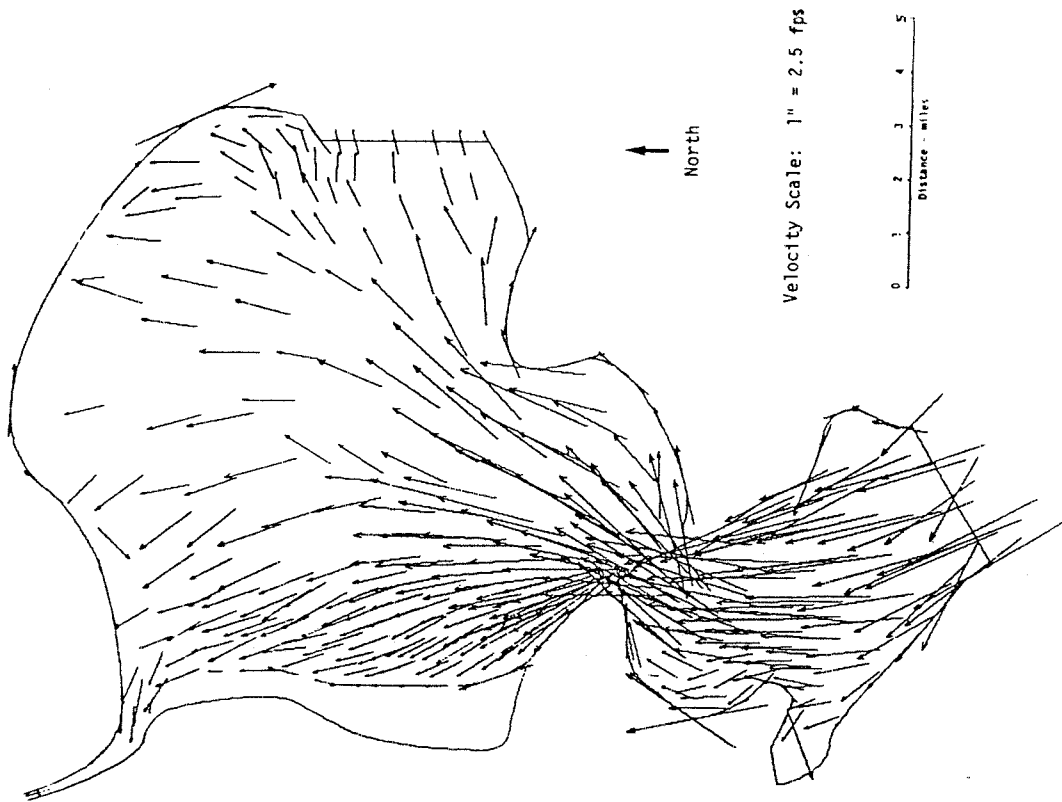
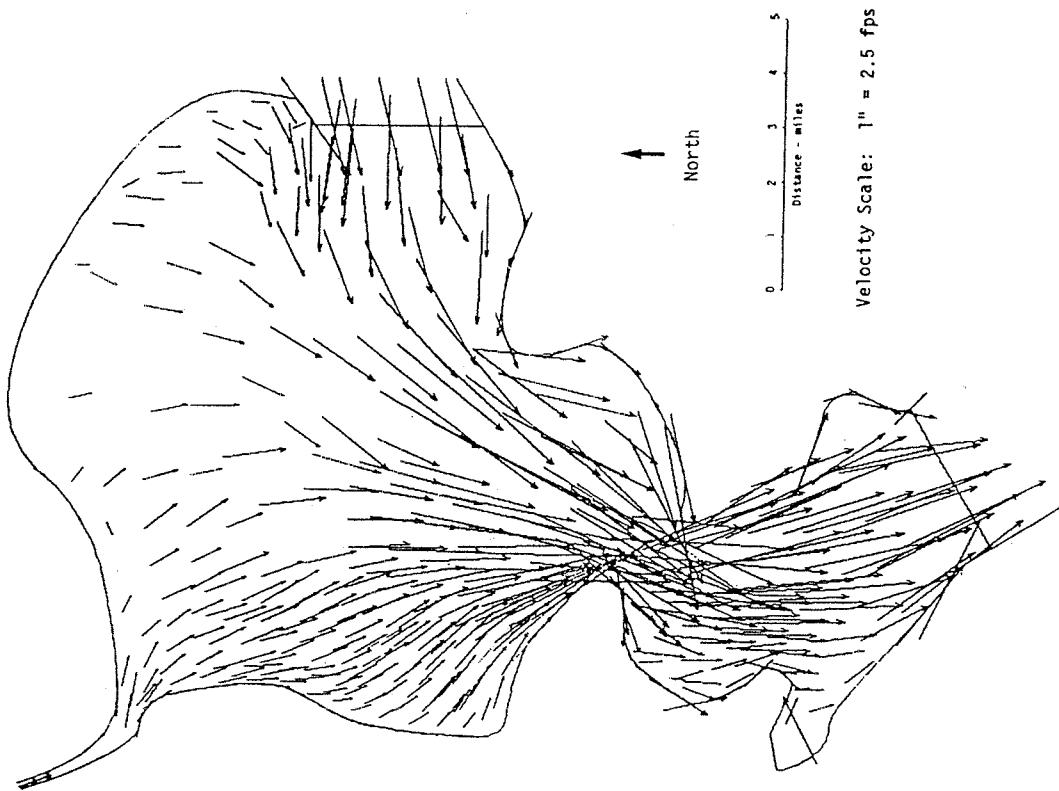
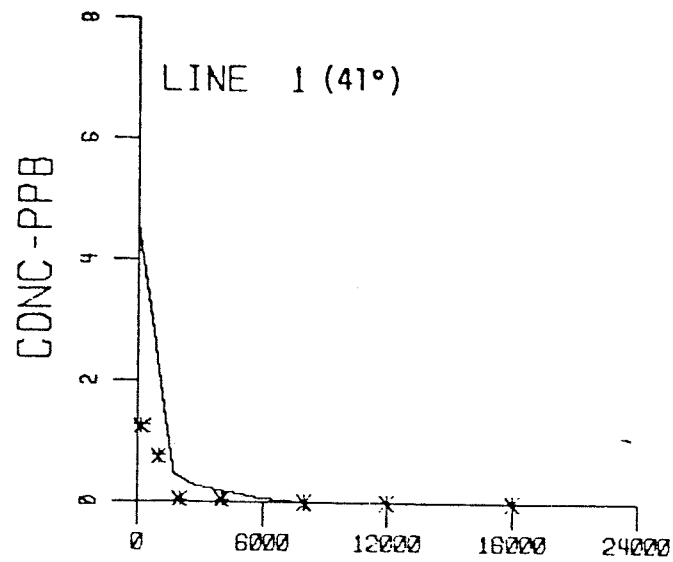

FIGURE 3

TYPICAL VELOCITY VECTORS FOR SAN PABLO BAY



* Observed Dye Concentration
 — Simulated Dye Concentration
 (110°) Transect bearing from dye release location

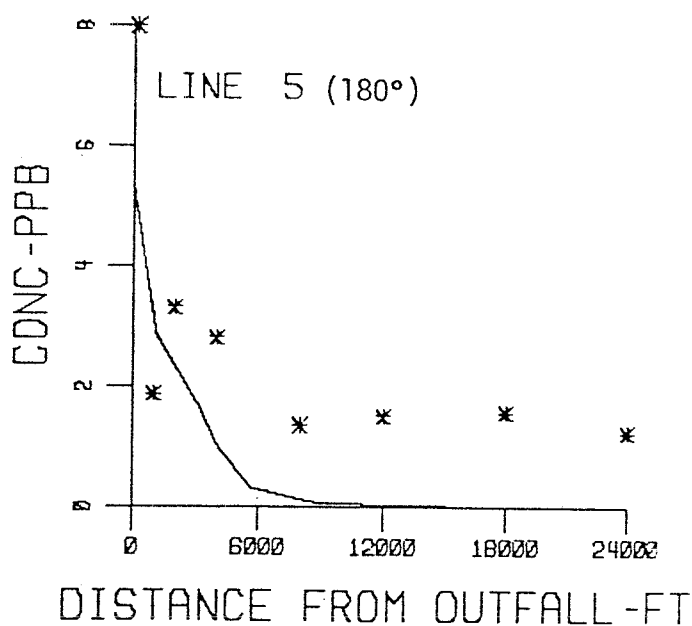
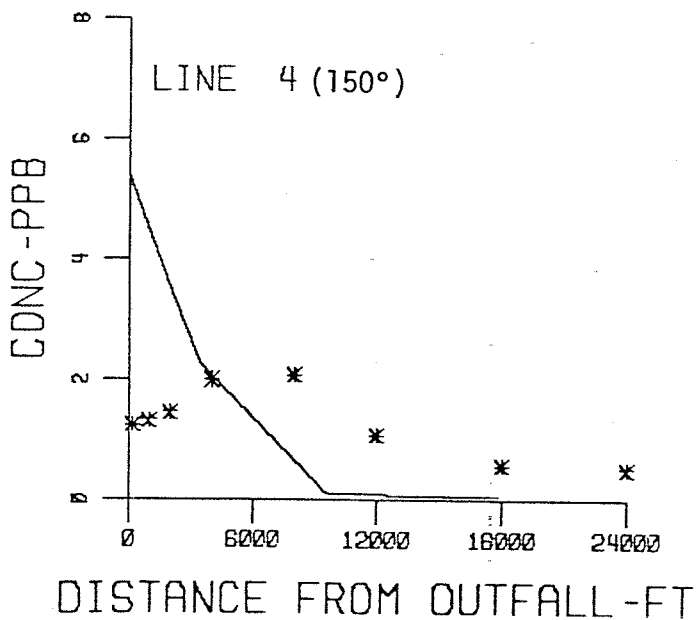
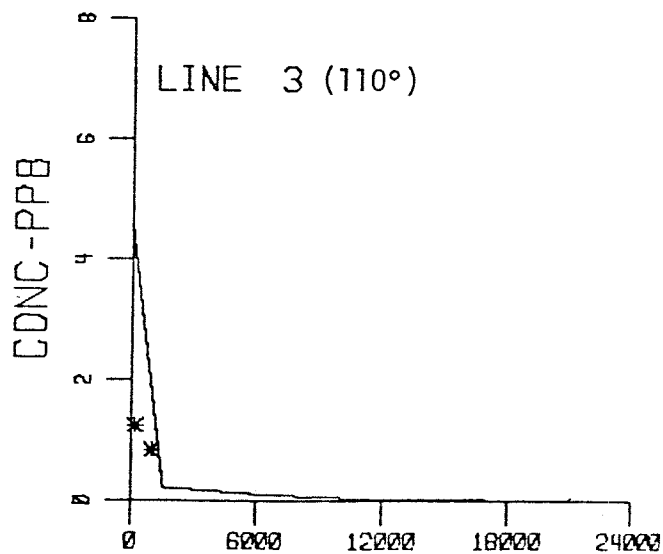
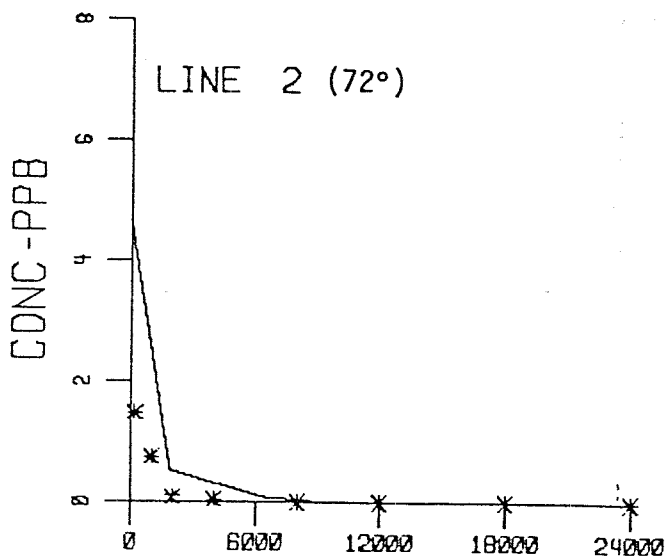

FIGURE 4
 COMPARISON OF OBSERVED AND SIMULATED DYE CONCENTRATIONS,
 DAY 5 OF DYE RELEASE

MODEL APPLICATION

The final activity was to simulate the effects of the proposed wastewater outfalls. Discharges from four locations were considered in this analysis. Their locations and flows are summarized in Table 1.

TABLE 1
DISCHARGE RATES FOR THE
FOUR EMSS OUTFALLS INCLUDED IN
THE MATHEMATICAL MODEL OF SAN PABLO BAY

Location	Average Dry Weather Flow (mgd)	Average Dry Weather Flow (cfs)	Mass Emissions @ C=100 mg/l (gm/sec)
Petaluma Discharge	5.25	8.12	23.00
Novato Discharge (Novato and Ignacio)	6.55	10.13	28.70
Las Gallinas Discharge	2.73	4.22	11.96
Marin Bay Discharge	0.25	0.39	1.10

The location of each outfall relative to the San Pablo Bay grid is indicated in Figure 1. The discharge from the Novato and Ignacio plants is combined for this analysis and enters San Pablo Bay through the existing Novato outfall.

The hydrodynamic and water quality models were run using these inputs, and the results output in graphical format. Typical plots of the dilution ratio for all discharges are shown in Figure 5. Through the use of this type of plot, plus time histories of concentrations at given locations, it was possible to quantify the expected effects of the EMSS discharges on the water quality of San Pablo Bay.

CONCLUSION

As a result of this work the following conclusions have been drawn. First, that two dimensional description of the west side of San Pablo Bay is adequate and there is no evidence that a three dimensional model is required. Also, it is apparent that a one dimensional model would be inadequate to describe the dynamic and spatial variability of this area.

Next, both the dye and modeling results indicate that most transport results from convective transport. This means that the models results are relatively insensitive to its "eddy coefficients" and relatively sensitive to a proper specification of the physical system.

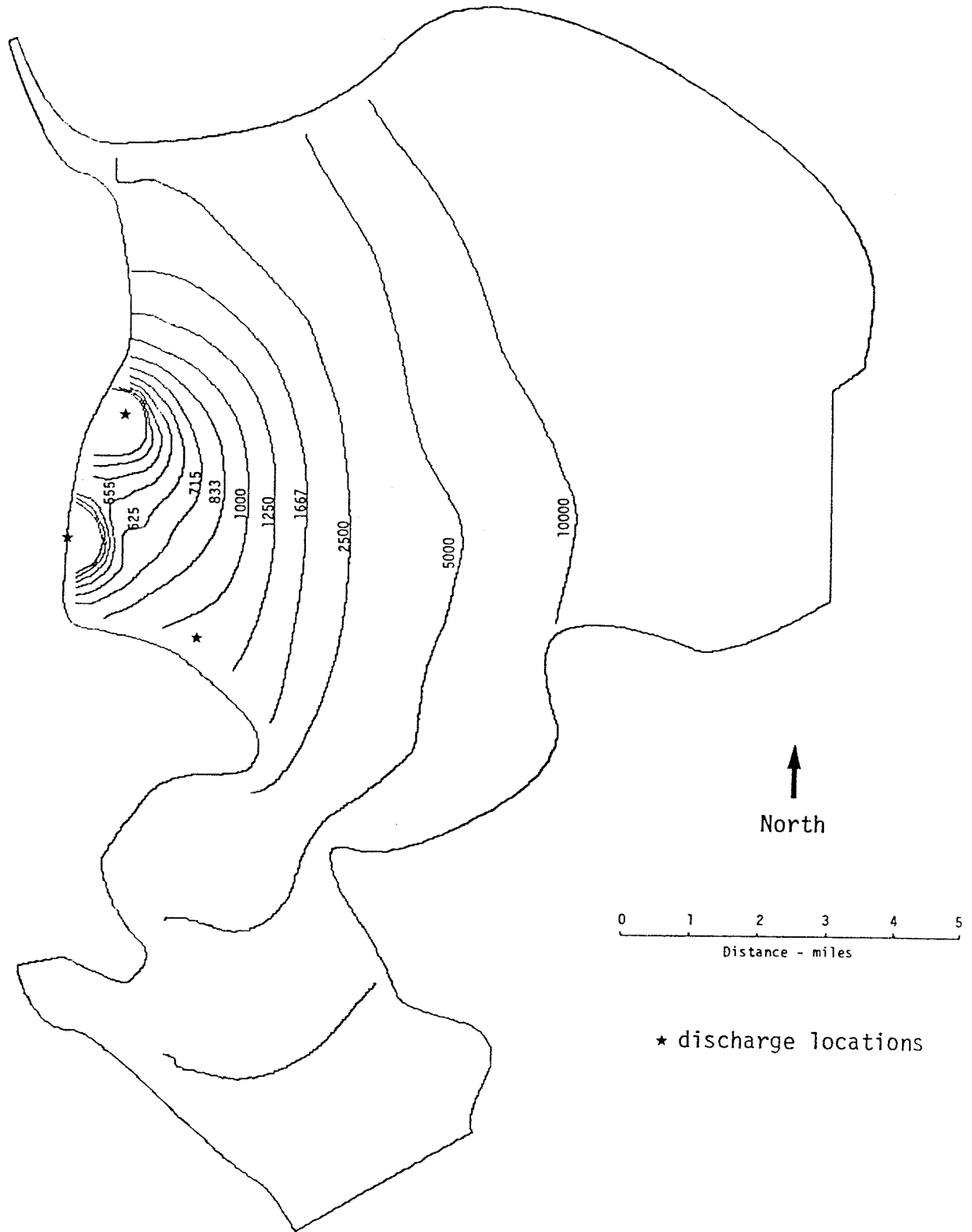

FIGURE 5

DILUTION CONTOURS FOR ALL DISCHARGES -
SLACK AFTER HIGHER LOW WATER

Field observations of dye released at Novato outfall in the Spring of 1978 show the dye staying close to the shoreline in the area south of the outfall. The model indicated the same general type of behavior, although the model had a tendency to move dye further offshore than was observed in the field. As a result, the model produced dilutions which were higher than those observed in the field. It is believed that this occurred due to a lack of accuracy in available data for the bottom elevation along the west side of San Pablo Bay.

Finally, simulation of the proposed EMSS outfalls with the mathematical models proved to be a straightforward operation. The models were able to produce the required estimates of individual and aggregated wastewater dilutions as desired, and all results appear reasonable and within expectations.

PAPER DISCUSSION

HYDRODYNAMIC AND WATER QUALITY SIMULATION IN
SAN PABLO BAY - A CASE STUDY

by
William R. Norton
Ian P. King

Question: How much did it cost you to conduct the study that you just reported?

Dr. King: For three tidal cycles and approximately 700 nodes it costs about \$500.00 in computer time or about \$160-\$170/tidal cycle. By using of the model's resolution technique, this can be cut to about \$15/tidal cycle for a six constituent quality simulation. Another advantage of this approach is its ability to compute a direct steady state solution, with a dramatic cost savings over iterative methods.

Question: Would you anticipate any particular problem with your moving boundary model if it were to be applied to the over banking flow problem with broad flood plains surrounding the channel?

Dr. King: No, we have done testing with large scaled problems requiring significant element sizes and involving large inundated areas. I anticipate that the code would have problems with flows that would overtop an embankment or levee causing weir type flow on the other side of the embankment. This type of problem is beyond our current capabilities but we are working on it.

Question: Has RMA been working on a fully 3-dimensional code?

Dr. King: It will simulate either homogeneous or non-homogeneous flow in steady-state or dynamic modes. This model is an extension of RMA's overall finite element approach to flow modeling and incorporates many of the ideas found in our two-dimensional codes. The three-dimensional code is now undergoing final tests and comparisons and should be available through WES before the end of 1981.

Question: Can a 2-dimensional model deal with the salt water wedge intrusion and flow reversal type problem that we experience in the bay?

Dr. King: Yes. We have applied our two-dimensional vertical model in several locations and reproduced the flow reversals and velocity distributions which are measured in the field. Our most recent application was to the Suisun Bay region of San

Francisco Bay, where we were able to dynamically reproduce the velocity and salinity effects measured by the Corps for calibration of the physical model. The results from this work can be made available if requested.

Question: Is that a vertical 2-D problem?

Dr. King: It's really a three-dimensional problem due to the configuration of the outlet. The downstream flume section was influenced by horizontal considerations while the upstream section was influenced by vertical considerations.

Question: Would you please describe briefly how your moving boundary code works and how you increase or decrease elements?

Dr. King: Yes. First you decide if an element is wet or dry by finding if it has any dry nodes. If it has some dry nodes, you locate a point of finite depth (say 0.2') along each element side and reconstruct the element using the point of finite depth as the new corner node point. With the assumption of zero velocity at the water's edge, we get away from parallel or sloping boundaries at the node point. The model checks for the moving boundary at each time step and automatically adjusts the network as required. There is very little extra input data that needs to be supplied by the user.

Question: Does it require more iterations and more money?

Dr. King: It requires more iteration per time step as you might expect. You have to iterate into something like this. The advantage of this is you are not stuck with any particular grid restrictions.

COMPUTER SIMULATION OF WATER
MOTIONS IN RIVERINE SYSTEMS

Bernie R. Bodine (1)

ABSTRACT

A method is presented for calculating water motions in riverine systems consisting of both flood plain areas and channels. The governing hydrodynamic relations are used in which the motions in channels are simulated in two horizontal dimensions. Provisions are made in the solution scheme to couple the one-dimensional channel flows with the two-dimensional flood flows - thus allowing the two flow regions to communicate with each other. Channels are taken such that they are embedded in the two-dimensional network.

In the explicit type solution scheme used, allowance is made for levees or barriers to be treated in connection with the simulations. These barriers can be provided at any location in the modeled system and may be located on one side of a channel or both sides of a channel if required. Also, the model can be used to simulate flows in independent channels and tributary channels to the independent channels. In addition, the model allows for a moving boundary both in the channels and in the flood plain areas. Thus, dry channels or flood plain areas can flood during periods of increasing water levels and dry up again after the passage of the flood wave.

Application is made to the channels and flood plain areas below Barker and Addicks reservoirs in and in the vicinity of Houston, Texas. A spillway design flood is simulated in which flows originate at the outlet works of both dams and around the ends of both dams.

INTRODUCTION

A hydrodynamic model is presented for simulating unsteady and spatially varied flow and elevations of the water surface in riverine systems consisting of flood plain areas, rivers and tributary streams. Water motions in the flood plain areas are calculated with equations which describe the motions in two horizontal dimensions while the motions in channels are calculated by equations which describe the motions in the solution scheme in such a manner that the water in flood plain areas and channels can communicate with each other.

The mathematical model developed provides a realistic approach to the problem where expansive flood plains are involved and where there is interaction between various streams and river basins as a result of overtopping drainage divides. Provisions are made in the solution scheme to calculate flows in tributary streams that are connected to each of the main stem channels. Also, the model allows for effects of barriers (levees, roadway embankments, etc.) on the resulting flows.

(1) Hydraulic Engineer, Hydrologic Engineering Section, Water Management Branch, Southwestern Division, US Army Corps of Engineers, Dallas, Texas.

In the absence of specifying channels in the model, the solution scheme reduces to one that simulates only two-dimensional flows. On the other hand, if water is totally contained in the channel during the entire simulation period, the flow analysis reduces to a purely one-dimensional approach.

The two-dimensional solution scheme incorporated in the riverine model was based on the concept of the model developed by Reid and Bodine (1968) for calculating storm surge in coastal embayments. Some minor modifications to the concept were made in the present investigation due to some fundamental differences in the riverine and storm surge problems. Reid, Vastano and Reid (1977) extended the Reid and Bodine storm surge model to include a method for analyzing flows in channels connected to an embayment. The methodology developed for including channels in the storm surge model was useful in formulating the channel solution technique in the riverine model. In the storm surge model, the method of characteristics was used for calculating the flow in channels - a solution technique not readily adaptable to flooding boundaries. Unlike channels in tidal areas which are almost always flooded due to the levels in the sea, many channels in river basins can be flooded or dry depending on the state of the flows. Because flooding boundaries are important both in the flood plain areas and channels in the solution of riverine problems, an alternate approach was used in formulating the solution scheme for channels.

Flood plains are represented by a two-dimensional grid network in which the local topography is portrayed in terms of uniform elevation for uniform grid squares. Channels are taken to be embedded in the grid network at the edge of the grid squares. Barriers, like channels, are subgrid scale features that are also located at the edge of the grid squares. Provisions are made to specify a barrier on one or both sides of a channel.

The model was applied to an area consisting of portions of the Buffalo Bayou, Oyster Creek and Brazos River watersheds in, and in the vicinity of, Houston, Texas. Hypothetical flooding of the area is simulated based on a spillway design flood from two flood detention reservoirs, namely Barker and Addicks Reservoirs. The modeled area is characterized by relatively flat topography and rather high density of homes, business establishments and factories. Flooding as a result of the spillway design flood is caused by water flowing through gated structures at the dam and around the ends of the dam. Extensive flooding of the area takes place due to the physical characteristics of the basins involved and overtopping of drainage divides.

GENERAL PHYSICAL THEORY

This section presents the St. Venant equations that are used in the development of a numerical computational scheme for calculating water motions in channels and flood plain areas for riverine systems. Hydrodynamic relations are presented in which the motions in channels are described in one horizontal dimension while motions in flood plains are described in two horizontal dimensions. Although the basic relations for channels and flood plains are different from the

standpoint of dimensions, they are ultimately coupled so that the two flow regions can communicate with each other.

Channel Dynamics.

Flows and elevations of the water surface in confined, relatively long and narrow channels can be described reasonably accurate with one-dimensional relations. A number of investigators have derived such relations, for instance, Stoker (1957) and Dronkers (1964). In the derivation of the channel relations, it is assumed that the water surface is uniform across the channel for any stage and that the velocities in the channel can be represented in terms of a mean velocity. Also, it is usually assumed that the effect of the earth's rotation can be neglected and that the effects of channel meandering can be adequately represented through specification of bottom resistance.

In the present investigation, the equations of motion and continuity are taken as follows:

$$\frac{\partial Q}{\partial t} + \frac{Q}{A} \left[\frac{\partial Q}{\partial \ell} - \frac{Q}{A} \frac{\partial A}{\partial \ell} \right] + \frac{g n^2 Q |Q|}{2.21 A R^{4/3}} + g A \frac{\partial H}{\partial \ell} = q_i u_i - q_o u_o \quad (1)$$

$$B \frac{\partial H}{\partial t} + \frac{\partial Q}{\partial \ell} = q_i - q_o \quad (2)$$

in which Q = discharge; t = time; g = gravity; ℓ is the horizontal coordinate along the axis of the channel; n is Manning's roughness coefficient; A is the area of channel cross section; R is the hydraulic radius ($R = A/P_e$); P_e is the wetted perimeter of the cross section; H is the water surface elevation relative to the local mean sea level (msl) datum; B is the water surface width; q_i is the lateral inflow per unit length; q_o is the lateral outflow per unit length; u_i is the channel-directed component of velocity; and u_o is the channel velocity (Q/A).

Boundary Conditions. At the limits of a channel at the upstream end, the boundary may be taken as either open or closed depending on whether the channel continues past the boundary or terminates. For either an open or closed boundary, the boundary condition is the specification of the discharges at uniform time intervals in which the discharges for a closed boundary are simply $Q = 0$ for all time t . At the downstream boundary, the boundary condition is taken in terms of the water level in which elevations of the water surface are either prescribed from available observational data or estimated based on predetermined information. Provided that known water levels are available at the downstream boundary, these levels should always be used for establishing the conditions at the boundary. Unfortunately, in the case of design studies, there is seldom, if ever, any information available with regard to the downstream water levels, and it is thus necessary to resort to an approximate condition at the boundary.

The approach used for approximating the downstream boundary condition is related to the computation scheme adopted. For this scheme, the channel bed is represented in terms of discrete reaches in which the elevation of the bed is taken uniform over each reach length, thus forming a stairstep-type representation of the actual channel bed. The elevation of the channel bed, Z , is considered to be located at the center of a given channel reach, and the elevation of the water surface H , is taken to be located at the same position as Z . At the downstream boundary, the elevation of the water surface is estimated by

$$H_1 = Z_1 + (H_2 - Z_2) \quad (3)$$

where the subscript 1 denotes the position at the boundary and 2 denotes the position at the adjoining reach immediately upstream from the boundary. This simple expression merely indicates that the water level at the boundary is equal to the elevation of the streambed at the boundary plus the water depth at the adjoining reach. Equation (3) is only valid, if and only if, $Z_1 < Z_2$.

Allowance is made in the solution scheme for channels to communicate with flood plain areas or potential ponding areas. Thus, channels are regarded as an open system since both water and momentum can be transferred laterally.

Initial Conditions. Two different types of starting conditions may be used. The first of these is to start the system dry in which H is taken equal to the bed elevations and Q is set to zero for all x . In advance of a flood, riverine systems are seldom completely dry due to the presence of relatively small flows or base flows. However, it is possible to start the system dry and perform the necessary computations, with approximate upstream boundary conditions, until such time that the base flow conditions are reproduced prior to starting the flood flow simulations.

The second type of starting condition is to initiate the calculations with a uniform water level in at least a part of the channel system. This type of starting condition is useful in the case that a channel is connected to a large water body, such as a lake, estuary, or the sea, where the water level in the water body is such that a portion of the channel is flooded. For this condition, provisions are made in the computational scheme to specify water levels in the inundated reaches of the channel and taking the water levels in the dry reaches as equal to the bed elevations. Analogous to the completely dry system, the discharge Q is taken as zero for all reaches, and base flows are simulated as previously described.

Flood Plain Dynamics.

The numerical computational scheme used in the present study for calculating water-motions in the two horizontal dimensions is essentially as that described by Reid and Bodine (1968) for computing storm surges in a coastal embayment area. Unlike the storm surge

problem, the effects of wind and direct precipitation on the system are neglected in riverine studies since the contribution of these effects can normally be considered of little consequence during the period of major flooding.

The effect of earth's rotation is also neglected in the two-dimensional flow theory because of the relatively small scale of the system and shallow depths where frictional forces are more dominant. In contrast to the channel flow theory presented, the effect of advection of momentum (or field accelerations) for flood plain areas is neglected which appears to be justified except at singular regions of the system (submerged barriers) where the effect is treated separately through the use of nonlinear discharge relations.

The vertically integrated equations of motion and of continuity appropriate for riverine flood plain areas are taken as follows:

$$\frac{\partial U}{\partial t} + g D \frac{\partial H}{\partial x} + \frac{g n^2 q U}{2.21 D^{7/3}} = 0 \quad (4)$$

$$\frac{\partial V}{\partial t} + g D \frac{\partial H}{\partial y} + \frac{g n^2 q V}{2.21 D^{7/3}} = 0 \quad (5)$$

$$\frac{\partial H}{\partial t} + \frac{\partial U}{\partial x} + \frac{\partial V}{\partial y} = 0 \quad (6)$$

in which x and y are the horizontal Cartesian coordinates; t = time; U and V are the vertically integrated x and y components of transport per unit width; g = gravity; H is the water level elevation relative to the local msl datum; D is the depth of water at position x , y and time t ; q is the magnitude of the transport per unit width; and n is Mannings coefficient of roughness.

The value of q is obtained in terms of U and V by

$$q = (U^2 + V^2)^{1/2} \quad (7)$$

The variables H and D are related by the expression

$$D = H - Z \quad (8)$$

in which Z is the elevation of the bed relative to the local msl datum. The bed elevation is assumed to be fixed at all time, t , for any position x , y ; i.e., the time dependent scour or accretion of the bed is ignored.

Boundary Conditions. A riverine system is represented in terms of a discrete grid in which all grid elements are taken as uniform square blocks. The topography of the flood plain is regarded as uniform over each grid square, thus forming a two-dimensional stair-step type of approximation of the actual topography. Water is allowed to flow onto a dry block during periods when the stage is rising and dry up again during the recession stage, thus allowance is made for a moving boundary in the course of a flood.

Along the line which forms the water-land boundary of the flood plain, two types of boundary conditions can be formulated depending upon the water elevation and the adjacent land topography. If the land elevation is greater than the water level, the boundary condition is simply

$$q_n = 0 \quad (9)$$

in which q_n is the component of flow normal to the boundary. On the other hand, if the water level is greater than that of the dry land, then the rate of flooding per unit land block width is evaluated by

$$q_n = \pm C_o D_b (g D_b)^{\frac{1}{2}} \quad (10)$$

where D_b is the water depth over the crest of the dry land block and C_o is an appropriate dimensionless overflow coefficient, generally less than 0.5 for a broad-crested weir or barrier. The choice of sign (+ or -) depends on the direction of flow in accordance with the orientation of the coordinate system as discussed in the subsequent section.

Equation (10) is equally valid for any subgrid scale barrier within or at the boundary of the system for which the water level on one side of the barrier is greater than the barrier crest elevation, Z_b , and for which the water level on the other side is less than Z_b . The depth of water over the barrier is given by

$$D_b = H_b - Z_b \quad (11)$$

where H_b is the water level on the high side.

For any subgrid scale barrier located internal to the system in which the water levels on both sides of the barrier exceeds the barrier crest elevation, the discharge per unit length of barrier is taken as that of a submerged weir,

$$q_n = \pm C_s D_b (g | H_1 - H_2 |)^{\frac{1}{2}} \quad (12)$$

where C_s is an appropriate dimensionless discharge coefficient, generally less than the 2, and H_1 and H_2 are the water levels on the two sides of the barrier. In this case the depth of water over the barrier is taken as

$$D_b = \left(\frac{H_1 + H_2}{2} \right) - Z_b \quad (13)$$

in which z_b is, as before, the elevation of the barrier crest.

Both equations (10) and (12) presume that the velocity of approach to the barrier is much less than the velocity over the barrier.

At the limits of the grid, a closed boundary is used on the top side and right side (as seen downstream looking upstream) in which any

flows normal to these boundaries are zero as given by equation (9). On the bottom and left hand sides of the grid, provisions are made for either a open or closed boundary on the level of flooding and the local topography. For an open boundary the discharge per unit length normal to the boundary is taken as

$$q_n = - \frac{1.486 D^{5/3} |S_B|^{1/2}}{n} \quad (14)$$

where S_B is the characteristic slope of the bed which is based on the topography in the general vicinity of the boundary for a given block. Equation (14) is derived from either equation (4) or (5) by considering that the surface slope term is in balance with the frictional resistance term and by assuming that the surface slope is equal to the bed slope at the boundary. Flows are taken positive in the upstream direction and in the direction of the right hand boundary. Conversely, flows in the downstream direction and in the direction of the left hand boundary are taken as negative values. At the limits of the grid downstream and at the left side, flow is only allowed to leave the system, thus the normal flow at the boundary is a negative quantity.

Initial Conditions. Generally, if calculations for blocks are began in advance of a flood, all blocks are dry, and thus it is only necessary to set U and V to zero for all x and y and set H for each block equal to the bed elevation. In the event that it is necessary to start the computations with some blocks flooded, it is sufficient to consider that the water surface elevations are uniform for all inundated blocks and that U and V are zero over the entire grid.

SOLUTION TECHNIQUES

The governing partial differential equations (Eqs. 1, 2, 4, 5 and 6) of motion and continuity for flood plain areas and channels are approximated by difference equations. An explicit formulation is used together with a staggered arrangement of variables (leap-frog scheme). The differences are centered in both space and time.

The numerical difference scheme used for the two-dimensional equations is essentially the same as discussed by Reid and Bodine (1968) except for the inclusion of coupling with channels. Increments in space for the two-dimensional network are taken uniformly in both x and y directions in which the spatial increment is denoted as S . The staggered arrangement of variables is shown in Figure 1.

Channels are considered to be embedded in the two-dimensional network in which the water level H is evaluated at the juncture of four adjoining grid blocks while Q is evaluated at the mid point along the line separating two adjacent blocks as depicted in Figure 2. The computational nodes along a channel are uniformly spaced in which the distance between any two consecutive H locations or two consecutive Q locations is S . The spacing is not necessarily equal to the grid spacing S since provisions are made to adjust the channel length to

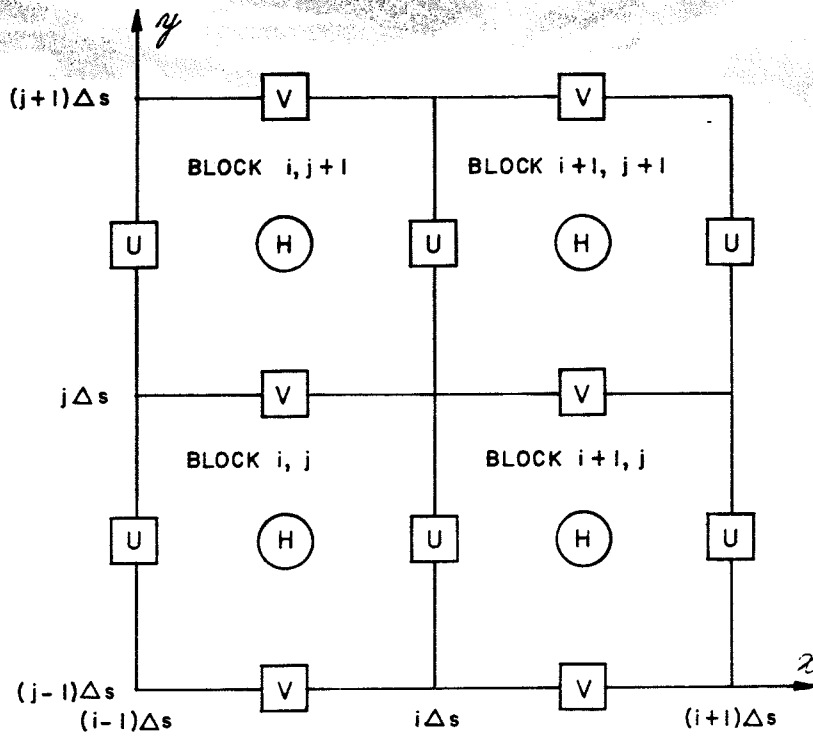

Figure 1. Grid scheme showing staggered system of variables

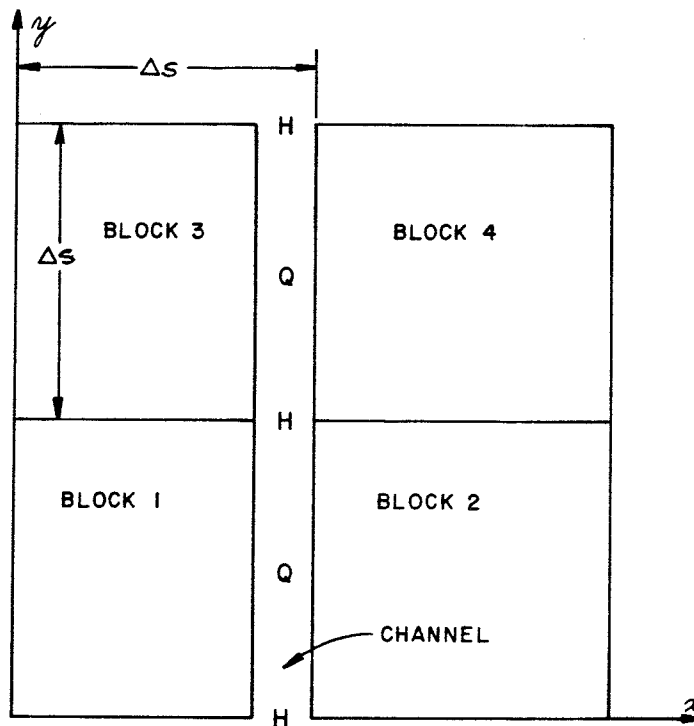

Figure 2. Location of H and Q channel nodes with respect to grid blocks

account for the effects of channel meandering and the imposed alignment with respect to the grid. For a given channel the spacing is estimated by

$$\Delta l = \frac{L_c}{N \Delta S} \quad (15)$$

where L_c is the actual length of the channel and N is the number of grid block spacings traversed by the simulated channel.

In the present solution scheme, provisions are made for calculating the water motions in one or more channel systems in which a channel system is defined herein as a system that consists of a principal or main channel and its tributary channels. Separate channel systems are not directly connected; however, such systems may communicate with each other during high flood stages when water overtops drainage divides via block flow.

Numerical stability. Numerical stability of the calculations for channels requires that

$$\Delta t < \frac{\Delta l}{|u| + \sqrt{gh}} \quad (16)$$

in which the value of the denominator on the right side of the equation is the maximum value expected in the channel system. The symbol h denotes the hydraulic depth of the channel ($h = A/B$).

An appropriate relation for numerical stability for the two-dimensional difference scheme given is

$$\Delta t < \frac{\Delta S}{(2g D_{max})^{1/2}} \quad (17)$$

in which D_{max} is the maximum depth of water over the blocks to be expected in the system.

Barrier Specifications. Barriers, like channels, are taken to be located along the line separating two adjoining blocks. A barrier block potentially has a barrier on the right side and upper side of the block. It is necessary to prescribe the values of Z_b , C_o , and C_s for both potential barriers in which Z_b is taken equal to the larger of the Z values of the adjoining blocks for a nonexistent or null barrier. Thus, a real barrier exists if Z_b is greater than the bed elevations of the adjoining blocks. In the event that a barrier block and a channel block have the same block location, it is possible to provide for a real barrier on either side of the channel or both sides of the channel. For a barrier block without channels, the barrier elevations are identified in the program as ZX and ZY on the right side and upper side of the block, respectively. On the other hand, if a barrier block and channel block are at the same location, then ZX and ZY represent the elevations of the barriers located on the inner side of block I ; J and the variables ZUX and ZUY are used to represent the elevations of the barriers on the outer sides of the block.

Constraints on Coupled Flows.

Reid et al. (1977) found during development of a two-dimensional and embedded channel storm surge model that for some situations care must be exercised in calculating the lateral exchange of water between grid blocks and channels. In particular, it was found that a change in the channel water level in a computational interval can be very sensitive to the transverse flows if the channel water surface width B is much smaller than the block size S . As a consequence, special care had to be taken in the model to avoid possible instabilities caused by improper calculation of the transverse flows. To insure proper evaluation of these flows, these investigators imposed certain constraints on the transverse flows. Those constraints are equally valid for the present solution scheme.

MODEL APPLICATION TO DRAINAGE BASINS

A multi-stream and flood plain system located in Houston and vicinity, Texas, was selected as an example to demonstrate application of the model to field conditions. The study involves the simulation of flows and elevations of the water surface both in channels and flood plain areas as a result of a hypothetical flood of probable maximum magnitude. Due to the physical characteristics of the study area and the magnitude of the flood, streams are drowned and extensive flooding of normally dry land occurs during periods of high stages. Also, drainage divides are overtopped during high stages, thus allowing water to be transported from one basin to another. As a consequence, the model is applied to a complex riverine problem.

At the present time the model has been verified only from the sense of separate two-dimensional flow calculations and one-dimensional flow calculations. In the solution of two-dimensional flows, the computer code used is essentially as that developed by Reid and Bodine (1968) - a code which was verified in the study of storm surge. The model as described herein reduces to solely a two-dimensional approach if no channels are specified and to a one-dimensional approach if water is contained only in the channels. The one-dimensional scheme in the model was verified from a separate one-dimensional model (presently unpublished) developed by the author in which the latter model has been verified.

Calibration of the present model can be achieved through the specification of appropriate bottom stress coefficients and barrier flow coefficients. In the example application it was impossible to calibrate the model due to the lack of information of bottom stress coefficients in the flood plain areas. Although the bottom stress coefficient can be varied spatially throughout the modeled system including both channels and flood plain areas, the coefficients were assumed for simplicity constant for the two flow regions. Specifically, the Manning's coefficient was taken as 0.04 for the channels and 0.1 for the flood plain areas. The barrier coefficients were also taken as constant values.

Site Description.

The study areas shown on Figure 3 consist of three major streams: Buffalo Bayou, Oyster Creek and Brazos River. Also shown is Brays Bayou - a tributary to Buffalo Bayou. Oyster Creek empties into Galveston Bay and Buffalo Bayou empties into Galveston via the Houston ship channel. Brazos River, on the other hand, empties into the Gulf of Mexico. Two flood control reservoirs, Barker and Addicks, exist in the Buffalo Bayou watershed. The dams for these reservoirs are shown on Figure 3. Outlet works consisting of gated structures at the junction of Buffalo Bayou and Barker Dam and at the junction of the outlet channel and Addicks Dam. The outlet channel from Addicks Dam is a tributary channel of Buffalo Bayou.

The study area is characterized by only moderate changes in topography throughout the system. A large percentage of the flood plain areas are urbanized consisting of dwellings and business establishments. Downtown Houston is situated in the area lying just west of where Buffalo Bayou and Brays Bayou merges.

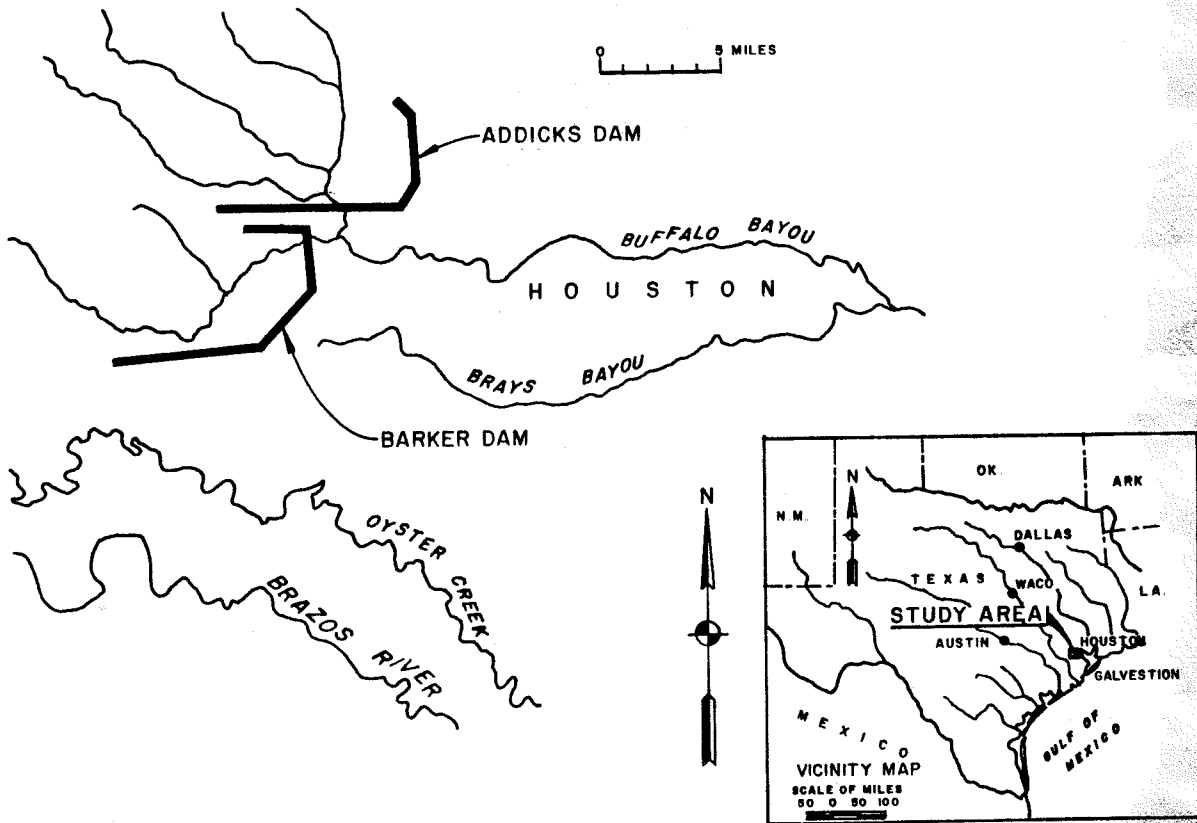

Figure 3. Location map for streams in Houston, Texas, and vicinity

Model Simulations.

Figure 4 shows the finite difference network representing the study area which was obtained initially by superimposing the network over USGS quadrangle maps. The network consists of 1,053 grid blocks in which the dimension of a block in either the x or y direction is 5,000 feet. Also shown on Figure 4 are the channels and the barriers used in representing the dams. It is to be noted that the modeled dams do not exhibit separate dams since this fact is not important to the flow simulations. One of the basic inputs to the model are the average elevation for each block. These elevations in feet above mean sea level are shown in the center of each block in Figure 4.

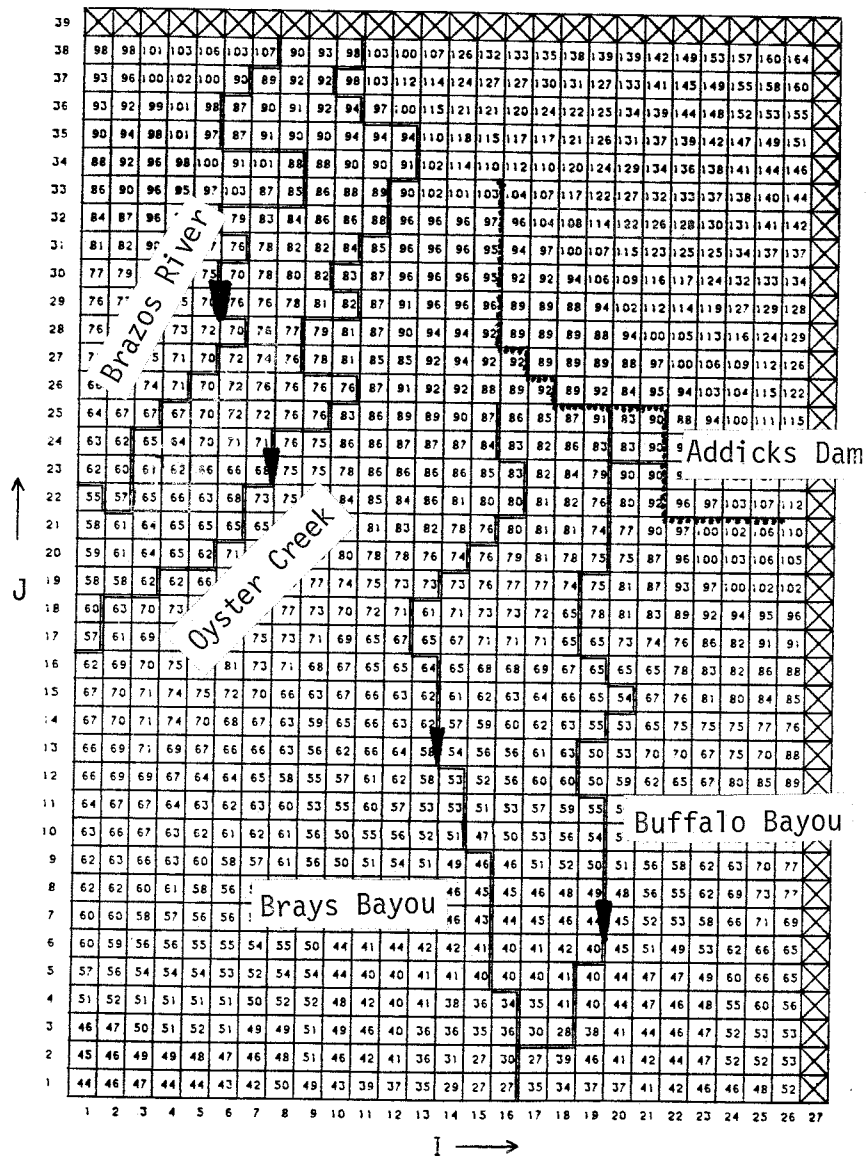

Figure 4. Average elevation of the land used in the numerical model for study area

Channel bed elevations and cross section data (not shown herein) were input for each channel segment. Total channel length was corrected for each channel to obtain correspondence between model and prototype.

Calculations of the model were begun with the water at rest, and all channels and blocks were taken to be dry with the exception of the lower ends of Buffalo and Brays Bayou where the water level was set equal to zero mean sea level - a level taken due to the influence of Galveston Bay. The bed elevations in this region of Buffalo and Brays Bayou are below mean sea level.

Inflow into the model as a result of the flood is based on discharge hydrographs at the reservoir outlet works and around the end of the dams. These hydrographs as shown on Figure 5 indicate that the major flooding occurs around the end of the dam.

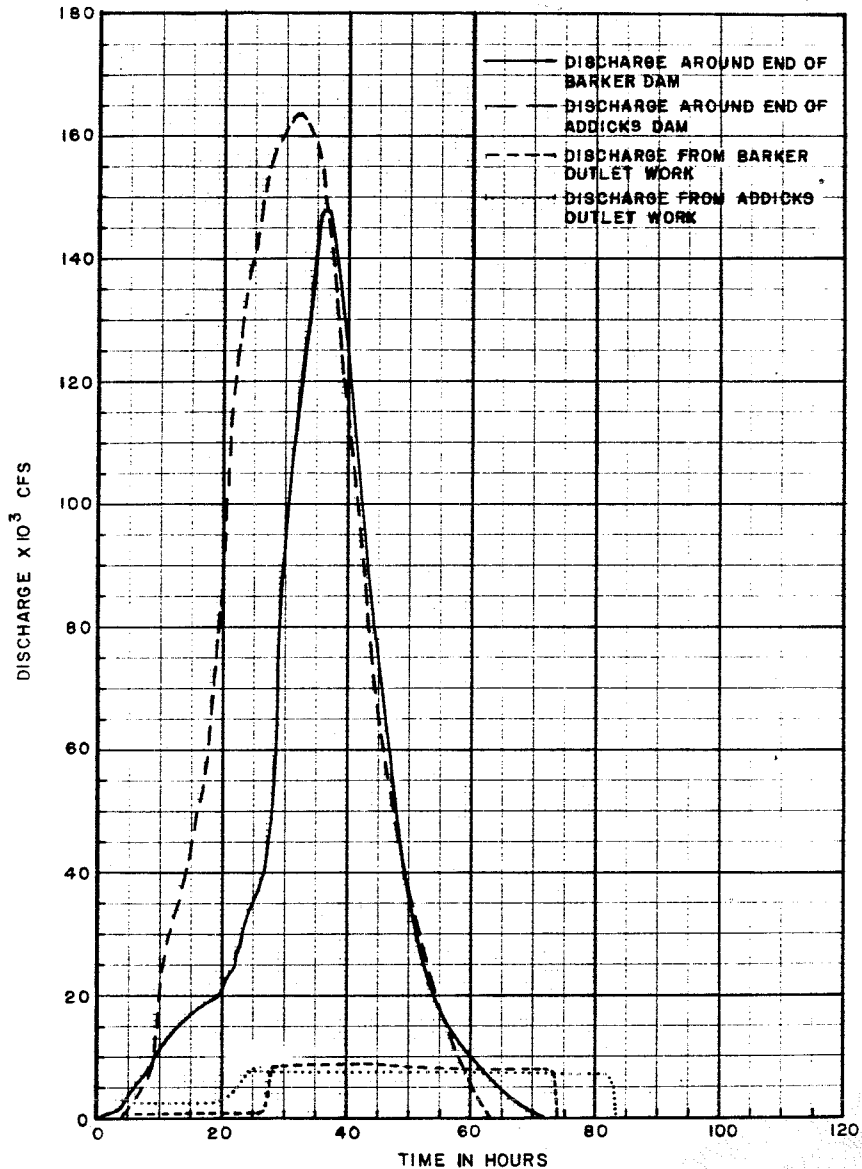

Figure 5. Discharge from Barker and Addicks reservoirs

Water movement was simulated for a period of 120 hours. Figure 6(a) shows the flow patterns (horizontal velocities) after a period of 10 hours. At this time it is seen that the water which flowed around the ends of Barker and Addicks dams is migrating toward the streams. Although water is being discharged from the outlet works at the dams, this water is confined to the channels (Buffalo Bayou and the tributary channel from Addicks Dam). The detailed output from the model shows that the water flowing around the end of Addicks Dam eventually flows into Buffalo Bayou at various locations along the channel, and the flow around end of Barker Dam eventually merges with Brays Bayou and Oyster Creek. Finally the water overtops the drainage divide between Oyster Creek and the Brazos River resulting in flooding along the Brazos River. Figure 6(b) shows the flow patterns at hour 60 just prior to the peak flooding. At hour 120 the flooding has subsided to the extent that the two-dimensional network is virtually dry.

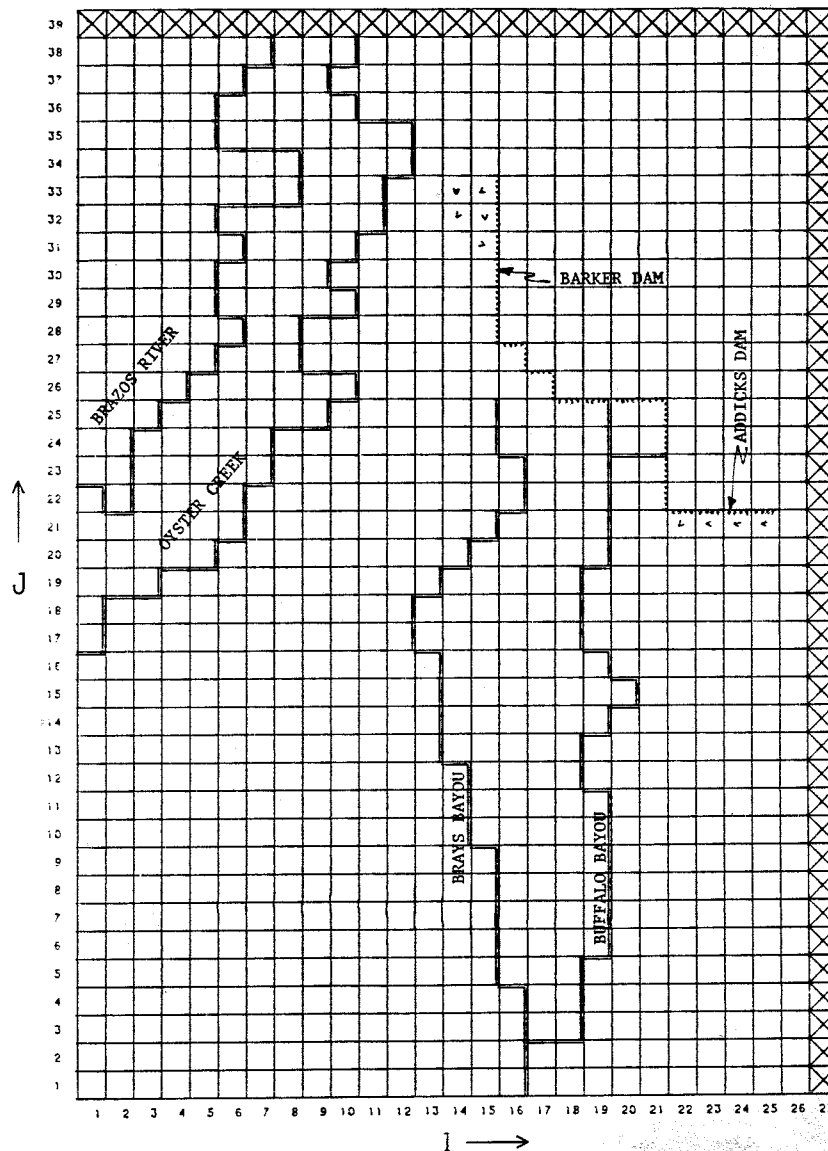

Figure 6a. Flow patterns for hour 10

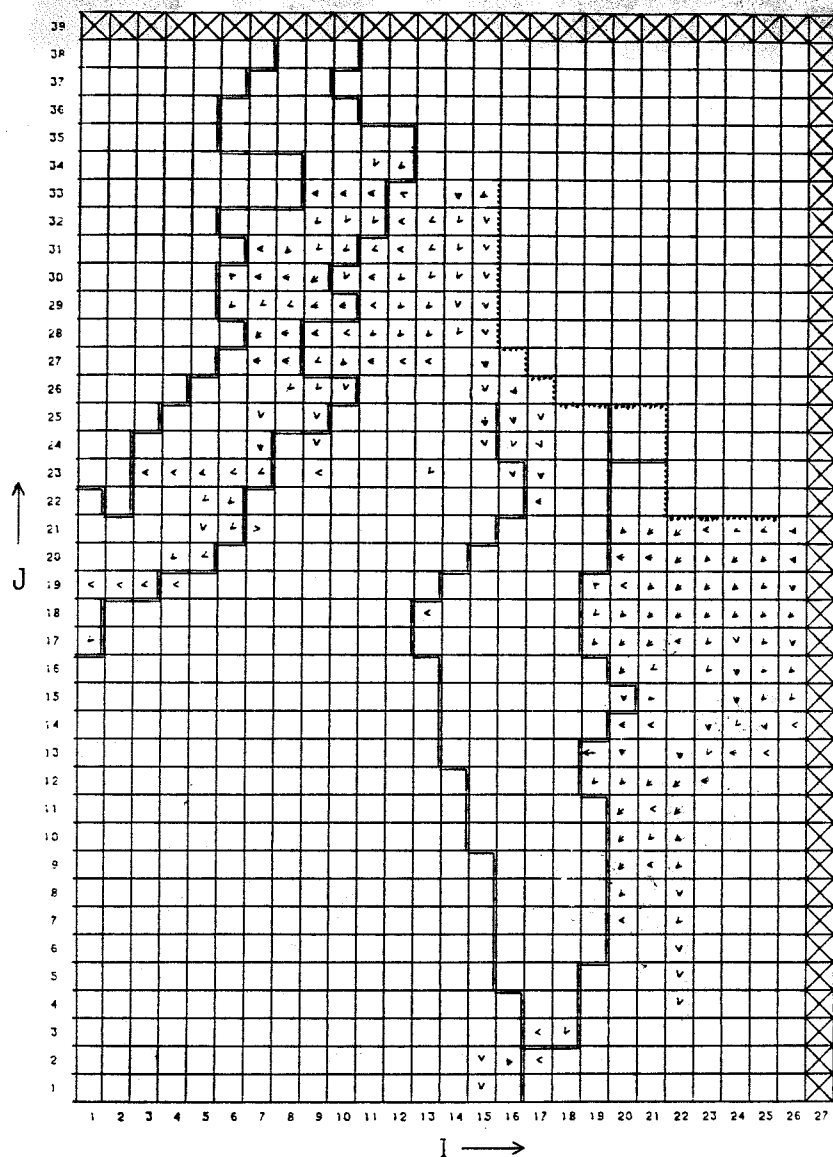

Figure 6b. Flow patterns for hour 60

A variety of results can be obtained from the model. For the blocks, results include the water surface elevations and flows as well as the peak values for each. Results for the channels consist of water elevations, velocities and discharges and the peak values for every computational node. Channel results also show the lateral discharges.

Application of the channel results revealed that the large quantity of water which moved downstream on Buffalo Bayou during early stage of the flood resulted in water moving upstream in Brays Bayou but finally reversed due to the lateral inflow at the head of the stream. Flow reversals also occurred on Oyster Creek and the Brazos River, upstream of the location where the primary lateral inflow merged with the streams.

V. SUMMARY AND RECOMMENDATIONS

A method for simulating water motions in channels and in flood plain areas has been presented in the preceding sections. The solution scheme is based on replacing the governing partial differential equations which describe the motions in both one and two horizontal dimensions with finite difference equations and solving the latter in uniform increments in space and time. The two systems of computation are coupled in such a manner that the channels and flood plain areas can communicate with each other. Also, special formulas are used in the solution scheme for calculating the flows over barriers (levees, road embankments, etc.) and treating moving boundaries. In the case of moving boundaries, dry channel reaches or grid blocks are allowed to flood with rising stages and dry up again as the flood water recedes.

The model developed is applicable to a large variety of riverine problems including those with a complex network of channels and independent channels. Modelling of channels in separate basins and accounting for the water transported from one basin to another as result of overtopping drainage divides is a degree of complication which has been generally ignored in previous studies. However, such a problem can be readily resolved with the present model.

The model can be used as a tool both from the standpoint of flood forecasting and engineering studies. In particular, the model can be used to study the effects of design floods and for carrying out design studies in the modification of existing channels or design of new channels. Once the model has been applied to a particular system, there is little difficulty in studying different alternatives in channel design to insure the best final design.

The model has been developed specifically for calculating flow in two horizontal dimensions or riverine systems consisting of channels and flood plains that will be inundated during the course of a flood. Although the model can be used to evaluate solely one-dimensional or channelized flow, it is not recommended that the model be used for this purpose. A more suitable approach would be to use a well formulated one-dimensional model in the case channelized flow since it is necessary with the present model to sweep the entire grid network for each time level, even in the absence of water over the blocks.

In the application of the model to urban areas there is considerable uncertainty as to the effects of structures on the resulting water motions and the appropriate frictional resistance that should be used. It is recommended that rational procedures be developed for estimating these effects.

VI. ACKNOWLEDGEMENTS

The author wishes to express his sincere appreciation to Robert O. Reid, Professor of Oceanography at Texas A & M University, for his many useful comments and suggestions during the period of model development.

Appreciation is also extended to Ronald L. Hula and Terry Coomes of the Southwestern Division, Corps of Engineers for their valuable suggestions and encouragements throughout the study. Also, considerable credit must go to Ming-Te Tseng of the Office of Chief of Engineers for his insight as to the need and encouragement in the development of two-dimensional methods for solving riverine flood plain problems.

The example problem presented for Houston and vicinity, Texas, is not intended to represent the views or position of the Corps of Engineers with regard to this study area.

References

Dronkers, J. J., Tidal Computations in Rivers and Coastal Waters, North Holland, Amsterdam, and Wiley and Sons, New York, 1964.

Reid, R. O. and Bodine, B. R., "Numerical Model for Storm Surges in Galveston Bay", Journal of Waters and Harbors Division, No. WWI, 1968, pp 33-57.

Reid, R. O., Vastano, A. C., and Reid, T. J., "Development of Surge II Program with Application to the Sabine - Calcasieu Area for Hurricane Carla and Design Hurricanes", Technical Paper No. 77-13, U.S. Army Corps of Engineers, Coastal Engineering Research Center, Washington, D.C., November 1977.

Stoker, J. J. Water Waves, the Mathematical Theory with Applications, Interscience, New York, 1957.

PAPER DISCUSSION

COMPUTER SIMULATION OF WATER MOTIONS
IN RIVERINE SYSTEMS

by
Bernie R. Bodine

Question: We noticed you took off the rainfall in your simulation of the river system; wouldn't that be important in this situation?

Mr. Bodine: The rain was not considered an important factor in the simulation because the direct rainfall over the modeled area (i.e., below the two reservoirs) occurred well in advance of the major flooding downstream. Outflow from the reservoirs lags the direct rainfall because a large quantity of the water entering the reservoirs must travel over relatively long distances from the upper reaches of the watersheds. The area delineated for the model study includes only a fraction of the watershed areas. Due to this phase difference, it was considered that the direct rainfall effect would have only a minor effect on the resulting flood waves moving downstream. In most cases the direct rainfall effect can be neglected in the flow simulations. As a consequence the rainfall term was omitted in the formulation. However, there are some cases when the direct rainfall could be important, such as in the case that an entire, or almost entire, watershed is to be modeled. Although both the effects of rainfall and wind stress were not included in the model, it is a simple matter to incorporate these effects.

Question: How would you describe the rainfall that would be input into the model?

Mr. Bodine: That's a good question. For design floods I would use the rainfall distribution, depths and patterns developed by the National Weather Service for the Corps of Engineers. Rainfall rates could be input into the model at various time levels on course grid network and interpolated in both space and time for performing the necessary calculations. This type of approach would appear to be a feasible technique.

Question: Ray, is infiltration important in these areas in terms of water that should be routed down the river?

Mr. Bodine: Yes, it could be. It can be very important in those watersheds where infiltration rates are high. For instance, in the simulation the flood wave resulting from the Teton Dam failure, it is essential that a rather large quantity of water be lost by infiltration to account for the substantial loss of

water at a gaging station at a distance of about 60 miles below the dam. Although the model described does not take into account such an effect, an infiltration or groundwater outflow term could be included. However, the difficulty with including such a term is how to prescribe the quantity of water to be lost as a function of both space and time. It can be a difficult and expensive task to estimate the infiltration rate accurately.

Question: With this model, does your river necessarily have to follow a straight line as you've shown in your schematic drawing?

Mr. Bodine: Yes, all rivers must be located along the edges of the grid blocks in either the x or y directions and thus are represented as straight line segments. Portraying the rivers in this fashion is a convenience for coupling the riverine flows to the flows over the blocks. As a consequence of representing the rivers in this manner, the total modeled channel length can differ significantly from total actual channel length. However, a correction is made to the modeled channel lengths to insure each main stem channel, tributary channel and subtributary channel correspond to the actual lengths of the prototype channels.

Question: Is your downstream boundary condition based on a uniform flow assumption using the bed slope?

Mr. Bodine: Yes, that is correct for the grid blocks. The relation used at the downstream boundary is derived by considering the surface slope is in balance with the fractional resistance and the bottom is parallel to the surface slope. The bottom slope is determined at the outset based on the local topography in the vicinity of the downstream boundary. Because of the simple boundary condition used, it is necessary to take the boundary sufficiently far away from the region where interest is centered to minimize the effects of taking such a simple boundary condition.

Question: How do you pick the discharge coefficients for your overbank and over channel flow conditions?

Mr. Bodine: You have to estimate this coefficient based on good engineering judgment. It's quite similar to estimating the bottom friction coefficients for hydraulic computations. In the application of the model that I presented, a value of 0.3 was taken for this particular discharge coefficient.

AN APPROACH TO HYDRAULIC SIMULATION OF COMPLEX FLOODPLAINS

by

Joseph E. Gurule¹

ABSTRACT

Simulating the hydrodynamics of rare flood events, whether actual or hypothetical, on large and complex floodplains, using one-dimensional techniques has strained the applicability of hydraulic theory to the point that it threatens the integrity of a competent analysis. Flood flows that extend far beyond river channel capacities and are influenced by floodplain irregularities such as discontinuous levees, diversions, sporadic topography, etc., can be extremely difficult to model mathematically using one-dimensional methodologies. These flood events are better analyzed by methods that can account for flow variations as they exist. The goal of this paper is to present an approach that addresses these conditions with a measure of authenticity by mathematically describing these variations in a more realistic and logical modeling capability. The approach to be presented will be a link/node method that formulates into an interconnecting network that forms a pseudo-two-dimensional simulation of a floodplain.

INTRODUCTION

Modeling floodplains to predict flood levels has been around for a long time. Considerable variations and improvements to calculation techniques have offered a greater flexibility for determining better estimates of flood levels. For the most part, these techniques have been based on one-dimensional (1D) methodologies. For those applications where 1D type analysis meet the needs of modeling, a variety of techniques are available. Only recently has there been heavy emphasis in modeling floodplains for other purposes. Water quality, sediment transport, turbidity, salinity, are but a few concerns that require a greater predictability of how water behaves in a three-dimensional world. Increased computer capacities and numeric capabilities have provided a means of approaching these modeling requirements. Considerable work has already provided some capabilities for modeling on the two-dimensional plain. This paper provides some experience on two-dimensional modeling in an effort to better simulate the behavior of flood waters in a floodplain.

The Jacksonville District Corps of Engineers became involved with two-dimensional modeling as a result of floodplain information studies and special flood hazard information reports for the island of Puerto Rico. This involvement was further augmented with flood insurance studies (FIS's) done

¹Civil Engineer, U.S. Army Corps of Engineers, Jacksonville, Florida

under an interagency agreement with the Federal Emergency Management Agency (formerly the Federal Insurance Administration). The FIS's provided communities with a report containing the necessary information to enable them to adopt floodplain management measures that meet certain requirements. The studies also determined flood insurance rates based upon probable flood levels.

Flooding conditions in many locations of Puerto Rico are complex and cannot be analyzed with traditional one-dimensional steady or unsteady flow techniques. The island of Puerto Rico is subject to heavy intensity rainfall, generally associated with tropical storms, that produce high discharge rates. All the major river systems originate in the central highlands as steep mountain streams that cascade down narrow channels into large coastal floodplains before emptying into the ocean. In many locations, particularly on the northern coast, more than one river flows into the same floodplain. During flooding conditions these floodplains act more like estuaries. In a number of floodplains, historical data has shown that a significant portion of the floodplain is flooded during flood frequencies of 10-years or less. For these conditions one-dimensional modeling techniques are inappropriate. If the flood levels developed for flood plain information and flood insurance studies were to be meaningful and withstand technical reviews, an appropriate form of two-dimensional modeling capability was necessary.

METHODOLOGY

A technique that is employed to simulate the behavior of water movement in floodplain studies is a link/node computer model. The model is a modified version of the Receiving Water Quality Model (RWQM) developed for the Storm Water Management Model (SWMM) (Ref 1). SWMM is a comprehensive mathematical model capable of simulating urban runoff for quantity and quality analysis. RWQM represents the body of water by a network of nodal points connected by links (channels). The nodal points and channels are fictitious hydraulic elements which are identified by parameters, such as surface area, node elevation, channel width, length and roughness. Equations of motion and continuity can thus be applied to each element to produce a time history of stage, velocity and discharge at each element. In a one-dimensional stream situation, the network would be a series of nodes throughout the river system that are connected by a channel. Each node would have a channel entering and leaving. For a lake, estuary or floodplain model, points would be located throughout the water system and connected by one or more channels enabling the representation of pseudo two-dimensional flow in the horizontal plan. A general representation is shown on Figure 1. Linking nodes by this technique allows for spatial variation of flow using known one-dimensional unsteady flow methodologies for computing flows.

FIGURE 1. LINK/NODE NETWORK

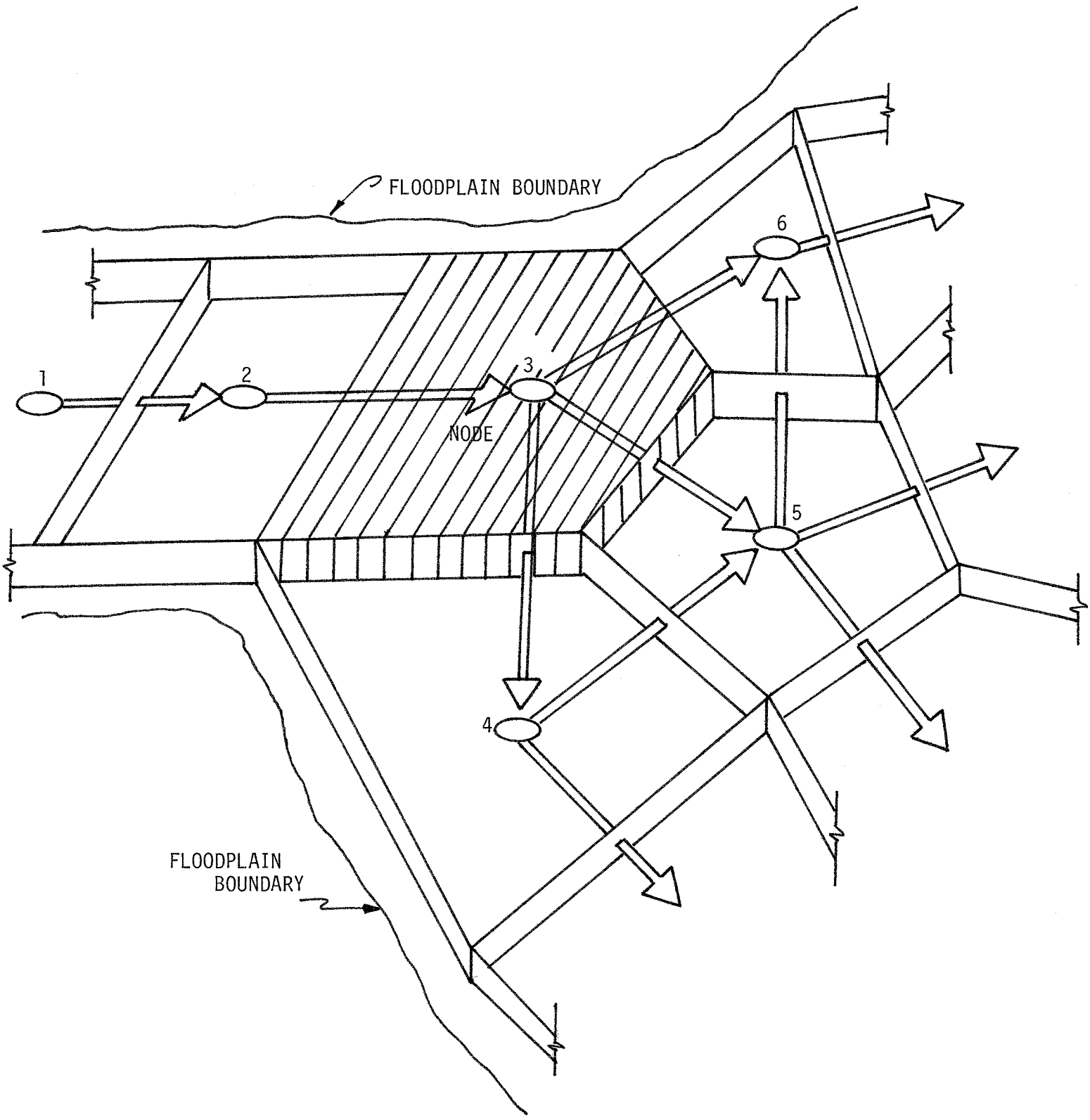

The theoretical description of the hydrodynamic equations that describe water motion and continuity for open channel flow are presented in Ref 1. Basically the equations are a hydraulic routing procedure based on the complete one-dimensional equation of unsteady flow, whose derivations are credited to Barré de Saint-Venant (1871). The equation of motion can be written as follows:

$$\frac{\partial v}{\partial t} = -v \frac{\partial v}{\partial x} - g \frac{\partial H}{\partial x} - g S_f$$

where v = Velocity

t = Time

x = Distance

H = Water surface elevation measured from the datum plane

g = Gravitational acceleration

s_f = Energy gradient

The energy gradient S_f of turbulent flow is proportioned to the square of the mean velocity according to Manning's equation,

$$S_f = \frac{n^2 V |V|}{2.2 R^{4/3}}$$

where n = Friction coefficient

R = Hydraulic radius of the channel

The equation of continuity addresses the net effect of water flowing into a node and is represented by:

$$A_{sj} \frac{\partial H_j}{\partial t} = \sum_{i=1}^K \partial_i + \partial_j$$

where A_{sj} = Surface area associated with j^{th} node

∂_i = Flow of a connecting channel

∂_j = Water importation rate to the node

The solution of these equations is accomplished by re-arranging them into finite difference form. The rate changes of flow and head can then be determined for short (finite differences) periods of time and thus the computation process continues through time at each successive time period.

MODEL DEVELOPMENT

Before any mathematical model can be implemented, the intent of its application must be clearly understood. The user must have a vision of what he or she expects the model to do. In formulating a network of nodes and channels some serious pre-planning is essential if a best possible solution is to be obtained. This requires a careful study of the best available topographic mapping and a best approximation of the limits to be modeled. When modeling for rare flood events, such as the 100-year flood event, the extent of flooding will most likely extend to the limits of the floodplain. Historical data such as that presented in the U.S. Geological Flood Atlas Series, provide excellent guidance for estimating flood limits. If historical data is insufficient, mother nature does a good job outlining the flooding limits. Once flooding limits are approximated, model development can be divided into two parts; (1) modeling conveyance trends, and (2) determining the detailed desired.

Modeling conveyance accurately is probably the most important procedure in determining flood levels. By conceptually super-imposing a flood on the topography and visualizing the most feasible direction that it could take provides an important insight on defining the channel directions of the network. Obviously the main channel is a key conveyance link and should be identified. Adequately defining the conveyance trends can eliminate potential problems of stability because the equations of flow reflect the accurate occurrence of the actual flow. Placing a channel in a location and/or direction where actual flow is not truly represented can render a model useless. Identifying the nodal points depends largely on the accuracy desired and the amount of money and effort affordable. The nodes represent the routing unit where the calculation of head (water surface elevation) is determined. With more nodes, more points in the floodplain will have head calculated, thus a more accurate answer is feasible. However, there is a price to pay; more nodes means more channels and larger networks, and larger networks mean considerably more work and computer costs. Obviously, the size of the network is a function of the purpose of setting up the model.

In the FIS's, the 100-year flood levels were of particular interest since they were the basis of the flood insurance program. As a minimum, a FIS should have the best possible estimation of the 100-year flood. This in itself was not particularly difficult since the 100-year flood generally extends to the limits of the floodplain and many isolated obstructions such as small bridges, culverts, small irrigation control structures, etc., make no significant impact on the flood level throughout the floodplain. In most cases, small bridges are overtopped or washed away during major flooding and their effects are of no consequence. When lesser flood magnitudes are introduced into a model designed for a larger flood event, the results need to be carefully analyzed.

According to Cunge (Ref 2), model building and calibration can be separated into four areas of concern.

- a. The reality that a river system can not be modeled exactly.
- b. The model must be calibrated and verified.
- c. The comprehensiveness of the model.

d. The role of the analyst in control of the model.

All mathematical modeling starts with some degree of simplification, from the form of the equations used to describe the physical phenomena, to the method of their solution, or approximate solution, and to the detail of describing the physical geometry of the river system. These simplifications need to be understood by the analyst. There is no benefit from solving the full form of the unsteady flow equation on a model developed from 25 foot contour interval topographic mapping. Undoubtedly, some simplifications and their impacts are not totally known or understood by the analyst. The errors that these simplifications produce can not be totally eliminated. At best, they can only be minimized. The process of calibration and verification is for that purpose. Taking known flood events and their effects and reproducing them with a mathematical model is the only true test of the models' effectiveness. Traditionally, the method of calibration and verification is by altering the coefficients that justify the mathematical identities that describe fluid motion. Most often the roughness coefficient is adjusted to reproduce known events. A second alternative and more radical method, is to alter the geometry by "blocking out" segments of the river system. This can be risky and should be done only if necessary and with a justified rationale for doing so. The calibration of the link/node model follows this procedure. Conveyance in the overbanks are defined by links (channels) whose widths are not truly known. Altering the widths has the effect of changing the conveyance and therefore can be part of the calibration process. For those situations where insufficient data exists for adequate calibration the analysis rests totally with the knowledge and experience of the analyst.

MODEL UTILIZATION

The application of a mathematical model requires controls if it is to be used effectively. These controls, or boundary conditions, set the pace for what the model is to simulate. The solving of any differential equations by finite difference or finite element techniques has to commence with values that are both realistic and compatible with the numeric scheme of solving the equations. For the link/node model a boundary condition is identifying the physical phenomena at specific nodes. These nodes are generally at the downstream and upstream portions of the model, and represent the outlet and inlet controls of the floodplain. Most often downstream boundaries are identified by known values of water surface elevation with time such as an ocean tide, or water surface elevation as a function of discharge. Upstream boundaries are generally inflow hydrographs that represent the flood event being simulated. A third boundary condition necessary for any type of simulation is the initial condition. The model must know what is happening at the time simulation begins. The initial condition is especially important in floodplain modeling because at time zero there may be no water in portions of the floodplain. These "dry" conditions do not provide a hydraulic continuum to the solution of the equation of motion and continuity. In the link/node model this "dry" condition is addressed by a algorithm that checks each node for depth after each time set of calculations. If the depth of water is less than 0.1 foot it is considered to be dry and does not enter into the calculation. If the depth check shows a depth greater than 0.1 foot the node is considered to be wet and therefore enters into the calculation scheme.

Initial use of the link/node model will require some editing. The input structure for identifying and integrating the link/node network is very specific. All links and nodes have to be accountable to the computation scheme. Invariably some links or nodes are lost or misplaced in the input structure and will need to be corrected. The present version of the program will not give any indication of where these errors are and finding them can be difficult. The initial runs should be carried out with steady state conditions. By inputting low discharges, known to be within channel capacity, the conveyance and linkage of the main channel can be verified. If needed, the main channel links can then be adjusted for proper conveyance. Knowing the maximum channel discharge and the approximate location where the flood waters will overflow into the floodplain is the transition from one-dimensional to two-dimensional flow simulation. Here again, steady state conditions should be executed for over-bank flows in order to verify linkage of the floodplain network. Operating the model for steady state condition and analyzing the results can give the analyst valuable information on the adequacy of the model. For example, is the main channel overflowing at the appropriate locations? Are velocities reasonable? What effects are the roughness coefficients having on the output? How long does it take the model to stabilize? These are but a few of the issues that the analyst may like to consider in the observation of the steady state runs.

An important concern is the question of stabilization. The link/node model goes through an explicit finite difference calculation that uses a modified Runge-Kutta technique where the interval of integration is divided into four (Ref 1). The stability criterion of the numerical integration technique is described by Garrison et al as follows (Ref 3).

$$\left(V - \sqrt{g \frac{A}{B}} \right) \frac{\Delta t}{\Delta x} < 1 - \frac{gn^2}{2.21 R^{4/3}} \Delta t$$

where V = Mean velocity

A = Cross-sectional area

B = Surface width

g = Gravitational acceleration

n = Manning's resistance coefficient

R = Hydraulic radius

Δt = Time interval

Δx = Channel length

For channels, A/B is equal to depth (h), so that the relationship reduces to:

$$\Delta t < \alpha \frac{\Delta x}{\sqrt{gh}}$$

where α = Proportionality constant, ranging from 0.7 to 0.8

\sqrt{gh} = Celerity of wave

This equation implies that a larger channel length would provide greater stability since Δt is an assumed input parameter at the start of a run. This creates a situation where the analyst must choose between stability and accuracy. A long channel reduces the accuracy of hydraulic simulation, but favors stability. The solution procedure for the hydraulic computation for each time interval proceeds as follows (Ref 1).

1. Compute the flow rate in each channel according to the hydraulic gradient and other hydraulic conditions existing at the beginning of a time interval.

2. Compute the rise or fall of the water surface (head) at each node based on the channel flow and the importation of withdrawal of water at the node.

3. Update the geometric and hydraulic conditions for the computation of the next time interval.

Hence, channel flows are calculated using the equation of motion and node water surface elevations as are determined with the continuity equation.

Once steady state conditions are ascertained, the appropriate flood hydrographs can be input at the proper upstream boundary location. The hydrograph should be input at some constant discharge (steady state) up to the time the computation stabilizes, then the change in discharge with time can be entered. Generally, Δt will need to be reduced when doing the unsteady flow runs. Adjustments of roughness coefficients and/or link widths can then be performed to calibrate the model.

REFERENCES

1. Lager, J.A., Pyatt, E.E., Shubinski, R.P. "Storm Water Management Model," Vol 1, Final Report, 110240C07/71, Environmets Protection Agency, U.S. Govern-ment Printing Office, Washington, D.C., Jul 71.
2. Cunge, J.A., "Applied Mathematical Modeling of Open Channel Flow," Unsteady Flow in Open Channels, Vol. 1, Water Resources Publication, Fort Collim, Colorado, 1975, pp 379-405.
3. Garrison, J.M., Granju, J.P., and Price, J.T., "Unsteady Flow Simulation in Rivers and Reservoirs," Journal of the Hydraulics Division, American Society of Civil Engineers, Vol. 95 No. H45, September 1969.
4. Liggett, J.A., "Stability," Unsteady Flow in Open Channels, Vol. 1, Water Resources Publications, Fort Collim, Colorado, 1975, pp 259-282.
5. Cunge, J.A., "Two-Dimensional Modeling of Flood Plains," Unsteady Flow in Open Channels, Vol. 2, Water Resources Publications, Fort Collim, Colorado, 1975, pp. 705-762.
6. Norton, W.R., King, I.P., Orlob, G.T., "A Finite Element Model for Lower Granite Reservior," Water Resource Engineer, Inc., Walnut Creek, Calif., Mar 1973.
7. Vicens, G.J., Harley, B.M., Schaake, J.C., "Flow 2D: A Two-Dimensional Flow Model for Flood Plains and Estuaries," presented at the September 3-5, 1975, ASCE Symposium on Modeling Techniques on Waterways, Harbors, and Coastal En-gineering, held at San Francisco, Calif.

PAPER DISCUSSION

AN APPROACH TO HYDRAULIC SIMULATION OF COMPLEX FLOODPLAINS

by
Joseph E. Gurule

Question: For the purpose of emergency planning, how do you describe the surface of Lake Okeechobee?

Mr. Gurule: For the present analysis, the lake is being described as a horizontal pool, even through it is sensitive to wind set-up. This is a valid assumption because it could quite possibly represent the most critical scenario of a levee failure. If a major hurricane ever approached the lake, the low lying areas around the lake would be notified to evacuate. In FY 83 we hope to develop a wind field model for Lake Okeechobee so that windset effects can be investigated.

Question: Joe, what is the overall affective submergence in that case? Does it extend the duration of the flood?

Mr. Gurule: It reduces the discharge and extends the duration. We might just consider the higher surface levels in the lake. The outflow will be based on an assumed breached width with the discharge being calculated by a weir relationship and connected for submergence. Tailwater will be based on the results of the link/node model south of the lake. Submergence effects will be a trial and error solution to match breach outflow with assumed inflow to the link/node model.

Question: Joe, how much money did you have when you first started this project and how much time did you have to complete the study?

Mr. Gurule: There is no break down for this analysis per se. It is simply one of several similar type analyses being done in the District. From what we have experienced so far, it has cost about \$2,000 in computer costs and about 4 man-months in manpower.

Question: Did you look at a triangular network of links in the overbank area? Does that make any difference?

Mr. Gurule: No, we didn't. Nor have we made any comparison for different network alignments.

Comment:

Joe Gurule: Using a link/node model offers a tremendous amount of flexibility in calibration if you have adequate data. Not only the roughness coefficients can be adjusted, but channel lengths and widths can be altered to reflect the appropriate convergence. We did this in the Rio Grande del Loiza flood insurance study.

EXPERIENCES WITH THE
APPLICATION OF THE FINITE ELEMENT METHOD
TO THE SOLUTION OF THE SHALLOW WATER EQUATIONS

by

Roy A. Walters¹

INTRODUCTION

An overview of the estuarine studies by the U.S. Geological Survey is presented in the paper by R. T. Cheng, which is located elsewhere in this volume. The specific problem to be addressed here is the application of finite element solution methods to estuarine flows which are governed by the shallow water equations. The ability of the method to easily handle a variety of boundary conditions as well as problems associated with the choice of elements are discussed. Finally, an application to the tidal and residual circulation in San Francisco Bay is presented.

FINITE ELEMENT METHOD

As shown by remarks made at this conference, there are several open questions concerning the capabilities, advantages, and disadvantages of finite element methods for modelling the shallow water equations, the simplicity of mesh grading, and the manner in which natural boundary conditions are treated. This discussion summarizes my experiences in attempting to apply the finite element method to "real world" problems in estuarine circulation. Because of space limitations, development of the methods, equations, and procedures is not discussed in detail. However, the interested researcher may use the references to provide these details.

For these problems, as with many applications, the true power of finite element methods is the ease with which complex spatial domains can be represented, including variations in both depth and boundary shapes. In regions with small scale features, large numbers of small elements can be used; in far field and uniform regions, smaller numbers of large elements can be used. Of course, the grading between element sizes must be relatively smooth; i.e., very large elements should not be adjacent to very small elements.

¹ U.S. Geological Survey, Water Resources Division
M.S. 96, Menlo Park, CA 94025

The governing equations used here, the shallow water equations, can be written as

the x-momentum equation,

$$\begin{aligned} \frac{\partial u}{\partial t} + u \frac{\partial u}{\partial x} + v \frac{\partial u}{\partial y} - fv \\ = -g \frac{\partial h}{\partial x} + \frac{1}{H} \left[\frac{\partial}{\partial x} (H \tau_{xx}) + \frac{\partial}{\partial y} (H \tau_{xy}) + \tau_x^s - \tau_x^b \right] \end{aligned} \quad (1)$$

the y-momentum equation,

$$\begin{aligned} \frac{\partial v}{\partial t} + u \frac{\partial v}{\partial x} + v \frac{\partial v}{\partial y} + fu \\ = -g \frac{\partial h}{\partial y} + \frac{1}{H} \left[\frac{\partial}{\partial x} (H \tau_{yx}) + \frac{\partial}{\partial y} (H \tau_{yy}) + \tau_y^s - \tau_y^b \right] \end{aligned} \quad (2)$$

and the continuity equation,

$$\frac{\partial h}{\partial t} + \frac{\partial}{\partial x} (Hu) + \frac{\partial}{\partial y} (Hv) = 0 \quad (3)$$

where density is assumed constant; x, y are the Cartesian coordinates in the horizontal plane (m); u, v are the depth-averaged velocity components in the x, y , direction (m/s); t is the time (s); h is the water surface elevation measured from mean lower low water (m); H is total depth of the water column (m); $f = 2 \Omega \sin \theta$ is the Coriolis parameter (s^{-1}); Ω is the rotation rate of the earth (s^{-1}); θ is the latitude (deg); g is the gravitational acceleration (m/s^2); τ_{xx} , τ_{xy} , τ_{yx} and τ_{yy} are the combination of the molecular and Reynolds stresses, and the dispersion terms (m^2/s^2); τ_x^b and τ_y^b are the components of the surface wind stress (m^2/s^2); and τ_x^s and τ_y^s are the components of the bottom stress. The Reynolds stress terms are approximated by a symmetric stress tensor with an eddy viscosity coefficient adjusted empirically. Because these stresses are small compared to bottom friction for the Bay, the eddy viscosity coefficient is kept at a small value ($1 - 100 \text{ cm}^2/s$) only to dissipate the energy cascaded to shorter wavelengths due to the nonlinear nature of the model (see discussion in next section). The surface stresses are specified by a quadratic form of the wind velocity. The Manning-Chezy formulation for bottom stress in open channel flows is extended to two dimensions to give the bottom stress. For further details, see Walters and Cheng (1979).

Initial conditions are arbitrary so long as these conditions satisfy the governing equations, whereas the boundary conditions are somewhat complicated because they depend upon a wide range of external forcing conditions. The boundary stresses at the surface and bottom are explicitly included in the governing equations. It can be shown by scaling that the lateral stresses are important only in the lateral boundary layer along the shoreline. Because the computational grid in a numerical model is typically larger than the thickness of the shoreline boundary layer, setting the velocity to zero along the boundary can distort the velocity field to an unrealistic extent. For this reason, no-slip conditions are relaxed at the shoreline and parallel flow conditions are applied such that there is no mass flux across the boundary.

At open boundaries, the water surface elevation and (or) the current velocity can be specified so long as the system is not over constrained. When the Coriolis force is included, there is some difficulty in the open boundary condition due to the lateral head gradient. Using a constant surface elevation causes the velocity to enter and exit at large angles with the normal to the boundary as well as creating a "half eddy" circulation pattern (Jamart and Winter, 1980). This problem is largely nullified by using a direction-elevation condition where elevation is specified at a central node and the velocity direction is specified at all the nodes on the open boundary (Walters and Cheng, 1980a; Jamart and Winter, 1980).

The finite element method is applied to the above equations by discretizing the spatial domain into elements which are usually of triangular or quadrilateral shape. Depending on the element type, the discretized values for velocity and depth are located at nodes which may be at the vertices, along the sides, or in the interior of the elements. The value of a variable within an element is found by interpolating from the element nodes with the use of basis or interpolation functions. (See Pinder and Gray, 1977, for further details.)

As a result, the shallow water equations can be evaluated at any point in an element by substituting in the interpolated values for the variables. The weighted residual (Galerkin) formulation is applied by multiplying each equation by each of the corresponding nodal interpolation functions and integrating over the element. The element contributions are then summed into a global matrix, which may be efficiently solved by a frontal solver (Walters, 1980) or by other sparse solution techniques.

Interpolating the velocity and surface elevation within an element as $u = [\phi] \{u\}$ and $h = [\psi] \{h\}$, and requiring that the weighted residuals equal zero, the governing equations take an integral form. (See Pinder and Gray, 1977). The dispersive stress can be expanded and expressed in a divergence form; the order of these terms is reduced by the use of integration by

parts. Further, the terms containing $\frac{1}{H} \frac{\partial H}{\partial x}$ and $\frac{1}{H} \frac{\partial H}{\partial y}$ are neglected. As a result, the governing equations can be written in integral form as,

$$\sum_e \int_e \left[\{\phi\} \left\{ [\phi] \frac{d\{u\}}{dt} + ([\phi]\{u\}) \frac{\partial[\phi]}{\partial x} \{u\} + ([\phi]\{v\}) \frac{\partial[\phi]}{\partial y} \{u\} - f[\phi]\{v\} + g \frac{\partial[\psi]}{\partial x} \{h\} - \frac{1}{[\psi]\{H\}} [\tau_{sx} - \tau_{bx}] \right\} + \frac{\partial\{\phi\}}{\partial x} \tau_{xx} + \frac{\partial\{\phi\}}{\partial y} \tau_{xy} \right] dx dy - \oint \{\phi\} [\tau_{xx} dy - \tau_{xy} dx] = 0 \quad (4)$$

$$\sum_e \int_e \left[\{\phi\} \left\{ [\phi] \frac{d\{v\}}{dt} + ([\phi]\{u\}) \frac{\partial[\phi]}{\partial x} \{v\} + ([\phi]\{v\}) \frac{\partial[\phi]}{\partial y} \{v\} + f[\phi]\{u\} + g \frac{\partial[\psi]}{\partial y} \{h\} - \frac{1}{[\psi]\{H\}} [\tau_{sy} - \tau_{by}] \right\} + \frac{\partial\{\phi\}}{\partial x} \tau_{yx} + \frac{\partial\{\phi\}}{\partial y} \tau_{yy} \right] dx dy - \oint \{\phi\} [\tau_{yx} dy - \tau_{yy} dx] = 0 \quad (5)$$

$$\sum_e \int_e \left\{ [\psi] \left\{ [\psi] \frac{d\{h\}}{dt} + \frac{\partial}{\partial x} \left[([\psi]\{H\}) ([\phi]\{u\}) \right] + \frac{\partial}{\partial y} \left[([\psi]\{H\}) ([\phi]\{v\}) \right] \right\} \right\} dx dy = 0 \quad (6)$$

where $[\phi]$ are the basis functions for velocity; $[\psi]$ are the basis functions for surface elevation; $[\]$ denotes a row vector, and $\{ \}$ denotes a column vector. Note that the lateral stress terms represented by the line integrals along the boundary can be neglected in shallow basins for reasons discussed previously.

The integral form of the governing equations allows for a manipulation of terms in the equations such that the boundary conditions appear as natural conditions of the problem. Natural boundary conditions are those which are automatically satisfied in the problem statement and require no further treatment. For instance, the term

$$\sum_e \int_e \psi_i \nabla \cdot \mathbf{H} \mathbf{u} \quad dx dy \quad (7)$$

appears in the continuity equation. Upon integrating by parts, this term becomes

$$\oint \psi_i \mathbf{H} \mathbf{u} \cdot \mathbf{n} dl - \sum_e \int_e \nabla \psi_i \cdot \mathbf{H} \mathbf{u} \quad dx dy \quad (8)$$

where the first term is the line integral of the normal discharge per unit width. For solid boundaries, this term then vanishes and need not be calculated.

In a similar manner, one can form natural boundary conditions for lateral stress by integrating the viscous stress terms by parts (see the line integral in (4) and (5). The natural condition is that there is no stress on the lateral boundary. In addition, head boundary conditions can be applied by integrating the pressure gradient terms by parts and specifying the value of the surface elevation in the resulting line integral. (See Walters and Cheng (1980a) for further details.) Finally, moving boundaries can be implemented easily with the use of deforming boundary elements and time dependent interpolation functions (Lynch and Gray, 1980).

As may be seen, the finite element method is extremely flexible in applying various degrees of refinement to an arbitrary spatial domain as well as flexible in applying a variety of boundary conditions at open and closed boundaries.

CHOICE OF ELEMENTS

A fundamental problem in the application of the finite element method lies in the occurrence of spurious oscillation modes (also known as numerical noise, instabilities, and internode oscillations). The cause of these modes is identified in an eigenmode analysis of various finite element formulations of the shallow water equations (Walters and Carey, 1981). The results of this analysis can be summarized with the use of figure 1. In the continuum, the phase speed of shallow water waves is \sqrt{gH} (where g is gravitational acceleration) and the amplitude of the waves depends upon initial conditions and frictional damping. When the spatial domain is discretized, the wavelength spectrum is truncated such that the shortest allowable wavelength is twice the grid spacing, d . Furthermore, an evaluation of the dispersion relation for the discretized domain indicates that in most finite element formulations the approximate solution exhibits poor phase speed for small wavelength modes and, in fact, zero phase speed at the wavelength $2d$. The phase speed characteristics shown in figure 1 are for a one-dimensional element with linear interpolation for both u and h (surface elevation). The corresponding eigenmode for a wavelength of $2d$ is characterized by $u = 0$ and h oscillates between adjacent nodes. Of utmost importance is the fact that this mode does not propagate nor can it be forced by boundary conditions; rather it is driven by numerical perturbations in the network. For simple test channels with rectangular geometry and constant depth, the amplitude of these modes is generally small. However, for realistic, irregular

networks the perturbations are generally larger and lead to a non-unique solution with large internode oscillations which then can couple into the velocity field by way of the continuity equation. In general, all elements in which the order of interpolation for h is greater than or equal to that for u will exhibit spurious modes. The preponderance of numerical experiments to date have employed elements of this type such that these modes have provided a serious impediment to the use of finite element methods.

There are, however, simple measures with which these modes can be mitigated or removed entirely: 1) use of filters, 2) use of dissipative time-stepping methods, 3) use of mixed interpolation, and 4) modification of the governing equations.

Filters are occasionally used to damp spurious oscillation modes when the amplitude of these modes is particularly large. The filter is applied by summing a weighted contribution from adjacent nodes and generally has a detrimental effect at longer wavelengths. The necessity for using a filter is usually a consequence of a poor choice of an element; that is, an element which contains spurious modes (see Malone and Kuo, 1981).

Dissipative time-stepping schemes are used relatively extensively with the shallow water equations. Gray and Lynch (1977, 1979) have examined the ability of various time-stepping methods to numerically damp the modes of wavelength $2d$. However, as with the use of filters, the amount of damping is governed by grid spacing, timestep size, and other parameters, all of which are determined by network constraints and not by physical dissipation needs. Thus the damping becomes a numerical artifact which is largely uncontrollable and therefore, these two options are not recommended. Some researchers have taken this method to the extreme and have formulated methods which severely attenuate waves with wavelengths of over 50 times the grid spacing. (See the discussion in Gray, 1980.)

For the third measure, a lower order interpolation is used for h than is used for u (mixed interpolation) so as to cut off the wavelength for h at $4d$ and thereby eliminate the spurious mode. This method is used much more extensively in the solution of the Navier-Stokes equations (Sani et al, 1981) than in the shallow water equations. A typical "good" element is the six-node triangle with quadratic velocity and linear h . Unfortunately, simpler triangular and quadrilateral elements with linear velocity and constant surface elevation (over an element) have numerical problems. The triangular element will not converge when large numbers of elements are used, and the quadrilateral has a single spurious mode. Of the commonly used linear and quadratic elements, the 6-node triangle and the 9-node quadrilateral with mixed interpolation have both an absence of spurious modes and favorable convergence properties (Walters and Carey, 1981; Sani et al, 1981). That is not to say

that other useable elements do not exist; rather, they have yet to be identified and/or tested. The eigenmode analysis provides a simple means of determining valid elements.

At this point, it is useful to examine the use of viscous dissipation in the mixed interpolation class of models. In the continuum, nonlinear interactions cause the energy input at various wavelengths to cascade to shorter wavelengths where dissipation takes place. When the wavelength spectrum is truncated by a discrete numerical network, this short wavelength energy can be removed only by propagation out of the network or through a separate subgrid-scale model. However, variations in velocity with wavelengths of $2d$ do not propagate; this behavior is similar to that of the spurious modes in h . Thus, there is an accumulation of energy at the short wavelengths, particularly with the grid-scale forcing found in coarse networks. Commonly, viscous dissipation is introduced as an approximation the subgrid-scale dissipation. Whereas viscous damping generally has small effect upon the dynamics of the larger scale motions, it provides a necessary and controllable approximation to the physical dissipation process. At any rate, one must resist the urge to use excessive damping to mitigate the effects of a poor choice of elements and an insufficiently refined network.

The fourth measure is to convert the continuity equation into the form of a wave equation which has the property that all wavelengths propagate and there are no zero velocity, spurious mode solutions. This method is, in fact, used more extensively than the literature would suggest. As an example, it is used in conjunction with tidal harmonics by Pearson and Winter (1977), and in conjunction with explicit and implicit time-stepping procedures by Lynch and Gray (1979). For simulations where the water surface elevation but not discharge is desired, this method may be particularly useful because of the economy in solving for only one dependent variable on a relatively coarse mesh.

APPLICATIONS

This section contains an application of finite element methods to the determination of circulation patterns in San Francisco Bay. (For a complete description of the Bay system, see Conomos (1979)). If one examines the spectra for either sea level or currents in the Bay, one finds a fundamental difference between the dominant processes operating at time scales greater than and less than 1 to 2 days. For motions with periods shorter than 2 days, the spectrum is dominated by the line spectra of the principal tidal constituents and their harmonics. For periods longer than 2 days the spectrum is continuous with peaks caused by wind forcing, and by fortnightly and lunar variations in tidal forcing. For this reason the circulation models are divided into a tidal model and a residual model.

The tidal model solves a finite element approximation to the shallow water equations with the use of 6-node triangular elements with mixed interpolation (quadratic u and linear h) and an implicit time integration (Walters and Cheng, 1979). A sample simulation of the M_2 tidal constituent (lunar semidiurnal, 12.42 hour period) for a coarse network of San Francisco Bay is shown in figure 2. This simulation employs a centered time integration, and solution of the nonlinear equations with a Newton-Raphson iterative procedure using a banded matrix solver. This method of solution is relatively inefficient so that the matrix solution algorithm has since been replaced with a modified frontal solver (Walters, 1980) which reduces the run time by about a factor of 3, and the trapezoidal time integration with a semi-implicit time integration which reduces the run time by about a factor of 6. The semi-implicit method was developed by Kwizak and Robert (1971) and provides a three-level implicit time integration without the need to solve a nonlinear system of equations. The time terms and pressure gradient terms are discretized implicitly using the upper and lower time levels, thus removing the gravity wave stability constraint. The friction term is evaluated at the lower time level and the remaining terms are evaluated at the middle time level. Thus the coefficient matrix is constant and need be solved only once. The frontal solver then forms the right hand vector and backsubstitutes to find the solution.

Modelling tidal flows in San Francisco Bay is complicated by the extreme variations in depth; extensive shoal areas are cut by deep, relict river channels. For this reason, elements with curved boundaries were used to model the deep channels and additional elements were added along the sides to finish the discretization of the Bay. For the simulation in figure 2, an M_2 tide was applied at Golden Gate (the straight boundary on the left) and the flow field was plotted at 3 hours after low water. As may be seen, there is an absence of small scale noise in the solution.

The governing equations for the residual circulation are the time averaged (or filtered) shallow water equations where the averaging interval is of the order of two days. After averaging, the linear terms become their residual counterpart. The nonlinear terms, however, are dominated by correlations between tidal quantities and become a forcing function known as the tidal stress. The bottom stress term is linearized using the root-mean-square tidal velocity for the current magnitude (see Walters and Cheng, 1980b). Thus the equations for the residual circulation are almost linear (as one would expect for low frequency motions) and are forced by the tidal stress and wind stress. Note that the tidal dynamics must be known before this method can be applied.

Using a moderately refined network for South San Francisco Bay, the tidal circulation was simulated using the tidal model

previously described. Using these values to calculate the tidal stress, the residual circulation shown in figure 3 was calculated. Whereas the tidal simulation shows no evidence of small scale variations, the residual circulation has considerable noise associated with the extreme variations in depth along the channels. (This noise is not to be confused with spurious oscillations as this noise appears in velocity and not surface elevation). Recalling the discussion of the phase speed behavior at small wavelengths, one may surmise that the network is too coarse to resolve the small scale variations associated with the channels. As a result, the short wavelength modes are strongly forced and can not be fully removed. When the large tidal signal is averaged out, these modes stand out as they are of the same order as the residual motions.

Attempts at calibration of the tidal model with field data also indicate that the channel is insufficiently resolved. With Chezy coefficients between 50 and 70 m/s, the correct magnitude for the tidal velocity can be reproduced everywhere except in the channel. The coarse resolution causes a relatively large coupling between velocities and smooths out the high current speed in the channel. Increased network refinement is clearly indicated.

CONCLUDING REMARKS

A great advantage of the finite element method is the ease with which it can represent the geometry and boundary conditions in complex spatial domains. With the use of a frontal solver, the solution is not sensitive to nodal ordering and has greatly reduced core memory requirements. A fundamental problem associated with the application of this method to the solution of the shallow water equations is the choice of elements. Most elements currently in use in shallow water studies lead to spurious oscillation modes; however, there are several simple methods which can be used to derive stable solutions. Several numerical examples which use one of these options (mixed interpolation) are presented here and indicate that tidal hydrodynamics can be simulated in a highly irregular network with little numerical noise.

Currently, the analysis of field data and the further refinement of the numerical models for San Francisco Bay are proceeding in parallel. The South Bay network is being refined and the tidal model is being modified to incorporate the harmonic method of Pearson and Winter (1977) described under option 4 previously. This method has been applied to Knight Inlet by Jamart and Winter (1979) and has led to efficient calculations on large networks. Following these modifications, the tidal stresses will be recalculated and applied to the residual circulation model. With the use of the calibrated tidal model and field data for velocity and sea level, the tidal stress will eventually be calculated solely from the sea level

at Golden Gate (the reference station) thereby obviating the need for the tidal model. At that point, it will be feasible to make seasonal simulations of the residual circulation for use in solute transport and ecosystem models.

Future research will encompass the study of residual circulation in the northern reach of San Francisco Bay. However, in this case the effects of density induced flows must be included. A question of primary importance is to ascertain the relative contribution to the salt flux due to density induced circulation and due to correlations between tidal variations in current and salinity (tidal dispersion).

REFERENCES

1. Conomos, T. J., ed., San Francisco Bay: The Urbanized Estuary, Pacific Division of the American Association for the Advancement of Science, Allen Press, Lawrence, Kansas, 1979, 493 pp.
2. Gray, W.G., "Do Finite Element Models Simulate Surface Flow?" Proceedings of the Third International Conference on Finite Elements in Water Resources. International Society for Computational Methods in Engineering, University of Mississippi, Oxford, May 1980.
3. Gray, W.G., and Lynch, D.R., "Time-Stepping Schemes for Finite Element Tidal Model Computations," Advances in Water Resources, Vol. 1, No. 2, 1977, pp 83-95.
4. Gray, W.G., and Lynch, D.R., "On the Control of Noise in Finite Element Tidal Computations: A Semi-implicit Approach," Computers in Fluids, Pergamon Press, Ltd., (Great Britain), Vol. 7, 1979, pp 47-67.
5. Jamart, B.M., and Winter, D.F., "Finite Element Computation of the Barotropic Tides in Knight Inlet, British Columbia," Fjord Oceanography, D.M. Farmer, and H.J. Freeland, eds., Conference Series IV, Marine Science, Plenum Publishing Co., New York, 1979, pp 283-289.
6. Jamart, B.M., and Winter, D.F., "Finite Element Solution of the Shallow Water Wave Equations in Fourier Space, with Application to Knight Inlet, British Columbia," Proceedings of the Third International Conference on Finite Elements in Flow Problems, Vol. 2, University of Calgary, July 1980, pp 103-112.
7. Kwizak, M., and Robert, A.J., "A Semi-Implicit Scheme for Grid Point Atmospheric Models of the Primitive Equations," Monthly Weather Review, Vol. 99, 1971, p 32.
8. Lynch, D.R., and Gray, W.G., "A Wave Equation Model for Finite Element Tidal Computations," Computers in Fluids, Pergamon Press, Ltd., (Great Britain), Vol. 7, No. 3, 1979, pp 207-228.
9. Lynch, D.R., and Gray, W.G., "Finite Element Simulation of Flow in Deforming Regions," Journal of Computational Physics, Vol 36, No. 2, July 1980, pp 135-153.

10. Malone, F.D., and Kuo, J.T., "Semi-implicit Finite Element Methods Applied to the Solution of the Shallow Water Equations," Journal of Geophysical Research, Vol. 86, No. C5, 1981, pp 4029-4040.
11. Pearson, C.E., and Winter, D.F., "On the Calculation of Tidal Currents in Homogeneous Estuaries," Journal of Physical Oceanography, Vol. 7, No. 4, 1977, pp 520-531.
12. Pinder, G.F., and Gray, W.G., Finite Element Simulation in Surface and Subsurface Hydrology, Academic Press, New York, 1977, 295 pp.
13. Sani, R.L., Gresho, P.M., Lee, R.L., and Griffiths, D.F., "The Cause and Cure (!) of the Spurious Pressures Generated by Certain FEM Solutions of the Incompressible Navier-Stokes Equations: Part 1," International Journal for Numerical Methods in Fluids, Vol. 1, No. 1, 1981, pp 17-43.
14. Walters, R.A., "The Frontal Method in Hydrodynamics Simulations," Computers in Fluids, Pergamon Press, Ltd., (Great Britain), Vol. 8, 1980, pp 265-272.
15. Walters, R.A., and Carey, G.F., "Analysis of Spurious Oscillation Modes for the Navier-Stokes and Shallow Water Equations," TICOM Report, No. 81-3, University of Texas at Austin, Austin, Texas, July, 1981.
16. Walters, R.A., and Cheng, R.T., "A Two-Dimensional Hydrodynamic Model of a Tidal Estuary," Advances in Water Resources, Vol. 2, Dec., 1979, pp 177-184.
17. Walters, R.A., and Cheng, R.T., "Accuracy of an Estuarine Hydrodynamics Model Using Smooth Elements," Water Resources Research, Vol. 16, No. 1, Feb., 1980a, pp 187-195.
18. Walters, R.A., and Cheng, R.T., "Calculations of Estuarine Residual Currents Using the Finite Element Method," Proceedings of the Third International Conference on Finite Elements in Flow Problems, Vol. 2, University of Calgary, July, 1980b, pp 60-69.

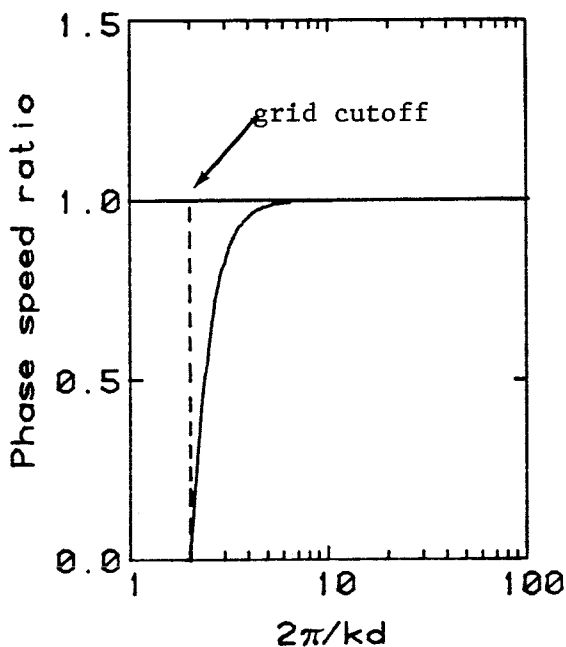

FIGURE 1. Phase speed for a linear element with equal-order interpolation as compared to that in the continuum.

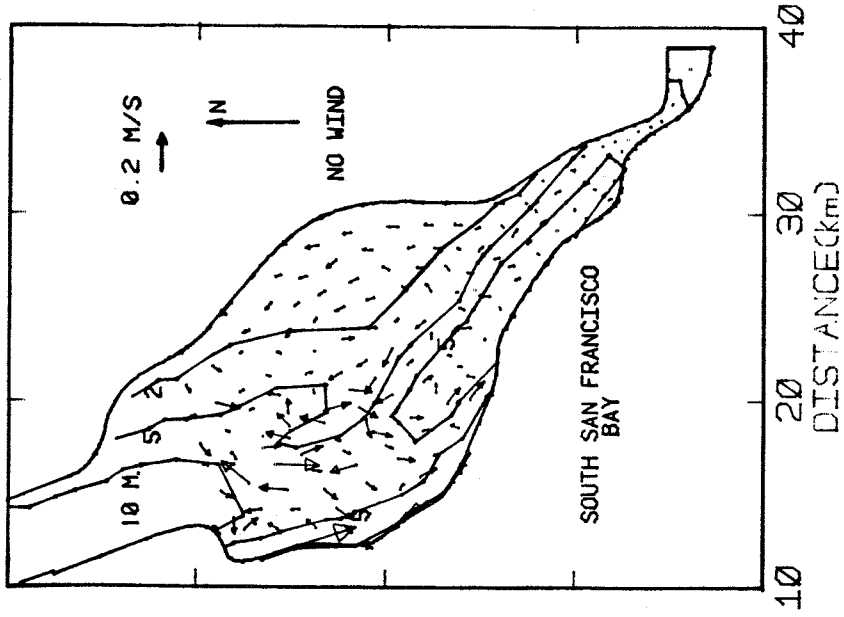

FIGURE 3. Sample simulation for residual volumetric transport in South San Francisco Bay.

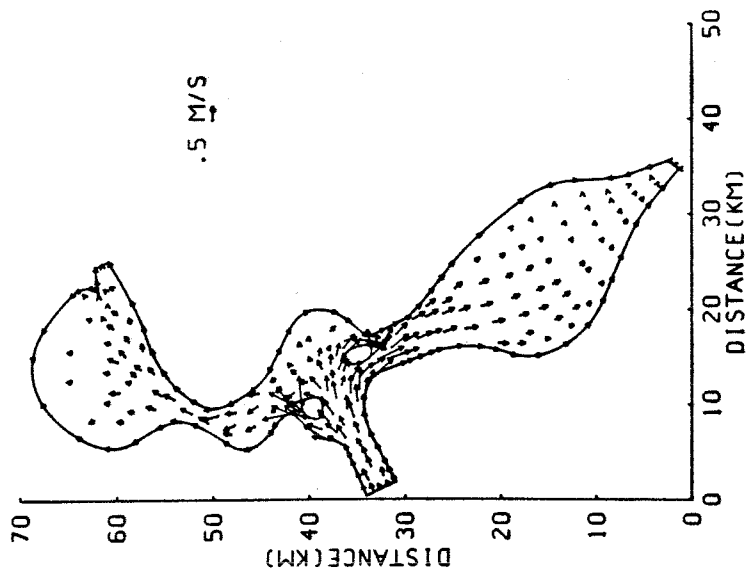

FIGURE 2. Sample Simulation for current velocity at approximately 4.5 hours after low water.

PAPER DISCUSSION

EXPERIENCES WITH THE APPLICATION OF THE FINITE
ELEMENT METHOD TO THE SOLUTION OF THE
SHALLOW WATER EQUATIONS

by
Roy A Walters

- Question: You mentioned that you have used a wave equation form of the continuity equation: have you tried using these equations without using the harmonic (spectral) form?
- Dr. Walters: No, I haven't tried that yet. However, Gray and Lynch (see references) have used this method extensively with both explicit and implicit time-stepping schemes. For our specific applications, we're dealing with long-term simulations and feel as though the harmonic has more promise.
- Discussion: Dr. Jan Leedertse and Roy Walters talked about the fine structure in the tidal bands in tidal estuaries and different ways of analyzing and integrating this information using spectral analysis.
- Discussion: Dr. Jan Leendertse included the following points. The problem area in finite elements that hasn't been addressed quite yet is the relationship between wave velocities and amplitudes as a function of frequency or wave number. Most of the problems in the finite difference scheme did not arise from that mode, but it did arise from spurious oscillations in the velocity field. Even though there are eigen solutions for these problems, we are finding now in the atmospheric sciences that if you set up your finite difference equations in the proper way, you can conserve not only momentum but vorticity, and in doing so have a much more robust and accurate solution scheme. But in the finite element area, it appears as though no one is trying to keep track of vorticity. That may be one of the major problem areas in the finite element area now because they don't have those laws for vorticity incorporated into their numerical schemes. This requires that the finite element schemes need to use smoothing or expanded values for their dispersion diffusing coefficient.
- Comment: Roy Walters: Yes, I agree that it unfortunately is still in the research area; and even though we are aware of these kinds of problems, we are just beginning to make inroads into investigating them. However, schemes have been investigated that conserve energy, concentration, and/or concentration squared. (See pg. 117, International Journal for Numerical Methods in Fluids, Vol. 1, 1981).

Question: Is there enough information in the literature so that the people from the Districts and Divisions can merely go to the literature and pick these values for eddy viscosity and mixing coefficient. Are you aware of published information pertaining to this?

Dr. Walters: Yes, there are published values but each set of these values tends to be applicable to specific problems. However, as noted in the text, only certain classes of numerical solution methods require viscosity to provide a physical dissipation process. The real criteria is that the viscous dissipation should have no significant effect upon the large scale motions, a criteria which can be tested numerically.

Discussions: Discussions continued concerning methods of looking at tidal harmonics and spectra in estuaries. The discussion continued for some time and it was terminated. Of particular interest was the technique of using cross-spectra between data and model output to define the system response to other values for input forcing.

MODELING OF TIDAL AND RESIDUAL CIRCULATION
IN SAN FRANCISCO BAY, CALIFORNIA

by

Ralph T. Cheng¹

INTRODUCTION

One definition of an estuary states that "An estuary is a semi-enclosed coastal body of water which has a free connection with the open sea and within which seawater is measurably diluted with freshwater derived from land drainage" (Pritchard, 1967). Another says, "Estuaries are something like pornography - hard to define exactly, but we know one when we see one" (Fischer, 1976). Because estuaries are usually surrounded by a heavily urbanized area, competing interests among those using the water way of an estuary for transportation and recreation, those using its basin for disposal of domestic and industrial wastes, and those using its embayments, wetlands, and marshes as fish and game refuges comprise a delicate and intangible balance between economic development and preservation of the natural ecological environment. This balance is maintained only by an understanding of the water properties, and of circulation and mixing of these waters. Studies of fluid motion in estuaries are of great importance because many transport phenomena are strongly dependent upon a proper description of the hydrodynamic processes.

A team of research scientists in the U.S. Geological Survey uses the San Francisco Bay system (Figure 1) as an outdoor laboratory to study the complex interactions between physical, chemical and biological processes which take place in estuarine systems (Cheng and Conomos, 1980 and Conomos, 1979). The broad goals of our studies are to understand processes and rates by which water, solutes, sediments, and organisms interact, to assist quantification of the relative importance of river outflow, wind, tides, and other dynamic forces which act on the estuary system, and to develop and to verify conceptual and numerical models of these interactions.

One of the most important considerations in modeling environmental hydrodynamics is the identification of the characteristic length and time scales. As may be noted, there is a wide variation of the time and space scales in the hydrodynamic processes in the Bay system alone. Meaningful modeling study will not result unless the models represent the proper spatial and temporal scales which dominate the process. To illustrate

¹Project Chief, Water Resources Division, U.S. Geological Survey, Menlo Park, California 94025

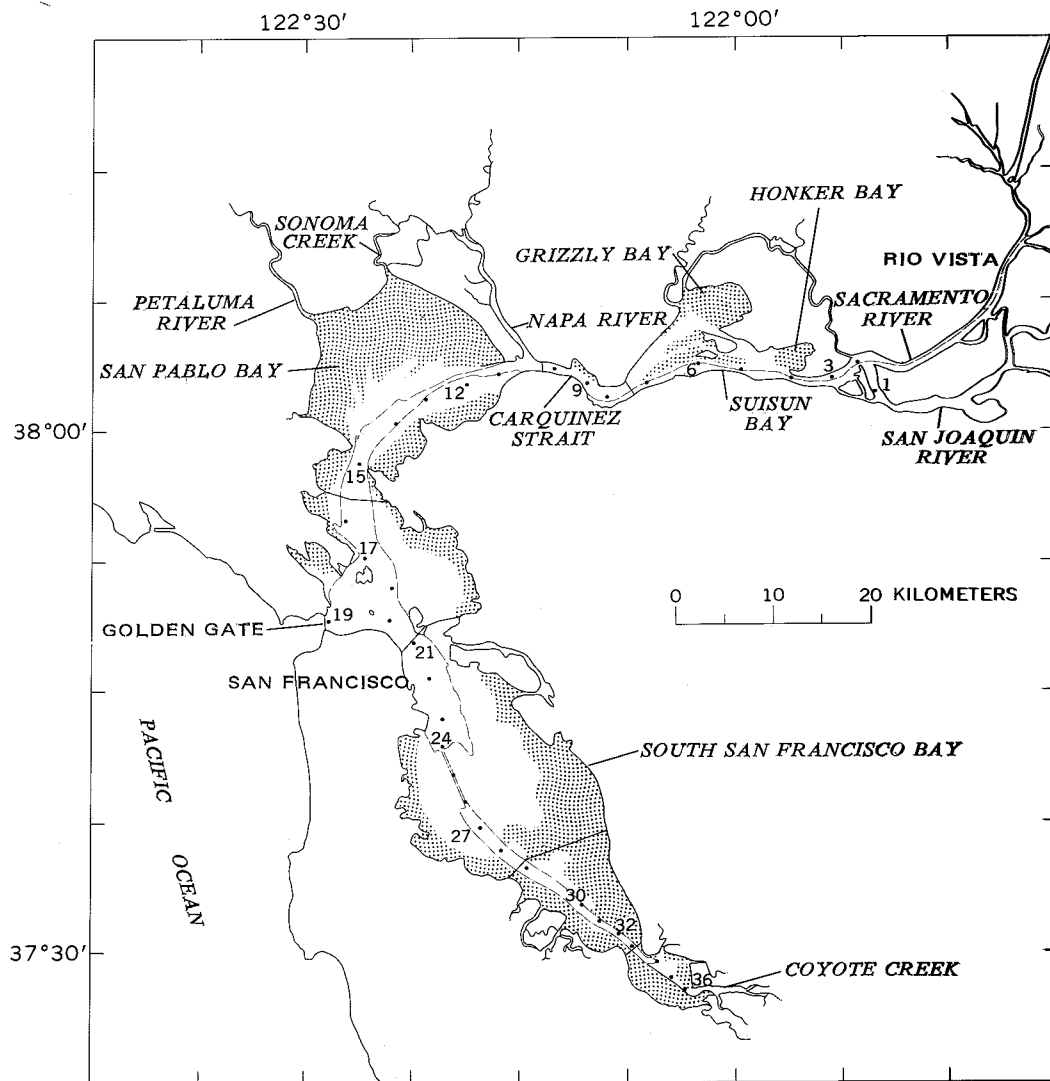

FIGURE 1. The San Francisco Bay system. The shaded areas denote depths of less than 2 meters below mean lower low sea level and the numbers indicate the U.S. Geological Survey sampling stations.

this modeling viewpoint, several models which are used to simulate both tidal and residual circulation in San Francisco Bay are discussed and summarized. These models are designed to simulate processes which take place within certain characteristic times.

THE BAY SYSTEM

The San Francisco Bay system is a complex estuary which consists of interconnected embayments, sloughs, marshes, channels, and rivers (Figure 1). The Bay system receives 90 percent of its freshwater from the Sacramento and San Joaquin Rivers, and the remaining 10 percent from other small tributaries and sewage treatment plants surrounding the Bay proper. For the most part, the Bay system can be represented by two basic estuarine types--a partially mixed estuary in the northern reach and a well-mixed estuary in South Bay. The salinity of South Bay waters varies seasonally and is primarily controlled by exchanges with the northern reach and the Pacific Ocean. Some salinity stratification may be present in winter due to local runoff during periods of heavy rainfall and due to fresh water originated from Sacramento and San Joaquin Rivers transported into South Bay, but the water is otherwise nearly isohaline due to low freshwater inflows and strong wind-induced mixing. The circulation in the northern reach is characterized by a combination of tidally driven, wind-driven, and density-driven currents. While the tidal component dominates the currents, the relative strength of these currents varies seasonally with changes in river discharge and prevailing wind. Many of the seasonal variations of biological and chemical properties are also related to river inflow and climate (Conomos, 1979).

A typical month-long current meter record (Figure 2) reveals the semidiurnal, diurnal, and fortnightly variations of the tidal currents. To place the question of the temporal scale in better perspective, a plot of the power spectra for water surface elevation at Golden Gate is shown in Figure 3. There are three major ranges of frequency discernable in the data: 1) high frequency turbulence, 2) the shallow water tidal harmonics at diurnal, semidiurnal, and shorter periods, and 3) low frequency residual motions. Based upon these time scales models have been formulated to answer specific questions.

THE TIDAL CIRCULATION MODELS

Because tidal circulation is one of the most important factors controlling the interactions among the various processes, considerable effort has been devoted to model the tidal circulation in the Bay system using both the finite element and finite difference methods.

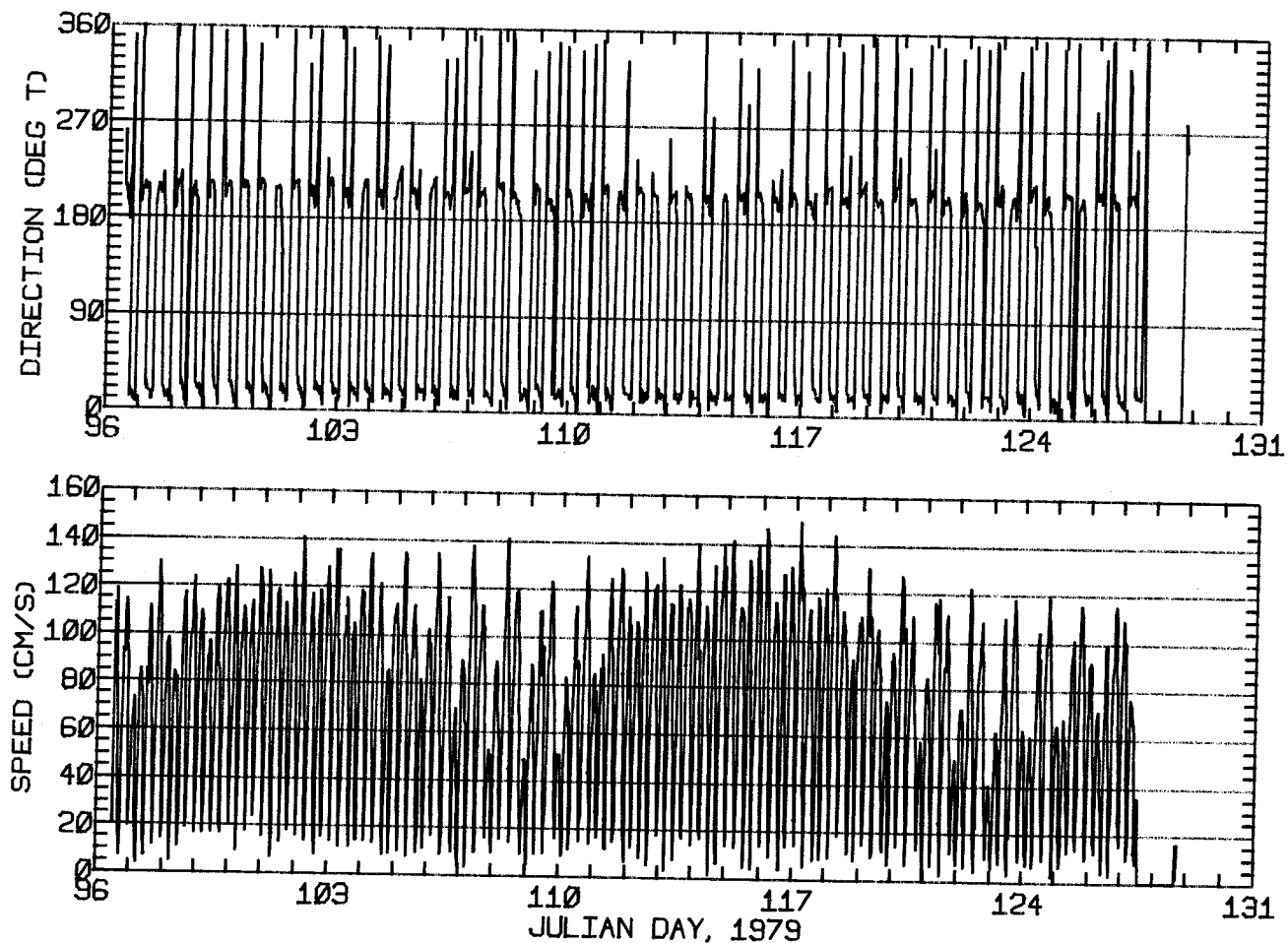

CURRENT METER OBSERVATIONS (30 MINUTE AVERAGES)
 SAN PABLO STRAIT (37°58.5N 122°26.5W)
 METER 39 FEET ABOVE BED. TAPE NUMBER GSC018B1.

FIGURE 2. A typical current meter record (observations were taken at 2-minute intervals and vector-averaged at 30-minute intervals) at San Pablo Strait (37°58.5N and 122°26.4W). The current meter was moored at 12 meters above bed.

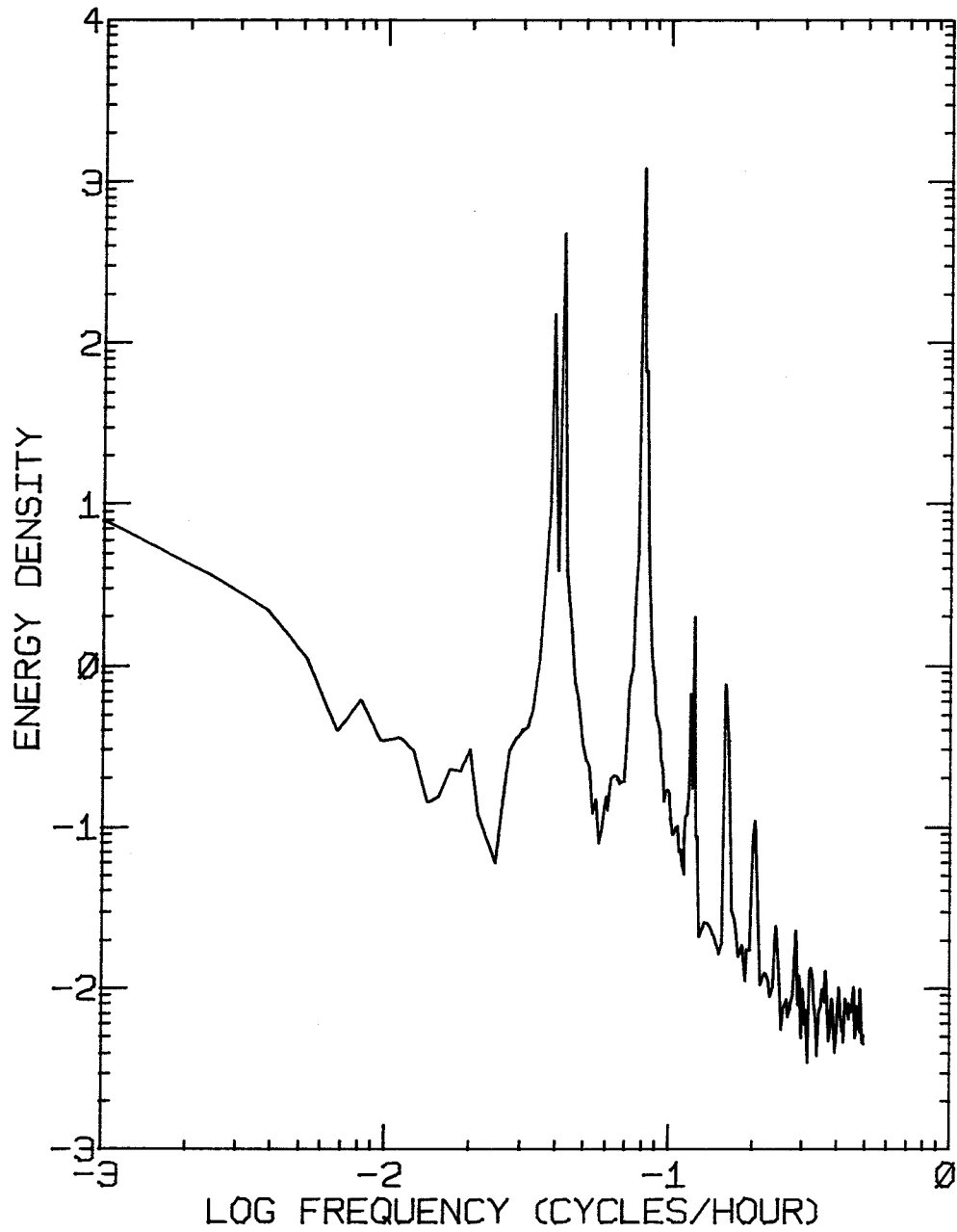

FIGURE 3. Power spectrum for surface deviation near the entrance to San Francisco Bay. The two large peaks are the diurnal and semidiurnal tidal constituents.

The starting point of the modeling effort is the shallow-water equations which are common to most estuarine models. The major driving force of the Bay system is tidal forcing at the open boundary. Whereas this approach works well in South Bay, the baroclinic density-driven components of circulation in the northern reach are not taken into account. However, since the time scales of the tidal circulation are much less than those for the baroclinic flow, reasonable results for tidal flows can still be derived.

The vertically integrated, shallow water equations can be written as

$$\frac{\partial U}{\partial t} + U \frac{\partial U}{\partial x} + V \frac{\partial U}{\partial y} - fV + g \frac{\partial \zeta}{\partial x} + g \frac{U(U^2 + V^2)^{\frac{1}{2}}}{C^2 H} - \frac{1}{\rho H} \tau_x^s = 0 \quad (1)$$

$$\frac{\partial V}{\partial t} + U \frac{\partial V}{\partial x} + V \frac{\partial V}{\partial y} + fU + g \frac{\partial \zeta}{\partial y} + g \frac{V(U^2 + V^2)^{\frac{1}{2}}}{C^2 H} - \frac{1}{\rho H} \tau_y^s = 0 \quad (2)$$

$$\frac{\partial \zeta}{\partial t} + \frac{\partial(HU)}{\partial x} + \frac{\partial(HV)}{\partial y} = 0 \quad (3)$$

where

x, y are the Cartesian coordinates in the horizontal plane (m),

U, V are the depth-averaged velocity components in the x, y direction (m/s),

f = Coriolis parameter (s^{-1}),

g = acceleration of gravity (m/s^2),

C = Chezy coefficient ($m s^{-1}$),

τ_x^s, τ_y^s = components of wind stress in the x, y direction ($dyne/m^2$),

ρ = water density (g/m^3),

t is the time (s),

ζ is the water surface elevation measured from mean lower low water (m),

H is total depth of the water column (m).

In equations (1) and (2), the horizontal dispersive stresses have been neglected because these stresses are small compared to the bottom friction for the Bay. The wind stresses are specified inputs, and Manning-Chezy formulation for bottom stress is used. With a proper specification of the initial and boundary conditions, Eqs (1)-(3) form a well posed initial boundary value problem.

The governing equations are solved using the Galerkin finite element method (Walters and Cheng, 1979). The actual solution method used here is robust in the sense that the full nonlinear equations are solved directly without simplifying assumptions. Six-node isoparametric, triangular elements with mixed interpolation are used, where quadratic functions are used to interpolate the velocity components U and V, and linear basis functions are used to interpolate the water surface elevation. The time integration is performed using a time-centered finite difference technique due to its stability. Additional detailed experience with the application of the finite element method in solving the shallow water equations is reported separately in this Proceedings by R.A. Walters or see Walters and Cheng (1979, 1980a).

Following Leendertse (1967, 1970), a simulation model of tidal circulation in South San Francisco Bay is set up on a PDP-11* microcomputer. Equations (1) to (3) are solved by spatially staggered grid using the finite difference method. The finite difference equations are formed based on an alternating direction implicit (ADI) scheme which has been shown to be unconditionally stable. The matrix equations take tridiagonal form, therefore the solution scheme is extremely efficient. The numerical properties of this type of model have been studied extensively by Leendertse (1967), and the stability and convergence properties of the scheme are well documented. Extensive application of this model in case studies demonstrated the validity of the model for a well-mixed estuary (Leendertse and Gritton, 1971a, b).

A typical simulation of tidal circulation in South San Francisco Bay using 1 km computational grid is shown in Fig. 4a, b. It is clear from both the finite element (see Walters in this Proceeding) and finite difference simulations that the tidal currents are controlled to a large extent by the relict river channels that underlie the Bay, thereby providing a measure of the smallest length scales in the system. Further, because there are large gradients in velocity associated with the transition from channel to shoal, refinement of the finite element network or the finite difference grid might be necessary to be able to resolve the detailed interaction between the channel and the shoals. Both the finite element and the finite difference models are being calibrated against field data at present. Perhaps, this interaction mechanism can be clarified through the calibration procedure.

THE RESIDUAL CIRCULATION MODELS

The simulation results based on a tidal circulation model can not be used to quantify the relative importance of river inflows, wind, tides, and stratification because all these factors have time scales on the order of a season while a tidal model only spans days. Seasonal residual circulation models whose inputs are derived from long-term data or tidal simulation, and whose output is long-term circulation pattern are needed and formulated.

*Mention of a commercial company or product in this article does not constitute an endorsement by the author or the U.S. Geological Survey.

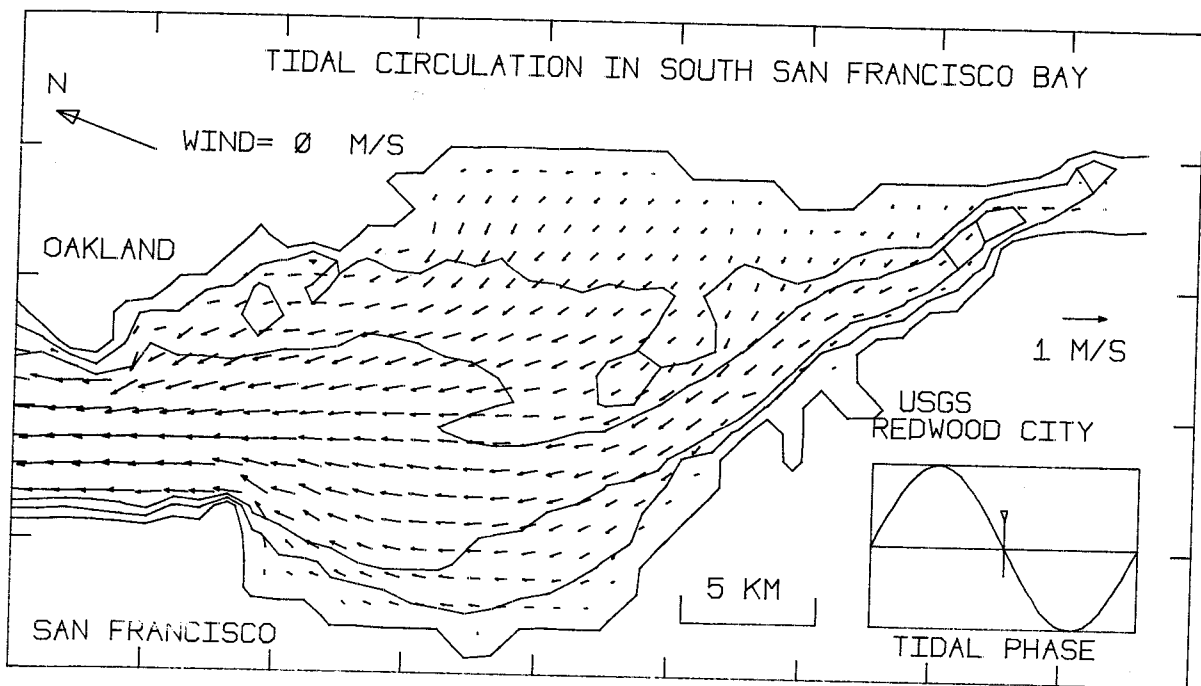
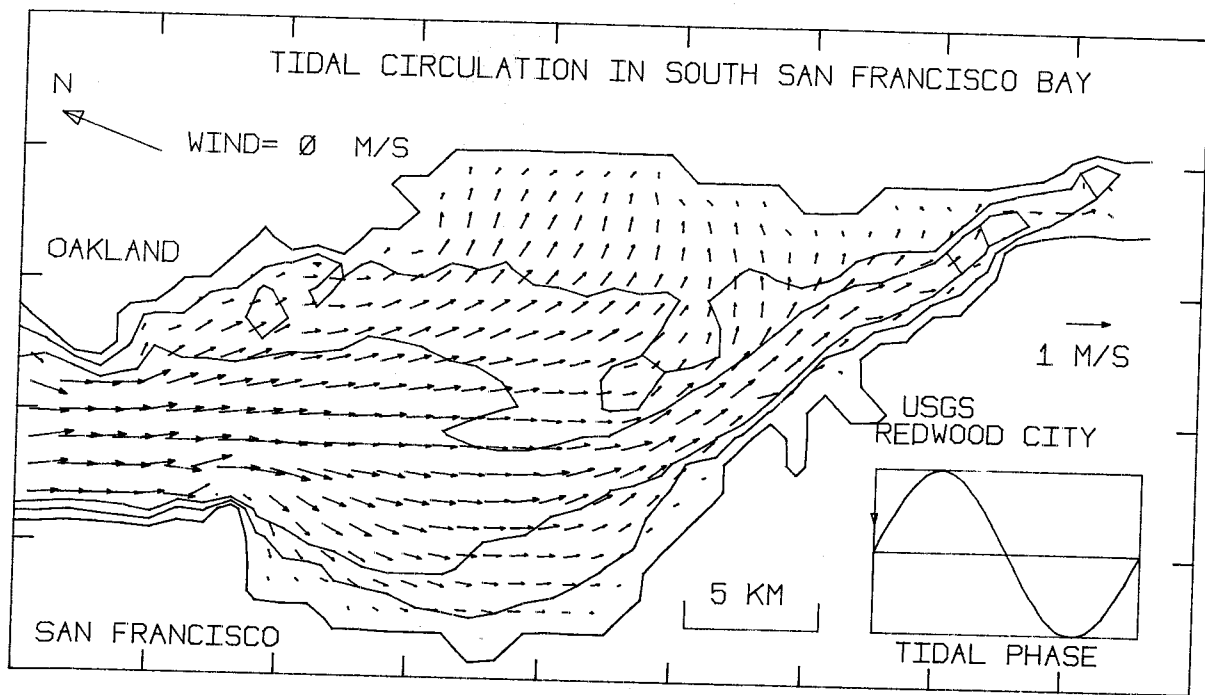

FIGURE 4. Simulation of tidal circulation in South San Francisco Bay using ADI finite difference method. An M_2 -tide, 1 m amplitude was specified at the open boundary between San Francisco and Oakland.
 (a) Tidal circulation in South Bay at 3 hrs after low water.
 (b) Tidal circulation in South Bay at 3 hrs after high water.

To study the residual circulation over seasonal time scales, the shallow-water equations, equations (1), (2), and (3) must be time-averaged to remove variations of tidal period or shorter. These techniques are used by Nihoul and Ronday (1975), and the time-averaged equations are derived in detail by Heaps (1978). Further, Heaps points out that reasonable results can also be obtained by directly time-averaging the velocities computed from a numerical tidal-model such as that described by Maier-Reimer (1977), and indicates that much work is needed to define the limits of these two approaches.

TIDAL STRESS FORMULATION

After expressing each dependent variable in terms of a slowly-varying residual part and a tidal part, the governing equations are integrated over a selected time interval as determined by the time scale to be resolved. The time-averaged shallow water equations take a form similar to the original equations. Additional correlation terms which are known as the tidal stresses appear as the forcing functions; see Nihoul and Ronday (1975) or Walters and Cheng (1980b) for a detailed discussion. The tidal stresses are specified externally either by direct measurement or by results of tidal model simulations. As with the tidal models, the governing equations are solved by the Galerkin finite element method. The spatial domain is discretized with six-node triangular elements; within each element, mixed interpolation is used for the dependent variables - quadratic functions for the depth-integrated residual velocity, and a linear function for the water surface elevation. The discrete system of ordinary differential equations is integrated with respect to time using an implicit finite-difference method. Some early results and experience of this approach are discussed by Walters and Cheng (1980b) and by R. A. Walters in this Proceedings.

LAGRANGIAN APPROACH

In a recent report by Alfrink and Vreugdenhil (1981), a complete survey of the literature on residual circulation was given. The authors point out that there are a number of ways of defining residual currents depending on either an Eulerian or Lagrangian point of view, and on the method of depth averaging.

Based on the framework of shallow water equations, the dependent variables are $U(x,y,t)$, $V(x,y,t)$, and $\zeta(x,y,t)$, where U, V are the depth-averaged velocity components in the x - and y -directions and ζ the free-surface elevation. Under the simplified situation when an M_2 tide is specified at the open boundary for a South San Francisco Bay model, the tidal circulation is simulated to a dynamic steady-state, i.e., the circulation distribution within the basin becomes periodic. Following Alfrink and Vreugdenhil (1981), the Eulerian residual velocity is defined as

$$(U_e, V_e) = \frac{1}{T} \int_{\tau - \frac{1}{2}T}^{\tau + \frac{1}{2}T} (U, V) d\tau \quad (4)$$

Under this definition, the Eulerian residual velocity is related to, but not equal to, the Eulerian residual transport. An example of the Eulerian residual circulation in South San Francisco Bay is shown in Fig. 5a, this result is derived from a tidal-circulation simulation using the ADI finite-difference method.

A Lagrangian viewpoint is of interest in dealing with convection dominated transport processes, because in principle the Lagrangian velocity is exactly the velocity with which substances are transported. Of course, additional dispersion will still be needed to account for the total transport. As was illustrated by Awaji et al. (1980), the net displacement of water in a periodic flow is caused by non-uniform distributions of amplitude and phase angle in space. In a semi-enclosed embayment like South San Francisco Bay, the rapid variation of bathymetry and bottom friction coefficient result in large variations in amplitude and phase angle distribution. As a result, net displacement of water parcels will take place.

To confirm this observation, massless tracers are followed in a simulation of a tidal-circulation model of South Bay. Within the framework of depth-averaged shallow-water equations, the position of a tracer particle is given by

$$\vec{X}(t_0 + t) = \vec{X}(t_0) + \int_{t_0}^{t_0 + t} \vec{U}[\vec{X}(\tau), \tau] d\tau \quad (5)$$

where $X(t_0)$ is the initial position of the tracer particle at time t_0 , and U is the depth-averaged tidal-velocity field. Note that Eq. (5) is an integral equation which was solved by finite difference approximation.

Since the massless tracers are followed, the net displacement of a tracer after a complete tidal cycle divided by the tidal period can be defined as a Lagrangian drift velocity (Zimmerman, 1979), i.e.

$$(U_L, V_L) = \frac{\vec{X}(t_0 + T) - \vec{X}(t_0)}{T} \quad (6)$$

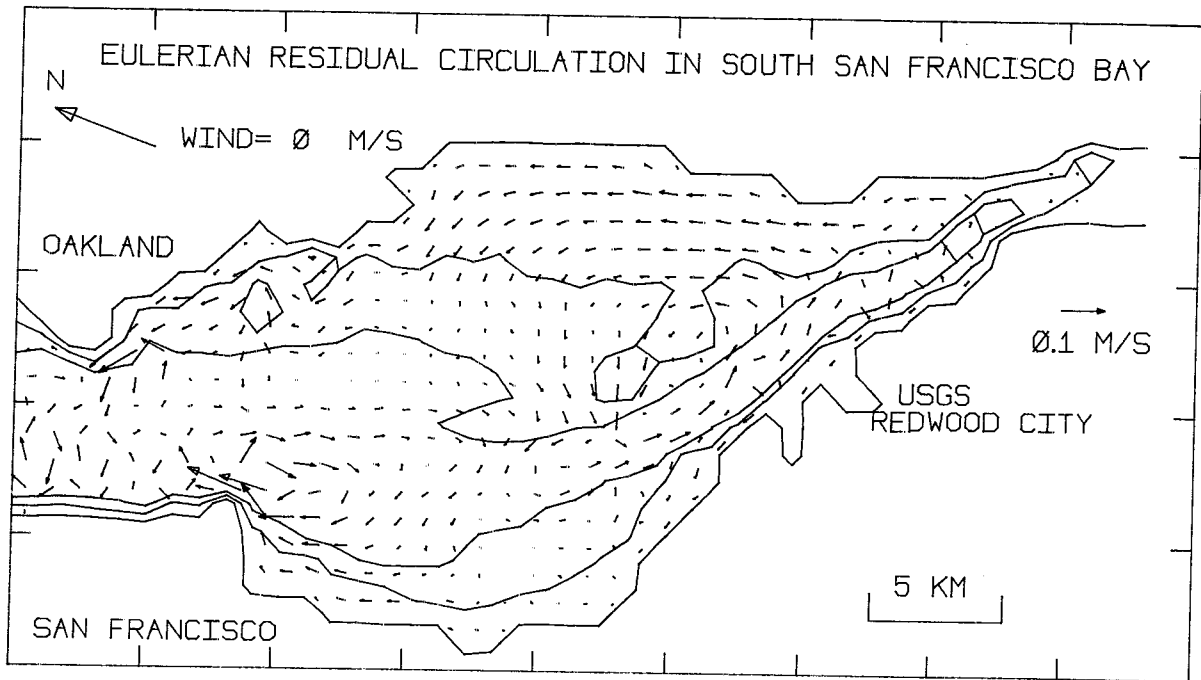

FIGURE 5a. Eulerian residual circulation in South San Francisco Bay derived from a tidal simulation. An M_2 -tide was specified (1 m amplitude) at the open boundary between San Francisco and Oakland.

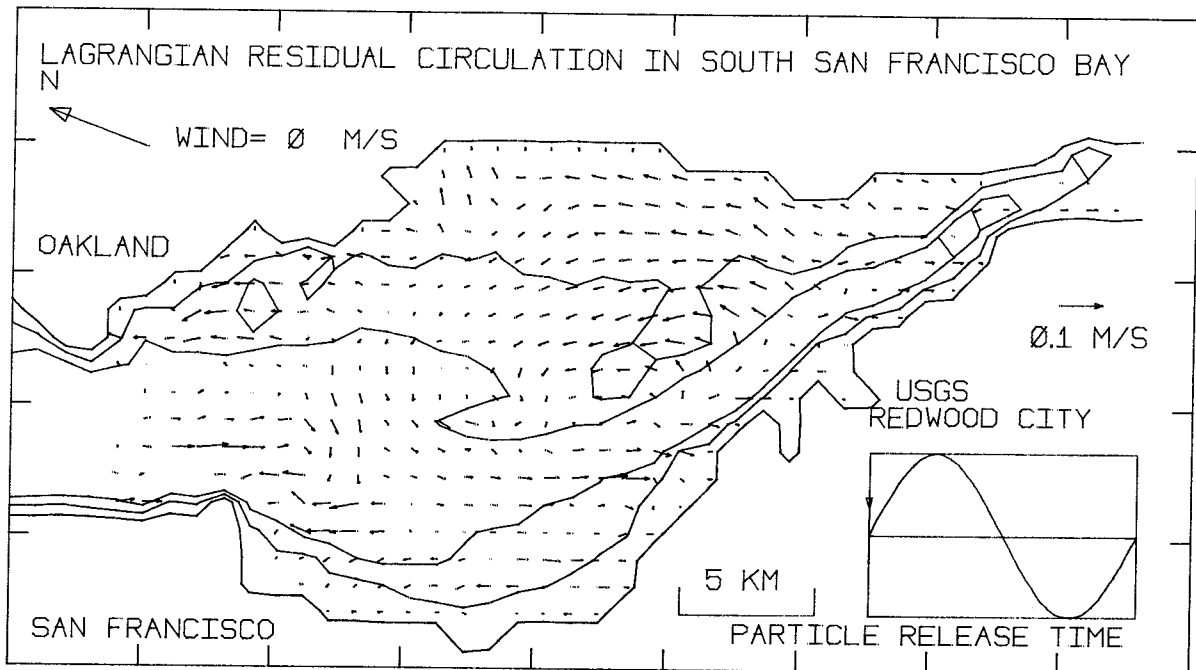

FIGURE 5b. Lagrangian residual circulation in South San Francisco Bay due to the same tidal simulation. The massless tracers were released at 3 hrs after low water.

where (U_L, V_L) are the components of the Lagrangian drift velocity and T is the tidal period. Shown in Fig. 5b is an example of the Lagrangian drift circulation pattern in South San Francisco Bay.

Since there are several different approaches that one may follow in the formulation of residual currents, direct comparison of simulation results is very difficult because these residual velocities are defined slightly differently. Nevertheless, all models give the general features of a bay-wide counterclockwise gyre located near the south end of South Bay (See Fig. 3, Walters in this Proceeding and Fig. 5a and 5b). It is worthwhile to note that these residual quantities are at least an order of magnitude smaller than their tidal counterparts. To deduce the residual quantities from measurement (current meter records) is also difficult because these quantities are on the same order of magnitude as the uncertainty of the instrument. Clearly much research is needed in this area.

CONCLUSION AND FUTURE RESEARCH DIRECTION

Several numerical models have been developed and implemented to simulate tidal and residual circulation in San Francisco Bay. Because of a broad distribution in time scales, hydrodynamic models must be formulated to account for the proper time and spatial scales which dominate the transport processes. A complete current survey of the San Francisco Bay system was conducted jointly between NOS/NOAA and USGS (Patchen and Cheng, 1979). Presently, these current meter data are being processed and analyzed, and concurrently further development of tidal and residual circulation models continues. When these data become available, they will be used to calibrate the numerical models and to guide refinement of hydrodynamic models in order to maximize our understanding of the Bay system. Our modeling efforts will be extended to the northern reach of the Bay system where a consideration of gravitational circulation, i.e., baroclinic flows, might be necessary.

Relative merits of using the finite element method or the finite difference method are of interest to many users, but a definitive answer to this question can not be expected. Nevertheless, attempts are being made to gain working experience with both numerical methods to permit a proper assessment of the pros and cons of each approach. Finally, it is important to note that most ecological processes in environmental systems take place on much longer time scales than those of the present-day hydrodynamic models. Undoubtedly, water circulation plays an important role in these ecological interactions; careful interfacing of hydrodynamic models (residual and gravitational circulation models) which are capable of simulation on seasonal time scales at reasonable computer cost with biological and chemical models will be most fruitful.

REFERENCES

1. Alfrink, B.J., and Vreugdenhil, C.B., 1981, "Residual Currents", Delft Hydraulic Laboratory, R1469-11.
2. Awaji, T., Imasato, N., and Kunishi, H., 1980, "Tidal Exchange Through a Strait: A Numerical Experiment Using a Simple Model Basin", J. Phys. Ocean, Vol. 10, p. 1499-1508.
3. Cheng, R.T., and Conomos, T.J., 1980, "Studies of San Francisco Bay by the U.S. Geological Survey", Proceedings, Inst. Environ. Sciences, p. 299-303.
4. Cheng, R.T., and Walters, R.A., 1981, "Modeling of Estuarine Hydrodynamics and Field Data Requirements", to appear in Finite Elements in Fluids, Vol. IV, Wiley.
5. Conomos, T.J., ed., 1979, "San Francisco Bay: The Urbanized Estuary", Pacific Division, AAAS, San Francisco, CA, 495 PP.
6. Heaps, N.S., 1978, "Linearized Vertically-integrated Equations for Residual Circulation in Coastal Seas", Deutsche Hydrographische Zeitschrift, 31, pp. 147-169.
7. Fischer, H.B., 1976, "Mixing and Dispersion in Estuaries", Annual Reviews of Fluid Mechanics, Vol. 8, p. 107-133.
8. Leendertse, J.J., 1967, "Aspects of a Computational Model for Long-Period Water-Wave Propagation", Report RM-5294-PR, Rand Corp., Santa Monica, California.
9. Leendertse, J.J., 1970, "A Water-quality Simulation Model for Well-Mixed Estuaries and Coastal Seas: Vol. I, Principles of Computation", Report RM-6230-RC, Rand Corp.
10. Leendertse, J.J., and Gritton, E.C., 1971a, "A Water-quality Simulation Model for Well-mixed Estuaries and Coastal Seas: Vol. II, Computation Procedures", Report R-708-NYC, Rand Corp.
11. Leendertse, J.J., and Gritton, E.C., 1971b, "A Water Quality Simulation Model for Well-mixed Estuaries and Coastal Seas: Vol. III, Jamaica Bay Simulation", Report R-709-NYC, Rand Corp.
12. Maier-Reimer, E., 1977, "Residual Circulation in the North Sea Due to the M_2 -tide and Mean Annual Wind Stress", Deutsche Hydrographische Zeitschrift, 30, pp. 69-80.
13. Nihoul, J.C.J., Roday, R.C., 1975, "The Influence of the Tidal Stress on the Residual Circulation", Tellus XXVII, 5, pp. 484-489.
14. Patchen, R.C., and Cheng, R.T., 1979, "Current Survey of San Francisco Bay by NOS/USGS", (Abstract), AGU, EOS, Vol. 60, No. 46, p. 843.
15. Pritchard, D.W., 1967, "Observations of Circulation in Coastal Plain Estuaries", in Estuaries, G.G. Lauff, ed., AAAS Publication No. 83, Washington, D.C.

16. Walters, R.A., Cheng, R.T., 1979, "A Two-dimensional Hydrodynamic Model of a Tidal Estuary", Advances in Water Resources, Vol. 2, p. 177-184.
17. Walters, R.A., and Cheng, R.T., 1980a, "Accuracy of an Estuarine Hydrodynamic Model Using Smooth Elements", Water Resour. Res., Vol. 16, No. 1, p. 187-195.
18. Walters, R.A., and Cheng, R.T., 1980b, "Calculations of Estuarine Residual Currents Using the Finite Element Method". Proceedings of the Third International Conference on Finite Elements in Flow Problems. Banff, Alberta, Canada.
19. Zimmerman, J.T.F., 1979, "On the Euler-Lagrange Transformation and the Stokes' Drift in the Presence of Oscillatory and Residual Currents", Deep Sea Research, Vol. 26A, pp. 505-520.

NOTE: There is no paper discussion for Dr. Cheng's paper. He was unable to personally present his paper. Dr. Roy Walters, also from the Menlo Park office of the U.S.G.S., answered general questions regarding Dr. Cheng's current research activities (see previous paper discussion by Roy Walters).

NUMERICAL MODELS FOR THE PREDICTION OF WIND AND TIDE
DRIVEN COASTAL CIRCULATION AND WATER LEVEL

by

JON M. HUBERTZ¹

INTRODUCTION

Significant advances have been made over the last twenty years in the science of predicting coastal flooding due to storm surges. Early methods employed parameterized one-dimensional models which supplied an estimate of water level at a non-flooding coastline. These were replaced by two-dimensional models with straight non-flooding coastlines. The two-dimensional models were improved by allowing the coastline to curve and the numerical grid to have a variable cell size. They extended from the coastline seaward to some depth and are referred to as Continental Shelf Models.

Flooding boundary models or Inland Flooding Models were developed to study the effects of storm surges along small sections of the coast. Generally, a Continental Shelf Model would be run first to supply ocean boundary conditions for the inland model. The present trend is toward development of one model which contains the features of both a Continental Shelf and Inland Flooding Model.

This paper discusses two Inland Flooding Models which have features applicable to the study of river flow and flooding. The models are presently being used to address field needs in the area of storm surge studies. They provide a tool to predict water level and currents where these variables are needed in the design of coastal protection projects. They are also being used to study the changes in water level or current patterns which a coastal project might cause. These could be changes in the daily tidal circulation as well as changes related to storm events.

¹Coastal Engineering Research Center

MODEL DESCRIPTION

The models discussed are the SURGE III model developed in stages by Reid and Bodine (1968), Reid, Vastano and Reid (1977), Reid (1979 unpublished) and the TWO-D-SURGE model Herchenroder and Hubertz (1981 unpublished). Both models are two-dimensional and time dependent. They solve the long wave equations using an explicit finite difference technique on a uniformly spaced numerical grid. Both are governed by the Courant Stability criteria $(\Delta t \leq \frac{\Delta x}{(2gh)^{1/2}}$ which requires the time step to be less than the ratio of grid spacing to long wave speed. Neither model contains the advective terms which are considered of minor importance on the scale of storm surge problems.

Both models allow for flooding of and recession from land and employ sub-grid scale representation of barriers and channels. This technique allows a large grid cell size to be maintained while still resolving small features such as rivers, interconnecting channels and topographic or man made barriers to the flow. This, in turn, permits a larger time step to be used than if these features were resolved by the individual grid blocks.

The equations solved over the two-dimensional region in each model are summarized below:

SURGE III

$$\frac{\partial U}{\partial t} + gD \frac{\partial H}{\partial x} = X - C_f \frac{(U^2 + V^2)^{1/2}}{D^2} U \quad (1)$$

$$\frac{\partial V}{\partial t} + gD \frac{\partial H}{\partial y} = Y - C_f \frac{(U^2 + V^2)^{1/2}}{D^2} V \quad (2)$$

$$\frac{\partial H}{\partial t} + \frac{\partial U}{\partial x} + \frac{\partial V}{\partial y} = R \quad (3)$$

TWO-D-SURGE

$$\frac{\partial U}{\partial t} + gD \frac{\partial H}{\partial x} - fV = X - \left[\frac{gn^2(U^2 + V^2)^{1/2} U}{D^{7/3}} - KX \right] \quad (4)$$

$$\frac{\partial V}{\partial t} + gD \frac{\partial H}{\partial y} + fU = Y - \left[\frac{gn^2(U^2 + V^2)^{1/2} V}{D^{7/3}} - KY \right] \quad (5)$$

$$\frac{\partial H}{\partial t} + \frac{\partial U}{\partial x} + \frac{\partial V}{\partial y} = R \quad (6)$$

u, v (m^2/sec) are the vertically integrated transports per unit width in the x, y directions.

D (m) is the total depth equal to $H-Z$ where Z is the still water depth from a datum plane and H is the increased depth above the datum. H includes the inverted barometer effect.

X, Y (m^2/s^2) are the components of windstress in the x, y directions.

f (sec^{-1}) is the Coriolis parameter, (m/sec^2)

g the acceleration of gravity,

t (sec) the time

n ($m^{-1/3} sec$) Mannings coefficient.

C_f a non-dimensional frictional coefficient

K is a non-dimensional coefficient relating surface and bottom stress effects and

R (m/sec) is the rainfall rate.

These two sets of equations differ in their representation of bottom friction and use of the Coriolis parameter. One value of the frictional parameter C_f is applied to all blocks in the SURGE III model while a different value of n^2 is possible for each block in the TWO-D-SURGE model. The Coriolis term has a minor effect in small scale inland flooding studies but is included in the TWO-D-SURGE model to make it applicable to continental shelf scale studies.

The boundary conditions applied are essentially the same in both models. On the seaward boundary, the water level is specified as a function of time. These values are usually supplied by a larger scale model or obtained from measurements. Water level values are also supplied along the portions of lateral boundaries which are always wet. Along the remainder of the lateral boundaries and along the landwardmost boundary, the flow normal to the boundary is taken as zero. The TWO-D-SURGE model allows for the possibility of flow across some specified portion of the lateral boundaries. The remaining boundary condition is applied to the interior of the model where the land-water boundary changes with time. The condition is obtained from a modification of the appropriate component momentum equations in each model. The modification is to the frictional term. The equation used is

$$\frac{\partial Q}{\partial t} + g\bar{D} \frac{\Delta H}{L} = X - \frac{\bar{D}}{LC_b^2} \frac{|Q|Q}{D_b^2} \quad (7)$$

where

$Q \frac{(m^2)}{sec}$ is transport/unit width to or from the land

\bar{D} (m) is the mean depth between blocks

ΔH (m) is the water level differential

L (m) the wetted distance between block centers

C_b is a non-dimensional overflow coefficient and

D_b (m) is the depth at the junction of the two blocks.

The TWO-D-SURGE version also contains the Coriolis term and KX term related to surface bottom stress interaction. For the case of steady state, no wind and no Coriolis effect the equations reduce to the relation for flow over a broad crested wier.

$$Q = C_b D_b (g\Delta H)^{1/2} \quad (8)$$

The same equations are also used for flow over overtopped and submerged barriers

Each model contains a one-dimensional representation of rivers or channels. Flood waters can drain into the channels and also flow out over the channel banks. The flow in the rivers is calculated interactively with the two-dimensional overland flow. The one dimensional equations used to calculate the flow in the rivers are:

SURGE III

$$\frac{\partial Q}{\partial t} + gA \frac{\partial H}{\partial s} = WT_s - \frac{WC_f |Q|Q}{A^2} \quad (9)$$

$$\frac{\partial A}{\partial t} + \frac{\partial Q}{\partial s} = L_f \quad (10)$$

TWO-D-SURGE

$$\frac{\partial Q}{\partial t} + gA \frac{\partial H}{\partial s} = WT_s - \left[\frac{gn W |Q|Q}{D^{7/3}} - KWT_s \right] \quad (11)$$

$$\frac{\partial A}{\partial t} + \frac{\partial Q}{\partial s} = L_f \quad (12)$$

where Q (m^3/sec) is the volume transport in the channel,

A (m^2) is the channel cross-sectional area,

W (m) is the channel width,

T_s (m^2/sec) is the component of windstress along the channel

and L_f (m^2/sec) is the lateral volume transport/unit distance along the channel.

The equations are the same with the exception of the frictional terms. However, there are differences in how some of the parameters are interpreted.

Rivers or channels are routed through the centers of grid blocks in the TWO-D-SURGE model while in the SURGE III model, they are routed along the top and right hand sides. Routing a river through the center of a block allows junctions to be resolved on a scale of one half the grid block size while routing along the sides requires a scale of one grid block.

The length of a segment of river is preserved when discretized in the TWO-D-SURGE model while in the SURGE III model it is approximated by the grid block size. The choice of a variable reach length provides greater flexibility in resolving meandering rivers.

The angle the prototype river axis makes with the grid is preserved in the TWO-D-SURGE model while it is approximated in the SURGE III model as lying along a grid line. This allows a better approximation of the wind stress to be applied along the river axis in the TWO-D-SURGE model.

The lateral flow to and from the river is calculated differently in each model. The TWO-D-SURGE model uses mass conservation on each block and river reach at each time step to determine lateral flow. This permits a channel to dry up which is not permitted in SURGE III. The barrier overflow relation is used in SURGE III to calculate lateral flow. This allows representation of levees along a channel bank which is not permitted in TWO-D-SURGE.

The technique to solve the river momentum and continuity equations differs in the models. The equations are solved directly in finite difference form in the TWO-D-SURGE model while the method of characteristics is used in the SURGE III model. The choice of one method over the other appears to be simply one of the modeler. The grid sweep sequence in solution of both nonriver and river equations, also differ somewhat but again is simply a choice of the modeler.

MODEL APPLICATION

Both models were developed to deal with features such as barrier islands, marsh lands, interconnecting channels, bays and rivers. Such features are important in blocking and channeling tidal flow as well as storm surges. The Charleston, South Carolina region is typified by such features and is used to illustrate an application of the models.

A 60 by 30 mile region is discretized with a uniform grid whose cell size is 1 mile. The gridded region is shown in Fig. 1. The subgrid scale features of the models allow a large region to be modeled while maintaining the ability to resolve the small features such as rivers, barrier islands and channels.

Once the grid is prepared, the data necessary to run the model can be collected. The data consists of three types: that necessary to describe the topography and bathymetry, that necessary to describe the driving forces and thirdly other parameters such as time and space steps and output information.

The topography data consists of

- a. The bed elevation and frictional coefficient of each grid block
(One frictional coefficient is used for all blocks in the SURGE III model),
- b. The location, height and frictional coefficient for each barrier,
- c. The location, depth, width and frictional coefficient of each

channel reach as well as any transport specified at the end of the channel. The angle and length of each channel reach are also needed in the TWO-D-SURGE model.

The data to drive the model consists of the windstress on each block and the water levels on the boundaries. The rainfall can also be specified.

Once the model grid has been prepared and the data collected, the model is calibrated using any available astronomical tide measurements. A field data collection program to gather a sufficient data set, if none exists, is now

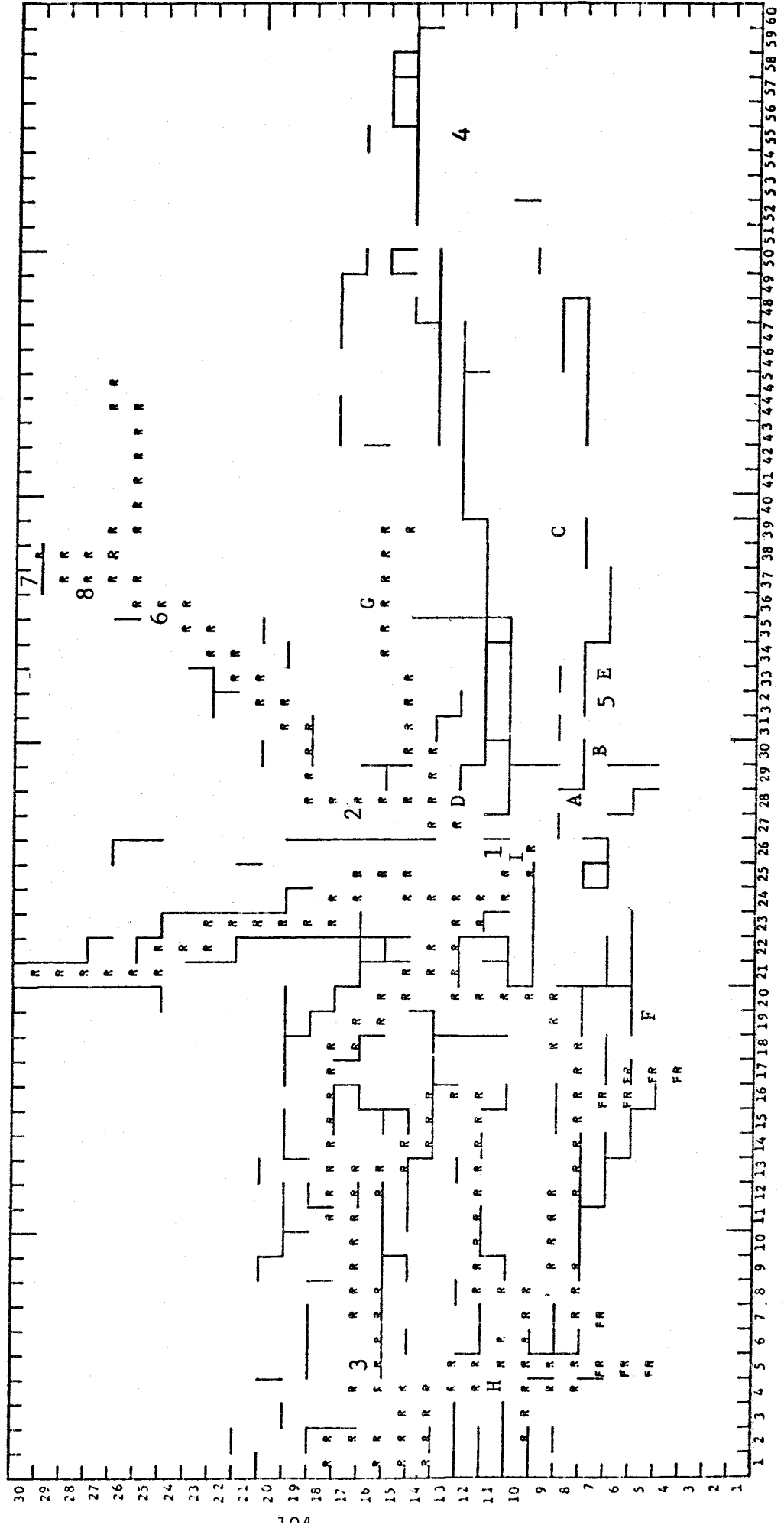

Fig. 1. Schematization of the Modeled Region and Location of Tide (numbers) and High Water Mark (letters) Measurements. Barriers are represented by _____ and blocks with a river reach by R.

considered essential when a region is being modeled. The tidal calibration should be done to insure that the response of the system is proper under normal conditions.

The results of the tidal calibration for the Charleston region are shown in Fig. 2. Tidal measurements were made by Charleston District personnel on 25 April 1974 at eight stations whose location is shown in Fig. 1. The results shown in Fig. 2 are the measured values and computed values from the TWO-D-SURGE and SURGE III models. The models were run for thirteen hours prior to the time of the first measurement to allow the system to come into equilibrium. The measured tide signal at the Custom house was extrapolated back in time to provide boundary conditions. Tide gage station six has only three measured heights due to instrument problems.

Eight tidal calibration runs were made for the TWO-D-SURGE model and five for the SURGE III. Changes in frictional coefficients and barrier and channel geometry constituted the calibration. The results shown are from the last calibration run of each model. Present field studies would collect longer time series to avoid problems with extrapolation and include velocity measurements which are a more sensitive calibration parameter. The present calibration results are considered satisfactory allowing for the limitations of the data and purpose of the model.

A satisfactory tidal calibration assures that the model is operating properly under normal conditions. It does not necessarily guarantee that the model is properly adjusted for abnormal flooding situations. This adjustment is accomplished through a storm calibration. This type of calibration is usually more difficult to do than the tidal calibration because of the lack of sufficient data.

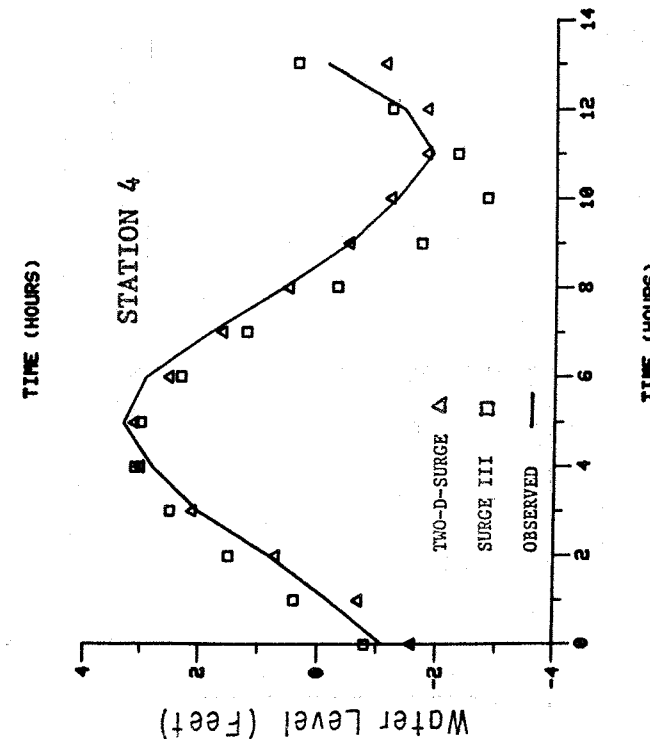
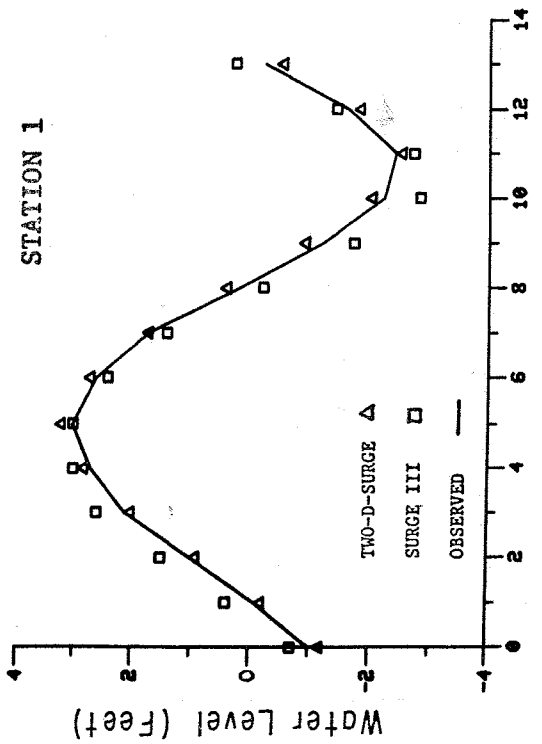
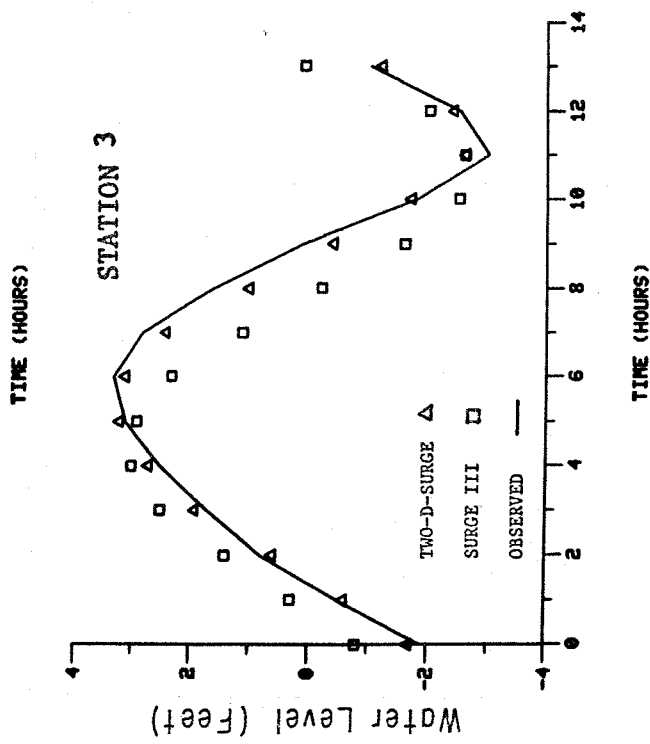
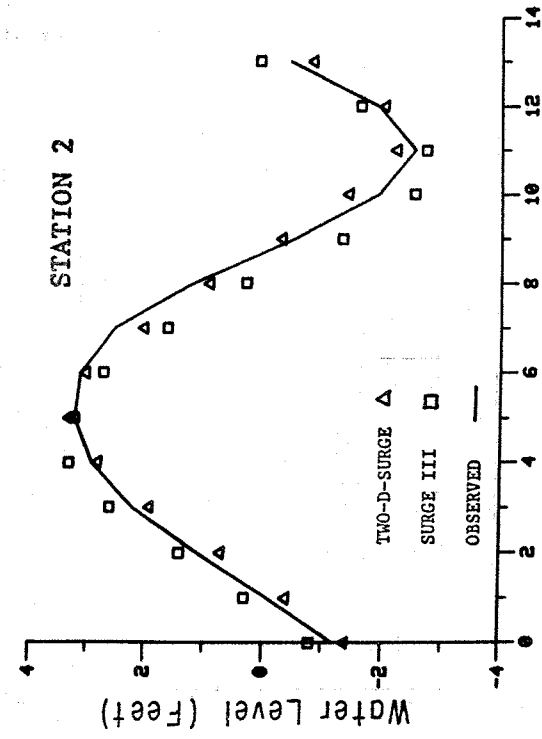

FIGURE 2 Tide Calibration Results

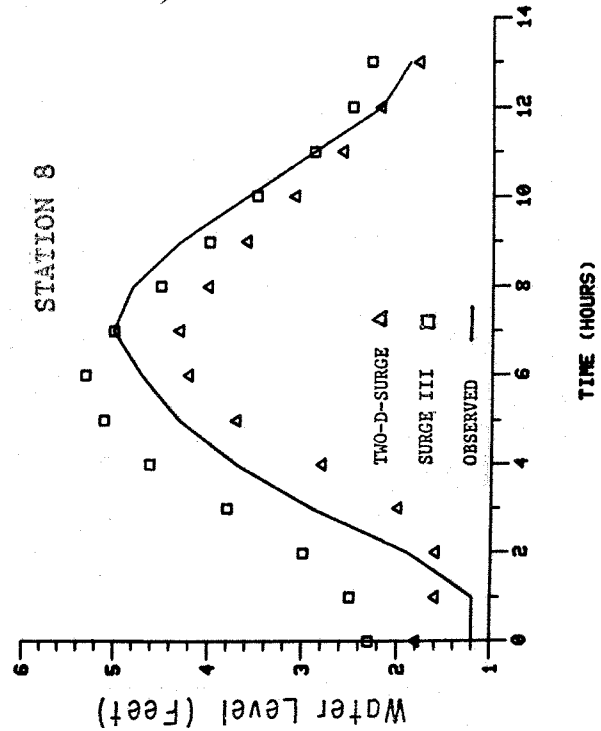
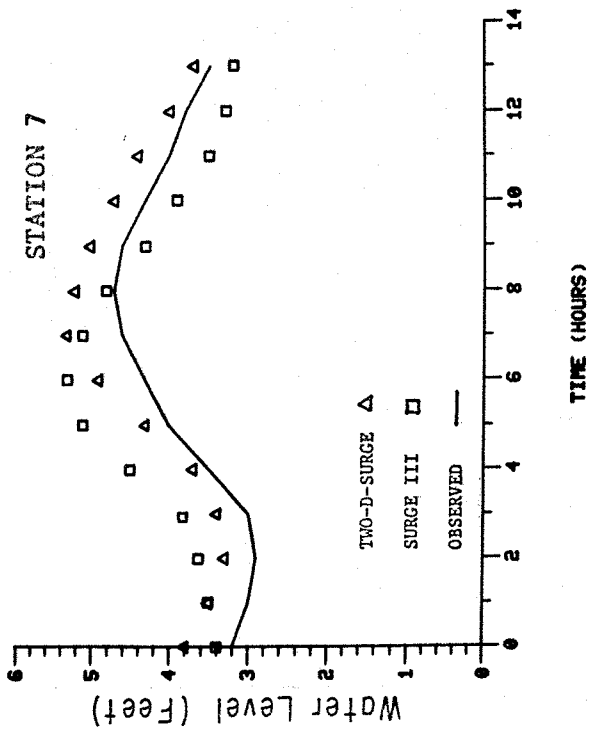
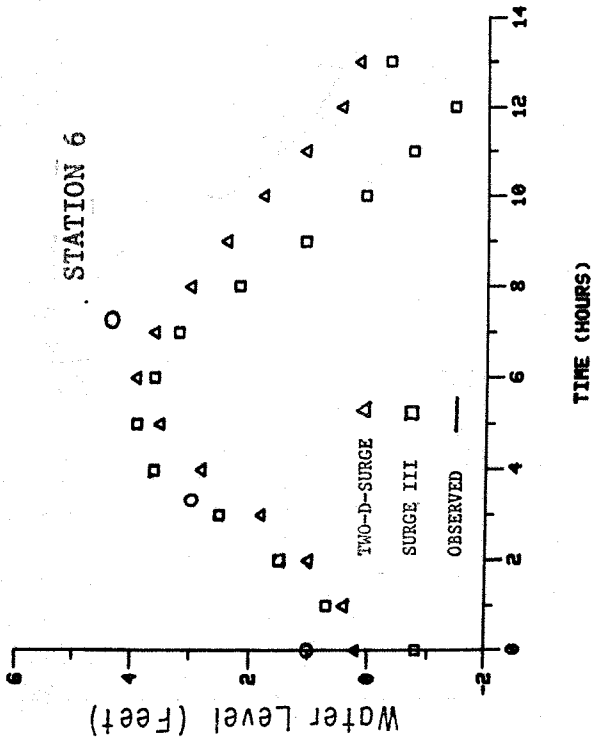
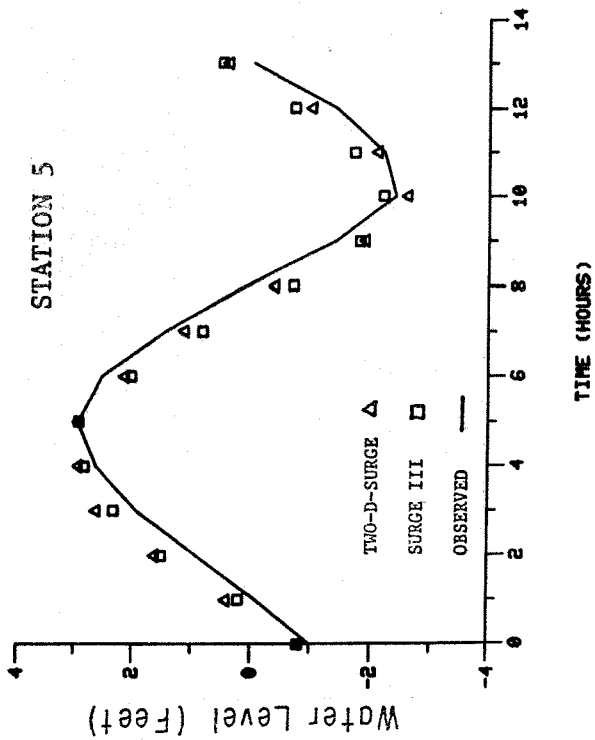

FIGURE 2 Tide Calibration Results

Hurricane Gracie provides the best data set for storm calibration in the Charleston area. The path of this storm is shown in Fig. 3. Gracie was a small intense storm which crossed the coast about 30 miles south of Charleston. The maximum surge hit the coast during a period of low tide so that flooding was somewhat reduced.

A hurricane wind model and Continental Shelf model were used to generate the water levels at the boundaries of the two Inland Flooding Models. Calibration was primarily made by comparing model results with a tide hydrograph at the Charleston Custom House. Scattered high water marks identified by letters in Fig. 1 were also used. The computed and measured time history of total water level is shown in Fig. 4. A comparison of computed and estimated high water marks is shown in Table 1. The agreement between computed and observed values is considered to be about as good as present day models can do.

The only other storm to affect Charleston was the storm of 1939 and data on the storm and water levels is not sufficient for a verification run. Both models were run for Hurricane Carla in the Galveston, Texas area and gave results of equal accuracy to the Charleston case.

Both models are available from CERC with some documentation. However, it is suggested that the models be used in collaboration with CERC personnel due to the complexity of the models and experience needed in data gathering and model application. Both models are applicable to the study of one-dimensional river flow with overflow and recession of river banks and levees to and from a two-dimensional region. These models were developed under the Waves and Coastal Flooding Program of the Coastal Engineering Research Center.

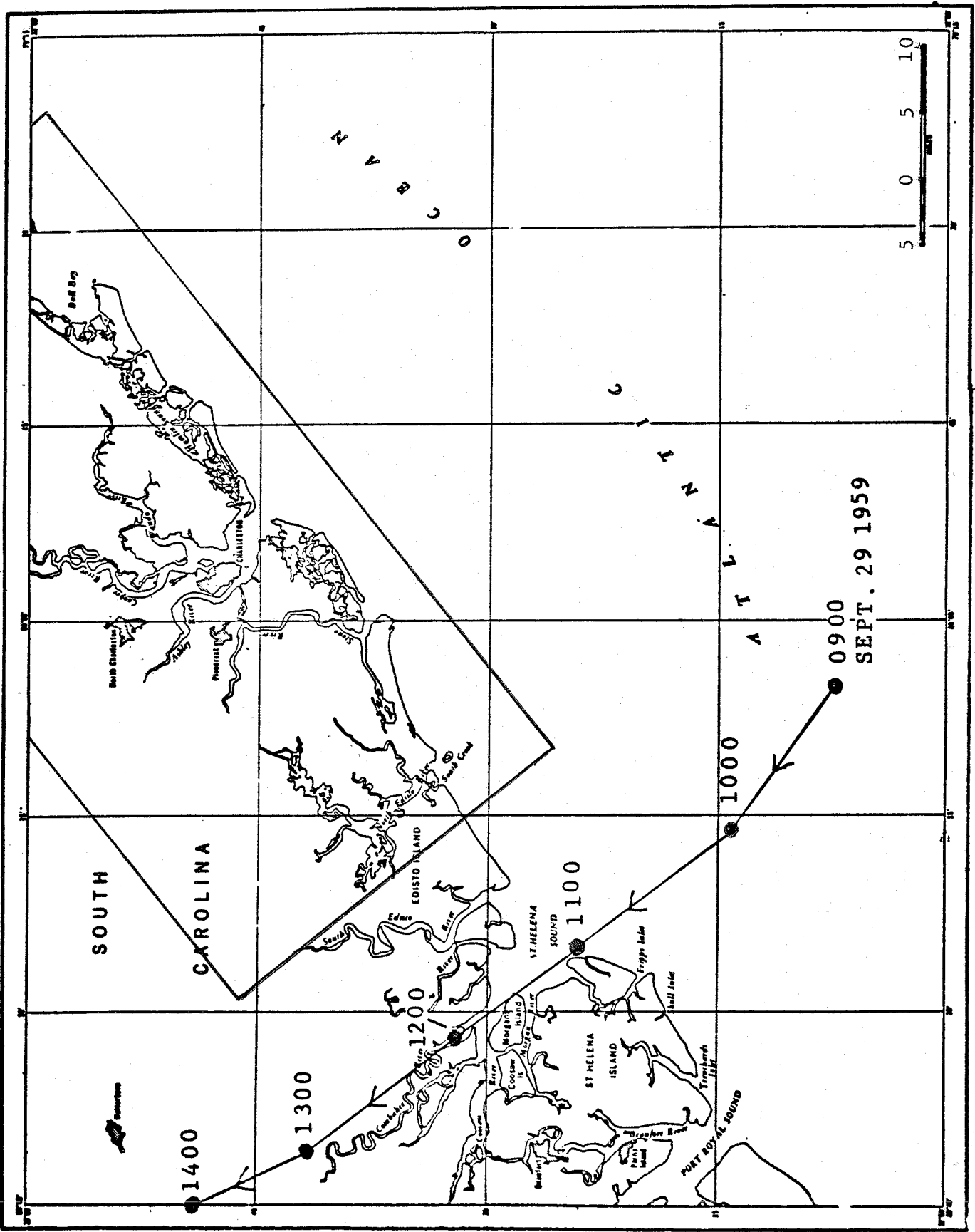
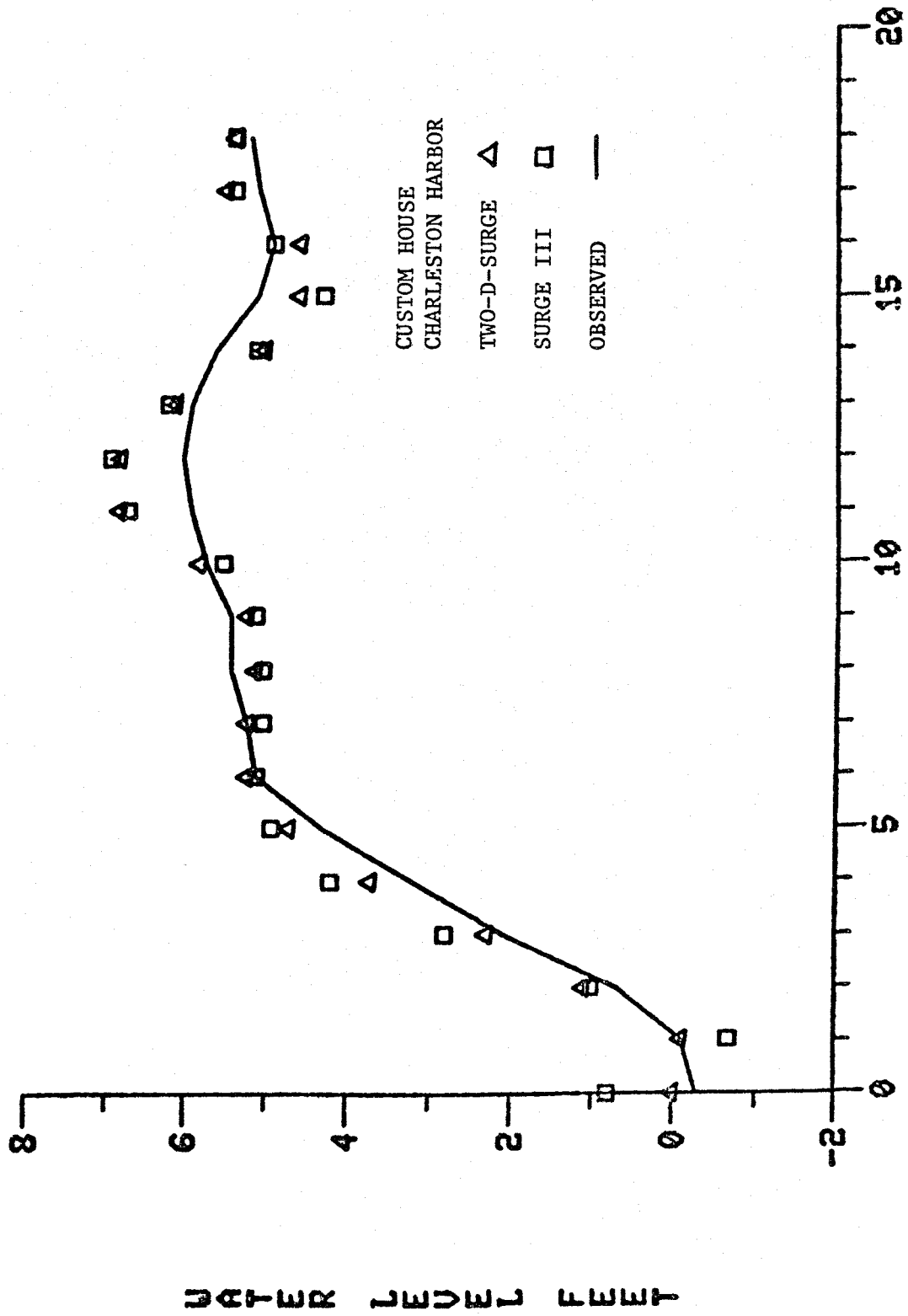

Figure 3 Track of Hurricane Gracie
 Times are LST. Model region shown by solid lines.



TIME (HOURS)

WATER LEVEL FEET

Fig. 4. Observed and Computed Time History of Water Level During Hurricane Gracie

TABLE 1

COMPARISON OF OBSERVED AND COMPUTED HIGH WATER MARKS

	LOCATION	OBSERVED	TWO-D-SURGE	SURGE III
	Sullivans Island			
A	West End	8.2	6.4	6.1
B	East End	8.0	6.5	6.1
C	Old Cove Inlet	7.7	4.4	7.7
D	Grace Memorial Bridge	5.9	7.0	7.1
E	Isle of Palms	7.9	6.1	5.6
F	Folly Beach	7.6	7.0	6.6
G	Wando River Bridge	6.7	7.3	7.2
H	Rockville	7.1	7.9	9.2
I	Custom House	6.0	6.9	6.9
			Mean Difference (obs-model)	
			0.6	0.3

REFERENCES

1. Reid, R. O. and B. R. Bodine "Numerical Model for Storm Surges in Galveston Bay" Journal of the Waterways and Harbors Division, ASCE, WW1, February 1968, pp 33-57.
2. Reid, R. O., Vastano, A. C. and Reid, T. J. "Development of Surge II Program With Application to the Sabine-Calcasieu Area for Hurricane Carla and Design Hurricanes" Coastal Engineering Research Center, Tech. Paper TP 77-13, November 1977, pp 218.

PAPER DISCUSSION

NUMERICAL MODELS FOR THE PREDICTION OF WIND AND TIDE
DRIVEN COASTAL CIRCULATION AND WATER LEVEL

by
Jon M. Hubertz

Question: I'm curious, Jon, as to the amount of time, manpower and the steps and procedures that you needed to go through to attack a problem such as the Charleston problem and study that you did. Could you please elaborate upon that for us?

Dr. Hubertz: Yes. The major steps in such a study would be:

1. Meet with district engineers to discuss their problems and examine the region to be modeled,
2. Collect the necessary data for input to the model such as bed elevations, channel and barrier characteristics,
3. Make the necessary field measurement of water level and velocity for calibration of the model if such measurements do not already exist,
4. Use the model to help solve the problems being studied.

Question: How many people over how long a period of time were involved in this study?

Dr. Hubertz: It varied depending on the task. Two or three district people were involved for about a month in field measurements and data analysis. A technician at CERC was involved three to four months setting up the model and the principle investigator was involved off and on for about a year. The manpower depends most on the availability and format of the model input and calibration data.

Question: What about computer cost; how expensive is it to make a simulation such as this?

Dr. Hubertz: That varies with the problem and computer used. An estimate for a problem such as this would be \$1.00 per real time hour of simulation. That is if you wanted an 18-hour simulation of a storm it would cost about \$18.

Question: During the simulation did you say that the channels went dry during parts of the study?

Dr. Hubertz: Yes, some of them did. Those channels which are fairly shallow may go dry because of drainage when the tide goes out or when the sea surface is set down due to offshore winds. This is usually the case in the left front quadrant of a storm at landfall.

A STORM SURGE MODEL

Michael H. Chen, David J. Divoky and Li-San Hwang¹

INTRODUCTION

A generalized two-dimensional moving-boundary surge model has been developed for the Federal Emergency Management Agency. This model has been applied in the studies of a number of coastal areas to determine the flood return period for the National Flood Insurance Program. The detailed discussion of the methodology and the user's guide for this numerical model are contained in the reports prepared by Tetra Tech (1981).

In this model, many special treatments have been implemented in order to model a very complicated coastal region. Some of these special treatments include those for moving-boundary, barrier islands, and embedded channels. The moving-boundary treatment simulates the water movement more realistically than the fixed boundary treatment. The treatments of barrier islands and embedded channels are tools which allow us to investigate effects of these islands and channels on the resulting surge values without having to use a much finer grid element. By using these tools, the cost of numerical simulation can be lowered substantially.

The hindcasting of 1961's Hurricane Carla in the Sabine Lake area, using this model, is presented in this paper. The overall agreement between the computation and the observation is quite close.

BASIC HYDRODYNAMIC EQUATIONS

The fundamental assumption in the theory of storm surge is that vertical accelerations are negligible, and lead to a hydrostatic pressure variation in the vertical. This results in the classical, vertically averaged, long-wave equations with forcing terms due to wind stress, atmospheric pressure differences, and bottom friction dissipation. As such, the equations are suited for computing forced disturbances with large horizontal length scales, that is, the rise in sea-level (storm surge) which is responsible for coastal inundation.

Presented here are the hydrodynamic equations governing storm surge. The detailed derivation is given elsewhere (e.g., Welander, 1961 and Platzman, 1965). The momentum and continuity equations are:

¹ Tetra Tech, Inc., Pasadena, California.

$$\frac{\partial u}{\partial t} + u \frac{\partial u}{\partial x} + \frac{\partial u}{\partial y} = -g \frac{\partial \eta}{\partial x} + fv - \frac{\tau_{bx}}{p(h+\eta)} + \frac{\tau_{wx}}{p(h+\eta)} - \frac{1}{p} \frac{\partial p}{\partial x} \quad (1)$$

$$\frac{\partial v}{\partial t} + u \frac{\partial v}{\partial x} + \frac{\partial v}{\partial y} = -g \frac{\partial \eta}{\partial y} = fu - \frac{\tau_{by}}{p(h+\eta)} + \frac{\tau_{wy}}{p(h+\eta)} - \frac{1}{p} \frac{\partial p}{\partial y} \quad (2)$$

$$\frac{\partial \eta}{\partial t} + \frac{\partial}{\partial x} \{(h+\eta) \cdot u\} + \frac{\partial}{\partial y} \{(h+\eta) \cdot v\} = 0 \quad (3)$$

The symbols used in equations (1) to (3) are defined below as (x,y) = rectangular Cartesian coordinates; (u,v) = vertically averaged components in the x and y directions, respectively; (t) = time; (η) = storm surge height above sea-level datum; (f) = Coriolis parameter = $2 \omega \sin \phi$; where $\omega = 7.28 \times 10^{-5}$ radians/sec and ϕ = latitude in degrees; (g) = gravitational acceleration; (ρ) = density of water; (h) = water depth below sea-level datum; (p) = atmospheric pressure; (τ_{bx}, τ_{by}) = bottom stress components in the x and y directions, respectively; and (τ_{wx}, τ_{wy}) = wind stress components in the x and y directions, respectively. The last three terms on the right hand side of equations (1) and (2) are associated with the surge driving and retarding forces.

FINITE-DIFFERENCE NUMERICAL SCHEME

The numerical model for the storm surge is obtained by expressing equations (1) to (3) in their finite difference forms using a time and space staggered method. In the space staggered arrangement, the water elevation, η , and the water depth, h , are placed at the center of a grid element, while the velocity components, u and v , are assigned to the corresponding edges of the grid element. Because of this arrangement, no two-flow quantities are needed at a particular location; a two-point or four-point averaging method is used to calculate those variables.

The actual time integration within each time increment, Δt , is split into two cycles. The water elevations and the velocity components are computed explicitly at alternate half-time steps. In the first cycle, the water elevations at $(t_0 + \Delta t/2)$ are calculated using the water elevation at $(t_0 - \Delta t/2)$ and the velocities at (t_0) . Then the velocities at $(t_0 + \Delta t)$ are calculated using the velocities at (t_0) and the water elevations at $(t_0 + \Delta t/2)$ in the second cycle.

Usually, the frictional terms are approximated by the particle velocities at the previous time step. This approximation is not proper when the effect on the particle velocities increases due to the wind stress. Eventually, it will lead to an erroneous result as the total water depth approaches zero. In view of this difficulty, Reid and Bodine (1968) approximated the frictional term with the particle velocity at both the current and the next time step. This

scheme was used by Verma and Dean (1969), Pearce (1972), and Pagenkopf and Pearce (1975).

In the current surge model, a new frictional treatment has been developed because it was felt that it was important to treat the coupling effect between the wind driving force and the bottom retarding force more accurately. When the total water depth approaches zero, a drastic change in the particle velocity may occur due to a very strong wind speed. In such a situation, the scheme discussed above cannot reflect this instantaneous change in the particle velocity. In order to avoid this difficulty, we have used the current velocity, including wind stress effect, to estimate the frictional force. This treatment is essential to the surge propagation over low-lying marshy areas.

MOVING-BOUNDARY TREATMENT

The importance of a moving-boundary treatment is twofold. First, it is the most direct way to determine inundation of low-lying coastal regions. Second, the fact that surge is free to penetrate inland means that surge levels at the open coast should be somewhat less than those computed under the assumption of a fixed wall condition at the original shoreline.

The onshore topography is included in the numerical computational basin by specifying the elevation at each grid point. Both bathymetry and onshore terrain are approximated by an array of steps. A grid point, (k,j) , is included in the computation if the water elevation at any one of the surrounding four cells is higher than its land elevation, $-h(k,j)$. A grid point is removed from the surge computation if its total water depth is nearly zero. In the region where the total water depth is small, the corresponding particle velocity is determined by the minimum of the absolute values of either a regular momentum equation or a weir-like formula. Invasion of a surge into a "dry" cell can be modeled more successfully by a weir-like formula.

The use of a weir formula to replace the momentum equation is limited to the initial flood stage only. No simplification is made to the governing equations for low-land areas after the total water depth is above a specified height.

ONE DIMENSIONAL EMBEDDED MODEL

There are many rivers and intracoastal waterways in low-lying coastal regions. Usually, the surge propagates inland through a relatively small river. An extreme amount of grid points must be used in a two-dimensional grid system to model the river cross-sections precisely. The resulting com-

computational cost is very substantial. Such a technique for modeling both river floods and overland flooding is not very desirable. An economical method is implemented to treat both floodings, simultaneously; assuming the fluid motion within the river is along a longitudinal direction, its movement can be modeled by a one-dimensional open channel model. With this one-dimensional model embedded within the two dimensional model, the flood-wave over the low-land area can be modeled in a realistic way without a tremendous amount of computational effort.

The equations describing flow within the river are similar to those of the two dimensional model. For a particular location, there is no interaction between one dimensional and two-dimensional flow until either one of two situations occurs, i.e., the water elevation within the river is above the specified two-dimensional land elevation, or the two-dimensional point is invaded by the surging water. The effect of this interaction is limited to the modification of water elevation only. The effect to the momentum is negligible. The amount of flux interchange, Q_s , is estimated by a weir-like formula, i.e.,

$$Q_s = \Delta h \sqrt{g l \Delta h} I$$

where Δh is the difference between one-dimensional and two-dimensional elevations at that particular point. The sign of Δh indicates the flow direction.

The set-up of a one-dimensional model is similar to that of a two dimensional model. At each reach, a corresponding two-dimensional location is assigned. Note that a river can be extended beyond the two-dimensional computational basin. The treatment of river flow outside the computational domain is different from the method described above; instead, a typical one-dimensional over-bank flooding model is used. Also, a junction where many rivers meet is allowed.

INLET AND BARRIER TREATMENT

Offshore barrier islands provide a natural protection to bodies of water behind them. Due to their existence, surging water can only enter protected waterbodies by flowing through tidal inlets or by overtopping barrier islands. The water movement of these two distinct situations is modeled independently of each other.

For flow over barriers, the particle velocity, v_b , encounters a severe retardation force because the Manning's "n" over highly vegetated barriers is much higher than that of water. For flow through the tidal inlets, the particle velocity, v_c , experiences other types of energy loss, such as channel loss. In order to include these extra amounts of

retardation force, the momentum equations are modified. This can be achieved by assigning either a higher frictional loss or including an extra loss term.

Sometimes, both inlet and barrier are located at the same grid point. It is then convenient to introduce a velocity quantity, V_a , representing the total effect of V_b and V_c . The treatment for the inlet is straightforward. The treatment for the barrier varies; conditions governing the flow depend on the water elevation at both sides of the barrier. For a total exposed barrier, the velocity is simply zero. For a submerged barrier, the amount of flux is limited by a weir formula. A treatment of the velocity similar to that used for the moving boundary is implemented.

BAY SIMULATION

There will be times when the grid size used in the initial open coast surge simulation is too large to accurately model some areas, such as bays or sections of a very irregular coastline. It may be possible to improve the results for such an area by selecting a finer grid and using information obtained from the open coast computation as input at the water boundary of the bay basin.

Prior to performing the open coast surge simulation, consideration should be given to the input requirements of subsequent small basin simulations. The desired peak surges and surge histories should be saved in the open sea area near the proposed boundary of the bay basin. The stored surge histories are used as input at the four corners of the open sea area of the small basin. The surge input at intermediate locations along the water boundary is then computed using double interpolation in time and space.

Consideration must also be given to the amount of extra running time in addition to the simulation time used in the open coast simulation in order to insure that peak surge will be attained during subsequent small basin simulations. Usually, it requires more time for the peak surge to propagate to the inland area after peak surge is reached at the open coast. In principle, the open coast simulation should be continued until peak surge occurs at the innermost points of the low-lying areas or waterways. Such an extension requires a tremendous amount of additional computer cost. As an alternative, the open coast computation is terminated when the surge at the original shoreline has peaked and then fallen to a value lower than the land elevation. With this condition in mind, the input surge history for the bay simulation is extended by a linear extrapolation to allow extra time for the peak surge to reach the inland area.

COASTAL FLOOD RETURN PERIOD

The calibration of storm surge can be performed using data from historical hurricanes, such as tracks and strengths. During the calibrations, the optimal size of computational basin, the open boundary treatment, the Manning's "n" for the frictional treatment, the inlet and barrier island treatments, etc. are determined. After completing these computations, the coastal flood return period can be obtained using the joint probability method over the computed peak surges of several hundred synthetic storms.

The track and strength of a storm having a straight path can be described by five parameters. They are (1) landing point, (2) traveling direction, (3) forward speed, (4) radius of the maximum wind, and (5) central pressure. The probability of the landing point is assumed to be uniform. The probability of each discrete value of the other parameters is obtained from each particular exceedance curve. These curves are derived from the data of all storms passing within a radius of 150 nm with respect to the center of the study area.

From these storm data, the storm occurrence rate is obtained. This is simply the total number of storms divided by the product of a duration of years and a distance of 150 nm. The expression used to determine the exceedance curve is $(R-0.5)/N$ where R and N are, respectively, the rank of a particular datum and the total number of data in the sample. The optimal number of discrete values used in the final simulation is based on the surge sensitivity analysis performed by varying each parameter. After the optimal number is determined, the exceedance curve is then subdivided into the same number of discrete values. The probabilities of each of the discrete values are then obtained from the curves. The total number of the synthetic storms is the product of the number of discrete values used for each of the five parameters. Accordingly, the rate of occurrence for every one of the synthetic storms is the product of the storm occurrence rate and the probabilities of each parameter.

At the completion of the surge simulation, all of the peak surges are tabulated at each location within the study area. These peak surges are then ranked in ascending order. During the ranking process, the rates are also relocated according to their corresponding elevations. The flood return period for a particular surge value is the summation of all the occurrence rates of every surge elevation from the highest elevation down to that particular value. Using a similar method, desired flood return periods, 10, 50, 100, and 500 years, can be obtained.

DISPLAY OPTIONS

The numerical model contains not only all features discussed in the previous sections but also several useful printout options. These options are as follows.

1. Printout of the depth grid.
2. Printout of arrays governing computations. In the interest of economy, computations are performed only at water and low-land points; land points with elevation above a specified value are skipped. When a row is scanned, computations are performed from the first to the last point of each computational segment; similar arrays govern the scan of columns.
3. Printout of surge elevation "snapshots" at any chosen time. Similar to the depth grid display.
4. Printout of tables of surge history versus time at selected grid points.
5. Plots of surge history versus time at selected grid points.
6. Tables of the extrapolated peak surge values at grid points along the original shoreline. The locations of these points are determined automatically from the input depth grid.
7. Tables of the unextrapolated peak surge values at specified grid points supplied by the user.
8. Summaries of storm data.
9. Printout of the storm wind and pressure fields as one-dimensional arrays versus radial distance from the storm eye (includes the influence of forward speed on wind velocity).

In the event that numerical instability occurs (should the time step have been selected too large, for example), computations are terminated and a message is printed specifying the time and location of the instability (defined as a computed surge height greater than 50 feet). Also printed are "snapshots" of the elevation and the velocity components at the time of termination. These are helpful in order to diagnose the numerical problems when in the hindcast mode.

SURGE SIMULATION OF A HISTORICAL HURRICANE

The surge simulation due to hurricane Carla at Sabine Lake, Texas is presented here. The riverine system is very complicated. In addition to natural rivers, there are

several man-made waterways. To the north, both the Sabine River and Neches River extend more than 50 nm. inland. To the south, the narrow Sabine Pass connects the Lake to the Gulf of Mexico. All of these waterways are treated by using the one-dimensional embedded model.

The computational basin for Sabine Lake consists of 29x34 grid points. The origin for this basin, namely, the center of the grid point (1,1), is located at (30°03', 94°10'). The angle between the x-axis and North is 199°, measured clockwise from the North. Both grid increments are 1 nm. The coastal region in this area is very low and subjected to flooding in the event of high tides due to a strong hurricane. In order to obtain realistic flood elevations, the moving boundary treatment is mandatory. Snapshots of peak surges over a portion of the computational basin are shown in Figures 1 and 2 for both moving and fixed boundary treatments. The results in the water area are remarkably similar to each other. This could be due to a long duration of the high tide at the coastal region. The results also indicate that most of the flood waves propagate inward through the tidal inlet. Similar results in the water area, obtained by using these two different treatments, do not de-emphasize the importance of the moving boundary treatment. Without the moving boundary treatment, the surge elevations at the low-land area could not be obtained at all.

REFERENCES

- Federal Emergency Management Agency, "Coastal Flooding Storm Surge Model," Parts 1, 2, & 3, prepared by Tetra Tech, 1981.
- Pagenkopf, J.R. and B.R. Pearce, "Evaluation of Techniques for Numerical Calculation of Storm Surges," Technical Report No. 199, Department of Civil Engineering, Massachusetts Institute of Technology, 120, 1975.
- Pearce, B. R., "Numerical Calculation of the Response of Coastal Waters to Storm Systems," Technical Report No.12. Coastal and Oceanographic Engineering Lab, University of Florida, 1972.
- Platzman, G.W., "The Prediction of Surges in the Southern Basin of Lake Michigan," Part I, "The Dynamical Basis for Prediction," Monthly Weather Review, Vol. 93, 275-281, 1965.
- Reid, R.O. and B.R. Bodine, "Numerical Model for Storm Surges in Galveston Bay," Journal of Waterways and Harbors Division, ASCE, Vol 94, No. WI, 33-57, 1968.
- Verma, A.P. and R.G. Dean, "Numerical Modeling of Hydro-mechanics of Bay Systems," Proceedings of the Conference on Civil Engineering in the Oceans II, ASCE, 1969.
- Welander, P. "Numerical Prediction of Storm Surges," Advances in Geophysics, Vol. 8, 316-379, 1961.

PAPER DISCUSSION

A STORM SURGE MODEL

by
Michael H. Chen
David J. Divoky
Li-San Hwang

Question: You mentioned that you had a lot of difficulties with your boundary conditions due to the utilization of a stair-stepped approximation of solid boundaries. Why don't you just go with finite element solutions with curve-linear boundaries and avoid that problem from the beginning?

Dr. Chen: In 1975, when F.E.M.A. requested a model, Tetra Tech had an in-house finite difference surge model. Through the years, we have simply added more features to the model whenever there was a need to treat a special problem. The possibility of using a finite element method (FEM) was looked into with little success. Later, such a FEM surge model was developed by the Virginia Institute of Marine Sciences for F.E.M.A.

Question: How expensive is it to run you model?

Dr. Chen: A surge simulation was performed for Hurricane Donna over southwestern Florida. The size of the grid used was 61 (y-direction) by 30 (x-direction) producing a total of 1830 grid elements. Of the 1830, only 1594 grid elements were actually calculated--236 were designed as land points which never flooded. The size of the grid elements was 4.5mm (x-direction) by 5mm (y-direction). The time increment was 200 seconds. For a simulation of 22 hours, 46.3 cpu seconds were spent on a CDC 7600 computer. The numerical model is very fast and inexpensive to run. We have done a lot of work to optimize the model and make it more usable for F.E.M.A.'s general applications, such as coastal surge floodings.

Question: How do you couple your open coast model with your inland flow model? Is that difficult? The size of the elements are quite different so that might lead to difficulties that are not correct. There is a potential difficulty in the Tetra Tech model in accounting for complex flows induced by wind shear in situations such as the Chesapeake Bay. This is because the models are decoupled; it is very difficult to be able to account for the resulting circulation patterns as a result of wind-induced shearing.

Dr. Chen: I don't see that decoupling the open coast basin with the inland basin creates any problems. You just have to pay close attention to the size and scale for the open coast basin and for the inland basin. Note that the region of the small bay is included in the open coast basin. Although the open coast grid is too large to model the bay precisely, the effect of the bay in the final results at the open coast region is included. The only question is this--how much is the error in the final results due to the inability of modeling the bay area using the large grid? If this error is very big, then, the solution to the problem is to adopt a smaller grid in the bay area and a larger grid in the open sea area and to perform these simulations simultaneously. This procedure is commonly used in the finite element method. From our extensive experience in surge simulation, we have found little difference in the surge results at the open coast region obtained from a single open coast computation and those obtained from two-stage computations. The main purpose for the bay basin or inland basin is to obtain a better resolution inside the bay.

The alternative of using a variable grid to simulate both open coast and bay, simultaneously, may not be a trouble free alternative because the accuracy in the scheme itself is reduced.

Comment: Dr. Walters: The grid size is very important. If you have an improper grid size, you will get a different answer and probably the wrong solution.

Dr. Chen: If the results vary because of a change in the space increment, it simply implies that the size used in the study was not appropriate. An optimal grid increment should be chosen based on the numerical experiments of varying the grid size. The rule of thumb is to use a grid spacing such that any further reduction in the space increment would not alter the computed results significantly. The person who implements the model should make his own decision regarding this matter.

Discussion: Mr. Roy Walters made a suggestion to set up a series of standard examples along with the test data in order to verify the solutions by using these example cases. He also suggested that we make available that library of standard examples as a means of testing, calibrating, and verifying the accuracy of the models of others. Therefore, there would be a standard to use in comparing the different models developed by different people all over the country.

Dr. Chen: Over the years, we have done this during development. For example, when the model was first developed, NOAA's standard basin for the surge simulation was used to perform the numerical experiments. Several examples can be found in F.E.M.A.'s "Coastal Flooding Storm Surge Model", prepared by Tetra Tech. A similar test has been performed by Tetra

Tech, CERC and WES on three different hurricanes. This report can be obtained from the Chief Office of the U.S. Army Corps of Engineers.

SIMSYS2D: A TWO-DIMENSIONAL FLOW AND WATER QUALITY SIMULATION SYSTEM*

by

J. J. Leendertse*

ABSTRACT

The SIMSYS2D system is designed for the two-dimensional simulation of hydrodynamics and water quality in well-mixed estuaries, coastal seas, harbors, and inland waters. The system can simulate the hydrodynamics in complicated geographical areas and the land/water boundary is determined by the model during simulation. The system accounts for sources of discharges, for tidal flats, for islands or dams, for time varying or time invaring flow restrictions in which sub or super critical flow occurs and such as generated by openings in dams, sluices, or storm surge barriers. The system is designed for planning, design and execution of engineering works and for the assessment of the impact thereof. The input and results of simulations are well documented in printed reports and graphical displays. The latter are of high quality and can be incorporated in engineering reports.

The investigator has the choice of numerous finite difference approximations of the vertically integrated hydrodynamic equations. He is able to graph many variables and their derivatives as time histories or charts, thus, displaying model input and results in a highly visible way.

The system is in daily use by a number of engineering groups in the United States and the Netherlands.

The SIMSYS2D system consists of nine programs; data is passed between these programs. In addition to these programs, a number of programs for extended data processing and data input preparation are being used.

*The Rand Corporation, Santa Monica, California

**Paper presented at the seminar on two-dimensional flow modeling at the Hydrological Engineering Center, Davis, California, 7-9 July 1981.

I. INTRODUCTION

The SIMSYS2D system is a system of interlocking computer programs for the two-dimensional simulation of hydrodynamics and water quality in well-mixed estuaries, coastal seas, harbors and inland waters.

It has its origin in a study[1] for the computation of long-period water waves and a Rand study[2] of water quality in Jamaica Bay for the City of New York. For these studies ad hoc programs were written and published, and are still widely used by many other investigators who make these modifications for their particular use.

Hand-in-hand with ongoing engineering investigations, in particular for the Netherlands Rijkswaterstaat, a system of programs has been developed which permits an investigator to make rapid model studies. The investigator has the flexibility to choose the finite difference approximation method he thinks is most suitable for his purpose, and if in doubt, he can perform sensitivity analysis by using other approximations by simply changing a few flags in the input.

The investigator has numerous choices of displaying and printing computation results. All these possibilities are easily accessible by simple instructions and, in our practice, it is common to receive hundreds of graphs already one day after the simulation. These possibilities, all thoroughly tested in ongoing investigations, also indicate new developments.

Due to imposed limitations on the size of this paper, only the main feature of the system will be presented. Similarly, we have to limit the presentation of results to a few examples of the many models which have been made.

An overview of the gross data flow in SIMSYS2D is presented in Fig. 1. This diagram shows the programs, the tape and disk storage of data, the reports, and graphical displays with different symbols. The data flow diagram assumes that all data which will be used is available on disk. From this data set we assemble, generally in blocks, the input data for a model. A very good guide for this is a report printed by the Input Data Processor, which we will discuss next. The assembly of data for the input is by far the largest job in an investigation. The thoroughness by which this task is executed will be greatly reflected in the accuracy of the results of a simulation.

II. THE PROGRAMS OF THE SYSTEM

IDP, The Input Data Processor

The Input Data Processor (IDP) reads a preliminary version of the input for the main simulation program which is called SIM2D. IDP checks the data for consistency, print error and warning messages. It prints the input data and the Input Report. In the latter every variable of the input data is explained. This report is kept for documentation and is generally the basis for modifications for the next experiment. The IDP program generates data dependent array definitions in the form of COMMON statements for inclusion in the compilation of the actual simulation program SIM2D. IDP writes the IDP Display File for the generation of charts on the two-dimensional input array variables and for the generation of time histories of the time varying data. Time varying data is inserted as data sequences for location. IDP processes this data and makes it available to SIM2D as data sets for each timestep or multiple of timesteps of the simulation. In the practice of numerical model studies, the actual simulations are generally made during the night when computation centers offer favorable rates for large computing jobs. The IDP program job step significantly reduces failures in the execution of the simulation or errors in the input data which would make the simulation of no value. Errors in input data can easily be checked by graphical display of the spatial and time varying inputs.

The IDP input report of a simulation is, in our practice, archived on microfiche together with pertinent graphical displays of the input data produced by SDDMAP on SDDHST programs.

SDDMAP

The Simulation Data Display of MAP's, SDDMAP, reads the IDP Display File and plots maps or charts of requested combinations of the input data. Data, such as the land boundary outline and titles, can be displayed and we are able to present contour charts of depth, the initial constituent concentrations, diffusion, and other coefficients. It is also possible to mark the location of the position of water level, current, and concentration stations, positions of dams, and tide openings barriers. On all of these graphs the computational grid can be indicated in many different ways. Figure 2 shows a graph made by SDDMAP. In this case, the outlines and titles were plotted together with the locations of different stations, outfalls, tide openings and the ranges through which the transports are computed.

A much used feature of SDDMAP is the plotting of computation points which participate in the simulation when the water is at a certain level. Application of this feature to a large series of water levels, gives an insight to how tidal flats and marshes will flood during the

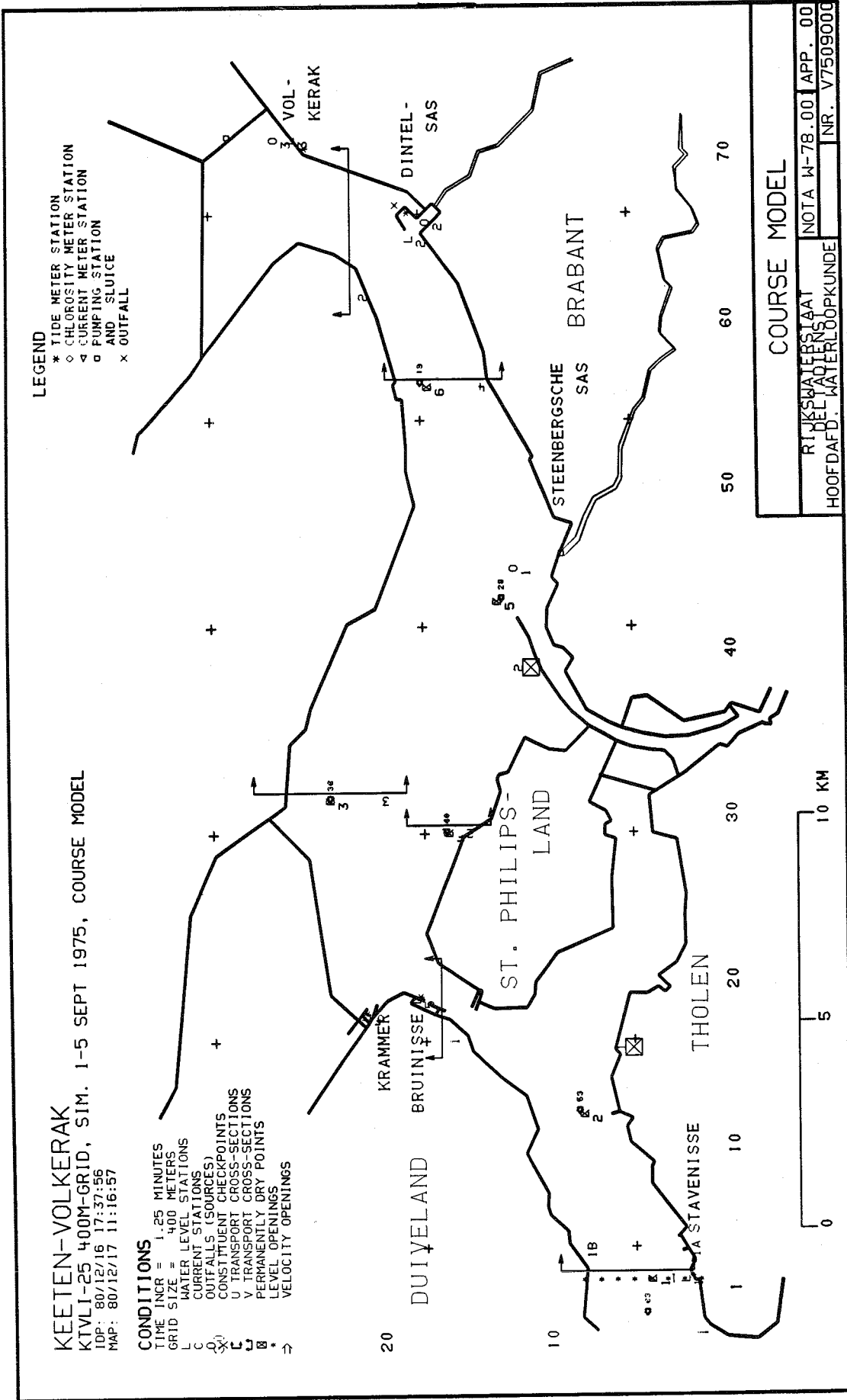

Fig. 2--Chart produced by SDDMAP to verify model inputs

simulation.

The graphic language used for all displays is IGS, the Integrated Graphic Language, developed by Rand in the 1960's. This language is quite commonly used and available for many computers and graphic devices. It is fast in execution of instructions and very powerful. Only ten basic instructions in this language are used in our system which makes interfacing with other graphic languages relatively uncomplicated, if the need arises.

SDDHST

The Simulation Data Display of Histories, SDDHST, plots time histories of data from different files. Generally one or two history files are plotted. Most plots take the conventional form of variable versus time and some variables may be plotted as time interval vector plots. The program can display data from different files simultaneously, thus we are able to compare, for example, observed data with computed data, or input data with observed data.

The program also allows for certain processing of data. Simple filters can be applied, adjustments for means can be made and standard deviations between two curves can be computed. It is also possible to plot differences between two data sets.

This program is extensively used for comparing overall results of different simulations and for making comparisons with prototype data. Data plotting can be done in intervals of one day to 30 days per graph. In the default mode, the scale of the variable is chosen on the basis of the maximum and minimum value of the data set to be plotted. Optionally the intervals can be set.

SIM2D

The Two-Dimensional simulation program (SIM2D) is the central computational program on the SIMSYS2D system. SIM2D receives input that has been processed by IDP. As IDP may have signaled warnings or errors or if we have a small change in plans, some variables of IDP may be overridden.

Using the bathymetry and physical characteristics described in the input, SIM2D computes water levels and currents as well as optionally the concentration and dispersion of constituents resulting from the time-varying effects of tide levels, wind, discharges, concentrations, and barriers. The computations can be made in many different ways, as described in the next chapter.

SIM2D will provide various outputs to the user upon request. These include printed tables of variables during the course of the run, plotted charts, and various data sets including the History tape, the Map

tape, and the Restart tape. The latter is used to enable SIM2D to restart using data computed during an earlier run. This allows a run to continue from any point at which restart information was saved, so that a normal run may proceed from some specified time, or a run that failed due to computer problems can be restarted without total loss.

Printed data can be put on different files. For example, one file is used for progress data, warning messages, and another file is used for tables of variables at particular times. In our practice this data is archived on microfiche.

During simulation the two-dimensional array data can be plotted as maps with velocity vectors or transport vectors. These maps can also be made by use of the Map tape described later, but this is much more costly in our computation environment due to more extensive input/output processing.

SIM2D, including IGS, requires about 450K bytes of core in addition to the amount needed for data-dependent COMMON generated by IDP and the input/output of buffer requirements. The amount of core needed for data-dependent COMMON is printed by IDP. Since IGS takes considerable core, its usage can be omitted during a simulation which eliminates the core requirements of IGS.

MAP2D

The post-simulation MAP display program reads the Map tape to draw constituent concentration distributions, velocity, mass transport rate, and water level contour charts similar to those produced during the simulation. MAP2D also draws charts of particle path or plots of a cloud of particles simulating the dispersion of a dye release.

This program can also compute and plot residual currents and transports and compute and plot the vectors of the semidiurnal, quarter-diurnal, and sixth-diurnal tide at a particular time.

OBSFILB

The OBServed history data FILING program version B, OBSFILB, takes observed data given in regular time interval series form and writes an OBServed history FILE to be read by the SDDHST program for plotting of observed time histories in conjunction with computed histories.

MAPHST

The MAP data for HiSTory data program, MAPHST, extracts data at selected grid points from the data on the Map tape to produce the MAP History tape. Since the Map tape is not written as often as the History tape, the resultant time histories are represented by sparse data and the line representation is less smooth than generally produced from the History Tape.

III. MODEL CHARACTERISTICS

The finite difference approximation of the model is made upon a staggered grid. Velocities are computed at locations between the water level points and the depth is determined at a location centered between four water level points. This approach has the advantage that we are accurately computing velocities as they are occurring in cross-sections, which is very desirable for engineering investigations (Fig. 3). The error by the finite difference approximation in the sections through which the flow is computed appears smaller than when the depth points is taken at the location of the water level. In making the depth schematization, an effort must be made that all cross sections are well represented. The solution technique is an alternating direction implicit method with a large choice of approximation of difficult terms of the hydrodynamic equations.

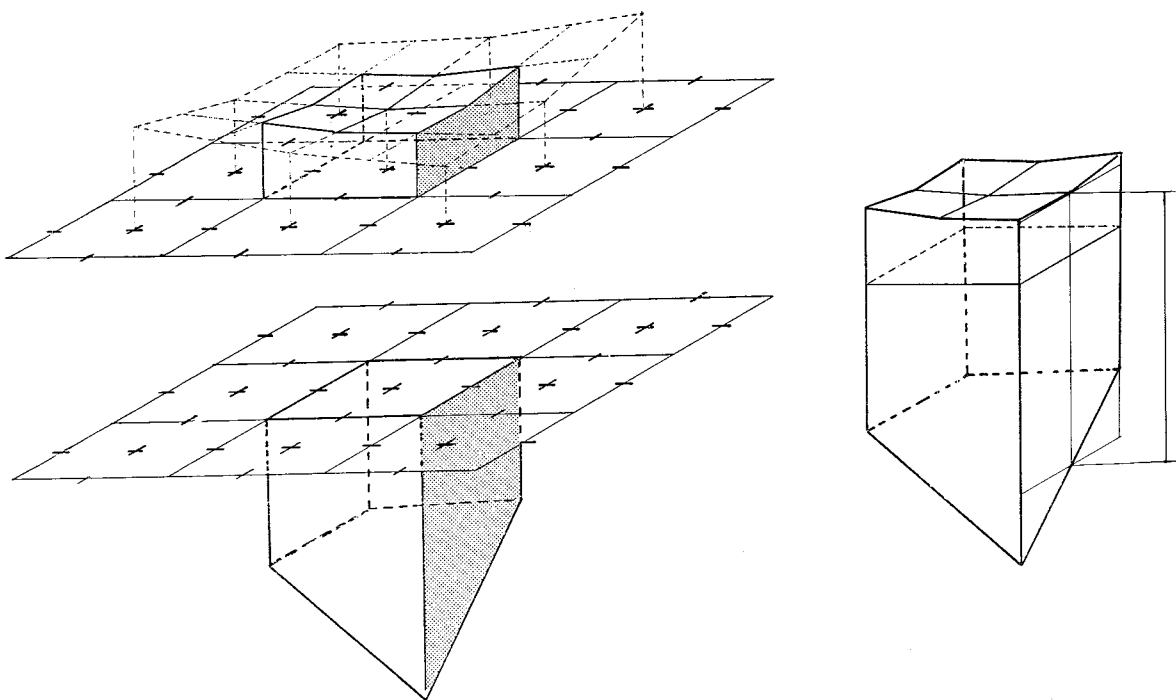

Fig. 3--Finite difference volume unit used for computation of the equation of continuity. Water level is computed in the center of the unit

Choices in Terms of the Hydrodynamic Equations

Advection. The advection can be taken on different time levels or forward and backward alternatively. Advection can be omitted and we can compute with schemes which have certain conservative properties such as velocity, vorticity, or the squared vorticity. The latter option is of great importance when jet type streams enter into water bodies with increasing depth. In such a case the vorticity per grid space increases and cannot be represented by the more simple advection representations.

By special means we are able to represent the effect of secondary flows and curves of channels and we can account for energy losses when the flow is diverging.

At a land/water boundary for flow parallel to the boundary several approximations can be selected such as the no slip and free slip condition. In total we can choose from five different approximations for flow parallel to the boundary and also from five different approximations for flow perpendicular to the boundary.

Bottom Stress. The bottom stress term can be taken at different time levels and can be a function of the Manning's n value, the Chezy C value or the K roughness value. The stress can be computed directly from the mean velocity or from a function of the local turbulent energy.

In practice it appears that the bottom stress value is not constant in regions with a salinity gradient but dependent on the direction of the flow. We have introduced an empirical correction factor which depends on the direction of the flow in relation to the salinity gradient and the value of the salinity gradient.

Salinity Pressure Gradient. When the salinity distributions are computed, the hydrodynamic equations can be coupled to the transport equation of the salinity. The pressure differential is computed from the density differences and the densities are computed with double precision from the computed salinities by an equation of state. The equation of state is valid for a very large range of the temperatures.

Viscosity. The viscosity can be introduced as a spatial variable, in addition to a value computed from the deformation of the flow field. Like the advection, five different approximations can be made for flow parallel to a land/water boundary and also five different approximations perpendicular to the land/water boundary.

Boundary Conditions

Two-Dimensional. Two-dimensional arrays of depth, Manning's n (or others), and viscosity define the usual two-dimensional input conditions for the hydrodynamic flow equations. The program allows for flooding and drying according to the water levels in the field. These procedures take care of a completely conservation of mass. In addition to these inputs, a spatial varying stress can be applied. This stress can be due to a spatially varying wind, e.g., by a hurricane or due to a radiation stress from short waves. This stress can be periodically given and is interpolated lineally between the time data is given.

One-Dimensional. One-dimensional array data is required every timestep at the open boundaries of the model. For water levels, a linear interpolation of the water levels is made when water levels at each section of the open boundary is supplied as a time series. If a Fourier series is given at each end of the boundary section a linear interpolation of amplitude and phase is used between the points specified. The interpolation of the phase occurs over the smallest angle. Similar procedures are used for velocities and transports. A radiative boundary condition for the water level is also programmed. Components of the incoming wave need to be supplied, the outgoing wave is computed from information in the flow field.

Singular points. At selected locations we are able to discharge water in a time varying way, thus, simulating outfalls. At other points we are able to introduce barriers. The flow can be sub- and supercritical freesurfaceflow conditions and sub- and supercritical gateflowconditions. The sill depth and the gate height can be time varying. The horizontal opening dimension can also be varied in time. Between the different basic flow conditions, which are determined from the upstream and downstream water levels, the gate height and the sill depth, we have made flow transitions so that no discontinuity is generated in the flow when a transition from one flow condition to another occurs. The barrier characteristics can be made dependent on the flow direction to allow for non-symmetrical structures. The barrier can flow in u or v direction or both. It is possible to take a single point or a series of points out of the computation. This then represents a dam.

The Transport Equations

Transport of Dissolved Substance. Optionally, together with the integration of the finite difference approximations of the hydrodynamic equations, the transport of constituents can be computed. Like the hydrodynamic equations, the transport equations have a second order accuracy and conserve mass. A large number of constituents can be computed simultaneously. The constituents can be conservative or have a

decay. Interaction between constituents is possible. Typical constituents used in the investigations are salinity, BOD and DO and coliform bacteria.

The dispersion coefficient can be set for each point of the grid and/or can be computed from information of the flow field. The dispersion in the direction of the flow can be taken different from that perpendicular to the flow.

In the sources the concentration can be variable in time.

In addition to the transport of dissolved substances, computations of heat and the turbulent energy can be made. For the energy computations, the energy loss due to the bottom stress over one timestep is added to the vertically average subgrid scale energy and simultaneously energy losses occur which are a power function of the energy intensity.

Transport of Particles or Particle Clouds

The system permits the release of single particles or groups of particles at arbitrary times. Following such a release the movement of each particle is computed with each timestep of the simulation. When particle clouds are released, each particle obtains, in addition to the advective transport, a random movement. The intensity of the movement is different in the direction of flow and perpendicular to the flow. The intensity is also dependent on the intensity of the computed subgrid scale energy.

Diagnostic Computations

During the simulation, special diagnostic computations can be optionally requested. It is standard practice in numerical model studies to compute discharges through ranges and simultaneously compute the mass transport through these ranges. The advective and diffusive transport through these ranges are being computed. The total flow from the beginning of the computation is also computed.

When the special diagnostic computations are made, it is possible to extract the contributions of the different terms of the momentum equation at selected points in order to assess their relevance. In cross-sections we are able to compute optionally the energy transport. All of this information can be graphed and is easily available to the investigator.

Run Log. The system keeps a log of every usage of a program and makes note of files and tapes, model version used. Job statistics are logged such as the number of graphs produced from each model run. Also warning and error messages are logged when failures occur. The Run Log appears to be indispensable in the management of computer simulation studies and it provides vital inputs for improvements and operation of the system.

IV. APPLICATIONS

In addition to the extensive series of publications of the first water quality simulations with a two-dimensional model for a study of Jamaica Bay [2]), the system is now being used for studies in the Delta Region of the Netherlands where a storm surge barrier is being built. An overview of these model studies are published in a few papers.[3,4] A very extensive report on these studies is being prepared. Large models are being used, as shown in Figs. 4, 5. These models contain about 20,000 points. Excellent agreement between observed and computed data has been obtained in the calibration and verification steps (Figs. 6, 7).

It has become evident that much time is spent on developing the operational and analytical experience of working with these models. The investigative teams found innovative methods for the adjustment of models and new ways of determining boundary conditions.[5]

To disseminate the experience gained, the principal investigators and the model development staff on both sides of the Atlantic have now given several training courses to engineering personnel of the sponsor, which has resulted in a very extensive usage of the system.

V. ASSOCIATED PROGRAMS

In addition to the programs of SIMSYS2D, a number of programs are routinely being used for processing of data. Very extensively we are using a programmed system for optimal linear estimation of relations between timeseries. The resultant estimates are used, for example, for the adjustment of parameters. Extensive use of these results is also made in a program which prepares the open boundary conditions of models for times that no detailed field data is available.

Very extensive use is made of a program which construct procedures for filtering data. With this program we can design non-recursive filters, make graphs of the filter characteristics and apply the filter.

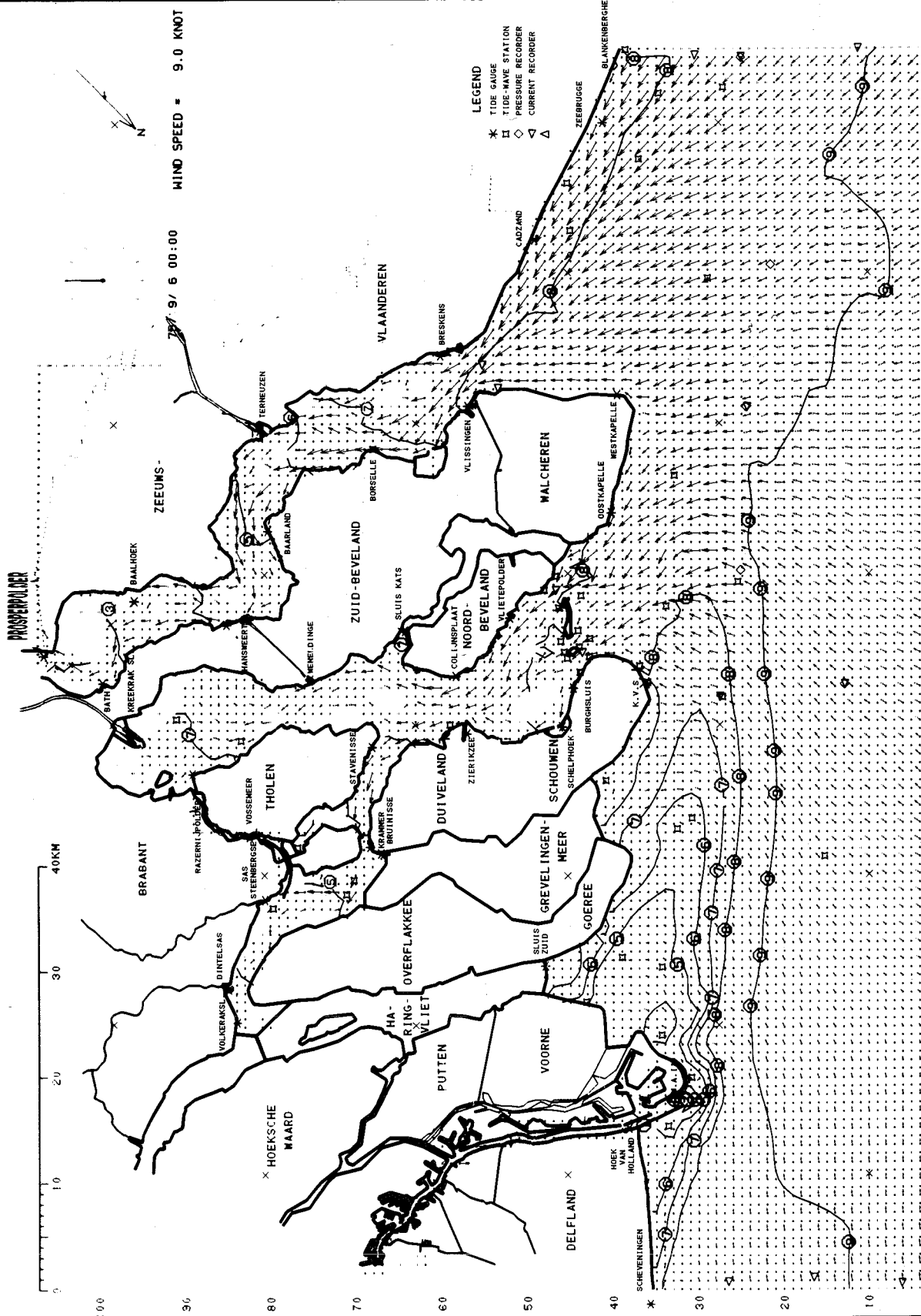

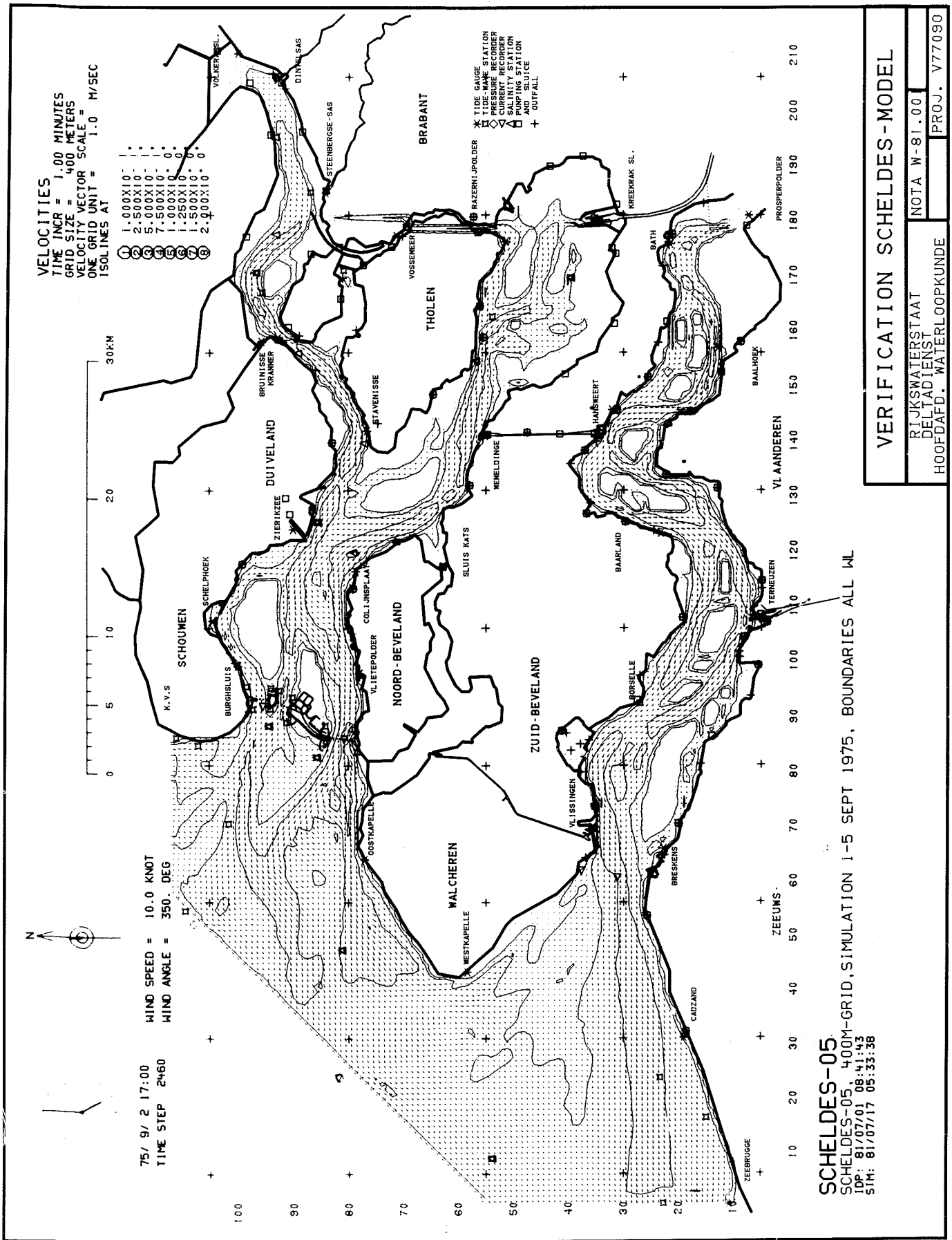

Fig. 5--Computed velocity vector field of the Scheldes model

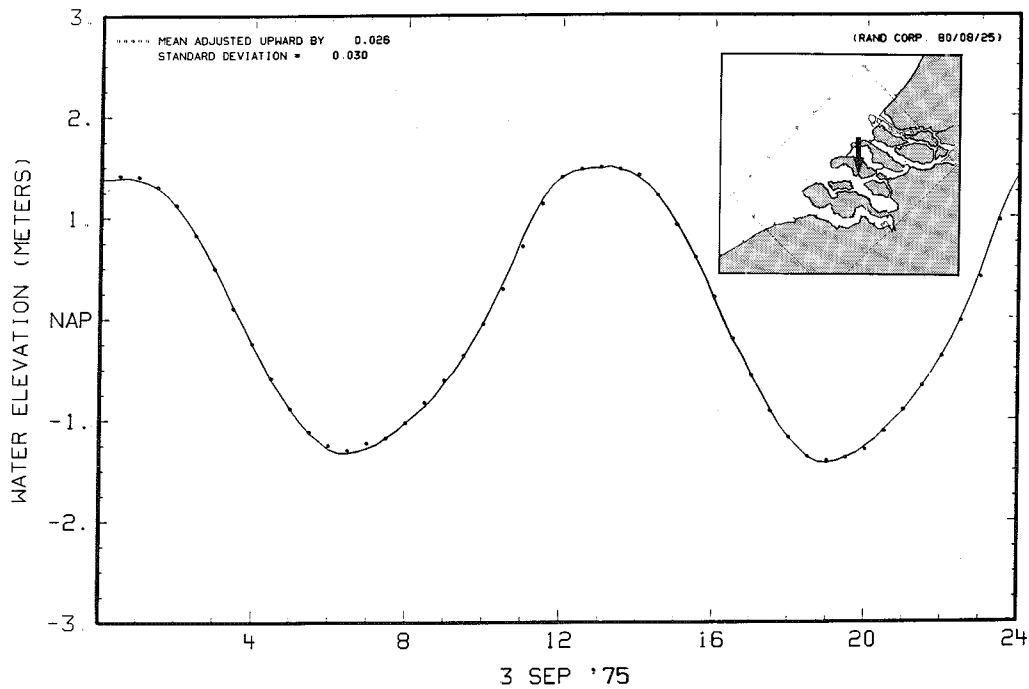

Fig. 6--Observed and computed water levels at a station in the Eastern Scheldt

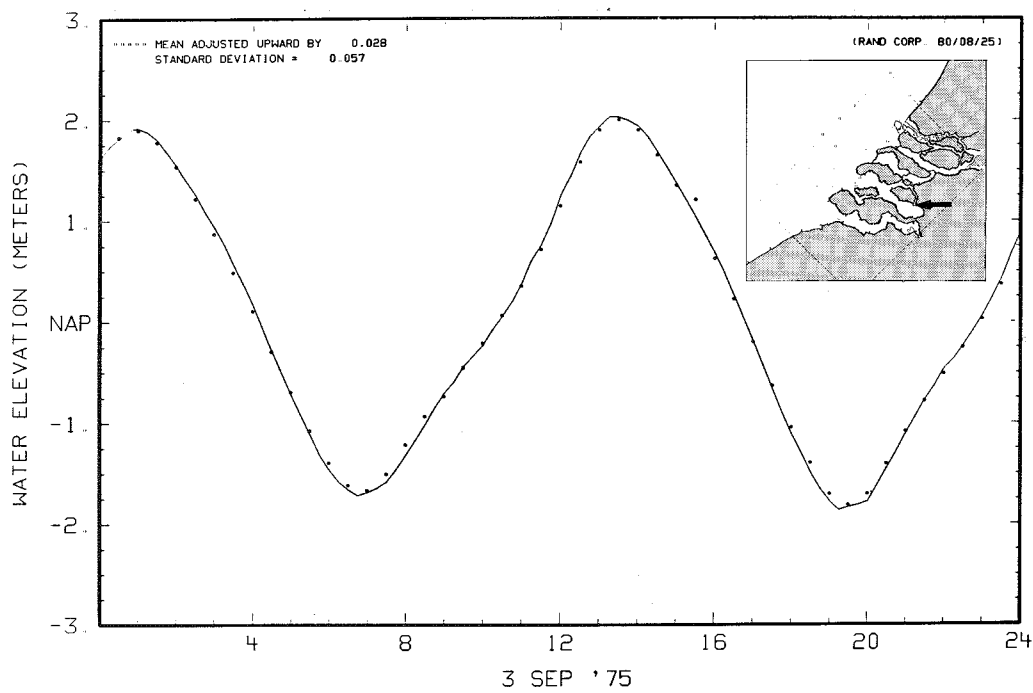

Fig. 7--Observed and computed water levels at a station in the Eastern Scheldt

V. FUTURE DEVELOPMENTS

Even though we still expect growth of the present version of SIMSYS2D, we consider the system now quite well matured.

A major effort is presently underway to streamline the computation procedures and make the main program easier accessible for maintenance.

Simultaneously, with 2D simulation studies and the development of SIMSYS2D, three dimensional modeling studies are made. Three dimensional models are now routinely being used and a simulation system is gradually being developed.

The three dimensional model is actively being used in the partly stratified waters of the Bering Sea. For this application the movement of ice fields has been added. Results of the hydrodynamic simulations in that area are used in computations with wind models to predict the movement of oil spills, if these would occur during oil exploitation.[6]

REFERENCES

1. Leendertse, J. J., Aspects of a Computational Model for Long-Period Water-Wave Propagation, The Rand Corporation, RM-5294-PR, May 1967, Santa Monica, CA.
2. Leendertse, J. J., et al., A Water Quality Simulation Model for Well-Mixed Estuaries and Coastal Seas: Vols. I-IX 1970-1977. The Rand Corporation, Santa Monica, CA.
3. Langerak, A., M. A. M. de Ras, and J. J. Leendertse, Adjustment and Verification of the Randdelta II Model, Proc. Sixteenth Coastal Engineering Conference, 1978, ASCE, New York, N.Y.
4. Leendertse, J. J., A. Langerak and M. A. M. de Ras, Two Dimensional Models for the Delta Works, Proc. Symposium on Predictive Abilities of Surface Water Flow and Transport Models, Academic Press (in print).
5. Van de Ree, W. J., J. Voogt, and J. J. Leendertse, A Tidal Survey for a Model of an Offshore Area. Proc. Sixteenth Coastal Engineering Conference, 1978, ASCE, New York, N.Y.
6. Liu, D. S. K., and J. J. Leendertse, A 3-Dimensional Oil Spill Model With and Without Ice Cover, Proc. International Symposium on the Mechanics of Oil Slicks, 1 September 1981, Paris. Also Rand Corporation P-6620.

PAPER DISCUSSION

SIMSYS2D: A TWO-DIMENSIONAL FLOW AND WATER QUALITY
SIMULATION MODEL

by
J. J. Leendertse

Question: Are all of your programs proprietary programs owned by The Rand Corporation or are they available to the public?

Dr. Leendertse: The SIMSYS2D models created by The Rand Corporation are proprietary models although we have an agreement with the U.S. Geological Survey to use some of our models. We would like to continue to develop our support from other agencies and make these models available to them, but our support level would require long-term commitments by such agencies. I would like to see some carry-over of the results between different studies, as well.

Question: If the Corps was interested in using your Two-dimensional model discussed here, how would one make the request, and how much would it cost?

Dr. Leendertse: We should sit down and discuss your specific needs first of all. We would not be interested in just getting the contract for a short period of time for a specific problem solution. We would be interested in a longer-term funding, so we need to discuss the specifics of that kind of arrangement.

Question: You were speaking of the extensions to 3-dimensions, has that been done with this specific model that you described?

Dr. Leendertse: No. Let me tell you what we've done with the 3-D code. We obtained a grant from OWRT for three years to develop a 3-dimensional model. It has been published and is available although it's really not a fully operational code. We are still continuing development work. It will probably be another 2, 3, or 4 years before it's fully operational like SIMSYS2D. We are working on that now, but we are also working on the modeling of oil spills in the Arctic and Bering Seas. We have developed oil spill models that are being used in conjunction with the 3-D model. Our problems that we are working on in 3-dimension are related to the positioning and placing of large structures in tidal currents, which is a 3-D problem with the intent to compute circulation around the base of these structures. We have also developed storm surge models at The Rand Corporation and have used them on sections of the North Sea.

Question: Have you developed any interactive computer graphics for the system that you have described to us?

Dr. Leendertse: No.

Question: Do you have any plans to do that?

Dr. Leendertse: No. We don't really see a need for that right now. The system graphics that we have available and have developed is already sufficient for all our needs and the needs of others, as far as we can see. With the system the way it's set up now, we have a capability of having plots created within 30 minutes anyway, so the system seems to be fast enough for our needs.

Question: We noticed during your discussion that you built into your model a number of automatic checks on boundary conditions, sufficiency, continuity of checks, order of magnitude evaluation and various terms in your equations. I have a philosophical question: what would be the minimum kinds of checks necessary to include in a model when it is being developed, or if the user was to go shopping for a model for his usage, what kinds of automatic checks should he look for as being desirable?

Dr. Leendertse: This is very difficult to say. We've included these kinds of capabilities in our models because we've seen a need to interrogate the system for these numbers and to check on the magnitudes of the kinds of things we compute. From system to system this can change. Of course, continuity is a very important aspect to keep track of, so conservation of mass as well as conservation of constituents are considered very important. One might also want to keep track of the costs incurred for making a run and break that into components of the costs required to process the data as input and output as opposed to cost for actually making the computer run and simulation. We have found also that the computer cost is considerably less than the manpower costs in a study.

Question: How large a core requirement and loading capabilities are necessary for your code that you've discussed today and can it fit, in fact, on some of these small or mini-type machines like the Harris that we have here.

Dr. Leendertse: If you include IGS data graphic capabilities, the SIMSYS2D requires about 450K (bytes) storage. If you eliminated the graphics package and the size and the loading requirements, it would be considerably less.

Question: When do you consider your subgrid scale model to be important?

Dr. Leendertse: It's especially important when dealing with a 3-dimensional problem. It is of somewhat lesser importance with 2-dimensions. But it is extremely important when dealing with 3-dimensions and complex kinds of mixing situations.

PAPER PRESENTATIONS
AND
DISCUSSIONS

DAY THREE

CHESAPEAKE BAY MODELING

by

Robert P. Shubinski¹ and Raymond Walton²

INTRODUCTION

As part of EPA's Chesapeake Bay Program, a three-dimensional model has been developed to simulate the circulation in Chesapeake Bay and its major tributaries. Known as the Chesapeake Bay Circulation Model (CBCM), it was developed as a management tool, and was designed to be flexible and to inter-link in the future with water quality, sedimentation, and perhaps ecosystem models of the Bay.

The model will be useful in identifying problems within the Bay, and to locate places where critical data should be collected. Both small and large scale circulations can be studied with this model because of its flexibility in handling prototype geometry. Further, certain hydrodynamic responses that cannot be handled efficiently by a physical model can be studied numerically.

Chesapeake Bay is the largest, most productive bay in North America (Figure 1), and was created by the flooding of the lower valley of the Susquehanna River. It is approximately 180 miles (290 km) long, 5-30 miles (8-48 km) wide and up to 174 feet (53 meters) deep. However, the mean depth, including tributaries, is 21.2 feet (6.4 meters), and the shoreline about 8100 miles (13,000 km) long (Corps, 1970).

External forces driving circulation in the Bay are the tide, wind, fresh water inflow, and atmospheric pressure gradients. The interaction of fresh and saline waters, aided by deep trenches and Coriolis acceleration, produces a highly complex density structure with saline waters reaching above Baltimore, and isohalines tilting across the Bay and, on occasion, even breaking the surface near the Eastern Shore.

The size and complexity of the Bay dictate that a model give special consideration to both the spatial and temporal variations of the forcing functions, the solution technique, and to the calibration procedure. It should be capable of describing the major spatial three-dimensional hydraulic variations, and be able to represent prototype physiography with geometric elements of variable sizes.

The aim of the study was to produce a model with good stability and accuracy properties, which at the same time would economically simulate the circulation in this highly complex region. To meet these requirements, a unique approach was proposed. The main Bay is approximated using a two-dimensional, layered, finite-element model. The tributaries and trenches, defined as the deep narrow sections of the Bay, are approximated using one-dimensional, layered models, linked to the main Bay model at common nodal points.

¹Vice President, Water Resources Division, Camp Dresser and McKee, 7620 Little River Turnpike, Annandale, VA 22003.

²Senior Engineer, Water Resources Division, Camp Dresser and McKee.

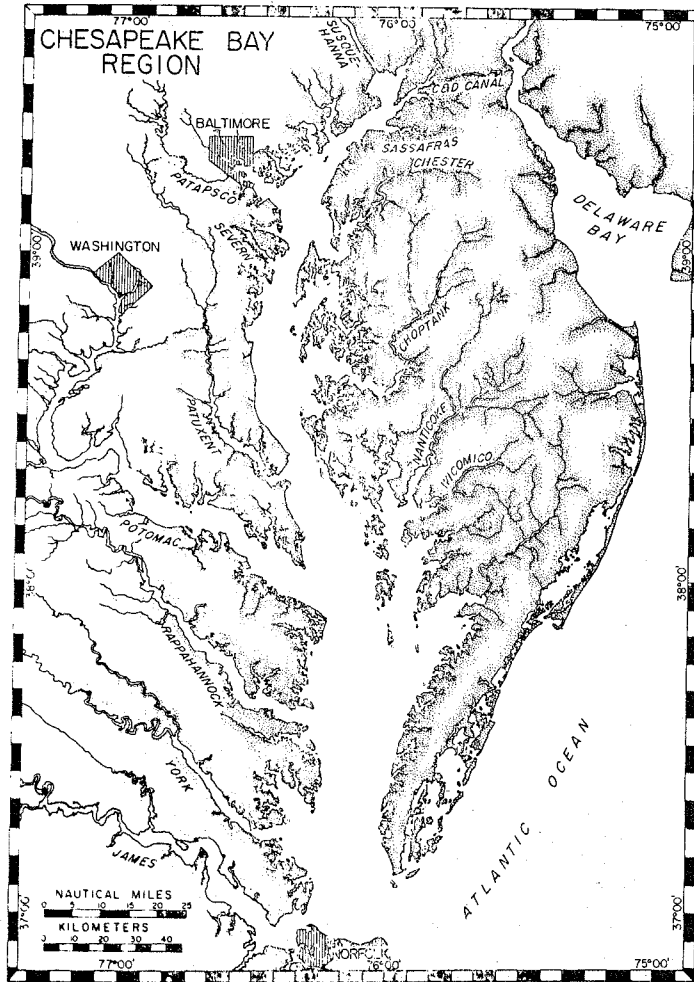

Figure 1. Map of Chesapeake Bay Region

GOVERNING EQUATIONS

Following Figure 2, the governing equations for the two-dimensional, layered model are (Leendertse et al., 1973),

momentum equations:

$$\begin{aligned} \frac{\partial q_x}{\partial t} + \frac{\partial(q_x u)}{\partial x} + \frac{\partial(q_y u)}{\partial y} + (uw) \Big|_{k+\frac{1}{2}}^{k-\frac{1}{2}} - f q_y + \frac{h}{\rho_0} \frac{\partial p}{\partial x} + \frac{\tau_{xz}}{\rho_0} \Big|_{k+\frac{1}{2}}^{k-\frac{1}{2}} \\ = \frac{\partial(N_x h \frac{\partial u}{\partial x})}{\partial x} + (N_z \frac{\partial u}{\partial z}) \Big|_{k+\frac{1}{2}}^{k-\frac{1}{2}} \end{aligned} \quad (1)$$

$$\begin{aligned} \frac{\partial q_y}{\partial t} + \frac{\partial(q_x v)}{\partial x} + \frac{\partial(q_y v)}{\partial y} + (vw) \Big|_{k+\frac{1}{2}}^{k-\frac{1}{2}} + f q_x + \frac{h}{\rho_0} \frac{\partial p}{\partial y} + \frac{\tau_{yz}}{\rho_0} \Big|_{k+\frac{1}{2}}^{k-\frac{1}{2}} \\ = \frac{\partial(N_y h \frac{\partial v}{\partial y})}{\partial y} + (N_z \frac{\partial v}{\partial z}) \Big|_{k+\frac{1}{2}}^{k-\frac{1}{2}} \end{aligned} \quad (2)$$

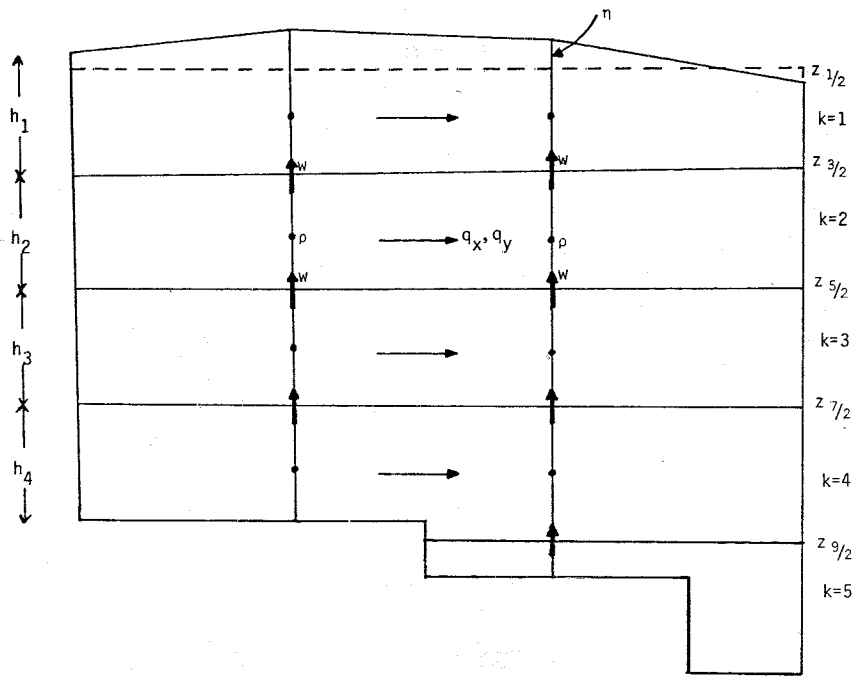

Figure 2. Location of Variables on the Vertical Grid

continuity equations:

$$w|_{k+1/2}^{k-1/2} + \frac{\partial q_x}{\partial x} + \frac{\partial q_y}{\partial y} = 0 \quad (\text{except in top layer}) \quad (3a)$$

$$\frac{\partial \eta}{\partial t} - w|_{3/2} + \frac{\partial q_x}{\partial x} + \frac{\partial q_y}{\partial y} = 0 \quad (\text{in top layer}) \quad (3b)$$

and mass transport equation:

$$\frac{\partial (hc)}{\partial t} + \frac{\partial (q_x c)}{\partial x} + \frac{\partial (q_y c)}{\partial y} + (cw)|_{k+1/2}^{k-1/2} = \frac{\partial (E_x h \frac{\partial c}{\partial x})}{\partial x} + \frac{\partial (E_y h \frac{\partial c}{\partial y})}{\partial y} + (E_z \frac{\partial c}{\partial z})|_{k+1/2}^{k-1/2} \quad (4)$$

and for the one-dimensional layered model (Blumberg, 1977; Elliott, 1976; Hamilton, 1977),

momentum equation:

$$\frac{\partial Q}{\partial t} + \frac{\partial Qu}{\partial x} + (Buw)|_{k+1/2}^{k-1/2} + \frac{A}{\rho_o} \frac{\partial p}{\partial x} + \frac{B}{\rho_o} \tau_{xz}|_{k+1/2}^{k-1/2} = \frac{\partial (N_L A \frac{\partial u}{\partial x})}{\partial x} + (BN_z \frac{\partial u}{\partial z})|_{k+1/2}^{k-1/2} \quad (5)$$

continuity equations:

$$(Bw)|_{k+1/2}^{k-1/2} + \frac{\partial Q}{\partial x} = 0 \quad (\text{except in top layer}) \quad (6a)$$

$$\frac{\partial (B\eta)}{\partial t} - (Bw)|_{3/2} + \frac{\partial Q}{\partial x} = 0 \quad (\text{in the top layer}) \quad (6b)$$

and the mass transport equation:

$$\frac{\partial(Ac)}{\partial t} + \frac{\partial(Qc)}{\partial x} + (Bwc) \Big|_{k+\frac{1}{2}}^{k-\frac{1}{2}} = \frac{\partial(AE_L \frac{\partial c}{\partial x})}{\partial x} + (BE_z \frac{\partial c}{\partial z}) \Big|_{k+\frac{1}{2}}^{k-\frac{1}{2}} \quad (7)$$

where

- x, y, z = longitudinal, lateral, and vertical (positive upward) directions, (L),
- t = time, (T),
- q_x, q_y = x, y components of flow per unit width, (L^2/T),
- u, v, w = x, y, z components of velocity, (L/T),
- f = Coriolis parameter, ($1/T$),
- ij = shear stress tensor, (M/LT^2),
- h = layer thickness, (L),
- p = pressure, (M/LT^2),
- ρ_0 = reference density (M/L^3),
- N_x, N_y, N_z, N_L = x, y, z , and longitudinal momentum transfer coefficients, (L^2/T),
- η = surface elevation above datum, (L),
- c = constituent concentration,
- E_x, E_y, E_z, E_L = x, y, z , and longitudinal dispersion coefficients, (L^2/T),
- Q = longitudinal flow in layer, (L^3/T),
- B = width of layer, (L),
- and A = cross-sectional area, (L^2).

The density is related to the salinity, s , and temperature, T , through an equation-of-state:

$$\rho = f(s, T) \quad (8)$$

The forms of the vertical dispersion and momentum transfer coefficients used in the model are (Elliott, 1976):

$$E_z = E_{z0} + \left(1 - \frac{4z}{H} \left(1 - \frac{z}{H}\right) \frac{Ri}{Ri_{max}}\right) E_{z3} \quad (9)$$

$$\text{and } N_z = N_{z0} + \left(1 - \frac{4z}{H} \left(1 - \frac{z}{H}\right) \frac{Ri}{Ri_{max}}\right) N_{z3} \quad (10)$$

where

- H = total fluid depth, (L),
- Ri, Ri_{max} = local and maximum Richardson numbers,
- $E_{z0}, E_{z3}, N_{z0}, N_{z3}$ = coefficients.

MODEL DEVELOPMENT

The numerical solution of the governing equations uses a split-time approximation and mixed interpolation, finite elements in a solution space of linear triangles. A lumped-mass quadrature is performed to diagonalize the solution matrices. The scheme developed solves the momentum equations at element centers, assuming constant values of flow, q_x and q_y , throughout the element. The continuity equations are solved at nodal locations coincident with element vertices, assuming a linear variation in pressure between nodes. Linkage between the one and two-dimensional models is achieved by conserving integral properties of the governing equations at common nodal points.

The resulting numerical procedure, which is similar in many respects to the schemes of Thacker (1977) and Shubinski et al. (1965), is an explicit technique that must satisfy the usual stability conditions. There are, however, several advantages to this approach over the common linear interpolation models (Wang and Connor, 1975; Chen, 1978). First, the Courant condition is eased by a factor of $\sqrt{3}$. Second, solution matrices are diagonalized giving much cheaper simulations. Third, the spurious oscillations known to be present in the common linear interpolation techniques, even when the non-linear and Coriolis terms are neglected (Lynch and Gray, 1979; Carey and Walters, 1981), are theoretically absent in this approach.

MODEL TESTS

To illustrate the accuracy and stability of the model, two test cases are presented. The first case is a hydrodynamic test of radial flow in the quadrant of an annulus (Figure 3) (Lynch and Gray, 1979). This is perhaps one of the severest tests of a two-dimensional shallow water equation model. It produces severe node-to-node oscillations in both the elevation and velocities fields of primitive equation models using common linear interpolations. Figures 4 and 5 demonstrate that the mixed interpolation scheme of this model is virtually free of these spurious oscillations, producing accurate results.

The second test is a comparison between the mass transport portion of the program and a two-layer model, DISPER2 (Christodoulou et al., 1976). In a two-layer, prismatic channel, Figure 6 shows the excellent agreement found. The major difference between the two models is the lumped-mass approach, which produces comparable results with no apparent loss of mass, and without the costly matrix inversions needed in DISPER2 at each time step.

APPLICATION TO CHESAPEAKE BAY

The data base used to calibrate the Chesapeake Bay Circulation Model consists of tidal elevations, velocities, and salinities collected in 1970-1973 to calibrate the Corps of Engineers hydraulic model of the Bay. This data was collected by intensely measuring each section of the Bay and its tributaries at a different time during the four year period. It was decided to calibrate CBCM in the same manner. First, each major tributary sub-model was calibrated independently. Next, the upper Bay above Annapolis was calibrated, followed by the Bay above the Patuxent River.

A second data set was gathered specifically for this study in July, 1980. It is a synoptic data set, but focused on the southern half of the Bay where less data existed previously. The model of the entire Bay and its tributaries will be verified using this data.

The first example of calibration presented here is for the Potomac River. Figure 7 shows the grid used, and Figure 8 shows comparisons with observed data for elevations, velocities and tidally-averaged salinities. The calibration was obtained using a friction factor dependent on Manning's n varying between 0.026 and 0.03.

The second example is a calibration in the Bay above the Patuxent River (Figure 9). Figure 10 shows comparisons with observations for elevations and velocities at the nodes shown in Figure 9. The calibration used $n = 0.015$ and 0.02 in the Bay and between $n = 0.026$ and 0.03 in the rivers and trenches (n was set higher in storage areas).

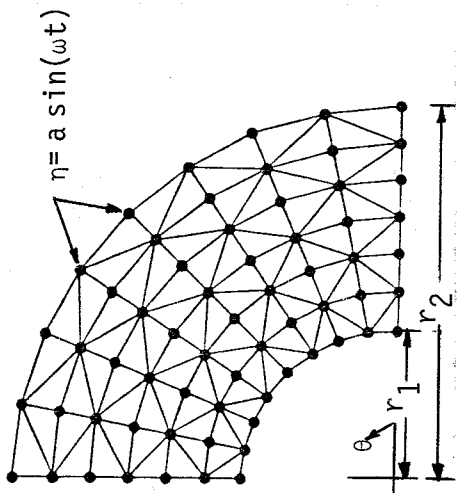

Figure 3. Polar Problem (Lynch, 1978)

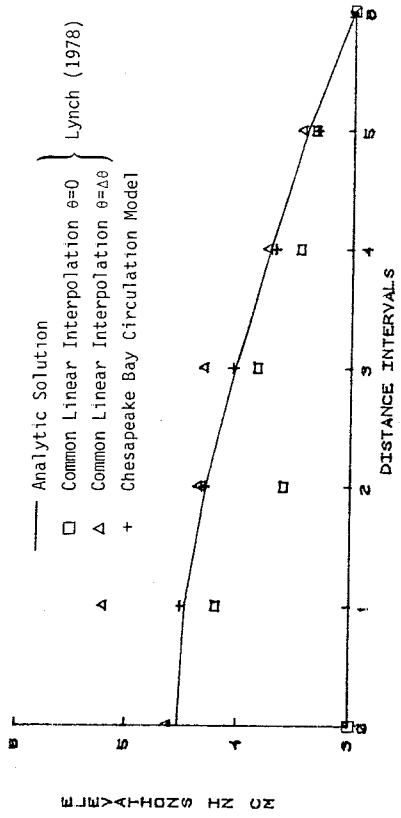

Figure 4. Comparison of Elevations for Polar Problem

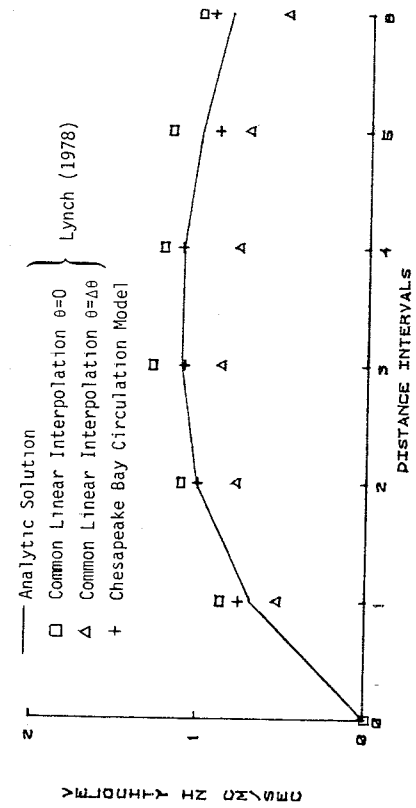

Figure 5. Comparison of Velocities for Polar Problems

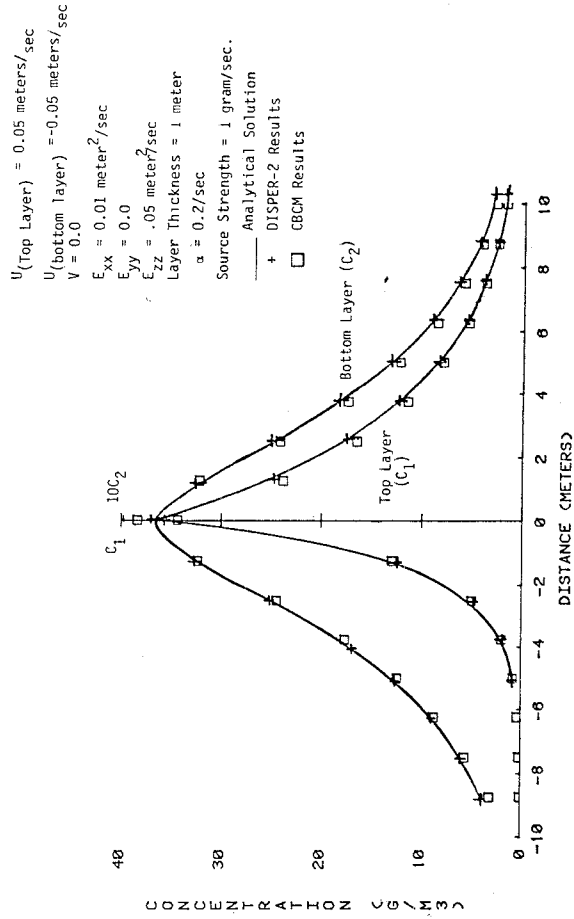

Figure 6. Comparison of Mass Transport Results

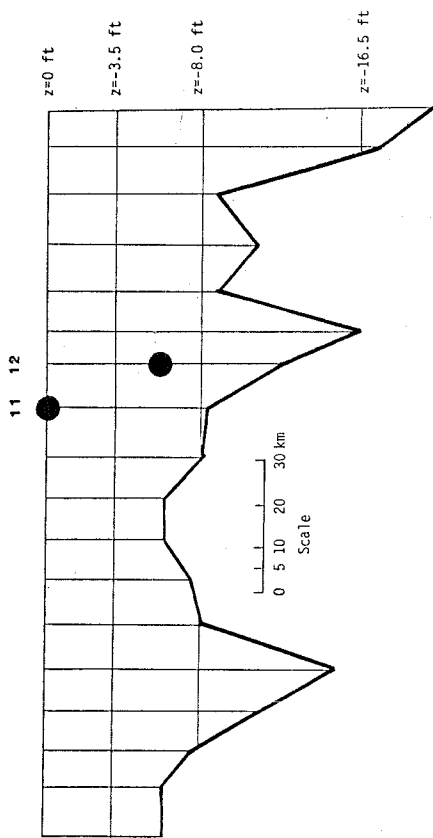

Figure 8a - Grid For Potomac River

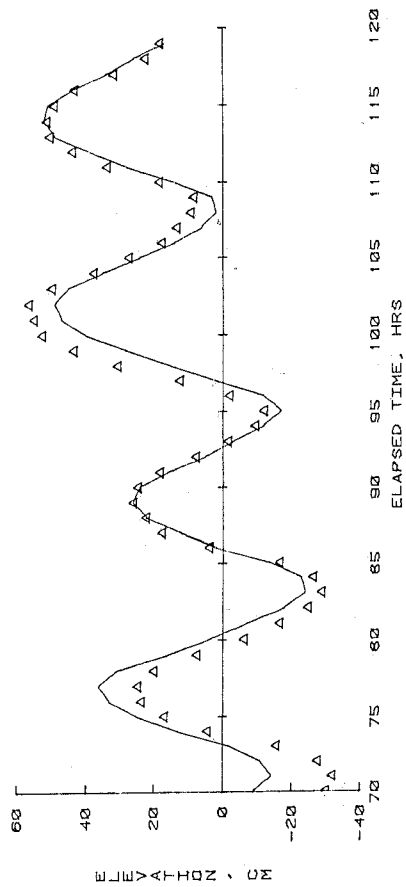

Figure 8b - Comparison of Elevations Between Computed Results (-) and Observations (Δ) at Node 11.

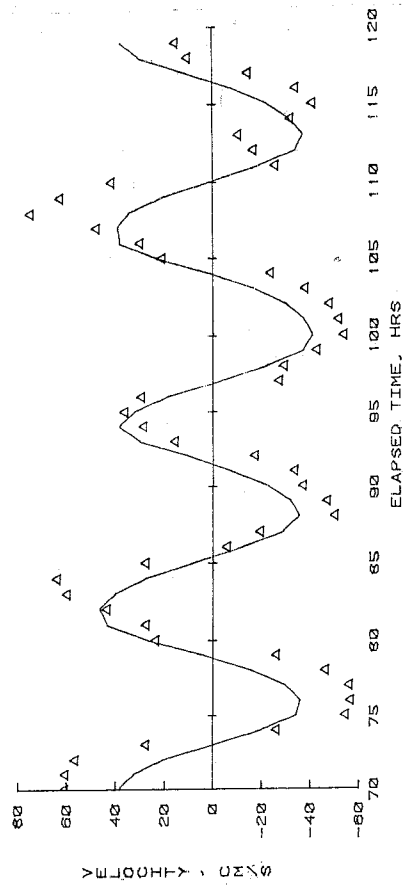

Figure 8c - Comparison of Velocities Between Computed Results (-) and Observations (Δ) at Node 12 Layer 2.

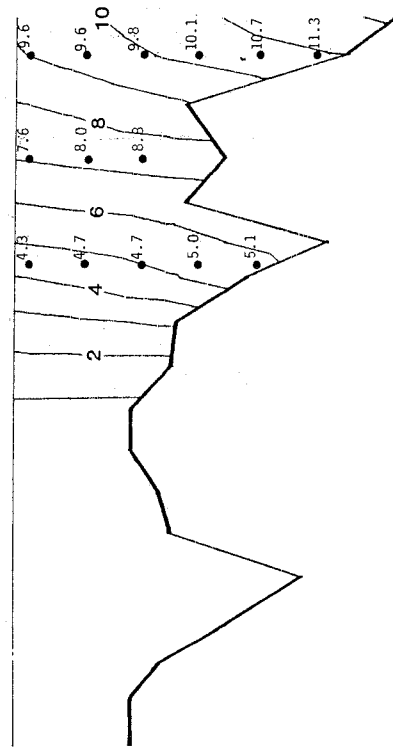

Figure 8d - Comparison of Tidally-Averaged Salinity Results.

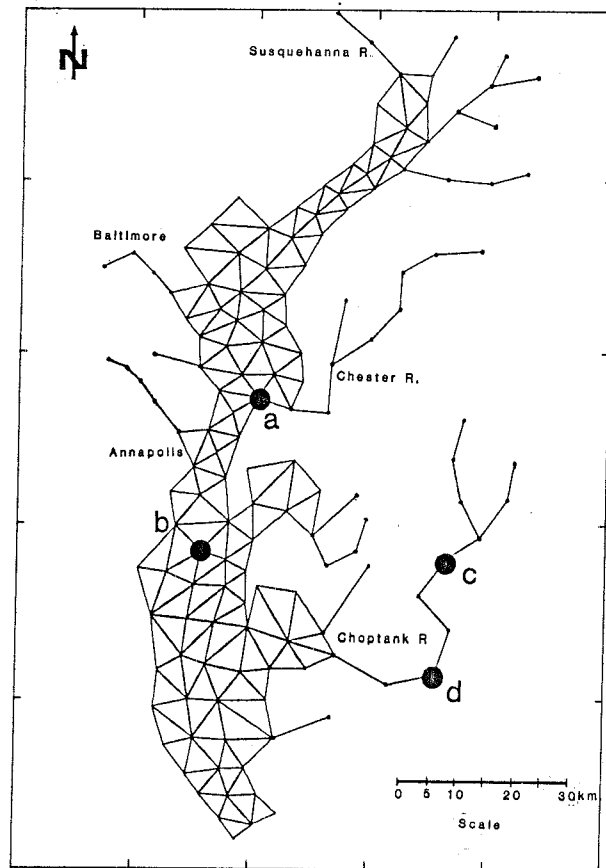

Figure 9. Bay Grid Above the Patuxent River

DISCUSSION

While the agreement with observed elevations was excellent, velocity comparisons were usually not as good. Velocities in the main Bay and trenches were generally acceptable. However, computed values in the tributaries were often 2 or 3 times smaller than those recorded on the current meters.

To investigate this, a tidal prism analysis was performed at the mid-point of the Patuxent River by integrating the recorded velocity from low to high tides. This calculation estimated that three times the volume of water needed to produce observed elevations passed this point.

Since recording meters are usually placed in the swiftest part of a river, they sometimes fail to measure the flow through a cross-section. Effects of varying velocity profiles and storage areas may be missed. The model, on the other hand, predicts a flow or mean velocity, consistent with the tidal prism result based on elevations.

The model outlined in this paper incorporates a very economic scheme, while at the same time maintaining excellent accuracy and stability properties. Spurious oscillations evident in similar models are not present here. The presented numerical tests and calibrations demonstrate the good points of this model. The next step will be to verify the calibration using the 1980 data set. This will be the subject of another paper.

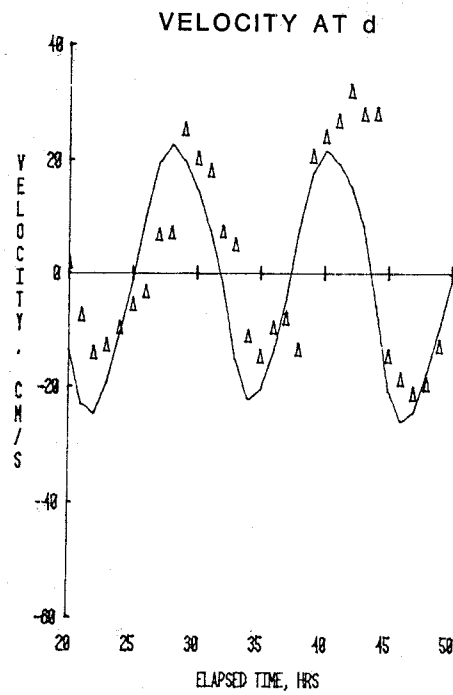
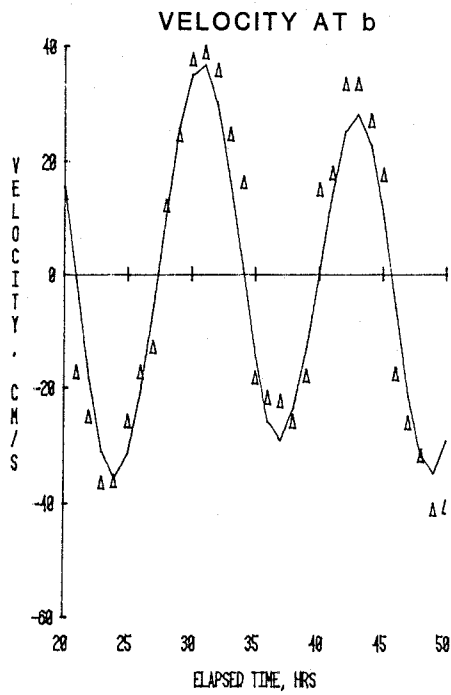
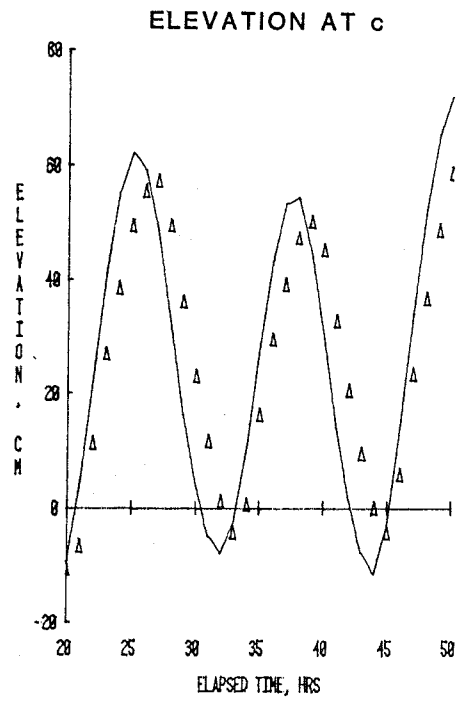
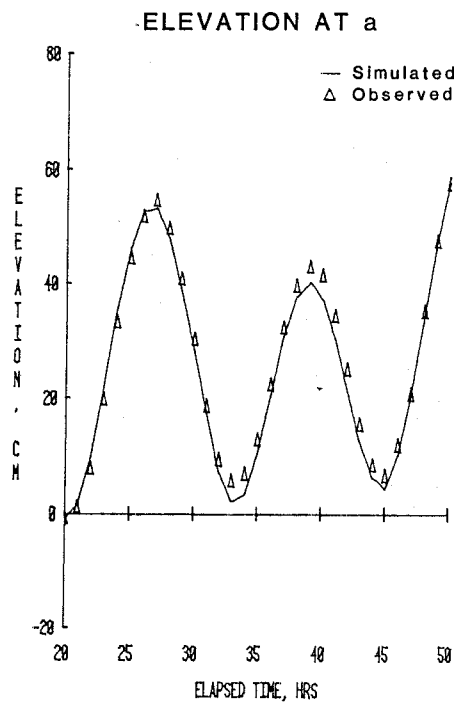

Figure 10. Calibration Results in Upper Chesapeake Bay

ACKNOWLEDGEMENTS

The work in this paper was sponsored under EPA Contract No. 68-01-5125. The authors would like to thank John Klein, the EPA Project Officer, for his guidance, and also John Aldrich and Drs. Daniel R. Lynch, Peter Hamilton, and Donald W. Pritchard for their contributions.

REFERENCES

- Blumberg, A. F., "Numerical Model of Estuarine Circulation," Journal of the Hydraulics Division, ASCE, HY3, March 1977, pp. 295-310.
- Chen, H. S., "A Storm Surge Model Study. Volume II. A Finite Element Storm Surge Analysis and its Application to a Bay-Ocean System," report to FIA-HUD, by Virginia Institute of Marine Science, SR 189, September 1978.
- Christodoulou, G. C., Pearce, B. R. and Connor, J. J., "Mathematical Modeling of Dispersion in Stratified Waters," Ralph M. Parsons Lab., MIT, Report No. 219, December 1976.
- Corps of Engineers, "The Chesapeake Bay Plan of Study," prepared for the National Science Foundation, Washington, D. C., P.B. 288554, by Baltimore District, June 1970.
- Elliott, A. J., "A Numerical Model of the Internal Circulation in a Branching Tidal Estuary," Chesapeake Bay Institute of the Johns Hopkins University, SR 54, June 1976.
- Hamilton, P., "On the Numerical Formulation of a Time Dependent Multi-Level Model of An Estuary, With Particular Reference to Boundary Conditions," Estuarine Processes, Vol. II, Academic Press, 1977, pp. 347-364.
- Leendertse, J. J., Alexander, R. C. and Liu, S-K, "A Three-Dimensional Model for Estuaries and Coastal Seas: Volume 1, Principles of Computation," R-1417-OWRT, The Rand Corporation, Santa Monica, CA, December 1973.
- Lynch, D. R., "Finite Element Solution of the Shallow Water Equations," Ph.D. Dissertation, Princeton University, June 1978.
- Lynch, D. R. and Gray, W. G., "A Wave Equation Model for Finite Element Tidal Computations," Computer and Fluids, 1979.
- Shubinski, R. P., McCarty, J. C. and Lindorf, M. R., "Computer Simulation of Estuarine Networks," Journal of Hydraulics Division, ASCE, HY5, September 1965, pp. 33-49.
- Thacker, W. C., "Irregular Grid Finite-Difference Techniques: Simulations of Oscillations in Shallow Circular Basins," Journal of Physical Oceanography, Volume 7, March 1977, p. 284-292.
- Walters, R. A. and Carey, G. F., "Analysis of Spurious Oscillation Modes for the Shallow Water and Navier-Stokes Equations," TICOM Report 81-3, Texas Institute for Computational Mechanics, University of Texas at Austin, August 1981.
- Wang, J. D. and Connor, J. J., "Mathematical Modeling of Near Coastal Circulation," Ralph M. Parsons Lab., MIT Report No. 200, April 1975.

PAPER DISCUSSION

CHESAPEAKE BAY MODELING

by

Robert P. Shubinski and Raymond Walton

Question: Simpson and Gray seem to use a Simpson Rule type integration when using these lower order type models. Do you see any problems with this approach?

Dr. Shubinski: We are not sure what their problem really was.

Question: Did you put velocity meters in the C and D canal?

Dr. Shubinski: No, we could not place instruments directly in the canal. Therefore, we placed a couple of velocity meters in the vicinity of the canal. Because it is a small shipping canal, we could not place anything inside the canal permanently.

Instantaneous flows through the C and D canal have been estimated to be as high as 30,000 cfs. This can occur in either direction as a result of tidal fluctuations. Flows of this magnitude are higher than the low flow conditions from the Susquahana River. Therefore flows from the C and D canal can effect circulation patterns in vicinity of the canal substantially. We don't feel too confident right now with our model's description of the complicated C and D canal area. We actually discovered this problem with the physical model that was developed. The Corps was obliged to include the C and D canal in the physical model. While trying to calibrate their model they discovered that these large flows through the canal created circulation problems in the vicinity of the canal. This created problems for the physical model and alerted us to the fact as well.

The greatest difficulty as we see it is that no one has collected any accurate data through the canal or in the vicinity of the canal in order to verify what is actually occurring there.

Question: Could you please tell us again the purpose of this study and the reason for developing your model?

Dr. Shubinski: The EPA decided that it would be too expensive to conduct a massive data collection effort every time they wanted to evaluate various circulation and transport problems in the Bay. Therefore, they concluded that a mathematical model would be useful to help them to identify problems and to located places where critical data should be collected. In this way the EPA hoped to tailor their field data collection efforts and save money as a result.

Question: Is the physical model study part of this whole program as well?

Dr. Shubinski: The physical model, of course, belongs to the Corps of Engineers who has been developing it somewhat independently from the EPA. There is some degree of cooperation and sharing of data but often one can find redundancy. They have had a very difficult time with the physical model because of the inability to simulate the effects of wind mixing. We feel that most of the physical model studies now are being directed toward small scale problems. For instance, they have recently looked at dredging effects in Baltimore Harbor.

Comment: One problem with the physical model, and other models as well, is the difficulty in considering the net effects of tributary inflows, point sources of pollution, and entrapment of materials in protected embayments. These areas tend to be critical areas. They are highly affected by population impacts and urban growth patterns. They will become eutrophied first and tend to be very sensitive. Most models deal with the large scale problem and don't account for these areas.

Question: Are these same problems part of the numerical model as well?

Dr. Shubinski: Not entirely. Although a mathematical model tends to be more flexible and can be adjusted to deal with more refined areas, we don't feel that this was the main purpose of our study for the EPA. We see that the purpose of this model is to be able to identify large scale problems and circulation within the bay as a whole. There are other multi-dimensional models that can be applied to the refined situations if need be.

We, therefore, want to evaluate the large scale circulation problems and identify problem characteristics and locations where detailed data collection should be conducted.

Question: Do you include eddy diffusion terms in your model?

Dr. Shubinski: No, we neglected those terms in this model.

Question: How do you account for momentum exchange between your vertical layers?

Dr. Shubinski: We use a momentum coefficient which is directly related to the vertical velocity gradient. We have found this approach to be reasonable and less costly than some of the other approaches.

APPLICATION OF A TWO-DIMENSIONAL FINITE ELEMENT MODEL FOR SHALLOW WATER COMPUTATIONS

by

A. M. Teeter¹ and W. H. McAnally¹

INTRODUCTION

The study of difficult estuarine problems often requires the application of relatively sophisticated modeling techniques. The hybrid modeling approach, used at the Waterways Experiment Station (WES), combines several physical and numerical models into an integrated solution that employs each technique to do those things for which it is best suited. By exploiting the strengths and avoiding the weaknesses of each solution method, an integrated solution is obtained that is more accurate and reliable than that attainable with any single solution technique. The example application to be described here is part of a study to predict sediment deposition in Atchafalaya Bay, Louisiana, and the response of the bay and river basin to that deposition. A number of models are utilized in this study to simulate river flows, sediment transport, tides, salinities, storm surges, and waves.

This paper describes a horizontal plane, two-dimensional hydrodynamic finite element model, some model tests, and preliminary application to a large, topographically-complex, well-mixed estuary. A vicinity sketch of the Atchafalaya Bay complex is shown in Figure 1. Flow to the system comes largely from outside the basin. Average annual river inflow (1938-1972) has been 5130 m³/sec. Average monthly flows reach 9200 m³/sec in April and decrease to 2070 m³/sec in September. Most of this inflow is proportioned between the lower Atchafalaya River and Wax Lake Outlet with a ratio of 70 to 30 percent, respectively. The bay is broad and shallow with an average depth of only 1.7 m. The boundary between the estuarine and offshore areas is long and complicated by shell reefs. Significant natural changes in the bay complex have been initiated by the increased flow and sediment captured from the Mississippi River during the last 20 years.

MODEL DESCRIPTION

Bay hydrodynamics are being modeled using RMA-2V, a new version of Resource Management Associate's two-dimensional horizontal finite element model, RMA-2. The original model is more fully described by King (1974), Norton (1973), and Walters (1979). It uses a finite element solution formulation with either triangular or quadrilateral shaped elements. The finite element method solves the governing equations in a weighted sense over each element, then assembles these into a global solution for the variables at the node points. The model uses mixed interpolation; water surface elevations are interpolated linearly over an element while velocity components use quadratic interpolation.

¹Estuaries Division, Hydraulics Laboratory, Waterways Experiment Station, U. S. Army Corps of Engineers, Vicksburg, MS

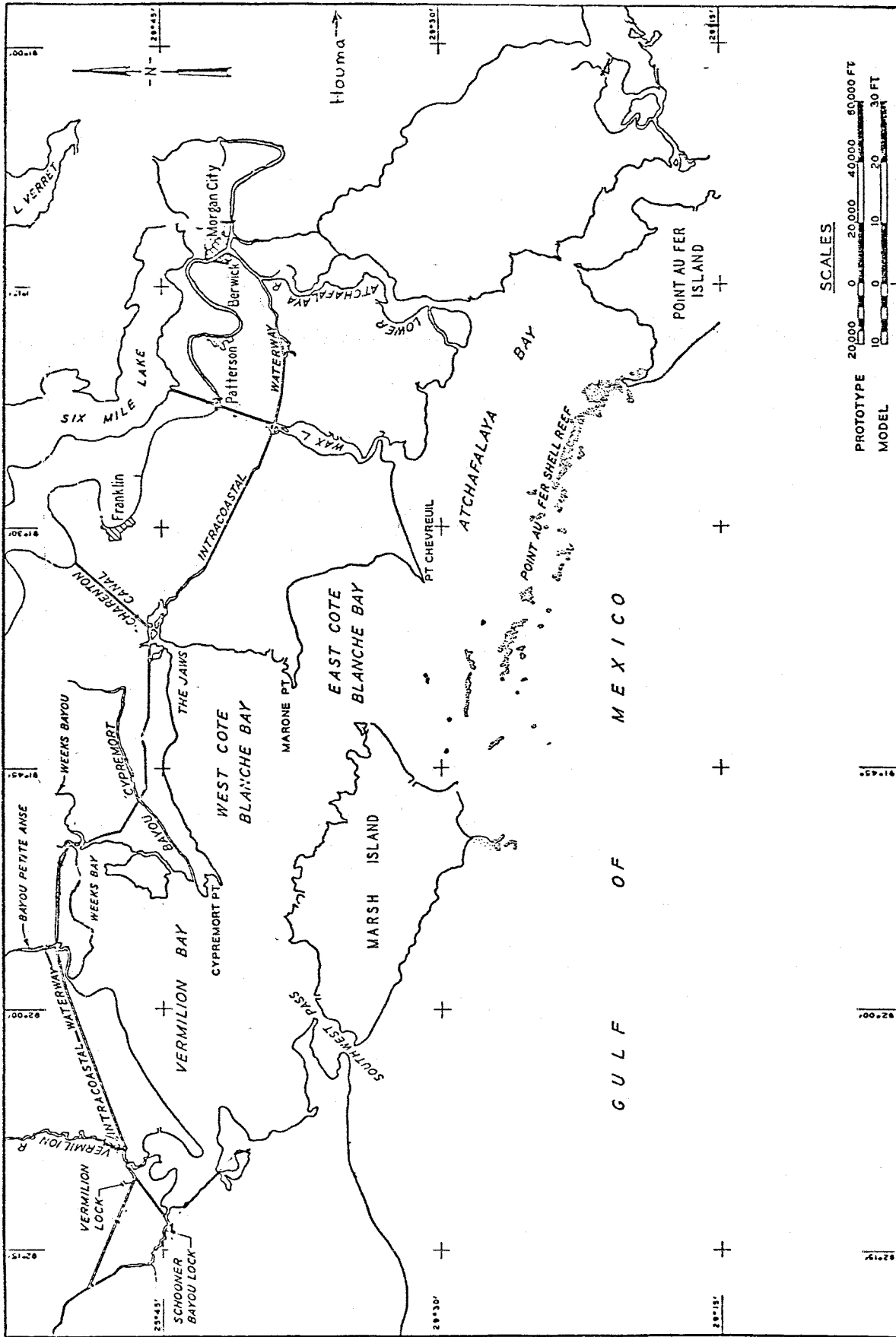

Figure 1. Atchafalaya Bay system

Governing equations for the model include the primitive continuity and turbulent Navier-Stokes (Reynolds) equations. Nonlinear terms are retained and Coriolis, wind stress, and bottom friction terms are added. The formulation of the model allows curved sided elements which are useful in fitting solid boundaries. Slip flow parallel to a boundary, zero flow, specified flow, or specified head are the boundary conditions which can be specified around the perimeter of the domain.

In the original model, flow was substituted for velocity in the governing equations to maintain a consistent order of approximation in the finite element method. The new version, RMA-2V, uses a straight velocity formulation. Although the first iteration cycle of the solution may be slightly less accurate, results of hydrodynamic simulations are generally improved. The model is more stable and less sensitive to element-wise depth changes or low eddy viscosities. Computer run times are reduced by 10 to 15 percent by staggered convergence in which nodal variables which have converged are omitted from further iteration cycles.

The new model has the capability of simulating moving boundaries. Water depths are tracked and, where negative depths occur, new land areas are formed by automatic creation of new elements with small positive depths maintained along the dry boundary. Zero flow conditions are given to these new boundary nodes. Eddy viscosities of the new or reformed elements are set at 15 percent of the old values to limit the influence of the zero flow specifications on the interior of the grid. Dynamic simulations use under-relaxation to prevent overshoot of land boundary locations during flooding of dry areas. Some additional iterations are necessary when simulating wetting and drying.

Another enhancement incorporated in RMA-2V gives local orientation to the eddy viscosity tensor. This makes specification of the eddy terms easier and more physically meaningful. The advantage of this will be discussed later.

MODEL APPLICATION

The hydrodynamic model has been applied at WES in the past to several different systems. Application has recently begun on the Atchafalaya Bay system. The spatial extent of the area covered by the computational grid was selected so that boundary conditions would not be affected by changes within the area of interest.

Computational grids are generated using a companion computer code. Topographic and bathymetric data, as well as boundary slopes, must be specified in this step.

To perform hydrodynamic computations on a computational grid, boundary conditions are required at all exterior nodes, and bottom friction and eddy viscosity coefficients are required for all elements in the grid. The necessary model coefficients are first estimated from experience and then calibrated, using field data. Bottom friction can be estimated based on grain size, bed form characteristics, and the presence of other protrusions such as vegetation. Eddy viscosity terms are somewhat more difficult to estimate. In the Reynolds equations these terms represent mean turbulent quantities not dependent on the velocity gradients, but on local turbulent intensities. In the

computational model they are adjusted by summing the estimated contributions of turbulence and vertically-generated components. The former increase as the 4/3 power to 2 power of the local grid scale.

Longitudinal and lateral momentum dispersion caused by the combined effect of vertical velocity variation and vertical diffusion increase the effective "eddy" terms in a vertically-averaged model. Dispersion effects can be related to the shear velocity and flow depth and are greatest in the direction of flow. The new capability to orient the eddy viscosity terms with the direction of flow makes it possible to correctly define the asymmetry of these terms.

Another means of estimating coefficients and the effects of the coefficients on the solution is the use of test grids. Strong river flow into an open bay resembles jet-type flow. The spreading rate of the jet as it issues into the bay depends on the lateral turbulent transport of momentum (eddy viscosity terms), friction, and bathymetry. An example test grid is shown in Figure 2 along with an example vector plot of computed velocities. Numerical experiments using test grids have been used to gain experience on the effects of input coefficients and boundary condition specification on the model flow fields.

ATCHAFALAYA BAY

Two computational grids have been developed for hydrodynamic simulation of the Atchafalaya Bay complex. These grids will also be used for sediment transport and salinity modeling. The two grids cover the same areas with different spatial resolution. The coarse grid is made up of about 300 quadrilateral elements and is shown in Figure 3. It covers the area of the delta, the bay complex, and a portion of the Gulf of Mexico. Three coastal connections between the bay complex and coastal area are included. The primary connection is the area between Point Afuer and eastern Marsh Island. Other connections from the bay complex to the gulf include Southwest Pass, which has deepened dramatically in the last hundred years and is the deepest area covered by the grid, and Oyster Bayou which is small but has depths of 10 m or more and could become more important in the future.

The fine grid consisting of 530 quadrilateral elements was developed after it became apparent that additional elements would be needed to provide more bathymetric detail in the area of active delta building and also to ensure that the resulting model computations conserved mass in areas of high flow. A portion of the grid near the river outlets is shown in Figure 4.

A difficult aspect of modeling bay hydrodynamics is proper specification of boundary conditions, particularly the offshore tidal conditions, which can greatly influence flows within the grid. Tidal data have been collected offshore of Atchafalaya Bay for more than a year and data analysis is well under way. The principal components of the tide in this area are K_1 , O_1 , and M_2 . The tides in the Gulf of Mexico are complicated by gravity or standing-wave modes. The K_1 constituent is in phase over most of the western gulf and is thought to be involved in a bi-modal oscillation through the Straits of Florida and Yucatan. Preliminary analysis of offshore tidal records indicate a 2- to 3-hour phase difference between tide gauges located on the gulf edge of

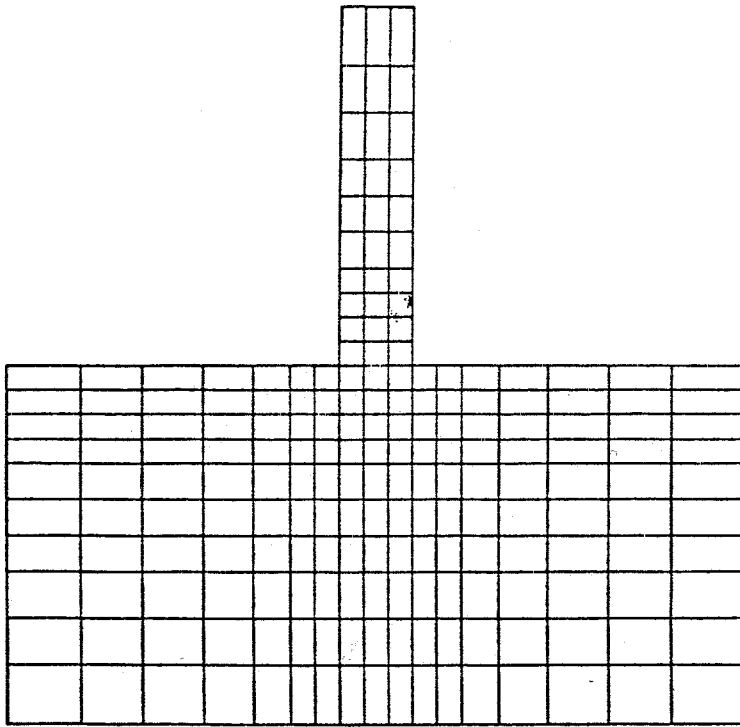

RMA2 TEST GRID FOR RMA2 - 200 ELEMENTS

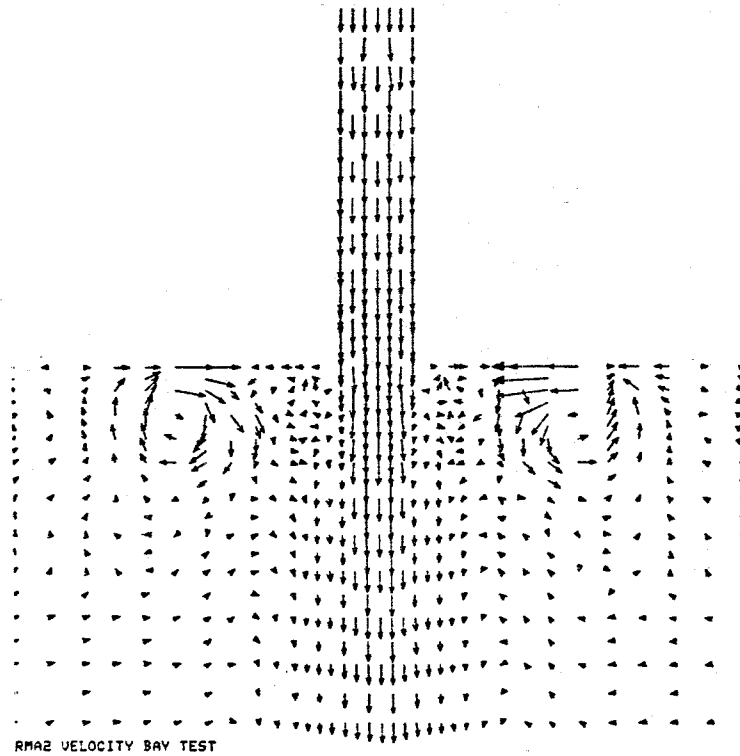

RMA2 VELOCITY BAY TEST

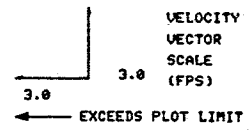

Figure 2. Schematic test grid (top) and example vector plot (bottom)

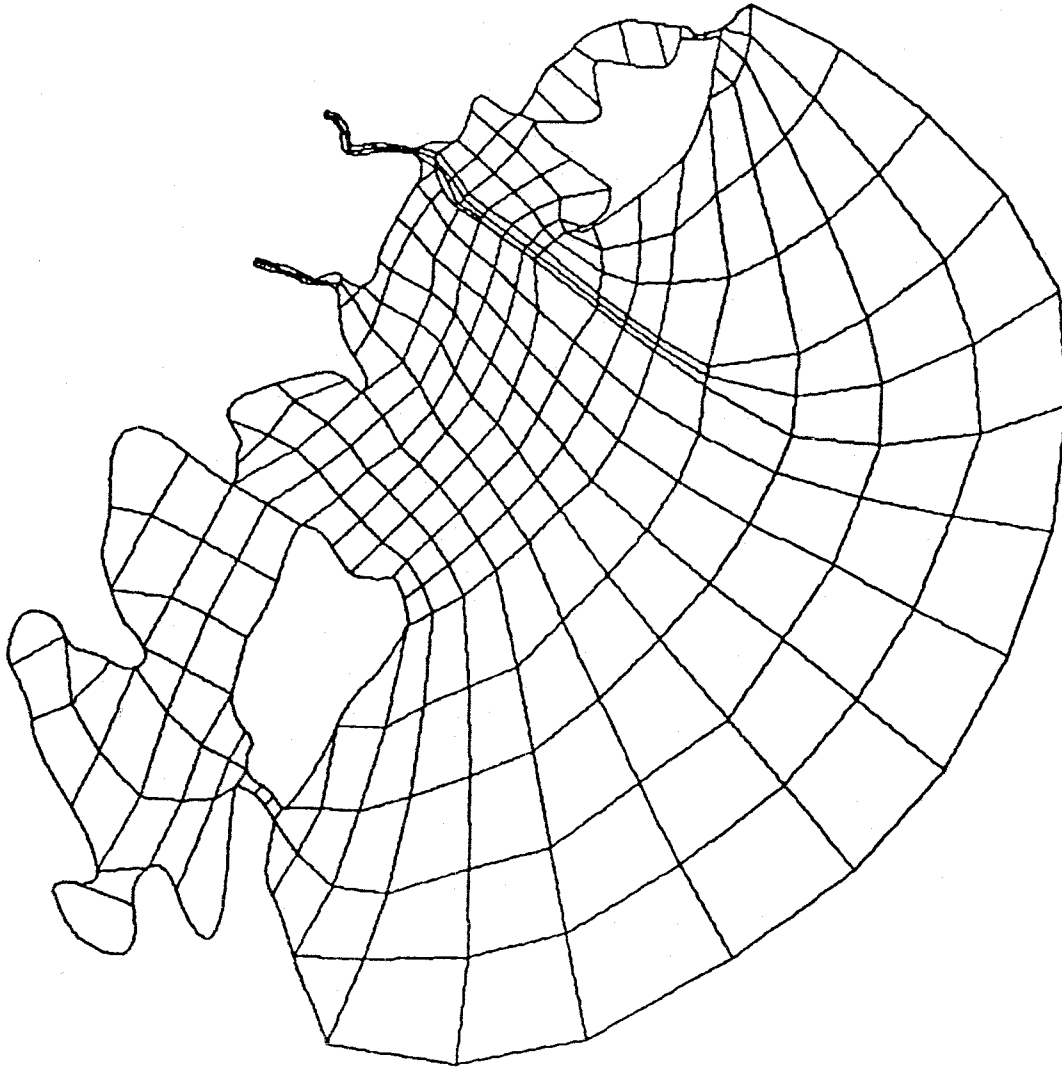

Figure 3. Coarse computational grid for RMA-2V

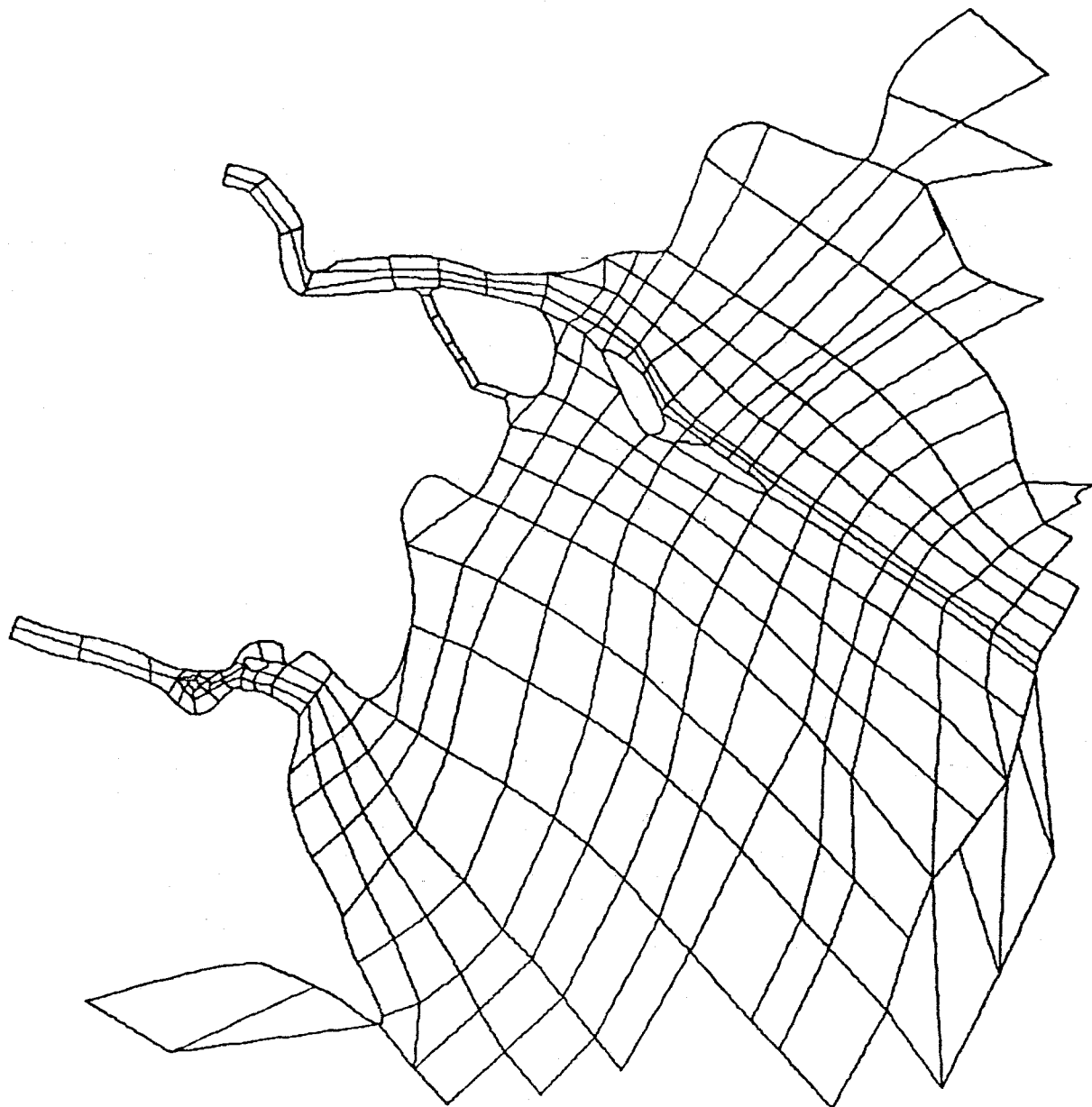

Figure 4. The big computational grid near the inflows of Lower Atchafalaya River and Wax Lake Outlet

the grid and the shell reef or coastal areas. The M_2 tidal constituent, on the other hand, is commonly believed to have a distinct phase gradient along the coastline. Preliminary harmonic analyses of the data indicate that the M_2 constituent is almost inphase in the offshore area. Some cross spectral analyses have been performed between offshore stations and they show similar trends in the tidal constituents. More work remains to ensure that the offshore boundary of the hydrodynamic grid is properly specified. To date, both steady and time-varying flow tests have been run. An example flow field during the ebb phase of an M_2 tidal component and a 5700 m³/sec river flow is presented in Figure 5.

Once the necessary field data collection is complete, model verification will be performed using a range of conditions incorporating major tidal constituents and freshwater inflows. Verification is performed to ensure that the model reproduces prototype behavior over the range of conditions of interest. Results from one-dimensional numerical river simulations, made as part of separate project task, will be used to adjust friction coefficients and verify slopes in the river reaches of the model. After tidal and freshwater verification, the model will also be adjusted to reproduce wind driven currents.

PRODUCTION MODELING

Probably one of the most underestimated tasks at the onset of 2-D modeling applications is the efficient handling of information. Data are needed to run and validate models and the models themselves generate new data. Both types must be efficiently handled for effective modeling. The problem is particularly acute in the Atchafalaya study because large numbers of simulations will be generated by many different models. Already, bathymetric data in the form of detailed surveys dating back to 1963 have been assembled as part of the sediment model validation process. Historic current and salinity data also have been compiled. New data are being collected on tides, currents, winds, waves, salinities, sediment concentration, bed properties, etc. A spatial data management system developed at WES is used in this project (LaGarde 1980). It consists of a series of computer-aided procedures for data recovery, transformation of grid coordinates, quality control, manipulation, analysis, and display. A list of the component programs and a brief description of their functions is given in Table 1.

In addition, a computer disc and tape file management program has been developed to automatically catalog, locate, describe, retrieve, and protect files created by various models. Another set of programs is used for field data reduction and time series analysis.

SUMMARY AND CONCLUSIONS

The two-dimensional model described here is a sound basis for modeling complex two-dimensional flows. Many auxiliary computer-aided tasks must be performed to integrate model results, manipulate information, and display data. Useful results depend on careful selection of input data and model coefficients. Two-dimensional modeling is a difficult task that requires knowledge of the physical process and of the models used to describe them.

ATCHAFALAYA COARSE GRID 200,000 CFS M2 COMPONENT 6-30-81

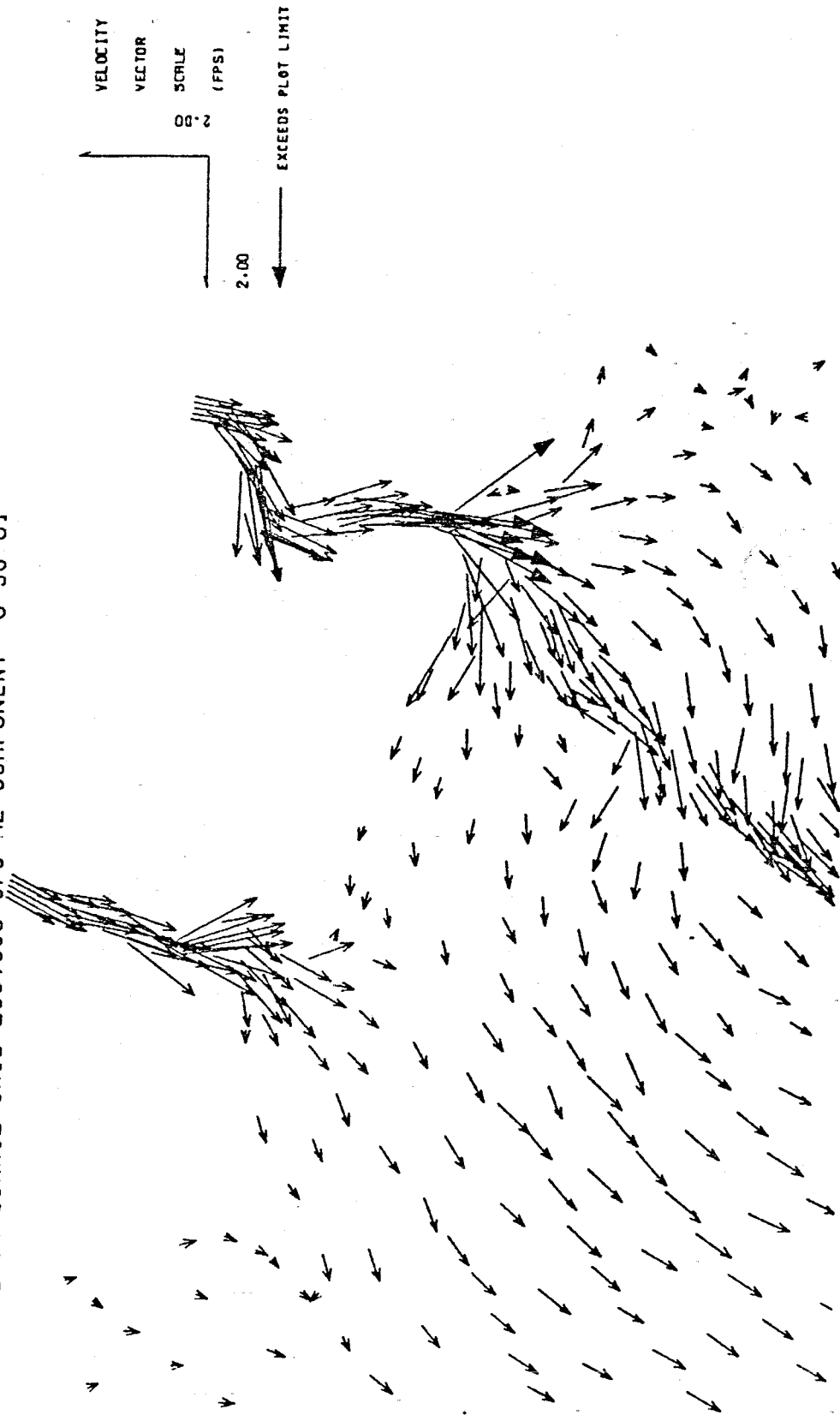

Figure 5. Example of a preliminary flow test, ebbing phase

Table 1. Description of Auxillary Computer Programs

Computer Program	Description
DGPLT	This program is used to quality control the collected raw data. It checks the data form and format and consistency of the identification codes and prepares a computer plotted map of the data for visual inspection.
FACGRD	This program transforms any factor map type data from a linear string of XY coordinates defining the boundaries of factor patches to a grid array format.
ELEVGRD	This program transforms any variable surface data from a string of values at sample points into a three-dimensional description of the surface in a grid format.
4VIEW	Used primarily for quality control, the program produces a series of computer plots showing the three-dimensional structure of any gridded data.
CONTA	This program is used to contour map any gridded variable surface data.
RMAFEG STUDHGRD	Programs used to rapidly transform multiple finite element grid sample locations into the grid system used in the DMS.
MESH1	A program used to mesh different types of water and sediment sample data in tabular form with digitized XY sample locations. Primarily used with state survey data to decrease manual data collection labor.
MESH2	A program used to mesh hydrographic survey data with digitized XY locations to decrease manual data collection labor.
TRANSA	A program to transform gridded data, particularly NOAA processed hydrographic survey data, into a form for input to the DMS data stream.
MESH3	Provided with data sets from several maps covering an extensive region, this program generates a single data set covering the entire region.
DUMPER2	Provides a high-speed printer map of any gridded data.
GRDSUB	This program aligns two grid maps using the master data base coordinate system and provides the difference between maps where there are data for both maps.
BATHAREA	Calculates the area of the underwater ground surface between any series of selected bathymetric contours.

REFERENCES

1. King, I. P., Norton, W. R., and Iceman, K. R., "A Finite Element Model for Two-Dimensional Flow," Finite Elements in Flow Problems, J. T. Oden, et al., ed, UAH Press, Huntsville, AL, 1974, pp 133-137.
2. LaGarde, V. E., and Heltzel, S. B., "A Data Management System for Finite Element Sediment Transport," presented at the May 1980 Third Annual Conference on the Finite Element Method in Water Resources, held at the University of Mississippi.
3. Norton, W. R., King, I. P., and Orlob, G. T., "A Finite Element Model for Lower Granite Reservoir," Water Resources Engineering, 1973, Walnut Creek, CA, 133 pp.
4. Walters, R. A., and Cheng, R. T., "A Two-Dimensional Hydrodynamic Model of a Tidal Estuary," Advances in Water Resources, Vol. 2, Dec. 1979, pp 177-184.

PAPER DISCUSSION

APPLICATION OF A TWO-DIMENSIONAL FINITE ELEMENT
MODEL FOR SHALLOW WATER COMPUTATIONS

by
A. M. Teeter
W. H. McAnally

- Question: Where do you stand on this study? it looks as though you are just getting started.
- Mr. Teeter: We are a little further than that. We're held up by availability of field data. We are having difficulty in getting the data that we need to verify certain portions of our model but we've just finished a field survey in June, we've got the grids up and tested, we've assembled historic data, and we've put our data management system in place.
- Question: How did you determine whether to use a finite difference type code like Lee Butler has or the finite element code that you're describing today?
- Mr. Teeter: We didn't have very much lead time for the implementation of this project so we had to go with a set of models that we had available and that could account for sediment transport. That sediment transport code happened to be already developed in terms of finite elements.
- Question: Don't you think your eddy viscosity coefficients are rather high in their magnitude?
- Mr. Teeter: No, we don't think so. We feel they are fairly well based upon the physical size and dimensions of the problem and the computational grid, which in this case are very large.
- Question: Could you briefly describe your approach for using and utilizing hybrid models in this situation?
- Mr. Teeter: Yes, we basically have used physical models, as we did on the Columbia River estuary, to describe the strong points of the three-dimensional flows, then used those physical model results to drive the numerical hydrodynamic codes. Other two-dimensional numerical codes were then used to describe the detailed sediment transport resulting from the hydrodynamics essentially generated by the physical model. We are using a similar approach in the Atchafalaya study where we'll use a physical model of the bay-river system to develop results of the hydraulic response. One-dimensional river and two-dimensional bay models will be run separate from each

other and the physical models, however. Numerical hydrodynamic results will be coupled to wind-wave, storm surge, sediment transport, and salinity codes. Results will be integrated even though the physical model will not drive the numerical models directly.

THE OHIO RIVER DIVISION'S EXPERIENCE WITH
TWO-DIMENSIONAL FLOW MODELING

By

Glenn Drummond¹

INTRODUCTION

Members of the Ohio River Division Reservoir Control Center staff have been involved in the development, application, and interpretation of mathematical hydraulic models for more than twelve years. The models have included one-dimensional steady- and unsteady-flow models, one-dimensional reservoir, heat budget models, the WQRRS water quality model (HEC, 1978), and the LARM two-dimensional reservoir model (Buchak and Edinger, 1979). We have witnessed the growth of the one-dimensional reservoir models from the simple Wunderlick graphical model to the complex EIKER (USAE, Baltimore, 1977) and WESTEX models. The applications have been numerous and it seems that each time the state-of-the-art has been advanced because of some peculiarity of the data set.

We learned many lessons in expanding the one-dimensional modeling experiences. When we felt that we were ready to undertake multi-dimensional modeling, we drew on those experiences. We established a set of criteria for the management and function of a two-dimensional reservoir model. Foremost among these were 1) computation efficiency, 2) accuracy, and 3) cost effectiveness. Our first step was to contract with Edinger and Associates, Inc., Wayne, PA, to examine the feasibility of developing a model within these criteria. The conclusion of Edinger's initial study was that a model could be developed to meet our needs.

We contracted again with Edinger and Associates to develop a two-dimensional hydrodynamic reservoir model and apply it to a test case. This led to LARM (Laterally Average of Reservoir Model) and its subsequent second generations, i.e., Son of LARM and LARM-Mark A as well as other variations (Buchak and Edinger, 1979).

Again, there were lessons learned. We feel it essential to make these points to those involved in application of multi-dimensional models. First and foremost, be aware of the state-of-the-art. It makes no sense to pay a contractor or a laboratory to reinvent their own, or someone else's, wheel. Second, have an understanding of the various computational procedures, or make an

¹Ohio River Division, Corps of Engineers, P.O. Box 1159, Cincinnati, OH 45201

extra effort to obtain an unbiased opinion, to insure your objective will be achieved in the most cost effective manner. The different solution techniques have their advantages and disadvantages. Determine which is most applicable to the immediate problem. Don't be overwhelmed with "super models." For some problems, the programmable desk calculator models are appropriate. Make the modeler talk your language. Mathematical and computer science jargon is an ego characteristic of some modelers. If they can't explain their needs, procedures, and results in terms that are clear and precise to you, take your modeling dollars elsewhere.

REFERENCES

- Buchak, Edward M. and John Eric Edinger, (June 1979), "A Hydrodynamic, Two-Dimensional Reservoir Model: The User Guide," report prepared for U.S. Army Engineer Division, Ohio River, Cincinnati, Ohio, by J. E. Edinger Associates, Inc., Wayne, PA.
- Hydrologic Engineering Center, (October 1979), Water Quality for River-Reservoir Systems, Hydrologic Engineering Center, Davis, CA.
- U.S. Army Engineer District, Baltimore, (November 1977), Thermal Simulation of Lakes, Users Manual, Distributed by the Hydrologic Engineering Center, Davis, CA.

PAPER DISCUSSION

THE OHIO RIVER DIVISION'S EXPERIENCE
WITH TWO-DIMENSIONAL FLOW MODELING

by
Glenn Drummond

Comment: Bob Shubinski: The questions you have raised here are very valid descriptions of the gap that exists between practical application and model development. Duplications in the model development area is not only something that comes along with it but it's the only way progress gets made, because when you are engaged in model development you simply can't assign responsibility and say you go solve this problem and you go solve that problem. Because the field doesn't work that way. Progress is made by people trying to do the same thing and some people getting things to work and others not getting them to work. But that also creates an impediment because it looks confusing to the guys on the end asking the questions "how do I apply this to my problems?". And I suspect that the problem was you're not as interested in how things work as the fact that they did. It's difficult for the guy on the other end to understand the problem of the model because he tends to interpret questions about the model operation in terms of what I want to know is will it work for my problem? Quite recently we end up in conversations talking at two different levels.

Comment: Glenn Drummond: Another problem I feel is that there is a gap between the technological producer of the codes and the actual user of the codes in the field offices, and that gap is going to increase and I don't really have a good answer for how we can help solve that problem--that is a real dilemma for me.

Comment: Ian King: In terms of applications we have to separate when we have confidence in the model and when we have to go back and retest it. We also need to say how many models we are going to allow to compete within the Corps to do roughly the same job. This is very difficult.

Discussion went on about the problems between the communications gap between the model developers, the universities and the Government funding agencies. The discussion included questions and suggestions with respect to the difficulties in actually identifying the problems that one wishes to solve and the difficulties that turn up with respect

to the funding agencies actually asking or posing the problem in the proper sense so that they get solutions to problems they really want to solve. In a lot of situations, the question is posed before the problem is really understood and therefore, the answer that you get might not be what you really wanted in the long run. This concluded the discussion for Glenn Drummond's presentation.