



**US Army Corps
of Engineers**

Hydrologic Engineering Center

Phase 1 Oconee Basin Pilot Study Trail Creek Test

An Investigation of Concepts and Methods for
Broadened Scope Flood Plain Information Studies

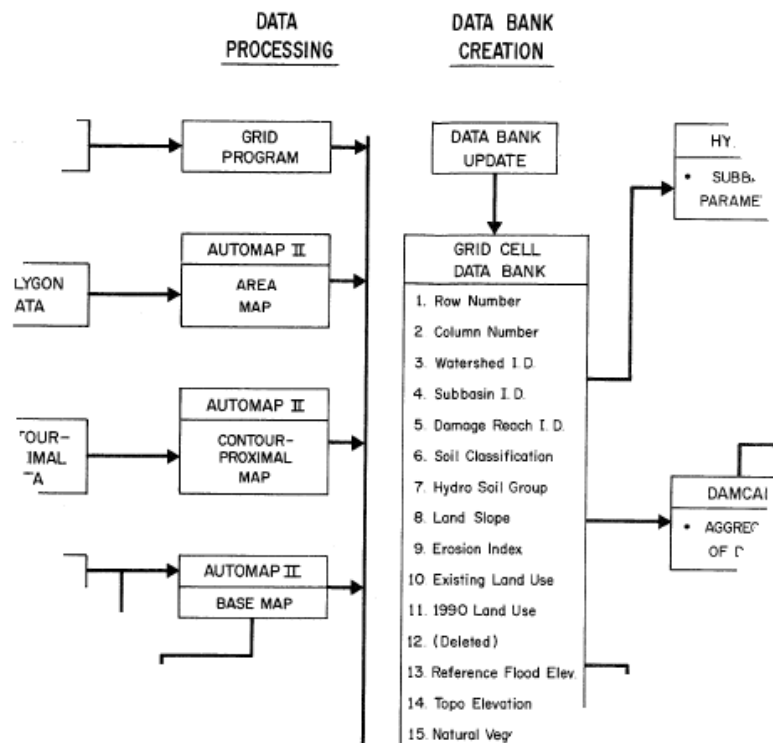

September 1975

Revised: March 1978

REPORT DOCUMENTATION PAGE

Form Approved OMB No. 0704-0188

The public reporting burden for this collection of information is estimated to average 1 hour per response, including the time for reviewing instructions, searching existing data sources, gathering and maintaining the data needed, and completing and reviewing the collection of information. Send comments regarding this burden estimate or any other aspect of this collection of information, including suggestions for reducing this burden, to the Department of Defense, Executive Services and Communications Directorate (0704-0188). Respondents should be aware that notwithstanding any other provision of law, no person shall be subject to any penalty for failing to comply with a collection of information if it does not display a currently valid OMB control number.

PLEASE DO NOT RETURN YOUR FORM TO THE ABOVE ORGANIZATION.

| | | | | | |
|--|-------------------------|---|---|-------------------------------------|--|
| 1. REPORT DATE (DD-MM-YYYY) September 1975 revised: March 1978 | | 2. REPORT TYPE Project Report | | 3. DATES COVERED (From - To) | |
| 4. TITLE AND SUBTITLE Phase 1 Oconee Basin Pilot Study Trail Creek Test An Investigation of Concepts and Methods for Broadened Scope Flood Plain Information Studies | | | 5a. CONTRACT NUMBER | | |
| | | | 5b. GRANT NUMBER | | |
| | | | 5c. PROGRAM ELEMENT NUMBER | | |
| | | | 5d. PROJECT NUMBER | | |
| 6. AUTHOR(S) Michael W. Burnham, R. Pat Webb | | | 5e. TASK NUMBER | | |
| | | | 5f. WORK UNIT NUMBER | | |
| | | | | | |
| 7. PERFORMING ORGANIZATION NAME(S) AND ADDRESS(ES) US Army Corps of Engineers Institute for Water Resources Hydrologic Engineering Center (HEC) 609 Second Street Davis, CA 95616-4687 | | | 8. PERFORMING ORGANIZATION REPORT NUMBER PR-1 | | |
| 9. SPONSORING/MONITORING AGENCY NAME(S) AND ADDRESS(ES) US Army Corps of Engineers Savannah District PO Box 889 Savannah, GA 31402-0889 | | | 10. SPONSOR/ MONITOR'S ACRONYM(S) | | |
| | | | 11. SPONSOR/ MONITOR'S REPORT NUMBER(S) | | |
| 12. DISTRIBUTION / AVAILABILITY STATEMENT Approved for public release; distribution is unlimited. | | | | | |
| 13. SUPPLEMENTARY NOTES | | | | | |
| 14. ABSTRACT Spatial data management techniques are fast becoming an accepted way of managing data in Expanded Flood Plain Information (XFPI), Survey and General Design Memorandum (GDM) studies of the Corps. This project report documents the basic aspects of the methodology developed in the test application study so that the techniques could easily be transferred to Corps personnel involved in XFPI studies. | | | | | |
| 15. SUBJECT TERMS pilot study, Oconee Basin, Trail Creek, flood plain information studies, spatial, data management, Expanded Flood Plain Information, XFPI, Survey and General Design Memorandum, GDM, studies, analytic, hydrologic, parameters, elevation-damage functions, HEC-1, structural, nonstructural, alternatives, choropleth, land use, categories, flood hazard, mapping, economic, damage reaches, reference flood, composite damage functions, aggregate damage functions, environmental, assessment, coincidental tabulation, water quality, urban storm runoff, sedimentation, land erosion, data encoding, data bank, data registration | | | | | |
| 16. SECURITY CLASSIFICATION OF: | | | 17. LIMITATION OF ABSTRACT UU | 18. NUMBER OF PAGES 128 | 19a. NAME OF RESPONSIBLE PERSON |
| a. REPORT U | b. ABSTRACT U | c. THIS PAGE U | | | 19b. TELEPHONE NUMBER |

Phase 1 Oconee Basin Pilot Study Trail Creek Test

An Investigation of Concepts and Methods for Broadened
Scope Flood Plain Information Studies

September 1975

Revised: March 1978

Prepared for:
US Army Corps of Engineers
Savannah District
PO Box 889
Savannah, GA 31402-0889

Prepared by:
US Army Corps of Engineers
Institute for Water Resources
Hydrologic Engineering Center
609 Second Street
Davis, CA 95616

(530) 756-1104

(530) 756-8250 FAX

www.hec.usace.army.mil

PR-1

FOREWORD

Spatial data management techniques are fast becoming an accepted way of managing data in Expanded Flood Plain Information (XFPI), Survey and General Design Memorandum (GDM) studies of the Corps. This report documents the basic aspects of the methodology developed by the Hydrologic Engineering Center in September 1975, for the initial test application of the technology to an XFPI study. Since this report was first published, significant advances have been made in the analytic and display capabilities of the programs. Examples of these advances are: 1) The ability to automatically interface the hydrologic parameters and the elevation-damage functions (derived directly from the spatial data files) with the HEC-1 simulation program, 2) the ability to easily evaluate structural and nonstructural alternatives and 3) the ability to use plotter graphics for choropleth, three dimensional and color display techniques. These advances have occurred because the technology is continually being improved and expanded by the Corps, universities, other government agencies and private industry.

This report was originally published to document the methodology developed in the test application study so that the techniques could easily be transferred to Corps personnel involved in XFPI studies, and so that other Corps elements could be informed of an emerging technology which has potential use in their areas of responsibility. The major thrust of the report has since been confirmed by further testing in Corps studies throughout the country. This report has been reprinted to help meet the continuing demand for information about spatial data management techniques from the Corps field offices, universities and private industry.

The Hydrologic Engineering Center
January 1978

TABLE OF CONTENTS

| Chapter | | Page |
|---------|---|-------|
| | FOREWORD | i |
| I | INTRODUCTION | I-1 |
| | General Scope | I-1 |
| | Acknowledgements | I-1 |
| II | GENERAL OVERVIEW | II-1 |
| | Oconee Pilot Study Objectives | II-1 |
| | Analysis Concepts | II-1 |
| | Data Management Process | II-2 |
| | Interactive Modeling | II-3 |
| | Example Applications | II-3 |
| III | LAND USE | III-1 |
| | General Study Focus | III-1 |
| | Land Use Categories | III-1 |
| | Development of Land Use Data | III-3 |
| | Trail Creek Land Use Data | III-3 |
| IV | FLOOD HAZARD EVALUATION | IV-1 |
| | General Approach | IV-1 |
| | Hydrologic Studies | IV-1 |
| | Flooded Area Mapping | IV-2 |
| | Trail Creek Test Application | IV-3 |
| V | ECONOMIC ANALYSIS | V-1 |
| | General Approach | V-1 |
| | Damage Function Development | V-1 |
| | Damage Reaches | V-1 |
| | Reference Flood | V-2 |
| | Composite Damage Functions | V-3 |
| | Aggregate Damage Functions | V-6 |
| | Land Use Pattern Damage Assessments | V-8 |
| VI | ENVIRONMENTAL ASSESSMENT | VI-1 |
| | General Scope and Approach | VI-1 |
| | Coincidental Tabulation | VI-1 |
| | Locational Attractiveness | VI-2 |
| | Water Quality | VI-3 |
| | Urban Storm Runoff | VI-3 |
| | In-Stream Quality | VI-4 |
| | Land Erosion and Sedimentation | VI-4 |
| VII | DATA MANAGEMENT AND PROCESSING | VII-1 |
| | Data Management Components | VII-1 |
| | Data Assembly | VII-1 |
| | Data Types | VII-1 |
| | Sources of Data | VII-2 |

TABLE OF CONTENTS (Cont'd)

| Chapter | Page |
|---|------------|
| Preparing Data for Encoding | VII-2 |
| Data Encoding | VII-3 |
| Data Processing | VII-4 |
| Data Editing | VII-4 |
| Preprocessing | VII-4 |
| Data Registration | VII-5 |
| Data Bank | VII-6 |
| Data Bank Creation | VII-6 |
| Data Bank Update | VII-6 |
| Utility Processing and Interactive Modeling | VII-6 |
| VIII ASSESSMENT OF TRAIL CREEK TEST | VIII-1 |
| Summary | VIII-1 |
| Assessment | VIII-1 |
| Concluding Comments and Recommendations | VIII-2 |

LIST OF FIGURES

| Figure Number | Following Page |
|---|----------------|
| II-1 DATA PROCESSING AND ANALYSIS PROCEDURE | II-1 |
| III-1 EXISTING LAND USE PATTERN | III-4 |
| III-2 1990 ALTERNATIVE LAND USE PATTERN | III-4 |
| IV-1 FLOOD HAZARD EVALUATION PROCEDURE | IV-1 |
| IV-2 HYDROLOGIC PARAMETER COMPUTATION | IV-2 |
| IV-3 TRAIL CREEK SUBBASINS | IV-3 |
| IV-4 HYDROLOGIC SOIL GROUPS | IV-4 |
| IV-5 LAND SURFACE SLOPES | IV-4 |
| IV-6 HYDROLOGIC PARAMETERS - EXISTING LAND USE | IV-4 |
| IV-7 HYDROLOGIC PARAMETERS - 1990 LAND USE | IV-4 |
| IV-8 DISCHARGE FREQUENCY CURVES, INDEX STATION 1 | IV-5 |
| V-1 ECONOMIC EVALUATION PROCEDURE | V-1 |
| V-2 DAMAGE FUNCTION DEVELOPMENT | V-1 |
| V-3 TRAIL CREEK DAMAGE REACHES | V-2 |
| V-4 REFERENCE FLOOD | V-2 |
| VI-1 ENVIRONMENTAL ASSESSMENT PROCEDURE | VI-1 |
| VI-2 LAND USE COINCIDENTS | VI-1 |
| VI-3 NEIGHBORHOOD PARKS LOCATIONAL ATTRACTIVENESS | VI-3 |
| VI-4 TRAIL CREEK STORM POLLUTOGRAPHS | VI-3 |
| VI-5 LAND SURFACE EROSION POTENTIAL - EXISTING LAND USE | VI-4 |
| VI-6 LAND SURFACE EROSION POTENTIAL - 1990 LAND USE | VI-4 |
| VII-1 DATA MANAGEMENT AND MODELING PROCESS | VII-1 |
| VII-2 ALTERNATIVE ENCODING CONCEPTS | VII-3 |
| VII-3 SOURCES OF REGISTRATION ERROR | VII-5 |

APPENDIX FIGURES

Figure Number

- A-1 TRAIL CREEK WATERSHED (VAR 3)
- A-2 TRAIL CREEK SUBBASINS (VAR 4)
- A-3 TRAIL CREEK DAMAGE REACHES (VAR 5)
- A-4 TRAIL CREEK SOIL CLASSIFICATIONS (VAR 6)
- A-5 TRAIL CREEK HYDROLOGIC SOIL GROUPS (VAR 7)
- A-6 TRAIL CREEK LAND SURFACE SLOPES (VAR 8)
- A-7 TRAIL CREEK EROSION INDEX (VAR 9)
- A-8 TRAIL CREEK EXISTING LAND USE PATTERN (VAR 10)
- A-9 TRAIL CREEK 1990 ALTERNATIVE LAND USE PATTERN (VAR 11)
- A-10 TRAIL CREEK REFERENCE FLOOD (VAR 13)
- A-11 TRAIL CREEK TOPOGRAPHY (VAR 14)

- APPENDIX C BOUND SEPARATELY

- D-1 TRAIL CREEK LOCATION
- D-2 SCS LOSS FUNCTION
- D-3 SCS DIMENSIONLESS UNIT HYDROGRAPH
- D-4 AUTHORIZED SCS RESERVOIR LOCATIONS

- E-1 AGGREGATE DAMAGE FUNCTION - EXISTING LAND USE
- E-2 AGGREGATE DAMAGE FUNCTION - 1990 LAND USE
- E-3 AGGREGATE DAMAGE FUNCTION - 1990 UNCONTROLLED LAND USE

LIST OF TABLES

| Table Number | | Page |
|---------------------|---|-------------|
| III-2 | ADOPTED LAND USE CATEGORIES, TRAIL CREEK | III-2 |
| IV-1 | RUNOFF RELATION SUMMARY | IV-4 |
| IV-2 | HYDROLOGIC DATA SUMMARY | IV-5 |
| V-1 | COMPOSITE DAMAGE FUNCTIONS | V-4 |
| V-2 | AGGREGATE DAMAGE FUNCTIONS - INDEX STATION 1..... | V-7 |
| V-3 | DAMAGE EVALUATIONS..... | V-9 |

APPENDIX TABLES

- A-1 DATA BANK VARIABLES LEGEND

APPENDICES

Appendix

- A GRID DATA FILE COMPUTER-PRINTER PLOTS
- B COMPUTER SOFTWARE SUMMARY
- C TRAINING WORKSHOP PROBLEM (Bound Separately)
- D FLOOD HAZARD EVALUATION
- E AGGREGATE DAMAGE FUNCTIONS
- F REFERENCES

CHAPTER I

INTRODUCTION

General Scope

Data management and analytical techniques have been developed by the Hydrologic Engineering Center for application in comprehensive flood plain information studies. The techniques make extensive use of gridded geographic data files and emphasize consistent comprehensive assessments of the effects of alternative land use patterns on the flood hazard, general damage potential, and environmental status of the detailed study areas. The techniques were developed for a pilot flood plain information study that is being conducted by the Savannah District, Corps of Engineers. This report describes and illustrates the application of the techniques on Trail Creek, a 12 square mile test basin in the Phase I, Oconee River Basin pilot study area that is located in Athens and Clarke County, Georgia. The techniques are being applied to those areas where land use projections indicate significant future development may occur. Reference (1)* defines the scope of the pilot study and outlines the detailed study areas.

This report focuses upon techniques and their applications rather than the specific development of the flood plain information. A variety of computer generated graphics will be found throughout the report. It is not intended that the computer graphics necessarily constitute the final form for reporting results of studies but instead illustrate the range of possible display types that may be appropriate for selected aspects of the studies. The report also includes a detailed discussion of data management, the key to the successful application of the techniques and assesses the degree to which the technical objective of the investigation is accomplished.

Acknowledgements

The investigation was undertaken by the Hydrologic Engineering Center (HEC) at the request of the Savannah District, Corps of Engineers. The project was performed under the direction of Darryl W. Davis, Chief, Planning Analysis Branch, by Michael Burnham and R. Pat Webb of the Planning Analysis Branch, and assisted by Dale Burnett, Chief Special Assistance Branch and Jess Abbott, Research Branch. Roger Nutter prepared the figures for the report. Mr. Bill S. Eichert was Director of HEC during the conduct of the study.

The keen interest and encouragement of the Savannah District and South Atlantic Division Flood Plain Management personnel was instrumental in the success of the project. The pioneering work in development and use of automated geographic data files of the Graduate School of Design, Department of Landscape Architecture, Harvard University provided the foundation for the techniques that were developed. The computer software AUTOMAP II that was used for manipulating the polygon data was acquired by HEC from Environmental Systems Research Institute, Redlands, California, Jack Dangermond Director. The capabilities of AUTOMAP II are a key ingredient in the techniques developed.

*References as listed in Appendix F, REFERENCES

CHAPTER II GENERAL OVERVIEW

Oconee Pilot Study Objectives

The objectives of the Phase I Oconee Basin Flood Plain Information pilot study include: (1) a critical examination of the concept of a broadened perspective of flood plain information (FPI), (2) a test of the capability for development of comprehensive analysis procedures, and (3) an assessment of the planning utility of the broadened FPI study as a framework for continued use by local planning agencies. This report concentrates primarily on objective (2). The general concept embodied in the pilot study is to develop flood plain information for existing and selected alternative future land use patterns and to provide carry-on capability to perform special investigations as needs arise. *Flood Plain Information* is broadened from hydrologic flood hazard, as normally developed in the past, to also include flood damage and environmental information. The significant points of departure that the analysis concepts were designed to be responsive to include:

- Broadened information perspective for existing conditions
 - hydrologic, hydraulic flood hazard
 - general damage potential
 - environmental status
- Information development for alternative futures
 - selected future alternative land use patterns
 - assessment of specific proposals

Analysis Concepts

The analysis concepts are designed to make use of traditional methods where possible and provided for automation of analysis and displays where appropriate, while providing the capability of performing consistent analysis over a very broad range of detail. For instance, an agency might wish a general assessment of the entire Trail Creek watershed for an alternative land use pattern, and desire the analysis to be performed with a minimum of prior data preparation, i.e., essentially only have available the land use pattern. On the other hand, an agency may wish a specific assessment of an area of a tributary to Trail Creek where a 300-acre shopping center with attendant surface drainage works, such as channel straightening and lining and detention storage, are proposed. These extreme levels of detail are accommodated by providing the capability of automated computer analysis that can be interrupted at a number of stages during the computations and more detailed, specifically tailored data substituted for the computer generated data. The general approach to the analysis is shown in Fig. II-1 DATA PROCESSING AND ANALYSIS PROCEDURE.

The analysis methodologies developed center on integrated use of spatial, gridded geographic data files. Data such as land use, topography, soil classification, and watershed units are coded into computerized data files. Utility computer programs then access those

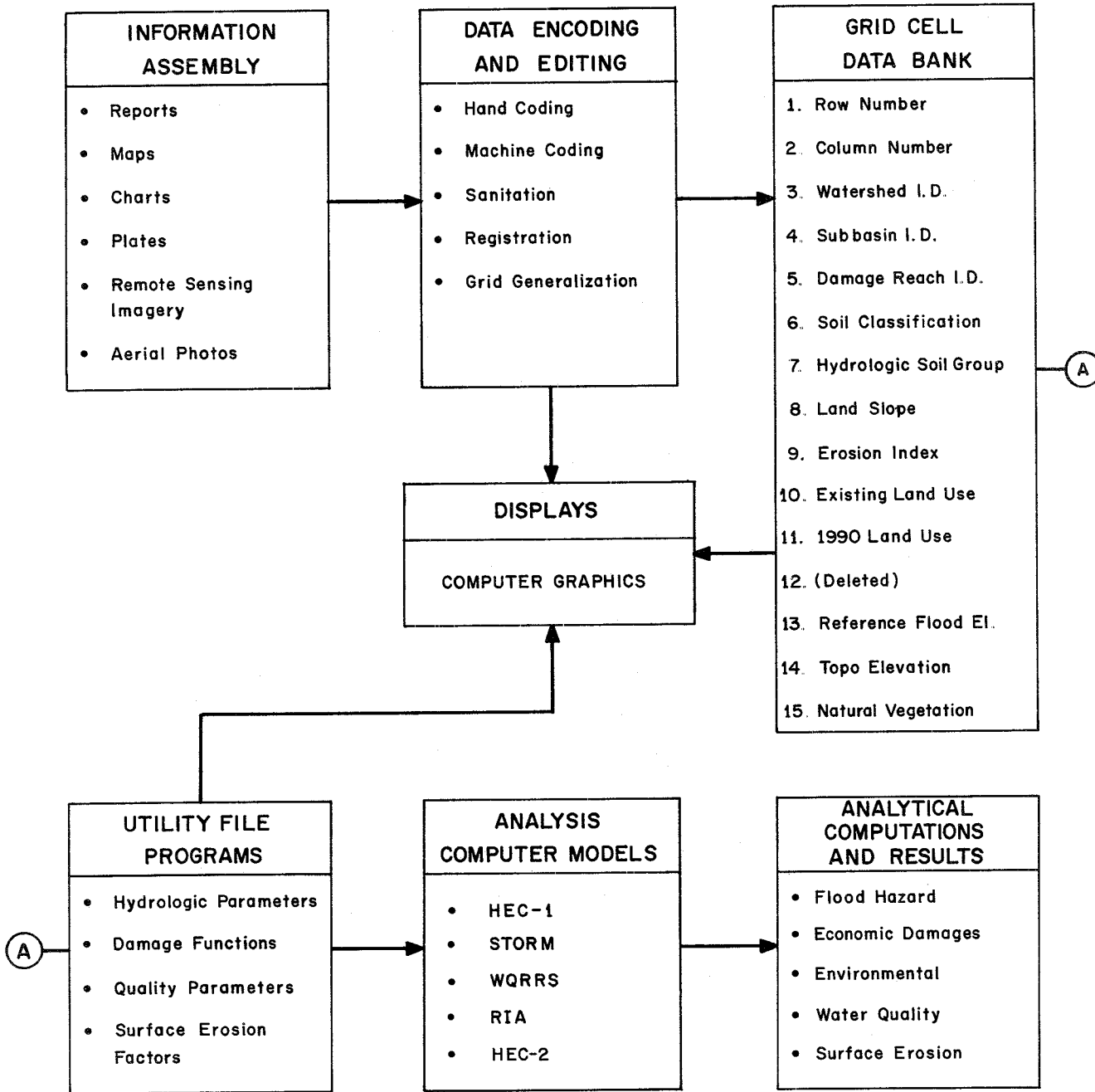

DATA PROCESSING AND ANALYSIS PROCEDURE

Figure II-1

files, coordinate and interpret the data into specific analytical parameters that are subsequently formatted for use by the modeling computer programs. The utility and modeling programs perform the computations and analysis and return certain types of data to the files for either display or further use.

The justifications for managing a significant part of the study data with a spatial gridded data file system are that:

- It provides a central, coordinated data set that will encourage consistent analysis in each functional area
- It enables consistent and expedient assessments of the effects of alternative land use patterns
- It provides for flexibility in the scope and detail of analysis that may be performed
- It provides a permanent data set that may serve as documentation or as a foundation for future studies

The capability was developed that permits access to the data files and provides for semi-automated assessments of:

- Alternative future land use patterns
 - Evaluations based on sequential time periods; say, ten-year interval projections from existing conditions to the desired future period condition
 - Sensitivity assessments of the effects of future watershed development for a given time period; say 1990, by analysis of several possible alternative future land use conditions for the desired period
- Specific location modifications of land use or system physical configuration
 - Assessments of land development on the watershed; shopping centers, new industries, commercial, or residential development
 - Evaluations of modifications within the flood plain, flood plain fills, reservoirs, channel improvements etc

Data Management Process

The data management process consists of assembling the necessary information (land use, drainage basin boundaries, topography, etc.), encoding the information into a spatial gridded form, and registering (to assure proper cell overlays) the data to a selected base condition coordinate system. Once the data is registered, it is placed into a grid cell data bank. Utility file programs access selected data sets from the data bank and output either analytical results or formatted input data used by computer modeling programs.

Computerized geographic data files consist of numeric records that reference location and characteristics of features of the landscape that have spatial variation. An example would be a computer file of the (x,y) coordinates of the boundaries of each of the selected land use types for the Trail Creek watershed. The entire area within a boundary then represents the specific land use and could be subdivided into any selected grid for use in further processing. The cataloging of data into files using the convention of x, y

coordinates of the bounded areas is referred to as the *polygon* system and is the primary method adopted for the Trail Creek pilot FPI study. The grid representation (the total study area is represented by a uniform network of small grid cells) is subsequently generated from the polygon representation as required for computer processing.

Because of the size of the Phase I Oconee Basin pilot study area (1700 square miles total of which 200 square miles will be studied in detail) and the grid scale that seems needed for good resolution for damage analysis and flooded area calculations (about 1.5 acres, or less), it is obvious that efficient overall data management is essential to the investigation. In order to work with manageable sized units during the encoding process, the pilot study area will be subdivided into smaller units then aggregated. A typical example of a smaller unit is the Trail Creek watershed, about 12 square miles in size.

A grid cell data bank has been constructed by HEC for the Trail Creek test area. The data bank consists of a complete 1.5 acre grid of the variables listed in *Grid Cell Data Bank* shown on FIG. II-1. Appendix A contains computer-printer plots of the data variables shown in FIG. II-1. Other variables may be added to the data bank for the Phase I Oconee Basin pilot study (or other studies) so that these should be considered the essential minimum data bank set.

Interactive Modeling

Upon completion, the data bank (or processed derivatives of it) is available for input into computer models that make use, to the extent possible, of traditional concepts of analysis. The family of data management and utility computer programs and modeling and analysis programs that comprise the operational form of the techniques developed are briefly described in Appendix B.

Flood Hazard evaluations will be made by a modified version of the computer program HEC-1 (2) that operates with parameters developed from the grid data file, and either the HEC-2 program (3) (the traditional situation) or a simplified automated flooded area computer program that has been developed.

General damage potential analysis will consist of 1) a delineation of land use, 2) single flood event damage computations, and 3) the computation of expected annual damages. Items 2) and 3) will be determined by automated analysis of land use and topographic data from the grid file and other data developed during analysis.

The environmental status assessment will consist of tabulating land use/habitat coincidents and specific activity locational attractiveness using the gridded data. Stream water quality and land surface erosion analysis will also be made using the STORM (4) and WQRRS (5) computer programs with certain parameters and information developed from the gridded data.

Example Application

The evaluations illustrated in the report are for the following conditions:

- Existing (1975) land use and existing water management facilities

- Existing (1975) land use and existing water management facilities plus certain authorized U.S. Soil Conservation Service reservoirs expected to be in operation soon
- An alternative future (1990) land use pattern and existing (1975) water management facilities
- An alternative future (1990) land use pattern and existing water management facilities plus certain SCS reservoirs

In addition, a problem developed for a workshop devoted to the techniques described herein is contained in Appendix C (bound separately). The workshop problem required essentially the complete evaluation of a hypothetical proposed planned unit development that would be located partially within the Trail Creek basin.

CHAPTER III

LAND USE

General Study Focus

Land use is the key factor used in performing the analysis in that it is used as the primary indicator of the existing and alternative future watershed conditions. The analysis methods, therefore, interpret the hydrologic, economic, and environmental consequences of alternative land use patterns in combination with other physical characteristics of the watershed. The specific methods used to interpret the consequences are discussed in later chapters. The definitions of categories and the important aspects of land use data development are discussed below.

Land Use Categories

Because land use is such an important focal point for much of the analysis, the development and use of a reasonable set of land use categories received special attention. The criteria applied to determine a rational set of land use categories included the following:

- The categories should be reasonably compatible with local and other agency land use classification schemes
- It must be reasonably possible to classify the land use within the study area by conventional or automated means
- The land use categories should allow rational, consistent determination of flood hazard, economic and environmental effects of land use change
- The land use categories should be compatible with those needed by certain available computer models
- The land use categories should provide a complete umbrella of classifications so that further breakdown of land use within each category would be possible if deemed necessary in future studies

The land use categories adopted for this study were eventually derived as a compromise between the technical requirements needed to be responsive to hydrologic, economic, and environmental analysis, and the other above criteria. For instance, from the hydrologic viewpoint, the concern in a land use sense is with moisture retention/precipitation excess and basin response characteristics which are related to impervious cover and land surface management measures. From the economic viewpoint the damage potential and disruption of community activities is a function of urban development in general and the size, density, and type of structures and contents. From the environmental viewpoint, the concern is mostly with the intensity of development and the potential for adverse impacts (such as pollution) that could derive therefrom.

Table III-1 ADOPTED LAND USE CATEGORIES, TRAIL CREEK describes the characteristics of each of the 10 categories adopted for test studies.

TABLE III-1
ADOPTED LAND USE CATEGORIES TRAIL CREEK

- 1. NATURAL VEGETATION**
Heavy weeds, brush, scrub areas, forest, woods
- 2. DEVELOPED OPEN SPACE**
Lawns, parks, golf courses, cemeteries
- 3. LOW DENSITY RESIDENTIAL**
Single Family: 1 unit per 1/2 to 3 acres; average 1 unit per 1-1/2 acres. *Areal Breakdown:* 5% structures; 10% pavement; 50% lawns; 37% vegetation. Proportion developed = 60%
- 4. MEDIUM DENSITY RESIDENTIAL**
Single Family: typical subdivision lots; 1 unit per 1/5 to 1/2 acres; average 1 unit per 1/3 acre. *Areal Breakdown:* 10% structure, 15% pavement, 45% lawns, 30% vegetation. Proportion developed = 70%
- 5. HIGH DENSITY RESIDENTIAL**
Multi-Family: row houses, apartments, townhouses, etc; structures on less than 1/5 acre lots; average 1 unit per 1/8 per acre. *Areal Breakdown:* 25% structures; 15% pavement; 35% lawns; 25% vegetation. Proportion developed = 100%
- 6. AGRICULTURAL**
Cultivated land, row crops, small grain, etc.
- 7. INDUSTRIAL**
Industrial centers and parks, light and heavy industry. Average 1 plant per 8 acres *Areal Breakdown:* 20% pavement, 50% structures, 30% open space. Proportion developed = 100%
- 8. COMMERCIAL**
Shopping centers and "strip" commercial areas. Average 3 structures per acre. *Areal Breakdown:* Structures 30%, lawns 5%, vegetation 10%, pavement 55%. Proportion developed = 80%
- 9. PASTURE**
Livestock grazing areas, ranges, meadows, agricultural open areas, abandoned crop land
- 10. WATER BODIES**
Lakes, large ponds, major streams, rivers

Development of Land Use Data

The procedure for developing the necessary land use data deserves special attention because of the necessity for consistency and rationality between present and future land use patterns. Inconsistencies in land use changes over time become glaringly (and perhaps embarrassingly) obvious to even the casual reviewer of the output resulting from application of the techniques developed. The consequences of inconsistencies will be pointed out as they arise later in this report. The type of inconsistency that is referred to is, for example, the conversion of industrial and commercial areas under existing conditions, to natural vegetation and pasture under an assumed future. Justification of this situation would require considerable explanation.

The most reasonable approach appears to be to develop and adopt, after considerable review and scrutiny by the study group and local agency representatives, the *existing conditions* land use pattern. This should then be used as the base from which any alternative future pattern is developed. The existing conditions land use pattern should be developed from a combination of local agency maps, aerial photo interpretation, field survey data, and perhaps interpretation of remote sensing data such as ERTS (currently known as LANDSAT). The information from all these sources should be transferred to a good quality base map that has been selected as the common base for the study. The *classification* accuracy or probably more accurately *the level of detail of classification* should be determined at this stage and documented. Obviously some categories, such as residential, commercial, and industrial uses will have varying amounts of vacant or undeveloped areas and this data will be essential at later stages of analysis. For example, for each category of land use, the average number of structures per acre and the average percent area that is structures, streets, vacant lots, etc., needs to be determined.

Ideally, the alternative future land use patterns should be available from local planning agencies and would be used for analysis after checking for consistency with the *existing conditions* land use pattern and resolution of any apparent conflicts. Realistically, however, in the general case, local agency future land use patterns will be—*being updated—under development—etc.*, and most likely what will be available are zoning maps that outline potential future land use areas to which expected (or proposed) activities must be allocated. The allocation spatially within the watershed area must be rational (consistent with zoning and projections) and reasonable from local agency and Corps viewpoints and, importantly, consistent with the existing land use pattern.

This discussion may appear to be belaboring the point but in the absence of sound classification of existing land use and development of consistent, rational, alternative future land use patterns, the application of the analysis techniques developed and reported herein would not be useful.

Trail Creek Land Use Data

Land use data for existing conditions for Trail Creek were developed by combined use of local agency data (Athens-Clarke County Planning Commission), aerial photo interpretation, and field surveys. The alternative future 1990 land use pattern was developed

by allocating projected population and manufacturing, converted to land use unit equivalents, to available areas as defined on zoning maps. The land use maps were constructed at a level of detail of 4-10 acre land use category polygons within the critical flood plain area and 10-50 acre polygons for the remainder of the watershed.

The land use data was developed by Savannah District personnel with assistance from the Athens-Clarke County Planning Commission. Fig. III-1 EXISTING LAND USE PATTERN is a computer-printer plot of the Trail Creek existing 1975 land use and similarly, Fig. III-2 1990 ALTERNATIVE LAND USE PATTERN is an alternative future 1990 projected land use pattern.

SPUR (ZONE PLAT #) 1
 MAIL CENTER AREA 2
 EXISTING LAND USE

RAW VALUE EXTREMES ARE 1,400 16,400

| LEVEL | SYMBOL | RAW VALUE RANGE | PERCENT VALUE RANGE | PERCENTILE OF RANGE | PERCENT OF AREA |
|-------|---------|-----------------|---------------------|---------------------|-----------------|
| 1 | 1111111 | 1,400 16,400 | 75 | 46.38 | 46.38 |
| 2 | 2222222 | 1,400 16,400 | 5 | 46.38 | 1.76 |
| 3 | 3333333 | 1,400 16,400 | 13 | 46.38 | 7.69 |
| 4 | 4444444 | 1,400 16,400 | 18 | 46.38 | 13.65 |
| 5 | 5555555 | 1,400 16,400 | 37 | 46.38 | 28.99 |
| 6 | 6666666 | 1,400 16,400 | 48 | 46.38 | 37.16 |
| 7 | 7777777 | 1,400 16,400 | 54 | 46.38 | 42.86 |
| 8 | 8888888 | 1,400 16,400 | 64 | 46.38 | 50.00 |
| 9 | 9999999 | 1,400 16,400 | 73 | 46.38 | 56.99 |
| 10 | 0000000 | 1,400 16,400 | 78 | 46.38 | 61.99 |

NATURAL VEGETATION

DEVELOPED OPEN SPACE

LOW DENSITY RESIDENTIAL

MEDIUM DENSITY RESIDENTIAL

HIGH DENSITY RESIDENTIAL

INDUSTRIAL

COMMERCIAL

PAVEMENT

WATER BODIES

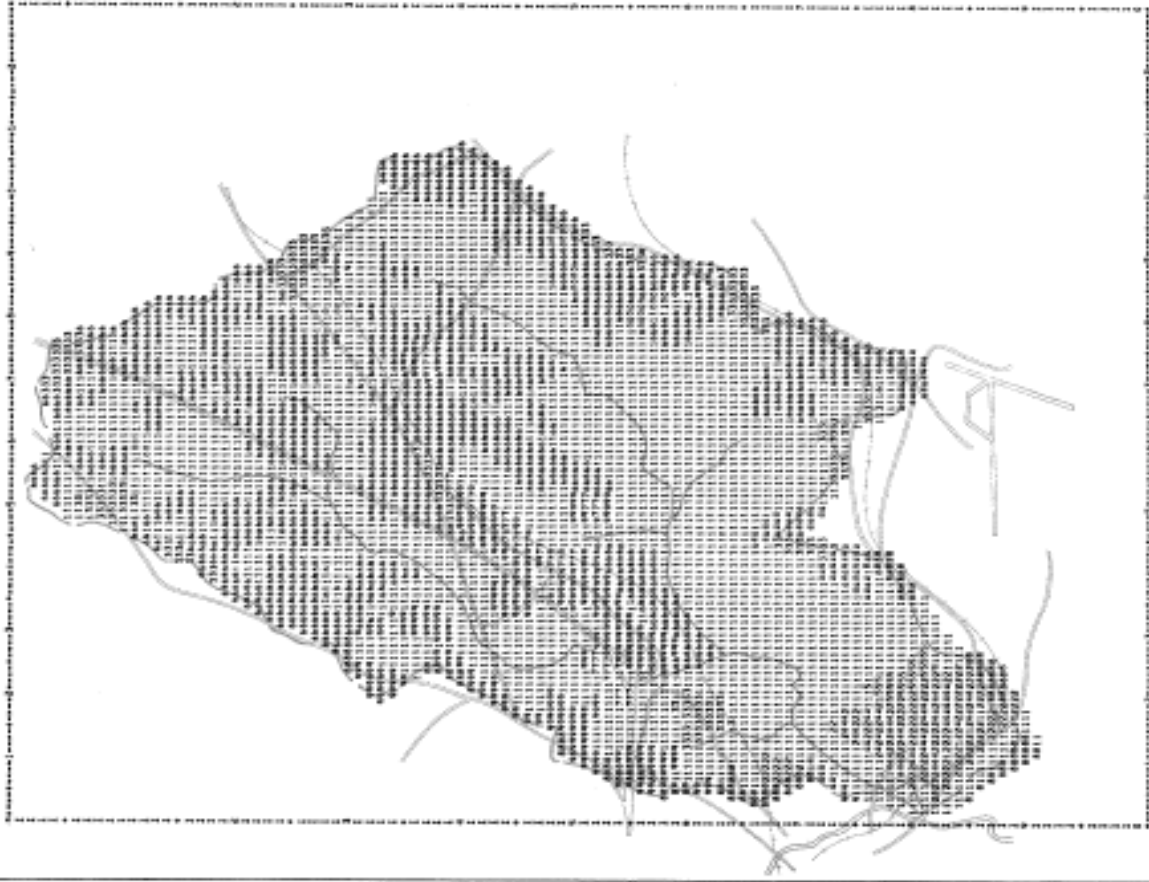

EXISTING LAND USE PATTERN

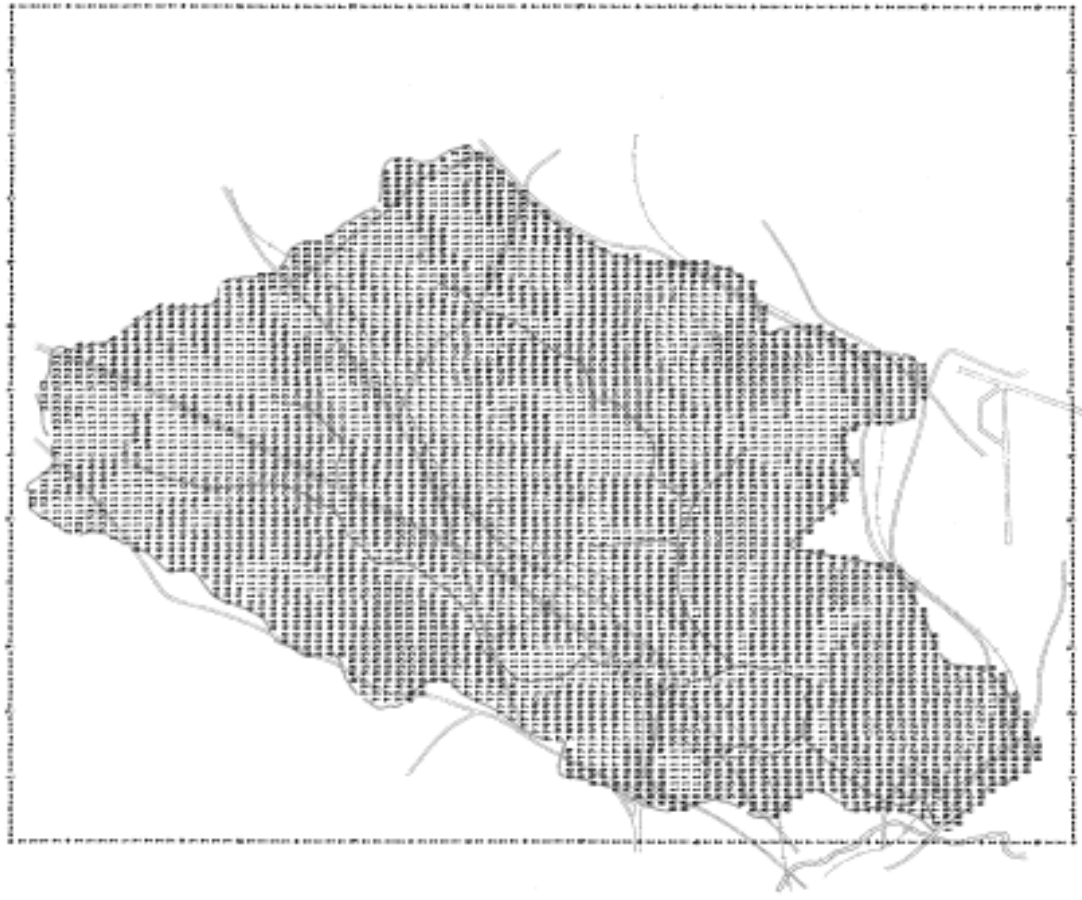

WELL DEVELOPMENT AND BRUSH
1990 ALTERNATIVE LAND USE PATTERN

SUM TOTAL EXTENDED USE 1,000 17,000

| LAND CLASS | AREA SQ. FT. | PERCENT OF TOTAL AREA | PERCENT OF TOTAL AREA | PERCENT OF TOTAL AREA | PERCENT OF TOTAL AREA |
|---------------|-----------------|-----------------------------|-----------------------------|-----------------------------|-----------------------------|
| 1 | 1111111 | 1,000 | 16.67 | 16.7 | 16.7 |
| 2 | 2222222 | 1,000 | 16.67 | 16.7 | 16.7 |
| 3 | 3333333 | 1,000 | 16.67 | 16.7 | 16.7 |
| 4 | 4444444 | 1,000 | 16.67 | 16.7 | 16.7 |
| 5 | 5555555 | 1,000 | 16.67 | 16.7 | 16.7 |
| 6 | 6666666 | 1,000 | 16.67 | 16.7 | 16.7 |
| 7 | 7777777 | 1,000 | 16.67 | 16.7 | 16.7 |
| 8 | 8888888 | 1,000 | 16.67 | 16.7 | 16.7 |
| 9 | 9999999 | 1,000 | 16.67 | 16.7 | 16.7 |
| 10 | 1010101 | 1,000 | 16.67 | 16.7 | 16.7 |
| 11 | 1111111 | 1,000 | 16.67 | 16.7 | 16.7 |
| 12 | 1212121 | 1,000 | 16.67 | 16.7 | 16.7 |
| 13 | 1313131 | 1,000 | 16.67 | 16.7 | 16.7 |
| 14 | 1414141 | 1,000 | 16.67 | 16.7 | 16.7 |
| 15 | 1515151 | 1,000 | 16.67 | 16.7 | 16.7 |
| 16 | 1616161 | 1,000 | 16.67 | 16.7 | 16.7 |
| 17 | 1717171 | 1,000 | 16.67 | 16.7 | 16.7 |
| 18 | 1818181 | 1,000 | 16.67 | 16.7 | 16.7 |
| 19 | 1919191 | 1,000 | 16.67 | 16.7 | 16.7 |
| 20 | 2020202 | 1,000 | 16.67 | 16.7 | 16.7 |
| 21 | 2121212 | 1,000 | 16.67 | 16.7 | 16.7 |
| 22 | 2222222 | 1,000 | 16.67 | 16.7 | 16.7 |
| 23 | 2323232 | 1,000 | 16.67 | 16.7 | 16.7 |
| 24 | 2424242 | 1,000 | 16.67 | 16.7 | 16.7 |
| 25 | 2525252 | 1,000 | 16.67 | 16.7 | 16.7 |
| 26 | 2626262 | 1,000 | 16.67 | 16.7 | 16.7 |
| 27 | 2727272 | 1,000 | 16.67 | 16.7 | 16.7 |
| 28 | 2828282 | 1,000 | 16.67 | 16.7 | 16.7 |
| 29 | 2929292 | 1,000 | 16.67 | 16.7 | 16.7 |
| 30 | 3030303 | 1,000 | 16.67 | 16.7 | 16.7 |
| 31 | 3131313 | 1,000 | 16.67 | 16.7 | 16.7 |
| 32 | 3232323 | 1,000 | 16.67 | 16.7 | 16.7 |
| 33 | 3333333 | 1,000 | 16.67 | 16.7 | 16.7 |
| 34 | 3434343 | 1,000 | 16.67 | 16.7 | 16.7 |
| 35 | 3535353 | 1,000 | 16.67 | 16.7 | 16.7 |
| 36 | 3636363 | 1,000 | 16.67 | 16.7 | 16.7 |
| 37 | 3737373 | 1,000 | 16.67 | 16.7 | 16.7 |
| 38 | 3838383 | 1,000 | 16.67 | 16.7 | 16.7 |
| 39 | 3939393 | 1,000 | 16.67 | 16.7 | 16.7 |
| 40 | 4040404 | 1,000 | 16.67 | 16.7 | 16.7 |
| 41 | 4141414 | 1,000 | 16.67 | 16.7 | 16.7 |
| 42 | 4242424 | 1,000 | 16.67 | 16.7 | 16.7 |
| 43 | 4343434 | 1,000 | 16.67 | 16.7 | 16.7 |
| 44 | 4444444 | 1,000 | 16.67 | 16.7 | 16.7 |
| 45 | 4545454 | 1,000 | 16.67 | 16.7 | 16.7 |
| 46 | 4646464 | 1,000 | 16.67 | 16.7 | 16.7 |
| 47 | 4747474 | 1,000 | 16.67 | 16.7 | 16.7 |
| 48 | 4848484 | 1,000 | 16.67 | 16.7 | 16.7 |
| 49 | 4949494 | 1,000 | 16.67 | 16.7 | 16.7 |
| 50 | 5050505 | 1,000 | 16.67 | 16.7 | 16.7 |
| 51 | 5151515 | 1,000 | 16.67 | 16.7 | 16.7 |
| 52 | 5252525 | 1,000 | 16.67 | 16.7 | 16.7 |
| 53 | 5353535 | 1,000 | 16.67 | 16.7 | 16.7 |
| 54 | 5454545 | 1,000 | 16.67 | 16.7 | 16.7 |
| 55 | 5555555 | 1,000 | 16.67 | 16.7 | 16.7 |
| 56 | 5656565 | 1,000 | 16.67 | 16.7 | 16.7 |
| 57 | 5757575 | 1,000 | 16.67 | 16.7 | 16.7 |
| 58 | 5858585 | 1,000 | 16.67 | 16.7 | 16.7 |
| 59 | 5959595 | 1,000 | 16.67 | 16.7 | 16.7 |
| 60 | 6060606 | 1,000 | 16.67 | 16.7 | 16.7 |
| 61 | 6161616 | 1,000 | 16.67 | 16.7 | 16.7 |
| 62 | 6262626 | 1,000 | 16.67 | 16.7 | 16.7 |
| 63 | 6363636 | 1,000 | 16.67 | 16.7 | 16.7 |
| 64 | 6464646 | 1,000 | 16.67 | 16.7 | 16.7 |
| 65 | 6565656 | 1,000 | 16.67 | 16.7 | 16.7 |
| 66 | 6666666 | 1,000 | 16.67 | 16.7 | 16.7 |
| 67 | 6767676 | 1,000 | 16.67 | 16.7 | 16.7 |
| 68 | 6868686 | 1,000 | 16.67 | 16.7 | 16.7 |
| 69 | 6969696 | 1,000 | 16.67 | 16.7 | 16.7 |
| 70 | 7070707 | 1,000 | 16.67 | 16.7 | 16.7 |
| 71 | 7171717 | 1,000 | 16.67 | 16.7 | 16.7 |
| 72 | 7272727 | 1,000 | 16.67 | 16.7 | 16.7 |
| 73 | 7373737 | 1,000 | 16.67 | 16.7 | 16.7 |
| 74 | 7474747 | 1,000 | 16.67 | 16.7 | 16.7 |
| 75 | 7575757 | 1,000 | 16.67 | 16.7 | 16.7 |
| 76 | 7676767 | 1,000 | 16.67 | 16.7 | 16.7 |
| 77 | 7777777 | 1,000 | 16.67 | 16.7 | 16.7 |
| 78 | 7878787 | 1,000 | 16.67 | 16.7 | 16.7 |
| 79 | 7979797 | 1,000 | 16.67 | 16.7 | 16.7 |
| 80 | 8080808 | 1,000 | 16.67 | 16.7 | 16.7 |
| 81 | 8181818 | 1,000 | 16.67 | 16.7 | 16.7 |
| 82 | 8282828 | 1,000 | 16.67 | 16.7 | 16.7 |
| 83 | 8383838 | 1,000 | 16.67 | 16.7 | 16.7 |
| 84 | 8484848 | 1,000 | 16.67 | 16.7 | 16.7 |
| 85 | 8585858 | 1,000 | 16.67 | 16.7 | 16.7 |
| 86 | 8686868 | 1,000 | 16.67 | 16.7 | 16.7 |
| 87 | 8787878 | 1,000 | 16.67 | 16.7 | 16.7 |
| 88 | 8888888 | 1,000 | 16.67 | 16.7 | 16.7 |
| 89 | 8989898 | 1,000 | 16.67 | 16.7 | 16.7 |
| 90 | 9090909 | 1,000 | 16.67 | 16.7 | 16.7 |
| 91 | 9191919 | 1,000 | 16.67 | 16.7 | 16.7 |
| 92 | 9292929 | 1,000 | 16.67 | 16.7 | 16.7 |
| 93 | 9393939 | 1,000 | 16.67 | 16.7 | 16.7 |
| 94 | 9494949 | 1,000 | 16.67 | 16.7 | 16.7 |
| 95 | 9595959 | 1,000 | 16.67 | 16.7 | 16.7 |
| 96 | 9696969 | 1,000 | 16.67 | 16.7 | 16.7 |
| 97 | 9797979 | 1,000 | 16.67 | 16.7 | 16.7 |
| 98 | 9898989 | 1,000 | 16.67 | 16.7 | 16.7 |
| 99 | 9999999 | 1,000 | 16.67 | 16.7 | 16.7 |
| 100 | 1001001 | 1,000 | 16.67 | 16.7 | 16.7 |

1990 ALTERNATIVE
LAND USE PATTERN

CHAPTER IV

FLOOD HAZARD EVALUATION

General Approach

The objective of the flood hazard evaluations that are the usual product of FPI studies are the spatial and elevation description of specific hazardous hydrologic events such as the 100 year exceedance interval flood. The analysis consists of hydrologic studies to define flows and exceedance frequencies, hydraulic studies to relate flow to stage and thus develop water surface elevation profiles, and mapping studies to relate the water surface elevation profiles to flooded area, usually presented as outlines of flooded area.

The methods of analysis developed for the pilot study are consistent with the objectives and the methods that have been implemented in past studies, but the task of obtaining basic hydrologic modeling data has been automated so that large scale, relatively rapid analysis of future land use patterns is possible. Fig. IV-1 FLOOD HAZARD EVALUATION PROCEDURE depicts the overall flood hazard evaluation process developed for the pilot study.

The approach is to generate HEC-1 model parameters automatically from the grid data bank, develop routing criteria from a utility program, and execute HEC-1 for a specific synthetic event (such as, the 100 year event) using the generated model parameters, and convert the flows at selected control points to stage and area flooded by one or two methods:

- By conventional analysis using HEC-2 to perform water surface profile computations and topographic map analysis to delineate flooded areas.
- By semi-automated analysis using spatial grid file analysis to automatically generate and computer plot flooded area as an overlay to an adopted standard mapping.

The approach for developing flooded area that is selected for a particular study reach will depend upon the degree of accuracy deemed appropriate (conventional methods are probably more accurate), the quality of map display desired (computer maps are not precisely accurate and are not of cartographic quality), and the time, energy and funds that can be devoted to this component of the analysis (automated is expected to be faster, cheaper and much simpler to perform).

Hydrologic Studies

The objectives of the hydrologic studies are the computation of streamflow hydrographs for selected storm events and the development of exceedance frequency curves at index locations of interest. The overall strategy adopted is based upon application of synthetic storm precipitation to an HEC-1 model calibrated for the conditions of interest. The HEC-1 model (rainfall-runoff parameters) will be developed by semi-automated analysis using data from the grid file and data from observed runoff events, if available, as follows:

- Select observed runoff events
- Develop U.S. Soil Conservation Service (SCS) calibration parameters by reconstitution studies of observed runoff events and literature review

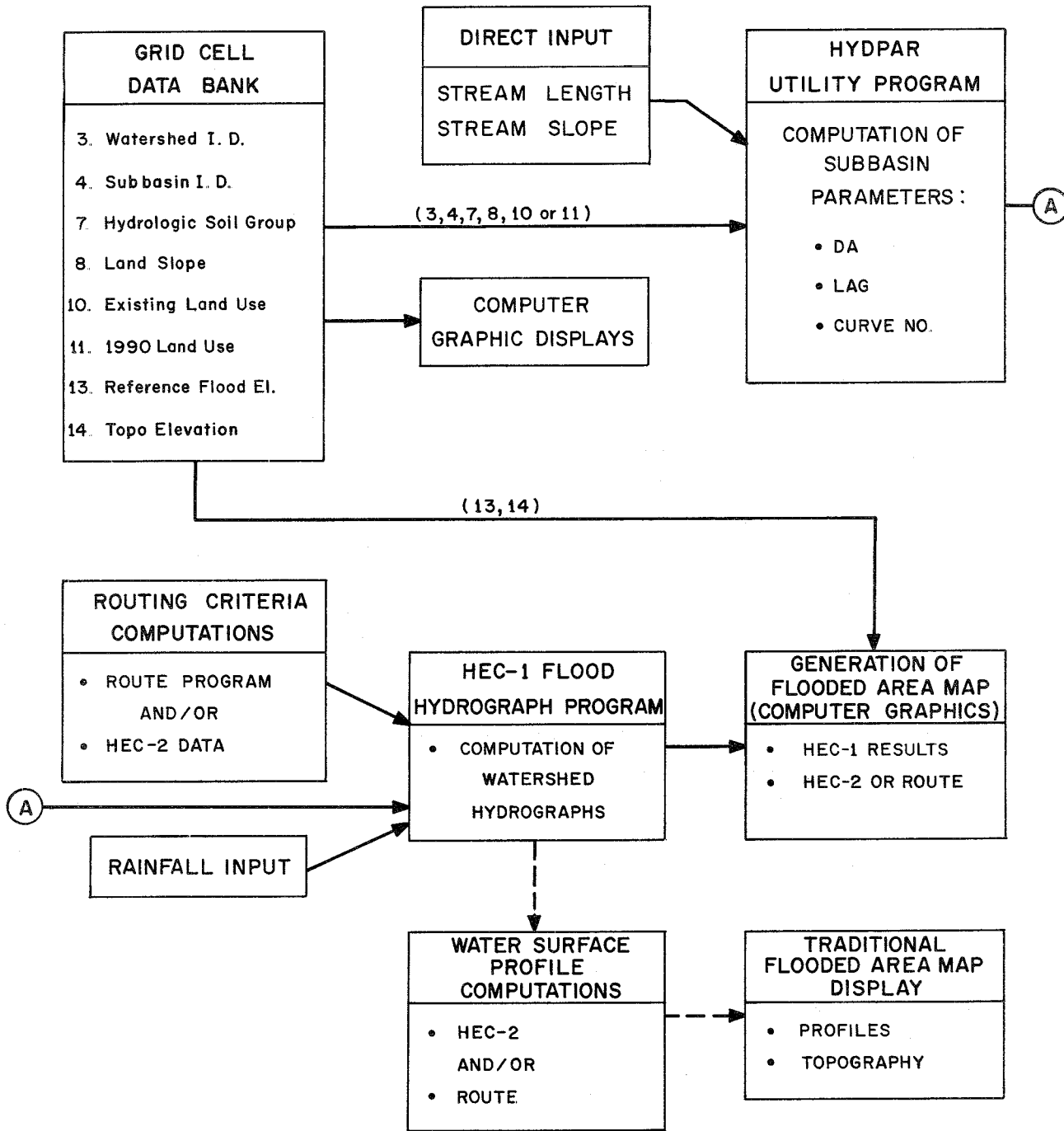

FLOOD HAZARD EVALUATION PROCEDURE

Figure IV-1

- Generate model parameters for all subbasins using grid data and the above calibration results
- Derive synthetic precipitation events
- Calibrate SCS antecedent moisture adjustment by reproducing an adopted exceedence frequency curve using the synthetic precipitation events
- Operate HEC-1 for desired information using above calibrations

An HEC-1 model requires precipitation, loss rates, unit hydrographs and routing criteria to be developed. The rainfall-runoff computation methods of the U.S. Soil Conservation Service (SCS) have been adopted and incorporated into HEC-1 to form the basic tool for hydrologic computations. The SCS methods were adopted because at present they are the only general techniques available that are responsive to land use considerations that have experienced large scale applications and could be readily automated. Within the SCS procedures, loss rates are characterized by a curve number (CN) which is a function of land use and soil characteristics (hydrologic soil group). The subbasin response to precipitation excess is characterized by a unit hydrograph which is directly determined from basin "lag" that is computed as a function of the curve number, mean land surface slope within the subbasin and subbasin hydraulic length. The curve number, slope determination, and lag computation are made automatically using the grid data file as shown schematically in Fig. IV-2 HYDROLOGIC PARAMETER COMPUTATION. The technique is a modest extension and automation of the method described by Reimer and Franzini in (6).

The respective subbasin mean curve numbers are determined by assigning the appropriate curve number to each grid cell within each subbasin depending upon the grid cell hydrologic soil group and grid cell land use, and computing the mean value for each subbasin. The average subbasin land surface slope is computed in a similar manner. The lag, and thus the unit hydrograph, is developed from an empirical lag equation containing relationships of curve number, land surface slope and subbasin hydraulic length.

Streamflow routing criteria are needed to translate hydrographs between control points throughout the system. A method has been developed that generates modified Puls routing criteria and a rating curve from stream reach data consisting of a representative cross section for the reach and reach length. This capability was developed so that routing criteria and rating curves could be developed for situations where detailed HEC-2 studies are not warranted.

Flooded Area Mapping

The automated mapping analysis consists of (1) generating a flood elevation grid file from point values (elevations computed by HEC-2 or from rating curves at selected index locations) by adjusting the *reference flood** grid file (data variable 13) and (2) overlaying the flood elevation grid file with the topographic elevation grid file and subtracting to compute depth of flooding; the zero depth of flooding line being the boundary of the flooded area. Both extent of flooding and depth of flooding could thus be generated and graphically displayed on a

*The *reference flood* development is described in Chapter V.

DATA REQUIRED

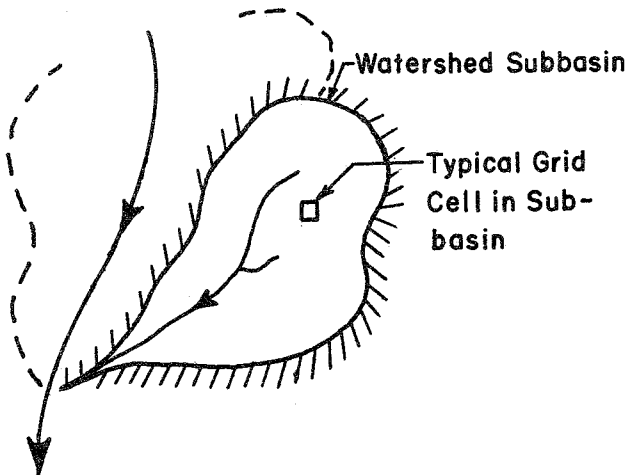

| | |
|----------------------------|--|
| 5 | Grid representation of land use (exhaustive for study area). |
| B | Grid representation of soil (hydrologic soil group). |
| 12A | Grid representation of Subbasin Boundary. |
| .32 | Grid representation of land surface slope. |
| <u> </u> <u> </u> | Tabulation of land use/soil type/curve number. Table IV-1. |
| 1420 ft. | Subbasin hydraulic length. |

PROCEDURE

LOSS RATE (Mean Curve Number)

- Determine land use from grid file.
- Determine hydrologic soil group from grid file
- Determine cell curve number (CN) from Table IV-1
- Determine cell subbasin assignment
- Aggregate CN's for all cells within subbasin and compute mean value

UNIT HYDROGRAPH

- Determine cell land surface slope from grid file
- Determine cell subbasin assignment from grid file
- Aggregate land surface slope for all cells within subbasin and compute mean value (\bar{S})
- Retrieve mean CN computed above
- Compute subbasin Lag
Lag = f(curve number, hydraulic length, mean slope)
- Shape SCS dimensionless unit hydrograph for computed Lag

HYDROLOGIC PARAMETER COMPUTATION

Figure IV-2

computer-printer plot. The present concept is to generate computer-printer plots that would overlay some standard mapping such as USGS 7.5 minute quadrangle maps.

Trail Creek Test Application

Selected summary highlights of the application of the techniques are presented below. A more detailed description of Trail Creek and the hydrologic study using the techniques that were developed is contained in Appendix D.

The HEC-1 rainfall runoff model was developed by subdividing the watershed into the 21 subbasins shown on Fig. IV-3 TRAIL CREEK SUBBASINS and determining model parameters. The loss rate functions and unit hydrograph lags were determined automatically from the grid cell data file using the calibration data developed and tabulated in Table IV-1 RUNOFF RELATION SUMMARY. The table is a printout of the hydrologic soil group-land use-curve number data and lag equation used in the automatic computation. Fig. IV-4 HYDROLOGIC SOIL GROUPS is a computer-printer plot of the hydrologic soil groups. Fig. IV-5 LAND SURFACE SLOPES is a computer-printer plot of is a computer-printer plot of grid cell land surface slopes. Figs. III-1 and III-2 of Chapter III are printouts of the existing and 1990 land use patterns. Fig. IV-6 HYDROLOGIC PARAMETERS—EXISTING LAND USE and Fig. IV-7 HYDROLOGIC PARAMETERS—1990 LAND USE are samples of the printout from the program that automatically determines the hydrologic parameters showing a sample of the data developed for each subbasin and summarizing curve number and lags by subbasin for input to HEC-1. The routing criteria were developed from representative cross section and reach length data for each of the routing reaches.

The flows for selected hydrologic events were computed by HEC-1 and converted to water surface elevations at key index locations from rating curves developed as a by-product of the routing criteria development. The usual means would be to use HEC-2 but the simplified procedure was used here for illustration purposes. Table IV-2 HYDROLOGIC DATA SUMMARY contains hydrologic data for the adopted evaluation conditions.

Flow-exceedance frequency curves were developed by operating HEC-1 for a range of synthetic storm events. Fig. IV-8 DISCHARGE FREQUENCY CURVES, INDEX STATION 1 shows a plot of the exceedance frequency curve for existing and 1990 land use for index station 1, which is near the mouth of Trail Creek.

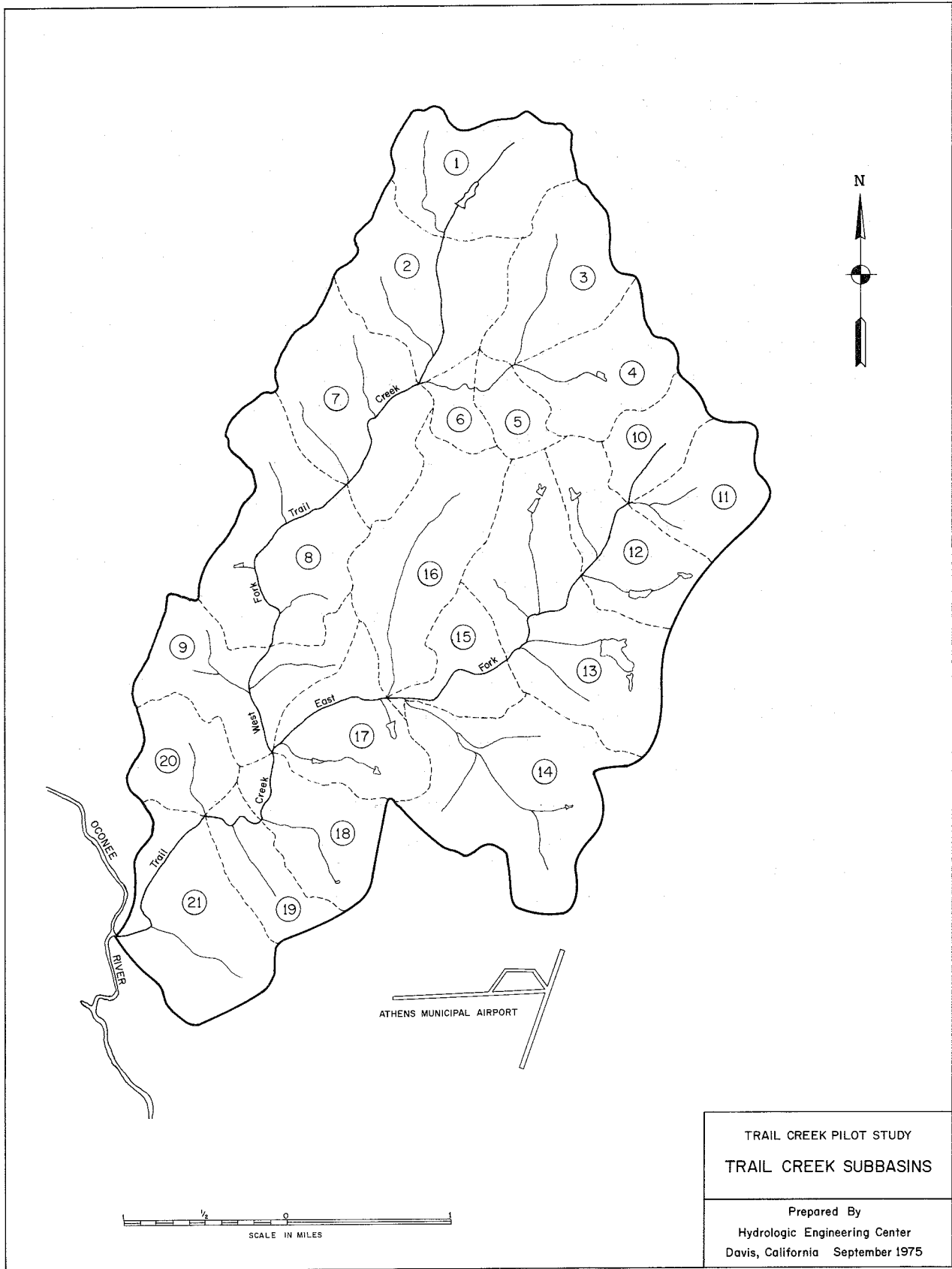

TRAIL CREEK PILOT STUDY
 TRAIL CREEK SUBBASINS

Prepared By
 Hydrologic Engineering Center
 Davis, California September 1975

Figure IV-3

UPPER O'CONNOR PILOT FPI
 TRAIL CREEK TEST AREA
 EXISTING LAND USE

CURVE NUMBER SUMMARY
 ANTECEDENT MOISTURE CONDITION II

| LAND USE CATEGORY | TITLE | HYDROLOGIC SOIL GROUP | | | |
|----------------------|----------------------------|-----------------------|-----|-----|-----|
| | | A | B | C | D |
| 1 | NATURAL VEGETATION | 36 | 60 | 73 | 79 |
| 2 | DEVELOPED OPEN SPACE | 39 | 61 | 74 | 80 |
| 3 | LOW DENSITY RESIDENTIAL | 47 | 66 | 77 | 81 |
| 4 | MEDIUM DENSITY RESIDENTIAL | 61 | 75 | 83 | 87 |
| 5 | HIGH DENSITY RESIDENTIAL | 80 | 85 | 90 | 95 |
| 6 | AGRICULTURAL | 67 | 78 | 85 | 89 |
| 7 | INDUSTRIAL | 83 | 88 | 92 | 96 |
| 8 | COMMERCIAL | 95 | 96 | 97 | 98 |
| 9 | PASTURE | 49 | 69 | 79 | 84 |
| 10 | WATER BODIES | 100 | 100 | 100 | 100 |

LAG EQUATION

$$\text{LAG(HOURS)} = \frac{0.8(L)^{0.7} + 0.7(S+1)}{(1900)(Y)^{0.5}}$$

WHERE ==

L = THE HYDRAULIC LENGTH OF WATERSHED IN FEET

Y = AVERAGE SUBBASIN LAND SLOPE IN PER CENT

S = (1000/CN)-10 CN IS THE CURVE NUMBER

RUNOFF RELATION SUMMARY

**SOIL GROUPS (GROUP A)
SMALL CREEK WATERSHED
HYDROLOGIC SOIL GROUPS**

| SOIL | AREA | PERCENT | PERCENTILE | PERCENT |
|------|-------|---------|------------|---------|
| NO. | (AC) | (AC) | (AC) | (AC) |
| 1 | 1,270 | 25.40 | 1 | 25 |
| 2 | 1,270 | 25.40 | 25 | 50 |
| 3 | 2,540 | 50.80 | 50 | 75 |
| 4 | 1,270 | 25.40 | 75 | 100 |
| 5 | 1,270 | 25.40 | 100 | 100 |

HYDROLOGIC SOIL GROUP A (VERY HIGH INFILTRATION)
SOILS WITH HIGH INFILTRATION RATES
AND LOW BULK DENSITY

HYDROLOGIC SOIL GROUP B (HIGH INFILTRATION)
SOILS WITH HIGH INFILTRATION RATES
AND MODERATE BULK DENSITY

HYDROLOGIC SOIL GROUP C (MODERATE INFILTRATION)
SOILS WITH MODERATE INFILTRATION RATES
AND MODERATE BULK DENSITY

HYDROLOGIC SOIL GROUP D (LOW INFILTRATION)
SOILS WITH LOW INFILTRATION RATES
AND HIGH BULK DENSITY



HYDROLOGIC SOIL GROUPS

UPPER CONCRETE PILOT PILE
 TAIL CHISEL TEST AREA
 ANTICIPATED SLOPE SIZES

| PILE SIZE (FT) DIA. | L ₁ (ft) | N ₁ (bl) | PERCENT TAIL CHISEL AREA | PERCENT TAIL CHISEL AREA |
|---------------------|---------------------|---------------------|--------------------------------|--------------------------------|
| 1 | 1.000 | 11.00 | 11.00 | 11.00 |
| 2 | 2.000 | 22.00 | 22.00 | 22.00 |
| 3 | 3.000 | 33.00 | 33.00 | 33.00 |
| 4 | 4.000 | 44.00 | 44.00 | 44.00 |
| 5 | 5.000 | 55.00 | 55.00 | 55.00 |

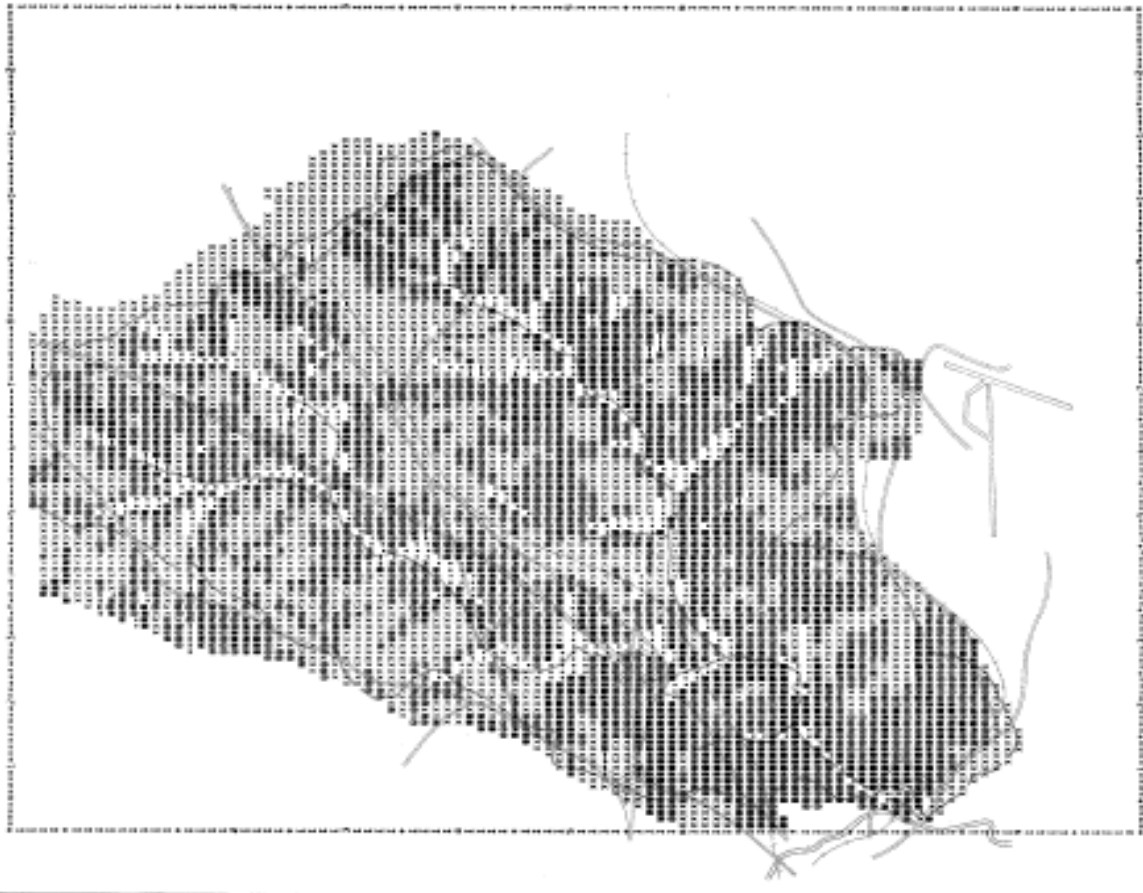

LAND SURFACE SLOPES

SUMMARY OF WATERSHED 1 DATA

| SUBBASIN NUMBER | DRAINAGE AREA SQ. MI. | PERCENT OF WATERSHED | AVERAGE CURVE NUMBER | SUBBASIN LAG (HOURS) | STREAM LENGTH (FEET) | STREAM SLOPE (PERCENT) | SUBBASIN SLOPE (PERCENT) | AVERAGE EROSION INDEX |
|-----------------|-----------------------|----------------------|----------------------|----------------------|----------------------|------------------------|--------------------------|-----------------------|
| 1 | .71 | 5.58 | 68.3 | .630 | 5000 | 2.1 | 6.53 | 2.13 |
| 2 | .74 | 5.79 | 69.6 | .847 | 7200 | 1.3 | 6.03 | 2.34 |
| 3 | .58 | 4.55 | 73.7 | .768 | 6600 | 1.7 | 5.10 | 1.73 |
| 4 | .50 | 3.90 | 67.4 | .788 | 6000 | 2.2 | 5.83 | 2.13 |
| 5 | .22 | 1.76 | 70.6 | .529 | 4000 | 2.3 | 5.71 | 2.06 |
| 6 | .16 | 1.22 | 73.4 | .403 | 3700 | 2.5 | 7.45 | 2.23 |
| 7 | .82 | 6.44 | 71.3 | .795 | 7400 | 2.0 | 6.53 | 2.13 |
| 8 | 1.01 | 7.89 | 66.9 | 1.023 | 9200 | 1.2 | 7.05 | 2.17 |
| 9 | .66 | 5.21 | 69.9 | .727 | 7000 | 2.2 | 7.72 | 2.35 |
| 10 | .30 | 2.32 | 64.1 | .674 | 4500 | 1.8 | 6.00 | 2.42 |
| 11 | .44 | 3.45 | 72.0 | .658 | 5300 | 1.5 | 5.36 | 1.96 |
| 12 | .57 | 4.50 | 72.3 | .654 | 5700 | 2.0 | 5.99 | 2.19 |
| 13 | 1.15 | 8.97 | 70.4 | .861 | 7700 | 1.5 | 6.23 | 2.02 |
| 14 | 1.15 | 8.99 | 66.2 | 1.046 | 9300 | 1.5 | 7.15 | 2.30 |
| 15 | .30 | 2.32 | 62.7 | .821 | 6000 | 2.0 | 6.88 | 2.52 |
| 16 | .87 | 6.82 | 70.8 | 1.036 | 9500 | 1.5 | 5.87 | 2.29 |
| 17 | .59 | 4.59 | 65.3 | .898 | 8400 | 1.9 | 8.59 | 2.36 |
| 18 | .51 | 3.97 | 64.6 | .587 | 4700 | 2.8 | 8.23 | 2.47 |
| 19 | .32 | 2.47 | 63.2 | .794 | 6000 | 2.2 | 7.17 | 2.61 |
| 20 | .36 | 2.79 | 64.6 | .537 | 4600 | 2.6 | 9.53 | 2.85 |
| 21 | .82 | 6.46 | 66.6 | .697 | 6400 | 2.7 | 8.64 | 2.81 |

SUBBASIN 7

CURVE NUMBERS ARE WEIGHTED AVERAGES FOR THE LAND USE WITHIN THE HYDROLOGIC SOIL GROUPS
 SUBBASIN SLOPE AND EROSION INDEX ARE SIMPLE AVERAGES
 SUBBASIN STREAM SLOPE AND LENGTH ARE DIRECT INPUTS

| LAND USE CATEGORY | LAND USE | AVE CURVE NO. | SURFACE SLOPE (PERCENT) | AVERAGE EROSION INDEX | AREA IN (ACRES) | PERCENT OF SUBBASIN |
|-------------------|-------------------------|---------------|-------------------------|-----------------------|-----------------|---------------------|
| 1 | NATURAL VEGETATION | 62.4 | 6.82 | 1.93 | 224.91 | 42.73 |
| 3 | LOW DENSITY RESIDENTIAL | 66.0 | 4.00 | 3.00 | 3.06 | .58 |
| 6 | AGRICULTURAL | 78.3 | 6.33 | 2.26 | 286.11 | 54.36 |
| 9 | PASTURE | 69.0 | 6.86 | 2.71 | 10.71 | 2.03 |
| 10 | WATER BODIES | 100.0 | 4.00 | 3.00 | 1.53 | .29 |
| SUBBASIN AVERAGE | | 71.3 | 6.53 | 2.13 | 526.32 | |

```
*****
* SUBBASIN 7 DATA
*-----*
* DRAINAGE AREA (ACRES) = 526.32 *
* DRAINAGE AREA (SQ. MI.) = .82 *
* STREAM LENGTH (FEET) = 7400.00 *
* STREAM SLOPE (PERCENT) = 1.99 *
* SUBBASIN SLOPE (PERCENT) = 6.53 *
* AVERAGE CURVE NUMBER = 71.28 *
* SUBBASIN LAG (HOURS) = .79 *
* NUMBER OF DATA CELLS = 344.00 *
*****
```

HYDROLOGIC PARAMETERS—
EXISTING LAND USE

SUMMARY OF WATERSHED 1 DATA

| SUBBASIN NUMBER | DRAINAGE AREA SQ. MI. | PERCENT OF WATERSHED | AVERAGE CURVE NUMBER | SUBBASIN LAG (HOURS) | STREAM LENGTH (FEET) | STREAM SLOPE (PERCENT) | SUBBASIN SLOPE (PERCENT) | AVERAGE EROSION INDEX |
|-----------------|-----------------------|----------------------|----------------------|----------------------|----------------------|------------------------|--------------------------|-----------------------|
| 1 | .71 | 5.58 | 65.7 | .674 | 5000 | 2.1 | 6.53 | 2.13 |
| 2 | .74 | 5.79 | 75.9 | .709 | 7200 | 1.3 | 6.03 | 2.34 |
| 3 | .58 | 4.55 | 72.8 | .786 | 6600 | 1.7 | 5.10 | 1.73 |
| 4 | .50 | 3.90 | 74.6 | .648 | 6000 | 2.2 | 5.83 | 2.13 |
| 5 | .22 | 1.76 | 78.9 | .417 | 4000 | 2.3 | 5.71 | 2.06 |
| 6 | .16 | 1.22 | 72.7 | .411 | 3700 | 2.5 | 7.45 | 2.23 |
| 7 | .82 | 6.44 | 73.8 | .740 | 7400 | 2.0 | 6.53 | 2.13 |
| 8 | 1.01 | 7.89 | 79.0 | .728 | 9200 | 1.2 | 7.05 | 2.17 |
| 9 | .66 | 5.21 | 80.7 | .530 | 7000 | 2.2 | 7.72 | 2.35 |
| 10 | .30 | 2.32 | 70.9 | .562 | 4500 | 1.8 | 6.00 | 2.42 |
| 11 | .44 | 3.45 | 67.5 | .743 | 5300 | 1.5 | 5.36 | 1.96 |
| 12 | .57 | 4.50 | 77.0 | .572 | 5700 | 2.0 | 5.99 | 2.19 |
| 13 | 1.15 | 8.97 | 78.8 | .677 | 7700 | 1.5 | 6.23 | 2.02 |
| 14 | 1.15 | 8.99 | 74.0 | .846 | 9300 | 1.5 | 7.15 | 2.30 |
| 15 | .30 | 2.32 | 70.3 | .673 | 6000 | 2.0 | 6.88 | 2.52 |
| 16 | .87 | 6.82 | 76.6 | .881 | 9500 | 1.5 | 5.87 | 2.29 |
| 17 | .59 | 4.59 | 71.1 | .771 | 8400 | 1.9 | 8.59 | 2.36 |
| 18 | .51 | 3.97 | 73.8 | .459 | 4700 | 2.8 | 8.23 | 2.47 |
| 19 | .32 | 2.47 | 74.8 | .581 | 6000 | 2.2 | 7.17 | 2.61 |
| 20 | .36 | 2.79 | 76.5 | .388 | 4600 | 2.6 | 9.53 | 2.85 |
| 21 | .82 | 6.46 | 76.9 | .525 | 6400 | 2.7 | 8.64 | 2.81 |

SUBBASIN 7

CURVE NUMBERS ARE WEIGHTED AVERAGES FOR THE LAND USE WITHIN THE HYDROLOGIC SOIL GROUPS
 SUBBASIN SLOPE AND EROSION INDEX ARE SIMPLE AVERAGES
 SUBBASIN STREAM SLOPE AND LENGTH ARE DIRECT INPUTS

| LAND USE CATEGORY | LAND USE | AVE CURVE NO. | SURFACE SLOPE (PERCENT) | AVERAGE EROSION INDEX | AREA IN (ACRES) | PERCENT OF SUBBASIN |
|-------------------|----------------------------|---------------|-------------------------|-----------------------|-----------------|---------------------|
| 1 | NATURAL VEGETATION | 63.0 | 5.56 | 1.68 | 85.68 | 16.28 |
| 3 | LOW DENSITY RESIDENTIAL | 66.0 | 8.88 | 2.48 | 32.13 | 6.10 |
| 4 | MEDIUM DENSITY RESIDENTIAL | 75.4 | 5.33 | 2.29 | 133.11 | 25.29 |
| 5 | HIGH DENSITY RESIDENTIAL | 85.1 | 7.11 | 2.32 | 58.14 | 11.05 |
| 6 | AGRICULTURAL | 78.3 | 6.20 | 2.05 | 61.20 | 11.63 |
| 7 | INDUSTRIAL | 88.0 | 8.38 | 3.00 | 18.36 | 3.49 |
| 8 | COMMERCIAL | 96.0 | 4.00 | 2.00 | 1.53 | .29 |
| 9 | PASTURE | 70.6 | 7.46 | 2.00 | 130.05 | 24.71 |
| 10 | WATER BODIES | 100.0 | 7.00 | 2.75 | 6.12 | 1.16 |
| SUBBASIN AVERAGE | | 73.8 | 6.53 | 2.13 | 526.32 | |

```

*****
* SUBBASIN 7 DATA
*-----*
* DRAINAGE AREA (ACRES) = 526.32 *
* DRAINAGE AREA (SQ. MI.) = .82 *
* STREAM LENGTH (FEET) = 7400.00 *
* STREAM SLOPE (PERCENT) = 1.99 *
* SUBBASIN SLOPE (PERCENT) = 6.53 *
* AVERAGE CURVE NUMBER = 73.83 *
* SUBBASIN LAG (HOURS) = .74 *
* NUMBER OF DATA CELLS = 344.00 *
*****
    
```

HYDROLOGIC PARAMETERS-
1990 LAND USE

Figure IV-7

TABLE IV-2
Hydrologic Data Summary
Trail Creek Test Results

| Index Location Figure IV-3 | 100-Year Discharge And W.S.E.L. ¹ | | | | | | | |
|-------------------------------|--|---------------|------------|---------------|------------|---------------|------------|---------------|
| | I | | II | | III | | IV | |
| | Q (cfs) | WSEL (msl) | Q (cfs) | WSEL (msl) | Q (cfs) | WSEL (msl) | Q (cfs) | WSEL (msl) |
| 1 | 7600 | 627.1 | 3900 | 623.8 | 9400 | 628.3 | 5400 | 625.2 |
| 2 | 3450 | 656.4 | 1600 | 653.9 | 3800 | 656.7 | 2150 | 654.8 |
| 3 | 2600 | 711.9 | 270 | 707.7 | 2900 | 712.2 | 380 | 708.4 |
| 4 | 3900 | 650.3 | 1550 | 648.4 | 5100 | 651.2 | 2200 | 649.0 |
| 5 | 1600 | 694.2 | 1600 | 694.2 | 1650 | 694.3 | 1650 | 694.3 |

- ¹I. Existing land use
- II. Existing land use with 3 Soil Conservation Service reservoirs in operation
- III. 1990 land use pattern without Soil Conservation Service reservoirs
- IV. 1990 land use pattern with Soil Conservation Service reservoirs in operation

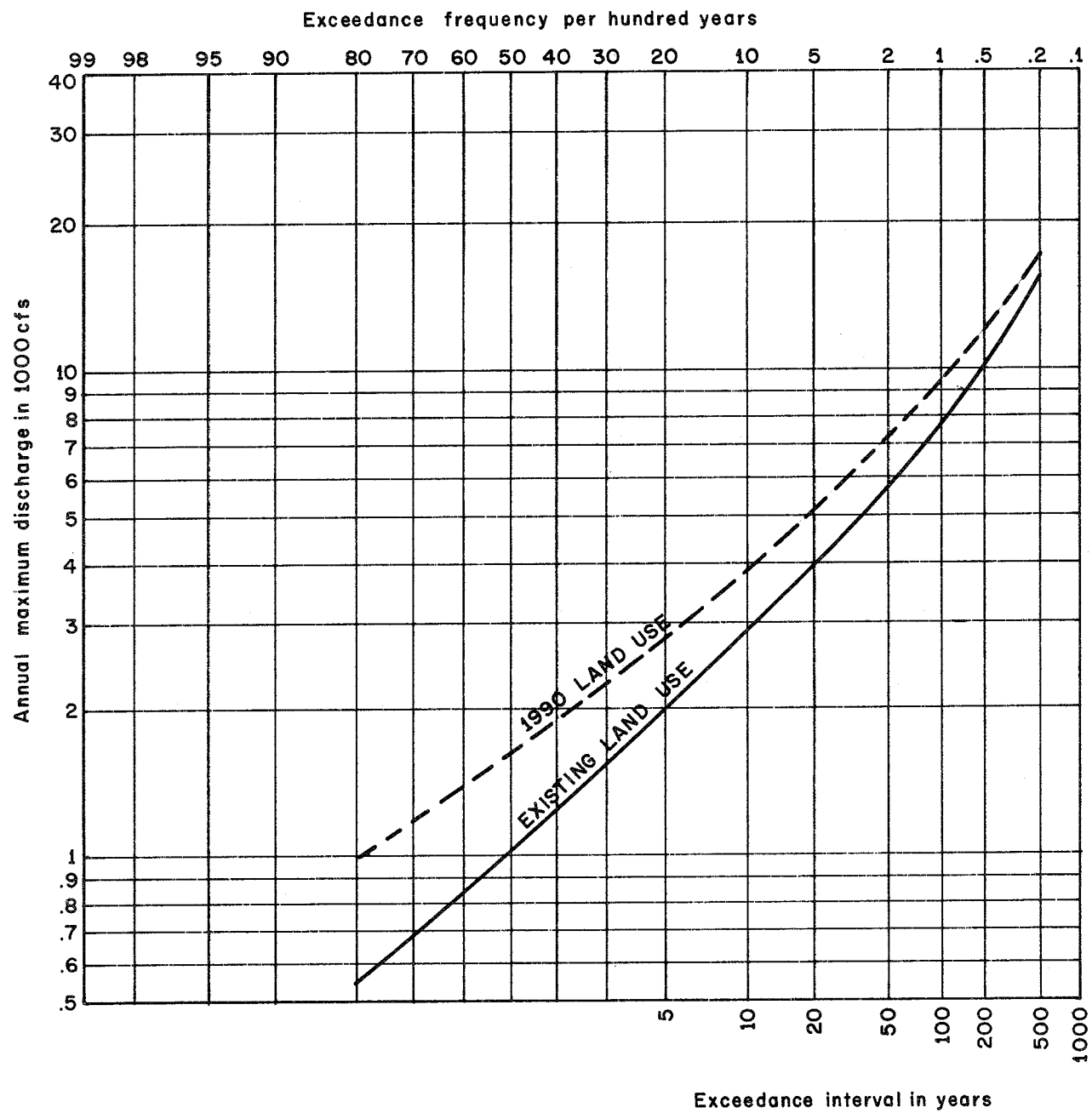

TRAIL CREEK PILOT STUDY
 DISCHARGE FREQUENCY CURVES,
 INDEX STATION 1

Figure IV-8

CHAPTER V ECONOMIC ANALYSIS

General Approach

The objective of the economic analysis is to present damage potential data so that a systematic assessment of alternative land use plans and/or specific development proposals is possible. The analysis focuses upon the damage potential consequences of these land use patterns. The existing conditions (1975) land use pattern should be evaluated as it exists with no assumptions as to development controls. The alternative future land use pattern evaluation should be capable of being performed with and without policy assumptions regarding land use development controls. The technique development objective was therefore the creation of the capability to automatically extract information from the data file and format it for single event evaluation (such as the 100-year event) and expected annual (equivalent to average annual) damage assessments for the alternative land use patterns for alternative land use development controls.

An automated method of generating damage potential functional relationships from the grid cell data bank was developed and applied during the Trail Creek test. In general, the method constructs a unique elevation-damage relation for each grid cell within the flood plain (based on ground elevation, land use, and damage potential) and aggregates the individual cell functions to the index location for each designated damage reach. The damage functions thus constructed are subsequently merged with hydrologic (flood frequency) and hydraulic (rating curve) data within the HEC-1 program so that expected annual damages for each damage index location, land use category, and evaluation condition can be computed. Fig. V-1 ECONOMIC EVALUATION PROCEDURE schematically depicts the overall economic analysis process and identifies the various inputs required for the economic evaluation.

Damage Function Development

The technique developed for automatically generating elevation-damage functions extends the traditional techniques to the grid cell data bank concept. Damage reaches are identified and catalogued into the data bank, a reference flood is selected and processed into the data bank, composite damage functions are developed and aggregation of grid cell damage functions to an index location is performed by an adaption of the conventional process. Fig. V-2 DAMAGE FUNCTION DEVELOPMENT describes the process of automatically generating the elevation-damage functions from the grid cell data bank.

Damages Reaches: Damage reaches must be outlined to define the grid cells from which damage data will be aggregated to an index location. The criteria for determination of the extent of damage reaches is consistent with traditional procedures in that it includes a balance between delineating reaches having consistent water surface profiles for a range of flows, and preserving the desired economic detail while keeping the number of damage reaches to a reasonable number. Because only those grid cells that may need to be

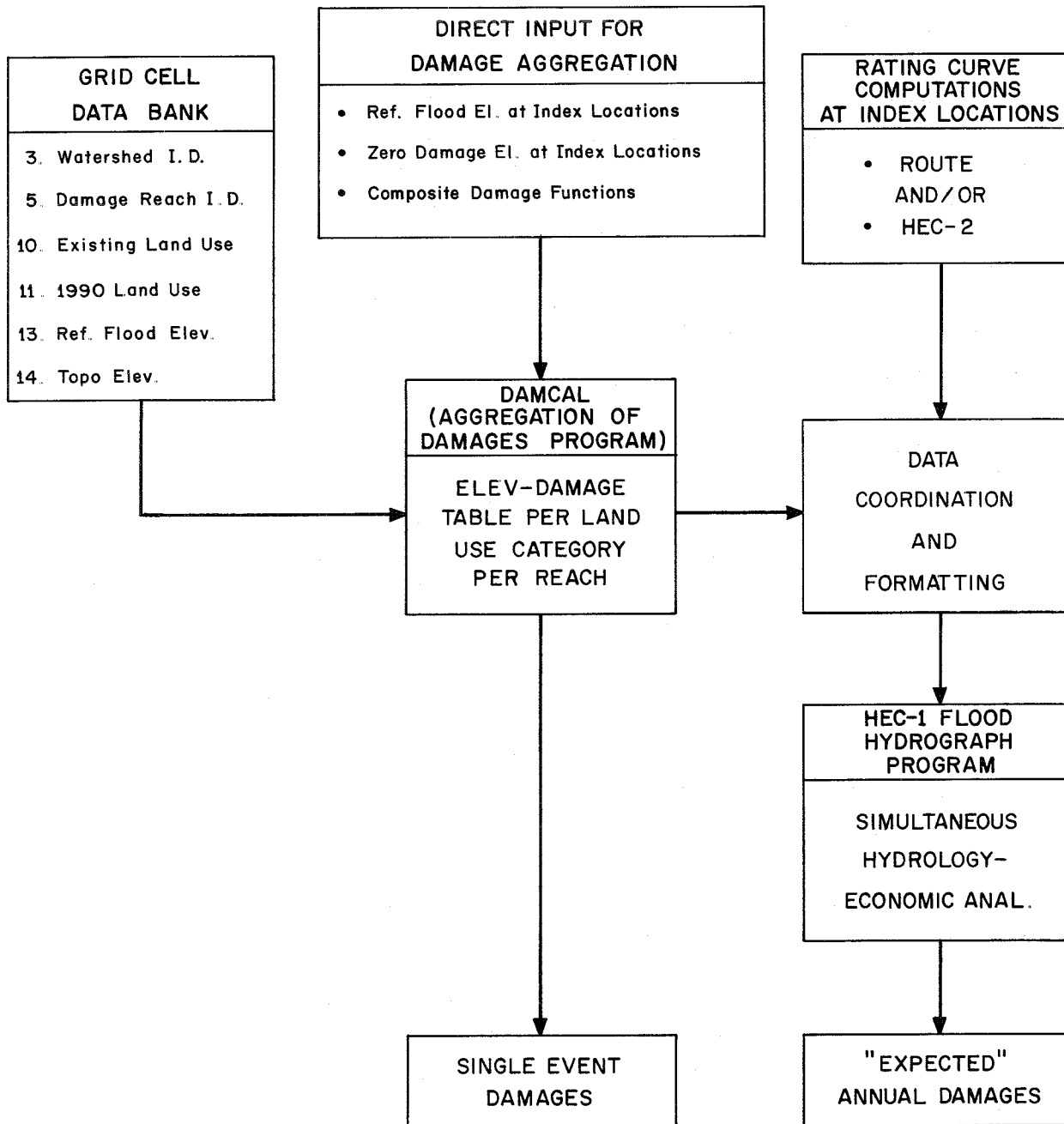

ECONOMIC EVALUATION PROCEDURE

Figure V-1

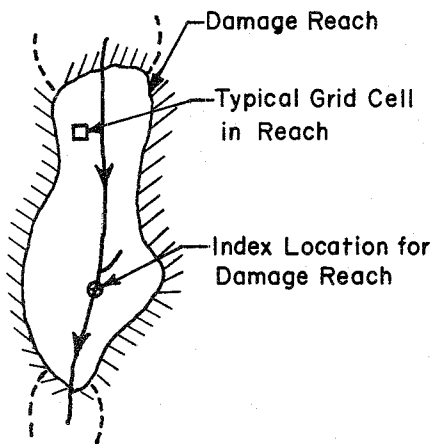

DATA REQUIRED

| | |
|-------|---|
| 5 | Grid representation of land use (exhaustive for study area). |
| 321.6 | Grid representation of topography (elevations). |
| 325.0 | Grid representation of reference flood (water surface elevation at reference flood) for each grid cell. |
| 12A | Grid representation of Damage Reach Boundary. |
| A | Composite stage-damage functions for each <u>significant</u> land use. |

INDEX LOCATION DAMAGE FUNCTION CONSTRUCTION

STEP 1, Develop Elevation - damage Function at Each Cell

- a. Determine land use from grid file
- b. Retrieve appropriate composite stage damage function
- c. Determine grid elevation of cell from grid file
- d. Tabulate elevation-damage for cell from above

STEP 2, Aggregate Cells to Index Location

- a. Determine cell damage reach assignment
- b. Determine index location reference flood elevation (X_1)
- c. Determine cell reference flood elevation (X_2)
- d. Adjust cell elevation-damage function by ($X_2 - X_1$)
- e. Aggregate cell adjusted elevation-damage function at index station
- f. Repeat for all grid cells

DAMAGE FUNCTION DEVELOPMENT

analyzed are of interest, there is no need to extend the lateral definition of the damage reaches beyond a reasonable limit (say standard project flood plus some arbitrary amount such as the flood plain encompassed by an additional 5-foot vertical distance).

The five damage reaches defined for the Trail Creek test, shown on Fig. V-3 TRAIL CREEK DAMAGE REACHES seems to be about the correct level of detail for aggregation for the general type assessment appropriate for the FPI pilot study. Note that the damage reaches extend up tributaries as well as along the main stem. This is necessary so that potential damages that may occur on the tributaries can be accumulated in the index location aggregate damage functions. The extension need not be done if it is desired to confine the damage assessment to main stem only areas. The grid data bank representation of the damage reaches is shown on Fig. A-3 TRAIL CREEK DAMAGE REACHES of Appendix A.

Reference Flood: The reference flood is needed to properly index an arbitrarily located grid cell to the index location so that aggregation of damage data to the index location may be properly performed. For example, since a flood profile for a specific event will result in different elevations along a damage reach, each cell needs to be referenced with respect to the flood profile at the location of the cell so that the damage potential of each cell can be correctly accumulated with that of the other cells in the reach.

An elevation of the reference flood is needed for each grid cell because each grid cell within each damage reach will be involved in constructing the aggregate function. It should be obvious that it would be extremely tedious to assign by manual means, a flood elevation to each cell. To avoid this, a method was devised that generates the reference flood grid file for subsequent placement in the data bank. The technique used is to assign reference flood elevations along the centerline of the reach at intervals that capture any significant variation in profile slope, such as 5 to 10 assignments per mile of stream, and also assign similar elevations along the boundaries of each damage reach. The elevations at the boundaries would be identical to the centerline elevations except where tributaries enter the main stream and the damage reach has been drawn to encompass them. The reference flood elevation file is then generated by application of a general contouring algorithm that fills in all vacant grid cells, e.g., those cells that are between the assigned cell values in the previous step. The contouring is performed by the same computer program that is used to generate the grid file for other data variables.

Ideally, the reference flood that would be used to assign the flood elevations and generate the grid file would be a consistent profile developed by detailed water surface profile analysis. The Trail Creek test made use of the Standard Project Flood profile previously published in the Trail Creek FPI report (7). Based on experience in the Trail Creek test, it seems that a less rare event, such as the 100-year or less would be more appropriate for use. In the absence of any flood profile data, the thalweg elevation of the main stream channel could be used as the reference flood since it would at least capture the sloping effect of a flood profile. Fig. V-4 REFERENCE FLOOD is a computer-printer plot of the reference flood grid file that was generated for Trail Creek.

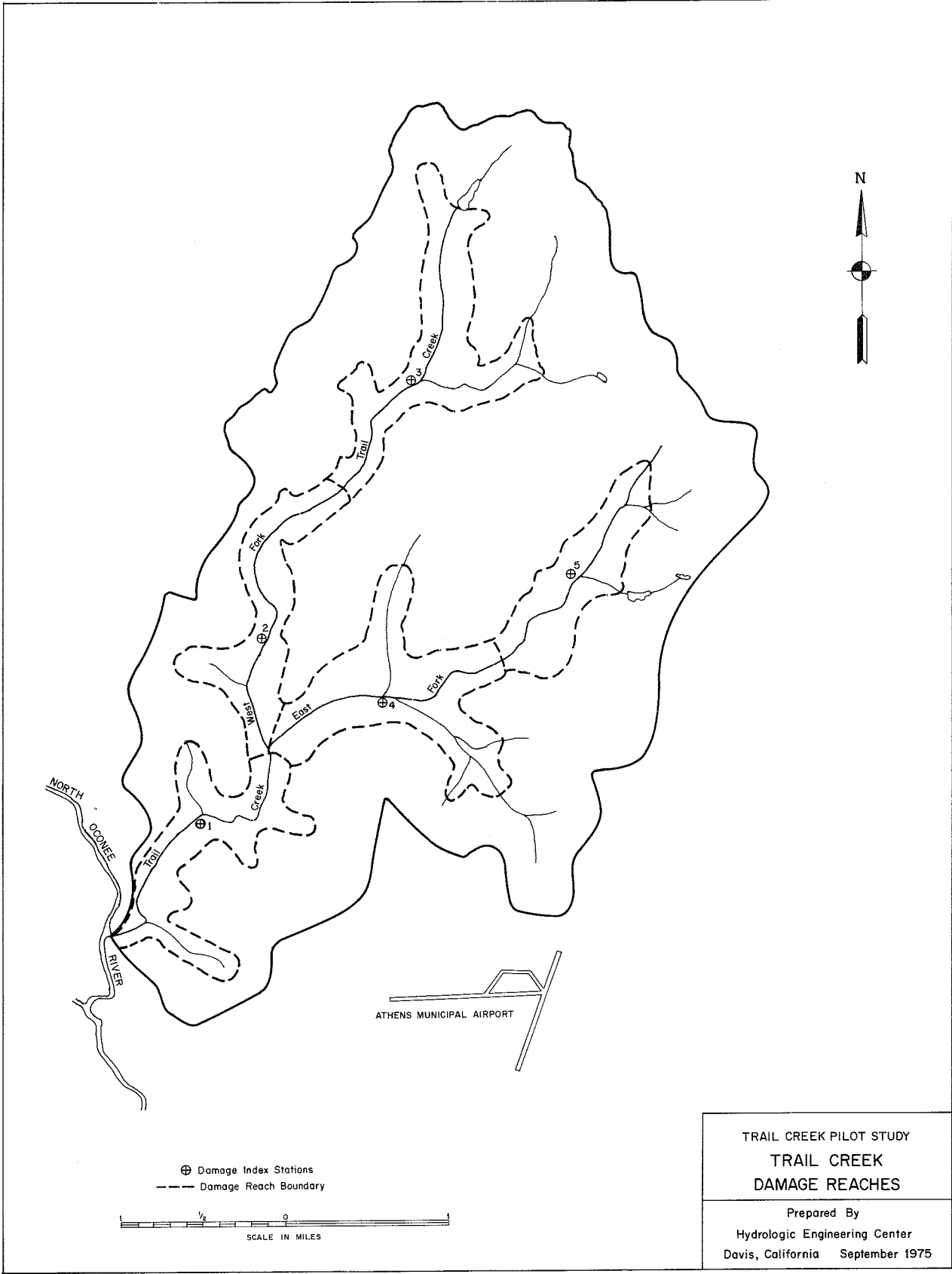
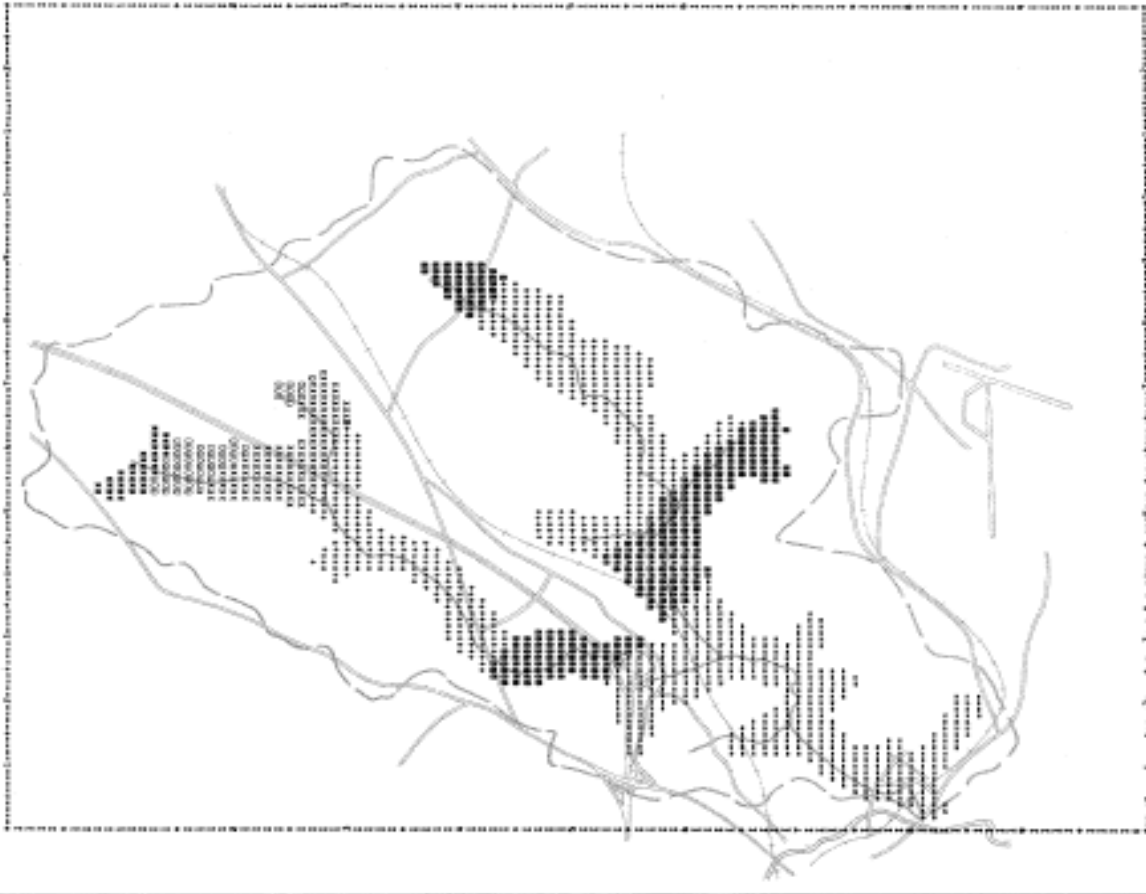

Figure V-3

SMALL AREA FLOOD ZONE
 REFERENCE FLOOD ELEVATIONS
 ECONOMIC EVALUATION

| AREA | AREA NO. | AREA NAME | AREA TYPE | AREA VALUE | AREA PERCENTAGE | PERCENTILE RISK | PERCENTAGE OF AREA |
|------|----------|-----------|-------------|------------|-----------------|-----------------|--------------------|
| | | | | | | | |
| 1 | 001 | AREA 001 | RESIDENTIAL | 1,113,000 | 0.0 | 10.00 | 10.00 |
| 2 | 002 | AREA 002 | RESIDENTIAL | 1,113,000 | 0.0 | 10.00 | 10.00 |
| 3 | 003 | AREA 003 | RESIDENTIAL | 1,113,000 | 0.0 | 10.00 | 10.00 |
| 4 | 004 | AREA 004 | RESIDENTIAL | 1,113,000 | 0.0 | 10.00 | 10.00 |
| 5 | 005 | AREA 005 | RESIDENTIAL | 1,113,000 | 0.0 | 10.00 | 10.00 |
| 6 | 006 | AREA 006 | RESIDENTIAL | 1,113,000 | 0.0 | 10.00 | 10.00 |
| 7 | 007 | AREA 007 | RESIDENTIAL | 1,113,000 | 0.0 | 10.00 | 10.00 |
| 8 | 008 | AREA 008 | RESIDENTIAL | 1,113,000 | 0.0 | 10.00 | 10.00 |
| 9 | 009 | AREA 009 | RESIDENTIAL | 1,113,000 | 0.0 | 10.00 | 10.00 |
| 10 | 010 | AREA 010 | RESIDENTIAL | 1,113,000 | 0.0 | 10.00 | 10.00 |



REFERENCE FLOOD

Composite Damage Functions: The general objective in technique development was emphasized to be systematic, consistent assessments of alternative land use patterns. In keeping with this spirit, a more general analysis than the traditional structure by structure aggregation, as is usually performed, seems appropriate. The adopted approach was to develop damage relationships by *land use* category rather than by structure. In fact as was discussed in Chapter III, the land use classifications adopted were greatly influenced by the economic damage analysis that would be performed. The concept of a composite damage function was selected as the mechanism to allow the desired general analysis.

A composite damage function is defined as a stage-damage *per unit area* function for each of the adopted land use categories that have significant damage potential. The idea is that general composite damage curves are constructed by averaging structural and content values of sampled field data for each category. The type of damage potential that comprise the composite damage curves for the Trail Creek study are the usual direct, indirect and emergency costs. The establishment of average base structural and content values of residential and commercial areas was based on review of tax records, field reconnaissance, and interviews with local agencies. For nonstructural areas, such as pasture, undeveloped open space and natural vegetation, typical damage functions were also developed, although the damage potential in these areas is small compared to the overall damage potential of structures and their contents. The composite damage function for the agriculture category was generalized to represent an *agricultural enterprise* in that the function considered a typical mix of farm structures, crops, farm machinery, livestock, etc. The damage function generation computer program that will be subsequently described was also designed to assist in construction of the composite damage functions. The Savannah District staff developed the data used for development of the composite function. Table V-1 COMPOSITE DAMAGE FUNCTIONS lists the composite damage function for each land use category for the Trail Creek test.

The concept of a composite damage function appears to be appropriate for future land use assessments since the exact structural location will not be known and also seems appropriate for most of the land use categories that were adopted for existing land use pattern assessments. However, because of the uniqueness of industry types and certain commercial categories, the composite function concept for *existing* industry in general and *existing* selected commercial enterprises is probably less than satisfactory. If these limitations appear significant for a particular study area, it is recommended that the conventional field investigation technique of tailoring a damage function to a specific industry in the study area be performed and the resultant damage function substituted for the more general one developed automatically. The techniques have been designed to accommodate this type of intervention as a normal method of operating as was described in Chapter III.

LAND USE CATEGORY NO. 1

WATER, AGRICULTURE
.....
* PER CENT * PER CENT * PERCENT IN DAMP
* WATER * STRUCTURES CONTAINS SIX THOUSAND DOLLARS
.....
* 6,000 * 6,000 * 6,000 *
* 15,000 * 6,000 * 6,000 *
.....
DENSITY OF THE LAND USE WATER PER GROSS CELL * 1,000
BASE VALUE OF THE STRUCTURE * 6,000
BASE VALUE OF THE CONTENTS * 0,000
VARIANCE FACTOR OVER COST DEVELOPMENT * 0,000
INDIRECT DAMAGES * 0,000

LAND USE CATEGORY NO. 2

RECREATION, OPEN SPACE
.....
* PER CENT * PER CENT * PERCENT IN DAMP
* WATER * STRUCTURES CONTAINS SIX THOUSAND DOLLARS
.....
* 6,000 * 6,000 * 6,000 *
* 15,000 * 6,000 * 6,000 *
.....
DENSITY OF THE LAND USE WATER PER GROSS CELL * 1,000
BASE VALUE OF THE STRUCTURE * 6,000
BASE VALUE OF THE CONTENTS * 0,000
VARIANCE FACTOR OVER COST DEVELOPMENT * 0,000
INDIRECT DAMAGES * 0,000

LAND USE CATEGORY NO. 3

LOW DENSITY RESIDENTIAL
.....
* PER CENT * PER CENT * PERCENT IN DAMP
* WATER * STRUCTURES CONTAINS SIX THOUSAND DOLLARS
.....
* 6,000 * 6,000 * 6,000 *
* 15,000 * 6,000 * 6,000 *
.....
DENSITY OF THE LAND USE WATER PER GROSS CELL * 1,000
BASE VALUE OF THE STRUCTURE * 6,000
BASE VALUE OF THE CONTENTS * 0,000
VARIANCE FACTOR OVER COST DEVELOPMENT * 0,000
INDIRECT DAMAGES * 0,000

LAND USE CATEGORY NO. 4

RESIDENT DENSITY RESIDENTIAL
.....
* PER CENT * PER CENT * PERCENT IN DAMP
* WATER * STRUCTURES CONTAINS SIX THOUSAND DOLLARS
.....
* 6,000 * 6,000 * 6,000 *
* 15,000 * 6,000 * 6,000 *
.....
DENSITY OF THE LAND USE WATER PER GROSS CELL * 1,000
BASE VALUE OF THE STRUCTURE * 6,000
BASE VALUE OF THE CONTENTS * 0,000
VARIANCE FACTOR OVER COST DEVELOPMENT * 0,000
INDIRECT DAMAGES * 0,000

LAND USE CATEGORY NO. 5

MEDIUM DENSITY RESIDENTIAL
.....
* PER CENT * PER CENT * PERCENT IN DAMP
* WATER * STRUCTURES CONTAINS SIX THOUSAND DOLLARS
.....
* 6,000 * 6,000 * 6,000 *
* 15,000 * 6,000 * 6,000 *
.....
DENSITY OF THE LAND USE WATER PER GROSS CELL * 1,000
BASE VALUE OF THE STRUCTURE * 6,000
BASE VALUE OF THE CONTENTS * 0,000
VARIANCE FACTOR OVER COST DEVELOPMENT * 0,000
INDIRECT DAMAGES * 0,000

LAND USE CATEGORY NO. 6

DENSITY OF THE LAND USE WATER PER GROSS CELL * 1,000
BASE VALUE OF THE STRUCTURE * 6,000
BASE VALUE OF THE CONTENTS * 0,000
VARIANCE FACTOR OVER COST DEVELOPMENT * 0,000
INDIRECT DAMAGES * 0,000

COMPOSITE DAMAGE FUNCTIONS

Aggregate Damage Functions: In order to perform single event damage analysis and “expected annual damage” analysis, the damage potential for each land use category and each grid cell must be aggregated to the index locations shown on Fig. V-3. The technique developed to perform the aggregation is described schematically in Fig. V-2. The basic process is to develop an elevation-damage function for each grid cell by matching the land use for a specific grid cell with the appropriate composite damage function while observing the elevation of a grid cell itself, then aggregating these individual functions to the index location by use of the mechanism of the reference flood. The level of detail that is being preserved is a function of the cell size and number of cells within a damage reach. For the 1.5 acre grid size, the average Trail Creek damage reach contains about 400 grid cells.

The DAMCAL computer program that performs the aggregation also assists in the construction of the composite damage functions. The program accepts the following types of data for the construction of the composite damage functions:

- stage vs % damage for structure
- stage vs % damage for contents
- option stage vs damage directly
- value of structure
- values of contents (option, % of structure value)
- indirect damage (dollar amount or % structure and contents)
- development density (number of structures per grid cell)
- vacancy allowance (amount of land classified in the particular category that is developed)

This data is prepared by land use category and the program then accesses the grid data file and computes elevation-damage relations for all pertinent land use categories and damage reaches. Table V-2 AGGREGATE DAMAGE FUNCTIONS - INDEX STATION 1 contains a tabulation of the aggregate damage functions for the existing and 1990 land use patterns by land use category for damage index location 1, which is the lower reach of Trail Creek and includes part of the city of Athens, Georgia. The 1990 tabulation observes a policy of not placing the future flood plain development below the 100-year flood elevations.

The development of the aggregate damage functions for alternative future land use patterns (and basin watershed developments for that matter) can be performed by one of two methods. The first is to simply apply the process just described to the future land use patterns with perhaps some adjustments for values of structures, contents, and the proportion of land developed. This method probably will place some future land use within the 100-year flood plain and will not observe any development control policy. A second method that has been developed will accept policy elevations for each index location and by essentially a reverse of the process described in Fig. V-2, place all such designated new land use (change from existing) no lower than the policy flood level. For example, this method would permit a policy of requiring future development to be designed and flood

TABLE V-2

**Trail Creek Test
Aggregate Damage Functions
Index Station 1
(1000's of Dollars)**

| Elev. | Exist. Land Use ¹ | | | | | 1990 Land Use ² | | | | | |
|-------|------------------------------|-----|-------|-----|-------|----------------------------|------|--------|--------|-----|--------|
| | 1 | 6 | 7 | 9 | Total | 1 | 4 | 7 | 8 | 9 | Total |
| 640.0 | 0.0 | 0.0 | 0.0 | 0.0 | 0.0 | 0.0 | 0.0 | 0.0 | 0.0 | 0.0 | |
| 645.0 | 0.5 | 0.1 | 0.0 | 0.0 | 0.6 | 0.6 | 0.0 | 0.0 | 0.0 | 0.0 | 0.6 |
| 650.0 | 1.2 | 0.4 | 0.0 | 0.0 | 1.6 | 1.1 | 0.0 | 0.0 | 0.0 | 0.1 | 1.2 |
| 651.0 | 1.4 | 0.4 | 0.0 | 0.1 | 1.9 | 1.3 | 0.0 | 0.0 | 0.0 | 0.1 | 1.4 |
| 652.0 | 1.5 | 0.4 | 0.0 | 0.1 | 1.9 | 1.4 | 0.0 | 0.0 | 29.9 | 0.2 | 31.5 |
| 653.0 | 1.6 | 0.4 | 0.0 | 0.1 | 2.1 | 1.6 | 0.0 | 0.0 | 57.3 | 0.2 | 59.1 |
| 654.0 | 1.9 | 0.4 | 0.0 | 0.1 | 2.4 | 1.7 | 0.0 | 0.0 | 91.9 | 0.2 | 93.8 |
| 655.0 | 2.4 | 0.4 | 0.0 | 0.1 | 2.9 | 1.9 | 0.0 | 7.4 | 132.2 | 0.2 | 141.8 |
| 656.0 | 2.8 | 0.4 | 1.2 | 0.2 | 4.6 | 2.1 | 0.0 | 68.9 | 181.9 | 0.3 | 253.2 |
| 657.0 | 3.1 | 0.4 | 1.2 | 0.2 | 4.9 | 2.2 | 0.0 | 285.1 | 400.1 | 0.3 | 687.7 |
| 658.0 | 3.2 | 0.4 | 20.4 | 0.2 | 24.2 | 2.3 | 0.0 | 507.4 | 695.5 | 0.4 | 1205.6 |
| 659.0 | 3.4 | 0.4 | 86.1 | 0.2 | 90.1 | 2.3 | 0.0 | 685.7 | 972.0 | 0.4 | 1660.5 |
| 660.0 | 3.7 | 0.4 | 175.9 | 0.3 | 180.3 | 2.5 | 0.5 | 842.8 | 1219.7 | 0.5 | 2066.5 |
| 661.0 | 4.0 | 0.4 | 267.5 | 0.3 | 272.2 | 2.5 | 2.2 | 1030.6 | 1499.9 | 0.6 | 2535.6 |
| 662.0 | 4.2 | 0.4 | 325.1 | 0.4 | 330.1 | 2.6 | 5.0 | 1170.9 | 1758.1 | 0.6 | 2937.2 |
| 663.0 | 4.4 | 0.4 | 372.2 | 0.4 | 377.4 | 2.9 | 8.4 | 1317.3 | 1947.3 | 0.7 | 3276.5 |
| 664.0 | 4.5 | 0.5 | 410.6 | 0.4 | 416.0 | 3.0 | 11.4 | 1542.9 | 2094.2 | 0.7 | 3652.2 |
| 665.0 | 4.6 | 0.5 | 442.8 | 0.5 | 448.3 | 3.2 | 13.0 | 1753.1 | 2196.3 | 0.8 | 3966.4 |

¹Land Use Categories Are:

- 1 = Natural vegetation
- 4 = Developed Open Spaces
- 6 = Agricultural

- 7 = Industrial
- 8 = Commercial
- 9 = Pasture

²1990 Land Use was elevated such that the zero depth of the composite damage function is at the existing conditions 100 yr. flood level.

proofed so as to not sustain damage from events that may occur more frequently than the 100-year event to be analyzed. The part of Table V-2 labeled 1990 LAND USE was developed for this policy assumption. The technique is not perfect but it is believed to be adequate for meeting the spirit of the policy and appropriate for the general assessments of alternative future land use patterns. A precisely accurate placement of future new land use at a policy level (say 100-year) could be obtained by adoption of the 100-year flood as the reference flood that would be placed in the grid cell data file.

Appendix E contains a complete printout of the damage functions for all Trail Creek damage index locations for each of the evaluation conditions and the alternative land use development policy of *not* placing future flood plain development below the *existing* 100-year flood elevations.

Land Use Pattern Damage Assessments

The single flood event damage calculations can be performed automatically by the DAMCAL computer program. The program accepts the water surface elevation of the event of interest for each damage index location and prints out the damage corresponding to those elevations.

The expected annual damage calculation requires that a rating curve (flow-stage relation) be developed for each index location (Chapter IV), that a flow exceedance frequency be developed for each index location (Chapter IV), and that these functions together with aggregate damage functions be coded for input to HEC-1. HEC-1 performs the integration to develop the existing conditions expected annual damages, automatically develops the modified conditions flow-exceedance frequency curves and performs the modified conditions evaluations. Table V-3 DAMAGE EVALUATIONS summarizes the single event (100-year flood) and expected annual damage assessments evaluated in the Trail Creek tests. The evaluation conditions are as described in Chapter II with the addition of an assessment of 1990 land use assuming no policy for land use development controls.

The results displayed in the Table are somewhat surprising and at first glance may be difficult to understand. An initial reaction might be that evaluation condition III should be similar to I since the policy of no new development occurring at elevations below the 100-year event is in effect. The Table shows a large increase in both expected annual damages and the damage due to the 100 year event. This increase is because (1) damage does occur below the zero depth elevation (see Table V-1 land use category 3), (2) the 100-year flood for 1990 land use conditions is higher than the 100-year flood for existing land use conditions, and (3) damages are sustained by new development from events that exceed the 100-year event.

The results are somewhat sensitive to assumptions and current policy is sufficiently ambiguous that the correct assumption to make is not obvious. It was assumed herein that the 100 year level that applies under the flood insurance program is that defined by existing land use conditions and that development is placed such that the finished ground floor (first floor) is placed at this 100-year elevation. The techniques can accept alternate

TABLE V-3
TRAIL CREEK TEST
DAMAGE EVALUATIONS
(1000's of Dollars)

| Evaluation Condition | Reach 1 | | Reach 2 | | Reach 3 | | Reach 4 | | Reach 5 | |
|---|----------|---------|----------|---------|----------|---------|----------|---------|----------|---------|
| | Ex. Ann. | 100 yr. | Ex. Ann. | 100 yr. | Ex. Ann. | 100 yr. | Ex. Ann. | 100 yr. | Ex. Ann. | 100 yr. |
| I Existing Land Use w/o SCS | 1.5 | 2.8 | 2.5 | 4.7 | 12.0 | 14.2 | .6 | 1.4 | 0 | 0 |
| II Existing Land Use w/SCS | 1.2 | 2.4 | 1.5 | 2.5 | 11.0 | 11.2 | .4 | .9 | 0 | 0 |
| III 1990 Land Use w/o SCS & w/100 yr. policy | 19.3 | 524.3 | 63.8 | 569.3 | 23.8 | 63.4 | .4 | .9 | 0 | 0 |
| IV 1990 Land Use w/SCS & w/100 yr. policy | 4.4 | 6.1 | 21.8 | 143.7 | 17.8 | 18.5 | .3 | .6 | 0 | 0 |
| V 1990 Land Use w/o SCS & w/o 100 yr. policy | 1033.3 | 1727.5 | 350.0 | 1300.0 | 32.7 | 152.0 | .4 | .9 | 0 | 0 |

assumptions such as use of a future 100-year flood elevation and placement of basements etc., above the designated flood. The consequences of the assumption regarding future damages seems sufficiently important that consistent policy should be established for use in future studies.

CHAPTER VI ENVIRONMENTAL ASSESSMENT

General Scope and Approach

The objective of the environmental assessment is a description of the environmental *status* of the watershed areas for alternative land use patterns. Since *environment* has many dimensions and essentially an unbounded potential analysis scope, the approach taken herein has been to confine the analysis to specific achievable and quantifiable assessments. The environmental assessments that have been adopted range from the quite simplistic coincident tabulation to intermediate complexities of locational attractiveness and water quality-soil erosion and the complex dynamic quality simulation of the receiving water in response to urban stormwater runoff and dry weather sanitary loading. The techniques draw heavily upon the grid cell data file for information, and on spatial analysis techniques for some computations. In general, utility computer programs access the data bank and either directly produce the results (as in the case of the coincident tabulation and locational attractiveness) or analyze and format the data for subsequent input to computer models that perform the analysis.

The specific evaluation/analysis concepts that will be discussed include:

- Coincident tabulation
- Locational attractiveness
- Urban stormwater quality
- Watershed land surface erosion
- Dynamic stream water quality

Fig. VI-1 ENVIRONMENTAL ASSESSMENT PROCEDURE is a flow chart of the environmental assessment process developed for the Trail Creek test evaluations.

Coincident Tabulation

The coincident tabulation is considered as a first level of analysis and is essentially a data display type of environmental cataloging of change. The concept is to track changes in watershed land use coincident with an environmental interpretation of the watershed. Assuming that grid files for any pair of data of interest are resident in the data file, and that a particular watershed polygon file (such as subbasins or damage reaches) also is resident in the data file, then the coincident analysis may be performed. The coincident tabulation that was selected to illustrate the capability was the two land use patterns; existing and 1990, because it also illustrates the consistency checking capability of the coincident analysis. Fig. VI-2 LAND USE COINCIDENTS is the coincident tabulation for the two land use conditions for damage reach no. 2.

The values displayed in the figure are the number of acres which are coincident with the row and column categories. The diagonal values in the matrix are the number of acres which have not changed land use classification from the existing condition to the 1990

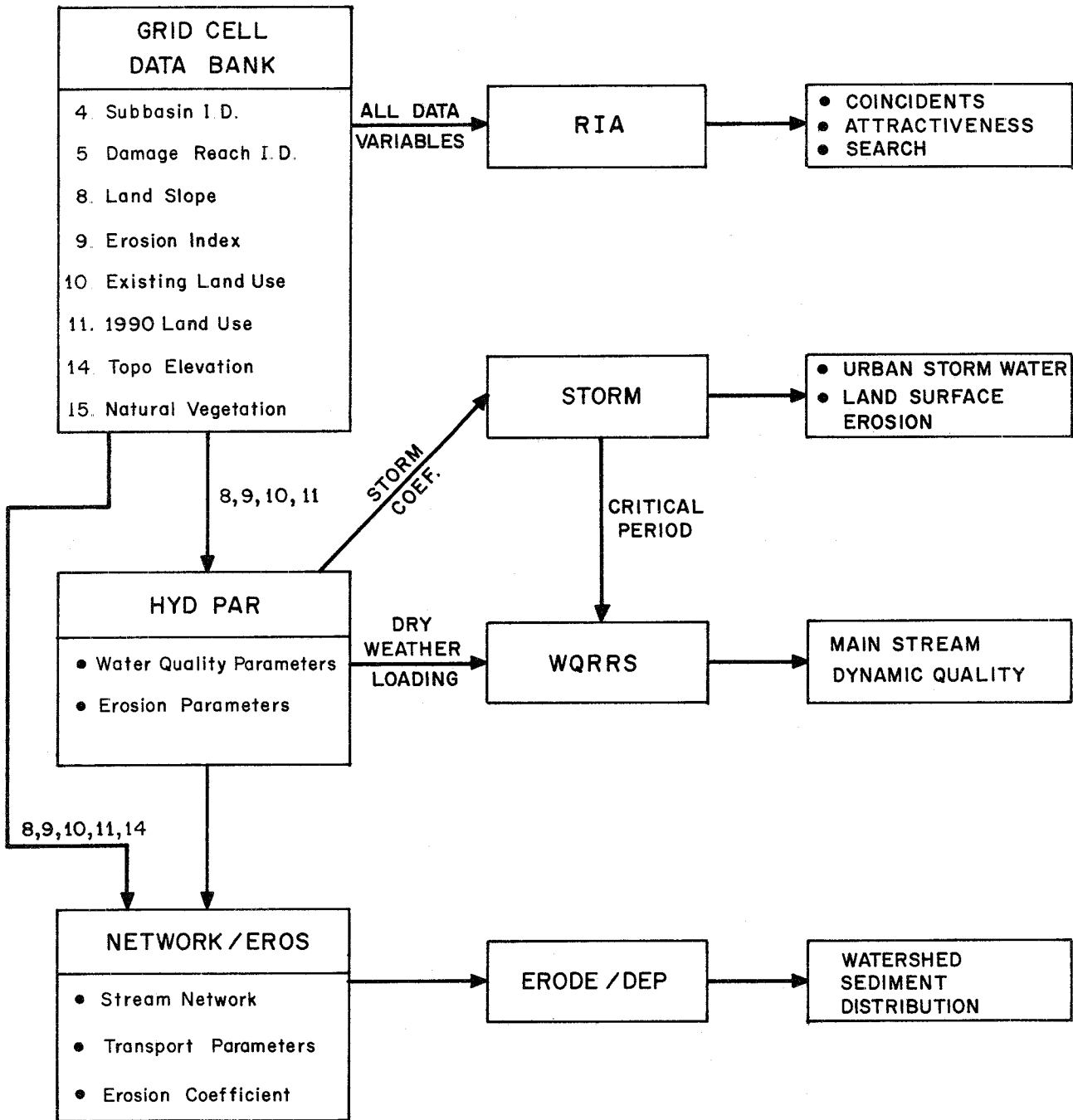

ENVIRONMENTAL ASSESSMENT PROCEDURE

Figure VI-1

UPPER OCONEE PILOT FPI
TRAIL CREEK TEST
LAND USE COINCIDENTS

DAMAGE REACH 2
COINCIDENTS MATRIX

| | 1 | 2 | 3 | 4 | 5 | 6 | 7 | 8 | 9 | 10 | TOTAL |
|-------|--------|------|------|-------|------|------|-------|-------|--------|------|--------|
| 1 | 105.57 | 0.00 | 0.00 | 6.12 | 0.00 | 0.00 | 41.31 | 27.54 | 91.80 | 0.00 | 272.34 |
| 2 | 0.00 | 0.00 | 0.00 | 0.00 | 0.00 | 0.00 | 0.00 | 0.00 | 0.00 | 0.00 | 0.00 |
| 3 | 0.00 | 0.00 | 0.00 | 3.06 | 0.00 | 0.00 | 0.00 | 0.00 | 0.00 | 0.00 | 3.06 |
| 4 | 0.00 | 0.00 | 0.00 | 0.00 | 0.00 | 0.00 | 0.00 | 0.00 | 0.00 | 0.00 | 0.00 |
| 5 | 0.00 | 0.00 | 0.00 | 0.00 | 0.00 | 0.00 | 0.00 | 0.00 | 0.00 | 0.00 | 0.00 |
| 6 | 6.12 | 0.00 | 0.00 | 0.00 | 0.00 | 0.00 | 6.12 | 0.00 | 7.65 | 0.00 | 19.89 |
| 7 | 4.59 | 0.00 | 0.00 | 0.00 | 0.00 | 0.00 | 13.77 | 0.00 | 4.59 | 0.00 | 22.95 |
| 8 | 0.00 | 0.00 | 0.00 | 0.00 | 0.00 | 0.00 | 0.00 | 0.00 | 0.00 | 0.00 | 0.00 |
| 9 | 24.48 | 0.00 | 0.00 | 1.53 | 0.00 | 0.00 | 10.71 | 9.18 | 24.48 | 0.00 | 70.38 |
| 10 | 0.00 | 0.00 | 0.00 | 0.00 | 0.00 | 0.00 | 0.00 | 0.00 | 0.00 | 0.00 | 0.00 |
| TOTAL | 140.76 | 0.00 | 0.00 | 10.71 | 0.00 | 0.00 | 71.91 | 36.72 | 128.52 | 0.00 | |

ROW CATEGORIES ARE EXISTING LAND USE

- 1 NATURAL VEGETATION
- 2 DEVELOPED OPEN SPACE
- 3 LOW DENSITY HOUSING
- 4 MEDIUM DENSITY HOUSING
- 5 HIGH DENSITY HOUSING
- 6 AGRICULTURE
- 7 INDUSTRIAL
- 8 COMMERCIAL
- 9 PASTURE
- 10 WATERBODY

COLUMN CATEGORIES ARE 1990 LAND USE

- 1 NATURAL VEGETATION
- 2 DEVELOPED OPEN SPACE
- 3 LOW DENSITY HOUSING
- 4 MEDIUM DENSITY HOUSING
- 5 HIGH DENSITY HOUSING
- 6 AGRICULTURE
- 7 INDUSTRIAL
- 8 COMMERCIAL
- 9 PASTURE
- 10 WATERBODY

LAND USE COINCIDENTS

Figure VI-2

alternative future condition. The off diagonal values are the number of acres which have been changed from the row category to the column category. For example, reading horizontally in row 1, 106 acres that were classified as natural vegetation under existing conditions remain so classified under 1990 conditions, 6 acres of land classified as natural vegetation under existing conditions is converted to medium density residential use, 41 acres that were classified as natural vegetation were converted to industrial land use, and similarly 28 acres to commercial land use and 92 acres to pasture. The total amount of land classified as natural vegetation under existing conditions is 272 acres (sum of row 1 horizontal values) while the total amount of land classified as natural vegetation under 1990 conditions is 141 acres (sum of column 1 values).

The ability of such a tabulation to pinpoint inconsistencies can be seen from examining row 7, industrial land use. Notice the tabulation indicates that 5 acres of industrial development under existing conditions is converted to natural vegetation (column 1) and an additional 5 acres are converted to pasture (column 9), an unlikely situation.

Locational Attractiveness

Locational attractiveness is an environmental land use pattern development technique that was developed at Harvard University and reported in (8) that emphasizes identifying the combination of locational characteristics that would be attractive for a particular land use activity. The technique is essentially a computerized extension of McHarg's original overlay system (9). Two potential applications of the technique are possible in the context of the pilot FPI, one as an assist in developing a specific land use pattern and the other a tool for *qualitatively* evaluating the environmental integrity of an entire land use pattern or of a particular land use category of a land use pattern.

In those instances where alternative land use patterns have not been developed, and must be for study, the development of attractiveness displays, indicating the relative attractiveness among portions of the study area, could be used as a guide in the allocation process described in Chapter III. A previously developed land use pattern could be *qualitatively* assessed by comparing the land use pattern to an attractiveness display for any or all land use categories.

"Attractiveness" is defined as the qualitative relative score of each grid of land within a specific study area. The score is computed and normalized based on subjective judgments as to attractive locational characteristics for a particular land use of interest. For example, land that is relatively flat and without severe construction problems, absent of endangered species wildlife and near major transportation routes is more attractive for industrial development than steep land that is far removed from major transportation routes. The relative attractiveness score is determined by computing an index for each grid cell from the land characteristics of concern and weights between variables (e.g., relatively speaking transportation access is more important than terrain) and normalizing the range to a standard range. The normalized scores may be then displayed in relative grey shades by computer-printer plots similar to other graphic displays contained in this report.

Fig. VI-3 NEIGHBORHOOD PARKS LOCATIONAL ATTRACTIVENESS is a computer-printer plot of locational attractiveness for neighborhood parks within the Trail Creek Basin. The darker shaded areas are, in a relative sense, more attractive for park development than the lighter shaded areas. The data variables of damage reaches (areas within the flood plain are preferred over areas outside the floodplain), land surface slope (flat and mild slopes are preferred over steep slopes), existing land use (natural vegetation, agriculture and pasture are favored over other categories), and distance to housing (areas near the low, medium and high density residential areas are preferred to areas removed and to areas near other land uses) were used in the determination.

A concerted effort is being exerted to ascertain the utility of this analysis procedure in the pilot FPI study. The nature of the logical use of this technique is such that a valid judgement will likely not be possible until near the end of the pilot study period.

Water Quality

The water quality analysis planned for the pilot study includes urban stormwater quality forecasting and in-stream dynamic water quality simulation of the response of the receiving water to stormwater inflows and projected domestic/industrial loading.

Urban Storm Runoff: The quantity and quality of urban storm runoff will be determined for a single synthetic event and for wet weather events during a critical continuous period of historic record. The single event pollutographs will constitute an evaluation objective in themselves and the short continuous period will be used as input to the in-stream dynamic simulation. A utility computer program accesses the data file and formats the appropriate data (land use, etc.) for operation by the model STORM. STORM is then executed for the events of interest generating pollutographs for each subbasin within a watershed (such as Trail Creek) for a single event and wet weather events pollutographs for each watershed for the short continuous period. Fig. VI-4 TRAIL CREEK STORM POLLUTOGRAPHS is the printout pollutographs from STORM for a selected subbasin within Trail Creek for the 10-year synthetic event for the existing and 1990 land use patterns.

The pollutograph procedure incorporated into STORM uses state-of-the art technology for computation of the quality of runoff. The present version will predict the mass and concentration of five pollutants normally of interest in stormwater runoff studies (suspended solids, settleable solids, BOD, total nitrogen, and total orthophosphate). The mass of each pollutant on the watershed at the beginning of a runoff sequence is regulated by two coefficients. These are the pollutant accumulation rate (lbs/acre/day) which is a function of land use and the number of dry days prior to the event, the mass of pollutant at the beginning of runoff being the result of multiplication of the two factors. The pollutant accumulation rates for this study were taken from the literature. Runoff quantity is computed using the Soil Conservation Curve Number technique. Pollutant masses are computed during each time step using an exponential function which represents a "scheduled release" of pollutants from the land use. The mass of pollutants remaining on each land use decreases with time during a runoff sequence. The runoff quantity rate and a washoff decay coefficient "drive" the pollutant washoff equation.



SUMMARY OF ATTRACTIVENESS MODEL FOR NEIGHBORHOOD PARK SITES
 11568 CELLS WERE EVALUATED
 0 CELLS WERE REJECTED

| VAR | REASONING FOR CLASSIFICATION | WEIGHT | VARIABLE NAME |
|-----|------------------------------|--------|--------------------------|
| 1 | 0 1 2 3 4 5 6 7 8 9 | 1.00 | FLAND PLAIN |
| 2 | 0 1 2 3 4 5 6 7 8 9 | 1.00 | SOC STATE CLASSIFICATION |
| 10 | 0 1 2 3 4 5 6 7 8 9 | 1.00 | EXISTING LAND USE |
| 11 | 0 1 2 3 4 5 6 7 8 9 | 1.00 | ESTIMATE TO HOUSING |

ATTRACTIVENESS MAP
 FUTURE NEIGHBORHOOD
 PARK SITES

| LEVELS | RELATIVE ATTRACTIVENESS | | | | | | | | | |
|--------------|-------------------------|-------|-------|-------|-------|-------|-------|-------|-------|--------|
| | 1 | 2 | 3 | 4 | 5 | 6 | 7 | 8 | 9 | 10 |
| NO. CELLS | 1400 | 0 | 140 | 381 | 329 | 0 | 181 | 0 | 181 | 181 |
| MEAN VALUE | 80.00 | 45.00 | 65.00 | 75.00 | 75.00 | 85.00 | 85.00 | 95.00 | 95.00 | 95.00 |
| MAX VALUE | 80.00 | 85.00 | 90.00 | 95.00 | 95.00 | 95.00 | 95.00 | 95.00 | 95.00 | 100.00 |
| PERCENT AREA | 10.00 | 0.00 | 5.00 | 12.50 | 10.00 | 0.00 | 5.00 | 0.00 | 5.00 | 5.00 |
| PERCENT AREA | 74.51 | 0.00 | 1.25 | 3.29 | 4.46 | 0.00 | 1.33 | 0.00 | 1.33 | 1.33 |

NEIGHBORHOOD PARKS
 LOCAL ATTRACTIVENESS

EXISTING LAND USE

| STORM WATER POLLUTOGRAPHS FOR SUBBASIN NO. 21 | | | | | | | | | | | |
|---|---------------|-------------|--------------|------------------------|-------------------------|---------------|----------------|----------------|-----------------|-----------------|------------------|
| 60 MIN. INTERVALS | RAINFALL (IN) | RUNOFF (IN) | RUNOFF (CFS) | SUSPENDED SOLIDS (LBS) | SETTLABLE SOLIDS (MG/L) | B O D 5 (LBS) | B O D 5 (MG/L) | NITROGEN (LBS) | NITROGEN (MG/L) | PHOSPHATE (LBS) | PHOSPHATE (MG/L) |
| 1 | .06 | 0 | 0 | 0 | 0 | 0 | 0 | 0 | 0 | 0 | 0 |
| 2 | .06 | .00 | .12 | .41 | 14.85 | .02 | .70 | 6.0 | 21.71 | .31 | 11.07 |
| 3 | .06 | .00 | .63 | 2.40 | 17.28 | .10 | .69 | 3.01 | 21.12 | 1.54 | 10.77 |
| 4 | .06 | .00 | 1.02 | 4.41 | 19.15 | .16 | .70 | 4.52 | 19.62 | 2.30 | 10.00 |
| 5 | .06 | .00 | 1.30 | 5.97 | 20.37 | .21 | .70 | 5.16 | 17.61 | 2.63 | 8.97 |
| 6 | .06 | .00 | 1.51 | 7.16 | 21.14 | .24 | .70 | 5.25 | 15.45 | 2.67 | 7.87 |
| 7 | .07 | .00 | 2.01 | 10.39 | 23.01 | .33 | .73 | 6.06 | 13.43 | 3.11 | 6.89 |
| 8 | .07 | .00 | 2.24 | 11.80 | 23.40 | .38 | .74 | 5.80 | 11.49 | 3.01 | 5.96 |
| 9 | .08 | .01 | 2.80 | 15.70 | 24.99 | .49 | .77 | 6.23 | 9.91 | 3.27 | 5.20 |
| 10 | .08 | .01 | 3.00 | 16.85 | 25.01 | .53 | .78 | 5.67 | 8.41 | 3.01 | 4.46 |
| 11 | .14 | .01 | 6.10 | 41.88 | 30.54 | 1.22 | .89 | 9.85 | 7.19 | 5.24 | 3.82 |
| 12 | .20 | .02 | 10.99 | 77.16 | 31.25 | 2.42 | .98 | 13.76 | 5.57 | 7.28 | 2.95 |
| 13 | .22 | .03 | 14.61 | 90.10 | 27.44 | 3.12 | .95 | 13.67 | 4.16 | 7.16 | 2.18 |
| 14 | .24 | .04 | 19.87 | 101.05 | 22.64 | 3.92 | .88 | 13.63 | 3.05 | 7.01 | 1.57 |
| 15 | .24 | .05 | 27.84 | 100.21 | 16.02 | 4.26 | .88 | 12.73 | 2.03 | 6.34 | 1.01 |
| 16 | .26 | .07 | 38.47 | 112.86 | 13.05 | 5.22 | .60 | 13.62 | 1.58 | 6.62 | .77 |
| 17 | 1.34 | .57 | 302.08 | 1045.37 | 15.40 | 101.81 | 1.50 | 111.92 | 1.65 | 54.90 | .81 |
| 18 | .66 | .37 | 195.49 | 168.04 | 3.83 | 11.32 | .26 | 17.58 | .40 | 8.64 | .20 |
| 19 | .05 | .03 | 15.76 | 3.02 | .85 | .27 | .07 | .33 | .09 | .16 | .04 |
| 20 | .05 | .03 | 15.89 | 3.04 | .85 | .27 | .07 | .33 | .09 | .16 | .04 |
| 21 | .05 | .03 | 16.01 | 3.05 | .85 | .27 | .07 | .33 | .09 | .16 | .04 |
| 22 | .05 | .03 | 16.13 | 3.05 | .84 | .27 | .07 | .33 | .09 | .16 | .04 |
| 23 | .07 | .04 | 22.77 | 4.79 | .94 | .39 | .08 | .50 | .10 | .25 | .05 |
| 24 | .07 | .04 | 23.00 | 4.81 | .93 | .39 | .08 | .50 | .10 | .25 | .05 |
| 25 | .06 | .04 | 19.88 | 3.91 | .88 | .33 | .07 | .41 | .09 | .20 | .05 |
| 26 | .06 | .04 | 20.04 | 3.92 | .87 | .34 | .07 | .41 | .09 | .20 | .05 |
| TOTALS 4.42 1.46 | | | | | | | | | | | |
| SUMMARY BY LAND USE | | | | | | | | | | | |
| LAND USE | | | | | | | | | | | |
| 01 | | | | 204.30 | | 8.91 | | 23.55 | | 10.93 | 1.30 |
| 02 | | | | 510.00 | | 23.01 | | 54.40 | | 26.35 | 2.84 |
| 04 | | | | 299.38 | | 23.69 | | 36.71 | | 18.27 | 1.58 |
| 05 | | | | 314.76 | | 31.39 | | 43.80 | | 23.70 | 1.79 |
| 08 | | | | 512.97 | | 51.26 | | 93.72 | | 47.31 | 2.98 |
| TOTALS 1841.46 138.25 252.20 126.56 10.48 | | | | | | | | | | | |

1990 LAND USE

| STORM WATER POLLUTOGRAPHS FOR SUBBASIN NO. 21 | | | | | | | | | | | |
|---|---------------|-------------|--------------|------------------------|-------------------------|---------------|----------------|----------------|-----------------|-----------------|------------------|
| 60 MIN. INTERVALS | RAINFALL (IN) | RUNOFF (IN) | RUNOFF (CFS) | SUSPENDED SOLIDS (LBS) | SETTLABLE SOLIDS (MG/L) | B O D 5 (LBS) | B O D 5 (MG/L) | NITROGEN (LBS) | NITROGEN (MG/L) | PHOSPHATE (LBS) | PHOSPHATE (MG/L) |
| 1 | .06 | 0 | 0 | 0 | 0 | 0 | 0 | 0 | 0 | 0 | 0 |
| 2 | .06 | .00 | .47 | .42 | 3.97 | .02 | .19 | 6.2 | 5.80 | .32 | 2.96 |
| 3 | .06 | .00 | 2.40 | 2.49 | 4.63 | .10 | .19 | 3.04 | 5.64 | 1.55 | 2.88 |
| 4 | .06 | .01 | 3.86 | 4.44 | 5.13 | .16 | .19 | 4.54 | 5.24 | 2.31 | 2.67 |
| 5 | .06 | .01 | 4.91 | 6.07 | 5.51 | .21 | .19 | 5.26 | 4.77 | 2.70 | 2.45 |
| 6 | .06 | .01 | 5.73 | 7.85 | 6.10 | .27 | .21 | 6.04 | 4.69 | 3.20 | 2.48 |
| 7 | .07 | .01 | 7.53 | 12.03 | 7.11 | .40 | .24 | 7.84 | 4.63 | 4.30 | 2.54 |
| 8 | .07 | .02 | 8.26 | 14.35 | 7.73 | .48 | .26 | 8.28 | 4.46 | 4.66 | 2.51 |
| 9 | .08 | .02 | 10.14 | 19.80 | 8.69 | .64 | .28 | 9.64 | 4.23 | 5.53 | 2.43 |
| 10 | .08 | .02 | 10.73 | 22.03 | 9.14 | .71 | .29 | 9.41 | 3.90 | 5.48 | 2.27 |
| 11 | .14 | .04 | 20.37 | 56.14 | 12.27 | 1.64 | .36 | 16.82 | 3.67 | 9.74 | 2.13 |
| 12 | .20 | .06 | 32.87 | 108.56 | 14.70 | 3.28 | .44 | 26.32 | 3.56 | 13.79 | 1.87 |
| 13 | .22 | .08 | 41.83 | 134.55 | 14.31 | 4.42 | .47 | 48.34 | 4.93 | 16.41 | 1.75 |
| 14 | .24 | .10 | 51.94 | 158.14 | 13.55 | 5.73 | .49 | 65.69 | 5.63 | 18.79 | 1.61 |
| 15 | .24 | .11 | 58.88 | 159.80 | 12.08 | 6.33 | .48 | 69.93 | 5.29 | 18.24 | 1.38 |
| 16 | .26 | .13 | 70.56 | 180.24 | 11.37 | 7.83 | .49 | 71.05 | 4.48 | 18.43 | 1.16 |
| 17 | 1.34 | .83 | 443.69 | 1554.89 | 15.59 | 157.22 | 1.58 | 268.24 | 2.69 | 97.72 | .98 |
| 18 | .66 | .47 | 252.72 | 192.01 | 3.38 | 15.07 | .27 | 25.08 | .44 | 10.67 | .19 |
| 19 | .05 | .04 | 19.82 | 3.34 | .75 | .33 | .07 | .49 | .11 | .19 | .04 |
| 20 | .05 | .04 | 19.90 | 3.35 | .75 | .33 | .07 | .47 | .11 | .19 | .04 |
| 21 | .05 | .04 | 19.98 | 3.36 | .75 | .34 | .07 | .45 | .10 | .19 | .04 |
| 22 | .05 | .04 | 20.07 | 3.37 | .75 | .34 | .07 | .44 | .10 | .19 | .04 |
| 23 | .07 | .05 | 28.23 | 5.28 | .83 | .49 | .08 | .65 | .10 | .29 | .05 |
| 24 | .07 | .05 | 28.38 | 5.29 | .83 | .49 | .08 | .63 | .10 | .29 | .05 |
| 25 | .06 | .05 | 24.45 | 4.30 | .78 | .42 | .08 | .51 | .09 | .23 | .04 |
| 26 | .06 | .05 | 24.55 | 4.31 | .78 | .42 | .08 | .50 | .09 | .23 | .04 |
| TOTALS 4.42 2.28 | | | | | | | | | | | |
| SUMMARY BY LAND USE | | | | | | | | | | | |
| LAND USE | | | | | | | | | | | |
| 01 | | | | 202.59 | | 8.78 | | 23.37 | | 10.84 | 1.29 |
| 02 | | | | 510.00 | | 23.01 | | 54.40 | | 26.35 | 2.84 |
| 04 | | | | 299.38 | | 23.69 | | 36.71 | | 18.27 | 1.58 |
| 05 | | | | 314.76 | | 31.39 | | 43.80 | | 23.70 | 1.79 |
| 07 | | | | 488.19 | | 48.73 | | 83.21 | | 47.77 | 2.75 |
| 08 | | | | 512.97 | | 51.26 | | 93.72 | | 47.31 | 2.98 |
| 09 | | | | 338.59 | | 20.80 | | 313.05 | | 61.38 | 33.19 |
| TOTALS 2666.49 207.65 648.27 235.63 46.40 | | | | | | | | | | | |

TRAIL CREEK
STORM POLLUTOGRAPHS

Figure VI-4

In-Stream Quality: In-stream water quality simulation is planned for the main stem Oconee River. The stream will be modeled some distance above the study area to a specified distance beyond the lower boundary of the study area. The input data for the simulation modeling will be very general in nature consistent with the objective of providing a general assessment of alternative land use patterns. The quality simulation, however, will be quite specific and complex. Model parameters will be determined primarily by transfer of coefficients developed in other nearby studies such as the metropolitan Atlanta Urban Study. Dry weather, sanitary, and treated effluent loading will be developed from general relationships that will relate land use as catalogued in the data file to quantity and quality of loadings. Stormwater loadings will be computed by STORM as described above. The simulation will be performed for a selected historic period that will probably be late summer when Oconee streamflows are low and intense thunder showers generate the urban storm runoff.

The simulation model that will be used is the WQRRS model (5) that has been under development by HEC and others for a number of years. No testing of the concept of a general simulation for this study has yet been performed because Trail Creek, because of its size, is inappropriate for in-stream quality simulation. Valid judgement of the utility of simulation of in-stream quality using very generalized inputs as is planned for the Phase I Oconee Basin pilot study will not be possible until near the end of the pilot study period.

Land Erosion and Sedimentation

Two levels of land surface erosion analysis have been developed for application in the pilot study. The basic level is to compute land surface erosion potential for each grid cell within the study area. The data variables of land use, slope and soil erosion index will be automatically retrieved from the data bank and formatted for use in erosion potential calculations. The computations will be performed by the STORM program for alternative land use patterns and the results displayed in computer graphic format. Fig. VI-5 LAND SURFACE EROSION POTENTIAL-EXISTING LAND USE and Fig. VI-6 LAND SURFACE EROSION POTENTIAL-1990 LAND USE are computer-printer plots graphic displays of land surface erosion potential for Trail Creek for existing and 1990 land use conditions.

The procedure used to compute land surface erosion is the Soil Conservation Service Universal Soil Loss Equation. The method is well-documented in the STORM users manual (4).

The equation is

$$SER = (EI) (K) (LS) (C) (P) (SDR)$$

where

SER = soil erosion note in tons/acre/storm event

EI = rainfall impact energy factor. A 10-year rainfall event was used in the Trail Creek Study.

K = soil erodibility factor, taken from local SCS information for each soil type found in the Trail Creek Watershed.

WATER RESOURCE PROTECTION
 MODEL DATA FILE
 REGIONAL MODEL DATA FILE
 EXISTING LAND USE

DATA NAME EXTENSION ARE VALUE PERCENT

| LAND USE | VALUE | PERCENT | PERCENTAGE | PERCENTAGE |
|----------|-----------|-----------|------------|------------|
| 1 | 1000000 | 1000000 | 1000000 | 1000000 |
| 2 | 2000000 | 2000000 | 2000000 | 2000000 |
| 3 | 3000000 | 3000000 | 3000000 | 3000000 |
| 4 | 4000000 | 4000000 | 4000000 | 4000000 |
| 5 | 5000000 | 5000000 | 5000000 | 5000000 |
| 6 | 6000000 | 6000000 | 6000000 | 6000000 |
| 7 | 7000000 | 7000000 | 7000000 | 7000000 |
| 8 | 8000000 | 8000000 | 8000000 | 8000000 |
| 9 | 9000000 | 9000000 | 9000000 | 9000000 |
| 10 | 10000000 | 10000000 | 10000000 | 10000000 |
| 11 | 11000000 | 11000000 | 11000000 | 11000000 |
| 12 | 12000000 | 12000000 | 12000000 | 12000000 |
| 13 | 13000000 | 13000000 | 13000000 | 13000000 |
| 14 | 14000000 | 14000000 | 14000000 | 14000000 |
| 15 | 15000000 | 15000000 | 15000000 | 15000000 |
| 16 | 16000000 | 16000000 | 16000000 | 16000000 |
| 17 | 17000000 | 17000000 | 17000000 | 17000000 |
| 18 | 18000000 | 18000000 | 18000000 | 18000000 |
| 19 | 19000000 | 19000000 | 19000000 | 19000000 |
| 20 | 20000000 | 20000000 | 20000000 | 20000000 |
| 21 | 21000000 | 21000000 | 21000000 | 21000000 |
| 22 | 22000000 | 22000000 | 22000000 | 22000000 |
| 23 | 23000000 | 23000000 | 23000000 | 23000000 |
| 24 | 24000000 | 24000000 | 24000000 | 24000000 |
| 25 | 25000000 | 25000000 | 25000000 | 25000000 |
| 26 | 26000000 | 26000000 | 26000000 | 26000000 |
| 27 | 27000000 | 27000000 | 27000000 | 27000000 |
| 28 | 28000000 | 28000000 | 28000000 | 28000000 |
| 29 | 29000000 | 29000000 | 29000000 | 29000000 |
| 30 | 30000000 | 30000000 | 30000000 | 30000000 |
| 31 | 31000000 | 31000000 | 31000000 | 31000000 |
| 32 | 32000000 | 32000000 | 32000000 | 32000000 |
| 33 | 33000000 | 33000000 | 33000000 | 33000000 |
| 34 | 34000000 | 34000000 | 34000000 | 34000000 |
| 35 | 35000000 | 35000000 | 35000000 | 35000000 |
| 36 | 36000000 | 36000000 | 36000000 | 36000000 |
| 37 | 37000000 | 37000000 | 37000000 | 37000000 |
| 38 | 38000000 | 38000000 | 38000000 | 38000000 |
| 39 | 39000000 | 39000000 | 39000000 | 39000000 |
| 40 | 40000000 | 40000000 | 40000000 | 40000000 |
| 41 | 41000000 | 41000000 | 41000000 | 41000000 |
| 42 | 42000000 | 42000000 | 42000000 | 42000000 |
| 43 | 43000000 | 43000000 | 43000000 | 43000000 |
| 44 | 44000000 | 44000000 | 44000000 | 44000000 |
| 45 | 45000000 | 45000000 | 45000000 | 45000000 |
| 46 | 46000000 | 46000000 | 46000000 | 46000000 |
| 47 | 47000000 | 47000000 | 47000000 | 47000000 |
| 48 | 48000000 | 48000000 | 48000000 | 48000000 |
| 49 | 49000000 | 49000000 | 49000000 | 49000000 |
| 50 | 50000000 | 50000000 | 50000000 | 50000000 |
| 51 | 51000000 | 51000000 | 51000000 | 51000000 |
| 52 | 52000000 | 52000000 | 52000000 | 52000000 |
| 53 | 53000000 | 53000000 | 53000000 | 53000000 |
| 54 | 54000000 | 54000000 | 54000000 | 54000000 |
| 55 | 55000000 | 55000000 | 55000000 | 55000000 |
| 56 | 56000000 | 56000000 | 56000000 | 56000000 |
| 57 | 57000000 | 57000000 | 57000000 | 57000000 |
| 58 | 58000000 | 58000000 | 58000000 | 58000000 |
| 59 | 59000000 | 59000000 | 59000000 | 59000000 |
| 60 | 60000000 | 60000000 | 60000000 | 60000000 |
| 61 | 61000000 | 61000000 | 61000000 | 61000000 |
| 62 | 62000000 | 62000000 | 62000000 | 62000000 |
| 63 | 63000000 | 63000000 | 63000000 | 63000000 |
| 64 | 64000000 | 64000000 | 64000000 | 64000000 |
| 65 | 65000000 | 65000000 | 65000000 | 65000000 |
| 66 | 66000000 | 66000000 | 66000000 | 66000000 |
| 67 | 67000000 | 67000000 | 67000000 | 67000000 |
| 68 | 68000000 | 68000000 | 68000000 | 68000000 |
| 69 | 69000000 | 69000000 | 69000000 | 69000000 |
| 70 | 70000000 | 70000000 | 70000000 | 70000000 |
| 71 | 71000000 | 71000000 | 71000000 | 71000000 |
| 72 | 72000000 | 72000000 | 72000000 | 72000000 |
| 73 | 73000000 | 73000000 | 73000000 | 73000000 |
| 74 | 74000000 | 74000000 | 74000000 | 74000000 |
| 75 | 75000000 | 75000000 | 75000000 | 75000000 |
| 76 | 76000000 | 76000000 | 76000000 | 76000000 |
| 77 | 77000000 | 77000000 | 77000000 | 77000000 |
| 78 | 78000000 | 78000000 | 78000000 | 78000000 |
| 79 | 79000000 | 79000000 | 79000000 | 79000000 |
| 80 | 80000000 | 80000000 | 80000000 | 80000000 |
| 81 | 81000000 | 81000000 | 81000000 | 81000000 |
| 82 | 82000000 | 82000000 | 82000000 | 82000000 |
| 83 | 83000000 | 83000000 | 83000000 | 83000000 |
| 84 | 84000000 | 84000000 | 84000000 | 84000000 |
| 85 | 85000000 | 85000000 | 85000000 | 85000000 |
| 86 | 86000000 | 86000000 | 86000000 | 86000000 |
| 87 | 87000000 | 87000000 | 87000000 | 87000000 |
| 88 | 88000000 | 88000000 | 88000000 | 88000000 |
| 89 | 89000000 | 89000000 | 89000000 | 89000000 |
| 90 | 90000000 | 90000000 | 90000000 | 90000000 |
| 91 | 91000000 | 91000000 | 91000000 | 91000000 |
| 92 | 92000000 | 92000000 | 92000000 | 92000000 |
| 93 | 93000000 | 93000000 | 93000000 | 93000000 |
| 94 | 94000000 | 94000000 | 94000000 | 94000000 |
| 95 | 95000000 | 95000000 | 95000000 | 95000000 |
| 96 | 96000000 | 96000000 | 96000000 | 96000000 |
| 97 | 97000000 | 97000000 | 97000000 | 97000000 |
| 98 | 98000000 | 98000000 | 98000000 | 98000000 |
| 99 | 99000000 | 99000000 | 99000000 | 99000000 |
| 100 | 100000000 | 100000000 | 100000000 | 100000000 |

0 TO 25 TONS PER SQUARE FOOT
 26 TO 40 TONS PER SQUARE FOOT
 41 TO 60 TONS PER SQUARE FOOT
 61 TO 80 TONS PER SQUARE FOOT
 81 TO 100 TONS PER SQUARE FOOT
 101 TO 120 TONS PER SQUARE FOOT
 121 TO 150 TONS PER SQUARE FOOT
 151 TO 175 TONS PER SQUARE FOOT
 176 TO 200 TONS PER SQUARE FOOT
 201 TO 250 TONS PER SQUARE FOOT
 251 TO 300 TONS PER SQUARE FOOT
 301 TO 350 TONS PER SQUARE FOOT
 351 TO 400 TONS PER SQUARE FOOT
 401 TO 450 TONS PER SQUARE FOOT
 451 TO 500 TONS PER SQUARE FOOT
 501 TO 550 TONS PER SQUARE FOOT
 551 TO 600 TONS PER SQUARE FOOT
 601 TO 650 TONS PER SQUARE FOOT
 651 TO 700 TONS PER SQUARE FOOT
 701 TO 750 TONS PER SQUARE FOOT
 751 TO 800 TONS PER SQUARE FOOT
 801 TO 850 TONS PER SQUARE FOOT
 851 TO 900 TONS PER SQUARE FOOT
 901 TO 950 TONS PER SQUARE FOOT
 951 TO 1000 TONS PER SQUARE FOOT

LAND SURFACE
 EROSION POTENTIAL -
 EXISTING LAND USE

Figure 3E-3

UNION COUNTY AGRICULTURAL
 SOIL CONSERVATION DISTRICT
 DISTRICT OFFICE IN THE NEW BRUNSWICK
 COUNTY COURTHOUSE

DATA VALUE OF ESTIMATED AREAS

| LEVEL | SPRINKLER | AREA VALUE | PERCENTAGE | PERCENTAGE | PERCENTAGE | PERCENTAGE |
|-------|-----------|------------|------------|------------|------------|------------|
| 100 | 110 | 120 | 130 | 140 | 150 | 160 |
| 1 | 110 | 120 | 130 | 140 | 150 | 160 |
| 2 | 110 | 120 | 130 | 140 | 150 | 160 |
| 3 | 110 | 120 | 130 | 140 | 150 | 160 |
| 4 | 110 | 120 | 130 | 140 | 150 | 160 |
| 5 | 110 | 120 | 130 | 140 | 150 | 160 |
| 6 | 110 | 120 | 130 | 140 | 150 | 160 |
| 7 | 110 | 120 | 130 | 140 | 150 | 160 |
| 8 | 110 | 120 | 130 | 140 | 150 | 160 |
| 9 | 110 | 120 | 130 | 140 | 150 | 160 |
| 10 | 110 | 120 | 130 | 140 | 150 | 160 |
| 11 | 110 | 120 | 130 | 140 | 150 | 160 |
| 12 | 110 | 120 | 130 | 140 | 150 | 160 |

0 TO 10 TONS PER ACRE
 10 TO 20 TONS PER ACRE
 20 TO 30 TONS PER ACRE
 30 TO 40 TONS PER ACRE
 40 TO 50 TONS PER ACRE
 50 TO 60 TONS PER ACRE
 60 TO 70 TONS PER ACRE
 70 TO 80 TONS PER ACRE
 80 TO 90 TONS PER ACRE
 90 TO 100 TONS PER ACRE
 100 TO 110 TONS PER ACRE
 110 TO 120 TONS PER ACRE
 120 TO 130 TONS PER ACRE
 130 TO 140 TONS PER ACRE
 140 TO 150 TONS PER ACRE
 150 TO 160 TONS PER ACRE

LAND SURFACE
 EROSION POTENTIAL -
 1990 LAND USE

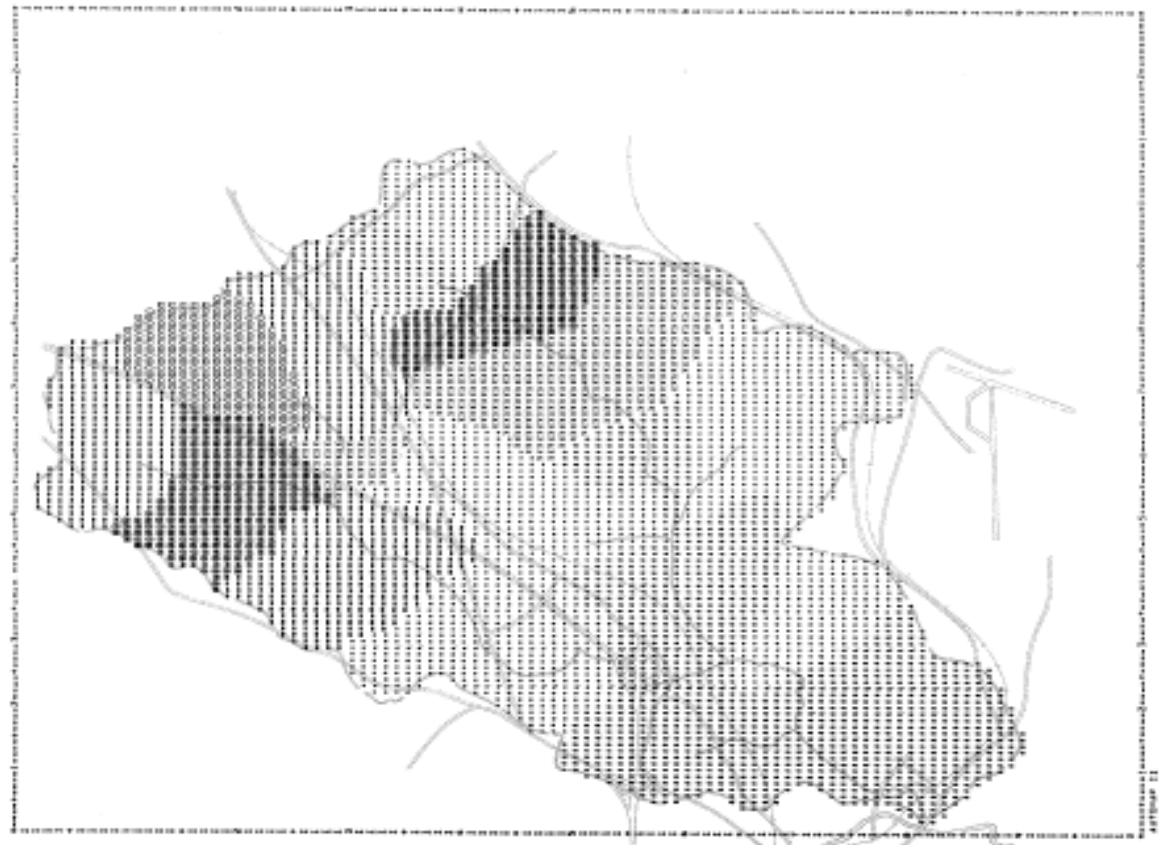

- LS = length slope factor, computed from a regression equation which uses the overland flow distance and the actual slope for each soil type. In this study the distance was a function of the slope.
- C = land surface cover factor, represents the character and extent of ground cover (i.e., trees, brush, grass, etc.). This factor was made a function of land use.
- P = erosion control factor, which is intended to represent manmade erosion control structures or practices. In this study P was indexed to imperviousness since streets, parking lots, driveways, etc., are very real erosion control measures.
- SDR = sediment delivery ratio, which represents the fraction of land surface erosion that finds its way out of the watershed in question. It has been related to watershed area in several studies. Reference 3 contains a curve which yielded $SDR = 0.4$ for the average subwatershed size used in the Trail Creek Study.

The equation is applied to each subbasin within a watershed for which the appropriate parameters have been aggregated from the grid data file.

CHAPTER VII

DATA MANAGEMENT AND PROCESSING

Data Management Components

Data management refers to the overall computer process beginning with acquisition of raw data through the creation of the grid cell data file and concluding with the computer model processing of formatted data to yield analysis results. Because the techniques discussed in this report have been developed around the concept of a central accessible gridded data file, the construction and efficient manipulation of the data bank is of paramount importance. The grid cell data file in effect becomes the dynamic heart of the capability to perform efficient, systematic analysis of alternative land use patterns, an important objective of the expanded FPI concept. Fig. VII-1 DATA MANAGEMENT AND MODELING PROCESS is an expanded version of Fig. IV-2 and displays a complete definition of the data management process, identifying the overall interactive use of the data file and modeling programs, and cataloging the output of the overall analysis process. The key components that are identified that will be discussed include:

- Data assembly
- Data encoding
- Data processing
- Data bank creation
- Utility processing and interactive modeling

Data Assembly

Data assembly includes all activities beginning at the completion of the definition of the objectives of the study and subsequent contents of the to-be-developed data bank and concluding upon initiation of the encoding process. It is also at this stage that the relative scope and detail of analysis needs definition so that data of the appropriate scale and resolution is assembled for encoding.

Particular attention must be paid to the scope and detail desired from the processing of the data. Creation of a data bank is a demanding, rather tedious task that is neither trivial nor inexpensive. It should be obvious that the validity of the analysis will only be as good as the integrity of the data bank permits.

Data Types: The various types of data that can be cataloged into data files may be classified as areal information, contour proximal information, line information and point information. Each data type is characteristic of categories of information as follows:

- Areal information is the most common type and constitutes most of the variables in the Trail Creek test data bank. Land use and soil types are examples of areal data.
- Countour-Proximal data generally constitutes information that has been extrapolated from point values. Census tracts, political subdivisions, and the like constitute *proximal* data sets (all cells within the *proximity* of a point such as the centroid have identical

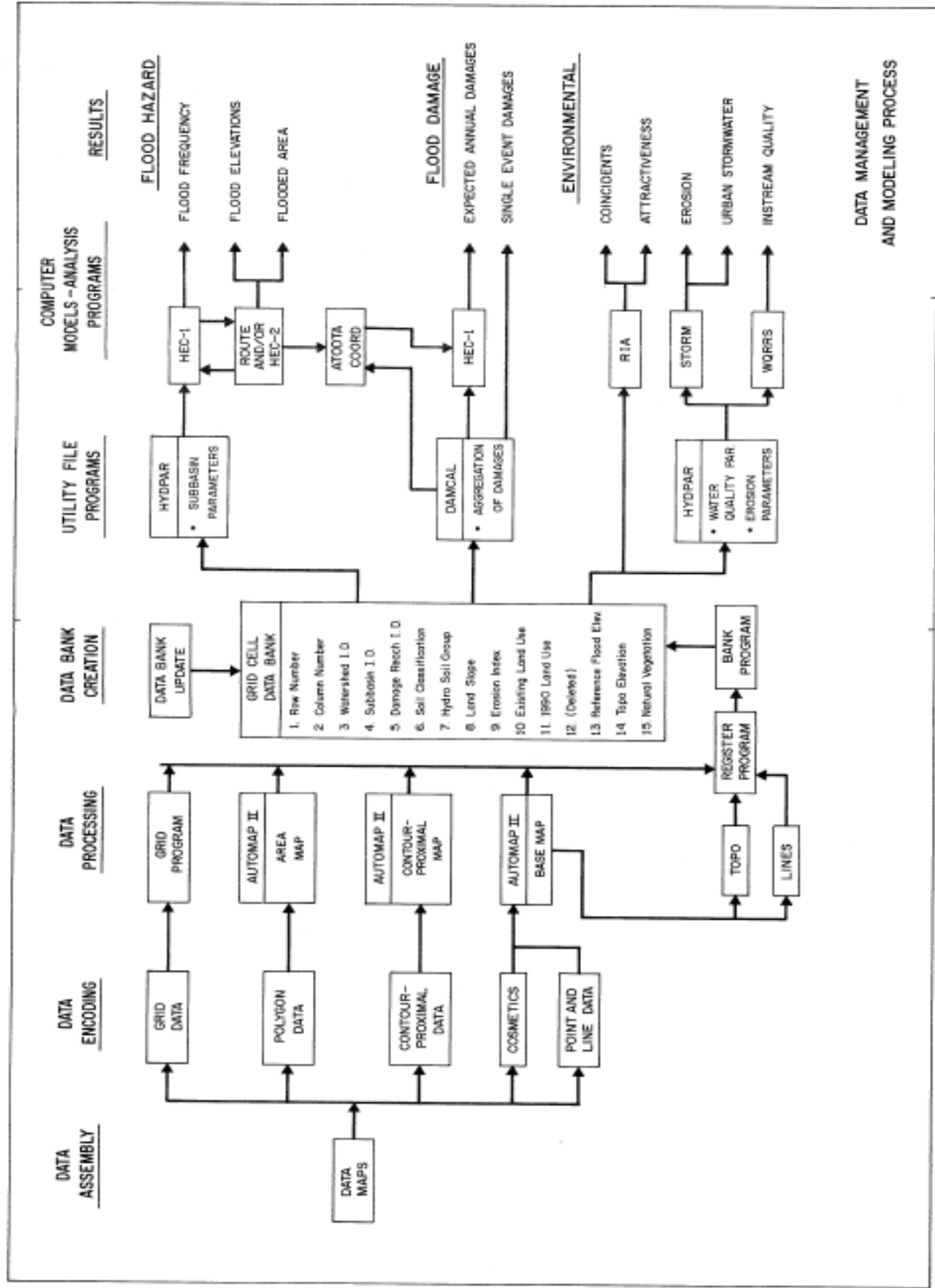

Figure XII-1

values). Topographic maps and precipitation isohyetal maps are examples of contour data sets.

- Line information is just what it says it is; it does not have areal character. The present permanent Trail Creek data file does not contain information of a line character but an example would be major transportation routes.
- Point information likewise does not have areal character and may constitute the final cataloging of a type of data, such as the location of important historical and cultural sites, or it may be used as an intermediate step in the process of generating contour data from point values. There are presently no variables in the Trail Creek data file that are solely *point* values but point value data constituted an intermediate step in the generation of the reference flood file component.

Sources of Data: The sources of data that were encoded into the Trail Creek data bank ranged from high quality cartographic maps (USGS quad sheets) to some quite crude hand sketches. The data source for each variable encoded in the file are as follows:

- Watershed (VAR 3), Subbasins (VAR 4) and Damage Reaches (VAR 5) were delineated on USGS 7.5 minute quadrangle sheets
- Soil Classification (VAR 6) was taken from SCS soils maps for Clarke County Georgia
- Hydrologic Soil Group (VAR 7), Land slope (VAR 8) and Erosion Index (VAR 9) were generated automatically from VAR 6
- Existing Land Use (VAR 10) was delineated on a 7.5 minute quadrangle sheet overlay based on analysis of local agency maps, aerial photos and field reconnaissance
- 1990 Land Use (VAR 11) was delineated on a 7.5 minute quadrangle sheet from analysis of local agency maps, population and manufacturing projections, etc.
- Reference Flood (VAR 13) was generated by automatic contouring beginning with point elevation value assignments on a 7.5 minute quadrangle sheet overlay of VAR 5
- Topo Elevation (VAR 14) was extracted from 7.5 minute quadrangle sheets
- Natural Vegetation (VAR 15) was taken from a State of Georgia, Department of Natural Resources map

Other sources of data that could prove useful in other studies include the usual agency resource reports, high altitude aircraft and ERTS multi-spectral scanner data, and census records.

Preparing Data for Encoding

A concerted effort should be made to prepare data on as few base maps as possible since distortions and inaccurate mapping can result in a data file having poor registration between variables. It is not necessary to transfer data that is ready for encoding (such as SCS soils data) to a base map, but other data sets that must be developed, such as from field interpretation, should be recorded on an adopted base map. An approach that will minimize later data registration problems is to adopt a base map at the very beginning for all participants to work from. Those activities that need to work from mapping at a larger scale could enlarge the base map and still maintain the consistency needed.

Two other important steps must be taken before the data sets will be ready for encoding. It is essential to establish an origin point and adopt a coordinate system. Any systematic, generally recorded coordinate system will function, but some, (such as state plane coordinates) have advantages over others. Reference (10) contains a detailed discussion of coordinate systems. The origin should be removed from the study area so that all coordinates are positive *downward* and to the *right*.

Since the ultimate file will be constructed from any number of individual maps or data sets, a scheme was devised for properly registering the files to one another. This method uses a system of *reference points* that are established and recorded on the base maps and other maps from which data will be encoded. The reference points should be selected so that the features used are spread across each individual map as uniformly as possible and can easily be identified from one map to another. Road intersections, prominent landmarks, stream junctions, etc., may be used as reference points. A sufficient number should be selected and recorded so that at least 6 or more are present on any one data set that will be registered.

Data Encoding

Data encoding refers to the process of transferring map, cartographic and other data into digital form for processing into the data bank. There are a variety of encoding approaches and administrative arrangements possible for securing the data encoding. The techniques adopted for Trail Creek and thus the Phase I Oconee Basin pilot were selected so that the full range of problems and opportunities for encoding would be examined and understood while also accomplishing the encoding task.

The means for accomplishing the encoding for the Oconee project include Savannah District study personnel hand encoding certain data variables (in fact all but those that would be commercially encoded) and contracting for encoding of the more complex variables of topography and soil classification. The Trail Creek test data bank was encoded by HEC staff by manual means.

The two basic data encoding approaches that are frequently used are the grid concept and the polygon concept. Each method has advantages over the other but the flexibility provided by polygon type encoding seems to tip the scale in its favor for certain categories of data even though the ultimate form of the data bank file is the grid form. Fig. VII-2 ALTERNATIVE ENCODING CONCEPTS indicates the nature of the two types of encoding approaches. Areal data is encoded in the grid method by placing a uniform grid of rectangles or squares over the map and assigning to each grid the character of the map at that location. The encoding method is simple and reliable, but the resultant grid representation is fixed. Areal data is encoded in the polygon method by superimposing an (x,y) scale on the map and recording coordinates of the boundary of each separable area (polygon). The original detail is preserved in the encoding, but another step is required to generate the grid file. However, the additional step is the mechanism for providing the flexibility of generating the final grid at any (within limits) desired scale. Even though the polygon method is more involved and thus more expensive, it was adopted for some data

CARTOGRAPHIC DATA

DATA ENCODING

GRID VALUE ASSIGNMENT

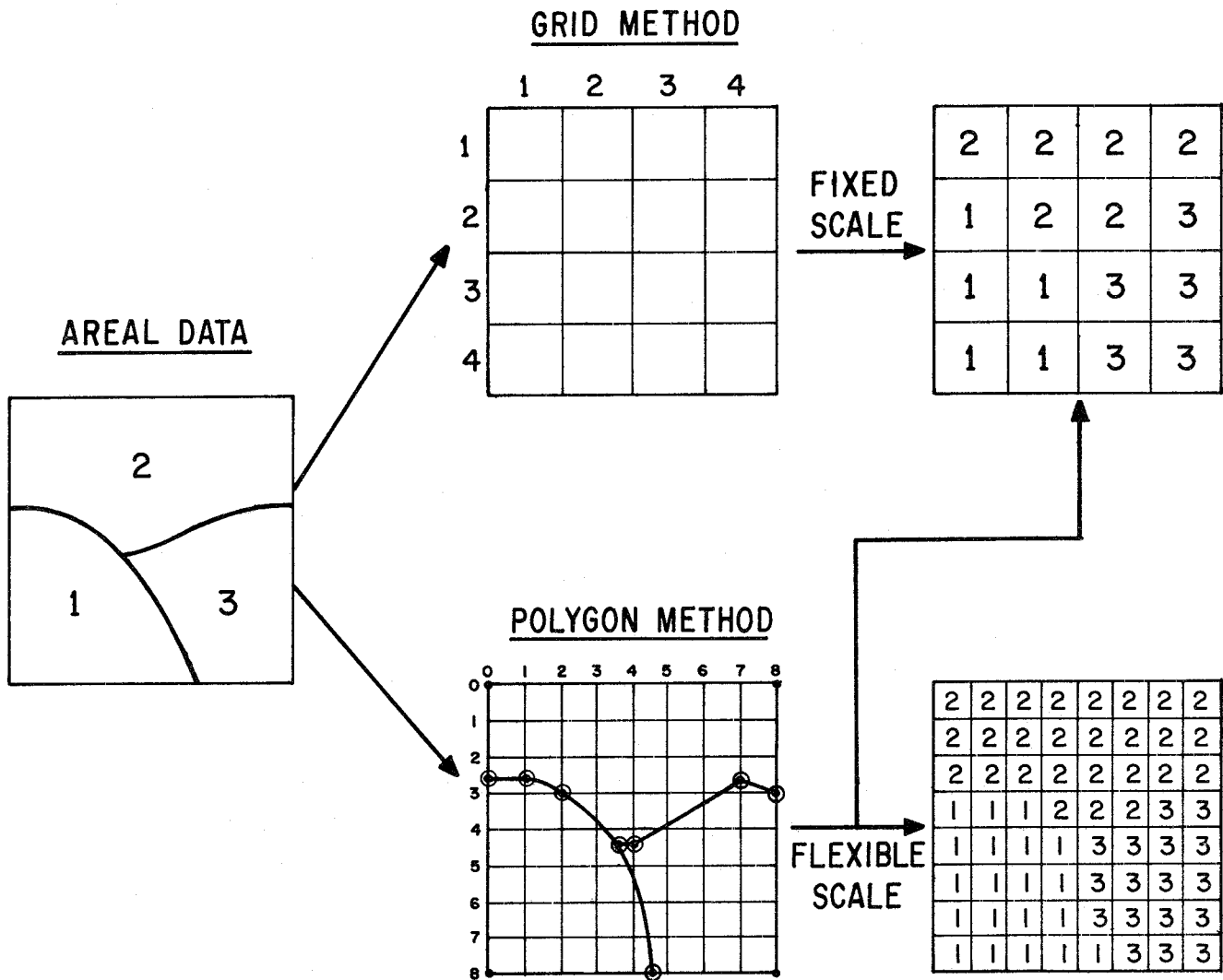

ALTERNATIVE ENCODING CONCEPTS

Figure VII-2

sets for the pilot study because of its flexibility while other data sets will be encoded by the grid method.

As an aside, notice that the scales and legending systems coordinates are positive to the right and positive *downward*. This convention is adopted because computer printers, that will ultimately constitute the display device, print the display from left to right from the top to the bottom

Data Processing

Data processing includes the tasks necessary to convert raw encoded data to a clean set of grid files ready for inserting into the data bank. The major tasks include editing of encoded data to remove errors, preprocessing of point and line data, and registration of data to a common base. The overall scope and intensity of efforts involved in data processing is almost completely a function of the integrity of the mapping from which data is encoded, and the quality of the encoding process. Because the amount of data to be processed is large, it is imperative that both the encoding and especially the processing be conducted systematically, one step at a time.

Data Editing: The objective of editing is to insure that what was originally on the raw data maps has in fact been converted to digital form. Lack of conformance can be caused by encoding errors (improper transfer of data to coordinates), sloppy encoding (overlapping or leaving gaps), and key punching and other machinery oriented problems. The primary means of editing is by a comparison of computer generated graphic plots of the encoded data with the raw data map *without* registration having been performed. The method used for Trail Creek was to generate the graphics at the scale of the maps from which the data was encoded, where this was possible, and overlay the two on a light table. The eye seems to be an extremely efficient visual editing device.

Without equivocation, it can be said that editing the data, and to a lesser extent registering the data, was the most time consuming tedious and frustrating task of the entire developmental effort by HEC. However, it could very well constitute the single most important facet needed to assure accurate, systematic, consistent assessment of alternative land use patterns. It is almost impossible to over-check the data bank for accuracy.

Preprocessing: Preprocessing was required for two of the data variables in the Trail Creek data bank. All others were already in the proper processable polygon format and therefore the grid file could be directly generated by use of the AUTOMAP II computer program. The reference flood data file required encoding the reference flood elevations along the stream channel and damage reach boundaries as point values and then processing by AUTOMAP II to generate the complete file using a general contouring algorithm. The generation of the topographic grid file was the most involved in that first the individual contour lines were encoded as line data, then the line data was converted to a grid file with elevations assigned to each grid cell through which a contour line passes, then a special computer program was written that interpolated the values for all vacant grid cells. This latter process obviously needs research so that an easier, more systematic methodology can be made generally available.

Data Registration

Registering each data variable in the grid data file to a common base is essential to assure that simultaneous acquisition of data for a specific cell will yield an accurate set of data for that location. For example, it is quite critical that the land use, topo elevation and reference flood be accurate for *each* cell if the resultant aggregate damage functions are to be accurate. If the elevation file for Trail Creek were off by 500 feet laterally (2 grid cells, or even 1 grid cell for that matter) the resultant damage functions would be worthless.

Fig. VII-3 SOURCES OF REGISTRATION ERROR illustrates the four sources causing improper registration of data between data sets. The obvious needs are to adjust all data variable files to a common origin, scale, and orientation (1-3 of Figure VII-3). These three adjustments are fairly straightforward. The adjustment needed to remove distortion from the encoded data is not so obvious and requires an added level of sophistication. The distortion correction is needed when maps from which data is encoded is either not photographically corrected, or the paper has swollen or shrunken nonuniformly, or the cartography was of poor quality. Certain types of maps consistently have large distortions. The SCS soils map from which soils data was encoded dramatically demonstrated the need for distortion correction. Apparently SCS soils maps are developed from uncorrected (optically) mosaics of aerial photos. Local agency maps used to depict data such as land use are generally quite inaccurate and distorted and thus must be substantially corrected.

The technique developed to perform adjustments simultaneously for all sources of registration errors was to fit (by least square methods), a higher order polynomial function to the relationship between the base map reference point coordinates and the identical reference point (but different coordinates) for the variable to be registered, and correct the polygon coordinates of encoded data set. The polynomial algorithm was taken from technology developed for processing satellite imagery. The fitting (derivation of polynomial coefficients) is performed by a multiple linear regression computer program.

The output from the data registration process is the final form of the grid file that will be cataloged into the data bank. The grid size adopted for Trail Creek was a balance between level of detail needed and the amount of grid cells that would thus need to be processed. The size works out to be about 1.5 acres. A smaller size, 0.4 acres, was tested to evaluate the sensitivity of the aggregate damage functions to grid cell size. The answers obtained were believed to be more accurate and overall about 10 percent lower for the small grids, but the increased amount of data to be processed (a factor of 4) did not seem to be justified for the nominal increase in accuracy. The 1.5 acre grid cell that is used is not square, but has the relative proportions of a standard computer-printer character so that contents of the data bank and any subsequent grid computations could be computer-printer plotted and remain undistorted. The 1.5 acres corresponds to the size of a standard computer printer character placed on a USGS 7.5 minute quadrangle sheet. In order to permit undistorted computer printer generated plots, other grid sizes would need to be in multiples of 4 (such as the 0.4 acres).

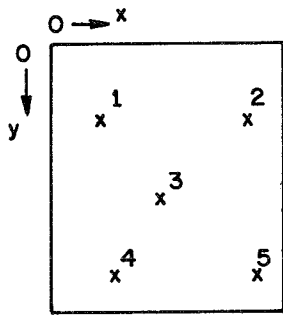

BASE MAP

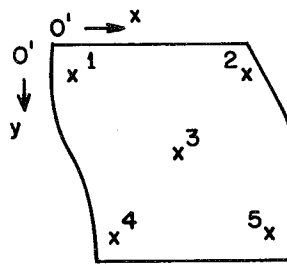

DATA MAP

ADJUSTMENTS TO ASSURE PROPER CELL ALIGNMENT

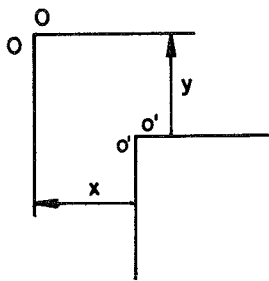

(1) TRANSLATION

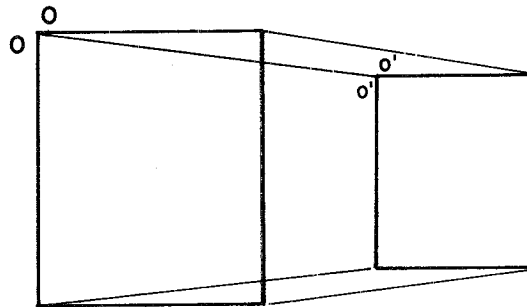

(2) SCALE

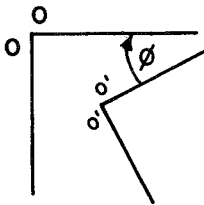

(3) ROTATION

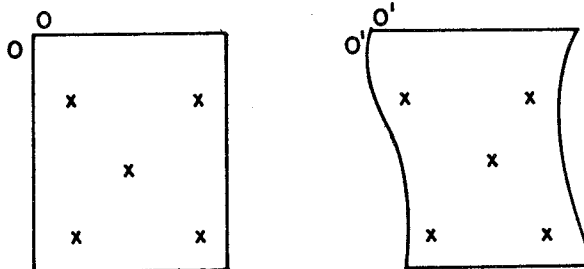

(4) DISTORTION

SOURCES OF REGISTRATION ERROR

Figure VII-3

Data Bank

Data Bank Creation: The data bank in its final form is constructed by stacking the individual grid representations of the data variables onto a computer storage device in a systematic fashion so that efficient access and manipulation is possible. The storage device could be magnetic tape, disc or rapid access drum. The Trail Creek data bank is resident on a magnetic tape for both long term storage and processing purposes. The concept of grid cell data storage adopted consists of storing all data variables for a given cell sequentially cell by cell from the upper left coordinates of the spatial surface to the lower right coordinates. This method permits efficient retrieval of multiple data variables for each cell so that regardless of the number of variables in the data bank to be used in an operation, or the number of grid cells for each variable, only one search of the data bank is necessary and only computer storage capacity to process the number of variables involved (say 15) is required.

A small special purpose computer program (BANK) was developed for placing the grid data into the data bank.

Data Bank Update: Two modes of data bank update capability are necessary to provide for the dynamic use of data files. The first is needed to allow addition of new data variables to the data files and the second to provide for updating or correcting errors in existing data bank variables. Both can be accommodated by repeating the process that has been the subject of this chapter, that is to proceed through the assembly, encoding, registration and data bank creation process. This method is necessary for addition of new variables and is appropriate if it is desired to maintain a continuous record (say in time) of data variable updates such as land use at 5-year intervals.

Correcting errors can be accomplished in two ways, (1) by revising the encoding and reprocessing or (2) by directly changing the value of a specific grid cell of a particular variable. The former approach is accomplished in the usual fashion and the data bank file rewritten. The latter technique is currently under development by HEC because not only will it permit error corrections, it will be available for use in the study of specific development proposals and/or land use changes at specific locations in the watershed.

Utility Processing and Interactive Modeling

The computer programs that have been developed for accessing the data file and manipulating the data for use by the major modeling programs have been termed *utility* programs. The real value of centralized data storage in a grid cell data bank is that an unlimited number of simple special purpose utility programs can be written quickly and easily that manipulate the data on a grand scale for either further processing or direct analysis. The payoff is in the use that can be made of the data in the data bank and the utility programs are a key link in that process.

The modeling computer programs that are used as the final processing element of the family of analysis techniques are in most instances the generally available HEC supported computer programs. Some modifications have been made to facilitate the methods but generally the modifications have been relatively minor. Appendix B contains a description

of all computer software that comprise integral components of the techniques developed. The listing indicates title, source and availability, whether newly developed for this project, and a brief description of its role in the overall process. The standard, available programs generally have good documentation available and have been extensively tested, while the new programs are at varying stages of documentation and have received varying amounts of testing. In general, the new programs will continue in the developmental stage throughout the Phase I Oconee Basin pilot study as any deficiencies or errors are continually rectified as the pilot project applications are performed.

CHAPTER VIII

ASSESSMENT OF TRAIL CREEK TEST

Summary

The objectives of the Upper Oconee Pilot Study were stated in the introduction to include: (1) a critical examination of the concept of a broadened perspective of Flood Plain Information studies, (2) a test of the capability for development of analysis procedures, and (3) an assessment of the planning utility of the broadened FPI study as a framework for continued use by local planning agencies. This report described the work associated with (2) and was concerned with development of techniques that could facilitate the overall objectives. The target was the development of an integrated, semi-automatic family of techniques that could yield comprehensive, systematic assessments of various alternative future conditions as reflected by alternative land use patterns.

Concepts have been defined and techniques have been developed that provides for:

- Comprehensive and detailed systematic assessment of alternative land use patterns and development proposals
- Data map encoding
- Editing, processing, and registration of digitized data
- Creating and updating a gridded data bank
- Accessing and processing gridded data for computer model input for
 - Hydrologic modeling
 - Flooded area mapping
 - Comprehensive damage function construction
 - Expected annual damage computations
 - Urban stormwater quality modeling
 - Land erosion analysis
 - In-stream water quality modeling
- Computer graphic display of analysis outputs

The above concepts and techniques have been applied to Trail Creek, a small test area of the Upper Oconee basin, for the purposes of refining perceptions of analysis needs and assessing the utility of the analytical methods.

Assessment

It is concluded that the capability has been developed to meet the objectives of the Phase I Oconee Basin pilot FPI investigation. The overall process of data collection and processing is rational and achievable although tedious and requiring especial attention to detail. The techniques are generally modest extensions (although somewhat automated) of traditional analysis methods familiar to most analysts serving the Corps planning function. The degree of automation (simplification and replacement for manual methods) adopted is less than was initially sought. For example, the effort in the analysis to generate hydrologic

model parameters endeavored to automate the process from acquisition of data from the data bank through execution of HEC-1, but the adopted approach requires the output of the utility program be coded and input to HEC-1. The reason for adopting the less automated approach was to assure that professional experience and judgments would be brought to bear before final execution. Similar reasoning proved to be appropriate for other aspects of the analysis. Experience with this mode of operation will assist in determining whether or not further automation is desirable.

In summary, the techniques focus upon consistent, systematic assessments that only fairly automated methods (for so comprehensive of an analysis) can achieve while preserving and requiring experienced judgment at specific steps in each process.

Concluding Comments and Recommendations

The investigation and test application have pointed to some obvious further needs and surfaced questions that need critical examination and perhaps action by higher authorities within the Corps. Selected key observations by the HEC project team are summarized below.

1. The advantages of integrated use of gridded geographic data files for many types of studies, as well as broadened FPI studies, and the exacting demands for the accurate creation of the heart of the methods, the data bank, point to the need for development within the Corps (preferable within the Districts) of the general capability for encoding, editing, and processing of spatial data. It seems this should be a service available to Corps technical staff similar to ADP and materials testing.

2. Land use data comprises such a key element in the process, being the prime indicator of alternative futures (and existing development), that efforts should be initiated to develop an integrated classification system for use by all Federal, and hopefully local, agencies. A recent publication by the Council of State Governments entitled *LAND, State Alternatives for Planning and Management*, speaks to the issue and the conclusions are confirmed by the experience in the test investigation.

3. The classification of land use and other geographic data on a comprehensive scale as required for the Pilot FPI studies points to the need for systematic, reliable, automated methods for compiling such data. Analysis of remote sensing imagery of the proper scale may be an effective method of acquiring such data. Because of the scale needed, high flying aircraft imagery is probably more appropriate for study than is LANDSAT imagery.

4. The significant impacts of changed storm runoff from continued urban development (increased magnitude and frequency of damaging floods and increased surface erosion) emphasizes the need for continued research in the hydrologic and economic damage potential effects of urbanization.

5. The degree of computer manipulation acumen and technical expertise required to efficiently and correctly make use of the automated methods that were developed for the pilot study suggests that the continuing planning service will need to continue as the responsibility of Corps offices. It is unlikely that local planning agencies would have access to the computer machinery and could develop the required technical capability.

6. The comprehensive nature of the assessments to be performed in the broadened FPI studies and the degree to which integrated use will be made of a centralized data bank and analysis process emphasizes the need for an integrated study team that can devote essentially their full-time energies to the study. Many of the techniques overlap various areas of responsibility and thus require close daily cooperative work efforts. As a *minimum*, the study team should include the study manager, economist, hydrologic engineer, environmental planner and data processing specialist.

7. Technology transfer from developers to users is a sufficiently important and demanding task that it should be undertaken systematically and progressively. It also seems prudent that the Phase I Oconee Basin pilot study be carried through to conclusion before judgments are made as to the utility of the methods developed and the desirability of developing further advanced methods or refining the ones that have been created. Research for the immediate future should concentrate on the obvious needs, e.g., data bank creation, comprehensive land use classification, and defer further technique development until experience in a few studies has been obtained.

APPENDIX A
GRID DATA FILE
COMPUTER-PRINTER PLOTS

TABLE A-1

DATA BANK VARIABLES LEGEND

- 3 TRAIL CREEK WATERSHED
 - 1 - Trail Creek
- 4 TRAIL CREEK SUBBASINS
 - 1 - Subbasin 1
 - 2-21 - Subbasins 2-21
- 5 TRAIL CREEK DAMAGE REACHES
 - 1 - Damage Reach 1
 - 2-5 - Damage Reaches 2-5
- 6 TRAIL CREEK SOIL CLASSIFICATIONS
 - 1 - Water Bodies
 - 2 - Appling Sandy Clay Loam, and Appling Coarse Sand Loam
 - 3 - Buncombe Loamy Sand
 - 4 - Cecil Soils
 - 5 - Colfax Sandy Loam
 - 6 - Congaree Soils and Alluvial Land
 - 7 - Chewacla Soils and Alluvial Land
 - 8 - Cecil Sandy Loam, and Cecil Sandy Clay Loam
 - 9 - Davidson Clay Loam, and Davidson Sandy Loam
 - 10 - Louisburg Stony Loamy Sand, and Louisburg Loamy Sand
 - 11 - Madison Sandy Loam, and Madison Sandy Clay Loam, and Madison-Louisa Complex
 - 12 - Musella Clay Loam
 - 13 - Pacolet Soil Group, Sandy Loam, Sandy Clay Loam, Gullied Land Complex, Stoney Sandy Loam
 - 14 - Rock Outcrop
 - 15 - Worsham Sandy Loam
 - 16 - Wehadkee and Alluvial Land
- 7 HYDROLOGIC SOIL GROUPS
 - 1 - Hydrologic Soil Group A (Low Runoff Potential)
 - 2 - Hydrologic Soil Group B (Moderate Infiltration Rates)
 - 3 - Hydrologic Soil Group C (Slow Infiltration Rates)
 - 4 - Hydrologic Soil Group D (High Runoff Potential)
- 8 TRAIL CREEK LAND SURFACE SLOPES
 - 0 - Water Bodies or Rock Outcrops
 - 1 - 0 to 2 percent slopes
 - 2 - 2 to 6 percent slopes
 - 3 - 6 to 10 percent slopes
 - 4 - 10 to 15 percent slopes
 - 5 - 15 to 25 percent slopes
 - 6 - 25 to 45 percent slopes
 - 7 - greater than 45 percent slopes

- 9 TRAIL CREEK EROSION INDEX
 - 1 - Slightly Eroded Soils
 - 2 - Moderately Eroded Soils
 - 3 - Severely Eroded Soils

- 10 TRAIL CREEK EXISTING LAND USE PATTERN
 - 1 - Natural Vegetation
 - 2 - Developed Open Space
 - 3 - Low Density Residential
 - 4 - Medium Density Residential
 - 5 - High Density Residential
 - 6 - Agricultural
 - 7 - Industrial
 - 8 - Commercial
 - 9 - Pasture
 - 10 - Water Bodies

- 11 TRAIL CREEK 1990 ALTERNATIVE LAND USE PATTERN
 - 1 - Natural Vegetation
 - 2 - Developed Open Space
 - 3 - Low Density Residential
 - 4 - Medium Density Residential
 - 5 - High Density Residential
 - 6 - Agricultural
 - 7 - Industrial
 - 8 - Commercial
 - 9 - Pasture
 - 10 - Water Bodies

- 12 DELETED

- 13 TRAIL CREEK REFERENCE FLOOD
 - Flood Elevations by Grid Cell

- 14 TRAIL CREEK TOPOGRAPHY
 - Topographic Elevations by Grid Cell

- 15 TRAIL CREEK NATURAL VEGETATION (not shown)
 - 1 - Pines
 - 2 - Hardwoods
 - 3 - Lowland Hardwoods
 - 4 - Hardwoods
 - 5 - Mixed Pines/Hardwoods
 - 6 - Water
 - 7 - Agriculture
 - 8 - Urban

SWAN CREEK PLANT #21
 WATERSHED TEST AREA
 WATERSHED 1,000

DATA VALUE EXTREMES ARE 1,000 10,000

| LEVEL | MINIMUM | MAXIMUM | PERCENT | PERCENTILE |
|--------|---------|---------|---------|------------|
| NUMBER | VALUE | VALUE | RANGE | NUMBER |
| 1 | 1,000 | 10,000 | 1 | 100.00 |



TRAIL CREEK WATERSHED

MAPS SHOWING 100-YEAR
TRAIL CREEK FLOOD AREAS
FOR VARIOUS SUBBASIN AREAS

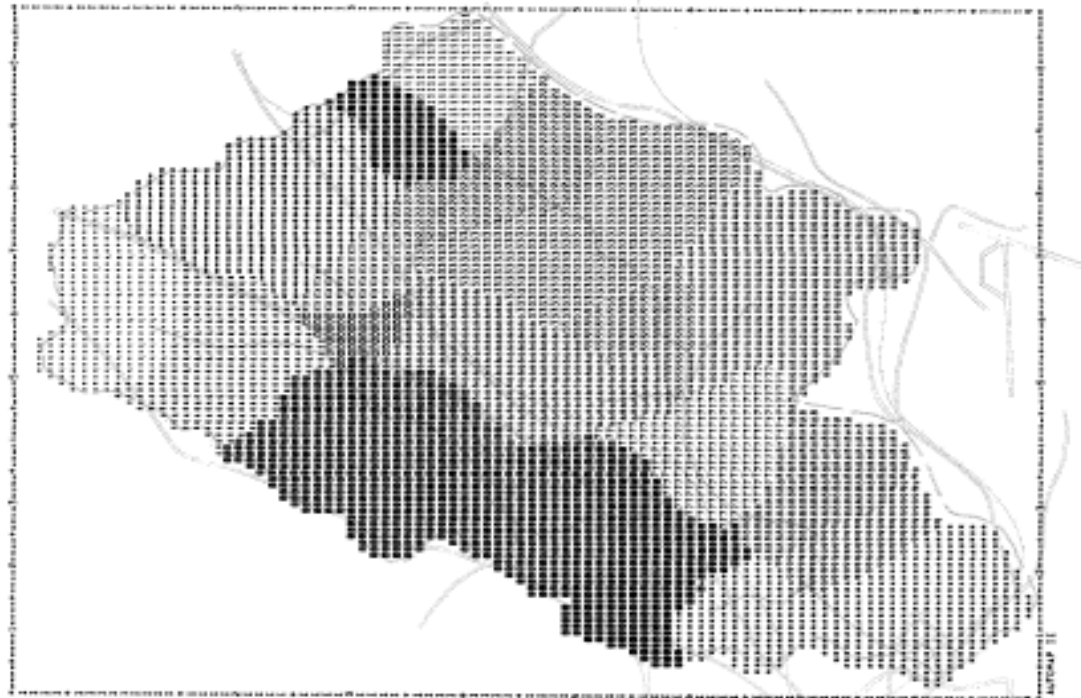

DATA NAME EXTREMES ARE 100-YR FLOOD

| 100-YR FLOOD | NO. OF VARIOUS EXTREMES AREAS | PERCENT OF AREA | PERCENT OF AREA |
|--------------|-------------------------------|-----------------|-----------------|
| 1 | 1,400 | 1.00 | 1.00 |
| 2 | 2,400 | 1.00 | 1.00 |
| 3 | 3,400 | 1.00 | 1.00 |
| 4 | 4,400 | 1.00 | 1.00 |
| 5 | 5,400 | 1.00 | 1.00 |
| 6 | 6,400 | 1.00 | 1.00 |
| 7 | 7,400 | 1.00 | 1.00 |
| 8 | 8,400 | 1.00 | 1.00 |
| 9 | 9,400 | 1.00 | 1.00 |
| 10 | 10,400 | 1.00 | 1.00 |
| 11 | 11,400 | 1.00 | 1.00 |
| 12 | 12,400 | 1.00 | 1.00 |
| 13 | 13,400 | 1.00 | 1.00 |
| 14 | 14,400 | 1.00 | 1.00 |
| 15 | 15,400 | 1.00 | 1.00 |
| 16 | 16,400 | 1.00 | 1.00 |
| 17 | 17,400 | 1.00 | 1.00 |
| 18 | 18,400 | 1.00 | 1.00 |
| 19 | 19,400 | 1.00 | 1.00 |
| 20 | 20,400 | 1.00 | 1.00 |

TRAIL CREEK SUBBASINS

AREA VALUE DISTRICTS ARE
 1,000 20,000 40,000

| LEVEL NUMBER | AREA VALUE DISTRICTS ARE | PERCENTAGE OF AREA | PERCENTAGE OF AREA | PERCENTAGE OF AREA |
|--------------|--------------------------|--------------------|--------------------|--------------------|
| 1 | 1,000 20,000 | 1 | 20.00 | 20.00 |
| 2 | 20,000 40,000 | 1 | 40.00 | 40.00 |
| 3 | 40,000 60,000 | 1 | 60.00 | 60.00 |
| 4 | 60,000 80,000 | 1 | 80.00 | 80.00 |
| 5 | 80,000 100,000 | 1 | 100.00 | 100.00 |



TRAIL CREEK
 DAMAGE REACHES

**UPPER CREEK TRAIL AREA
SOIL CLASSIFICATION**

| SOIL NAME | SYMBOL | AREA | PERCENTAGE OF TOTAL AREA | PERCENTAGE OF TOTAL AREA |
|-----------|----------|-------|--------------------------|--------------------------|
| 1 | 11111111 | 1,400 | 1 | 1.0 |
| 2 | 11111111 | 1,400 | 1 | 1.0 |
| 3 | 11111111 | 1,400 | 1 | 1.0 |
| 4 | 11111111 | 1,400 | 1 | 1.0 |
| 5 | 11111111 | 1,400 | 1 | 1.0 |
| 6 | 11111111 | 1,400 | 1 | 1.0 |
| 7 | 11111111 | 1,400 | 1 | 1.0 |
| 8 | 11111111 | 1,400 | 1 | 1.0 |
| 9 | 11111111 | 1,400 | 1 | 1.0 |
| 10 | 11111111 | 1,400 | 1 | 1.0 |
| 11 | 11111111 | 1,400 | 1 | 1.0 |
| 12 | 11111111 | 1,400 | 1 | 1.0 |
| 13 | 11111111 | 1,400 | 1 | 1.0 |
| 14 | 11111111 | 1,400 | 1 | 1.0 |
| 15 | 11111111 | 1,400 | 1 | 1.0 |
| 16 | 11111111 | 1,400 | 1 | 1.0 |
| 17 | 11111111 | 1,400 | 1 | 1.0 |
| 18 | 11111111 | 1,400 | 1 | 1.0 |
| 19 | 11111111 | 1,400 | 1 | 1.0 |
| 20 | 11111111 | 1,400 | 1 | 1.0 |
| 21 | 11111111 | 1,400 | 1 | 1.0 |
| 22 | 11111111 | 1,400 | 1 | 1.0 |
| 23 | 11111111 | 1,400 | 1 | 1.0 |
| 24 | 11111111 | 1,400 | 1 | 1.0 |
| 25 | 11111111 | 1,400 | 1 | 1.0 |
| 26 | 11111111 | 1,400 | 1 | 1.0 |
| 27 | 11111111 | 1,400 | 1 | 1.0 |
| 28 | 11111111 | 1,400 | 1 | 1.0 |
| 29 | 11111111 | 1,400 | 1 | 1.0 |
| 30 | 11111111 | 1,400 | 1 | 1.0 |
| 31 | 11111111 | 1,400 | 1 | 1.0 |
| 32 | 11111111 | 1,400 | 1 | 1.0 |
| 33 | 11111111 | 1,400 | 1 | 1.0 |
| 34 | 11111111 | 1,400 | 1 | 1.0 |
| 35 | 11111111 | 1,400 | 1 | 1.0 |
| 36 | 11111111 | 1,400 | 1 | 1.0 |
| 37 | 11111111 | 1,400 | 1 | 1.0 |
| 38 | 11111111 | 1,400 | 1 | 1.0 |
| 39 | 11111111 | 1,400 | 1 | 1.0 |
| 40 | 11111111 | 1,400 | 1 | 1.0 |
| 41 | 11111111 | 1,400 | 1 | 1.0 |
| 42 | 11111111 | 1,400 | 1 | 1.0 |
| 43 | 11111111 | 1,400 | 1 | 1.0 |
| 44 | 11111111 | 1,400 | 1 | 1.0 |
| 45 | 11111111 | 1,400 | 1 | 1.0 |
| 46 | 11111111 | 1,400 | 1 | 1.0 |
| 47 | 11111111 | 1,400 | 1 | 1.0 |
| 48 | 11111111 | 1,400 | 1 | 1.0 |
| 49 | 11111111 | 1,400 | 1 | 1.0 |
| 50 | 11111111 | 1,400 | 1 | 1.0 |

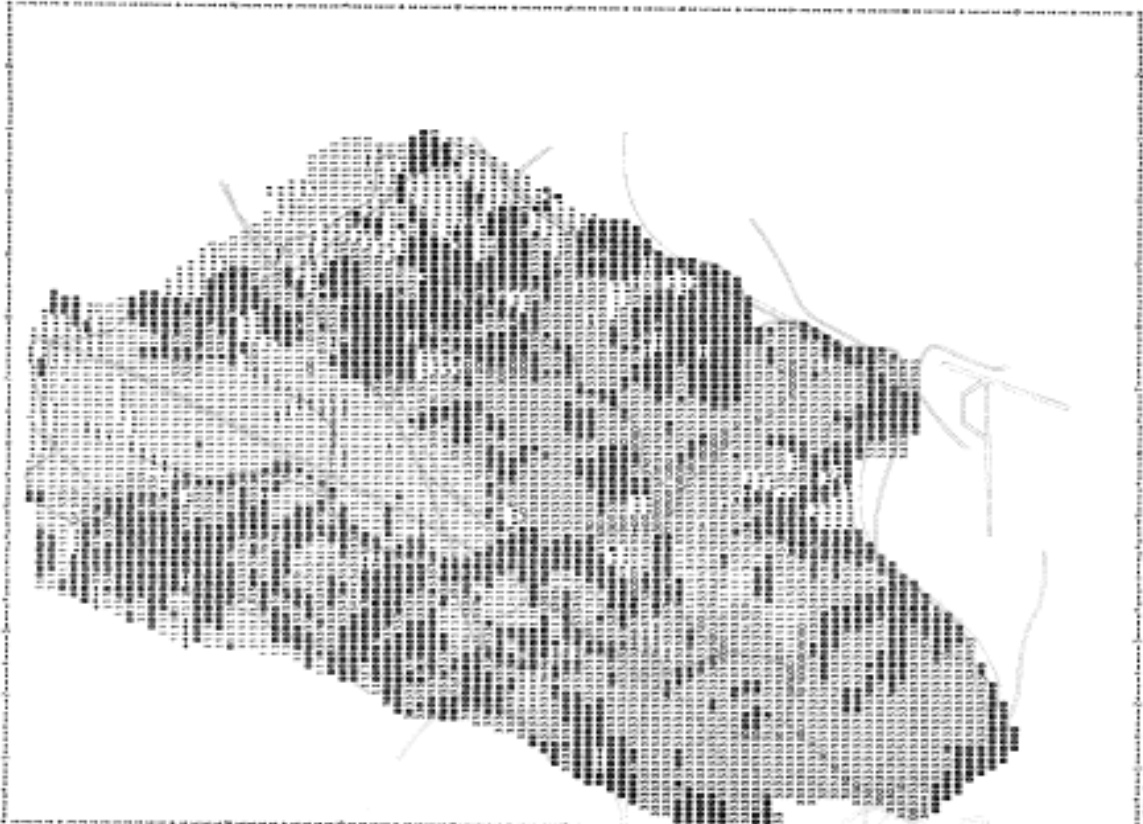

**TRAIL CREEK
SOIL CLASSIFICATIONS**

TRAIL CREEK FLOOD CONTROL DISTRICT
 HYDROLOGIC SOIL GROUPS
 SOIL SURVEY OF CLARK AND NEVADA COUNTIES, NEVADA

DATA VALUE EXTREMES ARE 1,000 4,000

| SOIL SYMBOL | SOIL NAME | PERCENT AREA | PERCENT AREA | PERCENT AREA | PERCENT AREA |
|-------------|-----------|-----------------|-----------------|-----------------|-----------------|
| 1 | 1,000 | 10.0 | 10.0 | 10.0 | 10.0 |
| 2 | 1,000 | 10.0 | 10.0 | 10.0 | 10.0 |
| 3 | 2,000 | 20.0 | 20.0 | 20.0 | 20.0 |
| 4 | 3,000 | 30.0 | 30.0 | 30.0 | 30.0 |
| 5 | 4,000 | 40.0 | 40.0 | 40.0 | 40.0 |

HYDROLOGIC SOIL GROUP 1 (VERY LOW INFILTRATION RATES)
 SANDS AND GRAVELS

HYDROLOGIC SOIL GROUP 2
 SANDS WITH SOME INFILTRATION RATES

HYDROLOGIC SOIL GROUP 3
 SANDS WITH SOME INFILTRATION RATES

HYDROLOGIC SOIL GROUP 4 (VERY LOW INFILTRATION RATES)
 CLAY SOILS WITH SOME INFILTRATION RATES

HYDROLOGIC SOIL GROUP 5 (VERY LOW INFILTRATION RATES)
 CLAY SOILS WITH SOME INFILTRATION RATES

TRAIL CREEK
 HYDROLOGIC SOIL GROUPS

TRAIL CREEK, 2010. 10/10/10
 SCALE: 1:10,000. 10/10/10
 DATE: 10/10/10. 10/10/10
 ALL RIGHTS RESERVED. 10/10/10

| AREA | AREA | PERCENT | PERCENT | PERCENT |
|------|------|---------|---------|---------|
| NO. | NO. | RANGE | RANGE | RANGE |
| 1 | 1 | 0.00 | 0.00 | 0.00 |
| 2 | 2 | 0.00 | 0.00 | 0.00 |
| 3 | 3 | 0.00 | 0.00 | 0.00 |
| 4 | 4 | 0.00 | 0.00 | 0.00 |
| 5 | 5 | 0.00 | 0.00 | 0.00 |



TRAIL CREEK
 LAND SURFACE SLOPES

MAPS SHOW EROSION INDEX
FOR THE TRAIL CREEK
WATERSHED

DATA FOR EROSION INDEX

| LAND COVER | AREA ACRES | PERCENT OF TOTAL AREA | PERCENT EQUIVALENT AREA | PERCENT OF TOTAL AREA |
|------------|---------------|-----------------------------|-------------------------------|-----------------------------|
| 1 | 1,500 | 11.8 | 15.2 | 21.7 |
| 2 | 1,500 | 11.8 | 15.2 | 21.7 |
| 3 | 2,000 | 15.6 | 20.3 | 29.4 |
| 4 | 3,000 | 23.4 | 30.4 | 43.8 |
| 5 | 3,000 | 23.4 | 30.4 | 43.8 |

AUTUMN EROSION INDEX
WINTER EROSION INDEX
SUMMER EROSION INDEX

TRAIL CREEK EROSION INDEX



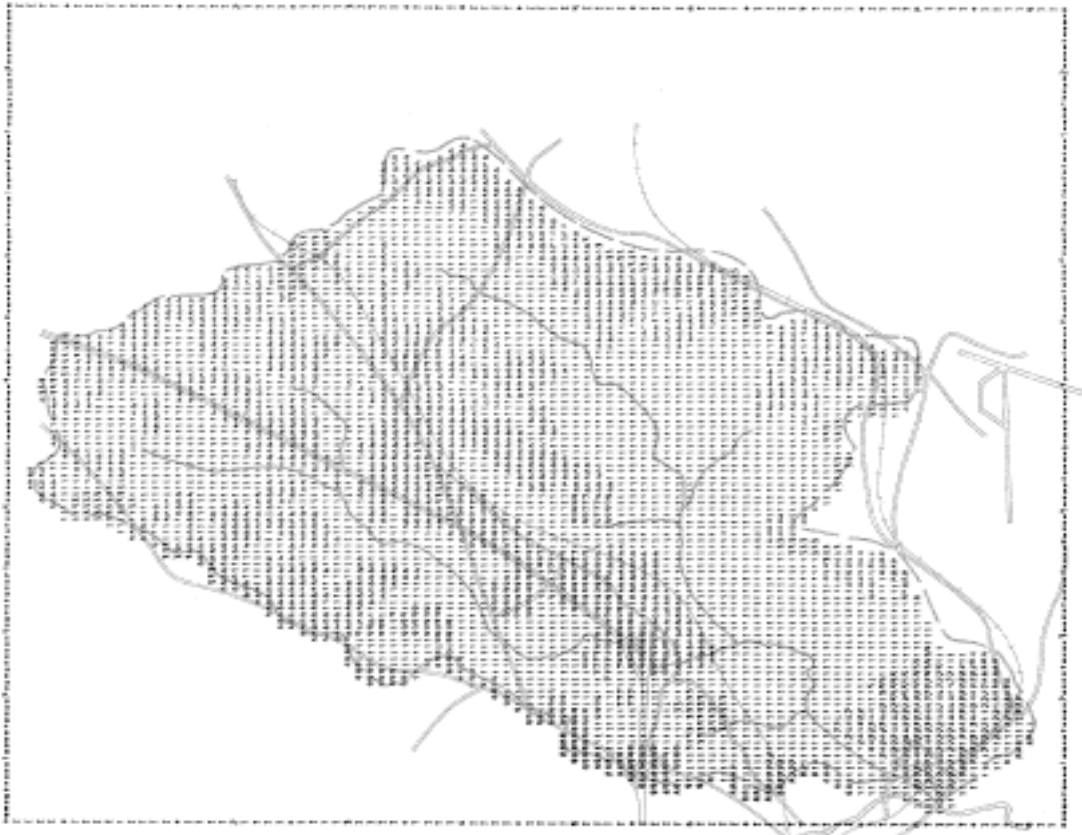

TRAIL CREEK PLUM MIT ONLY
EXISTING LAND USE

| LAND USE | AREA ACRES | PERCENT TOTAL | PERCENT TOTAL | PERCENT TOTAL |
|-------------|---------------|------------------|------------------|------------------|
| 1 | 111111 | 11.11 | 11.11 | 11.11 |
| 2 | 222222 | 22.22 | 22.22 | 22.22 |
| 3 | 333333 | 33.33 | 33.33 | 33.33 |
| 4 | 444444 | 44.44 | 44.44 | 44.44 |
| 5 | 555555 | 55.55 | 55.55 | 55.55 |
| 6 | 666666 | 66.66 | 66.66 | 66.66 |
| 7 | 777777 | 77.77 | 77.77 | 77.77 |
| 8 | 888888 | 88.88 | 88.88 | 88.88 |
| 9 | 999999 | 99.99 | 99.99 | 99.99 |
| 10 | 101010 | 10.10 | 10.10 | 10.10 |
| 11 | 111111 | 11.11 | 11.11 | 11.11 |
| 12 | 121212 | 12.12 | 12.12 | 12.12 |
| 13 | 131313 | 13.13 | 13.13 | 13.13 |
| 14 | 141414 | 14.14 | 14.14 | 14.14 |
| 15 | 151515 | 15.15 | 15.15 | 15.15 |
| 16 | 161616 | 16.16 | 16.16 | 16.16 |
| 17 | 171717 | 17.17 | 17.17 | 17.17 |
| 18 | 181818 | 18.18 | 18.18 | 18.18 |
| 19 | 191919 | 19.19 | 19.19 | 19.19 |
| 20 | 202020 | 20.20 | 20.20 | 20.20 |
| 21 | 212121 | 21.21 | 21.21 | 21.21 |
| 22 | 222222 | 22.22 | 22.22 | 22.22 |
| 23 | 232323 | 23.23 | 23.23 | 23.23 |
| 24 | 242424 | 24.24 | 24.24 | 24.24 |
| 25 | 252525 | 25.25 | 25.25 | 25.25 |
| 26 | 262626 | 26.26 | 26.26 | 26.26 |
| 27 | 272727 | 27.27 | 27.27 | 27.27 |
| 28 | 282828 | 28.28 | 28.28 | 28.28 |
| 29 | 292929 | 29.29 | 29.29 | 29.29 |
| 30 | 303030 | 30.30 | 30.30 | 30.30 |

TRAIL CREEK
EXISTING LAND USE PATTERN

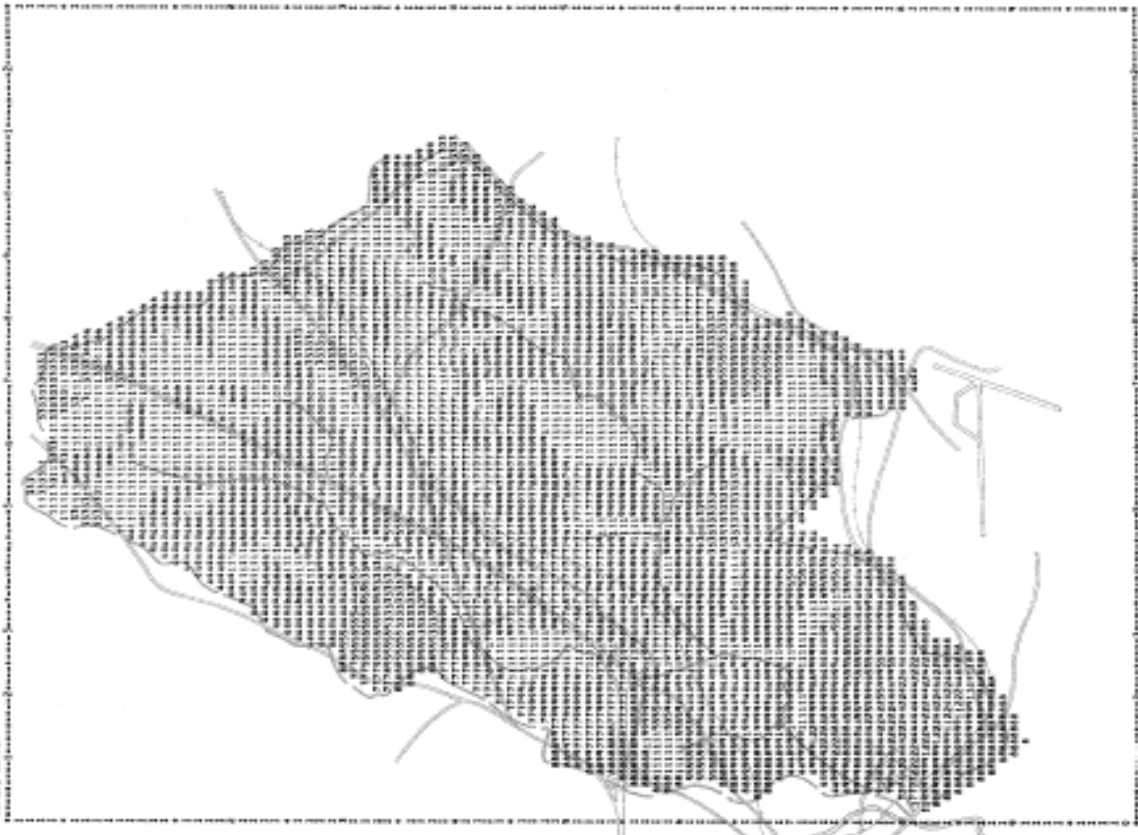

MAP 11

TRAIL CREEK PLANT AND ANIMAL ALTERNATIVE LAND USE PATTERN (1990)

| DATE | VAL OF ESTIMATED ASB | 1,000 | 10,000 |
|------|----------------------|--------|--------|
| 1 | 1,000 | 10,000 | 10,000 |
| 2 | 1,000 | 10,000 | 10,000 |
| 3 | 1,000 | 10,000 | 10,000 |
| 4 | 1,000 | 10,000 | 10,000 |
| 5 | 1,000 | 10,000 | 10,000 |
| 6 | 1,000 | 10,000 | 10,000 |
| 7 | 1,000 | 10,000 | 10,000 |
| 8 | 1,000 | 10,000 | 10,000 |
| 9 | 1,000 | 10,000 | 10,000 |
| 10 | 1,000 | 10,000 | 10,000 |

TRAIL CREEK
1990 ALTERNATIVE
LAND USE PATTERN

TRAIL CREEK FLOOD ZONE
 REFERENCE FLOOD ELEVATIONS
 GEOMETRIC PROJECTIONS

DATA VALUE EXTREMES ARE 818,000 800,000

| LEVEL NUMBER | FORM | VALUE RANGE | PERCENT FREQUENCY | PERCENTILE RANK | PERCENT OF AREA |
|--------------|----------|-------------|-------------------|-----------------|-----------------|
| 1 | AAAAAAAA | 850,000 | 1 | 1.00 | 0.00 |
| 2 | UUUUUUUU | 850,000 | 1 | 1.00 | 0.00 |
| 3 | UUUUUUUU | 850,000 | 1 | 1.00 | 0.00 |
| 4 | UUUUUUUU | 850,000 | 1 | 1.00 | 0.00 |
| 5 | UUUUUUUU | 850,000 | 1 | 1.00 | 0.00 |
| 6 | UUUUUUUU | 850,000 | 1 | 1.00 | 0.00 |
| 7 | UUUUUUUU | 850,000 | 1 | 1.00 | 0.00 |
| 8 | UUUUUUUU | 850,000 | 1 | 1.00 | 0.00 |
| 9 | UUUUUUUU | 850,000 | 1 | 1.00 | 0.00 |
| 10 | UUUUUUUU | 850,000 | 1 | 1.00 | 0.00 |
| 11 | UUUUUUUU | 850,000 | 1 | 1.00 | 0.00 |
| 12 | UUUUUUUU | 850,000 | 1 | 1.00 | 0.00 |
| 13 | UUUUUUUU | 850,000 | 1 | 1.00 | 0.00 |
| 14 | UUUUUUUU | 850,000 | 1 | 1.00 | 0.00 |
| 15 | UUUUUUUU | 850,000 | 1 | 1.00 | 0.00 |
| 16 | UUUUUUUU | 850,000 | 1 | 1.00 | 0.00 |
| 17 | UUUUUUUU | 850,000 | 1 | 1.00 | 0.00 |
| 18 | UUUUUUUU | 850,000 | 1 | 1.00 | 0.00 |
| 19 | UUUUUUUU | 850,000 | 1 | 1.00 | 0.00 |
| 20 | UUUUUUUU | 850,000 | 1 | 1.00 | 0.00 |
| 21 | UUUUUUUU | 850,000 | 1 | 1.00 | 0.00 |
| 22 | UUUUUUUU | 850,000 | 1 | 1.00 | 0.00 |
| 23 | UUUUUUUU | 850,000 | 1 | 1.00 | 0.00 |
| 24 | UUUUUUUU | 850,000 | 1 | 1.00 | 0.00 |
| 25 | UUUUUUUU | 850,000 | 1 | 1.00 | 0.00 |
| 26 | UUUUUUUU | 850,000 | 1 | 1.00 | 0.00 |
| 27 | UUUUUUUU | 850,000 | 1 | 1.00 | 0.00 |
| 28 | UUUUUUUU | 850,000 | 1 | 1.00 | 0.00 |
| 29 | UUUUUUUU | 850,000 | 1 | 1.00 | 0.00 |
| 30 | UUUUUUUU | 850,000 | 1 | 1.00 | 0.00 |
| 31 | UUUUUUUU | 850,000 | 1 | 1.00 | 0.00 |
| 32 | UUUUUUUU | 850,000 | 1 | 1.00 | 0.00 |
| 33 | UUUUUUUU | 850,000 | 1 | 1.00 | 0.00 |
| 34 | UUUUUUUU | 850,000 | 1 | 1.00 | 0.00 |
| 35 | UUUUUUUU | 850,000 | 1 | 1.00 | 0.00 |
| 36 | UUUUUUUU | 850,000 | 1 | 1.00 | 0.00 |
| 37 | UUUUUUUU | 850,000 | 1 | 1.00 | 0.00 |
| 38 | UUUUUUUU | 850,000 | 1 | 1.00 | 0.00 |
| 39 | UUUUUUUU | 850,000 | 1 | 1.00 | 0.00 |
| 40 | UUUUUUUU | 850,000 | 1 | 1.00 | 0.00 |
| 41 | UUUUUUUU | 850,000 | 1 | 1.00 | 0.00 |
| 42 | UUUUUUUU | 850,000 | 1 | 1.00 | 0.00 |
| 43 | UUUUUUUU | 850,000 | 1 | 1.00 | 0.00 |
| 44 | UUUUUUUU | 850,000 | 1 | 1.00 | 0.00 |
| 45 | UUUUUUUU | 850,000 | 1 | 1.00 | 0.00 |
| 46 | UUUUUUUU | 850,000 | 1 | 1.00 | 0.00 |
| 47 | UUUUUUUU | 850,000 | 1 | 1.00 | 0.00 |
| 48 | UUUUUUUU | 850,000 | 1 | 1.00 | 0.00 |
| 49 | UUUUUUUU | 850,000 | 1 | 1.00 | 0.00 |
| 50 | UUUUUUUU | 850,000 | 1 | 1.00 | 0.00 |

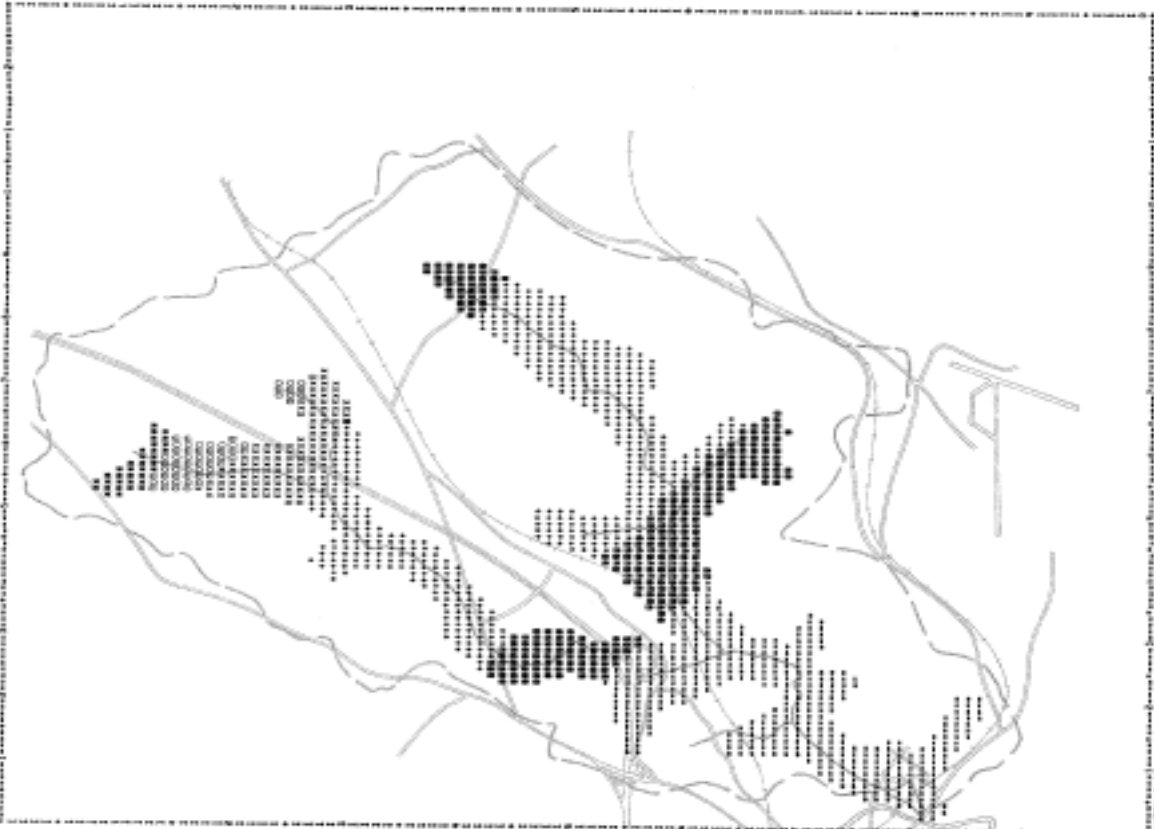

TRAIL CREEK
 REFERENCE FLOOD

Figure 4-10

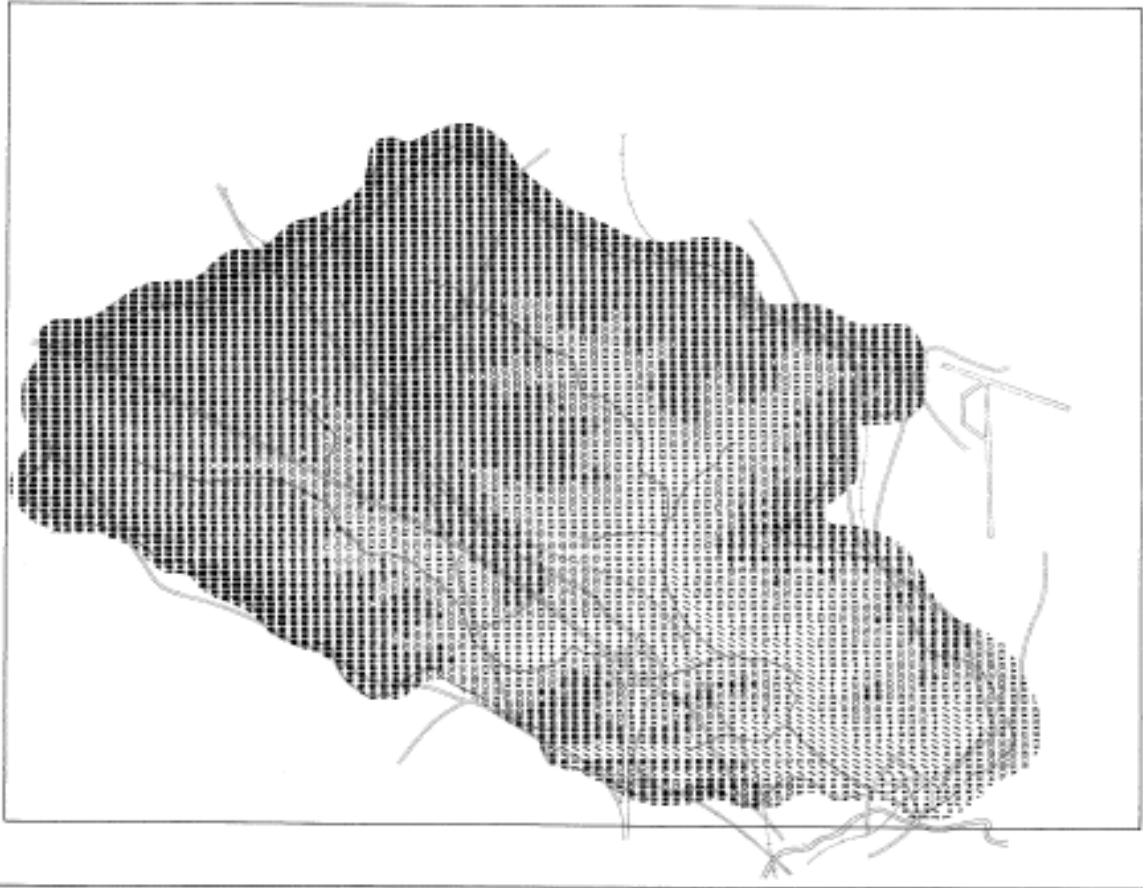

UPPER 50-MILE PAUL PINE
TRAIL CREEK FERT AREA
TOPOGRAPHY

| LEVEL | 0 | 1 | 2 | 3 | 4 | 5 | 6 | 7 | 8 | 9 | 10 |
|-----------|--------|--------|--------|--------|--------|--------|--------|--------|--------|--------|--------|
| WATER | | | | | | | | | | | |
| 50' ELEV | 1000 | 43 | 51 | 239 | 1499 | 1993 | 2471 | 2913 | 3324 | 3704 | 4054 |
| 50% W.C. | 91.00 | 506.20 | 815.51 | 884.50 | 876.13 | 921.48 | 928.78 | 942.07 | 951.38 | 957.49 | 962.49 |
| 80% W.C. | 100.00 | 615.51 | 884.50 | 876.13 | 921.48 | 928.78 | 942.07 | 951.38 | 957.49 | 962.49 | 967.49 |
| PRET AREA | 85.00 | 3.00 | 3.00 | 3.00 | 3.00 | 3.00 | 3.00 | 3.00 | 3.00 | 3.00 | 3.00 |
| FERT AREA | 10.00 | .16 | 2.26 | 2.46 | 15.19 | 5.21 | 26.82 | 15.19 | 15.19 | 15.19 | 6.00 |

TRAIL CREEK TOPOGRAPHY

APPENDIX B
COMPUTER SOFTWARE SUMMARY

Data Assembly, Encoding, Processing and Data Bank Creation

| Title | Source/Availability | Description |
|------------|------------------------|---|
| GRID | Harvard/HEC | Generates grid file and printer graphics used in mapping grid data bank variables and attractiveness mapping. Purchased from Harvard University by HEC - some modifications. A small role in project. |
| AUTOMAP II | ESRI/HEC | Generates grid file from polygon data and performs contouring. Purchased from ESRI by HEC - some minor modifications. Key data management program in study. |
| REGISTER | HEC (new) ¹ | Utility program developed by HEC to register all data sets to common coordinate and match points based on polynomial fit. |
| TOPO/INTPL | HEC (new) | Utility program developed by HEC to generate topographic elevation grid from digitized contour data. |
| BANK | HEC (new) | Utility program developed by HEC that places grid data sets into project grid file. |

Flood Hazard Evaluation

| | | |
|---------|----------------|--|
| *HYDPAR | HEC (new) | Utility program developed by HEC that accesses data bank & generates hydrologic model parameters (loss rates and unit hydrographs). |
| ROUTE | HEC (new) | Utility program that generates modified Puls routing criteria and index station rating curves for hydrologic model in lieu of detailed HEC-2 applications. |
| *HEC-1 | HEC (modified) | General hydrologic model available from HEC, modified to accommodate SCS methods. |
| HEC-2 | HEC | General water surface profile program available from HEC. No modifications, off the shelf and traditional use only. |
| *DAMCAL | HEC (new) | Single event computer generated flooded area map. |

*Has other functions described elsewhere

¹Programs labeled (new) have been developed for Phase I Oconee Basin pilot project and have not been released outside HEC.

| Title | Source/Availability | Description |
|------------------------------------|---------------------|---|
| Economic Damage Evaluation | | |
| *DAMCAL | HEC (new) | Develops elevation damage functions by damage reach by land use from grid data file and standard composite damage functions. |
| *HEC-1 | HEC | Accepts damage functions and frequency curves and computes expected annual damages for present and future conditions. |
| Environmental Evaluation | | |
| *HYDPAR | HEC (new) | Performs utility of aggregating and formatting parameters for soil erosion and urban storm quality calculation. |
| STORM | HEC | General urban storm quality model for period of record/continuous urban stormwater analysis/erosion. |
| STORM/1 | HEC (new) | Single event version of STORM, considerable modification of library version including SCS loss function addition. |
| WQRRS | HEC | General receiving water quality simulation model. Limited distribution. |
| EROS | HEC (new) | Erosion/deposition model for tracing sediment movement throughout watershed (under development). |
| RIA | Harvard/HEC (new) | Performs index computations for spatial environmental locational attractiveness analysis, distance determination, impact assessment, coincident tabulation, and line printer mapping. |
| General Processing/Updating | | |
| UPDATE/MGE | HEC (new) | Utility program for managing data files, updating for new/revised data and some consistency checking. (under development) |

APPENDIX C
TRAINING WORKSHOP PROBLEM
(Bound Separately)

APPENDIX D
FLOOD HAZARD EVALUATION

APPENDIX D

FLOOD HAZARD EVALUATION

Overview of Analysis

A basic requirement for flood hazard evaluation is to establish the relationship between stage, discharge, damage and frequency of occurrence. Records of observed data are, of course, the prime source for establishing the interrelation of these phenomena. Lacking this source, the engineer must resort to indirect methods and considerable professional judgment. The paragraphs which follow will present several approaches pursued in an effort to arrive at reasonable estimates of the hydrologic response of the Trail Creek basin and to establish a methodology to be followed on the remainder of the Oconee River basin pilot study.

Description of the Area

The Trail Creek watershed is located in Athens and Clarke County in the Piedmont region of northeast Georgia. The creek flows in a southerly direction from its headwaters near the Madison-Clarke County line to its mouth on the North Oconee River in the City of Athens. The North Oconee River is a major tributary in the Altamaha River Basin which flows into the Atlantic Ocean at the central Georgia coast. The Trail Creek Basin, 12.1 square miles, is generally rectangular shaped with a length of about five miles and an average width of about three miles. Over half of the basin is cleared land, mostly devoted to agricultural purposes. In recent years, considerable residential development has occurred in the lower portion of the basin due to the expansion of the Metropolitan Athens area. Also, a large industrial park is rapidly developing near the west fork between the north bypass and Highway 72. Fig. D-1 TRAIL CREEK LOCATION shows the location of Trail Creek and the boundary of the watershed.

Elevations in the basin range from a maximum of 900 feet mean-sea-level at the head of the basin to 590 feet mean sea level at its mouth on the North Oconee River. The topography of the basin varies from moderately steep slopes near the streams to gently rolling broad ridge lines.

From their respective headwaters, the east fork flows about three miles southwesterly and the west fork flows about four miles southerly and join to form Trail Creek. These streams meander through narrow valleys flanked by moderately steep hills. The east and west forks have steep gradients which average about 25 feet per mile. Trail Creek has an average slope of about 14 feet per mile.

The Trail Creek flood plain averages about 300 feet in width, varying from about 800 feet wide near its mouth to about 100 feet wide in the upper reaches of the stream. Land along the lower half-mile of Trail Creek is subjected to stream overflow from the North Oconee River. The probability of a major flood crest on the North Oconee River coinciding with the corresponding crest on Trail Creek is remote. However, greater flood heights along the lower half mile of Trail Creek will result if a major flood occurs on the North Oconee River.

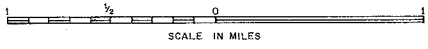
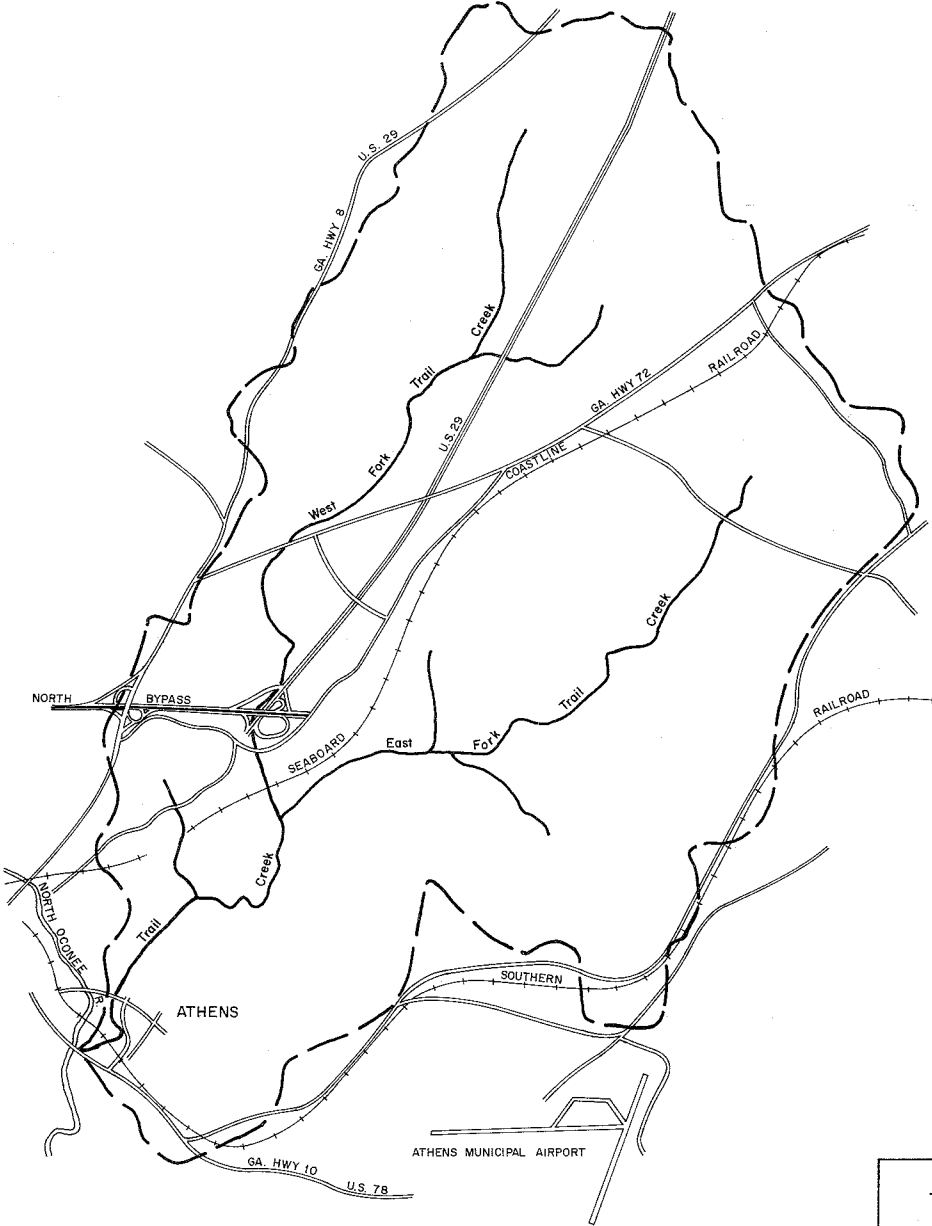

TRAIL CREEK PILOT STUDY
 TRAIL CREEK LOCATION

Prepared By
 Hydrologic Engineering Center
 Davis, California September 1975

Figure D-1

Summary of the Flood Situation

The U. S. Geological Survey has installed and maintained four crest gages on Trail Creek and its tributaries. Records are available for these gages since September 1966.

The June 1967 flood was the greatest flood known to have occurred on Trail Creek and its tributaries during the past 30 years. Investigations made after the occurrence of this flood by the Savannah District left no doubt that the June 67 event was far greater than any previously known flood. The flood resulted in damage along the lower portion of Trail Creek. Other large floods occurred in May 1966 and June 1963. Both of these floods, however, were considerably smaller than the 1967 flood. Damage for the floods were limited to street washouts and bank erosion.

The main flood season for the Athens and Clarke County area is in the spring and winter. Most of the larger floods have resulted from heavy rains during these periods. However, floods due to intense local thunderstorms occur in the summer months. Large floods may occur anytime, particularly on small streams such as Trail Creek.

The U.S. Department of Agriculture Soil Conservation Service has developed a watershed project for Trail Creek. This flood control project, which is under construction, includes three reservoirs and channel improvements on the east and west forks of Trail Creek. The effects of this project along with existing and alternative land use patterns is analyzed in this report.

Rainfall and Runoff Records

A search of basic data publications such as NOAA National Weather Service climatological data and U.S. Geological Survey surface water records discloses a paucity of hydrologic data for small drainage areas (less than 100 square miles in this region). Rainfall records are also lacking. Most of the counties of Georgia have only one or two locations of published rainfall records, about half of which are of the nonrecording type. The nearest station to Trail Creek basin is the Athens Airport with records from 1958 to 1974. The five greatest storms of record at this station are:

| Storm Dates | Maximum 1-hour (inches) | Storm Total (inches) |
|--------------------|------------------------------------|---------------------------------|
| 26 May 1959 | 1.35 | 5.47 |
| 28-30 Apr 1963 | 1.15 | 6.75 |
| 26-27 Jun 1963 | 1.42 | 5.51 |
| 3-5 Oct 1964 | .55 | 5.40 |
| 4 Jun 1967 | 1.98 | 9.93 |

There are no periods of continuous stage records on Trail Creek. The North Oconee River at Athens (D.A. 283 sq. mi.) has published flow data from 1929-31 and 1945-49.

Annual maximum stage records are available through 1972. Nearby streams with records which have some transferability to the overall study area and their recorded maxima are summarized in the table which follows:

| I.D. No. | Station Name and Location | D.A. (sq mi) | Period of Record | Maximum Flood of Record | | |
|----------|-----------------------------------|--------------|-------------------------|-------------------------|--------------|-----------------|
| | | | | Date | Stage (feet) | Discharge (cfs) |
| 2050 | Wildcat Cr near Laurenceville, Ga | 1.59 | 1953-74 | 6 May 56 | 8.2 | 906 |
| 2170 | Allen Cr at Talmo, Ga | 17.3 | 1952-71(72-74) | 4 Jun 67 | 13.3 | 4,300 |
| 2175 | Middle Oconee R. near Athens, Ga | 398.0 | 1901-02, 29-32, 1937-74 | 28 Feb 02 | 25.5 | 19,600 |
| 2205 | Whitten Cr near Sparta, Ga | 15.0 | 1960-74 | 24 Feb 61 | 16.0 | 3,770 |
| 2210 | Murder Cr near Monticello, Ga | 24.0 | 1952-71 (72-74) | 3 Mar 71 | 9.64 | 3,240 |

() Non-recording station

The storm of 4 June 1967 was the most severe storm of record with nearly 10 inches of rainfall recorded at Athens Airport and 9.2 inches estimated as basin average for Trail Creek. The flooding and destruction on Trail Creek was the worst in the memory of long-time residents of the area. Four crest gages on Trail Creek and tributaries, and high-water marks in adjacent stream reaches were used by the Geological Survey to estimate maximum discharges by a slope area calculation. The estimated discharge from Trail Creek at Moreland Avenue was 15,000 cfs. Efforts to corroborate this by rainfall data and unit hydrograph analyses were not very satisfactory, but there can be no doubt that the June 1967 flood was of a magnitude which would be exceeded only infrequently.

Hydrologic Study Approach

The objectives of the hydrologic studies are the computation of streamflow hydrographs for selected storm events and the development of exceedance frequency curves at index locations of interest. Because of the lack of long-term gaged records for Trail Creek, the overall strategy adopted is based upon application of synthetic storm precipitation to an HEC-1 model calibrated for the conditions of interest. The HEC-1 model parameters are developed from semi-automated analysis using data from the grid file and calibration data developed from (1) analysis of observed data (almost none was available), (2) transfer of data from similar nearby streams (a small amount was available), and (3) development of generalized relationships based upon literature review, interview of local practicing professionals and professional judgement.

For the methodology adopted for this study (which will be subsequently explained) the calibration data is comprised of a tabulation of the relationship between the parameters of the U.S. Soil Conservation Service (SCS) methodology and readily determined

physiographic data. A tabulation of the relationship between curve number (CN), hydrologic soil group, antecedent soil moisture, and land use together with the physiographic data of land surface slope, hydraulic stream length and subbasin drainage areas provides the required calibration data. When adequate observed data is available, the calibration data should be determined by conventional reconstitution studies, otherwise reliance must be placed upon more general methods as described herein.

The approach requires development of synthetic storm precipitation and an HEC-1 model based upon the calibration data of the watershed of interest. An HEC-1 model is comprised of:

- Watershed topologic description (subbasin definition and stream reach segments)
- Precipitation loss rates for each subbasin determined from calibration data for SCS method)
- Unit hydrographs for each subbasin (determined from calibration data for SCS method)
- Streamflow routing criteria for stream segments.

Subsequent sections in this appendix further describe the methods applicable for each of the above requirements and illustrate their application to Trail Creek.

Hypothetical Storms

An approach to developing discharge-frequency estimates for the various damage reaches of Trail Creek was to estimate peak runoff which would likely result from storms of a given exceedance frequency. National Weather Service (NOAA) Technical Paper No. 40 was utilized to generate 1-, 2-, 5-, 10-, 25-, 50- and 100-year hypothetical 6-hour storms. Procedures given in Corps of Engineers EM 1110-2-1411 were utilized to estimate a standard project storm with maximum storm centering over all subbasins simultaneously, since point rainfall is considered representative of areas up to 10 square miles. Storm rainfall for each of these events is:

Hypothetical Storm Data-Inches

| Duration/ Frequency | 15-minute | 30-minute | 1-hour | 6-hour (inches) |
|--------------------------------|------------------|------------------|---------------|----------------------------|
| 1-year | .81 | 1.21 | 1.55 | 2.50 |
| 2-year | .94 | 1.41 | 1.76 | 3.00 |
| 5-year | 1.17 | 1.75 | 2.20 | 3.70 |
| 10-year | 1.34 | 2.00 | 2.50 | 4.30 |
| 25-year | 1.48 | 2.21 | 2.84 | 5.00 |
| 50-year | 1.64 | 2.45 | 3.15 | 5.50 |
| 100-year | 1.78 | 2.65 | 3.50 | 6.00 |
| SPS | 2.06 | 3.09 | 4.11 | 10.80 |

Precipitation Loss Rates

A methodology for computing precipitation loss rates for alternative watershed conditions is required so that systematic assessments of the flood hazards is possible. The loss rate relationships that would comprise the methodology should be determined by studying the losses that occur during major historical and typical storm events of record. Since these data were lacking for Trail Creek, the probable runoff resulting from hypothetical events were estimated by (1) analysis of gaged runoff from Whitten Creek near Sparta, Georgia, (D.A. 15 sq. mi.) located 45 miles southeast of the Trail Creek basin, and (2) the SCS Curve Number methodology that was ultimately adopted. The Whitten Creek data (near the area) indicates loss rates ranging from an average of .10 inch per hour for the standard project and 100-year event, to .20 inch per hour for the 10-year event and as high as .30 inch per hour for the 2-year event, seem reasonable for soils found in this basin.

Loss rates determined by the SCS methods are characterized by curve numbers (CN) which are a function of land use and hydrologic soil group classification. Curve number values range from 0 to 100 with the runoff a function of the curve number and total rainfall. Fig. D-2 SCS LOSS FUNCTION taken from (11) shows the relationship between rainfall and runoff for a range of curve numbers.

Soil data was obtained from an SCS soils map for Clarke and Oconee counties, Georgia. This map was constructed from field reconnaissance by SCS soil scientists who classified soils data by soil name, slope, and erosion potential. Fig. A-4 of Appendix A shows the soil classifications for the Trail Creek watershed in computer-printer format. The SCS has categorized over 8000 soil classifications into four hydrologic soil groups according to their infiltration and transmission rates. The hydrologic soil groups for the Trail Creek watershed are shown in Fig. A-5 of Appendix A.

The relationship between soil group, land use and curve number shown in Table III-1 and condensed below was developed from analysis of available runoff data, review of available literature, field reconnaissance, and consultation with SCS hydrologists in the Athens Regional and California State offices.

Curve Number Summary

| | Hydrologic Soil Group | | | |
|----------------------------|-----------------------|-----|-----|-----|
| | A | B | C | D |
| Natural Vegetation | 36 | 60 | 73 | 79 |
| Developed Open Space | 36 | 61 | 74 | 80 |
| Low Density Residential | 47 | 66 | 77 | 81 |
| Medium Density Residential | 61 | 75 | 83 | 87 |
| High Density Residential | 80 | 85 | 90 | 95 |
| Agricultural | 67 | 78 | 85 | 89 |
| Industrial | 83 | 88 | 92 | 96 |
| Commercial | 95 | 96 | 97 | 98 |
| Pasture | 49 | 69 | 79 | 84 |
| Water Bodies | 100 | 100 | 100 | 100 |

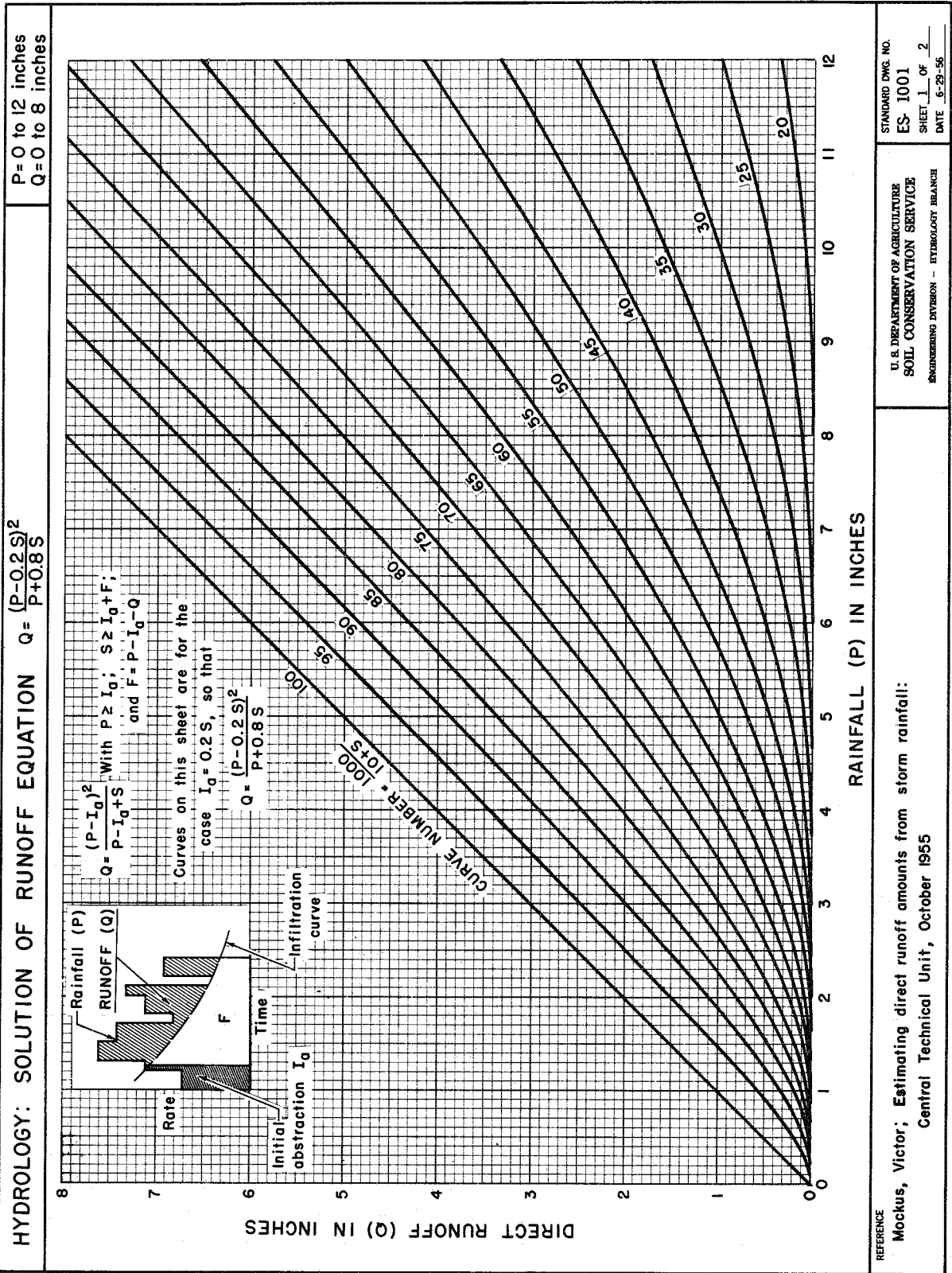

SCS LOSS FUNCTION

Figure D-2

The above relationship is used as the base relationship from which adjustments to drier or wetter antecedant soil moisture condition may be made, if appropriate. The SCS terms this the intermediate value of antecedant moisture condition (AMC II) and provides guidance in (11) for adjustments to other conditions. It is recommended herein, however, that adjustments only be made as necessary to reconstitute observed events (in effect a calibration mechanism) and to establish a relationship between synthetic precipitation events of specified exceedance frequencies and streamflow of similar desired exceedance frequency.

It seems reasonable that the antecedant moisture conditions would more likely be higher during the occurrence of infrequent events than for the more frequent events. The preferred method of determining the adjustments is to compute peak flow based on the base calibration data for the range of hypothetical precipitation events and derive the factors so as to cause the computations to reproduce an adopted flow-exceedance frequency curve. The adopted flow exceedance frequency curve for the base condition would ideally be determined by conventional frequency analysis of a long period of streamflow record for a specific location within a watershed. In the absence of adequate streamflow records, more general methods based upon regional equations, synthetic flood computations and professional judgement are required.

The adopted antecedant moisture condition for Trail Creek range from about 0.96 of the base curve number relationships for the 2-year event to 1.11 of the base relationship for the Standard Project Flood event.

Unit Hydrographs

Two approaches were used in deriving unit hydrographs for each subbasin for the Trail Creek area. One method was based on Snyder coefficients determined from an equation which is considered applicable to the Piedmont area of Georgia. Unit hydrographs based upon the coefficients from the equation were computed for each of the subareas. The second method was the SCS generalize dimensionless unit graph procedure described in Chapter 16 of (11). The characteristics of the SCS dimensionless unit hydrograph are illustrated in Fig. D-3 SCS DIMENSIONLESS UNIT HYDROGRAPH that was taken from (11). Unit graphs were computed by this method and compared to the Snyder unit graphs. The difference in the derived unit hydrographs by the two methods was considered insignificant. The SCS method was adopted.

The basin lag was determined automatically as described in Chapter IV. The lag equation shown in Table III-1 requires subbasin land surface slope that is computed from the grid file, subbasin mean curve number that is automatically computed from the grid file, subbasin mean curve number that is automatically computed from the grid file, and hydraulic length of watershed that was determined by conventional means from USGS 7.5 minute quadrangle sheets.

The curve numbers and lags used in the HEC-1 model are summarized in Figs. IV-6 and IV-7 of Chapter IV for existing and an alternative 1990 land use pattern. The hydrologic parameters for an alternative future land use pattern, or for that matter proposed immediate

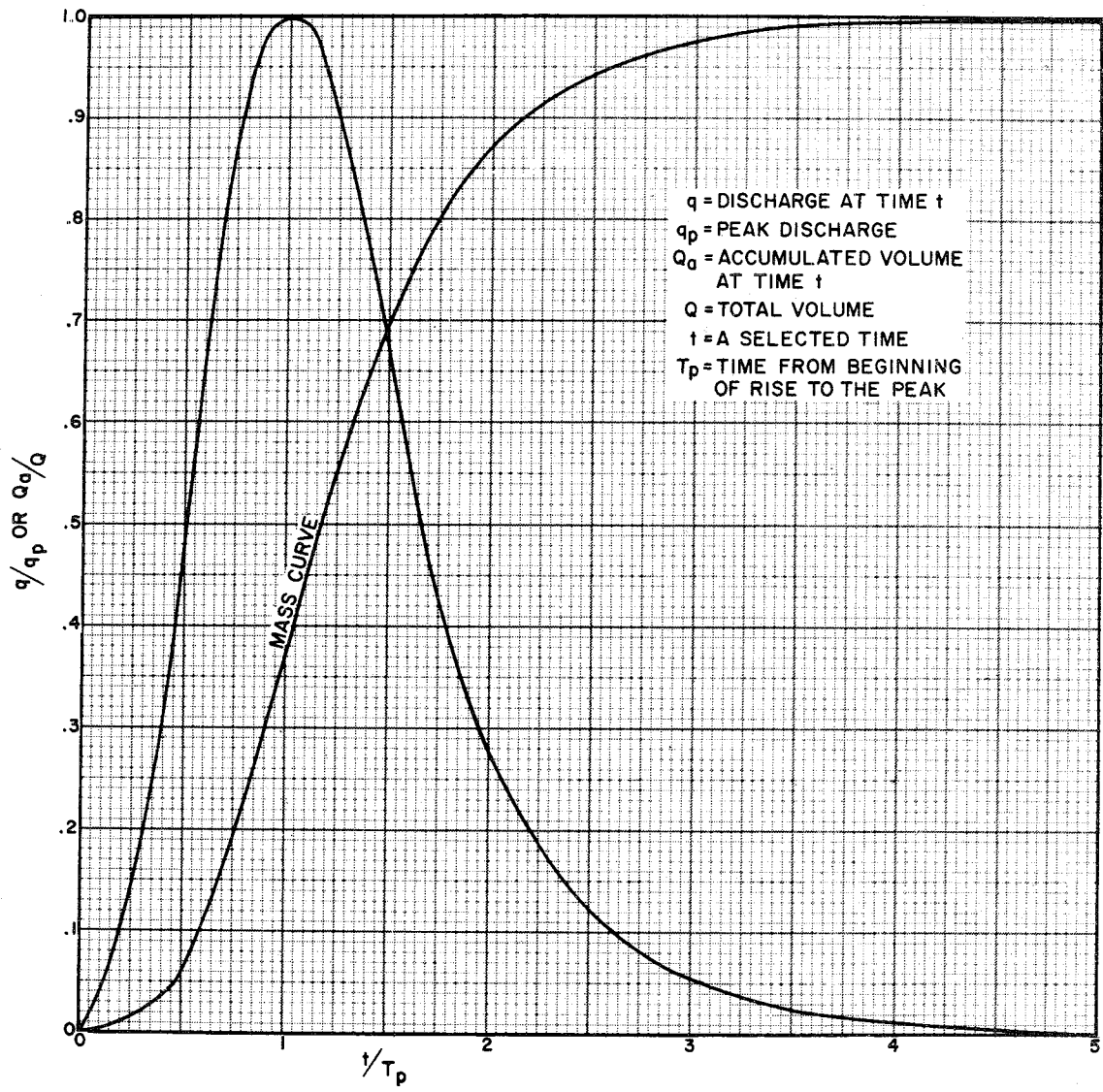

SCS DIMENSIONLESS UNIT HYDROGRAPH

Figure D-3

modifications to the existing land use pattern, can be quickly, and most importantly, consistently and systematically evaluated by the spatial grid file technique used here and described in Chapter IV.

Streamflow Routing

The modified Puls streamflow routing technique was adopted for use in the Trail creek test. It was adopted for a number of reasons including the need for a non-linear technique that could be applied for a range of flood events for development of flood frequency curves, its flexibility in using channel geometry data in the detail required for different types of analysis, and its potential for further automation for future studies. For the Phase I Oconee Basin pilot study, the storage-outflow relationships may be obtained from: (1) a detailed water surface profile analysis using HEC-2, or (2) a simplified method using ROUTE, a program that was developed for this study that computes the storage-discharge relationship of a channel reach from data describing a representative cross-section and using normal slope computation methods. The simplified method of computing modified Puls routing criteria may be applied when:

- Systematic evaluation of stream geometry changes are desired
- Time and monies constraints do not permit the more elaborate HEC-2 evaluations
- Sufficient reach geometry is not available for a detailed analysis
- A general assessment of the effects of alternative land use patterns and development proposals is desired and where detailed criteria or study evaluations may not be warranted

The routing criteria for Trail Creek was developed from typical eight point reach cross-sections that were obtained from available cross-section data where possible and from topographic maps otherwise. The energy grade-line slope, necessary to compute discharge and storage from Manning's equation, were obtained from the water surface profiles in (7). If water surface profiles are not available, the average flood plain slope for each routing reach may be used. Rating curves were also developed simultaneously at the index locations where economic analysis would be performed and flooded area maps generated.

Topologic Description

The basic analysis tool was an HEC-1 rainfall runoff model. The Trail Creek watershed was subdivided into the 21 subbasins shown on Figure IV-3. The subbasin breakdown was developed so that

- flows could be computed at major tributaries
- flows could be computed at key index locations such as damage centers
- flows could be computed at any location where streamflow measurements have been taken
- a sufficiently detailed breakdown was available to capture the effect of significant land use changes (say a land use change on the order of 100 or more acres)

The hydrologic parameters developed from the gridded data bank, the routing criteria for the stream reaches, and the synthetic precipitation data were coded into the HEC-1 format to form the model.

The modified Puls routing techniques was also used in evaluating the effects of the SCS three detention reservoirs shown on Fig. D-4 AUTHORIZED SCS RESERVOIR LOCATIONS. The storage-discharge relations associated with each of the three flood detention reservoirs, authorized for construction by the Soil Conservation Service under a Public Law 566 watershed study, were taken from data furnished by that agency.

Flood Frequency Analysis

In the absence of recorded runoff data for Trail Creek, it was necessary to develop discharge-frequency curves for each index location by means of regional criteria and hypothetical storm analysis. The U.S. Geological Survey has analyzed all available data from 102 small basins in Georgia (less than 20 square mile area). Regression equations presented in their report, "Preliminary Flood-Frequency Relations for Small Streams in Georgia, April 1973", are as follows:

$$Q_{2\text{-year}} = 202.A^{0.6}$$

$$Q_{10\text{-year}} = 415.A^{0.6}$$

$$Q_{25\text{-year}} = 525.A^{0.6}$$

$$Q_{50\text{-year}} = 606.A^{0.6}$$

Similar equations for the Blue Ridge province located adjacent to the upper Oconee River Basin result in discharges about 10 to 15 percent higher than similar areas of the Trail Creek area. The standard error of estimate of these regression equations are fairly high, but the absence of gage discharge records in any particular basin, they seem to be as reliable as can be obtained for the more frequently recurring events.

Peak discharges for the 2-, 5-, 10-, 20-, 50-, and 100-year storm events that were developed from Technical Paper No. 40 rainfall data for corresponding frequencies were computed. A symmetrical storm pattern was adopted. Answers from this procedure were compared with those from the previously cited regression equations. The adopted frequency curves (Fig. IV-10 of Chapter IV is an example for Index Station 1) were then used to determine flows for water surface profile analysis and expected annual damage computations.

Water Surface Profiles

The water surface profiles observed from the 4 June 1967 event were used in an effort to obtain a reasonable estimate of channel and overbank 'n' values (Manning's coefficient of roughness). However, the large discrepancy between the published estimates of the peak discharge and the estimates based on this study make it very difficult to have a high degree

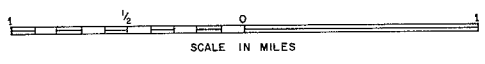
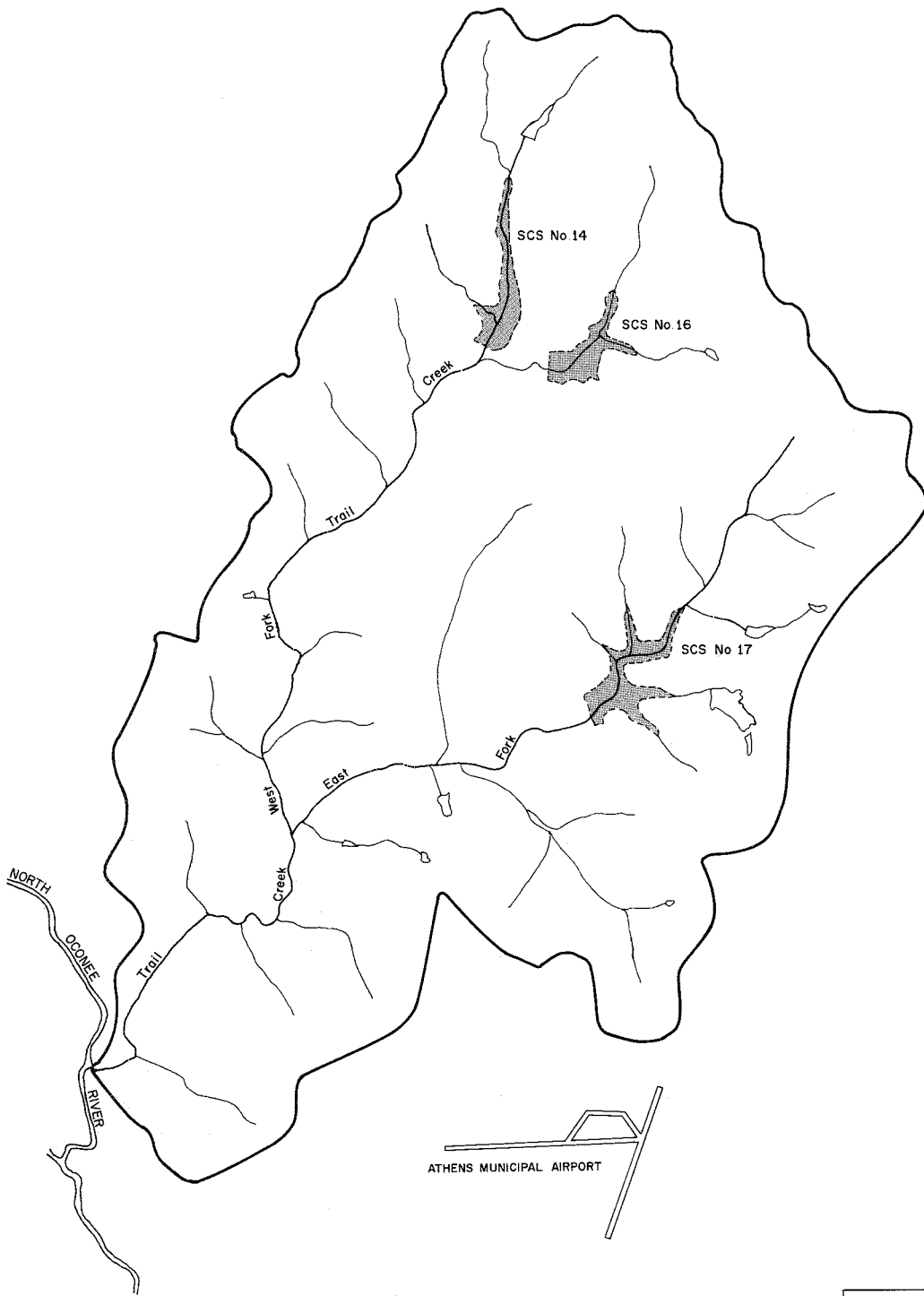

TRAIL CREEK PILOT STUDY
 AUTHORIZED
 SCS RESERVOIR LOCATIONS

Prepared By
 Hydrologic Engineering Center
 Davis, California September 1975

Figure D-4

of confidence in the reliability of water surface profile estimates. Cross sections were surveyed at about one-half mile intervals and supplemental cross sections were developed from the contours of a 400-foot per inch scale map with a contour interval of 5 feet. Water surface profiles were estimated for a variety of discharges covering the range of 2-year to SPF discharges. Channel roughness of 0.07 and overbank of 0.10 were adopted in developing profiles. A stage rating curve at the most downstream damage index point, and a storage-discharge relationship for this reach was calculated to evaluate the adopted curves developed from the simplified analysis using the ROUTE program.

Table IV-2 (repeated here) summarizes the results of the flood hazard evaluation of the four alternative watershed conditions that were studied.

Flooded Area Maps

A concept of automatically generating a flooded area - depth of flooding map for a particular flood event was developed using the spatial data files. The maps may be printed at a desired scale in a computer-printer format. The maps are intended to be used where quick and numerous assessments of flooded areas are required, for reports where cartographic quality displays are not necessary, and to expedite and assist the construction of traditional detailed cartographic flooded area maps by providing an initial estimate of the flooded area boundaries that could be transferred to the desired map and refined.

The maps are developed automatically from input of the computed or desired water surface elevation at each stream reach index location. The DAMCAL program then accesses the stream reach number, topographic, and reference flood elevation data sets from the grid cell data bank and automatically generates a flooded area-depth of flooding map. Each cell of a particular stream reach is assigned a stream reach number, topographic elevation and reference flood elevation. The reference flood elevation is adjusted a cell at a time to conform to the flood elevation of interest at the index location of the reach. The topographic elevation is then subtracted from this value to compute the depth of flooding for each grid cell. A spatial gridded map is then generated that displays the cells that are flooded. The printed output of an automatically determined flooded area for Trail Creek would be similar to Fig. V-4.

APPENDIX E
AGGREGATE DAMAGE FUNCTIONS

TABLE B16C-1 - FERRY SERVICE OF THE WEST COAST

| FERRY SERVICE | LAND USE CATEGORIES | | | | | | | | | | TOTAL |
|---------------|---------------------|------|------|------|------|------|------|------|------|------|-------|
| | 1 | 2 | 3 | 4 | 5 | 6 | 7 | 8 | 9 | 10 | |
| 810.0 | 5.00 | 5.00 | 5.00 | 5.00 | 5.00 | 5.00 | 5.00 | 5.00 | 5.00 | 5.00 | 5.00 |
| 811.0 | 5.00 | 5.00 | 5.00 | 5.00 | 5.00 | 5.00 | 5.00 | 5.00 | 5.00 | 5.00 | 5.00 |
| 812.0 | 5.00 | 5.00 | 5.00 | 5.00 | 5.00 | 5.00 | 5.00 | 5.00 | 5.00 | 5.00 | 5.00 |
| 813.0 | 5.00 | 5.00 | 5.00 | 5.00 | 5.00 | 5.00 | 5.00 | 5.00 | 5.00 | 5.00 | 5.00 |
| 814.0 | 5.00 | 5.00 | 5.00 | 5.00 | 5.00 | 5.00 | 5.00 | 5.00 | 5.00 | 5.00 | 5.00 |
| 815.0 | 5.00 | 5.00 | 5.00 | 5.00 | 5.00 | 5.00 | 5.00 | 5.00 | 5.00 | 5.00 | 5.00 |
| 816.0 | 5.00 | 5.00 | 5.00 | 5.00 | 5.00 | 5.00 | 5.00 | 5.00 | 5.00 | 5.00 | 5.00 |
| 817.0 | 5.00 | 5.00 | 5.00 | 5.00 | 5.00 | 5.00 | 5.00 | 5.00 | 5.00 | 5.00 | 5.00 |
| 818.0 | 5.00 | 5.00 | 5.00 | 5.00 | 5.00 | 5.00 | 5.00 | 5.00 | 5.00 | 5.00 | 5.00 |
| 819.0 | 5.00 | 5.00 | 5.00 | 5.00 | 5.00 | 5.00 | 5.00 | 5.00 | 5.00 | 5.00 | 5.00 |
| 820.0 | 5.00 | 5.00 | 5.00 | 5.00 | 5.00 | 5.00 | 5.00 | 5.00 | 5.00 | 5.00 | 5.00 |
| 821.0 | 5.00 | 5.00 | 5.00 | 5.00 | 5.00 | 5.00 | 5.00 | 5.00 | 5.00 | 5.00 | 5.00 |
| 822.0 | 5.00 | 5.00 | 5.00 | 5.00 | 5.00 | 5.00 | 5.00 | 5.00 | 5.00 | 5.00 | 5.00 |
| 823.0 | 5.00 | 5.00 | 5.00 | 5.00 | 5.00 | 5.00 | 5.00 | 5.00 | 5.00 | 5.00 | 5.00 |
| 824.0 | 5.00 | 5.00 | 5.00 | 5.00 | 5.00 | 5.00 | 5.00 | 5.00 | 5.00 | 5.00 | 5.00 |
| 825.0 | 5.00 | 5.00 | 5.00 | 5.00 | 5.00 | 5.00 | 5.00 | 5.00 | 5.00 | 5.00 | 5.00 |
| 826.0 | 5.00 | 5.00 | 5.00 | 5.00 | 5.00 | 5.00 | 5.00 | 5.00 | 5.00 | 5.00 | 5.00 |
| 827.0 | 5.00 | 5.00 | 5.00 | 5.00 | 5.00 | 5.00 | 5.00 | 5.00 | 5.00 | 5.00 | 5.00 |
| 828.0 | 5.00 | 5.00 | 5.00 | 5.00 | 5.00 | 5.00 | 5.00 | 5.00 | 5.00 | 5.00 | 5.00 |
| 829.0 | 5.00 | 5.00 | 5.00 | 5.00 | 5.00 | 5.00 | 5.00 | 5.00 | 5.00 | 5.00 | 5.00 |
| 830.0 | 5.00 | 5.00 | 5.00 | 5.00 | 5.00 | 5.00 | 5.00 | 5.00 | 5.00 | 5.00 | 5.00 |
| 831.0 | 5.00 | 5.00 | 5.00 | 5.00 | 5.00 | 5.00 | 5.00 | 5.00 | 5.00 | 5.00 | 5.00 |
| 832.0 | 5.00 | 5.00 | 5.00 | 5.00 | 5.00 | 5.00 | 5.00 | 5.00 | 5.00 | 5.00 | 5.00 |
| 833.0 | 5.00 | 5.00 | 5.00 | 5.00 | 5.00 | 5.00 | 5.00 | 5.00 | 5.00 | 5.00 | 5.00 |
| 834.0 | 5.00 | 5.00 | 5.00 | 5.00 | 5.00 | 5.00 | 5.00 | 5.00 | 5.00 | 5.00 | 5.00 |
| 835.0 | 5.00 | 5.00 | 5.00 | 5.00 | 5.00 | 5.00 | 5.00 | 5.00 | 5.00 | 5.00 | 5.00 |
| 836.0 | 5.00 | 5.00 | 5.00 | 5.00 | 5.00 | 5.00 | 5.00 | 5.00 | 5.00 | 5.00 | 5.00 |
| 837.0 | 5.00 | 5.00 | 5.00 | 5.00 | 5.00 | 5.00 | 5.00 | 5.00 | 5.00 | 5.00 | 5.00 |
| 838.0 | 5.00 | 5.00 | 5.00 | 5.00 | 5.00 | 5.00 | 5.00 | 5.00 | 5.00 | 5.00 | 5.00 |
| 839.0 | 5.00 | 5.00 | 5.00 | 5.00 | 5.00 | 5.00 | 5.00 | 5.00 | 5.00 | 5.00 | 5.00 |
| 840.0 | 5.00 | 5.00 | 5.00 | 5.00 | 5.00 | 5.00 | 5.00 | 5.00 | 5.00 | 5.00 | 5.00 |

TABLE B16C-2 - FERRY SERVICE OF THE WEST COAST

| FERRY SERVICE | LAND USE CATEGORIES | | | | | | | | | | TOTAL |
|---------------|---------------------|------|------|------|------|------|------|------|------|------|-------|
| | 1 | 2 | 3 | 4 | 5 | 6 | 7 | 8 | 9 | 10 | |
| 841.0 | 5.00 | 5.00 | 5.00 | 5.00 | 5.00 | 5.00 | 5.00 | 5.00 | 5.00 | 5.00 | 5.00 |
| 842.0 | 5.00 | 5.00 | 5.00 | 5.00 | 5.00 | 5.00 | 5.00 | 5.00 | 5.00 | 5.00 | 5.00 |
| 843.0 | 5.00 | 5.00 | 5.00 | 5.00 | 5.00 | 5.00 | 5.00 | 5.00 | 5.00 | 5.00 | 5.00 |
| 844.0 | 5.00 | 5.00 | 5.00 | 5.00 | 5.00 | 5.00 | 5.00 | 5.00 | 5.00 | 5.00 | 5.00 |
| 845.0 | 5.00 | 5.00 | 5.00 | 5.00 | 5.00 | 5.00 | 5.00 | 5.00 | 5.00 | 5.00 | 5.00 |
| 846.0 | 5.00 | 5.00 | 5.00 | 5.00 | 5.00 | 5.00 | 5.00 | 5.00 | 5.00 | 5.00 | 5.00 |
| 847.0 | 5.00 | 5.00 | 5.00 | 5.00 | 5.00 | 5.00 | 5.00 | 5.00 | 5.00 | 5.00 | 5.00 |
| 848.0 | 5.00 | 5.00 | 5.00 | 5.00 | 5.00 | 5.00 | 5.00 | 5.00 | 5.00 | 5.00 | 5.00 |
| 849.0 | 5.00 | 5.00 | 5.00 | 5.00 | 5.00 | 5.00 | 5.00 | 5.00 | 5.00 | 5.00 | 5.00 |
| 850.0 | 5.00 | 5.00 | 5.00 | 5.00 | 5.00 | 5.00 | 5.00 | 5.00 | 5.00 | 5.00 | 5.00 |
| 851.0 | 5.00 | 5.00 | 5.00 | 5.00 | 5.00 | 5.00 | 5.00 | 5.00 | 5.00 | 5.00 | 5.00 |
| 852.0 | 5.00 | 5.00 | 5.00 | 5.00 | 5.00 | 5.00 | 5.00 | 5.00 | 5.00 | 5.00 | 5.00 |
| 853.0 | 5.00 | 5.00 | 5.00 | 5.00 | 5.00 | 5.00 | 5.00 | 5.00 | 5.00 | 5.00 | 5.00 |
| 854.0 | 5.00 | 5.00 | 5.00 | 5.00 | 5.00 | 5.00 | 5.00 | 5.00 | 5.00 | 5.00 | 5.00 |
| 855.0 | 5.00 | 5.00 | 5.00 | 5.00 | 5.00 | 5.00 | 5.00 | 5.00 | 5.00 | 5.00 | 5.00 |
| 856.0 | 5.00 | 5.00 | 5.00 | 5.00 | 5.00 | 5.00 | 5.00 | 5.00 | 5.00 | 5.00 | 5.00 |
| 857.0 | 5.00 | 5.00 | 5.00 | 5.00 | 5.00 | 5.00 | 5.00 | 5.00 | 5.00 | 5.00 | 5.00 |
| 858.0 | 5.00 | 5.00 | 5.00 | 5.00 | 5.00 | 5.00 | 5.00 | 5.00 | 5.00 | 5.00 | 5.00 |
| 859.0 | 5.00 | 5.00 | 5.00 | 5.00 | 5.00 | 5.00 | 5.00 | 5.00 | 5.00 | 5.00 | 5.00 |
| 860.0 | 5.00 | 5.00 | 5.00 | 5.00 | 5.00 | 5.00 | 5.00 | 5.00 | 5.00 | 5.00 | 5.00 |
| 861.0 | 5.00 | 5.00 | 5.00 | 5.00 | 5.00 | 5.00 | 5.00 | 5.00 | 5.00 | 5.00 | 5.00 |
| 862.0 | 5.00 | 5.00 | 5.00 | 5.00 | 5.00 | 5.00 | 5.00 | 5.00 | 5.00 | 5.00 | 5.00 |
| 863.0 | 5.00 | 5.00 | 5.00 | 5.00 | 5.00 | 5.00 | 5.00 | 5.00 | 5.00 | 5.00 | 5.00 |
| 864.0 | 5.00 | 5.00 | 5.00 | 5.00 | 5.00 | 5.00 | 5.00 | 5.00 | 5.00 | 5.00 | 5.00 |
| 865.0 | 5.00 | 5.00 | 5.00 | 5.00 | 5.00 | 5.00 | 5.00 | 5.00 | 5.00 | 5.00 | 5.00 |

LAND USE NO. 1 IS MARINA, VISITATION
 LAND USE NO. 2 IS RESURFACED OPEN SPACE
 LAND USE NO. 3 IS LOW DENSITY RESIDENTIAL
 LAND USE NO. 4 IS MEDIUM DENSITY RESIDENTIAL
 LAND USE NO. 5 IS HIGH DENSITY RESIDENTIAL
 LAND USE NO. 6 IS INDUSTRIAL
 LAND USE NO. 7 IS UNIVERSITY
 LAND USE NO. 8 IS GOVERNMENT
 LAND USE NO. 9 IS PARK
 LAND USE NO. 10 IS WATER BODIES

AGGREGATE DAMAGE FUNCTION -
 1990 UNCONTROLLED LAND USE

APPENDIX F
REFERENCES

REFERENCES

- (1) Phase I, Oconee River Basin Flood Plain Information Scope Study, Savannah District Corps of Engineers, June 1973.
- (2) HEC-1 Flood Hydrograph Package, Users Manual, Hydrologic Engineering Center, January 1973.
- (3) HEC-2 Water Surface Profiles, Users Manual, Hydrologic Engineering Center, February 1972.
- (4) Urban Stormwater Runoff, "STORM", Users Manual, Hydrologic Engineering Center, August 1975.
- (5) Water Quality for River-Reservoir Systems, Hydrologic Engineering Center, September 1975.
- (6) Urbanizations Drainage Consequences, Journal of the Urban Planning and Development Division, Proceedings of ASCE, December 1971.
- (7) Flood Plain Information, Trail Creek, Athens and Clarke County, Georgia, October 1969, Savannah Corps of Engineers.
- (8) Honey Hill, A Systems Analysis for Planning the Multiple Use of Controlled Water Areas, IWR report 71-9.
- (9) Design with Nature, McHarg, Ian L., Natural History Press, Garden City, New York, 1969.
- (10) Terrain Analysis, Way, Douglas S., 1973.
- (11) Soil Conservation Service, National Engineering Handbook, U. S. Soil Service.

