

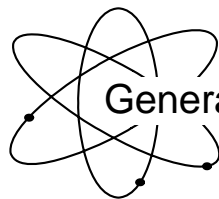

**US Army Corps
of Engineers**

Hydrologic Engineering Center



Generalized Computer Program

UNET One-Dimensional Unsteady Flow Through a Full Network of Open Channels

User's Manual

April 2001

Version 4.0

REPORT DOCUMENTATION PAGE

Form Approved OMB No. 0704-0188

The public reporting burden for this collection of information is estimated to average 1 hour per response, including the time for reviewing instructions, searching existing data sources, gathering and maintaining the data needed, and completing and reviewing the collection of information. Send comments regarding this burden estimate or any other aspect of this collection of information, including suggestions for reducing this burden, to the Department of Defense, Executive Services and Communications Directorate (0704-0188). Respondents should be aware that notwithstanding any other provision of law, no person shall be subject to any penalty for failing to comply with a collection of information if it does not display a currently valid OMB control number.

PLEASE DO NOT RETURN YOUR FORM TO THE ABOVE ORGANIZATION.

1. REPORT DATE (DD-MM-YYYY) April 2001		2. REPORT TYPE Computer Program Documentation		3. DATES COVERED (From - To)	
4. TITLE AND SUBTITLE UNET One-Dimensional Unsteady Flow Through a Full Network of Open Channels				5a. CONTRACT NUMBER	
				5b. GRANT NUMBER	
				5c. PROGRAM ELEMENT NUMBER	
				5d. PROJECT NUMBER	
6. AUTHOR(S) Dr. Robert L. Barkau; revised by CEIWR-HEC				5e. TASK NUMBER	
				5f. WORK UNIT NUMBER	
7. PERFORMING ORGANIZATION NAME(S) AND ADDRESS(ES) US Army Corps of Engineers Institute for Water Resources Hydrologic Engineering Center (HEC) 609 Second Street Davis, CA 95616-4687				8. PERFORMING ORGANIZATION REPORT NUMBER CPD-66	
9. SPONSORING/MONITORING AGENCY NAME(S) AND ADDRESS(ES)				10. SPONSOR/MONITOR'S ACRONYM(S)	
				11. SPONSOR/MONITOR'S REPORT NUMBER(S)	
12. DISTRIBUTION / AVAILABILITY STATEMENT Approved for public release; distribution is unlimited.					
13. SUPPLEMENTARY NOTES					
14. ABSTRACT UNET is a numerical model that simulates one-dimensional unsteady flow through a full network of open channels. In addition to solving the network system, UNET provides the user with the ability to apply many external and internal boundary conditions, including: flow and stage hydrographs, rating curves, gated and uncontrolled spillways, pump stations, bridges, culverts, and levee systems.					
15. SUBJECT TERMS unsteady flow, river hydraulics, numerical models					
16. SECURITY CLASSIFICATION OF:			17. LIMITATION OF ABSTRACT UU	18. NUMBER OF PAGES 400	19a. NAME OF RESPONSIBLE PERSON
a. REPORT U	b. ABSTRACT U	c. THIS PAGE U			19b. TELEPHONE NUMBER

UNET

One-Dimensional Unsteady Flow Through a Full Network of Open Channels

User's Manual

April 2001

Version 4.0

US Army Corps of Engineers
Institute for Water Resources
Hydrologic Engineering Center
609 Second Street
Davis, CA 95616

(530) 756-1104

(530) 756-8250 FAX

www.hec.usace.army.mil

CPD-66



REPLY TO
ATTENTION OF

DEPARTMENT OF THE ARMY
WATER RESOURCES SUPPORT CENTER, CORPS OF ENGINEERS
HYDROLOGIC ENGINEERING CENTER
609 SECOND STREET
DAVIS, CALIFORNIA 95616-4687

MEMORANDUM OF UNDERSTANDING
BETWEEN

HYDROLOGIC ENGINEERING CENTER AND DR. ROBERT L. BARKAU

SUBJECT: Computer Program UNET

1. The purpose of this memorandum is to modify the 1990 Memorandum of Understanding (1990 MOU) that defined the Corps' right to use the source code and documentation for computer programs USTDY and UNET, developed by Dr. Robert L. Barkau.
2. The 1990 MOU, effective October 1, 1989, allowed the Corps unrestricted use and distribution of the programs UNET and USTDY to Corps of Engineers offices. Dr. Barkau retains all rights to further develop, support, and apply his programs, and to market them in the public sector. The HEC and Dr. Barkau are successfully operating under this agreement.
3. The expanded use of program UNET by the Corps and others has resulted in concern by other Federal agencies because they do not have free access to the program under the 1990 MOU. For example, Corps UNET program applications for floodway computation must be reviewed and approved by FEMA; and Corps UNET applications for stage forecasts may be reviewed by NWS. In addition, Corps offices cannot give their contractors UNET under the 1990 MOU.
4. This revision to the 1990 MOU is to enlarge the Corps of Engineer's distribution rights for program UNET. (Program USTDY is no longer being used.) Under this modification, the Corps will have the right to distribute the executable version of the computer program to all others, including federal, state, public and private organizations - both domestic and foreign.
5. By signing this memorandum, HEC agrees to maintain and support the Corps' version of the UNET computer program in support of Corps activities. HEC will continue to have unrestricted rights to use, modify and distribute the UNET program source code within the Corps of Engineers. HEC will continue to provide Dr. Barkau information on any program problems or enhancements. Additionally, Corps offices will have the right to provide the executable program to others. Corps offices are restricted from releasing the program source code dealing with the network solver (subroutines starting with SKY.. in program modules CSECT and UNET), without Dr. Barkau's written permission.
6. By signing this memorandum, Dr. Barkau acknowledges the Corps' continued right of unrestricted use, modification and distribution within the Corps, of computer program UNET. Additionally, the Corps will have the right to distribute the executable version of the program to all others. Dr. Barkau retains all rights to further develop, support, and apply the programs, and to market it as he chooses.
7. Effective date is February 28, 1994.

Signature and date:

Darryl W. Davis 28 Feb. 1994
DARRYL W. DAVIS, Director
Hydrologic Engineering Center

Robert L. Barkau 4/15/94
ROBERT L. BARKAU, Ph.D.
Hydraulic Engineer

Table of Contents

Chapter	Title	Page
1	Introduction.....	1-1
2	Equations of Motion for the Channel and Floodplain.....	2-1
	2.1 Implicit Finite Difference Scheme.....	2-2
	2.2 Continuity Equation.....	2-4
	2.3 Momentum Equation.....	2-5
	2.4 Added Force Term.....	2-7
	2.5 Lateral Influx of Momentum.....	2-8
3	Finite Difference Form of the Unsteady Flow Equations.....	3-1
	3.1 Linearized, Implicit, Finite Difference Equations.....	3-1
	3.2 Flow distribution Factor.....	3-6
	3.3 Equivalent Flow Path.....	3-6
	3.4 Boundary Conditions.....	3-7
	3.4.1 Interior Boundary Conditions (for Reach Connections).....	3-7
	3.4.2 Upstream Boundary Conditions.....	3-8
	3.4.3 Downstream Boundary Conditions.....	3-9
4	Internal Boundary Conditions.....	4-1
	4.1 Levees.....	4-1
	4.1.1 Modeling of a Leveed Area.....	4-2
	4.1.2 Solution.....	4-3
	4.1.3 Levee Flow as a Lateral Inflow in the Continuity Equation.....	4-5
	4.2 Flow over a Spillway.....	4-6
	4.2.1 Equations for Flow over a Spillway Structure.....	4-6
	4.2.2 Overflow Weir.....	4-7
	4.2.3 Elevation Controlled Gate.....	4-7
	4.2.4 Numerical Analysis.....	4-8
	4.3 Modeling Bridges, Culverts, and Low Water Dams.....	4-12
	4.3.1 Yarnell's Equation.....	4-12
	4.3.2 Free and Submerged Rating Curves.....	4-14
	4.3.3 Numerical Analysis.....	4-16
	4.4 Flow Diversions.....	4-18
	4.4.1 Pumped Diversion.....	4-18
	4.4.2 Groundwater Interchange.....	4-19
5	Modeling of Bridge Hydraulics.....	5-1
	5.1 Free Flow.....	5-2
	5.1.1 Low Flow.....	5-2
	5.1.2 Pressure Flow.....	5-3
	5.1.3 Weir Flow.....	5-3
	5.2 Submerged Flow.....	5-4

	5.2.1 Low Flow using Yarnell's Equation.....	5-4
	5.2.2 Pressure Flow.....	5-4
	5.2.3 Weir Flow.....	5-4
	5.3 Strategy for Computing Free and Submerged Flow Rating Curves...	5-4
6	Modeling of Culverts.....	6-1
	6.1 Flow Types.....	6-1
	6.2 Three Flow Regions.....	6-2
	6.3 Culvert Discharge using the FHWA Procedure.....	6-2
	6.4 Verification of Culvert Algorithm.....	6-5
	6.5 Strategy for Computing Free and Submerged Flow Rating Curves...	6-6
	6.6 Addition of Risers, Bleeders, and Drop Inlets.....	6-6
	6.6.1 Riser.....	6-9
	6.6.2 Bleeders.....	6-9
	6.6.3 Drop Inlet Sump.....	6-10
7	Modeling of Closed Conduits.....	7-1
	7.1 Preissmann Slot.....	7-1
	7.2 Darcy-Weisbach Friction Factor.....	7-4
	7.3 Pilot Channel for Circular Conduits.....	7-6
8	Storage Areas.....	8-1
	8.1 Storage Areas.....	8-1
	8.2 Connections to the Downstream Terminus of a Reach.....	8-3
	8.3 Submerged Weir Equation.....	8-4
	8.3.1 Submergence Coefficient.....	8-5
	8.4 Special Connections.....	8-6
9	Simulation of Levee Breaches.....	9-1
	9.1 Modeling Approaches.....	9-2
	9.2 Levee Failures.....	9-5
	9.3 Include Files.....	9-6
	9.4 Output from Levee Systems.....	9-6
	9.5 Embankment Failure.....	9-6
	9.5.1 Overtopping Breach.....	9-7
	9.5.2 Piping Failure.....	9-8
	9.6 The Simple Embankment Failure.....	9-10
10	Using the UNET Package of Programs.....	10-1
	10.1 The UNET System.....	10-1
	10.2 The RUNUNET Interface for Windows 95,98, and NT.....	10-3
	10.3 HEC Data Storage System (HEC-DSS).....	10-5
	10.4 RAS2UNET User's Guide.....	10-7
11	References.....	11-1

Appendix	Title	Page
A	Derivation of the Continuity and Momentum Equations for One-Dimensional Unsteady Open Channel Flow.....	A-1
B	CSECT Input Data Description.....	B-1
C	UNET Input Data Description.....	C-1
D	Example Problems.....	D-1
	D-1 A Simple Full Network.....	D-1
	D-2 Advanced Features.....	D-23
	D-3 Ice Cover.....	D-33
E	UNET Mississippi Basin Model Features.....	E-1
	E-1 Missouri River Levee Conveyance Routing.....	E1-1
	E-2 Missouri River Dike Fields.....	E2-1
	E-3 Mississippi River Navigation Dam Algorithm.....	E3-1
	E-4 Mississippi Null Internal Boundary Condition (Estimation of Ungaged Inflow).....	E4-1
F	Other UNET Applications.....	F-1
	F-1 A UNET Tidal Hydraulics Application.....	F1-1
	F-2 Modeling of Ice Covered Streams.....	F2-1

List of Figures

Number	Title	Page
1-1	Split of Flow at a Junction	1-1
1-2	An Example of a Flow Network	1-2
2-1	Channel and Floodplain Flows	2-1
2-2	Typical Finite Difference Cell	2-3
3-1	Typical Flow Split and Combination.....	3-9
4-1	Stage Hydrograph of the Illinois River at Kingston Mines with and without the Breaching of the Agricultural Levees along the River	4-2
4-2	Family of Free and Submerged Rating Curves.....	4-15
4-3	Pump Station Capacity Curve for a Pumped Diversion.....	4-19
4-4	Effective Length for the Computation of Piezometric Head Differential.....	4-21
6-1	The Three Culvert Flow Regions.....	6-2
6-2	Riser Pipe and Culvert through an Embankment.....	6-9
6-3	Five Types of Bleeders in the UNET Program.....	6-10
6-4	Culvert with Upstream Inlet Sump	6-10
7-1	Circular Conduit with Preissmann Slot	7-3
7-2	Circular Conduit and Pilot Channel.....	7-6
8-1	A Typical Storage Area.....	8-1
9-1	Water Surface in the Vicinity of a Levee Breach	9-1
9-2	The Cell Layout used to Model the Columbia, Harrisonville, Stringtown, and Ft. Chartres Levee Systems	9-4
9-3	Pilot Channel in the Parallel Channel	9-5
9-4	Trapezoidal Overtopping Breach	9-7
9-5	Hexagonal Piping Breach	9-8
9-6	Final Trapezoidal Breach after the Breach has broken through the top of the Embankment	9-9
9-7	Simple Spillway Concept.....	9-10
10-1	UNET System	10-2
10-2	Form for RUNUNET	10-3
10-3	DSS Linkage of UNET and Hydrologic Models	10-6

List of Tables		
Number	Title	Page
3-1	Finite Difference Approximation of the Terms in the Continuity Equation	3-2
3-2	Finite Difference Approximation of the Terms in the Momentum Equation	3-3
3-3	Coefficients for the Continuity Equation	3-4
3-4	Coefficients of the Momentum Equation	3-5
6-1	Comparison between Culvert Flow Computed using the USGS Procedure and the Culvert Procedure in UNET	6-7
6-2	Comparison between Culvert Flow Computed using the SFWMD Procedure and the Culvert Procedure in UNET	6-8
7-1	Relative Roughness Vs. Darcy-Weisbach Friction Factor f for Fully Turbulent Flow	7-5

Preface

UNET is a one-dimensional unsteady open-channel flow model that can simulate flow in single reaches or complex networks of interconnected channels. Many types of in-channel hydraulic controls such as bridges, weirs and culverts can be modeled. Exchange of flow over levees with storage areas can be simulated. Because of its capability to include off-channel storage areas and simulate looped systems, UNET may be thought of as a quasi-two-dimensional model.

Primary development and application of UNET was done by Dr. Robert L. Barkau. This manual was prepared from documentation provided to HEC by Dr. Barkau. Under an agreement with Dr. Barkau the Hydrologic Engineering Center maintains, distributes and supports UNET for Corps of Engineers offices (ref. "Memorandum of Understanding").

This user's manual and associated software culminates HEC's development of UNET. The prior HEC release of UNET, Ver. 3.2, has been expanded for Ver. 4.0 to include general use developments that have been spun-off from the Mississippi Basin Modeling System.

Chapter 1

Introduction

UNET simulates one-dimensional unsteady flow through a network of open channels. One element of open channel flow in networks is the split of flow into two or more channels. Figure 1-1 illustrates such a flow split. For subcritical flow, the division of flow depends upon the capacities of the receiving channels. Those capacities are functions of downstream channel geometries and backwater effects. A second element of a stream network is the combination of flow; which is termed the dendritic problem. This is considered to be a simpler modeling problem than the flow split because flow from each tributary is dependent only on the stage in the receiving stream. A flow network that includes single channels, dendritic systems, flow splits, and loops (such as flow around islands) is the most general situation. Figure 1-2 illustrates a dendritic channel system, including a full network. The system shown includes flow bifurcations, a crossing canal, a four-node junction and a storage area. UNET has the capability to simulate flow in such a system.

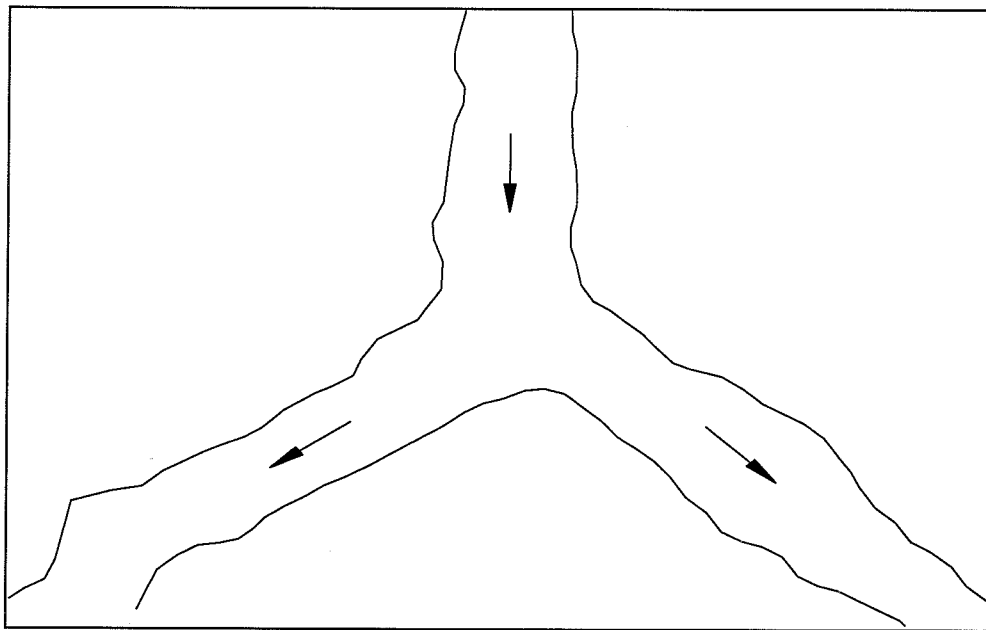

Figure 1-1 Split flow at a junction. The rate of flow into each reach depends upon the geometry of the downstream reaches and backwater effects.

Another capability of UNET is the simulation of storage areas; e.g., lake-like regions that can either provide water to, or divert water from, a channel. This is commonly called a split flow problem. In this situation, the water surface elevation in the storage area will control the volume of water diverted. That volume, in turn, affects the shape and timing of downstream hydrographs. Storage areas can be used as upstream or downstream boundaries for a river reach. In addition, the river can overflow laterally into storage areas over a gated spillway, weir, levee, through a culvert, or via a pumped diversion.

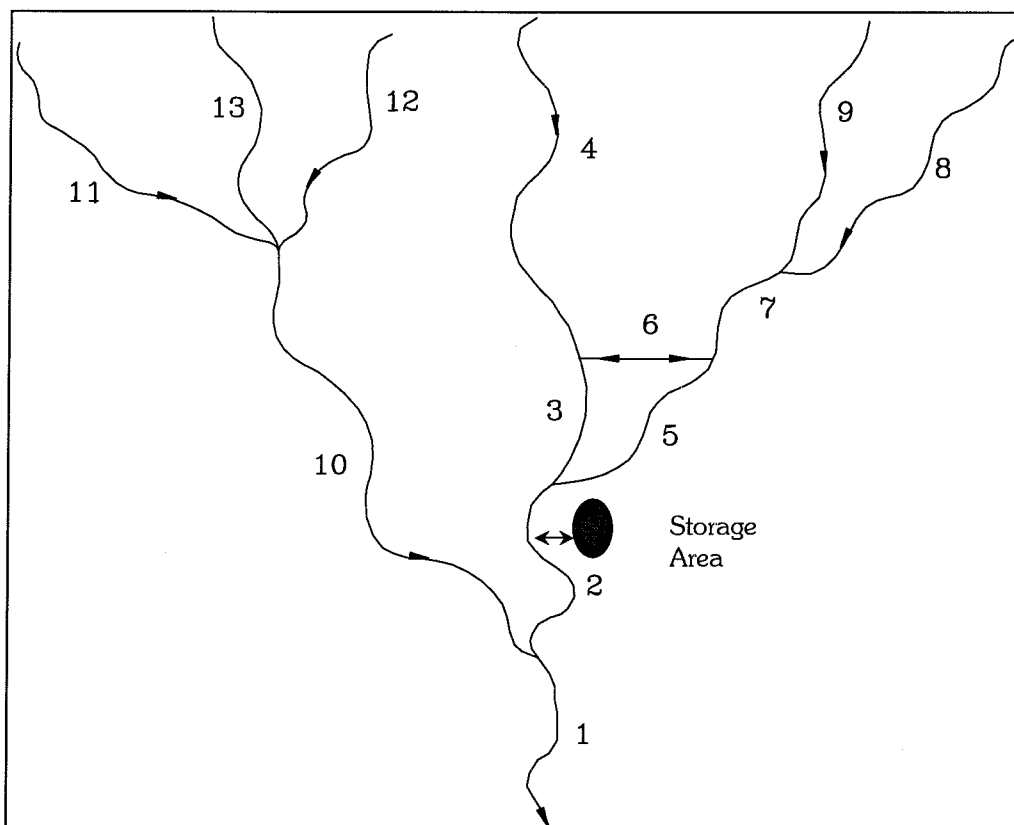

Figure 1-2 An example of a flow network. This network includes 13 reaches and one storage area.

In addition to solving the one-dimensional unsteady flow equations in a network system, UNET provides the user with the ability to apply many external and internal boundary conditions, including; flow and stage hydrographs, gated and uncontrolled spillways, bridges, culverts and levee systems.

To facilitate model application, channel cross sections are encoded in a modified HEC-2 or HEC-RAS format which requires that the geometric data sequence be from upstream to downstream. A large number of river systems have been modeled using HEC-2 or HEC-RAS; those existing data files can be readily adapted to UNET format. Boundary conditions (flow hydrographs, stage hydrographs, etc.) for UNET can be input from any existing HEC-DSS (HEC, 1995) data base. For most simulations, particularly those with large numbers of input hydrographs and hydrograph ordinates, HEC-DSS is advantageous to the point of necessity because it eliminates the manual tabular input of hydrographs and creates an input file which can be easily adapted to a large number of scenarios. Hydrographs and profiles computed by UNET are output to HEC-DSS for graphical display and for comparisons with observed data. Guidance for numerical modeling of river hydraulics is given in the Corps' River Hydraulics EM (USACE, 1993).

Chapter 2

Equations of Motion for the Channel and Floodplain

Figure 2-1 illustrates the two-dimensional characteristics of the interaction between the channel and floodplain flows. When the river is rising water moves laterally away from the channel, inundating the floodplain and filling available storage areas. As the depth increases, the floodplain begins to convey water downstream, generally along a shorter path than that of the main channel. When the river stage is falling, water moves toward the channel from the overbank supplementing the flow in the main channel.

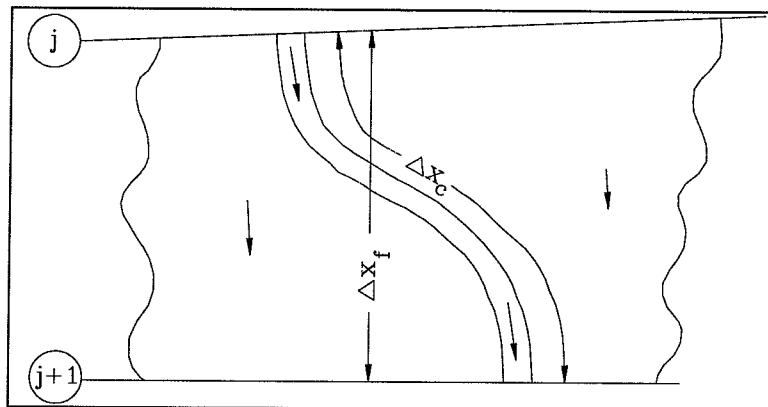

Figure 2-1 Channel and floodplain flows

Because the primary direction of flow is oriented along the channel, this two-dimensional flow field can often be accurately approximated by a one-dimensional representation. Off-channel ponding areas can be modeled with a storage areas that exchange water with the channel. Flow in the overbank can be approximated as flow through a separate channel.

This channel/floodplain problem has been addressed in many different ways. A common approach is to ignore overbank conveyance entirely, assuming that the overbank is used only for storage. This assumption may be suitable for large streams such as the Mississippi River where the channel is confined by levees and the remaining floodplain is either heavily vegetated or an off-channel storage area. Fread (1976) and Smith (1978) approached this problem by dividing the system into two separate channels and writing continuity and momentum equations for each channel. To simplify the problem they assumed a horizontal water surface at each cross section normal to the direction of flow; that the exchange of momentum between the channel and the floodplain was negligible; and that the discharge was distributed according to conveyance, i.e.:

$$Q_c = \phi Q \quad (2-1)$$

Where: Q_c = flow in channel,
 Q = total flow,
 ϕ = $K_c / (K_c + K_f)$,
 K_c = conveyance in the channel, and,
 K_f = conveyance in the floodplain.

With these assumptions, the one-dimensional equations of motion can be combined into a single set:

$$\frac{\partial A}{\partial t} + \frac{\partial(\Phi Q)}{\partial x_c} + \frac{\partial[(1-\Phi)Q]}{\partial x_f} = 0 \quad (2-2)$$

$$\frac{\partial Q}{\partial t} + \frac{\partial(\Phi^2 Q^2 / A_c)}{\partial x_c} + \frac{\partial((1-\Phi)^2 Q^2 / A_f)}{\partial x_f} + gA_c \left[\frac{\partial Z}{\partial x_c} + S_{fc} \right] + gA_f \left[\frac{\partial Z}{\partial x_f} + S_{ff} \right] = 0 \quad (2-3)$$

in which the subscripts c and f refer to the channel and floodplain, respectively. These equations were approximated using implicit finite differences, and the full nonlinear equations solved numerically using the Newton-Raphson iteration technique. The model was successful and produced the desired effects in test problems. Numerical oscillations, however, can occur when flow at one node bounding a finite difference cell is within banks and the other is not.

Expanding on the earlier work of Fread and Smith, Barkau (1982) manipulated the finite difference equations for the channel and floodplain and defined a new set of equations that were computationally more convenient. Using a velocity distribution factor, he combined the convective terms. Further, by defining an equivalent flow path, he replaced the friction slope terms with an equivalent force.

The equations derived by Barkau are the basis for UNET. These equations are derived in Appendix A. The numerical solution of these equations is described in the next section.

2.1 Implicit Finite Difference Scheme

The most successful and accepted procedure for solving the one-dimensional unsteady flow equations is the four-point implicit scheme, also known as the box scheme (Figure 2-2). Under this scheme, space derivatives and function values are evaluated at an interior point, $(n+\theta) \Delta t$. Thus values at $(n+1) \Delta t$ enter in to all terms in the equations. For a reach of river, a system of simultaneous equations results. The simultaneous solution is an important aspect of this scheme because it allows information from the entire reach to influence the solution at any one point. Consequently, the time step can be

significantly larger than with explicit numerical schemes. Von Neumann stability analyses performed by Fread (1974), and Liggett and Cunge (1975), show the implicit scheme to be unconditionally stable (theoretically) for $0.5 < \theta \leq 1.0$; conditionally stable for $\theta = 0.5$, and unstable for $\theta < 0.5$. In a convergence analysis performed by the same authors, it was shown that numerical damping increased as the ratio $\lambda/\Delta x$ decreased, where λ is the length of a wave in the hydraulic system. For streamflow routing problems where the wavelengths are long with respect to spatial distances, convergence is not a serious problem. In practice, other factors may also contribute to the non-stability of the solution scheme. These factors include dramatic changes in channel cross-sectional properties, abrupt changes in channel slope, characteristics of the flood wave itself, and complex hydraulic structures such as levees, bridges, culverts, weirs, and spillways. In fact, these other factors often overwhelm any stability considerations associated with θ . **Because of these factors, any model application should be accompanied by a sensitivity study, where the accuracy and the stability of the solution is tested with various time and distance intervals.**

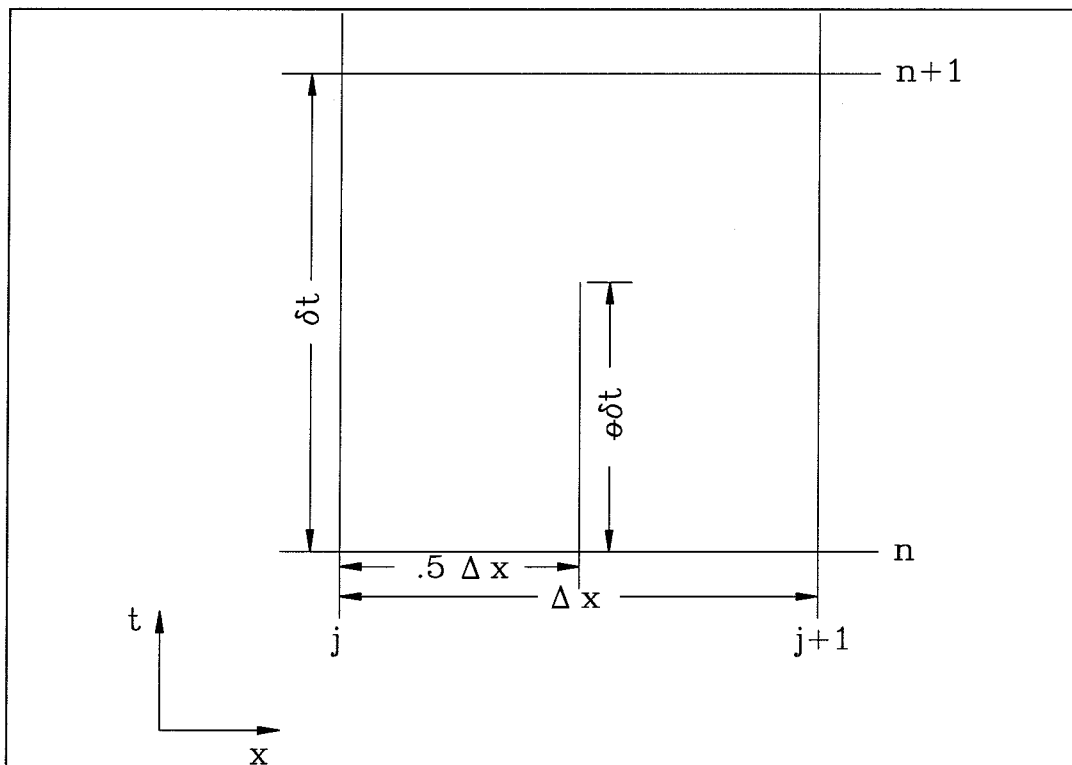

Figure 2-2 Typical finite difference cell.

The following notation is defined:

$$f_j = f_j^n \quad (2-4)$$

and:

$$\Delta f_j = f_j^{n+1} - f_j^n \quad (2-5)$$

then:

$$f_j^{n+1} = f_j^n + \Delta f_j \quad (2-6)$$

The general implicit finite difference forms are:

1. Time derivative

$$\frac{\partial f}{\partial t} \approx \frac{\Delta f}{\Delta t} = \frac{0.5(\Delta f_{j+1} + \Delta f_j)}{\Delta t} \quad (2-7)$$

2. Space derivative

$$\frac{\partial f}{\partial x} \approx \frac{\Delta f}{\Delta x} = \frac{(f_{j+1} - f_j) + \theta(\Delta f_{j+1} - \Delta f_j)}{\Delta x} \quad (2-8)$$

3. Function value

$$f \approx \bar{f} = 0.5(f_j + f_{j+1}) + 0.5\theta(\Delta f_j + \Delta f_{j+1}) \quad (2-9)$$

2.2 Continuity Equation

The continuity equation describes conservation of mass for the one-dimensional system. From Appendix A:

$$\frac{\partial A}{\partial t} + \frac{\partial S}{\partial t} + \frac{\partial Q}{\partial x} - q_l = 0 \quad (2-10)$$

where: x = distance along the channel,
 t = time,
 Q = flow,
 A = cross-sectional area,
 S = storage,
 q_l = lateral inflow per unit distance.

The above equation can be written for the channel and the floodplain:

$$\frac{\partial Q_c}{\partial x_c} + \frac{\partial A_c}{\partial t} = q_f \quad (2-11)$$

and:

$$\frac{\partial Q_f}{\partial x_f} + \frac{\partial A_f}{\partial t} + \frac{\partial S}{\partial t} = q_c + q_l \quad (2-12)$$

where the subscripts c and f refer to the channel and floodplain, respectively, q_l is the lateral inflow per unit length of floodplain, and q_c and q_f are the exchanges of water between the channel and the floodplain.

Equations 2-11 and 2-12 are now approximated using implicit finite differences by applying Equations 2-7 through 2-9:

$$\frac{\Delta Q_c}{\Delta x_c} + \frac{\Delta A_c}{\Delta t} = \bar{q}_f \quad (2-13)$$

$$\frac{\Delta Q_f}{\Delta x_c} + \frac{\Delta A_c}{\Delta t} + \frac{\Delta S}{\Delta t} = \bar{q}_c + \bar{q}_l \quad (2-14)$$

The exchange of mass is equal but not opposite in sign such that $\Delta x_c q_c = -q_f \Delta x_f$. Adding the above equations together and rearranging yields:

$$\Delta Q + \frac{\Delta A_c}{\Delta t} \Delta x_c + \frac{\Delta A_f}{\Delta t} \Delta x_f + \frac{\Delta S}{\Delta t} \Delta x_f - \bar{Q}_l = 0 \quad (2-15)$$

where \bar{Q}_l is the average lateral inflow.

2.3 Momentum Equation

The momentum equation states that the rate of change in momentum is equal to the external forces acting on the system. From Appendix A, for a single channel:

$$\frac{\partial Q}{\partial t} + \frac{\partial(VQ)}{\partial x} + gA\left(\frac{\partial z}{\partial x} + S_f\right) = 0 \quad (2-16)$$

where: g = acceleration of gravity,
 S_f = friction slope,
 V = velocity.

The above equation can be written for the channel and for the floodplain:

$$\frac{\partial Q_c}{\partial t} + \frac{\partial(V_c Q_c)}{\partial x_c} + gA_c\left(\frac{\partial z}{\partial x_c} + S_{fc}\right) = M_f \quad (2-17)$$

$$\frac{\partial Q_f}{\partial t} + \frac{\partial(V_f Q_f)}{\partial x_f} + g A_f \left(\frac{\partial z}{\partial x_f} + S_{ff} \right) = M_c \quad (2-18)$$

where M_c and M_f are the momentum fluxes per unit distance exchanged between the channel and floodplain, respectively. Note that in Equations 2-17 and 2-18 the water surface elevation is not subscripted. An assumption in these equations is that the water surface is horizontal at any cross section perpendicular to the flow. Therefore, the water surface elevation is the same for the channel and the floodplain at a given cross section.

Using Equations 2-7 through 2-9, the above equations are approximated using finite differences:

$$\frac{\Delta Q_c}{\Delta t} + \frac{\Delta(V_c Q_c)}{\Delta x_c} + g \bar{A}_c \left(\frac{\Delta z}{\Delta x_c} + \bar{S}_{fc} \right) = M_f \quad (2-19)$$

$$\frac{\Delta Q_f}{\Delta t} + \frac{\Delta(V_f Q_f)}{\Delta x_f} + g \bar{A}_f \left(\frac{\Delta z}{\Delta x_f} + \bar{S}_{ff} \right) = M_c \quad (2-20)$$

Note that $\Delta x_c M_c = -\Delta x_f M_f$.

Adding and rearranging the above equations yields:

$$\frac{\Delta(Q_c \Delta x_c + Q_f \Delta x_f)}{\Delta t} + \Delta(V_c Q_c) + \Delta(V_f Q_f) + g(A_c + A_f)\Delta z + g \bar{A}_c \bar{S}_{fc} \Delta x_c + g \bar{A}_f \bar{S}_{ff} \Delta x_f = 0 \quad (2-21)$$

The final two terms define the friction force from the banks acting on the fluid. An equivalent force can be defined as:

$$g \bar{A} \bar{S}_f \Delta x_e = g \bar{A}_c \bar{S}_{fc} \Delta x_c + g \bar{A}_f \bar{S}_{ff} \Delta x_f \quad (2-22)$$

where: Δx_e = equivalent flow path,
 \bar{S}_f = friction slope for the entire cross section,
 A = $\bar{A}_c + \bar{A}_f$.

Now, the convective terms can be rewritten by defining a velocity distribution factor:

$$\beta = \frac{(V_c^2 A_c + V_f^2 A_f)}{V^2 A} = \frac{(V_c Q_c + V_f Q_f)}{QV} \quad (2-23)$$

then:

$$\Delta(\beta VQ) = \Delta(V_c Q_c) + \Delta(V_f Q_f) \quad (2-24)$$

The final form of the momentum equation is:

$$\frac{\Delta(Q_c \Delta x_c + Q_f \Delta x_f)}{\Delta t} + \Delta(\beta VQ) + g \bar{A} \Delta z + g \bar{A} \bar{S}_f \Delta x_e = 0 \quad (2-25)$$

A more familiar form is obtained by dividing through by Δx_e :

$$\frac{\Delta(Q_c \Delta x_c + Q_f \Delta x_f)}{\Delta t \Delta x_e} + \frac{\Delta(\beta VQ)}{\Delta x_e} + g \bar{A} \left(\frac{\Delta z}{\Delta x_e} + S_f \right) = 0 \quad (2-26)$$

2.4 Added Force Term

The friction and pressure forces from the banks do not always describe all the forces which act on the water. Structures such as bridge piers, navigation dams, and cofferdams constrict the flow and exert additional forces which oppose the flow. In localized areas these forces can predominate and produce a significant increase in water surface elevation (called a "swell head") upstream of the structure.

For a differential distance, dx , the additional forces in the contraction produce a swell head of dh_i . This swell head is only related to the additional forces. The rate of energy loss can be expressed as a local slope:

$$S_h = \frac{dh_i}{dx} \quad (2-27)$$

The friction slope in Equation 2-26 can be augmented by this term:

$$\frac{\partial Q}{\partial t} + \frac{\partial(VQ)}{\partial x} + gA \left(\frac{\partial z}{\partial x} + S_f + S_h \right) = 0 \quad (2-28)$$

For steady flow, there are a number of relationships for computation of the swell head upstream of a contraction. For navigation dams, the formulas of Kindsvater and Carter, d'Aubuisson (Chow, 1959), and Nagler were reviewed by Denzel (1961). For bridges, the formulas of Yarnell (WES, 1973) and the Federal Highway Administration (FHWA, 1978) are used. These formulas were all determined by experimentation and can be expressed in the more general form:

$$h_i = C \frac{V^2}{2g} \quad (2-29)$$

where h_l is the head loss and C is a coefficient. The coefficient C is a function of velocity, depth, and the geometric properties of the opening, but for simplicity, it will be assumed to be a constant. The location where the velocity head is evaluated varies from method to method. Generally, however, the velocity head is evaluated at the tailwater for tranquil flow and at the headwater for supercritical flow in the contraction.

If h_l occurs over a distance Δx_e , then $h_l = \bar{S}_h \Delta x_e$ and $\bar{S}_h = h_l / \Delta x_e$ where \bar{S}_h is the average slope over the interval Δx_e . The result is inserted in the finite difference form of the momentum equation (Equation 2-26), yielding:

$$\frac{\Delta(Q_c \Delta x_c + Q_f \Delta x_f)}{\Delta t \Delta x_e} + \frac{\Delta(\beta V Q)}{\Delta x_e} + g \bar{A} \left(\frac{\Delta z}{\Delta x_e} + \bar{S}_f + \bar{S}_h \right) = 0 \quad (2-30)$$

2.5 Lateral Influx of Momentum

At stream junctions, the momentum of the flow from a tributary enters the receiving stream as well as the mass. If this added momentum is not included in the momentum equation, the entering flow has no momentum and must be accelerated by the flow in the river. The lack of entering momentum causes the convective acceleration term, $\partial(VQ)/\partial x$, to become large. To balance the spatial change in momentum, the water surface slope must be large enough to provide the force to accelerate the fluid. Thus, the water surface has a drop across the reach where the flow enters creating backwater upstream of the junction on the main stem. When the tributary flow is large in relation to that of the receiving stream, the momentum exchange may be significant. The confluence of the Mississippi and Missouri Rivers is such a juncture. During a large flood, the computed decrease in water surface elevation over the Mississippi reach is over 0.5 feet if the influx of momentum is not properly considered.

The entering momentum is given by:

$$M_l = \xi \frac{Q_l V_l}{\Delta x} \quad (2-31)$$

where:

Q_l	=	lateral inflow,
V_l	=	average velocity of lateral inflow,
ξ	=	fraction of the momentum entering the receiving stream.

The entering momentum is added to the right side of Equation 2-30, hence:

$$\frac{\Delta(Q_c \Delta x_c + Q_f \Delta x_f)}{\Delta t \Delta x_e} + \frac{\Delta(\beta V Q)}{\Delta x_e} + g \bar{A} \left(\frac{\Delta z}{\Delta x_e} + \bar{S}_f + \bar{S}_h \right) = \xi \frac{Q_i V_i}{\Delta x_e} \quad (2-32)$$

Equation 2-32 is only used at stream junctions in a dendritic model.

Chapter 3

Finite Difference Form of the Unsteady Flow Equations

Equations 2-10 and 2-16 are nonlinear. If the implicit finite difference scheme is directly applied, a system of nonlinear algebraic equations results. Amain and Fang (1970), Fread (1974, 1976) and others have solved the nonlinear equations using the Newton-Raphson iteration technique. Apart from being relatively slow, that iterative scheme can experience troublesome convergence problems at discontinuities in the river geometry. To avoid the nonlinear solution, Preissmann (as reported by Liggett and Cunge, 1975) and Chen (1973) developed a technique for linearizing the equations. This chapter describes how the finite difference equations are linearized in UNET.

3.1 Linearized, Implicit, Finite Difference Equations

The following assumptions are applied:

1. If $f \bullet f \gg \Delta f \bullet \Delta f$, then $\Delta f \bullet \Delta f = 0$ (Preissmann as reported by Liggett and Cunge, 1975).
2. If $g = g(Q, z)$, then Δg can be approximated by the first term of the Taylor Series, i.e.:

$$\Delta g_j = \left(\frac{\partial g}{\partial Q} \right)_j \Delta Q_j + \left(\frac{\partial g}{\partial z} \right)_j \Delta z_j \quad (3-1)$$

3. If the time step, Δt , is small, then certain variables can be treated explicitly; hence $h_j^{n+1} \approx h_j^n$ and $\Delta h_j \approx 0$.

Assumption 2 is applied to the friction slope, S_f and the area, A . Assumption 3 is applied to the velocity, V , in the convective term; the velocity distribution factor, β ; the equivalent flow path, x ; and the flow distribution factor, ϕ .

The finite difference approximations are listed term by term for the continuity equation in Table 3-1 and for the momentum equation in Table 3-2.

If the unknown values are grouped on the left-hand side, the following linear equations result:

$$CQ1_j \Delta Q_j + CZ1_j \Delta z_j + CQ2_j \Delta Q_{j+1} + CZ2_j \Delta z_{j+1} = CB_j \quad (3-2)$$

$$MQ1_j \Delta Q_j + MZ1_j \Delta z_j + MQ2_j \Delta Q_{j+1} + MZ2_j \Delta z_{j+1} = MB_j \quad (3-3)$$

Table 3-1
Finite Difference Approximation of the Terms in the Continuity Equation

Term	Finite Difference Approximation
ΔQ	$(Q_{j+1} - Q_j) + \theta(\Delta Q_{j+1} - \Delta Q_j)$
$\frac{\partial A_c}{\partial t} \Delta x_c$	$0.5 \Delta x_{cj} \frac{\left(\frac{dA_c}{dz}\right)_j \Delta z_j + \left(\frac{dA_c}{dz}\right)_{j+1} \Delta z_{j+1}}{\Delta t}$
$\frac{\partial A_f}{\partial t} \Delta x_f$	$0.5 \Delta x_{fj} \frac{\left(\frac{dA_f}{dz}\right)_j \Delta z_j + \left(\frac{dA_f}{dz}\right)_{j+1} \Delta z_{j+1}}{\Delta t}$
$\frac{\partial S}{\partial t} \Delta x_f$	$0.5 \Delta x_{fj} \frac{\left(\frac{dS}{dz}\right)_j \Delta z_j + \left(\frac{dS}{dz}\right)_{j+1} \Delta z_{j+1}}{\Delta t}$

Table 3-2
Finite Difference Approximation of the Terms in the Momentum Equation

Term	Finite Difference Approximation
$\frac{\partial(Q_c \Delta x_c + Q_f \Delta x_f)}{\partial t \Delta x_e}$	$\frac{0.5}{\Delta x_e \partial t} (\partial Q_{cj} \Delta x_{cj} + \partial Q_{fj} \Delta x_{fj} + \partial Q_{cj+1} \Delta x_{cj} + \partial Q_{fj+1} \Delta x_{fj})$
$\frac{\Delta \beta V Q}{\Delta x_{ej}}$	$\frac{1}{\Delta x_{ej}} [(\beta V Q)_{j+1} - (\beta V Q)_j] + \frac{\theta}{\Delta x_{ej}} [(\beta V Q)_{j+1} - (\beta V Q)_j]$
$g \bar{A} \frac{\Delta z}{\Delta x_e}$	$g \bar{A} \left[\frac{z_{j+1} - z_j}{\Delta x_{ej}} + \frac{\theta}{\Delta x_{ej}} (\Delta z_{j+1} - \Delta z_j) \right] + \theta g \Delta \bar{A} \frac{(z_{j+1} - z_j)}{\Delta x_{ej}}$
$g \bar{A} (\bar{S}_f + \bar{S}_h)$	$g \bar{A} (\bar{S}_f + \bar{S}_h) + 0.5 g \bar{A} [(\Delta S_{fj+1} + \Delta S_{fj}) + (\Delta S_{hj+1} + \Delta S_{hj})] + 0.5 g (\bar{S}_f + \bar{S}_h) (\Delta A_j + \Delta A_{j+1})$
\bar{A}	$0.5 (A_{j+1} + A_j)$
\bar{S}_f	$0.5 (S_{fj+1} + S_{fj})$
∂A_j	$\left(\frac{dA}{dz} \right)_j \Delta z_j$
∂S_{fj}	$\left(\frac{-2S_f}{K} \frac{dK}{dz} \right)_j \Delta z_j + \left(\frac{2S_f}{Q} \right)_j \Delta Q_j$
$\partial \bar{A}$	$0.5 (\Delta A_j + \Delta A_{j+1})$

The values of the coefficients are defined in Tables 3-3 and 3-4.

Table 3-3
Coefficients for the Continuity Equation

Coefficient	Value
CQ1 _j	$\frac{-\theta}{\Delta x_{ej}}$
CZ1 _j	$\frac{0.5}{\Delta t \Delta x_{ej}} \left[\left(\frac{dA_c}{dz} \right)_j \Delta x_{ej} + \left(\frac{dA_f}{dz} + \frac{dS}{dz} \right)_j \Delta x_{fj} \right]$
CQ2 _j	$\frac{\theta}{\Delta x_{ej}}$
CZ2 _j	$\frac{0.5}{\Delta t \Delta x_{ej}} \left[\left(\frac{dA_c}{dz} \right)_{j+1} \Delta x_{ej} + \left(\frac{dA_f}{dz} + \frac{dS}{dz} \right)_{j+1} \Delta x_{fj} \right]$
CB _j	$-\frac{Q_{j+1} - Q_j}{\Delta x_{ej}} + \frac{Q_1}{\Delta x_{ej}}$

Table 3-4
Coefficients of the Momentum Equation

Term	Value
MQ _{1j}	$0.5 \frac{\Delta x_{ej} \phi_j + \Delta x_{fj} (1 - \phi_j)}{\Delta x_{ej} \Delta t} - \frac{\beta_j V_j \theta}{\Delta x_{ej}} + \theta g \bar{A} \frac{(S_{fj} + S_{hj})}{Q_j}$
MZ _{1j}	$\frac{-gA\theta}{\Delta x_{ej}} + 0.5g(z_{j+1} - z_j) \left(\frac{dA}{dz} \right)_j \left(\frac{\theta}{\Delta x_{ej}} \right) - g\theta \bar{A} \left[\left(\frac{dK}{dz} \right)_j \left(\frac{S_{fj}}{K_j} \right) + \left(\frac{dA}{dz} \right)_j \left(\frac{S_{hj}}{A_j} \right) \right] + 0.5\theta g \left(\frac{dA}{dz} \right)_j (\bar{S}_f + \bar{S}_h)$
MQ _{2j}	$0.5 \left[\Delta x_{ej} \phi_{j+1} + \Delta x_{fj} (1 - \phi_{j+1}) \right] \left(\frac{1}{\Delta x_{ej} \Delta t} \right) + \beta_{j+1} V_{j+1} \left(\frac{\theta}{\Delta x_{ej}} \right) + \frac{\theta g A}{Q_{j+1}} (S_{fj+1} + S_{hj+1})$
MZ _{2j}	$\frac{g\bar{A}\theta}{\Delta x_{ej}} + 0.5g(z_{j+1} - z_j) \left(\frac{dA}{dz} \right)_{j+1} \left(\frac{\theta}{\Delta x_{ej}} \right) - \theta g \bar{A} \left[\left(\frac{dK}{dz} \right)_{j+1} \left(\frac{S_{fj+1}}{K_{j+1}} \right) + \left(\frac{dA}{dz} \right)_{j+1} \left(\frac{S_{hj+1}}{A_{j+1}} \right) \right] + 0.5\theta g \left(\frac{dA}{dz} \right)_{j+1} (\bar{S}_f + \bar{S}_h)$
MB _j	$- \left[(\beta_{j+1} V_{j+1} Q_{j+1} - \beta_j V_j Q_j) \left(\frac{1}{\Delta x_{ej}} \right) + \left(\frac{g\bar{A}}{\Delta x_{ej}} \right) (z_{j+1} - z_j) + g\bar{A} (\bar{S}_f + \bar{S}_h) \right]$

3.2 Flow Distribution Factor

The distribution of flow between the channel and floodplain must be determined. The portion of the flow in the channel is given by:

$$\phi_j = \frac{Q_{cj}}{Q_{cj} + Q_{fj}} \quad (3-4)$$

Fread (1976) assumed that the friction slope is the same for the channel and floodplain, thus the distribution is given by the ratio of conveyance, i.e.,

$$\phi_j = \frac{K_{cj}}{K_{cj} + K_{fj}} \quad (3-5)$$

Equation 3-5 is used in the UNET model.

3.3 Equivalent Flow Path

The equivalent flow path is given by:

$$\Delta x_e = \frac{\bar{A}_c \bar{S}_{fc} \Delta x_c + \bar{A}_f \bar{S}_{ff} \Delta x_f}{\bar{A} \bar{S}_f} \quad (3-6)$$

If we assume:

$$\bar{\phi} = \frac{\bar{K}_c}{\bar{K}_c + \bar{K}_f} \quad (3-7)$$

where $\bar{\phi}$ is the average flow distribution for the reach, then:

$$\Delta x_e = \frac{\bar{A}_c \Delta x_c + \bar{A}_f \Delta x_f}{\bar{A}} \quad (3-8)$$

Since Δx_e is defined explicitly:

$$\Delta x_{ej} = \frac{(A_{cj} + A_{cj+1})\Delta x_{cj} + (A_{fj} + A_{fj+1})\Delta x_{fj}}{A_j + A_{j+1}} \quad (3-9)$$

3.4 Boundary Conditions

For a reach of river there are N computational nodes which bound $N-1$ finite difference cells. From these cells $2N-2$ finite difference equations can be developed. Because there are $2N$ unknowns (ΔQ and Δz for each node), two additional equations are needed. These equations are provided by the boundary conditions for each reach, which for subcritical flow, are required at the upstream and downstream ends. For supercritical flow, boundary conditions are only required at the upstream end. UNET only solves the unsteady flow equations for subcritical flow conditions.

3.4.1 Interior Boundary Conditions (for Reach Connections)

A network is composed of a set of M individual reaches. Interior boundary equations are required to specify connections between reaches. Depending on the type of reach junction, one of two equations is used:

Continuity of flow:

$$\sum_{i=1}^l S_{gi} Q_i = 0 \quad (3-10)$$

where: l = the number of reaches connected at a junction,
 S_{gi} = -1 if i is a connection to an upstream reach,
 +1 if i is a connection to a downstream reach,
 Q_i = discharge in reach i .

The finite difference form of Equation 3-10 is:

$$\sum_{i=1}^{l-1} MU_{mi} \Delta Q_i + MU_{Q_m} \Delta Q_K = MUB_m \quad (3-11)$$

where: $MU_{mi} = \theta S_{gi}$,
 $MU_{Q_m} = \theta S_{gK}$,
 $MUB_m = - \sum_{i=1}^l S_{gi} Q_i$

Continuity of stage:

$$z_k = z_c \quad (3-12)$$

where z_k , the stage at the boundary of reach k , is set equal to z_c , a stage common to all stage boundary conditions at the junction of interest. The finite difference form of Equation 3-12 is:

$$MUZ_m \Delta z_k - MU_m \Delta z_c = MUB_m \quad (3-13)$$

where:

$$\begin{aligned} MUZ_m &= 0, \\ MU_m &= 0, \\ MUB_m &= z_c - z_k. \end{aligned}$$

With reference to Figure 3-1, UNET uses the following strategy to apply the reach connection boundary condition equations:

- Apply flow continuity to reaches upstream of flow splits and downstream of flow combinations (reach 1 in Figure 3-1). Only one flow boundary equation is used per junction.
- Apply stage continuity for all other reaches (reaches 2 and 3 in Figure 3-1). z_c is computed as the stage corresponding to the flow in reach 1. Therefore, stage in reaches 2 and 3 will be set equal to z_c .

3.4.2 Upstream Boundary Conditions

Upstream boundary conditions are required at the upstream end of all reaches which are not connected to other reaches or storage areas. An upstream boundary condition is applied as a flow hydrograph of discharge versus time. The equation of a flow hydrograph for reach m is:

$$\Delta Q_k^{n+1} = Q_k^n - Q_k \quad (3-14)$$

where k is the upstream node of reach m . The finite difference form of Equation 3-10 is:

$$MUQ_m \Delta dQ_k = MUB_m \quad (3-15)$$

where:

$$\begin{aligned} MUQ_m &= 1, \\ MUB_m &= Q_l^{n+1} - Q_l^n. \end{aligned}$$

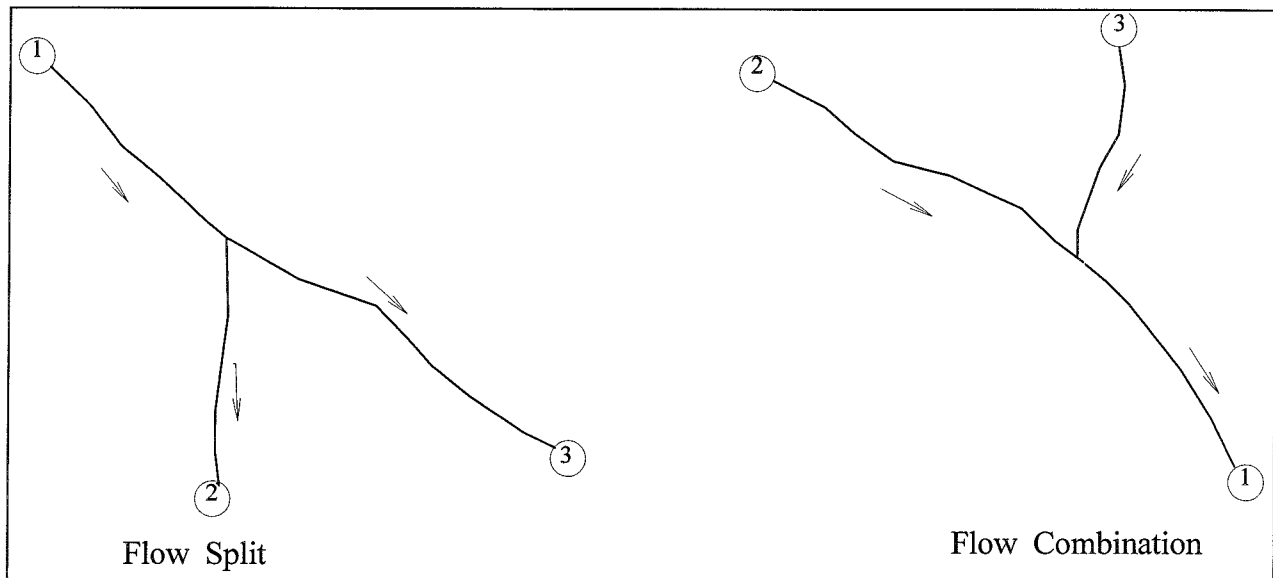

Figure 3-1 Typical flow split and combination.

3.4.3 Downstream Boundary Conditions

Downstream boundary conditions are required at the downstream end of all reaches which are not connected to other reaches or storage areas. Four types of downstream boundary condition can be specified:

- a stage hydrograph,
- a flow hydrograph,
- a single-valued rating curve,
- and, a looped rating curve that is computed by UNET using a simplified form of the momentum equation and Manning's equation.

Stage Hydrograph. A stage hydrograph of water surface elevation versus time may be used as the downstream boundary condition if the stream flows into a backwater environment such as an estuary or bay where the water surface elevation is governed by tidal fluctuations, or where it flows into a lake or reservoir of known stage(s). At time step $(n+1)\Delta t$, the boundary condition from the stage hydrograph is given by:

$$\Delta z_N = z_N^{n+1} - z_N^n \quad (3-16)$$

The finite difference form of Equation 3-16 is:

$$CDZ_m \Delta z_N = CDB_m \quad (3-17)$$

where: $CDZ_m = 1,$
 $CDB_m = z_N^{n+1} - z_N^n.$

Flow Hydrograph. A flow hydrograph may be used as the downstream boundary condition if recorded gage data is available and the model is being calibrated to a specific flood event. At time step $(n+1)\Delta t$, the boundary condition from the flow hydrograph is given by the finite difference equation:

$$CDQ_m \Delta Q_N = CDB_m \quad (3-18)$$

where: $CDQ_m = 1,$
 $CDB_m = Q_N^{n+1} - Q_N^n.$

Single Valued Rating Curve. The single valued rating curve is a monotonic function of stage and flow. An example of this type of curve is the steady, uniform flow rating curve. The single valued rating curve can be used to accurately describe the stage-flow relationship of free outfalls such as waterfalls, or hydraulic control structures such as spillways, weirs or lock and dam operations. This boundary condition should be avoided in otherwise free-flowing streams as errors can be introduced into the solution far upstream of the downstream boundary location. Further advice is given in (USACE, 1993).

At time $(n+1)\Delta t$ the boundary condition is given by:

$$Q_N + \theta \Delta Q_N = D_{k-1} + \frac{D_k - D_{k-1}}{S_k - S_{k-1}} (z_N + \Delta z_N - S_{k-1}) \quad (3-19)$$

where: $D_k = K^{\text{th}}$ discharge ordinate,
 $S_k = K^{\text{th}}$ stage ordinate.

After collecting unknown terms on the left side of the equation, the finite difference form of Equation 3-19 is:

$$CDQ_m \Delta Q_N + CDZ_m \Delta z_N = CDB_m \quad (3-20)$$

where: $CDQ_m = \theta,$

$$CDZ_m = \frac{D_k - D_{k-1}}{S_k - S_{k-1}},$$

$$CDB_m = Q_N + D_{k-1} + \frac{D_k - D_{k-1}}{S_k - S_{k-1}}(z_N - S_{k-1}).$$

Looped Rating Curve Approximation. Use of Manning's equation with a time-variable friction slope produces an approximation of the looped rating curve seen in natural rivers. This type of boundary condition has the advantage of being able to pass waves downstream, but should be used with the understanding that the approximation may not accurately reflect the true looped rating curve. Butler (1991) found that the use of this option in systems with very flat slopes (~0.5 ft/mile or less) and rapidly rising flood waves resulted in rating curves with almost no loop, essentially equivalent to the steady uniform flow rating curve. The example problems in Appendix D and related sections in Appendices B and C discuss how to minimize the error introduced into the solutions when applying rating curves as downstream boundary conditions.

Manning's equation may be written as:

$$Q = K(S_f)^{0.5} \quad (3-21)$$

where K represents the conveyance and S_f is the friction slope.

Using the first term of a Taylor series, this boundary condition at time step (n+1) Δt can be represented as:

$$Q_N + \theta \Delta Q_N = K_N (S_{fN})^{0.5} + \frac{\partial K_N}{\partial z_N} \theta \Delta z_N (S_f)^{0.5} \quad (3-22)$$

The finite difference form of Equation 3-22 is:

$$CDQ_m \Delta Q_N + CDZ_m \Delta z_N = CDB_m \quad (3-23)$$

where: $CDQ_m = \theta$

$$CDZ_m = -\frac{\partial K_N}{\partial z_N} \theta (S_{fN})^{0.5},$$

$$CDB_m = -Q_N + K_N (S_{fN})^{0.5}.$$

Chapter 4

Internal Boundary Conditions

Internal boundary conditions describe discontinuities in the stage profile which cannot be modeled using the unsteady flow equations. Four types of internal boundary equations are allowed:

- 1) Levee breaches and storage interactions;
- 2) Gated spillways and weir overflow structures;
- 3) Bridge and culvert hydraulics;
- 4) Pumped diversions.

4.1 Levees

A levee is an earthen embankment which protects a region of floodplain from the floodwaters of a river. A levee offers complete protection until either the embankment fails or is overtopped. Levees are the primary method of flood protection along many rivers where the floodplains are used primarily for agriculture. The area protected by a single levee system may be tens of thousands of acres in the Mississippi - Missouri River System.

Levees can have a significant impact on river hydraulics. The embankments restrict flow to a floodway, usually the channel, denying both the conveyance and storage of the floodplain to the river system. The overall impact of such facilities is to raise flood stages and discharges within the contained flowpaths while limiting the areal extent of inundation. For example, in 1973 the Mississippi River at St. Louis reached a stage of 43.3 ft at a measured flow of 855,000 ft³/s. In 1944 a flow of 844,000 ft³/s passed at a stage of 38.9 ft, 4.4 ft lower. The Alton to Gale levees that were completed after World War II are the primary reason for the change.

Should a levee be breached, the protected area once again becomes a part of the river system. A breach usually results from sustained high river stages saturating the embankment. A piping flow path through a weakened embankment, if unchecked, can enlarge into a breach. The rate of enlargement and the final breach size depend on the soil strength and the volume and velocity of the flow through the breach. The flow through a breach can withdraw a significant volume of water from the river and lower the river water surface as much as several feet. After the interior has filled (which may take two or three days) it acts as a damper, lessening changes in stage, in a manner similar to the natural floodplain with the flow interchange passing through the breach or over the top of the embankment.

4.1.1 Modeling of a Leveed Area

The change in storage behind the levee is approximated by the following ordinary differential equation:

$$\frac{dS}{dt} = Q_B + \int_0^{L_L} q_l dx \quad (4-1)$$

where: S = storage,
 Q_B = flow through the breach,
 q_l = flow over the levee embankment,
 dx = differential unit of levee length along the embankment,
 L_L = total length of the levee embankment.

Equation 4-1 must be solved simultaneously with the river model - a trivial problem as long as the water level in the levee interior has no impact on the river flow. When submergence is a factor, the stage within the area protected by the levee becomes part of the simultaneous solution. This situation lowers the efficiency of the numerical solution by adding new equations to the solution. Figure 4-1 illustrates the effect of levee failures on downstream stages.

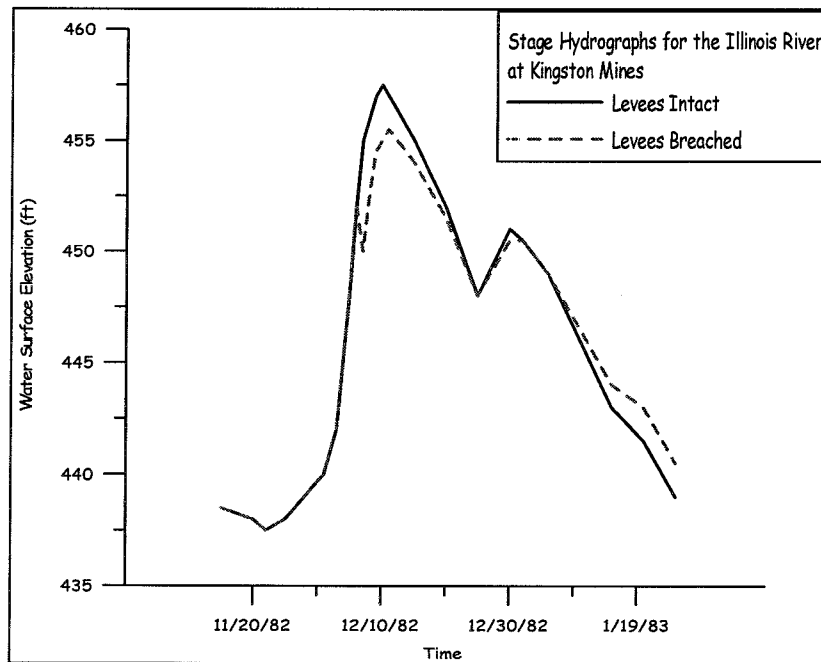

Figure 4-1 Stage hydrograph of the Illinois River at Kingston mines with and without breaching of the agricultural levees along the river.

For levees along the Illinois River, Barkau (1981) developed an efficient approach to this problem. At time $(n+1)\Delta t$ the stage river, Z_i^{n+1} is unknown. This stage depends, of course, on the flow into the storage area, Q_L^{n+1} . Now, Q_L^{n+1} is also dependent on Z_i^{n+1} . Barkau's solution was to develop a function which related Q_L^{n+1} to Z_i^{n+1} . Two plausible values of Z_i^{n+1} were assumed and the corresponding values of Q_L^{n+1} computed. From these two solution points, a linear function was developed which was input as a lateral inflow into the river model. The river model was solved and the levee flow, Q_L^{n+1} , could then be updated. This solution worked well but it slowed the overall model computational speed.

That solution was thought to be more elaborate than warranted. Because the breach geometry and evolution are seldom known, the computed breach flow would be in the attached file imprecise and the complex hydraulics could be simplified. Therefore, a simple procedure was developed that produced acceptable results. It is generally known how long it takes the protected area behind a levee to fill and where the breach will most likely occur. From the filling time a simple inflow hydrograph, and hence the right hand side of Equation 4-1, can be estimated. For simplicity, the area behind the levee is assumed to fill at a uniform rate until the last time step when the flow is adjusted so that the levee and the river attain the same elevation (equilibrium). This technique produces reasonable results with a minimum of computational overhead.

4.1.2 Solution

Storage. Except for depressions, the land inside an agricultural levee is nearly flat. Therefore, the storage can be given by simple linear function:

$$S = A_L D_L \quad (4-2)$$

where: A_L = surface area of land protected by the levee,
 D_L = an average depth of water inside the levee.

If the water surface inside the levee is nearly plane, then:

$$D_L = z_L - z_{Lo} \quad (4-3)$$

where: z_L = the average water surface inside the levee,
 z_{Lo} = the average elevation of the land inside the levee.

Flow through the levee during breaching. Major levee systems seldom fail by being overtopped. This is a catastrophic failure which could result in the destruction of long reaches of the embankment. Before this is allowed to occur, a breach would be cut or a low area would be allowed to overtop and degrade. Therefore, a gradual breach is

the primary mode of failure.

At the time of breaching, the storage to be filled is:

$$S_{LT} = A_L(z_{BR} - z_{Lo}) \quad (4-4)$$

Where z_{BR} is the average water surface elevation of the river at the breach location. It is assumed that the area behind the levee will fill in time T_f . To simplify the computations, the flow is assumed constant, hence:

$$Q_L = \frac{S_{LT}}{T_f} \quad (4-5)$$

where Q_L is the constant flow required to fill the storage S_{LT} in time T_f . After each time step, the stage behind the levee is updated:

$$z_L^{n+1} = z_L^n + \frac{Q_L \delta t}{A_L} \quad (4-6)$$

When the storage area is almost full, i.e. when (n is now the current time step):

$$z_{BR}^n < z_L^n + \frac{Q_L \delta t}{A_L} \quad (4-7)$$

then:

$$Q_L = (z_{BR}^{n+1} - z_L^n) \frac{A_L}{\delta t} \quad (4-8)$$

Flow to and from a full storage area. After the storage area is full, an exchange of flow can either go through the breach or over the levee crest, although in practice the latter is to be avoided. The exchange maintains the water surface inside the levee and the river stage at equilibrium. Hence, for flow through the breach:

$$Q_L = (z_{BR}^{n+1} - z_L^n) \frac{A_L}{\delta t} \quad (4-9)$$

and for flow over the levee crest:

$$Q_L = (z_{WR}^{n+1} - z_L^n) \frac{A_L}{\delta t} \quad (4-10)$$

where z_{WR} is the river elevation at the midpoint along the levee length.

4.1.3 Levee Flow as a Lateral Inflow in the Continuity Equation

The flow through the levee is added into the river model as a lateral inflow in the continuity equation. While the leveed area is filling, the coefficients for the continuity equation are augmented in the following manner:

$$z_{BR}^n > z_L^n + \frac{Q_L \delta t}{A_L} \quad (4-11)$$

then:

$$CB_j = CB_j - \frac{Q_L}{\Delta x_{ej}} \quad (4-12)$$

where Q_L is given by Equation 4-5 and j is the number of the river reach which encloses the breach.

After the storage area has filled, the coefficients for the continuity equation are augmented in the following manner:

$$z_{WR}^n \leq z_T \quad (4-13)$$

then:

$$CZ 1_j = CZ 1_j + 0.5 \frac{A_L}{\Delta x_{ej}} \quad (4-14)$$

$$CZ 2_j = CZ 2_j + 0.5 \frac{A_L}{\Delta x_{ej}} \quad (4-15)$$

else:

$$CZ 1_k = CZ 1_k + 0.5 \frac{A_L}{\Delta x_{ej}} \frac{x_{cj}}{L_L} \quad (4-16)$$

$$CZ 2_k = CZ 2_k + 0.5 \frac{A_L}{\Delta x_{ej}} \frac{x_{cj}}{L_L} \quad (4-17)$$

where Z_T is the average elevation of the levee crest and k is the set of all cells along the levee frontage.

4.2 Flow over a Spillway

A spillway controls the water surface elevation and flow in the channel or it diverts flow away from the channel. The diverted flow can pass completely out of the system or into another channel reach. This section presents the equations for spillway computations.

4.2.1 Equations for Flow over a Spillway Structure

The general equation for free and submerged discharge from spillway with a tainter gate is:

$$Q_s = CWA^\alpha B^\beta H^\eta \quad (4-18)$$

where:

- A = trunnion height,
- B = gate opening,
- C = a coefficient,
- W = gate width,
- H = $Z_u - KZ_d - (1-K)Z_{sp}$,
- Z_u = headwater elevation,
- Z_d = tailwater elevation,
- K = 1 for submerged flow and 0 for free flow,
- Z_{sp} = spillway elevation,
- α , β and η = exponents.

Equation 4-18 is a regression equation which was proposed by the U.S. Bureau of Reclamation to describe the rating for control structures on the Grand Canal in Arizona. All dimensions are in U.S. Customary units. Negative flow occurs when $Z_d > Z_u$.

Submerged flow is defined to occur when:

$$\frac{Z_d - Z_{sp}}{Z_u - Z_{sp}} > 2/3 \quad (4-19)$$

When the gate no longer controls the flow, which is assumed to occur when $B = 0.8H$, the flow is computed by the weir flow equation:

$$Q_w = C_w FW \left\{ (1-K)Z_u + KZ_d - Z_{sp} \right\} H^{1/2} \quad (4-20)$$

where: C_w = weir flow coefficient (see Section 4.3.2 for the relationship between the free and submerged loss coefficients),
 $F = 3 \{1 - (Z_d - Z_{sp}) / (Z_u - Z_{sp})\}$ when $K = 1$,
 $F = 1$ when $K = 0$,
 At $B = 0.8 H$, the flow calculated by equations 4-18 and 4-20 must be the same.

Hence:

$$(C_w A^\alpha) B^\beta H^\eta = C_{wc} F \{(1 - K) Z_u + K Z_d - Z_{sp}\} H^{1/2} \quad (4-21)$$

and:

$$C_{wc} = \frac{(C A^\alpha) B^\beta H^{(\eta-1/2)}}{F \{(1 - K) Z_u + K Z_d - Z_{sp}\}} \quad (4-22)$$

where C_{wc} is the computed value at $0.8H$.

When $B \geq H$, the gates have no contact with the flow and the weir coefficients are their normal values. For a concrete spillway C_w is about 4. If the C_{wA} is the assumed value, a linear interpolation is assumed between $0.8H > B > H$, such that:

$$C_w = C_{wc} + \frac{(C_{wA} - C_{wc})}{0.2H} (B - 0.8H) \quad (4-23)$$

4.2.2 Overflow Weir

In addition to the gated spillway, the spillway can include uncontrolled overflow weirs. Equation 4-20 is used in the weir flow calculation.

4.2.3 Elevation Controlled Gate

The elevation controlled gate is regulated by the upstream pool elevation. When the pool elevation exceeds a specified level, ZECOPEN, the gate begins to open at a rate of ECOPRATE. The gate continues to open until a maximum opening of ECMXOPENING. When the pool elevation falls below, ZECCLOSE, the gate begins to close at a rate of ECCLRATE.

The elevation controlled gate option is designed to simulate the failure of an embankment. The orifice type equation for flow under a tainter gate is identical to the

orifice equation for a piping failure of an embankment (Fread, 1985). For an overtopping failure and an eroding embankment, use of an opening gate is imprecise, but the imprecision is short lived because once the gate is open, the flow through the breach is governed by the weir flow equations.

The elevation controlled gate is an internal boundary condition which is specified in the *.BC file for both lateral and in-line spillways.

4.2.4 Numerical Analysis

In the implicit finite difference scheme, the discharge over spillway k at time $(n+\theta)\Delta t$ is:

$$D_k^{n+\theta} = D_k^n + \theta \bullet \Delta D_k \quad (4-24)$$

where: θ = the implicit weighting coefficient,
 $\Delta D_k = D_k^{n+1} - D_k^n$,
 $D_k = D_{sk} + D_{wk}$ - the sum of spillway and weir flow.

Assume that the nonlinear term ΔD can be approximated by the first order Taylor expansion, then:

$$\Delta D_k = \frac{\partial D_k}{\partial B_k} \Delta B_k + \frac{\partial D_k}{\partial Z_u} \Delta Z_u + \frac{\partial D_k}{\partial Z_d} \Delta Z_d \quad (4-25)$$

in which the superscript n has been dropped. For gated spillway flow:

$$\frac{\partial D_{sk}}{\partial Z_d} = \frac{-K D_{sk}}{H_k} \quad (4-26)$$

$$\frac{\partial D_{sk}}{\partial B_k} = \frac{\beta_k d_{sk}}{B_k} \quad (4-27)$$

For weir flow:

$$\frac{\partial D_{sk}}{\partial Z_u} = \frac{D_{sk} \eta_k}{H_k} \quad (4-28)$$

$$\frac{\partial D_{wk}}{\partial Z_d} = D_{wk} \left\{ \frac{K}{[(1-K)Z_u + KZ_d - Z_{SP}]} - 0.5K H_k^{-1} \right\} \quad (4-29)$$

$$\frac{\partial D_{wk}}{\partial Z_u} = D_{wk} \left\{ \frac{(1-K)}{[(1-K)Z_u + KZ_d - Z_{SP}]} + 0.5 H_k^{-1} \right\} \quad (4-30)$$

where the derivatives of F and B are neglected.

For a lateral spillway, the continuity equation:

$$CQ_{1j} \Delta Q_j + CZ_{1j} \Delta Z_j + CQ_{2j} \Delta Q_{j+1} + CZ_{2j} \Delta Z_{j+1} = CB_j, \quad (4-31)$$

is modified as follows:

$$CZ_{1j} = CZ_j + \frac{\theta}{\Delta x_e} \frac{\partial D_k}{\partial Z_j} \quad (4-32)$$

$$CZ_{1j+1} = CZ_{j+1} + \frac{\theta}{\Delta x_e} \frac{\partial D_k}{\partial Z_{j+1}} \quad (4-33)$$

$$CB_j = CB_j - \left[D^n + \theta \frac{\partial D_k}{\partial B_k} \Delta B_k \right] \frac{\theta}{\Delta x_e} \quad (4-34)$$

in which Δx_e is the equivalent flow distance.

If the spillway is in the channel controlling the flow, the continuity and momentum equations are replaced. The continuity equation is:

$$Q_j + \delta Q_j = Q_{j+1} + \delta Q_j \quad (4-35)$$

and:

$$CQ_{1j} = \theta \quad (4-36)$$

$$CZ_{1j} = 0 \quad (4-37)$$

$$CQ_{2j} = -\theta \quad (4-38)$$

$$CZ_{2j} = 0 \quad (4-39)$$

$$CB_j = Q_{j+1} - Q_j \quad (4-40)$$

The momentum equation is replaced by:

$$Q_j + \theta \delta Q_j = D_k + \theta \delta D_k \quad (4-41)$$

and:

$$MZ_{1j+1} = \theta \frac{\partial D_k}{\partial Z_{j+1}} \Delta Z_{j+1} \quad (4-42)$$

$$MZ_{1j} = \theta \frac{\partial D_k}{\partial Z_j} \Delta Z_j \quad (4-43)$$

$$MQ_{1j} = \theta \quad (4-44)$$

$$MQ_{2j} = 0 \quad (4-45)$$

$$MB_j = D_k - Q_k + \frac{\partial D_k}{\partial B_k} \Delta B_k \quad (4-46)$$

4.3 Modeling Bridges, Culverts, and Low Water Dams

Bridges, culverts, and low water dams restrict the flow to a contracted opening. These structures can be treated in UNET as interior boundary conditions. The procedure computes the change in water surface from the headwater section to the tailwater section. The flow is assumed the same at the headwater and tailwater sections.

Two types of energy loss functions can be used. The first employs Yarnell's equation for swell head through pile bents; the second uses a family of free and submerged rating curves computed from an outside source.

4.3.1 Yarnell's Equation

The bridge piers are assumed to be located between nodes j and $j+1$. Yarnell's equation is (HEC, 1990c and Henderson, 1966):

$$H = 2K (K + 10\omega - 0.6) (\alpha + 15\alpha^4) \frac{V_{j+1}^2}{2g} \quad (4-47)$$

where: H = difference in water surface from the upstream and the downstream sides of the bridge,
 K = Pier slope coefficient,
 ω = V_{Hj+1} / D_{j+1} ; ratio of downstream velocity head to the downstream depth,
 α = ratio of obstructed area to total unobstructed area.

To simplify the analysis, it is assumed that α equals the ratio of the obstructed top width to the total unobstructed top width.

Equation 4-47 can be expressed as the standard head loss equation:

$$H = \eta V_H \quad (4-48)$$

in which η is a head loss coefficient and V_H is the velocity head at $j+1$.

In the implicit finite difference scheme, at time $t=(n+\theta)\Delta t$:

$$H + \Delta H = \eta V_H + \Delta(\eta V_H) \quad (4-49)$$

If the change in head loss is approximated by a first order Taylor approximation, then:

$$\Delta H = \left(\frac{\partial \eta}{\partial Z_j} \right) \Delta Z_j + \left(\frac{\partial \eta}{\partial Q_{j+1}} + \frac{\partial V_H}{\partial Q_{j+1}} \right) \Delta Q_{j+1} + \left(\frac{\partial \eta}{\partial Z_{j+1}} + \frac{\partial V_H}{\partial Z_{j+1}} \right) \Delta Z_{j+1} \quad (4-50)$$

To simplify the analysis, we assume that the coefficient, θ , is constant over the time step, hence:

$$\frac{\partial \eta}{\partial Z_{j+1}} = \frac{\partial \eta}{\partial Q_{j+1}} = \frac{\partial \eta}{\partial Z_{j+1}} \rightarrow 0. \quad (4-51)$$

then:

$$\Delta H = \frac{\partial V_H}{\partial Q_{j+1}} \Delta Q_{j+1} + \frac{\partial V_H}{\partial Z_{j+1}} \Delta Z_{j+1} \quad (4-52)$$

The derivatives of V_H are:

$$\frac{\partial V_H}{\partial Q_{j+1}} = \frac{2V_H}{Q_{j+1}} \quad (4-53)$$

$$\frac{\partial V_H}{\partial Z_{j+1}} = \frac{-2V_H}{A_{j+1}} \frac{dA_{j+1}}{dZ_{j+1}} \quad (4-54)$$

where: A_{j+1} is the area at $j+1$.

The following term is added into the momentum equation as an added force term:

$$S_h = \frac{H + \Delta H}{\Delta x_e} \quad (4-55)$$

where Δx_e is the equivalent flow distance. The linear momentum equation is:

$$MQ_{1j} \Delta Q_j + MZ_{1j} \Delta Z_j + MQ_{2j} \Delta Q_{j+1} + MZ_{2j} \Delta Z_{j+1} = MB_j \quad (4-56)$$

$$MQ_{2j} = MQ_{2j} + \frac{\partial V_H}{\partial Q_{j+1}} \frac{1}{\Delta x_e} \quad (4-57)$$

where j corresponds to location 2. The coefficients are augmented by:

$$MZ_{2j} = MZ_{2j} + \frac{\partial V_H}{\partial Z_{j+1}} \frac{1}{\Delta x_e} \quad (4-58)$$

$$MB_j = MB_j - \frac{H}{\Delta x_e} \quad (4-59)$$

4.3.2 Free and Submerged Rating Curves

Bridge and culvert structures have the typical rating function which is shown in Figure 4-2. The free flow rating function describes the flow if tailwater submergence does not occur, such as free flow over a weir. Above the free flow rating are a family of submerged flow rating curves, one for each tailwater elevation.

UNET simulates submerged and free flow differently. For submerged flow, the momentum equation is augmented by the added slope term:

$$S_h = \frac{\Delta H}{\Delta x} \quad (4-60)$$

where:

S_h	=	added slope term,
ΔH	=	swell head from headwater to tailwater,
Δx	=	distance between headwater and tailwater cross sections.

The added slope term is simply the swell head divided by the distance.

The submerged head loss can be computed in two ways. First, the UNET program can store the family of submerged rating curves and interpolate the swell head directly, this is the recommended and default procedure. Secondly, the swell head can be computed from a set of exponential equations which are fitted to the family of submerged rating curves.

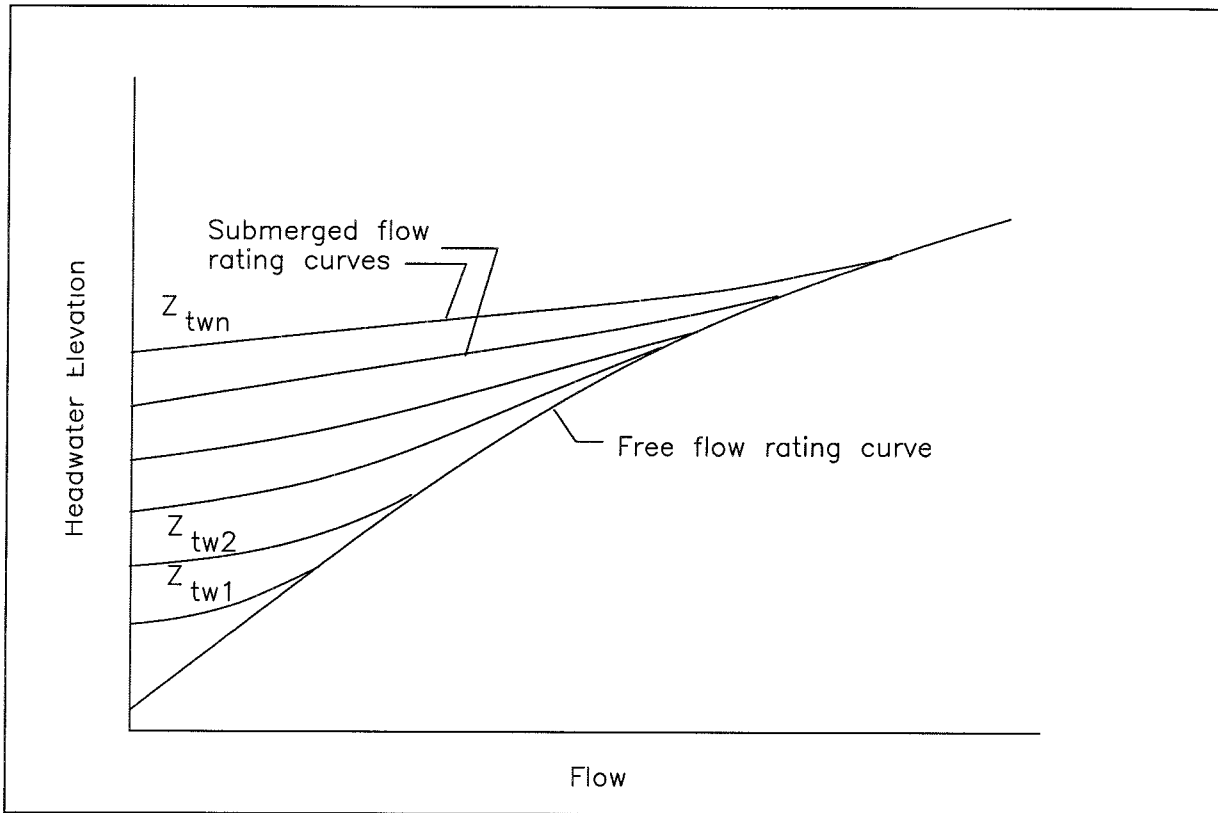

Figure 4-2 Family of free and submerged rating curves.

For each bridge or culvert crossing, a set of three exponential equations may be fitted using least squares regression. The equations correspond to three regions (Figure 6-1):

- 1) Open channel flow region - from the downstream invert to the downstream low chord or crown of the culvert.
- 2) Pressure flow - from the downstream low chord to the low point in the weir profile.
- 3) Pressure and weir flow - from the low point of the weir profile and upward.

The general form of the exponential equation is:

$$\Delta H = a Q^b A_T^c \quad (4-61)$$

where: ΔH = swell head from headwater to tailwater,
 Q = flow,
 A_T = area in the tailwater,
 $a, b,$ and c = regression parameters.

The free flow rating function is applied by table look up. Free flow occurs when the elevation computed from the submerged flow rating function is below the elevation computed from the free flow rating function.

4.3.3 Numerical Analysis

In UNET, values of stage, Z_j , and flow, Q_j , are known at the $n\Delta t$ time level and unknown at the $(n+1)\Delta t$ time level. UNET applies a linearized, implicit finite difference scheme to solve for the unknowns at the $(n+1)\Delta t$ time level; therefore a set of linear equations is solved at each time step. The equations are linearized using the first order Taylor approximation; higher order derivatives are assumed to be zero. For submerged flow the coefficients of the momentum equations are augmented as follows:

If $Q_{j+1} \geq 0$:

$$MQ_{2j} = MQ_{2j} + \frac{\partial S_h}{\partial Q_{j+1}} \quad (4-62)$$

$$MZ_{2j} = MZ_{2j} + \frac{\partial S_h}{\partial Z_{j+1}} \quad (4-63)$$

$$MB_j = MB_j + \alpha_{j+1} \frac{V_{j+1} |V_{j+1}|}{2g} \quad (4-64)$$

If $Q_{j+1} < 0$, then:

$$MQ_{1j} = MQ_{1j} + \frac{\partial S_h}{\partial Q_j} \quad (4-65)$$

$$MZ_{1j} = MZ_{1j} - \frac{\partial S_h}{\partial Z_j} \quad (4-66)$$

$$MB_j = MB_j - S_h \quad (4-67)$$

Free flow is given by:

$$R(Z_j) + \theta \frac{dR}{dZ_j} \Delta Z_j = 0.5(Q_j + Q_{j+1}) + 0.5\theta(\Delta Q_j + \Delta Q_{j+1}) \quad (4-68)$$

where R is the free flow rating function. The coefficients for the momentum equation are:

If $Q_{j+1} \geq 0$:

$$MQ_{1j} = MQ_{2j} = -0.5\theta \quad (4-69)$$

$$MZ_{1j} = \theta \frac{dR}{dZ_j} \quad (4-70)$$

$$MZ_{2j} = 0 \quad (4-71)$$

$$MB_j = 0.5(Q_j + Q_{j+1}) \quad (4-72)$$

If $Q_{j+1} < 0$:

$$MQ_{1j} = MQ_{2j} = -0.5\theta \quad (4-73)$$

$$MZ_{2j} = -\theta \frac{dR}{dZ_j} \quad (4-74)$$

$$MZ_{1j} = 0 \quad (4-75)$$

$$MB_j = 0.5(Q_j + Q_{j+1}) \quad (4-76)$$

4.4 Flow Diversions

UNET simulates two types of flow diversions - a pumped diversion and a diversion of flow into groundwater.

4.4.1 Pumped Diversion

The pumped diversion diverts water from:

- 1) One river reach to another river reach.
- 2) A river reach to a storage area.
- 3) A river reach to outside of the model.
- 4) A storage area to another storage area.

The magnitude of the pumped diversion is controlled by a pumping sequence. The pumping sequence consists of a staging elevation where the pumps are started and a pumping capacity at that point. The pumping capacity remains unchanged until the next staging elevation or a shutdown elevation is reached. This type of rating function is illustrated in Figure 4-3. The pump characteristics are not modeled directly.

The pumped diversion is governed by the PD data record which is placed in the cross section file between the two cross sections where the diversion occurs. If the diversion is between storage areas the PD record can be placed anywhere after the two storage areas have been defined by SA records.

The pumped diversion hydrograph is automatically written to DSS with the B part either:

- 1) The connecting river miles.
- 2) The connecting river mile and storage area.
- 3) The connecting storage areas.

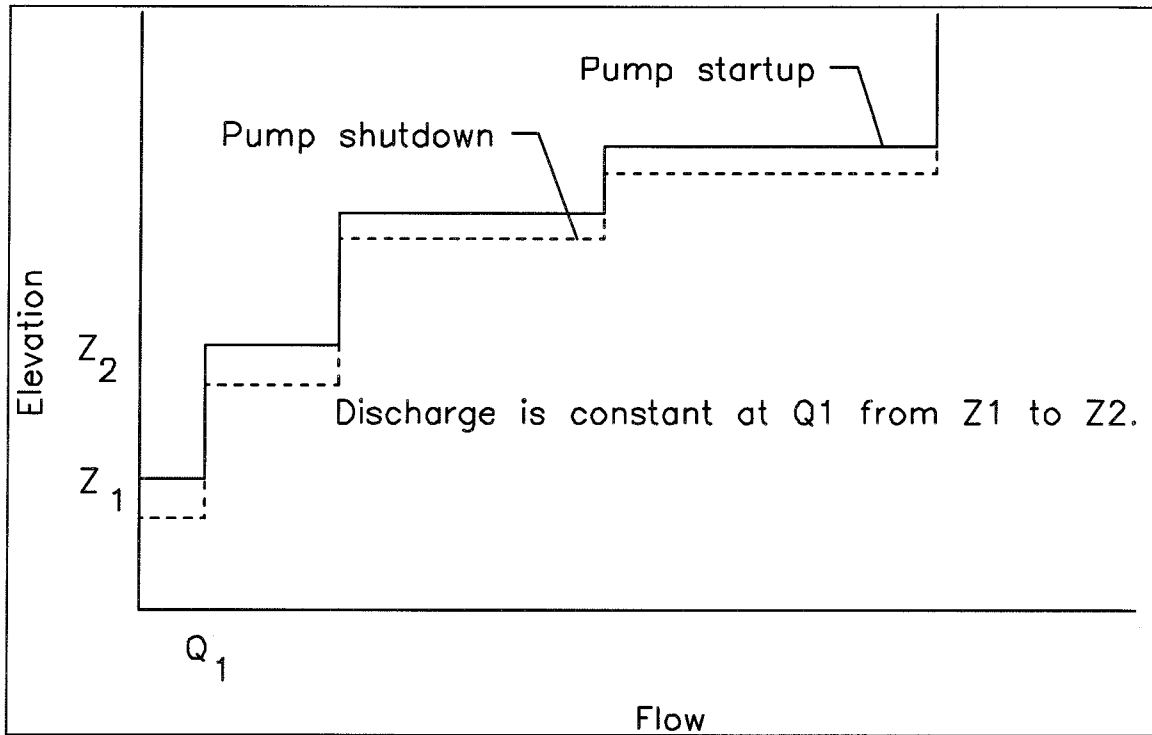

Figure 4-3 Pump station capacity curve for a pumped diversion.

4.4.2 Groundwater Interchange

The UNET program can simulate interchange of water between the river and the groundwater aquifer. The groundwater algorithm is simplistic; it simulates flow in only one direction, laterally perpendicular to the river. The groundwater aquifer is assumed to be very large such that the interchange of water with the river has no impact on the groundwater level.

The groundwater interflow is described by Darcy's equation:

$$Q_{gwj} = kA_s \frac{\Delta H}{L} \quad (4-77)$$

where:

- k = Darcy's coefficient,
- A_s = flow area perpendicular to the direction of flow,
- H = piezometric head,
- L = characteristic length over which the piezometric gradient acts.

In our simplified river modeling problem, we assume that the flow area is the wetted surface area between cross sections j and $j+1$. If the elevation of the groundwater table is below the channel invert, the wetted surface area is given by:

$$A_{sj} = 0.5(T_{wj} + T_{wj+1})\Delta X_{ej} \quad (4-78)$$

in which T_{wj} is the top width at cross section j and ΔX_e is the equivalent flow distance. If the groundwater table is above the channel invert, the wetted surface of the cross section is the sum of the length of the sides of the channel and the wetted top width of the overbank; hence, the wetted surface area is:

$$A_{sj} = 2[0.5(Z_j + Z_{j+1}) - Z_{gw}]\Delta X_{cj} + (T_{wj} + T_{wj+1})\Delta X_{vj} \quad (4-79)$$

where:

- T_{wj} = valley top width for cross section j .
- ΔX_c = channel distance.
- ΔX_v = valley distance.
- Z_{gw} = elevation of the aquifer.

The change in piezometric head is given by:

$$\Delta H = Z - \text{MAX}(Z_{gw}, Z_{Inv}) \quad (4-80)$$

in which Z is the river elevation, $Z = 0.5(Z_j + Z_{j+1})$ and Z_{Inv} is the elevation of the cross section invert, $Z_{Inv} = 0.5(Z_{Invj} + Z_{Invj+1})$.

The estimation of the distance L over which the head acts, needs to be approximated. In reality this distance would vary with time being dependent upon the relative orientation and magnitude of the difference between the heads. Hence, for a high head differential, the distance would be longer and for lower head differentials the distance would be shorter; see Figure 4-4. For use by UNET, the distance is assumed to be a constant.

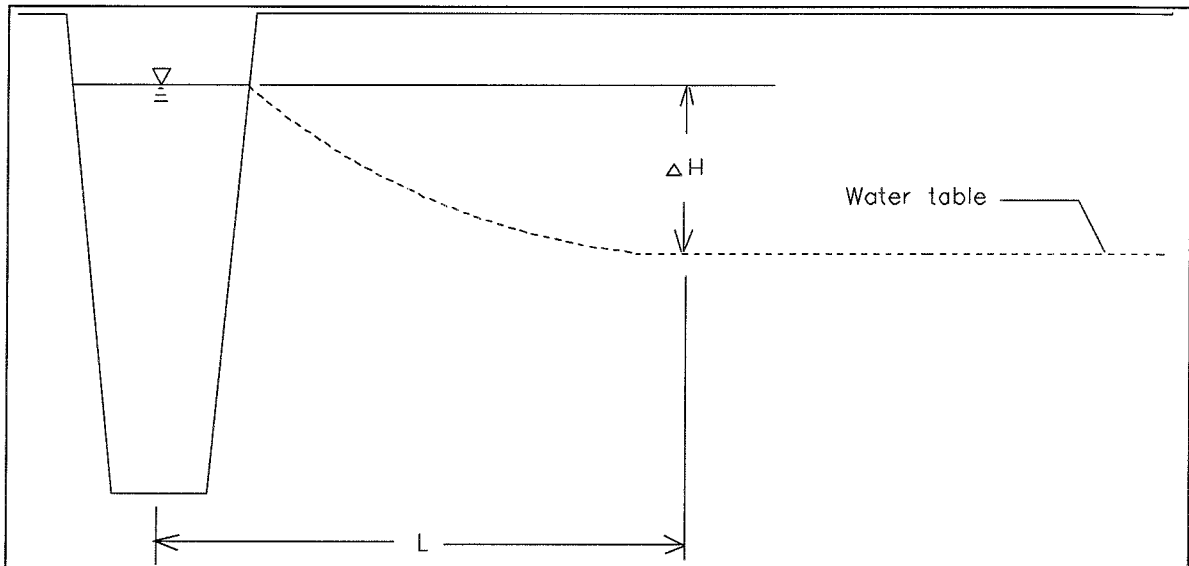

Figure 4-4 Effective length for the computation of piezometric head differential.

The groundwater interflow is a boundary condition which is applied to the model. The interflow is computed from the stages that were determined over the last time step and the observed groundwater stage and the interflow is applied explicitly as a lateral inflow or outflow over the next time step.

Chapter 5

Modeling of Bridge Hydraulics

Bridge crossings consist of two components: The bridge structure (piers and superstructure) and the roadway approach embankments. The roadway embankments block the floodplain, concentrating the flow at the bridge opening. The bridge piers and superstructure obstruct the flow, exerting a force in the upstream direction which must be overcome by a swell head (energy loss). During large floods, the embankments may overtop, lessening the flow through the bridge opening and therefore reducing the swell head.

The UNET program has two procedures for modeling bridge crossings. The first procedure, called the "normal" bridge procedure, subtracts the area of the embankments and bridge structure from the cross-sectional area. The wetted perimeter is also increased by the wetted length of the piers and the bridge superstructure; hence, the conveyance is decreased. The UNET normal bridge procedure is similar to the normal bridge procedure used by the HEC-2 backwater program. The cross section of the bridge structure and the embankments are specified on the BT records (see Appendix B). The area of the cross section is reduced by the area of the bridge structure and the wetted perimeter of the cross section is increased by the wetted perimeter of the structure. The normal bridge procedure is preferred when the embankments are low and greatly submerged. These crossings are commonly called perched bridges.

The second procedure, the "special" bridge procedure, models the bridge crossing as an interior boundary condition which substitutes a family of free and submerged rating curves for the unsteady flow equations. The free flow rating function describes the stage-discharge relation for the structure if the submergence from the tailwater is not a factor. The family of submerged flow rating curves relates the tailwater elevation and the flow to the swell head generated upstream of the structure. The insertion of an interior boundary condition using a family of rating curves is described in Chapter 4.

The key to the application of the special bridge procedure is the calculation of the family of rating curves. Bridge flow can be divided into three regions: **low flow** when the flow is concentrated in the bridge opening and the flow is resisted only by the bridge piers; **pressure flow** when the bridge chords are submerged; and **weir flow** when the approach embankments are overtopped. These flow regions can be combined; i.e., there can be low flow and weir flow, pressure flow and weir flow, etc.

For each flow region, empirical equations have been derived which relate the geometric, flow, and tailwater stage parameters to the swell head. The principal procedures for modeling bridge hydraulics are:

- 1) The HEC-2, "Water Surface Profiles," special bridge procedure (HEC, 1990c).

- 2) The procedure presented in *Hydraulics of Bridge Waterways* (FHWA, 1978).
- 3) The WSPRO bridge procedure, (FHWA, 1986).

Each of these procedures uses different equations and can produce different results. Each procedure will produce adequate results, however, when applied in a skillful manner.

5.1 Free Flow

5.1.1 Low Flow

Free flow through the bridge constriction assumes that critical depth occurs within the bridge constriction until the occurrence of pressure flow, which is given by equation 5-5. Free flow is modeled using a weir-type of equation with additional head losses from the piers. Two formulae are available. The FHWA (1978) suggested a formula based on critical depth in the constriction and an entrance loss. This procedure, which does not consider the width of the piers, was qualified by the FHWA as tentative. Yarnell (as described in WES, 1973) proposed a simple entrance loss function which included effects of the piers. The Yarnell procedure is used in the UNET program.

Two cross sections are assumed; cross section 1 is just upstream of the bridge and cross section 2 within the bridge constriction. The cross sections are identical except for the area occupied by the piers within the constriction. The energy equation is written between the two cross sections:

$$\frac{V_1^2}{2g} + D_1 = \frac{V_2^2}{2g} + D_2 + h_L \quad (5-1)$$

Critical depth is assumed at section 2. At critical depth, the velocity head is one-half the hydraulic depth:

$$\frac{V_c^2}{2g} = 0.5 D_c \quad (5-2)$$

where: V_c = velocity head,
 D_c = A_c / T_{wc} = hydraulic depth at critical depth,
 A_c = area at critical depth,
 T_{wc} = top width at critical depth.

The head loss is estimated by the Yarnell equation assuming critical depth in the constriction:

$$h_L = C_{Yc} \left(5.5 \left\{ \frac{A_p}{A_c} \right\}^3 + .08 \right) \frac{V_1^2}{2g} \quad (5-3)$$

where:

- C_{Yc} = Yarnell pier loss coefficient; from 1 for round nosed piers to 5 for square nosed piers,
 A_p = area of the piers.

An iterative procedure is used to solve equations 5-1 to 5-3 for flow associated with an upstream stage. For each stage, the following procedure is used:

- 1) Compute the hydraulic depth and area at 1.
- 2) Assume an initial stage at 2.
- 3) Compute the hydraulic depth and area at 2.
- 4) Compute the discharge using equation 5-2.
- 5) Solve equation 5-1 for the stage at 1.
- 6) If the computed stage at 1 is within a tolerance, the computation is finished.
- 7) Make a new estimate of the stage at 2 and go to step 3.

5.1.2 Pressure Flow

Pressure flow is assumed to occur when:

$$\frac{Z_{hw} - Z_o}{Z_{lc} - Z_o} > 1.3 \quad (5-4)$$

where: Z_{hw} = headwater elevation,
 Z_{lc} = elevation of the low chord,
 Z_o = invert elevation of the cross section.

The critical ratio of 1.3 parallels the accepted criterion used to separate open channel and pressure flow for culverts. It is a purely empirical ratio, without basis in theory.

Pressure flow is given by a sluice gate equation (FHWA, 1978):

$$Q = K_{pf} \sqrt{2g} A \left\{ Z_{hw} + \frac{V_{hw}^2}{2g} - 0.5(Z_{lc} + Z_o) \right\}^{0.5} \quad (5-5)$$

in which K_{pf} is the pressure flow coefficient; about 0.5 (FHWA, 1978).

5.1.3 Weir Flow

Weir flow is given by equation 4-18.

5.2 Submerged Flow

5.2.1 Low Flow using Yarnell's Equation

Yarnell's equation is used in the HEC-2 special bridge routine to estimate the swell head upstream of pile bents. The Yarnell equation is (HEC, 1990c and Henderson, 1966):

$$\Delta H = 2K(K + 10\omega - 0.6)(\alpha + 15\alpha^4) \frac{V_{tw}^2}{2g} \quad (5-6)$$

where:

- ΔH = difference in water surface from the upstream and downstream sides of the bridge,
- K = pier slope coefficient,
- ω = the ratio of the downstream velocity head to the depth,
- α = ratio of obstructed area to total unobstructed area.
- V_{tw} = the velocity downstream of the bridge.

It is assumed that α can be approximated by the ratio of the obstructed top width to the total unobstructed top width.

5.2.2 Pressure Flow

Pressure flow is assumed to occur when the tailwater elevation exceeds the low bridge chord elevation. Pressure flow is given by a submerged sluice gate equation:

$$Z_{tw} > Z_{lc} \quad (5-7)$$

$$Q = K_{ps} \sqrt{2g} A \left\{ Z_{hw} + \frac{V_{hw}^2}{2g} - Z_{tw} \right\}^{0.5} \quad (5-8)$$

in which K_{ps} is discharge coefficient; 0.7 to 0.9 (FHWA,1978).

5.2.3 Weir Flow

Weir flow is given by equation 4-18.

5.3 Strategy for Computing Free and Submerged Flow Rating Curves

Free and submerged rating curves are computed for the bridge-weir system for a range of headwater and tailwater elevations entered by the user. The free flow rating

curve is computed first, assuming a tailwater elevation below the downstream invert. The rating curve is currently defined by 50 points. Then, for each of 50 tailwater elevations uniformly distributed over the entered tailwater range, a submerged flow rating curve is computed. Each submerged flow rating curve is defined by a maximum of 50 points. The headwater elevations are chosen such that they lie in the feasible range indicated by the three flow regions (see Section 5.1). If optionally selected, three exponential equations (equation 4-61), which correspond to the three flow regions, may be derived from the 50 submerged flow rating curves, using least squares.

Chapter 6

Modeling of Culverts

Culverts restrict the flow to a small opening through an embankment. The constriction generates a head loss (swell head) which, for severe restrictions, can be several feet. During high flow, the embankment may be overtopped and act as a weir.

The UNET system models culverts using a set of free and submerged flow rating curves, as described in Chapter 4. The CSECT module has the capability of calculating the free and submerged flow rating curves for a system of up to five parallel culverts and four overflow weirs. The culverts can be circular and elliptical pipes, pipe arches, or box culverts. Corrugated metal and concrete materials are supported, as well as many different types of entrance conditions.

6.1 Flow Types

The USGS (Bodhaine, 1982) defines six different types of culvert flow, they are:

- 1) Critical depth at inlet, unsubmerged inlet control.
- 2) Critical depth at outlet.
- 3) Tranquil flow throughout.
- 4) Submerged outlet, pressure flow.
- 5) Rapid flow at inlet.
- 6) Full flow through barrel with free overfall at outlet.

For types 1, 2, 5, and 6, the discharge through the culvert is independent of the tailwater. These flow types define the free flow rating curve. The stability of type 6 flow depends on the length and roughness of the culvert barrel. For most situations, type 6 flow is highly unstable, oscillating between types 5 and 6. The discharge for types 3 and 4 depend on the tailwater elevation, hence defining the submerged flow rating curves. In addition to flow through the culvert, the roadway embankment may be overtopped, which adds a weir flow component.

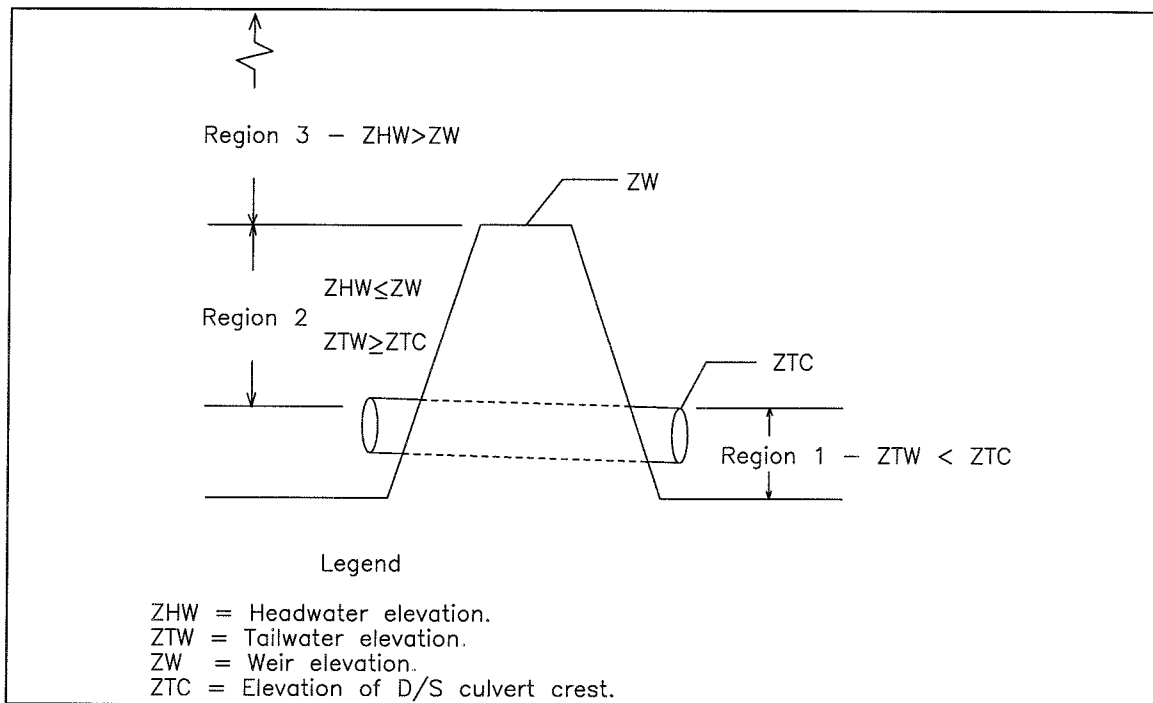

Figure 6-1 The three culvert flow regions.

6.2 Three Flow Regions

For submerged flow, three regions can be defined (Figure 6-1). The first extends from the culvert invert to the crest elevation of the downstream culvert exit. In this region, the flow through the culvert is tranquil open channel flow. The second region extends from the crest elevation of the culvert to the minimum weir elevation of the roadway embankment. In this region, the flow through the culvert is pressure flow. There is no weir flow. The third and final region extends from the minimum weir elevation upwards. In this region, the flow through the culvert is pressure flow and the flow over the weir may be submerged by the tailwater.

6.3 Culvert Discharge using the FHWA Procedure

There are two widely used procedures for computing culvert discharge: The USGS procedure (Bodhaine, 1982) and the Federal Highway Administration procedure (FHWA, 1978). The fundamental research for both procedures was conducted by the National Bureau of Standards in the 1950's (see FHWA, 1986 for a complete list of references). The USGS procedure establishes head loss parameters and, in some cases, the type of flow from a set of charts and graphs. The FHWA procedure tabulates head loss parameters for the various culvert types and geometry (see the table of culvert loss coefficients in Appendix B). Because tables are much more convenient than charts, the FHWA procedure was chosen for use in UNET.

Type 1 Flow, Inlet Control

For Type 1 flow, critical depth occurs at the inlet. The slope of the culvert barrel is greater than a critical slope and the tailwater elevation is below the critical elevation at the outlet. The inlet is assumed unsubmerged if:

$$\frac{Q}{AD^{0.5}} < 4 \quad (6-1)$$

where: Q = culvert discharge,
 A = area of the barrel flowing full,
 D = culvert diameter.

Equation 6-1 can be approximated by:

$$\frac{H_w}{D} < 1.3 \quad (6-2)$$

in which H_w is the headwater depth above the upstream culvert invert. Equation 6-2 is computationally more convenient than equation 6-1.

The FHWA proposes two equations for inlet control:

$$\frac{H_w}{D} = \frac{H_c}{D} + K \left[\frac{Q}{A} D^{0.5} \right]^M - CS \quad (6-3)$$

$$\frac{H_w}{D} = K \left[\frac{Q}{AD^{0.5}} \right]^M \quad (6-4)$$

where: H_c = critical depth at the inlet,
 $K, M,$ and C = coefficients,
 S = barrel slope.

The coefficients are identified by the program, given the appropriate culvert type, exit, and entrance conditions.

Type 2 Flow, Critical Depth at the Outlet

For Type 2 flow, critical depth occurs at the culvert outlet. The culvert slope is less than the critical slope and the headwater-diameter ratio. Equation 6-2 is less than 1.3. Tranquil flow extends upstream from the outlet. The water surface in the barrel is determined by solving the energy equation upstream from the outlet using the direct-step procedure at increments of 0.01 foot. The entrance loss is given by:

$$h_{LE} = K_E \frac{V^2}{2g} \quad (6-5)$$

in which K_E is the entrance loss coefficient given in Appendix B, under the section on culverts.

Type 3 Flow, Tranquil Flow Throughout

For Type 3 flow, the flow is tranquil throughout and the tailwater elevation controls the discharge. The headwater-diameter ratio is less than 1.3. The FHWA assumes that the exit loss at the outlet is equal to the full velocity head:

$$h_{LO} = K_o \frac{V^2}{2g} \quad (6-6)$$

in which $K_o = 1$. From the outlet, the water surface inside the conduit is determined by a direct solution of the energy equation at an interval of 0.01 foot. The entrance loss is given by Equation 6-5.

Type 4 Flow, Pressure Flow

For Type 4 flow, the tailwater elevation is above the elevation of the top of the culvert outlet. The full cross section of the barrel at the outlet is submerged and the headwater-depth ratio is greater than 1.3. The discharge is given by a submerged orifice equation

$$Q = A \left[\frac{2g(Z_{hw} - Z_{tw})}{\left\{ 1 + K_E + \frac{29.1n^2L}{R^{4/3}} \right\}} \right]^{0.5} \quad (6-7)$$

where: Z_{hw} = headwater elevation,
 Z_{tw} = tailwater elevation,
 n = Manning's n value,
 L = barrel length,
 R = hydraulic radius.

Type 5 Flow, Submerged Flow at Inlet

For Type 5 flow, the headwater-depth ratio is greater than 1.3 and a portion of the culvert barrel at the outlet is exposed. The FHWA proposes the following equation:

$$\frac{H_w}{D} = c \left[\frac{Q}{AD^{0.5}} \right]^2 + Y - CS \quad (6-8)$$

where c , Y , and C are coefficients.

Type 6 Flow, Full Flow through barrel with Free Overfall

For Type 6 flow, the headwater-depth ratio is greater than 1.3 and the tailwater is below the elevation of critical depth at the outlet. The major problem computing Type 6 flow is estimating the energy grade line at the outlet, which exceeds the top of the pipe. The FHWA assumes that the energy grade line at the outlet is given by the following simple relation:

$$EGL_o = 0.5(H_{co} + D) = Z_o \quad (6-9)$$

where: EGL_o = energy grade line at the outlet,
 H_{co} = critical depth at the outlet,
 D = pipe diameter,
 Z_o = invert elevation at the outlet.

The headwater elevation is obtained from the energy equation assuming the full flow friction losses and the entrance loss from Equation 6-5. Type 5 and Type 6 flows are computed concurrently. If the Type 6 flow is less than the Type 5 flow, then the flow is assumed to be Type 6.

Weir and Culvert Flow

If the headwater elevation exceeds the top of the roadway then the culvert discharge is supplemented by a discharge over the weir. The weir discharge is computed from the weir equation, Equation 4-18.

6.4 Verification of Culvert Algorithm

The UNET culvert algorithm exactly reproduced (within the limits of reading the FHWA charts) the flow computed from the FHWA nomographs (1985) for flow types 1, 4, and 5. For flow types 2, 3, 5, and 6 the algorithm was verified against the USGS example problems and the South Florida Water Management District's program (1985). The computed flow values are shown in Tables 6-1 and 6-2. The agreement is within 5%, depending on loss parameters, for the

majority of tests. The SFWMD program identified Test 3 as USGS Type 1 flow, rather than Type 2 flow, as was identified by the USGS algorithm and UNET. For Test 8, the results from the three programs were widely different. UNET and SWFMD identified the flow as Type 5 and the USGS algorithm identified the flow as Type 6. The range of the computed flow is also puzzling, SFWMD being 30% lower than the UNET value and the USGS being 30% higher. Because Type 6 flow (where the discharge is controlled by the culvert barrel) is a rare occurrence and, when it does occur, rather short lived, this ambiguity is not considered to be a limitation of the program. Rather, the problem is a topic for further research and study.

6.5 Strategy for Computing Free and Submerged Flow Rating Curves

Free and submerged rating curves are computed for the culvert-weir system for a range of headwater and tailwater elevations entered by the user. The free flow rating curve is computed first, assuming a tailwater elevation below the downstream invert of the culvert. Then, for an array of tailwater elevations, uniformly distributed over the entered tailwater range, a submerged rating curve is computed. The headwater elevations are chosen such that they lie in the feasible range indicated by the three flow regions (see Section 6.2). For each computed flow, the free flow rating is checked. If the elevation-flow point lies along the free flow rating, the point is discarded, because the flow is not submerged. Finally, if the user elects to use the exponential equations, three exponential equations (equation 4-61), which correspond to the three flow regions, are derived from the submerged flow rating curves, using least squares.

6.6 Addition of Risers, Bleeders, and Drop Inlets

The basic culvert can be modified by the addition of a riser, a bleeder, or a drop inlet upstream of the culvert intake.

Table 6-1
Comparison between Culvert Flow Computed
using the USGS Procedure and the Culvert Procedure in UNET.

Example Number	Culvert Type	Manning's <i>n</i>	U/S Invert Elev. (ft)	D/S Invert Elev. (ft)	Length (ft)	Headwater Elev. (ft)	Tailwater Elev. (ft)	USGS Flow (ft ³ /s)	USGS Culvert Flow Type	UNET Loss Type	UNET Flow (ft ³ /s)	UNET Culvert Flow Type
1	10' CMP	0.024	2.00	0.00	100	12.00	6.00	725	1	4	740	1
2	8' x 8' Conc. Box	0.015	2.00	0.00	100	10.00	4.00	530	1	15	519	1
3	10' CMP	0.024	0.00	0.00	100	6.00	2.00	268	2	4	255	2
4	8' x 8' Conc. Box	0.015	0.17	0.00	60	8.19	4.00	523	2	15	509	2
5	10' CMP	0.024	0.00	0.00	100	6.00	5.00	251	3	4	230	3
6	4' Conc. Pipe w. Bell Entrance	0.012	0.00	0.00	50	7.00	5.00	125	4	2	120	4
7	4' CMP Rounded Entrance	0.024	2.00	0.00	50	8.00	1.00	120	5	7	117	5
8	4' Conc. Pipe Beveled Entrance	0.012	1.00	0.00	50	8.00	1.00	209	6	48	166	5

Table 6-2
Comparison between Culvert Flow Computed
using the SFWMD procedure and the Culvert Procedure in UNET.

Example Number	Culvert Type	Manning's <i>n</i>	U/S Invert Elev. (ft)	D/S Invert Elev. (ft)	Length (ft)	Headwater Elev. (ft)	Tailwater Elev. (ft)	SFWMD Flow (ft ³ /s)	USGS Culvert Flow Type	UNET Loss Type	UNET Flow (ft ³ /s)	UNET Culvert Flow Type
1	10' CMP	0.024	2.00	0.00	100	12.00	6.00	750	1	4	740	1
2	8' x 8' Conc. Box	0.015	2.00	0.00	100	10.00	4.00	512	1	15	519	1
3	10' CMP	0.024	0.00	0.00	100	6.00	2.00	294	1	4	255	2
4	8' x 8' Conc. Box	0.015	0.17	0.00	60	8.19	4.00	514	2	15	509	2
5	10' CMP	0.024	0.00	0.00	100	6.00	5.00	259	3	4	230	3
6	4' Conc. Pipe w. Bell Entrance	0.012	0.00	0.00	50	7.00	5.00	116	4	2	120	4
7	4' CMP Rounded Entrance	0.024	2.00	0.00	50	8.00	1.00	114	5	7	117	5
8	4' Conc. Pipe Beveled Entrance	0.012	1.00	0.00	50	8.00	1.00	130	5	48	166	5

6.6.1 Riser

A riser is a vertical pipe which does not allow flow into the culvert until the water surface elevation reaches the crest of the riser pipe. A typical riser is shown in Figure 6-2. The length of the weir crest is not necessarily the circumference of the riser pipe. Often the top of the riser is restricted and the flow is limited to a portion of the circumference. The riser crest is modeled as a free flowing weir (note that the submergence from the riser barrel is ignored). The capacity of the riser-culvert combination is the lessor of the flow over the riser crest or the flow through the culvert. The riser is added by placing a RI record (see Appendix B) upstream of the culvert record.

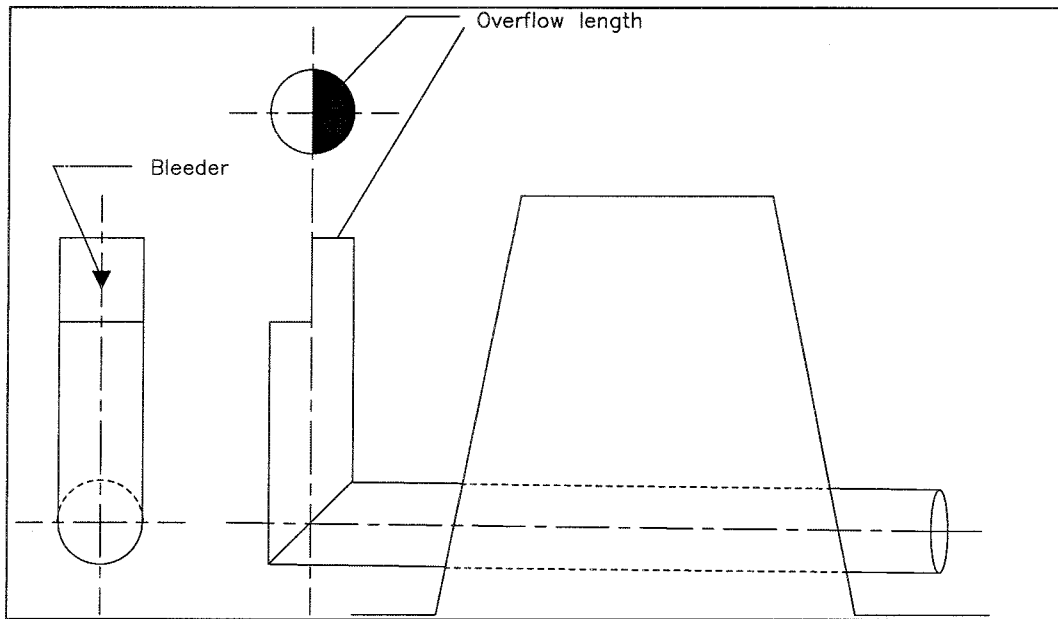

Figure 6-2 Riser pipe and culvert through an embankment. The riser pipe has a semi-circular overflow section and a bleeder on the upstream face.

6.6.2 Bleeders

A bleeder is a geometric opening in a riser pipe and in a weir which controls the upstream stage. Five types of bleeders can be included:

- 1) Triangular notch.
- 2) Rectangular notch.
- 3) Triangle.
- 4) Rectangle.
- 5) Circle.

The geometry of each type is shown in Figure 6-3. The bleeder is modeled by a weir equation which includes submergence. The bleeder is selected by adding a BD record before the culvert or riser. Note: only one bleeder can be added for each culvert.

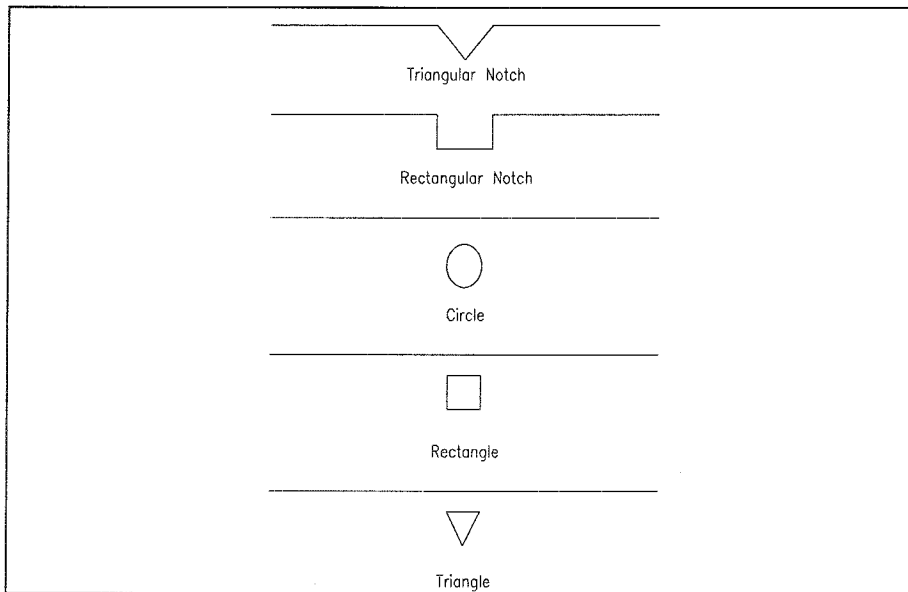

Figure 6-3 Five types of bleeders in the UNET program.

6.6.3 Drop Inlet Sump

An inlet sump is a vertical drop which occurs before the culvert. A typical inlet sump is shown in Figure 6-4. The drop is modeled by a free flow weir equation. The capacity of the culvert is the lesser of the culvert flow or the flow over the drop inlet for the given headwater and tailwater elevations. The sump is specified by including a DI record before the culvert. The width of the inlet sump is the sum of the widths of the crest of the drop before all the culverts. An inlet sump cannot be used with either a riser or a bleeder.

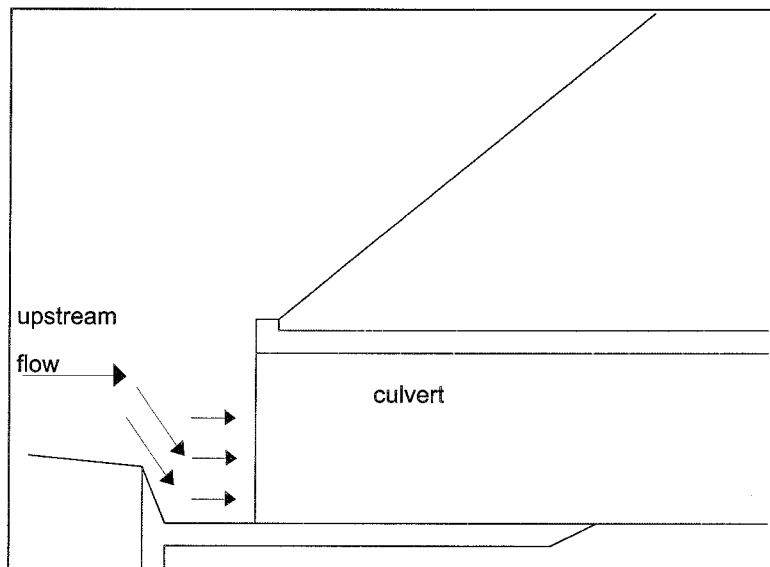

Figure 6-4 Culvert with upstream inlet sump.

Chapter 7

Modeling of Closed Conduits

7.1 Preissmann Slot

Closed conduits are assumed to experience flow under two different regimes: 1) open channel flow when the water surface is below the top of the conduit and 2) pressure flow when the pressure head exceeds the top of the conduit. Pressure flow is analyzed using waterhammer equations, which are presented below for a circular pipe (Streeter and Wylie, 1967):

Momentum -

$$g H_x + V_t + V(V_x) + \frac{f}{2D} V |V| = 0 \quad (7-1)$$

Continuity -

$$H_t + V(H_x) + \frac{a^2}{g} V_x = 0 \quad (7-2)$$

where: V = velocity,
 H = piezometric head,
 a = wave celerity,
 f = Darcy-Weisbach friction factor,
 D = diameter,
 t = time (independent variable),
 x = distance (independent variable).

These hyperbolic partial differential equations describe the translation of pressure waves through an elastic medium. Impulses travel at a rate given by the characteristic directions:

$$\frac{dx}{dt} = V \pm a \quad (7-3)$$

Because the wave celerity a is on the order of 1000 times larger than the water velocity, V , the advective terms in equations 7-1 and 7-2 are often dropped and the characteristic directions become (Streeter and Wylie, 1967):

For pressure flow, the celerity is that of an acoustic wave (sound wave) with a correction for the elasticity of the conduit material (Parmakian, 1963):

$$\frac{dx}{dt} = \pm a \quad (7-4)$$

$$a = \left[\frac{\gamma}{g} \left(\frac{1}{K} + \frac{D c_1}{E e} \right) \right]^{-0.5} \quad (7-5)$$

where: γ = specific weight of water,
 K = bulk modulus of elasticity of water,
 D = conduit diameter,
 e = conduit thickness,
 c_1 = conduit support parameter, typically 0.91 for conduits anchored at both ends,
 E = Young's modulus of elasticity.

If the conduit is buried or bored through rock, e is large and the elasticity correction becomes insignificant, hence:

$$a = \left(g \frac{K}{\gamma} \right)^{0.5} \quad (7-6)$$

If the bulk modulus is 43.2×10^6 lbs/ft², then the celerity is 4721 ft/s.

The shallow water equations, equations A-1 and A-17, can be rewritten using velocity V and depth h as the dependent variables.

Momentum -

$$V_t + V(V_x) + g(h_x) + g(S_o - S_f) = 0 \quad (7-7)$$

Continuity -

$$T_w(h_t) + V T_w(h_x) + V(A_x)_h + A(V_x) = 0 \quad (7-8)$$

where: A = the cross-sectional area,
 $(A_x)_h$ = the spatial derivative of area at constant depth (Liggett, 1975),
 T_w = top width.

Like the waterhammer equations, these equations are hyperbolic partial differential equations in the independent variables x and t for which impulses travel at a rate given by the characteristic directions:

$$\frac{dx}{dt} = V \pm c \quad (7-9)$$

in which c is the celerity of a gravity wave. The celerity of a gravity wave is:

$$c = \sqrt{gD} \quad (7-10)$$

where:

c	=	the celerity,
g	=	the acceleration of gravity,
$D=A/T_w$	=	the hydraulic depth,
A	=	the flow area,
T_w	=	the top width.

Equations 7-6 and 7-10 are identical with the exception of the values of the wave celerities. Recognizing this fact, Preissmann (Cunge et al., 1980) suggested that pressure waves can be approximated by the shallow water equations if the celerity c is set equal to the acoustic celerity. Preissmann proposed the insertion of a slot of constant width and infinite height above the top of the conduit (see Figure 7-1).

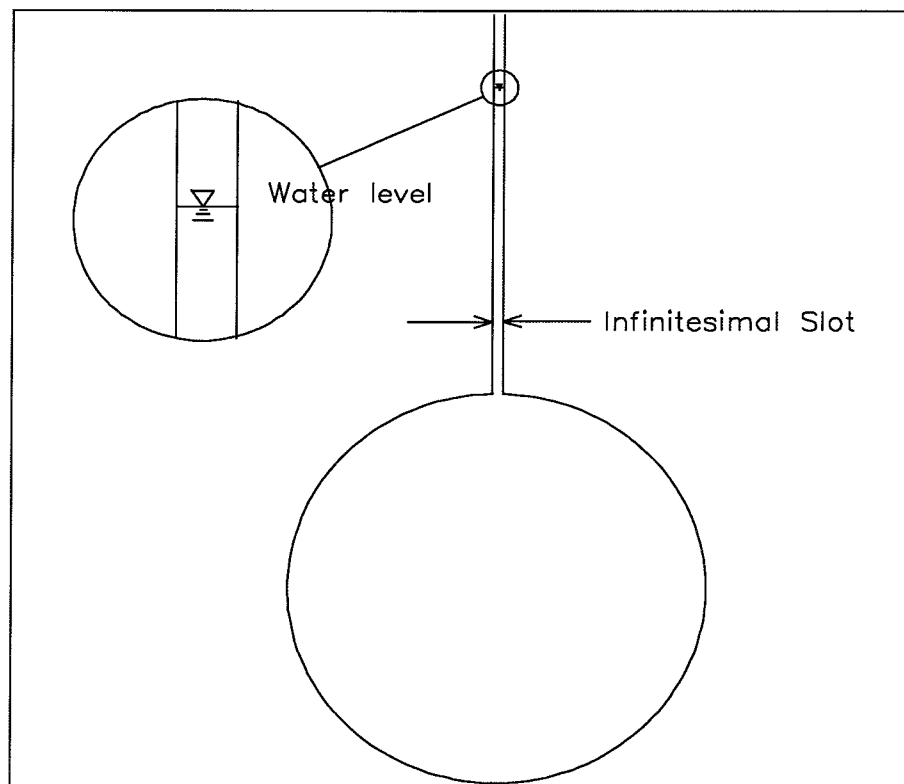

Figure 7-1 Circular conduit with Preissmann slot.

The width of the slot is determined by equating 7-6 and 7-10 and solving for the top width:

$$T_w = \frac{A\gamma}{K} \quad (7-11)$$

in which A is the full flow area.

Thus, the celerity of a gravity wave, when the water surface is in the slot, is equivalent to that of an acoustic wave. The procedure has utility because both open channel flow and pressure flow can be simulated by solving the same equations. The penalty in accuracy is a very slight attenuation due to the increase in area associated with the slot. However, because the total slot area at a head of 200 ft. is $2.98 * 10^{-4} * A$, the increase in storage is negligible.

In the UNET program the Preissmann slot can be used with circular and rectangular conduits. The conduit is specified by replacing the GR data which define the cross section with TN data for circular conduits or a TB data for defining a rectangular conduit.

7.2 Darcy-Weisbach Friction Factor

The general equation for estimating head losses through conduits and open channels of any section is (French, 1985):

$$h_L = 4f \frac{L V^2}{R 2g} \quad (7-12)$$

where: f = Darcy-Weisbach friction factor,
 L = conduit length,
 R = hydraulic radius,
 V = average velocity.

If the section is circular and the pipe is flowing full, it can be shown that $R = D/4$, and the conventional form of the equation is obtained.

Equation 7-12 describes the loss of energy over a length of pipe, but, the momentum equation includes the friction slope at a point. If equation 7-12 was written over an infinitesimal distance dx , then the friction slope would be $S_f = h_L / dx$ or:

$$S_f = f \frac{1 V^2}{R 2g} \quad (7-13)$$

The factor f is a function of the relative roughness and the Reynolds Number. For

circular sections, relative roughness is defined as the ratio of the roughness height, ϵ , to the diameter of the pipe, ϵ/D . For non-circular sections, $D = 4R$ and we assume that relative roughness is $\epsilon/(4R)$. Values of f are displayed on the Moody Diagram which can be found in any fluid mechanics text. If the flow can be assumed to be completely turbulent however, which is a good assumption for most situations of engineering interest, then the friction factor is only a function of relative roughness, simplifying the problem. The values of f versus relative roughness for turbulent flow are tabulated in Table 7-1. The roughness factors for common materials can be found in (French, 1985).

Table 7-1

**Relative roughness versus
Darcy-Weisbach friction factor f for fully turbulent flow.**

Relative Roughness ϵ/D	D.W.f
.00001	0.0082
.00005	0.0106
.0001	0.0120
.0002	0.0137
.0004	0.0160
.0006	0.0174
.0008	0.0185
.001	0.0195
.002	0.0235
.004	0.0282
.006	0.032
.008	0.035
.01	0.038
.015	0.044
.02	0.049
.03	0.057
.04	0.065
.05	0.072

7.3 Pilot Channel For Circular Conduits

For small depths, the width-depth ratio of a circular conduit under open channel flow is large. Since the first derivative of area with elevation is the top width, in the computer simulation, a small negative change in flow may produce an unreasonable large change in depth which may drop below the invert of the conduit. That negative depth would result in a computational error which will cause the simulation to abort.

One way to limit the occurrence of this problem is to keep the computation interval small. Unfortunately, the small time step also lengthens the simulation.

Another, more practical way, is to define a pilot channel at the invert of the conduit. The pilot channel is rectangular in shape. The area of the pilot channel is borrowed from the sides of the conduit producing a computationally more expedient shape (see Figure 7-2). The elevation-area function is modified only at the lower stages and not at the higher stages. Thus, for low flows, the computed stages would be lower and for higher flows, the computed flows would be unchanged.

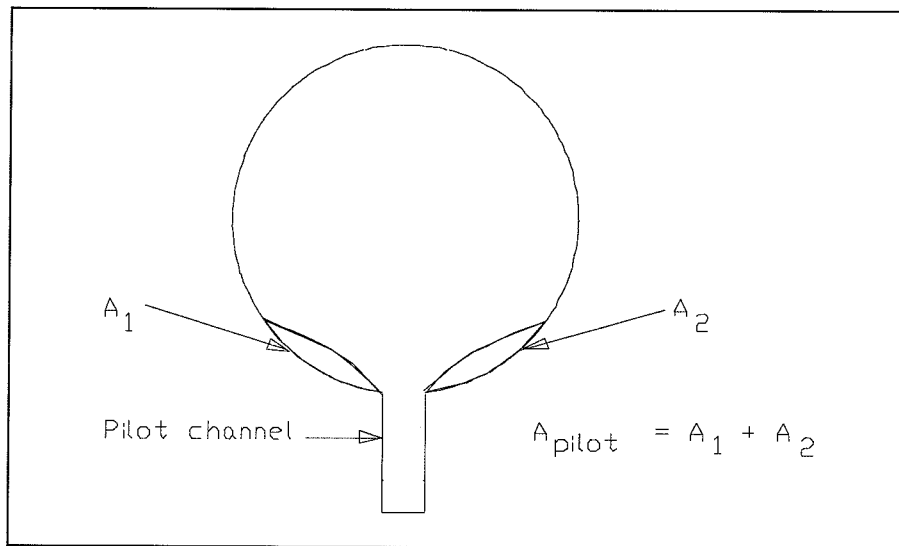

Figure 7-2 Circular conduit and pilot channel.

Chapter 8

Storage Areas

8.1 Storage Areas

A storage area is a lake-like region that can either provide water to, or divert water from a channel. Storage areas may be located at the termination of a stream reach or be connected to a channel reach by a lateral spillway. Figure 8-1 shows an example storage area. Reach 1 terminates at the storage area. Reach 3 discharges into the storage area over a lateral spillway, which contains a gated section and two uncontrolled weir sections.

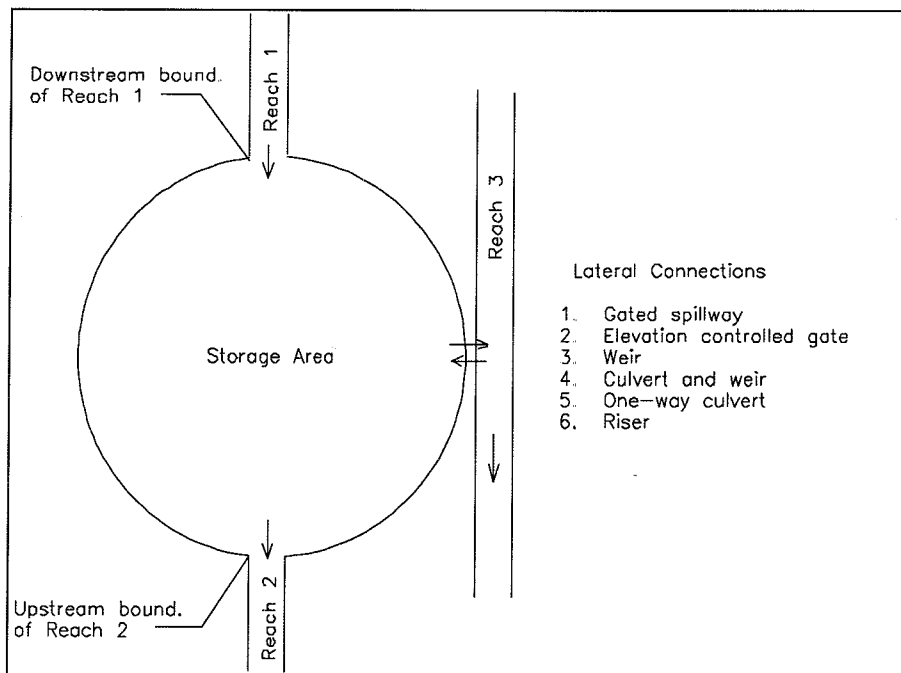

Figure 8-1 A typical storage area (plan view).

UNET assumes that storage areas have the following two properties: 1) the water surface is horizontal, and 2) a linear storage-elevation relationship exists and is defined by:

$$S = (Z_a - Z_{a0}) A_a \quad (8-1)$$

where:

S	=	storage,
Z _a	=	water surface elevation,
Z _{a0}	=	average elevation of the interior ground surface,
A _a	=	surface area.

The continuity equation for the storage area is:

$$\frac{dS_a}{dt} = \sum_{i=1}^n Q_i \quad (8-2)$$

Substituting this into equation 8-1 yields:

$$\frac{dZ_a}{dt} = \frac{1}{A_a} \sum_{i=1}^n Q_i \quad (8-3)$$

where: n = the number of flow inputs,
 Q_i = the flow values.

Using the implicit finite difference scheme, equation 8-3 can be approximated as:

$$\frac{\Delta Z_a}{\Delta t} = \frac{1}{A_a} \sum_{i=1}^n (Q_i + \theta \Delta Q_i) \quad (8-4)$$

If Q_i is from a connecting reach, then Q_i = Q_j where j is the downstream node of the reach. If Q_i is from a lateral spillway, then Q_i = Q_s + Q_w, the sum of the spillway and weir flows. For the latter case Q_i = f(H) where, H, the head across the weir, is a function of the water surface at the spillway and Z_a.

The discharge terms in equation 8-4 can be nonlinear if the flow comes from a lateral spillway. It is assumed that the nonlinearity can be approximated by the first order Taylor approximation. Hence, the following linear equation is formed:

$$\sum_{j=1}^N \{SA_{(2j-1)} \Delta Q_j + SA_{(2j)} \Delta Z_j\} - SA_l \Delta Z_{al} = SAB_l \quad (8-5)$$

where: SA_i = coefficient at column i,
 SA_l = A_a/Δt,
 N = number of nodes,
 l = row number of the storage equation.

Equation 8-5 assumes that the storage equations will be located in the coefficient matrix after the routing equations, hence, l > 2N.

Using the equations presented in section 4.2.5, equation 8-3 can be rearranged to obtain:

$$-\theta \left\{ \frac{\partial D_k}{\partial Z_a} \Delta Z_a + \frac{\partial D_k}{\partial Z_j} \Delta Z_j + \frac{\partial D_k}{\partial Z_{j+1}} \Delta Z_{j+1} \right\} = D_k \left(1 + \frac{\theta \beta_k}{B_k} \Delta B_k \right) \quad (8-6)$$

Equation 8-6 is then inserted into the linearized, finite difference form of the continuity equation:

$$CQ_{1j} \Delta Q_j + CZ_{1j} \Delta Z_j + CQ_{2j} \Delta Q_{j+1} + CZ_{2j} \Delta Z_{j+1} = CB_j \quad (8-7)$$

and into equation 8-5. The coefficients of the continuity equation are modified by:

$$CZ_{1j} = CZ_j + \frac{\theta}{\Delta x_e} \frac{\partial D_k}{\partial Z_j} \quad (8-8)$$

$$CZ_{1j+1} = CZ_{j+1} + \frac{\theta}{\Delta x_e} \frac{\partial D_k}{\partial Z_{j+1}} \quad (8-9)$$

$$CB_j = CB_j - \left[D^n + \theta \frac{\partial D_k}{\partial B_k} \Delta B_k \right] \frac{\theta}{\Delta x_e} \quad (8-10)$$

in which Δx_e is the equivalent flow distance. The coefficients in equation 8-5 are augmented by:

$$SA_{1,2(j+1)} = SA_{1,2(j+1)} - \theta \frac{\partial D_k}{\partial Z_{j+1}} \quad (8-11)$$

$$SA_{1,2j} = SA_{1,2j} - \theta \frac{\partial D_k}{\partial Z_j} \quad (8-12)$$

$$SAB_l = SAB_l + \left[D^n + \theta \frac{\partial D_k}{\partial B_k} \Delta B_k \right] \quad (8-13)$$

8.2 Connections to the Downstream Terminus of a Reach

For connections to downstream reach terminations where the downstream node number is j , $SA_j = 1$, and the downstream boundary equation becomes:

$$CQ1_j \Delta Q_j + CZ1_j \Delta Z_j + CQ1_j \Delta Q_{j+1} + CZ1_j \Delta Z_{j+1} + CZA_j \Delta Z_i = CB_j \quad (8-14)$$

where: $CZ1_j = 1$,
 $CZA_j = -1$; the coefficient for the stage of the storage area at row $2N + 1$,
 $CQ1_j = CQ2_j = CZ2_j = CB_j = 0$.

8.3 Submerged Weir Equation

The energy equation is written from headwater to tailwater spanning the weir structure:

$$Z_H + \frac{V_H^2}{2g} = Z_T + \frac{V_T^2}{2g} + h_L \quad (8-15)$$

where: Z_H = headwater elevation,
 V_H = approach velocity in the headwater,
 Z_T = tailwater elevation,
 V_T = velocity in the tailwater,
 h_L = head loss.

Assuming that:

$$h_L = \alpha \frac{V_T^2}{2g} \quad (8-16)$$

and:

$$V_T^2 = \frac{Q^2}{(Z_T - Z_w)^2 L^2} \quad (8-17)$$

where: Q = the flow,
 L = the weir length,
 Z_w = weir crest elevation,
 α = the energy loss coefficient,

then:

$$Z_H + \frac{V_H^2}{2g} - Z_T = (1 + \alpha) \frac{Q^2}{2g(Z_T - Z_W)^2 L^2} \quad (8-18)$$

Solving for Q, and defining $C_s = 2g/(1+\alpha)$:

$$Q = C_s (Z_T - Z_W) L \left(Z_H + \frac{V_H^2}{2g} - Z_T \right)^{\frac{1}{2}} \quad (8-19)$$

8.3.1 Submergence Coefficient

A simple criteria for estimating submergence is:

$$\frac{(Z_T - Z_W)}{(Z_H - Z_W)} > \frac{2}{3} \quad (8-20)$$

and at the point of submergence:

$$Z_T - Z_W = \frac{2}{3} (Z_H - Z_W) \quad (8-21)$$

Moreover, for a broad crested weir, when $Z_H > Z_W$ and $Z_T > Z_W$, then:

$$(Z_H - Z_T) = \frac{1}{3} (Z_H - Z_W) \quad (8-22)$$

Now, at the point of submergence, the equation for free flow is equivalent to equation 8-19, therefore:

$$C_B (Z_H - Z_W)^{\frac{3}{2}} L = C_s (Z_H - Z_T)^{\frac{1}{2}} (Z_T - Z_W) L \quad (8-23)$$

in which C_B is the free flow weir coefficient. Substituting equations 8-21 and 8-22 into the above equation and canceling L yields:

$$C_B (Z_H - Z_W)^{\frac{3}{2}} = C_s [0.33(Z_H - Z_W)]^{\frac{1}{2}} [0.67(Z_H - Z_W)] \quad (8-24)$$

and:

$$C_B (Z_H - Z_W)^{\frac{3}{2}} = C_s (0.38) (Z_H - Z_W)^{\frac{3}{2}} \quad (8-25)$$

Finally,

$$C_S = 2.60 C_B \quad (8-26)$$

8.4 Special Connections

In addition to lateral spillways, UNET can connect reaches and individual storage areas with families of rating curves. The two primary connections are culverts and weirs (the RW record, Appendix B). The culvert connections can include risers and bleeders. The weir connections can include bleeders. The special connections are directed by the SC record which precedes the culvert or RW records.

Chapter 9

Simulation of Levee Breaches

Levees are embankments that surround an area of the floodplain and protect that area from the floodwaters of the river. The segment of the levee that crosses the floodplain laterally, paralleling a tributary and connecting to high ground along the bluff, is called a flank (or tie-back) levee. The flank levee protects the interior from floodwaters from the tributary and from backwater from the main river. A typical levee system consists of an upstream flank levee, a frontage levee along the main stem, and downstream flank levee which form a [- shaped embankment that protects the interior area.

The breaching of a levee system is a dynamic event. The water surface elevation of the river at the breach is reduced. The flow from upstream is accelerated by the increased slope of the water surface. The flow downstream is either reduced by the flow through the breach or the flow may reverse because of the negative flow gradient. Figure 9-1 (USACE, 1993) shows the acceleration and deceleration of flow. The overall effect is a reduced water surface along the main river until the levee storage fills to equalize water surface elevations in both the river and the leveed areas. In 1993, the failure of the Columbia Levee and the subsequent failures of the Harrisonville, Stringtown, and Ft. Chartres systems reduced stages along the Mississippi River by several feet and delayed the flood crest downstream at Chester by six days.

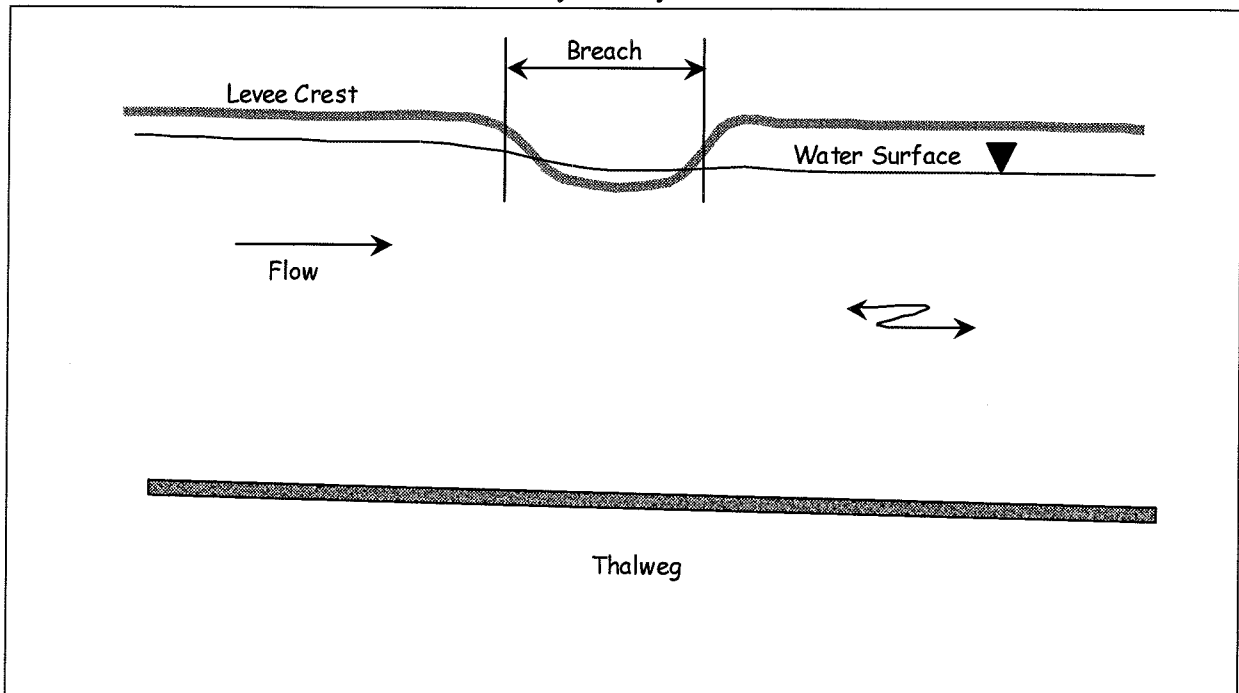

Figure 9-1. Water surface in the vicinity of a levee breach.

There are at least two geometric possibilities for describing the overbank flow areas. If the flow capacity of the breaches are small with respect to the total storage within the levee system, the levee will act similar to a lake with multiple connections to the river network. The water surface inside the levee will be nearly horizontal. With this scenario the levee embankments are still intact and there is no significant flow over the floodplain. During the 1973 and 1993 Mississippi River floods and the 1986 Missouri River flood, the levees were intact and the overbank areas functioning as interconnected lakes.

In the second situation, the embankments are severely eroded and the total breach capacity is large compared to the storage. The floodplain is then carrying a larger portion of the flow and the water surface in the overbank has a slope. During the third crest of the 1993 flood along the Missouri River, the embankments were severely eroded and the Missouri River was actively conveying flow over the floodplain; as if the levees had not existed. This condition cannot be modeled by the network of cells and must be modeled instead as open channel flow routing.

9.1 Modeling Approaches

In the foregoing paragraphs a levee system was described as functioning either as a series of cascading lakes or as a parallel channel where the embankments are eroded to a point where they no longer control the flow. For the latter condition, the areas behind the levees can function as a series of interconnected lakes before the embankments are severely eroded. Thus, the model must be able to simulate both the system of interconnected lakes and a parallel channel. The following paragraphs recommend an approach to modeling these two types of systems.

When the embankments still control the flow to and from the levee storage, the levees can be modeled as a network of storage cells. The modeler must assume that the water surface is horizontal within each of the cells. The cell connections may be culverts, weirs, riser pipes, etc. Figure 9-2 shows the cell layout that was used by Dr. Barkau to model the levees between St. Louis and Chester. Each levee cell is assigned a number. To distinguish cell numbers from reach numbers, the cell numbers are negative. Each levee has an upstream and a downstream breach that connects the levee cell to the river. The Columbia and Harrisonville systems are connected by a breach between the flank levees. Likewise, there is a potential connection between the Ft. Chartres and the Prairie Du Rocher Levee Systems. The cell model adequately reproduced the reduction in stage at St. Louis and Chester for the 1993 flood event. This UNET application indicated that the stages would have been one foot higher at St. Louis and two feet higher at Chester had the levees not failed. Furthermore, the crest at Chester was delayed by about 6 days by the levee failure. Normally, the routing time between St. Louis and Chester is about one day. The longer lag time is the result of flood water routed through the levee system. The model also adequately reproduced the shape and lag of the hydrograph being routed through the cells.

The connecting overbank channel concept attempts to simulate the levee system both as a cell and as a parallel channel. That component must simulate both cell and river attributes. Figure 9-2 shows the “cell parallel channel levee model” representation of the Harrisonville, Stringtown, and Ft. Chartres levee system. The fundamental component is a channel which is connected on the upstream and downstream ends by two small cells. The channel cross section has a small pilot channel as shown on Figure 9-3. The cells on either end maintain a horizontal water surface inside the cell while the levees are intact. The channel and cells fill during levee failure. The water surface will remain nearly horizontal throughout the system for small breaches. If the capacity of the upstream breach is greater than the downstream breach, a slope will be generated in the downstream direction and the system will function as a parallel channel.

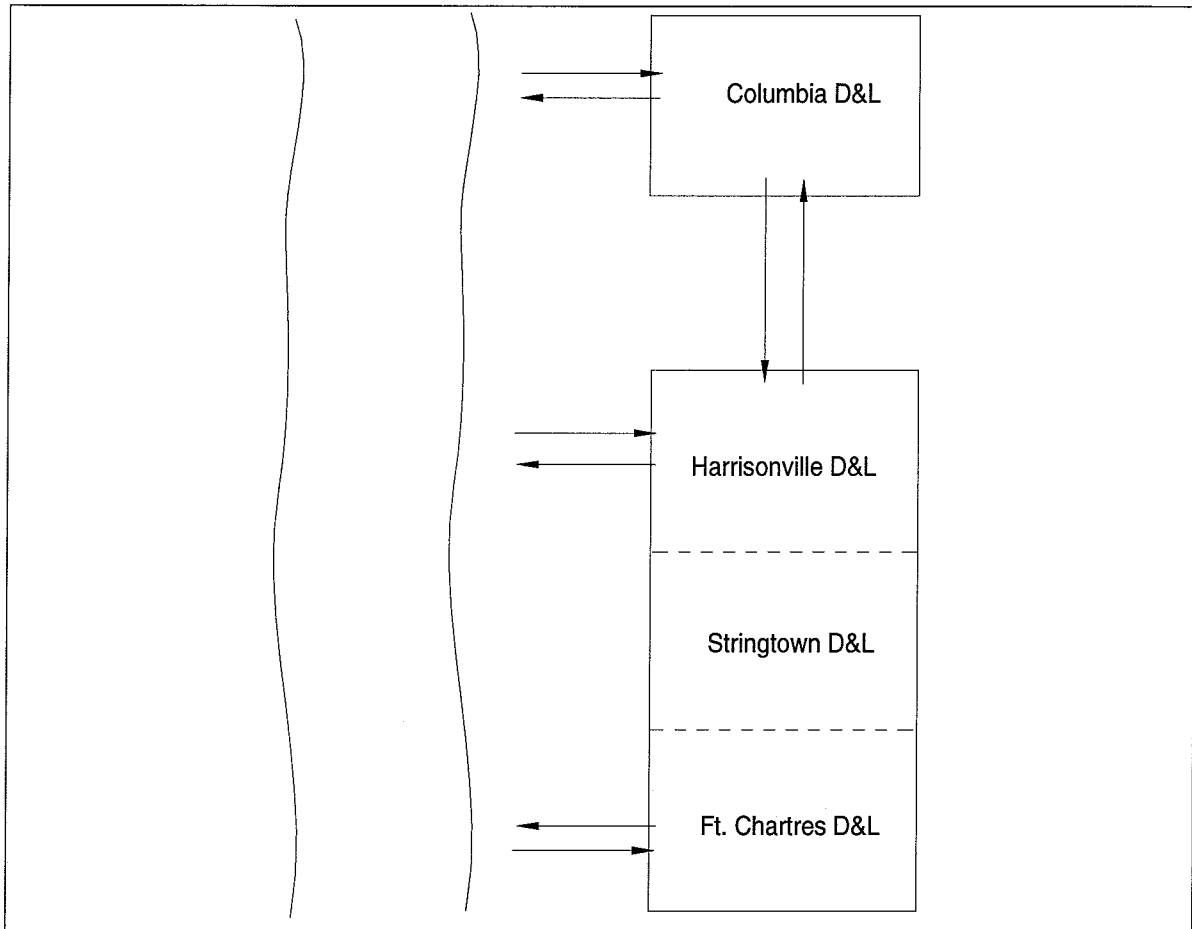

Figure 9-2 The cell layout used to model the Columbia, Harrisonville, Stringtown, and Ft. Chartres Levee Systems. The Harrisonville and Ft. Chartres levee are one contiguous storage area. The levee districts are political entities that are not separated by physical boundaries.

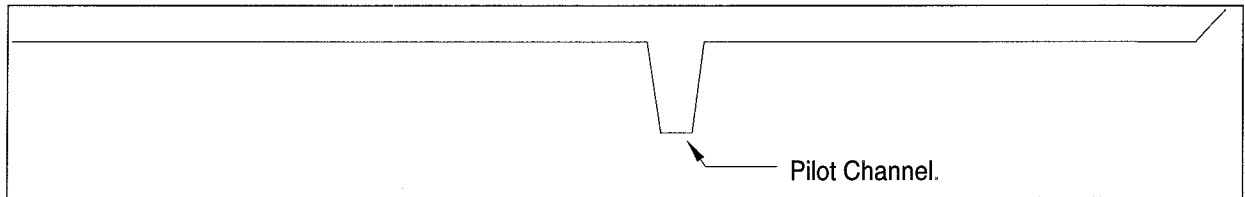

Figure 9-3 Pilot channel in the parallel channel. The water surface is maintained in the pilot channel by the storage cells at the cells at the upstream and downstream ends.

9.2 Levee Failures

The UNET program provides two procedures for the simulation of levee failures. The “simple” failure procedure applies the simple storage connection concept whereby the flow through the breach is computed by multiplying the volume of available storage by a coefficient (see Fig. 9-7). Knowledge of the size and evolution of breaches in levee systems is usually limited. Detailed levee breach information is often not available. Usually, the only information available for forecasting will be the names of the levee systems that have been breached. Detailed modeling of embankment failures when the details of the breach are unknown is therefore not practical. The UNET simple linear storage algorithm acknowledges this lack of data and applies a simple concept for the filling of a levee system. Flow into the area behind the levee is assumed to be proportional to the available storage; i.e. the flow is greatest at the start of failure and decreases as the leveed area fills. This procedure also has a computational advantage in that it is stable and will function with larger time steps. The simple connection is entered with an SF record.

The second failure procedure is a detailed simulation of a failure in the levee embankment. This procedure simulates an enlarging breach which corresponds to either a piping or an embankment failure. The breach starts when a trigger elevation is exceeded and the breach is assumed to enlarge at a linear rate. The breach can be placed between a river and a levee cell and/or between two levee cells. Flow through a piping breach is given by an orifice equation. When the pipe breaks through the top of a levee, the flow is given by a weir equation. The flow through an overtopping breach is also described by a weir equation. The embankment failure data is entered with an EF record.

A detailed discussion of the “embankment failure” procedure is given in Section 9.5 and the “simple failure” in Section 9.6.

9.3 Include Files

When a large number of levee systems (say, ten or more) are modeled, the cell and levee connection definitions begin to obscure the cross section geometry. In this case it is recommended that the UNET user define the cells and connections in a separate file that is called an **INCLUDE FILE**. After the cross section geometry has been entered, the include files are specified using the IS record and the data are read.

The include file enables the following functions:

- Define cells using the RE, SA, SV (optional), and HS records.
- Define simple levee failure RE and SF records.
- Define embankment failures using RE, SC, and EF records.
- Define culvert cell connections using RE, SC, CC, CB, CE, CA,WD, and CL records.
- Define riser pipe connections using RE, SC, RI, WD, and RL records.
- Define gated spillway connections using RE, SC, SP, and WD records.

Two notes regarding the above input data need to be made. The RE record defines the reach number and the cross section river mile (SECNAM on the X1 record) that the cell or connection is attached to. An RE record must precede every cell definition and connection. The SC (special connection) record defines the connection from reach to cell and from cell to cell for different types of flow connections. Refer to Appendix B for details.

9.4 Output from Levee Systems

The primary program outputs that describe the function of the levee cells are the flow and stage hydrographs written to HEC-DSS. The UNET model writes a stage hydrograph to HEC-DSS for each cell. For each flow connection UNET writes a stage hydrograph to HEC-DSS.

9.5 Embankment Failure

The embankment failure algorithm simulates the failure of a structure between storage cells, between a reach and a storage cell, or between reach cross sections (in-line in a reach). The failure algorithm does not simulate the erosion of material from the breach; rather, the algorithm simulates the enlargement of breach dimensions to an ultimate size during an assumed time of failure. Two types of breaches can be simulated: a piping breach where the failure results from seepage through the embankment, and an overtopping failure where the failure results from flow over the top of the structure.

The embankment failure algorithm can be used in conjunction with the following interior boundary conditions which simulate the primary outlets for a dam:

- 1) Gated spillway,
- 2) Culverts,
- 3) Riser pipes,
- 4) Weirs.

An embankment failure is specified by an EF record entered in the cross section data file. If the embankment failure is located between input cross sections, the EF record is placed immediately after the SP record for a spillway, the culvert data, the RI records for riser pipes, or the RW record for a weir. If the connection is between a reach and a cell, or between two cells, the EF record must be preceded by an SC record which defines the connections. These connections are illustrated in an example problem.

9.5.1 Overtopping Breach

The overtopping breach simulates the failure of an embankment after it has been overtopped. The failure begins when the water level exceeds a specified failure elevation Z_{FAIL} . If Z_{FAIL} is higher than the top of the dam and the water level exceeds the crown, weir flow is calculated over the embankment, but the failure of the embankment is not simulated. At the start of failure, the initial width and depth of the trapezoidal breach enlarges linearly with time to a final width, $WBREACH$, and a final invert elevation, $ZBRINV$. The side slopes of the breach are assumed to be constant. Figure 9-4 shows the enlargement process.

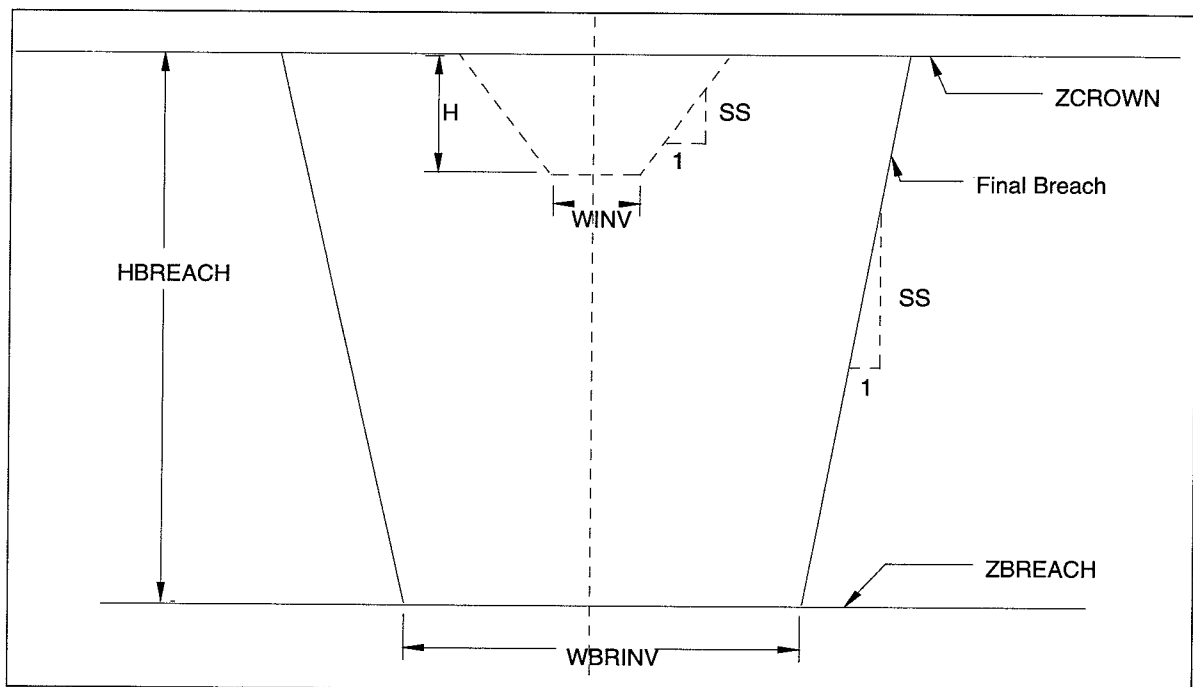

Figure 9-4 Trapezoidal overtopping breach.

The flow through the breach is computed from the weir flow equations which are presented in Chapter 4. The flow over the side slopes is computed by applying the average head to the average crest elevation along the sloping section.

9.5.2 Piping Failure

The piping failure assumes that a seepage through the embankment will enlarge into a conduit that will consume the embankment and form a trapezoidal breach. The cross section of the pipe is assumed to be a hexagon. The piping failure starts when the water exceeds the elevation Z_{FAIL} . If Z_{FAIL} is higher than the top of the dam and the water level exceeds the crown but not Z_{FAIL} , weir flow will be calculated, but the failure will not commence. At the start of failure, the initial base width and height of the breach is zero and the centroid of the breach is at the elevation, Z_{BREACH} . The base width is the lower horizontal segment of the hexagon. During the assumed time of failure, D_{TFAIL} , the width and height of the breach enlarge linearly around the axis of the centroid to its final trapezoidal shape. The side slopes of the hexagon are a constant SS . The breach becomes a trapezoid when the top of the hexagon breaks the crest of the embankment. The side slopes remain constant. In its final form, the breach is a trapezoid with an invert width W_{BREACH} and an invert elevation of Z_{BRINV} . Figure 9-5 shows the enlarging hexagonal breach and Figure 9-6 shows the final trapezoidal breach.

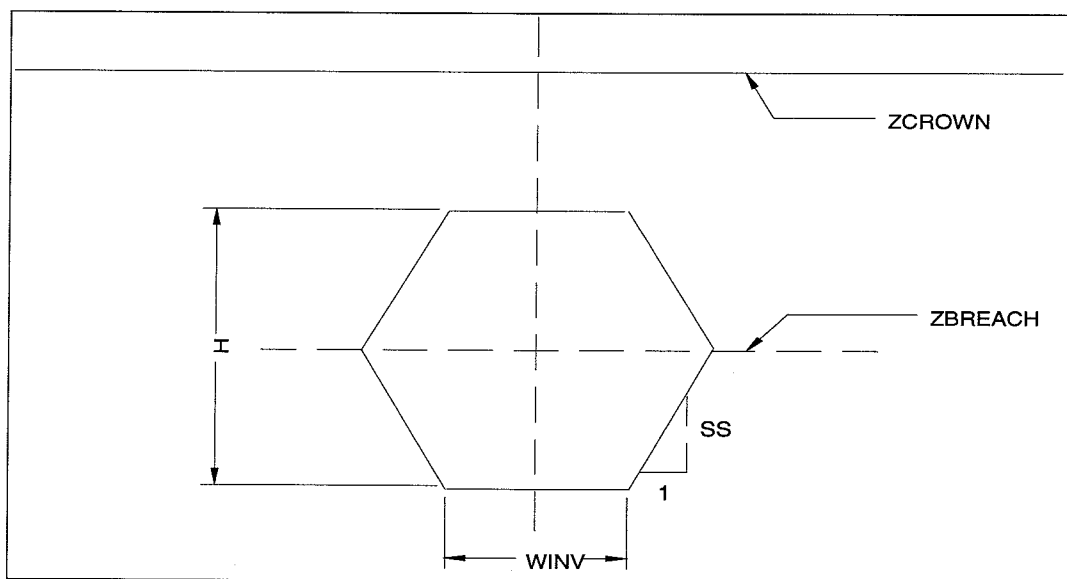

Figure 9-5 Hexagonal piping breach.

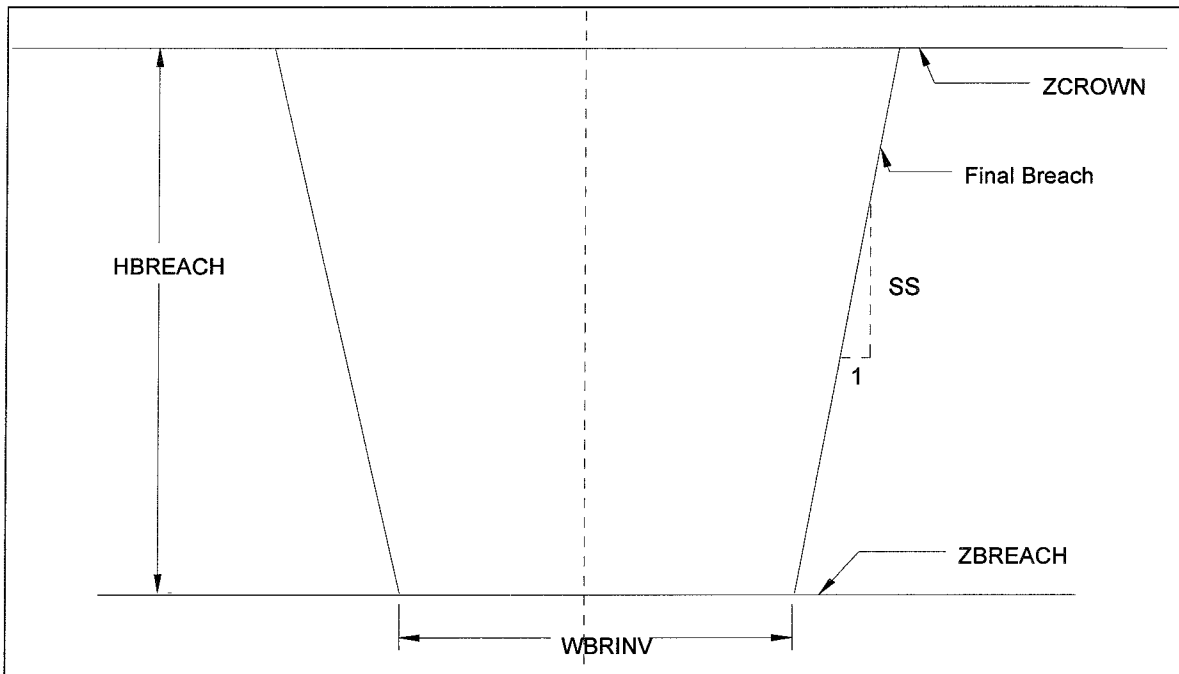

Figure 9-6 Final trapezoidal breach after the breach has broken through the top of the embankment.

The flow through a piping breach is given by orifice equations. For free flow, the flow is given by:

$$Q = C\sqrt{2g}A\left(Z_H + \frac{V^2}{2g} - Z_{BREACH}\right)^{1/2} \quad (9-1)$$

where: Q = flow
 C = orifice coefficient
 g = acceleration of gravity
 A = area of the orifice
 Z_H = headwater elevation
 V_H = headwater velocity
 Z_{BREACH} = elevation of the centroid of the pipe

For submerged flow, the flow is given by:

$$Q = \frac{C}{R_c(1-R_c)}\sqrt{2g}A\left(Z_H + \frac{V^2}{2g} - Z_T\right)^{1/2} \quad (9-2)$$

where: R_c = critical submergence ratio
 Z_T = tailwater elevation

9.6 The Simple Embankment Failure

The simple embankment failure algorithm assumes that the flow between two cells is via a “simple connection”; that is, the flow rate is proportional to the available storage to be filled, hence:

Where “Available Storage” is the volume to be filled and k is a linear routing factor with

$$Q = k \cdot (\text{Available Storage}) \quad (9-3)$$

the units of time^{-1} (hours^{-1}). This concept for two cells is illustrated in Figure 9-7.

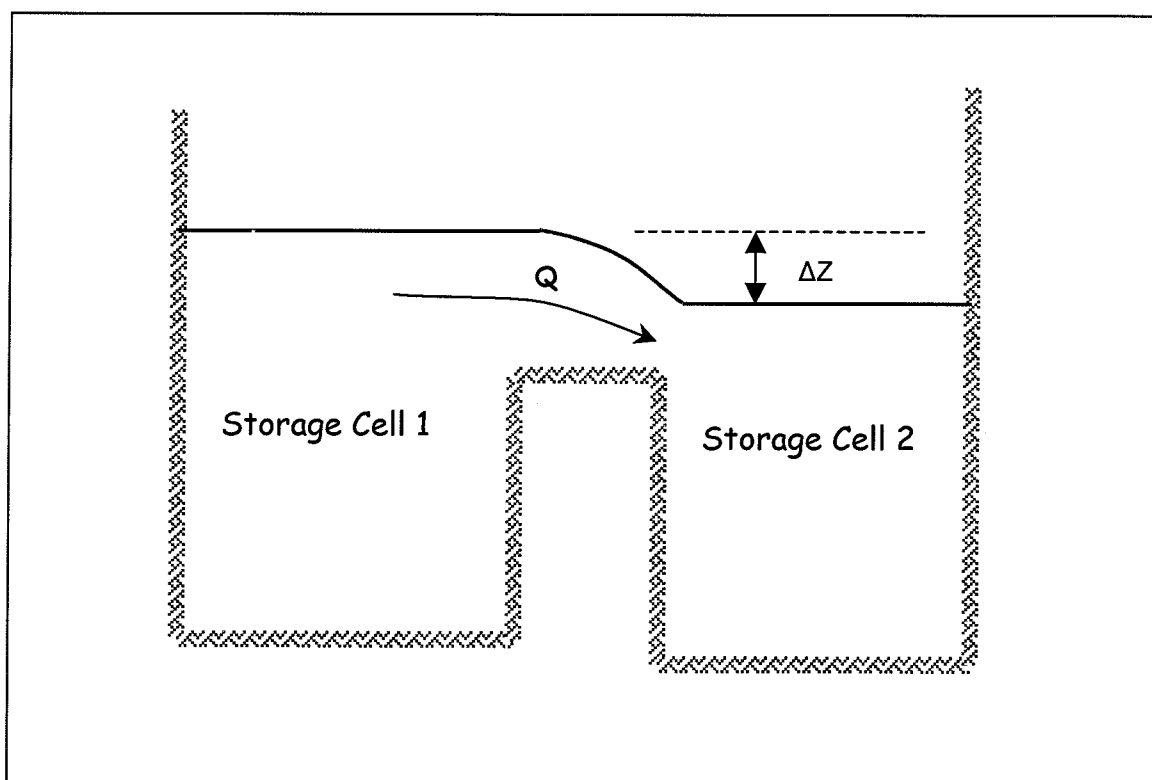

Fig. 9-7 Simple Connection Concept.

Here, the “Available Storage” is ΔZ times the surface area of Storage Cell 2.

The key to using a simple spillway is the selection of the routing coefficient, k . When the cell is connected to a river by a single breach, the constant is small, say 0.05 hours^{-1} . When the cell is connected by multiple breaches, there is a flow of water through the cell and the constant is much larger, say 0.2 hours^{-1} . When observed stage data are available, the routing coefficients may be calibrated to reproduce the observed stage data.

The simple embankment failure is enabled with the SF record. The embankment failure is assumed to begin when the water exceeds ZFAIL. The invert of the breach is given by ZBRINV. The linear routing coefficients for inflow and outflow are given by CINLV and COUTLV. To simulate the enlarging breach, the linear routing constant is assumed to increase from zero to its full value over the time DTFAIL. If the filling time is specified, the levee is assumed to fill in the time DTFILL. When the water falls below ZBRINV, the embankment is replaced.

Chapter 10

Using the UNET Package of Programs

10.1 The UNET System

The UNET system operates as a set of DOS programs. It consists of five modules (in addition to HEC-DSS). They are: **CSECT**, **RDSS**, **UNET**, **TABLE**, and **RUNUNET**. A brief description of them follows.

Program CSECT performs the following functions:

- Reads a geometry input file developed by the user and converts HEC-2 style cross section data into tables of elevation versus area, conveyance, and storage;
- Tabulates interior boundary conditions;
- Resolves network connections between reaches and storage areas.

The geometry input file is customarily denoted by the extension ".CS". The file is similar to an HEC-2 input file and contains all physical cross section information; oriented from upstream to downstream. This file may be developed from HEC-RAS data using the RAS2UNET utility (Sec. 10.4). CSECT writes tables of cross section properties and reach connection data to a binary file which is given the ".TC" extension. This file is then read by RDSS and UNET during the unsteady flow simulations. CSECT must be run prior to the first unsteady flow simulation and subsequently only when the geometry file is modified.

The following input records (that are somewhat similar to HEC-2 records) are typically used to describe a cross section: NC, X1, X3 and GR. Because UNET accounts for the conservation of mass (volume) throughout a routing reach, storage within the cross section should be described in addition to the traditional conveyance on the GR records. A thorough re-evaluation of existing HEC-2 or HEC-RAS geometric data is important when those data are being used for UNET (or any other unsteady flow model). The X3 record has been expanded to define both conveyance limits and storage areas, but the field definitions are similar to those in HEC-2. The principal records used in CSECT, other than those similar to HEC-2, are the following:

- XK: define elevation table limits and distance between interpolated cross sections,
- UB: define upstream boundary conditions and reach connections,
- DB: define downstream boundary conditions and reach connections,
- HY: write hydrographs to DSS at the cross section identified by the previous X1 record.

Hydraulic controls such as weirs, levees, pumps and storage areas are described by special input data. Appendix B describes the details of CSECT input data and Appendix D presents example problems which illustrate the construction of CSECT input files.

In addition to the CSECT input file, a UNET input file must be prepared prior to running the UNET system. This file is commonly denoted by the extension ".BC". The file contains program instructions and data required by the RDSS, UNET and TABLE programs. The data flow and program execution sequence are illustrated in Figure 10-1.

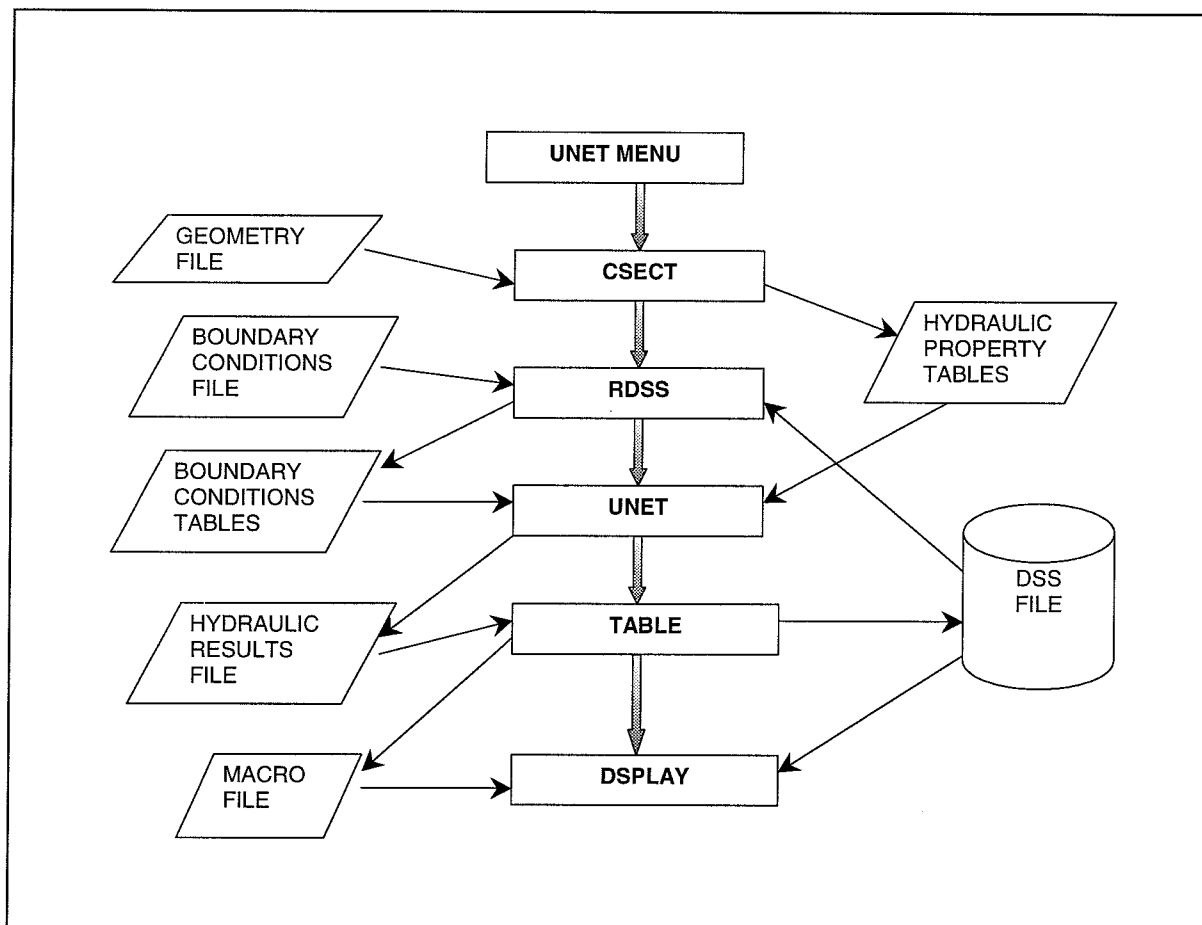

Figure 10-1 UNET System.

The unsteady flow portion of the UNET system consists of three programs:

- RDSS:** Reads and reformats the ".BC" input file. Reads pathnames for boundary condition input data from the .BC file, reads the associated DSS data, and converts it into tables. Appends the tables to the reformatted .BC file and creates a new file named "TAPE5". TAPE5 is then used as input to UNET.
- UNET:** The unsteady flow routing simulation model.
- TABLE:** Writes data, including computed hydrographs, maximum water surface elevation profiles, and instantaneous profiles of discharge and stage to DSS. Creates the plot macro file PLTCO for DSPLAY.

10.2 The RUNUNET Interface for Windows 95, 98, and NT

The RUNUNET interface is a program which runs the UNET program in Windows 95, 98, and NT. The RUNUNET form is shown in Figure 10-2.

Figure 10-2 Form for RUNUNET.

The RUNUNET form contains four control groupings and a upper menu bar. The control groupings are:

- The working directory.
- The river geometry definition and execution frame.
- The boundary condition definition and execution frame.
- The plotting frame.

The directory box shows the current computer drive and directory. The directory is the working directory for the program. Normally, the cross-section and boundary condition files are in the working directory. The interface writes all the temporary files and executes the UNET program files in the working directory. The cross-section, boundary condition, and DSS files can be in other directories.

The river geometry frame defines the cross-section file name and executes the CSECT program. The frame contains the following controls:

The name of the cross-section file. A new file name can be entered in the text box or chosen from an interactive form by clicking the “New” command button. The cross-section file can be edited by clicking the edit button.

The name of the cross-section output file. This file receives the ASCII output from the CSECT program. A file name can be entered in the text box or chosen from an interactive form by clicking the “New” command button.

The “Run” button starts the CSECT program converting the cross-section file into tables and establishing reach and storage cell connections. The interface writes the file scratch.bat to the working directory and executes the batch file. Output from the CSECT program can be viewed by clicking the “View button.”

The boundary condition file frame defines the boundary condition file and executes the UNET program. The frame contains the following controls:

- The boundary condition file text box contains the name of the boundary condition file. The name can be entered into the box or it can be entered from a form by clicking the “New” button. The boundary condition file can be edited by clicking the “Edit” button.
- The output file text box contains the name of the file that receives the output from the RDSS, UNET, and TABLE programs. The file is primarily used to debug a failed run. The file name can be entered directly into the text box or entered from a form by clicking the “New” button. The output file can be viewed by clicking the “View” button.
- The UNET program is run by clicking the “Run” button. The program writes the batch file, “scratch.bat” and executes the program. The batch file directs the running of the RDSS, UNET, and TABLE programs in sequence. The CSECT, RDSS, UNET, and TABLE programs can be all executed by clicking the “Run All” button. After executing the UNET programs the batch program automatically starts the plot program selected in the plotting frame.

The plotting frame chooses the plot program and independently starts the plot program. UNET automatically generates an HEC-DSS plot macro file, PLTCON, that contains plot macros for DISPLAY. At the end of a simulation the plot program is automatically started. The plot program can also be started by clicking the “Plot” button. Also, the plot macro file, PLTCON, can be edited by choosing the “Edit” button.

Within the upper menu bar, the “File” menu closes the RUNUNET interface and saves the final status of the interface. When the RUNUNET program is started, the program opens the last working directory and displays the names of the last cross-section and boundary condition files. The final program settings are stored in the file, RUNU.DAT, in the working directory.

The “File” menu items are:

“Quit” – stops the program without saving the current directory and settings.

“Save” – saves the current directory and settings.

“Save and Exit” – saves the current directory and settings and quits the interface.

“DOS Command Prompt” – starts the DOS command window.

The “Options” menu items are:

“Editor” – allows you to change the text editing program (the default is Programmer’s File Editor, provided by Dr. Barkau).

“Viewer” – allows you to change the name of the file viewing program (the default is Programmer’s File Editor, provided by Dr. Barkau).

The HPLOT, UNETPLOT, and View FW capabilities have been superceded with HEC-RAS functions and are not supported within UNET.

10.3 HEC Data Storage System (HEC-DSS)

An important feature of the UNET system is its interconnection to the DSS data base (HEC, 1987, 1995). The DSS data base is designed to store time series data; e.g., discharge and stage hydrographs, and paired function data; e.g., rating curves, sediment gradation data, etc., which are common to hydrologic problems. It is much more efficient than conventional relational data bases for time series data. Tests by Dr. Barkau have shown that DSS file sizes are 1/10 to 1/4 the size of relational data base files and that access times are about 1/10 of the latter.

DSS provides a convenient link between a hydrologic model, such as HEC-1 (HEC, 1990a), and UNET. Figure 10-3 depicts this relationship. HEC-1 may be used to compute a runoff hydrograph and to write the data to a DSS file, which can later be read by UNET.

For large problems, UNET requires vast amounts of hydrologic data to specify boundary conditions and observed hydrographs for calibration. As direct data entry for such problems can be quite time consuming, DSS can simplify input preparation significantly. The user specifies the DSS file, the time interval of DSS data, the simulation period (referred to as the time window), and the DSS pathname for each set of time series or paired function data.

The UNET system is able to compute and write the following types of data to DSS: (1) discharge and stage hydrographs, (2) maximum water surface profiles, (3) instantaneous discharge and stage profiles, (4) channel invert and bank profiles, and (5) elevation versus conveyance and area properties. DSPLAY¹ may then be used to plot or tabulate the computed results for review or for comparison with observed data. Other DSS utility programs may be used to manipulate, edit or further analyze the results. The user should refer to HEC (1995), for complete documentation on DSS and DSPLAY. Appendix A of that reference describes the convention for naming the six-part DSS pathname.

¹ Note that HEC-RAS (Ver. 3.0 and higher) may also be used to plot data from HEC-DSS.

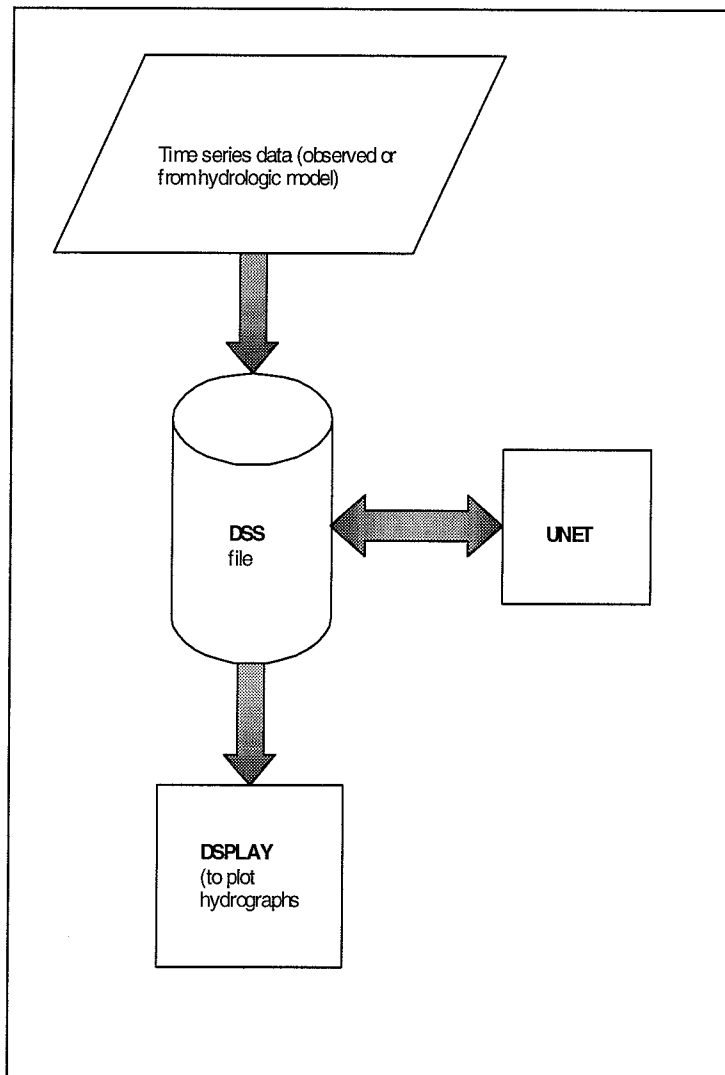

Figure 10-3 DSS linkage of UNET and hydrologic models.

10.4 RAS2UNET User's Guide

Introduction

RAS2UNET is a utility program designed to convert an HEC-RAS geometry file into an HEC-UNET geometry file. The geometry file(s) produced by HEC-RAS contain literally all the data entered into HEC-RAS through its geometry editor. However, not all HEC-RAS data has a direct parallel in HEC-UNET; therefore, not all data available in the HEC-RAS geometry file will find its way into the HEC-UNET geometry file through this utility program.

Installation

Install this program to the `\hecexe` directory on your computer. This directory should already exist if you have installed HEC-UNET. If you installed HEC-UNET to a directory other than `\hecexe`, install RAS2UNET.EXE in the same directory as the HEC-UNET executables. When finished, be sure that `\hecexe` (or the directory containing RAS2UNET) is on your computer's search path.

Usage

The command line syntax to execute RAS2UNET is:

```
RAS2UNET I=input_file O=output_file S=sort_flag
```

where:

input_file_name is the name of the HEC-RAS geometry file to be converted (No Default).
output_file_name is the name of the HEC-UNET (CSECT) geometry file to be created (Default is UNET.CS)
sort_flag is YES or NO. (Default is NO.) See Sorting section for details.

For example, if the name of the HEC-RAS geometry file that you wish to convert is MYPROJ.G01, then you might use the command:

```
RAS2UNET I=MYPROJ.G01 O=MYPROJ.CS
```

What You Need to Know

- The RAS2UNET input file must be a geometry file saved by HEC-RAS version 2.1 or newer.
- The RAS2UNET output file will be an HEC-UNET geometry file in CSECT format. Although almost all relevant data available in an HEC-RAS geometry file will be converted, the output file will be incomplete for HEC-UNET because certain required

records which are the responsibility of the user to add will be missing (e.g. the XK record).

- The first title record (T1) for each reach will begin with the string "REACH# nnn" where nnn is the reach number used by RAS2UNET to build the UB and DB records. Reach numbers (nnn) will be assigned to each reach in the order the reach is encountered in the input file unless sorting is turned on (in which case, each reach name must contain a unique whole number to be used to identify and order the reaches. See the section on Sorting for important details.) Following the reach number will be the river and reach names (separated by a comma) as specified in the HEC-RAS geometry file.
- Junction information in the input file will be used to build the UB and DB records in the output file that indicate reach connections to HEC-UNET. Junction names from the HEC-RAS data will be used internally in RAS2UNET but will not find their way into the output file. If for any reason RAS2UNET has problems building the UB or DB records, a 0 (zero) will be placed on the record to indicate that RAS2UNET expected to identify a reach connection but encountered an error. A UB or DB record with a 0 on it is not valid to HEC-UNET and must be corrected by the user. On the other hand, a blank UB or DB record indicates an external boundary condition and is valid input to HEC-UNET.
- HEC-RAS stores cross sections in decreasing RiverStation order. Typically, this means upstream to downstream and implies a positive flow direction from first to last cross section. HEC-UNET assumes that the order of the cross sections in the geometry file implies a positive flow direction; therefore, the order of the cross sections in the output file produced by RAS2UNET will be the same as that in the input file.
- Wherever possible, data stored in the input file will be exactly duplicated in the output file. However, cross section identifiers or RiverStations should be limited to six numeric characters (including the decimal) by the HEC-RAS user or the ID will get truncated by RAS2UNET when the X1 record is created for the cross section. This limitation is a result of the six character field available on the X1 record for cross section identification in the CSECT input format. This six character limitation also affects the elevation data for each cross section. The first field of each GR record is only six characters in size, therefore, every fifth elevation value of the cross section geometry data starting with the first may also get truncated (i.e., EL(1), EL(6), EL(11), etc.)
- Interpolated sections stored in the HEC-RAS geometry file (those whose RiverStations include a "*") will be treated in the same manner as any other section. However, the "*" will not be retained in the cross section ID and comment records will precede the section in the output file to indicate that the section is interpolated.
- The description data (if any) for a cross section in the input file will be included in the output as comment records preceding the X1 record for that section.
- NC and NH data records will be developed from HEC-RAS Manning's N data; however, equivalent roughness data is not used by HEC-UNET so will not be converted. A blank NC record will be placed in the output file at cross sections where equivalent roughness data was encountered. Also, contraction and expansion coefficients will be ignored since HEC-UNET does not use them.

- If encountered in the input file, “normal” ineffective flow and “normal” blocked encroachments will be converted to X3 record data (fields 4,5,6 &7). In UNET if the elevations (fields 5 & 7) are positive, the region outside the stations is "ineffective" or storage. The difference between RAS and UNET is that in RAS, once the water surface exceeds the specified elevation - the ineffective region becomes effective. In UNET, regardless of the water surface, the region outside the specified stations and below the specified elevations is ineffective - always... area above, however, can convey water. Similarly, if the elevations are "negative" (fields 5 & 7) then the region outside the stations is blocked. Think of it as physically modifying the cross section in UNET. The cross section modification will remain in effect regardless of the water surface. All area above the "encroachment" can convey water
- Bridges and culverts will NOT be converted. Their location in the reach will be marked with comment records in the output file.
- A cross section lid will be converted into BT data.

Sorting

In HEC-UNET, the order of the reaches in the geometric input file is significant in a number of ways. First, there is no mechanism that allows the user to label the reaches and use that label when defining the connections. Instead, the reach is identified by its position in the input file. The first reach is reach 1, the second is reach 2, and so on. The user must then use that number when defining the reach connectivity on the UB and DB records. If for any reason a reach needed to be inserted into the middle of an HEC-UNET geometry file, all the reaches from the new one down will effectively be renumbered and almost all the UB and DB records will need to be corrected.

The reach order and resulting connectivity can also affect the efficiency of the HEC-UNET solution matrix and therefore execution time. Most HEC-UNET users are aware of this issue and design their input files to increase efficiency. To enable the HEC-RAS modeler to produce a geometry file that will assemble into a preconceived order during conversion, a mechanism was added to RAS2UNET to sort the reaches. The rules are simple:

- Include in each reach name (in the HEC-RAS model) a whole number (made up only of digits) indicating the reach’s number or sequence after conversion.
- The number must be the only number in the reach name.
- No special characters or strings are required.
- The number does not need to be in a particular location in the name.
- Start numbering with 1 and do not skip numbers. (Although this is not required for sorting, if you do not start at 1 or if you skip numbers, the reach numbers used by RAS2UNET to label each reach will not match your numbering scheme.)

The following table illustrates some valid and invalid (for sorting) reach names:

Valid	Reason	Invalid	Reason
1	one number in name	Reach 1 seg#24	more than 1 number in name
7 Lower Rose Cr	one number in name	Sacramento	no number in name
reach9	one number in name	Stream 2.37	2.37 is not a whole number
seg#97 Yuba	one number in name	Upper Eel 1,234	1,234 will be seen as 1 & 234 - - 2 numbers!

Once the reaches have been defined following the above rules, the sort option of RAS2UNET must be turned on from the command line. This is done by adding SORT=YES after the specification of the input and output file names. For example, if the HEC-RAS geometry file named "MYPROJ.G01" has reach names that include a numbering scheme, then to convert that file for use by HEC-UNET, use the following command line:

```
RAS2UNET I=MYPROJ.G01 O=MYPROJ.CS SORT=YES
```

Chapter 11

References

- Amein, M. and Fang, C.S., 1970, "Implicit Flood Routing in Natural Channels," *Journal of the Hydraulics Division, ASCE*, Vol. 96, No. HY12, Proc. Paper 7773, pp. 2481-2500.
- Ashton, G.D., 1986, *River and Lake Ice Engineering*, Water Resources Publications, Littleton, CO 80161.
- Bathe, K. and Wilson, E.L., 1976, *Numerical Methods in Finite Element Analysis*, Prentice-Hall, Inc., Englewood Cliffs, NJ.
- Barkau, R.L., 1981, "Simulation of the Failure of Illinois River Levees," Memo to File, St. Louis District, Corps of Engineers, St. Louis, MO.
- Barkau, R.L., 1982, "Simulation of the July 1981 Flood Along the Salt River," Report for CE695BV, Special Problems in Hydraulics, Department of Civil Engineering, Colorado State University, Ft. Collins, CO.
- Barkau, R.L., 1985, "A Mathematical Model of Unsteady Flow Through a Dendritic Network," Ph.D. Dissertation, Department of Civil Engineering, Colorado State University, Ft. Collins, CO.
- Bodhaine, G.L., 1982, "Measurement of Peak Discharge at Culverts by Indirect Methods," *Techniques of Water Resources Investigations of the United States Geological Survey*, Book 3, Chapter A3, U.S. Geological Survey, WA.
- Butler, E.R., 1991, "Input Data Considerations and Analysis for Unsteady Flow Routing," Paper Submitted in Partial Fulfillment of the Requirements for the Master's Degree in Civil Engineering, University of California, Davis, CA.
- Chen, Y.H., 1973, "Mathematical Modeling of Water and Sediment Routing in Natural Channels," Ph.D. Dissertation, Department of Civil Engineering, Colorado State University, Ft. Collins, CO.
- Chen, Y.H. and Simons, D.B., 1979, "A Mathematical Model of the Lower Chippewa River Network System," Report CER-79 DBS-YHC-58, Department of Civil Engineering, Colorado State University, Ft. Collins, CO.
- Chow, V.T., 1959, *Open Channel Hydraulics*, McGraw-Hill Book Company, NY.

- Cunge, J.A., Holly, F.M., and Verwey, A., 1980, *Practical Aspects of Computational River Hydraulics*, Pitman Advanced Publishing Program, Boston, MA.
- Denzel, C.W., 1961, *Swellhead Effect on Navigation Structures*, WES MP 2-468, U.S. Army Corps of Engineers, Waterways Experiment Station, Vicksburg, MS.
- Federal Highway Administration (FHWA), 1978, *Hydraulics of Bridge Waterways*, Hydraulic Design Series No. 1, Second Edition, by J.N. Bradley, U.S. Department of Transportation, Hydraulics Branch, Washington, DC.
- FHWA, 1985, *Hydraulic Design of Highway Culverts*, Hydraulic Design Series No. 5, U.S. Department of Transportation, September 1985.
- FHWA, 1986, *Bridge Waterways Analysis Model*, Research Report No. FHWA/RD-86/108, U.S. Department of Transportation, Office of Engineering and Highway Operations Research and Development, McLean, VA.
- Fread, D.L., 1974, *Numerical Properties of the Implicit Four Point Finite Difference Equations of Unsteady Flow*, NOAA Technical Memorandum NWS Hydro-18, U.S. Department of Commerce, NOAA, NWS, Silver Spring, MD, 123pp.
- Fread, D.L., 1976, "Theoretical Development of an Implicit Dynamic Routing Model," Hydrologic Research Laboratory, Office of Hydrology, U.S. Department of Commerce, NOAA, NWS, Silver Spring, MD., presented at Dynamic Routing Seminar, Lower Mississippi River Forecast Center, Slidell, LA., 13-17 Dec 1976.
- French, R.H., 1985, *Open-Channel Hydraulics*, McGraw-Hill Book Company, New York.
- Friazinov, 1970, "Solution Algorithm for Finite Difference Problems on Directed Graphs," *Journal of Mathematics and Mathematical Physics*, Vol. 10, No. 2, (in Russian).
- Hydrologic Engineering Center (HEC), 1987, *HEC-DSS Programmers Manual*, U.S. Army Corps of Engineers, Davis, CA.
- HEC, 1990a, *HEC-1, Flood Hydrograph Package User's Manual*, U.S. Army Corps of Engineers, Davis, CA.
- HEC, 1990b, *Computing Water Surface Profiles with HEC-2 on a Personal Computer*, Training Document No. 26, U.S. Army Corps of Engineers, Davis, CA.

- HEC, 1990c, *HEC-2, Water Surface Profiles User's Manual*, U.S. Army Corps of Engineers, Davis, CA.
- HEC, 1995, *HEC-DSS User's Guide and Utility Program Manuals*, U.S. Army Corps of Engineers, Davis, CA.
- Henderson, F.M., 1966, *Open Channel Flow*, Macmillan Publishing Co., Inc., NY, 523pp.
- Liggett, J.A., and Cunge, J.A., 1975, "Numerical Methods of Solution of the Unsteady Flow Equations," *in Unsteady Flow in Open Channels*, edited by K. Mahmood and V. Yevjevich, Vol. I, Chapter 4, Water Resources Publications, Ft. Collins, CO.
- Liggett, J.A., 1975, "Basic Equations of Unsteady Flow," *in Unsteady Flow in Open Channels*, edited by K. Mahmood and V. Yevjevich, Vol. I, Chapter 2, Water Resources Publications, Ft. Collins, CO.
- Parmakian, J., 1963, *Waterhammer Analysis*, Dover Publications, Inc., NY.
- Schaffranek, R.W., et al., 1981, "A Model for the Simulation of Flow in Singular and an Interconnected Network of Channels," *Techniques of Water Resources Investigations*, Chapter 3, U.S. Geological Survey, Reston, VA.
- Shames, I.H., 1962, *Mechanics of Fluids*, McGraw-Hill Book Company, NY.
- Smith, R.H., 1978, "Development of a Flood Routing Model for Small Meandering Rivers," Ph.D. Dissertation, Department of Civil Engineering, University of Missouri at Rolla, MO.
- Streeter, V.L. and Wylie, E.B., 1967, *Hydraulic Transients*, McGraw-Hill Book Company, NY.
- Tucci, C.E.M., 1978, "Hydraulic and Water Quality Model for a River Network," Ph.D. Dissertation, Department of Civil Engineering, Colorado State University, Ft. Collins, CO.
- U.S. Army Corps of Engineers (USACE), 1965, *Hydraulic Design of Spillways*, Engineer Manual 1110-2-1603, Headquarters, U.S. Army Corps of Engineers, Washington, DC, 125pp.
- USACE, 1993, *River Hydraulics*, Engineer Manual 1110-2-1416, Headquarters, U.S. Army Corps of Engineers, Washington, DC, October 1993.

U.S. Bureau of Reclamation (USBR), 1985, *Canal Radial Gate Structure Design for Arizona Canal System*, WCPM 11.04.

Waterways Experiment Station (WES), 1973, *Bridge Pier Losses*, Section 010-6, Hydraulic Design Criteria, U.S. Army Corps of Engineers, Vicksburg, MS.

Appendix A¹

**Derivation of the Continuity and
Momentum Equations for
One-Dimensional
Unsteady Open Channel Flow**

¹ Prepared by Dr. Robert L. Barkau

The physical laws which govern the flow of water in a stream are: (1) the principle of conservation of mass (continuity), and (2) the principle of conservation of momentum. These laws are expressed mathematically in the form of partial differential equations, which will hereafter be referred to as the continuity and momentum equations. The derivations of these equations are presented in this appendix (Liggett and Cunge, 1975).

A.1 Continuity Equation

Consider the elementary control volume shown in Figure A-1. In this figure, distance x is measured along the channel, as shown. At the midpoint of the control volume the flow and total flow area are denoted Q and AT , respectively. The total flow area is the sum of active area A and off-channel storage area S .

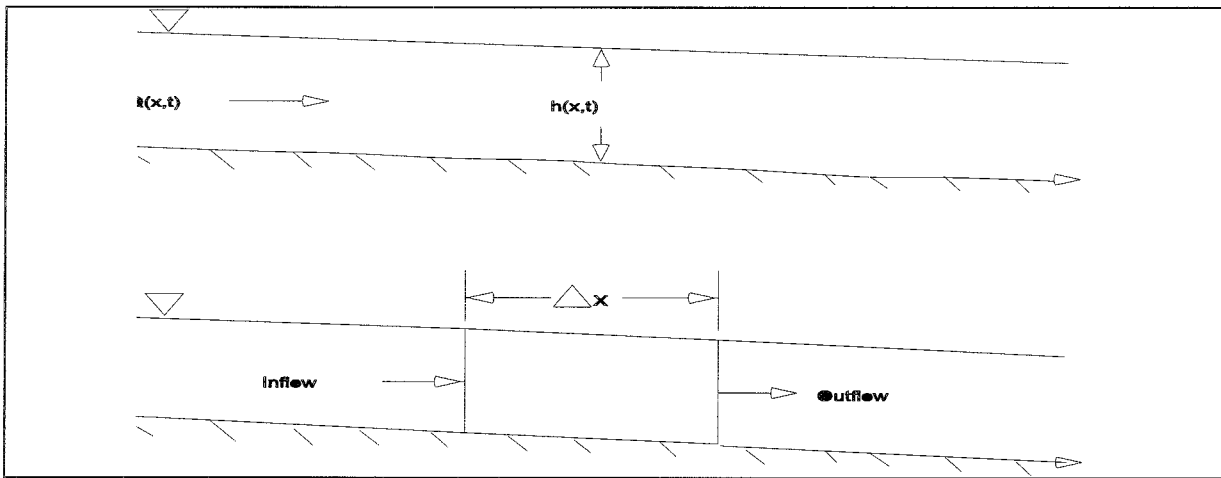

Figure A-1 Elementary Control Volume for Derivation of Continuity and Momentum Equations.

Conservation of mass for a control volume states that *the net rate of flow into the volume be equal to the rate of change of storage inside the volume*. The inflow to the control volume may be written as:

$$Q - \frac{\partial Q}{\partial x} \frac{\Delta x}{2} \tag{A-1}$$

and the outflow as:

$$Q \frac{\partial Q}{\partial x} \frac{\Delta x}{2} \quad (\text{A-2})$$

Assuming that Δx is small, the change in mass in the control volume is equal to:

$$\rho \frac{\partial A_T}{\partial t} \Delta x = \rho \left[\left(Q - \frac{\partial Q}{\partial x} \frac{\Delta x}{2} \right) - \left(Q + \frac{\partial Q}{\partial x} \frac{\Delta x}{2} \right) + Q_1 \right] \quad (\text{A-3})$$

where Q_1 is the lateral flow entering the control volume and ρ is the fluid density. Simplifying and dividing through by $\rho \Delta x$ yields the final form of the continuity equation:

$$\frac{\partial A_T}{\partial t} + \frac{\partial Q}{\partial x} - q_1 = 0 \quad (\text{A-4})$$

in which q_1 is the lateral inflow per unit length.

A.2 Momentum Equation

Conservation of momentum is expressed by Newton's second law as:

$$\sum \vec{F} = \frac{d\vec{M}}{dt} \quad (\text{A-5})$$

Conservation of momentum for a control volume states that *the net rate of momentum entering the volume (momentum flux) plus the sum of all external forces acting on the volume be equal to the rate of accumulation of momentum*. This is a vector equation applied in the x -direction. The momentum flux (MV) is the fluid mass times the velocity vector in the direction of flow. Three forces will be considered: (1) pressure, (2) gravity and (3) boundary drag, or friction force.

Pressure forces Figure A-2 illustrates the general case of an irregular cross section. The pressure distribution is assumed to be hydrostatic (pressure varies linearly with depth) and the total pressure force is the integral of the pressure-area product over the cross section. After Shames (1962), the pressure force at any point may be written as:

$$F_p = \int_0^h \rho g (h - \xi) T(\xi) d\xi \quad (\text{A-6})$$

where h is the depth, ξ the distance above the channel invert, and $T(\xi)$ a width function which relates the cross section width to the distance above the channel invert.

If F_p is the pressure force in the x -direction at the midpoint of the control volume, the force at the upstream end of the control volume may be written as:

$$F_p - \frac{\partial F_p}{\partial x} \frac{\Delta x}{2} \quad (\text{A-7})$$

and at the downstream end as:

$$F_p + \frac{\partial F_p}{\partial x} \frac{\Delta x}{2} \quad (\text{A-8})$$

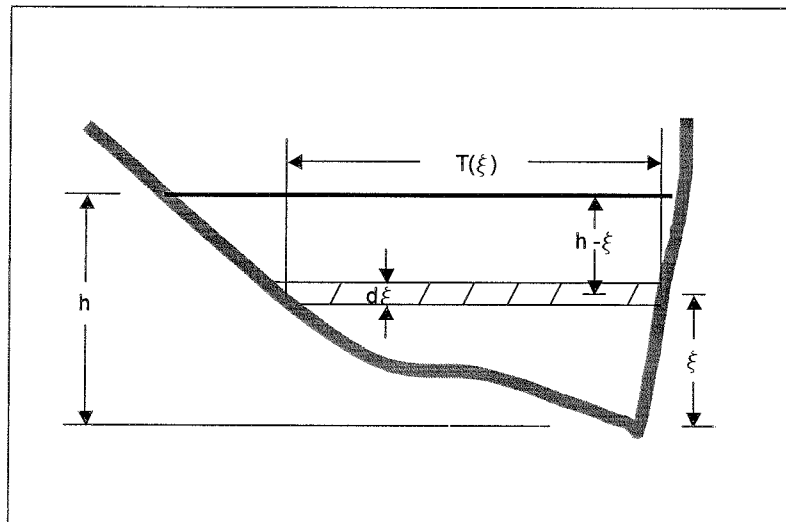

Figure A-2 Illustration of Terms Associated with Definition of Pressure Force.

The sum of the pressure forces for the control volume may therefore be written as:

$$\left| F_P - \frac{\partial F_P}{\partial x} \frac{\Delta x}{2} \right| - \left| F_P + \frac{\partial F_P}{\partial x} \frac{\Delta x}{2} \right| = F_B \quad (\text{A-9})$$

where F_B is the force exerted by the banks in the x -direction on the fluid. This may be simplified to:

$$-\frac{\partial F_P}{\partial x} \Delta x + F_B \quad (\text{A-10})$$

Differentiating equation A-2 using Leibnitz's Rule and then substituting in equation A-3 results in:

$$-\rho g \Delta x \left[\frac{\partial h}{\partial x} \int_0^h T(\xi) d\xi + \int_0^h (h - \xi) \frac{\partial T(\xi)}{\partial x} d\xi \right] + F_B \quad (\text{A-11})$$

The first integral in equation A-11 is the cross-sectional area, A . The second integral (multiplied by $-\rho g \Delta x$) is the pressure force exerted by the fluid on the banks, which is exactly equal in magnitude, but opposite in direction to F_B . Hence the net pressure force may be written as:

$$F_P = -\rho g A \frac{\partial h}{\partial x} \Delta x \quad (\text{A-12})$$

Gravitational force The force due to gravity on the fluid in the control volume in the x -direction is:

$$\rho g A \sin \theta \Delta x \quad (\text{A-13})$$

here θ is the angle that the channel invert makes with the horizontal. For natural rivers θ is small and $\sin \theta \approx \tan \theta = -\partial Z_0 / \partial X$, where z_0 is the invert elevation. Therefore the gravitational force may be written as:

$$F_g = -\rho g A \frac{\partial z_0}{\partial x} \Delta x \quad (\text{A-14})$$

This force will be positive for negative bed slopes.

Boundary drag (friction force) Frictional forces between the channel and the fluid may be written as:

$$-\tau_0 P \Delta x \quad (\text{A-15})$$

where τ_0 is the average boundary shear stress (force/unit area) acting on the fluid boundaries, and P is the wetted perimeter. The negative sign indicates that with flow in the positive x -direction, the force acts in the negative x -direction. From dimensional analysis, τ_0 may be expressed in terms of a drag coefficient, C_D , as follows:

$$\tau_0 = \rho C_D V^2 \quad (\text{A-16})$$

The drag coefficient may be related to the Chezy coefficient C by the following:

$$C_D = \frac{g}{C^2} \quad (\text{A-17})$$

Further, the Chezy equation may be written as:

$$V = C \sqrt{RS_f} \quad (\text{A-18})$$

Substituting equations A-16, A-17 and A-18 into A-15, and simplifying, yields the following expression for the boundary drag force:

$$F = -\rho g A S_f \Delta x \quad (\text{A-19})$$

where S_f is the friction slope, which is positive for flow in the positive x -direction. The friction slope must be related to flow and stage. Traditionally, the Manning and Chezy friction equations have been used. Since the Manning equation is predominantly used in the United States, it is also used in UNET. The Manning equation is written as:

$$S_f = \frac{Q|Q|n^2}{2.208R^{\frac{4}{3}}A^2} \quad (\text{A-20})$$

where R is the hydraulic radius and n is the Manning friction coefficient.

Momentum flux With the three force terms defined, only the momentum flux remains. The flux entering the control volume may be written as:

$$\rho \left[QV - \frac{\partial QV}{\partial x} \frac{\Delta x}{2} \right] \quad (\text{A-21})$$

and the flux leaving the volume may be written as:

$$\rho \left[QV + \frac{\partial QV}{\partial x} \frac{\Delta x}{2} \right] \quad (\text{A-22})$$

Therefore the net rate of momentum (momentum flux) entering the control volume is:

$$-\rho \frac{\partial QV}{\partial x} \Delta x \quad (\text{A-23})$$

Since the momentum of the fluid in the control volume is $\rho Q \Delta x$, the rate of accumulation of momentum may be written as:

$$\frac{\partial}{\partial t} (\rho Q \Delta x) = \rho \Delta x \frac{\partial Q}{\partial t} \quad (\text{A-24})$$

Restating the principle of conservation of momentum:

The net rate of momentum (momentum flux) entering the volume (A-23) plus the sum of all external forces acting on the volume [(A-12) + (A-14) + (A-19)] is equal to the rate of accumulation of momentum (A-24). Hence:

$$\rho \Delta x \frac{\partial Q}{\partial t} = -\rho \frac{\partial QV}{\partial x} \Delta x - \rho g A \frac{\partial h}{\partial x} \Delta x - \rho g A \frac{\partial z_0}{\partial x} \Delta x - \rho g A S_f \Delta x \quad (\text{A-25})$$

The elevation of the water surface, z , is equal to $z_0 + h$. Therefore:

$$\frac{\partial z}{\partial x} = \frac{\partial h}{\partial x} + \frac{\partial z_0}{\partial x} \quad (\text{A-26})$$

where $\partial z / \partial x$ is the water surface slope. Substituting (A-26) into (A-25), dividing through by $\rho \Delta x$ and moving all terms to the left yields the final form of the momentum equation:

$$\frac{\partial Q}{\partial t} + \frac{\partial QV}{\partial x} + gA \left(\frac{\partial z}{\partial x} + S_f \right) = 0 \quad (\text{A-27})$$

A.3 Skyline Solution of a Sparse System of Linear Equations

The finite difference equations along with external and internal boundary conditions and storage area equations result in a system of linear equations which must be solved for each time step:

$$Ax = b \quad (\text{A-28})$$

in which: A = coefficient matrix,
 x = column vector of unknowns,
 b = column vector of constants.

For a single channel without a storage area, the coefficient matrix has a band width of five and can be solved by one of many banded matrix solvers.

For network problems, sparse terms destroy the banded structure. The sparse terms enter and leave at the boundary equations and at the storage areas. Figure A-3 shows a simple system with four reaches and a storage area off of reach 2. The corresponding coefficient matrix is shown in Figure A-4. The elements are banded for the reaches but sparse elements appear at the reach boundaries and at the storage area. This small system is a trivial problem to solve, but systems with hundreds of cross sections and tens of reaches pose a major numerical problem because of the sparse terms. Even the largest computers cannot store the coefficient matrix for a moderately sized problem, furthermore, the computer time required to solve such a large matrix using Gaussian elimination would be very large. Because most of the elements are zero, a majority of computer time would be wasted.

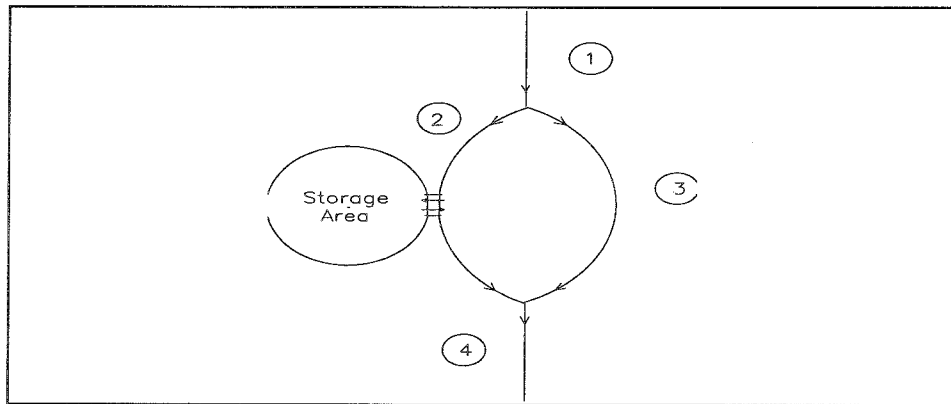

Figure A-3 Simple network with four reaches and a storage area.

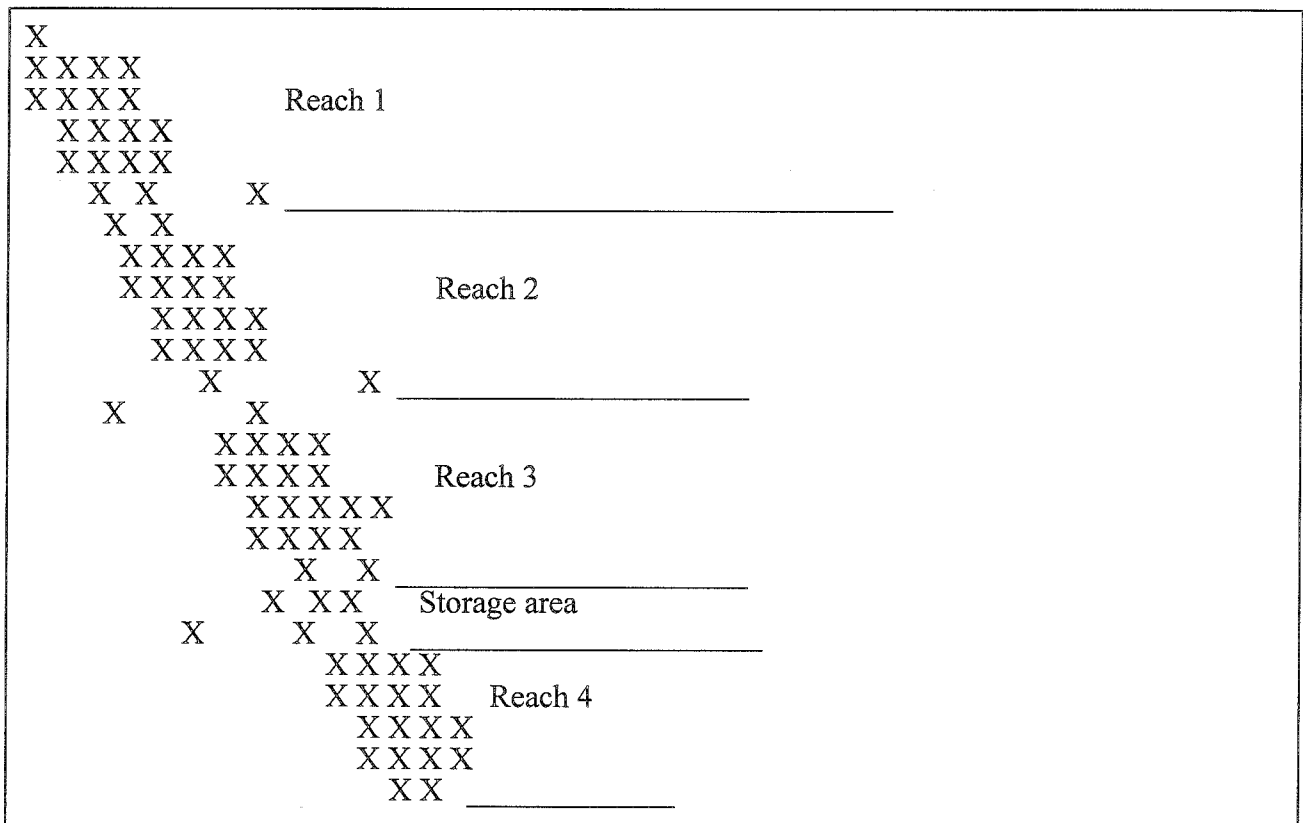

Figure A-4 Sparse coefficient matrix resulting from simple linear system. Note, sparse terms enter and disappear at storage areas and boundary equations.

Three practical solution schemes have been used to solve the sparse system of linear equations: Barkau (1985) used a front solver scheme to eliminate terms to the left of the diagonal and pointers to identify sparse columns to the right of the diagonal. Cunge et al. (1980) and Shaffranek (1981) used recursive schemes to significantly reduce the size of the sparse coefficient matrix. Tucci (1978) and Chen and Simons (1979) used the skyline storage scheme (Bathe and Wilson, 1976) to store the coefficient matrix. The goal of these schemes is to more effectively store the coefficient matrix. The front solver and skyline methods identify and store

only the significant elements. The recursive schemes are more elegant, significantly reducing the number of linear equations. All use Gaussian elimination to solve the simultaneous equations.

A front solver performs the reduction pass of Gauss elimination before equations are entered into a coefficient matrix. Hence, the coefficient matrix is upper triangular. To further reduce storage, Barkau proposed indexing sparse columns to the right of the band; thus, only the band and the sparse terms were stored. Since row and column operations were minimized, the procedure should be as fast if not faster than any of the other procedures. But, the procedure could not be readily adapted to a wide variety of problems because of the way that the sparse terms were indexed. Hence, the program needed to be redimensioned and recompiled for each new problem.

The recursive schemes are ingenious. Cunge credits the initial application to Friazinov (1970). Cunge's scheme and Schaffranek's schemes are similar in approach but differ greatly in efficiency. Through recursive upward and downward passes, each single routing reach is transformed into two transfer equations which relate the stages and flows at the upstream and downstream boundaries. Cunge substitutes the transfer equations in which M is the number of junctions. Schraffranek combines the transfer equations with the boundary equations, resulting in a system of $4N$ equations in which N is the number of individual reaches. The coefficient matrix is sparse, but the degree is much less than the original system.

By using recursion, the algorithms minimize row and column operations. The key to the algorithm's speed is the solution of a reduced linear equation set. For smaller problems Gaussian elimination on the full matrix would suffice. For larger problems, some type of sparse matrix solver must be used, primarily to reduce the number of elementary operations. Consider, for example, a system of 50 reaches. Schaffranek's matrix would be 200 X 200 and Cunge's matrix would be 50 X 50, 2.7 million and 42,000 operations respectively (the number of operations is approximately $1/3 n^3$ where n is the number of rows).

Another disadvantage of the recursive scheme is adaptability. Lateral weirs which discharge into storage areas or which discharge into other reaches disrupt the recursion algorithm. These weirs may span a short distance or they may span an entire reach. The recursion algorithm, as presented in the above references, will not work for this problem. The algorithm can be adapted, but no documentation has yet been published.

Skyline is the name of a storage algorithm for a sparse matrix. In any sparse matrix, the non-zero elements from the linear system and from the Gaussian elimination procedure are to the left of the diagonal and in a column above the diagonal. This structure is shown in Figure A.4. Skyline stores these inverted "L shaped" structures in a vector, keeping the total storage at a minimum. Elements in skyline storage are accessed by row and column numbers. Elements outside the "L" are returned as zero, hence the skyline matrix functions exactly as the original matrix. Skyline storage can be adapted to any problem.

The efficiency of Gaussian elimination depends on the number of pointers into skyline storage. Tucci (1978) and Chen and Simons (1979) used the original algorithm as proposed by Bathe and Wilson (1976). This algorithm used only two pointers, the left limit and the upper

limit of the "L", thus, a large number of unnecessary elementary operations are performed on zero elements and in searching for rows to reduce. Their solution was acceptable for small problems, but clearly deficient for large problems. Using additional pointers reduces the number of superfluous calculations. If the pointers identify all the sparse columns to the right of the diagonal, then the number of operations is minimized and the performance is similar to the front solver algorithm.

Skyline Solution Algorithm

The skyline storage algorithm was chosen to store the coefficient matrix. The Gauss elimination algorithm of Bathe and Wilson was abandoned because of its poor efficiency. Instead a modified algorithm with seven pointers was developed. The pointers are:

- 1) IDIA(IROW) - index of the diagonal element in row IROW in skyline storage.
- 2) ILEFT(IROW) - number of columns to the left of the diagonal.
- 3) IHIGH(IROW) - number of rows above the diagonal.
- 4) IRIGHT(IROW) - number of columns in the principal band to the right of the diagonal.
- 5) ISPCOL(J,IROW) - pointer to sparse columns to the right of the principal band.
- 6) IZSA(IS) - the row number of storage area IS.
- 7) IROWZ(N) - the row number of the continuity equation for segment N.

The pointers eliminate the meaningless operations on zero elements. This code is specifically designed for flood routing through a full network.

Appendix B

CSECT Input Data Description

Table of Contents

Section	Record	Page
<hr/>		
<u>Introduction</u>		B-1
<u>Job Control Records</u>		
	PR Output File Print Control	B-3
	T1, T2, T3 Title Records	B-4
	EJ End of Job	B-5
<u>DSS Control Records</u>		
	ZD Specify DSS File Name	B-6
	ZA Write Area and Conveyance Tables to DSS	B-7
	ZI Write the Channel Invert and Bank Station Profiles to DSS	B-8
	ZS Write Cross Sections to DSS	B-9
	ZX Read Limits for Cross Section Tables from DSS	B-10
	ZN Read Invert Profile from DSS	B-11
	ZF Read Reference Water Surface Profile from DSS	B-12
<u>Cross Section Change Records</u>		
	XK Limits of Cross Section Elevation vs. Hydraulic Property Tables	B-13
	XI Interpolated Cross Section Interval	B-15
	NC Manning's n Values	B-16
	NH Horizontal Variation in Manning's n	B-17
	PC Low Flow Pilot Channel	B-18
	OB Modify Overbank Storage	B-19
	BF Adjust Floodplain Area and Conveyance	B-20
	EN Define Encroachments for a Conventional Floodway Analysis	B-21
	DF Define Encroachments for a Density Floodway Analysis	B-22
	IC Ice Cover Data	B-23
<u>Reach Connection Records</u>		
	UB Upstream Reach Boundary Connection	B-25
	UZ Read Upstream Stage Boundary Condition Data	B-26
	DB Downstream Reach Boundary Connection	B-27
<u>Cross Section Records</u>		
	X1 General Items for Each Cross Section	B-28
	X2 Optional Items for Each Cross Section (Repeat Bridge Table)	B-30
	X3 Optional Items for Each Cross Section (Effective Area, Encroachments)	B-31
	X4 Additional Points for a Cross Section (optional)	B-33
	Z0 Gage Zero Elevation	B-34
	OH Read Observed Hydrograph	B-35

HY	Store Computed Hydrographs in DSS	B-36
HV	Store Computed Velocities in DSS.....	B-37

Cross Section Records - cont.

GR	Ground Profile Elevations and Stations.....	B-38
----	---	------

Storage Area Records

SA	Storage Areas	B-39
HS	Storage Area Name	B-40
SV	Elevation-Volume Rating for Storage Areas	B-40
SL	Lateral Simple Connection to a Storage Area.....	B-41
SS	Simple Connection between Two Storage Areas.....	B-42

Spillways and Navigation Dams

SP	In Line Spillway.....	B-43
LA	Lateral Spillway Diverting Water into a Storage Area.....	B-45
LS	Lateral Spillway Diverting Water to Another Reach.....	B-47
ND	Navigation Dam	B-49
CP	Navigation Dam Control Point	B-51

Normal Bridge Record

BT	Bridge Table of Elevations and Stations.....	B-52
----	--	------

Special Bridge Records

BR	Special Bridge Computations	B-54
BL	Limits on the Bridge Rating Curves	B-56

Culvert Records

CA, CE	Arch or Elliptical Culverts	B-57
CB	Box Culverts	B-58
CC	Circular Culverts.....	B-59
	Culvert Loss Types Listing.....	B-60
CL	Limits of Culvert Rating Tables	B-63
RI	Culvert Riser	B-64
BD	Bleeder Structure for a Riser.....	B-65
RL	Riser Limits.....	B-66
DI	Drop Inlet for Culvert	B-67

Uncontrolled Weir for Spillways, Bridges, and Culverts

WD	Uncontrolled Overflow Weirs.....	B-68
----	----------------------------------	------

Special Connection Record

SC	Special Connections Between Storage Areas and Channels to Storage Areas	B-70
----	--	------

Rating Curve Records

RF	Free Flow Rating Curves	B-71
RS	Submerged Flow Rating Curves	B-72
RW	Weir Flow Rating Curves	B-73
RC	Rating Curve at a Cross Section	B-74
LR	Lateral Outflow Rating Curve	B-75

Family of Rating Curves

FA	Use of Exponential Equations Rather than a Family of Rating Curves	B-76
CO	Combine Families of Rating Curves.....	B-77

Pumped Diversion

PD	Pumped Diversion.....	B-79
----	-----------------------	------

Closed Conduits

TN	Circular Tunnel	B-80
TB	Rectangular Tunnel.....	B-81

Alternative Geometry Specifications

TE	Elevations for Top Width Table	B-82
TC	Channel Top Widths	B-82
TL	Top Width of Left Overbank	B-83
TR	Top Width of Right Overbank	B-83
TS	Top Width of Storage Region.....	B-84

Levee Failures

SF	Simple Embankment Failure.....	B-85
EF	Embankment Failure.....	B-87

<u>Include Files</u>	B-89
----------------------	-------	------

Introduction

This appendix contains a detailed description of the data input requirements for each variable on each input record in the cross section (geometry) input file read by CSECT. Many of the records described can be omitted if their options are not required.

The data input structure mimics the fixed format style of HEC-2. The location of the variables for each input record is designated by a field number. Each record is divided into ten fields of eight columns each, except Field 1. A variable in Field 1 may only occupy columns 3 through 8 because columns 1 and 2 (called Field 0) are reserved for the required record identification characters. Depending on the type of input record, variable types may be real, integer, or logical. The values a variable may assume and the conditions for each are described. Integer variables begin with the letters I, J, K, L, M, or N (the standard FORTRAN convention). Integer fields must not contain a decimal point. Logical variables are given the values T (true) or F (false). All other variables are real numbers.

Some variables call for use of program options by using the numbers -1, 0, 1 or 10. Other variables are assigned numbers expressing the magnitude of the variable. For these, a plus or minus sign is shown in the description under "Value" and the numerical value of the variable is entered as input. Where the value of a variable is to be assigned a value of zero, the field may be left blank because a blank field is read as zero.

Any number without a decimal point must be right justified in its field. Any number without a sign is considered to be positive. The codes "+" and "-" under "Value" indicate positive and negative numbers.

It is suggested that the extensions .CS and .CSO be used when naming the input and output files for CSECT.

When using DSS input items, do not use "/" or "\" as a character in the pathname.

PR**PR Record - Output File Print Control - (Optional Record)**

The PR Record can be used prior to any X1 Record to control the detailed output of cross section and hydraulic structure data. CPRINT is a toggle switch that can be used to turn the output on or off as required. **Note:** If the PR Record is not used, the elevation vs. hydraulic property tables will not be written to the CSECT output file.

Field	Variable	Value	Description
0	ID	PR	Record identification.
1	CPRINT	ON	Begin writing elevation vs. hydraulic property tables to the CSECT output file.
		OFF	Stop writing data.

T1, T2, T3

T1, T2, T3 - Title Records - (Required Records)

Three Title Records are required at the beginning of each reach. TITLE1 is used as the A part of DSS pathnames written by the TABLE program. TITLE2 and TITLE3 provide additional documentation.

Field	Variable	Value	Description
0	ID	T1	Record identification
1 - 10	TITLE1	Alpha	River name and reach number. <u>If using more than one reach, TITLE1 should be unique for each reach, as it is used as the A part of the DSS pathname for computed hydrographs.</u>
0	ID	T2	Record identification
1 - 10	TITLE2	Alpha	Project name or other information.
0	ID	T3	Record identification
1 - 10	TITLE3	Alpha	User name, office name, date, or other information.

EJ

EJ Record - End of Job - (Required Record)

The EJ Record indicates the end of the CSECT input file, and is required as the last record in the file.

Field	Variable	Value	Description
0	ID	EJ	Record identification.

ZD

ZD Record - Specify DSS File Name - (Optional Record)

The ZD Record identifies the DSS file name to be used for which data will be read or written for the ZI, ZA and ZS Records. In addition, the ZD Record defines the F-part for DSS pathnames which are written to DSS. The two variables are in free format, separated by spaces or commas. The F-part may have any internal spaces since it is the last item of data on the record. The ZD Record can be placed anywhere in the CSECT input file, but it must precede any ZA, ZI or ZS Records.

Field	Variable	Value	Description
0	ID	ZD	Record identification.
1	DSSFIL	Char.	DSS filename.
2	FPART	String	DSS F-part of pathname (always use).

ZA

ZA Record - Write Area and Conveyance Tables to DSS - (Optional Record)

The ZA Record directs that the area and conveyance tables for cross sections be written to the DSS file specified on the ZD Record. The tables are written in paired data format. This record should be placed before the cross section for which you would like tables to be written, and following the cross section at which you want to stop writing tables.

Field	Variable	Value	Description
0	ID	ZA	Record identification.
1	CONT	ON	Start writing tables.
		OFF	Stop writing tables.

ZI

ZI Record - Write the Channel Invert and Bank Station Profiles to DSS - (Optional Record)

The ZI Record directs that the cross section invert profile and the pilot channel invert profile be written to DSS. The parameter is entered in free format. This record must be placed before the UB Record of the reach that you would like to include in the profile plots. It must be preceded by a ZD Record. Place a ZI OFF Record after the DB of the reach of interest to terminate this option.

Field	Variable	Value	Description
0	ID	ZI	Record identification.
1	UNITS	Char.	Units along the distance axis (MILES) and start writing profiles. Currently the program only uses "MILES".
		OFF	Stop writing profiles.

Example:

```
T1
T2
T3
.
.
.
ZD DSS FILENAME F-part
ZI MILES
UB
.
.
.
DB
ZI OFF
(next reach)
```

ZS

ZS Record - Write Cross Sections to DSS - (Optional Record)

The ZS Record directs that the total, encroached and bridge cross sections be written to the DSS file specified on the ZD Record. The cross section coordinates are written in paired data format. This record should be placed before the cross section for which you would like data to be written, and following the cross section at which you want to stop writing data.

Field	Variable	Value	Description
0	ID	ZS	Record identification.
1	CONT	ON	Start writing data.
		OFF	Stop writing data.

ZX

ZX Record - Read Limits for Cross Section Tables from DSS - (Optional Record)

This record directs that the maximum and minimum water surface profiles be read from DSS. The DSS pathname references a paired function record which stores the two curves. The CSECT program uses these maximum and minimum values for the limits of the cross section tables if the value of ELSTRT is negative on the XK Record. The program determines the elevation increment from these limits and the maximum number of increments for which the program is dimensioned.

Field	Variable	Value	Description
0	ID	ZX	Record identification.
1-10	PN	Alpha	DSS paired data pathname.

ZN**ZN Record - Read Invert Profile from DSS - (Optional Record)**

This record directs that an invert profile be read from DSS. The DSS pathname references a paired function record which stores a single curve. The CSECT program uses this invert value as the base for the cross section table if ELSTRT is negative on the XK Record. If the invert from the profile is below the invert from the cross section and no pilot channel is specified, then the higher invert is used. If a pilot channel (PC Record) is present, then the invert from the profile is always the top of the pilot channel and the start of the table.

Field	Variable	Value	Description
0	ID	ZN	Record identification.
1-10	PN	Alpha	DSS paired data pathname.

ZF

ZF Record - Read Reference Water Surface Profile from DSS - (Optional Record)

This record directs CSECT to read the profile of a reference water surface (base flood) from DSS. The DSS filename: pathname references a paired function file. It is necessary to use the ZF Record when doing floodway analysis.

Floodway computations are based on the one-percent chance flood (base flood). The base flood is routed through the study reach for existing conditions and the resulting maximum water surface profile is written to a DSS file (see Job Control variable PZMX in UNET input). In a separate floodway run, the base flood profile is read with the ZF Record specifying the pathname and the EN or DF Record defining the encroachment as a fraction of the flow and storage area. Note: this option is not based on conveyance reduction.

Field	Variable	Value	Description
0	ID	ZF	Record identification.
1-10	PN	Alpha	DSS paired data pathname.

XK**XK Record - Limits of Cross Section Elevation vs. Hydraulic Property Tables - (Required Record)**

This record defines the starting elevation and the elevation intervals in the area and conveyance vs. elevation (hydraulic properties) tables. It also sets the initial maximum distance between interpolated cross sections (nodes). It must appear before the first cross section (X1 Record), but it can appear before any or all subsequent cross sections to change the parameters. CSECT has several ways of specifying the starting point for the cross section tables:

1) Enter BELBK and ELINC in fields 1 and 5 respectively. The CSECT program starts the table at the minimum elevation of the channel bank minus BELBK. If the starting point is below the invert of the cross section (i.e. BELBK is too large a value), then the starting elevation is set at the invert elevation plus one foot. The elevation increment in the tables is ELINC. The number of vertical points in the hydraulic properties table is shown in the CSECT output file under the heading "PROGRAM DIMENSIONS".

2) The table is based on a slope profile, entered manually, which defines the upper limit of the table. The starting elevation is entered as ELSTRT in field 3 and the slope of the profile is entered as SLOPE in field 4. The table is started at a distance RISE below the profile and at an increment of ELINC. All subsequent tables will be based on this profile until another XK Record is encountered which either redefines the slope profile or directs another method for starting the table.

3) The table is based on a invert profile read from DSS either on a ZN or ZX Record. This option is enabled by entering a ELSTRT value of -1 in field 2. The table has an increment of ELINC.

Field	Variable	Value	Description
0	ID	XK	Record identification.
1	BELBK	+	The first elevation above the invert will be located BELBK feet below the lower bank elevation (XSTL or XSTR on X1 Record). A value larger than the channel depth will set this point one foot above the invert elevation.
2	RISE	+	Elevation span of the table. This is computed automatically based on ELINC (field 5). Older versions of the program required RISE to be specified. Field 2 is now ignored

XK (Cont.)

Field	Variable	Value	Description
3	ELSTRT	+	Starting elevation for slope profile.
		0	Do not use profile.
		-1	Use profile read from DSS on either ZN or ZX Record.
4	SLOPE	+	Slope of the profile.
5	ELINC	+	Elevation increment. The tables will consist of the number of points shown in the "PROGRAM DIMENSIONS" table in the output file <u>plus the invert elevation which is not listed in the output</u> . The first elevation above the invert will be computed based on the selection of BELBK. The selection of ELINC should be based on the maximum anticipated range of water surface elevations at the current cross section. Additional XK Records should be inserted throughout the input file so that the elevation table bounds the anticipated water surface elevation profiles while providing high resolution where geometric properties are rapidly changing. Some adjustment to XK limits should be expected as a model is being developed.
6	XMINC	+	Maximum interval in miles between interpolated cross sections (nodes).
7	FM	+	Factor to adjust SECNAM on X1 Record to the units of miles.
		0	Do not adjust SECNAM.
8	CMILE	+	River mile of the first cross section. The river miles of all subsequent cross sections are calculated from the channel distance. (This will not affect SECNAM but will change the output to units of miles.)
		0	The river mile of the cross section is accepted as SECNAM on the X1 Record.

XI**XI Record - Interpolated Cross Section Interval - (Optional Record)**

This record defines the maximum distance in the x-direction between interpolated cross sections. (Note, actual cross sections are not interpolated; however, additional computational nodes are inserted at the intervening locations.) It can be used prior to any X1 Record to change the distance set by XMINC (XK.6) without having to use a complete XK Record.

Field	Variable	Value	Description
0	ID	XI	Record identification.
1	XINC	+	Maximum interval, in miles, between interpolated nodes.

NC

NC Record - Manning's n Values - (Required Record)

The NC Record defines Manning's n values for the channel and overbanks. The expansion and contraction loss coefficients customarily used in fields 4 and 5 of HEC-2 data sets are not used in UNET. These losses are treated as internal forces by the program. Structures such as bridge piers, navigation dams and cofferdams constrict flow and exert external forces which oppose the flow. In rare situations these additional forces may not be adequately computed with the structure losses that are described elsewhere. Therefore, they may be empirically added, if necessary, with variable FNCH1. Refer to Section 2.4 of this manual for further details. The NC Record is required prior to the first cross section and may be used to change the parameters at any subsequent cross section.

Field	Variable	Value	Description
0	ID	NC	Record identification.
1	XNL	+	Manning's n for left overbank.
2	XNR	+	Manning's n for right overbank.
3	XNCH	+	Manning's n for channel.
4	Blank field		
5	Blank field		
6	FNCH1	+	Loss coefficient for optional added force (sec. 2.4).

NH**NH Record - Horizontal Variation in Manning's n - (Optional Record)**

Used to change the roughness coefficients to vary with horizontal distance from the left side of the cross section. Roughness coefficients should be redefined for each cross section that has new geometry.

Field	Variable	Value	Description
0	ID	NH	Record identification.
1	NHS	+	Total number of Manning's n values (maximum of 25) entered on NH Records. If NHS is greater than four, multiple NH Records are required, and the first field on the second and subsequent NH Records should contain a HS(I) value.
2,4,6,	HN(I)	+	Manning's n value between stations HS(I-1) and HS(I). The n value applies from the starting left station up to HS(I) (Field 3).
3,5,7,	HS(I)	+	Station corresponding to HN(I). These stations do not need to match an existing station on GR Records. Stations must be input in increasing order.

PC

PC Record - Low Flow Pilot Channel - (Optional Record)

The PC Record cuts a pilot channel into the bottom of a cross section defined on GR Records. Very wide and shallow cross sections which pass flows at small depths are difficult to model (problems with the backwater initial conditions or supercritical flow regimes) under low flow conditions. To assist the model in solving these cross sections, a pilot channel is cut into the section. The pilot channel provides greater flow depths at low discharges. The area and conveyance of the pilot channel are borrowed from the lower part of the entered cross section so that the total area and conveyance properties of the cross section relate to the original cross section at higher flows. Note that cross sections with pilot channels will compute unrealistically low stages for very low flows.

All cross sections following the PC Record will have pilot channels cut into them. The pilot channel option is turned off with a second PC Record with the string 'OFF' located anywhere in columns 3 - 80.

Note that this data can interact with data for the invert profile entered via the **ZN record**.

Field	Variable	Value	Description
0	ID	PC	Record identification.
1	PCTW +		Width of pilot channel (ft).
2	PCHT +		Depth of pilot channel below section invert (ft).
		0	Minimum elevation of pilot channel entered in field 4.
3	PCN	+	Manning's n for pilot channel conveyance.
4	PCZMIN	+	Minimum elevation of pilot channel. If PZMIN is above the channel invert, then no pilot channel will be cut.
		0	Use PCHT in field 2.

OB**OB Record - Modify Overbank Storage - (Optional Record)**

The OB Record is used to adjust storage in the channel and overbank areas. It is placed between the cross sections where the change in storage occurs. This option is useful to adjust HEC-2 data files that do not correctly model storage. The change in storage will be reflected in each cross section following the OB Record. To turn this option off, insert a second OB Record with FCSTOR and FVSTOR set equal to 0.0.

Field	Variable	Value	Description
0	ID	OB	Record identification.
1	FCSTOR	+	Increment storage by FCSTOR * AREA of channel.
2	FVSTOR	+	Increment storage by FVSTOR * AREA of the overbank.

BF

BF Record - Adjust Floodplain Area and Conveyance - (Optional Record)

The BF Record adjusts the overbank flow and storage area by a factor or confines the overbank flow area to a set floodway width. If the floodway width option is selected, the area outside the floodway is redefined as storage area. The BF Record overrides the encroachments that are specified on the X3 Record. It remains in effect until turned off by another BF Record.

Field	Variable	Value	Description
0	ID	BF	Record identification.
1	FVALLEY	+	Multiply overbank flow area, conveyance, and storage by FVALLEY.
		0	Not used.
2	BFWFWY	+	Width of the active flow floodway.
		0	Not used.

EN**EN Record - Define Encroachments for a Conventional Floodway Analysis - (Optional Record)**

The EN Record defines encroachments for a conventional floodway analysis. To use this option, a baseflood profile for existing conditions must be computed and written to a DSS file (see ZF description on page B-13). Area is removed starting from the outer limits of the cross section, as defined by the base flood.

Field	Variable	Value	Description
0	ID	EN	Record identification.
1	ENPAR	+	Fraction (ratio) of the total active flow and storage area in the overbank to be removed. Remaining area is in the floodway.
		0	If ENPARL or ENPARR is specified.
		OFF	stop floodway accounting.
2	ENPARL	+	Fraction of the total active flow and storage area in the left overbank to be removed to define the floodway.
3	ENPARR	+	Fraction of the total active flow and storage area in the right overbank to be removed to define the floodway.

DF

DF Record - Define Encroachments for a Density Floodway Analysis - (Optional Record)

The DF Record defines encroachments for a density floodway analysis. To use this option, a baseflood profile for existing conditions must be computed and written to a DSS file(see ZF description on page B-13).

Field	Variable	Value	Description
0	ID	DF	Record identification.
1	FDF	+	Fraction of the total active flow and storage area in the overbank to be redefined as a density floodway. Method assumes the fraction is proportionally lost.
		0	Stop density floodway calculations.

IC

IC Record - Ice Cover Data - (Optional Record)

The IC Record is used to input or change ice data. Calculations with a floating ice cover will start at the first cross section following the IC Record and will continue until an IC Record is read that has a negative value for SPGR (Field 5). Ice calculations will not be performed for areas outside the encroachment stations specified on the X3 Records. Pilot channel calculations are not affected by the presence of the ice cover.

The use of an IC Record will not effect any of the existing data output options that can be specified for writing UNET data to an output data file or a DSS datafile. However, when an IC Record is detected additional data will be written to the CSECT output file and additional data may be written to the DSS datafile.

The CSECT output file, specified by the user through the program RUNUNET, will contain information describing the ice conditions at each cross section where ice is specified on the IC Record. This data will consist of the ice thicknesses, the ice Manning's n and the ice specific gravity. The tables printed by CSECT will reflect the modifications in conveyance and area caused by the ice cover.

All data requested by the user to be written to the DSS datafile will be written without modification to the file. In addition, if the user has selected the Job Control Option of program UNET to write instantaneous flow and elevation profiles to DSS, the instantaneous elevation profiles of the top surface and the bottom surface of the ice cover will also be written to DSS at the same time intervals. The top and bottom ice surface profiles will be written only for those reaches in which ice exists. If a reach is only partially ice covered, the water surface elevation will be substituted for both the top and bottom ice surface for those portions of the reach where ice does not exist (see figures D-15 to D-17).

In computing the ice thickness, the user-supplied channel ice thickness will be used. If the channel ice thickness is zero, then the greater of the left or right overbank ice thicknesses will be used. The location and top and bottom ice surface elevations will be entered into DSS as paired data. The DSS pathname will be constructed with the following format:

A = 'ICE PROF. ' RNAME
B = Date AT Time
C = 'LOC.-ICE_ELEV'
D Not used.
E Not used
F = 'TOP' or 'BTM'

IC (Cont.)

where RNAME is the reach name entered on the T1 Record in the CSECT input file. A short summary of the ice data will also be listed at the beginning of each output table specified at a cross section where ice exists. Output tables are only developed for those sections that have an HY Record.

Field	Variable	Value	Description
0	ID	IC	Record identification
1	ZITL	+	Ice thickness in the left overbank.
		0	No change in the ice thickness in the left overbank.
		-1	Open water in the left overbank.
2	ZITR	+	Ice thickness in the right overbank.
		0	No change in the ice thickness in the right overbank.
		-1	Open water in the right overbank.
3	ZITCH+		Ice thickness for the channel.
		0	No change in ice thickness in the channel.
		-1	Open water in the channel.
4	ZIN	+	Manning's n for the ice cover.
		0	No change in Manning's n for the ice cover.
5	SPGR	+	Value of ice specific gravity.
		0	No change in specific gravity if a value was entered on a previous record. If no value had been previously specified, the default value of 0.916 will be used.
		-1	No ice calculations until another IC Record is read.

UB**UB Record - Upstream Reach Boundary Connection - (Required Record)**

The UB Record specifies the upstream boundary connection(s) for a reach. A maximum of five reaches may be connected. If the reach flows out of a storage area, the upstream boundary is connected to the storage area by specifying the storage area as a **negative** value. If the UB Record is left blank, the upstream boundary condition data will be specified in the UNET input file.

Field	Variable	Value	Description
0	ID	UB	Record identification.
1 - 5	IRUCON(I) +		Number(s) of reach(s) connected to the upstream reach boundary.
		-	Number of storage area connected to the upstream reach boundary.
		Blank	Upstream boundary condition data specified in UNET input file.

UZ

UZ Record - Read Upstream Stage Boundary Connection data from DSS - (Required record if using any Upstream Stage Data). The UZ record is analogous to the UB record.

Field	Variable	Value	Description
0	ID	UZ	Record identification.
1 - 5	IRUCON(I)	+	Number(s) of reach(s) connected to the upstream reach boundary.
		-	Number of storage area connected to the upstream reach boundary.
		Blank	Upstream boundary condition data specified in UNET input file.

DB**DB Record - Downstream Reach Boundary Connection - (Required Record)**

The DB Record specifies the downstream boundary connection(s) for a reach. A maximum of five reaches may be connected. If the reach empties into a storage area, the downstream boundary is connected to the storage area by specifying the storage area as a **negative** value. If the DB Record is left blank, the downstream boundary condition data will be specified in the UNET input file.

Field	Variable	Value	Description
0	ID	DB	Record identification.
1 - 5	IRDCON(I)	+	Number(s) of reach(s) connected to the downstream reach boundary.
		-	Number of storage area connected to the downstream reach boundary.
		Blank	Downstream boundary condition data specified in UNET input file.

X1

X1 Record - General Items for Each Cross Section - (Required Record)

This record is required for each input cross section and is used to specify the cross section geometry and program options applicable to that cross section. The maximum number of input sections, computational nodes, etc. allowed is shown in the CSECT output file under the heading "PROGRAM DIMENSIONS".

Field	Variable	Value	Description
0	ID	X1	Record identification.
1	SECNAM	+	Cross section identification number (river mile is recommended because this value is used for the x-axis on profile plots).
2	GPNO	+	Number of ground points.
		0	Previous upstream cross section is repeated for current section. GR Records are not entered for this cross section.
3	XSTL	+	The station of the left bank of the channel. Must be equal to one of the STA(I) on next GR Records.
4	XSTR	+	The station of the right bank of the channel. Must be equal to one of the STA(I) on next GR Records and equal to or greater than XSTL.
5	XLLGTH	+	Length of left overbank reach between current cross section and next cross section (*). Zero for the last cross section of the reach.
6	RLGTH	+	Length of right overbank reach between current cross section and next cross section (*). Zero for the last cross section of the reach.
7	XLGCH	+	Length of channel reach between current cross section and next cross section (*). Zero for the last cross section of the reach.
8	X		Unused HEC-2 parameter.

X1 (Cont.)

Field	Variable	Value	Description
9	ELADD	+ or -	Elevation increment to be added to all GR and BT low chord elevation data in the current cross section.

***NOTE:** Distance between sections is not considered at reach junctions as continuity of flow and stage are assumed.

X2

X2 Record - Optional Items for Each Cross Section (Repeat Bridge Table)

This record is used to repeat the BT Records from the previous cross section for the current cross section. The X2 Record is currently used only to repeat the bridge table. Prior to reversing existing HEC-2 data files, it may prove simpler to enter all BT Records and skip the X2 Record altogether.

Field	Variable	Value	Description
0	ID	X2	Record identification
1			Not read by UNET
2			Not read by UNET
3	IBRID	+	Repeat BT Records (bridge table) used on previous cross section.
		0	Do not repeat bridge table.

X3X3 Record - Optional Items for Each Cross Section (Effective Area, Encroachments)

This record defines the storage areas in a cross section.

Field	Variable	Value	Description
0	ID	X3	Record identification.
1	EFCH	0	Total area of cross section described on GR Records below the water surface elevation is used in the computations.
		10	Only the channel area as defined by (XSTL, X1.3) and (XSTR, X1.4) is used in the computations, unless the water surface elevation exceeds the elevations of the bank stations. This option can be utilized to contain flow between levees until overtopping occurs, if the bank stations are coded at the top of the levees. EFCHL and EFCHR can also be used to define the overtopping elevations.
2	SED	0	A sediment depth is not specified.
		+	Depth of sediment, in feet, that will be added to the channel invert. All elevations in the main channel below the invert + SED are set equal to the invert +SED.
3	WFWY	0	Floodway width is not changed or specified.
		+	Width of floodway to be centered in the channel, midway between the left and right overbanks. Conveyance and storage are computed within the floodway, while only storage is computed outside the floodway. This width will be used for all subsequent cross sections unless changed by a positive WFWY on the X3 Record of another cross section.
4	ELS	+	Left encroachment station. All area to the left of (less than) this station and below ELEL is treated as storage only.

X3 (Cont.)

Field	Variable	Value	Description
5	ELEL	+	Elevation of the left encroachment. All area below this elevation and less than station ELS has no conveyance, only storage.
		-	If negative, no conveyance or storage will be computed. This must be used to avoid double-accounting of levee storage defined by storage areas (SURFA, SA.2).
6	ERS	+	Right encroachment station. All area to the right of (greater than) this station and below EREL is treated as storage only.
7	EREL	+	Elevation of the right encroachment. All area below this elevation and greater than station ERS has no conveyance, only storage.
		-	If negative, no conveyance or storage will be computed. This must be used to avoid double-accounting levee storage defined by storage areas (SURFA, SA.2).
8	EFCHL	+	If EFCH=10, EFCHL overrides the elevation of the channel left bank station (XSTL, X1.3).
9	EFCHR	+	If EFCH=10, EFCHR overrides the elevation of the channel right bank station (XSTR, X1.4).

NOTE: The station data on the X3 Record must coincide with stations on the following GR Records.

X4**X4 Record - Additional Points for a Cross Section - (Optional Record)**

The X4 Record may be inserted following records X1, X2 or X3 to insert additional points that describe the ground profile of the cross section. Stations of X4 data points must fall within the range of GR stations. The X4 data point is an **added point** and cannot be used to replace any GR data point. This option is useful when modifying data records for a proposed obstruction as it allows points to be added anywhere in the cross section.

Field	Variable	Value	Description
0	ID	X4	Record identification.
1	X	+	Total number of X4 data points to be added to the current cross section GR data. If X is greater than four, multiple X4 Records are required, and the first field of the second and subsequent X4 Records should contain an ASTA(I) value.
2,4,etc	AEL(I)	+ or -	Elevation of additional ground point corresponding to ASTA(I) Elevations added by X4 Records are adjusted by ELADD (X1.9), <u>including those on repeated cross sections.</u>
3,5,etc	ASTA(I) +		Station of additional ground point. All stations must be less than the maximum station on the GR Records. The pairs of elevations and stations do not have to be in any particular order.

NOTE: If a second X4 Record is required at this location, start station and elevation data in field one of the second and subsequent X4 Records.

Z0

Z0 Record - Gage Zero Elevation - (Optional Record)

This record defines gage zero elevation at a cross section. The gage zero elevation is subtracted from the computed water surface elevation to calculate a stage. The Z0 (Z-zero) Record is used along with HY Records and must be placed immediately before the HY Record.

Field	Variable	Value	Description
0	ID	Z0	Record identification.
1	ZERO	+ or -	Gage zero elevation (ft).

OH**OH Record - Read Observed Hydrograph - (Optional Record)**

The OH Record specifies the DSS pathname of an observed hydrograph, which will be used when developing macros for DSPLAY. This allows macros to be developed automatically to compare computed results to observed data. The OH Record should be placed immediately before the corresponding HY Record in the input file.

Field	Variable	Value	Description
0	ID	OH	Record identification.
1	OBSPN	Alpha	Pathname of the observed hydrograph.

Example:

OH /A/B/C/D/E/F/

A through F are the pathname parts. The pathname may be preceded by the DSS filename followed by a colon (:); e.g., \path\dssfile:/A/B/C/D/E/F/.

HY

HY Record - Store Computed Hydrographs in DSS - (Optional Record)

The HY Record is used to write computed stage, elevation and flow hydrographs for the current cross section to the UNET output file and to the DSS file. They can then be plotted with DSPLAY. The HY Record is placed after the X1 and Z0 Records. The dimensions of the TABLE program, which actually does the writing of the hydrographs, may be found in its output file under "PROGRAM DIMENSIONS".

Field	Variable	Value	Description
0	ID	HY	Record identification.
1 - 10	F	Alpha	Name of cross section where hydrographs are to be plotted. This name will become the "B" part of the DSS pathnames for the hydrograph data.

HV

HV Record - Store Computed Velocities in DSS - (Optional Record)

The HV Record is used to write computed channel, overbank and average velocity hydrographs for the current cross section to the DSS file. They can then be plotted with DSPLAY. The HV Record is placed after the X1 and Z0 Records.

Field	Variable	Value	Description
0	ID	HV	Record identification.
1 - 10	F	Alpha	Name of cross section where hydrographs are to be plotted. This name will become the "B" part of the DSS pathnames for the hydrograph data.

GR

GR Record - Ground Profile Elevations and Stations - (Required Record)

This record specifies the elevation and station of each point in a cross section used to describe the ground profile, and is required for each X1 Record unless GPNO (X1.2) is zero. Cross sections should be defined perpendicular to the direction of flow. Cross sections are required at representative locations along a river reach and at locations where changes occur in discharge, slope, shape, or roughness, at locations where levees begin or end, and at bridges, culverts, spillways, or control structures such as weirs. Where abrupt changes occur, several cross sections should be used to describe the change regardless of the distance. A thorough re-evaluation of existing HEC-2 GR Records is important when they are being modified for use in UNET to ensure that storage is correctly represented as well as conveyance.

Field	Variable	Value	Description
0	ID	GR	Record identification.
1	EL(1)	+ or -	Elevation of the first ground point. May be positive or negative (ft).
2	STA(1)	+	Station of the first ground point (ft).
3	EL(2)	+ or -	Elevation of the second ground point.
4	STA(2)	+	Station of the second ground point.

5-10 etc.

Continue with additional GR Records using up to 600 points to describe the cross section. Stations must be in increasing order progressing from left to right across the cross section.

SA**SA Record - Storage Areas - (Optional Record)**

The SA Record defines a storage area. Storage areas may be connected to upstream or downstream reach boundaries, or may be filled (and drained) through a lateral spillway. The maximum number of storage areas allowed can be found in the CSECT output file under the heading "PROGRAM DIMENSIONS". A name can be attached to the storage area by placing an HS Record after the SA Record. The name placed on the HS Record will also be used as the B part of the DSS pathname. If the user does not supply an HS Record with the SA Record, the default name is SA#, where # is the user defined storage area number (IDSAENTERED).

Field	Variable	Value	Description
0	ID	SA	Record identification.
1	IDSAENTERED	+	The user defined storage area number.
2	SURFA	+	The surface area of the storage in acres.
		0	Elevation-volume relation will be defined on a subsequent SV Record.
3	ZOSA	+	Minimum elevation of storage area.
4...10	NSACON	+	Reach numbers of the reaches that use this storage area as a downstream boundary .
		-	Reach numbers of the reaches that use this storage area as an upstream boundary.

HS

HS Record - Storage Area Name - (Optional Record)

The HS Record defines the name of a storage area and the B part for the DSS pathname. The HS Record is placed following the SA Record.

Field	Variable	Value	Description
0	ID	HS	Record identification
1-10	SANAME	A32	Name of storage area.

SV

SV Record - Elevation-Volume Rating for Storage Areas - (Optional Record)

The SV Record allows the user to define an elevation-volume rating curve for storage areas. The SV Record should follow the corresponding SA Record. A maximum of 20 elevation-volume points may be entered.

Field	Variable	Value	Description
1,..,9	ZSAVOL(1)	+ or -	Elevation (ft).
2,..,10	VOLSA(1)	+	Volume of storage area at ZSAVOL(1) in acre feet.

SL

SL Record - Lateral Simple Connection to a Storage Area - (Optional Record)

The SL Record defines a simple linear routing connection between a reach and a storage area. The flow between the reach and the storage area is computed as:

$$Q = k * (\text{Available Storage})$$

Where k is either CIN or COUT. The "Available Storage" is determined as shown below (See also Fig. 9-7).

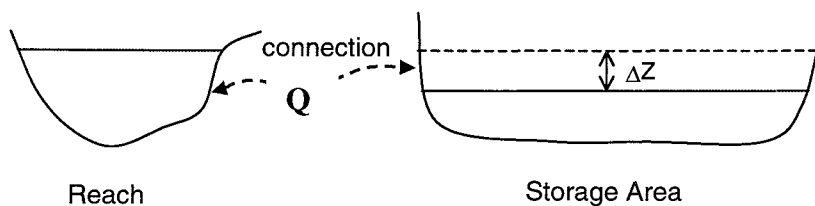

"Available Storage" is computed as ΔZ times the surface area of the storage area (see the SA record).

Field	Variable	Value	Description
0	ID	SL	Record identification
1	ICONN	+	Storage area number to connect to.
2	CIN	+	Linear routing coefficient for flow into the storage area ($0 < \text{CIN} \leq 1$. Generally about 0.2).
3	COUT	+	Linear routing coefficient for flow out of the storage area ($0 < \text{COUT} \leq 1$. Generally about 0.2).
4	ZSSUP	+	Elevation at which the connection is made.

SS

SS Record - Simple Connection between Two Storage Areas - (Optional Record)

The SS Record defines a simple linear routing connection between two storage areas. The **positive** flow direction is defined as **from** storage area #1 **to** storage area #2. This connection is analogous to the SL connection.

Field	Variable	Value	Description
0	ID	SS	Record identification
1	ICONN1	+	Storage area number 1.
2	ICONN2	+	Storage area number 2.
3	CIN	+	Linear routing coefficient for flow from SA 1 to SA 2 ($0 < CIN \leq 1$. Generally about 0.2).
4	COU	+	Linear routing coefficient for flow from SA 2 to SA 1 ($0 < COU \leq 1$. Generally about 0.2).
5	ZSP	+	Elevation of connection.

SP**SP Record - In Line Spillway - (Optional Record)**

The SP Record defines an in line, or cross channel spillway. In line spillways are located between two cross sections and may consist of two structural components: (1) a gated section, and (2) up to 25 weir overflow sections when the **WD record** is used in conjunction with the SP. UNET models radial, or Tainter type gates. For spillways with multiple gates, the individual gate widths are lumped together into a single width, with the gates assumed to operate simultaneously. The SP Record can also be used as a special connection between two storage areas.

Free and submerged flow calculations can be performed. If the gate opening equals or exceeds eighty percent of the flow depth, free flow is computed using weir flow equations. The time series of gate openings is entered as an internal boundary condition in the UNET input file. **For spillways without gates, fields 2 through 10 are left blank. Weir sections are defined on a WD Record immediately following the SP Record.**

Field	Variable	Value	Description
0	ID	SP	Record identification.
1	ZSP	+	Elevation at crest of spillway (ft).
2	WSP	+	Width of spillway at crest (ft). This width is equal to the total width of all gates in the spillway. Width of weir sections should be described on WD Records placed immediately after the SP Record.
3	S	0	Compute both free and submerged flow.
		1	Compute only free flow (use only if flow conditions are known)
4	CE	+	Discharge coefficient (ranges from 0.6 to 0.8).
5	AH	+	Trunnion height (ft) (from ZSP to trunnion pivot point).
6	AHE	+	Trunnion height exponent, typically about 0.16 (for sluice gate set to 0.0).
7	BE	+	Gate opening exponent, typically about 0.72 (for sluice gate set to 1.0).
8	HE	+	Head exponent, typically about 0.62 (for sluice gate set to 0.5).

SP (Cont.)

Field	Variable	Value	Description
9	QPLT	+	Pilot discharge for leakage or to keep downstream channel wet at low flows. An alternative is to enter a small lateral inflow at the spillway and to remove an equivalent flow at the end of the reach. A finite value is necessary for an in-line spillway.
10	CSPNAME	Alpha	Name of spillway. To be used in boundary conditions file for referencing time series of gate openings.

An empirical equation for tainter gate flow from Dr. Barkau is:

$$Q = CE \cdot \sqrt{2g} \cdot WSP \cdot AH^{AHE} \cdot B^{BE} \cdot H^{HE}$$

where: B = Gate opening in ft.
H = Head on the spillway
H = $Z_u - AVH$ A $Z_{sp} - (1 - AVH) Z_d$

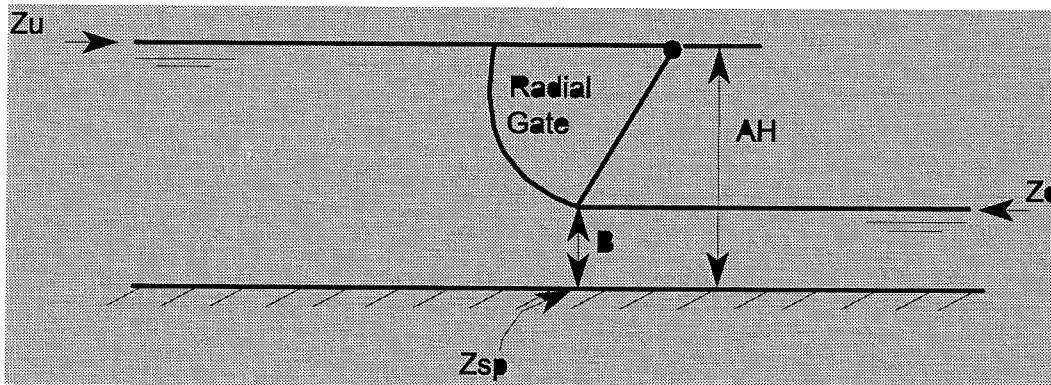

LA**LA Record - Lateral Spillway Diverting Water into a Storage Area - (Optional Record)**

The LA Record is used to define a lateral spillway which diverts high flows out of a reach into an adjacent storage area. The LA Record is placed just after the cross section that represents the upstream end of the spillway. The water surface elevation used in the computations is based on the average of the two cross sections that bound the spillway. Note that the spillway width is measured along the channel, as opposed to across the channel in the case of in line (SP Record) spillways. **For spillways without gates, fields 3 through 10 are left blank. Weir sections are defined on a WD Record immediately following the LA Record.**

Field	Variable	Value	Description
0	ID	LA	Record identification.
1	ICONN	+	Number of the storage area connected to the spillway.
2	ZSP	+	Elevation of crest of spillway (ft).
3	WSP	+	Width of spillway at crest (ft). This width is equal to the total width of all gates in the spillway. Width of weir sections should be described on WD Records placed immediately after the LA Record.
4	S	0	Compute both free and submerged flow.
		1	Compute only free flow (use only if flow conditions are known)
5	CE	+	Discharge coefficient (ranges from 0.6 to 0.8).
6	AH	+	Trunnion height (ft) (from ZSP to trunnion pivot point).
7	AHE	+	Trunnion height exponent, typically about 0.16 (for sluice gate set to 0.0).
8	BE	+	Gate opening exponent, typically about 0.72 (for sluice gate set to 1.0).
9	HE	+	Head exponent, typically about 0.62 (for sluice gate set to 0.5).

LA (Cont.)

Field	Variable	Value	Description
10	CSPNAME	Alpha	Name of spillway. To be used in boundary conditions file for referencing time series of gate openings.

An empirical equation for tainter gate flow from Dr. Barkau is:

$$Q = CE \cdot \sqrt{2g} \cdot WSP \cdot AH^{AHE} \cdot B^{BE} \cdot H^{HE}$$

where: B = Gate opening in ft.
H = Head on the spillway
H = $Z_u - AVH$ A $Z_{sp} - (1 - AVH) Z_d$

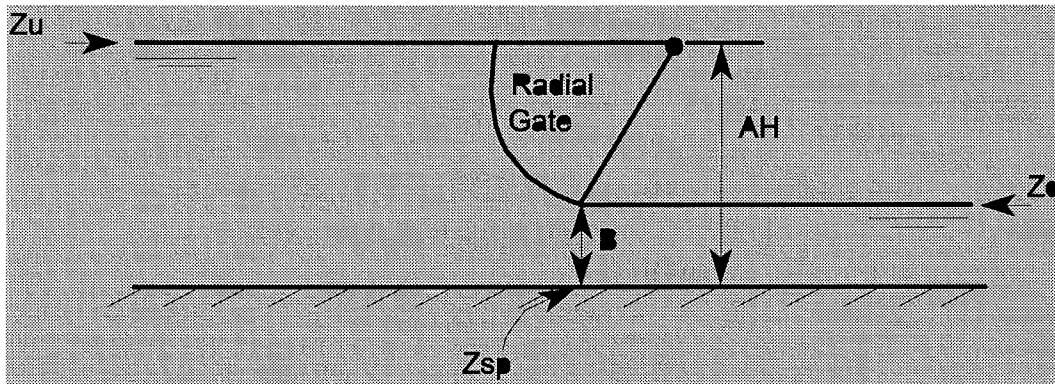

LS**LS Record - Lateral Spillway Diverting Water to Another Reach - (Optional Record)**

The LS Record is used to define a lateral spillway which diverts high flows out of a reach to another reach, or completely out of the system being modeled. This may occur as overflow from a reach enters an adjacent drainage network which is not part of the river system under study. The LS Record is placed just after the cross section that represents the upstream end of the spillway. The water surface elevation used in the computations is based on the average of the two cross sections that bound the spillway. Note that the spillway width is measured along the channel, as opposed to across the channel in the case of in line (SP Record) spillways. **For spillways without gates, fields 4 through 10 are left blank. Weir sections are defined on a WD Record immediately following the LS Record.**

Field	Variable	Value	Description
0	ID	LS	Record identification.
1	IRCH	+	Reach number which contains the connecting cross section.
2	RMILE	+	River mile of connecting cross section.
3	ZSP	+	Elevation at crest of spillway (ft).
4	WSP	+	Width of spillway at crest (ft). This width is equal to the total width of all gates in the spillway. Width of weir sections should be described on WD Records placed immediately after the LS Record.
5	CE	+	Discharge coefficient (ranges from 0.6 to 0.8).
6	AH	+	Trunnion height (ft) (from ZSP to trunnion pivot point).
7	AHE	+	Trunnion height exponent, typically about 0.16 (for sluice gate set to 0.0).
8	BE	+	Gate opening exponent, typically about 0.72 (for sluice gate set to 1.0).
9	HE	+	Head exponent, typically about 0.62 (for sluice gate set to 0.5).

LS (Cont.)

Field	Variable	Value	Description
10	CSPNAME	Alpha	Name of spillway. To be used in boundary conditions file for referencing time series of gate openings.

An empirical equation for tainter gate flow from Dr. Barkau is:

$$Q = CE \cdot \sqrt{2g} \cdot WSP \cdot AH^{AHE} \cdot B^{BE} \cdot H^{HE}$$

where: B = Gate opening in ft.
H = Head on the spillway
H = $Z_u - AVH A Z_{sp} - (1 - AVH) Z_d$

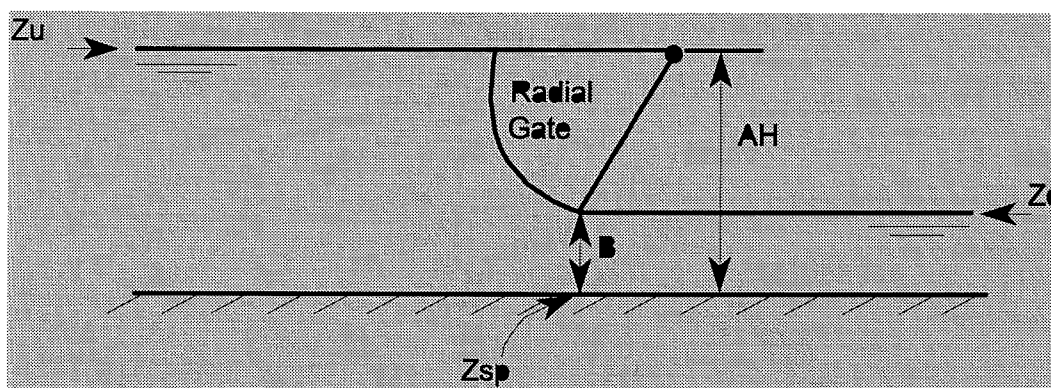

ND**ND Record - Navigation Dam - (Optional Record)**

The ND Record defines a navigation dam. Insert ND Records after the X1 Record at the dam location, with I1IBC blank. Alternatively, ND Records may be inserted anywhere if I1IBC is entered. "Control point" refers to the "hinge" location for hinge pool operated navigation dams. The hinge point may be defined on the ND Record with NAVCP or on a CP Record inserted after the X1 Record at the hinge point location. The dam may contain up to 25 uncontrolled weir overflow sections, defined on a WD Record following the ND Record.

Field	Variable	Value	Description
0	ID	ND	Record identification.
1	I1IBC	0	The navigation dam will be placed at the location defined by the previous X1 Record in the input file.
		+	Input cross section (ICS)* number for location of navigation dam.
2	NAVCP	0	The control or hinge point location is either defined on the previous CP Record or, if no CP Record is used, it is located at the previous X1 Record in the input file.
		+	Input cross section (ICS)* number for location of hinge point.
3	ZCP	+	Elevation of the control point (ft). This elevation will be maintained by navigation dam operation to a tolerance of +/- 10 percent.
4	NNAVQI	+	Input cross section (ICS) number at the headwater of the navigation pool. This location will be the first cross section downstream of the next upstream dam, or the first cross section in a reach with only one dam.
5	WSP	+	Width of navigation dam spillway (ft).
6	ZSP	+	Elevation at crest of spillway (ft).
7	ZPMIN	+	Minimum navigation pool elevation (ft) at the dam. This is usually defined in the navigation dam's design manual.

ND (Cont.)

Field	Variable	Value	Description
8	CE	+	d'Aubuisson's contraction coefficient (typical range is 0.6 to 0.9 with 0.8 frequently used for design purposes (Chow 1959, p. 502)).
		-	Known swell head (ft) at the dam.

*Note: The input cross section number (ICS) is determined by the order of X1 Records in the input file.

CP**CP Record - Navigation Dam Control Point - (Optional Record)**

The CP Record defines the location of the control or hinge point for a navigation dam. As with the ND Record, the CP Record can be inserted into the input file in two methods.

(1) The first method is position dependent. A blank CP Record is inserted after the X1 Record at the hinge point location. This record defines the control point for the next ND Record in the input file. This method provides convenient self-documenting input files.

(2) The second method is used when I1IBC is defined on the ND Records i.e., the ND Records are not position dependent. In this case, the CP Record is placed *immediately* before its associated ND Record with NAVCP specified.

CP Records are always associated with the next ND Record in the input file.

Field	Variable	Value	Description
0	ID	CP	Record identification.
1	NAVCP	0	The hinge point is placed at the location defined by the previous X1 Record. CP Record is position dependent.
		+	Input cross section (ICS)* number for location of hinge point. Associated ND Record follows CP Record. CP Record is not position dependent.

*Note: The input cross section number (ICS) is determined by the order of X1 Records in the input file.

UNET Bridge Modeling Tips: The input for bridge modeling with UNET is designed to describe these two approaches:

1. "Normal" meaning that there is an obstruction (bridge deck) described by BT records. This bridge model modifies the cross section geometry table that is used for routine open channel flow computations.
2. "Special" meaning that the bridge is described by BR records, the overflow portion with WD's and the family of rating curves defined by a BL record. This bridge description results in an internal boundary condition.

Refer to Chapter 5 for more information.

BT

BT Record - Bridge Table of Elevations and Stations - (Optional Record)

The BT Record defines the geometry of bridge structures and approach embankments. Bridge calculations are handled by a procedure similar to the normal bridge method in HEC-2. BT Records must appear before the GR Records in a cross section definition. Each BT station must correspond to a GR station. The program eliminates the area between top-of-road and low-chord profile defined by the BT data. If the top-of-road is above the overbank ground profile, the low-chord elevations should be equal to the ground (GR) elevation to fill in the overbank area between road and ground. Also, the top of the roadway must connect to the ground profile (this differs from HEC-2).

Field	Variable	Value	Description
0	ID	BT	Record identification.
1	X	+*	Number of points describing the bridge roadway and low chord to be read on the BT Records. Entered only on first BT Record. The maximum number of points is 600.
2	RSTA(1)	+	Roadway station corresponding to RHEL(1) and RLEL(1).
3	RHEL(1)	+	Top of roadway elevation at station RSTA(1).
4	RLEL(1)	+	Low chord elevation at station RSTA(1).
5	RSTA(2)	+	Roadway station corresponding to RHEL(2) and RLEL(2).

6	RHEL(2)	+	Top of roadway elevation at station RSTA(2).
7	RLEL(2)	+	Low chord elevation at station RSTA(2).
8	RSTA(3)	+	Roadway station corresponding to RHEL(3) and RLEL(3).
9	RHEL(3)	+	Top of roadway elevation at station RSTA(3).
10	RLEL(3)	+	Low chord elevation at station RSTA(3).

*Format for Additional BT Records

Standard format: If X is positive (+) BT data RSTA, RHEL and RLEL is to be input starting in the second and subsequent BT Records, all ten fields are available for data.

Optional format: If X is negative (-) BT data is to be input in the second through the tenth fields of the second and subsequent BT Records, only nine fields are available for data.

BR

BR Record - Special Bridge Computations - (Optional Record)

This record defines the loss parameters pertaining to a bridge crossing. The bridge crossing consists of two parts - the bridge structure, piers, chords, etc., which resists the flow; and the roadway embankment, which acts as a weir. The BR Record is normally used for a crossing where the roadway is overtopped and the embankment blocks a significant portion of the floodplain area; i.e., where the open channel flow equations and the normal bridge procedure (BT Records) do not apply and an internal boundary condition must be inserted. The BR Record sets the parameters and directs that a family of rating curves be defined for the crossing. Following the BR Record, a WD Record can be added to define the weir. Alternatively, the weir profile can be taken from BT Records associated with the prior cross section. A BL Record must follow the BR Record initiating the calculation of the rating curves.

Field	Variable	Value	Description
0	ID	BR	Record identification.
1	YK	+	Yarnell's pier loss coefficient, from 0.9 to 1.25.
2	BWP	+	Total width of the piers.
3	PK	+	Pressure flow loss coefficient, commonly 1.6. (Relative to Eq. 5-5, $PK = (1/K_{pf})^2$.)
4	BELC	+	Bridge entrance loss coefficient for free flow, commonly ranges from 0.3 to 0.6.
5	ZBRLC	+	Low chord elevation.

BR (Cont.)

Values of YK (Yarnell's Pier Loss Coefficient) for various pier shapes [1]

<u>Pier Shape</u>	<u>Coefficient</u>
Semicircular nose and tail	0.9
Lens-shaped nose and tail [2]	0.9
Twin-cylinder piers with connecting diaphragm	0.95
Twin-cylinder piers without diaphragm	1.05
90 deg triangular nose and tail	1.05
Square nose and tail	1.25

- [1] French, R.A., (1985). *Open-Channel Hydraulics*, McGraw-Hill Company, New York, page 396.
- [2] A lens-shaped nose or tail is formed from two circular curves each having a radius of twice the pier width and each tangential to a pier face.

BL

BL Record - Limits on the Bridge Rating Curves - (Optional Record)

The BL Record sets elevation limits on the family of rating curves which are computed for a bridge. The BL Record must follow a BR and WD (if used) Record, otherwise the program will abort.

Field	Variable	Value	Description
0	ID	BL	Record identification
1	ZTW2	+	Maximum tailwater elevation.
		0	Program will select ZTW2 from upstream cross section and weir data.
2	ZHW2	+	Maximum headwater elevation.
		0	Program will select ZHW2 from upstream cross section and weir data.
3	SHMAX	+	Maximum swell head expected across the roadway for roadway crossings.

CA, CECA or CE Records - Arch or Elliptical Culverts - (Optional Record)

The CA (CE) Record is used to define an arch (elliptical) type culvert. One record defines one culvert. Up to five culverts defined on CA, CE, CB or CC Records may be entered for each road crossing, with the culvert record(s) immediately following the cross section records (X1 and GR). A WD Record may follow the culvert records to define the weir overflow parameters associated with the roadway crown. A CL Record must follow the culvert(s) and weir records to define elevation limits of the computed culvert rating tables and to end the culvert sequence.

Field	Variable	Value	Description
0	ID	CA or CE	Record identification.
1	RISE	+	Maximum culvert height (ft).
2	SPAN	+	Maximum culvert width (ft).
3	ZIN	+	Upstream invert elevation (ft).
4	ZOUT	+	Downstream invert elevation (ft).
5	CLEN	+	Barrel length (ft).
6	CN	+	Manning's n value.
7	ICCOEFF	+	UNET index No. for culvert loss coefficient type.
8	IQDIR	0	Flow can go in both directions through the culvert.
		+1	Flow can only go in the positive flow direction.
		-1	Flow can only go in the negative flow direction.
9 - 10			Blank fields.

CB

CB Record - Box Culverts - (Optional Record)

The CB Record is used to define a box type culvert. One CB Record defines one culvert. Up to five culverts defined on CA, CE, CB or CC Records may be entered for each road crossing, with the culvert record(s) immediately following the cross section records (X1 and GR). A WD Record may follow the culvert records to define the weir overflow parameters associated with the roadway crown. A CL Record must follow the culvert(s) and weir records to define elevation limits of the computed culvert rating tables and to end the culvert sequence.

Field	Variable	Value	Description
0	ID	CB	Record identification.
1	RISE	+	Maximum culvert height (ft).
2	SPAN	+	Maximum culvert width (ft).
3	ZIN	+	Upstream invert elevation (ft).
4	ZOUT	+	Downstream invert elevation (ft).
5	CLEN	+	Barrel length (ft).
6	CN	+	Manning's <i>n</i> value.
7	ICCOEFF	+	UNET Index No. for culvert loss coefficient type.
8	IQDIR	0	Flow can go in both directions through the culvert.
		+1	Flow can only go in the positive flow direction.
		-1	Flow can only go in the negative flow direction.
9 - 10			Blank fields.

CC

CC Record - Circular Culverts - (Optional Record)

The CC Record is used to define a circular type culvert. One CC Record defines one culvert. Up to five culverts defined on CA, CE, CB or CC Records may be entered for each road crossing, with the culvert record(s) immediately following the cross section records (X1 and GR). A WD Record may follow the culvert records to define the weir overflow parameters associated with the roadway crown. A CL Record must follow the culvert(s) and weir records to define elevation limits of the computed culvert rating tables and to end the culvert sequence.

Field	Variable	Value	Description
0	ID	CC	Record identification.
1	DIA	+	Culvert diameter (ft).
2	ZIN	+	Upstream invert elevation (ft).
3	ZOUT	+	Downstream invert elevation (ft).
4	CLEN	+	Barrel length (ft).
5	CN	+	Manning's n value.
6	ICCOEFF	+	UNET Index No. for culvert loss coefficient type.
7	IQDIR	0	Flow can go in both directions through the culvert.
		+1	Flow can only go in the positive flow direction.
		-1	Flow can only go in the negative flow direction.
8 - 10			Blank fields.

Culvert Loss Types					
UNET	Culvert	Inlet	Entrance	FWHA	FWHA
Index No.	Type	Characteristics	Loss Coef.	Chart No.	Nomo. No.
1	Circular concrete	Square edge with headwall	0.5	1	1
2		Groove end with headwall	0.2	1	2
3		Groove end projecting	0.2	1	3
4	Circular CMP	Headwall	0.5	2	1
5		Mitered to slope	0.7	2	2
6		Projecting	0.9	2	3
7	Circular CMP	Beveled ring, 45 deg. bevels	0.2	3	a
8		Beveled ring, 33.7 deg.	0.2	3	b
9	Rectangular Box	30 deg. to 7 wingwall flares	0.4	8	1
10		90 deg. to 15 deg. wingwall flares	0.4	8	2
11		0 deg. wingwall flares	0.7	8	3
12	Rectangular Box	45 deg. wingwall flared= .043D	0.2	9	1
13		18 deg. to 33.7 deg. wingwall flare d=.083D	0.2	9	2
14	Rectangular Box	90 deg. headwall with 3/4in. chamfers	0.5	10	1
15		90 deg. headwall with 45 deg. bevels	0.2	10	2
16		90 deg. headwall with 33.7 deg. bevels	0.2	10	3
17	Rectangular Box	3/4" chamfers; 45 deg. skewed headwall	0.5	11	1
18		3/4" chamfers; 30 deg. skewed headwall	0.5	11	2
19		3/4" chamfers; 15 deg. skewed headwall	0.5	11	3
20		45 deg. bevels; 10-45 deg. skewed headwall	0.2	11	4
21	Rectangular Box 3/4" Chamfers	45 deg. non-offset wingwall flares	0.4	12	1
22		18.4 deg. non-offset wingwall flares	0.5	12	2

Culvert Loss Types (Continued)					
UNET	Culvert	Inlet	Entrance	FWHA	FWHA
Index No.	Type	Characteristics	Loss Coef.	Chart No.	Nomo. No.
23	Rectangular Box 3/4" Chamfers	18 4 deg non-offset wingwall flares; 30 deg skewed barrel	0.5	12	3
24	Rectangular Box Top Bevels	45 deg wingwall flares-offset	0.4	13	1
25		33.7 deg wingwall flares-offset	0.4	13	2
26		18 4 deg wingwall flares-offset	0.5	13	3
27	CM Boxes	90 deg headwall	0.5	16-19	1
28		Thick wall projecting	0.5	16-19	2
29		Thin wall	0.5	16-19	3
30	Horizontal Ellipse Concrete	Square edge with headwall	0.5	29	1
31		Groove end with headwall	0.2	29	2
32		Groove end projecting	0.2	29	3
33	Vertical Ellipse Concrete	Square edge with headwall	0.5	30	1
34		Groove end with headwall	0.2	30	2
35		Groove end projecting	0.2	30	3
36	CM Pipe Arch 18" Corner Radius	90 deg headwall	0.5	34	1
37		Mitred to slope	0.7	34	2
38		Projecting	0.9	34	3
39	CM Structural Plate Pipe Arch 18" Corner Radius	Projecting	0.9	35	1
40		No bevels	0.7	35	2
41		33.7 deg bevels	0.2	35	3
42	CM Pipe Arch 31" Corner Radius	Projecting	0.9	36	1
43		No bevels	0.7	36	1
44		33.7 deg bevels	0.2	36	2

Culvert Loss Types (Continued)					
UNET Index No.	Culvert Type	Inlet Characteristics	Entrance Loss Coef.	FWHA Chart No.	FWHA Nomo. No.
45	Arch CM	90 deg. headwall	0.5	40-42	1
46		Mitered to slope	0.7	40-42	2
47		Thin wall projecting	0.9	40-42	3
48	Circular	Smooth tapered inlet throat	0.2	54	1
49		Rough tapered inlet throat	0.2	54	2
50	Elliptical Inlet Face	Tapered inlet-beveled edges	0.2	55	1
51		Tapered inlet-square	0.2	55	2
52		Tapered inlet-thin edge projecting	0.2	55	3
53	Rectangular	Tapered inlet throat	0.2	56	1
54	Rectangular Concrete	Side tapered-less favorable edges	0.2	57	1
55		Side tapered-more favorable edges	0.2	57	2
56	Rectangular Concrete	Side tapered-less favorable edges	0.2	58	1
57		Slope tapered-more favorable edges	0.2	58	1

CL**CL Record - Limits of Culvert Rating Tables - (Optional Record)**

The CL Record is used to define tailwater and pool (headwater) elevations required to compute a series of rating curves used to solve for culvert flow. The CL Record is placed at the end of each culvert sequence. If the CL Record is blank, CSECT determines the limits from the upstream cross section. However, the user must ensure that the cross section table limits encompass the anticipated maximum and minimum water surface elevation.

Field	Variable	Value	Description
0	ID	CL	Record identification.
1	NTW	+	Number of tailwater elevations (maximum of 50).
		0	Default of 50 is used.
2	NP	+	Number of pool elevations (maximum of 50).
		0	Default of 50 is used.
3	ZTW1	+	Starting tailwater elevation (ft).
		0	D/S invert plus 0.15*RISE.
4	ZTW2	+	Final tailwater elevation (ft).
		0	From U/S cross section.
5	ZHW1	+	Starting headwater elevation (ft).
		0	U/S invert plus 0.15*RISE.
6	ZHW2	+	Final headwater elevation (ft).
		0	From U/S cross section.
7 - 10			Blank fields.

RI

RI Record - Culvert Riser - (Optional Record)

The RI Record defines a riser discharge structure. The structure consists of from 1 to 5 riser pipes and an optional overflow weir which is defined by a WD Record. The data input for the structure is ended with the RL Record.

Field	Variable	Value	Description
0	ID	RI	Record identification.
1	DIA	+	Culvert diameter in feet.
2	ZIN	+	Upstream invert elevation.
3	ZOUT	+	Downstream invert elevation.
4	CLEN	+	Barrel length in feet.
5	CN	+	Manning's n value.
6	ICCOEF	+	UNET Index No. for culvert loss coefficient type
7	CRISER	+	Riser discharge coefficient.
8	ZRISER	+	Elevation of the culvert riser.
9	RISERL	+	Perimeter of Riser opening (used as a weir length).

BD**BD Record - Bleeder Structure for a Riser - (Optional Record)**

The BD Record associates a bleeder with a riser pipe, RI Record. The BD Record should be placed immediately before the RI Record.

Field	Variable	Value	Description
0	ID	BD	Record Identification.
1	IBLTYP	1	Triangular notch.
		2	Rectangular notch.
		3	Triangle.
		4	Rectangle.
		5	Circle.
2	ZBLINV	+	Invert of Bleeder.
3	HBL	+	Height of Bleeder.
4	WBL	+	Width of Bleeder.
5	CBL	+	Bleeder discharge coefficient.

RL

RL Record - Riser Limits - (Optional Record)

The RL Record defines the limits of the family of free and submerged rating curves for a riser. This record is required when using an RI Record.

Field	Variable	Value	Description
0	ID	RL	Record identification.
1	NTW	+	Number of tailwater elevations.
		0	Assume 50.
2	NP	+	Number of pool elevations.
		0	Assume 50.
3	ZTW1	+	Starting tailwater elevation.
4	ZTW2	+	Final tailwater elevation.
5	ZHW1	+	Starting headwater elevation.
6	ZHW2	+	Final headwater elevation.

DI**DI Record - Drop Inlet for Culvert - (Optional Record)**

The DI Record inserts a drop inlet structure before a culvert. The DI Record, if used, must precede a CC, CB, or CA Record.

Field	Variable	Value	Description
0	ID	DI	Record identification.
1	ZDI	+	Elevation of crest of drop inlet.
2	WDI	+	Width of drop inlet.
3	CDI	+	Weir Coefficient of drop inlet structure (usually 3 - 4).
4	EXDI	+	Exponent for drop inlet equation (usually 1.5).

WD

WD Record - Uncontrolled Overflow Weirs - (Optional Record)

The WD record defines the overflow weir; it is only used in conjunction with a structure such as a bridge, culvert, navigation dam, etc. An inline weir must be modeled using the RW or SP (if gates are involved) records. The weir can be associated with the spillway (SP), lateral spillway (LA and LS), navigation dam (ND), culvert crossing (CC, CB, CA, and CE), and bridge crossing (BR) interior boundary conditions. The WD record cannot stand by itself; it must be associated with another structure type. The weir can be defined as set of horizontal weir segments or as an overflow profile. The WD Record should immediately follow the appropriate set of the above records in the CSECT input file.

Horizontal Weir Segments

Field	Variable	Value	Description
0	ID	WD	Record Identification.
1	NW	+	Number of weir segments, up to 25, that are entered on successive WD cards.
2	CW	+	Weir flow coefficient.
3, 5, ...	ZW(l)	+	Elevation of horizontal weir segment l.
4, 6. ...	WL(l)	+	Width of horizontal weir segment l.

Weir Profile

Field	Variable	Value	Description
0	ID	WD	Record Identification.
1	NW	-	Negative number of weir points, up to 25, that are entered on successive WD cards. Entering the number of points as a negative number differentiates the entry of the profile from the entry of the entry of weir segments.
2	CW	+	Weir flow coefficient.

3, 5, ...	ZW(I)	+	Elevation of horizontal weir point I.
4, 6. ...	STAW(I)	+	Station of weir point I.

*Note: For flow over a typical bridge deck, a weir coefficient of 2.6 is recommended. A weir coefficient of 3.0 is recommended for flow over elevated roadway approach embankments. A good reference for weir coefficients is Brater and King, 1976. *Handbook of Hydraulics*, McGraw-Hill.

SC

SC Record - Special Connections Between Storage Areas and Channels to Storage Areas - (Optional Rec.)

The SC Record redefines the connections for the next SP, RI, CC, CA, CB, and RW Records. The SC Record allows a spillway, a culvert, or a weir to be placed between two storage areas. Note that the numbers of the storage areas must be entered as negative numbers. The SC Record can also be used to connect a spillway, culvert, or weir from a cross section to a storage area. The SC Record must be placed immediately after the cross section that is to be connected to the storage area.

Field	Variable	Value	Description
0	ID	SC	Record identification.
1	ISA1	0	Upstream cross section will be used.
		-	Storage area number to connect from.
2	ISA2	-	Storage area number to connect to.

RF**RF Record - Free Flow Rating Curves - (Optional Record)**

Some hydraulic structures may need to be modeled by one or more rating curves which describe unsubmerged flow, submerged flow, or some combination of both.

The RF Record is used to describe a free flow (unsubmerged) rating curve. This curve may or may not be linked with a family of submerged flow rating curves (RS Records), where each submerged curve is associated with a unique tailwater elevation. A maximum of fifty points are allowed per curve.

Field	Variable	Value	Description
0	ID	RF	Record identification.
1	NSTRY	0	Hydraulic structure is described by free flow only.
		+	Number of submerged flow rating curves to be used with the free flow curve (maximum of fifty). These submerged flow curves are described on RS Records immediately following the RF Record.
2	NPRCF	+	Number of points on the free flow rating curve (maximum of fifty).
3,5,7,9	ZHRCF(I)	+	Headwater elevation (ft).
4,6,8,10	ORCF(I)	+	Discharge value (ft ³ /sec) at ZHRCF(I).

Note 1: Points 5 through 50 should be entered on a subsequent RF Records in fields 1 through 10.

Note 2: When an RF Record is read, the interpolated cross section routine is turned off at the current input cross section. This is done to avoid numerical problems related to having interpolated cross sections through an internal boundary condition, such as a lateral spillway. If interpolated cross sections are being used, the user should enter another XK or XI Record downstream of the internal boundary condition.

RS

RS Record - Submerged Flow Rating Curves - (Optional Record)

The RS Record is used to define submerged flow rating curves. RS Records immediately follow RF Records, which describe a free flow rating curve. CSECT is dimensioned for fifty submerged rating curves, each one having a maximum of fifty elevation-discharge points. Refer to the input description for the RF Record for details on the relation between free and submerged rating curves.

Field	Variable	Value	Description
0	ID	RS	Record identification.
1	NPSUB	+	Number of points on the rating curve (maximum of fifty).
2	ZTSUB	+	Tailwater elevation (ft).
3,5,7,9	ZHSUB(I)	+	Headwater elevation (ft).
4,6,8,10	OSUB(I)	+	Discharge value (ft ³ /sec) at ZHSUB(I).

Note: Points 5 through 50 should be entered on a subsequent RS Record in fields 1 through 10. The number of submerged rating curves following a RF Record is defined by NSTRY in field 1 on the RF Record.

RW**RW Record - Weir Flow Rating Curves - (Optional Record)**

The RW Record is used to define parameters which describe a cross-channel weir as a internal boundary condition. The record should be inserted between the upstream and downstream cross sections which bound the weir. The weir is assumed to coincide with the upstream cross section. UNET uses a weir flow equation to compute a free flow rating curve. Up to four overflow sections can be input to define the weir. If the computed tailwater elevation is greater than the corresponding rating curve elevation for a given discharge i.e., submerged flow conditions exist, the rating curve is released and the unsteady flow solution continues across the weir. When the tailwater elevation falls below the rating curve, the rating curve is once again applied in the computations.

Field	Variable	Value	Description
0	ID	RW	Record identification.
1	NSEG	+	Number of weir segments.
2	CWEIR	+	Weir discharge coefficient (typical range is 2.5 - 3.4)
3,5,7,9	ZWEIR	+	Weir crest elevation (ft).
4,6,8,10	WEIRL	+	Weir length (ft).

RC

RC Record - Rating curve at a Cross Section (Optional Record)

Computes a free flow rating curve at the upstream cross section assuming the given slope, using Manning's Equation or a weir equation assuming piecewise weir segments between the cross section points. For Manning's Equation, the area and conveyance properties computed by CSECT are used. If the cross section is entered as top widths, (the TC, TV, etc. cards), the weir computation will not work. If the computed tailwater stage plus the swell head from the submerged head loss factor is greater than the rating curve elevation, the rating curve is released and the solution is continued using the full unsteady flow equations. When the tailwater stage falls below the rating curve, the rating curve once again controls.

Field	Variable	Value	Description
0	ID	RC	Record identification.
1	S0	+	Friction slope (ft/ft) for Manning's equation.
		0	When using weir equation.
2	CW	+	Weir coefficient for weir equation.
		0	When using Manning's equation.
3	ALPHA	+	Submerged head loss coefficient (0.8 is reasonable).
		0	When using Manning's equation.

LR**LR Record - Lateral Outflow Rating Curve - (Optional Record)**

The LR Record is used to enter a rating curve of head versus discharge to define a lateral outflow at the previous cross section defined on an X1 Record. If NLSCON is left blank or zero, water flows out of the system and is lost to the model. Alternatively, an input cross section (ICS) number can be entered to define a connection to another reach. An example use of the LR Record is where gated culverts are used to provide flow out of a channel into adjacent lands which are not modeled in the system.

Field	Variable	Value	Description
0	ID	LR	Record identification.
1	NLSCON	0	Lateral outflow occurs at the location defined by the previous X1 Record in the input file. Water is diverted out of the system being modeled.
		+	Input cross section (ICS) number connected to the lateral outflow. Water is diverted from this point to another within the model. <u>Do not attempt to connect a lateral outflow to a storage area.</u>
2	NPRCF	+	Number of points on the rating curve (maximum of 50).
3,5,7,9	ZHRCF(I)	+	Head (ft) at upstream side of lateral outflow.
4,6,8,10	QRCF(I)	+	Discharge (ft ³ /sec) at ZHRCF(I).

Note: The input cross section number (ICS) is determined by the order of X1 Records in the input file.

FA

FA Record - Use of Exponential Equations Rather than a Family of Rating Curves - (Optional Record)

The FA Record directs that exponential equations rather than a family of rating curves be used for bridge and culvert interior boundary conditions. The FA Record should be placed before the culvert or bridge records. If the FA Record is not used, the culvert and bridge routines use a family of rating curves to calculate the head loss for submerged and free flow situations. The family of rating curves should normally be used. Commonly, the exponential curve fit exhibits large errors for situations, such as at multiple culverts, where the inlet elevations are substantially different.

Field	Variable	Value	Description
0	ID	FA	Record Identification
1	LFAMILYRC	ON	Start using the family of rating curves (default).
		OFF	Start using exponential equations (not recommended).

COCO Record - Combine Families of Rating Curves

The CO Record directs that families of rating curves be combined together. Families of rating curves which are in close proximity can oscillate one against the other. An example is two sequential culverts that span a dual lane highway. To eliminate the oscillations, the CO card directs that the families of rating curves be combined into a single set into a single set. The combination is started at the "COMBINE START" and ended at "COMBINE END," which are placed before the upstream bounding cross section and after the downstream bounding cross section, respectively. All of the interior cross sections (between the bounding cross sections) are included in the rating curves; therefore, these cross sections are not a part of the computations. An HY Record within the interior cross sections will produce unpredictable results. The parameters ON and OFF are entered in free format; they can appear anywhere in the record.

Field	Variable	Value	Description
0	ID	CO	Record identification.
1	CCO	START	Combine rating curves.
		OFF	Do not combine rating curves.

Example

For example consider the following culvert crossing for a dual lane highway:

```

.
.
.
X1    1
GR
COMBINE ON
X1    2
HY
GR
* FIRST CULVERT
CC
CC
WD
CL
X1    3          The two culverts and cross sections 3,4,

```

CO (Cont.)

GR and 5 are combined into a single set of rating
X1 4 curves between cross sections 2 and 6.

X1 5

GR

* SECOND CULVERT

CB

WD

CL

X1 6

HY

GR

COMBINE OFF

.
. .
.

PDPD Record - Pumped Diversion - (Optional Record)

The pumped diversion diverts water from one channel or storage area and inserts the water into another channel or storage area. Up to 10 pumps may be specified. Pumps should be entered by increasing starting elevation.

Field	Variable	Value	Description
0	ID	PD	Record identification.
1	IRCH1	+	Reach from which water will be diverted.
		0	For Storage Areas.
2	RMILE1	+	River mile from which water will be diverted.
		-	Storage Area Number to divert water from.
3	IRCH2	+	Reach that will receive water.
		0	For Storage Areas.
4	RMILE2	+	River mile that will receive water.
		-	Storage Area Number to divert water to.
5	NPUMP	+	Number of pumps.
6	ZPUMP(1)	+	Elevation when pump is stopped.
7	ZPUMPO(1)	+	Elevation when pump is started.
8	QPUMP(1)	+	Pump capacity.
9	ZPUMP(2)	+	Elevation when second pump is stopped.
10	ZPUMPO(2)	+	Elevation when second pump is started.
1	QPUMP(2)	+	Capacity of second pump. This value is placed on a second PD Record.
etc..	etc..	+	Continue in fields of subsequent PD Records for up to 10 pumps.

TN

TN Record - Circular Tunnel

The TN Record defines the basic circular tunnel geometry and the associated Darcy-Weisbach roughness parameters. Under low flow, a circular section has a large width to depth ratio. Hence, negative depths can be computed. The pilot channel redefines the shape of the tunnel invert into a rectangular shape which has better computation properties. The total area and conveyance are unaffected above 0.25 of the total depth.

Field	Variable	Value	Description
0	ID	TN	Record identification.
1	DIA	+	Tunnel diameter.
2	ZMN	+	Tunnel invert elevation.
		0	Use SLOPE to calculate ZMN.
3	BULKI	+	Bulk modulus for water, usually, 43.2×10^6 lbs per ft ² .
		0	Assume 43.2×10^6 lbs per ft ² .
4	DZ	+	Slope in ft. per mile. Compute ZMN from the minimum elevation of the past cross section, the slope, and the distance.
		0	Use ZMN.
5	ROUGH	+	Darcy-Weisbach grain roughness in feet.
		0	Use current Manning's <i>n</i> value.
6	PPCH	+	Fraction of the total tunnel area to be reallocated into a pilot channel.
7	HPCH	+	Depth of the pilot channel.
8	PCHN	+	Manning's <i>n</i> value for pilot channel.
9			Not used.
10	NTUNNEL	+	Number of parallel tunnels.

TB**TB Record - Rectangular Tunnel**

The TB Record defines the basic rectangular tunnel geometry and the associated Darcy-Weisbach roughness parameters. Under low flow, a rectangular section has a large width to depth ratio. Hence, negative depths can be computed. The pilot channel redefines the shape of the tunnel invert into a rectangular shape which has better computation properties. The total area and conveyance are unaffected above 0.25 of the total depth.

Field	Variable	Value	Description
0	ID	TB	Record identification.
1	HEIGHT	+	Tunnel height.
2	WIDTH	+	Tunnel width.
3	ZMN	+	Tunnel invert elevation.
		0	Use SLOPE to calculate ZMN.
4	BULKI	+	Bulk modulus for water, usually, 43.2×10^6 lbs per ft ² .
		0	Assume 43.2×10^6 lbs per ft ² .
5	DZ	+	Slope in ft. per mile. Compute ZMN from the minimum elevation of the past cross section, the slope, and the distance.
		0	Use ZMN.
6	ROUGH	+	Darcy-Weisbach grain roughness (in feet).
		0	Use current Manning's <i>n</i> value.
7	PPCH	+	Fraction of the total tunnel area to be reallocated into a pilot channel.
8	HPCH	+	Depth of the pilot channel.
9	PCHN	+	Manning's <i>n</i> value for pilot channel.
10	NTUNNEL	+	Number of parallel tunnels.

TE

TE Record - Elevations for Top Width Table

Input elevations for a top width table. A maximum of twenty elevations can be input.

Field	Variable	Value	Description
0	ID	TE	Record identification.
1, 2, 3, ...	EL(I)	+	Ground elevation.

TC

TC Record - Channel Top Widths

Input the top widths of the channel. The top widths must correspond to the elevations on the TE Record.

Field	Variable	Value	Description
0	ID	TC	Record identification.
1, 2, 3, ...	TWCH(I)	+	Channel top width.

TLTL Record - Top Width of Left Overbank

Input top widths of the left overbank. The top widths must correspond to the elevations on the TE Record. This record is not required for a top width table.

Field	Variable	Value	Description
0	ID	TL	Record identification.
1, 2, 3, ...	TWL(I)	+	Top width of the left overbank.

TRTR Record - Top Width of Right Overbank

Input top widths of the right overbank. The top widths must correspond to the elevations on the TE Record. This record is not required for a top width table.

Field	Variable	Value	Description
0	ID	TR	Record identification.
1, 2, 3, ...	TWR(I)	+	Top width of the right overbank.

TS

TS Record - Top Width of Storage Region

Input top widths of the storage region. The top widths must correspond to the elevations on the TE Record. This record is required for a top width table and starts the computation of cross-sectional properties.

Field	Variable	Value	Description
0	ID	TS	Record identification.
1, 2, 3, ...	TWL(I)	+	Top width of the left overbank.

SF**SF Record - Simple Embankment Failure**

The SF Record defines a failure of an embankment using a linear routing failure algorithm (simple connection). The SF Record may be between a reach and a storage cell and between two cells. Positive flow is from ICONN1 to ICONN2. The input fields define the connections, the elevation when the embankment is to fail, the invert elevation of the breach, the linear routing factors, and the type of failure. The embankment restores itself when the elevation of the water surface falls below the invert elevation of the breach.

Field	Variable	Value	Description
0	ID	SF	Record identification.
1	ICONN1	Blank	Connect to the last cross section entered.
		-	User defined storage cell number.
2	ICONN2	-	User defined storage cell number.
3	ZFAIL	+	Water surface elevation when the embankment is to fail.
4	ZBRINV	+	Elevation of the breach invert. The embankment is repaired when the water surface falls below ZBRINV.
5	CINLV	+	Linear routing constant for flow from ICONN1 to ICONN2. The units of CINLV are fraction of the total available volume per hour.
6	COU TLV	+	Linear routing constant for flow from ICONN2 to ICONN1. The units of COU TLV are fraction of the total available volume per hour.
7	DTFAIL	+	After the failure, the time in which the routing constant will increase to its full value. By increasing the routing constant from 0 to its full value over DTFAIL hours, the enlargement of a breach is approximated.
		0	Use the full value of the linear routing factor at the time of failure.

SF (Cont.)

Field	Variable	Value	Description
8	DTFILL	+	The time to fill the interior storage. The interior storage of the connecting cell is filled in DTFILL hours after failure. DTFILL cannot be specified in conjunction with DTFAIL.
		0	Use linear routing.

EF**EF Record - Embankment Failure**

The EF Record inserts an embankment failure between two cross sections (inline); or between a reach and a storage cell; or between two storage cells. The flow is computed using hydraulic equations - a weir equation for open channel flow and an orifice equation for flow through a pipe in the embankment. The hydraulic calculation is in contrast to the SF Record which simulates a failure using a simple spillway type of flow calculation. When the embankment failure is between cross sections, the EF Record must be associated with an in-line internal boundary condition such as a spillway (SP), a culvert crossing, riser pipe, or a weir. The EF Record requires an SC record when used between a reach and a cell, or between cells. Or it can follow another interior boundary condition in which case the flow is added to the flow from the inline IBC.

Field	Variable	Value	Description
0	ID	EF	Record identification.
1	ZFAIL	+	Elevation when the embankment failure is to commence.
2	ZBREACH	+	Starting elevation of the pipe through the embankment.
3	ZBRINV	+	Final elevation of the breach invert.
4	ZCROWN	+	Elevation of the top of the embankment.
5	COEF	+	Orifice flow coefficient for a piping breach (a typical value is 0.6).
		0	For overtopping breaches.
6	CWEF	+	Weir flow coefficient for an overtopping breach.
7	BRWIDTH	+	Maximum width of the breach invert.
		0	For a triangular breach.
8	DFAIL	+	Time in hours for a breach to enlarge to its maximum width (BRWIDTH) and its final invert elevation (ZBRINV).

EF (Cont.)

Field	Variable	Value	Description
9	EFSS	+	Vertical rise per unit of horizontal distance (slope of sides of breach). (vertical/horizontal)
		0	Vertical side slopes.

Examples of use of the EF are:

SA1 to SA2 –

SC -1 -2
EF

RM to SA2 –

SC -2
EF

Special case – with an inline IBC such as SP –

SP
EF

INCLUDE FILES

When a large number of levee systems are connected to a river model (say ten or more), the data that describe the cell definitions and levee connections may interfere with the readability of the cross section geometry. The UNET system incorporates the use of include files to ease this data situation. After cross section geometry has been entered, include files can be specified via the IS Record. The include files provide the following functions:

- Define cells using the RE, SA, SV (optional) and HS Records.
- Define simple levee failures; RE and SF Records.
- Define embankment failures using RE, SC, and EF Records.
- Define culvert cell connections using RE, SC, CC, CB, CE, CA, WD and CL.
- Define riser pipe connections using RE, SC, RI, WD, and RL Records.
- Define gated spillway connections using RE, SC, SP, and WD Records.

Two notes regarding the above input data. The RE Record defines the reach number and the cross section river mile (SECNAM on the X1 Record) that the cell or connection is attached to. An RE Record must precede every cell definition and connection. The SC (special connection) Record defines the connection from reach to cell and from cell to cell for different types of flow connections.

Table B-1 shows the include file that defines the Columbia and Harrisonville Levees. The levee storage is defined on the SA Record and the levee breaches on the SF Records. The RE Record defines the reach and cross section location of the levee and storage connections.

As shown on Table B-2, the IS Records are located at the end of the cross section (.CS) file, after the reach and cross section data. The sole parameter on the IS Record is the name of the include file.

NOTE: Include files must have the extension .INC.

Table B-1
Contents of the Include File MISSLV.INC referred to in Table B-2

*

* Columbia

*

RE 7 166.00
SA -112 13560. 395.10
HS Columbia - Cell -112

*

*

RE 7 165.00
SF -112 418.00 410.00 .150 .150 .0 30.0 .0

*

*

RE 9 156.50
SF -112 418.00 410.00 .050 .050

*

* Connection between Columbia and Harrisonville

RE 9 156.50
SF -112 -113 410 390 .10 .10 24

*

*

* Harrisonville, FT. Chartres, and Stringtown

*

RE 9 156.30
SA -113 46700. 390.10
HS Harrisonville - Cell -113

*

*

RE 9 130.90
SF -113 402.00 379.29 .060 .060 24 .0 .0

*

*

Table B-2
CSECT file reference to the Include File MISSLV.INC

X1	0.0	77	1582	4250						
GR	336	0	335	56	350	56	350	76	335	76
GR	330	280	350	280	350	300	330	300	323	500
GR	350	504	350	524	320	524	320	600	315	728
GR	350	728	350	748	315	748	316	952	350	952
GR	350	972	320	972	320	1176	350	1176	350	1196
GR	320	1196	315	1561	350	1561	350	1581	315	1582
GR	290	1950	288	2011	350	2011	350	2031	288	2031
GR	284	2200	264	2300	263	2461	350	2461	350	2481
GR	262	2481	265	2650	260	2850	272	3161	350	3161
GR	350	3181	272	3181	270	3611	350	3611	350	3631
GR	270	3631	275	4000	280	4061	350	4061	350	4081
GR	290	4081	320	4250	320	4446	350	4446	350	4466
GR	320	4466	320	4502	350	4502	350	4522	320	4522
GR	320	4726	350	4726	350	4746	320	4746	320	4900
GR	318	4950	350	4950	350	4970	317	4970	310	5400
GR	327	5450	336	5451						

DB

*

* INCLUDE FILE FOR MISSOURI RIVER CROSSOVER

*

IS CROSS.INC

*

* ILLINOIS RIVER LEVEES

*

IS ILRLV.INC

*

* MISSOURI RIVER LEVEES

*

IS MOLV2.INC

*

* MISSISSIPPI RIVER LEVEE SYSTEMS

*

IS MISSLV.INC

EJ

Appendix C

UNET Input Data Description

Table of Contents

Section	Record	Page
<u>General Description of Input Data</u>		C-1
<u>Job Control Records</u>		
	Title Lines (required) and Comments	C-2
	Job Control (required).....	C-3
	Individually Defined Parameters	C-5
	Time Window	C-8
	End of Job	C-9
<u>DSS Interface Control</u>		
	Open DSS File	C-10
	Close DSS File.....	C-11
	Write Hydrographs to DSS	C-12
<u>Initial Conditions</u>		
	Initial Flow Distribution	C-13
	Initial Storage Area Elevation.....	C-14
	Read Initial Conditions File.....	C-15
<u>Upstream Boundary Conditions</u>		
	Upstream Flow or Stage Hydrograph	C-16
	Upstream Stage and Flow Hydrograph.....	C-18
	Critical Upstream Boundary	C-19
<u>Downstream Boundary Conditions</u>		
	Downstream Flow Hydrograph.....	C-20
	Downstream Stage Hydrograph	C-21
	Downstream Stage and Flow Hydrograph	C-22
	Downstream Rating Curve.....	C-24
	Downstream Manning's Equation	C-25
	Pump Station as a Downstream Boundary Condition.....	C-26
<u>Internal Boundary Conditions</u>		
	Lateral Inflow Hydrograph.....	C-27
	Uniform Lateral Inflow Hydrograph.....	C-29
	Critical Lateral Inflow.....	C-31
	Interflow between a Groundwater Reservoir and a River.....	C-32
	Time Series of Gate Openings	C-33
	Elevation Controlled Gate	C-34
	Observed Stage Internal Boundary Condition	C-35
	Observed Stage and Flow Internal Boundary Condition	C-36
<u>Calibration Options</u>		

Conveyance Change Factors..... C-38
Discharge - Conveyance Relation..... C-39
Seasonal Conveyance Adjustment..... C-40

General Description of Input Data

The input file which controls the UNET program consists of several data types. These data define job control parameters, initial and boundary conditions, simulation and forecast times, hydrograph specifications, and many other physical conditions specific to each application. Each data type consists of two parts; a leading command line which must be left justified, and parameter variables on following line(s) entered in free format (a comma or blanks between data values).

Certain significant characters must appear in the UNET command lines. In the following documentation, these characters are underlined. Additional text further identifying the data type may appear anywhere in the remainder of the command line. First time users should enter the command lines as shown. With experience, editing can be added to provide improved documentation and appearance of data files. Additional comment lines may be added by entering an asterisk (*) in the first column of the line.

Except as noted, data do not have to be entered in any particular order. Not all data items are required for each UNET execution. Only the titles, job control, initial and boundary conditions, and end job sets are required. Other sets are optional and should be included as required.

Appendix D presents example problems which illustrate the use of many of the basic input data types. It is suggested that the extensions .BC and .BCO be used when naming the input and output files for UNET.

Title Lines (required) and Comments

Both title and comment lines are denoted by an asterisk (*) in column 1. UNET requires that the first three lines of the input file be title lines. Title lines are used by various routines for identification and documentation purposes. Comment lines can appear anywhere else in the file (except within a block of data). Title and comment lines may contain any alphanumeric text up to 80 characters in length, including the asterisk in column 1.

The first and second title lines are used as headings in the UNET output file. The third line can be used to control the F part of DSS pathnames for hydrographs and profiles written by the TABLE program. If the capitalized string SIMULATION appears anywhere on the line, the F part of the DSS pathname will be written as the string COMPUTED. In all other cases, the F part will be written as the first 20 characters of the line.

When using DSS input items, do not use “/” or “\” as a character in the pathname.

Example:

- * Project Title
- * Username, Location, Date, Filename
- * SIMULATION (limited to 20 characters for the F part of the HEC-DSS pathname)

Job Control (required)

This data record directs the flow and numerics of the program. Depending on the computer system, the logical constants T and F may or may not need to be surrounded by periods. A total of 78 characters (including blanks) is read.

Command Line: IOB CONTROL

Variables: IPRINT, PZMX, DT, TSP, PT, TLEVEE, THETA, STORGE, DPRINT, TWIC, TABINC

Variable	Value	Description
IPRINT	T	Print initial conditions (default = TRUE).
	F	Do not print initial conditions.
PZMX	T	Calculate maximum water surface profile and write results to HEC-DSS (default = TRUE).
	F	Do not compute water surface profile.
DT	+	Time step size in hours (default = 1). This can also be specified as an HEC-DSS interval; i.e., 1MIN, 10MIN, 1HOUR, 6HOUR, etc. DT must be a multiple of minutes and less than or equal to 24 hours.
TSP	0	Not used. Enter zero.
PT	+	Time interval of instantaneous flow and elevation profiles to be written to DSS (Time interval in hours).
	0, -	No profiles are written to DSS (default).
TLEVEE	T	Levee routines are enabled for the computations (default).
	F	Disable levee routines.
THETA	0.6-1.0	Implicit weighting factor (default = 1, 0.6 is recommended, see Note 1).
STORGE	T	Storage accounting for the simulation will be reported at the end of the UNET output.
	F	No storage accounting (default).

Job Control (continued)

Variable	Value	Description
DPRINT	T	At each time step, write flow and stage data at hydrograph nodes to the UNET output file. These nodes are defined by HY Records in the CSECT geometry input file (default = T). Also write status of spillway structures. This option can make the output file quite large, and should be turned off once an application has been debugged.
	F	Do not write trace information to output file.
TWIC	+	Time, in hours, after the beginning of this simulation at which flow and stage at each node will be written to a file of initial conditions (INTL.CON) to be used as a "hot start" file in a later simulation (default = -1). See READ INITIAL CONDITIONS Record.
	-1	Do not write initial conditions file.
TABINC	Alpha	Specify the DSS time interval to be used for computed flow and stage hydrographs. Only valid DSS time intervals may be selected (see note 2 below). TABINC is entered as an alphanumeric (character) string i.e., 15MIN, 3HOUR, 1DAY, 1WEEK, 1MON, 1YEAR, etc. The hydrographs will also be appended to the UNET output file in tabular format. TABINC must be a multiple of DT (see previous page).
	-Alpha	If the time interval is input as a negative value, no data will be appended to the UNET output file.

Example:

JOB CONTROL

T T 10MIN 4 6 F 0.6 F T -1 30MIN

Notes:

- (1) Users should begin an application using a THETA value of 1.0 for maximum stability. When geometric and other problems have been resolved, THETA can be reduced towards 0.6 (the maximum accuracy value, however, solutions may be susceptible to instabilities).
- (2) Only the following time intervals are considered valid by the DSS.
 1MIN, 2MIN, 3MIN, 4MIN, 5MIN, 10MIN (Block length = 1 day)
 15MIN, 20MIN, 30MIN, 1HOUR, 2HOUR, 3HOUR, 4HOUR, 6HOUR, 8HOUR, 12HOUR (Block length = 1 mo.)
 1DAY (Block length = 1 year)
 1WEEK, 1MON (Block length = 1 decade)

Individually Defined Parameters

Individually defined parameters are used to define specific variables used in the computations. One parameter is used per line and is identified by a keyword followed by an equals sign "=". For example, the line: ZERO=100.0, indicates that the next stage hydrograph in the input file will have a gage zero elevation of 100 feet.

Parameter	Value	Description
TINC	+	Specifies the time increment (in hours) of the hydrograph to be input to UNET. TINC should be specified in every UNET input file. If it is not, TINC defaults to DT, the computational time interval. Data in DSS files are often stored at very short time intervals i.e., 1 hour, 2 hours, etc. UNET has a limited number of ordinates per hydrograph, MORD (refer to the RDSS output file under the heading "PROGRAM DIMENSIONS"). The number of periods in the TIME WINDOW multiplied by TINC should be less than MORD. If MORD is exceeded and the input hydrographs are read from DSS, UNET will subdivide the TIME WINDOW and perform the computations for each subdivision sequentially. The DSS output will contain results for the full TIME WINDOW, but the output file will only reflect the last subdivision.
QMIN	+	Minimum flow value. Apply a minimum flow limit to input hydrographs (default = 0). Remains in effect until next QMIN= record.
QMULT	+ or -	Multiply input flows by QMULT (default = 1). Remains in effect until next QMULT= record. Commonly used to estimate ungaged lateral inflow from a gaged station by setting QMULT equal to the drainage area ratio.
QRATIO	+	Multiply the inflow for an entire simulation by QRATIO. This factor performs a blanket change which includes all the QMULT factors.
ZERO	+ or -	Gage zero to be added to the next stage hydrograph in the input file (default = 0). Use additional ZERO= records to add gage zero to subsequent hydrographs. This option is useful when DSS data is stored as stages rather than elevations.

Individually Defined Parameters - Continued.

Parameter	Value	Description
REACH	+	The reach number that corresponds to the river mile entered on LATERAL INFLOW, UNIFORM LATERAL INFLOW, CONVEYANCE CHANGE and DISCHARGE-CONVEYANCE Records.
WFSTAB	+	Weir flow stability factor. Increases rate of convergence in the numerical solution for submerged weirs (default = 2.0).
SFSTAB	+	Spillway flow stability factor. Increases rate of convergence in the numerical solution for submerged spillways (default = 1.0).
WFX	+	Weir flow submergence decay exponent. Specifies the rate of decay from free flow to zero flow (default = 1.0).
	-1	Use Cunge's linear submergence decay function.
SFX	+	Spillway flow submergence decay exponent. Specifies the rate of decay free flow to zero flow (default = 1.0).
	-1	Use Cunge's linear submergence decay function.
DTIC	+	Time step during initialization. The time step during initialization is often less than the base time step. The initial conditions from backwater assumes a flow distribution which is often somewhat different from the distribution computed by unsteady flow. The smaller time step helps the UNET program converge to the initial conditions.
QTOL	+	Flow convergence error criterion in Newton-Raphson solution (default = 1E20 ft ³ /s).
ZTOL	+	Channel water surface elevation error criterion in Newton-Raphson solution (default = 0.1 ft).
ZSATOL	+	Storage area water surface elevation error criterion in Newton-Raphson solution (default = 0.1 ft).

Individually Defined Parameters - Continued.

Parameter	Value	Description
MAXCRTS	+	Maximum number of interpolated time steps. UNET interpolates time steps on the basis of change in inflow and on the basis of the change in computed stage. The stage criterion is set by ZTOL1 and ZSATOL1.
MXITER	+	Maximum number of iterations in Newton-Raphson iterative solution of fully nonlinear St. Venant equations (default = 0). The default value selects a linearized solution to the system of equations.
DTMIN	+	Minimum time step (hrs) for interpolated time steps.
MAXINSTEPS	+	Maximum number of warm up time steps (default = 20). The UNET program iterates on the first time step MAXINSTEPS number of times. The iteration ensures that the simulation approaches a steady state at the start of the dynamic simulation.
VELOCITY	ON	Write maximum velocity profiles to DSS.
	OFF	Do not write maximum velocity profiles to DSS.

Time Window (required)

The TIME WINDOW is used to specify the starting and ending times of a simulation. It is applied to all time series data specified in the UNET input file to define one or more boundary conditions. TIME WINDOW should be placed immediately after the JOB CONTROL data.

Command Line: TIME WINDOW

Variables: SDATE, STIME, EDATE, ETIME

<u>Variable</u>	<u>Value</u>	<u>Description</u>
SDATE	Date	Military style starting date, for example 01JAN1984.
STIME	Time	Military style starting time, for example 1500 hours.
EDATE	Date	Military style ending date.
ETIME	Time	Military style ending time.

Example:

TIME WINDOW
24APR1990 0400 24APR1990 0800

Note:

When using DSS data, the TIME WINDOW must start and end at DSS data points.

End of Job (required)

This record is required at the end of all UNET input files.

Command Line: EI

Variables: None

Example:

EJ

Open DSS File

This data set specifies an existing DSS file to be read for time series data, the time window and TINC. Once a DSS file is open, other command data sets may use the DSS syntax to read specific pathnames from the opened DSS file for input of time series data. An opened file must be closed before another DSS file can be opened.

Manually entered time series data and the associated TIME WINDOW command(s) must appear prior to the OPEN DSS FILE command(s). The final variable, TINC, specifies the time increment of the hydrograph to be input into UNET. Data in DSS files are often stored at very short time intervals i.e., 1 hour, 2 hours, etc. UNET has a limited number of ordinates per hydrograph (refer to the RDSS output file under the heading "PROGRAM DIMENSIONS"). By specifying TINC, values are taken from the DSS data base every TINC hours.

Command Line: OPEN DSS FILE

Variables: DSSFIL, SDATE, STIME, EDATE, ETIME, TINC

Variable	Value	Description
DSSFIL	Name	DSS file name. If not included, the extension ".DSS" will be added automatically. A path of up to 40 characters including the file name may be specified.
SDATE	Date	Military style starting date, for example 01JAN1984.
STIME	Time	Military style starting time, for example 1500 hours.
EDATE	Date	Military style ending date.
ETIME	Time	Military style ending time.
TINC	+	Time increment (hrs). Must be an integer multiple of the time interval of the stored data.

Example:

OPEN DSS FILE

RRH179 01APR1979 1200 30MAY1979 1200 24

Assume that data is stored in 1 hour increments in the file RRH179.DSS. With TINC equal to 24 hours, every 24th data value would be read from the file beginning at noon on April 1, 1979 and ending at noon on May 30, 1979.

Note: Indent DSS filename to avoid having the name inadvertently interpreted as a command.

Close DSS File

This data set closes an open DSS file. An opened DSS file must be closed before another is opened. Input of hydrograph data reverts to the standard syntax.

Command Line: CLOSE DSS FILE

Variables: None

Example:

CLOSE DSS FILE

Write Hydrographs to DSS

This data set defines the DSS file where computed hydrographs are to be written. The DSS pathname is formed by UNET in the following manner:

- A part: The stream name from the T1 Record in the CSECT input file.
- B part: The station name from the HY Record in the CSECT input file.
- C part: The word "FLOW" or "STAGE" originates from the TABLE program.
- D part: The starting time from the time window.
- E part: TABINC, the DSS time interval from the JOB CONTROL data set.
- F part: From the third title line in the UNET input file. If the line contains the upper case word SIMULATION, the F part will be set to "COMPUTED". Otherwise it will be the first 20 characters of the third title line.

Command Line: **WRITE HYDROGRAPHS TO DSS**

Variables: **DSSFIL**

Variable	Value	Description
DSSFIL	Name	Name of the DSS file. If not included, the extension ".DSS" will be added automatically. A path of up to 40 characters including the file name may be specified.

Example:

WRITE HYDROGRAPHS TO DSS

PROBLEM1 (or if a pathname is used: **C:\UNET\EXAMPLES\PROBLEM1**)

Note 1: Care should be taken when selecting the name of the DSS file. If the first two characters of the name (in columns 1 and 2) match the first two significant characters of any command line, run time errors will likely occur in the program. This problem can be avoided by indenting the second line past column 2, as shown in the example.

Initial Flow Distribution

This data set specifies the initial flow distribution (initial conditions) for all reaches. If this data set is not specified, UNET will assume a starting flow distribution. The assumed distribution is usually adequate for dendritic systems and for simple networks. For complex networks which typically have four or more reaches intersecting at a junction, the assumed distribution may not be reasonable and the program may abort when computing the initial water surface profiles or when the unsteady flow solution is warming up.

The initial stages are calculated using a backwater technique. Because UNET assumes subcritical flow with downstream control, the reach numbers and discharge values must be entered in the backwater direction, i.e., downstream to upstream.

Command Line: INITIAL FLOW DISTRIBUTION

Variables: (IR, Q(IR), IR=1,NRCH)

Variable	Value	Description
IR	+	Reach number.
Q(IR)	+	Initial flow for reach IR (ft ³ /s).

Example:

INITIAL FLOW DISTRIBUTION
4 2000 3 800 2 1200 1 2000

or,

INITIAL FLOW DISTRIBUTION
4 2000
3 800
2 1200
1 2000

Note:

Both input formats are valid for all input records requiring paired function data.

Initial Storage Area Elevation

This data set specifies the initial water surface elevation inside each storage area. If the INITIAL STORAGE AREA ELEVATION data set is not specified, UNET assumes that the initial storage area elevations are the invert elevations (ZOSA on the SA Record).

Command Line: INITIAL STORAGE AREA ELEVATION

Variables: (IR, ZSA(IR), IR=1,NSA)

Variable	Value	Description
IR	+	Storage area number (determined by the order of appearance of SA Records in the CSECT input file).
ZSA(IR)	+	Initial water surface elevation for storage area IR (ft).

Example:

```
INITIAL STORAGE AREA ELEVATION  
1 1000 2 1005 3 995
```

or,

```
INITIAL STORAGE AREA ELEVATION  
1 1000  
2 1005  
3 995
```

Read Initial Conditions File

Instead of specifying initial conditions by flow distributions and storage area elevations, initial conditions may be computed in a prior execution of UNET and written to a binary file called INTL.CON. This file is created by setting TWIC on the Job Control Record. See the Job Control Record description for details. The UNET model is then run with the INITIAL FLOW DISTRIBUTION and INITIAL STORAGE AREA ELEVATION data sets included. Possible uses of this feature are:

(1) Simulations of long duration may be constrained by program parameter limits for the number of data points in a hydrograph. An initial conditions file can be used to restart the model to encompass the total desired simulation time.

(2) In multiple reach systems, instabilities may be observed at the initial time steps. If these instabilities are significant, some final results such as maximum water surface profiles may be altered. An initial conditions file may be written after these instabilities have damped out. By running the model again with the initial conditions file, the impact of the instabilities is removed from the computations. This concept also applies to tidal systems.

(3) For routine forecasting operation, this option can be used to start from the last forecast, rather than always running through a warm-up period.

Command Line: READ INITIAL CONDITIONS

Variables: FILNM

Variable	Value	Description
FILNM	Alpha	INTL.CON (This default can be changed with the DOS rename command.)

Example:

```
READ INITIAL CONDITIONS
INTL.CON
```

Upstream Flow or Stage Hydrograph

This data set specifies a flow (or stage) hydrograph to be used as an upstream boundary condition for reach IRCH. Use of an HEC-DSS stage hydrograph **requires** a UZ record in the CSECT data. If a DSS file is open, the DSS syntax should be used to define the DSS pathname, otherwise use one of the standard syntaxes to describe the hydrograph.

Command Line: UPSTREAM FLOW HYDROGRAPH (or UPSTREAM STAGE HYDROGRAPH)

Variables: Standard syntax

IRCH, NU, (UT(J), UQ(J), J=1,NU) (without TINC)

IRCH, NU, (UQ(J), J=1,NU) (with TINC)

DSS syntax

IRCH (1st line)

PN (2nd line)

Variable	Value	Description
IRCH	+	Reach number.
NU	+	Number of hydrograph ordinates.
UT(J)	+	Time values (hrs). Omitted if TINC is specified via "individually defined parameters".
UQ(J)	+	Flow values (ft ³ /s) (or elevations in ft.).
PN	A80	DSS pathname (left justified, must include parts A-F).

Examples (Standard syntax):

UPSTREAM FLOW HYDROGRAPH

1 4 0 2000 1 4000 2 3000 3 2000 (without TINC)

1 4 2000 4000 3000 2000 (with TINC)

or an alternate method, helpful for hydrographs with many data pairs,

UPSTREAM FLOW HYDROGRAPH

1 4

0 2000

1 4000

2 3000

3 2000

UPSTREAM FLOW HYDROGRAPH

1 4

2000

4000

3000

2000

Upstream Flow or Stage Hydrograph - Continued.

Example (DSS syntax):

UPSTREAM FLOW HYDROGRAPH

1

/RED RIVER/63000/FLOW/01JAN1979/1DAY/COMPUTED/

Upstream Stage and Flow Hydrograph

The upstream stage and flow hydrograph is a mixed boundary condition where a stage hydrograph is inserted as the upstream boundary until the stage hydrograph runs out of data; afterward a flow hydrograph is used. The end of data is identified by the HEC-DSS missing data code -901.0. The stage and flow hydrographs can be entered either in a table or from DSS. The mixed boundary condition is primarily used for forecast models where the end of stage data is the forecast time and the flow hydrograph is the flow forecast.

Command Line: **UPSTREAM STAGE AND FLOW HYDROGRAPH**

Variables: **Standard syntax**
 IRCH, NU, (UT(J), UZ(J),UQ(J), J=1,NU)

DSS syntax
IRCH (1st line)
PN (2nd line) stage
PN (3rd line) flow

Variable	Value	Description
IRCH	+	Reach number.
NU	+	Number of hydrograph ordinates.
UT(J)	+	Time values (hrs).
UZ(J)	+	Stage value (ft).
UQ(J)	+	Flow values (ft ³ /s).
PN	A80	DSS pathname (left justified, must include parts A-F).

Examples (Standard syntax):

```
UPSTREAM STAGE AND FLOW HYDROGRAPH
1 4
0 451 -901.
24 451 2000
48 -901 2000        <== Start using flow hydrograph
72 -901 2000
```

Example (DSS syntax):

```
UPSTREAM STAGE AND FLOW HYDROGRAPH
1
/RED RIVER/JONESBURO/STAGE/01JAN1979/1DAY/COMPUTED/
/RED RIVER/JONESBURO/FLOW/01JAN1979/1DAY/COMPUTED/
```

Critical Upstream Boundary

UNET has the capacity to dynamically select the computational time step (DT in the JOB CONTROL data set). Smaller time steps may be required when inflow rates are changing rapidly. By specifying the previous upstream flow hydrograph as a "critical" upstream boundary condition, UNET will monitor the rate of change of the specified inflow. If the rate of change in inflow exceeds DCRUP between any two consecutive flow values, DT will be adjusted according to the following equation:

$$NEWDT = \frac{BASEDT}{AMAX1(NINT(DQ(J) \div DCRUP(J)),1)}$$

- where: NEW DT = the adjusted computational time step,
- BASE DT = the initial user specified computational time step,
- DQ(J) = change in upstream inflow between previous and current times,
- DCRUP(J) = maximum change in upstream inflow between computation times, and where the denominator is computed as an integer result.

This command is placed immediately after the upstream boundary condition for which it applies.

Command Line: CRITICAL UPSTREAM BOUNDARY

Variables: DCRUP

Variable	Value	Description
DCRUP(J)	+	The maximum change in inflow allowed without adjusting the computational time step, DT.

Example:

```
CRITICAL UPSTREAM BOUNDARY
500
```

Downstream Flow Hydrograph

This data set specifies a flow hydrograph to be used as a downstream boundary condition for reach IRCH. If a DSS file is open, the DSS syntax should be used to define the DSS pathname, otherwise use one of the standard syntaxes to describe the hydrograph. The initial water surface elevation is given by ZDB.

Command Line: **DOWNSTREAM FLOW HYDROGRAPH**

Variables: Standard syntax
 IRCH, ZDB, NDB, (DBT(J), DBQ(J), J=1,NDB) (without TINC)
 IRCH, ZDB, NDB, (DBQ(J), J=1,NDB) (with TINC)

DSS syntax
 IRCH (1st line)
 ZDB (2nd line)
 PN (3rd line)

Variable	Value	Description
IRCH	+	Reach number.
ZDB	+	Initial water surface elevation (ft).
NDB	+	Number of hydrograph ordinates.
DBT(J)	+	Time values (hrs). Omitted if TINC is specified via "Individually defined parameters".
DBQ(J)	+	Flowrates (ft ³ /s).
PN	A80	DSS pathname (left justified, must include parts A-F).

Examples (Standard syntax):

```
DOWNSTREAM FLOW HYDROGRAPH
1 694.5 4 0 2000 1 4000 2 3000 3 2000 (without TINC)
1 694.5 4 2000 4000 3000 2000 (with TINC)
```

For an alternate method, helpful for hydrographs with many data pairs, see the input description for Upstream Flow Hydrographs.

Example (DSS syntax):

```
DOWNSTREAM FLOW HYDROGRAPH
1
1000
/RED RIVER/65000/FLOW/01JAN1979/1DAY/COMPUTED/
```

Downstream Stage Hydrograph

This data set specifies a stage hydrograph to be used as a downstream boundary condition for reach IRCH. If a DSS file is open, the DSS syntax should be used to define the DSS pathname, otherwise use one of the standard syntaxes to describe the hydrograph.

Command Line: `DOWNSTREAM STAGE HYDROGRAPH`

Variables: Standard Syntax
 IRCH, NDB, (DBT(J), DBZ(J), J=1,NDB) (without TINC)
 IRCH, NDB, (DBZ(J), J=1,NDB) (with TINC)

DSS Syntax
 IRCH (1st line)
 PN (2nd line)

Variable	Value	Description
IRCH	+	Reach number.
NDB	+	Number of hydrograph ordinates.
DBT(J)	+	Time values (hrs). Omitted if TINC is specified via "individually defined parameters".
DBZ(J)	+	Water surface elevations (ft).
PN	A80	DSS pathname (left justified, must include parts A-F).

Examples (Standard syntax):
`DOWNSTREAM STAGE HYDROGRAPH`
`1 4 0 1000 1 1010 2 1005 3 1000`

For an alternate method, helpful for hydrographs with many data pairs, see the input description for Upstream Flow Hydrographs.

Example (DSS syntax):
`DOWNSTREAM STAGE HYDROGRAPH`
`1`
`/RED RIVER/OSLO/STAGE/01JAN1979/1DAY/COMPUTED/`

Downstream Stage and Flow Hydrograph

The downstream stage and flow hydrograph is a mixed boundary condition where a stage hydrograph is inserted as the downstream boundary until the stage hydrograph runs out of data; afterward a flow hydrograph is used. The end of data is identified by the HEC-DSS missing data code of -901.0. The stage and flow hydrographs can either be entered in a table or can be entered from DSS. The mixed boundary condition is primarily used for forecast models where the end of stage data is the forecast time and the flow hydrograph is the flow forecast.

Command Line: `DOWNSTREAM STAGE AND FLOW HYDROGRAPH`

Variables: Standard syntax
 `IRCH, ND, (DBT(J),DBZ(J),DBQ(J), J=1,ND)`

DSS syntax
 `IRCH (1st line)`
 `PN (2nd line) stage`
 `PN (3rd line) flow`

Variable	Value	Description
IRCH	+	Reach number.
ND	+	Number of hydrograph ordinates.
UT(J)	+	Time values (hrs).
DBZ(J)	+	Stage value (ft).
DBQ(J)	+	Flow values (ft ³ /s).
PN	A80	DSS pathname (left justified, must include parts A-F).

Example (Standard syntax):
`DOWNSTREAM STAGE AND FLOW HYDROGRAPH`
`1 4`
`0 451 -901.`
`24 451 2000`
`48 -901 2000 <== Start using flow hydrograph`
`72 -901 2000`

Note: Be sure to include a point in time at which both the stage and flow are specified. The simulation must begin with stages. Note that the computed flow may not be that specified at the transition time. In the example above at time 24 hrs., the stage will be 451 with some computed flow (not necessarily 2000 cfs). For computations between time 24 and time 48, the flow will be set at that specified (interpolated between the values at 24 and 48 if necessary) and the resultant

stage computed.

Example (DSS syntax):

DOWNSTREAM FLOW HYDROGRAPH

1

/RED RIVER/JONESBURO/STAGE/01JAN1979/1DAY/COMPUTED/

/RED RIVER/JONESBURO/FLOW/01JAN1979/1DAY/COMPUTED/

Downstream Rating Curve

This data set specifies a single valued (non-looped) rating curve to be used as a downstream boundary condition for reach IRCH. The downstream rating curve option can only be used once. This boundary condition should be used with caution. Differences between this rating curve and the real looped curve may cause errors in the solution far upstream of the downstream boundary. This becomes a problem for streams with mild gradients where the slope of the water surface does not sufficiently dampen out the errors. This rating curve should be inserted a sufficient distance downstream of the study area so that errors are not propagated upstream into the study area. Similar considerations apply to HEC-2 applications.

Command Line: DOWNSTREAM RATING CURVE

Variables: IRCH, NDB, (DBZ(J), DBQ(J), J=1,NDB)

Variable	Value	Description
IRCH	+	Reach number.
NDB	+	Number of rating curve ordinates (limited to 20 points).
DBZ(J)	+	Water surface elevations (ft).
DBQ(J)	+	Flow rates (ft ³ /s).

Example:

DOWNSTREAM RATING CURVE

1 5 100 2000 105 2400 110 3000 115 4000 120 6000

or,

1 5
100 2000
105 2400
110 3000
115 4000
120 6000

Downstream Manning's Equation

This data set specifies that an approximate looped rating curve will be calculated dynamically by UNET for use as the downstream boundary condition for reach IRCH. Manning's equation is used to compute an estimate of the friction slope at each time step between the two most downstream cross sections. Because the method neglects the nonuniform and unsteady terms of the momentum equation, and only considers the final two cross sections, the approximation is quite crude. As recommended in the description of the single-valued rating curve, this boundary condition should also be inserted downstream from the area of interest being studied.

Command Line: DOWNSTREAM MANNING'S EQUATION

Variables: IRCH, DSF

Variable	Value	Description
IRCH	+	Reach number.
DSF	+	Estimate of initial friction slope, S_f . Water surface slope is a good estimate.

Example:

DOWNSTREAM MANNING'S EQUATION

1 0.00478

Pump Station as a Downstream Boundary Condition

This data set inserts a pumping station as a downstream boundary for a reach. The pumping station capacity is defined as stair-stepped rating where the pumps are started at a set elevation and stopped at a lower elevation. The capacity remains constant until the next elevation when the next group of pumps are started. Neither the submergence of the pumps nor the pump characteristics are considered in the calculations.

Command Line: DOWNSTREAM PUMPING STATION

Variables: IRCH, NPDS, (ZPUMPSTART(I), ZPUMPSTOP(I), QDSPUMP(I), I=1,NPDS)

Variable	Value	Description
IRCH	+	Reach number.
NPDS	+	Number of pumping levels (or steps)
ZDSPUMPIC	-,0,+	Initial water surface elevation. If zero, the elevation will be determined from pump elevation-capacity data for the initial flow.
ZPUMPSTART(I)	+	Elevation when pumping level I is started on the rising limb of the stage hydrograph.
ZPUMPSTOP(I)	+	Elevation when pumping level I is stopped on the falling limb of the stage hydrograph.
QDSPUMP(I)	+	Pumping capacity at level I.

Example:

DOWNSTREAM PUMPING STATION - PARISH LINE PUMPING STATION

```
47
4
10
0 0 0
14 13 1000
16 15 2000
18 17 4000
```

For the above example, the pumps are completely shut down below elevation 13. When the stage exceeds elevation 14 the pumps are started with a capacity of 1000. When the stage exceeds 16, the next set of pumps are started with a total capacity of 2000. On the falling limb, when the stage drops below 15, the second set of pumps are stopped and the pumping continues at a rate of 1000.

Lateral Inflow Hydrograph

This data set specifies a lateral inflow hydrograph which enters the model at a point along the stream. Effects of this inflow on flow and stage in the receiving reach will be seen at the next downstream cross section. Lateral inflows may also enter a storage area by adding the string STORAGE AREA to the command line. Lateral inflows defined using standard syntax must appear after a TIME WINDOW command and prior to any OPEN DSS FILE commands. The Lateral Inflow Hydrograph command must be preceded by a "REACH=" command, in order to find a match between reach and river mile.

Command Line: LATERAL INFLOW HYDROGRAPH, or
LATERAL INFLOW HYDROGRAPH INTO A STORAGE AREA

Variables: Standard syntax
 RMILE, NPQL, (TQL(J), QL(J), J=1,NPQL) (without TINC)
 RMILE, NPQL, (QL(J), J=1,NPQL) (with TINC)

 DSS syntax
 RMILE (1st line)
 PN (2nd line)

Variable	Value	Description
RMILE	+	River mile where lateral inflow enters the stream (SECNAM on CSECT X1 Records).
	-	User defined storage area number if STORAGE AREA string is specified in command line.
NPQL	+	Number of hydrograph ordinates.
TQL(J)	+	Time values (hrs). Omitted if TINC is specified via "individually defined parameters".
QL(J)	+	Flow rates (ft ³ /s).
PN	A80	DSS pathname (left justified, must include parts A-F).

Examples (Standard syntax):

```
REACH=4
LATERAL INFLOW HYDROGRAPH
2.0
5
0 500
1 500
2 750
```

Lateral Inflow Hydrograph - Continued.

3 500
4 500

REACH=4
LATERAL INFLOW HYDROGRAPH INTO A STORAGE AREA
2.0
5
0 500
1 500
2 750
3 500
4 500

Example (DSS syntax):

REACH=4
LATERAL INFLOW HYDROGRAPH
2.0
/RED RIVER/TURTLE/FLOW/01JAN1979/1DAY/COMPUTED/

Uniform Lateral Inflow Hydrograph - Continued.

UNIFORM LATERAL INFLOW HYDROGRAPH

5.0 4.0

/RED RIVER/RETURN/FLOW/01JAN1979/1DAY/COMPUTED/

Critical Lateral Inflow

UNET has the capability to dynamically select the computational time step (DT in the JOB CONTROL data set). Smaller time steps may be required when inflow rates are changing rapidly. By specifying the previous lateral inflow as a "critical" lateral inflow, UNET will monitor the rate of change of the specified inflow. If the rate of change in inflow exceeds DCRLQ between any two consecutive flow values, DT will be adjusted according to the following equation:

$$NEWDT = \frac{BASEDT}{AMAX1(NINT(DLQ(J) \div DCRLQ(J)),1)}$$

where: NEW DT = the adjusted computational time step,
 BASE DT = the initial user specified computational time step,
 DLQ(J) = change in lateral inflow between previous and current times,
 DCRLQ(J) = maximum change in lateral inflow between computation times,

Command Line: CRITICAL LATERAL INFLOW

Variables: ICRLQ, DCRLQ

Variable	Value	Description
ICRLQ	+	Upstream node number corresponding to the lateral or uniform lateral inflow to be designated as "critical". The node number can be obtained from the CSECT output file.
DCRLQ	+	The maximum change in lateral inflow allowed without adjusting the computational time step, DT.

Example:

CRITICAL LATERAL INFLOW

10

500

Interflow between a Groundwater Reservoir and a River

This data set identifies a reach of river which exchanges water with a groundwater reservoir. The stage in the groundwater reservoir is assumed independent of the interflow and entered either manually or from DSS. The interflow functions similar to a uniform lateral inflow where the flow is proportional to the head between the river and the groundwater reservoir.

Command Line: `GROUNDWATER INTERFLOW BETWEEN CANAL AND AREA 1`

Variables: Standard syntax:
 `RMILEU, RMILED, DARCYK, DX, NPZGW,`
 `(TIME(J), ZGW(J), J=1, NPZGW)`

DSS syntax:
`RMILEU, RMILED, DARCYK, DX`
`PN (2nd line)`

Variable	Value	Description
RMILEU	+	Upstream river mile.
RMILED	+	Downstream river mile.
DARCYK	+	Darcy's groundwater loss coefficient.
DX	+	Distance over which the head acts.
NPZGW	+	Number of groundwater stages.
TIME(J)	+	Time J.
ZGW(J)	+	Groundwater stage at time J.
PN	A80	DSS pathname (left justified, must include parts A-F).

Example (Standard syntax):

```
REACH=4
GROUNDWATER INTERFLOW BETWEEN CANAL 7 AND WESTERN AQUIFER
10.0 6.0 .4 2000
3
0.0 -6.3
24.0 -6.0
48.0 -6.3
```

Time Series of Gate Openings

This data set specifies a time series of gate openings for radial (tainter) gates on cross-channel and lateral spillways. Gate openings are interpolated between entered values.

Command Line: GATE_OPENING

Variables: Standard syntax:
 IBC (1st line)
 NGO (TGO(I),GO(I),I=1,NGO) (2nd line)

DSS syntax:
 IBC (1st line)
 PN (2nd line)

Variable	Value	Description
IBC	+	Internal boundary condition number. This number is obtained from the CSECT output file in the listing of "Navigation Dams and Spillways". It is a counter based on the order that various internal boundary conditions are entered in the CSECT input file.
	Alpha	CSECT CSPNAME from LA, LS, SP Records.
NGO	+	Number of points in the time series.
TGO	+	Time values (hrs).
GO	+	Gate opening (ft) at each TGO time value (ft).
PN	A80	DSS pathname (left justified, must include parts A-F).

Example (Standard syntax):

```
GATE OPENING
1
5
0 0.0 0.25 2.0 0.5 4.0 0.75 6.0 1 8.0
```

For an alternate method, helpful for time series with many data pairs, see the input description for Upstream Flow Hydrographs.

Example (DSS syntax):

```
GATE OPENING
1
/OHIO/DAM25/GATOP/01JAN1979/15MIN/COMPUTED/
```

Elevation Controlled Gate

The elevation controlled gate opens when the stage in the river exceeds elevation, ZECOPEN. The gate opens at a rate of ECOPRATE until it reaches a maximum opening of ECMXOPENING. When the river stage falls below ZECCLOSE the gate begins to close at a rate of ECCLRATE.

Command Line: ELEVATION CONTROLLED GATE

Variables: IBC (1st line)
 ZECOPEN, ZECCLOSE, ECOPRATE, ECCLRATE,
 ECMXOPENING, ECMINOPENING, GOP (2nd line)

Variable	Value	Description
IBC	+	Internal boundary condition number. This number is obtained from the CSECT output file in the listing of "Spillways". It is a counter based on the order that various internal boundary conditions are entered in the CSECT input file.
	Alpha	CSECT CSPNAME from LA, LS, SP Records.
ZECOPEN	+	Elevation (ft) at which the gate begins to open.
ZECCLOSE	+	Elevation (ft) at which the gate begins to close.
ECOPRATE	+	Opening rate in ft/min.
ECCLRATE	+	Closing rate in ft/min.
ECMXOPENING	+	Maximum gate opening in feet.
ECMINOPENING	+	Minimum gate opening in feet.
GOP	+	Initial gate opening in feet.

Example:

ELEVATION CONTROLLED GATE AT LEVEE SWAIL

```
1
200 196 .5 .6 50.1 0.1
```

or

ELEVATION CONTROLLED GATE

```
ABC
200 196 .5 .6 50.1 0.1
```

Observed Stage Internal Boundary Condition

This data set specifies an observed time series of navigation pool water surface elevations upstream of unregulated navigation dams. The stage hydrograph can be entered using either the standard or DSS syntaxes. In a forecasting model, the observed pool elevations are used as an internal boundary condition up to the time of forecast. At this point, the ND and CP Records in the CSECT input file provide the model with the information necessary to control the hinge point operation of the navigation dam.

Command Line: **OBSERVED STAGE INTERNAL BOUNDARY**

Variables: **Standard syntax:**
 IBC, NIBCI, (TIBCI(I), ZIBCI(I), I=1,NIBCI)

DSS syntax:
IBC (1st line)
PN (2nd line)

Variable	Value	Description
IBC	+	Internal boundary condition number. This number is obtained from the CSECT output file in the listing of "Navigation Dams and Spillways". It is a counter based on the order that various internal boundary conditions are entered in the CSECT input file.
NIBCI	+	Number of points in the hydrograph.
TIBCI	+	Time values (hrs).
ZIBCI	+	Navigation pool elevation values (ft).
PN	A80	DSS pathname (left justified, must include parts A-F).

Example (Standard syntax):

```
OBSERVED STAGE INTERNAL BOUNDARY
2 5 24 467.2 25 467.8 26 468.5 27 467.8 28 467.2
```

Example (DSS syntax):

```
OBSERVED STAGE INTERNAL BOUNDARY
2
/OHIO/DAM26/STAGE/01JAN1979/1HOUR/OBSERVED/
```

Observed Stage and Flow Internal Boundary Condition

The observed stage and flow internal boundary condition is a mixed boundary condition where a stage hydrograph is inserted as the observed boundary until the stage hydrograph runs out of data; afterward a flow hydrograph is used. The end of data is identified by the HEC-DSS missing data code, -901.0. The stage and flow hydrographs can either be entered in a table or can be entered from DSS. The mixed boundary condition is primarily used for forecast models where the end of stage data is the forecast time and the flow hydrograph is the flow forecast.

NOTE: The observed stage and flow data can also be applied to the SP, RC, RW, in-line embankment failure and ND internal boundary conditions.

Command Line: OBSERVED STAGE AND FLOW INTERNAL BOUNDARY
 CONDITION

Variables: Standard syntax
 IBC, NIBCI, (T(J), ZIBCI(J), QIBCI(J), J=1,NU)

 DSS syntax
 IBC (1st line)
 PN (2nd line) stage
 PN (3rd line) flow

Variable	Value	Description
IBC	+	Internal boundary condition number from CSECT file.
NIBCI	+	Number of hydrograph ordinates
T(J)	+	Time values (hrs).
ZIBCI(J)	+	Stage value (ft).
QIBCI(J)	+	Flow values (ft ³ /s).
PN	A80	DSS pathname (left justified, must include parts A-F).

Examples (Standard syntax):

```
OBSERVED STAGE AND FLOW INTERNAL BOUNDARY CONDITION
1 4
0 451 -901.
24 451 2000
48 -901 2000 <== Start using flow hydrograph
72 -901 2000
```

Observed Stage and Flow Internal Boundary Condition - Continued.

Example (DSS syntax):

OBSERVED STAGE AND FLOW INTERNAL BOUNDARY CONDITION

1

/RED RIVER/JONESBURO/STAGE/01JAN1979/1DAY/COMPUTED/

/RED RIVER/JONESBURO/FLOW/01JAN1979/1DAY/COMPUTED/

Conveyance Change Factors

This data set can be used to adjust conveyance and storage between cross sections defined on X1 Records in the CSECT input file. This option is primarily a calibration tool which allows the user to vary conveyance and storage without having to re-run CSECT.

Command Line: **CONVEYANCE CHANGE**

Variables: **RMILEU, RMILED, IEL1, IEL2, FC, FV, FCS, FVS, ELADD, AN**

Variable	Value	Description
RMILE1	+	Upstream river mile (SECNAM on X1 Record in CSECT input file).
RMILE2	+	Downstream river mile (SECNAM on X1 Record in CSECT input file).
IE1	+	Minimum table entry (CSECT tables) for adjustments (ex. 1-21).
IE2	+	Maximum table entry (CSECT tables) for adjustments (ex. 1-21).
FC	+	Conveyance change factor for channel.
FV	+	Conveyance change factor for overbanks.
FCS	+	Storage factor to multiply by channel area. Resulting area will be added to current storage area for this cross section.
FVS	+	Storage factor to multiply by overbank area. Resulting area will be added to current storage area for this cross section.
ELADD	+	Elevation increment to be added to cross sections (ft).
AN	+	Coefficient for the added force term in the momentum equation.

Example:

REACH=4

CONVEYANCE CHANGE FACTORS

10.0 4.0 10 21 .95 1.1 0.0 .15 0.1 1.2

Discharge - Conveyance Relation

This data set is used to redefine a discharge versus conveyance rating curve between cross sections defined by X1 Records in the CSECT input file. A maximum of fifty curves, each containing up to twenty values of discharge and conveyance can be computed.

Command Line: DISCHARGE CONVEYANCE RELATION

Variables: RMILEU, RMILED, QCSTRT, QCINC, NQCPT, (Q(I), FCONV(I), I=1,NQCPT)

Variable	Value	Description
RMILEU	+	Upstream river mile (SECNAM on X1 Record from CSECT input file).
RMILED	+	Downstream river mile (SECNAM on X1 Record from CSECT input file).
QCSTRT	+	Starting (lowest) discharge on curve (ft ³ /s).
QCINC	+	Increment between discharges on the curve (ft ³ /s).
NQCPT	+	Number of discharge increments on the curve.
Q	+	Discharge Identifier. For the convenience of the user to identify flows associated with conveyance factors (not used by the program).
FCONV(I, NQCPT)	+	Conveyance change factors corresponding to the series of discharges. These factors adjust the conveyances computed by CSECT and provide a calibration tool whereby conveyance in a given reach may be adjusted without editing the CSECT input file.

Example:

```
REACH=4
DISCHARGE CONVEYANCE RELATION
10.0 4.0 500 1000 20
500 0.9
1000 0.95
... Q, FCONV(20)
```

Seasonal Conveyance Adjustment

This data set is used to adjust conveyance on a seasonal basis. Large rivers, such as the Mississippi, undergo seasonal changes in bedform structure due to variations in water viscosity with temperature.

Command Line: SEASONAL CONVEYANCE

Variables: RMILEU, RMILED, NSEA, (NSDAY(I), FCVSEA(I), I=1, NSEA)

Variable	Value	Description
RMILEU	+	Upstream river mile (SECNAM on X1 record from CSECT input file) where seasonal adjustment begins.
RMILED	+	Downstream river mile (SECNAM on X1 record from CSECT input) file where seasonal adjustment ends.
NSEA	+	Number of date / conveyance factor data pairs.
NSDAY(I)	+	Date of first conveyance adjustment factor (can be input as 30JAN or 30JAN89).
FCVSEA(I)	+	First adjustment factor.

Dates and conveyance factors are continued up to NSEA.

Example:

```
*
SEASONAL CONVEYANCE
97.9 29.0
12
01JAN 1.05
01FEB 1.05
01MAR 1.05
01APR 1.00
01MAY 1.00
01JUN 1.00
01JUL 1.00
01AUG 1.00
01SEP 1.00
01OCT 1.00
```

01NOV 1.00
31DEC 1.05

Appendix D

Example Problems

Table of Contents

Example No.	Situation	Page
1	A Simple Full Network.....	D-1
2	Advanced Features.....	D-21
3	Ice Cover.....	D-31

Example Problem #1

A Simple Full Network

This problem illustrates a simple full network problem as shown in Fig. D-1. Flow from reach 1 splits into reaches 2 and 3 around the island, then recombines downstream into reach 4. Additionally, flow from reach 2 can divert into a storage area. The average slope of the system is 0.5 ft./mile (0.000095 ft/ft). Channel and overbank Manning's n values are 0.03 and 0.08 respectively.

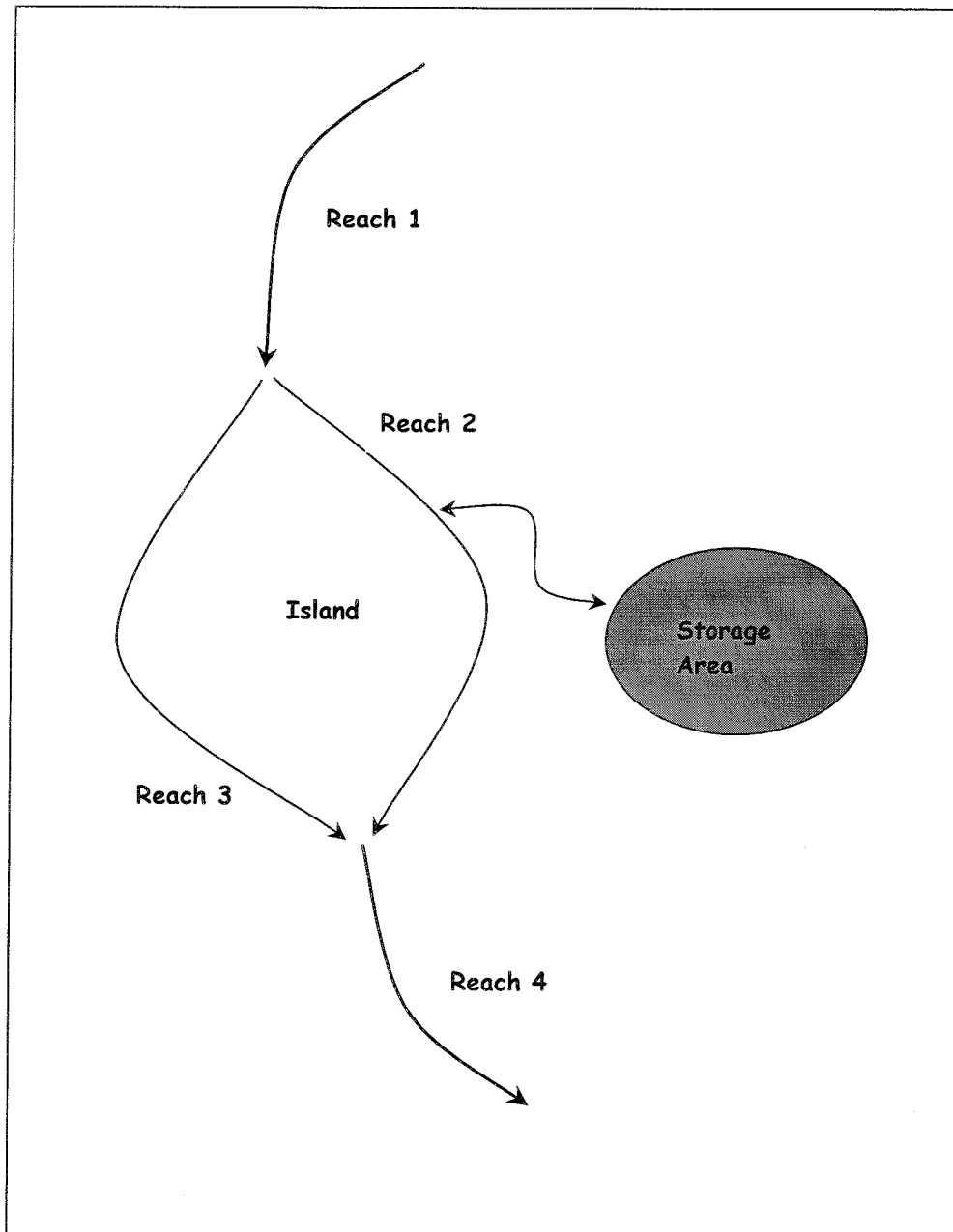

Figure D-1 Example problem with four reaches and a storage area.

Figures D-2 and D-4 show the cross sections used in the problem. Reaches 1 and 4 consist of a 250 foot wide cross section with a channel top width of 45 feet. Reaches 2 and 3 have 130 foot wide cross sections. Reach 2 has a channel top width of 40 feet while reach 3 has a channel top width of 20 feet.

D.1 CSECT Input File

Table D-1 is the CSECT input file for this problem. Appendix B contains detailed descriptions of each input record. The four reaches are arranged in order from upstream to downstream. Each reach begins with a set of title records (T1, T2, T3). Cross sections may be plotted using HEC-RAS. Each X1 record must have a unique cross section number (SECNAM) in field 1. The XK record defines limits for the elevation - hydraulic properties tables and the distance between interpolated nodes (cross sections). It must appear before the first cross section (X1) record, and may be repeated before any subsequent cross section to change the tables or interpolation distance.

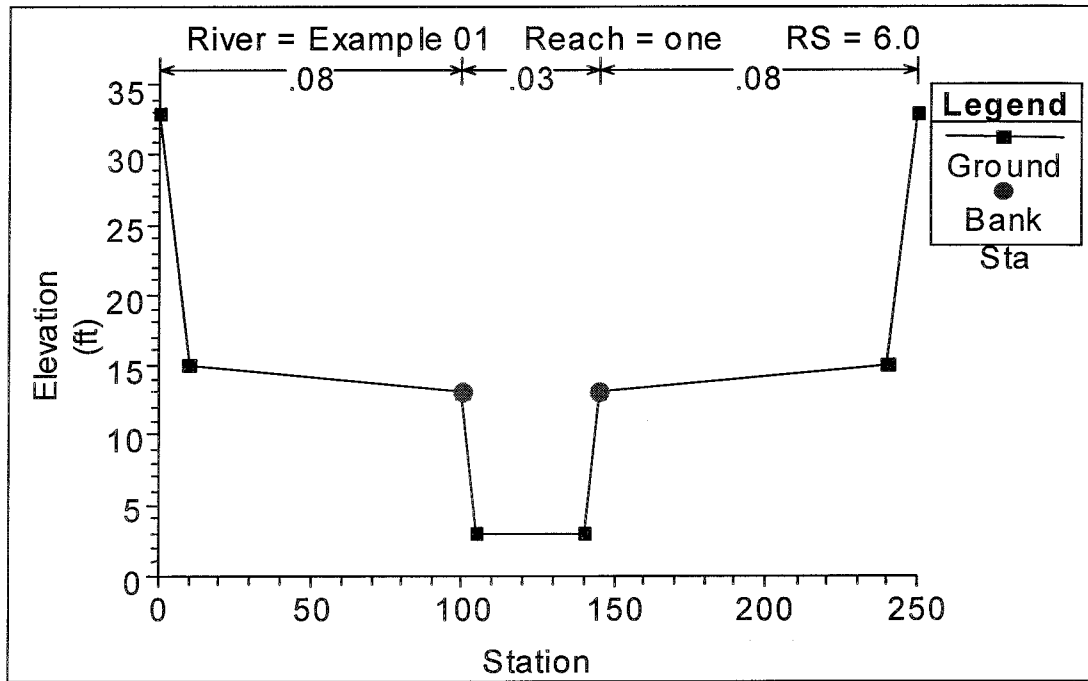

Figure D-2 Typical Cross Section for Reaches 1 and 4.

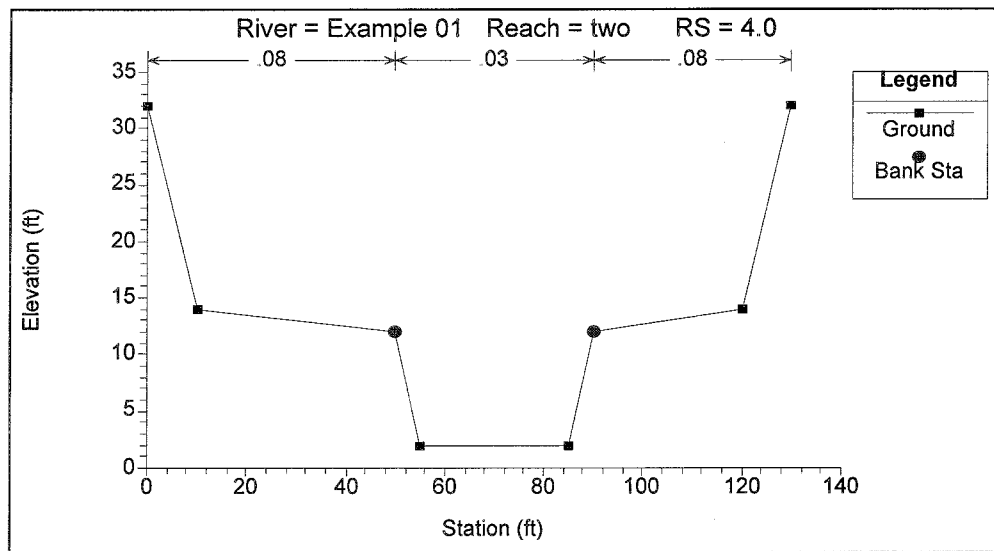

Figure D-3 Typical Cross Section for Reaches 2 and 3.

**Table D-1
CSECT Input File**

```

PR  ON
T1  REACH 1
T2  EXAMPLE NO. 1
T3  HEC May 1995
*
* J1 record required for compatibility with PLOT2.
*
J1
*
* XK record used to set limits on elevation tables and distance between
* interpolated cross sections for reach 1. Elevation tables begin 0.01 ft
* above the channel bottom and have twenty 1.25 ft intervals. Interpolated
* cross sections will be added at 0.50 mile intervals
*
XK 9.99          1.25  50
*
* Blank UB record specifies that the upstream boundary condition will be read
* via the UNET input file. In this problem, a flow hydrograph is used.
*
UB
*
* NC record is used to specify Manning's 'n' in the overbanks and channel.
*
NC  08  08  030
*
* X1 and GR records define the first cross section.
* HY record used to compute hydrographs
*
X1 6.0  8  100  145  5280  5280  5280
HY R1 RM 6.0
GR 33  0  15  10  13  100  3  105  3  140
GR 13  145  15  240  33  250
*
X1 5.0  8  100  145  5280  5280  5280
GR 32.5  0  14.5  10  12.5  100  2.5  105  2.5  140
GR 12.5  145  14.5  240  32.5  250
*
X1 4.0  8  100  145
HY R1 RM 4.0
GR 32  0  14  10  12  100  2  105  2  140
GR 12  145  14  240  32  250
*
* DB record used to connect downstream boundary of reach 1 to upstream
* boundaries of reaches 2 and 3.
*
DB  2  3
*
T1  REACH 2
T2  EXAMPLE NO. 1
T3  HEC May 1995
*
* XK record used to redefine elevation tables and interpolated cross section
* interval. Tables reset to 20 increments of 1.05 feet. Cross section
* interpolation turned off due to slower wave velocities.
*
XK 9.99          1.05  10
*
UB  1
*
X1 3.999  8  50  90  2640  2640  2640
HY R2 RM 4.0
GR 32  0  14  10  12  50  2  55  2  85
GR 12  90  14  120  32  130
*
* Last cross section repeated, elevations lowered 0.25 feet
*
X1 3.5          5280  5280  5280  -25
HY R2 RM 3.5
*
* SA record defines a storage area of 640 acres (1 sq mi.).
* LA record defines a lateral spillway with no gates between RM 3.5 and 2.5.
* WD record defines the weir section of the lateral spillway. The weir is
* 1/4 mile long with its midpoint at RM 3.0 and its average crest elevation
* equal to 17.50 ft.
*
SA  1  640  0.0  0
HS  STORAGE AREA #1
LA  1  17.50  0  0  0  0  0  0  0  0
WD  1  3.0  17.50  1320
*
* Last cross section repeated, elevations lowered 0.50 feet.
*

```



```

X1 2.5          5280 5280 5280    -50
HY R2 RM 2.5
*
* Last cross section repeated, elevations lowered 0.25 feet.
*
X1 2.0          -25
HY R2 RM 2.0
*
DB 4
*
T1 REACH 3
T2 EXAMPLE NO. 1
T3 HEC May 1995
*
* XI record used to change cross section interpolation to 1/3 mile intervals
* to account for faster wave velocities. No change in elevation table limits.
*
XI 0.33
*
UB 1
*
X1 3.998 8 50 70 10560 10560 10560
HY R3 RM 4.0
GR 32 0 14 10 12 50 2 55 2 65
GR 12 70 14 120 32 130
*
* Last cross section repeated, elevations lowered 1.0 feet
*
X1 1.998          -1
HY R3 RM 2.0
*
DB 4
*
T1 REACH 4
T2 EXAMPLE NO 1
T3 HEC 1995
*
* XI record used to change cross section interpolation to 1/5 mile intervals
* to account for faster wave velocities. No change in elevation table limits.
*
XI 0.2
*
* UB record used to connect upstream boundary of reach 4 to downstream
* boundaries of reaches 2 and 3.
*
UB 2 3
*
X1 1.997 8 100 145 5280 5280 5280
HY R4 RM 2.0
GR 31 0 13 10 11 100 1 105 1 140
GR 11 145 13 240 31 250
*
X1 1.0 8 100 145 5280 5280 5280
GR 30.5 0 12.5 10 10.5 100 5 105 .5 140
GR 10.5 145 12.5 240 30.5 250
*
X1 0.0 8 100 145 52800 52800 52800
HY R4 RM 0.0
GR 30 0 12 10 10 100 0 105 0 140
GR 10 145 12 240 30 250
*
* Last cross section repeated, elevations lowered 5.0 feet.
X1 -10.0          -5.0
HY R4 RM -10.0
*
* Blank DB record specifies that the downstream boundary condition will be read
* via the UNET input file. In this problem, a looped rating curve
* will be computed.
*
DB
*
EJ

```

UB and DB records are required for each reach in the problem. These records are used to specify the upstream and downstream connections for each reach. At flow splits, UNET applies a flow continuity equation for the upstream reach and stage continuity equations for the downstream reaches. At flow combinations, UNET applies stage continuity for the upstream reaches and flow continuity for the downstream reach. Where a single connection is specified, UNET applies stage continuity equations at the reach boundaries. Since reach 1 has no upstream connection, the UB record is left blank.

A flow hydrograph is specified as the upstream boundary condition in the UNET input file. The DB record connects reach 1 to reaches 2 and 3.

Cross sections are entered in HEC-2 forewater format i.e., in a downstream direction. Appendix E describes a procedure to reverse HEC-2 backwater data files to the forewater format required for CSECT. It also discusses additional data requirements and formats specific to the UNET system. X1, X3 and GR records are used to describe each cross section in a manner similar to HEC-2. HY records specify locations for hydrograph computation.

A second set of title records is used to begin reach 2. A UB record connects the upstream boundary of reach 2 to reach 1. An XK record is used to change the overall height of the elevation tables to obtain improved resolution of the computed hydraulic properties. Table D-2 compares elevation tables for reach 1, RM 6.0 and reach 2, RM 4. Cross section interpolation is not used for reach 2 due to slower flood wave velocities.

**Table D-2
Elevation Tables Computed by CSECT.**

ICS# 1, CROSS SECTION PROPERTIES AT R.M. 6.000

ELEV (ft)	ALOB <----- (ft^2) ----->	ACH (ft^2)	AROB (ft^2)	AREA (ft^2)	CLOB <----- x1000 cfs ----->	CCH x1000 cfs	CROB x1000 cfs	CONV x1000 cfs	BAREA (ft^2)	TW (ft)	SLOB (ft^2)	SROB (ft^2)	S (ft)	ALPHA <-- coeff -->	BETA (ft)
3.01	0.	0.	0.	0.	0.	0.	0.	0.	0.	35.	0.	0.	0.	1.00	1.00
4.26	0.	45.	0.	45.	0.	2.	0.	2.	0.	36.	0.	0.	0.	1.00	1.00
5.51	0.	91.	0.	91.	0.	8.	0.	8.	0.	38.	0.	0.	0.	1.00	1.00
6.76	0.	139.	0.	139.	0.	15.	0.	15.	0.	39.	0.	0.	0.	1.00	1.00
8.01	0.	188.	0.	188.	0.	24.	0.	24.	0.	40.	0.	0.	0.	1.00	1.00
9.26	0.	239.	0.	239.	0.	34.	0.	34.	0.	41.	0.	0.	0.	1.00	1.00
10.51	0.	291.	0.	291.	0.	46.	0.	46.	0.	43.	0.	0.	0.	1.00	1.00
11.76	0.	345.	0.	345.	0.	58.	0.	58.	0.	44.	0.	0.	0.	1.00	1.00
13.01	0.	400.	0.	400.	0.	72.	0.	72.	0.	46.	0.	0.	0.	1.00	1.00
14.26	36.	457.	38.	530.	0.	90.	1.	91.	0.	162.	0.	0.	0.	1.30	1.14
15.51	136.	513.	144.	792.	3.	109.	3.	116.	0.	231.	0.	0.	0.	1.99	1.38
16.76	249.	569.	263.	1082.	9.	130.	10.	149.	0.	232.	0.	0.	0.	2.43	1.49
18.01	363.	625.	383.	1372.	17.	152.	18.	187.	0.	233.	0.	0.	0.	2.64	1.52
19.26	478.	682.	505.	1665.	26.	176.	28.	230.	0.	235.	0.	0.	0.	2.72	1.53
20.51	594.	738.	627.	1959.	37.	201.	39.	277.	0.	236.	0.	0.	0.	2.73	1.51
21.76	711.	794.	750.	2255.	50.	227.	52.	329.	0.	238.	0.	0.	0.	2.72	1.50
23.01	829.	850.	874.	2553.	63.	254.	67.	385.	0.	239.	0.	0.	0.	2.69	1.48
24.26	947.	907.	999.	2852.	78.	283.	83.	444.	0.	240.	0.	0.	0.	2.66	1.47
25.51	1067.	963.	1124.	3154.	95.	313.	100.	508.	0.	242.	0.	0.	0.	2.63	1.46
26.76	1187.	1019.	1251.	3457.	112.	344.	119.	574.	0.	243.	0.	0.	0.	2.60	1.44
28.01	1308.	1075.	1378.	3761.	131.	376.	138.	645.	0.	244.	0.	0.	0.	2.57	1.43

ICS# 4, CROSS SECTION PROPERTIES AT R.M. 3.999

ELEV (ft)	ALOB <----- (ft^2) ----->	ACH (ft^2)	AROB (ft^2)	AREA (ft^2)	CLOB <----- x1000 cfs ----->	CCH x1000 cfs	CROB x1000 cfs	CONV x1000 cfs	BAREA (ft^2)	TW (ft)	SLOB (ft^2)	SROB (ft^2)	S (ft)	ALPHA <-- coeff -->	BETA (ft)
2.01	0.	0.	0.	0.	0.	0.	0.	0.	0.	30.	0.	0.	0.	1.00	1.00
3.06	0.	32.	0.	32.	0.	2.	0.	2.	0.	31.	0.	0.	0.	1.00	1.00
4.11	0.	66.	0.	66.	0.	5.	0.	5.	0.	32.	0.	0.	0.	1.00	1.00
5.16	0.	100.	0.	100.	0.	10.	0.	10.	0.	33.	0.	0.	0.	1.00	1.00
6.21	0.	135.	0.	135.	0.	15.	0.	15.	0.	34.	0.	0.	0.	1.00	1.00
7.26	0.	172.	0.	172.	0.	22.	0.	22.	0.	35.	0.	0.	0.	1.00	1.00
8.31	0.	209.	0.	209.	0.	29.	0.	29.	0.	36.	0.	0.	0.	1.00	1.00
9.36	0.	248.	0.	248.	0.	37.	0.	37.	0.	37.	0.	0.	0.	1.00	1.00
10.41	0.	289.	0.	289.	0.	46.	0.	46.	0.	38.	0.	0.	0.	1.00	1.00
11.46	0.	329.	0.	329.	0.	56.	0.	56.	0.	39.	0.	0.	0.	1.00	1.00
12.51	3.	370.	2.	375.	0.	68.	0.	68.	0.	39.	0.	0.	0.	1.02	1.01
13.56	24.	412.	18.	455.	0.	81.	0.	82.	0.	39.	0.	0.	0.	1.19	1.09
14.61	65.	454.	48.	567.	2.	95.	1.	98.	0.	111.	0.	0.	0.	1.43	1.18
15.66	107.	496.	81.	684.	4.	110.	3.	117.	0.	112.	0.	0.	0.	1.60	1.24
16.71	150.	538.	113.	802.	6.	126.	5.	137.	0.	113.	0.	0.	0.	1.72	1.28
17.76	194.	580.	147.	921.	10.	143.	7.	160.	0.	114.	0.	0.	0.	1.81	1.30
18.81	239.	622.	181.	1042.	13.	161.	10.	184.	0.	115.	0.	0.	0.	1.88	1.32
19.86	284.	664.	215.	1164.	18.	179.	13.	210.	0.	117.	0.	0.	0.	1.93	1.33
20.91	330.	706.	251.	1287.	22.	198.	16.	237.	0.	118.	0.	0.	0.	1.97	1.34
21.96	376.	748.	286.	1411.	27.	218.	20.	265.	0.	119.	0.	0.	0.	2.00	1.34
23.01	423.	790.	323.	1536.	32.	239.	24.	296.	0.	120.	0.	0.	0.	2.03	1.35

The storage area is defined by an SA record, where a size of 640 acres (1 sq.mi.) is specified. The LA record defines a lateral "spillway" along the channel between miles 3.5 and 2.5. The spillway crest elevation is 17.5 feet and has no gated sections (WSP = 0 in Field 3). When no gates are specified, the entire "spillway" length is assumed to be a side channel weir. A WD record defines the weir to be 1320 feet in length with a crest elevation of 17.5 feet. For this "spillway", equation 4-18 reduces to:

$$Q_s = CWH^\eta \tag{D-1}$$

where: C = weir discharge coefficient = 3.0,
 W = weir width = 1320 feet,
 H = (average spillway water surface elevation) - (weir crest elevation),
 $\eta = 1.5$.

The DB record connects the downstream boundary of reach 2 to reach 4. Reach 3 is identical to reach 4 except for the storage area.

Reach 4 is connected to reaches 2 and 3 via a UB record. A blank DB record is used at the downstream end of reach 4. A downstream boundary condition (specified in the UNET input file) is required to complete the input file. Although the study area ends at river mile 0.0, a final cross section is added 10 miles further downstream to apply the boundary condition. This technique is described in section D.2.

CSECT assigns node numbers to both input (ICS) and interpolated cross sections and resolves all connections between the reaches. Table D-3 is the reach connection table, while Table D-4 shows the node number assignments for input cross sections in the four reaches. Both tables are standard in all CSECT output files.

Table D-3
CSECT Reach Connection Table.

10APR95 11:24:55

PAGE 15

REACH CONNECTION TABLE

REACH	ICSU	NODEU	ICSD	NODED	IUSTYP	NUCON	IRCH	IDSTYP	NDCON	IRCH
1	1	1	3	5	1	0		5	6	10
						0			2	3
2	4	6	7	9	3	5		6	17	
						1			4	
3	8	10	9	16	3	5		6	17	
						1			4	
4	10	17	13	77	2	9	16	0	0	

**Table D-4
CSECT Node Assignments.**

10APR95 11:24:55
PAGE 16

2 3 0

NODE LOCATIONS FOR REACH 1

ICS	SECNAM	RM	ICS	NODE	SECNAM	RM	ICS	NODE	SECNAM	RM	ICS	NODE	SECNAM	RM
***	*****	**	***	****	*****	**	***	****	*****	**	***	****	*****	**
	6.0	6.00	1	1	5.0	5.00	2	3	4.0	4.00	3	5		

NODE LOCATIONS FOR REACH 2

ICS	SECNAM	RM	ICS	NODE	SECNAM	RM	ICS	NODE	SECNAM	RM	ICS	NODE	SECNAM	RM
***	*****	**	***	****	*****	**	***	****	*****	**	***	****	*****	**
7	3.999	4.00	4	6	3.5	3.50	5	7	2.5	2.50	6	8	2.0	2.00
	9													

NODE LOCATIONS FOR REACH 3

ICS	SECNAM	RM	ICS	NODE	SECNAM	RM	ICS	NODE	SECNAM	RM	ICS	NODE	SECNAM	RM
***	*****	**	***	****	*****	**	***	****	*****	**	***	****	*****	**
	3.998	4.00	8	10	1.998	2.00	9	16						

NODE LOCATIONS FOR REACH 4

ICS	SECNAM	RM	ICS	NODE	SECNAM	RM	ICS	NODE	SECNAM	RM	ICS	NODE	SECNAM	RM
***	*****	**	***	****	*****	**	***	****	*****	**	***	****	*****	**
13	1.997	2.00	10	17	1.0	1.00	11	22	0.0	0.00	12	27	-10.0	-10.00
	77													

10APR95 11:24:55
PAGE 17

IN-LINE AND LATERAL SPILLWAYS

NO	IBCTYP	N1IBC	SECNAM	N2IBC	NCONN	CE	WSP	ZSP	BE	HE	CWEIR	ZWEIR	WEIRL
**	*****	*****	*****	*****	*****	**	***	***	**	**	*****	*****	*****
1	3	7	3.5	7	-1	0.00	0.00	17.50	1.00	0.00	3.00	17.50	1320.00

10APR95 11:24:55
PAGE 18

SUGGESTED INITIAL STORAGE AREA ELEVATIONS

NO	ZSA
1	0.00

10APR95 11:24:55
PAGE 19

STORAGE AREAS

NO	SA	NODE	SUR	AR	ZMIN	ZSPMIN	CONNECTING NODES
1	1	7	640.		0.00	0.00	

D.2 UNET Input File

Table D-5 is the UNET input file for this problem. After CSECT has created the elevation - hydraulic property tables and computed reach connections, the unsteady flow calculations can proceed. It is not necessary to rerun CSECT unless changes are made to the CSECT input file. The UNET input file contains program instructions and data required by the RDSS, UNET and TABLE programs. This information includes:

boundary condition data stored in DSS pathnames, program control "switches" and variables, directly entered boundary and initial conditions, and specifications required to write computed results to DSS files. Appendix C provides detailed descriptions for all input to UNET.

A UNET input file consists of three title records followed by a series of "command" records and associated "parameter" records. The command records contain significant CAPITALIZED characters which specify specific routines to be performed. Additional text can be added, which is a convenient self-documenting feature. Immediately following most command records, parameter records pass specific variable assignments to the program routines. Title and comment records should begin with an asterisk and a space.

Table D-5
UNET Input File.

```
* EXAMPLE 1
* TRIANGULAR HYDROGRAPH WITH A 10000 CFS CREST
* BC at RM-10
*
* The first three lines should always be title records.
* In all command records, the significant characters are
* capitalized. Refer to Appendix C for details on all
* records used.
* -----
Job control
T T 15MIN 48 -1 F 0.8 F T -1 15MIN
* Print initial conditions.
* Write maximum water surface profiles to DSS.
* Timestep dT = 15 min.
* Duration of run = 0 (overridden by Time WINDOW).
* No instantaneous flow and stage profiles written to DSS.
* Levee routines disabled.
* Implicit weighting factor theta = 0.8, based on previous
* sensitivity analysis.
* This option not yet developed.
* Print flow and stage at HY nodes and spillway/weir flows at
* each timestep.
* No initial conditions file written.
* 15min DSS interval for computation of hydrographs.
* -----
* Set time period for simulation (not required when all
* boundary condition data will be read from a DSS file).
Time WINDOW
01APR1991 0800 03APR1991 0800
* -----
Write hydrographs to dss (.DSS filetype added to filename)
ex01_out
* -----
* Enter a hydrograph as the upstream boundary condition. The
* format used is:
*   Reach #,      # of data points in hydrograph
*   Time i,      Flow i,
*   Time i+1,    Flow i+1, etc.
* Linear interpolation is used between entered data.
*
UPSTREAM FLOW hydrograph boundary condition at RM 4, reach 1
1 4
0 1000
15 10000
30 1000
48 1000
* -----
* A looped rating curve will be computed for use as the
* downstream boundary condition. Note: errors may be introduced
* into the solution near this boundary as the approximation
* can be inaccurate. This error can be eliminated by moving
* the condition further downstream. The condition will
* be applied 10 miles downstream from the end of the study area.
*
Downstream MANNING's equation applied at RM -10, reach 4.
4 .0000947
* -----
* Initial flows in all reaches are required to start the
```

Full Network Example

```
* calculations. The format is: Reach i, Flow i, etc.
*
INITIAL FLOW distribution based on previous steady flow run.
4 1000
3 290
2 710
1 1000
*
* Initial water surface elevations are required for all
* storage areas. The format is:
* Storage area i, water surface elevation i, etc.
*
INITIAL STORAGE area elevation
1 10
* -----
* Individually defined parameters. For this problem, weir
* flow parameters are defined for the weir in Reach 2. A non-
* linear solution will be used, so the maximum # of iterations
* and a flow convergence error criterion is required by the
* Newton-Raphson iterative solution scheme.
*
WFSTAB = 3.0
WFX = 1.0
MXITER = 20
QTOL = 5
* -----
* An end of job record must be at the bottom of all files.
EJ
```

After the title records, the job control parameters are specified. The computational time step (DT) is entered and the DSS interval for computed hydrographs is entered as character data. Only valid DSS intervals (HEC, 1995) are permitted and must be selected greater than or equal to the computational time step.

The time window specifies the simulation period. It is required whenever time series data is directly entered in the UNET input file to specify a boundary condition. Computed hydrographs and profiles are written to the DSS file "PROBLEM1".

An upstream boundary condition is required for each reach with a blank UB record in the CSECT input file. Similarly, a downstream boundary condition is required for reaches with blank DB records in the CSECT input file. For this problem, reaches 1 and 4 meet this criteria. Boundary conditions must be specified to span the entire simulation time. A flow hydrograph is specified explicitly with a series of time-discharge (hr-ft³/s) pairs. Note that time 0 is equivalent to 8:00 am, April 1, 1991. Discharge values are linearly interpolated between data points. This example shows the simplest method to input a hydrograph. Other methods, including reading boundary conditions from DSS, are described in Appendix C.

A looped rating curve is applied at the downstream boundary of reach 4. The initial friction slope is set equal to the bed slope and is recomputed at each time step. The friction slope is then used in Manning's equation to solve for stage based on the current discharge. As described in Appendix C, this boundary condition only provides a rough approximation of the actual unsteady flow rating curve; therefore, errors can be introduced into the solution. A simple technique for eliminating these errors is to apply the boundary condition further downstream. In this example, ten miles of stream have been added to reach 4 in the CSECT input file, and the boundary condition is applied at river mile -10. The penalty for applying this procedure is an increase in computer solution time, as fifty interpolated cross sections are added to the system.

Initial conditions of flow and stage are provided at each cross section, as is the initial water surface elevation in the storage area. The initial flow distribution is specified from downstream to upstream for each reach. UNET performs a step-backwater analysis to compute the initial water surface profile. In this problem, the initial flows are the result of a previous steady flow simulation. An initial guess of the flow distribution was used ($Q_1 = Q_4 = 1000 \text{ ft}^3/\text{s}$, $Q_2 = 200 \text{ ft}^3/\text{s}$, $Q_3 = 800 \text{ ft}^3/\text{s}$) and the model was run until steady state conditions occurred. These values ($Q_2 = 290 \text{ ft}^3/\text{s}$, $Q_3 = 710 \text{ ft}^3/\text{s}$) were then used in the unsteady flow simulation. This procedure eliminates errors due to non-steady state initial conditions.

Depending on the problem, additional numerical parameters may be necessary to control the unsteady flow solution or to fine tune specific computations. Default values are listed on pages 6 and 7 of Appendix C. For this problem,

WFSTAB = 3.0,	Weir flow stability factor
WFX = 2.0,	Weir flow submergence exponent
MXITER = 20,	Maximum # of iterations in the nonlinear Newton-Raphson solution scheme
QTOL = 5 ft ³ /s,	Discharge convergence error criterion for Newton-Raphson

WFSTAB and WFX affect the solution of weir flow equations. The default value for MXITER is 0, i.e., a linearized solution method will be performed. Although this scheme may be faster than the nonlinear scheme, the linearization of terms in the unsteady flow solution matrix may result in less accurate solutions.

D.3 Results

Figure D-4 compares inflow hydrographs at the upstream boundary, river mile 6.0. The error introduced by placing the downstream boundary condition at river mile 0.0 influences stage results over the entire length of the system. Figure D-5 compares hydrographs for the flow split at river mile 4.0. Due to the wider channel, reach 2 conveys a larger portion of the total flow than reach 3.

Figure D-6 compares hydrographs on either side of the weir and storage area in reach 2. Once water begins to spill into the storage area, stage below the weir remains nearly constant until the water level in the storage area equals that in the channel. Flow in the channel below the weir drops to nearly zero as most of the water flows into the storage area, then increases again as the storage area water surface begins to equalize with that in the channel.

Figure D-7 compares hydrographs for the flow combination at river mile 2.0. Again, when water is spilling into the storage area, flow in reach 2 drops to nearly zero. At that time, flow in reaches 3 and 4 are equal, verifying that continuity is being maintained.

Figure D-8 compares two sets of maximum water surface profiles, showing the effect of location of the downstream boundary condition. Recall that the study area is composed of reach 1 (river mile 6.0 to 4.0), reaches 2 and 3 (4.0 to 2.0), and reach 4 (2.0 to 0.0). The dashed line is the profile computed when the downstream boundary is placed at river mile 0.0, while the solid line is the profile computed when the boundary is moved ten miles away from the study area. The difference in profiles can be understood by considering Figure D-9. This figure compares rating curves computed at river mile 0.0. The dashed curve is the downstream boundary condition applied at river mile 0.0. It is essentially a single-valued, monotonically increasing relationship, typical of steady, uniform flow conditions. The solid curve results when the boundary condition is relocated ten miles downstream, and represents the looped curve characteristic of the channel at river mile 0.0. Note that maximum stage for the dashed curve is higher than the stage for the same flow on the solid curve. For this problem, the error is shown to impact the results for the entire six miles of channel (recall Figure D-4).

When applying this type of downstream boundary condition away from the study area, the actual geometry of additional cross sections should be used. The prismatic channel used for reach 4 allowed use of a simple repeat cross section. If the added reach length contains backwater effects such as tributary inflows or hydraulic control structures, they should be included in the model as well.

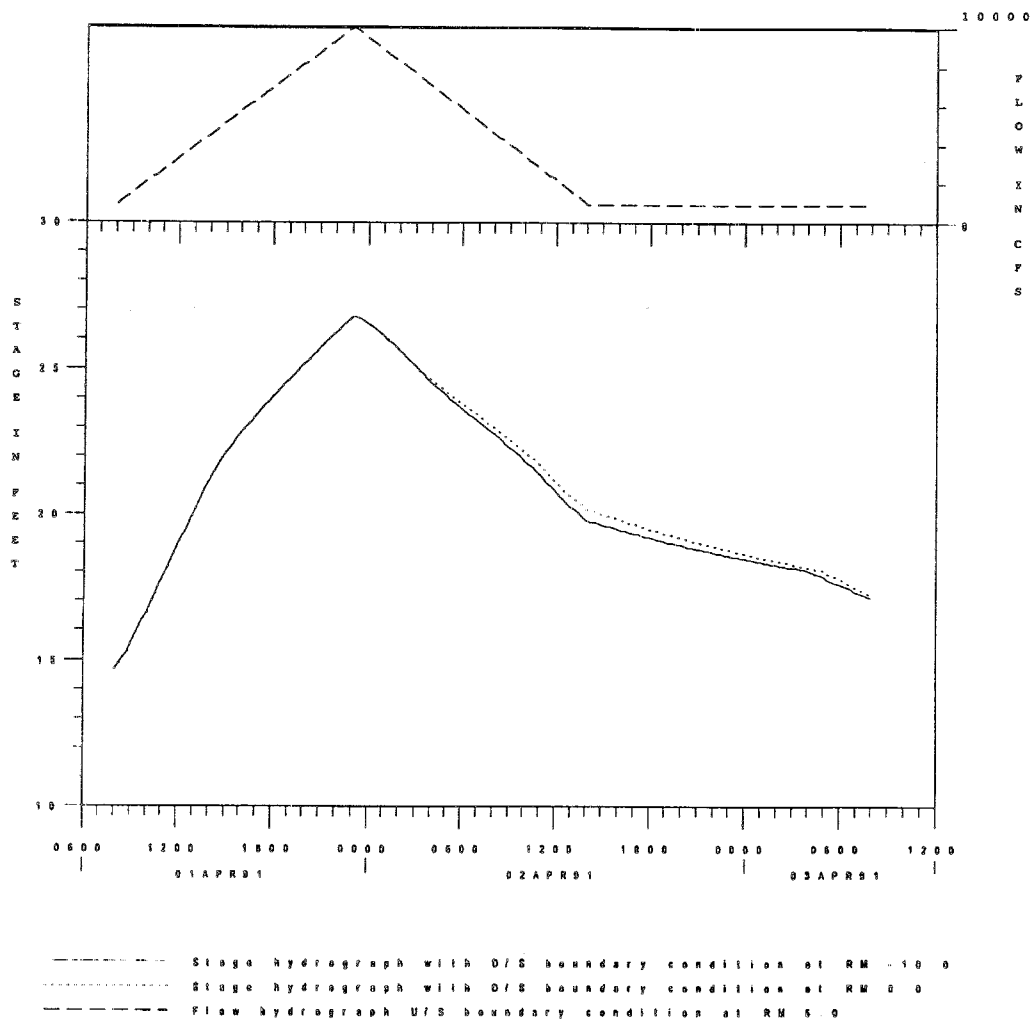

Figure D-4 Inflow Hydrographs at Reach 1, RM 6.0.

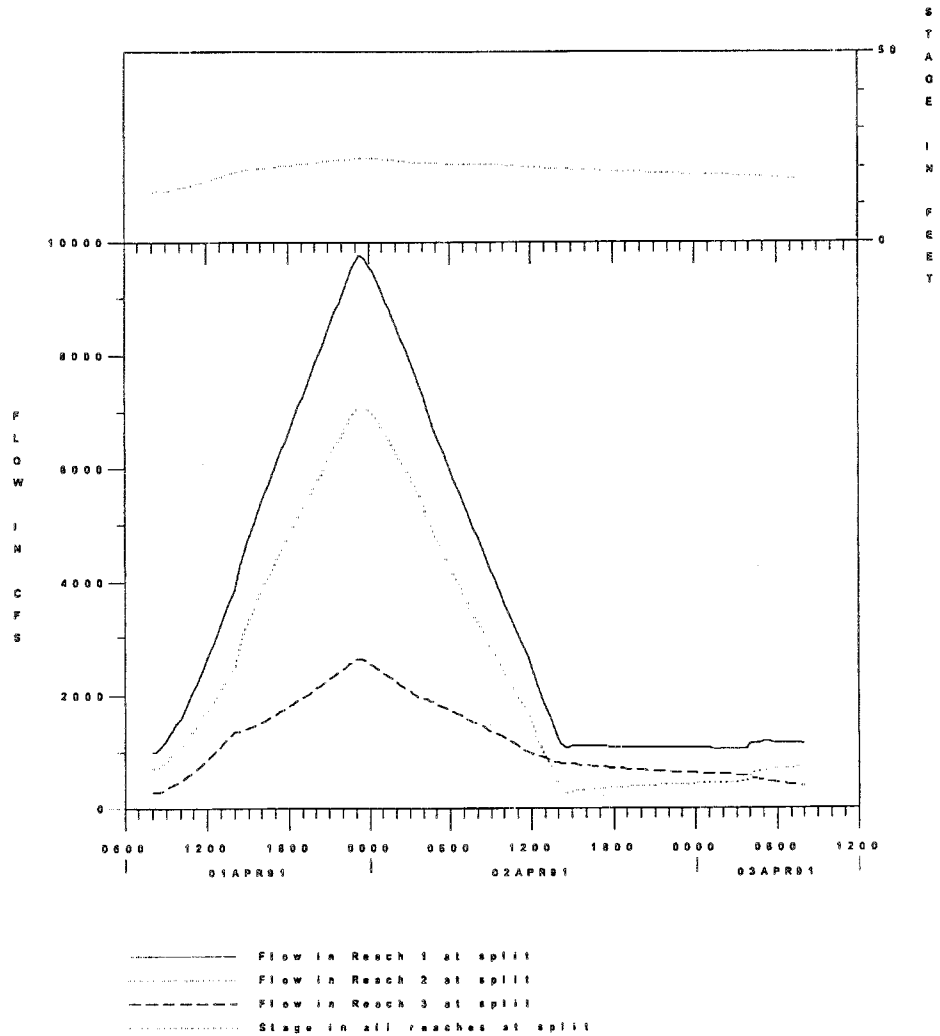

Figure D-5 Hydrographs for the Flow Split at RM 4.0.

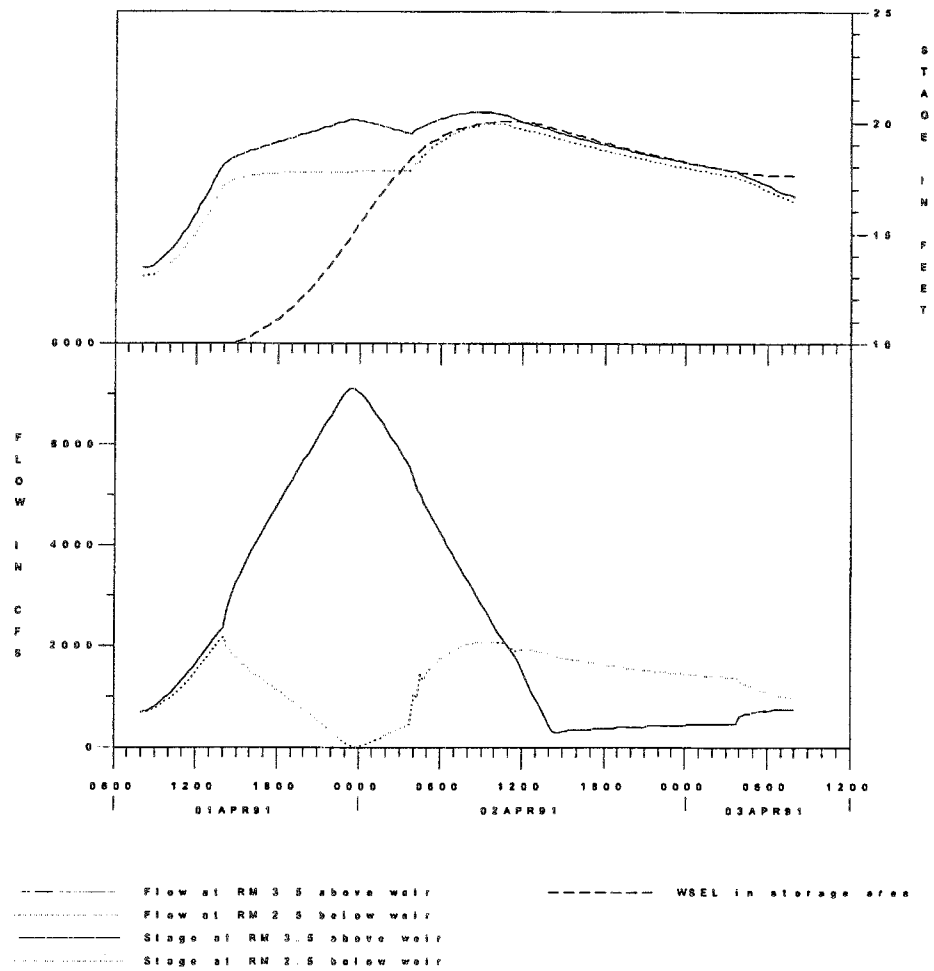

Figure D-6 Hydrographs at Weir in Reach 2.

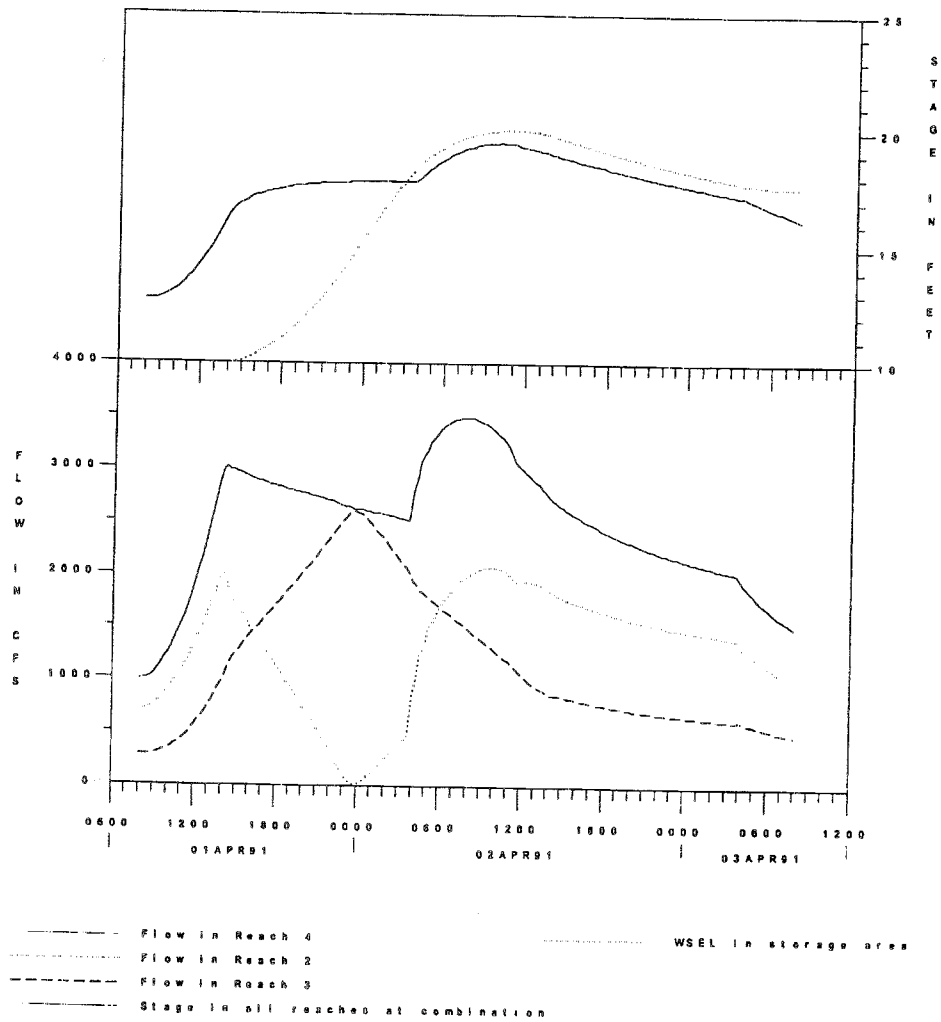

Figure D-7 Hydrographs for the Flow Combination at RM 2.0.

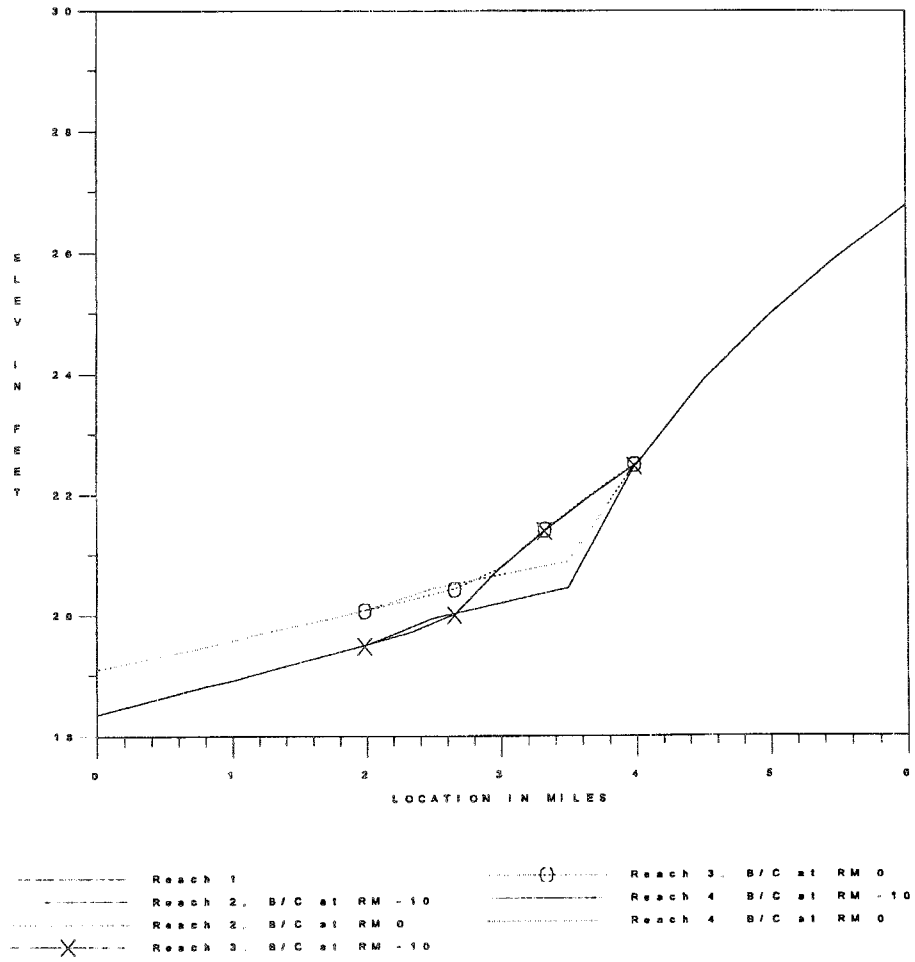

Figure D-8 Maximum Water Surface Elevation Profiles.

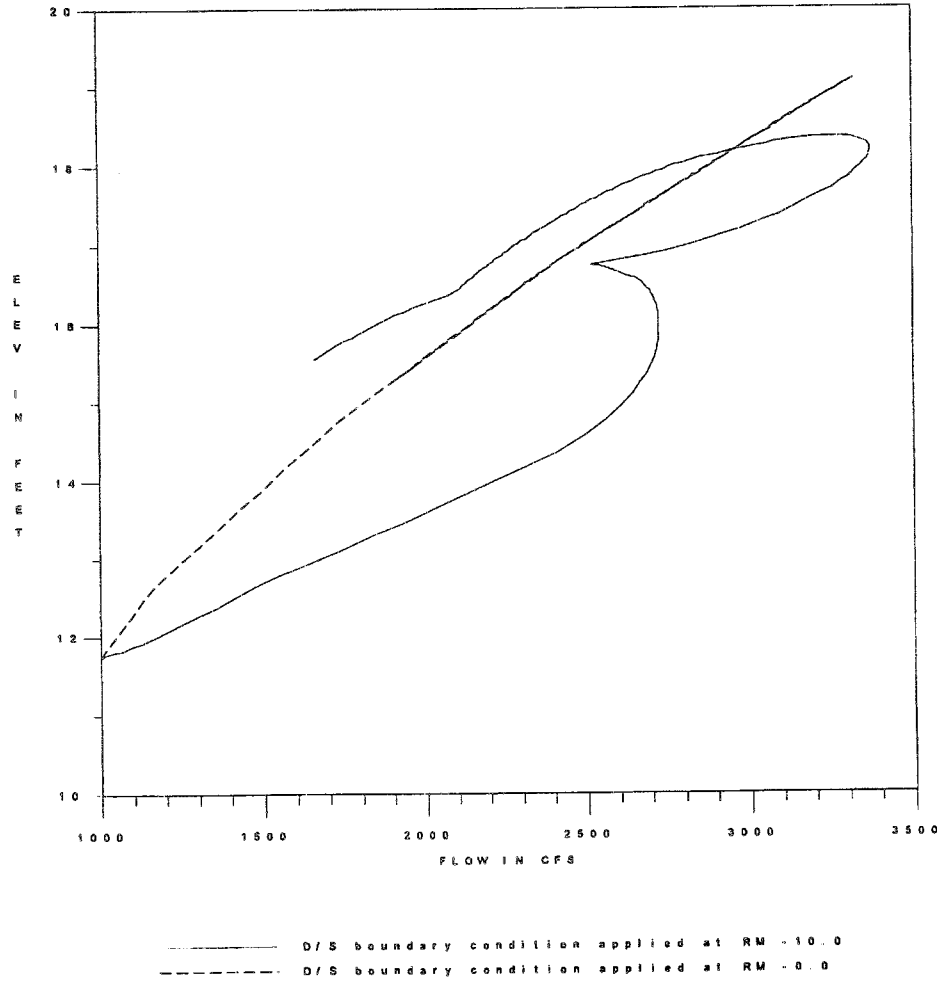

Figure D-9 Computed Rating Curves at RM 0.0.

Example Problem #2

Advanced Features

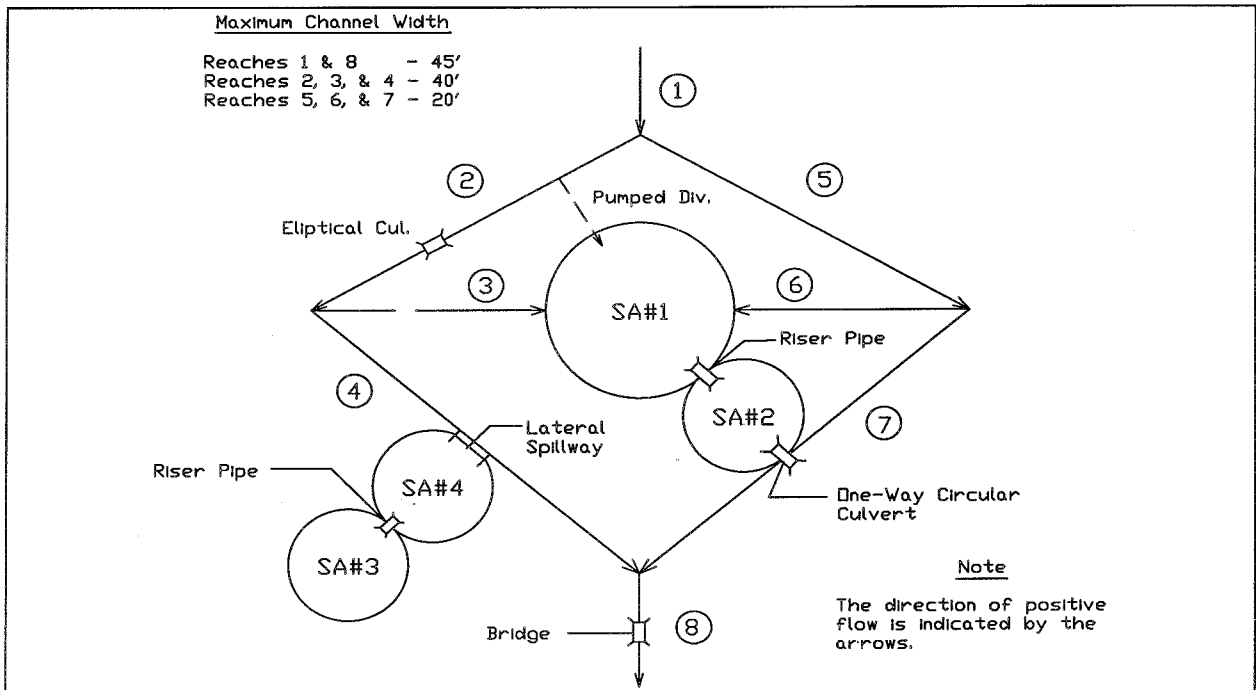

Figure D-10 Diamond Shaped River System.

To demonstrate some of the advanced features of the UNET program, a model was developed of the diamond shape that is shown in Figure D-10. The system consists of 8 reaches and 4 storage areas that are interconnected. The hydraulic structures in the system include; culverts, a pump diversion, riser pipes, a lateral spillway, weirs, and a bridge. The geometry file is shown in Table D-6 and the boundary condition file is shown in Table D-7.

Table D-6
Geometry File for the Diamond Shaped System.

```

PR ON
T1 REACH 1
T2 SFWMD DIAMOND
T3 BARKAU APRIL 1991
*
* XK record is used to define hydraulic table limits and cross-section
* interpolation.
*
XK 50          2.0  1
XI .25
*
UB
*
NC .08 .08 .030
*
X1 6.0  8  100  145  5280  5280  5280
HY 1 RM 6.0
GR 33  0  15  10  13  100  3  105  3  140
GR 13  145  15  240  33  250
*
X1 5.0  8  100  145  5280  5280  5280
HY 1 RM 5.0
X3          30  999  220  -.999
GR 32.5  0  14.5  10  12.5  100  2.5  105  2.5  140
GR 12.5  145  14.5  240  32.5  250
*
X1 4.0  8  100  145
HY 1 RM 4.0
GR 32  0  14  10  12  100  2  105  2  140
GR 12  145  14  240  32  250
*
* Downstream Boundary of reach 1 connects to reach 2 and 5.
*
DB  2  5
*
T1 REACH 2
T2 SFWMD DIAMOND
T3 BARKAU APRIL 1991
*
* Upstream Boundary of reach 2 connects to reach 1.
*
UB  1
*
X1 4.0  8  50  90  2640  2640  2640
HY 2 RM 4.0
GR 33  0  14  10  12  50  2  55  2  85
GR 12  90  14  120  33  130
*
* The next record is a Pump Diversion. Water is diverted from reach 2, at
* river mile 4.0, into storage area number 1. The pump is turned on at
* elevation 23 and off when the water drops down to elevation 21. The
* flow rate of pumping is 100 cfs.
*
PD  2  4.0      -1  1  21  23  100
X1 3.496          3900  3900  3900      -.25
*
* The default for the program is to use a family of rating curves, rather

```

Advanced Features

* than exponential equations (not recommended), for the following bridge and
* culverts. To use the exponential equations apply an FA OFF command, e.g.

*
* FA OFF
*
X1 3.400 8 50 65 50 50 50 -25
HY RCH 2 SEC 3.40
X3 55 20 60 20
GR 33 0 14 10 12 50 3 55 3 60
GR 3 65 14 120 33 130

* The next three records describe a circular culvert crossing, between sections
* 3.4 and 3.39.

*
CC 6 3 3 30 .025 7 0
WD 1 3.0 20 100
CL

*
X1 3.390 4000 4000 4000 -25
HY RCH 2 SEC 3.39
X3 55 20 60 20

*
X1 2.0 -75
HY 2 RM 2.0

* The downstream boundary of reach 2 connects to reaches 3 and 4.

*
DB 3 4

*
T1 REACH 3
T2 SFWMD DIAMOND
T3 BARKAU APRIL 1991

* The upstream boundary of reach 3 connects to reach 2.

*
UB 2
*
X1 1.0 8 50 90 5280 5280 5280 -75

HY 3 RM 1.0
GR 33 0 14 10 12 50 2 55 2 85
GR 12 90 14 120 33 130

* The next four records describe two storage areas located in the center of
* the diamond shaped reaches.

*
SA 1 1000 0 3 6
HS CENTER LAKE
SA 2 1000 0
HS SECOND LAKE

* The following SC record defines a "Special Connection" in the stream network.
* Special connections can be defined between two storage areas or from a
* river reach to a storage area. The next four records describe a special
* connection between storage area 1 and 2. The connection is defined with a
* riser pipe and a weir.

*
SC -1 -2
RI 5 2.6 2.5 50 .022 7 2.4 11.5 16
WD 1 2.5 16.5 500
RL 20 20 11.5 19 11.6 19.2

*
X1 0.0 7900 7900 7900 -75
*

* The downstream boundary of reach 3 is storage area number 1.

*

DB -1

*

T1 REACH 4

T2 SFWMD DIAMOND

T3 BARKAU APRIL 1991

*

* The upstream boundary of reach 4 is reach 2

*

UB 2

*

X1 2.0 8 50 90 500 500 500 -75

HY 4 RM 2.0

GR 33 0 14 10 12 50 2 55 2 85

GR 12 90 14 120 33 130

*

* The next four records describe storage areas 3 and 4.

*

SA 3 1000

HS THIRD LAKE

SA 4 1000

HS FOURTH LAKE

*

* The LA and WD records are used to describe a lateral weir from reach 4 into

* storage area number 4.

*

LA 4

WD 1 3 10 50

*

* The next four records describe a "special connection" between storage area

* 3 and 4. The connection is a riser pipe and a weir.

*

SC -3 -4

RI 5 2.6 2.5 50 .022 7 2.4 14 16

WD 1 2.5 16.5 500

RL

*

X1 1.9 8 50 90 10000 10000 10000 -75

HY 4 RM 2.0

GR 33 0 14 10 12 50 2 55 2 85

GR 12 90 14 120 33 130

*

X1 0.0 -2.0

HY 4 RM 0.0

*

* The downstream boundary of reach 4 is reach 8.

*

DB 8

*

T1 REACH 5

T2 SFWMD DIAMOND

T3 BARKAU APRIL 1991

*

* The upstream boundary of reach 5 is reach 1.

*

UB 1

*

X13.9999 8 50 70 10560 10560 10560

HY 5 RM 5.0

GR 33 0 14 10 12 50 2 55 2 65

GR 12 70 14 120 33 130

*

Advanced Features

X1 2.0 -1
HY 5 RM 2.0

*
* The downstream boundary of reach 5 is reach 6 and 7.

DB 6 7

*
T1 REACH 6
T2 SFWMD DIAMOND
T3 BARKAU APRIL 1991

*
* Upstream boundary of reach 6 is reach 5.

UB 5

*
X1 1.0 8 50 70 10560 10560 10560 -1
HY 6 RM 1.0
GR 33 0 14 10 12 50 2 55 2 65
GR 12 70 14 120 33 130

*
X1 0.0 0
HY 6 RM 0.0

*
* Downst
ream boundary of reach 6 is storage area number 1.

DB -1

*
T1 REACH 7
T2 SFWMD DIAMOND
T3 BARKAU APRIL 1991

*
* Upstream boundary of reach 7 is reach 5.

UB 5

*
X1 2.0 8 50 70 560 560 560 -1
HY 7 RM 2.0
GR 33 0 14 10 12 50 2 55 2 65
GR 12 70 14 120 33 130

*
* The next four records describe a special connection from reach 7 to storage
* area number 2. The special connection is a circular culvert. The culvert
* only allows flow to go from storage area 2 into reach 7. This is controlled
* by field seven of the CC record.

*
SC -2
CC 6 8 8 20 .022 7 -1
WD 1 2.5 17. 100

CL

*
X1 1.9 10000 10000 10000
HY 7 RM 1.9

*
X1 0.0 -2
HY 7 RM 0.0

*
* The downstream boundary of reach 7 is reach 8.

DB 8

*
T1 REACH 8
T2 SFWMD DIAMOND

T3 BARKAU APRIL 1991

*

* The upstream boundary of reach 8 is reach 4 and 7.

*

UB 4 7

*

* The next four cross sections area used with the special bridge option.

* The special bridge option (BR record) allows the flow to transition between

* low flow, pressure flow, and pressure and weir flow.

*

* FULL WIDTH CROSS-SECTION

*

X1 2.0 8 100 145 150 150 150 -1

HY 8 RM 2.0

GR 31 0 13 10 11 100 1 105 1 140

GR 11 145 13 240 31 250

*

* UPSTREAM CONSTRICTED CROSS-SECTION

*

X1 1.90 8 100 145 50 50 50

X3 70 999 170 999

GR 15 0 15 100 11 100 1 105 1 140

GR 11 145 15 145 15 250

*

* BRIDGE DATA

*

BR 12 10 1.6 .8 11 15 3.0

WD 1 3 15 100

BL 28 29 7

*

* DOWNSTREAM CONSTRICTED CROSS-SECTION

*

X1 1.89 8 100 145 600 600 600

X3 70 999 170 999

GR 15 0 15 100 11 100 1 105 1 140

GR 11 145 15 145 15 250

*

* FULL WIDTH CROSS-SECTION

*

X1 1.80 8 100 145 4500 4500 4500 -1

HY 8 RM 1.8

GR 31 0 13 10 11 100 1 105 1 140

GR 11 145 13 240 31 250

*

X1 1.0 8 100 145 5280 5280 5280 -1

GR 30.5 0 12.5 10 10.5 100 .5 105 .5 140

GR 10.5 145 12.5 240 32.5 250

*

X1 0.0 8 100 145 -1

HY 8 RM 0.0

GR 30 0 12 10 10 100 0 105 0 140

GR 10 145 12 240 30 250

*

* Reach 8 is the end of the model, therefore the downstream boundary does

* not connect to another reach or storage area. The downstream boundary

* of reach 8 defined by manning's equation; i.e. a normal depth rating.

* This rating curve is defined in the UNET input file.

*

DB

*

EJ

Table D-7
Boundary Condition File for the Diamond Shaped System.

* EXAMPLE NO. 2
* TRIANGULAR HYDROGRAPH WITH 10000 CFS AS A CREST
* DIAMOND HEC'S

*
JOB CONTROL
T T 15MIN 48 -1 T 0.6 F F -1 1HOUR

*
TIME WINDOW
01JAN1990 0800 04JAN1990 0800

*
UPSTREAM BOUNDARY

1
6
0 100
24 100
36 1000
39 5000
54 1000
74 100

*
CRITICAL UPSTREAM BOUNDARY AT REACH 1

1 500

*
LATERAL INFLOW INTO STORAGE AREA 1

-1
2
0 100
100 100

*
LATERAL INFLOW INTO STORAGE AREA 3

-3
6
0 10
24 10
36 1000
39 5000
54 1000
74 10

*
DOWNSTREAM MANNING'S EQUATION

8 .0000947

*
INITIAL STORAGE AREA ELEVATIONS

1 11
2 10
3 12
4 10

*
WRITE HYDROGRAPHS TO DSS

ex02_out.dss

*
INITIAL FLOW DISTRIBUTION

8 100
7 20
6 10
5 30
4 60
3 10

2 70
1 100
*
EJ

Example Problem #3

Ice Cover

In this example, flow in a river with an ice cover was modeled. The ice cover was assumed to begin 8.5 miles upstream from the downstream end of the river and to extend along the river for approximately 4.5 miles. The channel was a single river reach 20 miles long. The ice cover was assumed to be 1 foot thick in the left and right overbanks and 2 feet thick in the channel. The ice cover was assigned a Manning's n value of 0.07 (a rather large value, corresponding to an ice cover composed of rough broken ice pieces, for example), and a specific gravity of 0.916 (typical specific gravity of freshwater ice).

The initial flow rate was set at 500 ft³/s along the entire length of the river. After approximately 6 hours, the flow rate entering the upstream end of the river was increased, and reached a peak of about 18,000 ft³/s 18 hours after the start of the simulation. The entering flow was then decreased and reached about 1800 ft³/s after 40 hours of simulation. The flow rate was then slowly decreased to 1670 ft³/s over the next 24 hours.

The simulation was then repeated. However, for the second simulation the ice cover was removed. This allowed the water surface profiles for open water and ice cover conditions to be compared, as well as the flow and stage hydrographs at specific cross sections.

It is important to realize that, although UNET can model the influence of a stable ice cover on the channel hydraulics, the program will make no determination as to the appropriateness of the ice cover input data. As is well known, ice covers are only 'stable' under a limited range of flow conditions. A stable ice cover is one that remains in place without failure. Failure of an ice cover is generally termed 'break-up?'. Break-up of an ice cover can be induced by an increase in the flow rates in the channel, a weakening of the ice cover through the input of heat, or perhaps by other means. UNET will make no judgments regarding the stability of the ice cover being modeled, and it is up to the user to decide if the ice cover will be stable under the range of hydraulic conditions modeled.

CSECT Input File

Table D-8 is the CSECT input file for this problem. Appendix B contains detailed descriptions of each input record. The ice cover is described using an IC record. Note that the ice cover starts at cross section #5 and extends to cross section #8. It is important to note that cross section #8 is considered to be ice free. The ice cover information supplied by each IC record is assumed to start at the first cross section downstream of the IC record. The ice cover will be assumed to exist at all nodes interpolated between cross section #5 and cross section #8.

To remove the ice cover for the second simulation, the IC lines in the CSECT input file were simply commented out by placing an asterisk at the start of the line.

Table D-8
CSECT Input File.

```

PR ON
T1 STR REACH
T2 ICE EXAMPLE
T3 HEC
UB
*
NC .07 .07 .03
*
* ICE DATA FOR STRAIGHT RIVER REACH
*IC 1.0 1.0 2.0 .07
*
* CROSS-SECTION 1
*
XK 9.99          1.25 .3
X1 20.00  8  370  470 13200 13200 13200
HY RCH1 SEC1
ZO 938
GR 1000  0.0  950  20  948  370  938  380  938  460
GR 948  470  950  770 1000  790
*
* CROSS-SECTION 2
*
XK 9.99          1.3  .3
X1 17.5  8  370  470 9800 11200 10560
ZO 933
HY 1 SEC2
GR 995  50  945  70  943  370  933  380  933  460
GR 943  470  945  720 995  740
*
* CROSS-SECTION 3
*
XK 9.99          1.45 .3
X1 15.5  8  420  495 8150 8250 7920
ZO 929
GR 991  200  941  220  939  420  929  430  929  485
GR 939  495  941  695  991  715
*
* CROSS-SECTION 4
*
XK 12.99         1.5  .5
X1 14.0  8  445  505 5280 5280 5280
ZO 926
GR 988  300  951  320  939  445  926  450  926  500
GR 939  505  951  635  988  655
*
* CROSS-SECTION 5
IC 1.0 1.0 2.0 .07
*
X1 13.0  8  470  530 5280 5280 5280
ZO 924
HY 1 SEC5
GR 986  325  949  345  937  470  924  475  924  525
GR 937  530  949  630  986  650
*
* CROSS-SECTION 6
*
XK 12.99         1.3  .50
X1 12.0  8  470  540 8250 7920 7920
ZO 922
HY 1 SEC6
GR 984  300  947  320  935  470  922  475  922  535
GR 935  540  947  690  984  710
*
* CROSS-SECTION 7

```

Ice Cover

```
*
XK 11.99          1.25  50
X1 10.5   8  470  560 10560 10560 10560
Z0 919
GR 981  250  941  270  931  470  919  480  919  550
GR 931  560  941  760  981  780
*
* CROSS-SECTION 8
*
IC 1.0  1.0  2.0  .07  -1.
XK 9.99          1.0   .3
X1 8.5   8  530  630 15840 15840 15840
Z0 915
GR 977  200  927  220  925  530  915  540  915  620
GR 925  630  927  880  977  900
*
* CROSS-SECTION 9
*
X1 5.5   8  420  525 29040 29040 29040
Z0 909
HY 1 SEC9
GR 971  50  921  70  919  420  909  430  909  515
GR 919  525  921  825  971  845
*
* CROSS-SECTION 10
*
X1 0.0   8  420  525
Z0 898
HY 1 SEC10
GR 960  50  910  70  908  420  898  430  898  515
GR 908  525  910  825  960  845
*
DB
*
EJ
```

As described earlier, CSECT calculates a table of the geometric and conveyance properties at each cross section. At those cross sections where an ice cover is specified, the tables are modified to reflect the presence of the specified ice cover. The area of the channel is reduced to account for the submerged portion of the ice cover. The conveyance is modified to account for the composite roughness of the channel and the increase in the wetted perimeter of the channel. The composite roughness is found by combining the channel Manning's n value and the ice cover Manning's n value using the Balokon-Sabaneev formula (Ashton, 1986). Generally these modifications will have the effect of reducing the channel conveyance. The reduction in conveyance may be dramatic even in channels where the submerged area of the ice cover is quite small. This can be seen in Figures D-12 and D-13 in which the open water and ice-covered cross section areas and conveyances are shown for a typical cross section in this example.

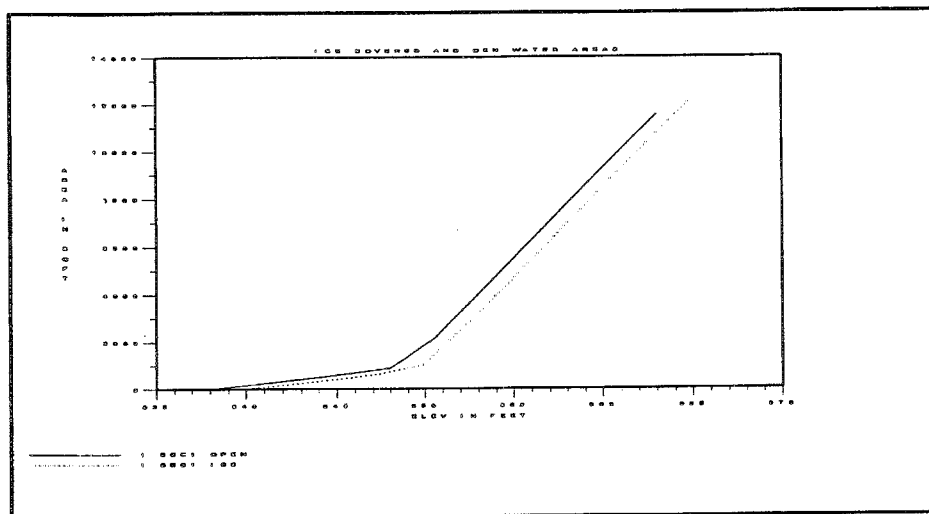

Figure D-12 Open water and ice-covered areas.

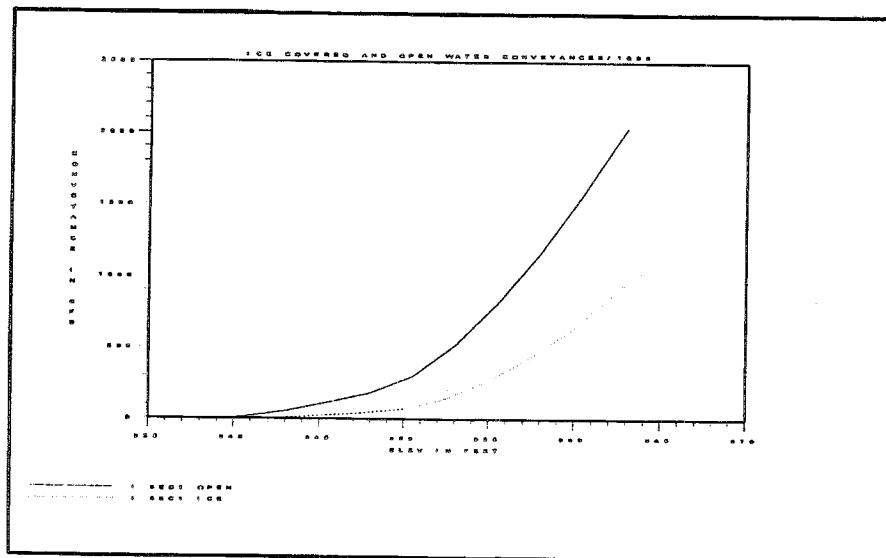

Figure D-13 Open water and ice-covered conveyances.

An example of the table produced by CSECT is shown in Table D-9. Note that ice information is displayed immediately before the table.

**Table D-9
CSECT Table Output.**

ICS# 5, ICE DATA AT R.M. 13.000
ICE THICKNESS: LOB: 1.00 CH: 2.00 ROB: 1.00 ICE n: 0.07 SPEC. GRAV: 0.916

ICS# 5, CROSS SECTION PROPERTIES AT R.M. 13.000

ELEV	ALOB	ACH	AROB	AREA	CLOB	CCH	CROB	CONV	BAREA	TW	SLOB
(ft)	SLOB	S	ALPHA	BETA	ft	ft	(ft ²)	(ft)	(ft ²)		(ft)
925.84	0	1	0	1	0	0	0	0	0	50	0
927.34	0	76	1.00	76	0	2	0	2	0	51	0
928.84	0	154	1.00	154	0	6	0	6	0	52	0
930.34	0	233	1.00	233	0	11	0	11	0	53	0
931.84	0	314	1.00	314	0	17	0	17	0	55	0
933.34	0	397	1.00	397	0	25	0	25	0	56	0
934.84	0	482	1.00	482	0	34	0	34	0	57	0
936.34	0	568	1.00	568	0	43	0	43	0	58	0
937.84	0	656	1.00	656	0	54	0	54	0	59	0
939.34	11	746	1.04	765	0	66	0	66	0	87	0
940.84	45	836	1.14	916	1	79	1	81	0	115	0
942.34	102	926	1.25	1109	2	94	2	98	0	143	0
943.84	183	1016	1.39	1345	5	110	4	119	0	171	0
945.34	287	1106	1.51	1623	9	127	7	143	0	199	0
946.84	415	1196	1.60	1943	15	144	12	171	0	227	0
948.34	566	1286	1.68	2305	23	163	18	204	0	255	0
949.84	741	1376	1.74	2709	33	182	26	241	0	284	0
951.34	929	1465	1.70	3138	47	202	37	287	0	287	0
952.84	1118	1556	1.65	3569	64	224	51	338	0	288	0
954.34	1309	1646	1.60	4002	82	246	65	393	0	290	0
955.84	1500	1736	1.55	4438	102	268	81	452	0	291	0

2MN = 924.00 XS2MN = 924.00

10APR95
PAGE 6

ICS# 6, ICE DATA AT R.M. 12.000
ICE THICKNESS: LOB: 1.00 CH: 2.00 ROB: 1.00 ICE n: 0.07 SPEC. GRAV: 0.916

ICS# 6, CROSS SECTION PROPERTIES AT R.M. 12.000

ELEV	ALOB	ACH	AROB	AREA	CLOB	CCH	CROB	CONV	BAREA	TW	SLOB
(ft)	SLOB	S	ALPHA	BETA	ft	ft	(ft ²)	(ft)	(ft ²)		(ft)
923.84	0	1	0	1	0	0	0	0	0	60	0
925.14	0	79	1.00	79	0	2	0	2	0	61	0
926.44	0	159	1.00	159	0	5	0	5	0	62	0
927.74	0	240	1.00	240	0	10	0	10	0	63	0
929.04	0	323	1.00	323	0	17	0	17	0	64	0
930.34	0	407	1.00	407	0	24	0	24	0	65	0
931.64	0	492	1.00	492	0	32	0	32	0	66	0
932.94	0	579	1.00	579	0	41	0	41	0	67	0
934.24	0	666	1.00	666	0	51	0	51	0	68	0
935.54	0	755	1.00	755	0	62	0	62	0	69	0
936.84	5	846	1.02	856	0	74	0	74	0	93	0
938.14	31	937	1.10	999	0	88	0	89	0	126	0
939.44	78	1028	1.10	1183	2	102	2	105	0	158	0
940.74	146	1119	1.22	1410	3	118	3	125	0	191	0
942.04	235	1210	1.34	1679	7	134	7	148	0	223	0
943.34	345	1301	1.46	1990	11	152	11	174	0	256	0
944.64	476	1392	1.57	2343	17	170	17	204	0	288	0
945.94	628	1483	1.67	2739	25	189	25	238	0	321	0
947.24	802	1574	1.75	3177	34	208	34	276	0	353	0
948.54	994	1665	1.80	3653	47	229	47	322	0	371	0
949.84	1190	1756	1.80	4135	63	250	63	376	0	372	0

UNET Input File

There are no changes required to the UNET input file when the ice option is selected. The UNET input file for this example is the following:

```
Example Problem #3
SINGLE REACH STREAM
ICE
*
* Job control information
*
JOB CONTROL
T T 5MIN 48 6 F 0.6 F F -1 30MIN
*
*
* Read upstream inflow hydrograph from DSS
*
OPEN DSS FILE
EX03_IN.DSS
*
UPSTREAM FLOW HYDROGRAPH
1
/WORKSHP2/SEC1/FLOW/18MAR1991/30MIN/INFLOW/
*
* Specify downstream boundary condition with Manning's
* This boundary condition was placed 5.5 miles downstream
* of the study area.
*
DOWNSTREAM MANNINGS
1 0.00038
*
* Set initial conditions in the reach
*
INITIAL FLOW CONDITIONS
1 500
*
* Close previously opened DSS file
*
CLOSE DSS FILE
*
* Set maximum number of iterations for Newton Raphson iteration scheme
*
MXITER = 10
*
* Set stage tolerance to 0.01 ft, for convergence criteria
*
ZTOL=0.01
*
* Open DSS file for writing results
*
TIME WINDOW
18MAR1991 0030 20MAR1991 2400
WRITE HYDROGRAPHS TO DSS
EX03_OUT.DSS
EJ
```

Results

All data requested by the user to be written to the DSS data file will be written without modification. In addition, if the user has selected the Job Control Option in the UNET input file to write instantaneous flow and water surface profiles to DSS, (Variable

PT on the JOB CONTROL record), the instantaneous top and bottom ice surface elevations are also written to DSS (see Appendix B for details). In the following figures, two of the instantaneous profiles are displayed; one with ice, and a second profile in which the ice cover was removed. The open water results are shown by the data marked by the circles. A brief discussion of the results, based on the figures follows.

In Figure D-14, the discharge hydrographs calculated at the downstream end of the river (SEC10) are shown. It can be seen that the open water hydrograph (dashed line) peak occurs before the ice-cover peak (solid line), and that the ice-cover peak is smaller than the open water peak. Both of these results can be attributed to the reduction in conveyance caused by the presence of the ice cover. This is true even though the ice cover covers only 4.5 miles of the 20 mile channel.

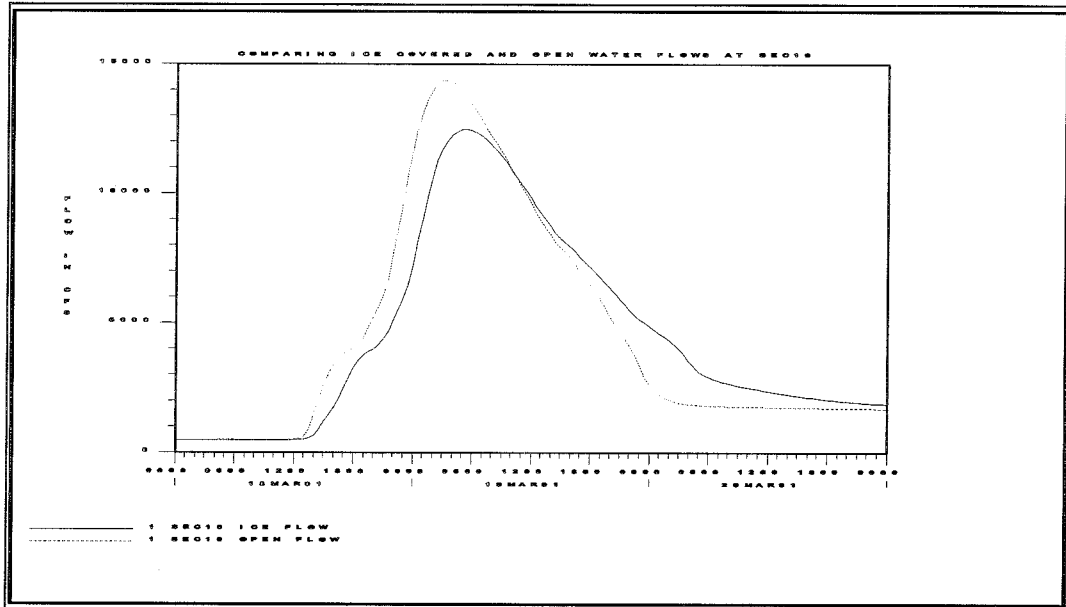

Figure D-14 Open water and ice-covered flows at the downstream end of the river (SEC10).

In Figure D-15, the open water and ice-cover water surface profiles are shown at the start of the simulation. At this time the flow is approximately $500 \text{ ft}^3/\text{s}$ along the entire length of the channel. The reduction in conveyance caused by the ice cover is clearly evident in the raised water surface profile relative to the open water profile which extends over the length of the cover and for some distance upstream. It is this reduction in conveyance which reduces the peak of the hydrograph and delays its passage.

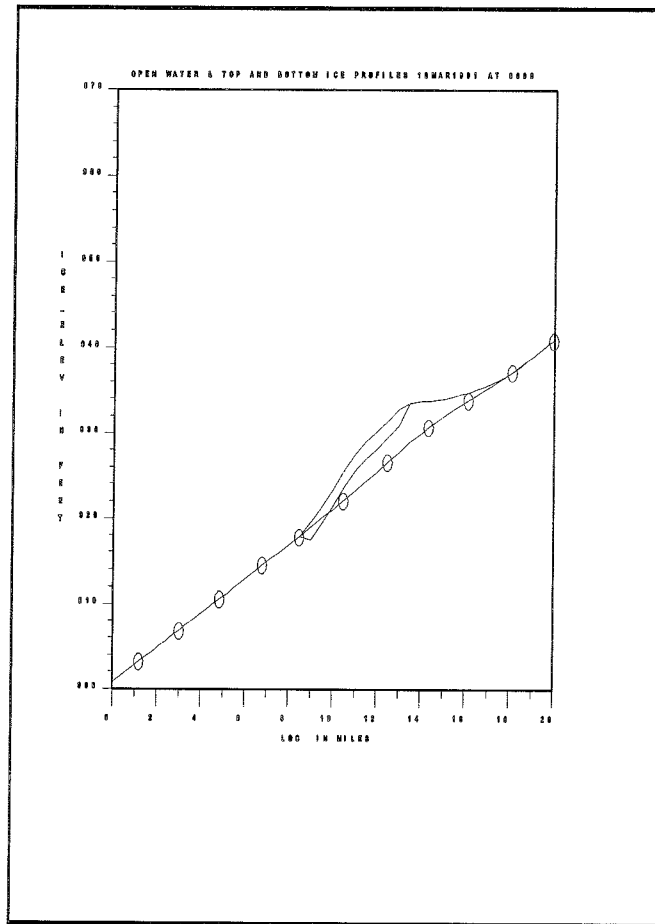

Figure D-15 Open water and ice covered water surface profiles. (Open water data marked with circles.)

In Figure D-16, the open water and ice-cover profiles are shown at a later time. At this time, because the open water hydrograph leads the ice-cover hydrograph, it can be seen that the open water stages in the downstream half of the river are greater than those of the ice covered stages.

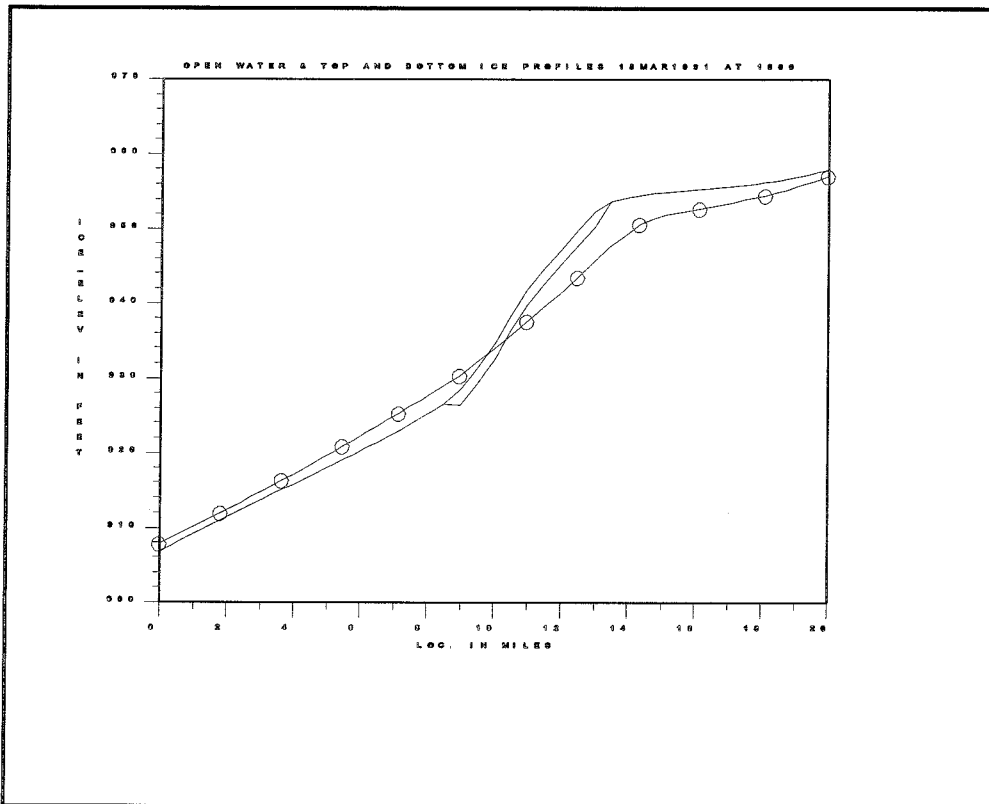

Figure D-16 Open water and ice covered water surface profiles.

In Figure D-17, the reverse of Figure D-16 has occurred. The open water hydrograph has largely passed through the river, and because the ice-cover hydrograph has been delayed, the stages in the downstream half of the river with an ice cover are greater.

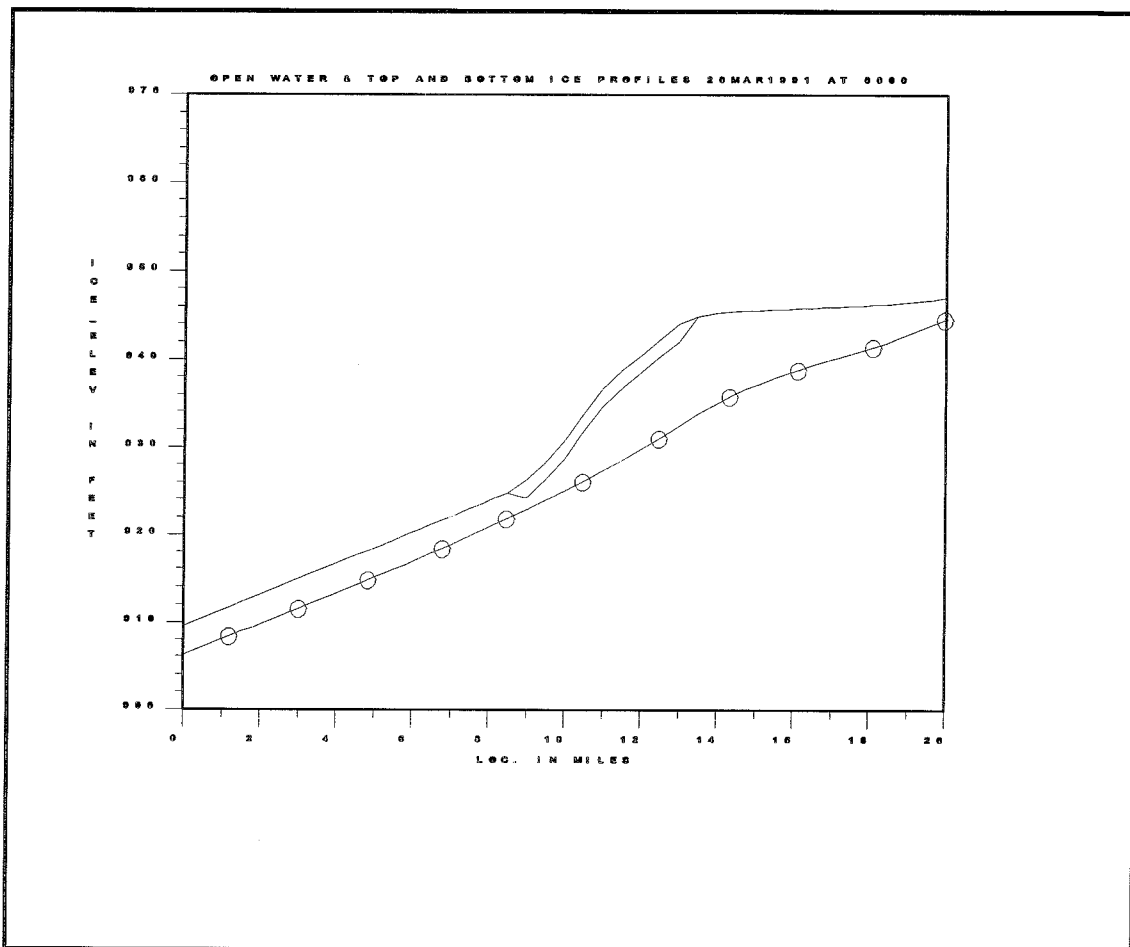

Figure D-17 Open water and ice covered water surface profiles.

In Figure D-18, the open water and ice-cover stage hydrographs are shown at the upstream end of the ice cover (SEC5). It can be seen that at this location the ice-covered stages always exceed the open water stages.

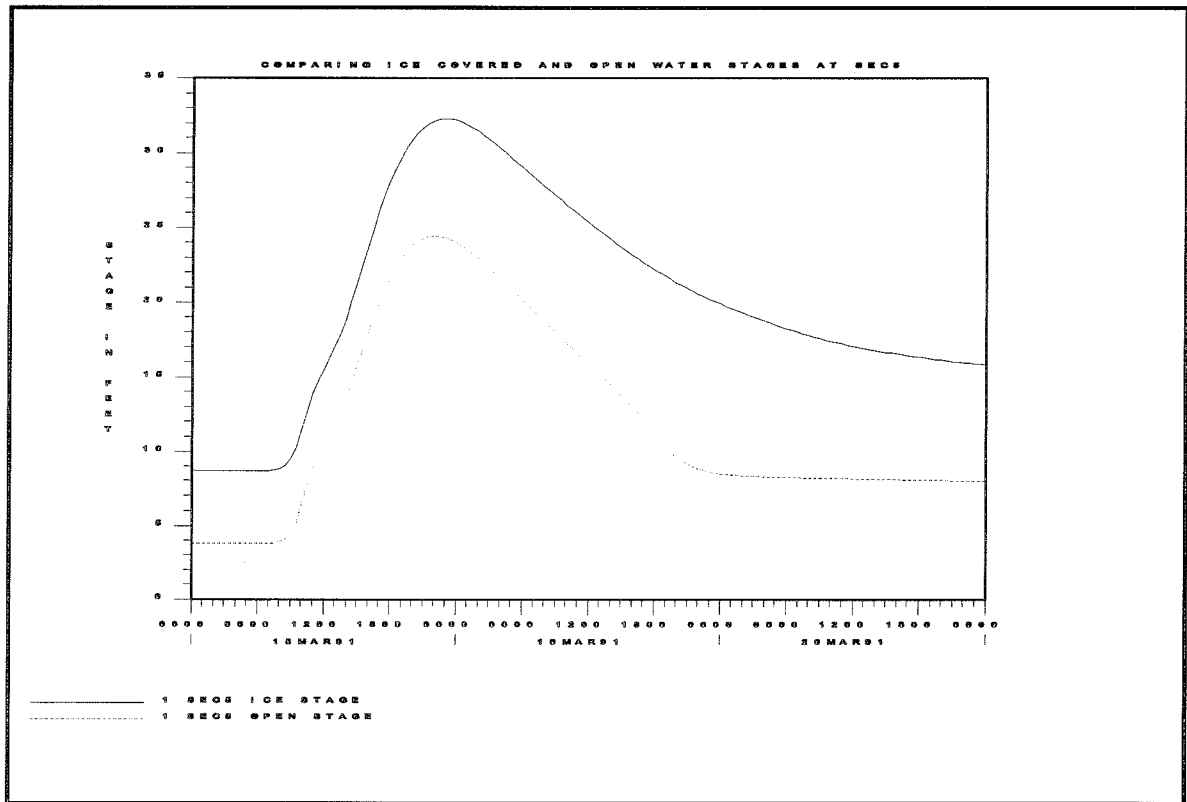

Figure D-18 Open water and ice-covered stage hydrographs at the upstream end of the ice cover (SEC5).

Appendix E

**UNET Mississippi Basin Model
Features**

Appendix E-1

Missouri River Levee Conveyance Routing

1. Introduction

During large flood events on the Missouri River, agricultural levees are overtopped and there is significant overbank flow. The method of handling levees in earlier UNET versions simulates levee systems as storage cells defined by a surface area and height of levee above the ground elevation. Levees are breached based upon a time at which the breach begins or on river stage versus top of levee elevation. This methodology is inadequate for modeling multiple levee system breaches along the Missouri River such as occurred in the 1993 Flood. To overcome this problem, a unique levee algorithm was developed and programmed for UNET. This new UNET levee algorithm simulates the unique hydraulics of the Missouri River levee system that evolves during large flood events.

These levees present a peculiar modeling problem. Up until the transition point, the levee interior operates as a cell which communicates with the river through a breach or breaches in the embankment. This scenario can be modeled by assuming that the levee interior functions as a storage cell or lake and then the breaches can be modeled either as simple embankment failures (linear routing connections) or as complex embankment failures (hydraulics computed from breach geometry). When the river flow exceeds the transition discharge, the area behind the levee no longer acts as a cell, instead it becomes a part of the river, conveying flow. Thus, we have two conditions that must be simulated -- a storage cell and a flowing river.

The "Kansas City levee algorithm" was developed which models a smaller levee by simulating it as a storage cell during breaching and at lower river discharges. When a certain transition discharge is exceeded, the area and conveyance of the cross-sections of the floodplain behind the levee are added to the river cross-sections and channel-floodplain routing starts. The channel-floodplain routing continues until the river flow drops below a cessation discharge when the levee cross-section properties are subtracted from the river cross-sections and the cell routing is restored.

The following different states of flow are defined:

1) Levee failure. A breach forms and the water enters the levee through the breach, filling the levee interior (Figure 1).

2) Storage cell routing. The leveed area has filled and multiple breaches have formed along the entire length of the levee frontage. The breaches still restrict the flow to and from the leveed area and the levee interior resembles a lake (Figure 2).

3) Transition from a storage cell to channel-floodplain routing. The flow in the river exceeds a critical discharge and the levees no longer control the flow. The breaches in the levee no longer restrict the flow; the water surface in the levee interior approaches the slope of the river and the floodplain conveys flow downstream.

4) Levee interior conveys flow. The slope of the water surface approaches the slope of the river and the flow is routed over the river and floodplain (Figure 3).

5) Transition from channel-floodplain routing to storage cell routing. The river flow has dropped below the cessation discharge. The breaches along the levee frontage once again control the flow to and from the leveed area and the levee interior begins to act as a lake. The leveed area returns to storage cell routing.

6) Cessation of storage cell routing. The elevation of the water surface inside the cell falls below the minimum elevation of the cell interior. The levee is considered to be repaired.

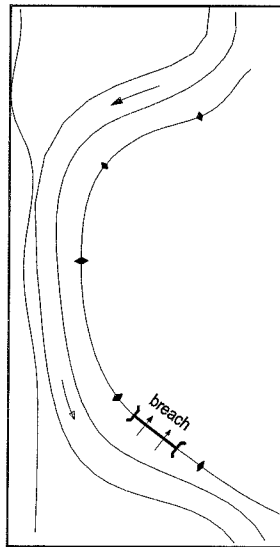

Figure 1. The levee system, functioning as a cell, is filled by flow through the breach.

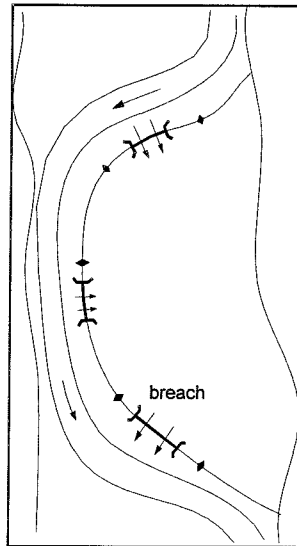

Figure 2. The filled levee, still functioning as a cell, exchanges water with the river through multiple breaches.

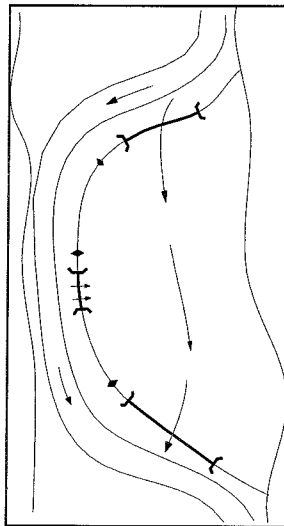

Figure 3. The levee breaches enlarge to a point where the once protected floodplain conveys flow.

2. Modeling Approach

The UNET program is a one-dimensional modeling system that can simulate a network of open channel and an interconnected network of lakes. The modeling approach is as follows:

- 1) Model the levees during failure and storage routing through a network of lakes.
- 2) Convert the levee interior into floodplain area and begin channel-floodplain routing.

We are therefore, modeling the levees as storage cells, converting the cells to cross-sections and modeling the flow through the levee as a channel and floodplain flow and then converting the cross-sections back to storage cells.

Because the levee interior must become a routing reach, the interior must be described by cross-sections. Therefore, to maintain the continuity of water, the volume of the storage cell must be defined by cross-sections. When the levee is breached, the water is transferred to and from the river through the breach and the storage is modeled by the cross-sections. When the levee has filled, numerous breaches are assumed to have formed along the entire length of the levee frontage. The water is routed to the leveed area along the entire length of the levee frontage. When the interior is conveying water, the area and conveyance properties of the cross-sections inside the levee are added to the river cross-sections; thus creating a river with a floodplain.

3. Levee Variables

The primary variables that describe the levees are:

RMLVU -- Upstream river mile of the levee frontage

RMLVD -- Downstream river mile of the levee frontage.

Z0SLV -- Initial elevation inside the levee storage.

ZBRCH -- The river elevation when the levee fails.

RMBRCH -- The river mile of the breach.

ROUTLVIN -- Linear routing coefficient for inflow (hours⁻¹).

ROUTLVOUT -- Linear routing coefficient for outflow (hours⁻¹).

XNLV -- Manning's *n* value behind the levee.

QFPON – River discharge when the floodplain starts to convey flow.

QFPOFF – River discharge when the floodplain stops to convey flow.

4. Levee Storage

The leveed area storage is described by cross-sections. River cross-sections are entered from bluff to bluff, including the area behind the levee. The levee storage is separated from the river cross-section by encroachments using the X3 card. When the CSECT program computes the properties (area and conveyance) for the cross-sections, it also computes the elevation-area table for the storage behind the levee. The storage within the levee is computed by the average end area method; thus for elevation z_k , the storage is

$$k = \sum_{j=m+1}^n \frac{(A(z_k)_{j-1} + A(z_k)_j) \cdot \Delta x_{j-1}}{2} \quad (1)$$

where: j = the cross-section number.

m = the upstream cross-section.

n = the downstream cross-section.

A_j = the area function for cross-section j .

Δx_{j-1} = the distance between cross-section $j-1$ and j .

5. Storage Routing to and from the Levee

Storage routing to and from the levee is governed by the hydrologic continuity equation,

$$\frac{dV}{dt} = \sum Q_i \quad (2)$$

in which V is the volume inside the levee and Q_i is the flow to and from the levee. Positive flow is into the leveed area.

6. Levee Breach

A levee is assumed to be overtopped and breached when the river elevation at the breach exceeds a specified failure elevation or at a specified time of failure. Two modes of filling are supported; linear routing into the levee storage and constant flow during a time of filling.

Linear routing assumes that the flow is proportional to storage in the leveed area that can be filled. The available storage is defined as

$$\Delta S = V(z_B) - V(z_L) \quad (3)$$

where: ΔS = the available storage.
 z_B = the river elevation at the breach.
 $V(z_B)$ = levee storage if the water surface inside the levee is the same as the river elevation at the breach.
 z_L = the water elevation inside the levee.
 $V(z_L)$ = existing levee storage.

During formation of the levee breach, the linear routing coefficient cannot be assumed constant. At failure the river elevation is high and the levee interior is nearly empty and the available storage is very large. Potentially, at failure, the discharge into the leveed area could be very large. To create a more realistic scenario, the linear routing coefficient is increased during a period of time which corresponds to the time of breach enlargement. The linear routing factor is given by

$$r = \frac{t - t_{fail}}{t_{enlarge}} r_{in} \quad (4)$$

where: r = linear routing coefficient.
 t = simulation time.
 t_{fail} = time of failure.
 $t_{enlarge}$ = time of enlargement.
 r_{in} = linear routing coefficient for inflow.

The flow into the levee by linear routing is given by:

$$Q_{in} = r \cdot \Delta S \quad (5)$$

If the time of filling is specified, then the levee is assumed to fill over that period. The flow into the leveed area is given by:

$$Q_{in} = \frac{\Delta S}{[(t_{fail} + t_{fill}) - t]} \quad (6)$$

in which t_{fill} is the time of filling.

7. Storage Routing

After the leveed area has filled, numerous breaches are assumed to have formed along the levee frontage and water passes between the river and the levee along the levee's entire length. The flow to and from the levee is given by the linear routing equation,

$$Q_L = r \cdot \Delta S_R \quad (7)$$

where: Q_L = levee flow.
 r = linear routing factor (hours⁻¹).
 ΔS_R = change in storage from cross-sections and river elevation.

Because the breaches are assumed to be uniformly distributed along the frontage, the potential levee storage is assumed to have the same slope as the river; therefore, the change in storage, ΔS_R , is computed using the average end area method and area at each levee cross-section between the river elevation and the leveed area elevation,

$$\Delta S_R = \sum_{j=m+1}^n \left[\frac{(A(z_{j-1})_{j-1} + A(z_j)_j) \cdot \Delta x_{j-1}}{2} - \frac{(A(z_L)_{j-1} + A(z_L)_j) \cdot \Delta x_{j-1}}{2} \right] \quad (8)$$

where: z_j = river elevation at cross-section j .
 z_L = levee elevation.
 m = the upstream cross-section.
 n = the downstream cross-section.
 A_j = the area function for cross-section j .

The flow is distributed along the levee frontage by distance; hence,

$$Q_{Lj} = Q_L \cdot \frac{\Delta x_j}{\sum_{i=m}^{n-1} \Delta x_i} \quad (9)$$

8. Transition to Open Channel Flow behind the Levee

When the river flow exceeds a critical value, the area inside the levee begins to convey flow. To transition from storage cell routing to open channel flow the following steps must be performed.

- 1) The water surface elevations of the levee cross-sections must equal the water surface elevations of the adjoining river cross-sections; therefore the storage inside the levee must equal the potential storage from the river elevations. The linear routing from equation (7) continues with a routing factor of $r = 0.17$.

When ΔS_R is less than 1% of the total storage, the linear routing factor is increased to 1.0 and the storage is the same over the next time step and $\Delta S_R = 0$.

- 2) The water surface is identical over the river and the levee and the cross-sectional area behind the levee can be added to the river cross-sectional area.
- 3) The river conveyance is increased linearly over a 24 hour period, after which, the floodplain inside the levee is fully conveying flow.

9. Transition from Floodplain Flow to Storage Routing

When the river flow falls below a critical value, the routing over the floodplain is stopped and the storage cell routing is restored. The following steps are performed.

- 1) The conveyance is reduced, linearly, over 24 hours from its full value to zero.
- 2) At zero conveyance, the levee cross-sectional area is subtracted from the river cross-sectional area.
- 3) Storage cell routing is restored.

10. Cessation of Levee Storage Routing

When the levee interior elevation falls below the minimum elevation of the levee, ZOSLV, the breach is repaired and the levee protection is restored.

11. Messages from the Levee Algorithm

The program produces the following messages to describe the status of the levee computations. The messages are displayed in a table in the program output file.

<i>Status</i>	<i>Description</i>
INTACT	Levee embankments are intact.
FILLING	Levee embankment has failed at the breach and the levee interior is filling
FAILED	Levee interior has filled and the levee storage is exchanging water with the river through breaches along the levee frontage through storage routing.
OB FILLING	First step in the initialization of overbank flow. The levee

<i>Status</i>	<i>Description</i>
	storage is coming to equilibrium with the river by storage routing.
OB FLOW STARTING	Second step in the initialization of overbank flow. The protected area behind the levee has been added to the river cross-sections. Storage routing from the river breaches has ceased. No conveyance, but the levee storage is now directly connected to the river.
OB FLOW INCREASING	Third step in the initialization of overbank flow. Conveyance of the protected area is being added to the river cross-sections. The overbank is conveying flow.
OB Flow	The overbank is conveying flow.
OB FLOW DECREASING	The conveyance of the protected area is being subtracted from the river cross-sections. The overbank is still conveying flow but the amount is decreasing.
OB FLOW STOPPED	The conveyance and area of the levee interior has been subtracted from the cross-sections and the levee storage once again is exchanging water with the river through the breaches via storage routing.

12. Example

A simple levee can be entered in two ways - either in the cross-section file or in an include file. When the levee is entered in the cross-section file, the LV card is positioned in the reach where the levee is located, preferably after the first cross-section along the levee frontage. Figure 4 shows the Grossermeyer levee system inserted in the cross-section file. The LV card is inserted after River Mile 234.99 which is near the start of the levee system at mile 235. The levee will breach at mile 235 when the water surface at the breach exceeds elevation 624.0 ft. The levee will fill in 72 hours; after filling, the levee will interact with the river through storage routing and a linear routing factor of 0.05 hr^{-1} . The presence of the LR card indicates that the levee interior can convey water if the levee has failed and the flow exceeds 290,000 cfs. The storage of the levee is computed from the cross-sections between miles 235 and 231.5. The levee stops conveying water when the flow falls below 200,000 cfs.

Figure 5 demonstrates the entry of the Grossermeyer levee in an include file. Except for the RE card, the entry of the levee is identical. The RE card specified the reach number which includes the starting river mile of the levee. The river mile field on the RE card is not used.

Figure 6 shows the stage hydrograph of the levee interior and flow hydrographs from the levee breaches. The stage hydrograph is an average across the levee interior. The breach flow hydrograph shows a zero flow when the levee interior is conveying water; therefore, one sees a positive flow when the leveed area is filling zero flow while the interior is conveying water, and negative flow while the levee is emptying.

During an event like the 1993 flood, the time at which the levee system is breached may be known. The "SIMPLE LEVEE FAILURE" record in the boundary condition file can specify that time. The "SIMPLE LEVEE FAILURE" record for the Grossermeyer Levee System is shown below.

```
SIMPLE LEVEE FAILURE FOR THE GROSSERMEYER LEVEE SYSTEM  
GROSSERMEYER 14JUL1993 0700
```

The name on the second line, which corresponds to the name on the HL card with all blanks removed, identifies the levee system. The levee fails at 14JUL1993 at 0700 in the morning.

```

DI          650.  603.8  350.  5.0
X1234.99    84 29770. 31100. 1760. 1760. 4435.
X3   -12     0.   .00 28991. -999.0 31347. -999.0 3 3
GR 620.0    900.  691.0 1852. 700.0 7200. 650.0 7700. 624.7 10891.
GR 620.0 28700. 650.0 28980. 633.5 28980. 632.0 29000. 620.0 29025.
GR 618.0 29190. 616.0 29260. 616.0 29580. 620.0 29660. 622.0 29690.
GR 624.3 29770. 620.0 29790. 619.0 29800. 610.0 29800. 599.1 29937.
GR 598.6 29957. 597.9 29977. 598.0 29998. 598.4 30019. 598.1 30039.
GR 598.0 30059. 597.6 30079. 597.9 30099. 597.5 30119. 597.3 30139.
GR 596.8 30159. 596.0 30179. 595.8 30199. 596.1 30219. 596.2 30239.
GR 596.5 30259. 595.8 30280. 596.0 30299. 594.5 30320. 595.9 30340.
GR 594.4 30360. 593.7 30380. 593.5 30400. 593.2 30420. 593.9 30440.
GR 592.7 30460. 591.5 30480. 591.2 30500. 591.9 30520. 592.4 30540.
GR 592.8 30560. 592.3 30580. 591.9 30600. 591.7 30620. 592.8 30640.
GR 592.2 30659. 591.5 30680. 590.5 30698. 591.5 30720. 592.6 30741.
GR 591.4 30761. 589.8 30781. 590.4 30802. 588.5 30822. 587.7 30842.
GR 586.2 30862. 585.4 30883. 584.7 30903. 584.2 30924. 586.2 30944.
GR 591.6 30963. 612.0 31000. 612.0 31030. 620.0 31070. 623.8 31100.
GR 624.0 31310. 627.0 31350. 620.0 31380. 620.0 31450. 620.2 31480.
GR 620.0 31950. 619.8 32170. 619.6 32270. 650.0 32270.

```

```

*
* Missouri River Levee Number -212 - Grossermeyer
* The levee is on the right bank
*

```

```

* IRCH      RM
RE   17     2.35

* ALV      TFILL  ZOSLV  RMLVU  RMLVD  ZTOPLV  RMLVB  ZBRCH  ROUTIN  ROUTOUT
LV          72  621.70   235   231.5   625.3   235  624.00   .050   .050

* n      ZFPON  ZFPOFF  BANK  QFPON  QFPOFF
LR  .640          R  290000  200000

```

HL Grossermeyer

*

```

DI          650.  603.2  350.  5.0
X1234.15   104 29890. 31650. 2472. 2472. 6230.
X3   -12     0.   .00 29046. -999.0 34226. -999.0 3 3
GR 700.0    2100.  650.0 3000. 640.0 6000. 620.0 12000. 621.0 28800.
GR 650.0 29060. 633.0 29060. 632.0 29085. 616.0 29130. 615.5 29350.
GR 616.0 29550. 616.5 29700. 620.0 29850. 624.0 29870. 625.0 29890.
GR 593.4 29920. 594.7 29945. 591.6 29965. 591.4 29985. 585.8 30005.
GR 583.1 30025. 584.1 30045. 585.0 30065. 586.5 30085. 587.1 30105.
GR 586.8 30125. 589.6 30145. 588.5 30166. 588.8 30186. 590.4 30206.
GR 590.3 30226. 589.3 30246. 589.0 30267. 589.5 30287. 590.1 30307.
GR 589.9 30327. 589.0 30347. 588.5 30367. 588.5 30387. 589.4 30407.
GR 588.3 30427. 588.7 30447. 589.6 30467. 589.7 30487. 590.0 30507.
GR 589.6 30527. 589.5 30548. 590.1 30567. 589.7 30587. 590.4 30607.
GR 591.0 30627. 592.4 30647. 592.8 30667. 592.8 30688. 592.8 30708.
GR 591.6 30729. 590.9 30750. 592.9 30770. 591.2 30790. 585.1 30811.
GR 577.8 30831. 572.4 30852. 569.8 30873. 568.0 30894. 568.8 30914.
GR 571.3 30934. 577.0 30954. 583.4 30974. 590.9 30994. 616.0 31000.
GR 620.0 31000. 620.0 31080. 620.0 31280. 624.0 31400. 625.0 31450.
GR 624.0 31540. 624.0 31600. 628.0 31640. 629.0 31650. 628.0 31660.
GR 624.0 31820. 622.0 32170. 621.0 32370. 622.0 32560. 624.0 32740.
GR 625.6 32750. 624.0 32770. 620.0 32810. 616.0 32840. 616.0 32920.
GR 624.0 32950. 624.8 32980. 624.0 33000. 622.0 33080. 620.0 33420.
GR 618.0 33600. 618.0 33640. 620.0 33650. 620.0 33760. 619.5 34010.
GR 619.5 34230. 650.0 34230. 620.0 36200. 670.0 36600.

```

Figure 4. Simple levee inserted in a cross-section file.

Missouri River Levee Conveyance Routing

```
*****
*
* Missouri River Levee Number -211 - Chariton R Mainstem
* The levee is on the left bank
*
*   IRCH      RM
RE   15  238.80
*
*   ALV  TFILL  ZOSLV  RMLVU  RMLVD  ZTOPLV  RMLVB  ZBRCH  ROUTIN  ROUTOUT
LV           72  620.30  238.8  227.3   628   238.8  633.50   .050   .050
*
*   n  ZFPON  ZFPOFF  BANK  QFPON  QFPOFF
LR .640  624.00  622.00   L  290000  200000

HL Chariton R Mainstem
*
*****
*
* Missouri River Levee Number -212 - Grossermeyer
* The levee is on the right bank
*
*   IRCH      RM
RE   17   2.35
*
*   ALV  TFILL  ZOSLV  RMLVU  RMLVD  ZTOPLV  RMLVB  ZBRCH  ROUTIN  ROUTOUT
LV           72  621.70   235  231.5   625.3   235  624.00   .050   .050
*
*   n  ZFPON  ZFPOFF  BANK  QFPON  QFPOFF
LR .640  624.50  622.50   R  290000  200000

HL Grossermeyer
*
*****
*
* Missouri River Levee Number -213 - Noth
* The levee is on the right bank
*
*   IRCH      RM
RE   17   2.31
*
*   ALV  TFILL  ZOSLV  RMLVU  RMLVD  ZTOPLV  RMLVB  ZBRCH  ROUTIN  ROUTOUT
LV           72   608   231  217.6   621  218.01  624.00   .050   .050
*
*   n  ZFPON  ZFPOFF  BANK  QFPON  QFPOFF
LR .110  623.00  621.00   R  290000  150000

HL Noth
*
```

Figure 5. Entry of the Grossermeyer levee in an include file.

LV Simple Levee System

The LV card defines the location and the breach parameters for a simple levee system. If the LV card is used by itself, the leveed area functions as a storage cell and the surface area of the levee, ALV, defines the elevation-volume relationship. Optionally, the SV card can be used to enter an elevation-volume relationship for the levee. If the LR card is entered following the LV card, the levee interior can convey water (channel-floodplain routing). The HL card define the name of the levee and the B part of the DSS pathname.

Field	Variable	Value	Description
0	ID	LV	Card identification.
1	ALV	+	The surface area of the levee in acres.
		0	The elevation-volume relationship for the cell will be defined either by an SV card or computed from the cross-sections as directed by a LR card.
2	TFILL	F6.0	The time required to fill the levee, assuming a constant inflow.
3	Z0SLV	F8.0	The invert elevation of the levee for storage computations.
4	RMLVU	F8.0	Upstream river mile or station number.
5	RMLVD	F8.0	Downstream river mile or station number.
6	ZTOPLV	F8.0	Elevation of the levee crown at the midpoint of the levee, at $(RMLVU + RMLVD) / 2$.
7	RMLVB	F8.0	River mile or station number of the levee breach.
8	ZBLV	F8.0	River elevation when the breach in the levee initiates.
8	ROUTLVIN	F8.0	Linear routing coefficient for inflow into the levee system, in hours^{-1} . Generally, $0 \leq \text{ROUTLVIN} \leq 1$.
9	ROUTLVOUT	F8.0	Linear routing coefficient for outflow from the levee

Field	Variable	Value	Description
			system, in hours ⁻¹ . Generally, $0 \leq \text{ROU TLVOUT} \leq 1$.
10	LVNAM	A8	Name of the levee system. The time of failure and other levee parameters may be specified in the boundary condition file. These run-time parameters are assigned to the levee system by the name of the levee system, LVNAM.

LR Simple Levee Floodplain Routing

The LR card defines the parameters that control the routing of water through the levee interior. The routing of water through the floodplain is initiated when river exceeds elevation ZFPON at the upstream end of the levee or the flow exceeds QFPON. The flow trigger takes precedence over the elevation trigger; therefore, if the QFPON is specified the value of ZFPON is ignored. The routing of water through the floodplain is halted when the river elevation falls below ZFPOFF or when the flow falls below QFPOFF. Likewise, the flow trigger takes precedence over the elevation trigger. The roughness of the floodplain is given by the parameter XNLV. Channel-floodplain routing cannot occur without a LR card.

Field	Variable	Value	Description
0	ID	LR	Card identification.
1	XNLV	F6.0	Manning's "n" value for the floodplain inside the levee.
2	ZFPON	F8.0	River elevation to initiate the starting of floodplain routing through the levee.
3	ZFPOFF	F8.0	River elevation to halt floodplain routing through the levee.
4	QFPON	F8.0	Flow to start floodplain routing through the levee.
5	QFPOFF	F8.0	Flow to stop floodplain routing through the levee.

HL Name of Simple Levee Floodplain Routing

The HL card defines the name of the levee system. That name becomes the B part of the DSS pathname.

Field	Variable	Value	Description
0	ID	HL	Card identification.
1	LVNAM	A32	The name of the levee system.

SIMPLE LEVEE FAILURE

The simple levee failure record specifies a time at which a simple levee system breaches. The record has three parameters - the name of the levee on the HL with all blanks removed, the breach date, and the breach time. The record can be placed anywhere in the boundary condition file.

Command Line: SIMPLE LEVEE FAILURE

Parameters: LVNAM, DATE, TIME

<i>Parameter</i>	<i>Value</i>	<i>Description</i>
LVNAM	Alpha.	Name of the levee system.
DATE	Alpha.	Military date (for example, 14JUL1993).
TIME	Alpha.	Military time (for example, 0730).

Example:

SIMPLE LEVEE FAILURE OF THE GROSSERMEYER LEVEE SYSTEM
GROSSERMEYER 14JUL1993 0730

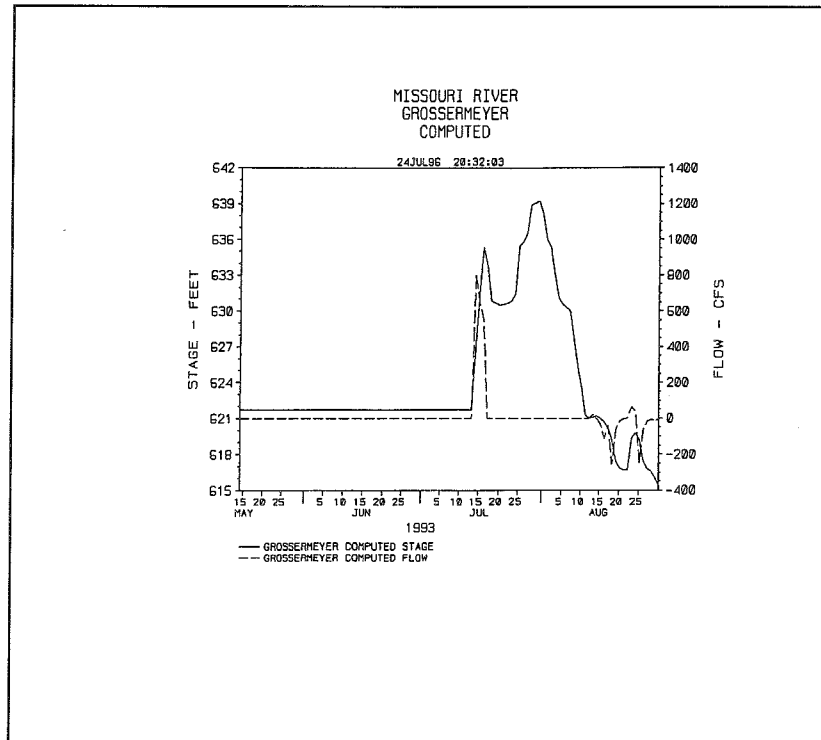

Figure 6. Levee stage and flow hydrograph for the Grossermeyer Levee system. The levee fails on July 14th. The strong positive flow is through the breach and fills the levee system. After filling the levee interior begins to convey flow, which is indicated by a flow through the breaches of zero. On August 12th the levee once again begins acting as a cell as shown by the positive and negative flow as the levee storage interacts with the river.

Appendix E-2

Missouri River Dike Fields

1. Description of a Dike Field

A dike field is a system of rock embankments or timber structures that protrude from the bank. The dikes block the flow along the bank, concentrating the flow along the opposite bank, deepening the channel. The slack water areas behind the dikes eventually fill with sediment burying the dike forming a narrower but deeper river channel. Dikes are generally located on the point bars on the inside of a river bend. Figure 1 shows a typical dike field along the Missouri River.

A typical dike on the left bank of the river is shown in Figure 2. The dike field creates a channel with a design width at a low flow profile which is called the construction reference plane (CRP) on the Missouri River and the low water reference plane (LWRP) on the Mississippi River. The target topwidth, TWCH, extends from the opposite bank to the end of the dike. In UNET the dike can have two steps - a lower step and an upper step. The lower step has a set width with a crest elevation defined by a distance below the CRP, $ZSTEP = ZCRP - DZLOW$. The width of the upper step is the remaining distance from the bank. The crest elevation of the upper step is an increment, $DZSTEP$, above the lower step, $ZUPPER = ZSTEP + DZSTEP$.

The following parameters define a dike field:

ZCRP - the elevation of the CRP or the LWRP at a cross-section.

TWCH - the design topwidth of the contracted channel cross-section.

TWSTEP - the topwidth of the lower step.

DZLOW - distance between the CRP and the lower step.

ZSTEP = ZCRP - DZLOW - elevation of the lower step.

DZSTEP - elevation difference between the lower step and the upper step.

ZUPPER = ZCRP + DZSTEP - elevation of the upper step.

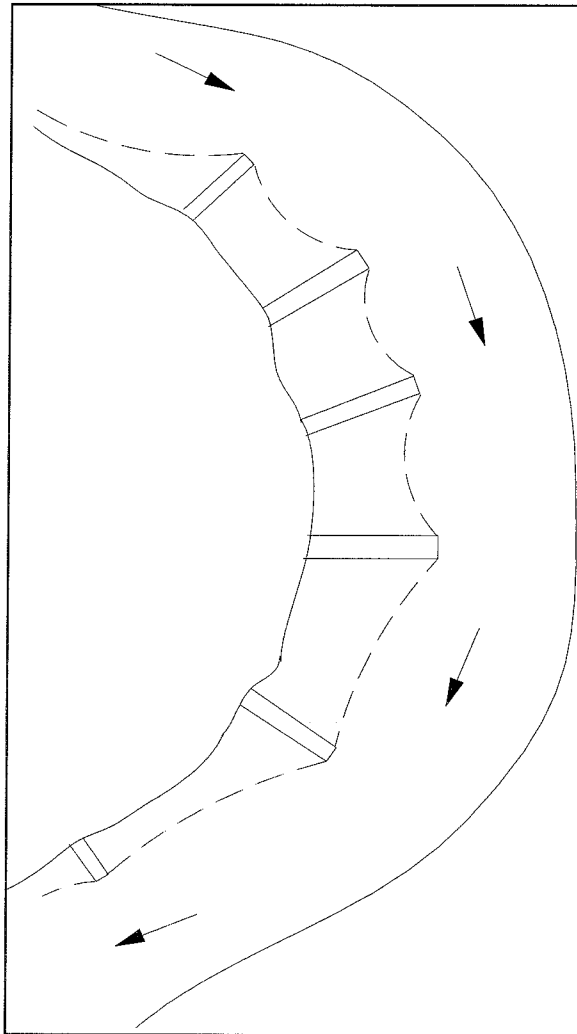

Figure 1. A dike field on the inside of the river bend. The dike field narrows the river to a design topwidth. The slack water area blocked by the dikes fills with sediment and a new bank line eventually develops.

2. Simulation of a Dike Field.

A dike field is defined as a system of structures that contract the low flow cross-section to the design width of the channel. UNET is a one-dimensional model; therefore, the effect of each individual dike cannot be simulated. Rather, the cross-sections are contracted to simulate the contraction of the dike field. The area blocked by the dike field can be modeled as storage area or as a dead area which is deducted from the cross-section. The storage area simulates the condition where the area behind the dike has not filled with sediment and the area stores water. When the water exceeds the top of the dike, the storage area is assumed to return to active flow area, because the submerged dike field has little impact on the conveyance of high flow. The added form roughness of the dike is part of the calibration of the model. The dead area simulates the condition when the area behind the dike has been filled with sediment and that area has been lost for all river stages.

The dike field may be positioned on either the left or right bank. The modeler can specify which bank or allow the program to choose the appropriate bank. The program always attempts to place the dike field on the point bar opposite the channel. The program uses the centroid of the area about the left bank station to locate the dike. The following rules apply:

1. If the centroid is located within the right 40% of the channel topwidth, the dike field is located on the left bank (Figure 2).
2. If the centroid is located within the left 40% of the channel topwidth, the dike is located on the right bank (Figure 3).
3. If the centroid is located within the middle 20% of the topwidth, then the dike field is located on the side opposite the minimum elevation (Figure 4).

Rules 1 and 2 apply to a pool cross-section where the point bar is on the left and right sides respectively. The 40% limit is based on the UNET program developer's judgment. Rule 3 applies to a crossing cross-section, where the area is uniformly distributed, and assumes that the appropriate location of the dike field is on the side opposite the invert.

The effect of the dike field can be modeled by entering five points into a cross-section (Figure 5). The five points are as follows:

1. Point S0 is at the end of the dike at the intersection of the ground and the dike.
2. Point S1 is at the end of the dike at the bottom of the lower step.
3. Point S2 is at the inner limit of the lower step.

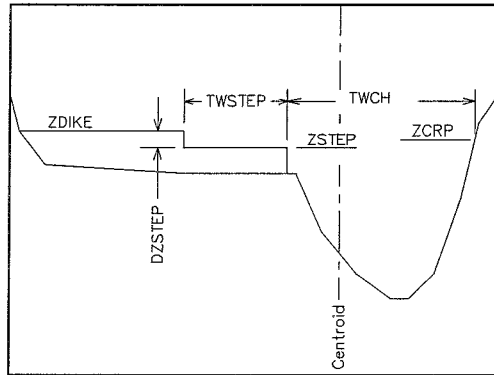

Figure 2. Dike on the left side of the channel. The dike is positioned on the left side of the channel because the centroid is within the right 40% of the channel.

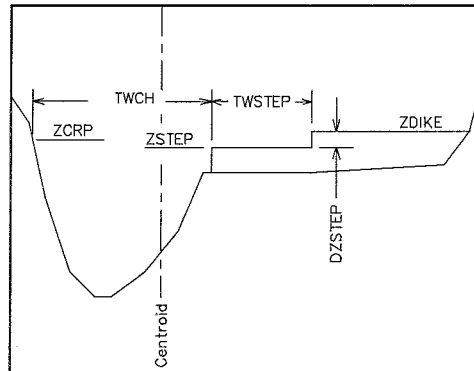

Figure 3. Dike on the right side of the channel. The dike is positioned on the right side because the centroid of the channel is within the left 40% of the channel.

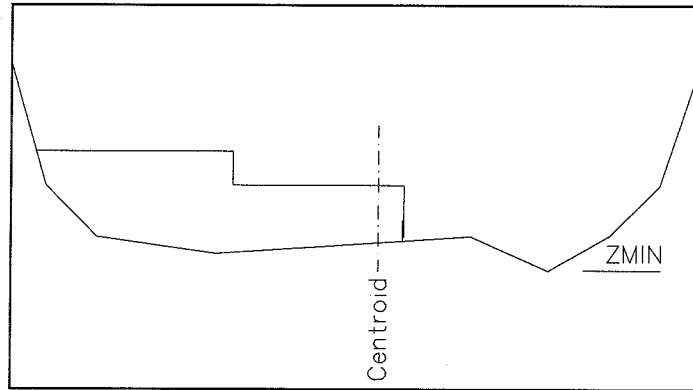

Figure 4. At this crossing cross-section, the dike is located on the left side because the centroid is in the middle 20% of the topwidth and the minimum elevation is on the right side.

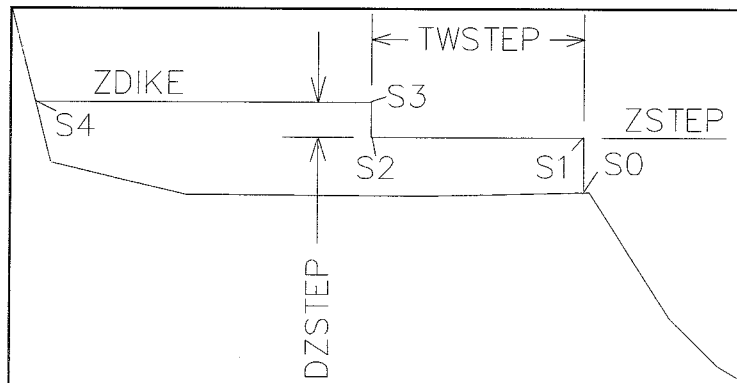

Figure 5. The dike is defined by 5 points, S0 through S5.

4. Point S3 is at the inner limit of the upper step.
5. Point S4 is at the intersection of the upper step with the bank line.

To insert the effect of the dike field into a cross-section, points S1 through S4 are entered into the dike cross-section and all cross-section points between S1 and S4 are brought up to the appropriate elevations, either ZUPPER or ZSTEP.

The minimum width of the dike field is the width of the lower step. If the width of the channel is insufficient to insert the lower step, the dike field is not inserted.

The dike field is inserted on the DI card which is described in appendix A. The DI card is inserted before the GR cards of a cross-section.

3. Example of Cross-Sections in a Dike Field

Figure 6 shows the insertion of a dike into a cross-section at RM of the Missouri River. The DI card is inserted after the X1 card for the cross-section. For this example, the area behind the dike is to be used as storage, which is specified by a value of 0 for the DFSTOR parameter on the DI card. Figure 7 shows the inserted dike and Figure 8 shows the property table for this cross-section. Note that the area behind the dike is now used as storage. Figure 9 compares the active channel area properties with and without the dike. The cross-section area properties are identical when the upper elevation of the dike is exceeded.

*		TWCH	ZCRP	TWSTEP	DZSTEP	DZLOW	DFSTOR		
DI		650.	591.6	350.	5.0	2.	0		
*									
X1220.05	100	9750.	11090.	4165.	4165.	5808.			
X3	-12	0.	.00	9236.	-999.0	11721.	-999.0	3	3
GR 700.0	8150.	612.0	8330.	610.8	8670.	610.4	9060.	608.9	9580.
GR 608.0	9750.	579.9	9846.	579.0	9870.	579.7	9893.	578.0	9914.
GR 578.0	9937.	578.8	9959.	578.0	9981.	578.5	10001.	578.2	10022.
GR 577.0	10043.	577.3	10064.	576.5	10085.	576.8	10108.	576.5	10129.
GR 576.2	10149.	576.3	10170.	575.8	10190.	575.7	10210.	575.9	10233.
GR 576.4	10251.	576.3	10271.	575.7	10292.	577.4	10312.	576.7	10332.
GR 577.1	10352.	578.3	10373.	578.0	10393.	574.7	10413.	576.4	10433.
GR 575.0	10453.	575.1	10474.	575.7	10494.	575.1	10514.	575.7	10534.
GR 575.4	10555.	575.4	10576.	575.1	10596.	575.8	10617.	570.5	10639.
GR 565.7	10659.	565.0	10679.	566.3	10700.	570.9	10721.	577.1	10741.
GR 583.5	10761.	586.3	10781.	587.7	10802.	586.6	10822.	587.2	10843.
GR 587.5	10862.	587.1	10882.	587.2	10904.	588.1	10924.	604.0	11000.
GR 609.4	11090.	602.9	11500.	618.5	11720.	601.1	11800.	609.7	12080.
GR 605.3	12430.	609.0	12650.	607.4	13030.	609.5	13060.	607.9	13270.
GR 610.8	13510.	607.5	13640.	605.9	13830.	608.8	14010.	607.5	14170.
GR 610.4	14410.	606.8	14740.	609.5	14950.	606.8	15170.	609.6	15700.
GR 613.7	15960.	607.5	16080.	610.3	16160.	607.8	16270.	611.5	16590.
GR 612.3	16720.	607.6	16950.	610.6	17090.	606.8	17330.	604.5	17570.
GR 603.1	17860.	618.8	17950.	604.0	18050.	604.7	18280.	608.4	18520.
GR 610.0	18610.	608.0	19000.	640.0	19170.	680.0	19820.	700.0	19920.

Figure 6. The DI card inserts a dike for cross-section 220.05. The value of 0 entered for DFSTOR directs that the area blocked by the dike will be used for storage.

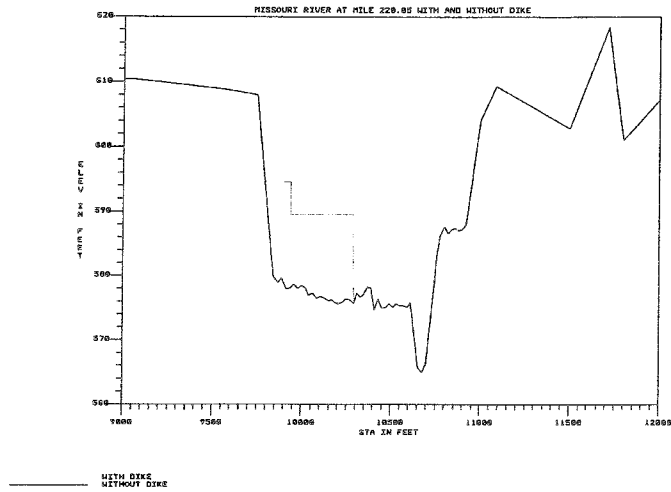

Figure 7. The cross-section at mile 220.05 on the Missouri River with and without the dike.

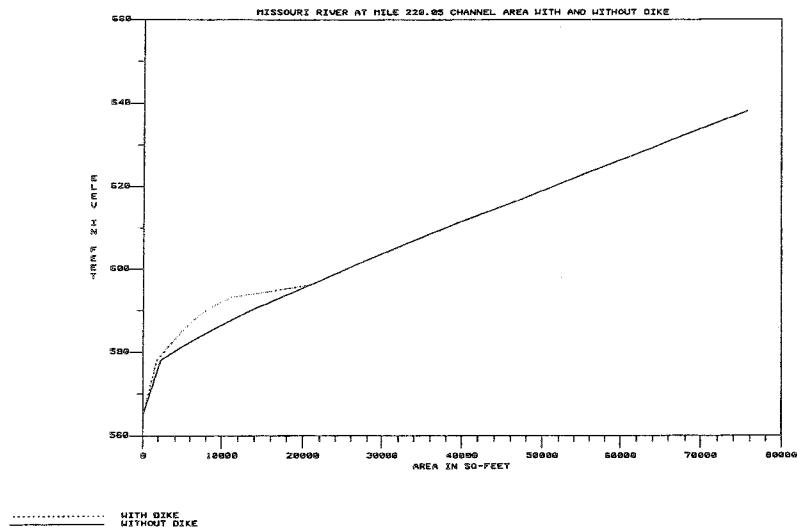

Figure 8. Channel area with and without dike for the Missouri River at mile 220.05.

Syntax of the DI Card

DI Dike Field

A dike field is entered on the DI card. The dike field modifies the cross-section specifying that a portion of the low flow channel which is blocked by the dike is either storage or dead area. The DI card is entered and applies to the next set of GR cards. Fields 1 and 2 define an old dike routine. Fields 3 through 8 define a newer dike routine that was used for the Missouri River.

Field	Variable	Value	Description
0	ID	DI	Card identification.
1	ZDIKE	+	Elevation of the crest of the dike.
		0	
2	AFDIKE	+	Fraction of the channel area below ZDIKE that is blocked by the dike field.
3	TWCH	+	Design topwidth of the channel.
4	ZCRP	+	Elevation of minimum low water at the cross-section. The crest elevations of the dike are based on this design low water elevation.
5	TWSTEP	+	Width of the lower step.
6	DZSTEP	+	Elevation difference between the lower step and the upper step.
		0	Halt dike computations.
7	DZLOW	+	Elevation difference between ZCRP and the lower step.
8	DZSTOR	0	The area blocked by the dike field is used as storage.
		+	The area blocked by the dike field is not used (dead area.)
9	DFSIDE	L	Dike on the left side.
		R	Dike on the right side.
		Blank	Dike automatically positioned.

Appendix E-3

Mississippi River Navigation Dam Algorithm

1. Introduction

This section presents a new algorithm for the simulation of navigation dams in the UNET program. The algorithm simulates two types of navigation dams - dams with the control point at the dam and dams with the control point within the pool, also called hinge pool operation. The UNET program has also been modified to include features which first exactly reproduce recorded pool stages and secondly allow a regulator to control the operation of the navigation pool during forecasting with the UNET program.

2. Types of Navigation Dams

Two types of navigation dams will be simulated by this algorithm:

Control point at the dam. This is the simplest regulation procedure for a navigation dam. The navigation pool is maintained at a target elevation at the dam. When the tailwater elevation plus the swellhead through the structure exceeds the target elevation, the pool is no longer controlled by the dam and the dam is in open river conditions. The target elevation can change with the seasons. For example, in the Rock Island District, the winter pool elevation is 0.5 foot lower than the summer pool elevation. Also, the target pool cannot be precisely maintained; therefore, a tolerance exists about the target pool elevation. In the Rock Island District, the tolerance range is +0.1 feet and -0.4 feet.

Control point within the navigation pool. For this type of operation, the navigation pool is adjusted to maintain a constant elevation at a control point in the navigation pool. This procedure is also called hinge pool operation because the pool conceptually tilts about the control point. The hinge pool operation was devised to minimize the amount of flooded land that had to be purchased by the Government in the upper reaches of the pool. The operation of a hinge pool is given by a operating curve (essentially a rating curve) at the dam. The operating curve is usually derived from experience. Figure 1 shows the rating curve for Lock and Dam No. 9 in the St. Paul District. The control point is Lansing, Iowa which is maintained at an elevation of 620.5 ft. NGVD. The stage is maintained at Lansing of 620.5 ft. until a flow of 32,000 cfs when the maximum allowable drawdown of the pool, 619.5 ft. NGVD, is attained. The maximum drawdown is maintained until the tailwater elevation plus the swellhead of the

structure exceeds the pool elevation and the dam is at open river. Hinge pool operation is also used for the dams in the St. Louis District, although the operating curves have a different appearance. The operating curves are a set of curves which relate control point elevation to pool elevation at constant flow.

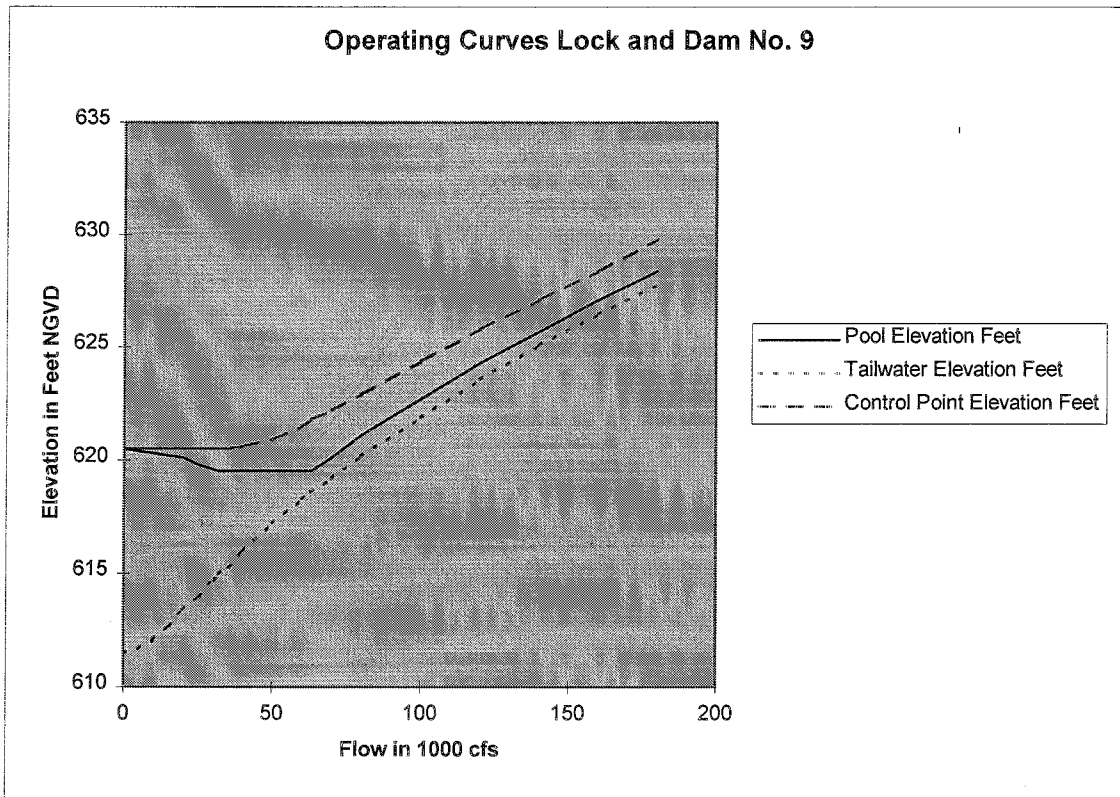

Figure 1. Operating Rule for Lock and Dam No. 9 Pool.

3. Types of Application

The navigation dam algorithm will function under two modes of application - simulation application and forecast application.

Simulation application. Under simulated operation, the navigation dam algorithm operates the dam exactly as specified in the regulation manual. Each time step, the UNET program (within the limits of computational, data and calibration accuracy) will exactly reproduce the target pool stage at the control point, whether the control point is at the dam or the control point is within the pool.

Forecast application. Under forecast operation, the navigation dam algorithm will exactly reproduce pool stages at the dam until the time of forecast. After the forecast time, the program will either:

1. Simulate the target elevations as specified by the regulation manual.
2. Simulate target pool elevations as specified by the regulator.
3. Simulate an outflow hydrograph as specified by the regulator.

The concept is to provide the forecaster with the information needed to make decisions quickly and easily.

4. Navigation Dam Algorithm for Simulation Application

The navigation dam algorithm under simulated operation will exactly reproduce the operation specified in the regulation manual. The navigation dam is treated as an internal boundary condition. During low flow, a pool stage is specified that produces the specified elevation at the control point. During higher flow, when the dam is open to the river, the swell head induced by the dam is added as an added force into the momentum equation.

4.1 Controlled Operation

The pool stage required to achieve an elevation at a control point is given by a family of operating curves. The operating curves for a control point within the pool are shown in Figure 2. Each operating curve corresponds to a elevation of the control point. When the control point is at the dam, the rating curves are horizontal lines. The algorithm requires that the target elevation at the control point be specified; therefore, summer and winter control point elevations must be specified as well as the transition periods.

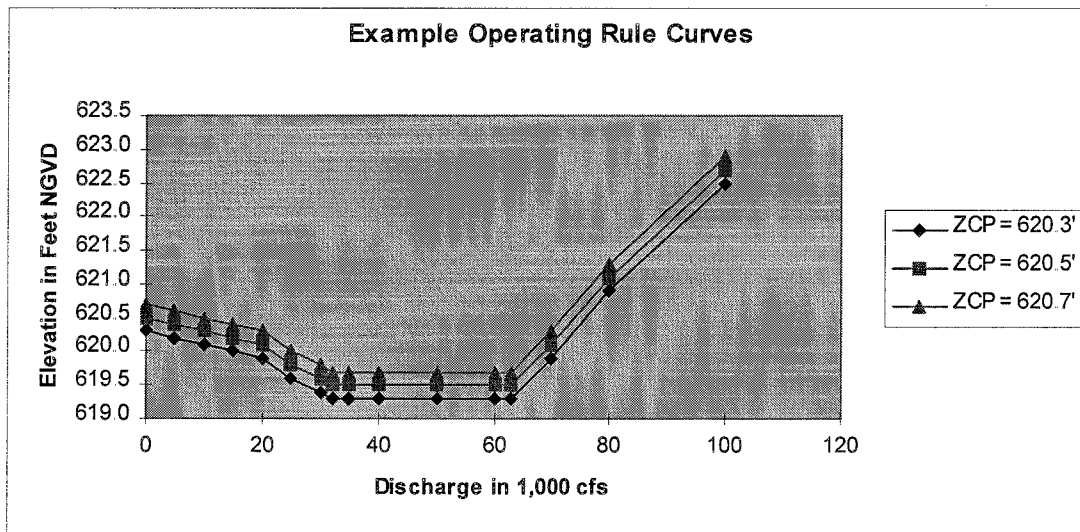

Figure 2. Example of the operating rules for a navigation dam. The three curves correspond to control point elevations of 620.3 ft., 620.5 ft., and 620.7 ft.

During low flow, the navigation dam is treated as an internal boundary condition where the continuity and momentum equations are replaced. If cross-sections j and $j+1$ bound the navigation dam, the exact continuity equation is

$$Q_j^{n+1} = Q_{j+1}^{n+1} \quad (1)$$

in which time step $n+1$ is at the unknown time line. The momentum equation is replaced by

$$z_j^{n+1} = Z_p(z_{target}, Q_j^n) \quad (2)$$

where: z_j^{n+1} = the pool stage at the unknown time step, $n+1$.

Z_p = the pool elevation corresponding to the target elevation, z_{target} , and the flow, Q_j^n at the known time step. The pool elevation is interpolated from the family of operation curves.

Equation 2 is missing a derivative of pool stage with respect to discharge. The derivative when multiplied by the change in flow estimates the change in the target pool over the time step. Including this change term resulted in oscillation because of the negative slope and the discontinuities in the operating rule.

4.2 Swellhead from the Dam

During uncontrolled operation, the constriction of the structure induces a swellhead upstream. If the structure is not influenced by backwater from a downstream tributary, the most accurate estimate of the swell head is from observed records. Figure 1 shows that the swellhead, Δh , from Lock and Dam No. 9 is approximately 0.7 ft.. Otherwise the swell head must be estimated from an empirical equation.

The d'Aubuisson formula (Chow, 1956) for flow through a contraction is

$$Q_{j+1}^n = K_A b_C (z_{j+1}^n - z_{sp}) \sqrt{2g \Delta h^n + V_j^{n2}} \quad (3)$$

where: Q_j^n = flow.

K_A = d'Aubuisson coefficient, commonly from 0.7 to 0.9.

b_c = width of the constriction.

z_{sp} = elevation of the spillway crest.

g = gravitational constant.
 $\Delta h^n = z_j - z_{j+1}$; swell head.
 V_j = upstream velocity.

For the navigation dam problem, the flow, Q_j and the tailwater stage, z_{j+1} is known at time n. Equation 3 is iteratively solved for the swell head, Δh^n . The upstream stage at time n is $z_j^n = z_{j+1}^n + \Delta h$. For the unknown time step n+1, the swell head is given by:

$$\Delta h^{n+1} = \Delta h^n + \left[\frac{\partial(\Delta h)}{\partial Q} \right]^n \Delta Q_j + \left[\frac{\partial(\Delta h)}{\partial z_{j+1}} \right]^n \Delta z_{j+1} \quad (4)$$

where: $\left[\frac{\partial(\Delta h)}{\partial Q} \right]^n$ = the partial derivative of swell head with respect to flow.

$\left[\frac{\partial(\Delta h)}{\partial z_{j+1}} \right]^n$ = the partial derivative of swell head with respect to tailwater stage.

The momentum equation is:

$$\frac{\partial Q}{\partial t} + \frac{\partial QV}{\partial x} + gA \left[\frac{\partial z}{\partial x} + S_f + S_h \right] = qV_i$$

The swell head is inserted into the momentum equation as an added slope,

$$S_h = \frac{\Delta h}{\Delta x} \quad (5)$$

in which Δx is the distance between the upstream and downstream cross-sections.

4.3 Uncontrolled Flow (Open River Conditions)

Open river conditions occur when the pool elevation for controlled flow is less than the tailwater elevation plus the swell head, i.e.,

$$Z_p < z_{j+1} + \Delta h$$

For open river conditions, the only impact of the dam is the swell head and the momentum equation is augmented by Equation 5.

5. Forecast Application

In real life the pool is not operated according to the regulation plan. Errors in estimating inflow, errors in gate rating curves, and errors in the operation of the gates all contribute to a difference between the target pool stage and the actual pool stage. The model must exactly reproduce the observed pool stages prior to the forecast time for the forecast to be valid. After the forecast time, the program simulates the navigation pool in three ways: According to the regulation manual, returning the pool to the target stages; according to pool stages entered by the regulator; or according to outflows entered by the regulator.

5.1 Reproduce Observed Pool Stages

The navigation dam is an observed internal boundary condition between cross-section j and $j+1$. The observed pool stages are entered as a boundary condition at cross-section j ,

$$z_j^{n+1} = Z_{\text{observed}} \quad (6)$$

The exact continuity equation transfers the flow downstream,

$$Q_j^{n+1} = Q_{j+1}^{n+1} \quad (7)$$

Equation 6 is a downstream boundary condition for the reach up to cross-section j . The outflow from this reach is computed from the inflow and the backwater induced by the observed stage. Equation 7 transfers the outflow from the upstream reach downstream. The stage at $j+1$ is computed from the hydraulics of the downstream channel. Potentially, a problem can occur if the model is poorly calibrated and the downstream stage is higher than the upstream observed flow.

5.2 Simulation of Target Stages

Observed stages are exhausted, when the HEC missing value of -901.0 is encountered in the time series, at the forecast time. At this point, the program automatically switches over to simulating the navigation dam according to the regulation plan, as described in Section 4. The algorithm will attempt to return the pool to the stages specified by the regulation policy. The change in pool stage, although limited by a maximum change per day, may not be the value desired by the regulator.

5.3 Entered Pool Stages

The observed pool stages can be extended beyond the forecast time. The time series is extended by adding a second pathname with the parameter (C-Part) of STAGE or

ELEVATION. The extended values are added at the start of the missing data (HEC missing value of -901.0).

5.4 Entered Flow Values

The time series can be extended with entered flow values. The observed internal boundary condition switches from stage to flow at the start of the missing data. Stage data takes precedence over flow. When the stage runs out, the program switches to flow. The extended flow data can be entered by appending a second pathname with the parameter (C-Part) of FLOW, in the OBSERVED INTERNAL BOUNDARY CONDITION record.

6. Special Input Records

The algorithm for navigation dams requires several new input records for the UNET program. In the cross-section file, the following new records are defined:

ND - the maximum change in daily pool stage was added to the card.

NR - the operating rule for a given control point elevation.

NP - seasonal variation in control point elevations.

The descriptions for these new records are shown in Insert A.

In the boundary condition file, the following new records were added:

OBSERVED INTERNAL BOUNDARY CONDITION Record - a second pathname was added to extend the observed stage record with stages input by a regulator.

SEASONAL CONTROL POINT ELEVATION - change the seasonal variation in control point elevations at run time.

The new input records are described in Insert B.

7. Examples

The navigation dam algorithm was applied to the Mississippi River Navigation Dams in the St. Paul, Rock Island, and St. Louis Districts.

The definition of the Dam No. 10 and its operating rule is shown in Figure 3. Pool 10 is operated as a hinge pool. From the historic record, it was observed that the pool was drawn down during the winter to an average elevation of 609.8 feet; so the

winter operating rule is entered on the first set of NR cards. The warm season operating rule is entered on the second set of NR cards. The operating rule is entered from the lowest control point elevation to the highest. The seasonal variation of the operating rule is entered on the NZ card. Figure 4 shows the reproduction of water years 1991 and 1992.

The definition of Dam 11 is shown in Figure 5. Dam 11 has a control point at the dam; therefore, an operating rule (NR card) is not required. The target pool elevation is 603.0 feet during the warm season and 602.5 during the winter season. The seasonal variation is defined on the NZ card. Figure 6 shows the reproduction of calendar year 1986.

Regulators often depart from the published operating rules; therefore, the operating rules entered into the program may require adjustment to reproduce the historic pool stages. The operating rule for Dam 24 had to be calibrated to reproduce the observed pool stage hydrograph. Figure 7 shows the definition of the dam and Figure 8 shows the reproduction calendar year 1986.

```

* LOCK AND DAM NO. 10 HW
X1615.20    36    .0 1210.0  520.0  520.0  520.0    .00  0.00    0
Z0    -.5
OH HISTMISS://DAM10-POOL/ELEV/01JAN1989/1DAY//
HY LD10HW
KR \SPMISS\RC\HSPMS:/MISSISSIPPI RIVER/DAM10 POOL/STAGE-FLOW/65 & 90 TO 94//OBS/
GR629.50    .0 591.00    .0 590.80    10.0 580.80    60.0 583.00    150.0
GR581.30   235.0 579.30   270.0 578.60   355.0 583.50   435.0 582.50   475.0
GR587.20   555.0 588.20   710.0 586.50   750.0 588.00   830.0 585.80   900.0
GR585.20   970.0 595.00  1125.0 590.10  1170.0 600.50  1210.0 602.30  1350.0
GR603.10  1505.0 599.50  1660.0 600.10  1720.0 603.50  1820.0 599.50  1855.0
GR599.50  2250.0 604.50  2280.0 604.50  2510.0 599.50  2550.0 599.50  2750.0
GR604.50  2780.0 604.50  4980.0 604.50  5680.0 599.50  5690.0 599.50  6700.0
GR629.50  6820.0    .00    .0    .00    .0    .00    .0    .00    .0
KR OFF

* L&D 10; POOL STAGE = 610.5
* R.M. 615.1
ND          610.5          -.2          L&D10
* Operating rule for winter
NR    2    609.8    0    609.8    89000    609.8
* Operating rule to summer
NR    8    610.5    0    610.5    40000    610.5    43000    610.5    45000    610.35
NR 50000    610    52500    609.5    78000    609.5    89000    610.5
* Seasonal variation of operating rule
NZ 28MAR 609.8  01APR 610.5  28NOV 610.5  01DEC 609.8

*
* POOL 11 POOL ELEVATION 603.00
*
* STARTING ELEV IN PROP TABLE = ELSTRT - RISE = 598
*
*      RISE  ELSTRT
XK          50    648          2.25
XI    1

NC 0.150    0.080    0.028
X1 614.9    40 10000.0 11050.0  1000.0  1000.0  1000.0    0.00  0.00    0
Z0    -.5
OH HISTMISS://DAM10-TAIL/ELEV/01JAN1989/1DAY//
HY L&D 10 TW
KR \SPMISS\RC\HSPMS:/MISSISSIPPI RIVER/DAM10_TW/STAGE-FLOW/65 & 90 TO 94//OBS/
GR650.00  4200.0  630.00  4250.0  620.00  4400.0  615.00  4450.0  604.00  4500.0
GR595.00  4600.0  595.00  5500.0  604.00  5620.0  612.00  5650.0  612.00  5920.0
GR610.00  6000.0  610.00  6250.0  610.00  6470.0  610.00  6700.0  612.00  6710.0
GR612.00  7650.0  606.00  7700.0  604.00  7720.0  600.00  7850.0  604.00  7940.0
GR606.00  7950.0  606.00  8020.0  608.00  8050.0  608.00  8220.0  608.00  8610.0
GR606.00  8880.0  604.00  8900.0  600.00  9000.0  600.00  9300.0  604.00  9340.0
GR608.00  9350.0  608.00  9650.0  606.00  9950.0  604.00  10000.0  586.00  10200.0
GR586.00  10900.0  604.00  11050.0  620.00  12600.0  630.00  13400.0  650.00  13500.0

```

Figure 3. Definition of Dam 10 and its operating rule.

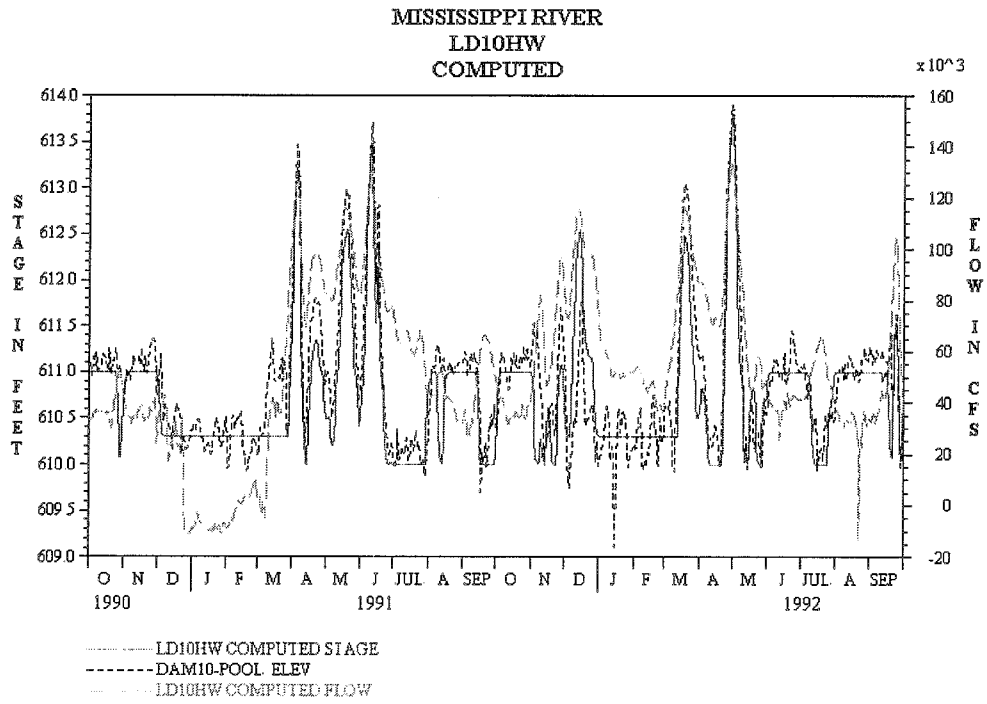

Figure 4. Computed and observed pools stage hydrographs for Lock and Dam 10 for water years 1991 and 1992.

```

X1 583.0      17      1025      7000      3500      2100      2450
KR \RIMISS\MISSRC:/MISSISSIPPI RIVER/L&D 11 POOL/STAGE-FLOW/CY 93//COMPUTED/
OH \RIMISS\MISS:/MISSISSIPPI BASIN/L&D 11 POOL/ELEV//1DAY/MISSISSIPPI RIVER/
HY L&D 11 POOL - RM 583.0
GR 650.0      0      640.0      25      630.0      50      620.0      175      610.0      975
GR 603.0      1025      594.4      5285      574.2      5825      569.1      6185      570.8      6305
GR 560.7      6505      581.7      6665      579.0      6785      603.0      7000      610.0      7025
GR 640.0      7100      650.0      7150      .0      0      .0      0      .0      0

* L&D 11; POOL STAGE = 603
* R.M. 583.0
ND          603.0          1080      583.0      602.6      -0.4
* Seasonal variation at the control point
NZ 12MAR 602.5  15MAR 603.0  07DEC 603.0  10DEC 602.5

*
* POOL 12 POOL ELEVATION 592.00
*
* STARTING ELEV IN PROP TABLE = ELSTRT - RISE = 587
*
*      RISE  ELSTRT
XK          50      637          2.25
XI      .5

KR OFF
X1 582.6      26      4400      5575      6700      4700      6250
KR \RIMISS\MISSRC:/MISSISSIPPI RIVER/L&D 11 TAIL/STAGE-FLOW/CY 93//COMPUTED/
X3 0.      0.      .00      0.      .00      5700.      -999.00      .00      .00
OH \RIMISS\MISS:/MISSISSIPPI BASIN/L&D 11 TAIL/ELEV//1DAY/MISSISSIPPI RIVER/
HY L&D 11 TAIL - RM 582.6
GR 620.0      0      600.0      150      592.0      250      595.0      750      592.0      1000
GR 595.0      1700      592.0      2025      595.0      2300      592.0      2900      595.0      3100
GR 592.0      3500      592.0      4400      567.4      4480      579.0      4860      578.4      4960
GR 579.1      5020      577.7      5080      578.9      5160      576.0      5260      577.9      5320
GR 575.9      5440      587.9      5520      592.0      5575      600.0      5800      610.0      5975
GR 620.0      6200      .0      0      .0      0      .0      0      .0      0

```

Figure 5. Definition of Dam 11. The dam has its control point at the dam; therefore, no operating rule is required. The seasonal variation of the control point elevation is defined on the NZ card.

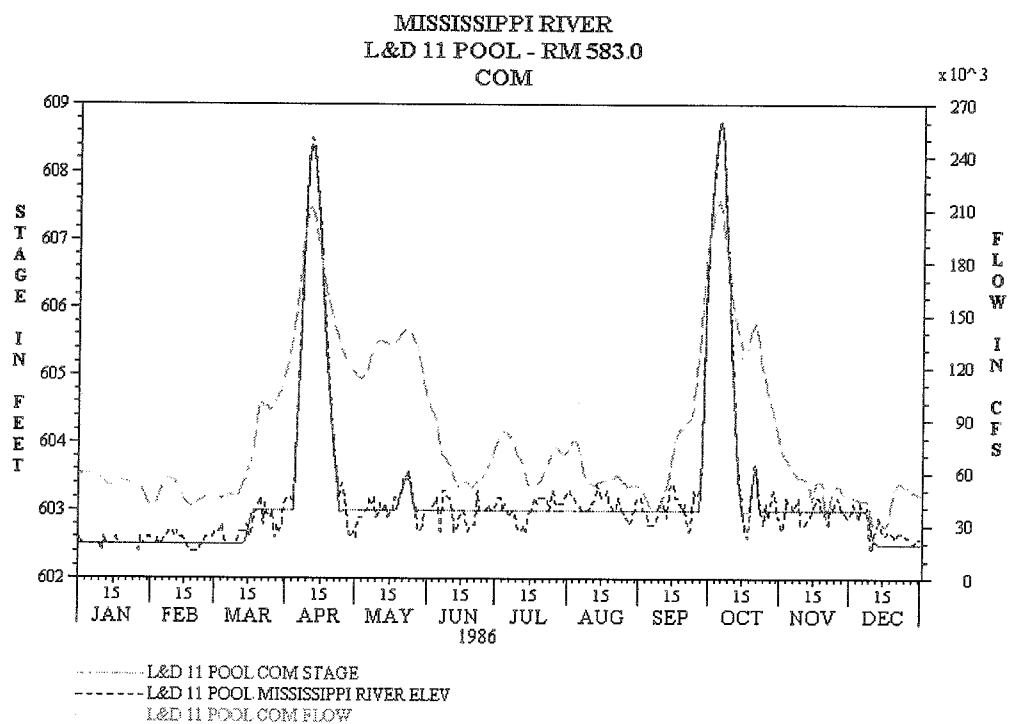

Figure 6. Computed and observed pool stage hydrographs at Dam 11 for calendar year 1986.

```

X1273.49      31  21900  25750      10      10      10
X3      0.      0.      0.  20700.  -462.      0.      0.      0.      0.      0.
GR 470.0      0  460.0    750  455.0    1250  450.0    5700  450.0    7900
GR 445.0  10700  445.0    19600  450.0    19800  450.0    20600  462.0    20700
GR 450.0  20800  440.0    21900  428.0    22000  428.0    22200  440.0    22300
GR 440.0  23450  431.0    23500  431.0    23750  428.0    23800  424.0    23900
GR 418.0  23950  414.0    23972  414.0    25250  422.0    25300  424.0    25400
GR 420.0  25500  422.0    25600  421.0    25650  440.0    25750  460.0    25900
GR 470.0  26100

*
* LOCK AND DAM 24
*
ND      449.0      1200    424  449.0      .9      LD24
* Operating rule
NR 11      449      0  449.0  10000  449.0  20000  448.99  30000  448.99
NR 40000  448.99  70000  448.88  110000  446.50  140000  446.00  146000  445.50
NR300000  445.50  330000  449.00
WD 1      2.8      450    3600

NC0.2000  0.2000  0.0260
X1273.45      33  20900  25730      300    300    270
Z0
KR MMRC:/MISSISSIPPI RIVER/L&D 24 TW/STAGE-FLOW/86 FLOOD//OBS/
OH \MM\MIDMISS:/MISSISSIPPI RIVER/L&D 24 TW/STAGE/01JAN1993/1DAY/OBS/
Z0 -.19
HY L&D 24 TW - RM 273.2
X3      0.      0.      0.  20700.  -462.      0.      0.      0.      0.      0.
GR 470.0      0  460.0    750  455.0    1250  450.0    5700  450.0    7900
GR 445.0  10700  445.0    19600  450.0    19800  450.0    20600  462.0    20700
GR 450.0  20800  449.0    20900  440.0    21900  428.0    22000  428.0    22200
GR 430.0  22300  430.0    23450  431.0    23500  431.0    23750  428.0    23800
GR 424.0  23900  418.0    23950  414.0    23972  414.0    25250  422.0    25300
GR 424.0  25400  420.0    25500  422.0    25600  421.0    25650  444.2    25730
GR 450.0  25750  460.0    25900  470.0    26100

```

Figure 7. Definition of Dam 24. The operating rule for Dam 24 was calibrated to reproduce the historic pool stage record.

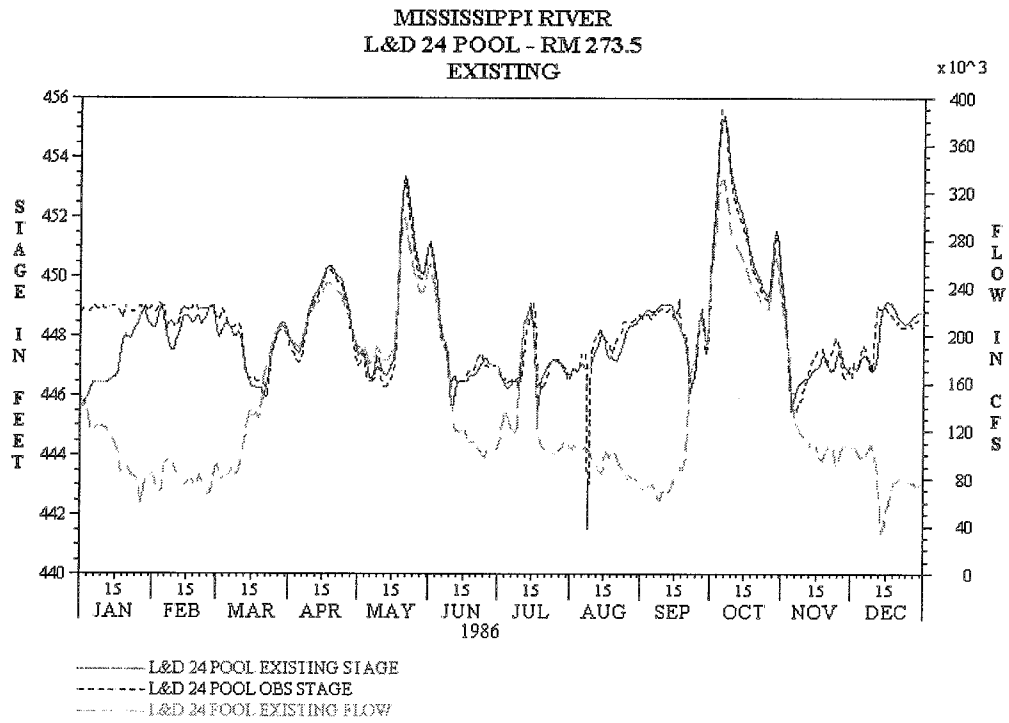

Figure 8. Comparison of computed and observed pool stages at Dam 24. The operating rule for Dam 24 was calibrated to reproduce the observed pool stages.

7. References

Chow, V. T., 1956. *Open Channel Flow*. McGraw Hill Book Company, New York.

Insert A
New Input Records in the Geometry File
for Navigation Dams

ND

ND Record - Navigation Dam - (Optional Record)

The ND record defines a navigation dam. The ND card is inserted between the cross-sections bounding the navigation dam. The card defines the geometry of the spillway, the elevation and the width of the spillway crest. If an overflow weir exists, the geometry is defined on the WD card. If the control point elevation is constant throughout the year, the control point is defined on the ND card; otherwise, a seasonal control point elevations can be defined on the NS card. Finally the name of the navigation dam is defined in the tenth field. The name is used to connect the navigation dam to the OBSERVED INTERNAL BOUNDARY CONDITION record in the BC file. The format of the ND card is compatible with earlier versions of the UNET program.

Field	Variable	Value	Description
0	ID	ND	Record identification.
1			Not used. ++
2			Not used. ++
3	ZCP	+	Target elevation of the control point.
4			Not used. ++
5	WSP	+	Width of the spillway in feet.
6	ZSP	+	Elevation of the spillway crest in feet.
7	SH	+	Known swell head for the dam in feet. The swell head is assumed constant for the structure for both positive and negative flow.
8	CE	+	d'Aubuissons's contraction coefficient. The typical range is from 0.6 to 0.9. A value of 0.8 is frequently used for design purposes (Chow 1959, page 502).
		-	Known swell head for the dam in feet. The swell head is assumed constant for the structure for both positive and negative flow. ++

Field	Variable	Value	Description
9	DZPMAX	+	Maximum allowable change in the pool elevation per day in feet. The change in pool elevation is less than DZPMAX unless the pool is approaching open river conditions.
10	SPNAM	A8	Name of the navigation dam. The name associates the dam with the observed stages or flow in an OBSERVED INTERNAL BOUNDARY CONDITION record in the BC file.

⁺⁺ Field was retained for compatibility with earlier versions of the program.

NR

NR Record - Operating Rule Curve for the Navigation Dam

The NR card defines the operating rule for navigation pool for a given control point elevation. Up to 8 of these operating curves can be defined for each structure. The operating rules are entered by control point elevation from the lowest to the highest. The curves are entered in succession. The pool elevation required to achieve the desired control point elevation is interpolated from the family of operating curves. If the operating rule is not entered, the control point is assumed to be at the dam and the navigation dam maintains the control point elevation from the ND card at the dam. The ND card applies to the last navigation dam entered on a ND card.

Field	Variable	Value	Description
0	ID	NR	Record identification.
1	ZCPR(ICP)	+	Control point elevation in feet.
2	NOR(ICP)	+	Number of points in the operating rule (maximum of 10).
3	QPR(1,ICP)	+	Flow in cfs.
4	ZPR(1,ICP)	+	Pool elevation in feet.
5, 7, 9	QPR(I,ICP)	+	Flow in cfs.
6, 8,10	ZPR(I,ICP)	+	Pool elevation in feet.

NR records are repeated until NOR points are input.

NZ

NZ Record - Seasonal Target Elevation at the Control Point - (Optional Record)

The NZ card defines the seasonal variation of the control point elevation at a navigation dam. A maximum of 20 points can be defined. The time ordinate is given by a military day and three character month abbreviation in capital letters; for example the April 10th is 10APR. If the NZ card is not entered, the control point elevation defined on the ND card is assumed constant throughout the time series. The NZ card applies to the last navigation dam entered on a ND card.

Field	Variable	Value	Description
0	ID	NZ	Record identification.
1,3,...	SDATE(I)	+	Military day and month (for example 10APR).
2,4,...	ZCP(I)	+	Control point elevation in feet.

Insert B
New Input Records in the Boundary Condition File
for Navigation Dams

Observed Stage Internal Boundary Condition

This data set specifies an observed time series of navigation pool water surface elevations upstream of unregulated navigation dams. The stage hydrograph can be entered using either the standard or DSS syntaxes. In a forecasting model, the observed pool elevations are used as an internal boundary condition up to the time of forecast. At this point, the ND, NR, and NZ records in the CSECT input file provide the model with the information necessary to control the operation of the navigation dam.

The program has the ability to merge the data from two pathnames into a single time series. This capability allows the program to merge observed data with a time series of pool stages prescribed by a regulator through the forecast period. The second pathname is optional and the merging process is identified by the second pathname following the first.

Command Line: OBSERVED STAGE INTERNAL BOUNDARY

Variables: Standard syntax:
IBC, NIBCI, (TIBCI(I), ZIBCI(I), I=1,NIBCI)

DSS syntax:
IBC (1st line)
PN (2nd line) ← Observed stage data.
PN (3rd line) ← Entered stage data (optional).

Variable	Value	Description
IBC	+	Internal boundary condition number. This number is obtained from the CSECT output file in the listing of "Navigation Dams and Spillways". It is a counter based on the order that various internal boundary conditions are entered in the CSECT input file.
NIBCI	+	Number of points in the hydrograph.
TIBCI	+	Time values (hours).
ZIBCI	+	Elevation values (feet).
PN	A78	DSS pathname (left justified, must include parts A-F).

Example (Standard syntax):
OBSERVED STAGE INTERNAL BOUNDARY

2 5 24 467.2 25 467.8 26 468.5 27 467.8 28 467.2

Example of DSS syntax:

OBSERVED STAGE INTERNAL BOUNDARY

2

/OHIO/DAM26/STAGE/01JAN1979/1HOUR/OBSERVED/

Example of DSS syntax with extended pool stages:

OBSERVED STAGE INTERNAL BOUNDARY

2

/OHIO/DAM26/POOL STAGE/01JAN1979/1HOUR/OBS/ ← Observed

/OHIO/DAM26/POOL STAGE/01JAN1979/1HOUR/FORC/ ← Extended

Observed Stage and Flow Internal Boundary Condition

The observed stage and flow internal boundary condition is a mixed boundary condition where a stage hydrograph is inserted as the observed boundary until the stage hydrograph runs out of data; afterward a flow hydrograph is used. The end of data is identified by the HEC missing data code -901.0. The stage and flow hydrographs can either be entered in a table or can be entered from DSS. The mixed boundary condition is primarily used for forecast models where the end of stage data is the forecast time and the flow hydrograph is the flow forecast.

Command Line: OBSERVED STAGE AND FLOW INTERNAL BOUNDARY
CONDITION

Variables: Standard syntax
IBC, NIBCI, (T(J), ZIBCI(J), QIBCI(J), J=1, NU)

DSS syntax
IBC (1st line)
PN (2nd line) stage
PN (3rd line) flow

Variable	Value	Description
IBC	+	Internal boundary condition number from CSECT file.
NIBCI	+	Number of hydrograph ordinates.
T(J)	+	Time values (hours).
ZIBCI(J)	+	Stage value (feet).
QIBCI(J)	+	Flow values (cfs).
PN	A80	DSS pathname (left justified, must include parts A-F).

Examples (Standard syntax):

OBSERVED STAGE AND FLOW INTERNAL BOUNDARY CONDITION
1 4
0 451 -901.
24 451 2000
48 -901 2000 ← Start using flow hydrograph

72 -901 2000

Example of DSS syntax:

OBSERVED STAGE AND FLOW INTERNAL BOUNDARY CONDITION

2

/OHIO/DAM26/POOL STAGE/01JAN1979/1HOUR/OBS/

/OHIO/DAM26/FLOW/01JAN1979/1HOUR/OBS/

Target Control Point Elevation

The seasonal array of target control point elevations for a navigation pool can be replaced in the boundary condition file. A maximum of 20 points can be defined. The time ordinate is given by a military day and three character month abbreviation in capital letters; for example the April 10th is 10APR.

Command Line: TARGET CONTROL POINT ELEVATION

Variables: Standard syntax
 SPNAM, NIBCI, (T(J), ZIBCI(J), QIBCI(J), J=1, NU)

DSS syntax
 SPNAM (1st line)
 PN (2nd line) stage
 PN (3rd line) flow

Variable	Value	Description
SPNAM	+	Name of the navigation dam on the ND card.
SDATE(I)	+	Military day and month (for example 10APR).
ZCP(I)	+	Control point elevation in feet.

Example

```
TARGET CONTROL POINT ELEVATION
L&D26
01JAN  418.9
01APR  419.0
15APR  419.1
15NOV  419.0
01DEC  418.9
31DEC  418.9
```

Appendix E-4

Mississippi Null Internal Boundary Condition (Estimation of Ungaged Inflow)

The Null Internal Boundary Condition (NIBC) is a tool for estimating ungaged lateral inflow in a river system. The NIBC is inserted between two identical cross-sections that are separated by a small distance. The NIBC assumes that the stage and flow at the two cross-sections are the same; hence, if the upstream cross-section is number j , then

$$\begin{aligned} Z_j^n &= Z_{j+1}^n \\ Q_j^n &= Q_{j+1}^n \end{aligned}$$

in which Z is the stage and Q is the flow. If an observed stage hydrograph is specified for the NIBC, the river routing reach is effectively broken into two routing reaches. The stage hydrograph is used as the downstream boundary for the upstream reach and the stage hydrograph is used as the upstream boundary for the downstream reach; cross-sections j and $j+1$ are downstream and upstream boundaries respectively. For the upstream reach, the flow at j is the routed flow from upstream. Since the ungaged inflow is unknown and not entered, the flow at j is missing the ungaged inflow. For the downstream reach, the flow at $j+1$ from a stage boundary condition is computed from the hydrodynamics and the geometry reach downstream. This flow does contain the ungaged inflow. Hence, the ungaged inflow is simply the difference between the flow hydrographs at j and the flow at $j+1$,

$$Q_U^n = Q_{j+1}^n - Q_j^n$$

in which Q_U is the ungaged inflow. This ungaged inflow is from the upstream boundary of the upstream reach to cross-section j , effectively the downstream boundary. To use the ungaged inflow in a model, the flow is lagged backward in time (usually one day) and inserted in the model as a uniform lateral inflow.

For a reach of river of any length, the NIBC is inserted at the principal gage locations where the stage records are the most accurate. Generally, these locations are the USGS gaging stations. If a reach includes k interior gages, inserting NIBC at each of the gages creates k independent routing reaches. The independence of the routing reaches is important, because, the system must be solved only once for all the ungaged inflow hydrographs. For example, to analyze the Missouri River between Rulo, Nebraska

and St. Charles, Missouri, NIBC's are inserted at the USGS gages at St. Joseph, Kansas City, Waverly, Boonville, and Hermann, breaking the model into five independent routing reaches. Inflow from tributaries do not effect the calculations; although backwater from a large tributary downstream from a NIBC will effect the accuracy of the calculations.

The NIBC is inserted using the NI card, which is described in Appendix A, between cross-section j and $j+1$. Cross-section j is a repeat of cross-section $j+1$ and the reach length between the cross-sections is zero. The only parameter on the NI card is a eight character name which uniquely defines the name of the NIBC when attaching an observed stage hydrograph in the boundary condition file. HY cards must be inserted at cross-sections j and $j+1$ to define output hydrographs. Figure 1 shows the definition of a NIBC at Boonville. The name on this station on the NI card is BOON. The OH cards upstream and downstream attach the USGS hydrograph to the plot macro.

The observed stage hydrograph is entered using the OBSERVED STAGE HYDROGRAPH record in the boundary condition file. A description of the record is shown in Appendix B. Figure 2 shows the definition of OBSERVED STAGE HYDROGRAPH record for the Boonville NIBC. The name of the station, BOON, is entered on the second line before the DSS pathname. The gage zero is entered using the ZERO= parameter.

For our example problem, Figure 3 compares the routed flow hydrograph upstream of the NIBC with the USGS observed flow hydrograph. This hydrograph does not include unged lateral inflow. Figure 4 compares the computed hydrograph, the USGS flow hydrograph, and the USGS flow measurements downstream of the NIBC. Since the model is well calibrated, the computed hydrograph almost exactly matches the USGS flow hydrograph and the observed flow measurements.

The unged inflow hydrograph is estimated by subtracting the routed hydrograph from the computed hydrograph and lagging the unged hydrograph backward one day. This operation is performed by the DSSMATH program. The input file for DSSMATH is shown in Figure 5.

The unged flow is entered as a uniform lateral inflow from Waverly, the upstream boundary of the reach, and Boonville. Figure 6 shows the routed flow hydrograph, USGS observed flow hydrograph, and the observed flow measurements at Boonville. The agreement is nearly exact. Figure 7 shows the computed stage hydrograph at Boonville. The agreement in stage is also very good because of the exact reproduction of flow.

```

NC .0500 .05000 .02100
X1197.22      94 19520. 21060.      1      1      1
KR \KCMO\FORECAST\RC\MORRC:/MISSOURI RIVER/BOONVILLE/STAGE-FLOW//1993-PRES/EST/
OH \KCMO\MOR.DSS:/MISSOURI RIVER/BOONVILLE/STAGE/01JUN1992/6HOUR/CORP/
Z0 565.4
HY BOONVILLE
X3 -12      0.      .00 18621. -900.99      0.      .00      3      3
GR 640.0 8050.      620.0 8160.      612.0 8240.      605.7 8330.      593.2 8780.
GR 594.8 8950.      597.2 9130.      598.2 9320.      597.6 9550.      602.0 9700.
GR 593.5 9770.      595.3 10110.      592.0 10580.      588.0 10860.      592.0 11190.
GR 590.0 11560.      593.2 11880.      590.9 12130.      593.2 12500.      592.0 12600.
GR 590.0 13150.      588.0 13170.      588.0 13260.      590.0 13500.      585.5 13680.
GR 589.7 14280.      589.5 14800.      589.3 15270.      600.0 15500.      600.0 16000.
GR 600.0 16500.      600.0 17000.      600.0 17500.      600.0 18000.      600.0 18500.
GR 600.0 19000.      594.4 19520.      583.5 19610.      586.2 19710.      589.0 19850.
GR 581.0 19850.      546.3 19962.      548.6 19981.      555.9 20002.      558.9 20022.
GR 556.5 20042.      556.1 20061.      556.2 20082.      556.0 20102.      553.3 20123.
GR 546.8 20143.      543.4 20160.      541.7 20183.      542.6 20202.      550.2 20224.
GR 558.3 20247.      557.2 20266.      547.2 20288.      534.1 20311.      534.3 20332.
GR 532.2 20353.      538.8 20373.      545.9 20393.      550.1 20413.      551.1 20433.
GR 555.2 20454.      556.7 20474.      556.3 20494.      557.1 20514.      555.6 20534.
GR 558.3 20554.      559.1 20574.      559.5 20594.      559.3 20614.      559.7 20634.
GR 556.9 20654.      558.4 20671.      559.8 20694.      558.8 20714.      558.9 20734.
GR 557.6 20754.      558.2 20774.      558.7 20795.      560.0 20813.      559.4 20836.
GR 557.3 20857.      556.3 20877.      555.8 20899.      557.2 20919.      558.1 20938.
GR 581.0 21020.      589.0 21020.      600.0 21060.      640.0 21150.

```

NI BOON

```

KR OFF
X1197.22      94 19520. 21060.      1282.      1282.      1426.
KR \KCMO\FORECAST\RC\MORRC:/MISSOURI RIVER/BOONVILLE/STAGE-FLOW//1993-PRES/EST/
OH \KCMO\MOR.DSS:/MISSOURI RIVER/BOONVILLE/FLOW/01JUN1992/1DAY/OBS/
Z0 565.4
HY BOONVILLE DS
X3 -12      0.      .00 18621. -900.99      0.      .00      3      3
GR 640.0 8050.      620.0 8160.      612.0 8240.      605.7 8330.      593.2 8780.
GR 594.8 8950.      597.2 9130.      598.2 9320.      597.6 9550.      602.0 9700.
GR 593.5 9770.      595.3 10110.      592.0 10580.      588.0 10860.      592.0 11190.

```

Figure 1. Null interior boundary condition at Boonville. The cross-section at Boonville was repeated and the NI card was inserted between the cross-sections. The name of the NIBC on the NI card was BOON.

```

ZERO=565.4
OBSERVED INTERNAL BOUNDARY CONDITION AT BOONVILLE
BOON
/MISSOURI RIVER/BOONVILLE/STAGE//1DAY/CORP/

```

Figure 2. Insertion of an observed hydrograph for the NIBC at Boonville into the UNET boundary condition file. The name BOON agrees with the name defined on the NI card.

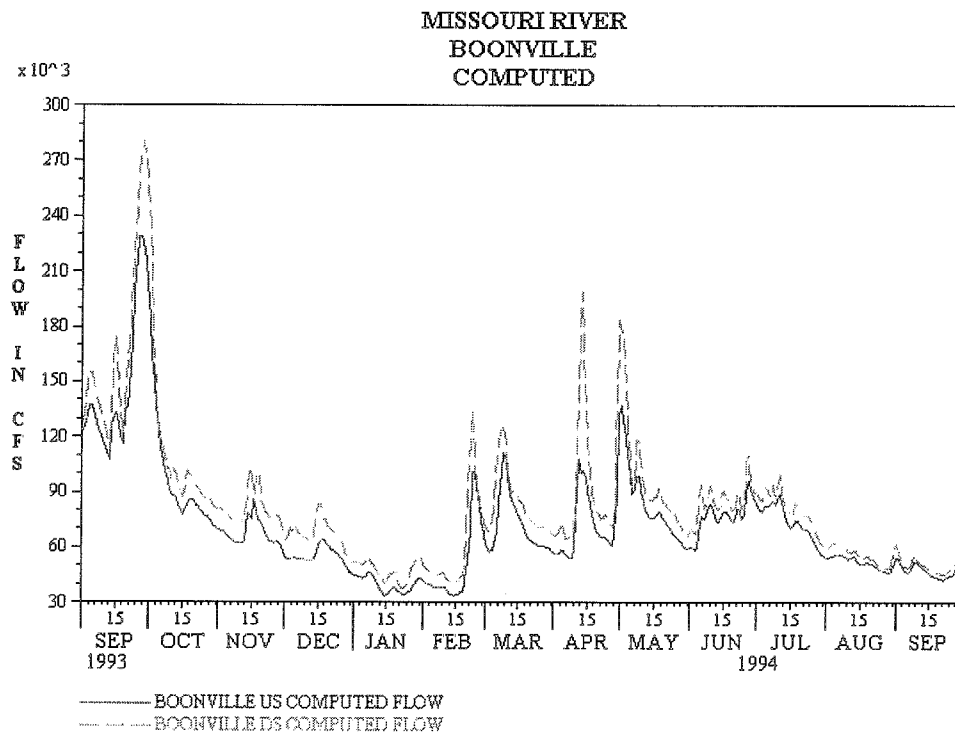

Figure 3. Routed flow upstream of the NIBC at Boonville and the flow computed downstream of the NIBC.. The difference is the ungaged lateral inflow.

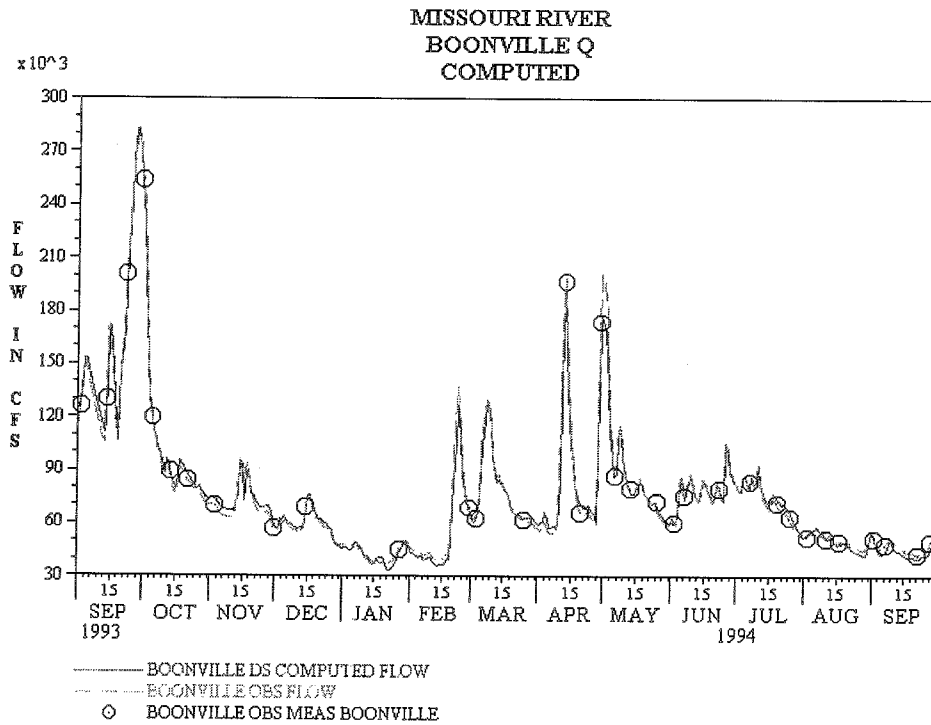

Figure 4. Computed flow downstream of the NIBC at Boonville. The computed flow is compared to the USGS observed flow and the USGS flow measurements at the gage. The computed flow is the flow required to reproduce the stages at the Boonville gage using the model with the current calibration

Mississippi Null Internal Boundary Condition

```
OPEN MOCN
TI 01SEP1993 0700 31DEC1994 0700
**
** RULO TO ST. JOSEPH
**
GET QUS=MOCN:/MISSOURI RIVER/ST. JOSEPH/FLOW//1DAY/COMPUTED/
GET QDS=MOCN:/MISSOURI RIVER/ST. JOSEPH DS/FLOW//1DAY/COMPUTED/
COM QDIFF=QDS-QUS
COM QLAT=TSHIFT(QDIFF,-1D)
PUT.A QLAT=\KCMO\MOR:/MISSOURI RIVER/RULO TO STJ/UG FLOW//1DAY/EST/
TA QUS QDS QDIFF QLAT
CLEAR ALL
**
** ST. JOSEPH TO KANSAS CITY
**
GET QUS=MOCN:/MISSOURI RIVER/KANSAS CITY/FLOW//1DAY/COMPUTED/
GET QDS=MOCN:/MISSOURI RIVER/KANSAS CITY DS/FLOW//1DAY/COMPUTED/
COM QDIFF=QDS-QUS
COM QLAT=TSHIFT(QDIFF,-1D)
PUT.A QLAT=\KCMO\MOR:/MISSOURI RIVER/STJ TO KC/UG FLOW//1DAY/EST/
TA QUS QDS QDIFF QLAT
CLEAR ALL
**
** KANSAS CITY TO WAVERLY
**
GET QUS=MOCN:/MISSOURI RIVER/WAVERLY/FLOW//1DAY/COMPUTED/
GET QDS=MOCN:/MISSOURI RIVER/WAVERLY DS/FLOW//1DAY/COMPUTED/
COM QDIFF=QDS-QUS
COM QLAT=TSHIFT(QDIFF,-1D)
PUT.A QLAT=\KCMO\MOR:/MISSOURI RIVER/KC TO WAV/UG FLOW//1DAY/EST/
TA QUS QDS QDIFF QLAT
CLEAR ALL
**
** WAVERLY TO BOONVILLE
**
GET QUS=MOCN:/MISSOURI RIVER/BOONVILLE/FLOW//1DAY/COMPUTED/
GET QDS=MOCN:/MISSOURI RIVER/BOONVILLE DS/FLOW//1DAY/COMPUTED/
COM QDIFF=QDS-QUS
COM QLAT=TSHIFT(QDIFF,-1D)
PUT.A QLAT=\KCMO\MOR:/MISSOURI RIVER/WAV TO BOON/UG FLOW//1DAY/EST/
TA QUS QDS QDIFF QLAT
CLEAR ALL
**
** BOONVILLE TO HERMANN
**
GET QUS=MOCN:/MISSOURI RIVER/HERMANN/FLOW//1DAY/COMPUTED/
GET QDS=MOCN:/MISSOURI RIVER/HERMANN DS/FLOW//1DAY/COMPUTED/
COM QDIFF=QDS-QUS
COM QLAT=TSHIFT(QDIFF,-1D)
PUT.A QLAT=\KCMO\MOR:/MISSOURI RIVER/BOON TO HERM/UG FLOW//1DAY/EST/
TA QUS QDS QDIFF QLAT
CLEAR ALL
**
FINISH
```

Figure 5. Input file for DSSMATH that determines unengaged lateral inflow at St. Joseph, Kansas City, Waverly, Boonville, and Hermann. The program subtracts the computed flow hydrograph upstream of the NIBC from the computed flow hydrograph downstream of the NIBC and lags the result backward one day. The lagged hydrograph is an estimate of the unengaged local inflow.

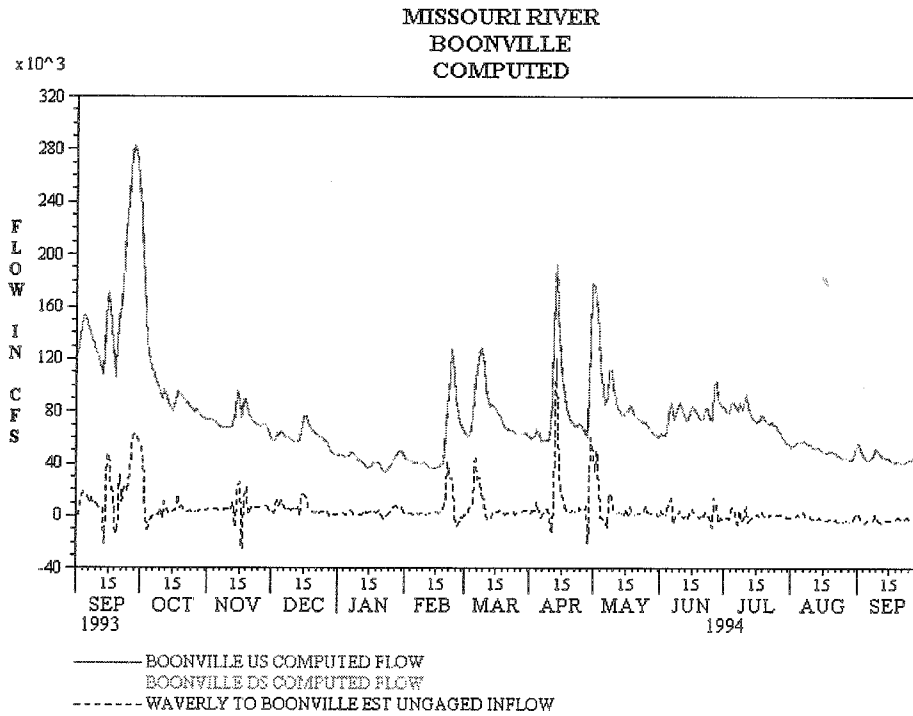

Figure 6. Flow at Boonville upstream and downstream of the NIBC after three iterations. The upstream flow is obtained by adding the unged inflow uniformly between Waverly and Boonville.

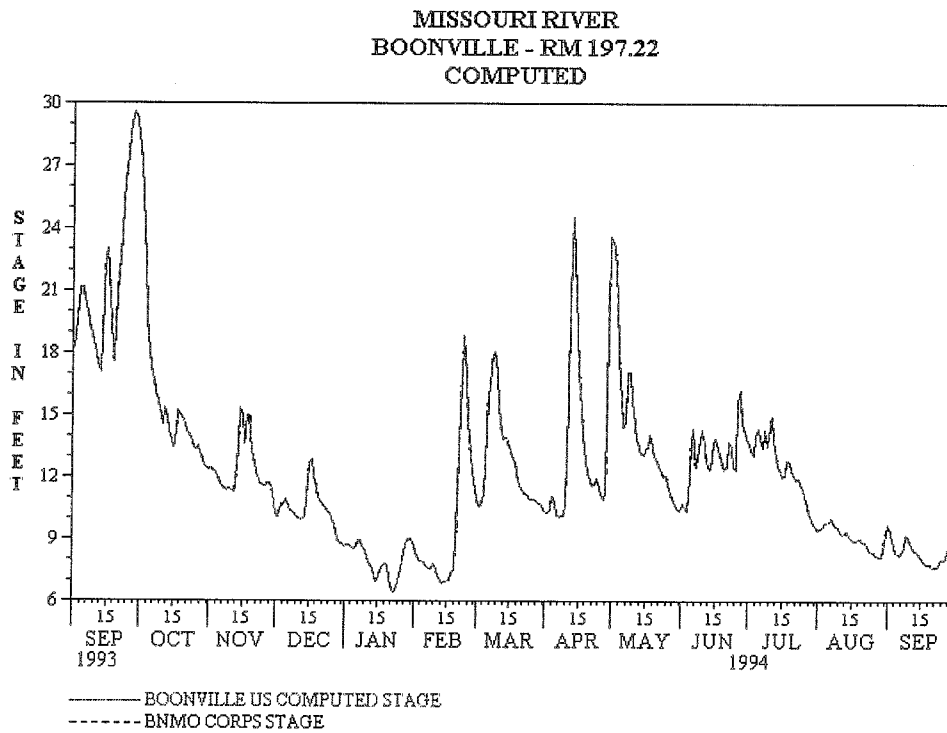

Figure 7. Computed and observed stage at Boonville after three iterations. The optimized ungaged inflow accurately reproduces the stage hydrograph at the NIBC station.

Attachment A

NI Card

NI Card Null Internal Boundary Condition

The NI card defines a null internal boundary condition (NIBC) connecting two cross-sections. The NIBC assumes that the flow and stage at the cross-sections are identical. The NIBC is used in conjunction with an OBSERVED INTERNAL BOUNDARY CONDITION record in the boundary condition file.

Field	Variable	Value	Description
0	ID	NC	Card identification.
1	IBCNAME	alpha	Name of the NIBC.

Attachment B

Observed Internal Boundary Condition Record

Observed Stage Internal Boundary

This data set specifies an observed time series of navigation pool water surface elevations upstream of unregulated navigation dams. The stage hydrograph can be entered using either the standard or DSS syntaxes. In a forecasting model, the observed pool elevations are used as an internal boundary condition up to the time of forecast. At this point, the ND and CP records in the CSECT input file provide the model with the information necessary to control the hinge point operation of the navigation dam.

Command Line: OBSERVED STAGE INTERNAL BOUNDARY

Variables: Standard syntax:
 IBCNAME, NIBCI, (TIBCI(I), ZIBCI(I), I=1,NIBCI)

DSS syntax:
 IBCNAME (1st line)
 PN (2nd line)

Variable	Value	Description
IBCNAME	+	Internal boundary name. This eight character name is entered on the SP, LS, LA, ND, or NI card in the cross-section file.
NIBCI	+	Number of points in the hydrograph.
TIBCI	+	Time values (hrs).
ZIBCI	+	Navigation pool elevation values (ft).
PN	A78	DSS pathname (left justified, must include parts A-F).

Example (DSS syntax):
OBSERVED STAGE INTERNAL BOUNDARY
DAM26
/OHIO/DAM26/STAGE/01JAN1979/1HOUR/OBSERVED/

Appendix F

Other UNET Applications

Appendix F-1

A UNET Tidal Hydraulics Application

1. Introduction

A time-dependent stage downstream boundary condition is used for the application of a one-dimensional unsteady flow model such as UNET to a tidal system. Note that, while UNET must initially be dead-started; a tidal system has no such condition, being in continual motion. Illustrated herein is the use of a “warmup” or “spinup” period to develop repetitive cycles within the system being modeled. The UNET hotstart feature can then be used instead of this warmup period for the analysis of alternate conditions if expedient.

When modeling a river-to-ocean situation, the first approach tried is usually to apply the tidal stage (as recorded by a tide gage) as a downstream boundary condition directly to the downstream-most section of the river. This can create modeling problems because the induced tidal velocity in the river cross section may have a significant velocity head that is not reflected in the tidal stage record creating a conflict between the computed energy and the imposed stage. This potential difficulty can be alleviated by locating the downstream boundary condition at an expanded section (seaward) so the velocity head is near zero at that section.

Computational time steps for a tidal simulations are usually not a severe constraint on computational effort. In general, for resolution of the tidal stage hydrograph, one hour time points are adequate for input stage hydrograph data. This suggestion can be applied to both mixed and diurnal tides. Time stepping for numerical accuracy of the solution will usually be less than the resolution requirement, and should reflect criteria presented in Cunge, et al (1980). The computational time step for a tidal simulation will usually be on the order of minutes, which should not create lengthy execution times for UNET.

2. An example application

This example is based on a simple horizontal channel of nearly rectangular cross section with bottom width of 500 ft. at elevation -10 ft. and top width of 520 ft. at elevation 50 ft. It is 25 miles long with a Manning's n of 0.07. A storage area of 5000 acres is connected to the reach downstream of section no. 6 (RM 12.5). The connection is about one river width long (520 ft.) at elevation 0.0 ft. with inflow/outflow coefficients of 0.1 hr^{-1} . The computational distance step is set at 0.5 mi. The computational time step is set at 5 min., giving a Courant No. (Cunge, et al., 1980) of about 2.

The downstream-most section is expanded to 5000 ft. width. It has been found in previous applications of one dimensional unsteady flow models that imposition of a tidal stage boundary condition should be located such that the velocity head is near zero.

The downstream forcing function is a simple sinusoidal function with a 24-hr. period $z(t) = z_0 \sin\left(\frac{\pi t}{12}\right)$, where z is stage and t is time in hours. This function gives one high tide and one low tide per 24-hour period. The tidal amplitude, z_0 is assumed to be 2 ft., giving a four foot tidal range. Note that, on the West coast of the United States tides are “mixed”. That is, there are two high tides and two low tides per twenty four hour period (Wiegel, 1964).

The upstream boundary condition is assumed to be a constant inflow of 5000 cfs., which yields a steady flow velocity of about 0.5 fps and an energy loss due to friction of about 5 ft. in the reach.

A schematic is shown in Fig. 1.

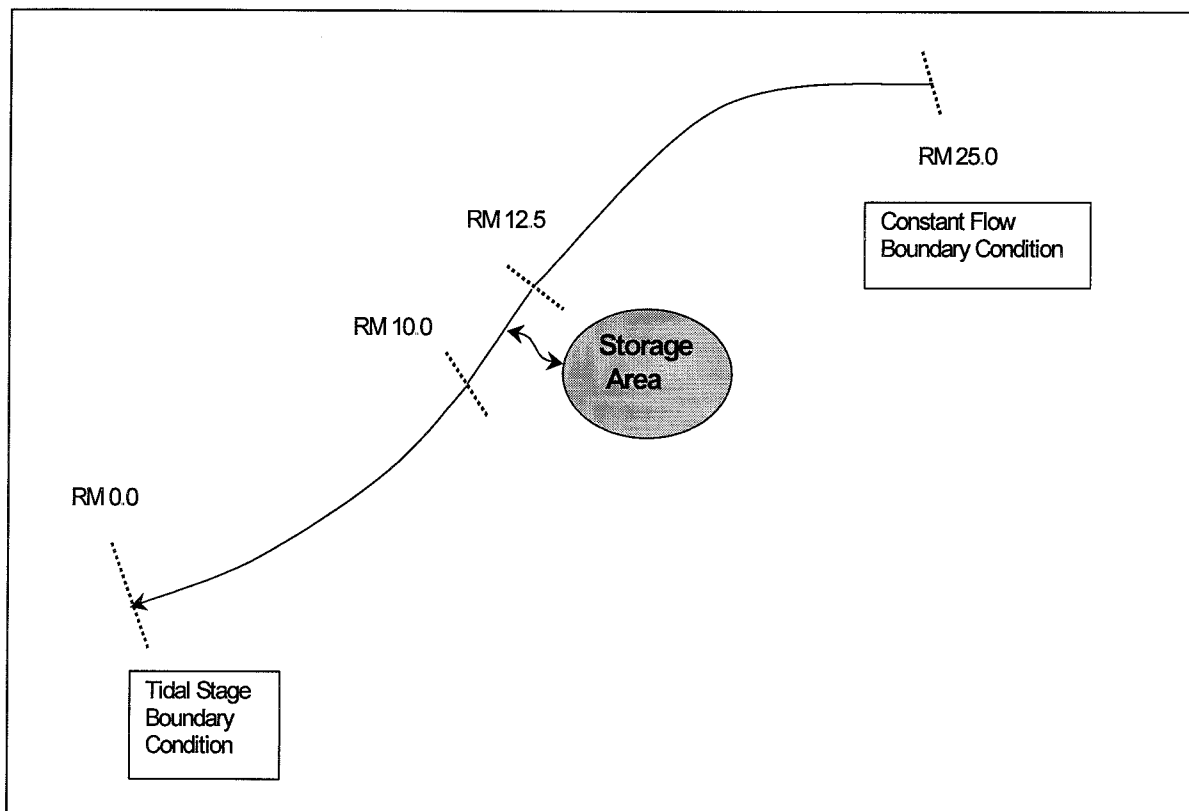

Figure 1 Schematic of Tidal System.

3. Initial conditions

UNET must always begin a simulation with steady flow, or the results from a previous, dynamic, solution. A tidal system may be thought of as having always been in a state of dynamic repetition. How one gets to such a state from an initial steady state is illustrated here. The fundamental approach is to use a “warm-up” or “spin-up” period (Thomas and McAnally, 1985) during which the solution evolves from the fixed, steady, flow to the repetitive tidal solution. This evolution is illustrated in Fig. 2 for this example problem. The stage in the storage area and that at cross section 6 are shown. Note that, initially (01Jan1998 at 06:00), the stages reflect the steady flow backwater at section 6 and the stage in the connected storage area beginning to increase due to flow through the connection. The initial conditions were 5000 cfs in the river and a water surface elevation of zero everywhere. After the backwater solution, the water surface profile in the river slopes from 0.0 ft. at the downstream end to about 5ft. at the upstream end; the storage area elevation remains at zero. The dynamic solution (Fig. 2) indicates that the warm-up period for the system (that is, the time until consecutive tidal cycles repeat) is more than ten days. One could examine study alternatives by running every alternative for ten days more than necessary and discarding the solution for the first ten days. This is probably a viable approach for simple systems such as this where computational time and data storage are negligible.

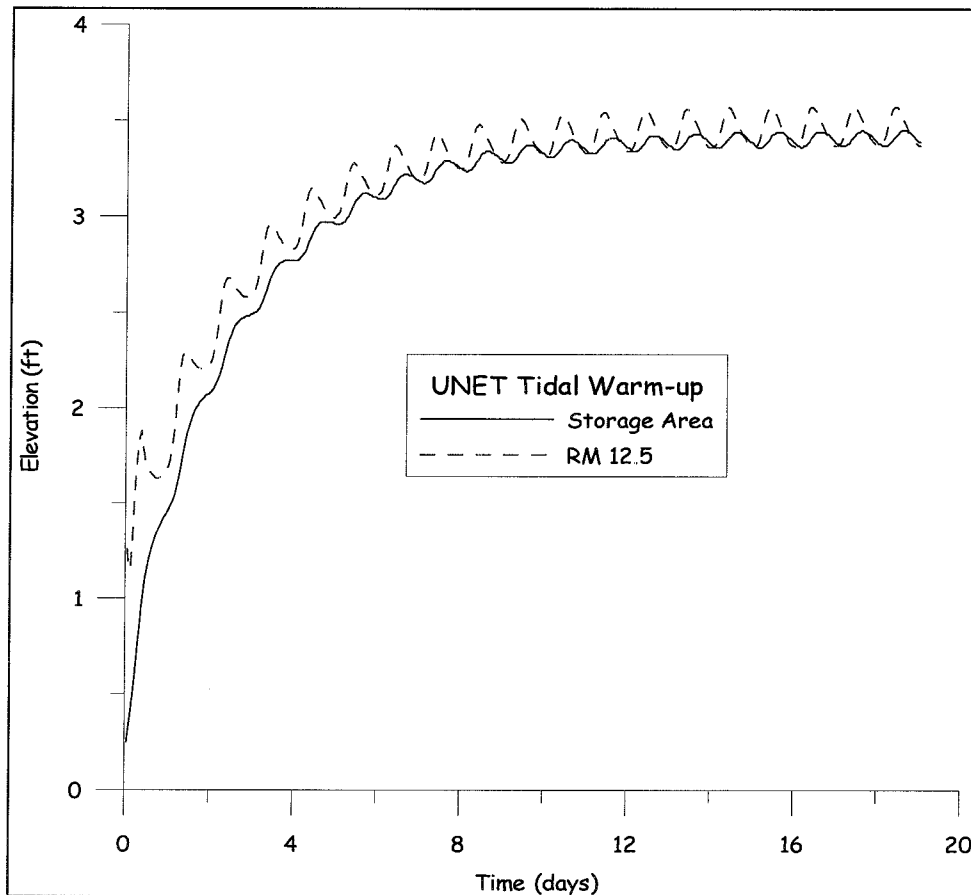

Figure 2 Tidal Warm-Up Solution

For other situations, however, it is expedient to run the warm-up period only once and save the warmed-up solution to be used as the initial condition for study analyses. Thus, UNET's hotstart capability may be used. To illustrate its use, the above problem was run with the results being saved at the end of 10 days by inserting 240 hours for variable TWINC on the UNET JOB CONTROL record. This causes the system status (stage and discharge at every computational point) at 240 hrs. to be stored in the default file INTL.CON. This file was then renamed, for convenience, to 10DAY.RST. Another BC file was created by removing the former initial conditions and inserting a READ INITIAL CONDITIONS record which refers to the file 10DAY.RST. The simulation time window was adjusted to begin at 11Jan98 0600. These files are reproduced below.

When studying such situations, plots similar to Fig. 2 should be constructed to identify what the warm-up time scale is for the system being simulated.

4. UNET data file structures for this problem

The CS input file is -

```
PR ON
T1 ST.R.REACH
T2 Tidal hydraulics example
T3 HEC/Gee/May 98
ZD  BEDPROF
ZI
UB
*
NC  .07  .07  .07
*
*
*  CROSS-SECTION 1
*
XK -8.00          0.5  .5
X1 25.00  4  10  510 13200 13200 13200
HY SEC1
GR  50  0  -10  10  -10  510  50  520
*
*  CROSS-SECTION 2
*
X1 22.50  4  10  510 13200 13200 13200
HY SEC2
GR  50  0  -10  10  -10  510  50  520
*
*  CROSS-SECTION 3
X1 20.00  4  10  510 13200 13200 13200
HY SEC3
GR  50  0  -10  10  -10  510  50  520
*
*  CROSS-SECTION 4
X1 17.50  4  10  510 13200 13200 13200
HY SEC4
GR  50  0  -10  10  -10  510  50  520
*
*  CROSS-SECTION 5
*
*
X1 15.00  4  10  510 13200 13200 13200
HY SEC5
GR  50  0  -10  10  -10  510  50  520
*
*  CROSS SECTION 6
*
```

Tidal Application

```
X1 12.50  4  10  510 13200 13200 13200
HY SEC6
GR  50   0 -10  10  -10  510   50  520
*
* STORAGE AREA
SL  1  0.1  0.1  0.0  0.0 12.40
SA  1 5000 -10.0
HS SA1
*
*
* CROSS-SECTION 7
*
X1 10.00  4  10  510 13200 13200 13200
HY SEC7
GR  50   0 -10  10  -10  510   50  520
*
* CROSS-SECTION 8
X1 7.50  4  10  510 13200 13200 13200
HY SEC8
GR  50   0 -10  10  -10  510   50  520
*
* CROSS-SECTION 9
*
X1 5.00  4  10  510 13200 13200 13200
HY SEC9
GR  50   0 -10  10  -10  510   50  520
*
* CROSS-SECTION 10
X1 2.50  4  10  510 13200 13200 13200
HY SEC10
GR  50   0 -10  10  -10  510   50  520
*
*
* CROSS-SECTION 11
X1 0.0  4  100 5100  0  0  0
HY SEC11
GR  50   0 -10  100 -10 5100  50 5200
*
DB
*
EJ
```

The BC file for dead start simulation is -

Example application of UNET to simple a simple system
Michael Gee, HEC, May 1998
tidal
*

* Job control information

*

JOB CONTROL

T T 5MIN 48 6 F 0.6 T F 240 1HOUR

*

* Time window of simulation

*

TIME WINDOW

01JAN1998 0600 20JAN1998 0600

*

UPSTREAM FLOW HYDROGRAPH

1 2 0 5000 3000 5000

*

*

* DOWNSTREAM BOUNDARY CONDITION

OPEN DSS FILE

TIDES2 01JAN1998 0600 30JAN1998 0600 1.0

DOWNSTREAM STAGE HYDROGRAPH

1

/TIDE/DSBC/STAGE/01JAN1998/1HOUR/OBS/

INITIAL FLOW CONDITIONS

1 5000

*

INITIAL STORAGE ELEVATION

1 0.0

*

CLOSE DSS FILE

*

*

* Open DSS file for writing results

*

WRITE HYDROGRAPHS TO DSS

STORAGE.DSS

EJ

The BC File for Hotstart 10 days into the warmup period is -

Example application of UNET to simple a simple system

Michael Gee, HEC, May 1998

restart

*

* Job control information

*

JOB CONTROL

T T 5MIN 48 6 F 0.6 T F -1 1HOUR

*

* Time window of simulation

Tidal Application

```
*
TIME WINDOW
11JAN1998 0600 20JAN1998 0600
*
UPSTREAM FLOW HYDROGRAPH
1 2 0 5000 3000 5000
*
*
* DOWNSTREAM BOUNDARY CONDITION
OPEN DSS FILE
TIDES2 01JAN1998 0600 30JAN1998 0600 1.0
DOWNSTREAM STAGE HYDROGRAPH
1
/TIDE/DSBC/STAGE/01JAN1998/1HOUR/OBS/
*
CLOSE DSS FILE
*
READ INITIAL CONDITIONS
10DAY.RST
*
* Open DSS file for writing results
*
WRITE HYDROGRAPHS TO DSS
STORAGE.DSS
EJ
```

NOTE: It appears that, when using a hotstart simulation, the volume accounting is corrupted in that the “starting reach vol” is set to zero.

References

Cunge, J.A., Holly, F.M., and Verwey, A. 1980. *Practical Aspects of Computational River Hydraulics*, Pitman, London.

Thomas, W. A., and McAnally, W. H., 1985. "Open Channel Flow and Sedimentation, TABS-2," *User's Manual*, US Army Engineer Waterways Experiment Station, Instruction Report HL-85-1, Vicksburg, MS.

U.S. Army Corps of Engineers, *Tidal Hydraulics*, Engineer Manual 1110-2-1607, 15 March 1991.

Wiegel, R.L. 1964, *Oceanographical Engineering*, Prentice-Hall, Inc., Englewood Cliffs, NJ.

Appendix F-2

Modeling Ice Covered Streams

The UNET ice cover option allows the user to model channels with floating, stationary ice covers. This option is appropriate where the ice cover is in place during the entire time simulated, and the ice cover thickness and the ice cover roughness, as defined by its Manning's n value, are known and unchanging with time. This option allows the user to input different ice thicknesses in the channel and the left and right overbanks. It allows the thickness and the roughness to be changed at every cross section, if required.

Based on the given ice thicknesses and ice roughness, this option modifies the tables of elevation versus flow area and conveyance that are created by the program CSECT. It is assumed that the ice cover is always floating at hydrostatic equilibrium. The flow areas of the channel and the left and right overbanks are reduced by an area equal to the submerged area of the ice cover. This submerged area is assumed to be a trapezoid with a top surface coinciding with the water surface elevation and a bottom surface at a depth equal to the thickness of the ice multiplied by the specific gravity of the ice. The user is allowed to input a specific gravity for the ice and to vary it from cross section to cross section. The default value is 0.916. The conveyance of the channel is modified by accounting for the change in area, the decrease in hydraulic radius, and the composite n value. This option determines a composite Manning's n value using the Balokon-Sabaneev formula (Ashton 1986) for the channel and left and right overbanks based on the given bed n value and the given ice n value. The hydraulic radius is found by dividing the flow area by the wetted perimeter, which includes the width of the underside of the ice cover.

The ice cover is assumed to occur only within the channel and left and right overbank areas. Storage area calculations are not effected. If encroachments are specified, the ice cover is not assumed to exist outside the encroachments at any elevation. Pilot channel calculations are not affected by the presence of an ice cover. The option also checks that the minimum elevation specified for the tables created by CSECT provides sufficient depth for the ice cover to float (that is, the bottom of the ice cover cannot be below the minimum elevation of the channel.). If there is not sufficient depth, the minimum elevation is increased by the submerged thickness of the ice.

See Appendix D-3, example problem #3, for more information.

