

U.S. ARMY ★ ★ ★ ★ ★ ★ ★ ★ ★ ★ ★ ★ ★ ★ ★ ★

JOURNAL

★ ★ ★ ★ ★ ★ ★ ★ ★ ★ of Installation Management

Fall 2011

WE ARE THE
ARMY'S HOME



PARTNERS IN
COMMUNITY

2011
ANNUAL SPECIAL
EDITION





The Journal is Now Available for the iPad

An ePublication version of the Journal is available from a link on the Journal Web page, <http://www.imcom.army.mil/hq/publications/journal/> or use this QR Code with your reader-equipped smartphone.



From the
COMMANDING GENERAL

★ ★ ★ ★ ★ **We are the Army's Home** ★ ★ ★ ★ ★



THE IM COMMUNITY AT A CROSSROADS

The Installation Management Community has reached a critical juncture. Our focus has been on building mental, emotional and physical resilience in an Army Family stressed by years of repeated and extended deployments. At the same time, we've been responsible for preparing the installations to change dramatically in shape and size as transformation reshaped the Army and BRAC restationed much of it. In short, the IM Community has long been decisively engaged in events of the moment.

While the turbulence of persistent conflict and BRAC reorganization are subsiding, the need for installation services will grow as Soldiers and Families settle into a more stable readiness cycle that will shorten deployments to nine months and provide more time at home. This is great news for the Army Family, but it will challenge the IM Community to absorb the increased population while maintaining a quality of life commensurate with their service.

We also know our resources are shrinking, now and for the foreseeable future. Our nation's economy is challenged by recession and a painfully slow recovery, and Defense is asked to do its part in cutting back. IMCOM funding was less in FY11 than it was in FY10, and FY12 will be less than FY11.

This is cause for concern, but not alarm at this point, although more cuts seem sure to follow. IMCOM is cutting about 15% of the workforce, but we expected it and we have positioned ourselves for it over the past year. We eliminated nearly 1,000 contractor positions and filled only

the most critical vacancies at the headquarters level. We have reduced from seven to four regions worldwide, with the intent of eliminating the remaining CONUS regions by FY14. We have alerted the garrisons to prepare for likely workforce reductions and have made reorganization tools available to ease the impact on their workforces.

We have to be prepared for an immediate future with a consistent or expanding mission, but shrinking resources. In his classic 19th-century treatise, "On War," Clausewitz states that military action is conducted to achieve certain ends (objectives) through a set of ways (actions), employing available means (resources). This theory applies very well to the IM Community as we continue striving to maintain high quality of life standards for Soldiers and Families (objective remains constant) with dwindling and uncertain funding (resources shrink). With constant ends and shrinking means our only course of action is to adjust our ways of doing business. I've said before that we can't do more with less, so we have to identify the most important things and do them the best we can.

This annual special edition of the Journal serves as a snapshot of the current IM Community and a look ahead through articles by our senior leaders. We open with the perspective of the Assistant Secretary of the Army for Installations, Energy and the Environment (ASA-IE&E), who reflects on three major successes of the past year: BRAC, Net-Zero and the Energy Initiatives Office Task Force.

In the operational arena, you'll find an article on Army stationing in 2020 by MG Al Aycock, ACSIM director of Operations. MG Reuben Jones, IMCOM deputy commander for Operations, has written about his explorations into possible future expeditionary basing—that is, an IM Community role in running garrisons in operational theaters. In the all-important resource management arena, ACSIM Resources

Division director Ms. Diane Randon has teamed with IMCOM G8 BG Thomas Horlander for an article on the practices and programs integral to creating and sustaining a cost culture.

Mr. Joe Capps recently joined IMCOM as the executive director, and he contributes an article looking at the human capital and talent management aspects of building and developing the civilian workforce for the IM Community of the future. In another area of profound change, each of the region directors has contributed an article discussing an aspect of their region as it looks today.

This is only a sampling of the content in this annual issue. There are several more articles, and in the back you will find an updated IMCOM world map, an organization chart that reflects the current state of the IM Community, photos of the senior leaders and a comprehensive garrison contact list. This should be a good reference volume for our stakeholders for the coming year.

As I prepare to turn command over to LTG Mike Ferriter in November, I'm talking to him routinely and including him in all long-term decisions, so we have a stable and predictable transition. You face a new and exciting set of challenges as an organization, and I know you will excel in fulfilling them, just as you did during my time as Defender 6.

Lieutenant General Rick Lynch
Commanding General
U.S. Army Installation
Management Command

Assistant Chief of Staff
for Installation Management
"Defender 6"



U.S. ARMY **JOURNAL** of Installation Management

Fall 2011

CONTENTS:

- 1 Great Sustainability Strides for the IM Community in FY11**
by Hon. Katherine Hammack, Assistant Secretary of the Army, Installations, Energy and Environment
- 6 A Necessary Way of Doing Garrison Business**
by Dr. Craig College, Deputy Assistant Chief of Staff for Installation Management
- 9 Army Installation Stationing 2020**
by MG Al Aycock, Director, Operations, OACSIM
- 14 Expeditionary Installation Management: IMCOM Is Up To The Challenge**
by MG Rueben D. Jones, Deputy Commander for Operations, IMCOM
- 20 IMCOM Talent Management - Preparing for the New Fiscal Reality**
by Joe C. Capps, Executive Director, IMCOM
- 23 Garrison Life and Leadership: Are we Ready for it?**
by CSM Neil Ciotola, IMCOM Command Sergeant Major
- 27 Institutionalizing Fiscal Reductions and a Cost Culture**
by BG Thomas A. Horlander, G8 IMCOM, & Diane Randon, Resources Director, OACSIM
- 31 IMCOM Garrisons Adjust For Future Missions While Preserving Historic Legacies**
by COL Scott D. Kimmell, Commander, U.S. Army Environmental Command & Deborah Reynolds, Acting Director, Installation Services, OACSIM
- 36 Thin Client and SharePoint Technology Form the Basis of the IMC Mobile Workspace**
by William Lay, Chief Information Officer/G6, IMCOM; & Levon (Rick) Anderson, Deputy Director, Information Technology, OACSIM
- 40 Adaptive Leadership: The Key to the Hard Problems of Combining Korea and Pacific Regions**
by Debra Zedalis, Director, Pacific Region, IMCOM
- 46 IMCOM Supports its Customers and Workforce Through the Pacific-Korea Merger**
by BG David G. Fox, Commander, Korea Region, IMCOM
- 49 Tactical Metrics Help Set Priorities in a Resource-Constrained Environment**
by Davis Tindoll, Director, Atlantic Region, IMCOM
- 54 IMCOM Central Region: Leading into the Future**
by J. Randall Robinson, Director, Central Region, IMCOM
- 60 Building Community Resilience in Europe: Art Supported by Science**
by Kathleen Marin, Region Director, Europe Region, IMCOM

JOURNAL OF INSTALLATION MANAGEMENT

★ ★ ★ CONTRIBUTORS' GUIDE ★ ★ ★

Topics and Contributors

The U.S. Army Journal of Installation Management is the Army's print forum for ideas, experiences, case studies and opinions relating to the many disciplines that pertain to the broad area of installation management. Each edition will feature articles from a select group of garrison leaders and other contributors discussing topics relating to the issue's designated theme, which will ordinarily stem from some part of the Installation Management Campaign Plan (IMCP). The IMCP is available at the IMCOM Web site, <http://www.imcom.army.mil/hq/>.

Articles will be evaluated for consistency with commander's intent and for topical fit within the theme. All submissions are carefully reviewed and may be shared with a subject matter expert to provide a second opinion as to accuracy and relevance. Where appropriate to maintain consistent focus and high editorial quality, authors may be asked to clarify or expand on some aspect of their papers.

All articles should be titled and designate the name of the author(s) of record, along with a short bio of approximately 50-60 words.

Length

Articles should be of adequate length to engage a reader in a substantial exploration of the topic. A good average length is about 2,000-3,000 words, although longer articles are acceptable. Articles lacking in depth or substance will be returned to the writer with suggestions for bringing the work up to standard. If the standard is not achieved, the article will be excluded.

Manuscript Style

Writing should be clear and concise, ideas should be the author's own, and cited material must be properly accredited. We are looking for a scholarly or expository text—not a Command Information news story.

Standard article structure normally proceeds from a thesis statement, to three main points of discussion, followed by conclusion, recommendations, and summary. Proposal outlines or abstracts are not required, but will be considered and feedback provided if writers want to test an article idea.

The Journal does not require adherence to a particular academic style, but rules of good writing always apply. A good and widely available reference book is *The Elements of Style*, by Strunk and White. For articles with several citations, an academic style such as the American Psychiatric Association (APA) Style or the Chicago Style can be helpful in managing references. Word processing programs have made these citation protocols much more user friendly than in the past.

The following stylistic guidance is offered to answer the most frequently asked questions:

- Military ranks are denoted in the military style, i.e. LTC, MG, SGT, etc.
- Names of people and organizations are spelled out on first reference with the acronym, if any, in parentheses following. Thereafter, people are normally referred to by last name only—organizations by acronym.
- IMCOM style calls for capitalizing Soldier, Civilian and Family, listed in that order.
- Senior Commander and Region Director are capitalized, garrison commander is not.

Although most of the audience is senior installation management professionals, vocabulary should be accessible to a general college-level audience, with technical or function-specific language used only as necessary and explained to the extent practical. The editorial staff will edit all manuscripts for general rules of good grammar and style. Substantive changes will be referred to the author for clarification. Editors will also consider security and appropriateness when editing manuscripts.

Writers should include a short biography that mentions current duty assignment, education, and any credentials or experiences that establish the writer's topical authority. Also include contact information that allows editorial staff to reach you. We will not publish contact information.

Accompanying Material

Photographs, charts, and other supporting visuals are encouraged, but will often have to be modified or recreated by the designers for reproduction quality. Photos must be print quality—normally 300 DPI or higher. Do not embed visuals into the text of an article—instead, submit them separately, with identifying information and relevance to the article.

Clearance

All articles and supporting visuals must have any required clearance for operational security. Editors will also screen for public releasability.

Engage the Audience

Authors wishing to invite discussion from community members are welcome to reference their articles in posts to IMCOM Garrison Commanders' Net, an Army Professional Forum established for members of the IM Community. Just log in to www.garrisoncommand.com and register with your CAC or AKO account if you're not already a member. Garrison Commanders' Net is not affiliated with the Journal.

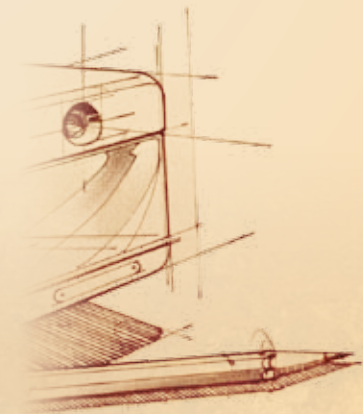



IMCOM Commander

Lieutenant General
Rick Lynch

**Deputy Commander -
Operations**

Major General
Reuben D. Jones

**Deputy Commander -
Support**

Brigadier General
John Uberti

Executive Director

Mr. Joe C. Capps (SES)

Chief of Staff

Mr. Luke Green

Command Sergeant Major

Neil L. Ciotola



Editorial Staff

Director of Public Affairs

Michael P. Thiem

Managing Editor

Ned Christensen

Assistant Editor

Shayna E. Brouker



Design / Print Procurement

Army Publishing Directorate



**U.S. Army Journal of
Installation Management**

Produced by the United States Army Installation Management Command Public Affairs Office. Bldg. 2261, 2405 Gun Shed Rd, Ft. Sam Houston, TX 78234-1233. The journal is published quarterly for senior leaders and stakeholders in the installation management community. **Email the Journal at imcomjournal@conus.army.mil**



EDITOR'S NOTE:

Once again, the journal features QR codes like this one to direct the reader to more resources on a given topic. These are read with a QR Reader app for any smart phone. Most are free and are useful in locating internet resources "on the fly." This one goes to the IMCOM Facebook page. Others with articles go to more information on the article topic. We hope you enjoy this feature in the journal.



Great Sustainability Strides for the IM Community in FY11

by Hon. Katherine Hammack, Assistant Secretary of the Army, IE&E

Over the past six years, the Army has undertaken the greatest organizational change since World War II while fighting in two theaters of war and defending the homeland.



October is traditionally the time of year when the Army inventories past actions and strategically refocuses on the future. For the Installation Management Community, our strategic focus should begin with a quick inventory of the events that have reshaped our Army over the past few months. Specific to this inventory is recognition of the Army's Base Realignment and Closure (BRAC) success across the Army; instituting the Net Zero vision and goals and the establishment of the Energy Initiatives Office Task Force (EIO).

Base Realignment and Closure

Over the past six years, the Army has undertaken the greatest organizational change since World War II while fighting in two theaters of war and defending the homeland.

Central to those changes was Base Realignment and Closure 2005. The

102 Army-managed BRAC recommendations, a total of 1,147 Army BRAC actions, were completed on or before our goal of 15 September. BRAC 2005 helped enable the Army to reshape the infrastructure sustaining the operating force, the generating force and the reserve component.

At completion, we will have realigned 53 installations or functions and closed 12 Active Component installations, one Army Reserve installation and 387 National Guard Readiness and Army Reserve Centers, while significantly reducing our occupancy in eight leased facilities.

With just under \$18 billion invested in construction and related areas — three times more than all four previous Army BRAC rounds combined — BRAC 2005 produced tremendous economic impacts for regional econo-

mies as well as the states and the communities that adjoin our installations.

The construction industry estimates that each \$1 billion in nonresidential construction spending adds about \$3.4 billion to Gross Domestic Product (GDP), contributes about \$1.1 billion to personal earnings and creates or sustains 28,500 jobs. This means that the Army BRAC efforts contributed more than \$60 billion to the GDP and almost \$20 billion to personal earnings while creating or sustaining 513,000 jobs.

Additionally, upon completion of BRAC 2005, the Army will have returned or repurposed 70,363 acres of excess property to local communities. The Army remains committed to and is working with BRAC 2005 communities to help them achieve their vision. On our installations, which serve as "The Army's Home," we have coupled



The Net Zero vision is to reduce energy, water, and waste on our installations. This approach is a force multiplier enabling the Army to appropriately conserve available resources, manage costs and provide our Soldiers, Families and Civilians with a sustainable future.

Army BRAC 2005 with Army Family Covenant programs and related investments. We have enhanced the support we provide for Soldiers and Families across our Active Army, Army Reserve and Army National Guard. These improvements in infrastructure, community facilities, housing, childcare centers and other areas enhance the resiliency of our Army families.

With BRAC 2005 behind us, we must continue to build upon these successes while continuing our focus on efficiencies, security and sustainability at home and abroad.

In our Army operations in theater, the logistical tail we need to support our war fighters has grown exceedingly long. During the fiscal year 2010 alone, the Army spent \$2.7 billion on operational energy costs. In addition, mission-essential fuel and water constitute nearly 70 to 80 percent of the weight of our logistics convoys, putting our Soldiers at great risk. Significant steps to reduce those convoys by increasing efficiency and better managing our resources will help save money and, more importantly, save lives.

At home, Soldiers live and train on installations dependent on vulnerable commercial power grids and complex water and wastewater distribution systems. We must continue our focus on energy initiatives, leveraging technology and enhancing operational perfor-

mance across the range of military operations, addressing Soldier, platform and sustainment capability needs.

Although our installations and forward operating bases (FOBs) are separated by hundreds of miles, they share many commonalities. Everything we learn and implement on our permanent installations can be leveraged into contingency base operations, in any theater, anywhere in the world.

In this era of reduced budgets and continuing expectations to “do more with less,” to fully take advantage of these successes, we must share best practices and take a holistic, enterprise approach to all that we do.

Net Zero

Last October we announced the Army’s Vision for Net Zero, a holistic enterprise approach to appropriately managing our natural resources with the goal of striving towards Net Zero installations. The Net Zero vision is to reduce energy, water, and waste on our installations. This approach is a force multiplier enabling the Army to appropriately conserve available resources, manage costs and provide our Soldiers, Families and Civilians with a sustainable future.

The Net Zero vision ensures that sustainable practices will be instilled and managed throughout the appropriate levels of the Army, while maximizing

operational capability, resource availability and well-being. The program establishes a framework of reduction, repurposing, recycling and composting, energy recovery and disposal to guide them towards achieving net zero in an environmentally responsible, cost-effective and efficient manner.

Last February we challenged our Army installations to self-nominate as Net Zero pilot installations. The installation response was overwhelming. We received 100 applications from 60 Army installations. As we worked with the Department of Energy to evaluate the installation submittals we decided to raise the number of pilot installations from five in each category to six and identified two integrated installations.

Last April we announced the six pilot installations each for energy, water and waste and two integrated installations striving towards Net Zero by year 2020. These installations are becoming centers of environmental and energy excellence by showcasing best management practices and demonstrating effective resource management. The intent of this pilot effort is not to hamper the motivation of all of our installations who are currently striving for Net Zero, but to work closely with a few so that those lessons learned can be shared with all.

Following the kick-off meeting and



This \$9.8-million project was funded by the U.S. Army Energy Conservation Investment Program. The solar grid will save FHL approximately \$1 million per year in energy costs, which will pay off the project lifecycle cost within 10 years.



training session in June, where they received training and were given the opportunity to showcase their plans and strategies to achieve Net Zero, these pilot installations continue to succeed and share best practices. They participate in monthly conference calls, provide quarterly status updates to the public and share experiences and lessons learned in newsletters, military and industry conferences.

While current activities at the Net Zero pilot installations are primarily focused on assessing energy, water and waste reduction status and developing action plans to achieve Net Zero, our pilots are already implementing projects and actions as they strive toward Net Zero by 2020.

Fort Hunter Liggett (FHL), in California, one of the Net Zero Energy

pilot installations, broke ground on a one-megawatt solar micro grid project on April 8, 2011. This \$9.8-million project was funded by the U.S. Army Energy Conservation Investment Program (ECIP). The solar grid will save FHL approximately \$1 million per year in energy costs, which will pay off the project lifecycle cost within 10 years. Up to 33 percent of FHL's current annual energy demand of three megawatts (MW), or 50 percent of its daytime demand, will be provided by the solar micro grid project. Another one-MW solar project has been approved for ECIP funding in FY11.

Aberdeen Proving Ground in Maryland, one of the Net Zero Water pilot installations, completed a 1.5 million-square-foot campus expansion in the fall 2010. The campus achieved Leadership in Energy and

Environmental Design (LEED) Silver designation. Water conservation features include low-flow fixtures, green walls on the south side of the courtyard, drainage to grass swales and retention to wetlands. A second 650,000-square-foot facility was completed in August 2011 and is on track to achieve LEED Silver certification. Water conservation features for this facility include a geothermal well system under the parking area, low-flow fixtures, drainage to grass swales and a detention basin to wetlands.

The Net Zero Waste pilot installations average more than 90 percent diversion of construction and demolition debris and more than 40 percent diversion of municipal solid waste. They are working to increase their repurposing, recycling and composting efforts and are evaluating their procurement activities for 'waste avoidance' opportunities.



*This will enable the Army to **obtain energy that is more secure, more sustainable and more affordable by assuring diversity of sources.** The Army's goal of **25 percent renewable energy by 2025** is the scale of renewable energy production the Army needs in order to meet Federal mandates.*

Each installation is unique and no 'silver bullet' or 'one-size-fits-all' solution exists to achieve its net zero status. Installations will utilize a variety of strategies to reach Net Zero. Installations will not be forced into a specific strategy; instead, lessons learned at each pilot installation will be highlighted for use by other Army installations. They will continue their journey to be Net Zero installations by the year 2020. Our strategic focus will be to add another 25 installations in each category that will strive to reach Net Zero by 2030.

As part of this strategy, we are also leveraging opportunities for private sector investment through authorities given us by Congress, such as power purchase agreements, enhanced-use leases, energy savings performance contracts and utilities energy service contracts. Many installations are already employing such contracts.

Energy Initiatives Office

We extended our outreach to the private sector in August as Secretary of the Army John McHugh announced the establishment of the Energy Initiatives Office (EIO) Task Force to serve as the central managing office for large-scale Army renewable energy projects. The EIO Task Force will foster strategic, technical and financial investment in the Army's Renewable Energy Program. They will work within the Army to streamline existing acquisi-

tion processes and leverage industry for the execution of cost-effective, large-scale renewable and alternative energy projects (more than 10 MWh each) on Army installations.

This will enable the Army to obtain energy that is more secure, more sustainable and more affordable by assuring diversity of sources. The Army's goal of 25 percent renewable energy by 2025 is the scale of renewable energy production the Army needs in order to meet federal mandates. This program will provide enhanced energy security and is estimated to require investment up to \$7.1 billion over the next 10 years. This level of investment is expected to generate 2.1 million MWh of power annually for the Army. In order to meet these targets, the Army must continue collaboration with the private sector.

The EIO Task Force will provide expertise to identify and evaluate technologies, negotiate with utilities and manage the construction, operation and maintenance of large-scale renewable projects. Strategically, this is expected to result in increased interest from project developers and improved financial options for the Army.

The EIO Task Force will continue to leverage the memorandum of understanding between the Department of Defense (DoD) and the Department of Energy (DOE) by accessing the ex-

pertise and resources of the DOE, the National Renewable Energy Lab and other DOE labs.

The Army's EIO Task Force is strategically focused on on-site, large-scale renewable energy generation that can mitigate mission risk stemming from service disruptions due to a reliance on an aging and vulnerable electric grid. This also provides a hedge against rising and volatile energy prices, and serves as a potential source of revenue for other energy and efficiency efforts.

The EIO Task Force will utilize the Army's Renewable Energy Execution Plan to address Basing Power needs, resulting in the implementation of large-scale renewable energy infrastructure on Army installations. The Renewable Energy Execution Plan will provide the Army with a process to pursue large-scale renewable energy projects in a manner that is predictable and transparent. The EIO Task Force will engage in financial risk management strategies, which will address installations' needs to reduce costs, mitigate energy supply liabilities from domestic transmission and distribution system reliability.

Again, many of the lessons we learn here can be applied across the Army.

Summary

Strategically, Army BRAC 2005 helped us reach numerous Transformation and Quality of Life milestones.



We must continue to build upon those successes.

The Army is striving for Net Zero, providing a range of long-term sustainable benefits to the Army and surrounding communities.

The EIO Task Force will lead the way in actively seeking and supporting industry partnerships to become less dependent on expensive and unstable energy sources and increase compatible renewable energy development.

We will continue to collaborate with industry, whether it's large-scale renewable energy generation at home or by testing and evaluating "off the shelf" technologies to find new ways to reduce the weight and increase the capabilities of energy-related Soldier systems in the field.

As we look far into the future, energy must be a consideration in all Army activities including major operations, construction of new buildings and tactical patrols. We must change our culture so every Soldier is a power manager, drive efficiency across the enterprise and build resilience through renewable energy.

Historically, the Army operated under the assumption that low-cost energy and other resources would be readily available when and where they were needed. Today, however, the Army faces growing challenges to its energy and water supply at home and abroad. It is essential that the Army take significant steps to protect reliable access to energy, water and other resources to ensure the Soldiers of future have the same access to resources to complete

their mission as the Soldiers of today. We must continue to ensure the Army Family has the resources needed to deploy, fight and win, while enjoying a safe and healthy environment, quality service and supporting communities. The end-state goal is greater operational effectiveness, measured in terms of endurance, agility, flexibility, resilience and force protection. We will enable that through energy management, diversification, increased efficiency and demand reduction, leading to an affordable, sustainable force. The outcome is fewer Soldier casualties and more dollars to reinvest in Soldier and Family quality of life.

Only through these efforts can we successfully "support and defend."

Army Strong!



Ms. Katherine Hammack is the Assistant Secretary of the Army for Installations, Energy and Environment, serving as the primary advisor to the Secretary and Chief of Staff of the Army on all matters related to installation policy, oversight and coordination of energy security and management. Ms. Hammack has more than 30 years' experience in energy and sustainability advisory services. She holds a Bachelor's Degree in Mechanical Engineering from Oregon State University and an M.B.A. from the University of Hartford. Ms. Hammack is a founding member of the U.S. Green Building Council in Washington, D.C.



A Necessary Way of Doing Garrison Business

by Dr. Craig College, Deputy Assistant Chief of Staff for Installation Management

Like many of you, I recently read *The Starfish and the Spider: The Unstoppable Power of Leaderless Organizations* by Ori Brafman and Rod Beckstrom. You know the gist of the story. If you cut off a spider's head, it dies. If you cut off a starfish's leg, it grows a new one and the amputated leg grows into another starfish. Traditional chain-of-command organizations (e.g. the Army, the Department of Defense (DoD), municipalities) are spiders and will fail if the leadership fails. Starfish organizations (e.g. Craig's List, Alcoholics Anonymous, Wikipedia, and the Apache Nation which evaded the Spanish Army for 200 years (but was finally subjugated by the U.S. Government, which established property rights and spider-like authority among the tribes) have no chain of command and prosper due to the non-directed but mutually reinforcing and collaborative efforts of the members of the group.

I struggled to find a compelling application of the starfish model to the Installation Management Community, but then, just a few months ago, I attended the Association of Defense Communities (ADC) conference in Norfolk, VA. ADC is a membership organization that, according to its website, "unites the diverse interests of communities, state governments, the private sector and the military on issues of base closure and realignment, community military partnerships,

defense real estate, mission growth, mission sustainment, military privatization, and base redevelopment. "

I spoke in several sessions on energy, sustainability, and Public-Public Partnerships (PPPs). ADC was beating the drum on the potentially catastrophic effects of budget reductions — military and civilian — and pushing PPPs as a way for communities and military installations to reduce costs and maintain services. I share their concerns based on budget discussions in the Pentagon and the oft-repeated history of what happens to military budgets after major conflicts end (they

fall) and who pays (disproportionately infrastructure activities, including installations). The chart shows DoD's history of crushing budget reductions after wars and the related drops in infrastructure. It doesn't take a Ph.D. economist to detect the pattern (although we do make nice charts!)

Representatives of many starfish organizations spoke at the ADC conference. They are all composed of very tightly linked individuals, but largely devoid of a chain of command. They are very successful in doing what they feel very strongly about (another distinguishing aspect of a starfish organization), in this case on behalf of Soldiers and their Families. The organizations often have a Founder or President, but rather than directing or controlling, these individuals catalyze the voluntary efforts of others. That is, they contribute energy and enthusiasm

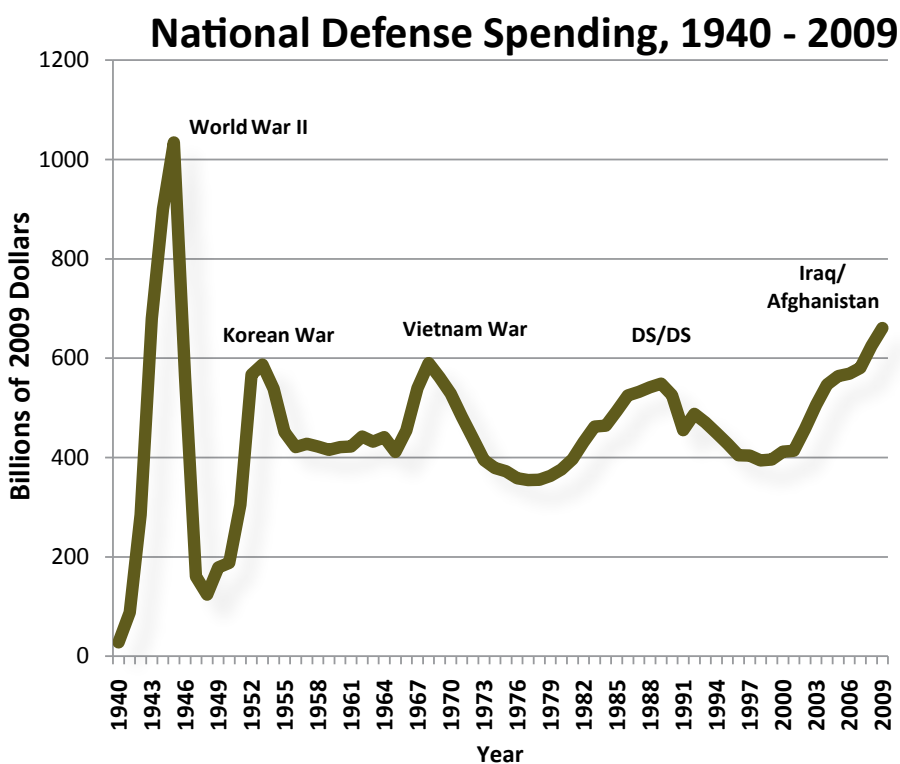



and create the conditions under which willing participants link arms and successfully accomplish amazing things.

Barbara Van Dahlen is such a catalyst. She is the founder and president of Give An Hour, an organization of some 6,000 mental health practitioners who give one hour per week of free behavioral health counseling to military and ex-military personnel. As she described her organization, it was quintessentially starfish in nature. She exuded energy, excitement, and genuine interest in others; had developed numerous very effective links to organizations and individuals to advance her cause; and displayed extremely effective social mapping skills, inspiration, trust in others, and so on (go back and review the book!)

And there were many other catalysts representing starfish organizations at the conference. Vivian Greentree represented Blue Star Families. Catherine A. Wilson is the executive director of the Virginia Wounded Warrior Program. Craig Quigley is executive director

for the Hampton Roads Military and Federal Facilities Alliance. Don Belk is the regional planner for the Fort Bragg Regional Alliance. These examples make the point that starfish organizations can comprise, in whole or in part, government organizations and not just well-meaning private individuals (Give An Hour) or commercial service providers (Craig's List). These organizations are not cookie-cutter starfish, but they do manifest many of the starfish characteristics and, more importantly, from an Installation Management Community perspective, they provide critical services to Soldiers and their Families or the Army without a chain of command, military or otherwise, and usually with low or no appropriated cost to military organizations.

I listened to a veteran base commander explain in detail to Ms. Van Dahlen why these homegrown efforts, while well-meaning and valuable, can be disruptive and difficult to support in a chain-of-command environment. He related that it is often difficult to receive higher-up approval from the

chain of command to enter into binding partnerships with such organizations. Often, lawyers advise caution in establishing such relationships or impose constraints (lawyers can be very spider-like, too). Finally, there is often little or nothing budgeted to support such partnerships. This was a stereotypically spider response: "My chain of command and budget constrain my ability to partner with starfish organizations."

Ms. Van Dahlen's response was stereotypically starfish: We're bringing to the table something Soldiers and their Families need. We don't want resources but we need access and support. Work with us. The commander responded that there are rules and regulations and oversight that regulate such arrangements. These efforts take time and money. And so the exchange ended in a draw. Neither side could respond positively to the fundamentally different realities perceived by the spider and the starfish orientations.

There are excellent examples of such arrangements now on our military installations. Many provide Soldier and Family services under the banner of the Army Community Covenant. Others are structured partnerships or cooperative agreements to provide municipal services, energy production, fire and emergency services, and so on. I believe that many of these efforts exhibit one or both of two characteristics: 1) The arrangements result from extreme peril felt by the garrison or local community (for example, a spike in electricity costs or inability to fund a capital project) or an extreme opportunity to greatly improve the provision of a service; and 2) passionate



individuals willing to expend personal time and reputation to make a partnership happen. These two characteristics also cause partnering activities to be episodic in nature rather than the routine way of arranging everyday business. Very visionary and brave starfish and spider leaders have achieved some remarkable results, but these accomplishments are few in number relative to all of the things which must be done to support the Army and its Soldiers and their Families.

I believe that the current budget environment constitutes a nationwide manifestation of extreme peril (characteristic #1) and requires all of us to become passionate risk-taking individuals (characteristic #2) on behalf of Soldiers and their Families. Moreover, we need to develop a new characteristic #3: a world in which spiders look for starfish-like solutions before defaulting to spider-like solutions. We need to catalyze the search for partnerships to solve everyday problems before we simply request more funds or personnel. These arrangements must become the default for doing the routine parts of day-to-day business rather than the result of the occasional flash of insight or desperation. The Office of the Assistant Chief of Staff for Installation Management must pursue additional authorities (based, in part, on garrison commanders' identification of areas in which they feel they cannot currently legally partner) and approve requests to create novel relationships. IMCOM must create the playbooks for garrison commanders to routinely and repeatedly identify and respond to opportunities to maintain services and reduce costs. And, as always, garrisons will have to execute.

The most affordable future for military installations and their surrounding communities is to create partnerships in far greater numbers that feed off each other's strengths and economize on our weaknesses to survive the coming economic challenge. These approaches must become routine and pervasive. Cooperative agreements, enhanced use leases (EULs), new authorities for municipal services, and on and on must be created, nurtured, and practiced in the future. We must seek to share overhead costs and increase scale and scope in our business practices so that we maintain garrison service levels and reduce garrison costs. Much remains to be done to effect such a future — new authorities, new ways of thinking, closer trust relationships among military and civilian communities.

Tomorrow's successful partnerships will be those that are more starfish-like. Our challenges will be to adapt rigid chains of command that think like spiders, rather than strive like starfish; ensure the support of our legal and statutory overseers; and create the levels of trust and energy necessary to execute these strategies on the ground. Our success on behalf of Soldiers and their Families will not derive from some new program devised in Washington, D.C. or San Antonio, but in the hard work and attention to opportunities that garrison commanders and their staffs will have to sort through at the local level — things that chip away at the deleterious effects of the reductions in garrison budgets that are sure to follow. Thinking like a starfish will be the solution to efficiency drills, the way to avoid cutting programs, the way to make programs better by integrating with communities to an extent not seen be-

fore and solving each other's challenges at less cost and with greater quality.



Scan the code for more on the cited book, **"The Spider and the Starfish: The Unstoppable Power of Leaderless Organizations"** by Ori Brafman and Rod A. Beckstrom



Dr. Craig College has served as the Deputy Assistant Chief of Staff for Installation Management since May 2006. His previous Senior Executive Service assignments include Deputy Assistant Secretary of the Army for Infrastructure Analysis, Assistant Deputy Chief of Staff for Programs (G-8), and Deputy Director of Program Analysis and Evaluation. He has a Ph.D. in Economics from Stanford University, CA, and is a graduate of the U.S. Military Academy at West Point.



Army Installation Stationing 2020

by MG Al Ayccock, Director, Operations, OACSIM

“In the next four years, the next four POM submissions, the ‘13-’17, the ‘16-’20, we will build the Army that will be employed in 2020”



GEN Martin Dempsey
37th Chief of Staff of the Army

Senior Commanders and garrison commanders will be at a critical point between now and 2020 to ensure our Army is stationed properly with the right facilities, training ranges and command support. The stationing of forces is a critical enabler for the Army of 2020 to maintain operational readiness within the resources available. To succeed, we must have strategic planning with an understanding of readiness, facilities, costs and the Army’s long-term plans to sustain the greatest amount of tooth with the most effective and least costly tail. The role of installation leaders is even more important as the Army adapts to future force structure changes at the strategic, operational and tactical levels to provide what the nation needs in a turbulent strategic environment abroad and challenging economic conditions at home. Understanding how stationing works and executing properly at the installation level is essential to building the Army of 2020.

The first key is to know the strategic guidance and direction of the Army and apply what must be done at the installation

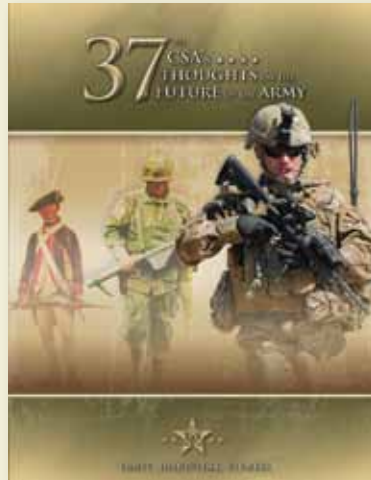

in terms of readiness and cost savings. The Secretary of the Army and Chief of Staff of the Army provided their shared vision and intent for the future of the Army in a document titled *Thoughts on the Future of the Army*. The document also provided focus areas the Army must execute to prepare for the Army of 2020. It is also important to understand the Army Campaign Plan (ACP) and the other documents in The Army Plan (TAP) as these will be used to develop focused requirements and to set priorities for the Army. Recently, the Army developed a Facility Investment Strategy (FIS) to accurately direct military construction (MILCON) toward overall Army objectives with an additional focus on the application of funding for sustainment, restoration and modernization (SRM) to maintain the right facilities for readiness. This guidance, and the processes used to advance Army initiatives that affect stationing,

must be fully embraced at all levels to make the best use of existing facilities and ranges at the greatest cost savings for Army readiness.

Army installations are platforms of readiness that prepare our units for deployment in support of Combatant Commanders and employment during domestic emergencies, while supporting Families in preparing for these events. Senior Commanders will be faced with maintaining this high current readiness while focusing on future requirements, cycles of modernization and aligning with the Army’s FIS. The Chief of Staff of the Army tasked senior military and civilian leaders to “...make our Army smarter, better, and more capable — with the resources we are given...” This makes the future of facilities and stationing dependent on establishing the right priorities based on needs, according to Army standards and guidance.

Beginning with the end in mind, facilities and training ranges are often the most challenging part of planning the future because of long timelines involved in planning, approval and building. As the Army works to align end strength with future resources, we must take advantage of the opportunity to improve readiness while making the best use of our existing and planned facilities and taking unnecessary facilities out of the funding stream to better apply our resources. Planned stationing to make the best use of existing resources while ensuring focused



While there are always areas for improvement, the Army now has the best facilities in our history. The prospect of reducing overall force structure through the Total Army Analysis process along with prudent restationing provides us with the opportunity to focus on keeping the best of our facilities to support readiness and eliminating the worst to save costs.

funding based on needs are key components of the way ahead.

Army facilities have been vastly improved in recent years through a variety of initiatives such as Transformation and Base Realignment and Closure (BRAC), with record MILCON and a commitment to keep SRM at 90 percent of requirements. Beginning with Modular Force Transformation in early 2004, the Army began realigning divisional brigades into modular Brigade Combat Teams (BCT) with augmented combat support and combat service support. In an effort to improve the BCT commander's span of control, installations/garrisons have been shifting subordinate companies and battalions to facilities within closer proximity to the BCT headquarters. BRAC 2005 resized and realigned installation infrastructure to more efficiently and effectively support the Army, increase operational readiness and facilitate stationing that improved command and control. In January 2007, the president recommended the Grow the Army (GTA) initiative, increasing the Army by 74,200 Soldiers.

With this increase came simultaneously programmed MILCON. In 2009, the Army was authorized a temporary end strength increase (TESI) of up to 22,000 without additional MILCON. Also in 2009, an announcement by the

Secretary of Defense and the Secretary of the Army capped BCT growth as part of GTA, but maintained the same number of Soldiers, keeping the Army's personnel end strength at 547,000. While there are always areas for improvement, the Army now has the best facilities in our history. The prospect of reducing overall force structure through the Total Army Analysis (TAA) process along with prudent restationing provides us with the opportunity to focus on keeping the best of our facilities to support readiness and eliminating the worst to save costs.

To facilitate the direction provided by senior leaders, Army Installation Stationing 2020 will be a planning effort integrated into existing Army processes. It will be an Army Enterprise approach across the Active and Reserve Components that actively assists the decision-making required to enhance readiness and lower costs. Using the strategic and operational guidance contained in the Army Campaign Plan, the stationing effort will be updated as the future azimuth is adjusted for the operating force, generating force and business operations. Under Campaign Objective 2-0 (Provide Facilities, Programs & Services to Support the Army and Army Families), OACSIM and the commands' operating garrisons will emplace tasks and directives that contribute to readiness and cost

savings. This will ensure the best use of facilities and lowering of costs involved through critical considerations such as excess facilities, leases, proper space allocation and energy use. In coordination with the Army Staff, the Stationing Annex of the ACP will include policy and guidance to support installations in supporting Army directives. Army Installation Stationing 2020 is an integrated effort to align facilities and stationing with readiness and increased cost savings.

A vital component of the enterprise approach is ensuring support for the Army Facility Investment Strategy (FIS). The FIS sets Army Senior Leader priorities and emphasis for MILCON and SRM. Installation leaders must focus MILCON requests on these Army priorities to fix space shortfalls most affecting readiness and potential cost savings. Further, SCs and GCs must develop a plan for SRM that accounts for future MILCON and then focuses on maintaining and improving the quality of existing facilities. While this is an Army-wide enterprise approach, local implementation is critical to success.

By maintaining an appropriate balance between MILCON, SRM (MCA & OMA), leasing oversight, demolition funding, space allocation and standard Army systems supporting facility use, the Army can meet mission require-



ments, enhance readiness and lower potential costs. This requires analysis down to the installation level to be able to accurately inform senior Army leadership for decisions regarding requirements and funding in the POM process.

MILCON

At the local level, it is important to understand the Army Senior Leader priorities and the FIS scoring system. The process for creating MILCON requests is time-consuming and labor-intensive, so developing a MILCON project outside of Army priorities that scores low will result in wasted effort. Instead, using the Army priorities as a guide, build out facility shortfalls by focusing the MILCON requirement on the most critical shortages. Focus on Army standard designs for facilities rather than making the effort for a custom facility. Showing a MILCON project as energy efficient and compliant with Army space utilization standards makes a difference in packet consideration.

Before working a MILCON solution, ensure all the facilities on the post are properly reflected in the real property inventory, as these records are checked before MILCON project approval. Analyze opportunities for investing in O&M R&M work. Always consider an existing facility for repurposing where possible or modernizing existing facilities for adequate solutions.

SRM

At the installation level, have a plan for SRM that reflects the current status of facilities, planned MILCON and Army priorities. After record levels of MILCON over the last few years, the future will almost certainly bring a lower level for the long term, so the planned use of SRM will be important to our success in maintaining the facilities we have. The key at installation level is to have a program for SRM based on the master plan of each post. Properly maintaining our inventory is our most sound invest-

ment to maintain quality and save energy. To save SRM funds for critical needs, installations must aggressively divest excess facilities by demolition or mothballing. Further, by emphasizing efficient space management to Army standards, installations can consolidate activities to move units out of our lowest-rated facilities and eliminate the cost of utilities and major renovation. The planned use of SRM improves the quality of Soldier facilities now rather than waiting for MILCON.

Leasing

One area where installations can assist in reducing costs to the Army is by closely reviewing the requirement for leases. As the need for deployment stocks and mobilization shrinks, the space previously used should be considered to eliminate leases. The Overseas Contingency Operation (OCO) funding previously used for leases in support of deployments will end. Advanced planning to move into existing space on the installation will reduce costs migrating from OCO to base operations.

Demolition

As installations develop an integrated MILCON and SRM plan that moves units into Army approved standard space allocation, a key part of the overall plan is to demolish or mothball excess facilities. With the end of TESI and a potential reduction in force structure, the opportunity to eliminate our lowest-quality facilities by demolition or mothballing is important to cost savings. While additional funding is in the POM for demolition costs, SCs and GCs should look at alternative means of destruction such as burning for fire department training or

...the opportunity to eliminate our lowest-quality facilities by demolition or mothballing is important to cost savings.





Previous TAAs enabled the Army to grow and adjust forces to meet the needs of the nation. Now, the purpose of TAA 14-18 will be to set a new end strength while ensuring the best Army within total obligation authority.

offering moveable buildings such as World War II wood for reuse off-post through excess property channels. Installation leaders should review the use of every facility beyond essential unit needs for the purpose of saving the operating costs to use for more important priorities in support of Army guidance.

Space Allocation

The Army has space allocation rules, and installations should make certain that units take the efforts within available facilities to meet this guidance. The end result should be to consolidate into the best facilities while allowing the lowest quality facilities to be prepared for demolition or mothballing to save costs. A key to space allocation is ensuring all units confirm their Army Stationing Installation Program (ASIP) information is correct to account for changes in force structure with sufficient time for the installation to reallocate adequate space as units activate, inactivate and increase or decrease tables of distribution and allowances (TDAs) and modified tables of equipment (MTOEs) during force structure actions. Space allocation can be further enhanced in conjunction with projects that refurbish and repurpose existing facilities to eliminate excess space and realign to Army standards.

Standard Systems

Multiple Army systems support proper facility use. Emphasis on accurate input at installation level enables better decision making at all levels to meet Army guidance. As the process to ensure the best force in 2020 is long-term, a continuing effort to achieve high levels of accuracy in systems such as the Real Property Planning and Analysis System (RPLANS) and the new Real Property portion of the General Fund Enterprise Business System (GFEBS) will enhance the Army's ability to evaluate the success of stationing efforts and the Facility Investment Strategy.

While installation efforts are important, at levels above the installation are many efforts that will ensure we establish a disciplined approach for the programming and execution of resources for facilities that supports readiness and lowered costs. One key effort will be fully synchronizing this effort with Total Army Analysis (TAA) 14-18 as it determines how to allocate and station force structure adjustments within the long-term end strength for all Army components. Previous TAAs enabled the Army to grow and adjust forces to meet the needs of the nation. Now, the purpose of TAA 14-18 will be to set a new end strength while ensuring the best Army within total obligation authority. Having facilities considered on the front end of the TAA process will

maximize cost savings and enhance readiness at the end. Added to the Facility Investment Strategy, this early common operating picture will further enhance the Army's ability to develop the best 2020 force at the lowest costs.

Another effort ongoing is to confirm the Army stationing process under Army Regulation (AR) 5-10 works to support the TAA effort and actions are aligned to support the ACP. A large part of the issue is the increase in the number of unit relocations, activations, inactivations and realignments since 2005. Many stationing actions involve costs and facilities that are currently managed outside the larger Army Plan and inside the planning timelines for being included in the POM. While the rationale for the AR 5-10 process is sound, it is important for stationing actions to work toward a common goal defined by Army priorities and to have all funding requirements identified and programmed before execution. Clearly, the normally rare immediate operational demands approved through the Stationing Senior Review Group (SSRG) process or other Army Senior Leader forums will be implemented while other stationing actions of lower operational need or less immediacy should be reviewed closely for costs, necessity, and alignment with Army direction.

Among the options available for routine stationing actions may be modeling other Army processes such as force structures management or the FIS. For example, most Army force structure actions are submitted during an annual management of change (MOC) window and evaluated against Army requirements. Having stationing actions



submitted in a similar manner could facilitate evaluation of these actions in prioritized alignment with Army guidance. Like the successful implementation of a 1-N list for MILCON under the FIS, the establishment of a prioritized 1-N stationing list could be integrated and aligned with current POM actions and included in TAA 14-18. Even with this higher-level review of stationing processes, all installations should continue conducting full reviews of stationing packets with a closer and thorough analysis of stationing costs and facility requirements to ensure funds and requested facilities are available on the requested stationing action timeline. By having stationing issues addressed in the staffing process, we collectively ensure Army goals are met in a coordinated manner. Overall, by developing accepted criteria and coordinated priorities that support stationing initiatives, the Army can make sure these actions are programmed for funding and follow Senior Leader priorities.

With the Secretary of the Army addressing the GovEnergy conference and announcing the Army's Energy Initiative Office Task Force, the inclusion of energy programs in MILCON and SRM planning is important in the evaluation of stationing actions. The cost of energy is the second highest cost to Army garrisons after personnel funding. By making energy a major consideration in the cost-benefit analysis of stationing, we align our actions with the mandates from Congress and OSD to meet reduced energy consumption targets. In addition to facility demolition, mothballing and space allocation consolidation, installation leaders must also use the lessons learned from garrisons selected as pilots for the net zero

strategy. Further, the Army is committed to incorporating Energy Efficient Measures (EEMs) into the MILCON program, and starting in FY 2012 all standard design facility types will incorporate EEMs. Full participation from all garrisons will result in reduced energy consumption and lower costs across the Army while assuring we achieve energy mandates and increase energy surety and security.

Army Facility Stationing 2020 is a major step forward in meeting the expectation of the Chief of Staff of the Army to build the best force for 2020 in the right facilities at the lowest overall cost to the Army. The focused effort on stationing will work within existing Army systems throughout the TAA process and ACP to ensure full consideration of facilities. As the Army Facility Investment Strategy continues to be refined and the AR 5-10 process is improved, installations can take action now to align MILCON, SRM, demolition, leasing oversight and systems input to support the effort to consolidate and improve facilities while lowering the costs of facility operation. Building the Army of 2020 is a high-level priority and ensuring that Army facilities are included in the planning process for stationing with the right effort from installations to HQDA in enhancing readiness and lowering costs is critical to our success.



BG Al Aycock is the Director of Operations in the Office of the Assistant Secretary of the Army for Installation Management. His prior assignment was as Deputy Commanding General and Chief of Staff of U.S. Army Installation Management Command. During his prior tenure as IMCOM-Korea Region Commander, three of five garrisons were nominated for Army Community of Excellence (ACOE) awards within two years. He holds a Bachelor of Science from the U.S. Military Academy, a Master of Education from Fayetteville State University and a Master of Strategic Studies from the Army War College.



Expeditionary Installation Management: IMCOM Is Up To The Challenge

by MG Rueben D. Jones, Deputy Commander for Operations, IMCOM

Since its inception, the Installation Management Command has brought its unique skills and processes to bear on standardizing and improving base operations (BASOPS) on Army installations all over the world. Until now, however, no process has existed to engage the installation management professionals in running the bases that provide a home away from home to troops deployed in the operational theater. That precedent is now changing as the Army looks to IMCOM to actively engage in the base operations (BASOPS) at two major expeditionary bases currently operating in the two most significant operational theaters of our time — Camp Leatherneck in Afghanistan and Bagram Airfield in Iraq.

A mobile training team (MTT) of five personnel deployed in September 2011 and will spend three months training mission units at each base in the finer points of running an installation. The MTT includes a specialist in the logistics civil augmentation program (LOGCAP), expeditionary contracting, public works, facilities management and force protection.

Following the MTT's deployment, IMCOM will deploy two "proof-of-principle" garrison leadership and management teams — one to Camp Leatherneck and the other to Bagram Airfield to run the garrison operations there for a full year. These teams of 12 civilian installation management



experts will augment a military O6 command and staff. The principle that needs proving is the one that says an adequate supply of willing and deployable civilian volunteers is available to form a reliable cadre of augmentees. The principle has already been partially proven as the call for volunteers for the current mission netted far more volunteers than needed.

IMCOM civilians have been deploying for years in response to calls for individual volunteers. In fact, IMCOM currently has more than 50 civilians deployed in various roles in the two theaters, and calls for volunteers invariably garner wide interest across the commu-

nity. Yet IMCOM has never institutionalized an expeditionary civilian force structure in the way that the Army Corps of Engineers has long done. For the long term, the Army must develop a deployable civilian force structure trained to conduct this most critical mission. Since the Installation Management Command is the Army's expert in base operations (BASOPS), why not have IMCOM provide its expertise in an expeditionary environment? Following a recent visit to Afghanistan, Iraq and Kuwait to assess installation management in theater, I have concluded this question represents a tremendous opportunity for willing IMCOM civilians and Soldiers to say, "Take me, I will serve!"



Figure 1

A Different Environment, But Still BASOPS

Providing BASOPS support to current contingency operations requires understanding the fundamentally different BASOPS environments in the Combined Joint Operations Area (CJOA), employing an expeditionary professional civilian workforce with BASOPS expertise, taking advantage of existing and emerging force structure and BASOPS leadership to meet the demand and leveraging training resources to close the knowledge gap about BASOPS.

The start point should be, “What problems are we attempting to solve?” If the problem is finding ways to provide standard, effective and efficient base operations services, regardless of the location, then IMCOM is clearly part of the solution. Providing these standard,

effective and efficient services, facilities and infrastructure is the key to operating Army installations anywhere in the world. Providing these services better enables our war fighters to conduct the business of fighting and winning our nation’s wars.

Commanders and Soldiers need the expertise of the Installation Management Command to allow them the ability to focus on their war-fighting mission. The goal is to develop a capability that provides the U.S. Army, in a joint, interagency, intergovernmental, and multinational (JIIM) environment at all levels, adequate sanctuaries that can enable power projection throughout full-spectrum operations. Effectively managed camps and bases form the platform to enable power projection and operational mission success in the most effective, efficient and sustainable manner to administer protection and

minimize the burden of added administration and operational overhead for commanders. Such effective oversight also provides leadership to reduce waste and fraud in these very fragile locations.

What is a Base Camp?

Training and Doctrine Command Pamphlet (TRADOC Pam) 525-7-7 refers to Field Manual (FM) 3-34.400 in defining a base camp as “an evolving military facility that supports the military operations of a deployed unit and provides the necessary support and services for sustained operations. Base camps support the tenants and their equipment. While they are not permanent bases or installations, they develop many of the same functions and facilities the longer they exist. A base camp can contain one or multiple units from JIIM organizations. It has a defined perimeter and established access controls, and takes advantage of natural and manmade features.” Figure 1 shows many of the environments in which our forces are currently operating.

In other words, bases in an expeditionary environment provide sanctuary, a reasonable RESET capability and a power projection platform for units in theater. This sounds much like what any other base does, however very little formal guidance exists in operational doctrine to define how a base should be planned, designed, constructed, managed or deconstructed at the end of U.S. Army engagement in the theater. As contingency bases continue to mature, they often come to resemble permanent bases and installations. The bases tend to grow as long as forces remain. If forces remain for multiple years, or even decades, of conducting stability and training operations,



Supply (DIRECT AND GENERAL SUPPORT OPERATIONS)	Field Services	Soldier Support Services	Other Services & Related Operations
<ul style="list-style-type: none"> • Class I (subsistence) • Class II (clothing and individual equipment) • Class III (bulk and packed petroleum) • Class IV (construction materials) • Class V (ammunition) • Class VI (personal demand items) • Class VII (medical supplies) • Class IX (repair parts) • Miscellaneous 	<ul style="list-style-type: none"> • Food service/preparation • Water/ice production and distribution • Shower • Sanitation • Clothing renovation • Light textile repair • Mortuary affairs • Aerial delivery 	<ul style="list-style-type: none"> • Billeting • Personal and administrative support • Legal services • Financial services • Medical services • Laundry • Clothing renovation • Quality of life • Morale, Welfare, and Recreation 	<ul style="list-style-type: none"> • Engineering design and construction • Fire and emergency response • Facilities operations and maintenance • Airfield operations • Retrograde operations • Signal Operations • Transportation operations • Maintenance and motor pool operations • Standard Army Management Information Systems operations • Convoy support operations

Figure 2: Typical Services and Functions Associated with Base Camps

poorly planned and constructed bases can become poorly functioning, inefficient, and even dangerous without the proper installation management planning and expertise.

Adapting Operations to Environments

Environments in the combined/joint operational area (CJOA) are very different from permanent bases in the CONUS and in peaceful, stable locations abroad. But expeditionary environments can be just as different from each other. The environment in Afghanistan is rugged and the infrastructure is either nonexistent, temporary or, in many cases, just coming out of the ground. The availability of skilled local labor to support BASOPS is scarce in many cases. It is a true expeditionary environment.

Existing roads and facilities in Afghanistan are poorly designed and in need of modernization, repair or replacement. Travel is difficult and often dangerous while supply lines are long, making deliveries of materials unpre-

dictable. In this environment, sustainability becomes paramount to effectively conserve resources to minimize the need for external support. The master planning and design of bases contributes heavily to sustainability, so professionals with knowledge of nearly every skill in the IM inventory are needed to get it right.

Life is extremely difficult outside the wire in these areas, so commanders and their Soldiers rely on installation management professionals to provide and provision a home with relative comfort when they come back to their contingency bases. The operating environment and typical services and functions associated with these bases are maturing and need the professionals to ensure the rapidly improving infrastructure is done right. The typical services needed generally fall in the area of supply, field services, Soldier support services and related services and operations (see Figure 2).

Compared to Afghanistan, the Iraq environment has more definition and

structure to manage. Many of the contingency basing areas amount to small existing cities, and most of these facilities are in need of major repair and maintenance. Operating in Iraq is further complicated by internal politics and the security agreement which limits the number of U.S. professionals allowed to execute the BASOPS functions.

The leadership team to deliver BASOPS services and functions in the Iraq environment will be very small and require a major reach back capability to IMCOM headquarters. In this case, instead of a military and civilian leadership team, civilians will make up the entire BASOPS team.

Base Operations

Currently there are a number of organizations delivering BASOPS support in Afghanistan and Iraq, ranging from an Infantry Brigade Combat Team (IBCT) to Regional Support Groups. Many of these units are not trained or organized to operate a base, and in some cases, they only receive the BASOPS mission shortly before deployments.



Figuring it out often leads to wasted resources and poor execution. A recently released report by the Wartime Contracting Commission estimated that wartime contracting in Iraq and Afghanistan lost at least \$31 billion in waste and fraud and that major reforms are need to conserve tax payer dollars.



In an effort to accomplish their mission, these units often spend a large part of their deployment learning the complexities of delivering BASOPS support. In short, they figure out a way to do it without knowing how to avoid the long-term, potentially expensive pitfalls of setting up and running an installation. Figuring it out often leads to wasted resources and poor execution. A recently released report by the Wartime Contracting Commission estimated that wartime contracting in Iraq and Afghanistan lost at least \$31 billion in waste and fraud and that major reforms are need to conserve tax payer dollars.

Based on our assessment, providing BASOPS in both of these environments requires knowledge of contract oversight, including the LOGCAP and other contract vehicles used to provide basic services. Most of the BASOPS services and functions are performed

by contract employees, which means every member of the team must become a contracting officer's representative (COR) for functions normally performed by government employees. As the environment matures and enduring locations are designated by the combatant commander, properly managing the resources becomes even more important for the BASOPS leadership team. The environment requires leadership and IMCOM expertise to ensure resources are expended efficiently.

The Emerging Long-Term Solution

The Army has revised a previous Regional Support Group force structure to tailor it to conducting the contingency BASOPS mission. The Army Structure Memorandum details the emerging structure designed and targeted to perform in a contingency environment.

The Army has approved 44 RSG units that will come into the force starting

in FY13. As opposed to the previous RSG mission of providing administrative and training support to reserve units, the new RSGs will be dedicated to managing expeditionary bases with IMCOM augmentation. Commanded by an O6 colonel with a traditional Army staff, the RSGs will have a wartime mission of providing command and control of assigned units and civilian personnel needed to operate and manage contingency bases. Of particular note, they will determine contract requirements for base operations and oversight of contracts for BASOPS support. They are equipped to deploy to an operational environment and establish contingency bases for extended periods to include providing required services beyond basic life support.

During contingency operations, RSGs are designed to manage base camp operations for combatant commanders, but they need ongoing and predictable civilian augmentation to be successful. This support includes, but is not limited to, contingency contracting, military police, civil affairs and medical services. This is where the Installation Management Community can prove indispensable to the expeditionary basing mission. RSGs will require IMCOM to provide a small but agile force of trained and experienced installation management professionals that may be organized similar to those assembled for the proof of principle teams deployed to Iraq and Afghanistan (See figure 3).

IMCOM's plan to add its intellectual muscle and expertise in expeditionary environments is centered on three fundamental processes:



IMCOM USFOR-A GARRISON ENABLERS (BAGRAM & LEATHERNECK)

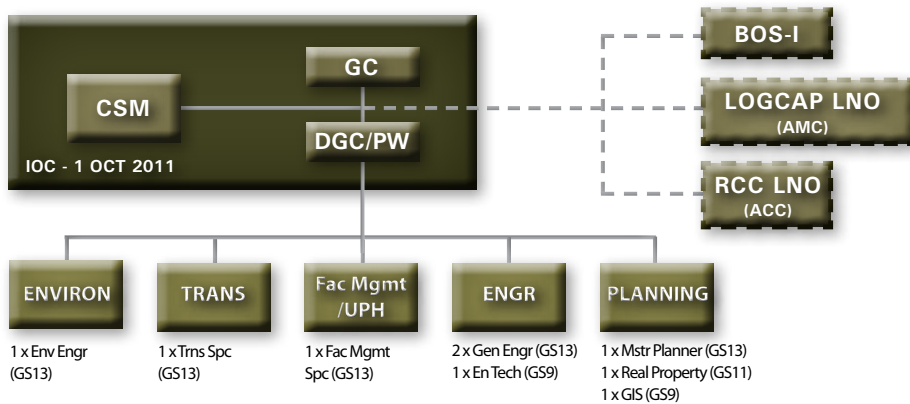

Figure 3

- Packaging teams of experts based on the size and capability required for each particular mission;
- Training team members, either as teams or individually;
- Providing reach-back capability to help solve problems encountered in executing the BASOPS mission.

Training will center on using MTTs to deploy and train units currently conducting BASOPS in theater. These teams will conduct and coordinate training in the tasks most in need. The IMCOM MTT will be augmented by a LOGCAP expert from Army Materiel Command (AMC) and a contingency contracting expert from Army Contracting Command (ACC). Another training resource is the IMCOM Academy, which can develop training tailored to the needs of deploying units and individuals.

Expeditionary Civilians are the Key to Success

The key to expeditionary basing is a cadre of trained, deployable civilian

installation management professionals assembled from the Installation Management Community ranks because this where the installation management expertise resides. Deploying with an untrained pick-up team or deploying with experienced professionals — which would you choose? The answer is clear that trained professionals are the solution to getting at the core of the problem.

The Department of Defense and the Army have established a program called the Civilian Expeditionary Workforce (CEW) to encourage civilians to deploy in support of the uniformed force. The CEW website has messages from recently departed Secretary of Defense Robert Gates and others urging civilians to take the next step in their Army careers by supporting Soldiers and commanders in theater. As stated on the CEW website:

“It is Army’s policy that civilians will be used to support the military in carrying out their missions. Installations/Activities will develop and have in place those plans

required to support military contingency operations and all other levels of mobilization. The objective of the Civilian Expeditionary Workforce program is to ensure that qualified Army civilian employees are available in adequate numbers and skills to meet worldwide mission requirements during periods of national emergency, mobilization, war, military crisis, or other contingency.”

The CEW website is a central resource that provides pay and benefit information, medical requirements for volunteers, vacancy announcements and applications for civilians who wish to volunteer for an expeditionary assignment. All who are interested can go to the CEW website at <http://www.cpmos.osd.mil/expeditionary/cew-home.aspx>.

To quote the CEW website again, the CEW is “a subset of the DoD civilian workforce that is to be organized, trained, cleared and ready in a manner that facilitates the use of their capabilities either in a temporary reassignment and/or duty status or to stay in place overseas to support the DoD mission. Members of the CEW are organized, trained, cleared, equipped, and ready to deploy in support of combat operations by military; contingencies; emergency operations; humanitarian missions; disaster relief; restoration of order, drug interdiction; and stability operations in accordance with DoDD 3000.05. The CEW is composed of the existing category of Emergency-Essential (E-E) positions and new categories of positions, Non-Combat Essential (NCE), Capability-Based Volunteers (CBVs) and former Army employee volunteers.”

Successful contingency installation



“The Civilian Expeditionary Workforce (CEW) serves alongside our military men and women at the forefront of America’s mission around the globe. A mission to protect. A mission to build communities and renew nations. A mission to spread freedom and democracy. A mission to stand up for the disadvantaged and for the oppressed. Our uniformed forces deploy around the globe in service of this mission, but we will not ask them to do it alone. Stand up and join them because when we go, we go together.”



Robert M. Gates,
Former Secretary of Defense



Follow this link to the Civilian Expeditionary Workforce website.

management requires an experienced team of BASOPS professionals. IMCOM has the leadership and professionals to meet this critical mission. The time has come for IMCOM to train, man and equip BASOPS professionals to bring their expertise to the operational environment, where it has been sorely needed.

Commanders need the capability IMCOM provides to allow them to focus on their war time mission without diverting their mission-focused man-

power and resources to figure out how to conduct the BASOPS functions. Soldiers on expeditionary missions deserve a fully functioning place to call home when they return from missions. I think the IM Community is ready to take the Army’s Home to where it has perhaps been lacking the most — to our expeditionary bases.



MG Reuben D. Jones is the Deputy Commanding General, Operations for IMCOM. His previous assignment was as commander of the Family and Morale, Welfare and Recreation Command (FMWRC), now incorporated into IMCOM as the staff G9. MG Jones has also been Adjutant General of the Army; Commanding General, U.S. Army Physical Disability Agency; and Executive director, Military Postal Service Agency.

References:

1. IMCOM ASSESSMENT TEAM, Theater Outbrief, 25 July 2011.
 - a. MG Reuben Jones, Deputy Commander, Operations, IMCOM
 - b. COL David Shutt, OACSIM, Operations Directorate
 - c. LTC Michael Daniels, Garrison Commander, Yakima Training Center
 - d. Greg Chislett, Chief, Public Works Division,

IMCOM G4

e. SGM Tracey Anbiya, SGM, OACSIM

f. CPT Amber Ziegler, IMCOM

2. DAMO FMF, Army Structure Memorandum 13-7.

3. Under secretary of defense Memorandum, Increased Annual Pay Limitations, April 11, 2011

4. Under secretary of defense Memorandum, Building Increased Civilian Deployment Capacity, Feb, 12, 2008

5. CEW Website, SECDEF Gates quote

6. Tradoc Pam 525-7-7, Concept Capability Plan for Army Base Camps in Full Spectrum Operation for the Future Modular Force

7. Commission on Wartime Contracting, Final Report, on Wartime Contracting in Iraq and Afghanistan



IMCOM Talent Management - Preparing for the New Fiscal Reality

by Joe C. Capps, Executive Director, IMCOM

*“Now, when your weapons are dulled, your ardor damped, your strength exhausted **and your treasure spent**, other chieftains will spring up to take advantage of your extremity. Then no man, however wise, will be able to avert the consequences that must ensue.”*

*- Sun Tzu,
On the Art of War*

In the coming decade, the Army will face the most significant challenge to its strategic operations since the end of the Cold War. Having played a crucial role in the defeat of global communism during the long Cold War, and having made the largest contribution to the global war to defeat terrorism, the

Army must now transform its business operations to lead our nation’s engagement in the coming global economic confrontation.

Increasingly, a nation’s ability to influence events in a global marketplace will be determined by its economic position relative to its peers; sovereign debt has become one of the leading metrics in establishing that relative economic position. In an over simplification of macroeconomics, the amount of sovereign debt held by our nation is directly proportional to the size of the combined annual budgets of all federal agencies. In other words, bigger budgets equal more debt and smaller budgets equal less debt. For the United States to reduce its sovereign debt, the Army, as well as other federal agencies, must spend less.

Nonetheless, while spending less we must still accomplish our core mission — to defend the nation. We must therefore transform the Army’s strategic business operations to ensure we accomplish our respective missions with the least possible expenditure of resources. More importantly, we must do so in amounts measured in tens of billions of dollars. The key factor — the “game

changer” — in transforming the way the Army conducts its business is the people who serve the Army, both military and civilian.

The people who will transform the Army’s strategic operations will require several essential skills. First, they will need leadership skills of a specific nature. They must be “detail-oriented” in order to understand the nuances of their mission and the relationship between mission and resources. They must be willing to make difficult decisions in a timely manner, choosing which programs and projects to cancel or reduce based solely and accurately on their value in achieving mission success. They must be the type of leader who can place a greater emphasis on mission accomplishment than on “burn rate,” and be willing to live with the results. Perhaps most importantly, they must be able to influence subordinates and peers as well as their leaders in order to exponentially expand the effect of their efforts across the Army’s strategic operations.

Second, these leaders must be skilled in financial management. They will need to personally acquire the analytical tools of financial management — translating income statement and balance sheet line items into meaningful relational numbers to identify the root cause of expense growth. As leaders, they, not their resource managers, must take ownership of the de-





The Army must seek out people who have reduced expenditures in an environment where success is measured in financial terms as well as in achieving organizational goals.

tails of their organization's finances, developing a fundamental understanding of revenue and expense, asset and liability, and the relationship between those facets and essential missions.

Third, the people who will transform the Army must be experienced in business operations. They must apply skills that our colleagues in the business world apply to turning a profit in a climate of decreasing sales. They must be able to make value judgments regarding the service they deliver, and relate that value to the cost of delivering the service. They must understand the difference between cost avoidance and cost savings, choosing the latter over the former to generate savings in absolute terms.

To find and attract people with the right mix of leadership, financial management skills and business operations

experience will be challenging. Some will come from within the organization. There are talented business-minded leaders who are addressing the financial challenges that the Army faces in pockets of excellence across the Army. This untapped human capital resource must be identified and focused on the problem.

For the Army to overcome the inertia of past financial practices that produced some of the growth in debt, it must also look to external sources to obtain some of its transformational human capital. The Army must seek out people who have reduced expenditures in an environment where success is measured in financial terms as well as in achieving organizational goals. We need people experienced in business operations who have been judged relative to the bottom line.

Leaders across the Army must play an active role in managing the talent that will transform the Army's business operations. To this end, LTG Rick Lynch established the Talent Management Center (TMC) as the commander's mechanism to place people with the right skills in the right place at the right time within the Installation Management Community (IMC). The TMC is poised to lead the way in seeking out and acquiring the human capital that will reshape our approach to business operations. To do so, the TMC focuses on three key areas: (1) Positions, (2) People, and (3) Policies and Procedures. The "Positions" element includes approximately 800 key leadership positions across the IMC. At the garrison level, director positions such as the Deputy to the Garrison Commander, the Director of Public Works and the Director of Plans, Training, Mobilization and Security will be managed as key leadership positions. At the regional and headquarters level, Chief of Staff and Division and Chief positions will be similarly managed. The "People" element focuses on the "who" of talent management — matching individual skills and development potential with leadership positions in a managed career progression. In terms of professional development, the TMC serves as the proponent for those who apply for the Senior Service Colleges, Defense Senior Leader Development Program, Harvard Senior Executive Fellows and the Federal Executive Institute. Finally, the "Policies and Procedures" element of the TMC establishes and defines rules, responsibilities and requirements that will chart the way ahead for talent management within the IMC.



*In terms of innovative problem-solving in the face of unsure times, the Army is one of the **most proven successful organizations in the world.***

Ultimately, the degree to which we succeed in managing talent will depend on the level of participation by the entire IMC team. In order to build talent portfolios for managed positions, individuals must demonstrate their willingness to compete by providing relevant documents for consideration, such as their updated biographies, civilian record briefs and individual development plans. Leaders at all levels must also actively scout out the talent we need to transform our business operations. They must identify and develop people within their sphere of influence who possess the essential skills and experience to transform our business operations; people who have already demonstrated their ability to manage change through innovation.

The United States Army has faced many challenges in the forefront of our nation's growth in the years since 1776. In terms of innovative problem-solving in the face of unsure times, the Army is one of the most proven successful organizations in the world. Continuing that legacy of leadership, we must leverage the human capital that exists within the Army while adding experienced business leaders to our ranks. We must employ and enable leaders with financial management skills and business savvy, and focus their efforts on the task of reducing the national debt. Our Army can lead the

way for our nation in the coming global economic confrontation. To do so, it must reshape its approach to acquiring and utilizing its most precious resource the people that make the Army great.

The Talent Management Center is currently developing the policies and procedures for talent management placement within the Installation Management Community and will publish the policy once signed.



Mr. Joe C. Capps was selected for the Senior Executive Service in May 2003 and he assumed his current position in July 2011. He serves as the Executive Director of the U.S. Army Installation Management Command, where he directs the multi-disciplinary management of facilities, programs, services and infrastructure for Army installations worldwide, overseeing a \$13 billion annual budget, 85,000 employees, 15.7 million acres and 934 million square feet of facilities. His previous assignment was as Deputy to the Commanding General, Signal Center of Excellence, Fort Gordon, GA. He has held several key positions in electronics engineering and information technology with the Army.



Garrison Life and Leadership: Are we Ready for it?

by CSM Neil Ciotola, IMCOM Command Sergeant Major

We (the Army) have realized huge successes in the Iraq and Afghanistan theaters of operations. We have done this on the selflessness, sacrifice, tenacity and capacity of our uniformed Soldiers, our Families and our great Civilian workforce. We have welcomed far more Soldiers home this year, with ever-increasing dwell time, than at any other point over the last seven to eight years. Now these young officers, non-

commissioned officers and Soldiers, after having invested themselves in sustained combat operations over the course of one, two, four, five or even more combat deployments, express disaffection and frustration at the prospect of returning to garrison life. Many contemplate leaving the military rather than face what they perceive to be a less rewarding, exciting and challenging future. The situation

is exacerbated by some senior officer and enlisted leaders who profess that we should not and must not “go back to doing business the way we used to.”

So we have two apparently separate and unrelated perspectives expressed by senior and junior Army leaders that actually have everything to do with one another. If we fail to acknowledge the capacity resident in our deployed formations and the Soldiers within their ranks, we raise questions about the training and development processes that have brought much of the success we have experienced during this period of sustained hostilities. On the other hand, if we fail to adequately



We have welcomed far more Soldiers home this year, with ever-increasing dwell time, than at any other point over the last seven to eight years.



...we have accrued a vast amount of insight and experience in treating and caring for our emotionally and physically wounded and the Families of our fallen. ...I contend we can clearly see that which has served us well in the past, that which we ought to retain...

articulate the unlimited reward to be gained by investing oneself in the development of our next generation, we fail to manifest in the minds of present and future leadership the true reward of service in our Army.

A great many profound and positive changes have taken place in the Army over the last ten years: we are a smarter Army; we are a better equipped Army; we are a far more responsive and agile force; we have quantified and qualified the programs and services necessary to care for ourselves and our Families (at home and while deployed); and finally, and most importantly, we have accrued a vast amount of insight and experience in treating and caring for our emotionally and physically wounded and the Families of our fallen. If we have the courage and conviction to separate fact from fiction, I contend we can clearly see that which has served us well in the past, that which we ought to retain, and that which has increased the capacity and resilience of the force (Soldiers, Families and Civilians) and ought to be embraced now and in the future.

We have in our ranks three generations of Soldiers who have only known this reality: train, deploy, fight, redeploy, reintegrate, rebuild, train, revalidate, deploy, fight, etc. Those three generations have endured considerable stress and hardship, while simultaneously participating in a seemingly unlim-

ited, ongoing national investment in Defense and Homeland Security in the name of fighting terrorism. That investment amounted to more than \$1 trillion over the last four years in the Army alone.

Over the same period of time, we have raised three generations of young troopers who have seen the manifestation or enhancement of Family support services included in the Army Family Covenant¹; experienced an unprecedented level of local community support as embodied in the Army Community Covenant; and seen expansion and enhancement of quality-of-life initiatives including Survivor Outreach Services (SOS), Residential Communities Initiative (RCI) and the First Sergeants' Barracks Program (FSBP) to name but a few.

And finally, we have three generations of troopers who have seen the ranks of our civilian and contracted workforce swell in order to disencumber our expeditionary forces of various garrison duties so they can better prepare for and then deploy into our combat theaters.

We, as a nation, now find ourselves confronted with a national debt in excess of \$14 trillion, much of which is attributable to our protracted commitment to the Global War on Terror. We cannot continue to do business as usual, literally and figuratively speak-

ing. As the Civilian workforce begins to shrink under congressionally mandated spending reductions, we are now in the process of assessing and reintroducing Soldiers into many facets of our garrison operations. History shows us that after every great conflict in which we committed large portions of our Army, we have ultimately withdrawn back into/onto our garrisons and allowed the nation to redirect its wealth to other critical programs and efforts or pay back the debt it has accrued as a result of sustained combat. That time on our installations is used to absorb lessons learned from the previous conflict and retrain ourselves for the next time the nation calls. As we have done throughout our history, we once again will do in the future.

Where we had large numbers of Department of the Army and/or contracted security guards controlling installation access, we will now see greater numbers of Soldiers once again manning our gates. That this concerns some makes me, for one, scratch my head. We as Soldiers guard and secure ourselves, our installations (at home and abroad), our bases, our outposts, patrol bases, our forward lines of troops (FLOT), our flanks, etc. Guarding/securing is not a waste of time; it is a fundamental duty that we as guardians of the republic have done and will continue to do. Seeing Soldiers at our gates ought to remind everyone



of our charge as selfless servants who stand at the frontiers.

Where we've seen large numbers of Civilians working in our dining facilities and military personnel offices; patrolling the streets of our installations with Department of Defense Police; cutting grass and cleaning the areas where we live, work, and train; processing and training our newest recruits; managing our barracks spaces; operating our ranges and training facilities; we'll see ever-increasing numbers of Soldiers performing those duties. These demands are not new to our Army and they are not an attempt to deliberately, callously or cold-heartedly place a devoted Civilian employee on the unemployment rolls of a state or municipality. They are a fiscal imperative and something our Army has done repeatedly over the course of its 236-year history.

That we find ourselves confronted with

a fundamentally different fiscal reality does not mean we will casually terminate the litany of programs that have sustained our Soldiers and Families over our history or this era of persistent conflict. What it does mean is our senior leaders will have to make some tough decisions on what programs and activities need to continue intact, which we can combine with other programs and which we will scale back or terminate with acceptable risk.

In this new, more garrison-centric reality, we are reviving some important training opportunities that languished out of necessity during the years of intense deployments. The potential will once again exist for a noncommissioned officer in the generating or deployable force to consolidate a detail of Soldiers in the wee hours of the morning, move to a range and establish it in preparation for a day of training. This activity is training in its own right, and

it satisfies two requirements. First, it reduces cost, and second, it imbues the noncommissioned officer and troopers with the knowledge necessary to establish these training venues in deployed theaters. That we'll once again have noncommissioned officers training individual augmentees or units destined for deployment is not just a product of fiscal limitation, it's what we sergeants do. We train Soldiers, and the only way to get good and remain good at it is to do it, do it right and do it repeatedly.

To those who are either considering or have decided to separate when confronted with extended periods in garrison, I say if you're determined to depart the Army regardless of my perspective or the collective wisdom of even greater leaders in our military, I thank you for your service, your sacrifice and your selflessness, and wish you god speed in all your future endeavors. If you're sitting on the proverbial fence as it relates to future service in a fundamentally different operating environment (garrison), I say these two things: Nothing worth doing is easy or glamorous; and, from those to whom much is given, much is expected and much is required. You may have seen the relevance, as I did, in all you were engaged in in our theaters of operation. You may have been determined to deploy in an effort to care for the men and women under your charge. You may have been committed to the fight for no greater reason than the fact that you gave your word.

Whatever may have added substance or satisfaction to your service to this Army, there is yet tremendous satisfaction to be found in shaping the hearts and minds of our youth — the next

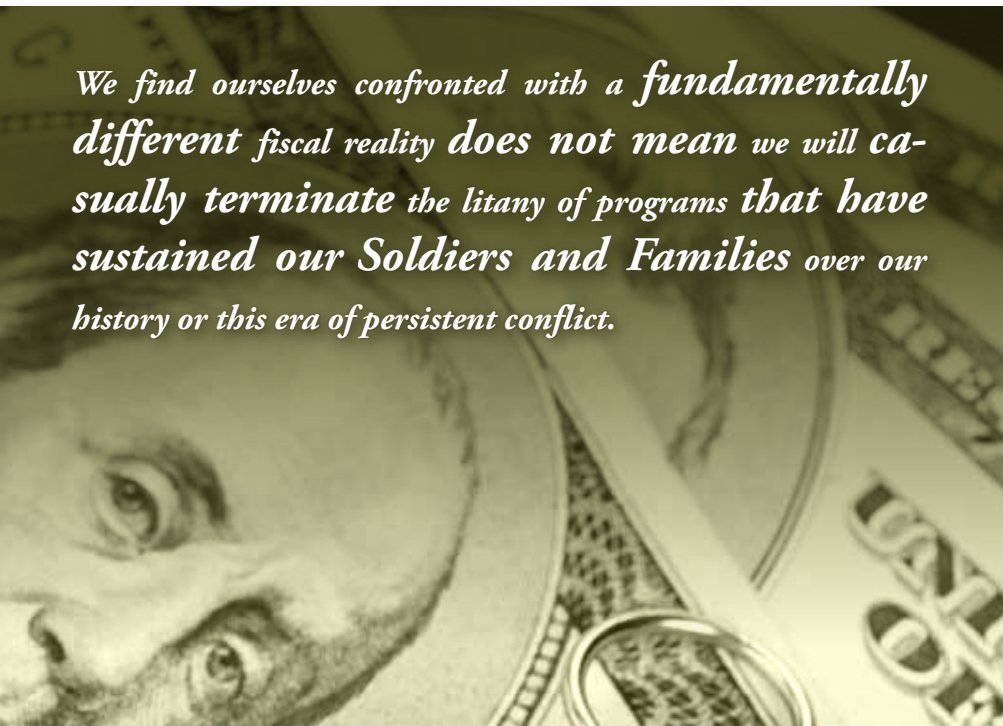

We find ourselves confronted with a fundamentally different fiscal reality does not mean we will casually terminate the litany of programs that have sustained our Soldiers and Families over our history or this era of persistent conflict.



generation of young troopers. If you thought it was fulfilling saving and/or securing the lives and or livelihood of an Iraqi or Afghan civilian, wait until you see the enlightenment that can manifest itself in your youth when you invest in them the same time, determination and effort you did in a combatant theater. If you are, or aspire to be, a commander or noncommissioned officer in this institution, the true reward of service in our Army is bringing out in our youth the potential which is resident in just about all of them. Don't get me wrong — this can and will be challenging, frustrating and debilitating at times. But again, there is no greater reward. If you wanted to be a leader in this Army, you said, in effect, you wanted to be responsible for human life. If you thought otherwise you thought wrong.

We are confronted with a convergence of two realities. we find our mission(s) in two operational theaters either winding down, being scaled back or being handed off to the indigenous population, and we are confronted with a huge national debt that requires business as some have known it to change dramatically. While there are challenges associated with both realities there are opportunities as well.

There are things we've done throughout the Army's history that have stood us well in the past, prepared us for future conflict and will continue to do so in the more distant future. In-ranks inspections, in-quarters inspections, police call, etc., have instilled in us not only a sense of accountability, ownership, attention to detail and situational awareness but also an understanding of why pre-combat checks and in-

spections, while mundane, are critical to our success in combat. There are those things we've had to do to forecast training requirements, resource those requirements, and facilitate that training that have made us noncommissioned officers the envy of many nations' armies around the world. Yes, while the operations in a garrison environment can tax one's patience and yes, there will be more folks competing for the same resources, there are ample opportunities to tax, test and build on the capacity of our youth, and they are infinitely more gratifying than anything you might have previously done.

And finally, while we are confronted with huge challenges, fiscally and contextually, this does not mean "End of Mission." The mission does not end in the United States Army; we support and defend the Constitution of the United States and that mission is enduring. The command is "Change of Mission." The challenge is a fundamentally different fiscal reality — a reality that many in our Army do not have much familiarity with because of wartime spending and force generation. But our youth, many of whom volunteered for service well after our sustained period of conflict began, have the strength and fortitude to live — and thrive — in this new reality, just as they have been fighting in two concurrent conflicts for nearly a decade. If you share this perspective and commit to invest in our youth so that they may learn, develop and grow in this new reality, then thank you for your continued service. This is serious business and the American people deserve a serious, determined effort — one that will require unequivocal commitment from every Soldier and every Army Civilian.

The command has been given — and it is "Change of Mission."



CSM Neil Ciotola is the Command Sergeant Major of Installation Management Command. He has attended various military schools, including the Command Sergeants Major Designee Course; U.S. Army Sergeants Major Academy; Airborne School; Air Assault School; the M1/M1A1 Master Gunner Course; and the M60A3 Master Gunner Course. He previously served as Command Sergeant Major of III Corps and Fort Hood, Texas

References

¹It needs to be emphasized that the Army Family Covenant is all about "The Army Family". It was conceived and designed to address the needs of single Soldiers, single parents, married Army couples and the nuclear and extended Family.



Institutionalizing Fiscal Reductions and a Cost Culture

by **BG Thomas A. Horlander**, G8, IMCOM &

Diane Randon, Resources Director, OACSIM

“We are asking ourselves: What are the essential missions our military must do to protect America and our way of life? What are the risks of the strategic choices we make? And what are the financial costs? Achieving savings based on sound national security policy will serve our nation’s interests, and will also prove more enforceable and sustainable over the long-term.”



Secretary of Defense
Leon Panetta

A critical component of national security is economic security. A key concern in this area must be the unsustainable federal deficit, especially as the country continues to struggle to emerge from the current protracted recession and the reduced federal revenues that accompany it. As we’ve seen over the last few months the political leadership of the country is beginning the hard work of dealing with the deficit.

With the stark realization that the Defense community’s ability to change is tantamount to our fiscal survival, today’s Defense leaders must find ways to not only reduce funding requirements and realize greater efficiencies, but to institutionalize the necessary changes to ensure the country can sustain itself

given a fundamentally different fiscal reality. More simply stated, change equates to survival.

The Department of Defense and the armed services have embarked on a campaign to do this very thing. The Army’s Installation Management Community has been a leader in this effort, institutionalizing key management programs and processes with the focus on ensuring optimal use of the organization’s resources commensurate with its intended outcomes and outputs. These efforts include, but are not limited to, the establishment of a corporate contract management program, the conduct of requirements and resourcing validation boards chaired personally by the IMCOM commanding general (in his role as Assistant Chief of Staff for Installation Management, or ACSIM), and a robust attendance of the Army’s Cost Management Certification Course, to name a few.

The key to any successful change operation is leadership, and institutionalizing fiscal sustainment and a cost culture throughout the Installation Management Community is no exception. Leaders at every echelon, from the highest tiers of the organization down to the laborer and lower-level manager on the ground, must fully embrace this new fiscal reality and seek to effect change in their spheres of influence. This requires courage and

discipline and a willingness to forego many “wants,” not “needs” that we have grown accustomed to. To change a “consumption” culture that has existed throughout the Cold War and most recently magnified during the past decade of fiscal largesse, leaders must become creative and seek innovative solutions to long standing practices. This is perhaps more easily viewed through five lenses of change that, when synergized, can help inculcate the cost culture that the Department of Defense is seeking.



1. Process & Procedures

I rely on the Clausewitzian “Ends, Ways and Means” triad to make the point that the “End” (objective) — to provide security for our nation — will not change. The “Means” (resources) are being significantly reduced over the next 10 years. So the “Ways” (methods) must change and change rapidly to ensure an equitable balance between the constant ends and rapidly changing means. Leaders can no longer afford to rely on the corporate processes and vintage systems that served them well during the more predictable times of the second half of the 20th century. This holds true at all leadership and



management levels; we must embrace new behavior and this can only come through changing the culture we are all a part of. One way to ensure that happens is to make cost management practices integral to our business processes, like requiring a cost-benefit analysis (CBA) for funding requirements above a certain threshold. Tying a CBA to an approved funding stream will ensure this practice becomes integral to our culture.

2. Organize For Success

At least in the U.S. Army, over the last century, we stayed true to the belief that one can only effectively manage three to five subordinate elements or the span of control was too large and uncontrollable. This led to the development of intermediate and sometimes redundant levels of leadership or management in an organization, often with little additive value to the operation. It also led to the belief that building more structure was often necessary to address problems that on the surface seemed so massive and out of control that another headquarters and staff was required. Over time, this brought us to become a top-heavy organization burdened with unaffordable and often dysfunctional overhead structures that breed inefficiency. Leaders today must seek to flatten their organizations and organize as efficiently as possible, leveraging other tools that allow them to be equally effective without an intermediate layer of structure.

3. Train The Right Skill Sets At Each Level

To inculcate a cost culture requires skilled leaders and practitioners at every level of the organization. These skills are not resident in our workforce



Over time, this brought us to become a top-heavy organization burdened with unaffordable and often dysfunctional overhead structures that breed inefficiency.

today and a deliberate effort to develop them is vital to changing our culture. This requires investment, and as the

“means” become smaller and smaller, leaders cannot allow this to impact the future of an Army that must learn to



To complicate matters, most leaders are not equipped with the technical knowledge to make the best decisions about which system(s) their organization should use, so they depend upon subject matter experts and consultants to arrive at a best solution.

fiscally sustain itself and optimize its resources. We must ensure we establish a deliberate professional development program that enables us to have the right skills in the right positions at the right time to empower leaders to make better cost-informed decisions.

4. Leverage Technology

Today's world is abundant with technology, to the point where it is difficult to discern what is really the best automation, information management and communication system(s) for any one organization. It is easy to be overwhelmed with options, resulting in confusion. To complicate matters, most leaders are not equipped with the technical knowledge to make the best decisions about which system(s) their organization should use, so they depend upon subject matter experts and consultants to arrive at a best solution. This is an area where rushing to a decision can be problematic and it is best to move slowly and deliberately in deciding upon which is the best system that an organization should be using for the next 10 to 20 years of its existence.

5. Auditing & Reporting

"What doesn't get inspected gets neglected!" Leaders know where to focus their energy and how to identify those critical pieces of information that require their personal attention. These Commanders' Critical Information

Requirements (CCIR) need to be tailored to ensure that they complement our goals of establishing a cost culture across our Army. Furthermore, to generate the reports required by the U.S. Government, DoD will require organizations to establish a reporting battle rhythm that a leader will want to track and guide. The sooner a leader makes these checkpoints a part of his CCIRs, the sooner he will be able to guide his organization to being a more efficient and cost conscious entity.

Even with the recognition that change is not optional and with the view of the five lenses, living in a new fiscal reality will be challenging. Expanding and adding programs is easy. Contracting and constraining programs is very hard. We're seeing this play out in the national dialogue and we have each wrestled with it within our installations and, for that matter, at home. Nonetheless the Department of Defense must do its part in promoting economic security by reducing costs.

Beginning in May 2010, then-Defense Secretary Robert Gates began a hard, unsparring look at how DOD is structured, staffed and organized. The review resulted in a four-track approach to moving the defense enterprise to become more efficient, effective and cost conscious in its business. The mandated reductions of bloated over-

head and wasteful and duplicative spending, along with other cost-cutting measures, were labeled "efficiency initiatives".

According to Merriam-Webster dictionary, efficiency means to be productive of desired effects; especially, productive without waste. The difficulty in reducing programs — "creating efficiencies" — is magnified by the need for nearly immediate results versus the time required to institute change. This was apparent in the need to make adjustments to the FY12 President's Budget and, subsequently, to the FY13 to FY17 funding program in the absence of the time necessary to develop plans to implement the reductions.

Now we must address the fiscal realities, and we all must do our part. At the Headquarters Department of Army (HQDA) level we must make programmatic adjustments that will ensure some consistency across the department and we must communicate the nature of these adjustments to all customers in order that they not be surprised based on their previous expectations. An HQDA review that drives programmatic changes (top-down approach) must also equip commands with the right policies, guidance and direction to implement change. At the HQ IMCOM level, we must scrutinize expenses to ensure effective reductions consistent across the command. At the installation level, where the real service delivery occurs, we must find innovative ways of delivering services. It is not expected that we continue to do more with less, but that we do the same with less or even do less while carefully managing customer expectations. A grassroots effort demands that service providers not only find



year-of-execution efficiencies but also create repeatable ways to produce the same savings every year thereafter.

Generally speaking, no matter the organizational level, there are really only three ways to adjust service cost down: do less, do it at a lower-quality level or lower its unit price. We can cut less grass, we can let it grow longer or we can find a way to cut it for less. Obviously, the last is the preferred alternative. It requires redesigning the business process. Lowering administrative costs is one way. Finding alternative providers is another way. Changing the workforce mix is yet another way. This requires truly out-of-the-box thinking, which is an outstandingly creative opportunity.

Sometimes, however, in the face of significant impediments, it may not be possible to redesign the business process and we must confront the reality of doing less or doing it at a lower quality. This requires collaborative decision-making with our leaders and extraordinary expectation management for our customers.

It sounds like a lot of work, and it is, but that's what the taxpayers expect of us. And we owe them no less.

The unfortunate reality is that the funding to perform installation services has already been reduced in advance of figuring out how to lower the cost. And some of that reduction will occur starting Oct. 1, 2011.

Time may ultimately be our most valuable asset. Even as this article is going to print, uncertainty remains high. The Budget Control Act of 2011 was signed into law on August

2, 2011, and it contains several provisions to reduce our nation's debt. The Department of Defense is assessing impacts to the FY12 President's Budget and the Future Years Defense Program (FYDP). By all accounts, we may be experiencing the tip of the iceberg relating to spending cuts. Let's make an effective use of time and commit to not wasting another minute. We must all work to realize our new fiscal reality through a deliberate and informed approach.



BG Thomas Horlander is G-8, Installation Management Command. He has served in numerous financial management and operational assignments at all levels and holds Masters Degrees in Business Administration, International Studies, and National Strategy and Security. He is a linguist, Army Master Strategist and CDFM



Ms. Randon has served as the Director, Resources, Office of the Assistant Chief of Staff for Installation Management since April 2009. Her previous senior management experience includes Executive Director of the Resources and Program Agency in the Office of the Administrative Assistant to the Secretary of the Army and Comptroller in the Department of Defense Inspector General's office. A graduate of the Army Comptrollership Program at Syracuse University, N.Y., she holds a Master's Degree in Business Administration.



IMCOM Garrisons Adjust For Future Missions While Preserving Historic Legacies

by COL Scott D. Kimmell, Commander, U.S. Army Environmental Command & Deborah Reynolds, Acting Director, Installation Services, OACSIM

Change is a constant for our Army, and in the last five years we have seen a more extraordinary degree of transition than at any time since the end of World War II. We have supported wars on two different fronts while fighting major regional conflicts. At the same time we implemented the Grow the Army initiative and undertook rebalancing the force, an Army-wide transformation to change its entire structure from larger Cold War configurations to more agile units capable of fighting virtually anywhere. And don't forget Base Realignment and Closure (BRAC) 2005.

The record-setting BRAC 2005 was successfully completed this fall. Its \$18 billion- investment was more than all four previous BRAC rounds combined. It brought more than 327 military construction projects to 43 states, fostering economic growth and jobs. However, its far-reaching changes impacted a force already stretched taut. This myriad of change also required more support for Family members to help them deal with the dramatically increased tempo of deployments and operations.

With the current economic uncertainty and the Army facing this new fiscal reality, BRAC 2005 also drastically reduced Department of Defense (DoD) costs and has returned, or is in the process of returning more than 200,000

acres of land to local communities.

Still, with all the changes on and within the Army landscape there are places on the Army's worldwide installations where the Army's mission is ensuring things remain the same. Lands containing historic buildings, archeological sites and Native American sacred sites will be preserved and protected for future generations, even in the midst of a modernizing Army and world.

"There are challenges associated with BRAC and present day budget realities, but the Army has an important responsibility to its historically sig-

nificant properties, buildings and archaeological sites," said Kristin Leahy, architectural historian with the U.S. Army Environmental Command (USAEC). "It's a huge mission, but here at USAEC, we try our best to assist our installations in meeting those challenges head on."

The Army is a responsible steward to tens of thousands of these priceless sites and USAEC assists and guides installation cultural resource managers (CRMs) to ensure the sites are managed in accordance with Army Regulation 200-1, Chapter 6, Cultural Resources. CRMs balance the protec-

Policy guidance states that these are the four tenets of a successful CR program:

- a. Integrated Cultural Resources Management Plan (ICRMP), developed in consultation with SHPO and tribal governments, as appropriate, and coordinated with Senior Mission Commanders and Directorate of Plans, Training, Mobilization, and Security (DPTMS) or Range Control staff (or equivalent), to preclude conflicts between range operations and military training, natural and cultural resources management, environmental management, facilities management, and master planning activities, as appropriate;
- b. Programmatic Agreement(s) or Army Alternate Procedures, developed in consultation with the State Historic Preservation Office and Advisory Council on Historic Preservation (SHPO/ACHP), and internal stakeholders to streamline the NHPA compliance process;
- c. Memorandums of Understanding outlining consultation protocols with each Federally-recognized tribe or NHO(s) with cultural or historic affiliations to the installation; and
- d. Native American Graves Protection and Repatriation Act (NAGPRA) Comprehensive Agreement stipulating a written process to follow in the event of an unanticipated discovery under NAGPRA.



tion of these historic treasures with the primary mission of training Soldiers. They develop, manage, and implement, by law, compliance procedures to protect against encumbrances to training and readiness missions while managing their installations' cultural resources. In order to facilitate the mission and keep projects on schedule, it is imperative that garrison commanders include CRMs early in the planning process for military construction (MILCON), renovation, range control and all other undertakings.

USAEC supports installation CRMs as they protect historical legacies and meet compliance needs. The command's cultural resource experts help by developing programmatic compliance solutions and technical documents, as well as by providing advice and technical support.

While all Army installations recognize the seriousness of cultural resource management, three large installations — forts Bliss, Benning, and Eustis — are excellent examples and information resources on technical, regulatory and policy issues.

Fort Bliss

As a result of BRAC 2005, Fort Bliss gained multiple missions requiring concentrated coordination of expanding training needs and cultural resources management efforts. The 160-year-old Army post will experience a massive 300 percent population increase by 2012. The additional personnel moving onto Fort Bliss correspond directly to re-stationing several brigade combat teams, the 1st Armored Division headquarters, and numerous support units.



Fort Bliss currently manages more than 19,000 archaeological sites and more than 550 historic buildings, structures, and landscapes on more than 1.12 million acres of training land.

The Army has invested \$5 billion in construction to accommodate incoming personnel and their Families.

In spite of the turmoil, Fort Bliss was recognized as the winner of the fiscal year 2010 Secretary of the Army Environmental Award for installation cultural resource management.

Fort Bliss currently manages more than 19,000 archaeological sites and more than 550 historic buildings, structures, and landscapes on more than 1.12 million acres of training land. The installation annually trains thousands of active and reserve military personnel from all branches of the armed services while protecting their precious cultural resources through proactive and early planning.

“The Fort Bliss Integrated Cultural Resources Management Plan (ICRMP) was designed to identify and manage the installation's significant

cultural resources, while reducing any obstacles to the training mission and the accommodation to incoming units and their Families,” said Brian Knight, acting conservation branch chief for Fort Bliss. “We have one of the largest, most extensive cultural resources programs in the entire Army and accomplished our goals through an innovative programmatic agreement (PA). In 2006, the PA was signed by the Fort Bliss garrison command, the New Mexico and Texas State Historic Preservation Officers and the Advisory Council on Historic Preservation for the Management of Historic Properties on Fort Bliss.”

The PA was amended in 2009 and since its implementation has resulted in a streamlined management of historic properties affected by growth and training undertakings. It also saved approximately 75,000 review days per year and is used as a model by



...Fort Benning is responsible for 52% of the Army's initial entry training. The BRAC-mandated consolidation with Fort Knox's Armor School brings new missions and training challenges to the installation where training infantrymen has been the primary mission since 1918.

other Army installations, as well as some Air Force bases.

"One of the most important things we can do at Fort Bliss is to allow our Soldiers to train as they fight," said Command Sgt. Maj. William A. Green IV, Fort Bliss garrison command sergeant major. "This allows Soldiers real boots-on-the-ground capabilities and realistic training."

Through the PA and advance planning, Fort Bliss' CRMs are making sure the changes of BRAC 2005 and the mission to preserve the installation's historic sites do not alter the training experience of its Soldiers.

Fort Benning

Fort Benning is another installation significantly affected by BRAC 2005 and is now the Army's Maneuver Center of Excellence (MCoE), one of only nine CoEs Army-wide.

As the MCoE, Fort Benning is responsible for 52 percent of the Army's initial entry training. The BRAC-mandated consolidation with Fort Knox's Armor School brings new missions and training challenges to the installation where training infantrymen has been the primary mission since 1918. This major move is expected to increase the installation's working population by 30 percent.

This isn't the first time land around the Chattahoochee River, where Fort Benning is located, has experienced change and growth. There is evidence, including known prehistoric Native American villages, graves and many artifacts, showing humans have occupied the area for at least 10,000 years. Newer historic buildings, constructed before World War I, and facilities associated with distinguished and famous Soldiers such as generals George Patton, Benjamin O. Davis, Jr. and Dwight D. Eisenhower are evidence of the installation's expansion over the past nine decades.

So how do Fort Benning decision makers balance protecting these cultural resources from the past without impeding the increased military training mission of the future?

According to Dr. Christopher E. Hamilton, chief of Environmental Programs Management Branch, Cultural Resource Manager (CRM), "While we are excited and ready to take on this huge increase in mission, it is very important to preserve our historical cultural resources."

Hamilton says the initial requirement is to know what resources you have. "We knew BRAC would require more training land, ranges, and overall facility im-

provement, so we started the planning process years earlier," Hamilton said.

Each installation has an Integrated Cultural Resources Management Plan (ICRMP) and Fort Benning's ICRMP takes into account 130,000 acres of a total of 182,000 acres considered safe training land because it does not contain unexploded ordnance (UXO). The ICRMP is an important component of the Installation Master Plan, the document used by the commander for cultural resource actions and compliance.

According to Hamilton, the Environmental Programs Management Branch has completed planning-level surveys for buildings and for cultural sites. It also reviews all action on post, including training, to ensure cultural resource damages are avoided or actions affecting cultural sites/historic properties are not adverse to the sites.

"We have discovered 3,974 archeological sites on post. We have more than 600 historic buildings, but only three that date from the pre-installation period," Hamilton said. "We also have historic landscapes that are generally focused on open areas.

"Buildings and historic districts can be vulnerable to unintended negative consequences if environmental aspects are not considered early in the project process," Hamilton said. "Archeological sites, however, have the added protection of the Archeological Resources Protection Act and in some instances, the Native American Graves Protection and Repatriation Act, both of which have civil and criminal penalties. So far, BRAC training requirements have been successful, on time and in consultation with our stake-



holders and U.S. Army Environmental Command. We've avoided cultural resources impacts using project design or mitigated them through excavations." Hamilton is pleased with Fort Benning's progress in preserving the rich legacy of historical Native American archeological sites, facilities and artifacts in and around the Chattahoochee River, but notes there is more work to be done.

Fort Benning leadership and the CRM staff are committed to seeing Soldiers have ample land to train while cultural resources are protected. "We all believe we need to achieve a balance between new missions, along with the resulting need for space, new facilities and increased personnel, and protecting existing and future cultural resources at Fort Benning. This will be achieved through cooperation and dialogue with the SHPO, Tribes and our stakeholders," Hamilton said.

Fort Eustis

An installation honored for balancing mission requirements with protecting the Chesapeake Bay region natural resources, Fort Eustis developed an effective, comprehensive natural resources and cultural resources program. The post proactively restored and protected historic sites and natural areas unique to the bay area while improving the ability of the garrison to carry out its Soldier readiness and other important training missions.

"There are 229 identified archeological sites on Fort Eustis," said Christopher L. McDaid, Fort Eustis Cultural Resource Manager. "The sites date from about 10,000 B.C. up to 1918 when the Army took over the area. The

Newport News vicinity has more than 350 archeological sites, 68 percent of which are located on our post."

The success of Fort Eustis' CRM Program is evident in the fact that no project submitted for NHPA review has been delayed due to CRM-related issues. Determination of eligibility of effect to historic properties made by the Eustis program was supported by the Virginia SHPO. Many stakeholders were made aware of the post's exemplary stewardship of historic properties as Fort Eustis and the Army have continually demonstrated their stewardship through varied outreach efforts. This program is viewed by other Army installations as a resource for information regarding CR technical, regulatory and policy issues.

McDaid leads a three-person team at Eustis, consisting of himself, a field director and a field archeologist who manage sites on the approximately 6,000 acres of training lands used by a wide variety of military units. Of the 39 historic buildings, only one — the Matthew Jones Houses, built c. 1700 and on the National Registry of Historic

Places — requires ongoing preservation. The other historic buildings have had their compliance requirements fulfilled through the various program comments issued from the Advisory Council on Historic Preservation.

There are a great variety of archaeological sites at Fort Eustis. The earliest known include evidence of every Native American culture in eastern Virginia, except the Paleo-Indian, and show that Fort Eustis was occupied by Native Americans at the time of European contact. There are several structural sites that include Fort Crafford, a Confederate Civil War earthworks site, Liberty Farm and the Matthew Jones House, which houses the FECRMP team.

"This structure also serves as one of the focal points for our public interpretation, as well as the site of our annual Archaeology Month open house and for other events, such as last year's Earth Day," McDaid said. For that Earth Day event, we invited the community to learn about eighteenth century herbal medicine while we expand-

Active Engagement is Key to successful CRM:

- Work with internal POCs (master planners, training officers, range managers, tenants, G-4, post engineers, etc.)
- Make sure all other garrison staff members are aware of your CR program
- Understand critical garrison actions/missions, construction and building early in the process so your plan is considered
- Ensure decisions are made based on information entailing impacts of actions on historically significant properties
- Bring external stakeholders (state, local, and federal agencies and regulators including SHPO and federally-recognized tribes) in early in the planning process
- Be vigilant with your installation's cultural resources and review/update your CRM Program



ed the herb garden next to the Jones House. Plants were selected based on research into the medicinal practices of colonial Virginia.”

The Eustis CRM program directly supports the mission of Fort Eustis by ensuring all projects and training are coordinated and conducted in accordance with applicable laws and regulations. Whether it is site compliance issues or public outreach programs, the team strives to demonstrate environmental stewardship to our on- and off-post communities. Fort Eustis and the Army not only make history, but preserve history every day.

Summary/Conclusion

The Army Cultural Resources Program has more than 12,000 listed or eligible historic buildings/structures with an additional 75,000 buildings and structures over 50 years old that require evaluation for historical significance. There are 21 National Historic Landmarks, including districts that contain over 1,600 buildings. There are approximately 79,000 archeological sites with 7,801 of the sites listed or eligible for the National Register and another 45,000 requiring evaluation. Seventeen of our installations have Native American sacred sites.

The breadth and scope of the Army Cultural Resources Program is huge. Soldiers, Department of the Army Civilians and Families, as well as local community members, are keenly aware of how our installations and the Army take care of the precious cultural resources that have been entrusted to our care.

It all boils down to planning, supporting Soldier readiness missions and

training while protecting the existing historically significant cultural resources. Each installation has different needs, areas and missions but all strive to lessen the impact increased training activities may have on archaeological sites and resources.

“One of our biggest Cultural Resources Program challenges is ensuring the historical sites, structures and landscapes, and Native American sacred sites are preserved for future generations while reaching a sustainable balance between new missions. The need for space and new facilities and the increase in personnel must be achieved along with protecting existing and future cultural resources,” said Leahy.



COL Scott D. Kimmell serves as the Commander of U.S. Army Environmental Command. He holds a Bachelor of Science in Geology from Eastern Illinois University and a Masters in Education from Long Island University. Prior to USAEC, COL Kimmell served at Army Materiel Command. He completed the Army War College and held executive officer positions at the U.S. Military Academy, N.Y.; Fort

Hood, TX, and to the Deputy G8 in Washington, D.C. He deployed to Baghdad, Iraq, where he was Chief of Operations, CJ3, Multinational Forces. Among his decorations are the Bronze Star Medal and the Meritorious Service Medal.



Deborah Reynolds is the acting director of the Installation Services Directorate, OACSIM. Her education includes a Bachelor of Business Administration from the University of Louisiana, and a Master of Public Administration from Strayer University. Prior to her current appointment, she had served as the chief of the Army Housing Division since 2006.



Thin Client and SharePoint Technology Form the Basis of the IMC Mobile Workspace

by **William Lay**, Chief Information Officer/G6, IMCOM; & **Levon (Rick) Anderson**, Deputy Director, Information Technology, OACSIM

Microsoft SharePoint

The Installation Management Community (IMC) is adopting a new way to collaborate. New Microsoft SharePoint sites are starting to appear all over the IMC. The reasons for the appearance of these new sites are many. Primarily, these sites offer far greater capability than what has been available with email attachments and network share drives. These new sites will be seen simultaneously by the Assistant Secretary of the Army for Installations, Energy and the Environment (ASA IE&E), the Services and Infrastructure Core Enterprise (SICE) team, the Office of the Assistant Chief of Staff for Installation Management (OACSIM), IMCOM Headquarters, regions, and garrisons, greatly simplifying the task of sharing and tracking documents and files. SharePoint will serve as the IMC system of record and shared information repository.

One of the most powerful aspects of the SharePoint product is its capability to support workflows. The bane of IMC organizations is the never ending processing of Form 5, Army Staffing Form, paperwork. Form 5 processing is the primary means for staffing documents throughout the Army. Unfortunately, within the IMC, the processing of Form 5 paperwork is a very manual process involving multiple hardcopy papers. The process is slow due to the physical movement of

paper. It is also, by its physical nature, a serial process, not a parallel process. Even when the process is automated, the primary means of delivery is via the email inbox which makes it very easy to overlook an important task. SharePoint's workflow capability will significantly expedite this entire process.

SharePoint will be used as the single repository for IMC documents. This will alleviate the requirement to search through massive network share drives

to find a document. SharePoint also handles the version control of a document that is being edited by multiple people. No longer will you be updating an older version of a document because you were unaware of the existence of a newer version. SharePoint workflow will route the document simultaneously to all stakeholders for concurrence or non-concurrence. The workflow process also tracks the real-time progress of the routing process for easy status checks.

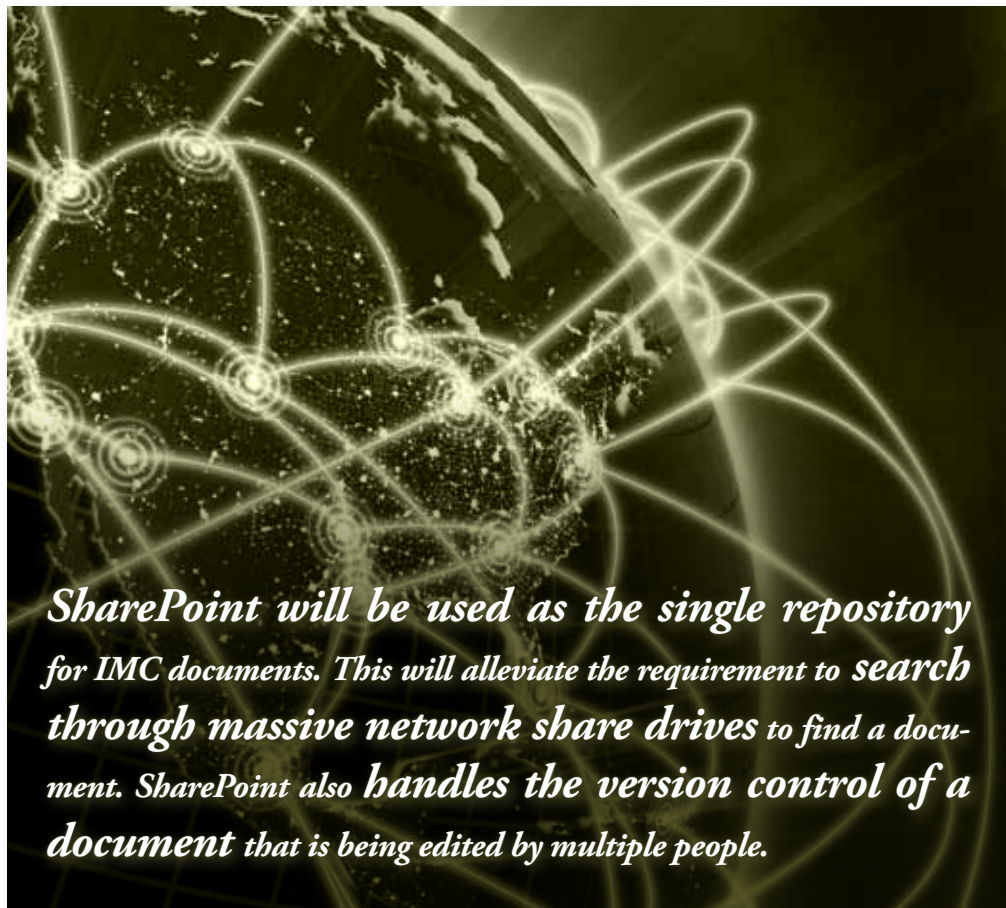

SharePoint will be used as the single repository for IMC documents. This will alleviate the requirement to search through massive network share drives to find a document. SharePoint also handles the version control of a document that is being edited by multiple people.



*The beauty of this new architecture is that system **security is simplified**, user profiles are hardware- independent, **system support costs are reduced**, mobile/telework solutions are expanded and **energy costs are reduced**.*

The IMCOM operations order tracking process will also greatly benefit from the use of SharePoint. Everyone at all levels in the organization will be able to monitor the status of tasks with the confidence that everyone else is receiving the same status. The power of this tool resides in fact that everyone is using it. If only a small number of the IMC organizations use the product then the expected productivity gains will be greatly diminished.

SharePoint is quickly becoming the primary tool of choice when requirements for new databases and reports arise. In the past, IMC software requirements would result in mission support systems being created using dozens of different software products. The maintenance costs and the skill sets necessary to keep multiple systems operational in this type of environment quickly become cost prohibitive. Many existing IMC mission systems should be evaluated in light of the current fiscal reality facing the Army.

SharePoint possesses the capability to support most databases and report requirements resident in the IMC. By focusing on the internal capabilities of SharePoint, this product can be used to standardize the mission system needs of the IMC. Focusing the mission software development needs of the IMC on SharePoint will improve pro-

ductivity and quality and reduce costs and development time.

Thin Client Architecture (VMware)

The physical move of the IMCOM Headquarters to Fort Sam Houston has resulted in a technological move to thin client architecture. This new architecture is based upon EMC2 VMware software and ClearCube Zero Client workstations. The beauty of this new architecture is that system security is simplified, user profiles are hardware- independent, system support costs are reduced, mobile/telework solutions are expanded and energy costs are reduced.

The thin client architecture that is being deployed in the IMCOM Headquarters moves the users' documents and files from the local laptop disk drive to a storage area network located in the Fort Sam Houston Network Enterprise Center data center. This migration of the users' files greatly reduces the risk of catastrophic data loss in the event of a laptop being stolen, lost or simply dropped. Security breaches, classified data spillages or personally identifiable information losses are more easily addressed and remediated with the thin client architecture.

The primary difference that IMC personnel will experience after migrating

to the thin client architecture involves how and where they store their files. While some may view this as a limitation, others will appreciate the flexibility that is introduced with moving between different hardware platforms. The advantages to having user documents and files stored in the data center are in having a nightly backup take place and access to data from multiple hardware platforms. Many people prefer to store their documents and files on the local disk drive of their laptop computer. While this provides data access in the event of a network outage, a significant risk is incurred whenever the laptop is dropped, lost or stolen.

The thin client architecture is being used as the single means to deliver SIPRNet capability in the IMCOM Headquarters. Thin client technology is very secure and the architecture really lends itself to use in a high-security environment. By using thin client technology for both NIPRNet and SIPRNet capability, only one skill set is necessary to support both requirements.

The thin client technology that is being employed by IMCOM Headquarters is based on the Personal Computer over Internet Protocol (PCoIP) protocol. This new protocol compresses, encrypts and encodes the entire computing experience at the data center and transmits only the display pixels across a standard IP network to stateless PCoIP zero clients. The user's actual data never leaves the data center. The advantage to using this protocol is speed. The PCoIP protocol is implemented in silicon for hardware accelerated performance, and in software in VMware view. This protocol supports high resolution, full frame rate



3D graphics and High Definition media, multiple large displays, full USB peripheral connectivity, and high-definition audio, all connected over the local or wide area network.

A thin client implementation also reduces energy consumption. While in use, a laptop consumes about 50 watts of power, and an LCD flat panel monitor consumes about 30 watts of power. Using an example of an employee using a laptop and a LCD flat panel monitor, an average of 6.5 hours a day and an electrical cost of 8.5 cents per kWh the resulting electrical costs would be:

$$= [(50 \text{ watts} + 30 \text{ watts}) \times 6.5 \text{ hours}] / 1000 \text{ --to get kilowatts}$$

$$= 0.52 \text{ kWh} \times 8.5 \text{ cents/kWh}$$

$$= \text{\$4.42 per day}$$

This calculation is for only one employee. When you multiply a 1,200 person workforce into the equation the energy costs become \$5,304 per day. When in use, the thin client ClearCube devices use only about 4 watts of power. Replacing the laptop with a thin client device would result in the following electrical costs:

$$= [(4 \text{ watts} + 30 \text{ watts}) \times 6.5 \text{ hours}] / 1000 \text{ --to get kilowatts}$$

$$= 0.22 \text{ kWh} \times 8.5 \text{ cents/kWh}$$

$$= \text{\$1.87 per day}$$

Using the 1,200 person workforce thin client example, the daily use would be \$2,244. The daily electrical cost savings for this 1,200 person workforce would be \$3,060. Even when the electrical requirements for the thin client servers are added to the equation, the electrical

use and costs are still very much in favor of the thin client architecture.

Apple iPad 2

One of the most innovative products to come along in many years is the Apple iPad, along with the proliferation of competitive tablet computers and electronic readers that have also come to market. In just the past year, these devices, have truly transformed how many people think about using a computing device. Its success can be partly gauged by the fierce competition that has sprung up among the various product offerings to emerge over the past few months. It seems that every other day another international corporate brand is announcing the release of a tablet form factor



device. Tablet computing is altering the product life-cycle plans for many organizations.

The huge appeal of tablet computers is in large measure due to the excellent user interface, lightweight portability and the ability to deliver mixed media on a single device. As a consumer

device, the tablet is outstanding in the delivery of internet content such as digital photographs, books, magazines, music and video. As a productivity tool in the office environment it has the potential to become the ultimate thin client. The untapped potential of the tablet form factor is tremendous.

Part of the appeal of using the iPad within the IMC is the ease of using it to view documents. The need to carry around paper documents is greatly reduced. For the commanding general, the advantage to carrying an iPad in place of a 40-plus pound read bag is obvious. The key, however, is to be able to provide this capability securely.

To truly leverage the power of the tablet form factor, it must be unfettered from cable connections. The tablet form factor quickly becomes unwieldy if power, network and peripheral cables are hanging from the device. To use the tool as it was designed, wireless connectivity is a must. The goal is to establish permanent, secure, encrypted wireless networks that will facilitate the tablet devices inside the office workplace. To accomplish this goal, the risk assessment paperwork necessary to garner the required information assurance approvals is being completed. In the interim, the use of approved 3G/4G wireless network cards will provide the necessary connectivity until the permanent Army wireless networks are operational.

Tying the technologies together

When these three different technologies are used together, suddenly new capabilities begin to emerge. A goal for many organizations over the past year has been to figure out how to securely



deliver mission information to a tablet computer. The iPad was designed from the start to be primarily a consumer device. This fact has made it very difficult to secure the device from compromise. By using the thin client architecture to display the mission data, the security issues inherent to the iPad are mitigated.

The entire ensemble of technologies will result in the documents and files being stored and routed within SharePoint. The VMware thin client server will provide a “view” of the SharePoint data to the iPad through the VMware Client software. Since the data is encrypted and never resident on the iPad the device is made secure. Because no mission data resides on the device, there is no data loss or spillage in the event that the iPad is lost or stolen. The final piece of the puzzle is to add a Bluetooth Common Access Card sled that will provide for full CAC authentication on the iPad. This configuration meets the DOD Information Assurance compliance requirements and makes it easy to upgrade to new client devices as new technologies become available.

The ultimate goal is to consistently deliver the same user experience regardless of the hardware platform being used. Through the use of Microsoft SharePoint and EMC2 VMware, IMC personnel should be able to access their documents and files the same way in the office, at home or on the road. The common denominator is the VMware client. Currently, the VMware client is available for Microsoft Windows, Apple OS and Google Android operating systems. Once the system is fully operational and the information assur-

ance approvals are completed, an IMC member would be able to work from any workstation in the office building, their laptop computer, their home computer, their tablet or their smart phone. Regardless of their hardware preference, the user profile and permissions will consistently follow them.

The convergence of these multiple technologies will expand our capability to collaborate, increase our productivity, improve our information assurance security posture, reduce our help desk support costs and use less electricity. It will require us to change some of our existing work processes, but the benefits will be well worth the price.



William Lay serves as the Chief Information Officer/G6 for the Army's Installation Management Command. He is responsible for the software development life-cycle, knowledge management, enterprise architecture, service management, portfolio management, information assurance, IT governance and customer support for Army entities that comprise Installation Management. During the past 27 years, he has

worked in many information technology roles within the federal government, including the Army, Department of Energy, Department of Commerce, Federal Communications Commission and Minerals Management Service.



Levon (Rick) Anderson is Deputy Director, Information and Technology Directorate, OACSIM. Before joining OACSIM, he was a charter member in the Army's Senior Fellows Program, where he was detailed as Information Technology (IT) Advisor for the Army Civilian Personnel Development Office where he was instrumental in helping develop the Army Career Tracking System; and as Army Chief Representative to the Office of the Secretary of Defense (OSD), Defense Industrial Base Cyber Defense Task Force. Over a 30-year civilian and military career, he has served in many key IT roles.



Adaptive Leadership: The Key to the Hard Problems of Combining Korea and Pacific Regions

by *Debra Zedalis, Director, Pacific Region, IMCOM*

On October 1, 2011 two Installation Management Command (IMCOM) regions — Pacific and Korea — will become one and form the new Pacific Region. The new Pacific Region, combining CONUS and OCONUS installations from the arctic cold to sunny beaches, will cover 105 million square miles and serve more

than 170,000 Soldiers, Civilians and Families. Pacific and Korea Regions have successfully served some of the Army's best for 10 years and each region is powerfully proud of what they have done — so how do we capitalize on each region's strengths to make the newer, larger region the absolute best? The answer lies in adaptive leadership.

Adaptive leadership is defined as “the practice of mobilizing people to tackle tough challenges and thrive¹” and “requires a change in values, beliefs, or behavior,”² according to “The Theory Behind the Practice,” a chapter written by Ronald Heifetz, Alexander Grashow and Marty Linsky in the *Harvard Business Review*. Heifetz



*The new Pacific
Region combining
...installations from
the arctic cold to
sunny beaches, will
cover 105 million
square miles
and serve more than
170,000
Soldiers, Civilians
and Families.*



The most effective leadership anchors change in the values, competencies, and strategic orientations that should endure in the organization. A successful adaptation enables an organization to take the best from its traditions, identity and history into the future.

asserts “the most common cause of leadership failure is treating adaptive challenges as technical problems. Technical problems are those which have known solutions that can be implemented by current know-how and are resolved with the organization’s current structures, procedures, and ways of doing things. Adaptive challenges are those which must be addressed through changes in people’s priorities, beliefs, habits, and loyalties.”³ In the integration of Pacific and Korea Regions we will be faced with both: how we solve known problems with our current structures — programs, processes and people — and how we adapt to new changes and challenges with new vision, new priorities and renewed vigor.

“The Theory Behind the Practice” lists key points for exercising adaptive leadership:

1. Adaptation builds on the past

Determine what should be preserved from an organization’s heritage and make the best possible use of previous wisdom and know-how. The most effective leadership anchors change in the values, competencies, and strategic orientations that should endure in the organization. A successful adaptation enables an organization to take the best from its traditions, identity and history into the future.

2. Adaptation relies on diversity

Adaptive leadership should build a culture that values diverse views and relies less on central planning.

3. Adaptation occurs through experimentation

Those seeking adaptive change need an experiential mind set and must improvise to face new challenges with new solutions.

4. Adaptations displace, reregulate and rearrange

Adaptive challenges can generate a sense of loss as innovation may cause people to feel incompetent, betrayed or irrelevant. Collective and individual disequilibrium is a byproduct generated when you draw people’s sense of responsibility beyond current norms and job descriptions.

5. Adaptation takes time

Organizational adaptation takes time to consolidate into new norms and processes. Adaptive leadership requires persistence as cultures change slowly.⁴

Successfully applying these guidelines is key to the integration of Pacific and Korea Regions.

A key component of adaptive leadership is the focus of the action — not just the goal itself but the “values that

the goal represents and also the goal’s ability to mobilize people to face, rather than avoid, tough realities and conflicts.”⁵ At stake is how Pacific and Korea Regions successfully provide quality oversight and services while reducing overhead. The United States is facing tough economic challenges that cascade from the federal government to the Department of Defense to the U.S. Army to IMCOM to the regions to the garrisons and to each of our employees. It is our task to support our organization, our Army, and our government to reduce resources, forthrightly face the fundamentally different fiscal environment and yet not lose our passion to serve Soldiers, Civilians and Families.

Building on our past as adaptive leaders, there are similarities on which we can capitalize — programs, processes, and people — that will aid the integration. Both regions execute programs to a standard directed by higher headquarters. These programs, although perhaps currently executed at a region headquarters, can be shifted to garrison-level execution with no degradation in service delivery. Although processes may change, both regions execute in accordance with Headquarters IMCOM regulations, operations orders (OPORDs) and commander directives. Finally, although the region personnel composition may vary, there are similarities in age (average age in Pacific is 55; in Korea it is 53) and grades (average grade in both regions is GS-13). Empowering these battle-hardened leaders who can handle technical and adaptive challenges in programs, processes, and people bodes well for Pacific Region.



Adaptive challenges are more easily met when we rely on our diversity. Looking at the two regions, it may appear that there are many differences. The current Pacific Region is very geographically dispersed — from Region HQ in Hawaii to Alaska is 3,825 miles; Region HQ to Okinawa is 4,655 miles. The current Korea Region, however, is considerably more compact, with three of five garrisons within 40 miles of the Region HQ and the most distant, Daegu, just 146 miles away. Pacific Region is much larger than Korea Region, with 1.8 million acres of installation property compared to 19,000 in Korea; 47 million square feet of buildings to Korea's 3 million; and 10,000 housing units to Korea's 1,458. Beyond just size, these differences translate into a completely different culture and organization. Given the geographical scope of the current Pacific Region, authority is decentralized to the garrison commander and Senior Commander, and the region provides oversight but does not execute any base operations (BASOPS) missions. While Pacific Region provides the standard array of BASOPS programs, Korea Region has a high-priority wartime support mission. Korea Region, by its very location and existence, is focused on both BASOPS and war fighting. The importance of this mission, the Region support to

both 8th U.S. Army and U.S. Forces Korea, and the physical closeness of the Korea garrisons have led to more centralized oversight and, in some cases, actual execution of BASOPS services at the region headquarters. Korea Region also has two major workforce differences: (1) The Department of the Army Civilians (DACs) serve a three- to five-year tour and (2) The majority of the region personnel are Korean National employees. As the DACs serve in management positions, the turnover and learning curve are much higher and steeper in the Korea Region as Pacific Region employees do not rotate positions.

The above reflection on the organization, culture, differences and similarities of the two regions was key to defining actions necessary for both technical and adaptive challenges. The technical challenges (execution of programs, revision of processes) are easily addressed by regulation research, face-to-face meetings on current and proposed process changes, resource requirement identification, and development of business rules, guiding principles, memoranda of understanding and/or standard operating procedures. The technical actions can be listed, baselined, timelined, tracked and then measured to determine if services continue to be provided to standard.

Much more difficult is dealing with the adaptive challenges — how do we determine what should be preserved from each region, obtain diverse input from everyone in the organization, set a vision bigger than either region, experiment to get new solutions to new challenges and change people's priorities, beliefs, habits, and loyalties?

The figure below from *The Practice of Adaptive Leadership* indicates that technical and adaptive issues cannot always be easily identified and “solved” and, instead, “most problems come with technical and adaptive elements intertwined.”⁶ Most importantly, “making progress requires going beyond any authoritative expertise to mobilize discovery, shedding certain entrenched ways, tolerating losses and generating new capacity...”⁷ The integration of the Pacific and Korea Regions will include many challenges in all three categories. While some will be “easy fixes” with technical answers and directed by authority figures, others will require collaborative insight from garrison employees to senior commanders — all who are engaged in or impacted by the process changes, identified as “stakeholders” in the diagram below.

Much of our forthcoming adaptation work will occur through experimentation. An example of a technical

Distinguishing Technical Problems and Adaptive Challenges⁸

Kind of Challenge	Problem Definition	Solution	Locus of Work
Technical	Clear	Clear	Authority
Technical and Adaptive	Clear	Requires Learning	Authority and Stakeholders
Adaptive	Requires Learning	Requires Learning	Stakeholders



Adjusting from a model of centralized control to one of decentralized control and remote leadership will offer many opportunities to mobilize discovery, shed entrenched ways, tolerate loss, generate new capacity, succeed and fail.

leadership challenge will be integration of financial systems as Pacific Region will use the General Fund Enterprise Business System (GFEBS) while the Korea Region will not; additionally, there are challenges in dealing with foreign currency exchange in the GFEBS financial system. The problems are clear, the solutions will be forthcoming for all Army OCONUS installations and headquarters (authority) will direct resolution.

The execution functions that were performed by Korea Region (e.g., warehousing, cable television) will present both a technical and adaptive challenge

as we devolve the centralized tasks from the headquarters and establish new operations at the garrisons. Some technical problems will be easily identified, fixed, and documented; however, the adaptive challenge arises when the garrisons who receive these new tasks may not have the requisite experienced personnel to execute quickly to standard. Entrenched ways must be shed; new capacity must be built.

Another adaptive challenge will be the devolution of leadership authorities and responsibilities on the peninsula, which will change processes for Korea garrisons, Army staffs and Senior

Commanders. Adjusting from a model of centralized control to one of decentralized control and remote leadership will offer many opportunities to mobilize discovery, shed entrenched ways, tolerate loss, generate new capacity, succeed and fail. From each experiment, we will learn and adapt.

Adaptations displace, reregulate and rearrange. "However you ask the questions about adaptive change and the losses they involve, answering them is difficult because the answers require tough choices, trade-offs, and the uncertainty of ongoing, experimental trial and error. That is hard work not only because



More than 250 specific services are being assessed as to capability and conditions required for successful integration. ...Communication strategies have been developed and are being executed. Adaptation takes time and we will not accomplish everything in one year.

it is intellectually difficult but because it challenges an organization's relationships, competence and identity."⁹

The technical aspects of integration have begun. OPORDs have been issued, specific tasks are suspended on milestone charts, face-to-face functional meetings are detailing required actions in programs and processes and standard briefings are being executed. More than 250 specific services are being assessed as to capability and conditions required for successful integration. Human capital and financial resources have been analyzed and projected for October 2012 and beyond.

Communication strategies have been developed and are being executed. Adaptation takes time and we will not accomplish everything in one year. While there will be some experimentation as programs and processes are refined and there will be some missed missions as well as some exceptional execution, the technical challenges will be identified, assessed, improved and documented. By September 30, 2012, all functions will have been performed at least once, which will allow us to review, revise and prepare for FY 2013 execution.

The adaptive challenges, however, will be more problematic as these chal-

lenges will require "buy-in" from all the stakeholders on the peninsula in Korea, at the region in Hawaii and at the headquarters in both Texas and Washington, D.C. The sense of loss for the Korea Region personnel who have dedicated their lives to that organization and mission is immense. "What people resist is not change, per se, but loss. When change involves real or potential loss, people hold on to what they have and resist the change. We suggest that the common factor generating adaptive failure is resistance to loss. A key to leadership, then, is the diagnostic capacity to find out the kinds of losses at stake in a changing



situation. Adaptive leadership puts you in the business of assessing, managing, distributing, and providing context for losses that move people through those losses to a new place.”¹⁰ For the Pacific and Korea Region Directors and managers, adaptive leadership is a must; “leaders should recognize those losses and the predictable defensive patterns of response that operate at the individual and systemic level and also focus on how to counteract these patterns.”¹¹ A key leadership challenge will be to avoid adaptive failure by exhibiting concern and care for people, revising processes to meet mission and minimize loss and using this opportunity to build new individual skill sets/capacity and new organizational capacity.

The Army is Army Strong. The Army comprises Soldiers, Civilians and Families who have a shared history of having excelled against daunting odds. Pacific and Korea Region employees are truly “good Soldiers” who will expertly execute their assigned mission. They will use adaptive leadership to communicate and address the human element, allay apprehension and unease and compassionately deal with all issues will ensure successful integration.



Ms. Debra (Debbie) Zedalis is the Director, Installation Management Command-Pacific. Her previous assignments include: Deputy Garrison Commander, U.S. Army Garrison West Point, N.Y., and Chief of Staff, IMCOM-Europe. She has an MBA from Syracuse University and is a graduate of the Army War College.

References:

- ¹ Ronald Heifetz, Alexander Grashow, and Marty Linsky, *The Practice of Adaptive Leadership* (Boston, MA: Harvard Business School Press, 2009) p. 14.
- ² Ronald Heifetz, *Leadership Without Easy Answers* (Cambridge, MA: The Belknap Press of Harvard University Press, 1994) p. 22.
- ⁴ Heifetz, Grashow, and Linsky, p. 15-17
- ⁵ Heifetz, p. 23.
- ⁶ Heifetz, Grashow, and Linsky, p. 19.
- ⁷ Heifetz, Grashow, and Linsky, p. 19.
- ⁸ Heifetz, Grashow, and Linsky, p. 20.
- ⁹ Heifetz, Grashow, and Linsky, p. 23.
- ¹⁰ Heifetz, Grashow, and Linsky, p. 22-23.
- ¹¹ *Ibid.* 17





IMCOM Supports its Customers and Workforce Through the Pacific-Korea Merger

by **BG David G. Fox**, Commander, Korea Region, IMCOM

Like any significant reorganization, the integration of IMCOM Pacific and Korea Regions brings uncertainties for the workforce and for the former Korea Region customers. Recognizing that many uncertainties surround the Pacific-Korea Integration (PKI), IMCOM's leaders are devoted to reassuring its customers and its people. Information and compassion are valuable commodities in times like this, and underscore IMCOM's three objectives for working through this process: keeping people informed, helping find new employment for displaced workers and remaining open to concerns and feedback of all affected.

Keeping People Informed

The integration environment creates a high demand for information — not only among the approximately 300 members of the workforce affected by the consolidation, but also among the IMCOM customers on the Korean peninsula. For this reason we are making information available through various media and locations.

From the beginning of the consolidation planning process, Korea and Pacific Regions have been in constant communication, laying the groundwork for how to execute PKI. We have delivered a series of briefings to officials at U.S. Forces Korea, 8th Army and other organizations IMCOM supports to ensure everyone is on the same page and that operations go on unaffected. IMCOM



is committed to providing the same quality service whether that service originates from Korea or Hawaii.

IMCOM is just as committed to its workforce. To ensure the workforce is informed of changes and milestones, multiple town hall meetings have been held and continue to be held as information becomes available. Pacific and Korea Regions are producing a special newsletter for wide distribution as new information is released. Information is accessible through social media platforms such as Facebook, targeting

both the workforce and organizations that depend on IMCOM's service. Additionally, informal communication through professional networks, supervisors and the chain of command continues to play a large role in informing audiences. Whatever the means, both Pacific and Korea Regions remain committed to distributing information in real time.

Open to Concerns and Feedback

But it is not enough to simply disseminate information about PKI to those who need it. Any basic communication



Leadership understands information is not a fire-and-forget delivery platform. There is a human element to it that must address people's apprehension and unease.



model demonstrates the value of feedback, and IMCOM's communication process has left abundant opportunity for its customers and people to express their concerns. One of the most valuable characteristics of town hall meetings is the face-to-face interaction. Attendees are encouraged to ask questions and voice concerns at these meetings.

Leadership understands information is not a fire-and-forget delivery platform. There is a human element to it that must address people's apprehension and unease. Town hall meetings aren't the only way this is done. The act of addressing concerns must be, and is, interwoven into the most in-

formal interactions. Supervisors make themselves available to their people, who are encouraged to use the chain of command. Those who are more comfortable communicating electronically can send emails or address general concerns via email or Facebook. There are multiple ways leaders can receive feedback, and both regions take each person's concerns seriously.

A Human Dimension to Employment Opportunities

We are doing everything we can to make this transition as agreeable as possible. We developed, and continue to update and refine, a comprehensive Human Resources (HR) plan that ensures each

person's employment preference is considered in seeking opportunities after Korea Region. Here is how it works.

Part 1 of the plan involves canvass letters that seek employee feedback as to their employment preferences when consolidation eliminates the Korea headquarters. Several weeks ago, we prompted both appropriated fund (AF) and nonappropriated fund (NAF) employees affected by PKI to provide in writing their three preferred options for employment after the regions consolidate. The choices include alternative employment in Korea, a possible transfer to Pacific Region, or a return to the continental United States. The



We understand the difficulty and hardship involved in this integration. There may be a few bumps along the way and not everyone will get their first choice of employment.



canvass letters enable us to collect employee preferences and align them with available vacancies.

Although all of Korea Region officially belongs to Pacific Region as of Oct. 1, Korea Region staff will likely be in employment transition through December. Until the integration is complete, employees will be contacted individually as G1 Civilian Personnel coordinates placement details specific to each person's situation.

Part 2 of the HR plan involves identifying jobs. As placement opportunities are identified, our HR staff matches the opportunities with Korea Region employees' pay plan, title, series and grade. They confirm position qualifications and submit placement approval for each person. Once approved, valid job offers will be extended to individuals by Headquarters or Region Directors. A fact sheet will be provided addressing the options employees have to consider after accepting or declining voluntary offers. Once an offer is extended, the employee will be given five to seven work days to respond. If placement is accepted, the gaining activity will take action to issue orders. Declination of the offer indicates the individual has opted to seek a job in-

dependently. The employee then will have the following options:

1. If the individual has reemployment rights, they would exercise those rights.
2. If the employee has no reemployment rights to current grade or no reemployment rights to any grade, the individual will be registered in the Defense Priority Placement Program (PPP).
3. If permanent employment cannot be secured through PPP, individuals can be reassigned by management direction within the new region or detailed to work in a garrison until permanent employment is obtained.

The Good News Summarized

As the region consolidation proceeds, IMCOM will continue to provide high-quality service to customers throughout the vast new Pacific Region, from Korea, to Hawaii, to Alaska and even the west coast of the continental United States. Members of the workforce have a whole staff of people, including leaders, dedicated to ensuring IMCOM's employees have the best possible employment options after the dust settles. That is the good news.

We understand the difficulty and

hardship involved in this integration. There may be a few bumps along the way and not everyone will get their first choice of employment, but we can assure that everyone will have a reasonable option to consider.

We continue to hold strong to IMCOM's objectives during this integration. Our priorities are to keep our people and customers informed, find jobs for those who are displaced and remain open to concerns and feedback of those affected. This is how we take care of our own, and we are confident in this process.



BG David G. Fox was the Region Commander for IMCOM-Korea Region until integration with Pacific Region Oct. 1, 2011. He began his military career as an enlisted Soldier. After completing Officer Candidate School, he was commissioned a second lieutenant in the Infantry in 1982. His military education includes the U.S. Army War College, Command and General Staff College, Combined Arms Services Staff School, and Infantry Officer Basic and Advanced Courses. His civilian education includes a Bachelor of Arts from the University of Nevada at Las Vegas, and a Masters in Strategic Studies from the Army War College.



Tactical Metrics Help Set Priorities in a Resource-Constrained Environment

by *Davis Tindoll*, Director, Atlantic Region, IMCOM

The Installation Management Community is committed to providing standardized, essential services and infrastructure necessary to achieve and maintain individual readiness throughout the ARFORGEN cycle for our Soldiers, Families and Civilians.¹

For the first time in 10 years, the Army is faced with a fundamentally different fiscal reality. However, the requirement to provide Soldiers and their Families with a quality of life commensurate with their service does not change. The Army is clearly meeting the needs of Soldiers and Families as evidenced by exceeding recruitment and retention goals and survey results indicating the majority of spouses are satisfied with the Army as a way of life. In light of constrained resources, the challenges and risks are greater than ever for the Installation Management Community to continue to provide the same level of base operations services and programs enjoyed in the past. We are faced with the same questions Families ask when looking at their own budgets: Do we really need it? Is it worth the cost? What are we willing to do without?²

The expense of providing Soldiers and Families services at the level they currently enjoy is challenging in this environment of reduced resources. As resources become scarce, programmatic

competition will increase. For example, what is more important — guards at the installation front gate or child and youth services? There is not a “right” answer. It is imperative, therefore, that base operations services are delivered effectively, not only because of their value to their users, but also because every dollar spent on one program will mean one less available dollar to fund other efforts. To defend a service’s effectiveness and get better results, directors at the garrison level will need increased process knowledge and process details: measurable performance standards, cost, capacity and effectiveness. Interconnected performance metrics at the enterprise, operational and tactical levels are needed to provide better visibility on total program requirements and cost estimates.

We are the Army’s Home

Installation Management Command (IMCOM) manages 83 Army garrisons supporting Army installations worldwide. IMCOM is organized into four geographically-based regions (Atlantic, Central, Europe and Pacific) that are structured to facilitate the delivery of installation (base operations) services and monitor the performance of assigned garrisons. The U.S. Army garrison is the organizational structure that provides efficient and effective installation services to the installation community and customers. Garrison essential tasks include:³

- Command and control garrison assets
- Support and enable mission readiness of stationed units and care for people
- Conduct daily operations to provide installation support to mission commanders
- Maintain and improve installation services, infrastructure and environment

Garrisons report performance data through many different Army systems. Two major systems are the Installation Management Campaign Plan (IMCP) and the Installation Status Report (ISR). The IMCP brings the Installation Management Community commander’s vision to life by bringing effective and efficient services, programs and infrastructure to bear on the challenges faced by commanders, Soldiers, Civilians and Families in a fluid operating environment. It lays out the enterprise strategy through six lines of effort, 34 keys to success and 59 metrics to track progress. The six lines of effort are Soldier, Family and Civilian Readiness; Soldier, Family and Civilian Well-being; Leader and Workforce Development; Installation Readiness; Safety; and Energy and Water Efficiency and Security. ISR is a decision support tool used from the installation up to Headquarters Department of the Army (HQDA) that evaluates the cost and quality of providing installation services at Army installations worldwide. It assesses installation service quality against established Army standards as well as



the cost to provide the service. ISR also communicates the status of installation services to the Army, Secretary of Defense and congressional leaders through the program objective memorandum (POM) process.⁴

Challenges

Success depends on everyone in the organization knowing and understanding the objectives and goals so that they can work toward achieving them. For years the Army successfully used cascading metrics through Army Training and Evaluation Plans (ARTEP) and Mission Training Plans (MTP) from the individual to the brigade level. Soldiers knew the tasks, conditions

and standards and how they fit into the unit's Mission Essential Tasks. This concept is a basic principle in every Army organization — the expectation to do certain things and to execute them to a standard. Not only is this the basis for training for war, but it helps promote unit cohesiveness. Similar to a Mission Training Plan, garrisons use tactical metrics and Common Levels of Support (CLS) to provide quality installation services to Soldiers and Families within Army directed capability levels and available resources. This type of metrics system is very helpful for IMCOM leaders and employees to embrace the commander's intent within the context of Army-directed

capability level and published tasks, conditions and standards.

Field Manual 7-0 states, "Commanders are responsible for training their direct subordinate units. They guide and evaluate two echelons down. For example, brigade commanders train battalions and evaluate companies; battalion commanders train companies and evaluate platoons. Commanders develop leaders at one and two levels below their own through personal interaction and by providing them clear guidance." The figure below provides perspective when you consider U.S. Army garrisons as brigades, and garrison directors as battalion commanders.⁵ The commanding general, IMCOM,

LEVEL VI/VII (CG IMCOM/ACSIM)





Metric Hierarchy

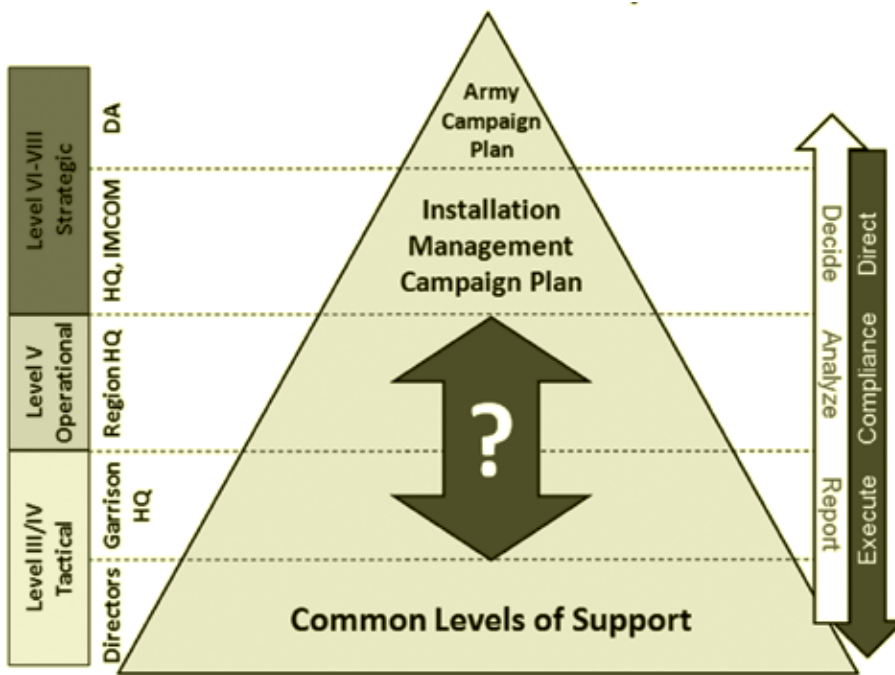

mentors the garrison commander to successfully lead a multi-faceted organization focused on garrison-level service delivery, Army Forces Generation (ARFORGEN) support and the Army Family Covenant. Similarly, the region director coaches, teaches and mentors the garrison directors to deliver installation services and programs at the Army-directed capability level. Directors must know their tasks, the metric to measure performance, how their performance aligns to the standard and how much it costs to provide the service. Tracking service cost is each director’s responsibility. The resource manager is the banker and knows how much each director spent but only the director knows how and why resources were spent within a service.

The 59 IMCP metrics provide IMCOM with important strategic information, but less than half are connected to tactical-level metrics (either

CLS or ISR). Bridging the gap between the garrison directors’ focus on delivery of services and the headquarters’ focus on keys to success is critical. The key is cascading metrics linking the services and programs executed at the garrison level to the business decisions and resource distribution at the enterprise level. Linking top-down and bottom-up demonstrates how both elements are needed for setting realistic program baselines and managing risk. Clear metrics at each management level provide leaders with situational understanding to champion issues impacting the delivery of services to Soldiers and Families. Linking from the top-down and bottom-up results in a better overall view of a program so that when a service changes due to directed capability level or resources, risks and other opportunities can be communicated in time to plan for and mitigate the impact of change.

Garrisons deliver the 79 ISR services similarly, but at different cost rates demonstrated by widely varying base operations support (BOS) cost per Soldier calculation results.⁶ When systems work independently, services are more expensive at the enterprise level and service delivery variances adversely affect Soldiers and Family members. Soldiers expect consistent services to be available at every installation, anywhere in the world. Metrics that define the standard level of service are critical to understanding what we do, how well we do it and how much it costs. Can the Army continue to afford each respective service level? The challenge is to continue delivering the level of service Soldiers and Family members deserve in a constrained resource environment.

The Army is built on standards, discipline and core values. Common standards at the installation level are a way to help the Army clearly understand how to make the most effective use of its available resources. The Army senior leadership is able to make informed installation service support decisions based on capabilities and associated risk. Common standards enable the Army to demonstrate how it uses installation support resources efficiently and in accordance with Army priorities. Furthermore, it allows the Army to identify in detail how installation services are impacted by funding reductions and plan for contingencies as necessary.

Former Army Chief of Staff GEN Martin Dempsey said in the 37th CSA’s Thoughts on the Future of the Army, “To ensure consistency and manage expectations across the Army, we will establish common levels of support at posts, camps, and stations...



Within this focus area, we will identify the menu of activities that currently exist to support the Army Family, assess where there are gaps and redundancies, measure outcomes, prioritize programs and resource those programs producing the best results.”⁷

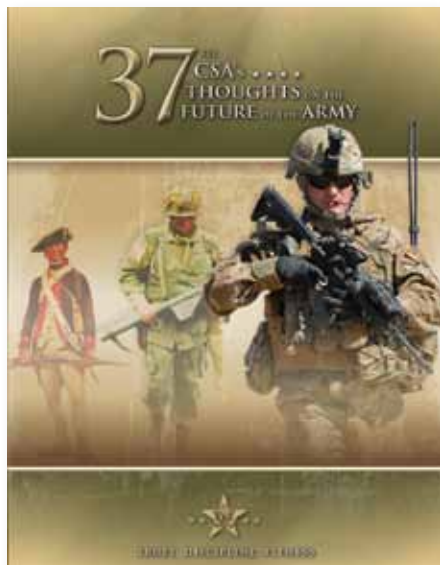

The Army needs a coordinated strategy for transforming the management of installation services by focusing on service delivery costs and performance. A corporate management process of linking strategic-tactical metrics and performance standards would bring a disciplined process to installation management across every installation. This process would allow IMCOM to achieve the following objectives:

- Standardized installation services. Installation customers receive the same elements of service, to the same level of service, regardless of the installation at which they are located (condition-based for unique missions, geographic or demographic considerations).

- Accountability for service delivery performance. Garrisons report service delivery performance quarterly and are held responsible for meeting performance targets.
- Equitable distribution of available resources. Available resources are distributed across garrisons so each has adequate resources to deliver installation services to expected standards as efficiently as possible.

Today, at the garrison level, there are 79 installation management services (tasks) broken down into 479 discrete and measurable sub-tasks. These tasks define the elements of each respective service and a metric that defines the standard of service delivered to installation customers. Linking these tactical metrics with strategic metrics would provide a commonly understood structure for resource allocation and performance reporting (task, conditions, and standards), leading to better management of installation service delivery.

- Cost (relative to the overall service-validated requirement).
- Output and outcome performance measures.
- Efficiency targets for each capability level standard.

Many garrison commanders continue to conduct quarterly garrison-level performance management reviews (PMR). A PMR is similar to a quarterly training brief, where the directorate-level leaders present performance data to the garrison commander. Garrison leaders analyze the data and the region monitors resultant action plans to better manage service delivery processes. Directors capture their costs by ser-

vice and performance by each sub-task then brief the garrison commander and Region Director on the overall service effectiveness and ability to deliver at the Army-directed capability level. One of the greatest strengths of the PMR are directors’ action plans to improve performance capabilities. The garrison commander uses many options to ensure the directors deliver the directed service levels to standard, including reshaping the workforce to align resources, realigning MDEP resources and identifying and sharing best practices and efficiencies. The results of the PMR back briefs become a contract between the Region Director and garrison commander on the way ahead to provide first-class installation services to Soldiers and their Families.

Conclusion

The challenges and risks are greater than ever for the Installation Management Community to continue to provide the same level of services and programs enjoyed in the past. We must constantly ask ourselves: Do we really need it? Is it worth the cost? What are we willing to do without? Similar to a large corporation in America, we can capitalize on proven Fortune 500 practices of establishing metrics from the strategic to the tactical level, enforcing those metrics with a performance review process, thereby assessing gaps, eliminating redundancies and basing decisions on measured outcomes. Effective, customer-driven programs will be resourced, while ineffective, redundant or undesirable programs will be retooled or eliminated per customer preferences. Garrisons will continue to face demanding challenges and tough decisions, but we will not waiver in our commitment to



provide Soldiers and Family members with services commensurate with their dedication to our country.



Joe Staton, Management Integration Branch Chief, IMCOM Atlantic Region, contributed to this article. He was the deputy garrison commander for transformation at Fort Bragg, NC, from 2007 to 2010, and is a recent graduate of the Cost Management Certificate Course at the Naval Postgraduate School in Monterey, CA.



Scan the code with a smart phone to access the 37th CSA's Thoughts on the Future of the Army.



Dave Tindoll is the Director, Installation Management Command-Atlantic Region. Previously, he served as the Director, Southeast Region; Deputy Director of IMCOM-Korea Region; and as the Chief of Staff, Southeast Region. Mr. Tindoll served as a regular Army officer for 30 years before entering civilian service. He earned a Bachelor of Science Degree from Eastern Kentucky University and a Master's Degree from the Command and General Staff College, Fort Leavenworth, Kansas. He also attended the School of Advanced Military Studies and the Army War College.

References:

- ¹ Installation Management Campaign Plan (IMCP) 2010-2017, ver 3.0, April 2011, pg. 6
- ² LTG Rick Lynch, Defender 6 Sends: New fiscal reality, same commitment to Soldiers, Families, 4 May 2011
- ³ IMCOM Regulation 10-1, Organization, Mission, and Functions, Headquarters, U.S. Army Installation Management Command, 10 June 2011, pgs 2, 77-78, 96-97.
- ⁴ Installation Management Campaign Plan (IMCP) 2010-2017, ver 3.0, April 2011, pg. 2
- ⁵ Field Manual 7-0, Training for Full-Spectrum Operations, Headquarters, Department of the Army, 12 Dec 2008, pg 2-2.
- ⁶ Staton, Joseph, Cost Management vs Budget Management: Performance Based Band of Excellence, U.S. Army Journal of Installation Management, Spring 2011, pg 35.
- ⁷ GEN Martin E. Dempsey (CSA), 37th CSA's Thoughts on the Future of the Army, June 2011



IMCOM Central Region: Leading into the Future

by **J. Randall Robinson**, Director, Central Region, IMCOM

If you are a part of Installation Management Command (IMCOM), you must understand the journey we have undertaken, where we are going and the need to become a “flatter” organization as a part of the Army’s transformation. As IMCOM has evolved, always looking to positive change, the Central Region has helped chart the course through an efficient, restructured command.



Organizational Change Management experts talk about leading change, but in IMCOM, change is led from the front.

IMCOM actively pursues the organizational change many just read about. Take a look at any of the recognized organizational change models and you will be able to trace our command’s movement through the process. IMCOM leadership is aware that we must continue and maintain the momentum we have established. To accomplish this we must operate, evolve and recreate ourselves in a continuous process. IMCOM is a global industry leader within the Army, providing services on a consistent and equitable basis to our Soldiers throughout the world. Let us not forget that history is filled with organizations that at one point in time were industry leaders, but have vanished because they failed to change and maintain their competitive advantage.

For those new to IMCOM, it is instructive to understand how the command has matured into being. Since October 2002, “the creation of the Installation Management Agency (IMA) offered a profound commitment to eliminate inequities, focus on installation management and enhance the well-being of Soldiers, Families, and Civilians” (IMCOM — A Short History 2001 to 2010). IMCOM Central Region’s predecessors, Northwest, Southwest and West Regions, were major contributors to several key initiatives to meet IMA’s commitment, including:

- IMA’s implementation of the Productivity Management Program in April 2003
- Implementation of Common Levels

of Support (CLS) and Standard Garrison Organization (SGO) to eliminate the “have and have-not” garrisons by 2004

- Validation of the phrase “IMA is a learning organization” by encouraging the workforce to embrace training opportunities
- Improving cost culture and business transformation through Lean Six Sigma

After five years of organizational growth and development, the Army recognized the need to evolve from an agency to a command, renaming IMA as IMCOM and becoming the “Army’s Home.” As the Army’s Home we “provide a source of balance that ensures an environment in which Soldiers and Families can thrive; a structure that supports unit readiness; and a foundation for building the future,” (IMCOM — A Short History 2001 to 2010).

Central Region and its predecessors have a rich history of change and innovation. The Base Realignment and Closure (BRAC) 2005 decision to





...reflecting the first major “flattening” effort within IMCOM. This merger placed 18 garrisons, with a total Army Stationing and Installation Plan (ASIP) population of more than 398,000 personnel, under a single region while saving 149 authorized spaces.

consolidate the Northwest and Southwest Regions formed the West Region (the predecessor of Central Region), reflecting the first major “flattening” effort within IMCOM. This merger placed 18 garrisons, with a total Army Stationing and Installation Plan (ASIP) population of more than 398,000 personnel, under a single region while saving 149 authorized spaces.

After the BRAC announcement in May 2005, the leadership of both the Northwest and Southwest Regions determined the impact of BRAC across their regions would require the stand-up of a special staff section called the

Region Transformation Office (RTO) to assist the garrisons with transformation management. Although the BRAC announcement was the impetus for the RTO, there were also other significant transformation impacts on our installations simultaneous to BRAC. Those impacts included Army and Department of Defense (DoD) initiatives such as the Army Modular Force (AMF), Grow the Army (GTA) and Global Defense Posture Realignment (GDPR). The net result of these initiatives was a 75 percent population increase in the region and an additional \$17 billion in military construction. The role of the RTO was to support

the affected installations by working with the Army Staff to align unit activation dates with facility availability, facilitate staff integration among stakeholders for stationing actions, obtain resourcing, manage joint base implementation, maintain a current transformation common operating picture and track issues to resolution. Central Region’s measure of success for the RTO is our full BRAC law compliance and synchronization of AMF/GTA unit reorganizations, activations and inactivations in accordance with the Army Campaign Plan.

Central Region opened a new chap-



Meeting the Army's intent is a challenge, but we are dedicated to meeting our Nation's expectation of an Army that is effective, yet efficient, in this fast-changing, innovative world.

ter on August 11, 2011 with its redesignation from the West Region, in compliance with IMCOM Operation Order 11-487 — IMCOM Realignment. Central Region assumed command and control (C2) of five garrisons from the newly formed Atlantic Region and relinquished C2 for two garrisons to IMCOM Headquarters. Meeting the Army's intent is a challenge, but we are dedicated to meeting our Nation's expectation of an Army that is effective, yet efficient, in this fast-changing, innovative world. Former Army Chief of Staff GEN Martin Dempsey stated in the 37th CSA's "Thoughts on the Future of the Army," *"We must be the Army the Nation needs us to be. This means we must expect and embrace change. WIN-LEARN-FOCUS-ADAPT. These are our imperatives."* Central Region now supports the Army's Home to 449,000 Soldiers who receive direct support from a devoted and experienced workforce on 22 garrisons spanning 27 states.

In support of the IMCOM Campaign Plan (IMCP) Lines of Effort (LOE), the Central Region staff embraces our goals of providing quality, predictable support to Soldiers, Families, and Civilians; ensuring our installations' infrastructure is able to support the demands of the Army Force Generation Model (ARFORGEN); and provide balanced support to the operating force, generating force and industrial base. As we enter an era of a fundamentally dif-

ferent fiscal reality our key roles are to:

- Teach, coach and mentor garrison commanders and their staff
- Engage Senior Commanders and solicit input
- Serve as installation advocate
- Validate resources and monitor execution
- Provide oversight and ensure compliance

IMCOM Commanding General LTG Rick Lynch has provided directives and guidance to assist the regions in clarifying and codifying these roles:

- IMCOM Regulation 10-1, defining IMCOM's Organization, Mission and Function
- IMCOM Campaign Plan (version 3), which contains the shared vision of the Installation Management Community and includes Annex G, greatly reducing reporting requirements throughout the enterprise
- IMCOM Leaders Handbook, a sister publication of the Campaign Plan that serves as a common desk-side reference for our leadership teams
- Other publications and use of electronic media and social networks like the Journal of Installation Management, Garrison Commander's Net, Facebook, Twitter, YouTube and AKO, constituting a unified strategic communication effort.

Central Region has initiated and matured several concepts to gain efficiencies through the application of best practices and engaging employees to drive success. These include:

- Region Installation Support Teams (RIST) — Two years ago the region embraced the RIST concept as a combat multiplier for region leadership, garrisons and their respective staffs. Four RIST teams focus on the multi-dimensional, cross-functional challenges at our garrisons and keep closely attuned to their assigned installations' needs, missions, and Senior Commanders' focus.
 - The RIST specialist is highly knowledgeable of each assigned garrison, establishing collaborative, effective relationships with garrison and installation leadership. Central Region RISTs play many roles at their garrisons. Two examples include:
 - The RIST specialist for Fort Huachuca provided critical interface support by serving on the ground at the installation as the region liaison officer (LNO) during the June 2011 Monument Fire that threatened mandatory evacuation of the entire installation. The RIST specialist has also been intimately involved in helping Fort Huachuca increase their air-field operational hours due to the Unmanned Aerial Systems training requirement to support deployment to the operational force, resulting in Army recognition of the requirement.



- The RIST specialist for Fort Hunter Liggett and Fort McCoy has developed unparalleled expertise in the unique resource requirements of these Army Reserve Installations.

Central Region has looked to the RIST to assume two challenging and critical missions associated with the continuing evolution of installation management: Joint Basing and the Army Materiel Command (AMC) Special Installation Pilot.

- Joint Basing — Central Region has within its boundaries the largest Air Force led joint base, Joint Base San Antonio (JBSA), and the largest Army led joint base, Joint Base Lewis McChord (JBLM).
 - As Region Director, I serve as the Intermediate Command Summit

(ICS) in the Joint Management Oversight Structure (JMOS) for JBSA and JBLM in conjunction with the BRAC-directed merger of 26 Army, Air Force, and Navy installations into 12 joint bases. The role of the ICS includes (1) providing oversight of memorandum of agreement (MOA) compliance, dispute resolution, equitable allocation of funding requirements to the responsible entities, and (2) serving as a decision chain and chain of command for operational and joint base-specific performance issues.

- The Joint Base RIST has played an integral role in the establishment of the two joint bases, which adopted Office of the Secretary of Defense (OSD)-directed Common Output Level Standard (COLS) services to provide instal-

lation support to all tenants regardless of service. This includes the ICS serving as the lead Army negotiator at both JBLM and JBSA for the development of and changes to the MOAs, the joint bases' governance documents. Negotiations involved the commitment of tens of millions of dollars between the lead service and the supported service for delivery of COLS at the joint base. It also identified areas where the Army would pay the lead service additional funds to provide certain services (i.e. Army Substance Abuse Program) above the COLS standard to match the Army standard. Our overriding objective in MOA development is to ensure Soldiers and Families receive the same level of support and services as they would at an Army-managed installation.

- Notwithstanding the designation of lead services for each joint base, joint base management is a partnership requiring extensive coordination, negotiation and problem solving with the Joint Base Partnership Councils, our Air Force ICS counterparts (Air Mobility Command for JBLM and Air Education and Training Command for JBSA) and OACSIM (the Army service level lead in the JMOS).
- Initial priority was on the momentous reorganization and transfer of installation service responsibilities to another service at Fort Sam Houston and McChord Air Force Base by Full Operational Capability (FOC) date, Oct. 1, 2010. FOC included Transfer of



Through our joint basing interface with JBLM and JBSA we continually share best practices with our Air Force counterparts.

Authority (TOA) and real property transfer to the lead service. To set the conditions for success, the senior leadership of all stakeholders was involved early and remains engaged. The involvement of the RIST has ensured a remarkable absence of service parochialism among key leaders and in the decision-making process. The transition to joint basing at both JBSA and JBLM has been successful thus far and largely transparent to customers. Joint basing remains a positive work in progress.

- Army Materiel Command (AMC) Special Installation Pilot — Central Region has represented IMCOM as the lead with the Army initiative to determine the feasibility of reassigning installation support functions and real property accountability from AMC to IMCOM for AMC Installations.
 - The goal is to utilize best business practices to capitalize on core competencies within the Installation Management Community.
 - This effort is being executed in accordance with a memorandum of understanding (MOU) signed by the commanding generals of AMC and IMCOM, the Army G3 warning order (WARNO) and other senior leadership guidance. A cost-benefit analysis (CBA) is being conducted by the Army Materiel Systems Analysis Activity (AMSAA) to assess the

economic and operational advantages and disadvantages of transitioning responsibility for installation management of 21 “special installations” from AMC to IMCOM.

- This initiative requires daily collaboration and coordination with OACSIM, AMC Headquarters and its major subordinate commands, IMCOM Headquarters and its CONUS Regions, and other Army staff and agencies. IMCOM Central Region’s dedicated RIST is a key to this initiative’s success.
- The pilot program focuses on alignment of core enterprises which will allow AMC special installation commanders to focus on mission accomplishment.
- Upon approval of the results of the CBA, the goal is to transfer the real property of eight Government Owned Contractor Operated (GOCO) installations from AMC to IMCOM followed by a phased transfer of installation support functions and real property accountability of 13 Government Owned Government Operated (GOGO) installations starting in FY14.
- The Central Region special installations RIST also provided advice and assistance for updating Installation Support Agreements for two AMC activities that are tenants on Navy installations.

Through our joint basing interface with JBLM and JBSA we continually share best practices with our Air Force counterparts. Recently we hosted a team from the U.S. Navy Region Southwest and established a framework to exchange installation management practices into the future.

- Services and Infrastructure Enterprise Contract Management Program (SIECMP) and Service Contract Request (SCR) processes —
 - Central Region has established a formal, structured contract review approach to gain total contract visibility and reduce costs.
 - We review our installations’ service contract requests (SCR) weekly to recommend approval, disapproval, or provide guidance on contract modification. The SCR review boards are directly responsible for more than \$26 million in contract savings and/or avoidance over a period of two quarters in Central Region. These efficiencies align to IMCOM’s cost culture initiatives, which are in concert with the Army’s efficiencies and goals and are helping us meet the fundamentally different fiscal reality.
 - The board is chaired by the region chief of staff and includes division chiefs, special staff, RIST chiefs and Mission Installation Contracting Command (MICC) Liaisons.
 - Cost Management Certificate Course (CMCC) graduates, known as “cost warriors,” are included as key participants to assist in the evaluation of the cost benefit analysis, cost savings and



alternative courses of action.

- The region's primary staff principals have taken ownership of their functional-area contracts for the purpose of gaining efficiencies and reducing our contract costs. Cost savings and efficiencies across each staff section are now visible due to the increased oversight.
- The weekly board provides the staff a more in-depth understanding of our current contract environment and facilitates an enterprise view on the usage of service contracts in terms of standardization, benchmarking and best practices. This proactive approach to enterprise management of service contract costs provides the Central Region a valuable tool to use in formulating current and future use of service contracts in the execution of the IMCOM mission.

This article highlights only a few of the numerous initiatives Central Region addresses in a routine work week. Our goal remains to provide a source of balance that ensures an environment in which Soldiers and Families can thrive, a structure that supports unit readiness and a foundation for building the future. As IMCOM continues to evolve, Central Region will posture itself to be an integral part of the best prepared DoD organization to successfully assume the role of installation management responsibilities as we move into the joint "purple" world of the future.



J. Randall Robinson is Director, IMCOM-Central Region. He has more than twenty years of installation management experience. Prior to the standup of IMCOM, he was Director, FORSCOM Installation Management Support and Deputy Garrison Commander, Fort Hood. He holds a master's degree in public administration.



Building Community Resilience in Europe: Art Supported by Science

by Kathleen Marin, Director, Europe Region, IMCOM

The Army Family Covenant is a pledge of our commitment to provide a quality of life to Soldiers and Families commensurate with their service to our nation. More specifically, it seeks to provide a supportive environment in which Soldiers and Families can thrive, a goal that at its core demands building resilience — building connections — across our garrison communities in Europe.

The Army in Europe and Installation Management Command Europe Region joined forces and are breaking exciting ground for the Army by inculcating the tenets of resilience — supported by scientific research — into the art of building enduring garrison communities. We are delivering on the promise of the Army Family Covenant by innovatively fostering Army Families' ability to grow and thrive in the face of challenges. Our goal is not only to promote an environment and teach skills so they can bounce back instead of succumbing to adversity at their garrison "homes away from home" in Europe, but also to leverage cost-conscious approaches with ever-scarce resources while we do it.

This is an especially tall order in Europe, where building resilience and delivering on the promise of the Army Family Covenant is complicated by the inherent challenge associated with having Army Families forward-

stationed in foreign countries throughout an endlessly recurring cycle of deployments over the last 10 years. When Soldiers deploy from Europe, risk factors are multifaceted for Families left behind on smaller, dispersed foreign garrisons. They must exist without built-in cultural familiarity, community relationships, a support structure and other resources that are taken for granted in large CONUS garrisons.

Garrison staffs in Europe have intuitively adapted to the challenge by promoting resilience in a multitude of ways despite a tumultuous period

that began in 2003 with the wholesale force structure transformation of the Army in Europe and the underlying stationing plan to comply with the Department of Defense's Global Defense Posture Review. This upheaval has challenged commanders as they focus their resilience efforts to establish stable, thriving garrison communities amidst the swirl of constant change.

It's important to recognize that building resilience, though it has become a bit of a bumper sticker, is really not new. In fact, since introducing the covenant, we as an Army have been very much a learning organization regarding the building blocks of resilience and how to improve it through outcomes we can control in our garrison communities.

The Army Family Covenant documentation, penned in 2007, talked about resilience long before the term

Children hold up the Army Family Covenant following its signing on Campbell Barracks in Heidelberg. Photo by Spc. Joseph McAtee





Soldiers, Families and Civilians gathered at the Storck Barracks, Illesheim pedestrian zone to celebrate the Army's 236th Birthday. The pedestrian zone was created to help develop a stronger sense of community at U.S. Army Garrison Ansbach. U.S. Army Photo by Gini Sinclair

was mainstream when it mentioned one of its goals was to “build strength and resilience” in the force. But just as with the covenant, in the past there was a misperception that these concepts simply represent a suite of programs, rather than an overall approach to planning communities.

Comprehensive Soldier Fitness divides resilience into five simple, easily understood dimensions of strength: physical, emotional, social, family and spiritual. Additionally, by reviewing scientific research about resilience in children and Families, I have developed a more holistic view of both what contributes to and deters resilience in our communi-

ties, how those insights can be applied in community master planning, and how current initiatives are validated.

Notably, my review of the study compiled by the Military Family Research Institute at Purdue University titled *Understanding and Promoting Resilience in Military Families* (2008, by MacDermid, S., Samper, R., Schwarz, R., Nishida, J., & Nyaronga, D.) has allowed me to view garrison resilience efforts I see in Europe through a more effective and informed lens.

The research behind the building of strength and resilience indicates that resilience can be developed over time,

and that we have the capability to influence building strength and resilience in three realms: the individual realm, representing general individual coping skills; the family realm, representing the interplay of family/marital/child rearing dynamics; and the social/community realm, representing unit/church/community and other interpersonal relationships. The research supports that if people achieve a “trifecta” of success in possessing adequate levels of skill in each of these realms, then they are much more likely to bounce back than break when dealing with all those stressors.

This scientific backdrop is a very impor-



Commanders at garrisons in Europe are demonstrating an intuitive understanding of the importance of creating a sense of community as a powerful means to strengthen resilience...

tant dynamic to understand as a construct to cross-level what we are doing as providers of communities in Europe in terms of what behaviors we are looking to strengthen in our communities.

So what does this tell us about what we ARE doing and what we SHOULD be doing in our own communities provide a supportive environment where Soldiers and Families can build resilience?

Commanders at garrisons in Europe are demonstrating an intuitive understanding of the importance of creating a sense of community as a powerful means to strengthen resilience, and the means to do it in a manner that ensures the highest-value approaches are used. Europe commanders know that resilience is all about creating connections, within yourself, with family, with your greater community, and as a result they are taking very deliberate approaches to effect changes, working with the region headquarters to develop a sense of community and attempt to elicit the very behaviors that we know the science of resilience supports, be it with single Soldiers, families, or youth.

One notable example is U.S. Army Garrison Ansbach, home of the 12th Combat Aviation Brigade, where former garrison commander COL Chris Hickey conceived of a “town center” concept at Storck Barracks in Illeshiem, Germany and adapted his entire master planning approach to create a renewed

sense of community by addressing what he saw as a chronic deficiency in the layout of his garrison that hampered social and individual resilience.

Well aware of the effect of repeated, long deployments on Families in the garrison that occupies an idyllic, but relatively isolated location in the Upper Franconian region of Bavaria, he was intent on drawing families and spouses out of confined stairwell housing and into gathering areas where they could socialize and establish connections in a shared space that has a “draw”. He struck upon the idea of closing a street and converting it into a pedestrian mall, allowing a hub to evolve around previously separated community support facilities, including the library, community activities center, AAFES facilities, the bank, Shoppette and Commissary. The community response has been fantastic, and stands as a prime example of how a community planning solution can promote all three realms of resilience.

Moreover, garrison master planning for communities of the future in Europe has also embraced resilience as an implied task. In Vicenza, Italy, for example, the former Italian air force base at Dal Molin where the 173rd Airborne Brigade headquarters, four battalions, and U.S. Army Africa Headquarters will be consolidated is being constructed from the ground up to resemble a state-of-the-art university campus.

Soldiers will be able to go from operational and command facilities to barracks, religious, dining, AAFES support, fitness, Better Opportunities for Single Soldiers (BOSS) and recreation facilities within a five-minute walk in a beautifully landscaped green space, without the need for vehicular transportation and the added stress of having to find parking. Research supports that this physical space enhances a sense of community for Soldiers who will live there by optimizing opportunities for them to feel connected and strengthen skill areas in individual, family (in this case, unit as a family) and community realms of resilience. Europe Region has also made great progress for the Army with initiatives designed explicitly to give single Soldiers a place to play, socialize and relax on their own terms at dispersed, isolated garrisons across Europe.

Utilizing a novel approach to renovate existing facility space with Appropriated Fund Sustainment, Restoration and Modernization (SRM) program funds, coupled with a bulk equipment buy using Non-Appropriated Fund Capital Purchase Minor Construction money, Region Morale Welfare and Recreation (MWR) officials outfitted Warrior Zones at 14 garrisons in Europe to provide high-energy entertainment and recreation that enhance individual and community relationships and resulting resilience among young, single Soldiers.

As a result, for a cost far lower than that of traditional military construction (MILCON), Soldiers can now “totally lose themselves” at facilities that are one-stop shops for access to high-end, cutting-edge video and interactive gaming (Xbox, PlayStation,



Spc. Stephen Buck, Outlaw Troop, 2nd Stryker Calvary Regiment, slides along a mountain route equipped with fixed cables, stemples, ladders, and bridges as part of an Installation Management Command-Europe Warrior Adventure Quest outing in Hirschbachthal, Germany. Europe Region was the first to pilot the Warrior Adventure Quest initiative in 2008 through a partnership between the former Family and Morale, Welfare and Recreation Command and the Office of the Surgeon General under the Battlemind blueprint.

Wii, Multiplayer On-Line Games), home theater, table game area, arcade, Internet Café, and sports lounge with food and beverage operations and collocated BOSS offices. The facilities strengthen resilience by creating on-base gathering points for cash-strapped Soldiers impacted by the weak dollar-to-Euro conversion who are looking to avoid barracks room boredom and isolation. They also deter high-risk behaviors common to Europe: access to European beverages with high-alcohol content, the need to travel long distances on a motorcycle or in a car

in search of fun, and the inherently risky travel on Europe's dangerous, high-speed highways.

Similarly, Europe Region MWR was the first to pilot the Warrior Adventure Quest initiative in 2008 through a partnership between the former Family and MWR Command (now the IMCOM G9) and the Office of the Surgeon General under the Battlemind blueprint. The program evolved to help Soldiers effectively transition from a combat to home-station environment during the 90-day period after redeploying and completing block leave, when the risk factors are highest due to "adrenaline deficit" following their return from deployment — by exposing them to safe alternatives to obtain an adrenaline rush in a safe, controlled environment in a variety of active endeavors that include paintball, rappelling, white-water rafting, cycling, canyoning, and rock climbing. The program has proven to increase individual resilience by sparking lifelong, positive outlets for Soldiers' energies and to relieve stress and anxiety in their everyday lives, not to mention reducing the chances that Soldiers will engage in risky activities in an attempt to amplify adrenaline levels they may have grown accustomed to in the combat environment.

By applying lessons learned from studying research on resilience we can also draw a bead on how enterprise partnerships between IMCOM and U.S. Army Europe also contribute to strengthening resilience in Families. Just one unique example of this focus is manifested in Europe Region's Library Support Branch that oversees 16 main libraries and 8 branch librar-

ies in what is termed the "Community Couch" initiative, which ultimately rewards the customer with an improved sense of community in access to high-quality, efficient information services, even in spite of staff reductions. Garrison libraries, particularly overseas where English language products are scarce and the cost of off-base leisure activities high, serve as a vital life-ring of support for customers, both for professional/personal development and pure entertainment — functions that inherently contribute to individual and community resilience. Through a vast overhaul that has encompassed enterprise acquisition, leveraging automation, info-sharing via centralized web management, workforce development and effective marketing, a number of efficiencies have emerged to ensure we receive the most value for our information service dollars. Moreover, employees are now investing more time in becoming customer-service experts — and making the "Community Couch" more comfortable — than in archaic and cumbersome administrative processes that previously hampered customer service. The result has enabled interest in libraries to skyrocket, evidenced by enrollment of more than 98 percent of eligible patrons at Europe garrisons, nearly 22 percent of whom have items checked out at any one time.

Youth of our Army Families are also sharing in our resilience-building initiatives, which recognize that stable and cohesive family life can be a rare luxury to Army kids, especially if you consider the effects of extended and often repeated deployments of one or both parents. Two notable examples are youth adventure camps



Youths learn the art of building a fire in the wilderness at COMPASS a spiritual resilience retreat for all Army youth, regardless of their religious tradition and/or personal spiritual journey. U.S. Army Garrison Vicenza piloted the program in partnership with U.S. Army Europe's Office of the Chaplain and Installation Management Command Europe. The program's primary goal is to encourage young people to explore the spiritual dimension of their lives by providing them a safe place and sacred space for personal growth and development where all religious traditions and personal spiritual journeys are respected.

and COMPASS spiritual resilience programs aimed at youth.

First, the region successfully piloted the Camp Army Challenge (CAC) summer program beginning in 2008 for children of deployed Soldiers. Part traditional summer resident camp, part experiential adventure immersion and part eco-awareness and/or sports-

based programs, these camps gave kids a rare opportunity to experience all the benefits of an extended Family, with a healthy dose of adventure and education to boot. Using the lessons region learned through CAC, it mentored and facilitated similar, collaborative initiatives among garrisons locally and assumed a more advisory role, while also incorporating resilience building

activities into its annual Region Youth Leadership Forum. Furthermore, the region has been able to successfully secure grants — first with the Boy/Girl Scouts of America and the National Military Family Association in 2010, and this year with the Under Secretary of Defense for Military Community and Family Policy in conjunction with the U.S. Department of Agriculture—to

deliver quality, resilience-building, military teen adventure camp programming in a fiscally-constrained environment.

Second, through a partnership with U.S. Army Europe's Office of the Chaplain and region headquarters, U.S. Army Garrison Vicenza piloted COMPASS, a spiritual resilience retreat for all Army youth, regardless of their religious tradition and/or personal spiritual journey. The program's primary goal is to encourage young people to explore the spiritual dimension of their lives by providing them a safe place and sacred space for personal growth and development where all religious traditions and personal spiritual journeys are respected. The program focuses on developing individual and social/community realms of resilience by building skills to establish and maintain trusted and valued relationships and friendships; explore sources of personal fulfillment and meaning; practice communication skills to enhance a comfortable exchange of ideas, views and experiences; and identify support systems to use as resilience resources.

These are just a few of Europe's success stories that are proof that IMCOM professionals are taking it to the next level, in partnership with U.S. Army Europe, even in spite of the unique challenges of the forward-stationed environment. When I view the challenges to building resilience we have in European garrisons, and the vigor with which IMCOM leaders are orienting locally to address them, I am encouraged, particularly given that what I see happening appears to closely mirror results supported by the science of resilience.

In order to make good on our promise to stay true to the covenant, more creatively-inspired, cost-conscious solutions such as those discussed in this article are needed to "operationalize" and sustain community resilience building, not only in Europe but also across IMCOM. We have seen an incredible dividend through efforts that seek to build community connections, particularly those that ensure the highest value in an environment of scarce resources. What I observe through a lens informed by scientific research is that we are headed down the right path, and are only restrained by our imaginations in how to promote and ensure resilience in our garrison communities.



Kathleen Marin is the Director for IMCOM Europe Region. Prior to assuming Region Director duties, she was the Director of Installation Services, Office of the Assistant Chief of Staff for Installation Management. Ms. Marin honed her skills in Soldier and Family programs as Deputy Director of Personnel and Community Activities, Fort Sam Houston, TX. She is a graduate of the Defense Leadership and Management Program and is a distinguished graduate of the National Defense University Industrial College of the Armed Forces.



INSTALLATION MANAGEMENT COMMAND

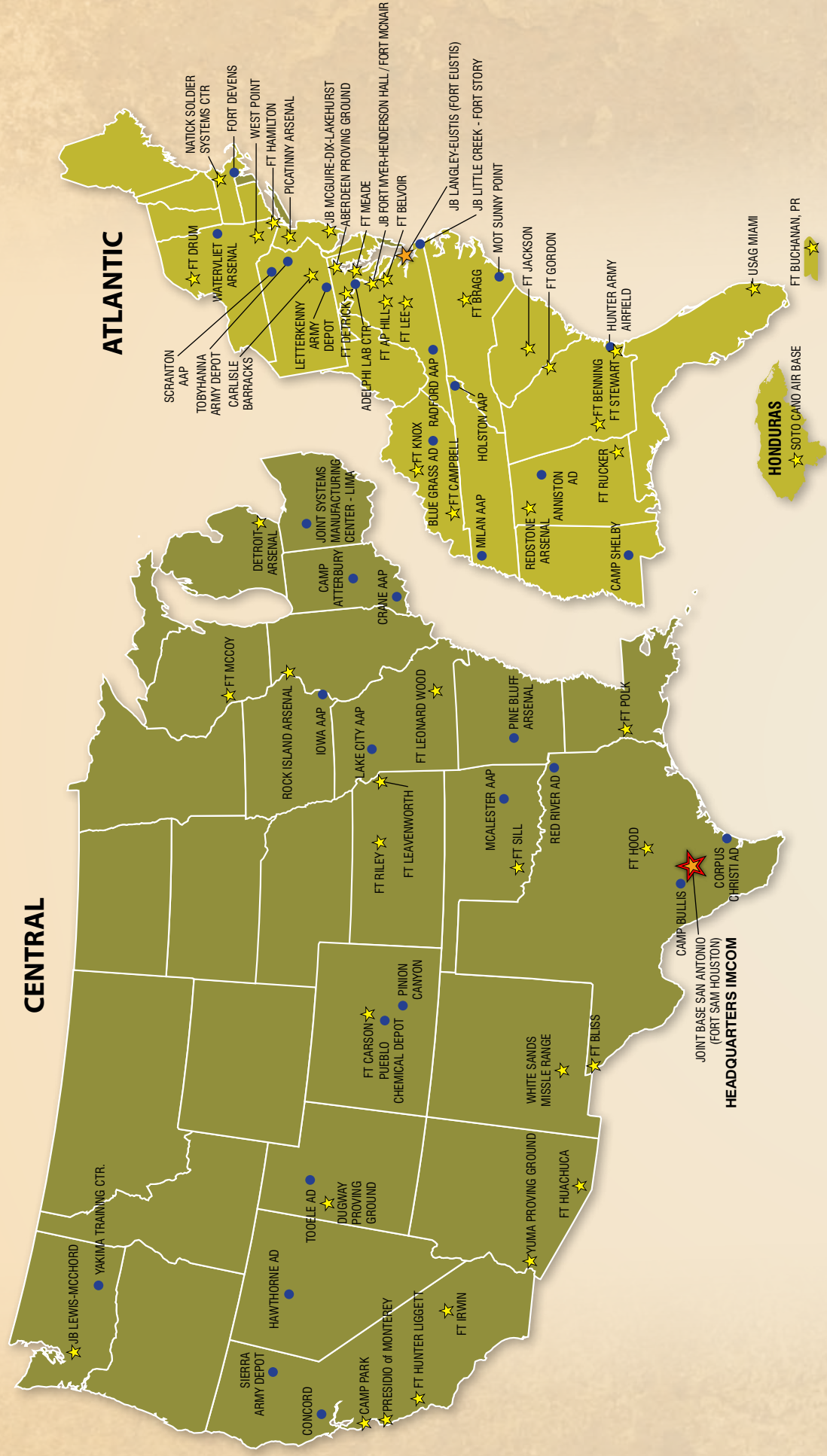

PACIFIC

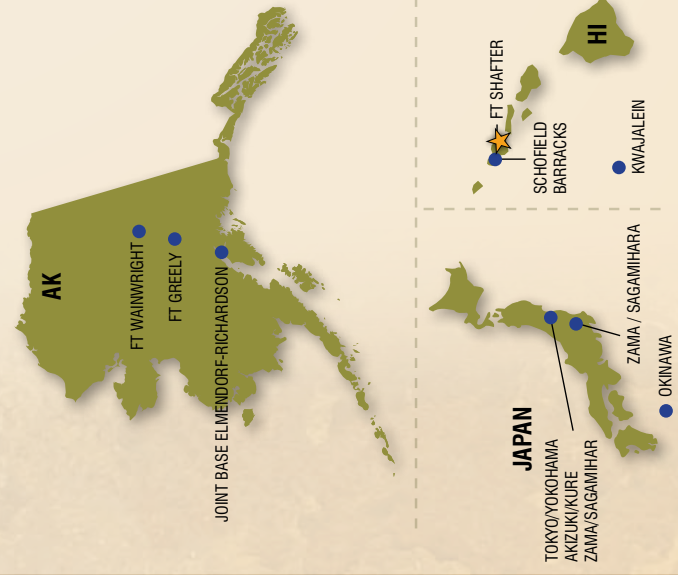

EUROPE



MAP LEGEND



- HEADQUARTERS IMCOM
- REGION HQ
- MAJOR INSTALLATION
- OTHER INSTALLATION

- ★ HEADQUARTERS IMCOM
- ★ REGION HQ
- ★ MAJOR INSTALLATION
- ★ OTHER INSTALLATION

IMCOM HEADQUARTERS
Joint Base San Antonio (Fort Sam Houston)

IMCOM REGIONS
ATLANTIC: Joint Base Langley-Eustis (Fort Eustis)
CENTRAL: Joint Base San Antonio (Fort Sam Houston)
EUROPE: USAG Baden-Wuerttemberg
PACIFIC: Fort Shafter

IMCOM Command Structure



OACSIM Structure

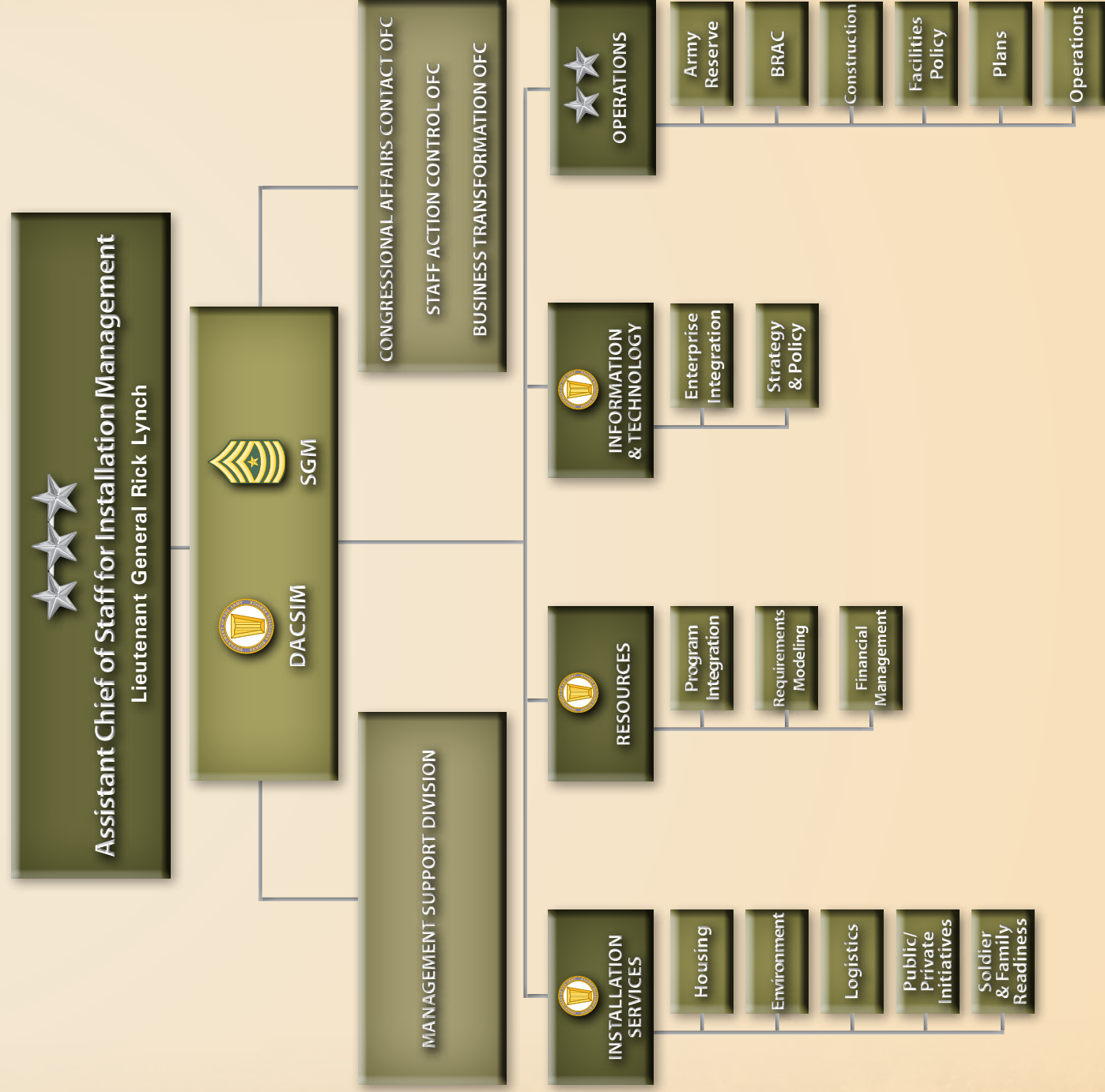

U.S. Army Environmental Command Structure



ASA IE&E



HON Katherine Hammack
Assistant Secretary of the Army, Installations,
Energy and Environment (IE&E)



Mr. L. Jerry Hansen
Principal Deputy Assistant Secretary
of the Army (PDASA)



Mr. Mark Rocke
Deputy Assistant Secretary of the Army,
Strategic Integration (DASA SI)

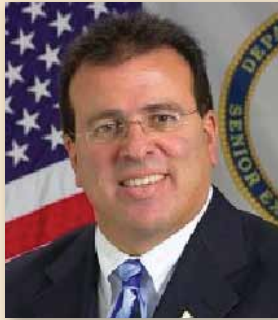

Mr. Joseph F. Calcara
Deputy Assistant Secretary of the Army for
Installations, Housing and Partnerships



Mr. Richard G. Kidd IV
Deputy Assistant Secretary of the
Army for Energy and Sustainability



Mr. Hershell E. Wolfe
Deputy Assistant Secretary of the Army for
Environment, Safety and Occupational Health

OACSIM



LTG Rick Lynch
ACSIM



Dr. Craig E. College
Deputy ACSIM



SGM Tracey Anbiya
Sergeant Major



MG Al Aycok
Director of Operations



Ms. Diane M. Randon
Director, Resources Directorate



Ms. Deborah Reynolds
(Acting) Director, Installation Services



Mr. Levon Anderson
Deputy Director, Information Technology

IMCOM Command Group



LTG Rick Lynch
Commanding General



MG Reuben Jones
Deputy Commander, Operations



BG John Uberti
Deputy Commander, Support



Mr. Joe Capps
Executive Director



Mr. Luke Green
Chief of Staff



CSM Neil Ciotola
Command Sergeant Major

IMCOM Principal Staff



Ms. Karen Perkins
Director of Personnel - G1



COL Michael S. Weaver
Director of Operations - G3



Mr. Greg Kuhr
Director of Logistics - G4



Mr. Tim Weathersbee
Director of Plans - G5



Mr. William Lay
Chief Information Officer - G6



COL Matthew T. Margotta
Director of Training - G7



BG Thomas Horlander
Director of Resource Management - G8



Mr. J.C. Abney
Director, Family and
MWR Programs - G9

IMCOM Special Staff



COL Gregory Baldwin
Staff Judge Advocate



COL Derrick Rountree
Inspector General



CH (COL) Charles Howell
Chaplain



Mr. Michael Thiem
Director, Public Affairs



Mr. Rufus Caruthers
Director, Equal Employment Opportunity



Ms. Thomasin Converse
Director, Internal Review



Ms. Marie Doyle
Director, Talent Management Center



MSG Greagory Study
Equal Opportunity Advisor



Mr. Stephen Fant
Director, Safety



Mr. Keith Elder
Headquarters Commandant



Ms. Heidi Malarchik
Director, Strategic Communications

AEC



COL Scott D. Kimmell
Commander, AEC



CSM Earlene Lavender
Command Sergeant Major, AEC

IMCOM Europe



Ms. Kathleen Marin
Director



CSM Barry E. Maieritsch
Command Sergeant Major

IMCOM Central



Mr. J. Randall Robinson
Director



CSM Donald R. Felt
Command Sergeant Major

IMCOM Atlantic



Mr. Dave Tindoll
Director



CSM Charles Durr
Command Sergeant Major

IMCOM Pacific



Ms. Debra Zedalis
Director



CSM Karl Schmitt
Command Sergeant Major

★ ★ ★ INSTALLATION MANAGEMENT COMMUNITY ★ ★ ★

List current as of publication date.

Aberdeen Proving Ground

Senior Commander: MG Nick Justice
Garrison Commander: COL Orlando W. Ortiz
CSM Rodney Rhoades
2201 Aberdeen Blvd., Bldg. 305
Aberdeen Proving Ground, MD 21005
410-298-1511
<http://www.apg.army.mil/apghome/sites/local/>

Adelphi Laboratory Center

Senior Commander: MG Nick Justice
Garrison Manager: Joseph F. Watson
2800 Powder Mill Road
Adelphi, MD 20783
301-394-1385
<http://alc.army.mil/ima/sites/local/>

Carlisle Barracks

Senior Commander: MG Gregg Martin
Garrison Commander: LTC William McDonough
CSM Robert Blakey
22 Ashburn Drive
Carlisle, PA 17013
717-245-3232
<http://carlislebarracks.carlisle.army.mil/default.cfm>

Fort A.P. Hill

Senior Commander: MG Michael S. Linnington
Garrison Commander: LTC John W. Haefner
CSM Miguel E. Reyna
18436 4th St.
Fort A.P. Hill, VA 22427-3114
804-633-8205
<http://www.aphill.army.mil/sites/local/>

Fort Belvoir

Senior Commander: MG Michael S. Linnington
Garrison Commander: COL John J. Strycula
CSM Gabriel Berhane
9820 Flagler Road
Fort Belvoir, VA 22060
703-805-2052
<http://www.belvoir.army.mil>

Fort Devens

Senior Commander: MG William D. Waff
Garrison Commander: LTC Warren F. Bacote
CSM Donald Thelen
31 Quebec St.
Devens, MA 01434-4424
978-796-2126
<https://www.devens.army.mil/>

Fort Detrick

Senior Commander:
Garrison Commander: COL Allan J. Darden Sr.
CSM Federico E. Boyce
810 Schreider Street
Fort Detrick, Maryland 21702-5000
301-619-7314

Detroit Arsenal

Senior Commander: MG Kurt J. Stein
Garrison Manager: Alan Parks
6501 E. 11 Mile Road, MS 502
Warren, MI 48397-5000
586-282-5115
<http://garrison-michigan.army.mil/sites/garrison/garrison%20main.htm>

Fort Drum

Senior Commander: MG James L. Terry
Garrison Commander: COL Noel T. Nicolle
CSM John F. McNeirney
Bldg.10000, 10th Mountain Division Drive
Fort Drum, NY 13602
315-772-5501
<http://www.drum.army.mil/sites/local/>

Fort Hamilton

Senior Commander: MG Michael S. Linnington
Garrison Commander: COL Michael J. Gould
CSM Sylvia P. Laughlin
113 Schum Ave.
Brooklyn, NY 11252
718-630-4706
<http://www.hamilton.army.mil>

★ ★ ★ INSTALLATION MANAGEMENT COMMUNITY ★ ★ ★

List current as of publication date.

Joint Base Langley-Eustis

Senior Commander: LTG John Sterling, Jr.

Army Support Activity Commander:

COL Thomas Wetherington

CSM Carolyn Johnson

210 Dillon Circle

Fort Eustis, VA 23604

757-878-2908

<http://www.eustis.army.mil/>

Fort Lee

Senior Commander: MG James Hodge

Garrison Commander: COL Rodney D. Edge

CSM June Seay

3312 A Ave., Suite 208

Fort Lee, VA 23801

804-734-7188

<http://www.lee.army.mil/>

Fort Leonard Wood

Senior Commander: MG David Quantock

Garrison Commander: COL Charles Williams

CSM Kenneth Barteau

320 Manscen Loop, Suite 120

Fort Leonard Wood, MO 65473

573-596-4004

<http://www.wood.army.mil/GC/sites/local/>

Fort Meade

Senior Commander: MG Michael S. Linnington

Garrison Commander: COL Edward C. Rothstein

CSM Charles E. Smith

4551 Llewellyn Ave., Room 203b

Fort Meade, MD 20755-5000

301-677-4844

<http://www.ftmeade.army.mil/>

Joint Base McGuire-Dix-Lakehurst

Senior Commander: MG William D. Waff

Army Support Activity Commander: COL Patrick Slowey

CSM Steven J. Whittaker

5417 Alabama Ave.

Fort Dix, NJ 08640

609-562-2458

<http://www.dix.army.mil/>

Fort McCoy

Senior Commander: MG Glenn J. Lesniak

Garrison Commander: COL David E. Chesser

CSM William Bissonette, Jr.

100 E. Headquarters Road

Fort McCoy, WI 54656-5263

608-388-3001

<http://www.mccoy.army.mil/pw/sites/local/>

Joint Base Myer-Henderson Hall

Senior Commander: MG Michael S. Linnington

Garrison Commander: COL Carl R. Coffman

CSM Necati Akpinar

204 Lee Ave.

Fort Myer, VA 22211

703-696-3250

<http://www.jbmhh.army.mil/JBMHHhomepage.html>

Picatinny Arsenal

Senior Commander: BG Jonathan A. Maddux

Garrison Commander: LTC Charles "Herb" Koehler III

CSM Scott Koroll

Bldg. 151 Farley Ave.

Picatinny Arsenal, NJ 07806-5000

973-724-7010

<http://garrison.pica.army.mil/pw/sites/local/>

Rock Island Arsenal

Senior Commander: MG Yves Fontaine

Garrison Manager: Joel G. Himsl

1 Rock Island Arsenal

Rock Island, IL 61299-5000

309-782-5555

<http://www.ria.army.mil/>

US Army Soldier Systems Center-Natick

Senior Commander: BG Harold J. Greene

Garrison Commander: LTC Frank K. Sobchak

CSM Brian Warren

10 Kansas St., Room 120

Natick, MA 01760

508-233-4205

<http://www.natick.army.mil/garrison/>

★ ★ ★ INSTALLATION MANAGEMENT COMMUNITY ★ ★ ★

List current as of publication date.

West Point

Senior Commander: LTG David H. Huntoon, Jr.

Garrison Commander: COL Michael J. Tarsa

CSM Jose M. Powell

681 Hardee Place

West Point, NY 10996

845-938-2022

<http://www.usma.edu/Garrison/sites/local/>

Fort Benning

Senior Commander: MG Robert B. Brown

Garrison Commander: COL Jeffrey Fletcher

CSM Mark E. Moore

35 Ridgway Loop, Room 385

Fort Benning, GA 31905

706-545-1500

<https://www.benning.army.mil/>

Fort Bragg

Senior Commander: LTG Frank Helmick

Garrison Commander: COL Stephen J. Sicinski

CSM Samuel B. Campbell

2175 Reilly Road, Stop A

Fort Bragg, NC 28310

910-396-4011

<http://www.bragg.army.mil/>

Fort Buchanan

Senior Commander: MG Bill Gerety

Garrison Commander: COL John D. Cushman

CSM Derrick T. Simpson

218 Brooke St

Fort Buchanan, PR 00934

Tel (787) 707-5776

<http://www.buchanan.army.mil/sites/local/>

Fort Campbell

Senior Commander: MG John F. Campbell

Garrison Commander: COL Perry C. Clark

CSM Mark F. Herndon

39 Normandy Blvd.

Fort Campbell, KY 42223

270-798-9921

<http://www.campbell.army.mil/>

Fort Gordon

Senior Commander: BG Alan R. Lynn

Garrison Commander: COL Robert A. Barker

CSM Kevin S. Schehl

307 Chamberlain Ave.

Darling Hall, Bldg. 33720

Fort Gordon, GA 30905

706-791-6300

<http://www.gordon.army.mil/>

Fort Jackson

Senior Commander: MG James Milano

Garrison Commander: COL James J. Love

CSM Christopher Culbertson

4325 Jackson Blvd.

Fort Jackson, SC 29207-5015

803-751-7613

<http://www.jackson.army.mil/>

Fort Knox

Senior Commander: LTG Benjamin C. Freakley

Garrison Commander: COL Bruce Jenkins

CSM Steven M. Voller

127 6th Ave., Suite 202

Fort Knox, KY 40121-5719

502-624-2749

<http://www.knox.army.mil/IMA/sites/local/>

USAG Miami

Senior Commander: Air Force GEN Douglas Fraser

Garrison Manager: Audy R. Snodgrass

9301 NW 33rd St., Suite 110e

Doral, FL 33172

305-437-1700

<http://www.southcom.mil/usag-miami/sites/local/default.asp>

Fort Polk

Senior Commander: BG Clarence Chinn

Garrison Commander: COL Roger L. Shuck

CSM Theodore R. Sutton

6661 Warrior Trail, Bldg. 350

Fort Polk, LA 71459-5339

337-531-1606

<http://www.jrtc-polk.army.mil/>

★ ★ ★ INSTALLATION MANAGEMENT COMMUNITY ★ ★ ★

List current as of publication date.

Redstone Arsenal

Senior Commander: MG James E. Rogers
Garrison Commander: COL John Hamilton
CSM Rickey Cooper
4488 Martin Road
Red Stone Arsenal, AL 35898
256-876-8861
<http://www.garrison.redstone.army.mil/>

Fort Rucker

Senior Commander: MG Anthony G. Crutchfield
Garrison Commander: COL James A. Muskopf
CSM Dwaine E. Walters
5700 Nobosel St.
Fort Rucker, AL
334-255-2095
<http://www-rucker.army.mil/imcom>

Fort Stewart

Senior Commander: MG Robert B. Abrams
Garrison Commander: COL Kevin W. Milton
CSM James E. Ervin
954 William H. Wilson Ave., Suite 130
Fort Stewart, GA 31314
912-767-8606
<http://www.stewart.army.mil>

Hunter Army Airfield

Senior Commander: MG Robert Abrams
Garrison Commander: LTC Edward A. Kovalski
CSM Gilbert D. Adkins
685 Horace Emmet Wilson Blvd.
Hunter Army Airfield, GA 31409
912-315-5801
<http://www.stewart.army.mil>

Joint Base San Antonio

Fort Sam Houston
Senior Commander: LTG Guy Swan
502d Mission Support Group Commander:
COL John P. Lamoureux
CSM Donald J. Freeman
1206 Stanley Road, Suite A
Fort Sam Houston, TX 78234-5004
210-221-2632
<http://www.samhouston.army.mil>

Camp Bullis Training Site

Senior Commander: LTG Guy Swan
Garrison Manager: Paul Dvorak
Rural Rte. 2, Bldg. 5000
San Antonio, TX 78257-9708
210-295-7508
<http://www.samhouston.army.mil/Bullistraining/Headquarters.asp>

Fort Bliss

Senior Commander: MG Dana Pittard
Garrison Commander: COL Joseph A. Simonelli, Jr.
CSM Phillip D. Pandey
1 Pershing Road
Fort Bliss, TX 79916
915-568-2833
<http://www.bliss.army.mil/>

Fort Carson

Senior Commander: BG James H. Doty (Acting)
Garrison Commander: COL Robert McLaughlin
CSM James Kilpatrick Jr.
1626 Ellis St., Bldg. 1118
Fort Carson, CO 80913
719-526-5600
<http://www.carson.army.mil/gcima/index.html>

Dugway Proving Ground

Senior Commander: MG Genaro J. Dellarocco
Garrison Manager: Christopher Grigsby
SGM Stanley Morton
5450 Doolittle Ave., MS 2
Dugway, UT 84022-5002
435-831-3314
<https://www.dugway.army.mil>

Fort Hood

Senior Commander: LTG Donald M. Campbell Jr.
Garrison Commander: COL Mark A. Freitag
CSM Michael E. Ashford
1001 761st Tank Battalion Ave
Fort Hood, TX 76544
254-288-3451
<http://www.hood.army.mil/>

★ ★ ★ INSTALLATION MANAGEMENT COMMUNITY ★ ★ ★

List current as of publication date.

Fort Huachuca

Senior Commander: BG Gregg C. Potter

Garrison Commander: COL Timothy L. Faulkner

CSM Jorge Soriano

2837 Boyd Ave., Bldg. 41402

Fort Huachuca, AZ 85613-7027

520-533-1562

<http://www.army.mil/huachuca> .

Fort Hunter Liggett

Senior Commander: BG Jon D. Lee (Acting)

Garrison Commander: COL James Suriano

CSM Kevin Newman

Bldg. 238 California Ave.

Fort Hunter Liggett, CA 93928-7000

831-386-2505

<http://www.liggett.army.mil/>

Fort Irwin

Senior Commander: BG Terry Ferrell

Garrison Commander: COL Kurt J. Pinkerton

CSM Christopher R. Morse

Bldg. 237, 237 Third Street, Rm 11

Fort Irwin, CA 92310

760-380-6267

<http://www.irwin.army.mil/Pages/default.aspx>

Fort Leavenworth

Senior Commander: LTG Robert L. Caslen, Jr.

Garrison Commander: COL Wayne A. Green

CSM Peter L. Cramer

290 Grant Ave, Unit 1

Fort Leavenworth, KS 66027-1292

913-684-2993

<http://garrison.leavenworth.army.mil/>

Joint Task Force-Bravo, Soto Cano Air Base

Army Support Activity Commander: COL Barry Graham

CSM Joseph Rodgers

Soto Cano Air Base, Honduras

011-504-234-4634

<http://www.jtfb.southcom.mil/units/index.asp>

Joint Base Lewis-McChord

Senior Commander: LTG Curtis Scaparrotti

Garrison Commander: COL Thomas Brittain

CSM Matthew Barnes

Mail Stop 1AA, Box 339500

2025 Liggett Avenue

Fort Lewis, WA 98433-9500

253-477-1005

<http://www.lewis-mcchord.army.mil/>

Presidio of Monterey

Senior Commander: LTG Robert L. Caslen, Jr.

Garrison Commander: COL Joel J. Clark

CSM Olga B. Martinez

1759 Lewis Rd., Suite 210

Monterey, CA 93944

831-242-6601

<http://www.monterey.army.mil/>

Camp Parks

Senior Commander BG Jon D. Lee (Acting)

Garrison Commander: LTC Michael Friend

CSM Patrick McKie

Bldg 620 6th Street

Dublin, CA 94568

925-875-4650

www.parks.army.mil

Fort Riley

Senior Commander: MG William C. Mayville

Garrison Commander: COL William J. Clark

CSM Colvin Bennett

Bldg. 500 Huebner Road

Fort Riley, KS 66442

785-239-2092

<http://www.riley.army.mil>

Fort Sill

Senior Commander: MG David D. Halverson

Garrison Commander: COL Paul Hossenlopp

CSM Terry A. Hall

462 Northwest Hamilton Road, Suite 120

Fort Sill, OK 73503

580-442-3106

<http://sill-www.army.mil/usag/>

★ ★ ★ INSTALLATION MANAGEMENT COMMUNITY ★ ★ ★

List current as of publication date.

White Sands Missile Range

Senior Commander: BG John S. Regan

Garrison Commander: COL Leo G. Pullar

CSM Glenn Robinson

Bldg. 100 Headquarters Ave.

White Sands Missile Range, NM 88002-5000

575-678-2220

<http://www.wsmr.army.mil/Pages/Home.aspx>

Yakima Training Center

Senior Commander: LTG Curtis Scaparrotti

Garrison Commander: LTC Michael Daniels

CSM Joseph E. Santos

970 Firing Center Road

Yakima, WA 98901

509-577-3205

www.lewis.army.mil/yakima

Yuma Proving Ground

Senior Commander: MG Genaro J. Dellarocco

Garrison Manager: Richard T. Martin

CSM Forbes Daniels

301 C St., Bldg. 2607

Yuma, AZ 85365

928-328-3474

<http://www.yuma.army.mil/>

USAG Ansbach

Senior Commander: LTG Mark P. Hertling

Garrison Commander: COL Kelly J. Lawler

CSM Lester Stephens

Unit 28614

APO AE 09177-8614

DSN 314-468-1600; Commercial 49-0981-183-1500

www.ansbach.army.mil

USAG Bamberg

Senior Commander: LTG Mark P. Hertling

Garrison Commander: LTC Steven L. Morris

CSM Daniel Ocanas

Unit 27535

APO AE 09139

DSN 314-469-1600; Commercial 49-0951-300-2000

www.bamberg.army.mil

USAG Baden-Württemberg

Senior Commander: LTG Mark P. Hertling

Garrison Commander: COL Bryan D. DeCoster

CSM Annette Weber

Unit 29237

APO AE 09102-9237

DSN 314-373-1300; Commercial 49-06221-17-1400/1600

<http://www.bw.eur.army.mil/>

USAG Baumholder

Senior Commander: LTG Mark P. Hertling

Garrison Commander: LTC Sam R. McAdoo

CSM Augustus M. Wah

Unit 23746

APO AE 09034-0027

DSN 314-485-7517; Commercial 49-0-6783-6-7517

www.baumholder.army.mil

USAG Benelux

Senior Commander: LTG Mark P. Hertling

Garrison Commander: COL Rick Tillotson

CSM Allan K. Fairley

Unit 21419

APO AE 09708-1419

DSN 314-361-5419; Commercial 32-068-27-5419

www.usagbenelux.eur.army.mil

USAG Brussels

Senior Commander: LTG Mark P. Hertling

Garrison Commander: LTC Francesca Ziemba

CSM Robert G. Lehtonen II

Unit 8100 Box 01

APO AE 09714-9998

DSN 314-368-9702; Commercial 32-02-717-9702

<http://www.usagbrussels.eur.army.mil/sites/local/>

USAG Grafenwoehr

Senior Commander: LTG Mark P. Hertling

Garrison Commander: COL Avanus R. Smiley

CSM William Berrios

Unit 28130

APO AE 09114

DSN 314-475-8103; Commercial 49-09641-83-8103

<http://www.grafenwoehr.army.mil/>

★ ★ ★ INSTALLATION MANAGEMENT COMMUNITY ★ ★ ★

List current as of publication date.

USAG Garmisch

Senior Commander: LTG Mark P. Hertling

Garrison Manager: Karin Santos

Unit 24515

APO AE 09053-4515

DSN 314-440-3701; Commercial 49-08821-750-3701

<http://www.garmisch.army.mil/>

USAG Hohenfels

Senior Commander: LTG Mark P. Hertling

Garrison Commander: LTC Kevin J. Quarles

CSM Brenda J. Kadet

Unit 28216

APO AE 09173

DSN 314-466-1500; Commercial 49-09472-83-1500;

www.hohenfels.army.mil

USAG Kaiserslautern

Senior Commander: LTG Mark P. Hertling

Garrison Commander: LTC Lars Zetterstrom

CSM Richard D. Jessup

Unit 23152

APO AE 09227

DSN 314-493-4213; Commercial 49-0631-3406-4213;

<http://www.kaiserslautern.army.mil/>

USAG Livorno

Senior Commander: LTG Mark P. Hertling

Garrison Commander: LTC Kevin Bigelman

CSM Felix Rodriguez

Unit 31301

APO AE 09063

DSN 314-633-7229; Commercial 39-050-54-7229

<http://www.usag.livorno.army.mil/>

USAG Schinnen

Senior Commander: LTG Mark P. Hertling

Garrison Commander: LTC Chad R. Arcand

CSM Alicia Castillo

Unit 21602

APO AE 09703-1602

DSN 314-360-7585; Commercial 31-046-443-7585

<http://www.usagschinnen.eur.army.mil/sites/local/>

USAG Schweinfurt

Senior Commander: LTG Mark P. Hertling

Garrison Commander: LTC Michael Runey

CSM Eric K. Gordon

CMR 457

APO AE 09033

DSN 314-354-1600; Commercial 49-09721-96-1600

www.schweinfurt.army.mil

USAG Stuttgart

Senior Commander: LTG Mark P. Hertling

Garrison Commander: COL Carl D. Bird III

CSM Anthony M. Bryant

Unit 30401

APO AE 09107

DSN 314-431-1300; Commercial 49-07031-15-1300

www.stuttgart.army.mil

USAG Vicenza

Senior Commander: LTG Mark P. Hertling

Garrison Commander: COL David W. Buckingham

CSM Jeffrey S. Hartless

Unit 31401

APO AE 09630

DSN 314-634-7111; Commercial 39-0444-718020

www.usag.vicenza.army.mil

USAG Wiesbaden

Senior Commander: LTG Mark P. Hertling

Garrison Commander: COL Jeffrey W. Dill

CSM Hector A. Prince

Unit 29623

APO AE 09005-9623

DSN 314-337-5142; Commercial 49-0611-705-5142

www.wiesbaden.army.mil

Joint Base Elmendorf-Richardson

Senior Commander: MG Raymond P. Palumbo

Army Support Activity Commander: COL Timothy R. Prior

CSM Thomas G. Kimball, Jr.

10480 22nd Ave., Suite 123

Joint Base Elmendorf-Richardson, AK 99506

907-552-3846

<http://www.jber.af.mil/>

★ ★ ★ INSTALLATION MANAGEMENT COMMUNITY ★ ★ ★

List current as of publication date.

Fort Greely

Senior Commander: LTG Richard P. Formica

Garrison Commander: LTC Terry Clark

CSM Carolyn Reynolds

P.O. Box 31269

Fort Greely, AK 99731

907- 873-4604

<http://www.greely.army.mil>

Fort Wainwright

Senior Commander: BG Raymond P. Palumbo

Garrison Commander: COL Ronald M. Johnson

CSM Todd E. Wentland

1060 Gaffney Road, #5900

Fort Wainwright, AK 99703-5900

907-353-6701

<http://www.wainwright.army.mil/sites/local/>

USAG Japan-Camp Zama

Senior Commander: MG Michael T. Harrison

Garrison Commander: COL Eric Tilley

CSM Scarlett Stabel

Unit 45006

APO AP 96343-5006

DSN 315-263-5978; Commercial 81-46-407-7060

<http://www.usagj.jp.pac.army.mil/ima/sites/local/>

USAG Hawaii-Schofield Barracks

Senior Commander: LTG Francis J. Wiercinski

Garrison Commander: COL Douglas S. Mulbury

CSM Robert E. Williamson III

742 Santos Dumont

Wheeler Army Airfield

Schofield Barracks, HI 96857-5000

808-656-1153

<http://www.garrison.hawaii.army.mil/>

USAG Hawaii Pohakuloa Training Area

Senior Commander: LTG Francis J. Wiercinski

Garrison Commander: LTC Rolland Niles

CSM Lynice D. Thorpe

ATTN: IMPC-HI-PS

P.O. Box 4607

Hilo, HI 96720

808-969-2407

<http://www.garrison.hawaii.army.mil/sites/subordinate/usag-ptawelcome.asp>

USAG Humphreys

Senior Commander: LTG John D. Johnson

Garrison Commander: COL Joseph P. Moore

CSM Spencer L. Gray

Unit 15716

APO AP 96271-5716

DSN 315-754-5108; Commercial 82-31-619-5108

<http://humphreys.korea.army.mil>

USAG Yongsan

Senior Commander: LTG John D. Johnson

Garrison Commander: COL Bill Huber

CSM John C. Justis

Unit 15333

APO AP 96205-5333

DSN 315- 738-7453; Commercial 822-7918-7453

<http://yongsan.korea.army.mil/>

USAG Red Cloud

Senior Commander: LTG John D. Johnson

Garrison Commander: COL Hank Dodge

CSM Nidal Saeed

Unit 15707

APO AP 96258-5707

DSN 315- 732-7845; Commercial 82-31-870-7845

<http://redcloud.korea.army.mil>

USAG Casey

Senior Commander: LTG John D. Johnson

Garrison Commander: LTC Steven D. Finley

CSM Wayne LaClair

USAG Daegu

Senior Commander: LTG John D. Johnson

Garrison Commander: COL Kathleen A. Gavle

CSM Gabriel S. Arnold

Unit 15746

APO AP 96218-5746

DSN 315-768-8174; Commercial 82-53-470-8174

<http://daegu.korea.army.mil>



WE ARE THE
ARMY'S HOME



U.S. Army Installation Management Command

Bldg. 2261, 2405 Gun Shed Rd.
Ft. Sam Houston, TX 78234-1233
www.IMCOM.army.mil

Social Media Addresses

<http://twitter.com/armyimcom>
<http://www.facebook.com/InstallationManagementCommunity>
<http://www.youtube.com/installationmgt>
<http://www.scribd.com/IMCOM>
<http://ireport.cnn.com/people/HQIMCOMPA>
<http://www.flickr.com/photos/imcom/>